

DOCUMENT RESUME

ED 295 818

SE 049 199

TITLE The Harnessed Atom: Nuclear Energy & Electricity.
INSTITUTION Department of Energy, Washington, DC. Nuclear Energy Office.
REPORT NO DOE/NE-0072
PUB DATE 86
NOTE 139p.; For teachers guide, see SE 049 198. Drawings may not reproduce well.
AVAILABLE FROM Superintendent of Documents, U.S. Government Printing Office, Washington, DC 20402.
PUB TYPE Guides - Classroom Use - Materials (For Learner) (051) -- Tests/Evaluation Instruments (160)

EDRS PRICE MF01/PC06 Plus Postage.
DESCRIPTORS *Controversial issues (Course Content); *Energy Education; Environmental Education; Middle Schools; *Nuclear Energy; *Nuclear Power Plants; *Science Activities; Science and Society; Science Curriculum; Science Education; Secondary Education; *Secondary School Science; Social Studies

ABSTRACT

This document is part of a nuclear energy curriculum designed for grades six through eight. The complete kit includes a written text, review exercises, activities for the students, and a teachers guide. The 19 lessons in the curriculum are divided into four units including: (1) "Energy and Electricity"; (2) "Understanding Atoms and Radiation"; (3) "The Franklin Nuclear Powerplant"; and (4) "Addressing the Issues." This student guide is intended to review the basic scientific principles that underlie nuclear energy. It includes an appendix which contains a map of the Franklin nuclear powerplant, and a glossary of terms. (TW)

 * Reproductions supplied by EDRS are the best that can be made *
 * from the original document. *

Nuclear Energy & Electricity

The Harnessed

Atom

ED295818

U.S. DEPARTMENT OF EDUCATION
Office of Educational Research and Improvement
EDUCATIONAL RESOURCES INFORMATION
CENTER (ERIC)

This document has been reproduced as
received from the person or organization
originating it
 Minor changes have been made to improve
reproduction quality

• Points of view or opinions stated in this docu-
ment do not necessarily represent official
OERI position or policy

U.S. Department of Energy
Assistant Secretary, Nuclear Energy ■ Office of Program Support

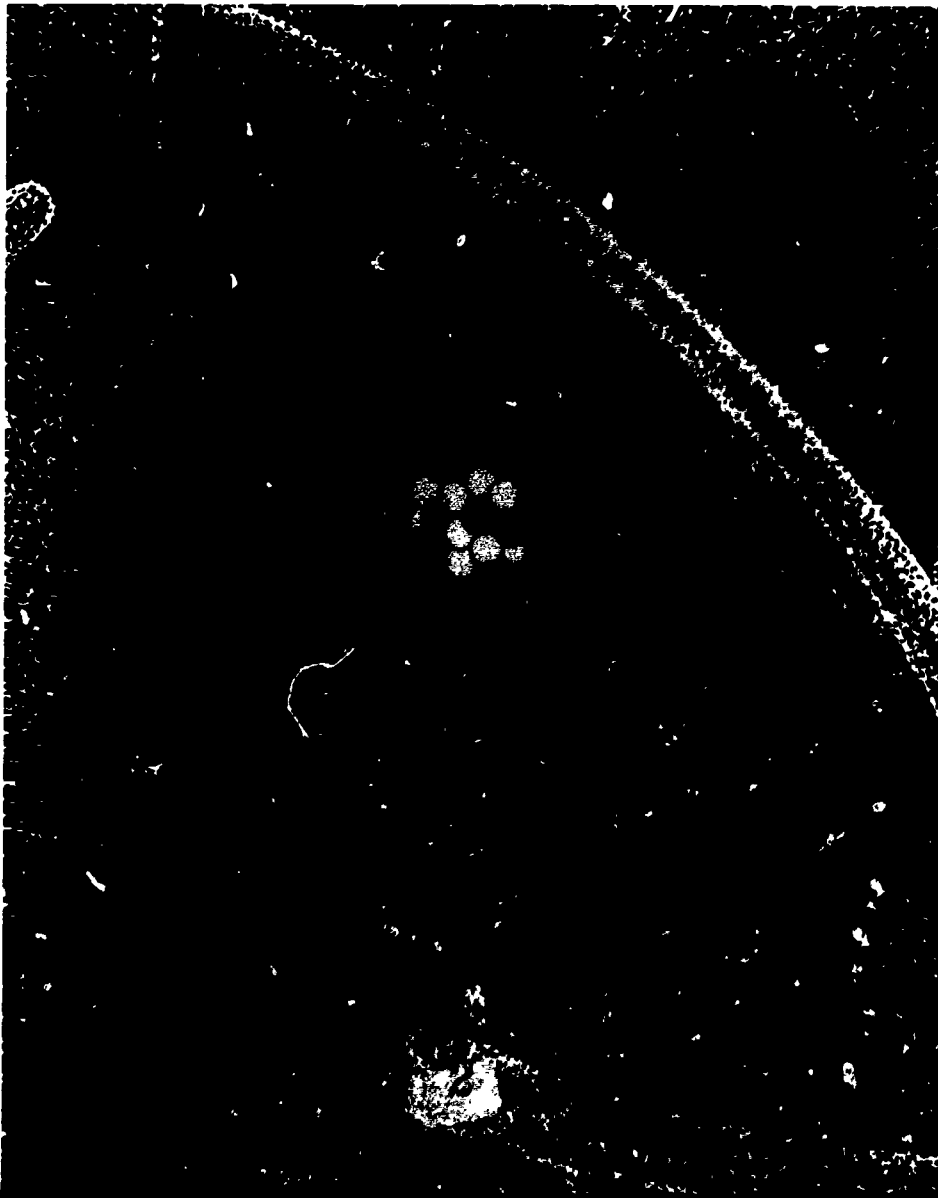

661 6409 199



The Harnessed ATOM

Foreword

The Harnessed Atom is a comprehensive middle school teachers' kit that provides students and teachers with accurate, unbiased, and up-to-date materials about nuclear energy. The text reviews the basic scientific principles that underlie nuclear energy and focuses on atoms, radiation, the technology of a nuclear powerplant, and the issues concerning nuclear energy.

One responsibility of the U.S. Department of Energy is to keep people informed about our Nation's different energy sources. *The Harnessed Atom* helps meet this goal by providing students with the factual information they need to draw their own conclusions and make informed decisions about nuclear energy and related topics.

Table of Contents

Unit 1	Energy and Electricity	Page
	Lesson 1	
	Energy Review	3
	Lesson 2	
	Electricity Review	10
Unit 2	Understanding Atoms and Radiation	
	Lesson 1	
	Atoms and Isotopes	17
	Lesson 2	
	Radiation and Radioactive Decay	22
	Lesson 3	
	Detecting and Measuring Radiation	27
	Lesson 4	
	Background Radiation	32
	Lesson 5	
	Uses of Radiation	38
	Lesson 6	
	Fission, Chain Reactions, and Fusion	45

Unit 3 The Franklin Nuclear Powerplant	Page
Introduction	53
Lesson 1	
Planning the Franklin Nuclear Powerplant	55
Lesson 2	
How the Reactor Works	61
Lesson 3	
Producing Electricity at Franklin	69
Lesson 4	
Franklin's Fuel	76
Lesson 5	
Franklin's Waste	81
Lesson 6	
Franklin's Safety Systems	89
Lesson 7	
Other Reactors	94
Unit 4 Addressing the Issues	
Lesson 1	
Energy and Money	105
Lesson 2	
Safety	112
Lesson 3	
Energy Decision Making	118
Appendix A	123
Glossary	127

Nuclear Energy & Electricity

The Harnessed

Atom

Unit 1

Energy & Electricity

What is energy?

We use *energy* all the time. Whenever work is done, energy is used. In fact, energy is the ability to do work. All activities involve energy. Here are some of the things we need energy for:



- To power our factories and businesses



- To heat and light our homes and schools



- To run our appliances and machines

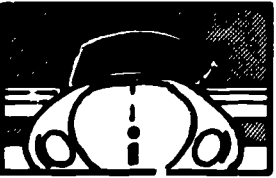

- To fuel our cars, airplanes, and ships

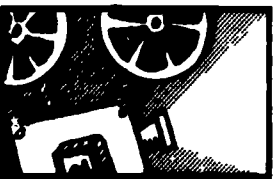

- To run television and films



- To use our telephones and computers



- To make our food and clothes.

What are the types of energy?

We can divide energy into two basic types: *kinetic* (ki-NET-ik) *energy* and *potential* (pə-TEN-shəl) *energy*. Potential energy is stored energy that is waiting to be used. A mousetrap that has been set has potential energy; but if a hungry mouse accidentally trips it, the potential energy is changed into kinetic energy, which is energy in action.

Heat, light, and motion all indicate that kinetic energy is present and can be used. Potential energy is often harder to detect. It must be changed into kinetic energy before we can use it.

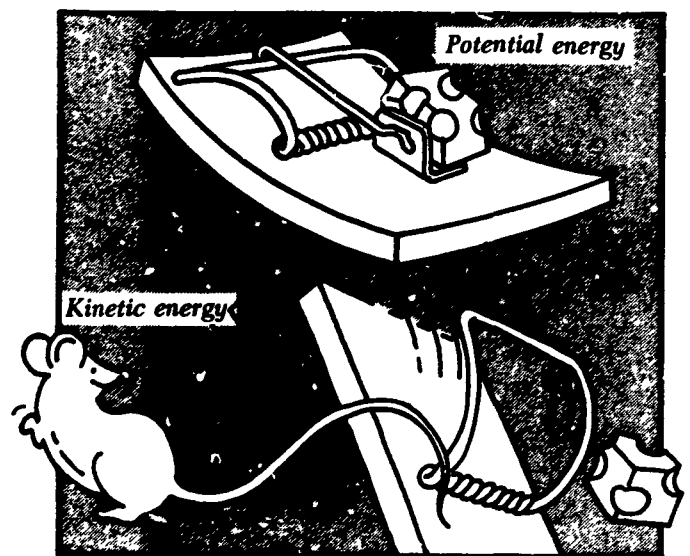

What are the forms of energy?

There are many forms of potential and kinetic energy. These include mechanical, chemical, thermal, electrical, radiant, and nuclear.

- *Mechanical* (mə-KAN-i-k'l) *energy* is the energy of motion. Mechanical energy turns the wheels of a car.

Lesson 1

- **Chemical** (KEM-i-k'l) *energy* is the energy released when the chemical composition of materials changes. Coal contains a lot of chemical energy, which is released when the coal is burned.
- **Thermal** (THER-mə!) *energy* is heat energy, which is often used to generate electricity.
- **Electrical** (ih-LEK-tri-k'l) *energy* is the movement of *electrons* (ih-LEK-trons), one of the three basic particles that make up an atom. Electric current is the continuous flow of millions of electrons through a conductor, such as a copper wire.
- **Radiant** (RAY-dee-ənt) *energy* is the energy in light. The Sun's energy comes to us in this form.
- **Nuclear** (NYOO-klee-ər) *energy* is released when certain elements change the make-up of their centers. Sometimes they split apart or sometimes two centers are forced together.

Where does energy come from?

Much of the Earth's energy comes from the Sun in the form of radiant energy. Plants convert this energy to chemical energy by using a process called *photosynthesis* (fo-to-SIN-thə-sis).

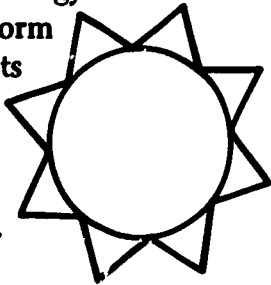

This new chemical energy is stored in the form of sugars and starches, which provide energy for the plant as well as for animals that eat the plant. When we burn plants such as trees, stored potential energy is released immediately in the form of heat and radiant energy, which we call fire.

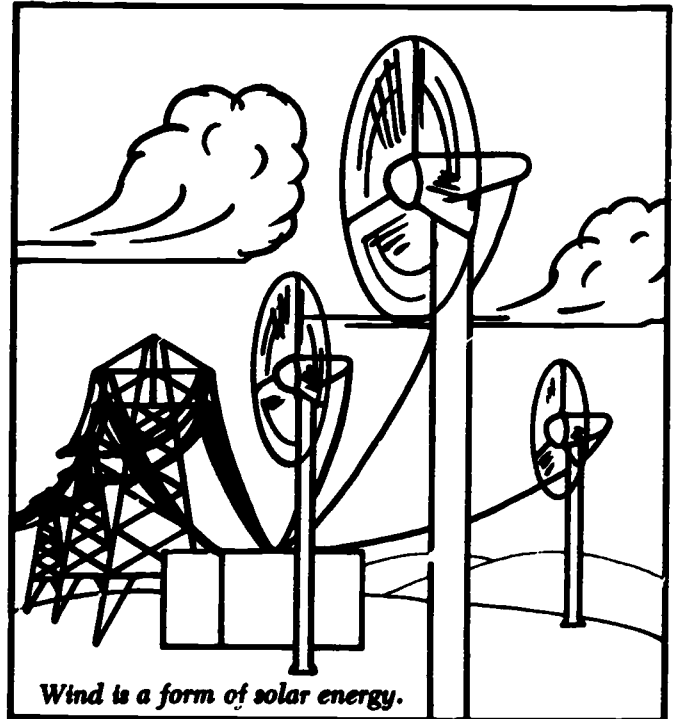

Radiant energy from the Sun makes some parts of the Earth warmer than other parts. Air surrounding these warmer surfaces is heated, which causes it to rise. Cooler air from the less heated surfaces then flows in to replace the heated air that has risen. This flow of air is called wind.

Radiant energy from the Sun can also cause water to evaporate and turn into water vapor, which rises into the upper atmosphere where it forms clouds. The tremendous energy in storms and winds is actually caused by the Sun's radiant energy.

Over millions of years, countless plants and animals died and were slowly buried beneath the Earth, where they were compressed. The chemical energy stored in them was concentrated, making such *fossil fuels* as oil, coal, and natural gas. Fossil fuels currently provide about 90 percent of all our energy.

The five main or *primary* (PRIGH-mehr-ee) *energy sources* that we use today are:

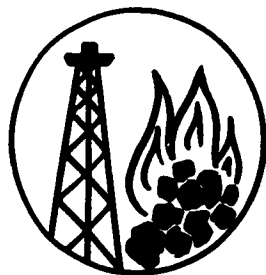

fossil fuel energy
(coal, natural gas,
oil);

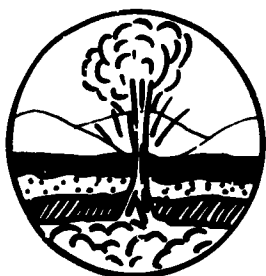

geothermal
energy (heat from
inside the
Earth);

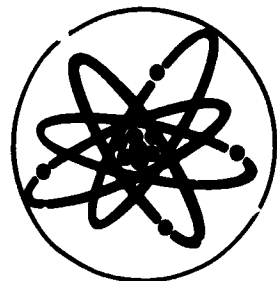

nuclear energy
(*uranium*
yu-RAY-nee-əm
and *plutonium*
plo-TOH-nee-əm);

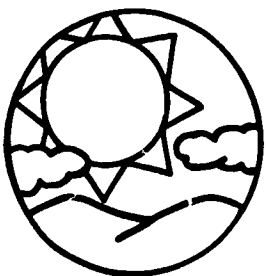

solar energy (Sun);
and



tidal energy (the
effect of the gravity
of the Moon on the
oceans).

In addition to the primary energy sources, there are also *secondary* (SEK-ən-dehr-ee) *energy sources*, which are produced by using the primary sources. *Electricity* (ih-lek-TRIS-ə-tee) is a secondary source of energy that can be produced by using any of the primary sources mentioned above. Water power, wind power, the wood we burn, and the food we eat are other secondary sources of energy that come from the primary source of the Sun.

Fossil fuels are thought of as primary energy sources, even though they originally took their energy from the Sun. Because it takes millions of years to make fossil fuels, there is a limited amount of these fuels on Earth. Consequently, fossil fuels are a *nonrenewable* energy source, and when we have used them up, they will be gone. Nuclear fuels, such as uranium and plutonium, are also nonrenewable energy sources.

Geothermal, solar, and tidal energy are called *renewable* sources because they cannot be used up.

How do we convert energy from one form to another?

Energy can change from one form into another, but cannot be created or destroyed. In fact, when we say that we use energy, we simply mean that we change it or harness it to do the work that we need done.

We are always losing heat energy. This lost energy cannot be used again. It is similar to helium balloons that escape into the sky. They still exist, but we can no longer enjoy them. We must constantly put energy into things, or they will run down.

Energy is converted in hundreds of ways every minute. For instance, inside our bodies many different *energy conversions* (kən-VER-zhəns) take place constantly. Chemical energy in food enables us to walk, talk, and be alive. In

Lesson 1

order to walk or run, and to keep our hearts beating, our bodies must convert the chemical energy in food into other forms of energy such as mechanical and thermal energy.

Burning gasoline to power cars is another energy conversion process that we rely on. The chemical energy contained in gasoline is converted to mechanical energy.

When we exercise, we also produce heat energy. You can easily feel this heat when you do a lot of work because your body will heat up. This happens because the process used to transform the chemical energy in your food into mechanical energy is not very *efficient* (ə-FISH-ənt).

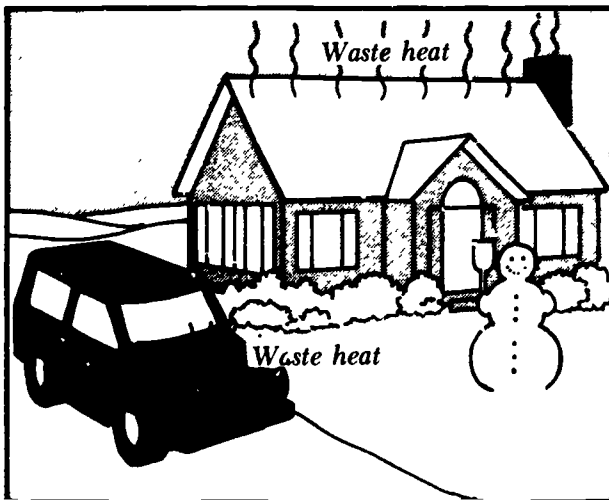

In fact, most energy conversion processes are not very efficient, and as a result, they lose energy to the environment. Only about a quarter of the energy that we use in our bodies and automobiles is transformed into mechanical energy. The rest is lost as heat. When a conversion process wastes a lot of energy, it is called *inefficient* (in-ə-FISH-ənt).

The inefficient conversion and use of energy costs money and wastes nonrenewable resources. This is why people today are looking for ways to save energy by carefully using our energy sources and trying to convert energy as efficiently as possible.

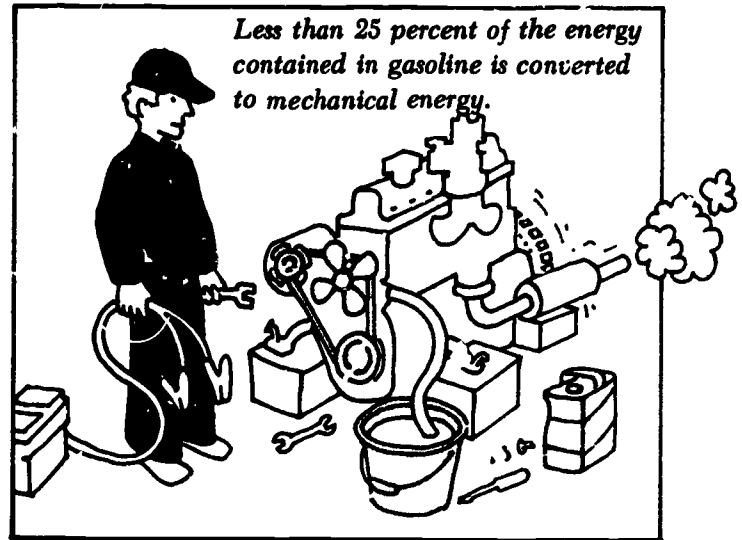

How can we save energy?

Saving energy is called *conservation* (KON-sər-VAA-shən). Although conservation is not an energy source, we can use it to extend the length of time nonrenewable energy sources will be available in the future.

Energy conservation is something that we all can practice by being careful about how much energy we use. Things that we can do to conserve energy include: carpooling and driving less; insulating our homes; making sure thermostats are set correctly; recycling glass, metals, and paper; and turning off lights and appliances that are not being used.

As conserving energy becomes more important, manufacturers are starting to make more efficient machines. Choosing automobiles and appliances that use energy efficiently is another way we can practice energy conservation.

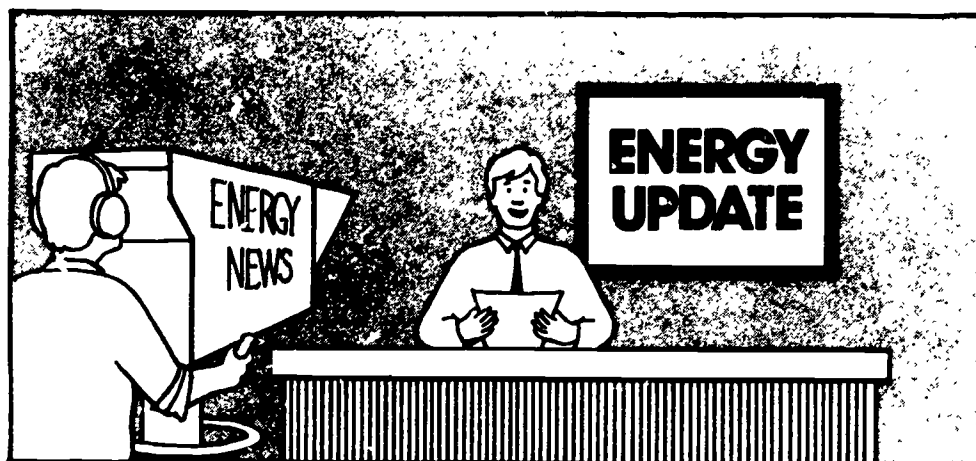

Energy update

We use energy for almost everything that we do. Energy is the ability to do work. The two basic types of energy are potential energy and kinetic energy. Potential energy is stored energy. Kinetic energy is energy in action.

These two types of energy can be divided into different forms: mechanical, chemical, thermal, electrical, radiant, and nuclear energy.

The energy we use comes from several different primary energy sources that include fossil fuels, as well as geothermal, nuclear, solar, and tidal energy. These primary sources can be used to make such secondary energy sources as electricity, food, wind power, and water power. Conservation is not an energy source, but can extend the length of time some energy sources will be available.

Energy can be converted from one form to another, but cannot be created or destroyed. When we convert energy, we lose some in the form of heat. The more energy lost during conversion, the more inefficient the conversion process is.

LESSON 1 REVIEW EXERCISE

A. List the two basic types of energy.

1. _____ 2. _____

B. List the five primary energy sources.

1. _____ 2. _____

3. _____ 4. _____

5. _____

C. Indicate whether the following statements are true (T) or false (F) by circling the correct letter. If the statement is false, correct it to make it true.

- | | |
|---|-----|
| 1. Energy cannot be created or destroyed. | T F |
| 2. Fossil fuels originally got their energy from the Sun. | T F |
| 3. Automobiles are energy efficient. | T F |
| 4. Kinetic energy is stored energy. | T F |
| 5. In any energy conversion process, some energy is lost. | T F |

D. The following are examples of potential energy. Tell how to convert each example into kinetic energy.

1. A lump of coal _____

2. Water held behind a dam _____

3. A coiled spring _____

4. A flashlight battery _____

5. An apple _____

E. Where we get our energy and how we use it.

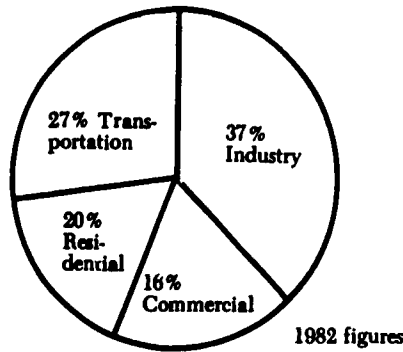

The chart above divides our energy use into four groups.

1. In what group do we use the most energy? _____
2. What ranks second? _____
3. In what ways do you use energy in the transportation and residential groups? _____

4. Where do you have the most opportunity to cut down on your energy consumption? _____

Which of the groups below use energy when the following types of work are done? Check the box or boxes in the appropriate columns.
 (The first one is done for you.)

1. Drive to a hamburger stand
2. Take a hot bath
3. Fly an airplane
4. Switch on an air-conditioner
5. Buy a new baseball
6. Ride a school bus
7. Blow dry your hair at home
8. Buy a frozen pizza
9. Ride a motor bike
10. Manufacture a motor bike

	Industry	Transportation	Commercial	Residential
1. Drive to a hamburger stand	✓			
2. Take a hot bath				
3. Fly an airplane				
4. Switch on an air-conditioner				
5. Buy a new baseball				
6. Ride a school bus				
7. Blow dry your hair at home				
8. Buy a frozen pizza				
9. Ride a motor bike				
10. Manufacture a motor bike				

What is electricity?

Of all the forms of energy, *electricity* is the one we rely on most in our day-to-day lives. In fact, we are so accustomed to using electrical energy that we tend to take it for granted--until service stops and everything comes to a halt.

One reason we use so much electricity is that it is our most versatile and adaptable form of energy. We use it at

home, at school, and at work to run numerous machines and to heat and light buildings.

What is electricity? To the scientist, it is the flow of *electrons*, usually through a wire. However, sometimes we see it in the sky as lightning or experience it as static electricity when hair is attracted to a comb or when someone takes off a sweater and there is a crackling sound.

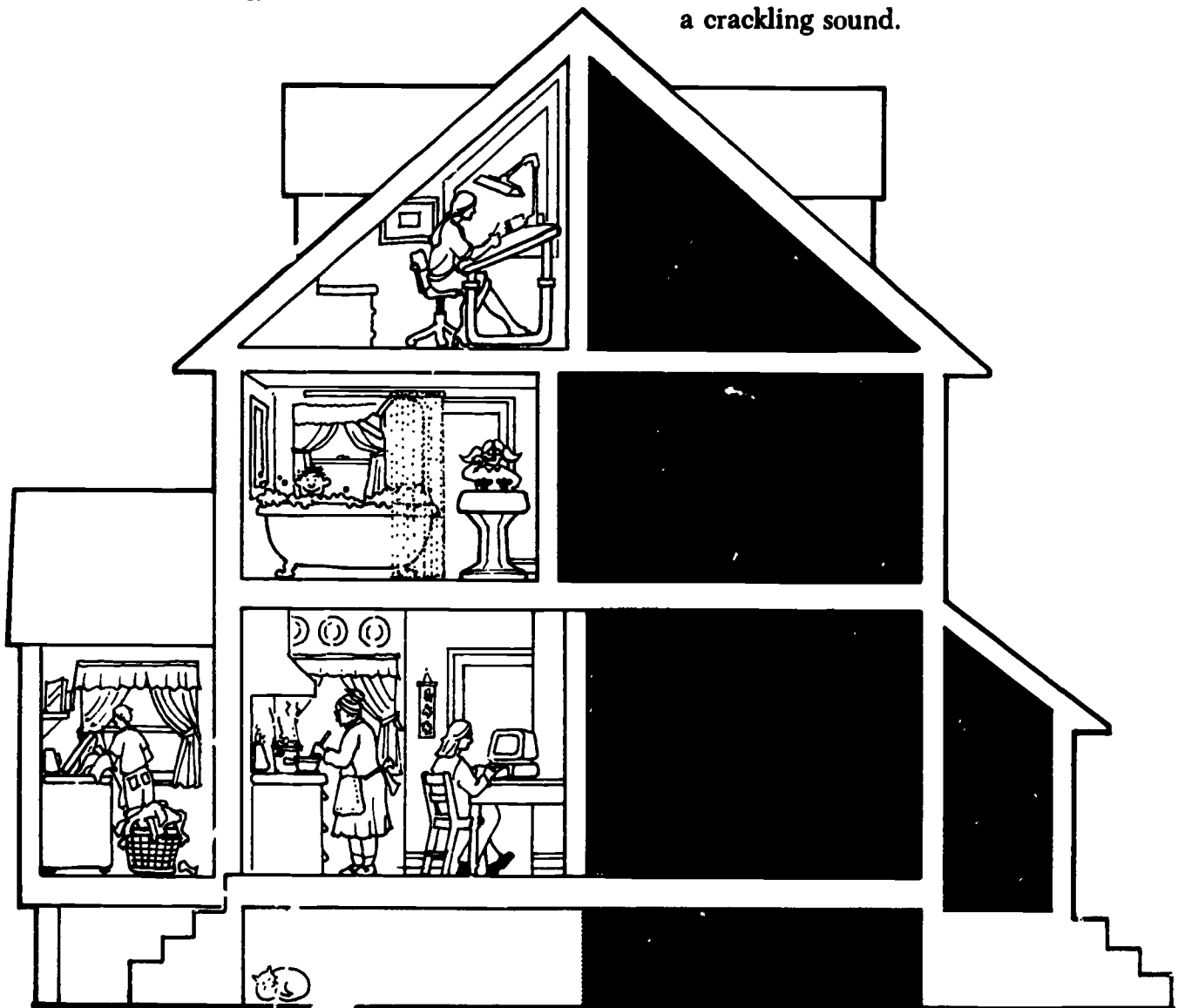

We are so accustomed to using electrical energy that we tend to take it for granted...

...until service stops and everything comes to a halt.

How is electricity produced?

Electricity is generally produced at a powerplant by converting one of the sources of energy into electricity. In the United States, the source is usually a fossil fuel (coal, oil, or natural gas), uranium, or water. Solar power, wind, *biomass* (BIGH-o-mass), or geothermal energy can also be used.

Most powerplants are very similar in several important ways. Most are designed to *generate* (JEN-ə-rayt) electricity by heating water to produce steam. The steam is then directed against the blades of a *turbine* (TUR-bin), making it spin much the way air makes a windmill spin. A coil of wire attached to the shaft of the *generator* (JEN-ə-ray-tər) spins inside a magnet. This causes electrons to flow in the coil--and the flow of electrons is electricity.

The generating plants and wires are owned and operated by about 1,000 different electric power companies all across the nation. These companies must build powerplants, string wires or bury them underground, buy fuel for the plants, and hire workers to do all the jobs that must be done. As you can imagine, all that takes a lot of money.

That is why the users of electricity must pay to use it. Meters keep track of how much electricity travels from a power company's wires into homes, businesses, schools, and factories. The company sends a worker to read the meter to determine how much each user must pay and sends the user a bill.

How do we get electricity to the place where we use it?

The electricity produced in the generator is sent out over wires to homes, schools, hospitals, farms, and factories. Getting it there is not a simple job.

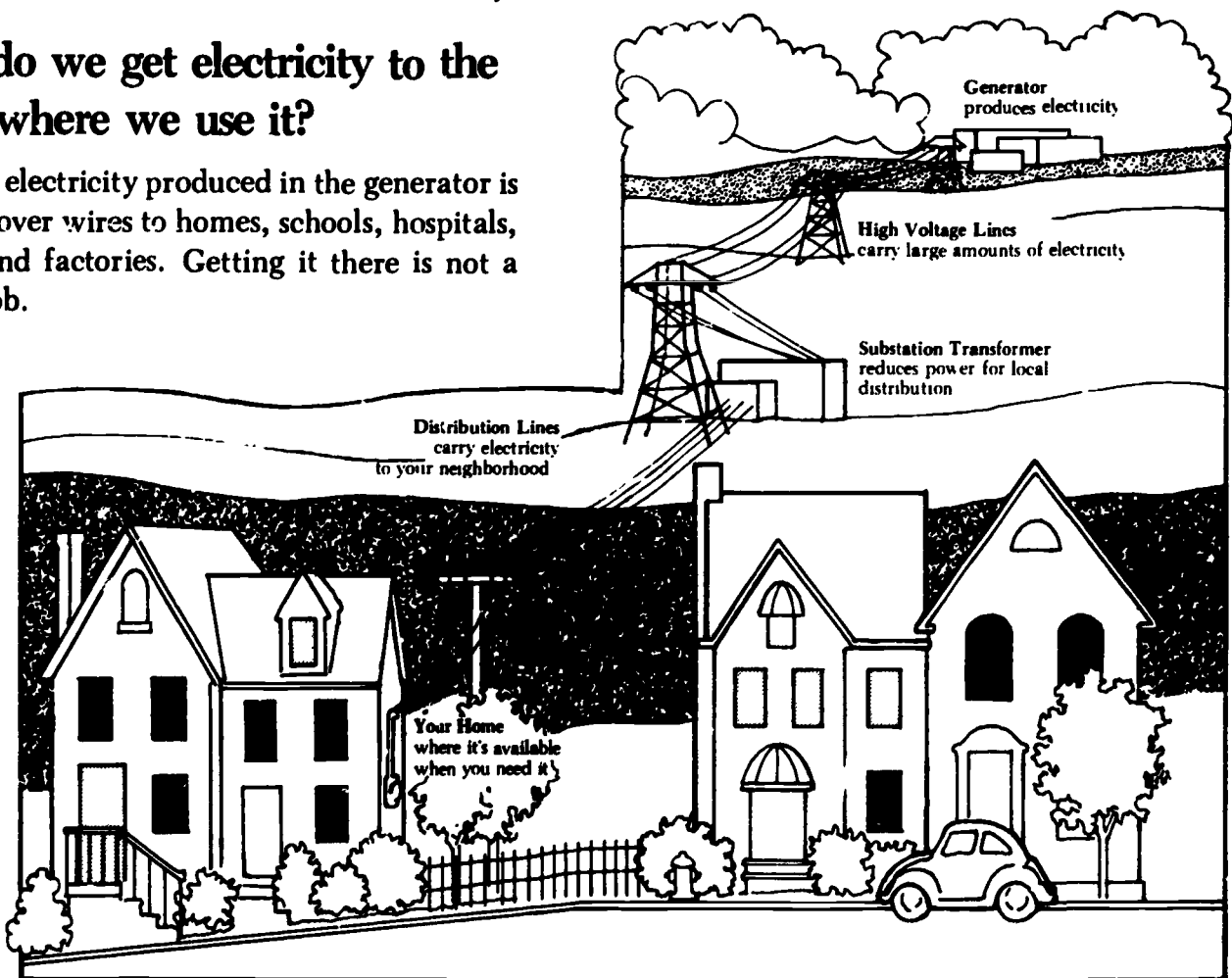

What is an electric utility company?

Companies that sell electricity are called **utilities**. A *utility* (yoo-TIL-ə-tee) provides something useful or essential to the public, like electric power, gas, water, or telephone service.

Because a utility provides an essential service to its customers, it has special duties. For instance, it must be able to supply all the electrical needs of its customers. A utility can't promise to deliver its product in two weeks the way some other companies can. Therefore, an electric utility must have generating plants, fuel, and sufficient power lines ready to do their jobs at any instant.

It would be wasteful and costly if more than one electric company served the same group of customers. Each company would have generating plants, fuel, power lines, and workers. So, a utility is assigned a specific area

to serve, and no other electric company may sell electricity in that area. In exchange for that privilege, State and local governments *regulate* (REG-yə-layt) the utility. They tell a utility how much it can charge, what services it must provide its customers, and how much profit it can make.

Because an electric utility must serve the needs of the public, it must plan carefully so that it can produce enough electricity. Decisions made today must anticipate the public's need for electricity in the future. These decisions are very difficult because it can take as long as ten years to build a fossil fuel powerplant or fourteen years to complete a nuclear powerplant. This means that utilities must act on predictions of what customers will need in the future.

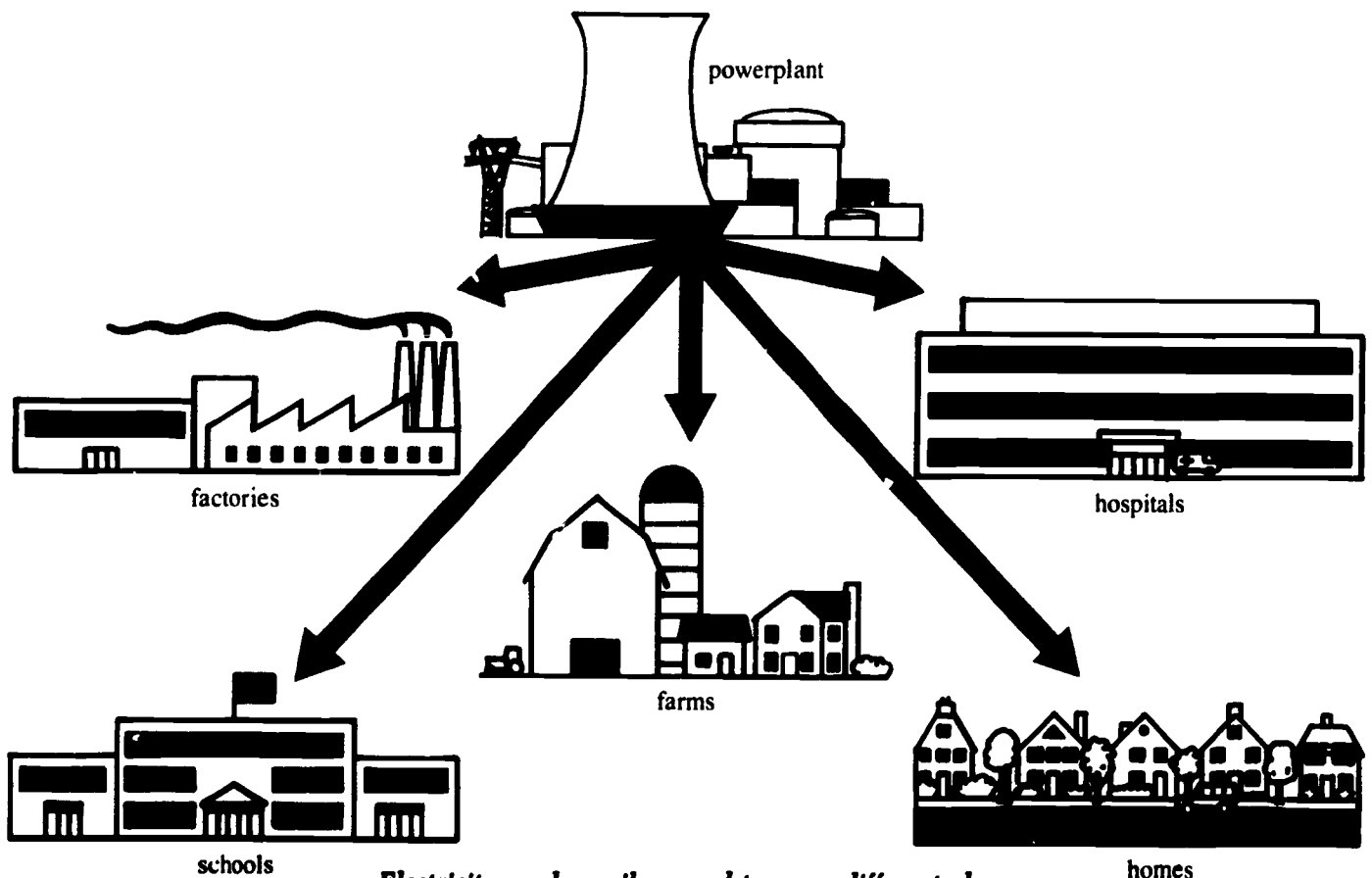

Electricity can be easily moved to many different places where it can be used to do work.

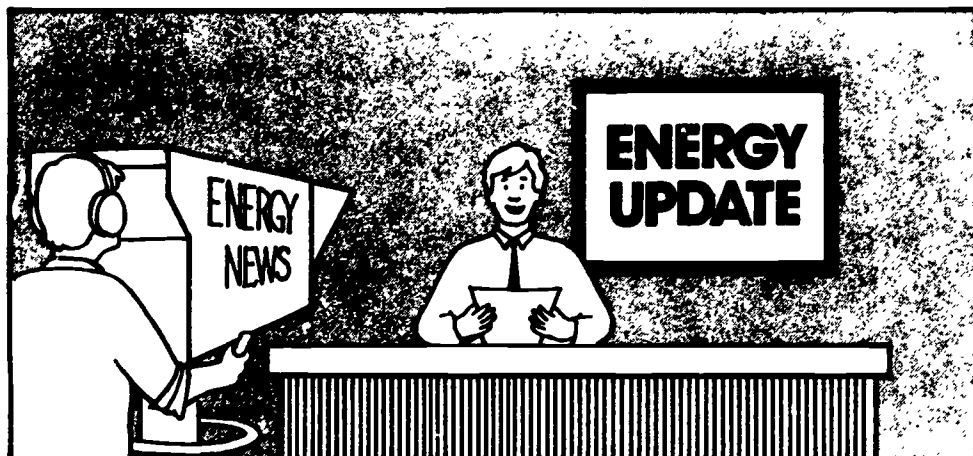

Electricity update

Electricity is the form of energy we rely on most in our day-to-day lives. We use it at home, school, and work for many important purposes.

Electricity is the flow of electrons, usually through a wire. It is produced at a powerplant by converting one of the primary sources of energy into electricity. In the United States most powerplants use fossil fuels (coal, oil, natural gas), uranium, or falling water.

Most powerplants use fossil fuels and uranium to heat water to make steam. The steam turns a turbine, which makes a generator spin. The result of a spinning generator is a flow of electrons--which is electricity. Electricity is delivered through wires to people who want to use it.

A company that produces and sells electricity is a utility. Because utilities supply something that is considered essential, the government regulates them. Utilities must plan carefully so that they can produce enough electricity when people need it.

LESSON 2 REVIEW EXERCISE

A. Circle the letter of the best answer for each item.

- Which one of these energy sources is not used in the United States to produce electricity?
a. water c. tidal energy
b. uranium d. coal
- Most powerplants make electricity by heating water to produce _____.
a. oil c. electrons
b. steam d. heat energy
- The steam made at the powerplant turns a _____.
a. windmill c. bolt
b. turbine d. steel rod
- How many electric power companies are there in the United States?
a. about 250 c. about 1,000
b. about 400 d. about 2,000
- What is the name of the utility that supplies electricity to your community?

B. Indicate whether each statement is true (T) or false (F) by circling the correct letter. If the statement is false, correct it to make it true.

- Electricity is the flow of electrons, usually through a wire. T F
- Many electric utilities may sell electricity to the same town. T F
- Meters keep track of how much electricity you use. T F
- Demand for electricity is always the same. T F
- State and local governments regulate utilities because a utility is allowed to be the only electric power company in the area. T F

C. List three reasons why governments regulate utilities.

Nuclear Energy & Electricity

The Harnessed

Atom

**Unit 2
Understanding
Atoms & Radiation**

What is an atom?

In order to understand nuclear energy, it is important to first understand the *atom* (AT-əm).

What do you suppose would happen if you took a lump of salt and began to break it up into smaller and smaller pieces? Sooner or later you would get pieces so small that you wouldn't be able to see them. The smallest piece that still is salt is called a *molecule* (MOL-ə-kyool).

Everything is made of molecules--tables, chairs, sugar, salt, and even the cells of your own body. However, all molecules are not alike. A molecule of sugar is different from a molecule of salt.

But that is not the whole story. Molecules are made of even smaller parts, which are called atoms. Atoms are so small that it takes millions of them to make a speck of dust. We know that at least 92 different kinds of atoms occur in nature. These different kinds of atoms are known as *elements* (EL-ə-mənts). Combining atoms of different elements or atoms of the same element makes molecules. The kind of molecule depends on which atoms combine. This combining is called a *chemical reaction* (KEM-i-kəl ree-AK-shən). In chemical reactions, atoms do not change; instead, they combine with other atoms or separate from other atoms.

For example, a bar of pure gold contains only atoms of one element, gold. A molecule of table salt has one atom of the element sodium and one atom of the element chlorine. A molecule of water has two atoms of hydrogen and one atom of oxygen. This is why chemists call water H_2O .

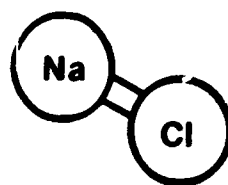

NaCl

The symbol for sodium is Na and the symbol for chlorine is Cl, so table salt is NaCl; the symbol for hydrogen is H and the symbol for oxygen is O, so water is H_2O .

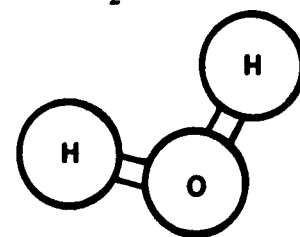
 H_2O

So, atoms are basic building blocks of everything in the universe. They are the smallest particles of matter that have all of the characteristics of an element.

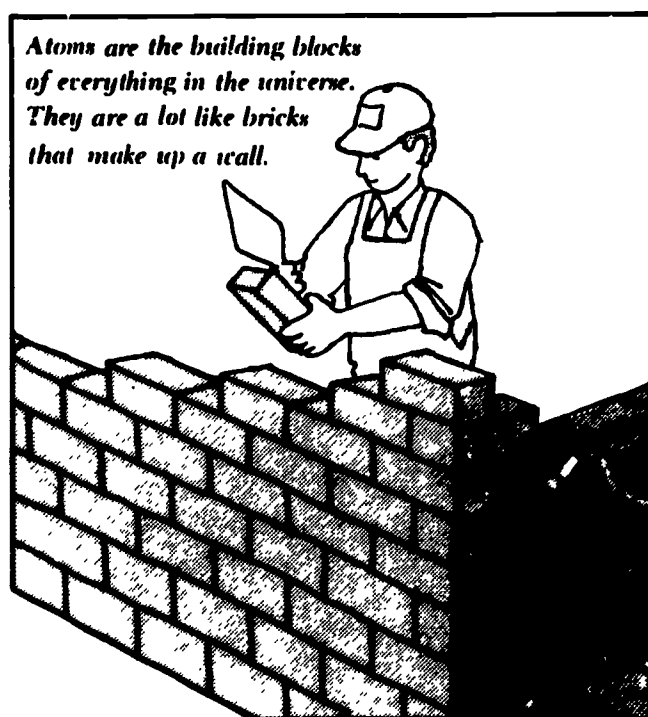
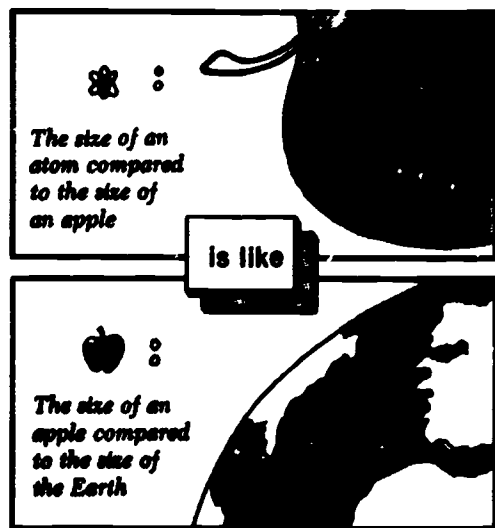

What are the parts of an atom?

As small as atoms are, they are made of even smaller particles. There are three basic particles in most atoms--*protons* (PROH-tahns), *neutrons* (NYOO-trons), and *electrons* (ih-LEK-trons).

Protons carry a positive electrical charge. Neutrons have no electrical charge. Protons and neutrons together make a bundle at the center of an atom. This bundle is the *nucleus* (NYOO-klee-äss).

Electrons have a negative electrical charge and move around the nucleus. Normally, an atom has the same number of protons and electrons. If the positively charged protons and the negatively charged electrons are equal in number, they balance each other. As a result, the atom has no electrical charge.

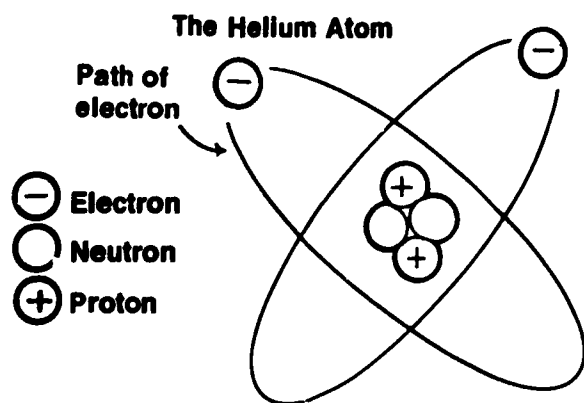

We use protons to identify atoms. For instance, an atom of oxygen has 8 protons in its nucleus. Carbon has 6, iron 26, gold 79, lead 82, *uranium* (yu-RAY-nee-əm) 92, and so on.

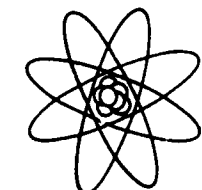

Carbon — 6 protons

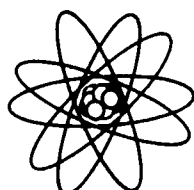

Iron — 26 protons

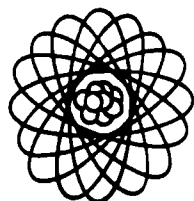

Gold — 79 protons

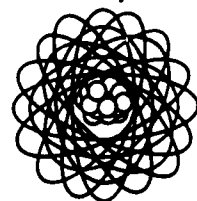

Uranium — 92 protons

What is an isotope?

The nucleus in every atom of an element always has the same number of protons. However, the number of neutrons may vary. Atoms that contain the same number of protons, but different numbers of neutrons, are called *isotopes* (II-suh-tophs) of the element.

All atoms are isotopes. To show which isotope of an element we are talking about, we total the number of protons and neutrons. Then we write the sum after the chemical symbol for the element. For example, in the nucleus of one isotope of uranium there are 92 protons and 143 neutrons. We refer to it as uranium-235 or U-235 ($92 + 143 = 235$). A second uranium isotope, which contains 3 additional neutrons, is uranium-238 or U-238 ($92 + 143 + 3 = 238$).

Uranium-235

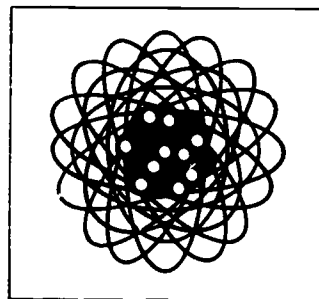

$$92 + 143 = 235$$

Uranium-238

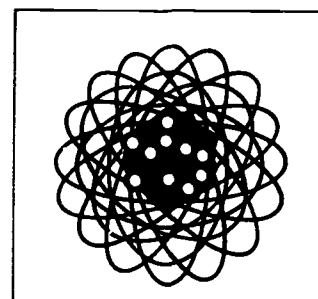

$$92 + 143 + 3 = 238$$

Isotopes of a given element have the same chemical properties, but they may differ in their nuclear properties. Also, isotopes of an element have different numbers of neutrons and the same number of protons. However, some proton-neutron combinations are more stable than others.

Some unstable isotopes stabilize themselves by *emitting* (ee-MIT-ing) or shooting out energy rays similar to x rays. Others may emit particles from their *nuclei* (NYOO-klee-ii) and change into different elements. These rays and particles are called *radiation* (ray-dee-AY-shən), and the process of isotopes emitting them to become more stable is called *radioactive* (ray-dee-oh-

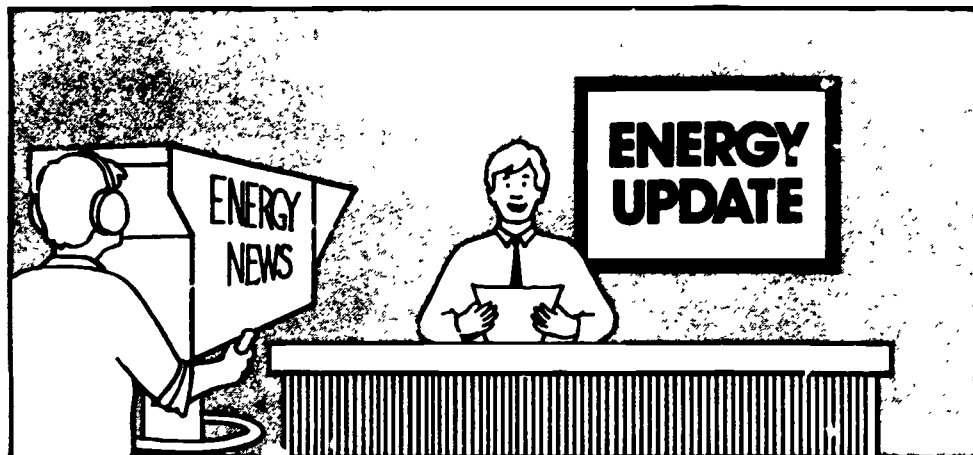

Atoms update

Atoms are the smallest units of matter that have all of the characteristics of an element. Atoms combine to form molecules. Atoms are composed of smaller particles known as protons, neutrons, and electrons.

Protons have a positive electrical charge, neutrons have no electrical charge, and electrons have a negative electrical charge. Protons and neutrons together form the nucleus or center of the atom, and electrons move around the nucleus.

The nucleus of each atom of an element contains the same number of protons, but the number of neutrons may vary. Isotopes of an element are identified by adding the number of protons and neutrons together and writing the sum after the chemical symbol for the element. Unstable isotopes can change from one form to another by emitting particles or energy rays in a process called radioactive decay.

LESSON 1 REVIEW EXERCISE

A. Select the word that best fits the definition given.

- _____ the smallest unit of matter that has all the characteristics of an element
- _____ the bundle consisting of protons and neutrons, which is found in the center of an atom
- _____ atoms of an element containing the same number of protons, but different numbers of neutrons
- _____ a part of an atom with a positive charge
- _____ a part of an atom with a negative charge

B. Indicate whether each statement is true (T) or false (F) by circling the correct letter. If the statement is false, correct it to make it true.

- Unstable isotopes can change from one form to another by emitting particles and rays. T F
- An atom is identified by the number of protons in its nucleus. T F
- Protons and electrons together make up the nucleus of an atom. T F
- Atoms are so small that humans cannot see them. T F
- Atoms combine to form molecules. T F

C. Using the periodic table, tell which elements make the molecules of the following substances.

- H_2SO_4 _____
- $C_6H_{12}O_6$ _____
- KOH _____
- $AgNO_3$ _____
- $ZnCl_2$ _____

D. Models

1. Label the model of the carbon atom shown below. An atom of carbon has 6 protons, 6 neutrons, and 6 electrons. Remember that protons have a positive (+) charge, electrons have a negative (-) charge, and neutrons have no electrical charge.

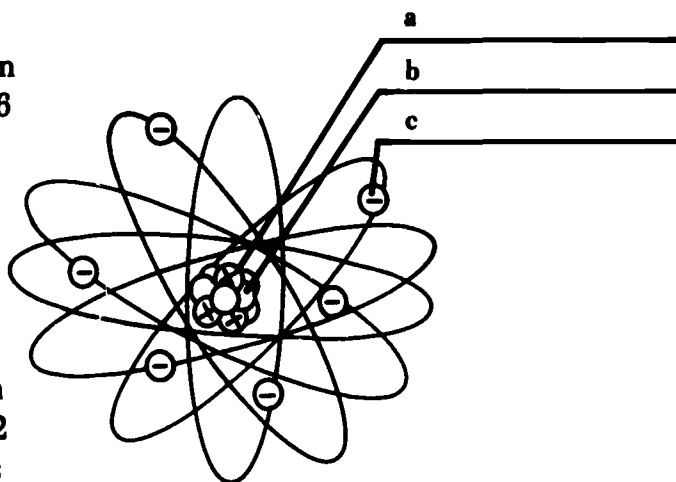

2. Draw a model of a helium atom. An atom of helium has 2 protons, 2 electrons, and 2 neutrons. Show protons as \oplus , electrons as \ominus , and neutrons as \circ .

What is radiation?

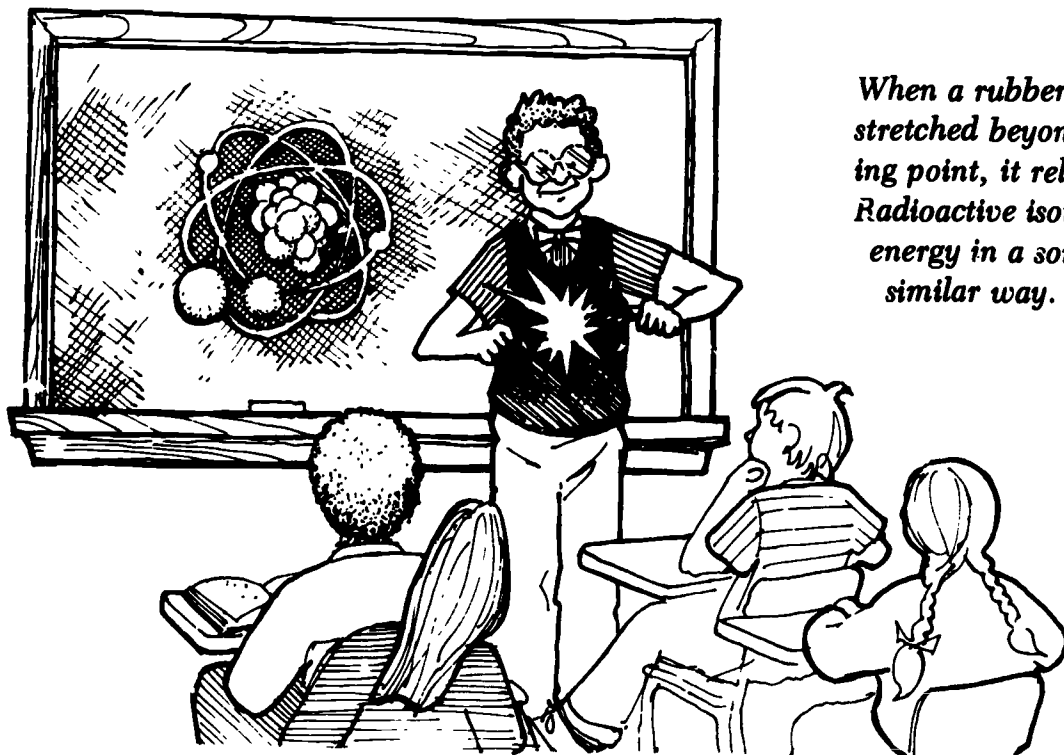

When a rubber band is stretched beyond its breaking point, it releases energy. Radioactive isotopes release energy in a somewhat similar way.

What happens when you snap a rubber band? If you pull a rubber band slowly to its limit, it will break, and the energy that was holding it together will be suddenly released.

As you recall, the isotopes of an element have different numbers of neutrons in their centers. Some of these isotopes are similar to rubber bands that are stretched too far. They may break and change instantly to a different energy level. Scientists believe that elements do this in order to become more stable and that everything in the universe seeks these lower, more stable energy levels. We call these elements *unstable isotopes* and we call their journey towards becoming stable *radioactive decay*.

When a rubber band breaks, the energy used to pull it apart is suddenly released. You can't see this energy. But you can see the effect on the rubber band, which often shoots across the room.

Sometimes similar things happen when the centers of isotopes break apart. An invisible energy is quickly released. And although all atoms are extremely small, the energy that holds their centers together is much stronger than a rubber band.

The energy that is released is quite powerful and moves very fast. This energy is called *radiation*. Substances that give off radiation in such a way are called *radioactive*.

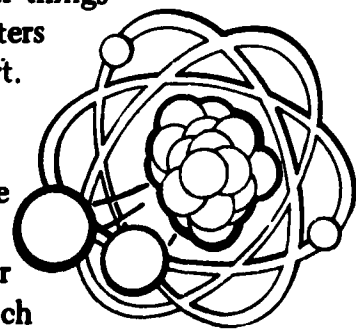

What are the types of radiation?

Radiation comes in many forms. But the three main kinds that come from isotopes are *alpha* (AL-fə), *beta* (BAYT-ə), and *gamma* (GAM-ə).

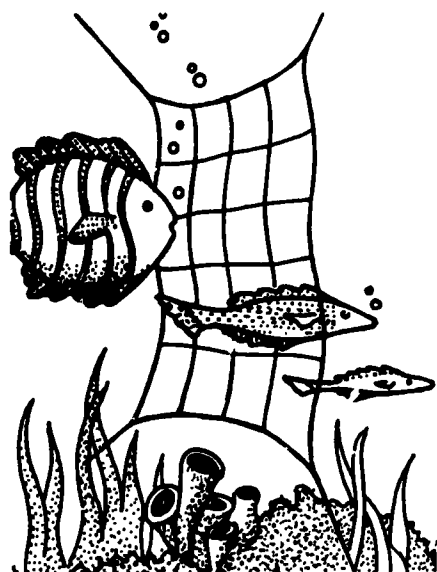

The arrangement of atoms in paper is like twine in a large net; there is lots of space in between. So paper can only "catch" large alpha particles, which are the slowest-moving type of radiation.

Alpha and beta radiations are made of extremely tiny bits of the atoms that *emit* them. They are thrown from unstable isotopes that are in the process of becoming unstable. Alpha radiation is easily stopped by a piece of paper and will actually travel only a few inches through air before being stopped by air molecules. Beta radiation is faster and lighter than alpha radiation, but may be stopped with aluminum foil.

Gamma radiation is a little different because it is a type of *electromagnetic wave*, just like radio waves, light, and x rays. However, gamma radiation is a very strong type of electromagnetic wave. Gamma radiation is generated by certain unstable isotopes that are going through radioactive decay. Because gamma radiation has no weight and travels even faster than alpha and beta radiation, a thick wall of cement, lead, or steel is needed to stop it.

Alpha, beta, and gamma radiations are all known as *ionizing* (II-ən-II-z-ing) *radiation*. Ionizing radiation can change the chemical makeup of many things, including the delicate chemistry of living organisms. For this reason it

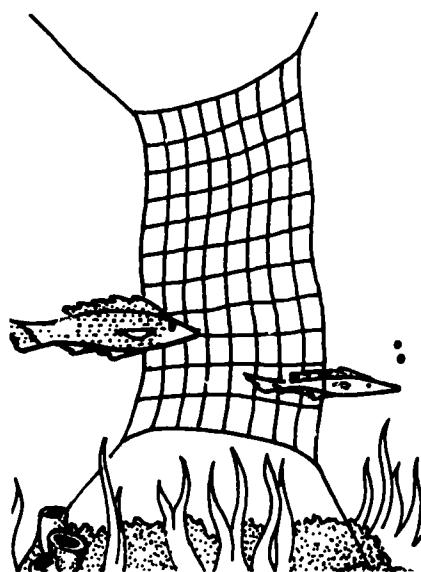

Aluminum foil is a little more dense. Its atoms form a tighter net, which can catch faster and lighter beta particles.

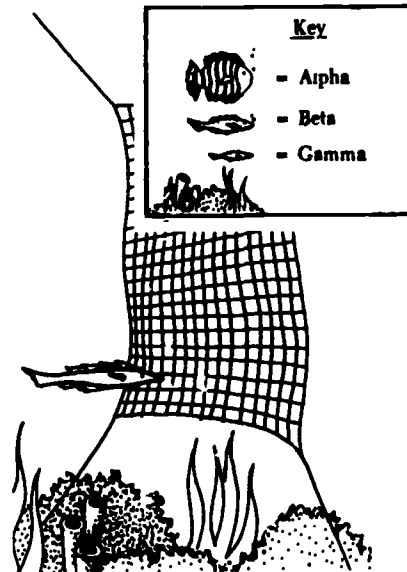

The atoms in water and in dense substances such as concrete and lead behave like very tightly-woven nets and capture gamma radiation, which has no weight and travels faster than alpha and beta particles.

is good to avoid unnecessary exposure to ionizing radiation.

Anything that can be used to stop different kinds of radiation from coming in contact with people is known as *shielding* (SHEELD-ing). Different types of radiation require different types of shielding. To stop the more penetrating types of radiation, we use water and dense substances like cement and lead.

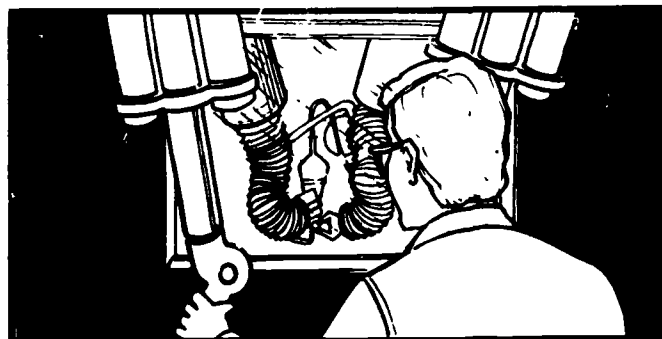

People are shielded when they work with radioactive materials.

We have also developed mechanical hands and robots that may be used to handle radioactive isotopes, while the people operating the hands or robots remain safely behind shielding.

What is half-life?

One peculiar thing about radioactive isotopes is that nobody knows exactly when one will decay and produce radiation. It is a little like the hiccups. Everybody has probably had the hiccups at least once. It is almost impossible to know exactly when they will happen. It would be amazing if everyone suddenly got the hiccups at the same time. Yet, we are still able to say that within a week a certain number of people will have the hiccups.

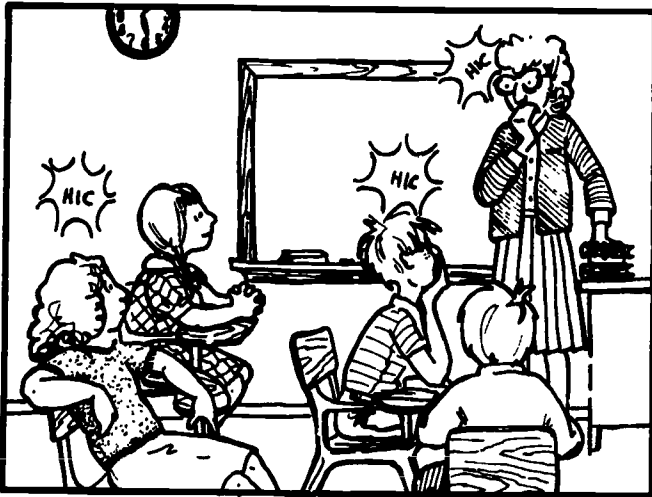

It is the same way with radioactive decay. Radioactive isotopes decay at random, and it is impossible to guess which one will decay or "step down" next. Yet, when we gather these atoms together, a pattern can be seen. We describe this pattern by using the term *half-life*.

The amount of time it takes for a given isotope to lose half of its *radioactivity* is known as its half-life. If a substance has a half-life of 14 days, half of its atoms will have decayed within 14 days. In 14 more days, half of the remaining half will decay. In 14 more days, half of that remaining half will decay, and so on.

If there are 20 people in your classroom and in 14 days 10 of them get the hiccups, the hiccup half-life of your class is 14 days.

An unstable isotope will eventually decay into a stable element. However, this process is often drawn out into something called a *decay chain*. For example, the isotope uranium-238 transforms into many different isotopes before it becomes stable lead.

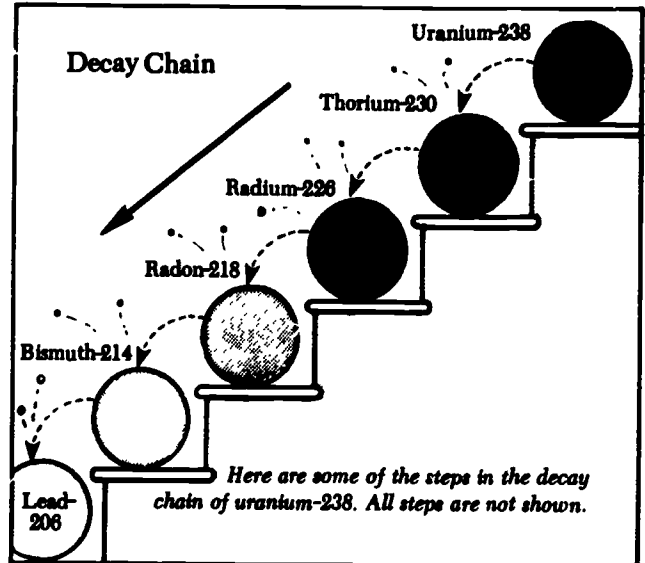

Just as there is probably somebody in the class who rarely or never gets the hiccups, there are isotopes that also seem to hold out. This is why we measure half-life the way we do: to allow for stragglers. Some isotopes may change in the next second, some in the next hour, some tomorrow, and some next year.

Other isotopes will not decay for thousands of years. Half-lives range from fractions of a second to several billion years.

Half-lives of Some Radioactive Isotopes	
Americium-241	475 years
Californium-252	2.2 years
Carbon-14	5,760 years
Hydrogen-3 (Tritium)	12.26 years
Iodine-131	8 days
Iridium-191	4.9 sec.
Krypton-85	10.6 years
Phosphorous-32	14.29 days
Uranium-235	700 million years

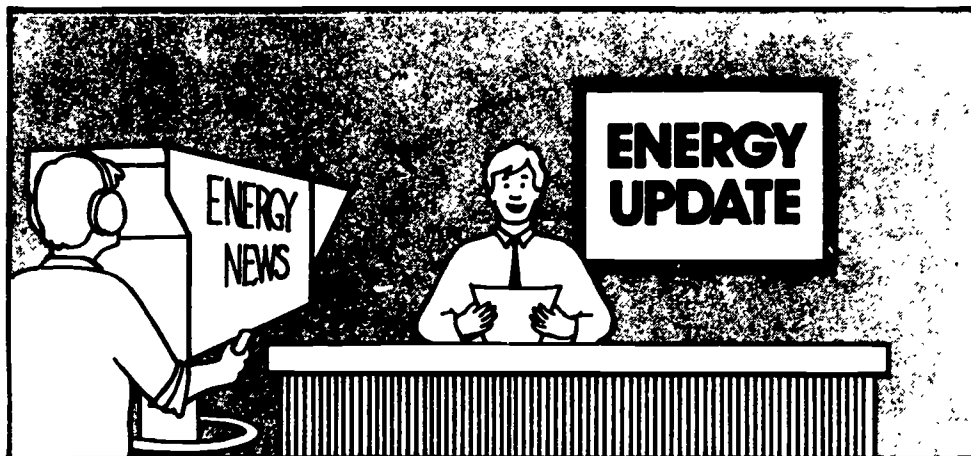

Radiation update

Radiation is a type of energy. It is given off by unstable isotopes.

Alpha, beta, and gamma radiation are all types of ionizing radiation. Paper serves as shielding from alpha radiation. Aluminum foil serves as shielding from beta radiation. Water and dense materials such as concrete or lead serve as shielding from gamma radiation.

Radioactive isotopes seek to become stable, and to do this they decay. The half-life is the amount of time it takes for a radioactive material to lose half of its radiation. Half-lives range from fractions of a second to several billion years.

LESSON 2 REVIEW EXERCISE

A. Select the word which best fits the definition given.

- _____ 1. energy released by unstable isotopes
- _____ 2. atoms of an element with the same number of protons, but different numbers of neutrons
- _____ 3. process of becoming more stable and less radioactive as time passes
- _____ 4. amount of time it takes for a material to lose half its radiation

B. Indicate whether each statement is true (T) or false (F) by circling the correct letter. If the statement is false, correct it to make it true.

1. Radiation is a form of energy. T F
2. Radioactive isotopes emit radiation. T F
3. Gamma radiation can be stopped by paper. T F
4. Aluminum foil is a shielding material that will stop gamma radiation. T F
5. Alpha and beta radiations are tiny bits of atoms. T F
6. Gamma radiation is a type of electromagnetic wave. T F

C. Match alpha, beta, and gamma radiation with the materials that can stop them.

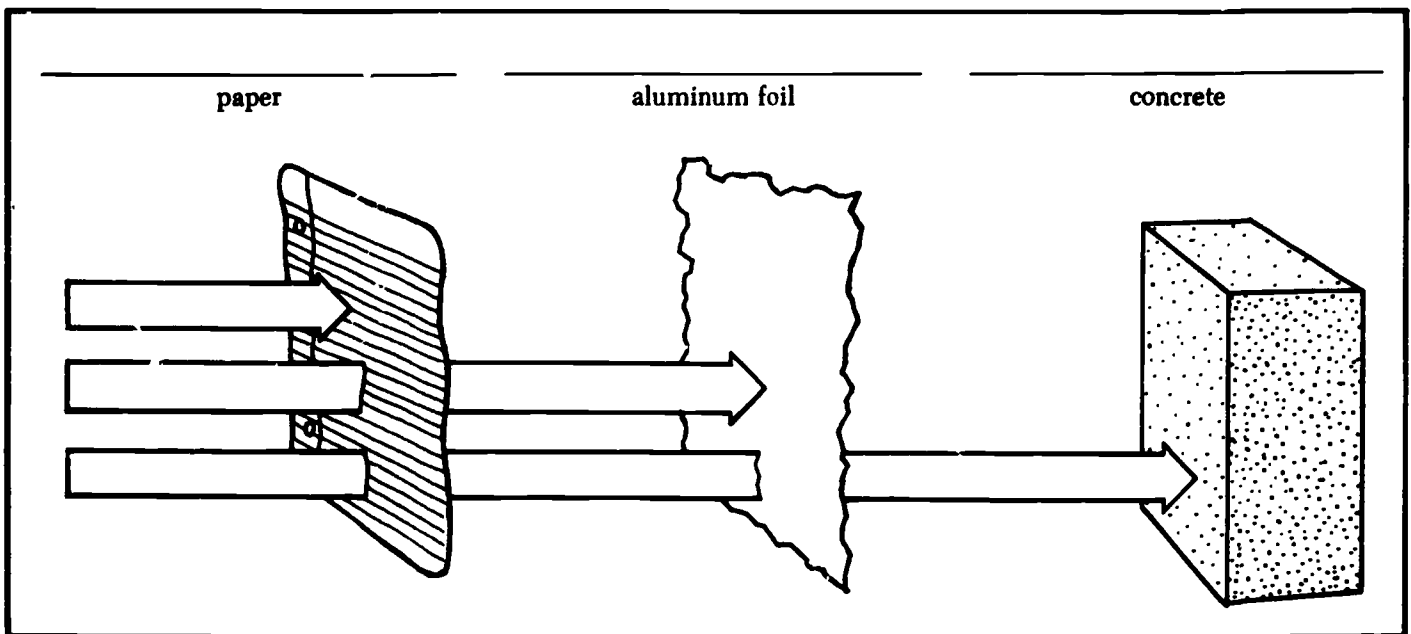

D. A radioactive substance contains 1,000 radioactive atoms. The half-life of the element is 10 years. At the end of 30 years, approximately how many of the atoms in the sample will still be radioactive?

E. Challenge Question

If a quantity of a radioactive substance has lost $\frac{7}{8}$ of its radioactivity in 30 seconds, what is its half-life?

How do we recognize radiation?

When we look at a painting or a beautiful view, we see it because our eyes react to different types of electromagnetic waves that we call visible light. We adjust our vision with eyeglasses, and we extend it with telescopes and microscopes.



Telescopes allow us to see into outer space.

We must sense the things around us in order to understand them. But we are unable to see, hear, touch, smell, or taste radiation. Because we are unable to use our senses to detect radiation, it has become necessary to build scientific instruments that can detect and measure it for us.

Ionizing radiation has enough energy to knock electrons off the atoms it touches. Since electrons have a negative charge, atoms that lose electrons become positively charged because the number of positively charged protons left in their centers is greater than the number of negatively charged electrons. We use the fact that ionizing radiation makes atoms electrically charged to help us build instruments that "see" radiation.

When an atom "loses" an electron, it becomes positively charged.

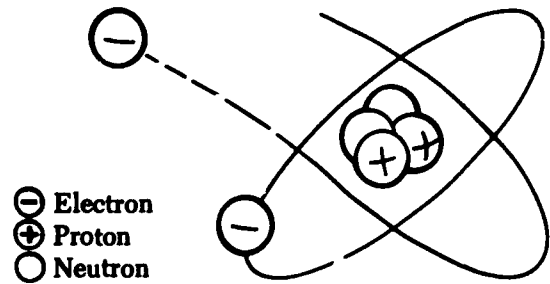

By using this concept, we design *Geiger* (GIGH-gar) *counters* (KOWN-tars) to sense extremely tiny electrical impulses caused by ionizing radiation. In a Geiger counter, an electric current is passed along the walls of a tube. A thin wire passes through the center of the tube. The tube is filled with a gas that easily loses electrons if it is hit with ionizing radiation. When this happens, an electric current can jump through the gas to the wire. This completes an electrical circuit and the resulting electricity causes a loud clicking noise or moves a needle on a dial.

Radiation that strikes photographic film affects it much the way light does. The difference is that radiation can penetrate through materials that can stop light. As a result, photographic film can be used to test for radioactivity. People who might be exposed to radiation often wear a *film badge* that contains a small bit of photographic film. This film badge records exposure to ionizing radiation, if there is any.

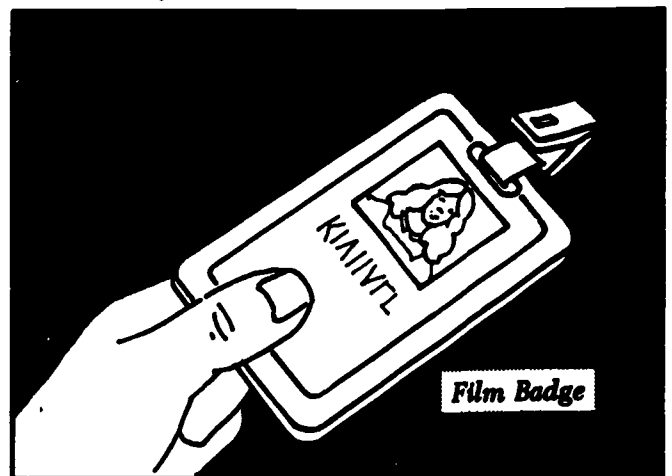

Lesson 3

Curiously, our skin can behave like photographic film. When we are exposed to even small amounts of radiation from the Sun, our skin gets darker. This is called getting a suntan, or if we are less fortunate, a sunburn. To avoid overexposure to the Sun's radiation, we use several types of shielding, including umbrellas and sunscreen lotions.

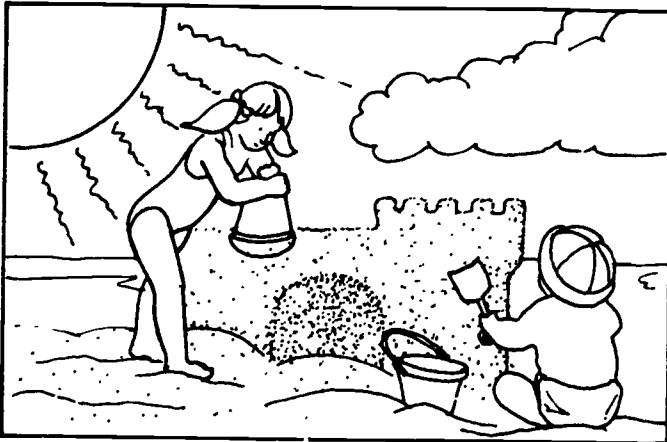

A suntan or sunburn is the result of exposure to the Sun's radiation.

Because we cannot detect radiation with our senses and because exposure to too much ionizing radiation is harmful, a symbol has been developed to warn us when radioactive materials are present. The symbol is used on packages of radioactive materials, such as isotopes, and on doors to rooms or areas where radioactive materials are used or stored.

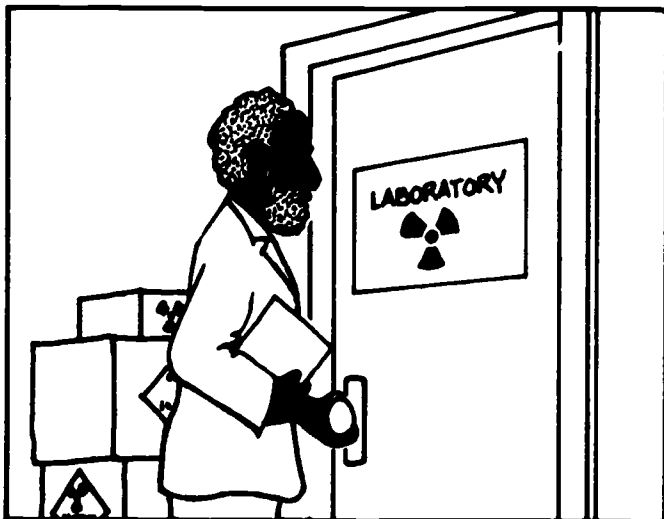

A symbol warns us when radioactive materials are present.

This symbol is also used to mark boxes, cartons, and other containers of radioactive materials when they are being transported by train, truck, or plane. The laws regulating labeling of radioactive materials also require that explosives, poisons, flammable materials, combustible gases, and other hazardous substances be labeled to protect people.

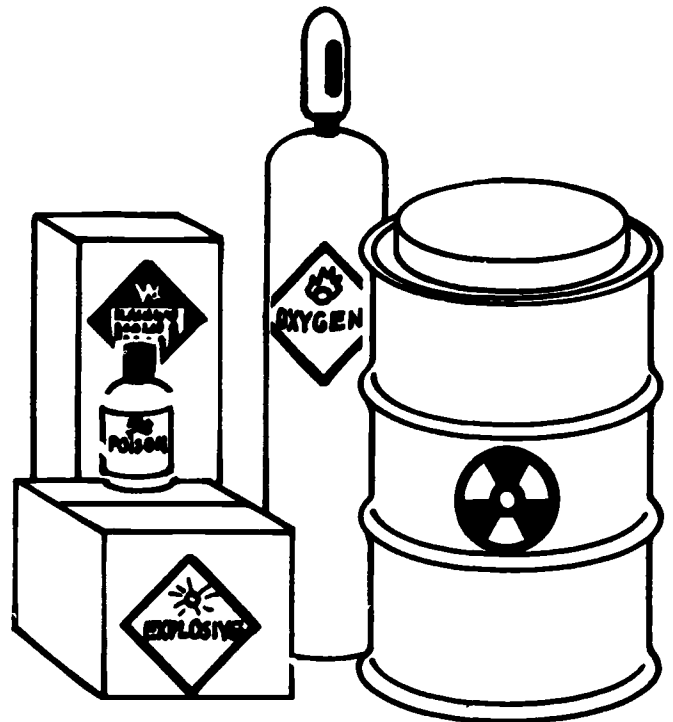

Laws require that hazardous materials be labeled to protect people.

How do we measure radiation?

If you are asked how far it is from school to your house, you can answer the question in several different ways. For instance, you may live a half mile away, but you also live 2,640 feet from school, or 31,680 inches.

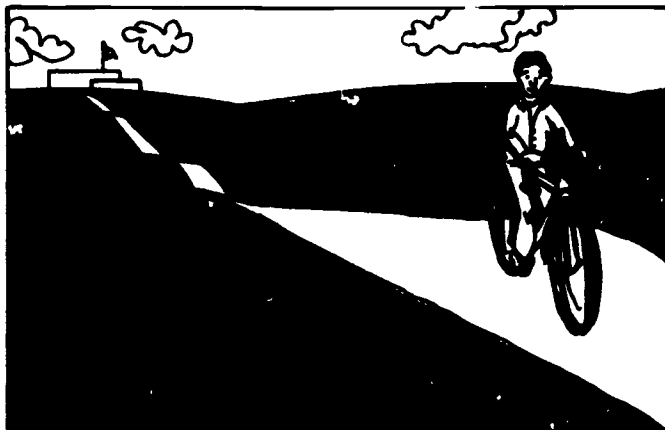

It is the same with measuring radiation. Scientists have come up with many names or units of measure. These units include *curie* (KYUR-ee), *roentgen* (RENT-gən), *rad*, *rem*, and *millirem* (MIL-ə-rem).

To tell how different amounts of ionizing radiation affect people we use the term *radiation dose*. As in taking medicine, the effects of a dose depend on the amount of the drug you take and the period of time in which the drug is taken. Two aspirin may cure your headache. Twenty aspirin in a week may cure ten headaches. But twenty aspirin all at once could do serious damage.

The amount of time that a person is exposed to ionizing radiation, and the amount of shielding used help determine the radiation dose. Because air provides additional shielding, the distance between a person and a radioactive substance is also important. Decreasing *time*, and increasing *distance* and *shielding* are the three main ways to reduce radiation doses.

The effect ionizing radiation has on people is measured in millirems. Most people receive between 150 and 200 millirems a year, and any

level less than 5,000 millirems a year is considered low-level. Even exposures to levels as high as 50,000 millirems have not had immediately *discernible* (dis-ƏRN-nə-bal) *adverse* (ADD-vərs) effects. Some scientists believe low levels of radiation can have a harmful effect. However, most scientists believe that low levels of radiation have an insignificant effect on people. If radiation exposure is low, or the radiation is received over a long period of time, the body can usually repair itself. Of course, if an exposure is big enough and happens quickly, it can cause damage.

Scientists have found that radiation doses of over 100,000 millirems will usually cause radiation sickness. Doses of over 500,000 millirems, if received in three days or less, will usually kill a person. Fortunately, exposures to such large quantities of radiation are extremely unusual.

On the average, people receive between 150-200 millirems of radiation per year. A large part of this is natural background radiation that you will read about in the next chapter.

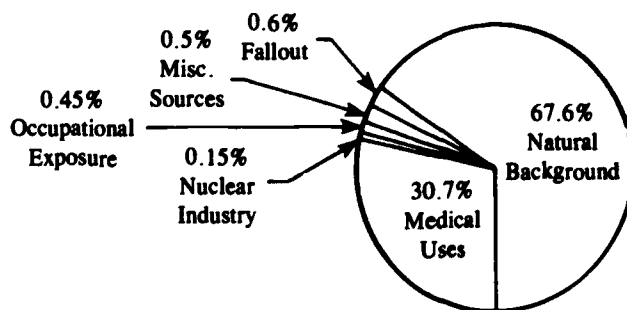

The highest percentage of the 150-200 millirems of radiation the average American receives each year is from natural background radiation.

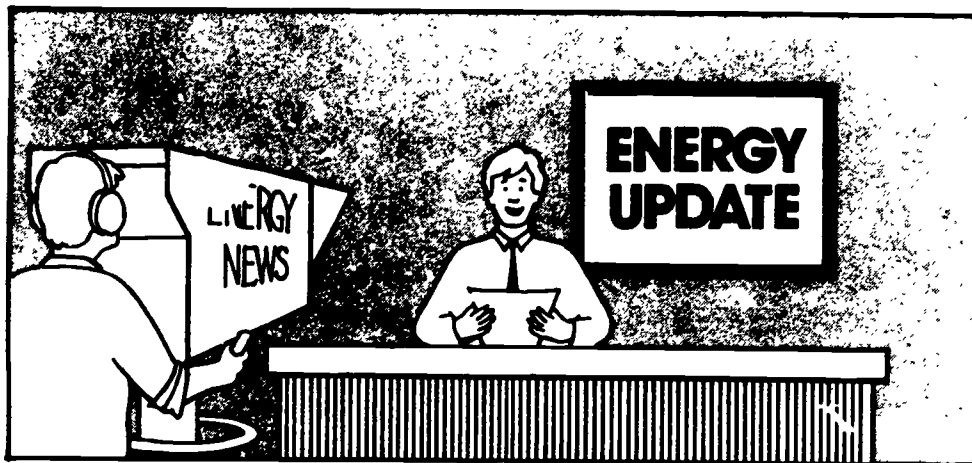

Detecting and measuring radiation update

Radiation is invisible. We are also unable to hear, taste, touch, or smell it. Yet we are able to detect and measure radiation with certain scientific instruments such as Geiger counters and photographic film. These devices allow us to use radiation safely because they let us know when even tiny amounts of radiation are around. We also mark radioactive materials and areas where they are used with special symbols that remind people to be careful.

We have many units of measure that describe different amounts of radiation. These include curies, rads, rems, and millirems. The effect that radiation has on people is measured in millirems. We protect ourselves by limiting the amount of time we are near radioactive substances and by increasing the distance and shielding between ourselves and sources of radiation.

LESSON 3 REVIEW EXERCISE

A. Select the term which best fits the statement.

1. To reduce exposure to radiation, we limit the amount of _____ we are near radioactive substances.
2. To avoid exposure to radiation, we keep as great a _____ away from radioactive substances as possible.
3. Thick leaded glass is used as _____ to protect workers from exposure to radiation.
4. The effect radiation has on people is measured in _____.
5. The average annual radiation dose that most Americans receive is _____ millirems.
6. Any radiation dose less than _____ millirems is considered low-level.
7. A radiation dose of over _____ millirems will usually cause radiation sickness.
8. A _____ is used to detect radiation.

B. Indicate whether each statement is true (T) or false (F) by circling the correct letter. If the statement is false, correct it to make it true.

- | | | |
|--|---|---|
| 1. Photographic film can detect radiation. | T | F |
| 2. The average person receives 5,000 millirems a year as natural background radiation. | T | F |
| 3. The period of time over which we receive radiation determines how strongly it will affect us. | T | F |
| 4. Radioactive materials are the only hazardous materials that must be labeled. | T | F |
| 5. It is easy to hear radiation, although we cannot feel it or see it. | T | F |

C. Make a sketch or drawing for the symbol for radiation.

D. List two places where you might see this label.

1. _____
2. _____

What is background radiation?

Everything in the world is radioactive and always has been. The ocean we swim in, the mountains we climb, the air we breathe, and the food we eat all expose us to small amounts of natural *background radiation*. This is because unstable isotopes that give off or emit ionizing

amounts of rocks and minerals. Some regions are rich in coal or oil. Others may have copper or lead. So it is not surprising to learn that certain areas on Earth have deposits of substances like uranium, which emit radiation. There are places all over the world where this is true. In

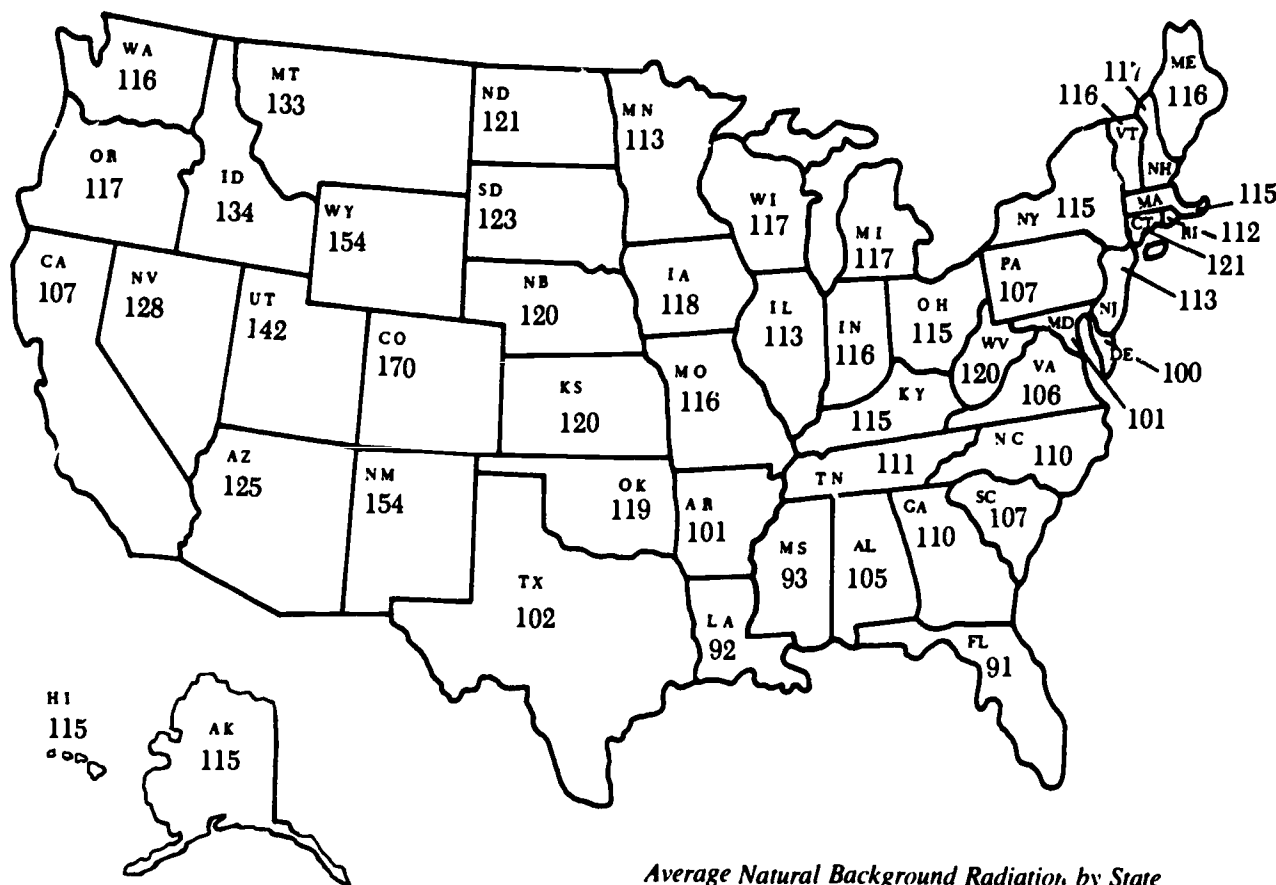

*Average Natural Background Radiation by State
(in millirems per person per year)*

radiation are found everywhere. Much of the Earth's natural background radiation is in the form of gamma radiation, which comes from outer space. Background radiation also comes from such elements as potassium, thorium, and uranium, which constantly decay and emit radiation. This means that no matter where we go or what we do, we are always surrounded by small amounts of radiation.

Different places on Earth have varying

the United States, some of the best known deposits are in New Mexico, Nevada, Utah, Wyoming, and Colorado. Some parts of India and Brazil have very high levels of natural background radiation from their rocks and soil. In fact, these levels exceed the safety limit of 5 millirems each year that the U.S. Government has set as a maximum limit at the boundary of nuclear powerplants.

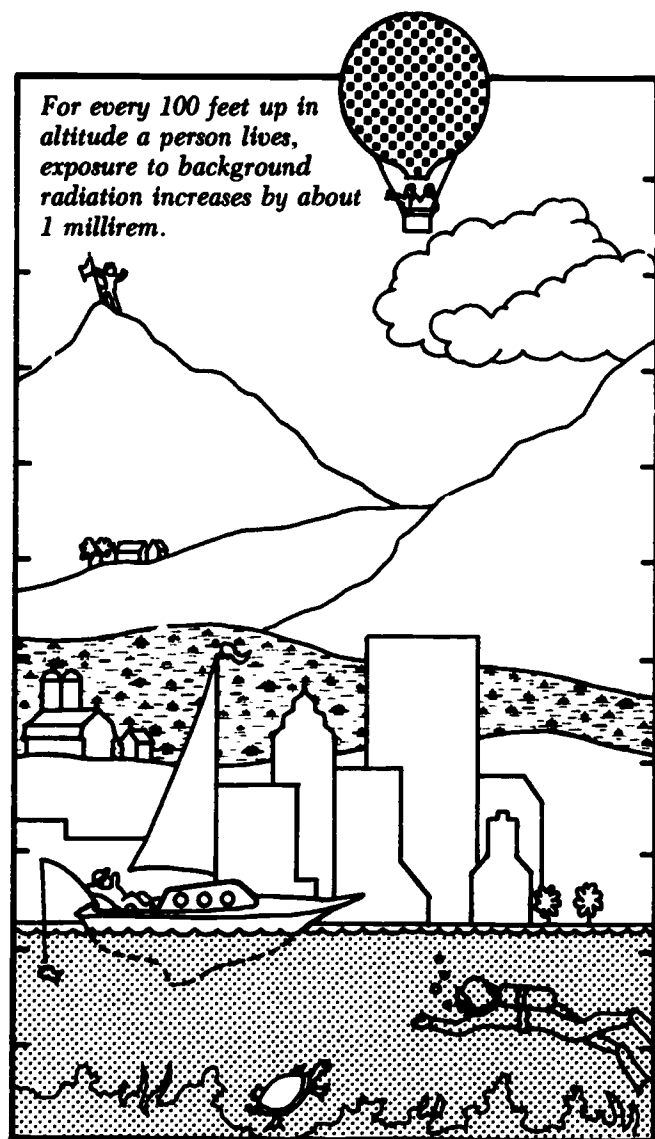

A person living in Kerala, India receives about 3,000 millirems of natural background radiation each year. In the United States the background level varies. Colorado has the highest average at 170 millirems a year. Florida has the lowest at 91 millirems per year. Of course, background radiation levels in rocks and soil vary because of geology and not because of state boundaries. Different kinds of rocks emit different amounts of radiation. For example, living near a granite rock formation can increase your background radiation level by as much as 100 millirems a year.

Many different building materials, such as bricks, wood, and stone also emit natural

background radiation. In fact, people living in brick homes are exposed to between 50 and 100 millirems a year, while people living in wooden homes receive between 30 and 50 millirems yearly. So our homes, schools, churches, factories, and businesses all are sources of natural background radiation too. The materials used to make buildings determine how much background radiation each building will give off.

Another large portion of natural background radiation comes from outer space in the form of *cosmic rays*. Many of these rays are screened out by the clouds and air that surround the Earth. So the amount of air and clouds between people and outer space helps to control the amount of background radiation people get from cosmic rays.

Generally, exposure increases by about 1 millirem a year for every 100 feet up in altitude a person lives. As a result, people who live at higher altitudes get more background radiation than people who live at lower altitudes. A ski instructor at a mountain resort will receive more background radiation than a fisherman at sea level. An airplane trip across America exposes a person to about 4 millirems of radiation because most airplanes fly at high altitudes.

Natural background radiation is also found in plants, animals, and people. After all, living things are also made of radioactive elements, such as carbon and potassium, which are a natural part of the Earth. Americans get about 25 millirems of radiation from the food and water that they eat and drink each year. This number varies depending on what is eaten, where it is grown, and how much is eaten. However, all foods contain some radioactive elements, and certain foods such as bananas and Brazil nuts contain higher proportions than most other foods.

Lesson 4

We get additional amounts of radiation from manmade sources. In the United States most manmade radiation comes from medical and dental sources, mainly x rays. We also receive radiation from building materials such as bricks, the nuclear industry, coal-fired powerplants, and aboveground testing of nuclear weapons done in the 1950s.

Americans average between 150 and 200 millirems of radiation from all sources each year. This is a small amount of radiation when you consider that radiation levels 250 times greater (50,000 millirems) have not produced any evident ill effects.

To figure out how many millirems of radiation the average person in your State

receives each year, add the average manmade radiation level (80 millirems) to the natural background radiation level of your State (shown in the map on page 32).

There are strict safety standards that govern how much radiation certain workers can receive in a year. These safety standards allow people who work with radiation in science, medicine, construction, and in nuclear powerplants to receive a little more radiation than the average person. Current standards allow people who work with radiation to get an average of 5,000 millirems annually. However, a person working as an x-ray technician or in a nuclear powerplant control room generally receives only 50 extra millirems in a year.

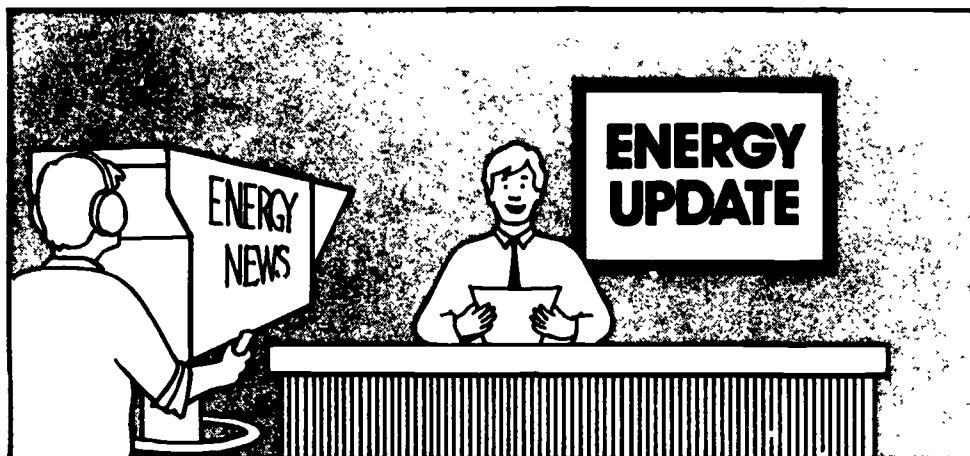

Background radiation update

Radiation surrounds us all in a form that we call background radiation. This type of radiation comes from materials on Earth and from outer space. Natural radiation has been with us since the beginning of time. Even our bodies are naturally radioactive. Man has also added sources of radiation, like x rays.

The average American receives between 150 and 200 millirems a year. There are places in India and Brazil where the natural background radiation is 3,000 millirems yearly.

LESSON 4 REVIEW EXERCISE

A. Fill in the blanks below.

1. Name three sources of natural background radiation.

2. Name three sources of manmade radiation.

B. Indicate whether each statement is true (T) or false (F) by circling the correct letter. If the statement is false, correct it to make it true.

1. Radiation exists in nature. T F
2. People who live at sea level are exposed to more background radiation than people who live at high altitudes. T F
3. Nuclear and coal-fired powerplants contribute to manmade background radiation. T F
4. A large source of background radiation is cosmic rays from outer space. T F
5. Most of the radiation the average American is exposed to comes from nuclear powerplants. T F
6. The human body is naturally radioactive. T F

C. Compute the average background radiation level for a person living in the States listed below.

Use the amounts given on the map on p. 32 and add 80 for manmade radiation.

Oregon _____

Oklahoma _____

Utah _____

Maryland _____

Vermont _____

Nevada _____

Iowa _____

The State you live in _____

Alabama _____

D. Explain how where you live affects the amount of exposure you receive from natural background radiation. _____

What are the uses of radiation?

Although scientists have only known about radiation since the 1890s, they have developed a wide variety of uses for this remarkable natural force. Today, to benefit mankind, radiation is used in science, medicine, and industry, as well as for generating electricity.

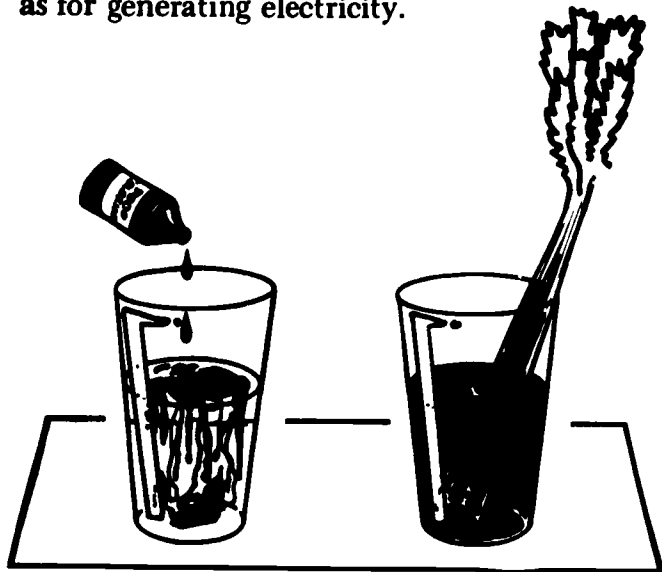

If you put food coloring in a glass of water, you make it easier to see the water. We could say you are *labeling* the water. If you then put a piece of celery in the glass of colored water and leave it overnight, you will be able to see how the celery takes up the colored water.

Scientists use *radioactive isotopes* in a similar way. They can label substances like *hormones*, foods, or drugs with small amounts of radioactive materials. Then, by using modern scientific instruments, scientists can see how people, animals, or plants use the labeled substances. The slight amount of added radioactivity does not change the way these materials behave. Instead, it provides a window that looks into the chemistry of life.

George de Hevesy was probably the first scientist to use a radioactive isotope to invisibly label a substance. While working as a scientist, de Hevesy ate his dinner at the boarding house where he lived. He thought his landlady saved the food he did not eat and served it again days later. To find out if this were true, the clever scientist placed a tiny bit of radioactive isotope on the remains of a meal. Several days later, he used an instrument called an *electroscope* to detect the radioactivity and proved that he was being served leftovers!

Of course, the electroscope de Hevesy used is quite crude by today's standards. Modern detection equipment can identify various types of radiation in extremely tiny amounts.

George de Hevesy used radioactive materials to prove he was being served leftovers.



De Hevesy suspected that he was being served leftovers.

He placed a small amount of radioactive isotope in his dinner.

Several days later he detected that the radioisotopes were in his food and proved he was being served leftovers.

How is radiation used in medicine?

X rays are a type of radiation that can pass through our skin. However, our bones are denser than our skin, so when x-rayed, bones and other dense materials cast shadows that can be detected on photographic film. The effect is similar to placing a pencil behind a piece of paper and holding them in front of a light. The shadow of the pencil is revealed because most light has enough energy to pass through the paper, while the denser pencil stops all the light. The difference is that we need film to see the x rays for us.

Doctors and dentists use x rays to see inside our bodies. This allows them to spot broken bones and tooth problems. X-ray machines have now been teamed with computers to make machines called *CAT scanners*, which can provide doctors with color TV pictures that show the shape of internal organs. Doctors can also give people slightly radioactive substances that are attracted to certain internal organs such as the pancreas, kidney, thyroid, liver, or brain. After one of these organs has been labeled with a radioactive isotope, a machine called a *scintillation* (sint-l-AA-shən) *counter* can be used to measure the radiation and provide an image of some of the many chemical reactions

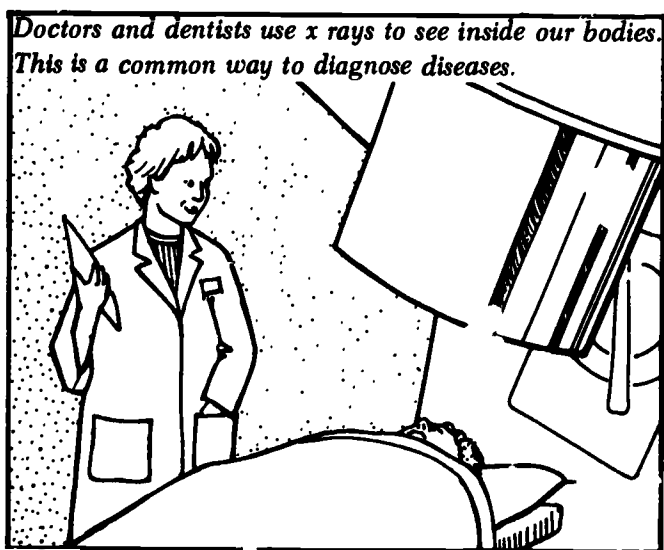

taking place within a specific organ. Medical machines like the ones mentioned above have changed the way doctors diagnose diseases and hold even greater promise for the future.

Doctors have also learned that radiation is more likely to kill cancerous cells than normal cells. As a result, radiation is often used to treat certain types of cancer.

How is radiation used in science?

Radiation is used in science in a surprising number of ways. Just as doctors can label substances inside people's bodies, scientists can label substances that pass through plants, animals, or our world. This allows us to study such things as the paths that different types of air and water pollution take through the environment. It has helped us learn more about a wide variety of things, such as what types of soil different plants need in order to grow, the size of newly discovered oil fields, and the track of ocean currents.

Scientists also use radioactive substances to find the age of ancient objects. In the upper reaches of our atmosphere, cosmic rays hit atoms of nitrogen and form a naturally radioactive isotope called carbon-14. Carbon is found in all living things, and a small percent of this carbon is carbon-14. When a plant or animal dies, it no longer takes in new carbon and the carbon-14 it contains begins the process of radioactive decay. However, new isotopes of carbon-14 continue to be formed in our atmosphere, and after a few years the percent of radioactivity in an old object is less than it is in a newer one. By measuring this difference scientists are able to determine how old certain objects are. This process is called *carbon dating*.

Recently, we have learned to study the decay chains of elements such as uranium,

rubidium (ru-BID-ee-əm), and potassium in order to date much older objects such as mountain ranges and moon rocks. Scientists also monitor the cosmic radiation that comes to Earth in order to learn more about how the universe was formed and what it is like in the depths of outer space.

How is radiation used to solve crimes?

You already know that detectives often search the scene of a crime for traces of paint, glass, hair, gunpowder, or even blood. But you may not know that after such evidence is collected, it is often exposed to radiation and then analyzed to find out its exact makeup. Radiation can activate some of the elements in most materials by adding neutrons to their nuclei. This makes certain elements in the sample slightly radioactive. Scientists are then able to read the exact chemical signatures of these substances. This is called *activation analysis*, and it is precise enough to tell if a single hair found at the scene of a crime came from a certain person. Activation analysis is also used to find out the chemical makeup of materials when scientists only have small samples, as well as to prove that older works of art are not made of modern materials.

How is radiation used in industry?

Radiation can kill germs without harming the items that are being disinfected and without making them radioactive. When treated with radiation, foods take much longer to spoil, and medical equipment such as bandages, hypodermic syringes, and surgical instruments don't have to be exposed to toxic chemicals or extreme heat. Although today we use chlorine, which is toxic and difficult to handle, in the future we may use radiation to disinfect our drinking water and even kill all the germs in our sewage.

Our agricultural industry makes use of radiation to improve food production. Plant seeds have been exposed to radiation in order to bring about new and better types of plants. Many of our modern, fast-growing, and disease-resistant farm plants came from seeds that scientists changed with radiation. Beyond making stronger plants, radiation can also be used to help control insects. Thousands of male insects can be raised in a lab, treated with radiation, and then set free to mate in an area where that species of insects is a problem. Because the radiation makes them unable to produce offspring, the insect population shrinks. This use of radiation to control harmful insects decreases the use of pesticides, which also kill helpful insects.

Decreasing the use of pesticides saves helpful insects.



Many modern machines rely on radioactive materials to help control the thickness of plastics, paper, foil, paint, and many coatings such as the glue on tape or the print on paper. Engineers use a source of radioactive material that gives off a standard amount of radiation. Then they measure the amount of radiation that is stopped by the proper thickness of the material they are producing. If more radiation is measured, the machine detects that the material is becoming too thin. If less radiation is measured, the machine detects that the material is becoming too thick. In this way materials can be monitored without being touched. A similar system can be used to fill cartons and boxes. When a carton is filled to the proper level, more shielding is placed between the radioactive source and the sensor. When this happens, the sensor signals the machine to stop filling.

In addition, radiation in the form of x rays may be used to check the quality of many things we build. This is called *radiography* (ray-jee-OG-rə-fee), and it helps us to find invisible defects within many types of metals and machines. Radiography can also be used to check such things as the flow of oil in sealed engines, the blending of different types of metals, or the rate and way various materials wear out.

Radioactive materials provide fuel to make electricity for our cities, farms, and towns. Today, more than 80 nuclear powerplants supply about 13 percent of our electricity. Beyond this, because only small amounts of radioactive substances are needed to produce a lot of energy, they are used in pacemakers as well as for lights on remote airplane runways and ocean buoys. Radioactive materials are also used in our space program to provide power to space crafts traveling beyond our solar system. Such materials were also used during our missions to the moon.



Radioactive materials were used during our missions to the moon to provide backup electricity.

We are finding more uses for radioactive materials all the time. They take us back to ancient civilizations and into the depths of outer space, and they improve the quality of our lives with better medical techniques, energy sources for producing electricity, and many powerful tools for science and industry.

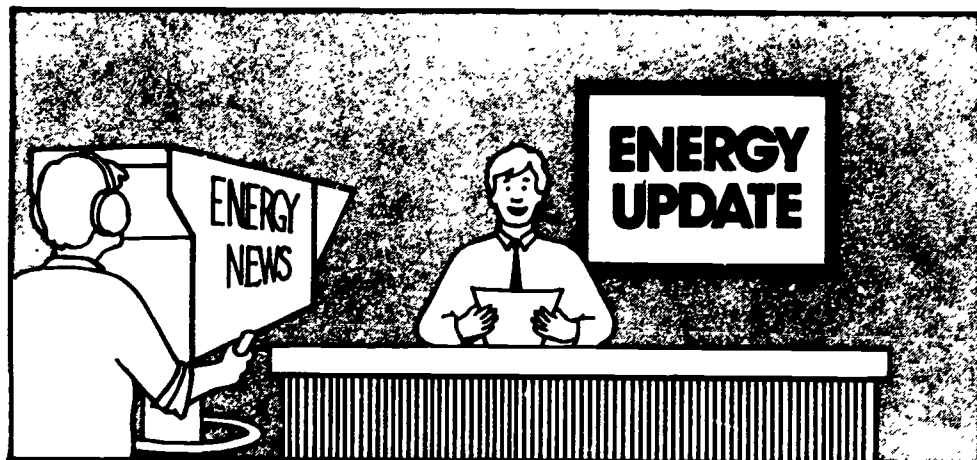

Uses of radiation update

Radioactive materials have many different uses. They are used in medicine, scientific research, industry, and to help generate electricity.

Doctors have learned many different ways to use radioactive materials in the treatment and diagnosis of many diseases, including cancer.

We also use radiation to label things. When substances are labeled with radioactive elements, we can trace the path these substances take through living plants or animals.

Industry uses radiography to check the quality of many different products. In addition, radioactive elements are used in thickness gauges, for analyzing evidence from the scene of a crime, for preserving foods, for dating art and antiques, and for generating electricity.

LESSON 5 REVIEW EXERCISE

A. Select the term that best fits the blank space.

1. Our bones are _____ than our skin.
2. Doctors and dentists use _____ to see inside our bodies.
3. We can use radioactive materials to _____ different substances and then see where they go in our bodies or our environment.
4. We use radioactive materials to help us generate _____.
5. _____ helps us find invisible defects in metal objects.
6. Carbon _____ helps us find the age of artifacts.
7. Devices called _____ help people's hearts keep beating.

B. Indicate whether each statement is true (T) or false (F) by circling the correct letter. If the statement is false, correct it to make it true.

1. Dentists use x rays to polish people's teeth. T F
2. More than 80 nuclear powerplants are currently operating in America. T F
3. Activation analysis helps police solve crimes. T F
4. George de Hevesy discovered celery in his leftovers. T F
5. Radiation can be used to determine the correct volume to fill cartons and boxes. T F

C. List four uses for x rays.

1. _____
2. _____
3. _____
4. _____

D. Tell how the following segments of our society use radioactive materials.

construction _____

archaeology _____

agriculture _____

medicine _____

electric utilities _____

Which of these uses occur in your community? _____

List any additional uses of radioactive materials in your community.

What is fission?

After scientists found out about atoms and isotopes, they were able to build machines that cause atoms to split in a process called *fission* (FISH-ən). The fission process releases energy.

When a neutron strikes the nucleus of a heavy and unstable isotope such as uranium-235, it can cause the nucleus to split apart. All this takes about a millionth of a second.

When the atom of uranium-235 splits apart, many things happen. We end up with two lighter-weight atoms of new elements, which are called *fission products*. Two or three neutrons are released. And most importantly, energy is released, mainly as heat.

What is a chain reaction?

Considering the size of an atom, splitting it apart releases a lot of energy. But splitting one single atom does not produce enough heat to be really useful. We need to fission millions of atoms to get enough heat to do work.

How can we do that? The answer lies in the two or three neutrons that fly off when the first atom splits. If these neutrons hit other uranium-235 atoms, these atoms may also fis-

sion, each releasing heat and two or three more neutrons. Within seconds, millions of atoms can be fissioning, and with millions of atoms, we can get a lot of heat. This sequence of events--or chain of events--is called a *nuclear chain reaction*.

Keeping a chain reaction going is actually very difficult. This is because many of the neutrons that fly away from each fission will not hit another uranium atom's nucleus. If more are wasted than are produced by new fissions, the chain reaction will slow down and eventually stop.

The usable heat we get from a chain reaction comes mainly from the fission process. A small amount of heat is also produced as the neutrons and fission products bounce off neighboring atoms, producing heat by friction.

At a nuclear powerplant, uranium-235 is used as fuel. The heat produced by the fissioning of many millions of uranium-235 atoms is used to heat water, which produces steam. This steam turns turbines to generate electricity. The major difference between a nuclear powerplant and one that burns coal or oil is the way the heat to make steam is produced.

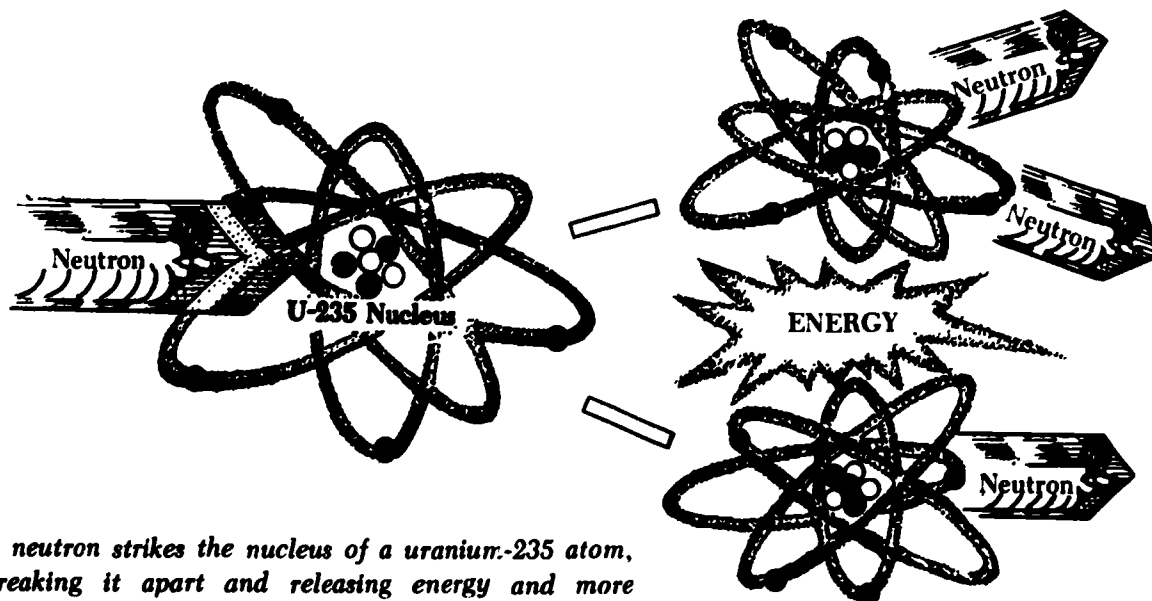

A neutron strikes the nucleus of a uranium-235 atom, breaking it apart and releasing energy and more neutrons.

What is fusion?

In addition to fissioning, or splitting the atom, modern scientists are learning how to bring about another type of nuclear reaction called *fusion* (FYOO-zhən).

Fusion occurs when light isotopes of the element hydrogen join together (or fuse) to create a new atom and release a large amount of energy.

The isotopes of hydrogen to be used in fusion are called *deuterium* (dyu-TIR-ee-əm) and *tritium* (TRIT-ee-əm). They are driven together with tremendous force at incredibly high temperatures, producing an atom of the element helium, a neutron, and a lot of energy.

The energy of the Sun and stars is produced through fusion. Scientists are trying to build machines that can imitate the Sun to produce heat for powerplants. However, on the Sun,

gravity holds atoms together so they can fuse. On Earth, scientists are trying to use magnetic fields to confine hydrogen isotopes for fusion.

Atoms can be forced together more easily at very high temperatures. The greatest challenge in producing fusion energy is to heat the hydrogen fuel to 100 million degrees Celsius (212 million degrees Fahrenheit) and confine it long enough for fusion to occur. Such temperatures are over six times hotter than the surface of the Sun.

At high temperatures, hydrogen fuel becomes a *plasma* (PLAZ-mə). Plasma is similar to a gas, yet it differs slightly because electricity alters it and magnetism molds it.

Imagine how difficult it is to hold a plasma heated to 100 million degrees Celsius (212 million degrees Fahrenheit). One method being

Deuterium and tritium are joined,

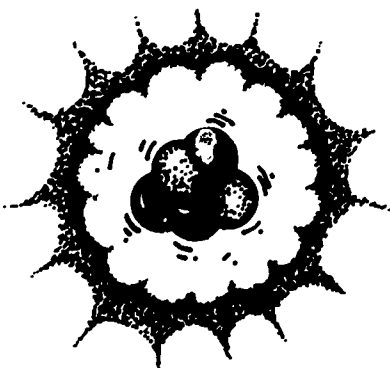
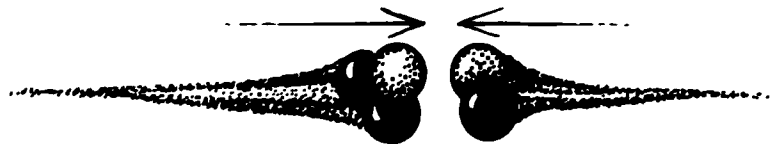

forming an unstable nucleus, and

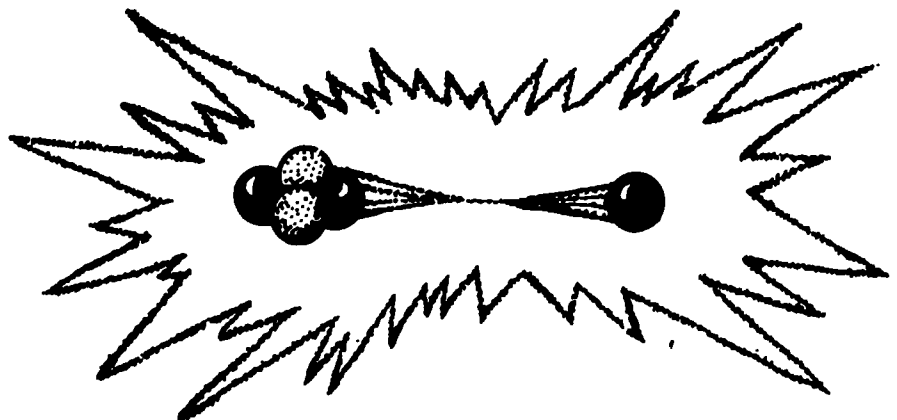

producing an atom of helium, a neutron, and a lot of energy.

developed would use incredibly strong magnetic fields to keep the hot plasma away from container walls. In one type of fusion experiment, magnetic fields spin the plasma in a donut shape. Magnetic coils "squeeze" the plasma until atoms are forced together.

Fuel used for fusion is abundant and can be taken from sea water. One gallon of sea water contains enough hydrogen isotopes for fusion to

equal the energy which would be released by burning 300 gallons of gasoline. It is expected that fusion could begin to contribute abundant, economical energy to our country in the 21st century, if research presently underway is successful. So far, scientists have been able to maintain a controlled, continuous fusion reaction for only fractions of a second.

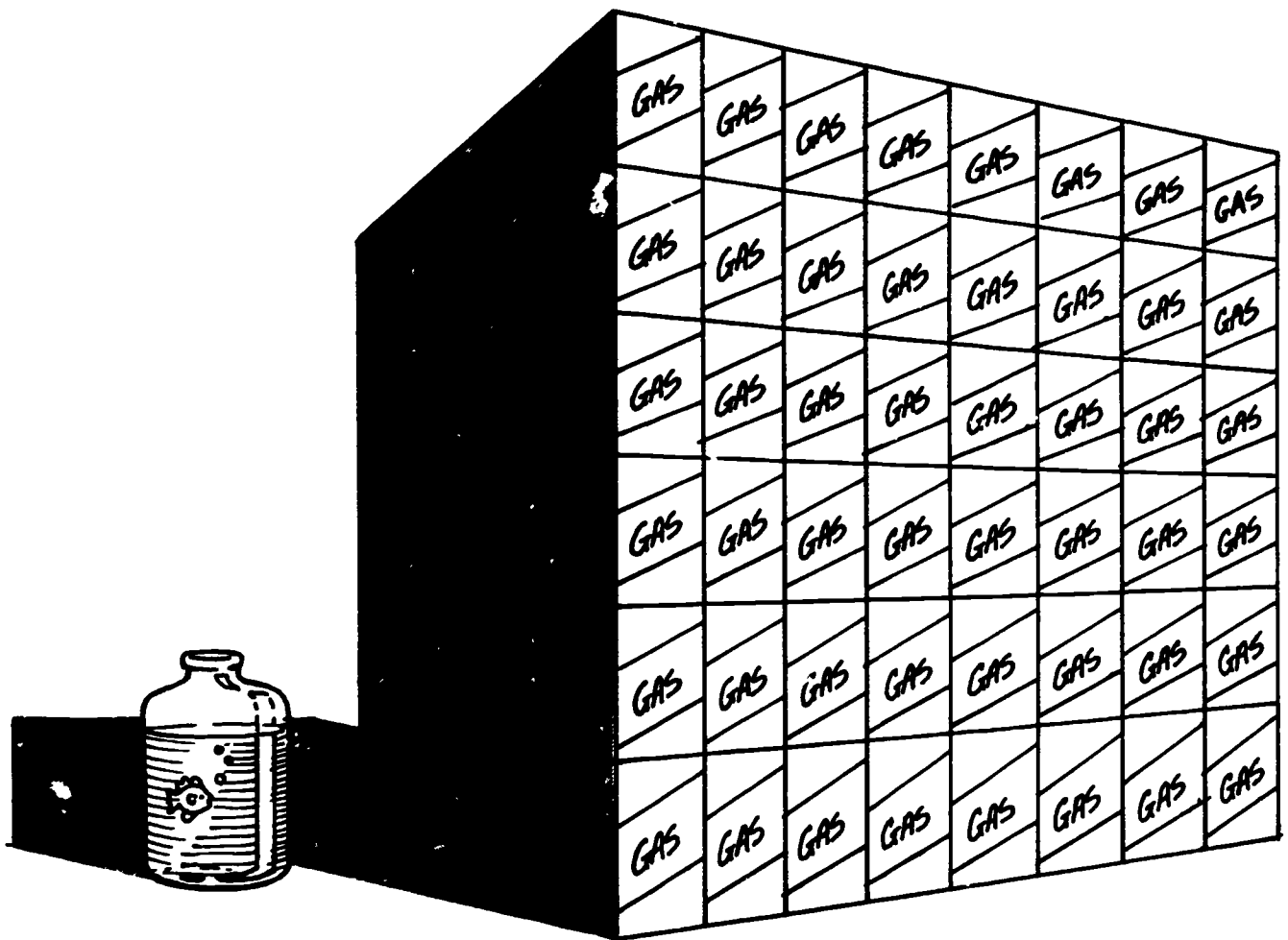

1 = 300

If used in fusion, one gallon of sea water contains enough hydrogen isotopes to equal the energy that would be released by burning 300 gallons of gasoline.

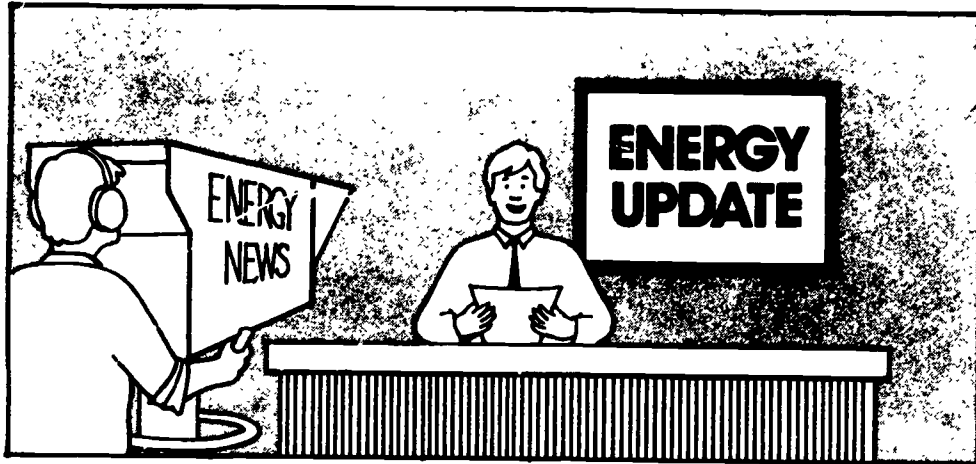

Fission and fusion update

Energy is released when the nucleus of an atom is split apart in a reaction called nuclear fission. Scientists are able to make uranium atoms fission. This process releases energy as heat, fission products, and neutrons.

When neutrons cause additional uranium atoms to fission, there is a chain reaction. The heat from fission chain reactions is used at nuclear powerplants to make steam, which turns turbines to generate electricity.

Scientists and engineers hope to be able to produce heat to generate electricity in the future by forcing atoms of hydrogen isotopes to fuse, or join together, in a reaction called nuclear fusion.

LESSON 6 REVIEW EXERCISE

A. Select the term that best fits the definition given.

- _____ 1. nuclear reaction in which an atom is split apart
- _____ 2. sequence of atoms fissioning and releasing neutrons that cause additional atoms to fission
- _____ 3. particle of an atom that flies off when a uranium atom is split
- _____ 4. type of atoms split apart in nuclear powerplant to produce heat
- _____ 5. nuclear reaction in which two atoms are joined together

B. Indicate whether each statement is true (T) or false (F) by circling the correct letter. If the statement is false, correct it to make it true.

1. Fission occurs when the nuclei of certain atoms are hit by neutrons. T F
2. When fission occurs, energy is released as heat. T F
3. A nuclear chain reaction occurs when electrons from fissioning atoms hit other atoms. T F
4. In a nuclear reaction, the atom is changed. T F
5. Fusion takes place under conditions of extreme cold. T F
6. In a nuclear powerplant, fission is used to heat water to make steam. T F

C. Circle the letter of the best answer for each item.

1. In today's nuclear powerplants, the fuel used is _____.
- a. helium c. uranium
b. proton d. tritium
2. Nuclear fusion uses _____ for fuel.
- a. petroleum c. oxygen
b. hydrogen isotopes d. uranium
3. A uranium-235 atom splits when a(n) _____ hits its nucleus.
- a. atom c. electron
b. proton d. neutron

(Continued on next page) 49

D. Label the following reactions as chemical or nuclear. Remember that in chemical reactions, atoms of various elements combine with one another to form molecules. In nuclear reactions, the atoms themselves change, often forming new elements.

- _____ 1. An atom of sodium combines with an atom of chlorine to form a molecule of table salt.
- _____ 2. A neutron is added to the nucleus of a uranium-235 atom, causing it to become unstable and split apart.
- _____ 3. An atom of sulfur combines with two atoms of oxygen, forming a molecule of sulfur dioxide.
- _____ 4. An atom of oxygen combines with two atoms of hydrogen to form a molecule of water.
- _____ 5. Deuterium and tritium atoms are forced together, releasing energy, an atom of the element helium, and a neutron.

Nuclear Energy & Electricity

The Harnessed

ATOM

Unit 3
The Franklin
Nuclear Powerplant

Introduction

Our country depends on an abundant, affordable supply of energy to power the many machines we use in our complex society. About one third of our energy resources are used to produce electricity.

Electricity can be produced, or generated, in different ways. One way is by using *nuclear fission* (NYOO-klee-ər FISH-ən). In fact, 13 percent of America's electricity comes from nuclear powerplants. In some areas of the country, the percentage is even higher. For instance, in Vermont 73 percent of the electricity comes from nuclear energy. Other states also get a significant percentage of their electricity from nuclear power.

Even in states where there are no nuclear powerplants, some electricity may come from nuclear energy. In fact, 89 percent of the people in the United States get at least some of their electricity from nuclear powerplants. This is because a *utility* sometimes buys electricity from utilities in neighboring states. This might happen during a heat wave or when a utility shuts down a powerplant for service.

A nuclear powerplant is very complex. It is somewhat like a small city. It has many different buildings, each of which has a specific function. In order to help you understand how a nuclear-powered electricity-generating plant works, you will read about a typical, but fictitious, plant named the Franklin Nuclear Powerplant, located in Franklin County, in the state of Franklin.

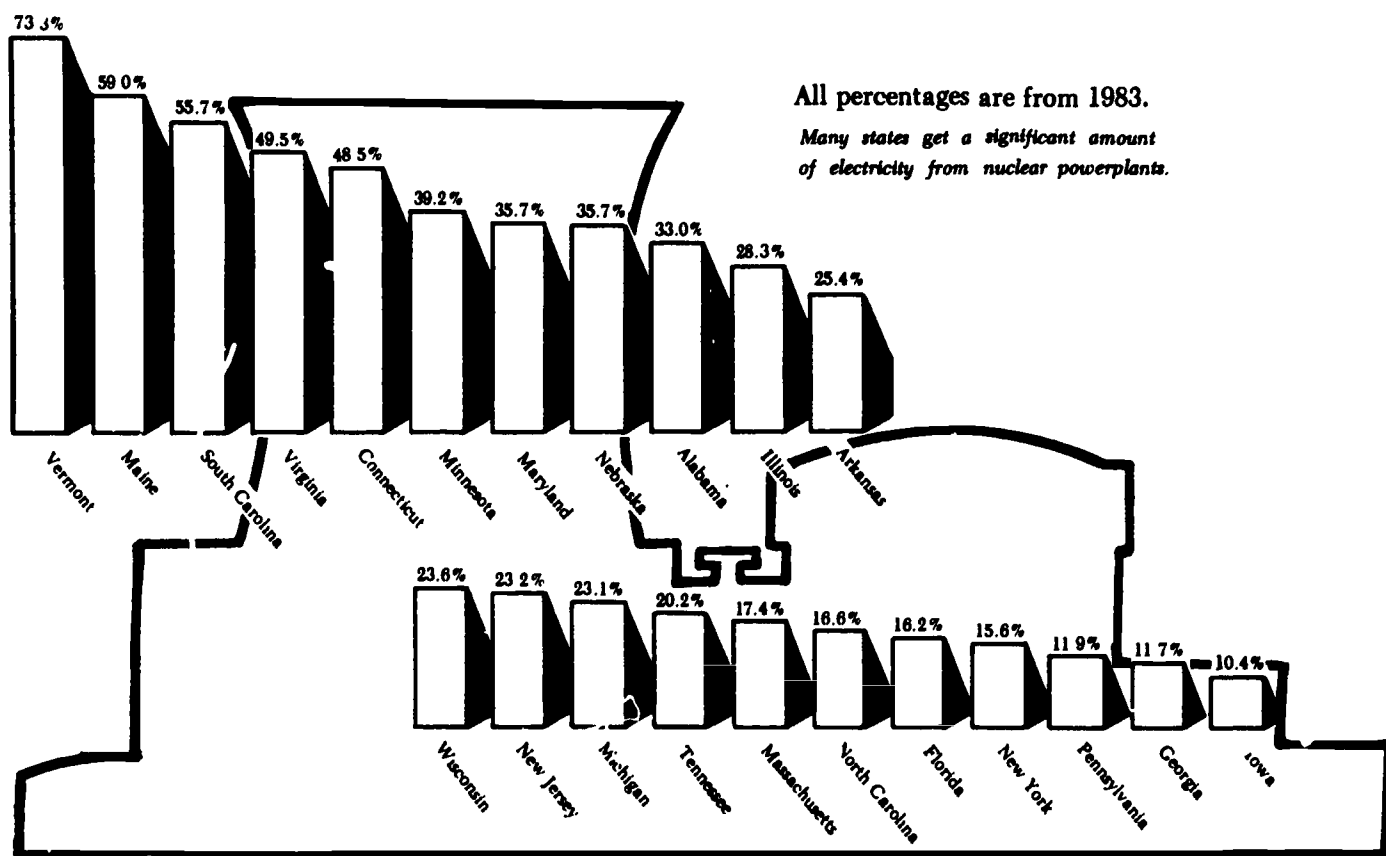



Why build the powerplant?

In the 1970s Franklin County needed more electricity because the area was growing. Industries and businesses were thriving, and people were moving into the area. The future looked promising, but with it came the possibility of electricity shortages.

The utility that served the area, Franklin Utility, conducted careful studies that indicated more electricity would be needed in the future. Their estimates showed that by the turn of the century, half of all the energy used would be in the form of electricity. They decided to build a new powerplant.

The utility had to make a choice about what kind of powerplant to build. They considered using oil, coal, gas, and *uranium* (yu-RAY-nee-əm) as energy sources. In making the decision, the major considerations were safety, the costs of construction and operation, the availability and cost of fuel, and *environmental* (en-VII-rən-mən-tl) effects. After careful consideration, Franklin Utility decided to build a nuclear powerplant.

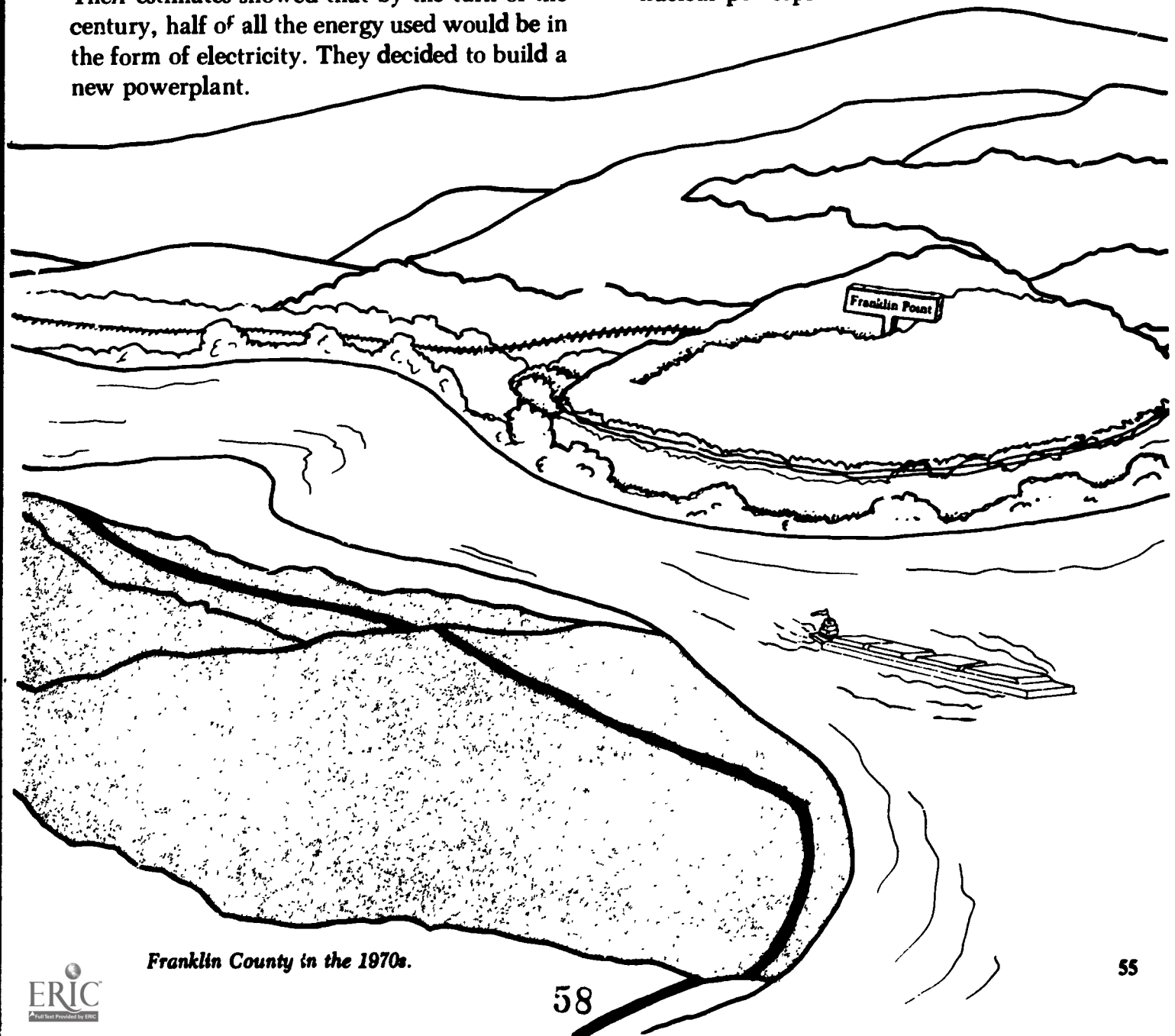

Franklin County in the 1970s.

What steps were required before the powerplant was built?

To maintain high safety standards, all nuclear powerplants in the United States must have *licenses*. Therefore, before Franklin Utility began building the Franklin Nuclear Powerplant, it went through a long and complex licensing procedure that took several years. The first step in this process involved getting a *construction permit* before building could begin.

The part of the U.S. Government responsible for licensing nuclear powerplants is the Nuclear Regulatory Commission, called the NRC for short. To assure the health and safety of the public, the NRC also must approve the design and oversee the construction and operation of all nuclear powerplants built in the United States.

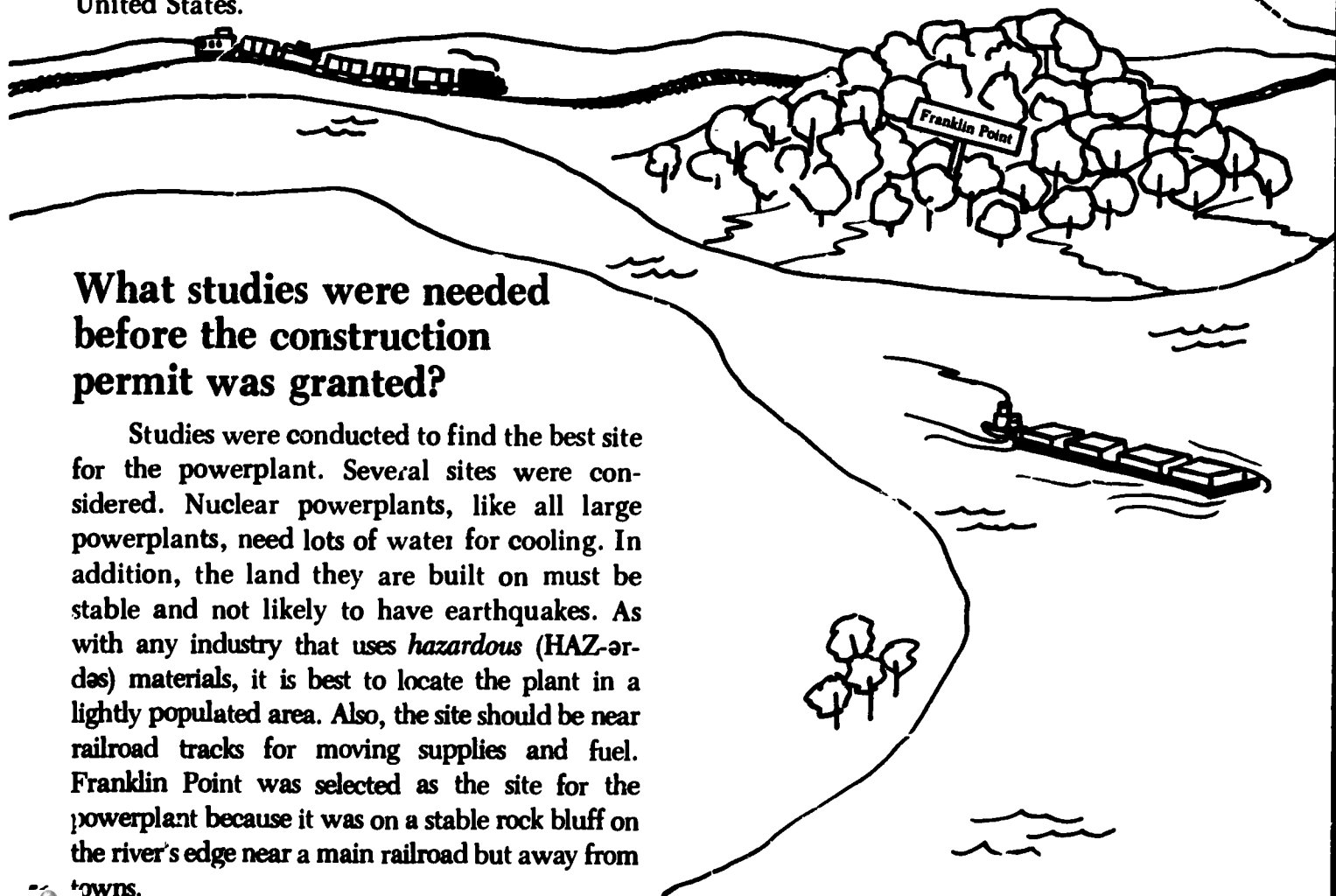

What studies were needed before the construction permit was granted?

Studies were conducted to find the best site for the powerplant. Several sites were considered. Nuclear powerplants, like all large powerplants, need lots of water for cooling. In addition, the land they are built on must be stable and not likely to have earthquakes. As with any industry that uses *hazardous* (HAZ-ər-dəs) materials, it is best to locate the plant in a lightly populated area. Also, the site should be near railroad tracks for moving supplies and fuel. Franklin Point was selected as the site for the powerplant because it was on a stable rock bluff on the river's edge near a main railroad but away from

towns.

The location and characteristics of the land were not the only things considered. During one study, scientists dug up the ground searching for historical objects. They found no evidence that American Indians or early settlers had ever lived there. Nevertheless, it is always important to check any possible site to make sure that valuable historical objects are not lost when a powerplant is built.

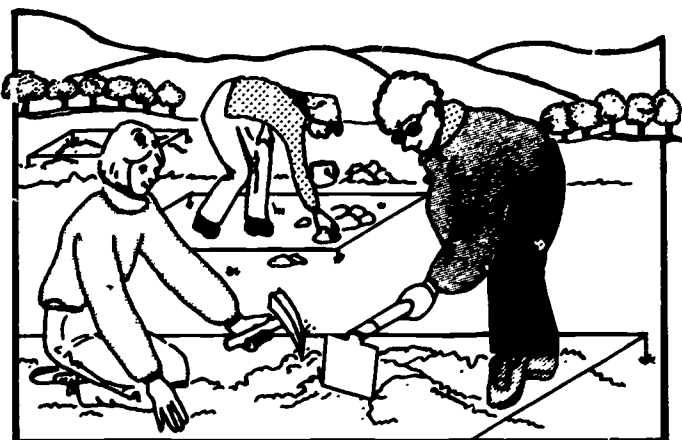

Scientists study each powerplant site to make sure no valuable historical objects will be lost.

Another study was conducted to predict how building and operating the Franklin Powerplant would affect the local *economy* (i-KON-ə-mee). It was estimated that during construction, the project would employ about 4,000 people. Afterwards, 450 people would continue to work at the plant. Some of their earnings would go toward taxes. Money would also be spent on food, clothing, homes, automobiles, and other necessities. This, in turn, would create other jobs and strengthen the local economy.

But an increase of people can create problems. The Franklin area would need more homes, schools, teachers, firemen, policemen, and services such as sewer, water, and garbage collection. In addition, the small roads around Franklin Point would get more traffic and would have to be improved.

The possible effects on the environment were also considered. Scientists needed to determine whether the heated water that the Franklin Plant would discharge into the river would harm local plant life or animals, especially fish. Many things were studied, including river currents, natural changes in water temperature, and the range of water temperatures in which local plants and animals could survive. Scientists found the actual construction of the powerplant would cause short-term minor disturbances of the environment. During construction, dust could *pollute* the air. There would also be permanent changes at the site. Trees would be cut down and some animals would lose their homes. These changes would meet the standards set by all the government environmental agencies involved, and after the plant was built, some animals would be able to live there again.



More people would mean more traffic.

How did Franklin get its construction permit?

While the studies were underway, a design for the powerplant was selected by the utility. Scientists, *economists*, and *engineers* finished their studies and developed detailed plans for the plant. Afterwards, they wrote several reports. These reports were about the safety of the plant's design, as well as the effects the powerplant could have on the environment and the local economy. The reports were long and detailed. They were sent to the NRC, along with the utility's request to build a nuclear powerplant, and were also made available locally at community gathering places such as public libraries.

Finally, many days of public meetings, called *hearings*, were held before the NRC could grant Franklin a construction permit. During these hearings, *physicists*, nuclear engineers, *environmentalists*, and economists, as well as concerned local people and representatives of many citizens' groups, came and testified. Many different people shared their thoughts and feelings about building a nuclear powerplant in Franklin County.

There was a lot of controversy because people disagreed about the powerplant. Some of the speakers wanted the plant to be built. Others were opposed to it. People expressed concern over the effect the plant might have on the river, the local environment, and the health of the public. Others felt that the plant would provide electricity and that the results would be a growing economy and more jobs. Still others were concerned about how much the electricity from the plant would cost. Some were concerned about what kind of plant would be built if Franklin Utility decided not to build a nuclear powerplant. Some were concerned about possible *pollution* problems that would result from building other types of powerplants or that electricity from a different energy source would cost more.

After the hearings were over, the NRC studied the reports and all the testimony for many months. On the basis of all this information, NRC specialists decided to grant Franklin Utility a construction permit. Then and only then, construction started.



"Nuclear powerplants provide a safe way of making electricity."

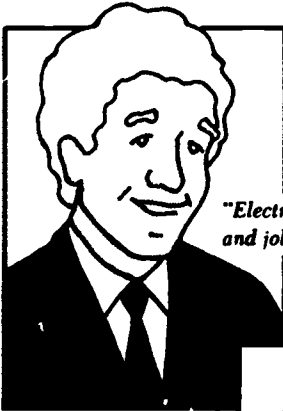

"Electricity equals jobs, and jobs equal prosperity for Franklin County."



"We have to learn to conserve our resources instead of always building new powerplants."

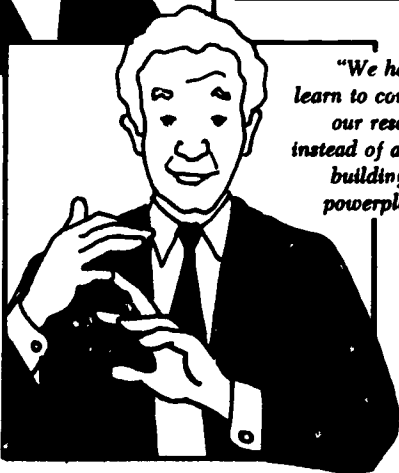

"If the powerplant doesn't hurt the fish, I don't care if they build it or not."

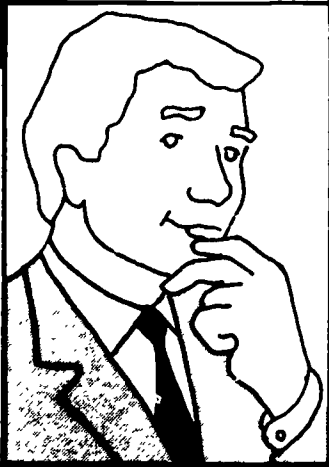

"I'm worried about radiation and what it could do to my family."

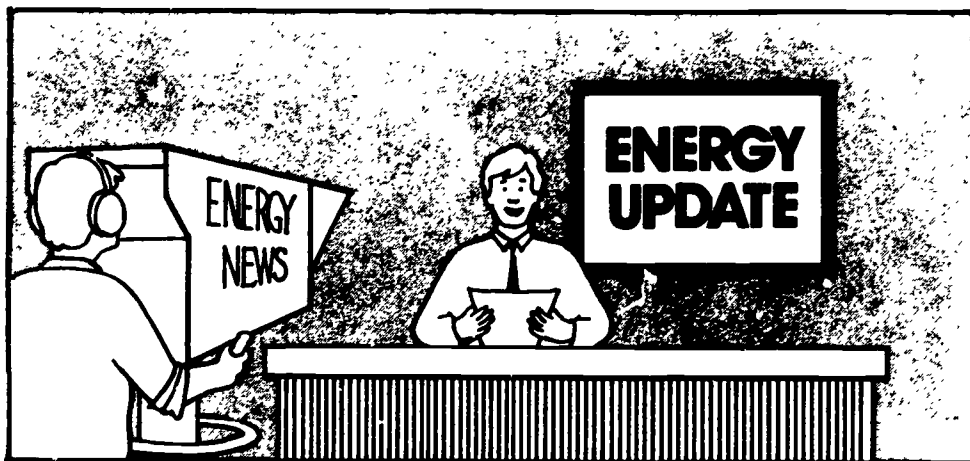

Planning Franklin update

Franklin Utility decided that the increasing demand for electricity meant that they would have to build a new plant in the 1970s. To meet the need for electricity, Franklin Utility decided to build a nuclear powerplant. But before they could start building, they had to do economic, historic, engineering, and environmental studies.

When the studies were complete, the scientists and engineers who had done the studies published their findings, and the utility sent them to the Nuclear Regulatory Commission with an application for a construction permit. Before the permit could be granted, public hearings were held.

A great deal of information was presented at Franklin's public hearings. People had many different opinions about building a nuclear powerplant. Following the hearings, the NRC studied all the information carefully, granted a construction permit, and construction started.

LESSON 1 REVIEW EXERCISE

A. Indicate whether each statement is true (T) or false (F) by circling the correct letter. If the statement is false, correct it to make it true.

1. About one-third of our energy resources are used to produce electricity. T F
2. Nuclear powerplants supply 13 percent of the electricity we use in the United States. T F
3. Some of the electricity used in States where no nuclear powerplants are located may still come from nuclear powerplants. T F
4. Sometimes a utility may need to buy electricity from a neighboring utility in order to supply all the electricity its customers want. T F
5. A construction permit to build a nuclear powerplant is issued by the State where it is located. T F
6. The part of the U.S. Government that is responsible for licensing nuclear powerplants is the Department of Energy. T F
7. It is important to check the powerplant site for historic objects before construction begins. T F
8. There are strict requirements that regulate the effects that building a nuclear powerplant may have on the environment. T F
9. At public meetings, local people may testify about building a nuclear powerplant. T F
10. A utility may build a nuclear powerplant without a construction permit. T F

B. Number the events in the order in which they occur.

- _____ Utility decides to build a nuclear powerplant.
- _____ Construction begins.
- _____ Utility selects preferred site for powerplant.
- _____ Public hearings are held.
- _____ NRC issues construction permit.

Introduction

A powerplant consists of many separate buildings, each of which has a special purpose. The systems in these buildings work together to produce electricity for people.

Most powerplants produce electricity by first boiling water to produce steam. The main difference between a nuclear powerplant and other kinds of powerplants is that at a nuclear powerplant, the heat used to make the steam is produced by fissioning atoms.

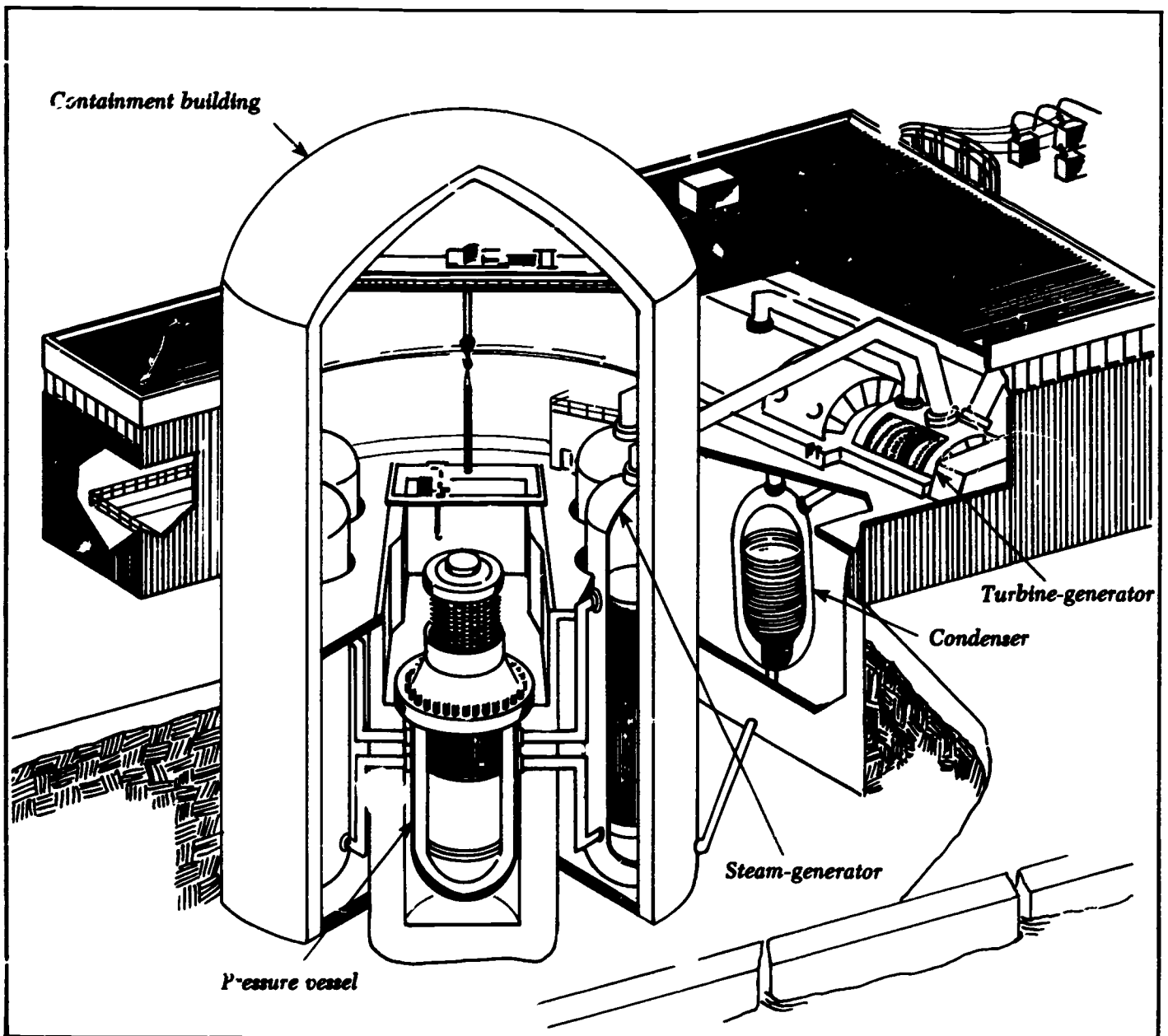

The major parts of a nuclear powerplant work together to produce electricity.

Lesson 2

Where does fission take place?

At a nuclear powerplant, fission takes place in the *reactor*, which is the heart of the powerplant. The reactor is basically a machine that heats water.

Franklin's reactor has four main parts: 1) the uranium *fuel assemblies*, 2) the *control*

rods, 3) the *coolant/moderator* (KOO-lənt/MOD-ə-RAA-tər), and 4) the *pressure vessel*. The fuel assemblies, control rods, and coolant/moderator make up the reactor's core. The core is surrounded by the pressure vessel.

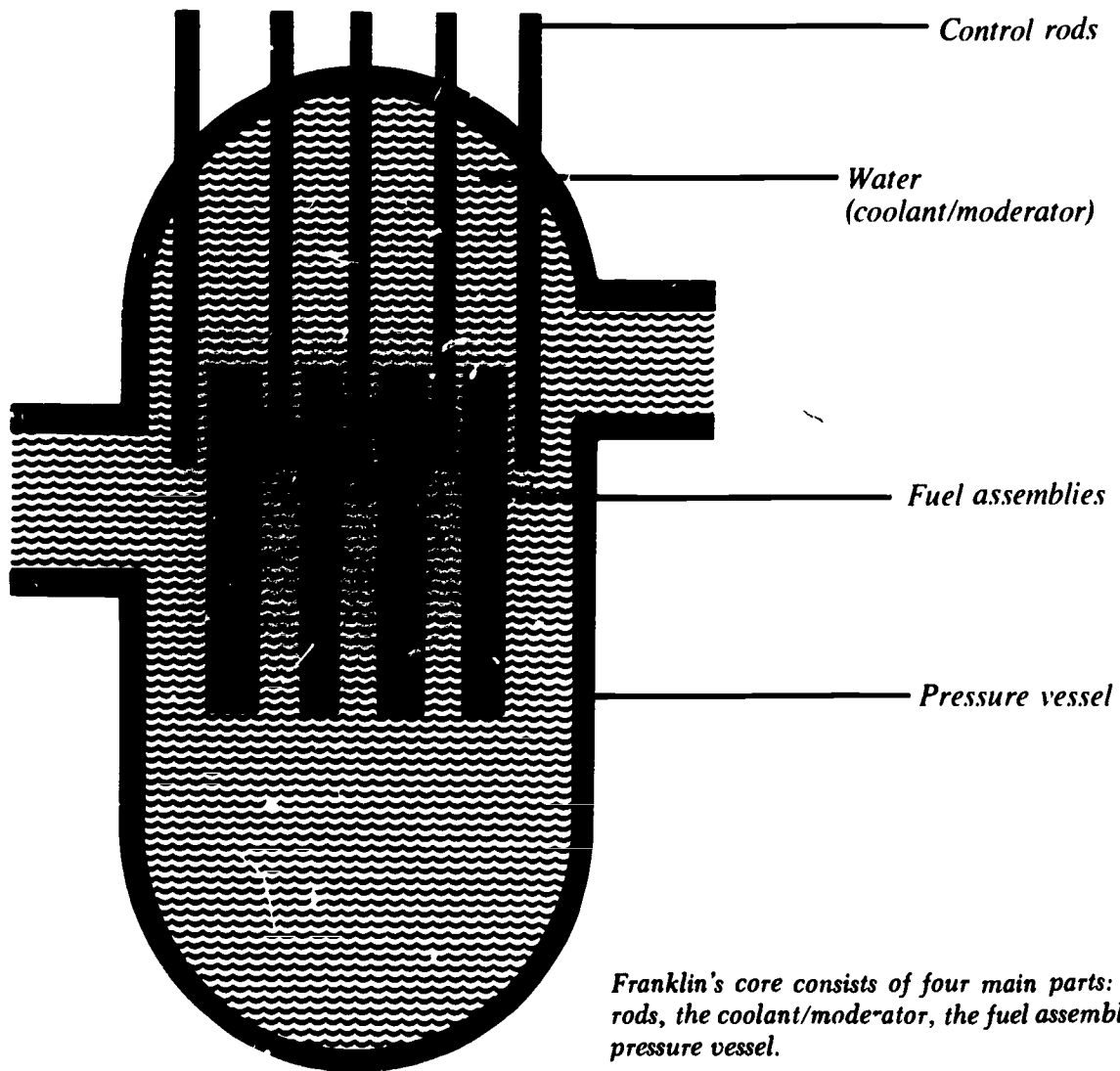

What are fuel assemblies?

Uranium is the fuel of the nuclear powerplant. But we cannot just throw uranium into the reactor the way we can shovel coal into a furnace. Uranium must be processed and formed into *fuel pellets*, which are about the size of your fingertip. Fuel pellets are then stacked in hollow metal tubes called *fuel rods*, which keep the pellets in the proper position.

Each of the Franklin Powerplant's fuel rod contains about 200 fuel pellets and is 20 feet long. However, a single fuel rod cannot generate the heat needed to make the amount of electricity used in the Franklin area. So fuel rods are carefully bound together in fuel assemblies, each of which contains about 240 rods. The assemblies hold the fuel rods apart so that when they are submerged in the reactor core, water can flow between them.

The fuel assemblies contain the uranium that the Franklin Powerplant uses as fuel. Franklin's reactor core holds 157 fuel assemblies. Before it is used in the reactor, the uranium fuel is not very radioactive.

What are control rods?

When a uranium-235 atom splits, it releases energy and two or more *neutrons* from its *nucleus* (NYOO-klee-əss). These neutrons can then hit the *nuclei* of other uranium atoms and cause them to fission. These neutrons keep a *chain reaction* going.

The control rods, another important part of the reactor, slide up and down in between the fuel rods or fuel assemblies in the reactor core. Control rods regulate or control the speed of the nuclear reaction. These rods contain material such as *cadmium* (KAD-mee-əm), and *boron* (BOR-on). Because of their atomic structure, cadmium and boron absorb

neutrons, but do not fission. The control rods work like sponges that absorb extra neutrons. When the control rods absorb neutrons that could otherwise hit uranium atoms and cause them to split, the chain reaction slows down.

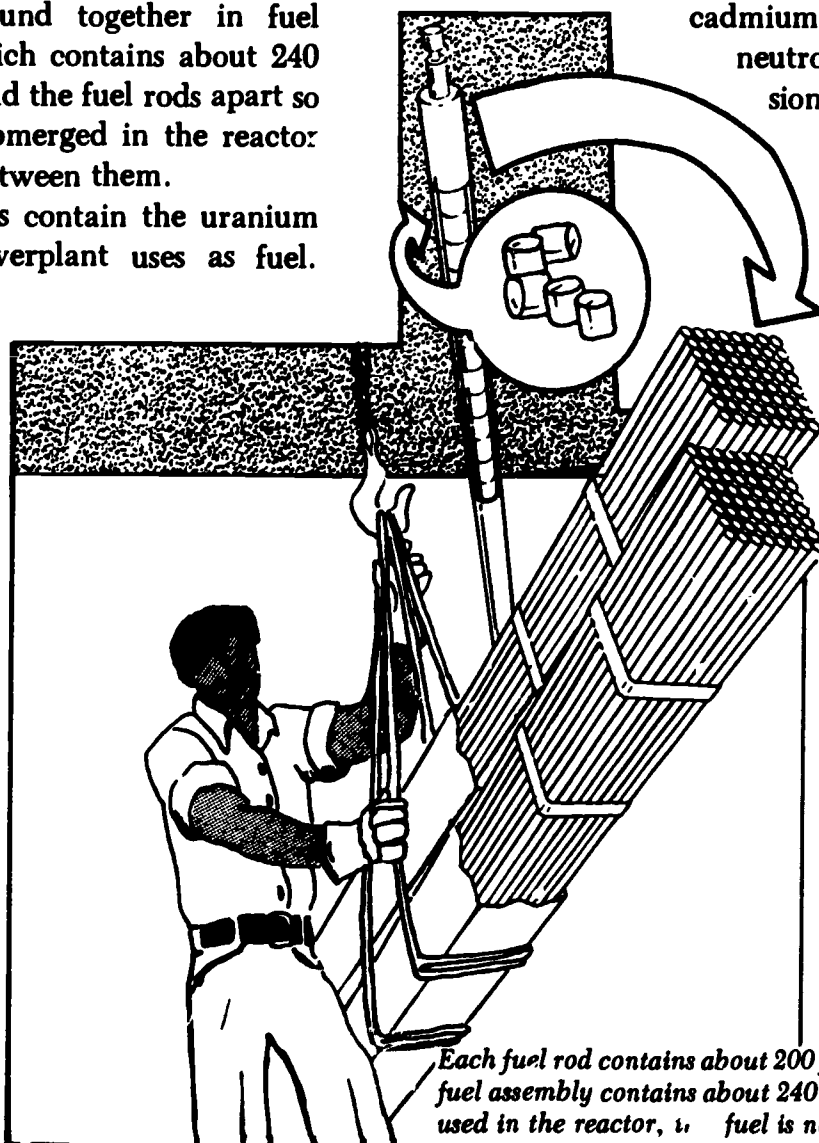

Each fuel rod contains about 200 fuel pellets, and each fuel assembly contains about 240 fuel rods. Before it is used in the reactor, the fuel is not very radioactive.

How do control rods control the speed of the reaction?

The temperature in Franklin's core is carefully monitored and controlled. When the core temperature goes down, the control rods are slowly lifted out of the core, and fewer neutrons are absorbed. Therefore, more neutrons are available to cause fission. This releases more energy and heat. When the temperature in the core rises, the rods are slowly lowered and the energy output decreases because fewer neutrons are available for the chain reaction. To maintain a controlled nuclear chain reaction, one neutron from each uranium-235 atom that splits

will cause another uranium-235 atom to fission, while the other neutrons are absorbed. This keeps the number of fissioning atoms constant.

Temperature changes in the core are usually gradual. But should Franklin's monitors detect a sudden change in temperature, the reactor would immediately shut down automatically by dropping all the control rods into the core, absorbing neutrons. A shutdown of this type takes only a few seconds and stops the nuclear chain reaction. This is because the neutrons necessary to keep a chain reaction going are absorbed by the control rods.

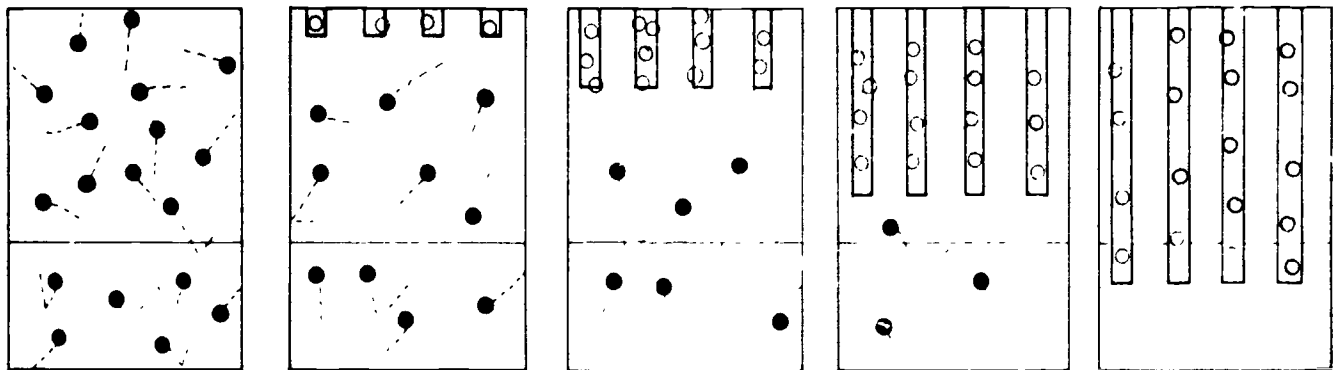

As the control rods are lowered into the reactor core, the nuclear chain reaction slows down.

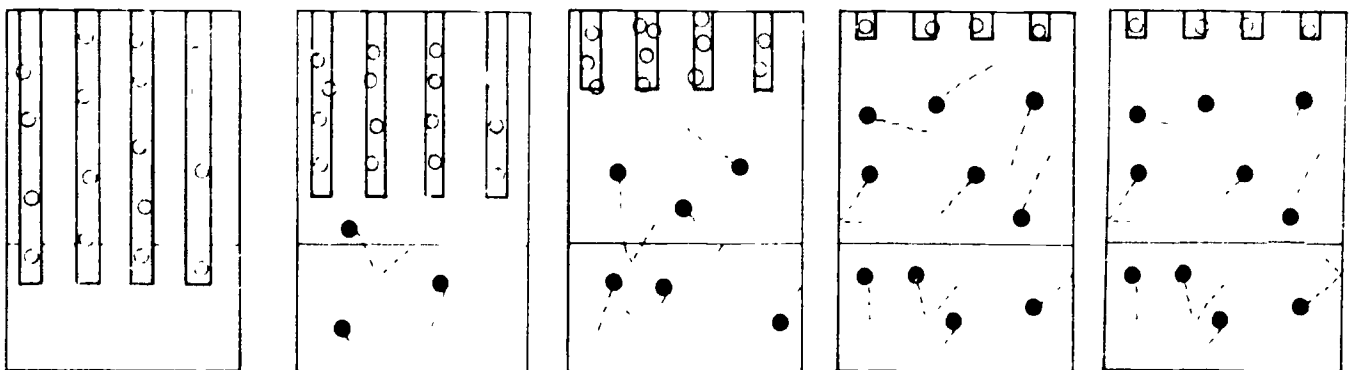

As the control rods are lifted, the chain reaction speeds up.

What is the coolant/moderator?

A third essential part of the reactor is the coolant/moderator. At most nuclear powerplants in the United States, the coolant/moderator is nothing more than purified treated water. Any material used for cooling is called a coolant. In nuclear powerplants, the cooling water is also used to move the reactor's heat to places where it can be used to generate electricity. If the reactor is not cooled, the heat inside could damage the core. So it is necessary to always have coolant in the reactor core to keep it from getting too hot.

A moderator is a material that slows down neutrons, and water is also a moderator. Just as it is easier to catch a ball that is thrown softly, neutrons are more likely to be captured and cause fission when they are not moving too fast. Water slows down the neutrons. Using water as the moderator allows enough neutrons to be captured by the uranium to permit a chain reaction to occur.



Just as it is easier to catch a ball that is thrown softly, neutrons are more likely to be captured and fission when they are not moving too fast.

What is a pressure vessel?

The fourth part of the reactor is the pressure vessel. The pressure vessel is enormous. Its walls are 9 inches thick, and it often weighs more than 300 tons. The pressure vessel surrounds and protects the reactor core. It provides a safety barrier and holds the fuel assemblies, the control rods, and the coolant/moderator.

Pressure vessels are made of carbon steel, which is extremely strong. This is because the pressure vessel must hold together under high temperature and high pressure. Also, because they are always filled with water, pressure vessels are lined with a layer of stainless steel that prevents rust and wear. Franklin's pressure vessel was carefully checked over before it could be used. Every square inch of the thick metal vessel was x-rayed to make sure there were no defects inside the metal where people could not see them.

The pressure vessel is located inside the *containment building*, which is made of thick concrete that is reinforced with thick steel bars.

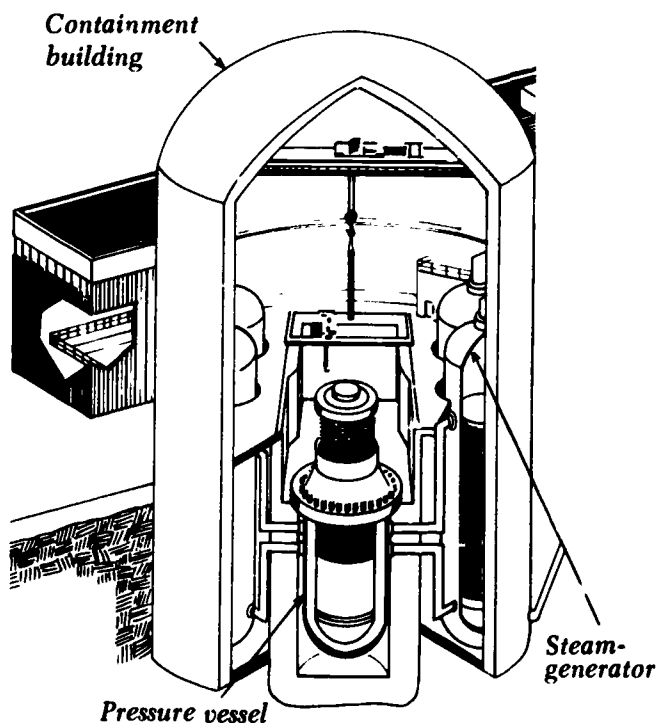

The reactor is located inside the containment building. 65

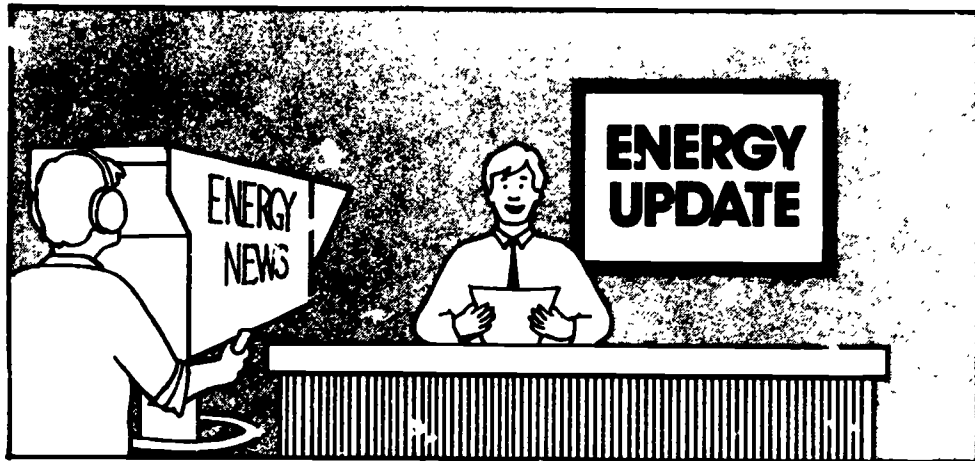

Franklin's reactor update

Because nuclear fission takes place in the reactor's core, the core is the heart of the nuclear powerplant.

The reactor has four main parts: the fuel assemblies, the control rods, the coolant/moderator, and the pressure vessel. Fuel assemblies hold the uranium, which fissions. Control rods regulate the speed of the fission reaction. The coolant/moderator does two things: it allows the fission reaction to take place by slowing down the neutrons, and it carries heat from the fission reaction in the reactor's core to the steam-generators. Water passing through the steam-generators is converted to steam. This steam turns the turbine used in the process of generating electricity. The pressure vessel surrounds and protects the other reactor parts.

LESSON 2 REVIEW EXERCISE

A. Indicate whether the following statements are true (T) or false (F) by circling the correct letter. If the statement is false, correct it to make it true.

- | | |
|--|-----|
| 1. A uranium fuel pellet is about the size of your fingertip. | T F |
| 2. Before it is used in the reactor, the uranium in the fuel rods is very radioactive. | T F |
| 3. To speed up a chain reaction, control rods are lowered into the reactor core. | T F |
| 4. Control rods regulate the speed of a chain reaction by absorbing neutrons that could otherwise cause fission. | T F |
| 5. The faster neutrons move, the more likely they are to cause uranium-235 atoms to fission. | T F |
| 6. Purified treated water is used to keep the core of the reactor from becoming too hot. | T F |
| 7. Fission takes place inside the steam-generator. | T F |
| 8. In a nuclear powerplant, boron is used in the fuel rods. | T F |
| 9. The fuel assemblies, control rods, coolant/moderator, and pressure vessel make up the reactor core. | T F |
| 10. The water from the reactor and the water in the steam-generator that is turned into steam never mix. | T F |

B. Label the following parts of the reactor.

fuel assemblies
pressure vessel

control rods

coolant/moderator
containment building

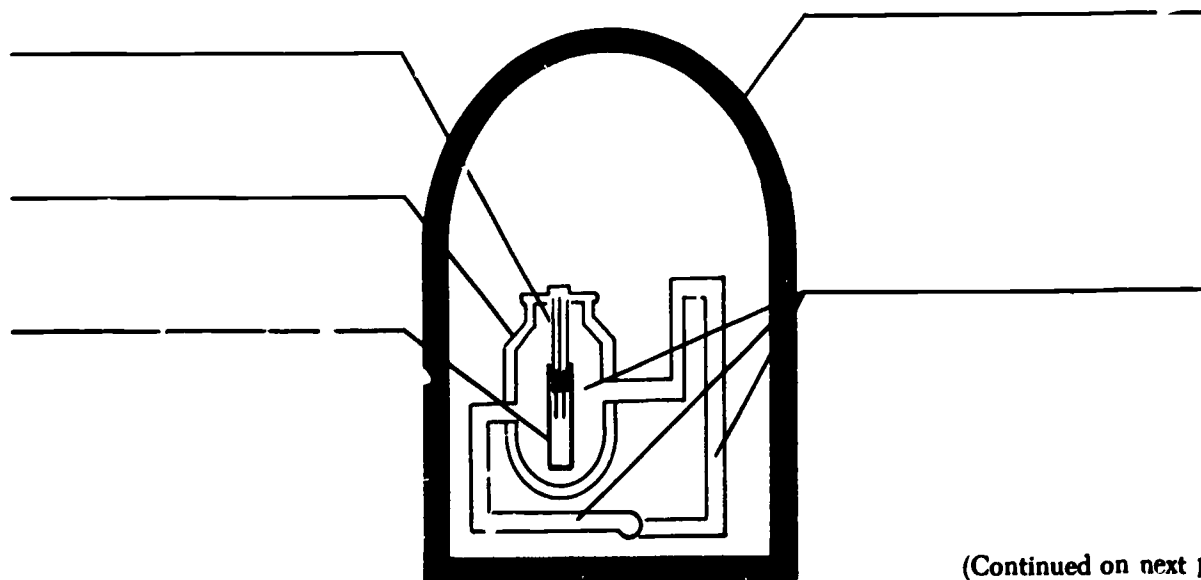

(Continued on next page) 67

C. Arrange the following phrases in the correct order. Then draw a diagram that illustrates the sentence you have made.

causing the nucleus to split apart
a neutron
releasing energy and more neutrons
strikes the nucleus of a uranium-235 atom

D. Your goal is to keep the temperature inside the reactor at 900°F. If the temperature reaches 950°F, do you raise or lower the control rods?

If the temperature is 800°F, do you raise or lower the control rods?

E. How many fuel pellets would normally be installed in the Franklin Plant? _____

Does splitting atoms produce electricity?

Franklin was built for one purpose—to produce electricity. But splitting atoms does not produce electricity. A nuclear reactor produces heat. So at Franklin, heat energy must be changed into electrical energy.

The way that nuclear powerplants produce heat energy through fission is unique. However, the way that energy is converted into electrical energy is basically the same as in most powerplants.

Because the water in the core is under enough pressure to remain a liquid, Franklin is called a *pressurized (PRESH-ə-riizd) water reactor*, or PWR for short.

What is heat transfer?

When you pour hot cocoa into a mug, you may notice that the mug soon becomes warm, perhaps even too hot to hold. This is because heat will always flow from a hot material into a cooler one.

This scientific law helps us understand how to move the heat energy from inside Franklin's reactor to a place where it can be changed into electrical energy.

Because of the heat produced by the fission reaction, water that is circulated through Franklin's core becomes extremely hot. Generally, when water reaches 100° Celsius (212° Fahrenheit), it boils and turns into a gas called steam. Gases take up more space than liquids. But inside Franklin's reactor, there is only a limited amount of space and the water cannot turn into steam. As a result, it can be heated to 315° Celsius (600° Fahrenheit) while still remaining a liquid. We say that the water is under pressure.

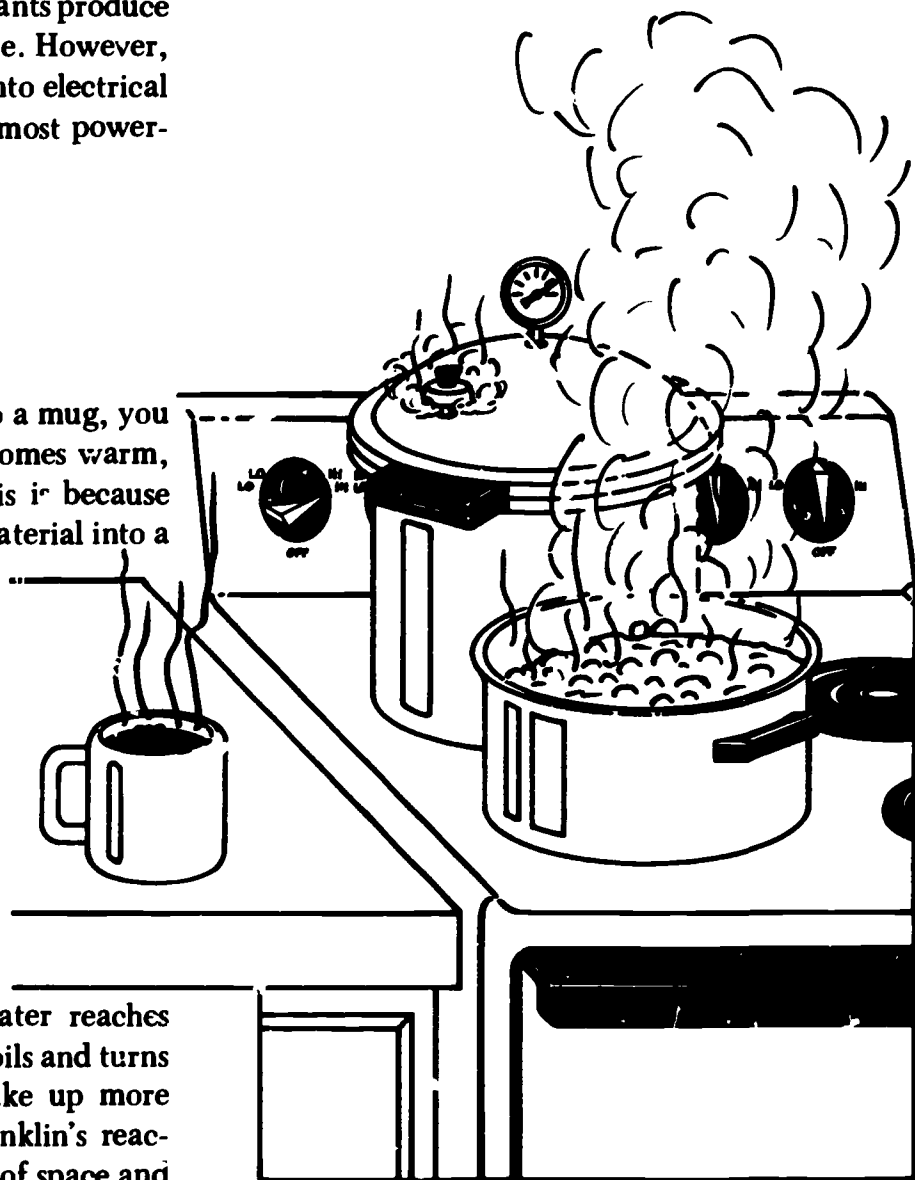

Energy in the form of steam escapes from a pot of boiling water, but a pressure cooker doesn't allow steam to escape. The energy stays in the pot where it is used to cook things faster because the temperatures are higher.

Lesson 3

How is water used to move heat energy at Franklin?

Pressurized water reactors like Franklin have three separate systems of pipes, or loops, for moving heat. Water in these loops never mixes together. However, heat energy from one loop moves to another.

In Franklin's first loop, pressurized water is pumped through the reactor and then through extremely strong pipes that lead to several steam-generators.

Inside the steam-generators, water in the first loop flows through hundreds of pipes. Water from the second loop flows around these pipes. The first loop carries water that is 315° Celsius (600° Fahrenheit). Because heat flows away from heated surfaces toward cooler surfaces, the heat in the first loop transfers to the second loop. When water in this second loop takes on the heat from the first loop, it turns to steam. This is because water in the second loop is under less pressure.

Where does the second loop go?

The second loop carries the steam to the *turbine* (TER-bin). A turbine is basically a pinwheel with many blades that are spun by steam. At powerplants, turbines are attached to generators, which change the mechanical energy of the spinning turbine into electrical energy.

A generator works by rapidly spinning a coil of wire inside a magnetic field. This produces electricity. Franklin's generator weighs many tons and can produce enough electricity to supply a city of 500,000 people.

Where does the steam go after it spins the turbine?

After turning the turbine, the steam in the second loop has lost most of its heat energy. It is cooled and turned back into water so that it can be used again in the second loop. This operation takes place in the *condenser* (kən-DEN-sər), which is located under the turbine. In the condenser, the second loop transfers some of its heat to the third loop. Again, heat is transferred from a heated substance to a cooler one.

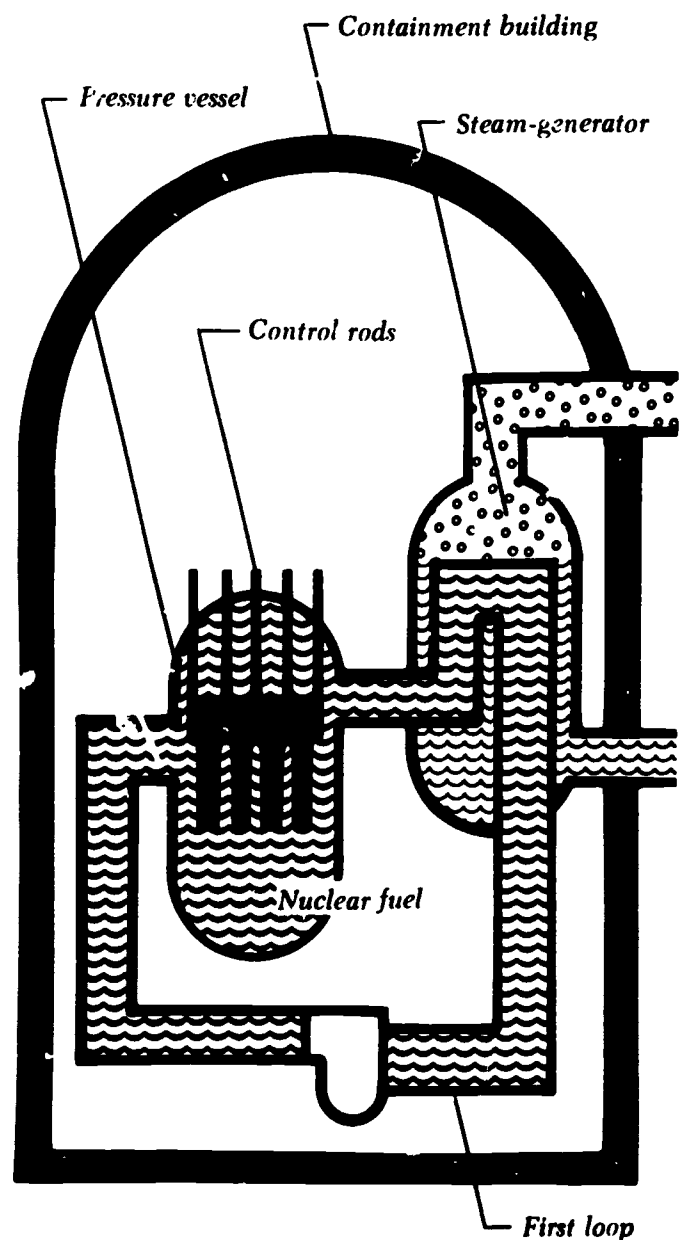

A glass of ice water in the summer is a model of how a condenser works. If you pour ice water into a glass and leave it on a table for a while, you will find that the glass seems to be sweating. Beads of water form on the outside of the glass. What is going on?

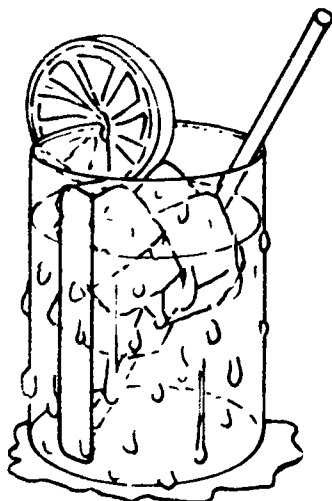

We know water cannot pass through the glass. The drops of water have come from moisture in the air. Heat energy from the warm summer air has moved to the cold glass. Just as water turns into steam when it is heated, water vapor condenses back into water when it loses heat energy.

In the powerplant, a third loop contains cooling water drawn from the river. Steam in the second loop is cooled in the condenser when it transfers some of its heat to water in the third loop. The purpose of the third loop is to remove heat from the steam in the second loop.

It is important to remember that the water from one loop never mixes with the water from another loop. Only the heat is transferred.

When the cooling water in the third loop has passed through the condenser, it has absorbed heat from the second loop. This heat has to be removed.

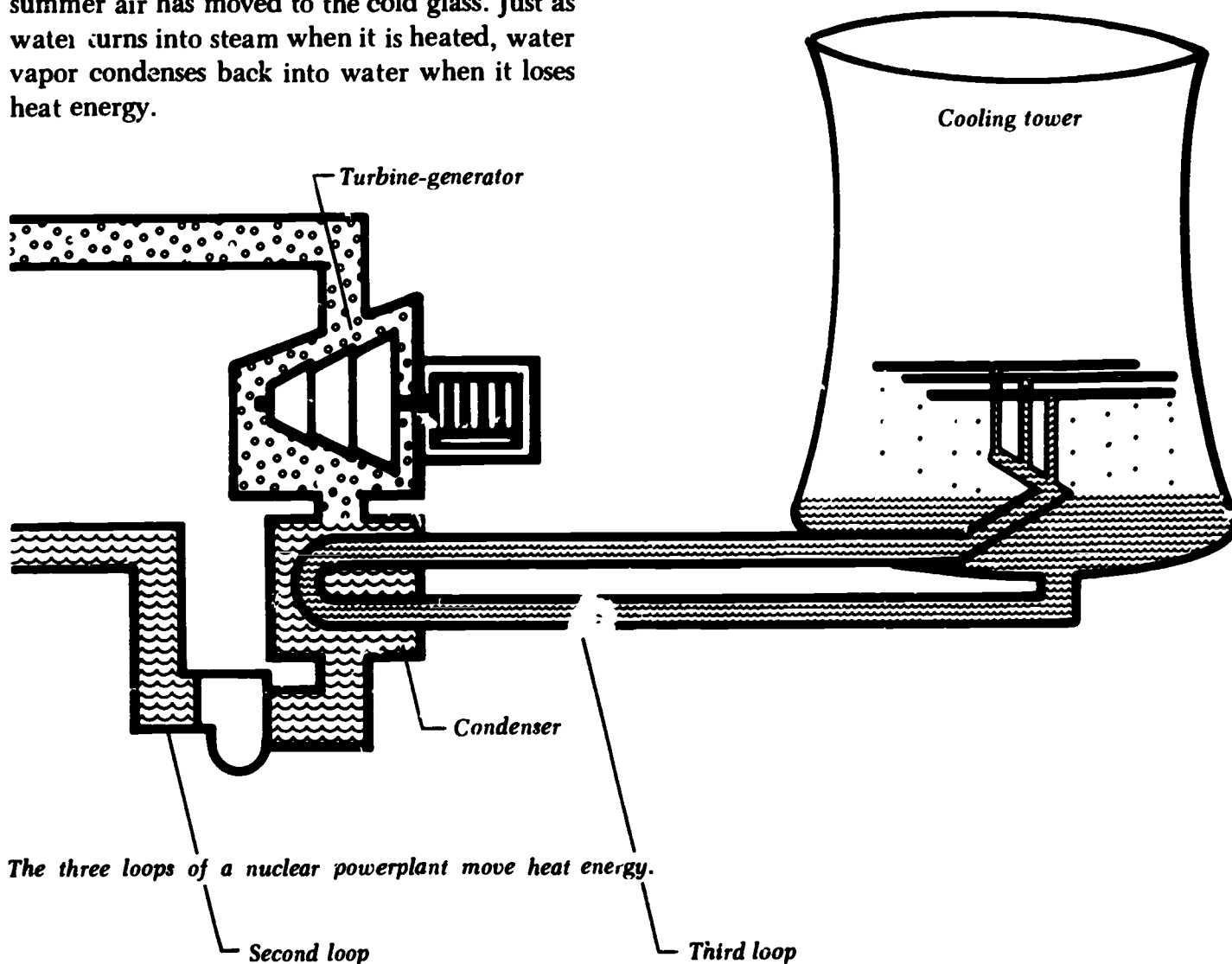

Why does the heat have to be removed?

Because heated water could have an adverse effect on the environment, most states have laws that prohibit powerplants from returning water that is too hot directly to the river. In fact, most states have laws that prohibit the powerplant from increasing water temperature by more than 2.8° Celsius (5° Fahrenheit) at the point where water is returned to the river. For this reason, cooling water in the third loop has to be pumped to the *cooling tower* to have some of its heat removed.

Franklin's 500-foot-tall cooling tower is by far the powerplant's tallest structure. The cooling tower is a giant hollow cylinder, pinched in near the top. It is supported on 88 legs that allow air to flow under the tower. Like many other powerplant structures, the tower is made of concrete and thick steel reinforcement bars.

About 50 feet up inside the cooling tower there are several layers of special tiles called *baffles* (BAF-els). The baffles in Franklin's cooling tower provide 390 acres of surface area for cooling water. Heated water in the third loop is sprayed on these tiles. This water trickles down through many stair-stepped layers of baffles, losing heat as it goes.

Heat from the third loop is transferred into the air. Hot air rises and moves up through the cooling tower. This causes more air to flow under the tower to replace the heated air. As this process continues, a natural breeze begins to blow up through the baffles and out of the cooling tower. This process evaporates about 11,000 gallons of water each minute.

However, most of the cooling water does not evaporate. It is cooled to about 24° Celsius (75° Fahrenheit) and collected at the bottom of the cooling tower. Some of this water is returned to the river, but most is used again in the third loop.

Evaporated water leaves the tower at about 10 miles per hour and spreads out into the atmosphere. Because there are separate loops used in the powerplant, this vapor has never come in contact with the reactor core and is not radioactive.

In cooling towers, excess heat is removed from the cooling water by the process of natural evaporation. Water sprinklers spray water from the third loop onto the baffles where some of it evaporates. The rest drips to a collection basin underneath the tower and is pumped to the third loop and the condenser.

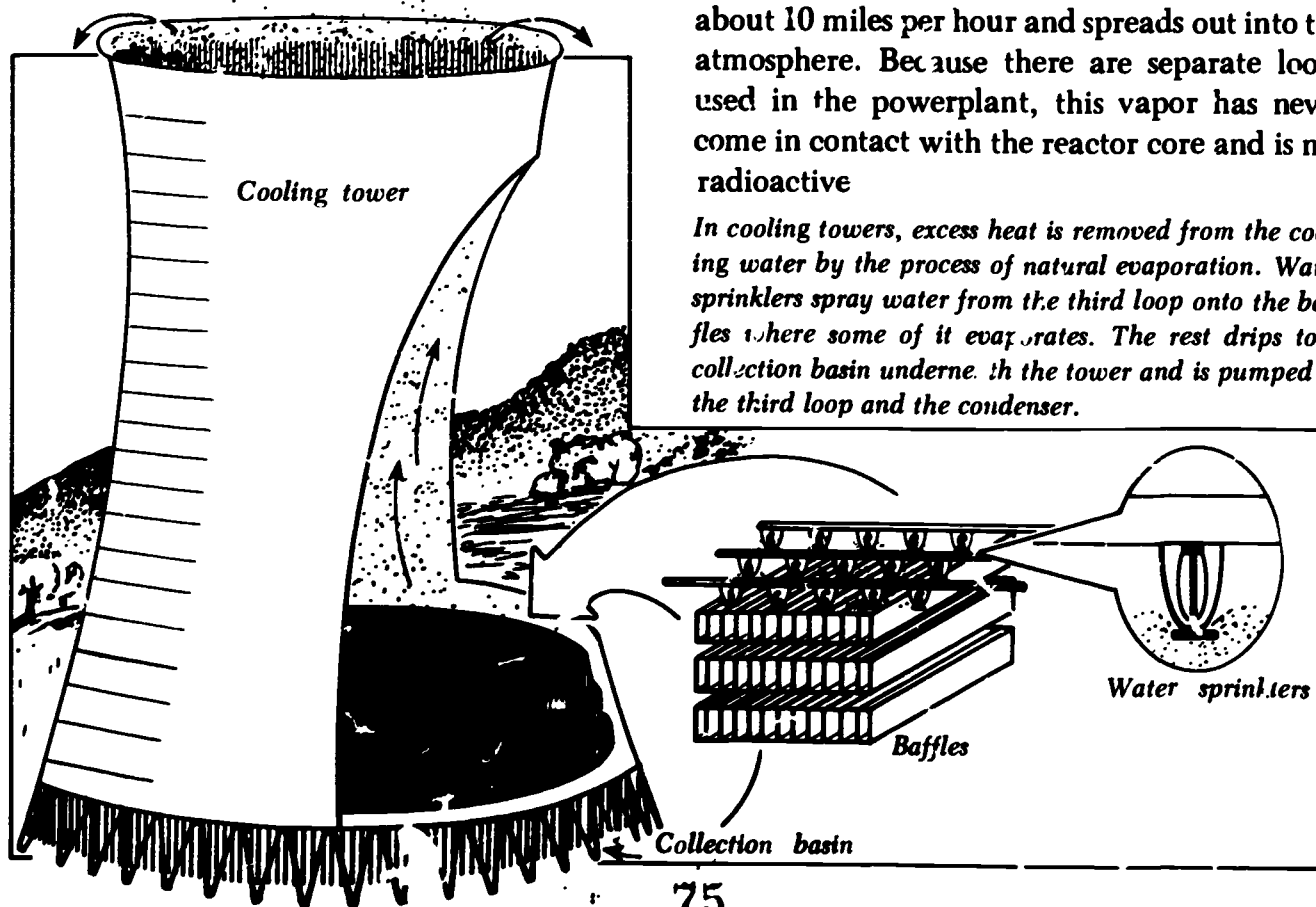

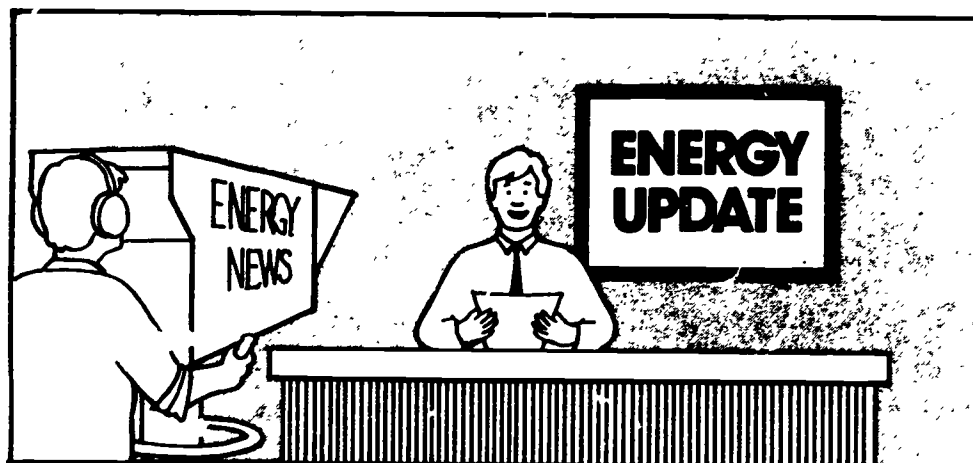

Producing electricity update

The heat energy produced by fissioning uranium at Franklin must be moved from the reactor core to a place where it can be used to make electricity. Water carries Franklin's heat from place to place through a series of three loops of piping. Water in these loops never mixes, but heat is transferred from loop to loop.

The first loop is under pressure and is very hot (315°C). Water in the second loop takes heat from the first loop and turns to steam. This steam is used to turn the turbine, which is attached to a generator that produces electricity.

Afterwards, the steam is condensed back into water and is used again in the second loop. Heat in the second loop that was not used to spin the turbine transfers to the water in the third loop. This water is pumped to the cooling tower. In the cooling tower, excess heat is removed from the water of the third loop. Most of this water is returned to the third loop, some is returned to the river, and some evaporates.

LESSON 3 REVIEW EXERCISE

A . From the reading, select the word that best fits the statement

1. Nuclear powerplants produce heat energy through _____.
2. Although water reaches very high temperatures in the reactor, it does not turn to steam because it is under _____.
3. Franklin is called a _____ water reactor, or PWR.
4. When it takes on heat from the first loop, water in the second loop turns to _____.
5. The water in the third loop is pumped to the cooling tower to have most of its heat _____.

B . Indicate whether the following statements are true (T) or false (F) by circling the correct letter. If the statement is false, correct it to make it true.

1. The way that nuclear powerplants convert heat energy into electrical energy is basically the same as in most other powerplants. T F
2. The electrical energy of the spinning turbine is changed into mechanical energy in the generator. T F
3. Water from the powerplant's different loops never mixes together. T F
4. Heat always flows from a hot object into a cool object. T F
5. Most of the water in the cooling tower evaporates and goes into the atmosphere. T F

C. Arrange the following steps in order by writing the correct numbers from the diagram below in the spaces.

- _____ In the second loop water turns to steam.
- _____ In the condenser, the second loop transfers some of its heat to the third loop. When the steam in the second loop loses its heat energy, it turns back into water.
- _____ Water in the first loop moves to the steam-generator.
- _____ The second loop carries steam to the turbine, causing the turbine to spin. The mechanical energy of the spinning turbine is changed into electrical energy in the generator.
- _____ The water in the third loop is pumped to the cooling tower to have some of its heat removed.
- _____ Water circulates through the reactor core where heat from fission is transferred to the water.
- _____ Inside the steam-generator the first and second loops meet. The heat in the first loop transfers to the second loop.

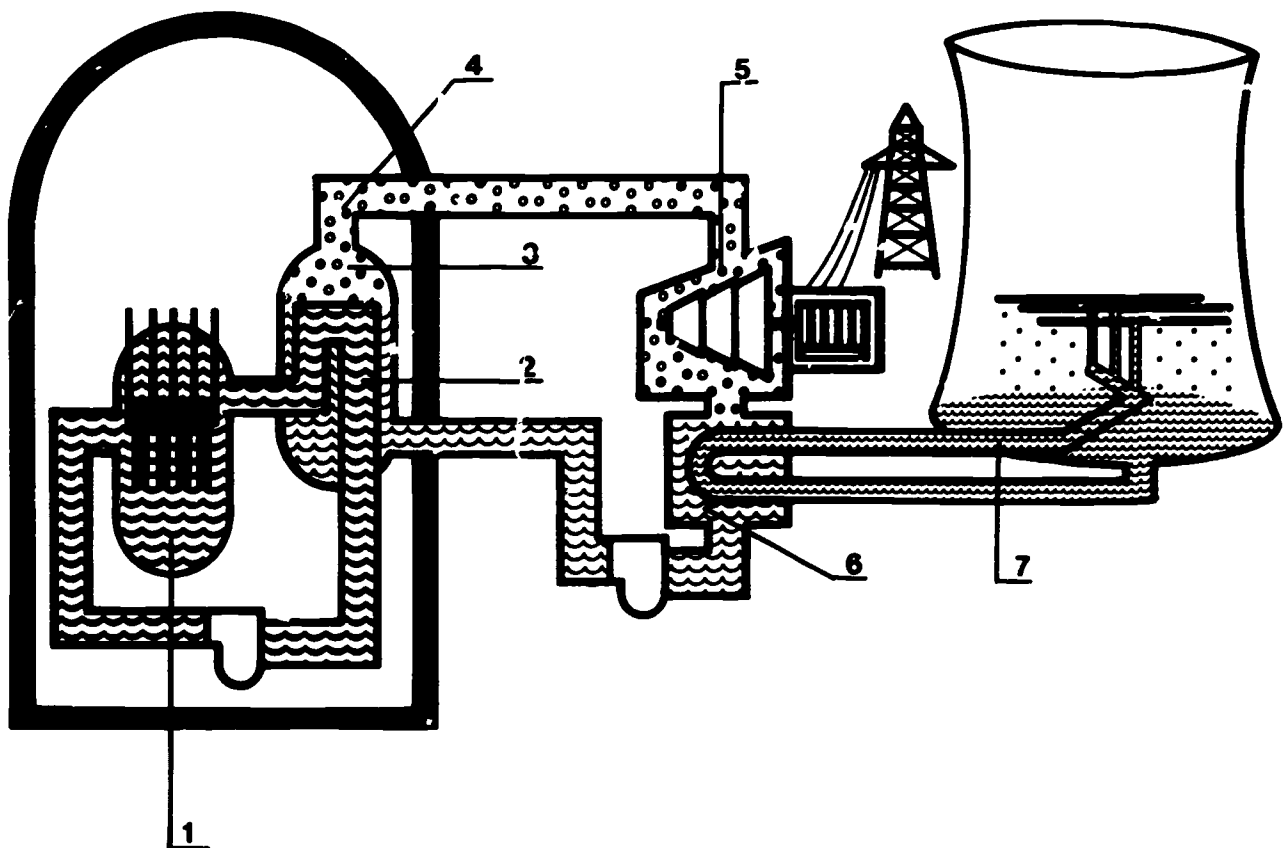

What does Franklin use for fuel?

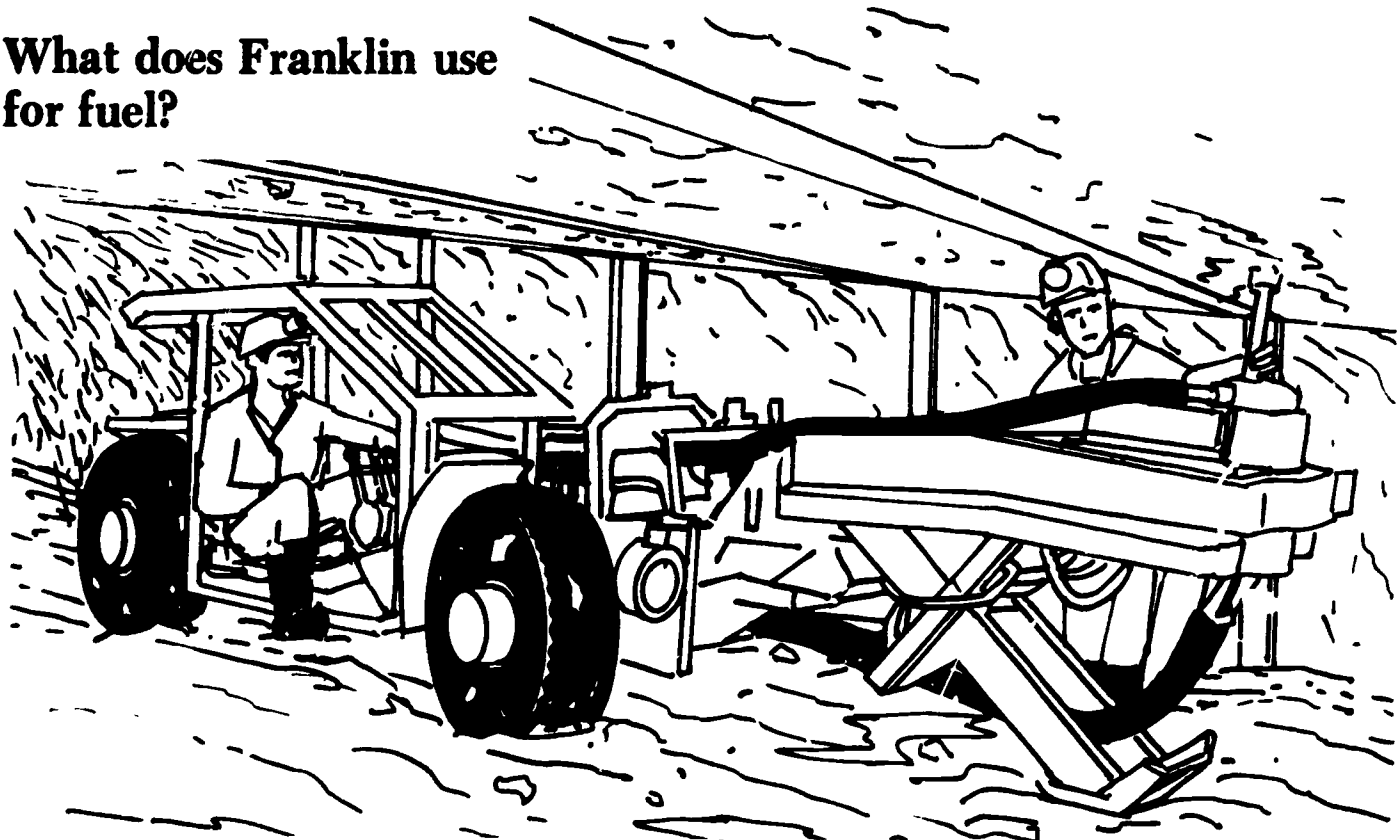

Franklin Nuclear Powerplant uses *uranium* for fuel. Uranium is found in small amounts all over the world, even in seawater. Rocks that contain a lot of uranium are called uranium ores. A ton of uranium ore contains 4 to 5 pounds of uranium. Before we can use uranium to generate electricity, it must be mined, separated from the rock in which it is found, and processed in a number of ways.

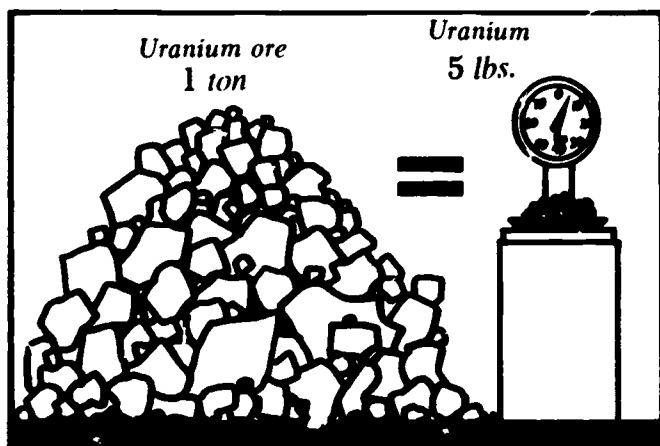

It takes about a ton of uranium ore to produce 4 to 5 pounds of uranium.

How much uranium do we have?

Like all metals, there is a limited amount of uranium in the world. This makes uranium a nonrenewable resource. An average powerplant like Franklin will use about 6,000 tons of uranium in its 40-year lifetime. However, it is estimated that there are at least 690,000 tons of uranium in the United States that can be recovered at a reasonable cost. This means that the Franklin Powerplant can depend on having fuel available for as long as it operates. In fact, the United States has enough known uranium to power all currently operating and planned nuclear reactors until the year 2020.

How is uranium mined?

Workers mine uranium ore in much the same way they mine coal, either in deep underground mines or in open-pit surface mines. Large machines are used to scrape the ore from the Earth. So, mining can cause environmental damage and disturb the *habitat* (HAB-ə-tat) of plants and animals. To protect the environment, when mining is finished, the land must be replanted and restored. This process is called *reclamation* (REK-lə-MAY-shən). Many Federal, State, and local agencies enforce mining laws that help protect mine workers and the environment.

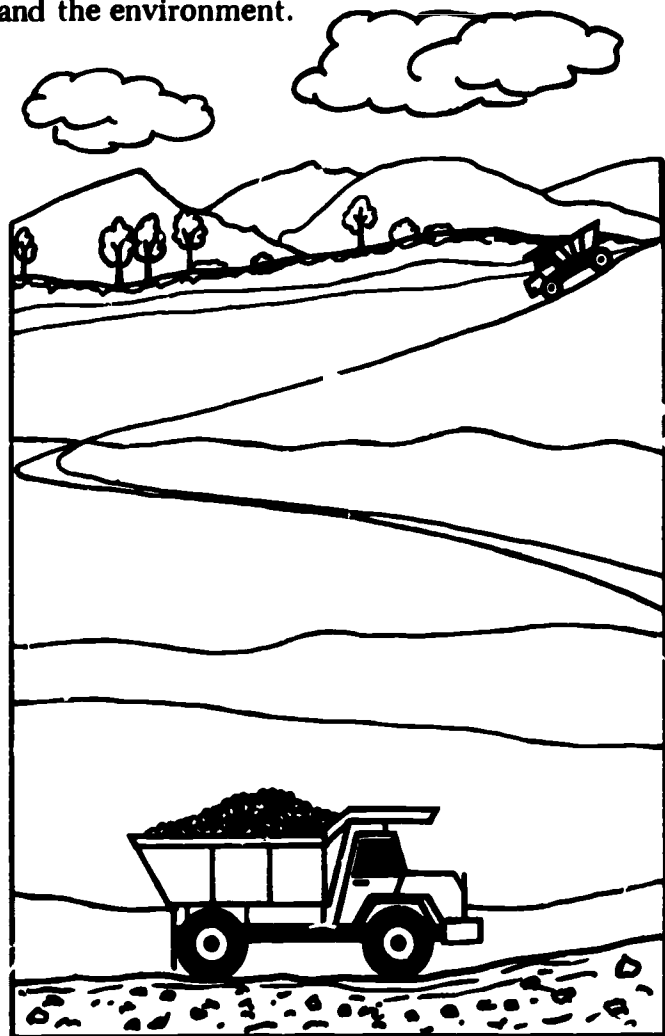

After it is mined, uranium ore is taken to nearby mills.

What is uranium milling?

After it has been mined, uranium ore is crushed. The crushed ore is usually poured into an acid, which dissolves the uranium, but not the rest of the crushed rock. The acid solution is drained off and dried, leaving a yellow powder, called *yellowcake*, which is mostly uranium. This process of removing uranium from the ore is called *uranium milling*.

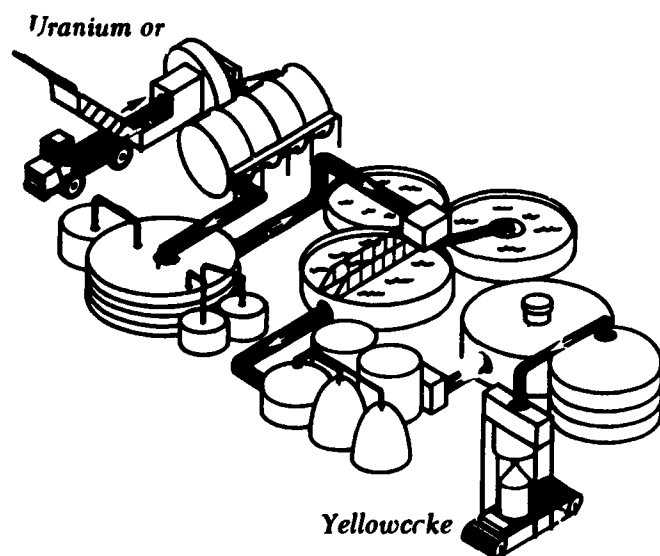

The milling process changes uranium ore into yellowcake.

The leftover crushed rock is known as *mill tailings*, and mill tailings produce a small amount of radioactive gas called *radon* (RAY-don). Radon gas is also found in underground mines. To keep amounts of radon very low, uranium mining and milling is carefully monitored and uranium tailings are disposed of carefully.

Less than 1 percent of the atoms in uranium are uranium-235 atoms. Almost all the rest of the atoms are uranium-238. However, powerplants like Franklin must have uranium that is at least 3 percent uranium-235. This means that, before it can be made into reactor fuel, uranium has to be treated to increase the concentration of uranium-235 in a process called *uranium enrichment*.

How do we enrich uranium?

Isotopes of uranium-238 contain three more neutrons than isotopes of uranium-235, and this makes them weigh a tiny bit more. This tiny difference in weight makes it possible to enrich uranium.



The difference in the weight of uranium isotopes makes it possible to enrich uranium.

Before uranium can be enriched, it is purified and chemically converted to a gas at a *conversion plant*. The gas is *uranium hexafluoride* (HEK-sə-FLUR-iid), which is also called UF_6 .

Next, it is shipped to a *gaseous* (GAS-ee-əs) *diffusion* (di-FYU-zhən) *plant* where it is pumped through filters that contain extremely tiny holes. Being about 1 percent lighter, uranium-235 moves through the holes more easily than uranium-238. So, by the time the gas has passed through thousands of filters, the percentage of uranium-235 has increased from less than 1 percent to 3 percent.

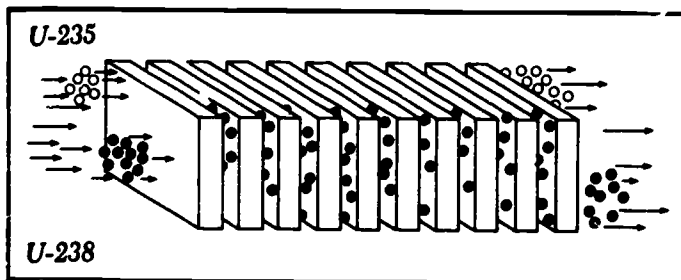

During enrichment, uranium atoms are forced through thousands of filters. Uranium-235 moves through the filters more easily, increasing the concentration of 78 uranium-235 to about 3 percent.

How is the uranium prepared for the reactor?

Enriched uranium is then taken to a *fuel fabrication* (FAB-rə-KAA-shən) *plant* where it is prepared for the reactor. The uranium is made into a *ceramic* (sə-RAM-ik) material, which is formed into small barrel-shaped pellets. These ceramic fuel pellets can withstand very high temperatures, just like the ceramic tiles on the space shuttle. Fuel pellets are about the size of your fingertip ($\frac{3}{8}$ inch in diameter and $\frac{3}{4}$ inch long). These pellets are stacked and sealed in metal fuel rods, which are then bundled together in fuel assemblies. The uranium in the pellets is the fuel that the Franklin Powerplant uses to make electricity.

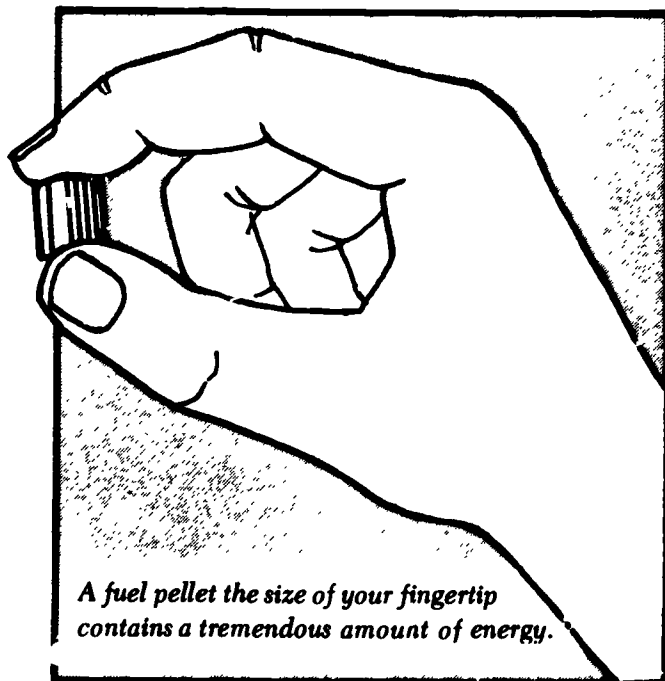

A fuel pellet the size of your fingertip contains a tremendous amount of energy.

A uranium fuel pellet weighs less than half an ounce, which is less than an empty aluminum soft drink can. Each pellet can release as much energy as 126 gallons of oil, 2,000 pounds of coal, or 5,000 pounds of wood. This means that by the time the pellets are stacked in rods, bound together in fuel assemblies, and then placed in the reactor, there is a very large amount of potential energy available to generate heat and make electricity.

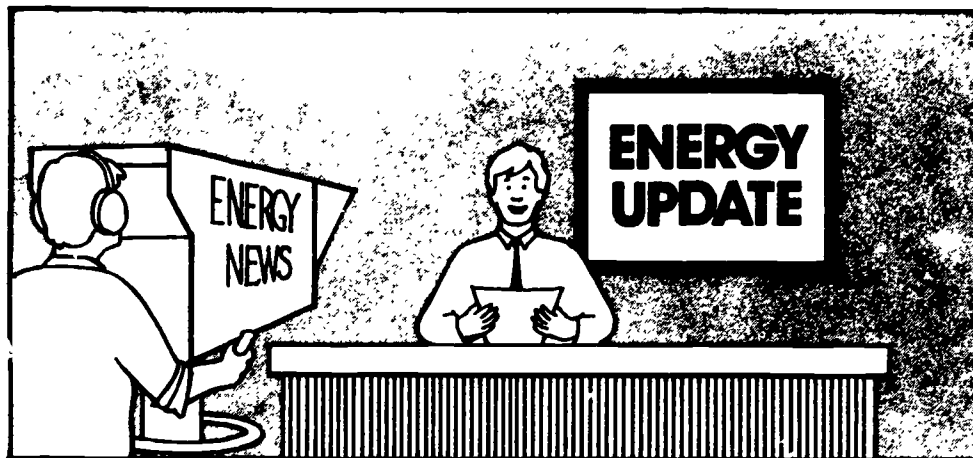

Franklin's fuel update

The Franklin Powerplant uses uranium for fuel. The uranium comes from uranium ores. Uranium is present in small amounts throughout the world, but there are only a few places where uranium is concentrated enough to mine at a reasonable cost.

Uranium cannot go straight from the ground to the powerplant. It must be milled, converted, enriched, and made into pellets before it can be used. Milling is the process of removing the uranium from the rock in which it is found. Milled uranium is called yellowcake because of its yellow color. Conversion involves purifying the uranium and converting it to uranium hexafluoride (UF_6). Enrichment involves increasing the concentration of uranium-235 isotopes to 3 percent. We currently enrich uranium by using a process called gaseous diffusion.

After it is processed, the uranium is taken to a fuel fabrication plant and made into fuel pellets that are about the size of your fingertip. Fuel pellets are put into fuel rods, which are bound together into fuel assemblies.

LESSON 4 REVIEW EXERCISE

A. From the reading, select the word that best fits the statement.

1. For fuel, a nuclear powerplant uses enriched _____.
2. To protect the environment when mining is finished, the land is replanted and restored in a process called _____.
3. At a fuel fabrication plant, enriched uranium is made into a ceramic material that can withstand _____.
4. Mill tailings produce a small amount of radioactive gas called _____.
5. Before it can be used as a reactor fuel, uranium has to be treated to increase the concentration of uranium-____.

B. Indicate whether the following statements are true (T) or false (F) by circling the correct letter. If the statement is false, correct it to make it true.

1. Rocks that contain a lot of uranium are called uranium ores. T F
2. There is an unlimited supply of uranium in the United States. T F
3. Milled uranium is called yellowcake because it looks like flour. T F
4. Less than 1 percent of the atoms in ordinary yellowcake are uranium-235 atoms. T F
5. Although a uranium pellet is small, it can release a lot of energy. T F

C. Write a sentence explaining how each of the following numbers relates to uranium or nuclear energy.

- | | |
|------------------|-------------------------|
| 1. 4 to 5 pounds | 6. 2,000 pounds of coal |
| 2. 40 year | 7. 126 gallons of oil |
| 3. 690,000 tons | 8. 3/4 inch |
| 4. 235 | 9. 3 percent |
| 5. 238 | 10. 1 percent |

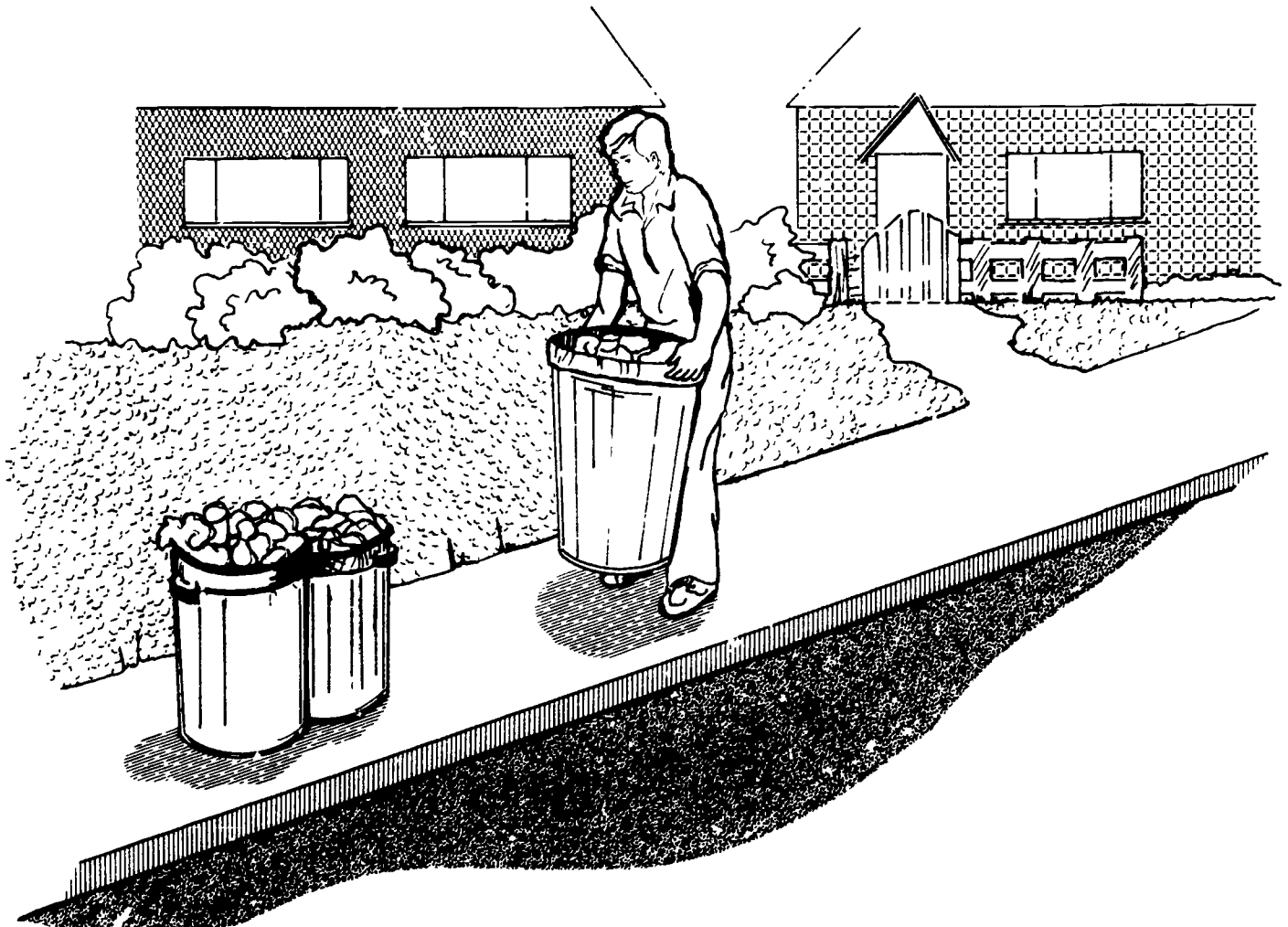

What is waste?

In the process of day-to-day living, people produce garbage and trash. Think of how much garbage and trash your family collects in a day, or in a week. Think of how much trash results from just one visit to a fast-food restaurant—from bags, to straws, to soft drink containers.

Industries also have trash and garbage as a result of doing or making something. The leftovers of an industrial process are called wastes.

Like all industries, nuclear powerplants produce waste. One of the main concerns about nuclear powerplants is what to do with the waste.

Why is this such a problem?

The problem with nuclear powerplants is not the amount of waste they make, which is quite small compared with the amount of waste produced by many other industries. The problem is that some nuclear powerplant wastes are radioactive. This means that disposing of the waste requires special care to protect workers and the public. The way it is disposed of depends on how radioactive the waste is and the half-life of the waste.

What is low-level waste?

Waste that is only slightly radioactive and gives off small amounts of radiation is called *low-level waste*. In the United States, the largest percentage of low-level waste comes from hospitals and industry. Most radioactive waste from a nuclear powerplant is also low-level. This waste includes such things as filters, clean-up rags, lab supplies, and discarded protective clothing.



Low-level radioactive waste from a nuclear powerplant includes such things as filters, clean-up rags, lab supplies, and discarded protective clothing.

Because it emits only small amounts of radiation, Franklin's low-level waste is usually sealed in steel drums and buried at special sites. Presently, all the low-level waste from nuclear powerplants in the United States is disposed of at three sites: Barnwell, South Carolina; Hanford, Washington; and Beatty, Nevada.

Drums containing low-level waste are placed in special trenches and are covered with at least 6 feet of soil and packed clay. To ensure that the materials remain undisturbed, the trenches are constantly monitored with devices that can detect radiation.

What is high-level waste?

Powerplant waste that is very radioactive is called *high-level waste*. Once a year, about one third of Franklin's fuel assemblies are replaced with new ones. The fuel near the center of the core is used up more rapidly than the fuel in the outer assemblies. So, generally, the fuel assemblies in the center are removed first, and the remaining ones are moved toward the middle. New assemblies are placed around the outside.

Fuel that has been removed from the reactor is called *spent fuel*. The majority of high-level waste at Franklin is in this form. This used fuel is highly radioactive, and this radioactivity produces a lot of heat.

Spent fuel from a nuclear powerplant is stored near the reactor in a deep pool of water called the *spent fuel pool*. During storage, the spent fuel cools down and also begins to lose most of its radioactivity through radioactive decay. In 3 months the spent fuel will have lost 50 percent of its radiation, in one year it will have lost about 80 percent, and in 10 years it will have lost 90 percent. Nevertheless, because some radioactivity remains for thousands of years, the waste must still be carefully and permanently *isolated* from the environment.



Spent fuel is stored in a 35-foot-deep pool of water near the reactor. While it is stored here, it rapidly becomes less radioactive as a result of radioactive decay.

How can we isolate Franklin's high-level waste for thousands of years?

In 1982, the U.S. Congress passed the Nuclear Waste Policy Act. This law set up a schedule for the site selection, construction, and operation of America's first high-level nuclear waste storage facility, called a *repository* (ri-POZ-ə-TOR-ee).

Before it is placed in a repository, some parts of the spent fuel can be recycled and used again as reactor fuel. If the fuel is not recycled, then all of it will be treated as waste. This high-level waste will most likely be converted into a ceramic material that will not rust, melt, or dissolve, even over very long periods of time. This ceramic waste will then be sealed in heavy metal canisters.

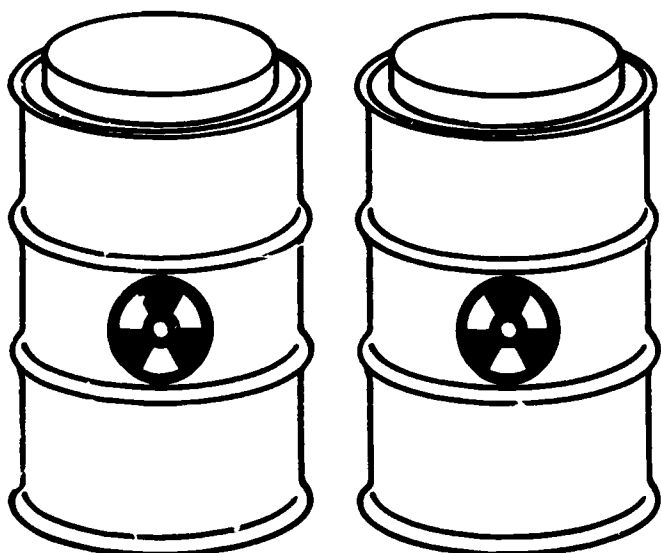

After being sealed in heavy metal canisters, high-level waste will be stored in underground repositories.

Canisters of high-level waste will be stored in underground repositories drilled into stable rock formations such as granite, basalt, salt, or tuff. Repositories must be located in these stable and dry types of formations because it is essential that radioactive substances do not leak into underground water. This is especially important because portions of the waste will remain radioactive for a long time.

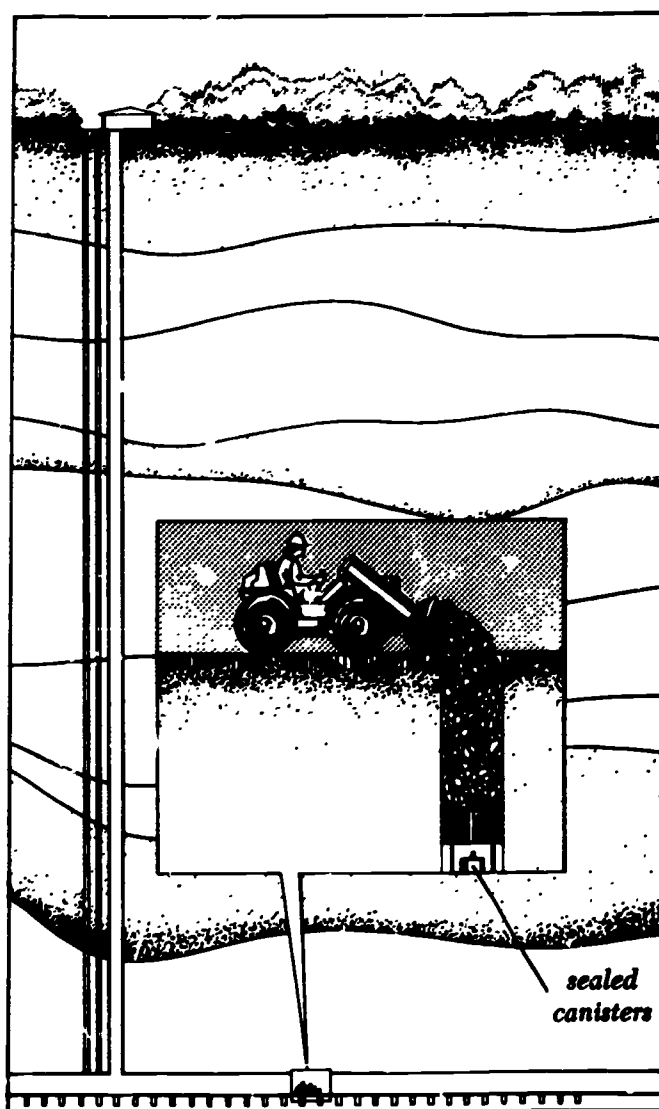

High-level waste will be stored permanently in repositories located between 1,000 and 3,000 feet beneath the surface of the Earth.

Lesson 5

How will we transport the waste?

In time, Franklin's fuel assemblies will be taken from the spent fuel pool and may be shipped to a permanent repository. When this time comes, the spent fuel assemblies will be carefully loaded in their shipping containers, which are called *spent fuel casks*.

If you own a musical instrument, it probably has a case that you keep it in. The case prevents damage that could happen while you take your violin or saxophone to music class.

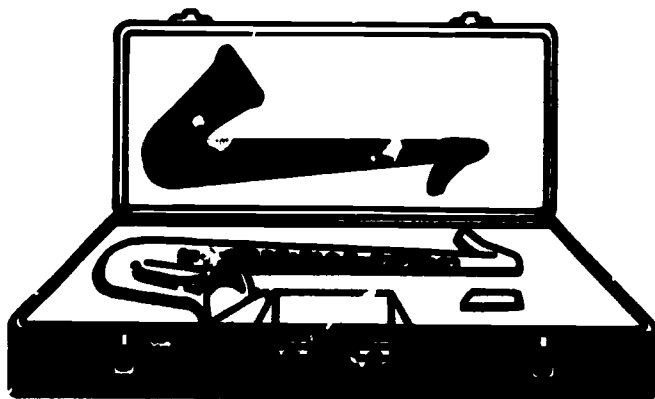

A saxophone case is specially built to protect its contents.

A spent fuel cask is similar to an instrument case in that both are specially made to protect their contents. In addition, a spent fuel cask must also protect people and the environment from the fuel it holds.

As a result, spent fuel casks are designed with heavy shielding that protects people from radiation, as well as with thick walls that prevent radioactive substances in the spent fuel assemblies from getting into the environment.

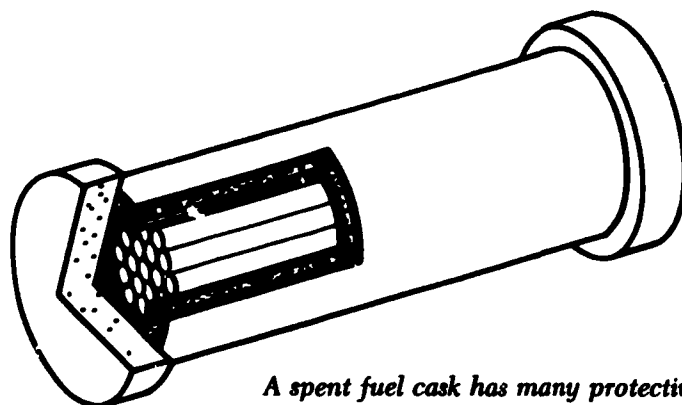

A spent fuel cask has many protective layers of steel and shielding.

A spent fuel cask is designed to withstand the worst sorts of disasters and accidents, and a series of tests is also conducted on sample casks to make sure the casks really work. These tests include:

- 1) being dropped from 30 feet onto reinforced concrete;
- 2) being dropped from 40 inches onto a thick steel bar;
- 3) being burned in a hot fire for 30 minutes; and
- 4) being put under water for 8 hours.

These tests are carefully monitored and measured with high-speed cameras that help engineers and scientists study these containers under conditions that *simulate* (SIM-yə-laət) an accident.

One spent fuel cask was even mounted on a tractor trailer that was hit broadside by a train engine moving at 80 miles per hour. The impact demolished the train engine, but did not damage the cask. Afterward, the cask was put into a fire for two hours. Scientists carefully examined the cask for any damage and found that the cask's contents had remained intact. The type of spent fuel cask used to transport Franklin's high-level waste is the same type of cask.

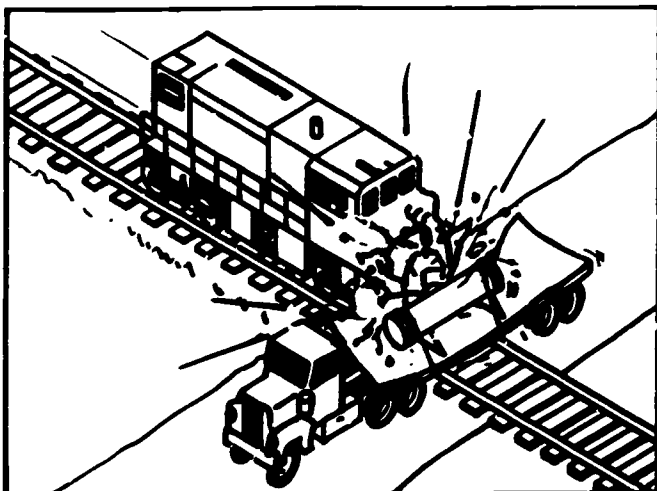

In one test, a train engine was demolished, but the cask was hardly dented.

When spent fuel is shipped, the spent fuel assembly is fitted inside its cask and the cask is sealed. The outside of the cask is cleaned and then tested for radioactive *contamination* (kən-TAM-ə-NAA-shən). The cask is then loaded on the truck or train car that will carry it. Before shipping can begin, however, the cask must be inspected again to make sure that it is properly installed on the vehicle. Finally, the spent fuel cask and the vehicle transporting it must both be labeled.

In addition to all the requirements that casks must meet in order to be shipped by truck, the truck driver must be trained in the hazards of radioactive materials, transportation regulations, and emergency procedures. The route that the cask takes is also given careful consideration in order to avoid large cities and undesirable road conditions.

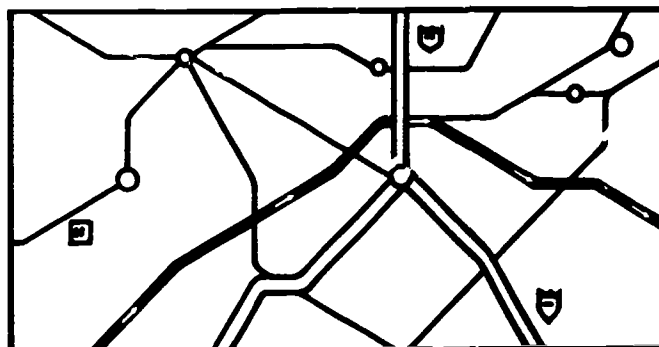

Routes are carefully selected.

What happens to a nuclear powerplant when it is no longer being used?

After operating for about 40 years, nuclear powerplants are shut down, or *decommissioned* (DEE-kə-MISH-ənd). During the life of the powerplant, many parts within the reactor will have become radioactive. When the plant closes, they begin the natural process of radioactive decay. So each passing year, materials in a closed plant become less radioactive and easier to dismantle because workers do not have to worry as much about radiation. As a result, many scientists recommend that nuclear powerplants be left standing for 10 to 50 years after they close.

It is expensive to handle radioactive materials, and the longer you wait to dismantle a nuclear powerplant, the less it costs. During this time these plants can be sealed up and protected by on-site security people or monitored by remote cameras and alarm systems. However, if the plant cannot be left standing, it is also possible to dismantle it immediately and dispose of all wastes properly.

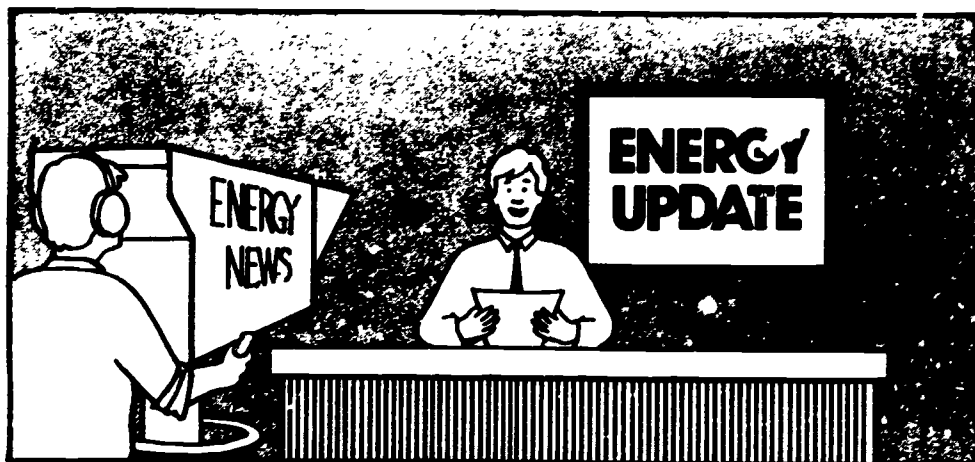

Franklin's waste update

Like most industrial plants, Franklin produces waste. But because Franklin is a nuclear powerplant, some of its waste is radioactive and requires special methods for disposal. Most of Franklin's waste is low-level and gives off only a little radiation. This waste is sealed in metal drums and then buried at special sites. A small amount of Franklin's waste is high-level. Most of this waste is spent fuel, which is stored in the powerplant's spent fuel pool.

The National Waste Policy Act, a law passed by the U.S. Congress, provides a plan for isolating high-level nuclear waste in repositories. When the first repository is complete, Franklin's high-level waste will be taken there in special casks that are designed to hold together under extreme conditions and have already been extensively tested.

When a powerplant is no longer being used, it can be safely decommissioned in a number of ways.

LESSON 5 REVIEW EXERCISE

A. From the reading, select the word that best fits the definition given.

- _____ 1. Waste that is only slightly radioactive and gives off small amounts of radiation.
- _____ 2. Powerplant waste that is very radioactive.
- _____ 3. One form of high-level waste.
- _____ 4. Permanent storage facility for high-level nuclear waste.
- _____ 5. Place where the spent fuel cools down and also begins to lose most of its radioactivity through radioactive decay.

B. Circle the letter of the best answer for each item.

- The problem with nuclear powerplant waste is
 - there is a large amount of waste.
 - some of the waste is radioactive.
 - the waste is flammable.
 - all of the above.
- Most radioactive waste from a nuclear powerplant is
 - low-level.
 - high-level.
 - ceramic.
 - spent fuel.
- Low-level waste is usually
 - burned at high temperatures.
 - dumped in a sanitary landfill.
 - sealed in steel drums and buried at special sites.
 - disposed of by each state according to its own regulations.
- About one-third of Franklin's fuel assemblies are replaced with new ones
 - once a month.
 - once every 6 months.
 - once a year.
 - once every 5 years.
- Transportation of spent fuel assemblies involve
 - a series of tests to make sure the casks that will be used really work.
 - careful loading and inspection for proper installation of the spent fuel cask.
 - training of the truck driver in the hazards of radioactive materials, transportation regulations, and emergency procedures.
 - all of the above.

C. Indicate whether the following statements are true (T) or false (F) by circling the correct letter. If the statement is false, correct it to make it true.

1. A spent fuel cask protects its contents and also protects people and the environment from the fuel it holds. T F
2. After shutdown, the longer you wait to dismantle a nuclear powerplant, the less it costs. T F
3. The largest percentage of low-level radioactive waste in the United States comes from nuclear powerplants. T F
4. After 1 year in a spent fuel pool, the spent fuel will have lost 25 percent of its radioactivity. T F
5. High level wastes will be isolated from underground water supplies. T F
6. In a test, the contents of a spent fuel cask remained intact when hit by a train engine traveling at 80 miles per hour. T F
7. High-level waste must be isolated from the environment for thousands of years. T F

What are Franklin's safety concerns?

In any industry there are possible hazards. Workers and the public have to be protected from dangerous falls, harmful substances, hazardous machines, noise, chemical explosions, poisons, and similar dangers.

Many of Franklin's safety concerns are like those in most industries. However, Franklin also has to protect people and the environment from radioactive substances produced as a result of fissioning uranium.

Franklin's containment, monitoring, and backup systems protect people and the environment from this radiation.

What is Franklin's containment system?

Many *safety systems* center around Franklin's core. The core is the most radioactive place in the powerplant because this is where fission occurs. The building where Franklin's reactor is located is called the containment building, not only because it houses the reactor, but also because it is built to keep radiation and radioactive materials from going anywhere in the event of an accident.

Reactor containment buildings are among the strongest structures in the world. In fact, Franklin's containment building has 3-foot-thick concrete walls that were first framed with thick steel reinforcement bars to add strength. In addition, Franklin's containment building is lined with a thick steel plate and is airtight. This construction makes the containment building strong enough to withstand earthquakes, tornadoes, hurricanes, floods, or even the crash of a large airplane.

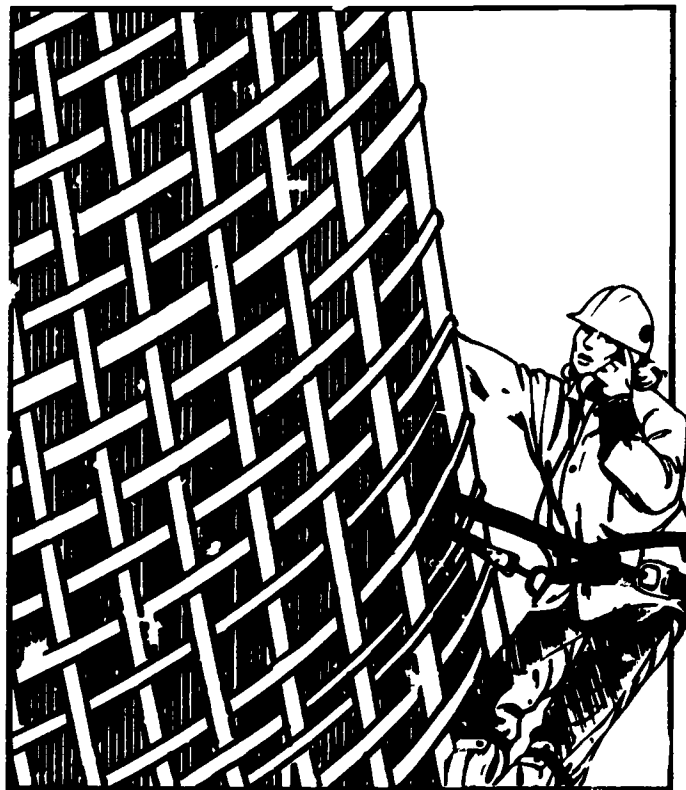

Thick steel reinforcement bars add strength to the containment building.

The pressure vessel, with its 9-inch-thick steel walls, helps to contain radiation and radioactive materials within the reactor core. Because it is extremely strong, the pressure vessel also protects the nuclear fuel from outside forces.

The metal fuel rods provide an additional physical barrier and keep the uranium fuel pellets in the proper position for fission.

In addition to all these barriers, putting uranium in a ceramic form also contributes to safety. It is important that fuel never melt or leak out of the fuel rods, and Franklin's ceramic fuel pellets resist melting, even at extremely high temperatures.

Another place where radioactive materials are concentrated is in the spent fuel pool. Submerging the spent fuel in a deep pool of water shields people from radiation.

What is Franklin's monitoring system?

In addition to the many barriers mentioned, Franklin is also equipped with a complex system of *monitors* (MON-ə-tərs) that are placed throughout the powerplant to help detect any changes in operating conditions. A monitoring system is important because it can detect problems as soon as they begin to develop. Franklin's monitors are connected to a computer, which is located in the *control room*.

The control room is Franklin's brain. It is in a reinforced concrete building located beside the containment building. People working in the control room use the information the monitors provide to help operate the powerplant. Should monitors detect a problem such as unexpected changes in temperature, radiation, or pressure, people and computers would immediately respond by activating a *backup safety system*.

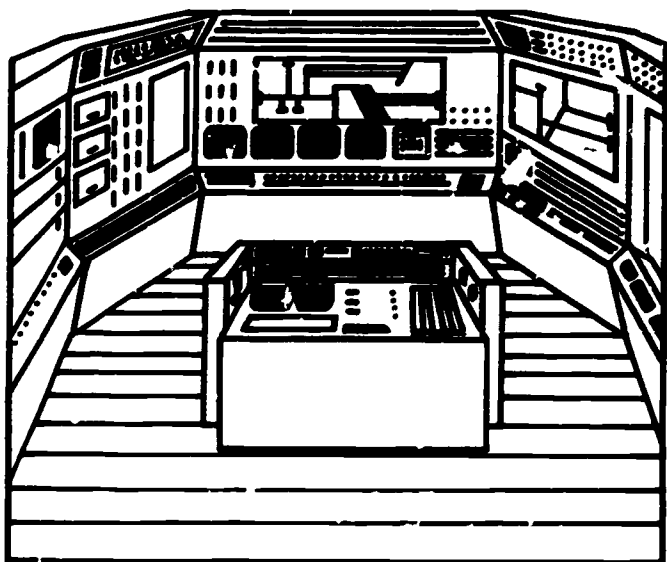

The control room is Franklin's brain.

What are Franklin's backup safety systems?

Your car's parking brake is an example of a backup safety system. Should the main brakes fail, the parking brake would still allow you to stop the car. The Franklin Nuclear Powerplant has many important backup safety systems to guard against malfunctions, mistakes, and potential accidents. Nuclear plants contain several backup cooling systems that can do the work of the first and second loops. This is important because cooling the core is essential to safety. Because the control room and many backup systems run on electricity, Franklin is also equipped with diesel electric generators. These would supply electricity to the plant if the plant could not generate electricity and all outside sources of power were lost. All backup safety systems in nuclear powerplants are tested regularly to assure that they are working properly, just the way your school tests its fire alarm equipment during fire drills.

How do the workers contribute to safety at Franklin?

The men and women who operate Franklin are highly trained. They have taken many classes, have practiced in model control rooms and on computer programs, and have had experience in helping to operate actual nuclear powerplants. In addition to their standard training, one-fifth of their working hours must be spent in school so that they can keep up with all new developments. The Nuclear Regulatory Commission (NRC) requires all of Franklin's operators to return to school every two years to renew their licenses by passing difficult exams. Without licensed operators, the NRC would not allow Franklin to operate.



The men and women who operate Franklin Nuclear Powerplant are highly trained.

People who work at Franklin must follow special safety rules. Workers wear film badges that will show if they have been exposed to radiation above background levels. The government has set strict standards that regulate how much radiation workers at a nuclear powerplant can receive. Also, workers in certain areas are required to wear protective clothing.

What security measures are taken at Franklin?

Security at Franklin is strict. In order to enter the site, workers must pass through metal detectors similar to those used at airports. Workers must also show identification (ID) badges to security guards. The site is enclosed by high barbed wire fences, and the boundaries are monitored with television cameras and alarm devices. Franklin's workers have magnetic cards that work like keys to let them into specific areas. Only workers who are

authorized to be in specific places may enter, and even authorized people are only allowed to enter at the times when they are scheduled to work.

How does the Nuclear Regulatory Commission enforce safety regulations?

Franklin must have a license to operate. This *operating license* is issued by the NRC. The same kinds of steps are taken to get an operating license that are taken to get a construction permit, except that a second public hearing is not always needed. Scientific reports and studies about the powerplant are carefully reviewed by the NRC. Then, after careful consideration, the NRC issues the operating license. After the powerplant begins operation, the NRC inspects it regularly. Careful records are kept on all aspects of plant operation, and the NRC can revoke a powerplant's license or impose large fines on the utility if any violations of safety standards are found.

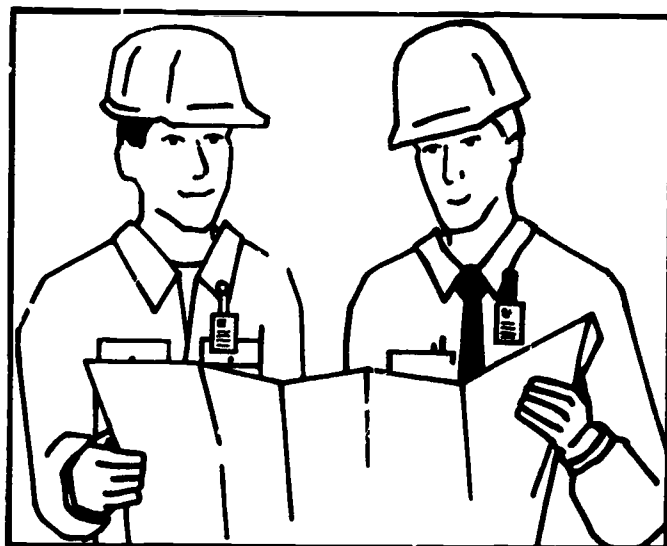

Workers wear film badges that will show if they have been exposed to radiation above background levels.

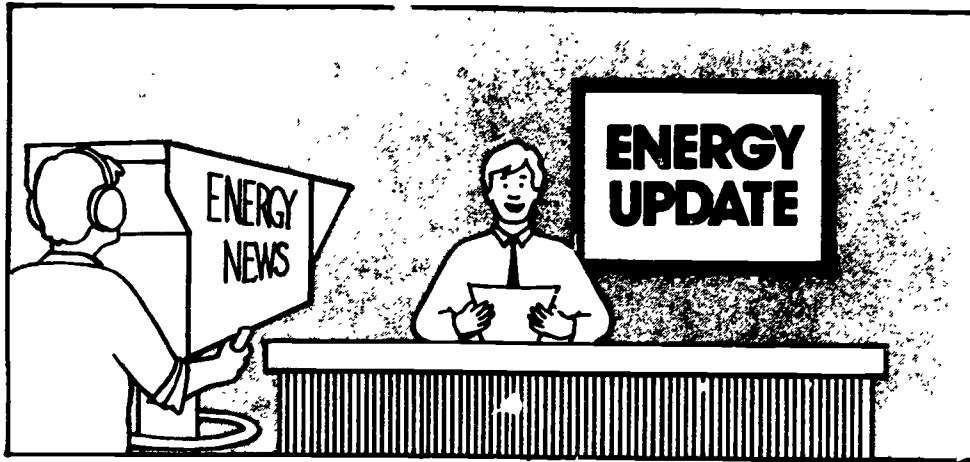

Safety systems update

Franklin was designed and built for maximum safety. In addition, it is operated with safety as a main concern. Many safety concerns are the same as in other industries. Also, Franklin must protect people and the environment from radiation. Therefore, Franklin has many containment, monitoring, and backup safety systems.

Most of the containment systems center around the reactor and the spent fuel pool. The monitoring systems can alert plant workers to problems as soon as they begin to develop. Monitors can also automatically activate backup safety systems. Franklin's workers must follow special safety rules. They wear film and identification (ID) badges. People who work in certain areas wear special protective clothing. For added safety, reactor operators receive special training and must be licensed. Security is important at Franklin. The powerplant site is fenced and the boundaries are carefully monitored. Guards check all people entering the plant, and workers may only enter areas they are authorized to enter.

Franklin has an operating license granted by the NRC. The NRC inspects the plant to ensure safety standards are met and can revoke the license or fine the utility if there are violations.

LESSON 6 REVIEW EXERCISE

A. From the reading, select the word which best fits the definition given.

- _____ 1. This is the most radioactive place in the powerplant.
- _____ 2. This is the building where the reactor is located.
- _____ 3. With its 9-inch-thick steel walls and the water inside, this helps to contain the radiation within the reactor.
- _____ 4. These provide a physical barrier and keep the uranium fuel pellets in the proper position.
- _____ 5. Spent fuel is submerged here in water that blocks radiation and cools the fuel.
- _____ 6. This system can detect problems as soon as they begin to develop.
- _____ 7. Located in a reinforced concrete building beside the containment building, this room is Franklin's brain.
- _____ 8. These would supply electricity to the control room, safety systems, and backup systems if the powerplant could not generate electricity.
- _____ 9. Identification badges, television monitors, alarm devices, magnetic cards, and high barbed wire fences are examples.
- _____ 10. Unexpected changes in temperature, radiation, or pressure would be detected by monitors or people, or computers would immediately activate them.

B. Indicate whether the following statements are true (T) or false (F) by circling the correct letter. If the statement is false, correct it to make it true.

1. All backup safety systems in nuclear powerplants are tested regularly to make sure they are working correctly. T F
2. Once the highly trained operators finish their training and begin work, they do not have to return to school. T F
3. The containment building is strong enough to withstand earthquakes, storms, floods, and even the crash of a large airplane. T F
4. As a normal part of operation, the ceramic fuel pellets melt at extremely high temperatures. T F
5. In any industry there are possible hazards. T F

What are some other types of nuclear reactors?

Just as there are many different types of houses and cars, there are different types of nuclear powerplants that generate electricity. Until now, we have only discussed pressurized

water reactors. However, there are other types. These include *boiling water reactors*, *high temperature gas-cooled reactors*, and *breeder reactors*.

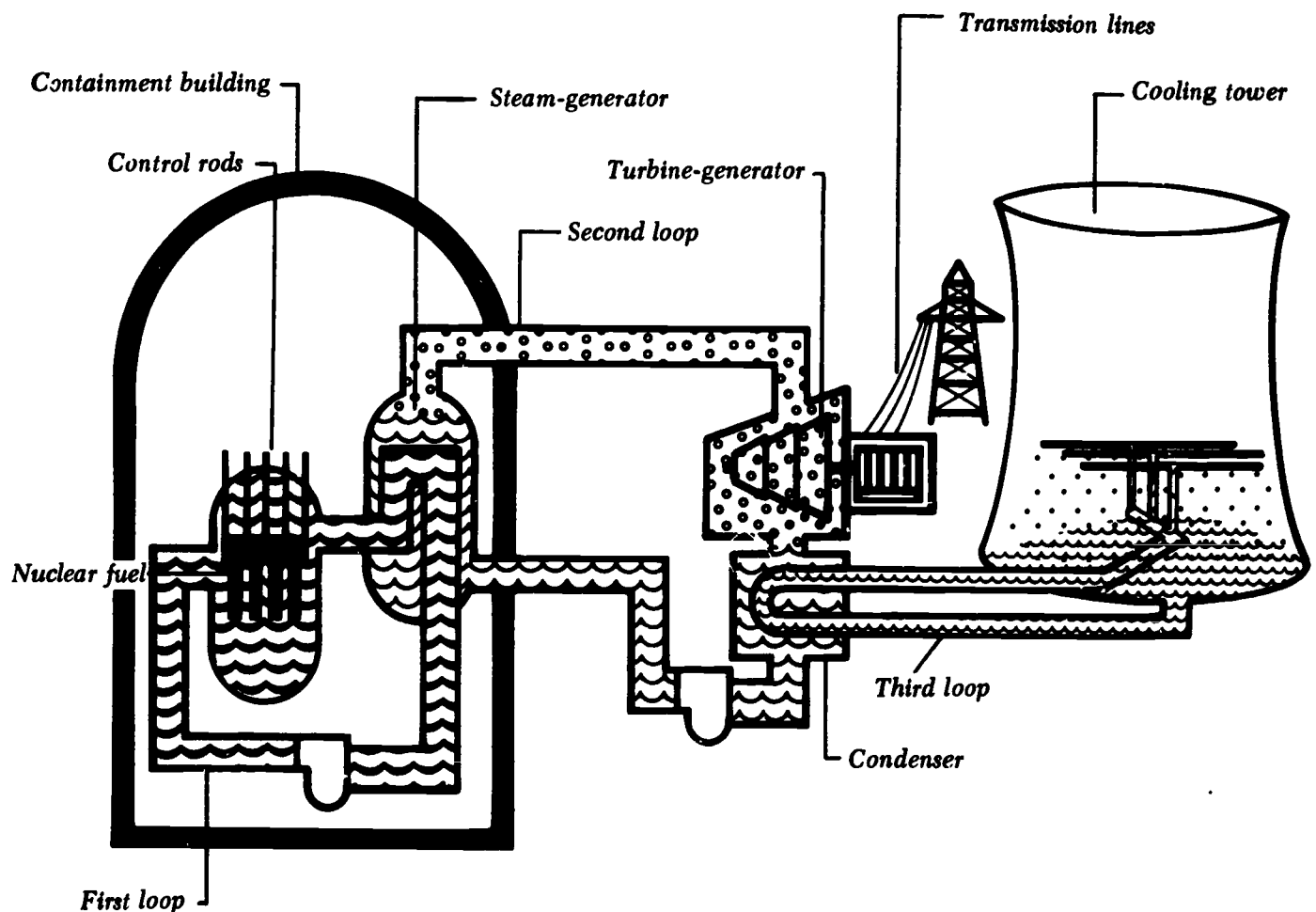

Pressurized Water Reactor

What are light water reactors?

Franklin is in a family of reactors called light water reactors. These reactors are by far the most common type of reactors in the United States. Franklin is a pressurized water reactor, or *PWR*. The other common type of light water reactor is the boiling water reactor, or *BWR*. The main difference between a *PWR* and a *BWR* is that *PWRs* have three loops, while *BWRs* only have two loops.

This means that *BWRs* do not have steam generators. Instead, water in *BWRs* boils inside the pressure vessel, and the steam is used directly to turn the turbine. The control rods in a *BWR* come up from the bottom instead of coming down from the top. In the United States today, there are about 30 *BWRs* and about 50 *PWRs*.

Pressurized water reactors and boiling water reactors are both types of light water reactors.

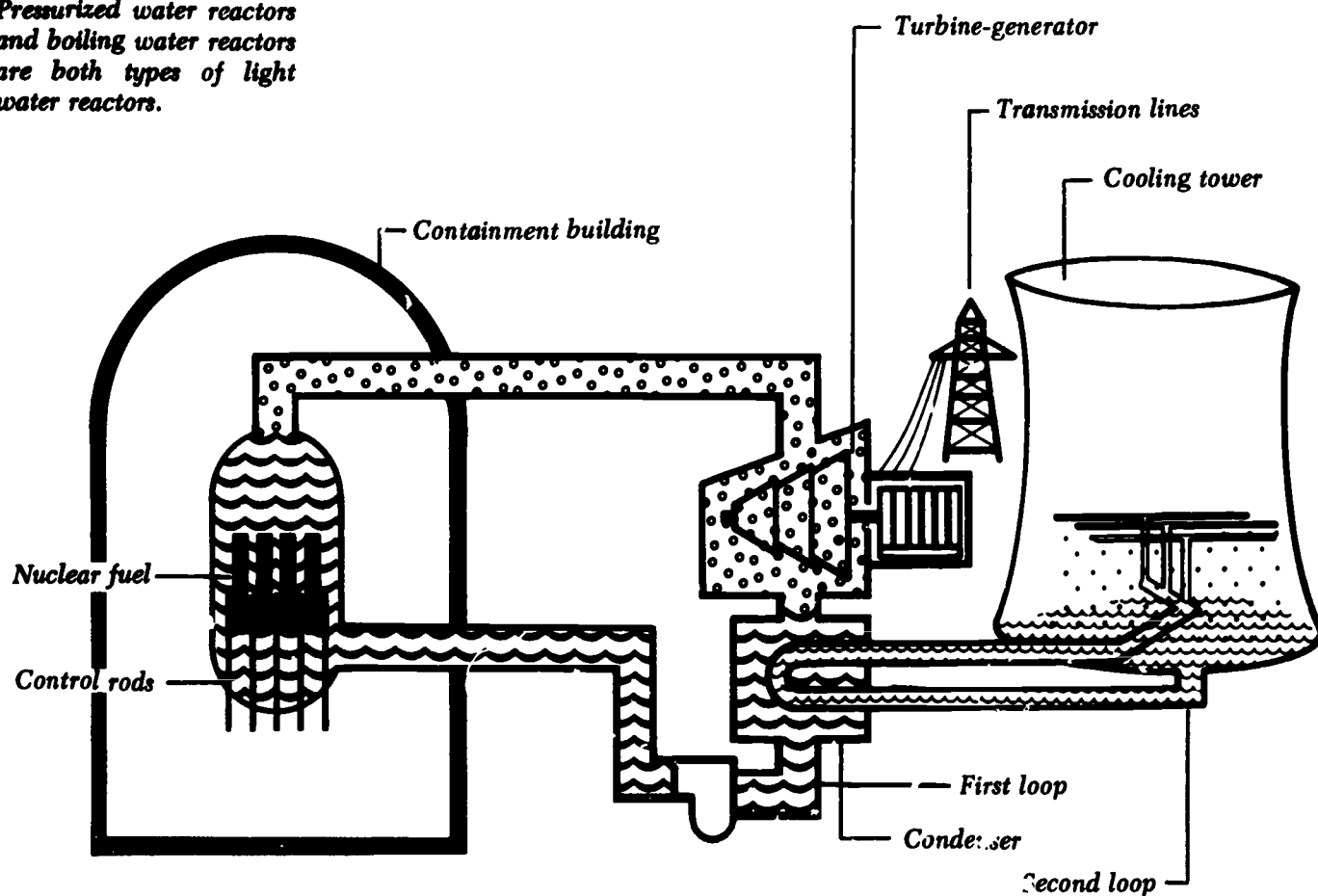

Boiling Water Reactor

What is a high temperature gas-cooled reactor?

Another type of nuclear reactor is the high temperature gas-cooled reactor, or *HTGR* for short. There are many differences between HTGRs and light water reactors. The main difference is that HTGRs use *helium* (HEE-lee-əm) gas instead of water as a coolant in the first loop. Helium gas is kept under pressure and is heated to 760° Celsius (1400° Fahrenheit). However, because helium is not a moderator, the HTGR uses *graphite* (GRAF-iit) to slow neutrons down enough to help cause fission.

Graphite was used in the first reactors that were ever built. *Uranium carbide*, the fuel used in HTGRs, is dispersed within the graphite, where it is kept in proper position for fissioning

and where it cannot melt, even at the high temperatures inside the HTGR's core. Blocks made of graphite and uranium carbide are stacked to form the HTGR core. Control rods slide in between the stacks to regulate the speed of the nuclear chain reaction.

After the heated helium gas is circulated throughout the core of the HTGR, it goes to a steam-generator. Here the heat from the helium is transferred to water, which then boils, turns to steam, and is used to turn a turbine. The only HTGR operating in the United States is located in Fort St. Vrain, Colorado.

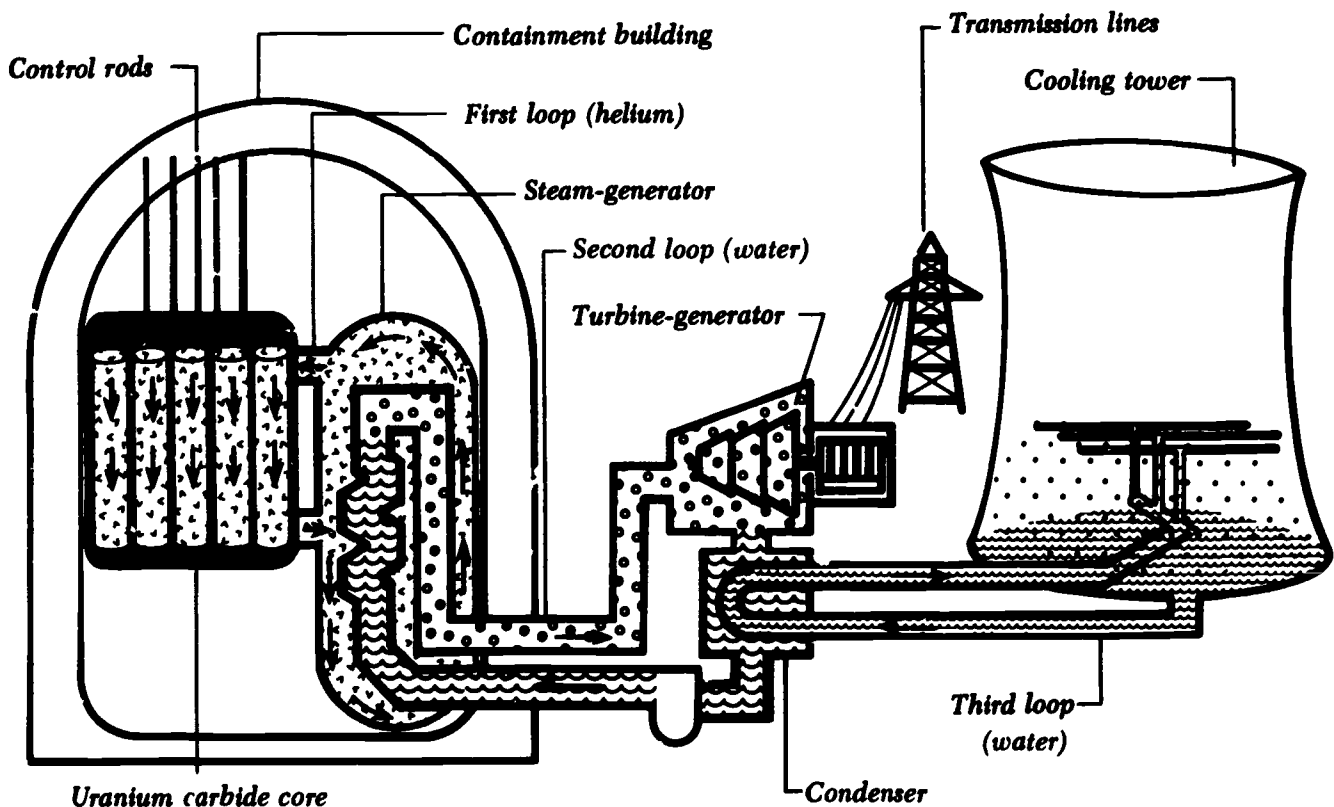

High Temperature Gas-Cooled Reactor

What is a breeder reactor?

Imagine you have a car and begin a long drive. When you start, you have half a tank of gas. When you return home, instead of being nearly empty, your gas tank is full.

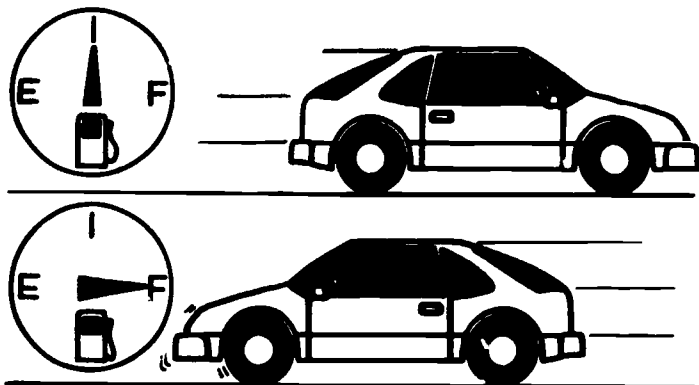

A breeder reactor is like this magic car. A breeder reactor not only generates electricity, but it also produces new fuel. In fact, a breeder reactor can produce more fuel than it uses. This is because breeders turn uranium-238 into a new fuel called plutonium-239.

How does a breeder reactor work?

The breeder reactor holds fuel assemblies that contain a mixture of plutonium-239 and uranium-238. The core is surrounded by a layer, or blanket, of fuel assemblies that contain only uranium-238. The uranium blanket does not release any energy. However, the uranium in the blanket does absorb neutrons from the fission process. When these neutrons are absorbed, the uranium-238 in the blanket is turned into plutonium-239. We call this breeding.

Plutonium-239 is the fuel in a breeder reactor. It splits apart and releases neutrons and heat energy. Some of these neutrons are absorbed by atoms of uranium-238 in the blanket, making more plutonium-239. Some fuel and blanket assemblies are removed about once a year and replaced with fresh ones. Used assemblies can

then be recycled to reclaim the plutonium-239, giving us more fuel than we used.

Uranium-238 absorbs an extra neutron and becomes plutonium-239.

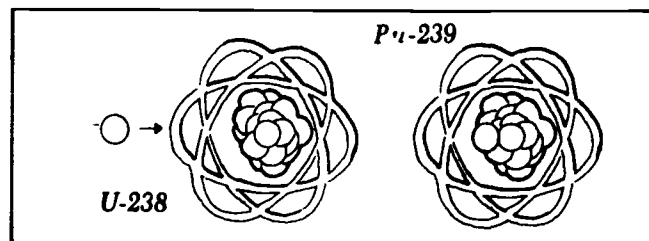

This means that breeder reactors can stretch our nuclear fuel supplies while producing electricity.

What is a liquid metal fast breeder reactor?

The breeder reactor design that has been developed most thoroughly is the *liquid metal fast breeder reactor*, or *LMFBR* for short. The term "fast" is used because the neutrons from the chain reaction are allowed to travel faster than in light water reactors. This is because fast neutrons cause plutonium-239 to release more neutrons for breeding new fuel. Because the neutrons travel faster, the breeder reactor generates more heat than a PWR or BWR. At the same time, water cannot be used as a coolant because water is a moderator, and it would slow fast neutrons. As a result, a breeder reactor uses a metal called *sodium* as a coolant instead of water or helium. Sodium turns to liquid in the reactor and flows like water. A familiar example of a liquid metal is the mercury in a thermometer.

One of the reasons breeders use sodium is because metals conduct heat better than other substances. If you touch something made of metal, it feels cooler than other objects made of wood or glass. This is not because the metal is colder. It is because the metal conducts the heat away from your hand faster than the other materials do.

How is heat in a breeder used to make electricity?

The liquid metal fast breeder powerplant has four loops of piping. Two carry liquid sodium and two carry water. It is essential to keep the sodium that passes through the core from any contact with water. Therefore, a second loop containing sodium separates the first loop from the water/steam loop.

In an LMFBR, sodium is circulated through the core and heated to about 540° Celsius (1,000° Fahrenheit). This sodium passes through a heat exchanger to transfer its heat to an intermediate sodium loop. The sodium in this secondary loop then moves to the steam-generator where it heats water in a third loop to steam at about 480° Celsius (900° Fahrenheit). This steam turns the powerplant turbine. A final loop condenses and cools the water heated in the third loop.

Is the breeder a new idea?

Using breeder reactors could enable us to obtain 70 times more energy from natural uranium than we can get by using PWRs or BWRs. But breeder reactors are not really new. One was operating in Idaho in 1951, and another larger one is working there now. In fact, the breeder in Idaho produced the world's first electricity ever generated by nuclear fission.

France, West Germany, Japan, the United Kingdom, and the Soviet Union also have breeder reactors. Other countries, including Italy, Belgium, the Netherlands, Switzerland, India, and South Korea, have cooperative programs with the nations that have these breeder reactor programs. Several different breeder reactor designs have been researched, but the major effort is on the LMFBR.

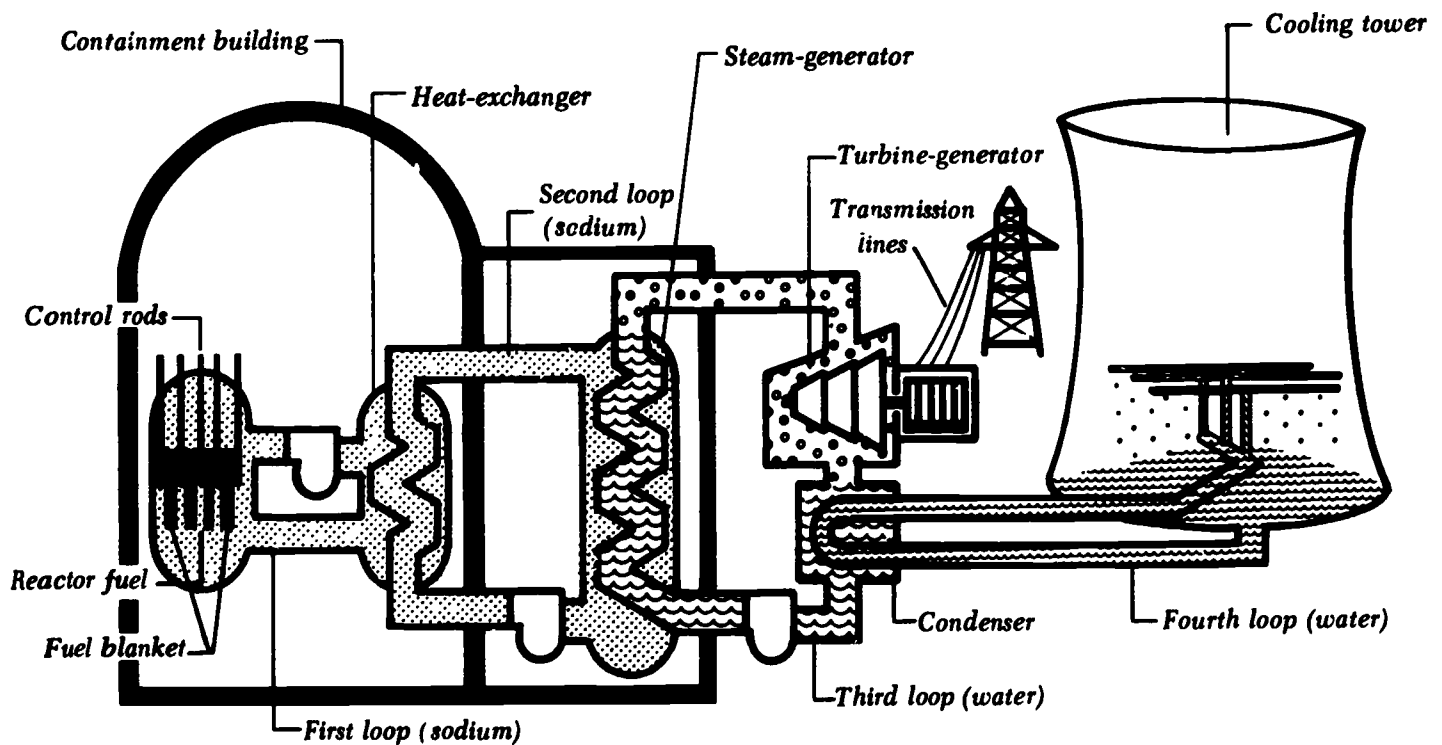

Liquid Metal Fast Breeder Reactor

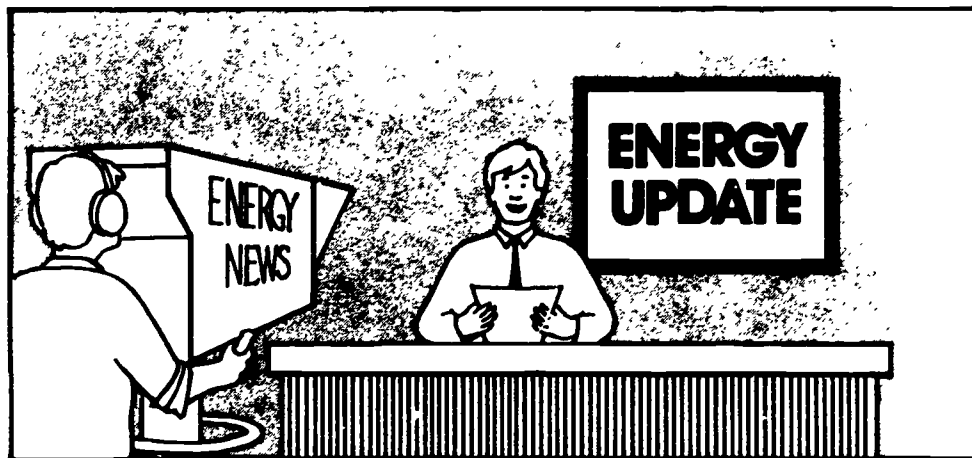

Other reactors update

There are several different types of nuclear reactors. These include pressurized water reactors (PWRs), boiling water reactors (BWRs), high temperature gas-cooled reactors (HTGRs), and breeder reactors.

A BWR is very similar to a PWR like Franklin. The main difference is that BWRs have only two cooling loops. The HTGR uses helium gas as the coolant in its first loop, graphite as its moderator, and uranium carbide for fuel. A breeder reactor is a type of fission reactor that generates electricity and produces new fuel at the same time.

LESSON 7 REVIEW EXERCISE

A. From the reading, select the word that best fits the statement.

1. A breeder reactor produces more _____ than it uses.
2. The outer layer of the breeder reactor core is called a fuel _____.
3. Bricks made of graphite and uranium carbide are stacked to form the core of the _____.
4. PWRs and BWRs are both _____.
5. The main difference between HTGRs and light water reactors is that HTGRs use _____ gas instead of water as a coolant in the first loop.

B. Indicate whether each statement is true (T) or false (F) by circling the correct letter. If the statement is false, correct it to make it true.

1. Control rods in the BWR come in from the bottom. T F
2. There are several different types of nuclear powerplants. T F
3. BWRs do not have steam-generators. T F
4. Breeder reactors require enriched uranium for fuel. T F
5. Graphite is a neutron moderator. T F

C. Answer the following questions.

1. Explain why adding a neutron to uranium-238 would turn it into plutonium-239.

2. If there is a nuclear powerplant near you, what type is it? _____

Nuclear Energy & Electricity

The Harnessed

Atom

Unit 4
Addressing the Issues

How does energy affect economics?

In order to understand why America needs abundant energy, it helps to understand something about *economics* (EK-ə-NOM-iks). Economics is the study of how we produce, use, and trade *goods* and *services*.

Goods are objects that we own, use, buy, and sell. Food, medicine, houses, cars, televisions, telephones, shoes, and clothes are all examples of goods.

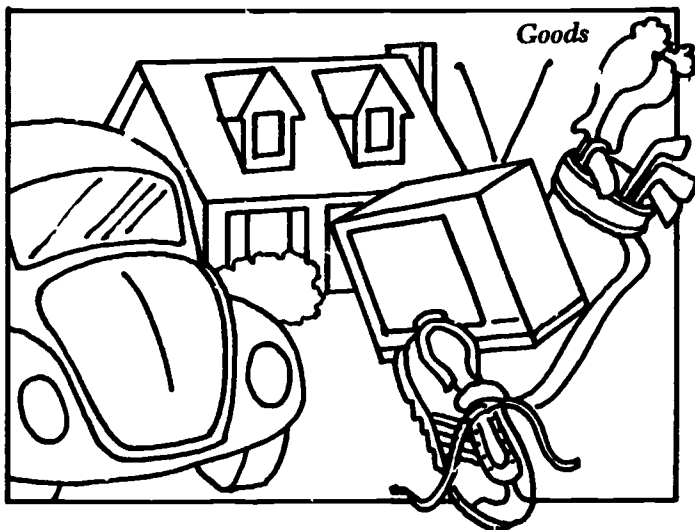

When a person sells his or her work, it is called a service. A carpenter builds things, doctors and nurses heal the sick, and teachers educate people. Building, healing, and educating are all examples of services.



Like people, countries can be rich or poor. One way to measure the economic health of a country is by its *standard of living*, or the necessities, comforts, and even luxuries that the people feel are essential to their way of life. In America, these things can include having food, automobiles, stereos, television sets, hot and cold running water, indoor plumbing, free education, and many other things that we take for granted. This is not true everywhere in the world.

America enjoys a high standard of living partly because for many years we have had abundant amounts of affordable energy. This energy has allowed us to produce plenty of goods and to provide services. To maintain our standard of living, people will have to continue to be able to buy energy at prices they can afford to pay.



Ancient people generally traded one good or service directly for another. Today we use money, but it stands for goods and services.

What is supply and demand?

Another concept in economics is *supply and demand*. Supply and demand determine the value of things. Demand is how much something is wanted, while supply is how much is available.

Supply and demand set prices. For example, gold is expensive because it is in short supply, and there is a lot of demand for it. Aluminum costs less because it is much more abundant.

Utilities build powerplants to meet our demand for electricity, and the demand for electricity changes from year to year. In the 1960s, experts predicted that the demand for electricity in the United States would increase by 10 percent each year until the year 2000. However, in the early 1970s, electric demand became harder to predict because the world entered an *energy crisis*.

What was the energy crisis?

Before the energy crisis began, most of our energy came from imported oil that we bought from other countries. In 1973, the countries belonging to the Organization of Petroleum Exporting Countries (OPEC) stopped selling oil to the United States to protest our country's involvement in the Arab-Israeli War. As a result, the supply of oil was suddenly limited and prices went up. There was not enough available oil to make as much gasoline as people wanted. People had to wait in line to buy gasoline, they could only buy limited amounts, and they had to pay high prices for what they were allowed to buy. Businesses and industries dealt with the shortage by cutting back on production, which caused people to lose their jobs. Also, because energy had cost more, companies raised prices on the goods they sold in order to continue to make a profit.

In 1979, a revolution in Iran caused Iran to stop selling oil. Again the world faced shortages, and again prices skyrocketed. In fact, the price of crude oil increased from \$7.00 a barrel in 1974 to \$32.00 a barrel in 1980. The increase in the price of oil has affected the price of almost all goods and services.

The oil shortages of the 1970s have caused people to be more aware of the importance of energy in their lives. Many people now believe our country should be less dependent on oil from other countries. One result has been increased use of electricity.

The question is how we will produce the electricity we want. Most experts now agree that we must use coal and nuclear energy to fuel our powerplants for the next several decades. This is because our country has an abundant supply of coal and uranium. At the same time, we should also continue to develop other energy sources.

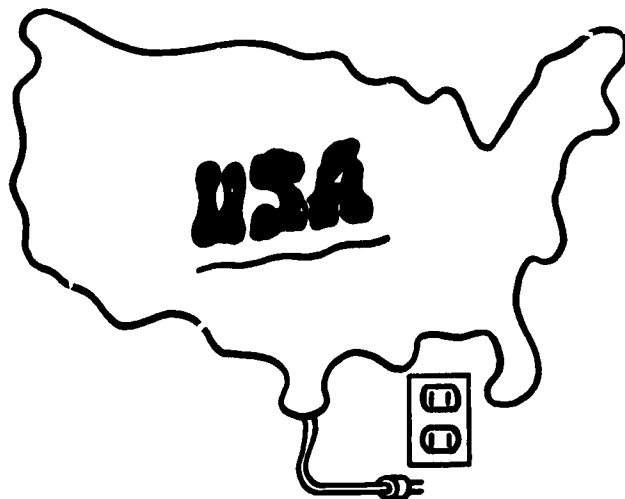

Without affordable energy, our economy suffers.

Some people believe that our country can wait for energy sources of the future such as solar power or fusion to be developed so that they can be used to supply our energy needs at reasonable prices. However, if we stop planning for electricity and wait for the perfect energy source to come along, our supply of electricity could fall short and our economy could slow down. This would cause our standard of living to decline, and most Americans do not want this to happen. Time may be the most precious resource we have.

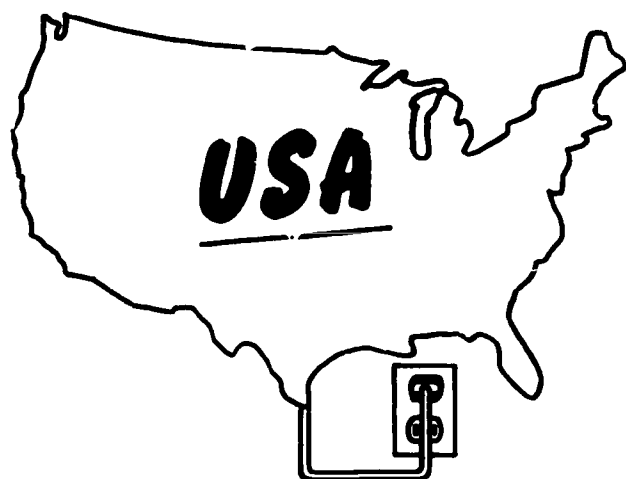

Since the energy crisis, our country has relied more and more on electricity for our energy needs.

What does a utility consider when deciding what kind of powerplant to build?

Before deciding what type of powerplant to build, utilities consider many things. They try to figure the cost of building the powerplant, including the cost of borrowing money. They estimate the cost of operating the powerplant over its entire lifetime. They also base their choice on the cost of the fuel and how easy it will be to get a continuous supply. Beyond these, another very important consideration is the safety of building the plant at the locations that are available for it. Finally, the effects the plant will have on the environment must be given close consideration.

What are the costs of building powerplants?

A utility must carefully consider all costs before building any new powerplant. Powerplant costs can be divided into three categories: *construction costs*, *fuel costs*, and *operating costs*.

The construction cost is the amount of money it takes to build a powerplant, plus *interest*, which is the cost of borrowing that money. The construction cost depends on the type, size, and location of the powerplant and the length of time it takes to build it. In order to meet very strict safety standards, nuclear powerplants must be built with high-quality materials that are expensive. Also, it takes longer to build a nuclear plant than most other types. As a result of all these factors, nuclear powerplants are more expensive to build than most other powerplants.

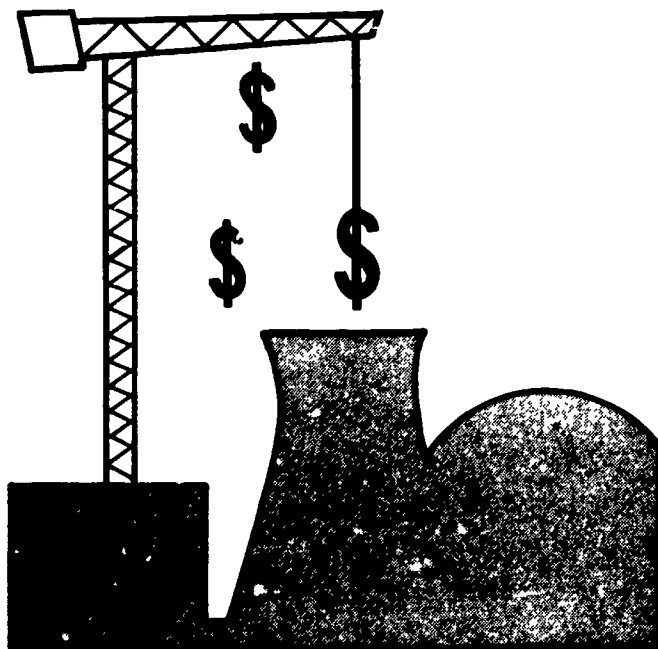

There are many costs involved in building powerplants.

Lesson 1

Different fuels have different amounts of energy in them. There is a lot of energy in a little bit of uranium, so only a little is needed. This makes fuel costs at nuclear powerplants lower, even with the expense of storing spent reactor fuel also included. In addition, the cost of uranium is not easily affected by such things as weather, strikes, or *embargoes* (em-BAHR-gohz), and the United States has an abundant supply. This makes the fuel costs of nuclear powerplants lower than fuels for other types of powerplants.

Operation costs go toward keeping the powerplant running after it has been built. These costs cover workers' salaries, as well as repair and upkeep of the powerplant. Furthermore, after a nuclear powerplant has operated for its 40-year lifetime, it must be dismantled and decommissioned. Part of the operating cost is the future expense of decommissioning the powerplant and of disposing of radioactive wastes. During the life of the powerplant, money is set aside for these two purposes.

When a utility decides to build a powerplant, it must consider all the costs. Then, because the public wants to have reasonably priced electricity, the utility must choose the energy source that costs less after all costs are considered.

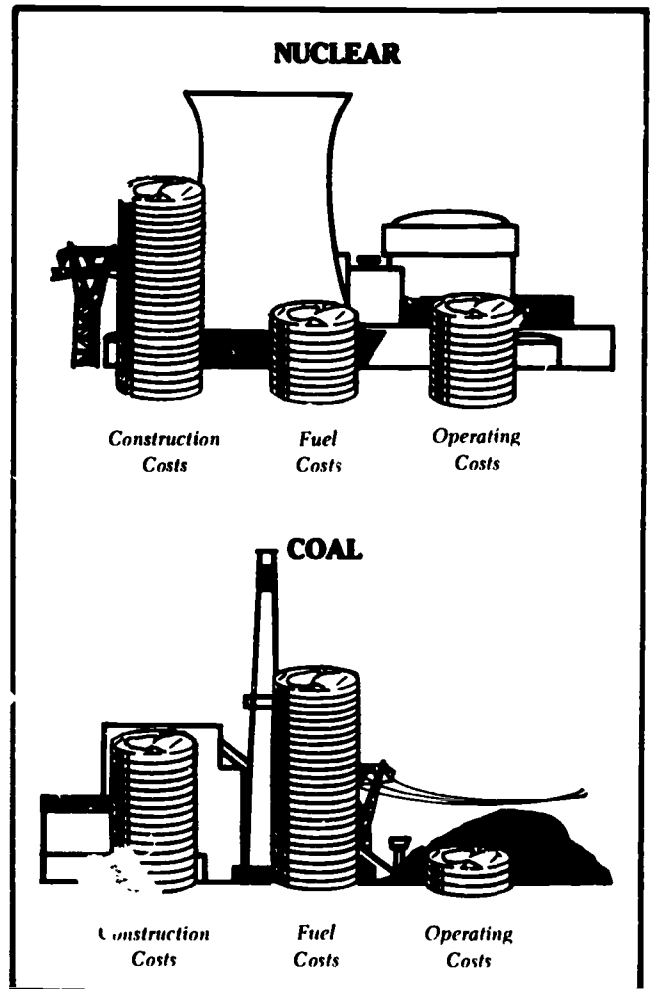

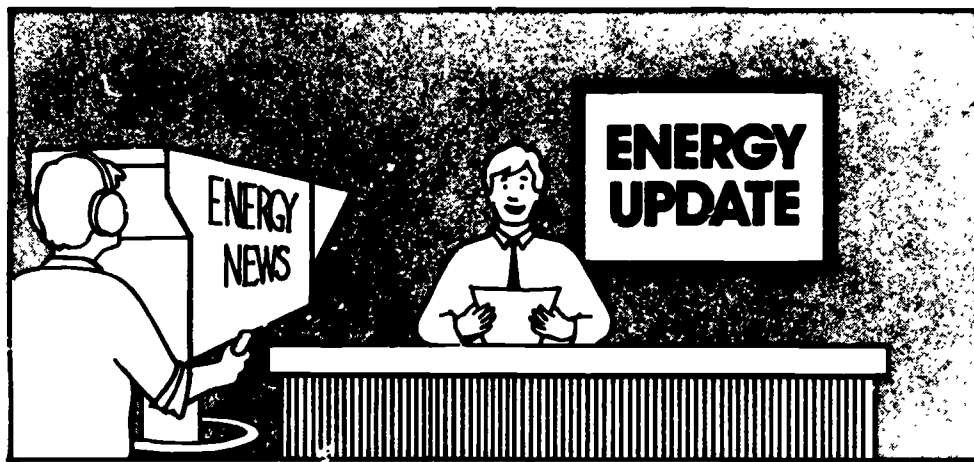

Energy and money update

Today, the average American enjoys a high standard of living. One reason for this is that we are able to produce goods and services efficiently. Yet, efficient production of goods and services requires abundant and affordable energy.

Supply and demand dictate the cost of all things, and this holds true with energy. Because of dwindling energy supplies, energy costs are going up. This makes it harder to produce goods and services, and, as a result, they cost more.

People are using more electricity, and this trend is expected to continue. The question we need to answer is how America will produce this electricity. In deciding what type of powerplant to build, utilities must consider construction, fuel, and operating costs. The sum of these costs will help them decide how to make electricity tomorrow.

LESSON 1 REVIEW EXERCISE

A. Indicate whether the following costs are construction costs, fuel costs, or operating costs.

- _____ 1. Mining uranium.
- _____ 2. Decommissioning the powerplant.
- _____ 3. Building the powerplant.
- _____ 4. Doing the environmental studies needed before the powerplant can be built.
- _____ 5. Milling uranium ore.
- _____ 6. Replacing old fuel assemblies.
- _____ 7. Paying the powerplant workers.
- _____ 8. Updating training of powerplant workers.
- _____ 9. Making repairs and paying for general upkeep.
- _____ 10. Enriching the uranium.

B. Indicate whether each statement is true (T) or false (F) by circling the correct letter. If the statement is false, correct it to make it true.

- 1. America has a low standard of living. T F
- 2. Supply and demand dictate the value of a good or service. T F
- 3. OPEC stands for the Organization of Petroleum Exporting Countries. T F
- 4. Demand is how much of something is available. T F
- 5. Most experts say that we must use coal or nuclear power to produce the electricity that we need for the next few decades. T F

C. Complete the following story with the appropriate words from the list below. You may use words more than once, or you may not use them at all.

supply

standard of living

demand

service

goods

image

The Spiders are America's newest and most popular rock and roll band, and everyone wants to hear their music. You could say that they are in _____. But the Spiders will only give their concerts in small auditoriums because they don't like the sound in large stadiums. This tends to limit the _____ of tickets to their concerts. In fact, people have been known to pay \$100.00 for a single ticket!

"We consider playing a concert as performing a _____. It is our job and we want to do it well," the Spiders' lead singer Bob recently told our music reporter. "After we record them, records become _____, and they can be sold like orange juice or steam irons. Selling 8 million records has really improved our popularity. As a result, there is more _____ for our group's music than before."

What is the main safety concern people have about nuclear powerplants?

The main concern that the public has about nuclear powerplants centers around radioactivity. However, little radioactivity is actually ever released from nuclear powerplants. Still, nuclear powerplants produce large amounts of radioactivity, and large amounts of radioactivity can be dangerous. If this radioactivity were somehow accidentally released into the outside world, people living near the powerplant would be in danger and might have to be evacuated. Therefore, many safety systems have been designed and built into nuclear powerplants to prevent major accidents from happening. As a result, nuclear powerplant safety is excellent.

Scientists, engineers, and architects all work together when plants are designed. Their work is based on years of careful planning and extensive studies. They pay close attention to the rigorous safety standards that experts have developed. This means that every safety-related system inside a nuclear powerplant has at least one backup system that is tested regularly to make sure it will work if it is ever needed.

In addition, the building that holds the reactor is designed to work as a barrier that keeps radiation inside, away from the environment. There are many other barriers that also hold in radiation. The uranium fuel, which becomes highly radioactive in the reactor core, is put into a ceramic form to contain the radioactivity. This solid fuel is in turn contained in strong metal fuel rods that also serve as a barrier between radiation and the environment.

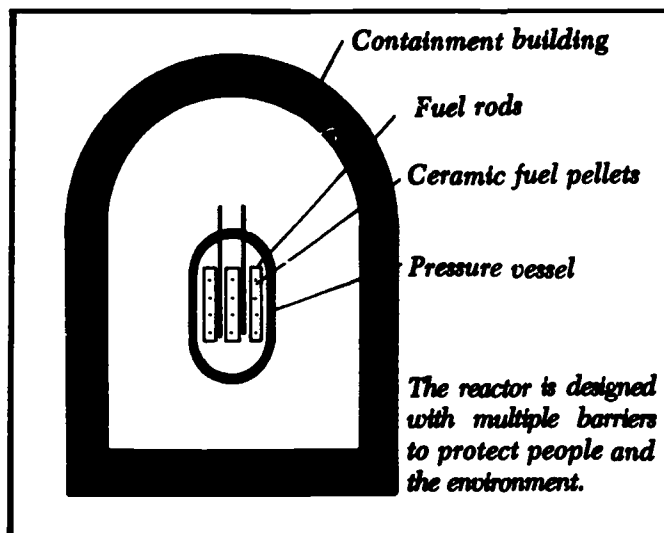

A third protective barricade between radioactive material and the environment is the pressure vessel. The pressure vessel is located in the air-tight containment building, which is built of steel-reinforced concrete. This building can withstand tremendous impacts or severe weather without releasing radiation into the environment.

Finally, powerplant sites are also selected to minimize risks to the public and the environment. The law requires that utilities operating nuclear powerplants must develop plans for responding to emergencies involving the plant. These plans involve quickly notifying the public, the Nuclear Regulatory Commission, and emergency personnel such as firemen, rescue workers, and police if a problem occurs. The utility also must make plans for evacuating people who live nearby.

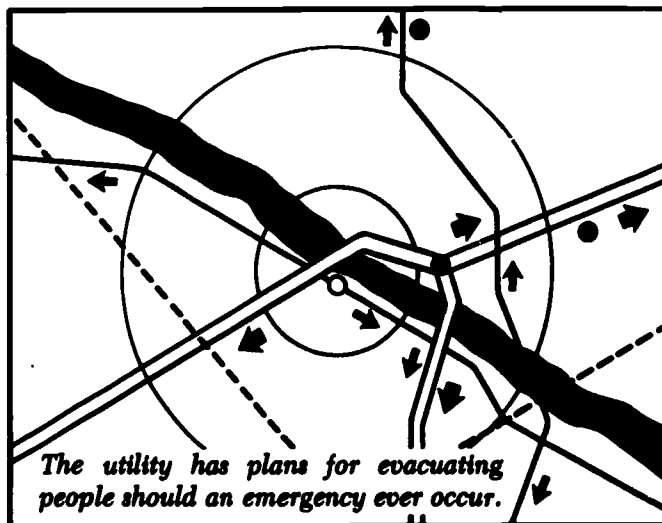

Isn't even a small amount of radiation harmful?

Some people are concerned about the tiny amounts of radioactivity that are released during normal operations at nuclear powerplants. Most scientists agree, however, that the tiny extra amounts of radioactivity released from nuclear powerplants during normal operations are insignificant when compared to normal levels of natural background radiation we receive every day.

Exposure to radiation is measured in units called millirems. The average American receives between 150 and 200 millirems of radiation each year from all sources. This radiation comes from sources such as cosmic rays and naturally radioactive atoms of elements such as potassium and carbon, which are part of our environment. Smaller amounts of background radiation also come from man-made sources like medical x rays.

Nuclear powerplants are not allowed to add more than 5 millirems a year to the radiation we receive. In fact, the average American receives far less than 1 percent of his or her total radiation exposure from the nuclear power



Many things contribute to the background radiation exposure of the average American.

What about the radioactivity from spent fuel?

Because some parts of the spent fuel and other reactor wastes remain radioactive for thousands of years, many people have questions about how these wastes will be isolated from the environment. The main concern is whether these radioactive materials can be safely contained for enough time to allow them to go through the process of radioactive decay while becoming less and less hazardous. Some people also worry that future generations may accidentally unearth these wastes.

The United States and other countries, including France, Sweden, and West Germany, are currently planning to build geologic repositories to permanently dispose of highly radioactive wastes. The wastes will be buried in large rock formations that have not shifted or moved in thousands of years. The wastes will be deposited at depths between 1,000 and 3,000 feet beneath the Earth's surface, and careful precautions will be taken to ensure that the radioactive materials are not released into the environment.

The Nuclear Waste Policy Act of 1982 requires that the United States develop the technology, locate a site, and build a high-level waste repository by 1998. However, siting of these disposal sites may still be an issue to some people who do not want repositories located near them.

Can't spent fuel also be made into bombs?

An additional concern that some people have about nuclear powerplants is that terrorists could steal or hijack a shipment of unused or spent fuel and then use it to build bombs. However, these materials cannot explode like a bomb. The materials used in nuclear weapons are different from those used in powerplants. It is impossible to use new or spent reactor fuel for weapons unless the fuel is specially treated. This treatment would require expensive and sophisticated processes that are only available in a few places in the world.

How do nuclear powerplants affect our dependence on foreign oil?

An issue that involves national security is our dependence on imported oil. Some people say we must use more of our abundant resources of coal and uranium, or we will continue to be vulnerable to economic problems. We have already experienced economic hardships that can be blamed on our dependence on foreign oil.

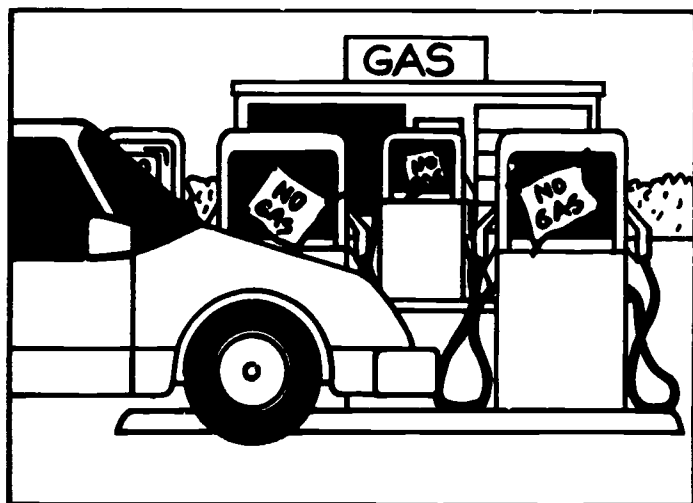

Many people feel that making lots of affordable electricity by using nuclear power would ease our dependence on foreign oil. This would free fossil fuels for use in plastics, medicines, chemical production, and other industrial uses. Other people argue that our dependence on foreign oil can be decreased through conservation of existing resources, and by using such technologies as solar power and fusion energy that have yet to be developed.

What happened at Three Mile Island?

In March 1979, an accident occurred at the Three Mile Island Nuclear Powerplant, near Harrisburg, Pennsylvania. Mechanical failures and mistakes of people who were operating the reactor caused it to lose some of its coolant. As a result of the accident, high levels of radiation were released into the containment building and the reactor core was damaged.

Many people living near the plant were frightened, but extensive studies now show that the accident had little effect on people's physical health. People living within 50 miles of the plant received some radiation—less than they would have received from a normal dental x ray. Studies also predict that there will be little long-term effect.

Cleaning up has been a very expensive process. The Three Mile Island accident frightened many people. Nevertheless, no one was killed or injured, and the land was not contaminated.

One effect of the 1973 oil embargo was gasoline shortages.

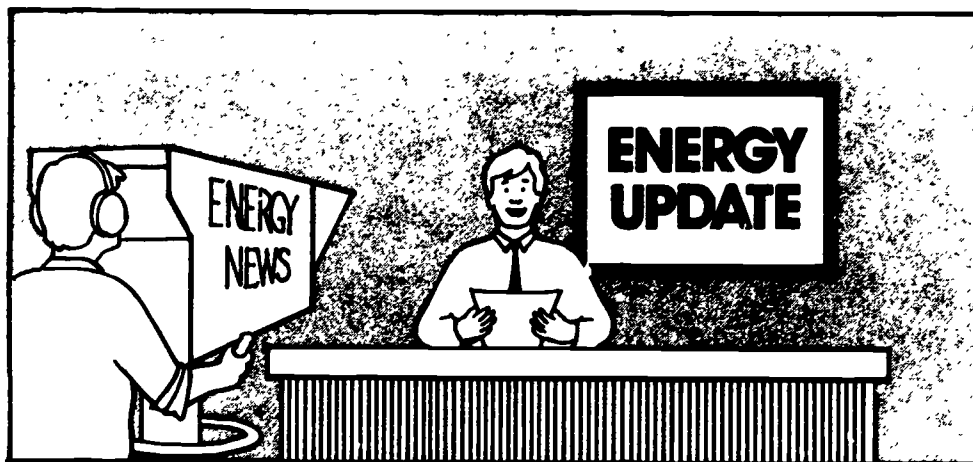

Safety update

The main concern that most people have about nuclear power is radiation. Nuclear powerplants produce radioactive materials and must be equipped with containment and backup safety systems that assure this radiation is never released into the environment. Consequently, nuclear powerplants are built to avoid problems and contain radiation.

Provisions are also made for properly disposing of spent reactor fuel, which remains radioactive for a long time after it leaves the reactor. Federal law requires that the United States build a geologic repository where high-level waste can be safely stored for thousands of years.

Another worry people have is that terrorists can use stolen fuel to build bombs. However, the nuclear material in spent or unused fuel cannot be made into bombs, and the technology required to make them suitable is expensive and complex.

The Three Mile Island accident is another thing that worries people about nuclear powerplants. No one was hurt or killed, and the surrounding land was not contaminated.

LESSON 2 REVIEW EXERCISE

A. Indicate whether each statement is true (T) or false (F) by circling the correct letter.
If the statement is false, correct it to make it true.

1. The accident at Three Mile Island released large amounts of high-level radiation to the environment. T F
2. Radioactive materials used in nuclear powerplants cannot explode like the materials used in nuclear weapons. T F
3. Uranium fuel becomes highly radioactive in the reactor core. T F
4. Powerplant sites in the United States are located inside large cities so the electricity is close to the customer. T F
5. High-level nuclear waste repositories will be located deep in sandy soils. T F
6. The average American receives less than 1 percent of his or her total radiation exposure from the nuclear power industry. T F
7. High-level nuclear waste can remain radioactive for thousands of years. T F
8. After it is removed from the reactor, nuclear waste becomes less radioactive. T F
9. Every safety-related system in a nuclear powerplant has at least one backup safety system. T F
10. The United States is the only country in the world planning to store high-level radioactive wastes in geologic repositories. T F

B . Complete the following story with the appropriate words from the list given. You may use some words in the list twice, while you may not need to use some words at all.

- | | | |
|-------------|---------------|-----------|
| backup | public | safety |
| barriers | radioactive | sites |
| environment | radioactivity | technical |

The _____ of the public is a main concern at nuclear powerplants. These powerplants have many _____ systems that are designed to make sure that the _____ materials powerplants produce are never released into the _____. The building where the reactor is located and many other reactor parts are designed to serve as _____ that keep radioactivity inside the reactor. In addition, every system that is necessary for safe operation must have a _____ system that can perform the same function if necessary.

C. List three aspects of nuclear powerplants that cause some people to worry.

1. _____
2. _____
3. _____

D. List three safety features that make nuclear powerplants safe.

1. _____
2. _____
3. _____

How does our country rely on energy?

Energy is vital for many of the things that we rely on in our modern world. Without abundant energy it would be impossible to grow and prepare the food needed by all the people in our country. It would be impossible to build, heat, or light all our homes. Mass producing clothing and shoes would be out of the question. Modern transportation would become a luxury that only a few could afford.

To meet our energy needs, we are turning more and more to electricity. This is partly because electricity can be produced by using a number of energy sources such as coal, oil, natural gas, uranium, and solar and water power. In addition, we have networks of power lines for easily moving electrical energy from powerplants where it is produced to the many different places where it is used.

One of the more complex and controversial issues in the United States today is whether we should use nuclear energy to produce the electricity we need now and the electricity we will need in the future. The decisions our nation makes about this issue could affect greatly how we will live tomorrow. Most experts predict that we will have to use coal or uranium to produce the amount of electricity people will

need at a cost they can afford. There are problems with using uranium, and there are also problems with using coal. Therefore, we need to understand the facts so we can make informed decisions about how to generate electricity.

How do you make an informed decision?

The first step in making an informed decision is to define the problem or choice you have to make. This is true whether you are making a decision that affects only you or whether you are making a decision that affects society as a whole.

Even if you are making a decision by yourself, the first definition of the problem may be inaccurate. For example, if you are babysitting, you may say the problem is, "Should I let my younger brother ride his bicycle?" But when you examine the question, it may turn out that the real problem is not the bicycle riding, but where to ride the bicycle. A better definition might be, "Should I let him ride the bicycle downtown where the traffic is dangerous?"

When groups of people make decisions, it may be more difficult to define the problem because people may not agree about the nature of the problem.

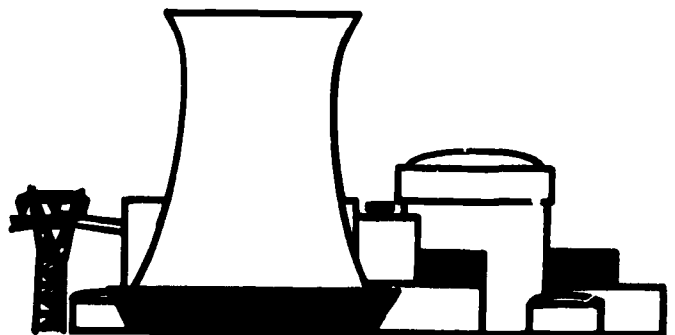
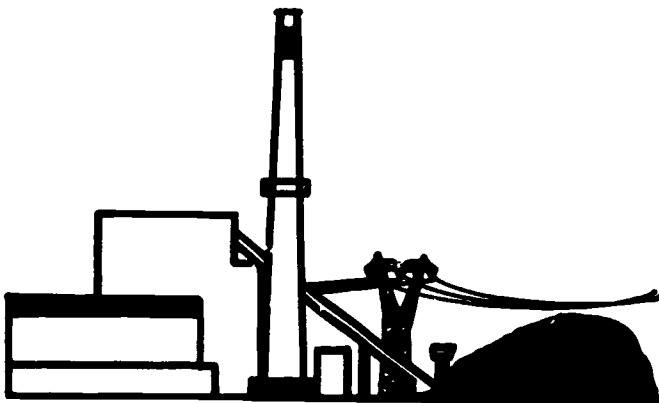

Most experts predict that we will have to rely on coal and uranium to produce our electricity over the next several decades.

The second step in making an informed decision is to gather information. The amount of information you need varies according to how complicated the problem is. To decide what you need to know, you may ask some questions. What are the possible risks? What are the possible benefits? How likely is it that these risks or benefits will happen? What can you do instead, and will that be better or worse?

What are the problems in energy decision making?

There are problems with all energy sources. For example, we have a limited supply of oil and natural gas. We have to buy oil from other countries to meet our demands. It is hazardous to mine and process coal, uranium, and the materials that are used in solar cells. Radioactive wastes are produced at nuclear powerplants. Burning wood, coal, and oil causes air pollution. We have run out of good places for building large new dams for water power. Sources that depend on wind or direct sunlight are only useful when the wind is blowing or the sun is shining.

So with each source of energy, trade-offs must be made. There are some good things and some bad things about each energy source. Most people feel that the benefits of having abundant energy are worth some risks.

In deciding how to make our electricity, we will have to weigh the risks and benefits of using various energy sources.

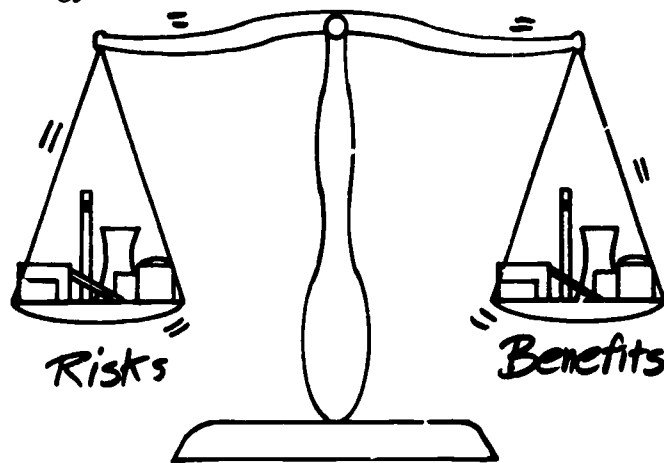

In fact, everything we do exposes us to some risk. Walking across the street or down a flight of stairs, riding a bicycle around the block, and participating in sports all present certain risks.

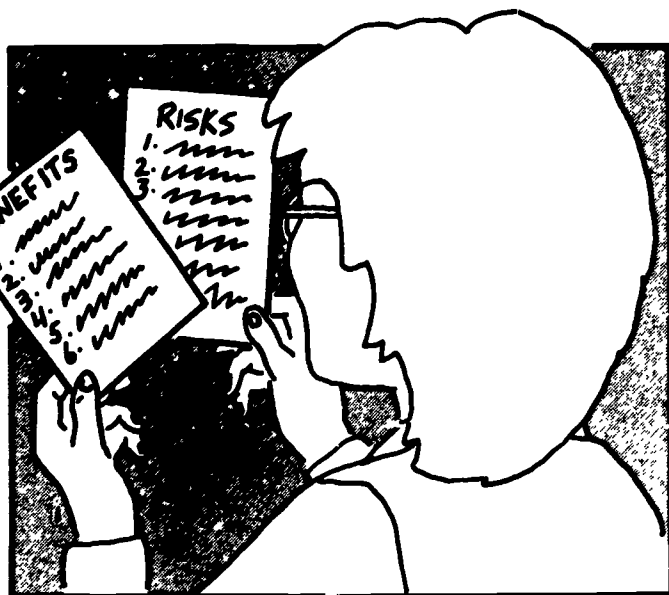

One step in making a decision is to compare risks and benefits.

After you have gathered information about the problem, you will need to evaluate this information. One way to do this is by making two lists, one of the benefits and one of the risks. When the lists are complete, the next step is to compare risks and benefits. By the end of this process, you should be able to arrive at a decision based on what you think about the facts.

If a group of people is making a decision, then the different opinions of people can be combined to reach a group decision based on the facts as people see them. This process can take a long time.

Lesson 3

There is a new area of science called *risk assessment* (ə-ses-mənt) that has been used to study the risks in various industries. Risk assessment can be very complicated. For example, in studying risks in the nuclear power industry, scientists examine every aspect, beginning with mining the fuel, building and operating the powerplant, and ending with decommissioning the powerplant and disposing of nuclear waste.

How do people make decisions about risks?

People who study human behavior tell us that we are especially distrustful of new or unfamiliar things. When electricity, trains, and automobiles were first developed, many people were hesitant to use them. When given choices, we are most likely to pick things that are more familiar. For example, many people refuse to fly in airplanes, but will travel in cars, even though statistics show that airplanes are less likely to have accidents. Medical vaccinations, prescription drugs, food additives, and nuclear powerplants are other examples of new developments that have changed the way we live, but that also concern many people.

Scientists have found evidence that many everyday foods contain tiny amounts of harmful substances. However, in most cases the benefits of eating food easily outweigh the risks that these substances pose because food provides our bodies with the energy that keeps us alive.

On the other hand, we have grown accustomed to certain hazards even though they are comparatively dangerous. For example, thousands of people are injured in automobile accidents each year. Most young people accept some risks in their lives when they bicycle or skateboard, go sledding or swimming, or participate in sports like football, basketball, soccer, or softball.



Many of our favorite activities involve risk.

What are the risks and benefits of nuclear energy?

As with all energy sources, nuclear energy has both risks and benefits. Perhaps the major questions that must be answered about nuclear energy as a source of electricity are:

- 1) Do the benefits outweigh the risks?
- 2) What are the risks of using other sources of energy for generating electricity, and are those risks worth taking?
- 3) What are the risks of not using electricity, and are those risks better or worse than taking some risks to have electricity and the quality of life that goes with it?

These are very difficult questions and there are no simple answers.

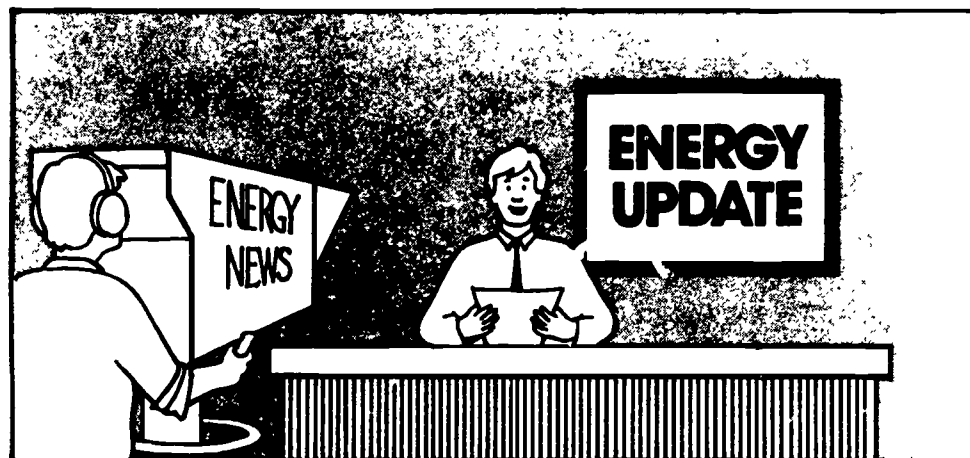

Energy decision making update

One controversial issue in the United States today is whether we should use nuclear energy to produce electricity. In order to make decisions about this issue, it is important to be well informed about the risks and benefits of this energy source and all other energy sources.

Making an informed decision about nuclear energy involves defining the problem accurately, gathering information, and evaluating the information by comparing and weighing the risks and benefits.

An area of science called risk assessment studies the risks involved in many industries.

LESSON 3 REVIEW EXERCISE

- A. Name six energy sources and then identify a problem involved in using each source as a fuel to make electricity.

Energy Source	Problem
1. _____	_____
2. _____	_____
3. _____	_____
4. _____	_____
5. _____	_____
6. _____	_____

- B. From the reading, select the word that best fits the statement.

1. Most experts predict that in the future the United States will rely on _____ and _____ to produce electricity.
2. In making decisions, many people balance the _____ and the _____.
3. Many people were afraid to use _____, _____, and _____ when they were first invented.
4. An area of science called _____ studies and compares the hazards of different industries.

- C. What are three steps that can be used to help make an informed decision?

1. _____
2. _____
3. _____

Nuclear Energy & Electricity

The Harnessed

Atom

Appendix A

MODEL OF FRANKLIN

Appendix A

Powerplant floor plan

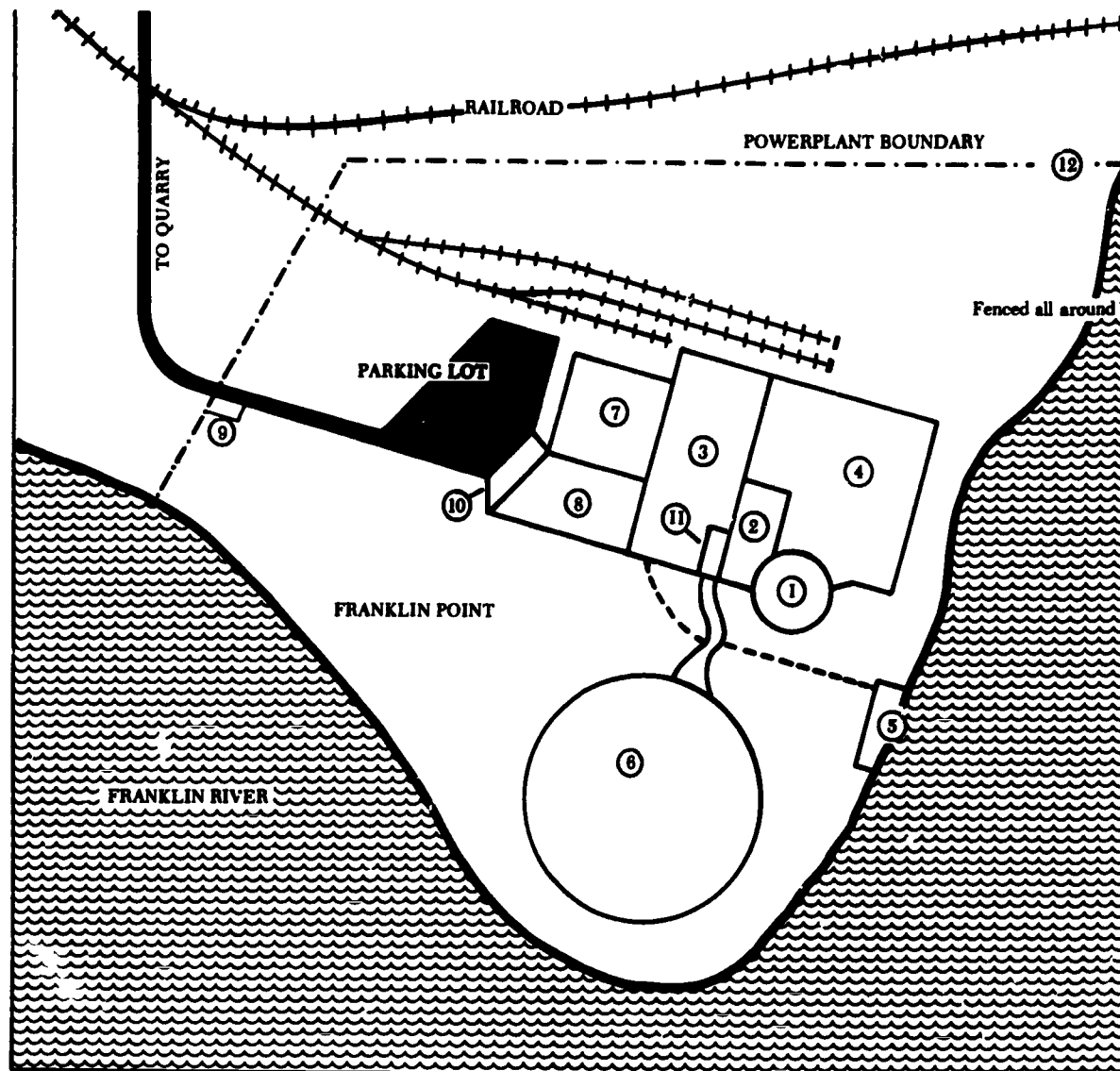

1) Containment building

This building holds the reactor pressure vessel, which contains the reactor and Franklin's four steam-generators. Each steam-generator is 67 feet tall, 14 feet in diameter, and weighs 331 tons. The pressure vessel is 40 feet tall, 14 feet in diameter, and weighs more than 300 tons. This building also houses pumps to circulate water, devices to keep the pressure in the pressure vessels, and several cranes that are used to load and unload reactor fuel. The containment building is extremely strong. Its walls are made of steel-reinforced concrete, 3 feet thick.

2) The control building

The powerplant's computers are located in the control building, along with all sorts of instruments and control boards that monitor the reactor, powerplant electricity output, and even local weather conditions. The control room is located here, so the people who operate the reactor can have all the information they need without having to move about the powerplant.

3) Turbine-generator building

The turbine-generator building is where Franklin's 1-million-kilowatt electric generator is located. Turbine-generators are basic to almost all facilities that make electricity. Franklin's is quite large: 210 feet long and 120 feet wide.

4) Auxiliary building

The auxiliary building holds the equipment used to service the reactor. This includes areas for handling new and used reactor fuel. Used fuel, which is very radioactive, is stored here in a 35-foot-deep pool of water that provides shielding. Less hazardous radioactive wastes are treated here as well.

5) Water intake building

The water intake building is located on the bank of the Franklin River. The building contains pumps that supply about a million gallons of water each minute to the cooling tower.

6) Cooling tower

This 500-foot-tall tower uses natural evaporation to remove the heat from the powerplant's cooling water before returning it to the Franklin River.

7) Warehouse and shop building

This building provides space to store equipment and spare parts needed to repair and maintain the entire powerplant. The building also contains machine shops, electrical shops, locker rooms, welding areas, and even scientific labs where such things as workers' radiation doses and water quality are carefully monitored.

8) The office building

This building provides work space for the clerks, typists, security workers, managers, engineers, scientists, and record keepers who take care of day-to-day business at the powerplant.

9) The first guard station 10) The second guard station 11) The third guard station

Security guards are stationed at these three sites to monitor all people and materials entering and leaving the powerplant site.

12) The powerplant boundary

The powerplant boundary is fenced and carefully monitored.

Nuclear Energy & Electricity

The Harnessed

Atom

Glossary

Pronunciation Key

The pronunciation guide can help you say the glossary words correctly. The spellings in the parentheses show the way the word sounds.

(ə) represents any vowel sound that is weak or unaccented.

Examples include: a in amuse
e in given
i in resident
o in connect
u in tantrum

Accented syllables are shown in capital letters. For example, in adventure (ad-**VEN**-chər) **VEN** is the accented syllable.

Double vowels indicate a long vowel sound.

Examples include: aa in nature
ee in equal
ii in exercise
oo in cope

GLOSSARY

activation analysis (AK-tə-VAA-shən ə-NAL-ə-sis) - A form of scientific investigation where the chemical makeup of different materials is figured out by bombarding them with neutrons or other types of radiation. This produces radioactive atoms that give off specific types of radiation, and this radiation reveals what types of elements are in the samples.

adverse (ADD-vərs) - Unfavorable.

alpha (AL-fə) - A positively charged particle emitted by certain radioactive materials. Alpha particles can be stopped by a sheet of paper.

atom (AT-əm) - The smallest part of an element that has all the properties of that element.

background radiation (BAK-grownd ray-dee-AY-shən) - The natural radioactivity in the environment. Most natural background radiation results from cosmic rays that come from outer space and from radiation from the naturally radioactive elements.

backup safety system - A safety system that will go into operation if the first-line safety system fails.

baffles (BAF-els) - Tiles inside the cooling tower of a nuclear powerplant that slow the rate of water flow and provide area for cooling.

beta (BAYT-uh) - A fast-moving electron that is emitted from unstable atoms that are becoming stable. Beta particles can be stopped by aluminum foil.

biomass (BIGH-o-mass) - Any kind of organic substances that can be turned into fuel, such as wood, dry plants, and organic wastes.

boiling water reactor - A nuclear reactor in which water, used as both coolant and moderator, boils in the reactor core. The steam from the boiling water is used to turn the turbine-generator.

boron (BOR-on) - A nonmetallic element that occurs in borax and other compounds. Boron is used in nuclear powerplants. Its atomic number is 5 and its atomic weight is 10.811. Its symbol is B.

breeder reactor - A type of nuclear reactor that makes more new fuel (plutonium-239) than it uses.

BWR - Abbreviation for boiling water reactor.

cadmium (KAD-mee-əm) - A soft, bluish-white metallic element resembling tin, used in control rods in nuclear reactors. Its atomic number is 48, and its symbol is Cd. Its atomic weight is 112.40.

carbon dating (KAR-bən) - A way of discovering the age of old objects by determining the amount of radioactive carbon-14 that such objects contain.

CAT scanner - A medical instrument that combines x-ray machines with computers in order to provide color television images of internal organs. CAT is an abbreviation for Computerized Axial Tomography.

GLOSSARY

ceramic (sə-RAM-ik) - An article made of pottery, earthenware, or porcelain. Uranium fuel is made into a ceramic material at a fuel fabrication plant.

chain reaction - A reaction that stimulates its own repetition. In a nuclear chain reaction, some of the neutrons given off by a nucleus that has been split collide with other nuclei, which give off neutrons that collide with more nuclei. The reaction continues to repeat itself.

chemical energy (KEM-i-k'l EN-ər-jee) - The energy released when the chemical makeup of materials changes. The energy in coal is released when the coal is burned.

chemical reaction (KEM-i-k'l ree-AK-shən) - A chemical reaction occurs between the electrons of atoms, but it does not change the element itself.

condenser (kən-DEN-sər) - The equipment that cools steam and turns it back into water.

conservation (KON-sər-VAA-shən) - Protection or preservation.

construction costs (kən-STRUK-shən) - The amount of money it takes to build a powerplant.

construction permit - Permission given by law to build something.

containment building (kən-TAAN-ment) - A structure made of steel-reinforced concrete that houses the nuclear reactor. It is designed to prevent the escape of radioactive material into the environment.

contamination (kən-TAM-ə-NAA-shən) - The act of making some substance impure, radioactive, or unclean.

control rods - Devices that can be raised and lowered in the reactor core to absorb neutrons and regulate the chain reaction. The speed of the chain reaction is controlled by control rods.

control room - The room in a nuclear powerplant where operators work. The equipment in the control room tells the operators what is happening in the reactor and other parts of the plant.

conversion (kən-VER-zhən) - Changing from one form to another.

conversion plant (kən-VER-zhən) - A plant where mined uranium is converted to a gas and is purified.

coolant (KOO-lənt) - Substance used for cooling.

coolant/moderator (KOO-lənt/mod-ə-RAA-tər) - Substance used to cool the reactor and to slow neutrons. In most nuclear powerplants, water is used for cooling to keep the reactor from getting too hot and to slow neutrons down so they are more likely to cause uranium-235 to fission.

GLOSSARY

cooling tower - A structure in a nuclear powerplant used to remove heat from cooling water from the condenser. The cooling tower prevents thermal pollution of lakes and rivers.

cosmic rays (KOZ-mik) - A very powerful stream of energy that comes toward Earth from beyond the Earth's atmosphere.

curie (KYUR-ee) - A unit of measure to describe the intensity of radioactivity in materials.

decay chain (di-KAY CHAYN) - The ordered process that certain elements pass through in order to become stable.

decommissioned (DEE-kə-MISH-ənd) - The process of closing a nuclear powerplant after it has operated about 40 years.

demand - See supply and demand.

deuterium (dyu-TIR-ee-əm) - An isotope of hydrogen whose nucleus contains one neutron and one proton and is about twice as heavy as the nucleus of normal hydrogen, which has only a single proton. Deuterium is often referred to as heavy hydrogen. Deuterium is the fuel used in fusion.

discernible (dis-ERN-nə-bəl) - Recognizable as separate or distinct.

economics (EK-ə-NOM-iks) - The science concerned with how we make, use, and distribute goods and services.

economists (i-KON-ə-mists) - People who study or manage workers, money, and goods.

economy (i-KON-ə-mee) - A country's or area's system of resources, workers, money, and goods.

efficient (ə-FISH-ənt) - Doing or producing something with the least amount of wasted energy.

electrical energy (ih-LEK-tri-k'l EN-ər-jee) - A form of energy produced by the flow of electrons, usually through a wire.

electricity (ih-lek-TRISS-ə-tee) - Energy in the form of moving electrons.

electromagnetic wave (ih-lek-troh-mag-NET-ik) - A wave that comes from the action of electric and magnetic forces and moves at the speed of light.

electron volts (ih-LEK-tron VOOLTS) - Units of energy equal to the energy of one electron moving through a potential difference of one volt.

electrons (ih-LEK-trons) - The smallest existing particles with a negative electric charge. Electrons are one of the three basic types of particles that make up the atom; they orbit the nucleus.

GLOSSARY

electroscope (i-LEK-trə-skope) - An instrument that measures small electrical charges and shows whether they are positive or negative.

elements (EL-ə-mənts) - One of more than 100 simple substances that cannot be chemically broken down and of which all matter is composed.

embargoes (em-BAHR-gohz) - Laws putting restrictions on the shipping, buying, or selling of goods.

emit (ee-MIT) - To send out.

emitting (ee-MIT-ing) - Sending out.

energy (EN-ər-jee) - The ability to do work; energy is found in the forms of mechanical energy, chemical energy, electrical energy, nuclear energy, heat, and light.

energy conversions (EN-ər-jee kən-VER-zhənz) - Processes of changing one form of energy into another.

energy crisis - A period when the supply of an energy source (such as oil) is limited and prices go up.

engineers (en-jə-NIERS) - People trained to plan, design, build, and operate machines, bridges, roads, and other types of complicated construction or equipment.

environmental (en-VII-rən-men-tl) - Having to do with our surroundings.

environmentalists (en-VII-rən-men-tl-ists) - People who study our surroundings and the effects that certain conditions have on these surroundings.

film badge - A piece of film that is worn by workers in order to see whether they have been exposed to radiation.

fission (FISH-ən) - To divide or split apart; the process of dividing or splitting into parts.

fission products (FISH-ən PROD-əktivs) - The atoms formed when uranium is split in a nuclear reactor. Fission products are usually radioactive.

fossil fuels (FOSS-əl FYOO-əlz) - Natural, burnable substances formed from ancient plant or animal matter; coal, oil, and natural gas are fossil fuels.

fuel assemblies (FYOO-əl ə-SEM-blees) - Structures that contain about 240 fuel rods of uranium pellets. Fuel for a nuclear powerplant is loaded in the reactor core in fuel assemblies.

fuel costs - The amount of money it takes to get fuel ready to use in a powerplant. These costs include mining, processing, transportation, and storage.

GLOSSARY

fuel fabrication plant (FAB-rə-KAA-shən) - A plant where uranium fuel is made into a ceramic material called uranium dioxide.

fuel pellets - Cylinders into which nuclear fuel is formed for use in a reactor. A fuel pellet is about the size of your fingertip.

fuel rods - 12- to 14-foot-long rods that hold fuel pellets.

fusion (FYOO-zhən) - A combining of atomic nuclei, releasing an enormous amount of energy.

gamma (GAM-ə) - A type of radiation that is released in waves by unstable atoms when they stabilize. Gamma rays can be stopped by lead.

gaseous diffusion plant (GAS-ee-əs di-FYU-zhən) - A plant where uranium hexafluoride gas is filtered and the percentage of uranium-235 is increased from 1 percent to 3 percent.

Geiger counter (GIGH-gər KOWN-tər) - An electronic instrument for detecting and measuring radiation and radioactive substances.

generate (JEN-ə-rayt) - To produce or make.

generator (JEN-ər-ray-tər) - A machine that makes electricity. It uses mechanical energy to spin a turbine that turns a coil of wire in the presence of a magnetic field. When this happens, an electric current is produced.

geothermal (JEE-oo-THER-məl) - Energy from the heat inside the Earth.

goods - Objects that we own, use, buy, and sell. Food, houses, cars, televisions, telephones, clothes, and shoes are all examples of goods.

graphite (GRAF-iit) - A very pure form of carbon used as a moderator in some nuclear reactors.

habitat (HAB-ə-tat) - The place where a plant or animal naturally grows or lives.

half-life - The amount of time needed for half of the atoms in a type of radioactive material to disintegrate.

hazardous (HAZ-ər-dəs) - Dangerous or risky.

hearings - Meetings where all points of view are presented.

helium (HEE-lee-əm) - A very light, colorless, odorless gas that is used as a coolant in some nuclear reactors. Its atomic number is 2 and its atomic weight is 4.0026. Its symbol is He.

high-level waste - Nuclear powerplant waste that is very radioactive.

GLOSSARY

high temperature gas-cooled reactor - A nuclear reactor cooled with helium.

hormones (HOR-mohnz) - Chemical substances made by body organs that regulate the activity of other organs.

HTGR - Abbreviation for high temperature gas-cooled reactor.

hydropower (HI-dro-pou-ər) - Electric energy produced when the force of falling or moving water is used to spin a generator.

indirect observation - A type of scientific investigation that is used to study things that cannot be directly sensed. This is often done by observing the interaction and effects that such things have with and on their environment.

inefficient (in-ə-FISH-ənt) - Wasteful of energy.

interest - The cost of borrowing money.

ionizing radiation (i-ə-NIZ-ing ray-dee-AY-shən) - Radiation that has enough energy to remove electrons from substances that it passes through, thus forming ions.

isolated (II-sə-laətd) - Set apart; kept alone.

isotopes (II-suh-tohps) - Atoms of the same element that have equal numbers of protons, but different numbers of neutrons.

kinetic energy (ki-NET-ik EN-ər-jee) - Energy in action.

labeling - Attaching radioisotopes to a substance so that it can be followed closely.

license (LII-sns) - Permission given by law to do something.

liquid metal fast breeder reactor - A type of nuclear reactor that uses a liquid metal such as sodium to transfer heat from the reactor to a steam-generator. A breeder reactor makes more fuel than it uses by converting uranium-238 to plutonium-239.

LMFBR - Abbreviation for liquid metal fast breeder reactor.

low-level waste - Waste that is only slightly radioactive. Most radioactive waste from a nuclear powerplant is low-level.

mass - The amount of matter a body contains.

mechanical energy (mi-KAN-i-k'l EN-ər-jee) - Energy made or run by machine.

mill tailings - The leftover crushed rock after the uranium (yellowcake) has been removed from uranium ore.

GLOSSARY

millirem (MIL-ə-rəm) - A unit of radiation dosage equal to one-thousandth of a rem. A member of the public can receive up to 500 millirems per year according to Federal standards. The average American receives 150-200 per year from all sources.

moderator (mod-ə-RAA-tər) - Substance that slows neutrons down so that they are more likely to cause fission.

molecule (MOL-ə-kyool) - The smallest unit into which a substance can be divided and still keep all its characteristics.

monitors (MON-ə-tərz) - Machines used for checking and listening.

neutrons (NYOO-trons) - Particles that appear in the nucleus of all atoms except hydrogen. Neutrons are one of the three basic particles that make up the atom.

nonrenewable - Not able to be replaced. Fossil fuels are nonrenewable energy sources.

nuclear chain reaction (NYOO-klee-ər CHAYN ree-AK-shən) - A nuclear reaction takes place in the nucleus of an atom and changes the atom into one or two entirely different elements. A chain reaction stimulates its own repetition. For example, if you knock over the first domino in a line of standing dominos, the next one will fall as the first one hits it; then the next one will fall as the second one hits it; and the reaction will continue.

nuclear energy (NYOO-klee-ər EN-ər-jee) - The energy released when the nucleus of an atom splits or when two nuclei fuse.

nuclear engineers - People who design and operate nuclear powerplants.

nuclear fission (NYOO-klee-ər FISH-ən) - The process of dividing or splitting the nucleus of the atom.

nuclei (NYOO-klee-ii) - The plural form of nucleus.

nucleus (NYOO-klee-əss) - The central part of an atom that contains protons, neutrons, and other particles.

operating costs - The amount of money it takes to keep the powerplant running after it has been built. This includes workers' salaries and the repair and upkeep of the plant.

operating license - Permission given by law to operate something, in this case, a nuclear powerplant.

orbit (OR-bit) - The path an electron takes around the nucleus of an atom.

photosynthesis (fo-to-SIN-thə-sis) - The process in which a green plant makes its food by using energy from the Sun.

GLOSSARY

physicists (FIZ-ə-sists) - Scientists who study and work with matter, energy, and motion.

pitchblende (PITCH-blend) - The ore from which uranium and radium are obtained.

plasma (PLAZ-mə) - A gaseous mixture of positive and negative ions. High-temperature plasmas are used in controlled fusion experiments.

plutonium (ploo-TOH-nee-əm) - A radioactive element used in producing nuclear energy with an atomic number of 94 and an atomic weight of 244. Its symbol is Pu.

pollute (pə-LOOT) - To make impure.

pollution (pə-LOO-shən) - The contamination of the environment.

potential energy (pə-TEN-shəl) - The capability to produce energy. Coal has potential energy; when it is burned, it gives off heat and light.

powerplants - Plants that produce electricity.

pressure vessel - An extremely strong steel container that surrounds the core of the nuclear reactor.

pressurized water reactor - (PRESH-ə-riizd) - A nuclear reactor in which water is kept under pressure to keep it from boiling. Steam is made in a second loop.

primary energy sources (PRIGH-mehr-ee) - These energy sources can be used directly to produce heat, light, or motion. The primary energy sources are fossil fuels, geothermal, nuclear, solar, and tidal.

protons (PROH-tahns) - Extremely small particles or bits of matter carrying one positive charge of electricity. Protons are one of the three particles that make up an atom; they are found in the nucleus.

purified (PYUR-ə-fiid) - Impurities have been removed.

PWR - Abbreviation for pressurized water reactor.

rad - The basic unit of absorbed dose of ionizing radiation.

radiant energy (RAY-dee-ənt) - Solar energy which strikes the ground or air and becomes heat.

radiation (ray-dee-AY-shən) - Fast particles and electromagnetic waves emitted from the center of an atom during radioactive disintegration.

radiation dose (ray-dee-AY-shən dos) - The amount of radiation received during a given amount of time.

GLOSSARY

radioactive (ray-dee-oh-AK-tiv) - Giving off radiant energy in the form of particles and rays by the disintegration of atomic nuclei.

radioactive decay (ray-dee-oh-AK-tiv di-KAY) - The spontaneous changing of the atom into a different atom or a different state of the same atom.

radioactive isotopes (ray-dee-oh-AK-tiv I-suh-tohps) - Varieties of elements that emit ionizing radiation when they decay. Radioactive isotopes are commonly used in science, industry, and medicine.

radioactivity (ray-dee-oh-ak-TIV-ə-tee) - The property possessed by some elements, such as uranium, of spontaneously emitting alpha or beta particles or gamma rays.

radiography (ray-dee-OG-rə-fee) - The use of ionizing radiation for the production of shadow images on a photographic film. Some of the gamma or x rays pass through the subject while others are partially or completely absorbed by the more opaque parts of the subject and cast a shadow on the photographic film.

radium (RAY-dee-əm) - A radioactive metallic element discovered by the Curies in 1898 with an atomic number of 88 and an atomic weight of 226. Its symbol is Ra.

radon (RAY-don) - A heavy radioactive gas formed by the decay of radium. Its atomic number is 86 and its atomic weight varies from 200 to 226. Its symbol is Rn.

reactor (ree-AK-tər) - The part of a nuclear powerplant where fission takes place.

reclamation (REK-lə-MAY-shən) - Restoration to a useful, good condition.

regulate (REG-yə-layt) - To change or adjust in order to be in agreement with a standard or rule.

rem - A unit of absorbed dose of ionizing radiation.

renewable - Able to be replaced. The Sun's energy is a renewable energy source.

repository (ri-POZ-ə-TOR-ee) - A storage facility for high-level nuclear waste.

risk assessment (ə-ses-mənt) - The science of studying the amount of risk associated with doing something.

roentgen (RENT-gən) - A unit of exposure to ionizing radiation.

rubidium (ru-BID-ee-əm) - A soft, silver-white, metallic element. Its atomic number is 37 and its atomic weight is 85.47. Its symbol is Rb.

safety systems - Procedures and equipment designed to keep accidents from happening.

GLOSSARY

scintillation counter (sint-əl-AA-shən) - A detector that measures the amount of ionizing radiation in different materials; used in medical and nuclear research and in looking for radioactive ore.

secondary energy sources (SEK-ən-dəhr-ee) - These energy sources are produced by the primary energy sources. Electricity, a secondary source, can be made by burning fossil fuel.

services - Performance of work paid by someone else. When a person sells his or her work, it is called a service. Doctors, teachers, waiters, and mechanics are paid for their services.

shielding (SHEELD-iŋ) - Material used to protect people or living things from ionizing radiation. Lead can act as shielding for gamma waves.

simulate (SIM-yə-laət) - To act like or imitate.

sodium (SOO-dee-əm) - A soft, silver-white, metallic element used as a coolant in some nuclear reactors. Its atomic number is 11 and its atomic weight is 22.9898. Its symbol is Na.

spent fuel - Uranium fuel that has been used and then removed from the reactor.

spent fuel casks - Shipping containers for spent fuel assemblies.

spent fuel pool - A deep pool of water near the reactor where spent fuel from a nuclear powerplant is stored.

standard of living - The necessities, comforts, and luxuries that people feel are essential to their way of life.

steam-generators (JEN-ə-ray-tərz) - Machines that use heat in a powerplant to produce steam to turn turbines.

supply and demand - Terms used in economics. Demand is how much something is wanted; supply is how much is available. Supply and demand determine the value of things.

thermal energy (THER-məl) - Having to do with heat.

thorium (THOR-e-əm) - A naturally radioactive element with atomic number 90 and an atomic weight of 232. Its symbol is Th.

time, distance, shielding - The three most important factors for limiting exposure to radiation.

tritium (TRIT-ee-əm) - A radioactive isotope of hydrogen with two neutrons and one proton in the nucleus. It is manmade and is heavier than deuterium. Tritium is used in industrial thickness gauges and as a label in chemical and biological experiments.

turbine (TER-bin) - A wheel with many blades that are spun by steam. A turbine converts heat energy into mechanical energy.

GLOSSARY

unstable isotopes (uhn-STAY-bəl II-suh-tohps) - Isotopes that are likely to change.

uranium (yu-RAY-nee-əm) - A heavy, hard, shiny, metallic element that is radioactive. Its atomic number is 92 and its atomic weight is 238. Its symbol is U. Uranium is used as the fuel for nuclear powerplants.

uranium carbide (KAHR-biid) - The fuel used in high temperature gas-cooled reactors.

uranium dioxide (dii-OX-siid) - The chemical form of uranium when it is made into fuel pellets.

uranium enrichment (en-RICH-mənt) - The process that increases the percentage of uranium-235 isotopes in uranium fuel from 1 to 3 percent.

uranium hexafluoride (HEK-sə-FLUR-iid) - A gas form of uranium that is made from yellowcake and fluoride. The gas is made and purified at a conversion plant and then shipped to a gaseous diffusion plant for enrichment.

uranium milling - The process of removing uranium from uranium ore. Milling produces a substance called yellowcake.

utility (yoo-TIL-ə-tee) - A company that provides a public service or product such as electricity, water, or telephone.

yellowcake - A yellow powder that is mostly uranium. Yellowcake is produced by pouring crushed uranium ore into an acid which dissolves the uranium. The acid is drained from the crushed ore and dried, leaving a yellow powder called yellowcake.