

DOCUMENT RESUME

ED 281 566

IR 051 918

AUTHOR Hampel, Viktor E.; And Others
TITLE "TIS": An Intelligent Gateway Computer for Information and Modeling Networks. Overview.
INSTITUTION California Univ., Livermore. Lawrence Livermore Lab.
SPONS AGENCY Department of Energy, Washington, D.C.
REPORT NO UCRL-53439
PUB DATE Aug 83
CONTRACT W-7405-Eng-48
NOTE 13p.; For a related report, see IR 051 916.
PUB TYPE Reports - Descriptive (141)

EDRS PRICE MF01/PC01 Plus Postage.
DESCRIPTORS Access to Information; Communications Satellites; *Computer Networks; *Data Analysis; Information Retrieval; *Information Systems; Information Transfer; *Man Machine Systems; Models; *Technology Transfer; Telephone Communications Systems
IDENTIFIERS Computer Security; Gateway Systems; *Technology Information System

ABSTRACT

TIS (Technology Information System) is being used at the Lawrence Livermore National Laboratory (LLNL) to develop software for Intelligent Gateway Computers (IGC) suitable for the prototyping of advanced, integrated information networks. Dedicated to information management, TIS leads the user to available information resources, on TIS or elsewhere, by means of a master directory and automated access procedures. Other geographically distributed information centers available through TIS include six federal and commercial systems in the United States, one in France, and one in West Germany. This overview of the system summarizes the following aspects of TIS: (1) Automated Access Procedures; (2) Creation of Program-Dependent Information Systems; (3) Data Analysis and Modeling; (4) Communications; (5) The META-MACHINE User Interface; (6) Technology Transfer; (7) Information Networks; (8) Integrity and Security; (9) Future Plans; and (10) Acknowledgements and Sponsors. The text is supplemented with diagrams and illustrations, and 17 references are provided. (KM)

 * Reproductions supplied by EDRS are the best that can be made *
 * from the original document. *

ED281566

U.S. DEPARTMENT OF EDUCATION
Office of Educational Research and Improvement
EDUCATIONAL RESOURCES INFORMATION
CENTER (ERIC)

UCRL-53439

- This document has been reproduced as received from the person or organization originating it.
 - Minor changes have been made to improve reproduction quality.
-
- Points of view or opinions stated in this document do not necessarily represent official OERI position or policy.

"TIS"

AN INTELLIGENT GATEWAY COMPUTER FOR INFORMATION AND MODELING NETWORKS

OVERVIEW

Viktor E. Hampel
Carolyn Bailey, Richard A. Kawin, Neil A. Lann
Stephen K. McGrogan, Walter S. Scott
Soren M. Stammers, and John L. Thomas

August 1983



Lawrence
Livermore
National
Laboratory

IR 051 918

DISCLAIMER

This document was prepared as an account of work sponsored by an agency of the United States Government. Neither the United States Government nor the University of California nor any of their employees, makes any warranty, express or implied, or assumes any legal liability or responsibility for the accuracy, completeness, or usefulness of any information, apparatus, product, or process disclosed, or represents that its use would not infringe privately owned rights. Reference herein to any specific commercial products, process, or service by trade name, trademark, manufacturer, or otherwise, does not necessarily constitute or imply its endorsement, recommendation, or favoring by the United States Government or the University of California. The views and opinions of authors expressed herein do not necessarily state or reflect those of the United States Government thereof, and shall not be used for advertising or product endorsement purposes.

Work performed under the auspices of the U.S. Department of Energy by Lawrence Livermore National Laboratory under Contract W-7405-Eng-48.

"TIS"

**AN INTELLIGENT GATEWAY COMPUTER FOR
INFORMATION AND MODELING NETWORKS**

OVERVIEW

**Viktor E. Hampel
Carolyn Bailey, Richard A. Kawin, Neil A. Lann
Stephen K. McGrogan, Walter S. Scott
Soren M. Stammers, and John L. Thomas**

Manuscript date: August 1983

LAWRENCE LIVERMORE NATIONAL LABORATORY 
University of California · Livermore, California · 94550

Available from: National Technical Information Service • U.S. Department of Commerce
5285 Port Royal Road • Springfield, VA 22161 • \$7.00 per copy • (Microfiche \$4.50)

"TIS"

AN INTELLIGENT GATEWAY COMPUTER FOR INFORMATION AND MODELING NETWORKS

OVERVIEW

Viktor E. Hampel

Carolyn Bailey, Richard A. Kawin, Neil A. Lann

Stephen K. McGrogan, Walter S. Scott

Soren M. Stammers, and John L. Thomas

Technology Information System
Lawrence Livermore National Laboratory
University of California
Livermore, CA 94550
Tel: (415) 422-4357

The Technology Information System (TIS) is being used to develop software for Intelligent Gateway Computers (IGC) suitable for the prototyping of advanced, integrated information networks. Dedicated to information management, TIS leads the user to available information resources, on TIS or elsewhere, by means of a master directory and automated access procedures. Other geographically distributed information centers accessible through TIS include federal and commercial systems like DOE/RECON, NASA/RECON, DOD/DROLS, DOT/TIC, CIS, and DIALOG in the United States, the chemical information systems DARC in France, and DECHEMA in West Germany. New centers are added as required.

1. Automated Access Procedures

Users are granted selective access to external resources on a need-to-use basis. Communications are established automatically, with redundant alternative communication paths. Authorized users simply give the target name of the desired resource, e.g., *connect darc*, to search the chemical structure and nomenclature file of 6.0 million substances in Paris. Access rights can be removed when users' work is completed. TIS keeps track of all transactions for accounting purposes.

We are establishing a master directory of available resources. Detailed descriptions of resources, examples of their use, and uptimes can often be downloaded to TIS and updated from the online directories of the geographically distributed topical information centers. This information, available on TIS, helps users to plan the use of a distant resource before connecting to it. This saves time and money. Incompatible formats of external information centers and data are translated into common formats as needed during transfer.

Standard login and logout commands on TIS are used to connect to other machines, as are commands for keyboard operations. New powerful features permit the suspension of processes. This permits users to be connected simultaneously to more than one distant host, to suspend operations on one or the other machine, and to aggregate downloaded information, numeric data, and graphics, without reconnecting.

THE TECHNOLOGY INFORMATION SYSTEM "TIS"



(An Intelligent Gateway Computer)

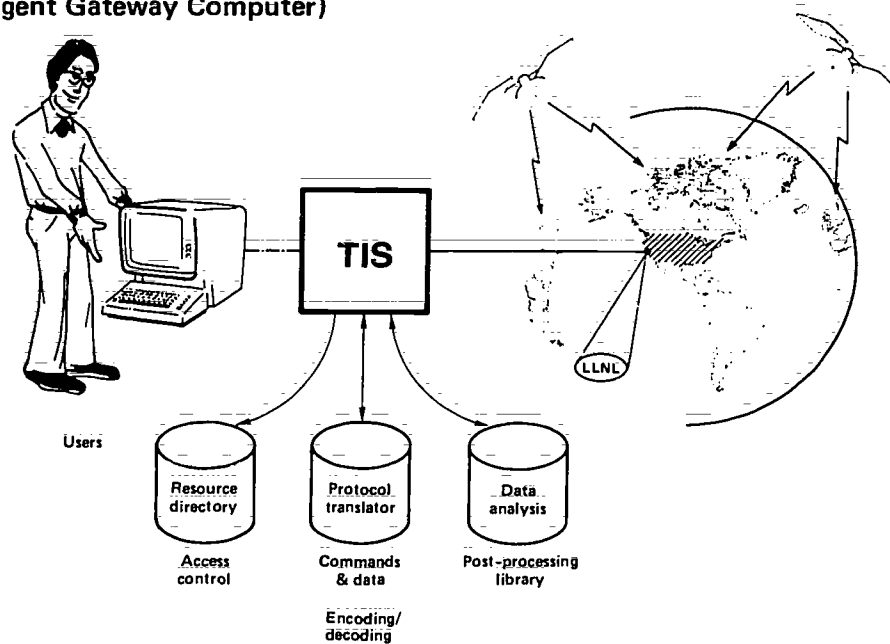

2. Creation of Program-Dependent Information Systems

These capabilities lend themselves to the creation of program-dependent information systems consisting of internal and external resources of a particular user community or program in an integrated manner. Such systems can also be used for the compilation of dynamic data books, available online for up-to-date interactive consultation, and ready for periodic printing and conventional distribution. Several expert groups can thus work on their projects on TIS simultaneously and independently.

USER-ORIENTED PROGRAMMATIC VIEWS OF "TIS"

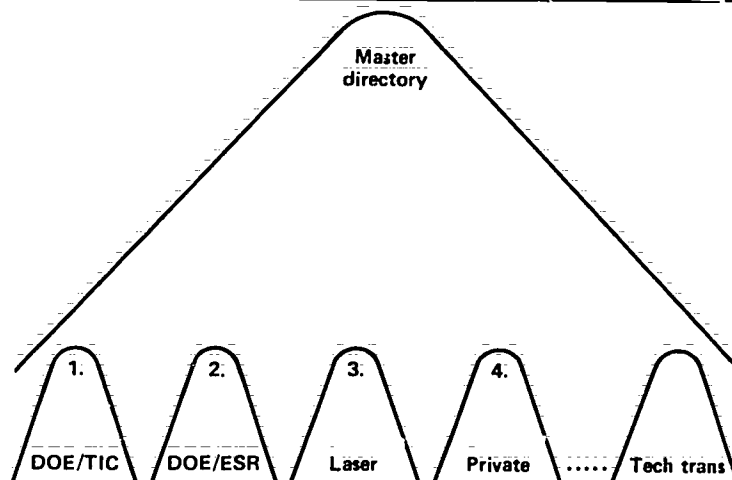

Each information system can be created with only minimal or no assistance from computer programmers or system analysts. The resultant integration is extensible and flexible. It includes report writers, visual editors, interactive numeric data analysis tools, and interactive graphics. It can be established, modified, and updated online, in real time, without recompilation.

This is accomplished by deposition of the directory, lookup tables, and commands to the operating system and application programs, as Meta-Instructions in a relational program database, and/or as structured files with linked records, which can both be easily modified and extended by the Information System Administrator.

With this approach, the TIS Intelligent Gateway Computer provides a unified view of the available resources, but leaves the data and associated programs with their evaluators and developers, at their original site. Internal and external resources available to a particular user community may differ and are controlled by the Information System Administrators identified with and responsible for each program. TIS provides overall transaction control, accounting, and security.

Interactions with users are menu-driven and self-guided and offer online help for several levels of expertise. They also provide those not familiar with computers an efficient means to find and use the desired information with relative ease. Electronic mail and the interconnection of TIS to electronic word processors and typesetters are being explored to establish fully integrated information systems for DOE administrators, representatives from other federal agencies, and prime contractors to the government.

3. Data Analysis and Modeling

Unlike other information systems, TIS not only provides authorized users with direct access to a growing number of national information resources in a selectively controlled manner, but also permits the transfer of files from TIS to other computers and vice versa. Extracted and downloaded information can be placed into topical datafiles on TIS for subsequent postprocessing, analysis, and graphical display. These TIS options can be used freely with information in the public domain. Copyrighted information requires individual contractual agreements with copyright holders.

This approach also permits the preparation of controlled input to models maintained on different host computers, as well as the saving and comparison of their calculations via TIS. A gateway computer can thus be used to establish an integrated modeling network, analogous to an information network.

COMPARISON OF DIFFERENT MODELS VIA "TIS" 

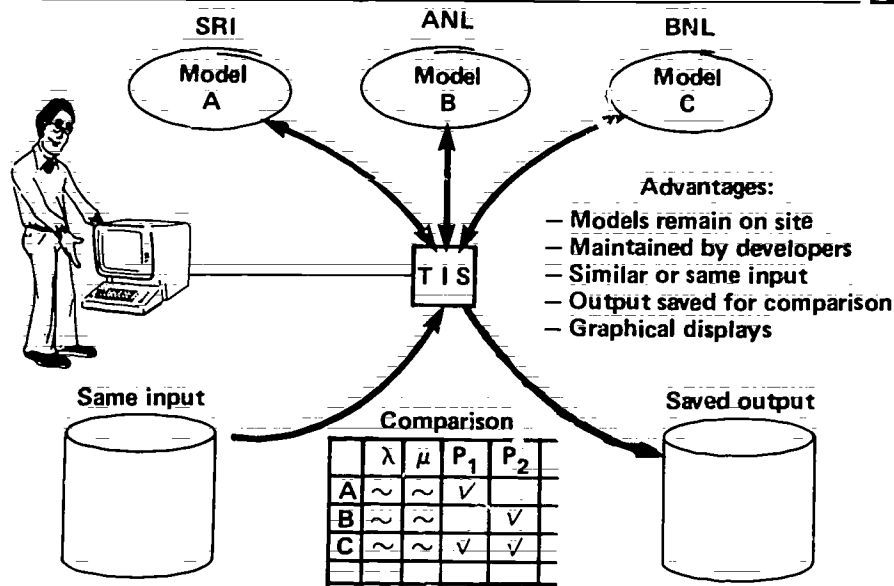

In support of this pragmatic and heuristic approach to information management, we are developing a library of interactive postprocessing routines, a tool box, for the extraction of intelligence from text and numeric data. Results of analyses can then be shared with others by electronic mail, which permits intermixed transmission of text, tabular data, and graphs. Such reports, filtered and edited, can be transferred electronically for immediate printing on typesetters. This eliminates dependence on the conventional analysis and dissemination of scientific and technological information from computer printouts, their manual inspection, and rekeyboarding.

4. Communications

TIS is accessible by telephone dialup over FTS and commercial telephone lines, WATS, the ARPA computer network, and TYMNET. In 1984 we are planning to make good use of the forthcoming DOE/OPMODEL satellite communications network and mini/micro computers. Descriptive and numeric information can thus be transferred to and from other information centers and computers to TIS for subsequent use with savings in time and costs.

To simplify the exchange of information, we pioneered the linking of the information requestor to the expert by simultaneous computer-and-voice communications. This makes it possible to schedule crosscontinental, audio-visual tutorials for individuals and classes, to link the information specialist and expert with the end user, and to share downloaded data and programs simultaneously among users at different geographic locations. The link command makes the terminals at two or more locations fully equivalent with regard to keyboards and video displays.

DEMONSTRATION OF "CIS" BY DR. SULLIVAN TO CLASS IN BRAZIL VIA "TIS" IN 1981

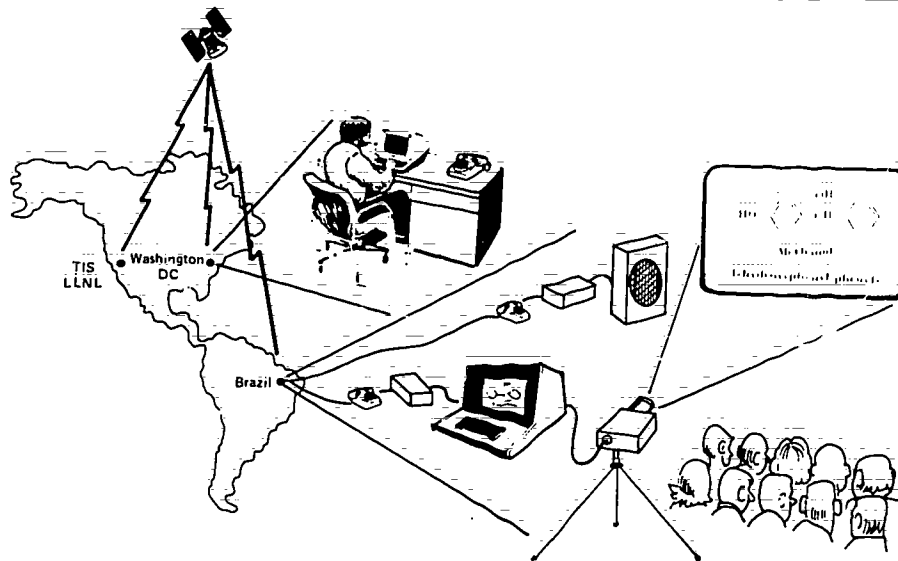

**Simultaneous graphical display and voice communication!
Terminals of expert and student(s) are equivalent!**

Communications of an Intelligent Gateway Computer place considerable burden on the CPU of the PDP-11/70. This is the case especially during interactive access procedures with asynchronous communications to other host computers, when large volumes of data are being streamed continuously during downloading operations to the TIS/IGC machine, or via TIS/IGC to the users' host machines. This is especially the case during multiple, simultaneous executions of the LINK command where the stream of data from a distant host machine is downloaded to TIS/IGC and/or to more than one terminal or workstation. To remedy this situation, we devised performance enhancements that reduced the burden on the CPU to 1-3% of that nominally encountered. This permits users to continue full-duplex asynchronous operations without needing an additional synchronous connection for large file transfers.

"IGC" – A PRACTICAL INTERMEDIARY TO EXPERT INFORMATION:

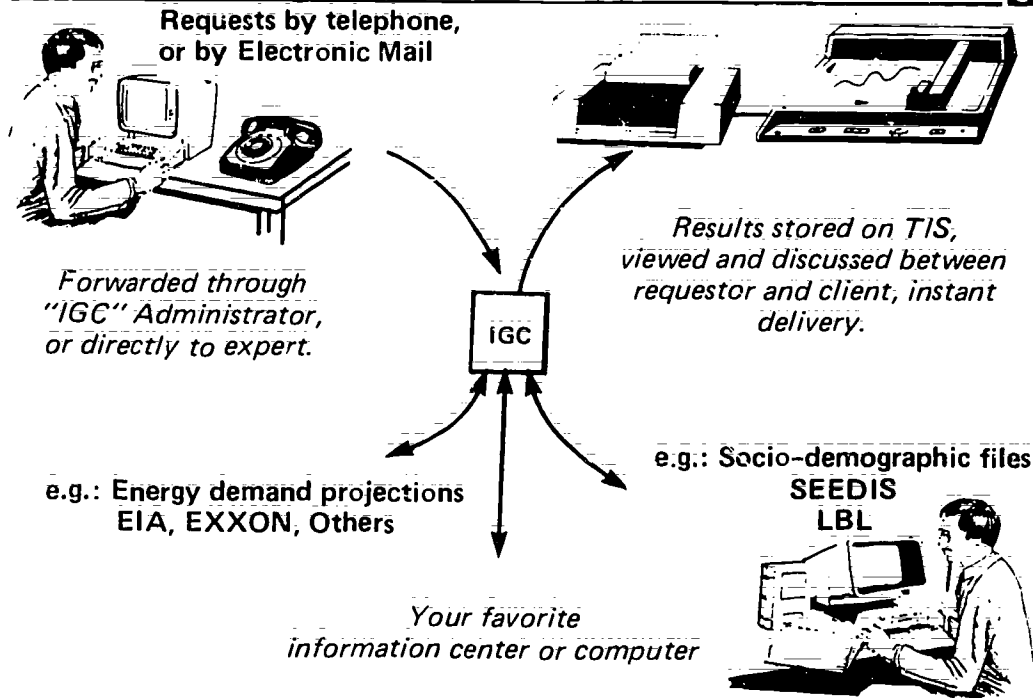

5. The META-MACHINE, A Unique User Interface

The primary concept embodied in the TIS is a novel approach to information management, made possible through state-of-the-art software and the unique META-MACHINE user interface developed at LLNL. It uses an interpreter deposited in a relational database and in structured linked files for all man-machine and machine-machine communications. Extensions and improvements to views of the integrated information resources, consisting of datafiles, models, and communications required by each user community, can therefore be carried out online without recompiling of software programs, and without programmer intervention.

INTEGRATED INFORMATION SYSTEM

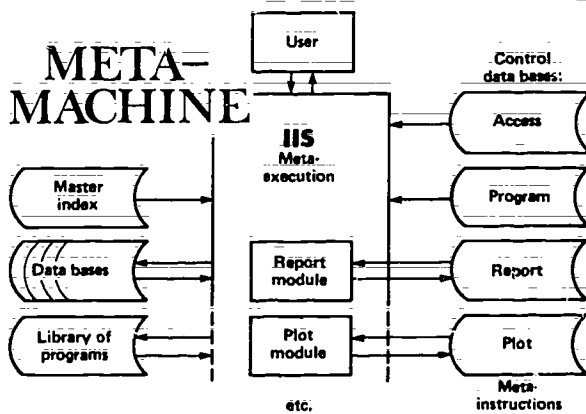

META-MACHINE (SYMBOLIC EXAMPLE OF OPERATION)

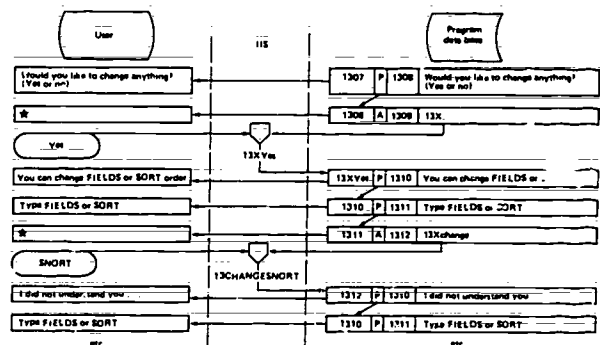

The META-MACHINE software and its supporting programs are written primarily in "C," although the interactive mathematics library routines are written partially in FORTRAN-IV. The TIS integrated information system is operational on a PDP-11/70 computer with UNIX-7 (2.9 bsd) as the operating system, and INGRES-6.3 as the invisible relational data base management system (DBMS). Adaptation to UNIX-7 (4.2 bsd) for use on a VAX-780 machine, and replacement of INGRES by the Intelligent Database Management (IDM-600) backend processor or its equivalent, are in progress.

6. Technology Transfer

This approach to information management and communications is exceptionally well suited for the transfer of advanced technologies among government agencies and to the public domain. For example, this approach establishes de facto a focal point for technology transfer: Dissimilar and geographically distributed technological resources, available at installations of the Federal Laboratories Consortium (FLC), can be viewed and used as an integrated system which is being expanded to provide a cost-effective means for the exchange of information among National Laboratories, and to technologists at universities and in industry. Work toward this goal is being done to support a successful implementation of the Stevenson-Wylder Technology Innovation Act of 1980, under auspices of the LLNL Office of Research Technology and Administration (ORTA).

LLNL Technology Transfer Program

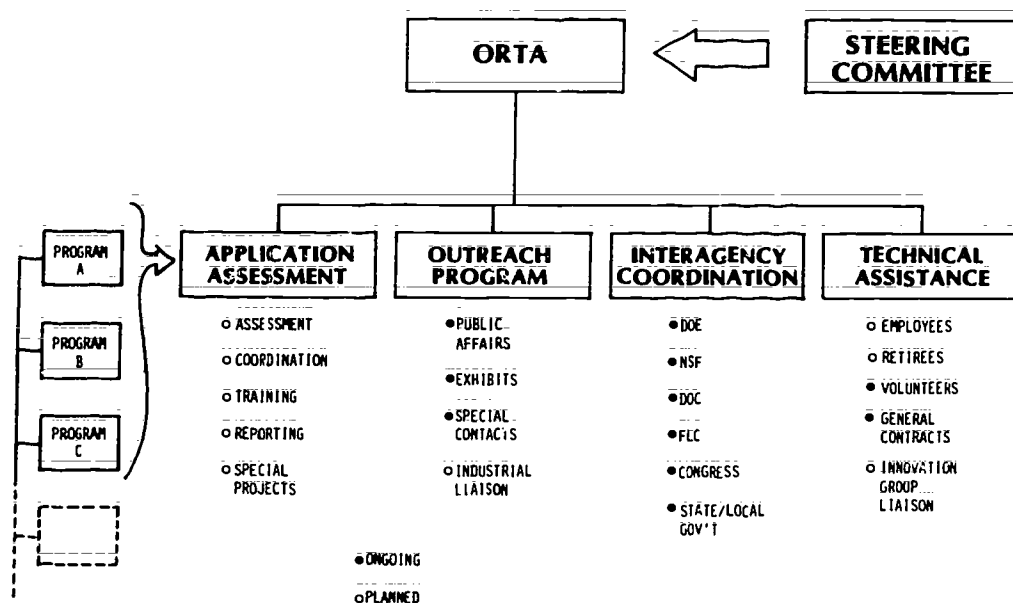

This technique makes it possible for administrators without personal computer experience to benefit from the new technology of "informatics." They can issue their requests for information and data by TIS electronic mail through a staff assistant. Their requests can then be forwarded by the TIS administrator to the expert at some distant facility. The expert executes the work and returns it to the requestor via electronic mail for online review and/or printing, or for graphic hardcopy. In the future, these requests could also be issued via a digitized voice message store-and-forward system.

An example of this use of TIS as an electronic intermediary is the quick translation of information and text, downloaded from a foreign host overseas. By transferring the extracted non-English information via TIS electronic mail to a translating agency like Agnew in Woodland Hills, CA, one can receive its machine translation, polished online by its linguistic experts with a visual text editor, in hours rather than weeks. The same can be done with programming languages; software firms today are accepting source codes by electronic means and are delivering their translated work in a similar manner.

7. Information Networks

The concept and operational capabilities of the Intelligent Gateway Computer are being studied as the basis for a future materials properties information network. This approach would permit immediate access and use of the major numerical data information centers, scattered throughout the country and overseas, via a single access to an intelligent TIS-like gateway. Previous attempts to establish a national data center for science and technology failed, in part, because they required the transfer of data files and application programs to a central, costly computer complex.

The TIS approach has the advantage that different information services, providing different prompting and self-guided routines, readily recognize the desirable features of their competitors and quickly adopt the best to serve their own customers.

A future network for engineering data is envisioned as a distributed hierarchical system of intelligent gateway computers for access to local, regional, national, and international resources. Super microcomputers would be the workstations for scientists and engineers. The UNIX operating system, now available on the majority of mainframe computers, mini- and micromachines, would permit the downloading of information analysis tools, and the upward mobility of enhancements carried out by the unprecedented surge of programming by end users.

A DISTRIBUTED NETWORK OF INTELLIGENT GATEWAY COMPUTERS & WORKSTATIONS

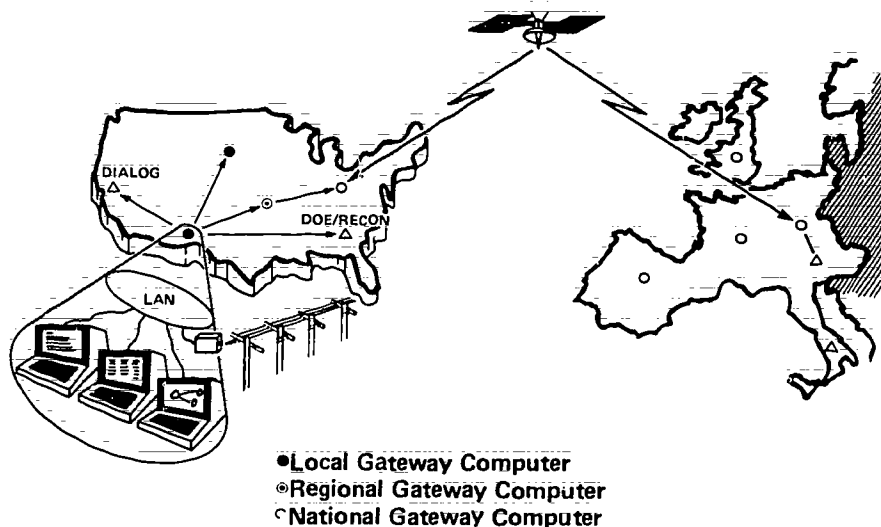

8. Integrity and Security

Gateway computer operations necessarily bear greater risks than those of stand-alone machines: They have to provide integrity for large volumes of transactions among diverse user groups, and they connect to other host machines whose security has to be equally well guarded.

The role of the electronic gateway is therefore similar to that of historic gateway keepers, or watchmen of times past, who controlled traffic, monitored the movement of merchandise, and ascertained safe passage.

To this end, we have equipped the IGC software with extensive transaction control and monitoring capabilities, which have dual benefits. First, the analysis of recorded transaction permits us to establish usage statistics of available resources and commands. This leads to improvements in the design of the overall systems and hence to greater performance and cost-effectiveness. Second, transaction patterns that deviate from statistical and specified norms can be used to trigger alerts or intercepts and to decrease the risk of covert, adverse actions.

9. Future Plans

We are developing the software for a second-generation, dedicated IGC. Our plans include encryption and secure communications required for use of satellites. Gateway computers of this type may find potential applications in future CAD/CAM systems at LLNL and elsewhere.

In the latter case, the flow of traffic is especially high during both data transfers among computers via gateways directing communications traffic in a dynamic manner and the archiving of digitized engineering drawings. The initial large volume of video-scanned engineering drawings, even when compressed to 8-12% of their original bit matrix, is enormous. Significant improvements are being made by data compression techniques and timing controls.

For the efficient transfer of large volumes of data, we designed communications front end (CFE) controllers to function as intelligent concentrators that can short-circuit high communication fluxes, bypassing the central processing unit (CPU), or peripheral processor units (PPU), of a regional gateway computer. The authorization tables, encrypted with the data encryption standard (DES) and the public key encryption (PKE), would be downloaded from the TIS/IGC to the CFEs.

Unique identification and control of communications among gateway computers in the information/modeling networks could thus be ascertained. This concept has considerable merit in terms of decentralizing communications traffic, while offering redundancy of communication paths.

EVOLUTION OF "INTELLIGENT GATEWAY COMPUTERS"

Communications are processed by:

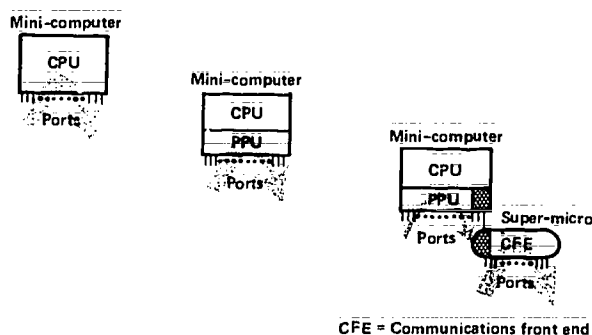

COMMUNICATIONS TRAFFIC CONTROL

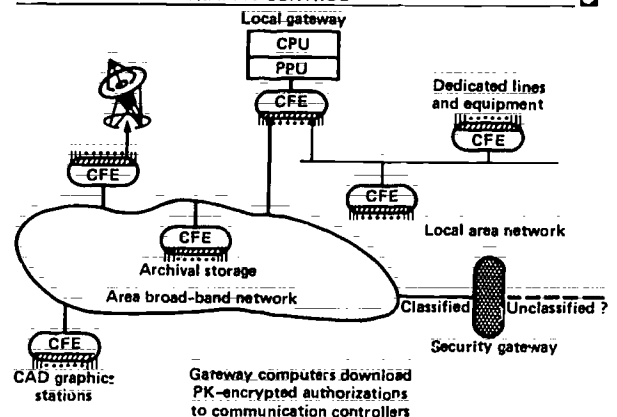

10. Acknowledgment and Sponsors

The META-MACHINE integrated information system software has been under development at LLNL since 1975. System analysts from Control Data Corporation (CDC) and several consulting firms have contributed unique talents and expertise.

The major supporting agencies are the DOE Office of Energy Systems Research, the DOE Technical Information Center, the DOE Office of Nuclear Safety, NASA, NASA/NIAC, Department of Defense/Defense Technology Information Center (DOD/DTIC), Navy Ships Research and Development Center (NSRDC), and the Air Force Logistics Command, Communication, Control and Intelligence, Special Projects Office.

The development of the Intelligent Gateway Computer project is being guided by a technical steering committee under auspices of the sponsoring agencies.

REFERENCES

1. V. E. Hampel, J. Hilsenrath, J. H. Westbrook, C. A. Gaynor, and P. S. Johnson, *A Directory of Databases for Material Properties*, Presented to the 1983 ASME International Computers in Engineering Conference & Exhibit (Chicago, IL, August 7-11, 1983); also published by the Lawrence Livermore National Laboratory, Livermore, CA, as UCAR-10099 (August 1983).
2. V. E. Hampel, J. B. Cain, R. A. Kawin, G. Pavel, N. A. Lann, G. T. Richards, and W. S. Scott, *TIS-A Focal Point for Technology Transfer*, Lawrence Livermore National Laboratory, Livermore, CA, UCRL-53342 (September 1982).
3. R. K. Hunt, H. L. Fisher, V. E. Hampel, R. A. Kawin, and N. A. Lann, *The "TIS" Intelligent Gateway Computer, An Alternative to the "Doomsday Scenario,"* Presented to the 4th National ONLINE Meeting at the Sheraton Center (New York, NY, April 12-14, 1982); also published by the Lawrence Livermore National Laboratory, Livermore, CA, as UCRL-88784 (February 1, 1983).
4. I. Harrison, Jr., V. E. Hampel, and R. A. Kawin, *Downloading and Post-processing of Bibliographic Information with the TIS Intelligent Gateway Computer*, Proceedings of the Online '82 Conference (Atlanta, GA, November 1-3, 1982); also published by the Lawrence Livermore National Laboratory, Livermore, CA, as UCRL-88119 (September 9, 1982).
5. V. E. Hampel, R. A. Kawin, N. A. Lann, and W. S. Scott, *TIS-An Interactive System for Technology Transfer*, Proceedings of the 7th International Symposium of the Technology Transfer Society (Pasadena, CA, June 13-14, 1982); also published by the Lawrence Livermore National Laboratory, Livermore, CA, as UCRL-87703 (June 1982).
6. V. E. Hampel, *Fact Retrieval for the 1980's*, Proceedings of the Technical Information Panel (TIP), NATO/AGARD Conference (Munich, West Germany, AGARD-CPP-304, 1981); also published by the Lawrence Livermore National Laboratory, Livermore, CA, as UCRL-85749 (July 1981).
7. V. E. Hampel, W. S. Scott, L. E. Gallo, R. A. Kawin, V. Kopytoff, B. Mallon, S. K. McGrogan, G. Pavel, W. G. Rabe, J. A. Schriebman, and J. E. Swanson, *User's Manual for the Technology Information System*, Second Edition, Lawrence Livermore National Laboratory, Livermore, CA, M-0112 (1981).
8. J. A. Schriebman, *UNIX Performance Enhancements Through the Use of a Large-Block Buffering Scheme*, Lawrence Livermore National Laboratory, Livermore, CA, UCRL-52890 (1980).
9. V. E. Hampel and J. A. Schriebman, *EM-A Personal System for Electronic Mail*, Lawrence Livermore National Laboratory, Livermore, CA, M-115 (September 1980).
10. J. A. Schriebman and J. E. Swanson, *Crosslinking of Computer Terminals for Nationwide Tutorial Instruction*, Lawrence Livermore National Laboratory, Livermore, CA, UCRL-52964 (November 1980).
11. V. E. Hampel, S. K. McGrogan, L. Gallo, and J. E. Swanson, *The LLL "META-MACHINE"-A Flexible, Extensible, and Practical Technique for Interactive Data Management, Modeling, and Distributed Networking*, Lawrence Livermore National Laboratory, Livermore, CA, UCRL-83064, Extended Summary (August 1979).
12. V. E. Hampel, et al., *The META-MACHINE - A New Way of Making a Mini-Computer Do A Maxi-Job in Data Management*, Presentation to the CUBE Symposium (Los Alamos, NM, October 4-5, 1978); also published by the Lawrence Livermore National Laboratory, Livermore, CA, as UCRL-81170 (September 1978).
13. V. E. Hampel, L. E. Gallo, R. A. Kawin, V. Kopytoff, S. McGrogan, L. G. O'Connell, G. Pavel, J. A. Schriebman, and J. E. Swanson, Editors, *Proceedings of the First DOE/LLL Workshop on the Technical Management Information System (TMIS)*, CONF-791258 (1979). (TIS was formerly known as TMIS).
14. E. W. Birss, J. E. Donnelley, and J. W. Yeh, *A Monitor of Distributed Data Systems (MODDS): Parts-1 and 2, Digest of Functional Specifications for the Department of Transportation*, Lawrence Livermore National Laboratory, Livermore, CA, UCID-17314 (November 15, 1976).
15. V. E. Hampel, *Decision Making with Interactive Access to Integrated Administrative & Technological Data Bases*, Proceedings of the ERDA/AESOP XVII Conference (Boston, MA, September 1977); also published by the Lawrence Livermore National Laboratory, Livermore, CA, as UCRL-80353 (September 1977).
16. *Electrohome DataGraphics Video Projector, EDP-57*, Electrohome Limited, 809 Wellington Street North, Kitchener, Ontario, Canada, N2G 4J6.
17. *Agnew-Tech-Tran Inc.*, 6415 Independence Avenue, Woodland Hills, CA 91367.