

DOCUMENT RESUME

ED 271 240

RC 015 743

TITLE Occupational Resources: Career Information. CHOICE (Challenging Options in Career Education). [Grade 5].

INSTITUTION Mid-Hudson Migrant Education Center, New Paltz, NY.

SPONS AGENCY Office of Elementary and Secondary Education (ED), Washington, DC. Migrant Education Programs.

PUB DATE 83

GRANT 28-84-0023

NOTE 299p.; For related documents, see ED 248 086 and RC 015 742.

AVAILABLE FROM CHOICE, P.O. Box 250, New Paltz, NY 12561.

PUB TYPE Guides - Classroom Use - Guides (For Teachers) (052)

EDRS PRICE MF01/PC12 Plus Postage.

DESCRIPTORS Career Awareness; *Career Education; Career Exploration; Grade 5; *High Interest Low Vocabulary Books; *Instructional Materials; Job Skills; Language Arts; Learning Activities; *Migrant Education; *Occupational Clusters; *Occupational Information; Open Book Tests; Reading Materials; Secondary Education

IDENTIFIERS *CHOICE (Career Education Curriculum)

ABSTRACT

Designed to teach migrant students about the world of work and how academic subjects relate to jobs and careers, this illustrated CHOICE (Challenging Options in Career Education) Occupational Resources text provides career and job information and basic job market entry skills information for junior and senior high school students written at a fifth grade reading level. Using stories, fact sheets, cartoons, poems, and interviews, the text describes the skills, tasks, tools, training, work environment, and advancement opportunities for 60 occupations from 15 different work clusters: agribusiness, arts and humanities, business and office, communication and media, construction, consumer and homemaking, environment control, health and safety, hospitality and recreation, manufacturing, marine science, marketing and distribution, personal services, public services, and transportation. Sections on each occupation conclude with a set of self-quiz questions. Occupations included are cooperative extension agent, horticulturist, organic truck farmer, bilingual adult instructor's aide, studio musician, keypunch operator, small business owner, library technician, telephone operator, heavy equipment operator, painter/paperhanger, day care worker, hotel cook, stock clerk, exterminator, surveyor, dental assistant, x-ray technician, executive housekeeper, ski instructor, optical mechanic, upholstery repairer, fish hatchery technician, auto parts salesworker, buyer, building maintenance worker, cosmetologist, minister, paralegal, diesel mechanic, and taxicab driver. (NEC)

ED271240

OCCUPATIONAL RESOURCES

"PERMISSION TO REPRODUCE THIS MATERIAL HAS BEEN GRANTED BY

Else M.
Pitta

TO THE EDUCATIONAL RESOURCES INFORMATION CENTER (ERIC)."

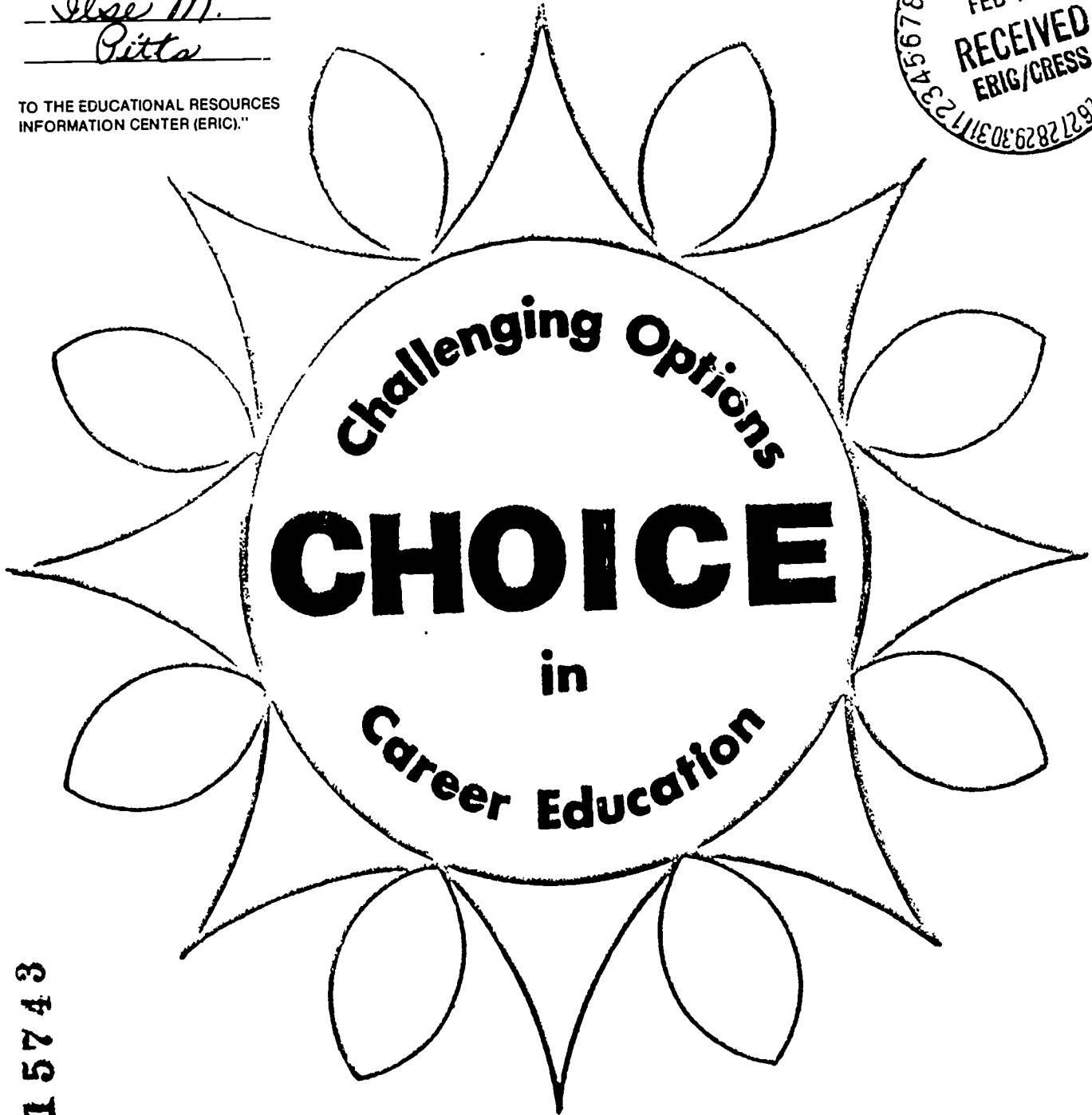

RC015743

Career Information

U.S. DEPARTMENT OF EDUCATION
Office of Educational Research and Improvement
EDUCATIONAL RESOURCES INFORMATION CENTER (ERIC)

This document has been reproduced as received from the person or organization originating it.

Minor changes have been made to improve reproduction quality.

Points of view or opinions stated in this document do not necessarily represent official OERI position or policy.

The CHOICE (Challenging Options in Career Education) Basic materials are now available in Spanish. Like the English, these materials are presented on seven levels, B1 - B7. Each level includes two career clusters. For each level there are (1) a pre and post assessment with student test leaflets and teacher guides; (2) a student workbook containing language arts and mathematics activities related to the career cluster content; (3) a teacher guide to the student workbook containing the student workbook pages along with additional information for the teacher on the pages facing the student pages; and (4) three sets of student activity folders, one set concerning Self Awareness activities, one set concerning Job and Role activities, and one set concerning Decision Making Goal Attaining activities (all activities are presented in the context of the career clusters covered on a given level).

Included here are the assessments and the teacher guides to the workbooks. (The Spanish student workbook pages are included in the teacher guides, and the Spanish activities parallel the English activities available for review on ERIC microfiche.)

The CHOICE Advanced materials now include three versions of the Occupational Resources text. One is written on a 3rd grade reading level, one on a 5th grade reading level, and one on a high school reading level. All three Occupational Resources texts contain the same basic career information content and are designed for secondary age students. This book is written on a 5th grade reading level.

Occupational Resources

This book represents information about 60 occupations from 15 different work clusters. An occupational cluster is simply a name for a group of occupations that are alike in some way. The workers you observe in your community and the work you do at home, at school, and in your community may fit into one of these clusters. The work clusters are:

AGRIBUSINESS

ARTS AND HUMANITIES

BUSINESS AND OFFICE

COMMUNICATION AND MEDIA

CONSTRUCTION

CONSUMER AND HOMEMAKING

ENVIRONMENTAL CONTROL

HEALTH AND SAFETY

HOSPITALITY AND RECREATION

MANUFACTURING

MARINE SCIENCE

MARKETING AND DISTRIBUTION

PERSONAL SERVICES

PUBLIC SERVICES

TRANSPORTATION

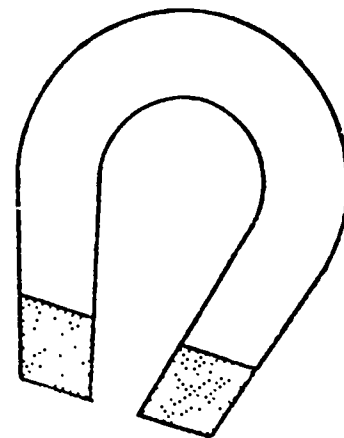
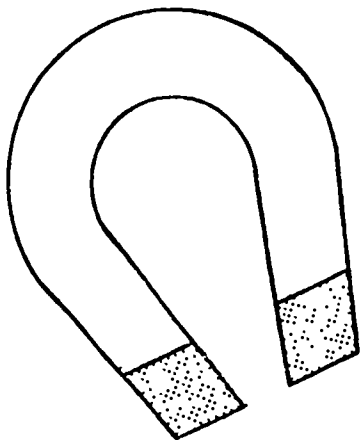

On the next 2 pages you'll find definitions of the work clusters and examples of jobs in each one. Where do you fit in?

CAREER CLUSTERS

Workers from the Agribusiness cluster remove and process natural resources, and they use land to raise and protect animals and crops.

Occupations from this cluster include cooperative extension agent, wild-life biologist, animal inspector, dairy farmer, agronomist, groundskeeper, migrant worker, gardener, tree farmer, and florist.

Workers from the Arts and Humanities cluster use their creativity to teach, write, perform, and study the arts and humanities, which include literature, dance, music, painting, and historical subjects.

Occupations from this cluster include book illustrator, art restorer, astronomer, musician, radio announcer, offset printer, archeologist, photographer; poet, conductor, architect, guidance counselor, and actor.

Workers from the Business and Office cluster usually work in office settings to record, store, and distribute information.

Occupations from this cluster include stock clerk, librarian, bank teller, typist, payroll clerk, actuary, stenographer, mail clerk, receptionist, switchboard operator, and accountant.

Workers from the Communication and Media cluster use various media to circulate information. They may work with telephones, radio, TV, books, magazines, and film.

Occupations from this cluster include data processor, author, bookbinder, reporter, commercial artist, telephone line worker, telephone operator, television director, and newspaper editor.

Workers from the Construction cluster are involved with designing, building, restoring, and demolishing structures.

Occupations from this cluster include highway road worker, mason, welder, plasterer, bridge builder, cabinetmaker, safety inspector, drafter, heavy equipment operator, architect, and demolition servicer.

Workers from the Consumer and Homemaking cluster help to produce and improve food, clothing, home furnishings, and care of family members.

Occupations from this cluster include nutritionist, real estate agent, appliance repairer, day care worker, waitress, janitor, landscaper, fashion designer, butcher, hotel cook, and tailor.

Workers from the Environmental Control cluster help to protect land, water, and air. They also encourage healthy physical relationships among all living things.

Occupations from this cluster include ecologist, pest exterminator, sanitation engineer, game warden, chemical analyst, zoologist, fire fighter, conservation officer, meteorologist, and forest ranger.

Workers from the Health and Safety cluster help care for and repair the human body and mind. Some workers care for animals, too. Occupations from this cluster include school nurse, optometrist, dance therapist, surgeon, life guard, psychologist, ambulance driver, inhalation therapist, dental hygienist, medic, and pharmacist.

Workers from the Hospitality and Recreation cluster improve the quality of people's leisure time, or spare time, activities. Their work often involves sports, resorts, hobbies, or amusements. Occupations from this cluster include recreational therapist, hotel clerk, flight attendant, chef, usher, scout leader, puppeteer, camp counselor, dance instructor, tour guide, and film projectionist.

Workers from the Manufacturing cluster design, assemble, and produce processed goods which are not in their natural forms. Occupations from this cluster include machinist, weaver, welder, machine tool operator, mechanic, millwright, boilermaker, shipper, optical technician, production supervisor, and tool and dye maker.

Workers from the Marine Science cluster study, grow, explore, harvest, and care for life and minerals in and around bodies of water. Occupations from this cluster include fish retailer, coast guard quartermaster, research biologist, scuba diver, lockmaster, navigator, salvager, sailor, fish hatchery technician, and seafood processor.

Workers from the Marketing and Distribution cluster package, advertise, and transport goods and services to make them available to customers. Occupations from this cluster include market researcher, stock clerk, sales representative, insurance salesperson, model, commercial artist, stock broker, truck driver, freight handler, and advertising copywriter.

Workers from the Personal Services cluster perform a wide variety of tasks, from drycleaning to dog grooming, in order to make life more comfortable for individuals. Occupations from this cluster include animal groomer, chauffeur, minister, caterer, cosmetologist, mortician, barber, tailor, jeweler, waiter, interior decorator, housekeeper, and shoe repairer.

Workers from the Public Services cluster protect the rights, property, and general well-being of community members. Occupations from this cluster include state senator, researcher, town mayor, mail carrier, police officer, court reporter, national guard, public park attendant, parole officer, and sanitation worker.

Workers from the Transportation cluster help to move people and goods from one place to another. Occupations from this cluster include airplane pilot, auto mechanic, security agent, railroad engineer, bus driver, freight handler, inspector, diesel mechanic, dispatcher, merchant marine, and reservationist.

Table of Contents

<u>Title</u>	<u>Format</u>	<u>Page</u>
Introduction		i
Career Clusters		ii
Agribusiness		1
Cooperative Extension Agent	(story)	2
Farm Co-op Manager	(interview)	7
Horticulturist	(fact sheet)	14
Organic Truck Farmer	(cartoon)	17
Arts and Humanities		25
Animation Cartoonist	(cartoon)	26
Bilingual Adult Instructor's Aide	(story)	32
Sculptor (Welded Metal)	(interview)	36
Studio Musician	(poem)	42
Business and Office		45
Keypunch Operator	(story)	46
Real Estate Agent	(interview)	50
Small Business Owner	(poem)	56
Tax Assessor's Aide	(fact sheet)	59
Communication and Media		62
Computer Systems Analyst	(cartoon)	63
Library Technician	(fact sheet)	68
Offset Press Operator	(interview)	71
Telephone Operator Trainee	(story)	79
Construction		83
Architectural Drafter	(poem)	84
Conservation Laborer	(story)	88
Heavy Equipment Operator	(story)	92
Painter/Paperhanger	(fact sheet)	95
Consumer and Homemaking		98
Day Care Worker	(story)	99
Hotel Cook	(poem)	104
Refrigeration and Air Conditioning Mechanic	(fact sheet)	107
Stock Clerk	(interview)	111
Environmental Control		117
Earth Science Teacher	(poem)	118
Ecologist	(interview)	122
Exterminator (Pest Control Routeworker)	(poem)	128
Surveyor	(story)	131

Table of Contents (cont.)

<u>Title</u>	<u>Format</u>	<u>Page</u>
Health and Safety		134
Chiropractor	(interview)	135
Dental Assisstant	(fact sheet)	140
Licensed Practical Nurse	(story)	143
X-Ray Technician	(poem)	146
Hospitality and Recreation		149
Cross Country Ski Instructor	(cartoon)	150
Executive Housekeeper	(story)	157
Recreational Therapist	(story)	161
Roller Rink Owner/Manager	(poem)	167
Manufacturing		171
Optical Mechanic	(fact sheet)	172
Production Supervisor	(story)	175
Solar Engineer	(interview)	178
Upholstery Repairer	(fact sheet)	185
Marine Science		190
Coast Guard Boatswain's Mate	(interview)	191
Coast Guard Quartermaster	(poem)	198
Fish Hatchery Technician	(fact sheet)	202
Fish Retailer	(poem)	205
Marketing and Distribution		208
Advertising Copywriter	(fact sheet)	209
Auto Parts Salesworker	(poem)	213
Buyer	(cartoon)	216
Mechanical Artist	(story)	220
Personal Services		227
Building Maintenance Worker	(fact sheet)	228
Business Machine Service Technician	(cartoon)	230
Cosmetologist	(story)	241
Masscuse	(story)	247
Public Services		250
Clergy Member/Minister	(interview)	251
Employment Counselor	(fact sheet)	257
Paralegal	(story)	262
Wastewater Treatment Plant Operator	(cartoon)	267
Transportation		272
Diesel Mechanic	(interview)	273
Long Distance Truck Driver	(poem)	279
Motorcycle Salesworker	(story)	283
Taxicab Driver	(fact sheet)	288

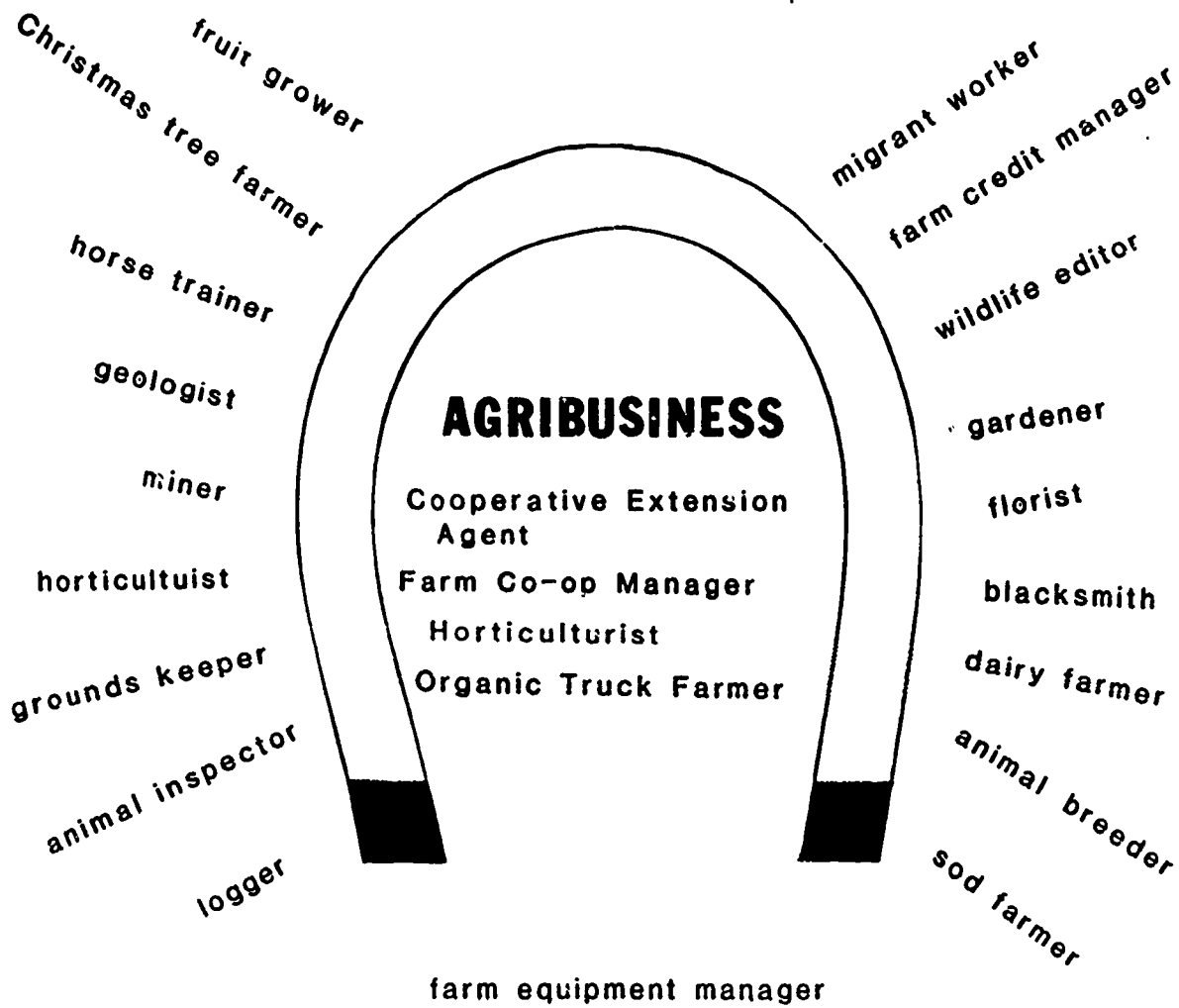

Workers from the Agribusiness cluster remove and process natural resources, and they use land to raise and protect animals and crops.



COOPERATIVE EXTENSION AGENT

Hi. My name is Sue Brown. I am a Cooperative Extension Agent in Baxter County. My two bosses are the County and the State Land Grant College. I teach and provide services to the people in the county. I help them solve their problems on farms, at home, and in the community. I use newspapers, magazines, radio, and TV to get information to farmers and others. Sometimes I write pamphlets or create slide and picture shows. I also work with groups of farmers.

There are three branches of Cooperative Extension. I work in the Agriculture branch, which services all the farms and farmers in our area. The Home Economics branch helps homemakers with their problems. The 4H branch is for helping young people, ages eight to eighteen.

I studied agriculture in college. Some of my courses were about planting, growing, and sales management. Summers I worked on a farm. I helped with haying and vegetable planting. When I got my B.S. degree, my college helped me find a job. I filled out an application to be kept on file. My college called me when there was a job.

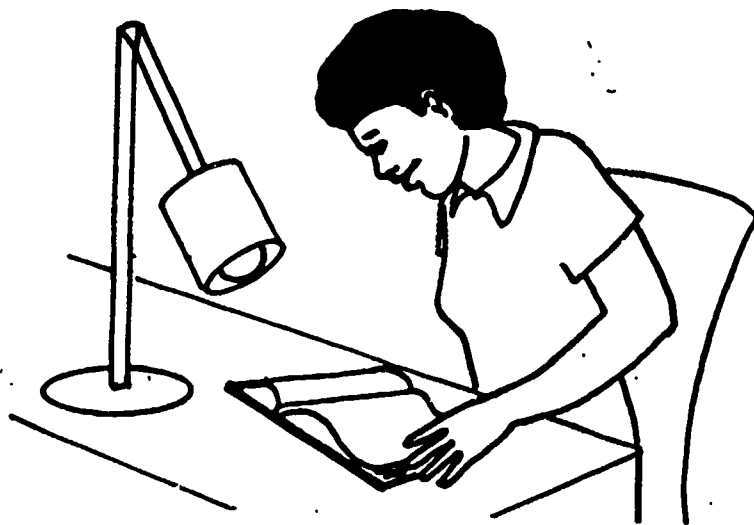

I worked in one county for five years as an agent's aide. Then I went back to college and got my Master's Degree in Agronomy (that deals with raising crops and care of the soil). My college helped me to find this job in Baxter County.

I teach classes in vegetable growing. I visit farms and help farmers plan their vegetable growing. This helps them make a profit. I also tell them about new vegetables, and I answer questions about gardening. Sometimes I don't know the answers. Then I find the answers in books written by the United States Department of Agriculture (USDA). I use other resource books and technical journals, too. My college also helps me find answers. People in agricultural colleges are always finding out new things about farming. They send this information to me. I share it with farmers who need it.

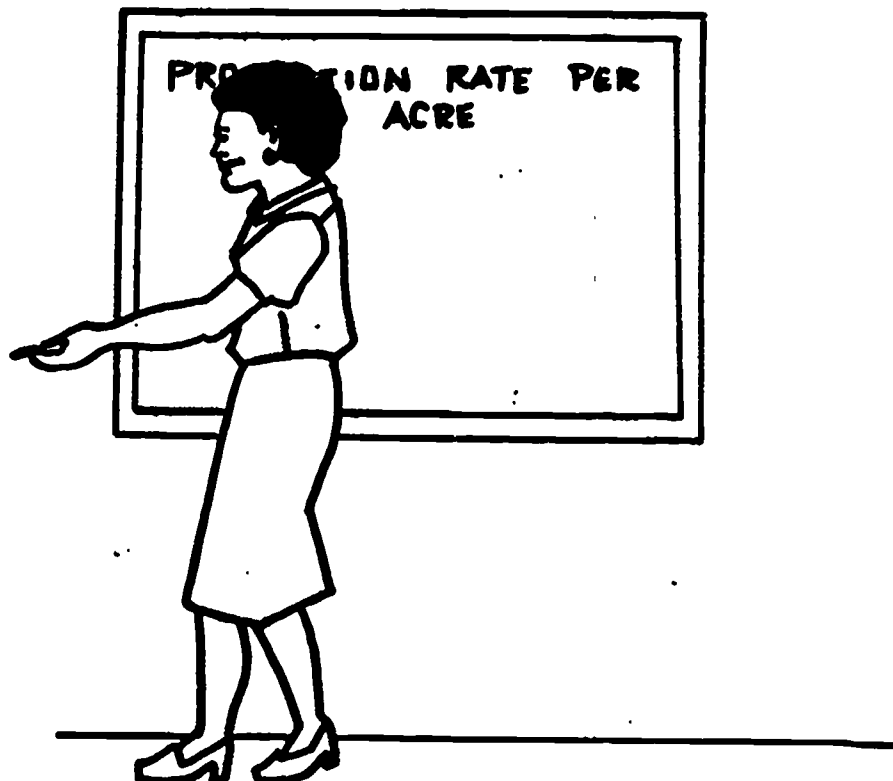

What do I do on a typical day? First, I answer the mail and make phone calls. In the afternoons, I may help a homeowner with gardening problems. I may call the college about setting up a county-wide program. I also visit farmers who need help. Sometimes I go to conferences for two or three days. I may attend week-long training courses at the college.

I use many tools. Some are date books, calendars, computers, research books, and information from the USDA. I use the telephone a lot. People call up needing help or information. I use the phone to arrange meetings or times for teaching. Because I travel a lot, my car is an important tool.

I have a very busy schedule, but I always try to keep up with my reading. Reading and math are important skills on this job. I read many technical journals. Because I have many reports to fill out, I need to write clearly. I report on nutrition, plant pathology, energy conservation, and many other things. I give the information in my reports to farmers and others who need it. I need math skills to understand and make graphs and charts. They can help me explain things to the farmers. I also need to speak well in front of people. That way, I can reach many farmers at one time.

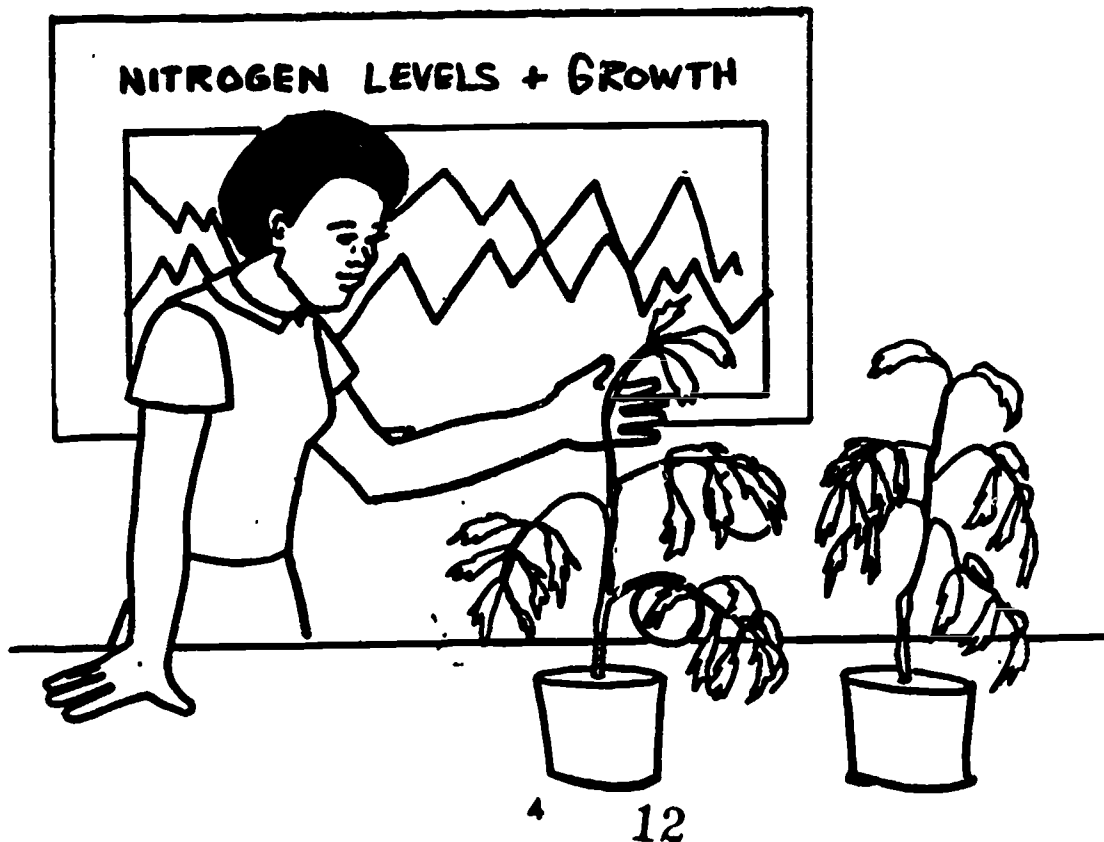

I try to keep the farmers' trust. I carefully check into any problems they may have. I try to find the best answers to their problems. If I am not correct, their problems could get worse. Then the farmers wouldn't trust me anymore.

If I wanted to advance on this job, I could go back to school for a higher degree. My job is fun. I get to do many different things. And I get to meet and work with many people.



QUIZ YOURSELF:

COOPERATIVE EXTENSION AGENT

A cooperative extension agent does many different things at her job. One main task is to teach classes. Name three other skills or tasks an agent does on the job.

An agent uses many tools and pieces of equipment on the job. Name three of these and one use for each.

To become a Cooperative Extension Agent, she had to go to college. What kind of college did she attend?

What kinds of courses did she take?

Now name two of the work places.

Name one way an agent can advance in the job.

Name one way that an agent uses math and reading on the job.

Name two other skills that are necessary for an agent to do her job well.

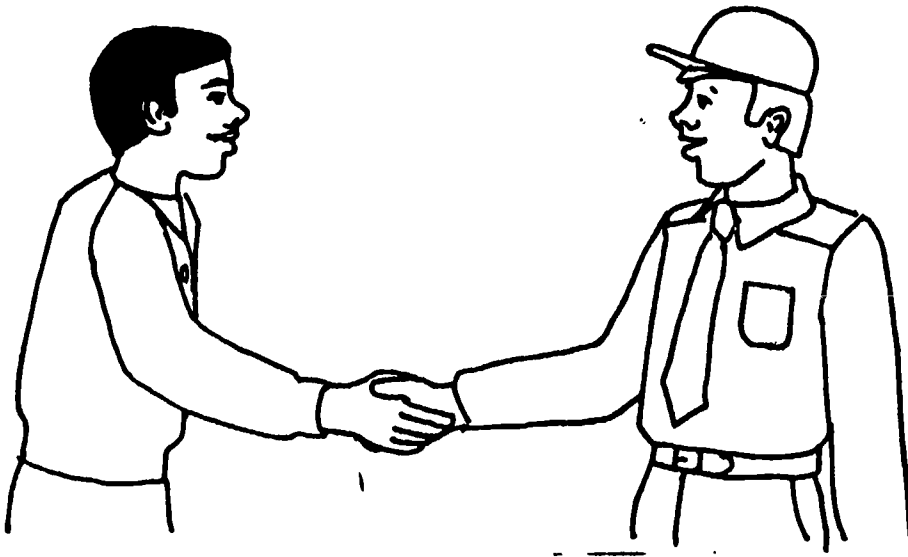

Farm Co-Op Manager

Mark: Hello, Mr. Lyons. Thank you for taking the time to talk with me. I know you're very busy here at Farmway Feeds and supplies.

Mr. Lyons: That's all right, Mark. We are busy selling all kinds of things. We sell feeds and grains for animals, seeds, garden plants, fertilizers, lawn mowers, cooking grills, work boots, and jackets. We also have fuel oils for home heating, as well as appliances, canning supplies, and repair or replacement parts for farm equipment. We sell anything you can name to be used on the farm or in the home. Farmway is a big company. It has many stores in this state. Since Farmway is big, it can buy goods in large quantities. The savings are then passed on to the customers.

Mark: That sounds like a good deal, but what makes this a co-op?

Mr. Lyons: Well, Mark, Farmway started out as a co-op more than 40 years ago. A group of farmers got together and bought a train car full of grain. Each farmer took a portion and paid for it. Each time these farmers needed grain or seeds, they would buy in bulk and share the costs. Eventually the co-op got bigger and supplied more and more items. The farmers sold stock in the company. Each farmer bought shares of stock. Today the co-op aspect of Farmway is still alive. During the years, Farmway offers bulk buying of different things. We offer paper products, fresh fruit, and frozen foods. Customers order merchandise ahead of time and pick it up on a certain delivery date.

Mark: So buying in bulk can pay off for the customer?

Mr. Lyons: That's right, Mark. What can I tell you next?

Mark: You have an important job here. How did you become a manager at Farmway Feeds?

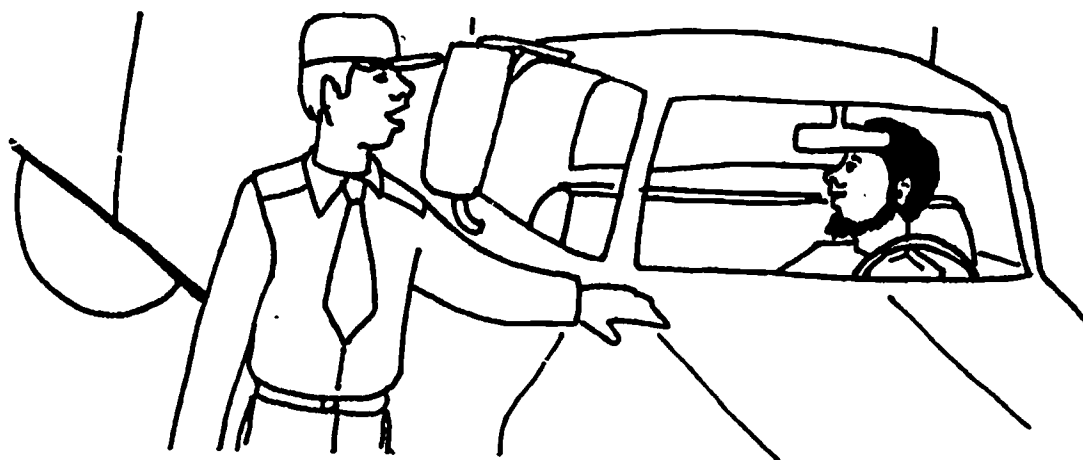

Mr. Lyons: It was easy. I lived on a farm as a boy, so I knew about this company. After high school I got a job with Farmway driving a gas truck. That was OK for a couple of years, but I wanted more responsibility--something that would lead to more pay. So I went back to school for courses in retail business. The Farmway company sent me to a different store as a trainee. During summer vacations I took courses, often paid for by Farmway, sometimes paid for by me. The next step was to become a trainee manager. This meant another move to a different location. I became a full manager with a store of my own. I still took courses during vacation time to keep up with new ideas in management. I also have a special degree in Turf Management. That means I know about lawns and landscaping. Now I can help my customers with planning and planting.

.. Mark: Gee, I didn't know you had to have that much schooling!

Mr. Lyons: Oh, it wasn't so bad Mark. Sometimes the courses were only three weeks long, sometimes six weeks. But they were hard weeks.

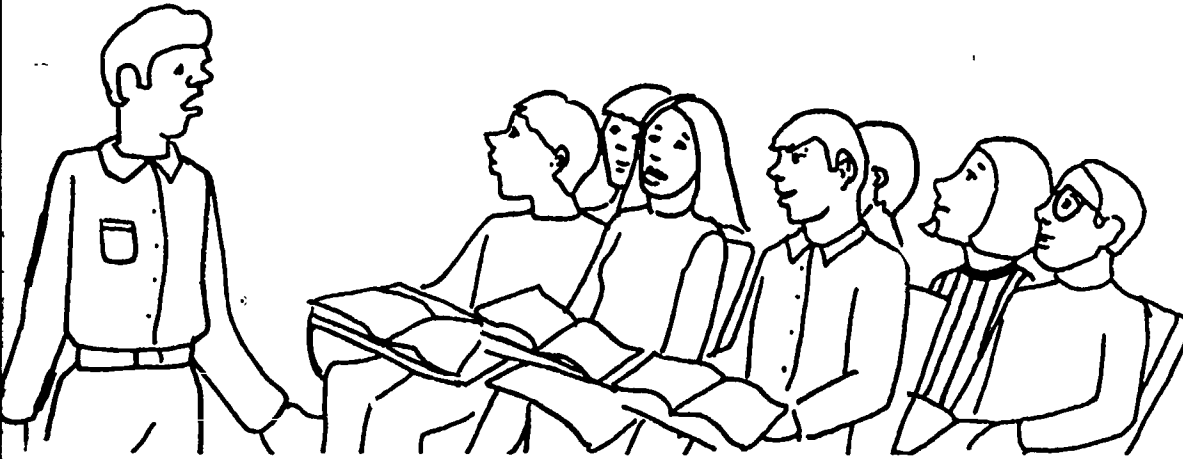

Mark: Now that I've asked you all about your training, I'd like to know what you do at work all day long.

Mr. Lyon: Well, Mark, I'm in charge of what goes on in this store. Personnel handling is one of the biggest parts of my job. I hire employees to work in the store. They stock shelves and keep them clean. They also run the cash register, carry large bags to customers' cars, and price the stock. If employees work well, I will help them to advance. If they don't work out, I'm the one who has to fire them. Advertising is also a part of my job. The company helps with advertising by supplying me with advertising layouts--as much as seven months in advance. That way I know which products will be on sale, and when they will be on sale. Then I choose which specials to advertise in the newspapers and I send the ads in to the papers. I must also make sure I have enough inventory on hand so I don't run out during a sale. When an item is on special, I try to give it a special display place in the store. I give this work to one of the store clerks, but I am the one who says where it should go to attract the most customers.

Mark: Wow!

Mr. Lyons: That's not all. Some inventory, or stock, is seasonal. One of my jobs is to order merchandise or stock in advance so that it's available before the season begins. I have summer stock on the shelves in March. By the time July is here, I bring in fall merchandise. So you see, I do a lot of planning on my job. I try to keep sales volume up by offering items my customers need and want. If sales drop, I'm in trouble. I have to change the store layout or offer special sales to draw customers into the store.

Mark: What's the hardest part of your job?

Mr. Lyons: The hardest part of my job is customer relations. I try to keep all the customers happy. If they buy a faulty item, I give them a fair exchange or their money back. Sometimes the customer is wrong, but I have to be careful with them so they will be happy. This way I won't lose their business. When customers apply for credit, I have to check to see if they're a good risk. I then accept or reject their credit applications.

Mark: Do you spend most of your time in this office?

Mr. Lyons: Oh, no. I don't sit in this office all day. Sometimes I go out on the floor to help the customers, sometimes I'm on the truck with the delivery workers. Other times I go out in the field to check on products we've sold. I check out seeds, plants, or even animal feeds. I also work with cooperative extension agents in this county. We share information. Many times I attend meetings with people who have interests in farming, planting, or anything to do with agriculture.

Mark: Now that I know what you do on the job and where you work, I'd like to know what your tools are and what they are used for.

FARMWAY ★ ★ SUMMER SALE



11

Mr. Lyons: That's hard, Mark. I don't have many specific tools for my job. I guess you could say that the telephone is one tool. I do use it often during the day. The same goes for my pen. I might use a cash register sometimes if the store gets really busy. I also have special newsletters and magazines sent to me that are helpful in my business. I feel that my main tools are my education and my ability to deal with people. My schooling and my degree in Turf Management are big assets. I need a wide background of knowledge to help my customers choose the right item. I help them solve problems with their animals, crops, or lawns. If I don't know the answers, I must know where to get them. Getting along with people is an important tool. For Farmway to run well, the customers and workers have to be happy.

Mark: Gee, Mr. Lyons, it seems like you know a little bit about everything. How do you do it?

Mr. Lyons: Mark, you know your teachers are always telling you to read? Well, reading is a big part of my job. I have to be able to read the publications I receive and the advertisements I send out. I must also be able to read and understand receiving invoices, freight bills of loadings, and charts and graphs. I am responsible for filling in all kinds of forms. I must be able to read them before I can fill them in. For example, I fill in payroll forms and environmental protection forms (to show that Farmway follows the environmental regulations). Math is important, too. I have to understand bills and taxes. Knowing percentages and how to figure out prices helps me in my work.

Mark: Mr. Lyons, I have one more question. Are there any dangers?

Mr. Lyons: I don't think there are any dangers, Mark. I have a pleasant office to work in. The store is warm in the winter and cool in the summer. This is a clean and pleasant place to work. The company has coffee for all the workers. There is a refrigerator to store lunches. There is also a place to eat and take a break. We all get health insurance, a retirement plan, and vacation time. Even though I have a lot of jobs to do in one day, I really like my work and enjoy doing a good job.

Mark: Thanks for this interview, Mr. Lyons. You've helped me to see what your job is like. I would like your kind of job in a few years.

Mr. Lyons: It was my pleasure, Mark. Keep up the good work in school. Come see me when you're ready to start work. I'll see if there are any jobs open. Meanwhile you are welcome to come into the store any time as a customer.

QUIZ YOURSELF:

Farm Co-Op Manager

What are two places where Mr. Lyons got the training he needed to become a Farmway manager?

What are three skills or on-the-job tasks which Mr. Lyons performs at Farmway?

What are two places where you might find Mr. Lyons at work?

What are three tools or pieces of equipment that Mr. Lyons uses on the job? How is each one used?

How do reading and math skills come in handy for a farm co-op worker?

Mr. Lyons talks a little about the working conditions at the co-op. What is one of the benefits he mentions?



Horticulturist

SKILLS AND TASKS

Feeds and cares for plants to make them look pretty, grow better or grow bigger.

Helps make plants like fruit and nut trees or vegetables be better to eat and stronger so the bugs can't destroy them.

Studies and does research on plants to improve and make them stronger.

Tests how fertilizers and bug killers affect the plants.

Teaches farmers how to grow better crops.

Takes care of plant nurseries and greenhouses.

Must like plants and have good eyesight.

TOOLS AND EQUIPMENT

Special soil mixture — to give the plant a better place to grow.

Soil sterilizer — to remove germs from the soil.

Brushes for pollen grains — to cross pollinate the plants.

Insecticides — to kill bugs.

Scales — to weigh the plants.

Microscope — to magnify tiny seeds and bugs.

Chromatograph — to measure the insecticide in the plants.

TRAINING

High school science classes

Work in a greenhouse

Two year college program

College degree in plant sciences

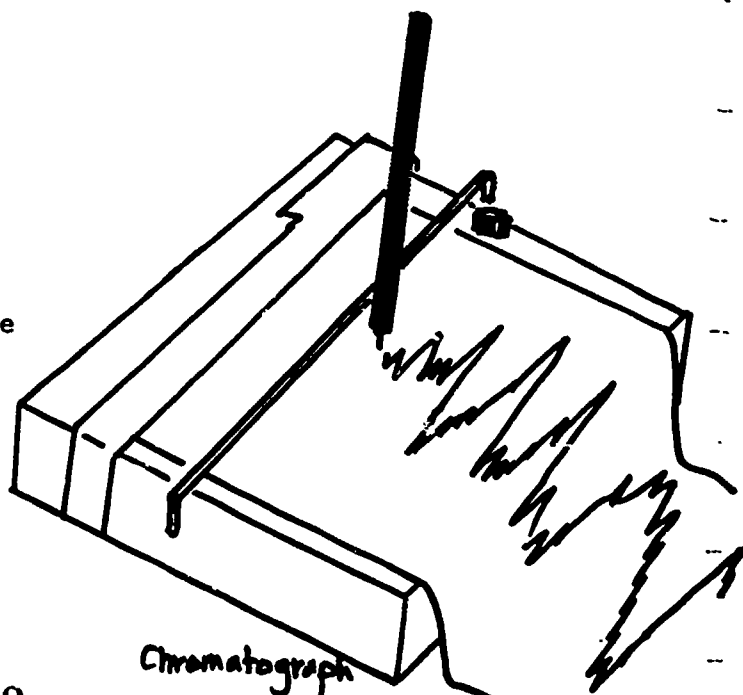

WORK PLACES

Greenhouse
Farm
Forest
Seed and food companies

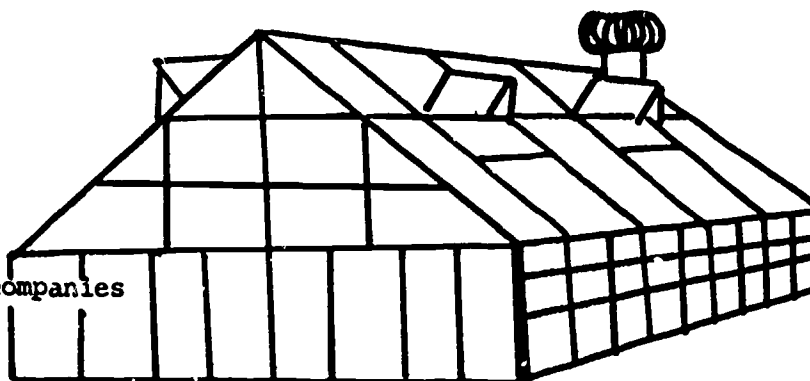

WORK CONDITIONS

Plants and trees are pleasant to look at, and they often have pleasant smells. A love of plants and trees and good eyesight are important for a horticulturist.

Chemical fertilizers and pesticides must be used carefully. They can be poisonous to people.

ADVANCEMENT

With continued formal schooling and on-the-job experience, a horticulturist can

- supervise nurseries, greenhouses, or laboratories,
- become a specialist in one area of horticulture,
- change to related work like landscape architect.

WORD MEANINGS

parasites: things that harm plants by living on them and eating them

pesticides: chemicals that kill parasites

bacteria: tiny living things that can be seen only with a microscope.

specimens: samples, or examples

horticulture: the science of growing flowers, fruits, vegetables, and shrubs, usually in gardens or orchards

landscape architect: a worker who designs and draws up plans to change an area of ground to make it more attractive, usually by adding things like lawns, trees, or bushes

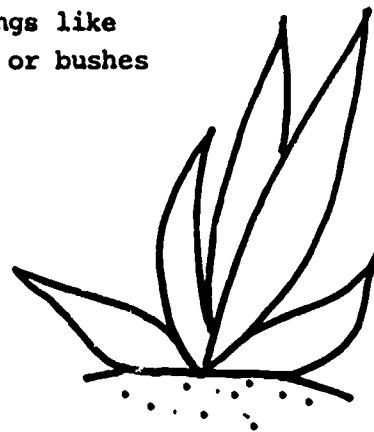

Quiz Yourself

HORTICULTURIST...HORTICULTURIST...HORTICULTURIST...HORTICULTURIST...

Below are some questions about the skills and tasks, tools and equipment, training and work places of a HORTICULTURIST.

If there are any questions you can not answer, reread the fact sheet and go back over these quiz questions until you can answer all the questions correctly.

Name 3 tools or pieces of equipment used by a HORTICULTURIST.

What is one use for each tool or piece of equipment you named?

Name one training place for a HORTICULTURIST.

Name 3 skills and/or tasks of a HORTICULTURIST on the job.

Name one place where you might find a HORTICULTURIST at work.

..HORTICULTURIST...HORTICULTURIST...HORTICULTURIST...HORTICULTURIST

HORTICULTURIST...HORTICULTURIST...HORTICULTURIST...HORTICULTURIST...HORTICULTURIST...HORTICULTURIST...HORTICULTURIST...HORTICULTURIST...HORTICULTURIST...HORTICULTURIST

HORTICULTURIST...HORTICULTURIST...HORTICULTURIST...HORTICULTURIST...HORTICULTURIST...HORTICULTURIST...HORTICULTURIST...HORTICULTURIST...HORTICULTURIST...HORTICULTURIST

ORGANIC TRUCK FARMER

A FARMER WHO GROWS VEGETABLES AND TRANSPORTS (TRUCKS) THEM TO THE PLACE WHERE THEY'LL BE SOLD

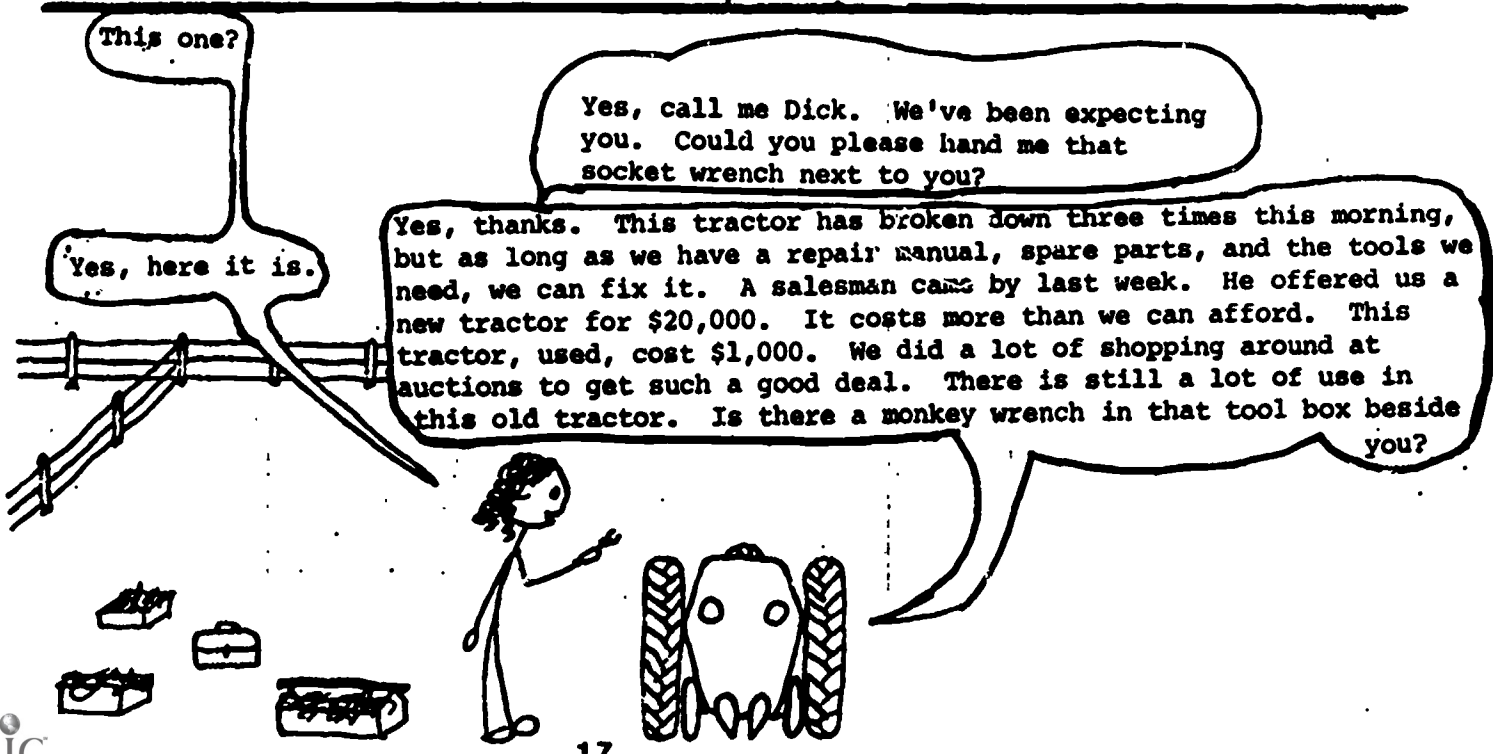
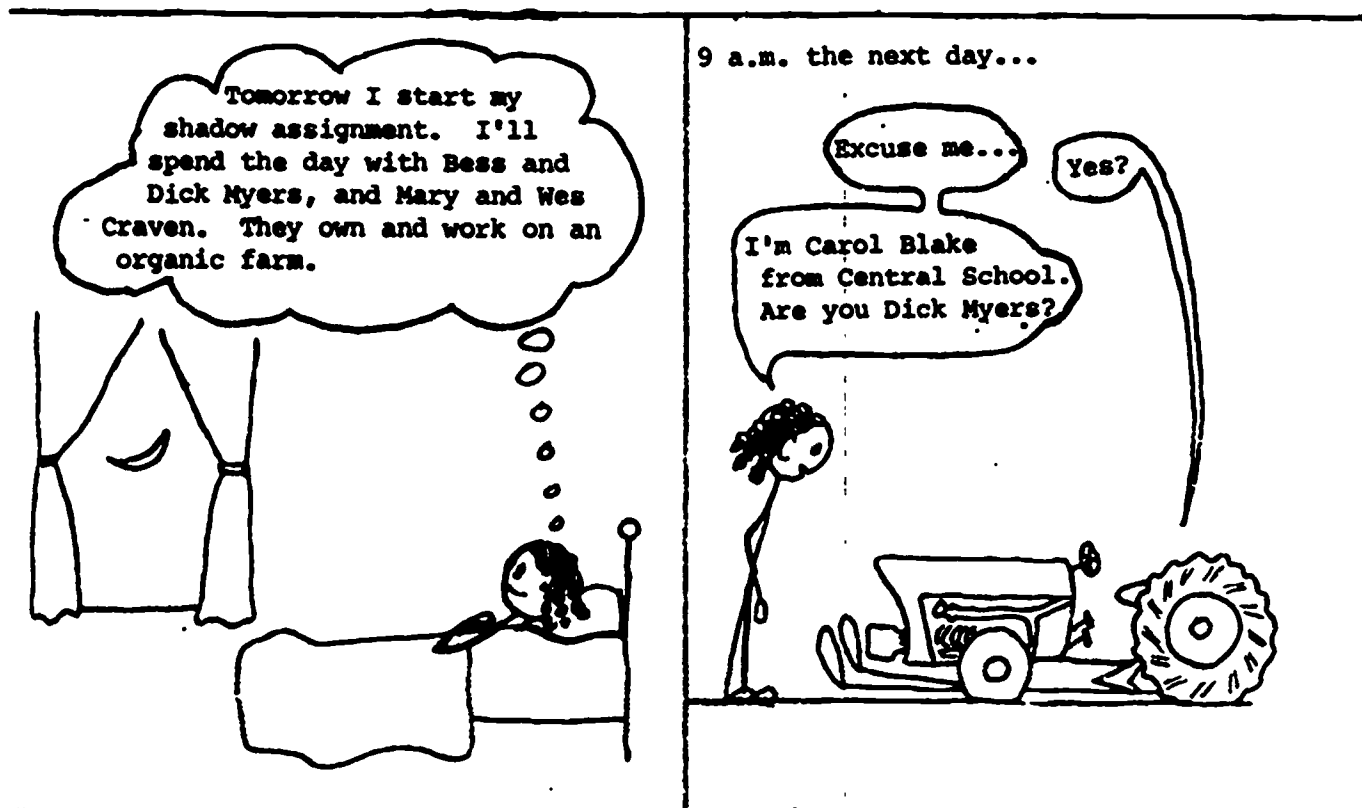

There are a lot of tools in this box, and I see more tool boxes, too.



There are still more tools in the barn. We keep our implements for the tractor in there too: the spreader, the tiller, and the harvester. That's the seeder behind you. The cultivator's in the barn also. I have to repair that next. We use many tools on the farm: mechanic's tools to repair the tractor and the truck, and carpentry and masonry tools to fix the buildings. We built that packing house next to the barn. The electrical and plumbing tools are used to repair the house and outbuildings.

You seem to be able to do everything by yourselves.

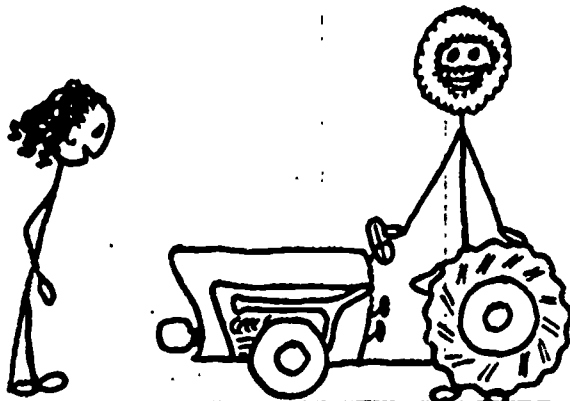

We try to. Repairing the farm equipment and machinery is an important skill on this farm. We depend on the tractor for all stages of growing food. The tractor is needed for tilling and fertilizing the soil. It is used also for harvesting what we grow. We need to keep our truck in good running condition, too. We use it to take our produce to market. Mary is tuning the engine on our truck now. There! The tractor is ready to work some more. Come with me and I'll introduce you to Mary.

How is it going, Mary?

The truck will be ready to go to market this afternoon.

Mary, this is Carol Blake.

JOHNSON-MARGO FARM

That's my son Mike. I'll take him with me now, Mary. I'm going to repair the cultivator. We plan to cultivate the beans this afternoon, if the tractor doesn't break down again.

HI.

Do you sell your vegetables at the Farmers' Market?

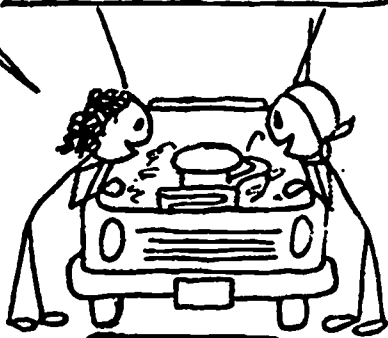

Wh/ is that?

Yes, and we also sell wholesale to the health food store and to a few restaurants in town. But I like the retail sales at the Farmers' Market the best because I enjoy setting up attractive displays and dealing with the customers. People like me right off because I'm always smiling. Also I can figure out prices and change quickly and correctly, and people know that I deal fairly with them. Being able to work with people is an important skill in sales. We really need that ability in selling our organic vegetables.

Well, we don't use chemical fertilizers or sprays on our farm. Instead, we use manure and compost as fertilizers. For pest control we use things like wood ash. And ours is the only farm around here owned and run by two families who live on it. Also, we raise produce, and the others are dairy farms. Our lifestyle is different. Sometimes people don't trust those who are different. These folks need to see that we are honest and hardworking and trustworthy.



Bess, this is Carol Blake.

Hi, Carol. Come with me and I'll show you how the seeder works.

Mary?

Over here, Bess.

Let's see. . . I want to plant five acres of corn. I'll need ten pounds of seed per acre. . . that's 50 pounds.

Do you just pour the 50 pounds of seed into the seeder?

No, not yet. First I have to calibrate the equipment.

How do you calibrate it?

I make two adjustments on it. First I set the size of the opening. This way only one kernal can fall through at a time. Next, I change the width of the cylinder that holds the corn. Now the kernals will drop out eight inches apart.

Do you have to calibrate the seeder every time you plant a different kind of seed?

Yes, each seed is different. In fact, to know how much of anything to put on the fields, we need to figure out the right amount for each acre. We have to compute basic amounts each day. Math skills are an important part of farming. We need to know how much it costs to grow our crops so we can make a profit when we sell them. The profit helps to pay our two hired men, money we owe on the farm, taxes, and our day-to-day living expenses.

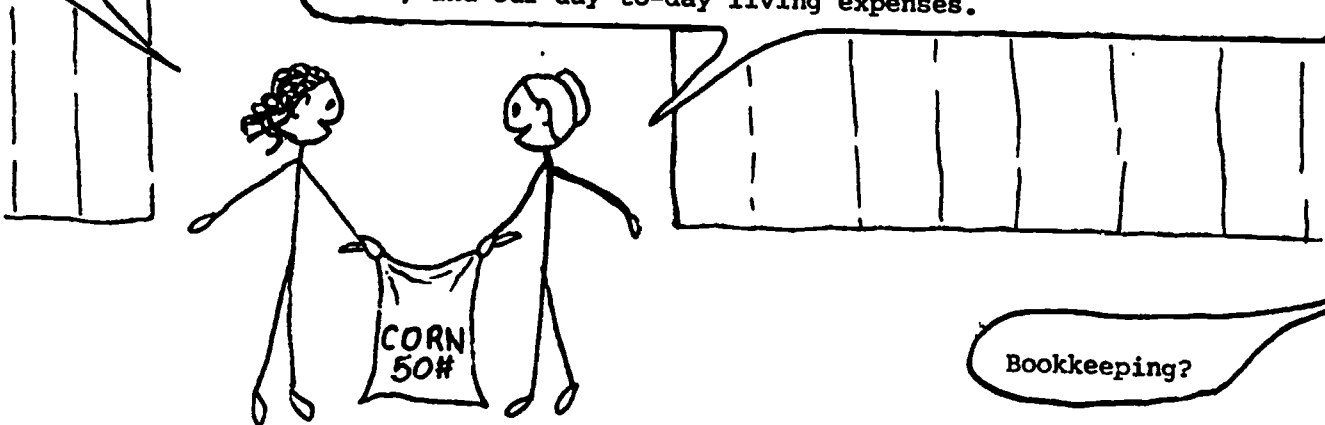

Bookkeeping?

That sounds like bookkeeping.

That's right, Wes. I was just telling Carol about some of the skills we use to run the farm.



Hello, Carol, I'm Wes. Why don't you come with me to get Mike, then up to the house. While I make lunch, I'll tell you about more of the skills and tasks needed for farm management.

Bookkeeping is important for us. We have to keep correct records of the money coming in and going out. It even helps us figure out what we can afford to grow.

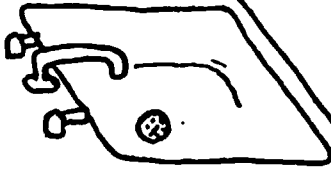

What do you mean?

If we planted five acres of asparagus instead of corn, we'd be planting \$300 worth of asparagus roots. Our \$50 worth of corn seed will make about \$500 this year. It takes three years for asparagus to make money. Then we would make about \$3,000. Right now we can't afford to wait three years for a return on our money. We are planning to start asparagus roots in about two years.

But I thought farmers were given a tax break for losing money.

Yes, the money farmers lose each year can be taken off their income taxes for the first five years. But Dick, Bess, Mary, and I just don't feel happy losing money and being in debt. So we plan to pay off our mortgage quickly. We always buy used equipment we can afford. That way we don't have to borrow money from the bank to buy new machinery.



It sounds like you have to watch your money pretty carefully.

What's cooking, Wes?
It sure smells good.

That's my homemade pea cassarole.

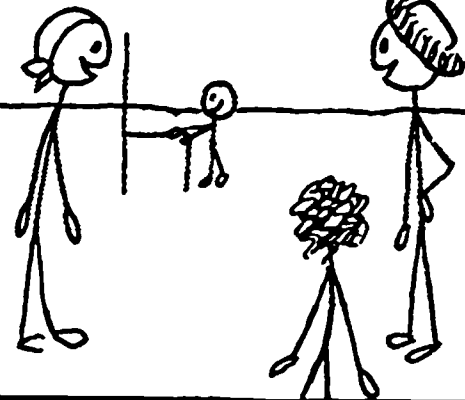
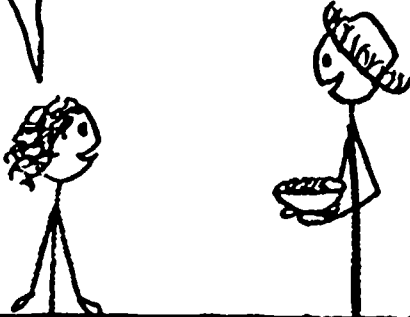

We do. Right now two of us have outside jobs to help pay for the farm. Mary teaches English to Spanish speaking students in night school, and Dick's a computer programmer for I.O.M.

I'll be working up here in the office for the rest of the day. I have to send out some letters to our suppliers and pay some bills. I also want to look over those new catalogs we got last week.

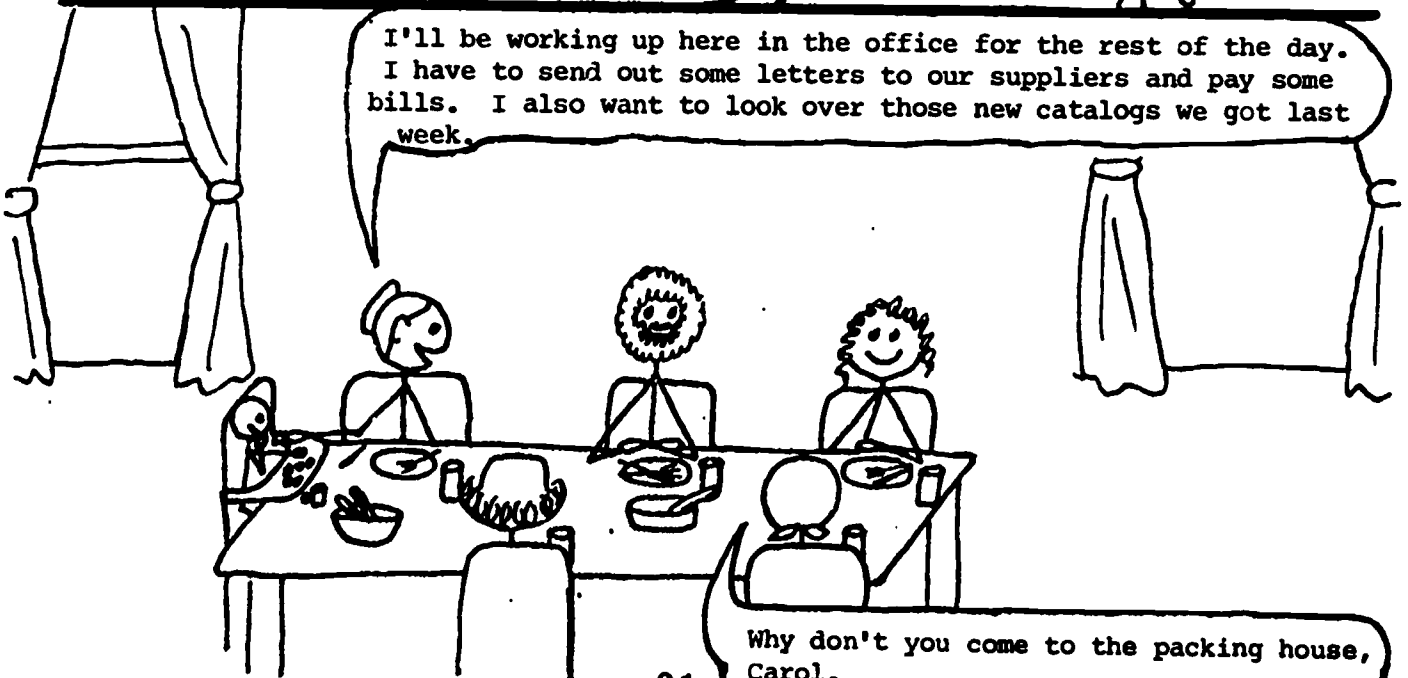

Why don't you come to the packing house, Carol.

I've seen the barn, the fields and the office, and now I'm in the packing house. Do you work anywhere else?

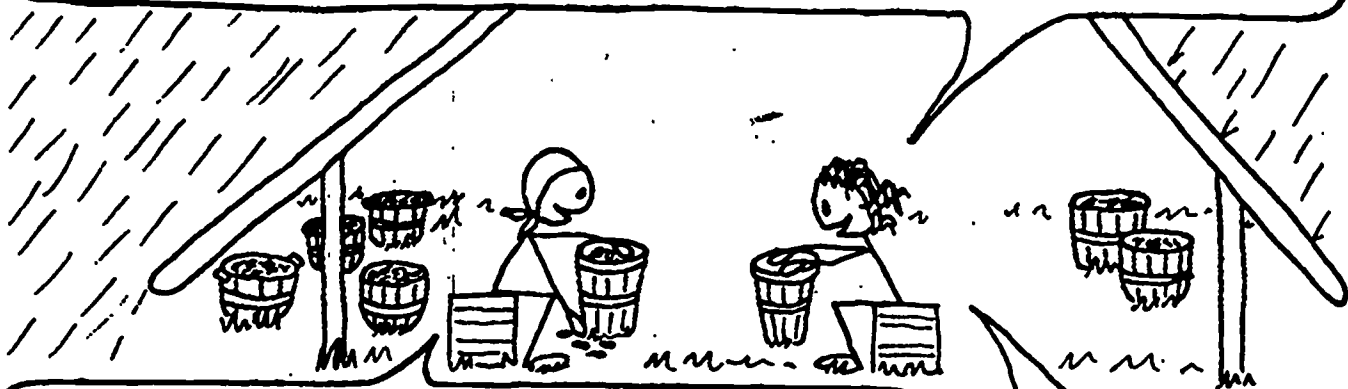

Most of our work is right here on the farm. And we work rain or shine. We also work at the Farmers' Market and vegetable stores. Now all the peas are packaged. I'll drive the truck over and we'll load it. Will you tell Dick that we're ready to go?

Sure, and I'll say goodbye to everyone before I ride back to town with you.

I can see lots of advantages in being an organic farmer. You're not exposed to large quantities of toxic chemicals. The air and water on the farm are cleaner than in town. And you sure get lots of exercise and good food. Are there any hazards in farming?

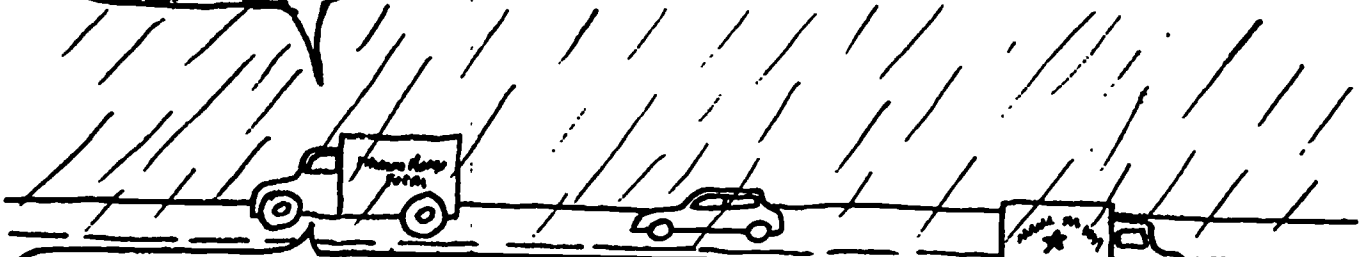

Yes, the weather can be a hazard when it destroys crops. And you always have to be careful when working around machinery. Even organic pesticides can be dangerous in large quantities. People with allergies have to be very careful.

It stopped raining. And here's the Farmers' Market.

I don't have allergies, and I really like the work I saw today. How can I get training to become an organic truck farmer?

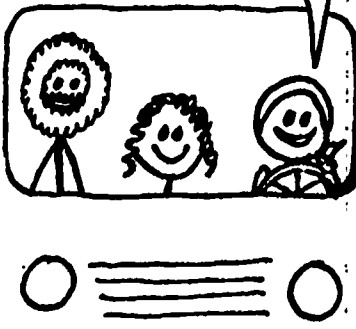

To learn management skills, you could work in a small store that buys and sells vegetables. You could also work in the produce section of a supermarket. Agricultural colleges also teach management skills. You can learn how to grow organic crops in your own garden. If you work on a truck farm, you'll learn how important discipline is.

What do you mean?

Farming is not a nine to five job. There are long periods of very boring work in the sun or rain.

I didn't think of that. You seemed to be having such a good time working today.

Our work is not easy. We share the chores and the responsibilities. And we like what we are doing.

JOHNSON - MARGO FARM



I like it too. When school is over I'd like to talk to you about a summer job.

Good!

We'll be seeing you then.

These snow peas look delicious! How much are they?

Ninety-five cents a pound, and they taste as good as they look. Try one.

I'll take three pounds.

I'll have four pounds of peas, please.

How much are these gorgeous peas?

I learned so much today from shadowing. Now I'll write about it in my "Mission Information" report.

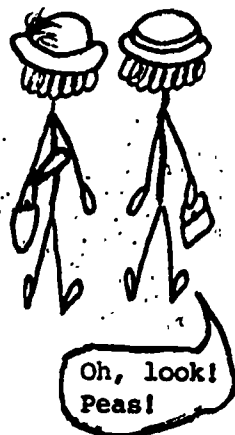

ORGANIC TRUCK FARMER REPORT

Name 3 skills and tasks an organic truck farmer performs on the job.

Name 3 tools or pieces of equipment and one on-the-job use for each.

Name 3 math skills used on the job.

Name 2 kinds of things an organic truck farmer might read.

Organic truck farmers use other skills that can be learned in school. Name 2 of them.

Name 3 places where an organic truck farmer might be found at work.

Name 3 places where a person might get training to become an organic truck farmer.

Working conditions of an organic truck farmer are discussed in the cartoon. Name 2 advantages and 2 hazards.

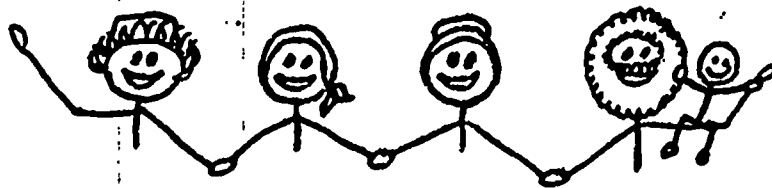

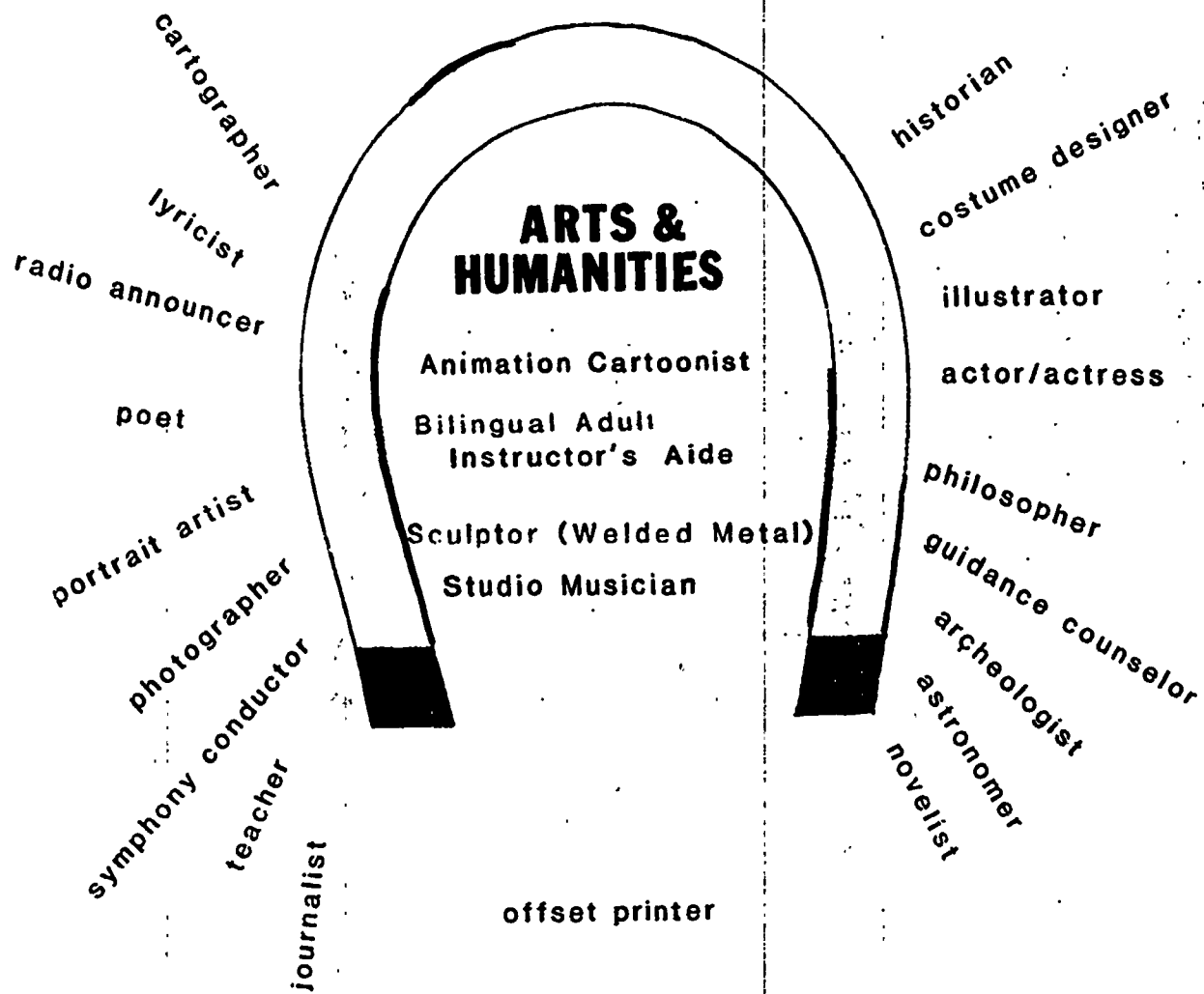

Workers from the Arts and Humanities cluster use their creativity to teach, write, perform, and study the arts and humanities, which include literature, dance, music, painting, and historical subjects.

Animation - Cartoonists

Storyboard



Peg Price
Interviewer

I know this is an animation studio. You make commercials here. But what goes into making a one-minute commercial?

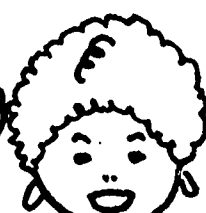

For every minute of animated film, 1,440 pictures must be drawn. These pictures must be drawn in a series. Each picture is a tiny bit different from the one before it. Shown together in a fast sequence, the pictures look as if they are moving. The person in charge of this is called an in-betweener.



Jerry Fine
Director



Carol
Assistant

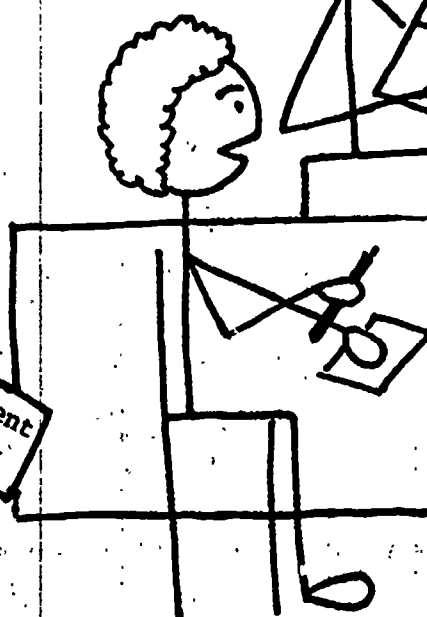

Bruce Vell
Animator



Dan Jenley
In-betweener

That's me. I draw the pictures that go in between the animator's drawings. This makes the cartoon run smoothly.

It's like tracing. The pictures must look a lot alike.

Yes, they do. At this light table, I can see the lines of the pictures very easily. It is my most important tool. I also use pencils, paper, and lots of erasers.

After being an in-between, what comes next?

If I do well as an in-between, I'll get to be an animator's assistant. Sue is an animator's assistant.

What does she do?

She cleans up rough drawings and adds details. Bruce, our animator, looks like he would like to talk with you now, Peg.

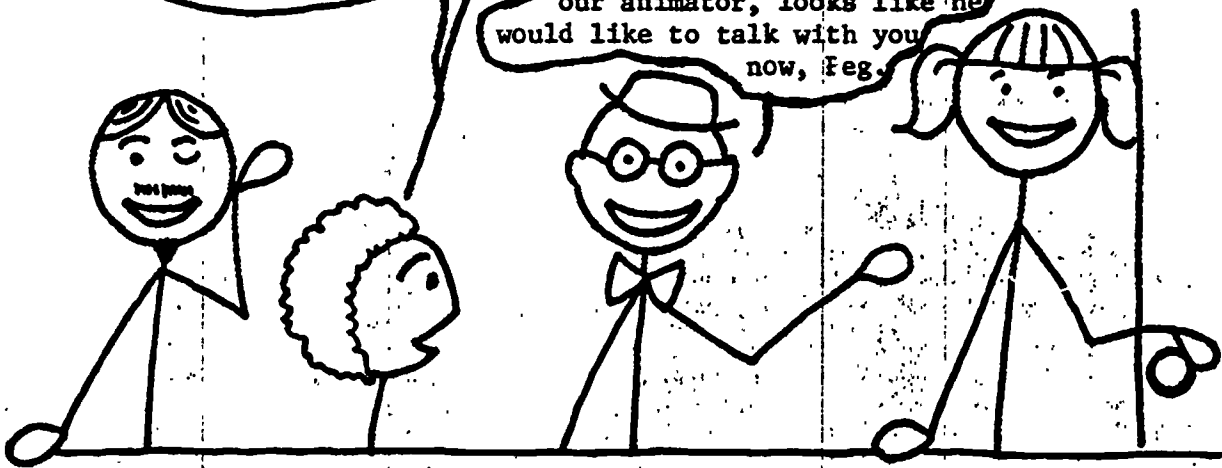

Hi. I have been listening to you talking with Dan. I am an animator. In the future, I could be an art director, or a film producer. I really want to be a free-lance film maker.

Would you make a lot more money?

As a free-lance film maker I would get paid by the job. Here, I get paid by the hour.

So do I. This is a union shop. We all get paid at least minimum wage.



Carol Climent Assistant

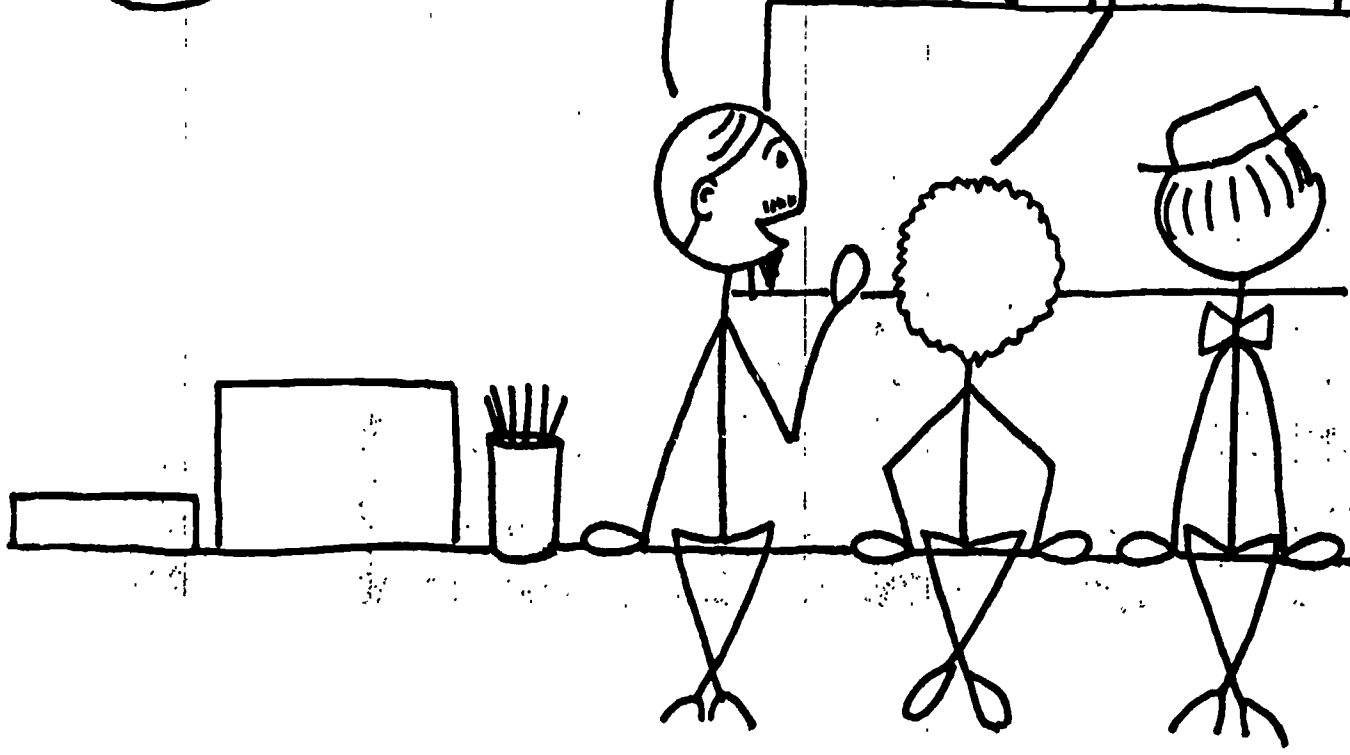

A union shop! That is interesting. Where else can people work who want to do animation?

Some companies have animation studios. Motion picture studios hire animators, and free lancers do work at home in their own studios.

Chuckle, Chuckle

What are the working hours like here?

In the summer and early fall we work many hard hours. Sometimes we work around the clock. We have to get ready for the new TV shows. Then we have a real easy season. Sometimes too easy. Then people can even be laid off.

Bruce, what kind of training did you have?

I had no formal training, except in high school art classes. Mostly, I practice drawing a lot. Our director, Jerry, went to an art school. Sue, our assistant, took courses at a two-year college. All artists keep portfolios, or collections of their best work. Sometimes, a good portfolio will get you a job faster than a lot of training. That's what happened to me.



Hi, everybody. What do you think so far, Peg?

Hi, Jerry!
I have a good idea of what you all do, but I'm still not sure about how it all starts. How do you know what to do?

Come with me and I'll show you.

This storyboard has frames with pictures and words. It is used as an outline for the animators. They draw the pictures that go between the storyboard frames.

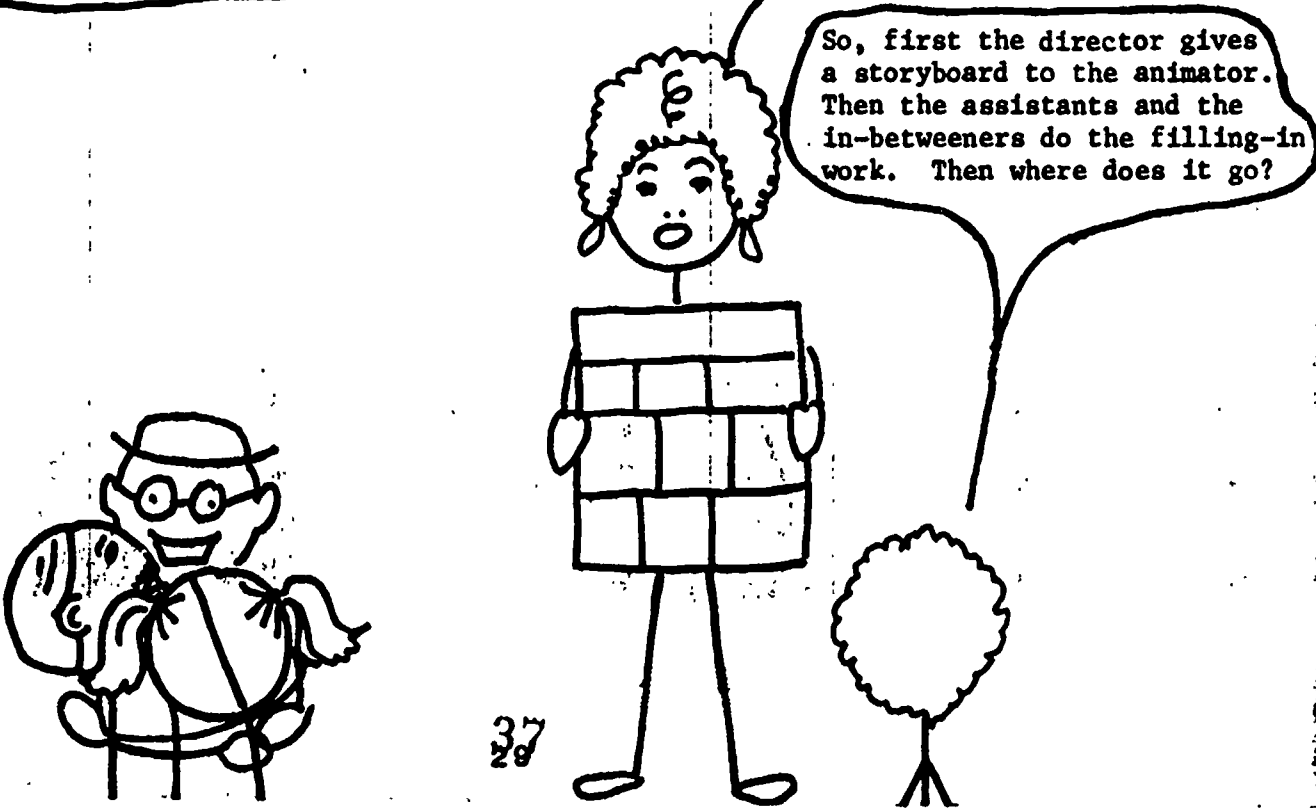

So, first the director gives a storyboard to the animator. Then the assistants and the in-betweeners do the filling-in work. Then where does it go?

Next it goes to the camera and sound crews. Oh, but it can't go anywhere without an exposure sheet. That explains what will happen in a given amount of time. The exposure sheet tells what the camera should be doing. It also tells what the sound people should be doing. The exposure sheet tells everyone all the things they should be doing.

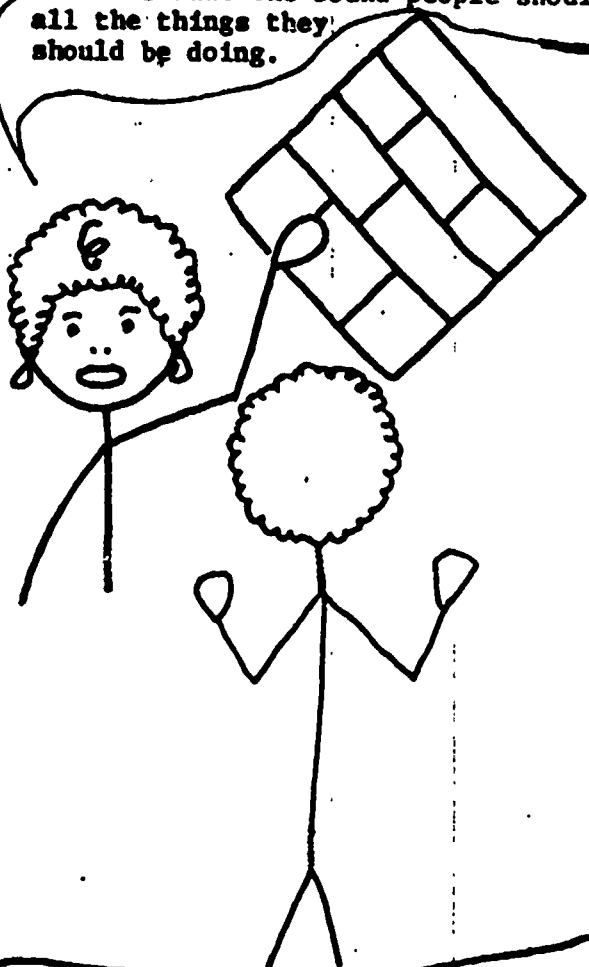

So, an animator must be easygoing and has to be able to draw very well.

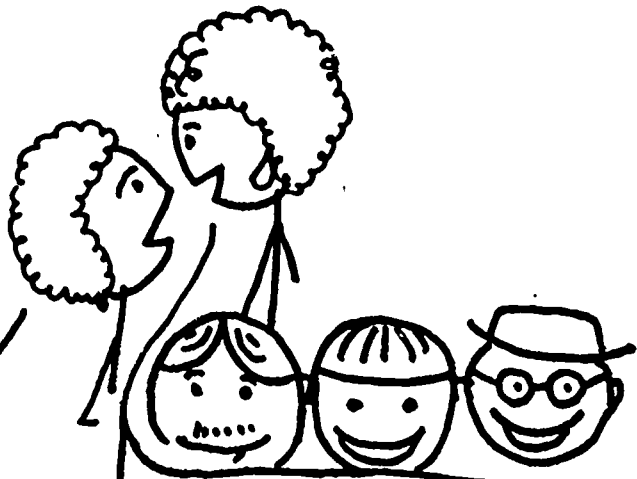

The most important thing is a good sense of humor.

What kind of dog keeps the best time?

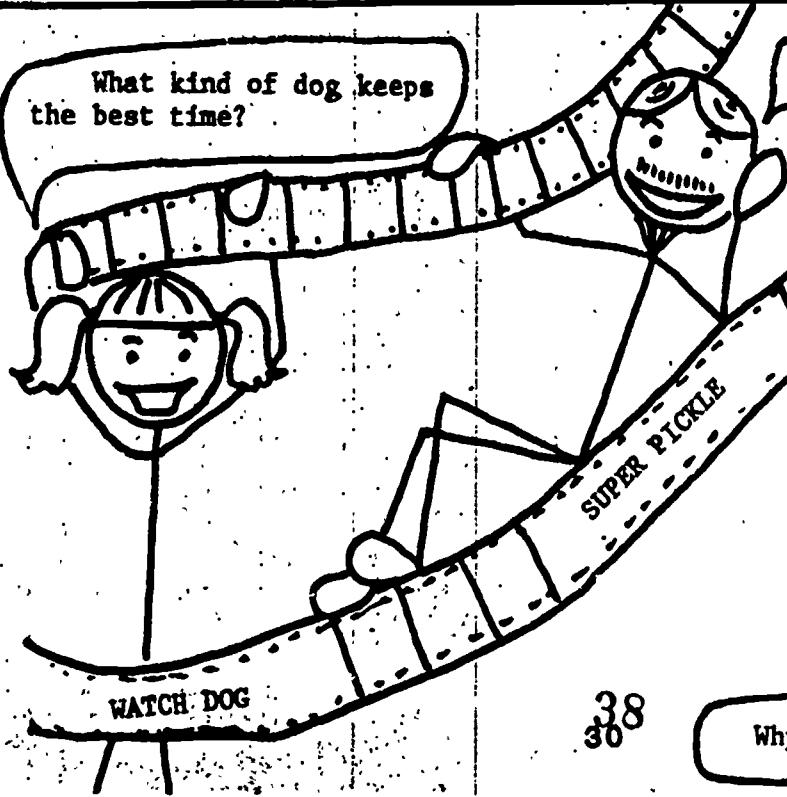

What's green and flies?

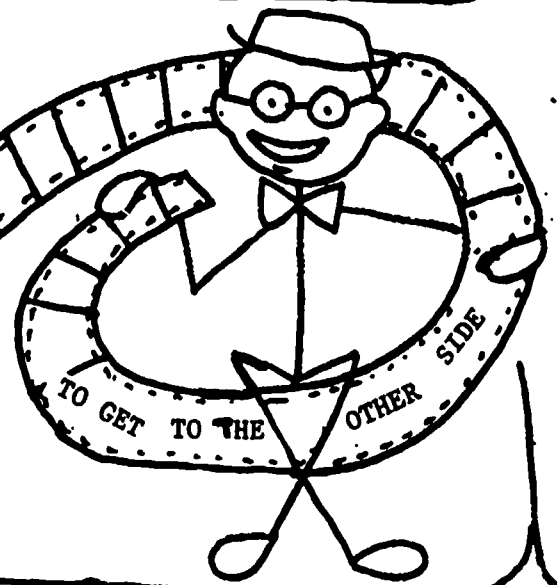

Why did the chicken cross the road?

Quiz Yourself: Animation Cartoonist

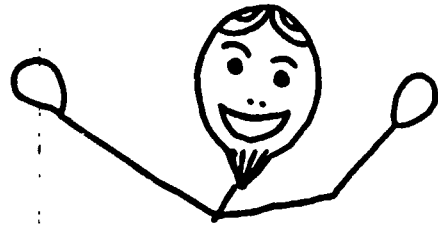

Name 3 of our tools or pieces of equipment and 1 use for each.

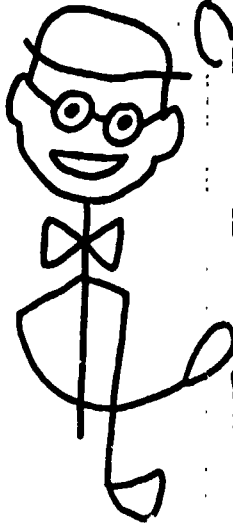

Name 1 of our training places.

Name 1 of our work places.

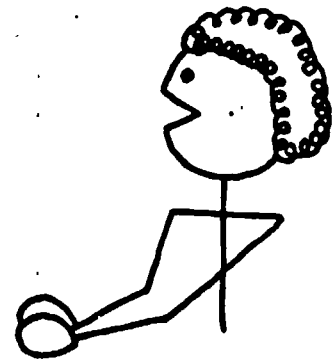

What are 3 of our on-the-job tasks and/or skills?



Reread the cartoon to find answers to things you don't remember.

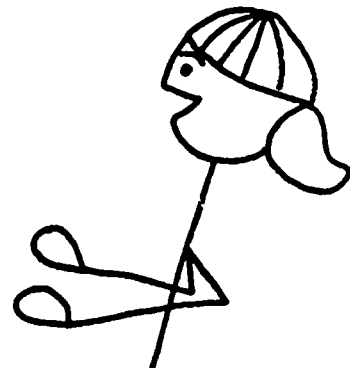

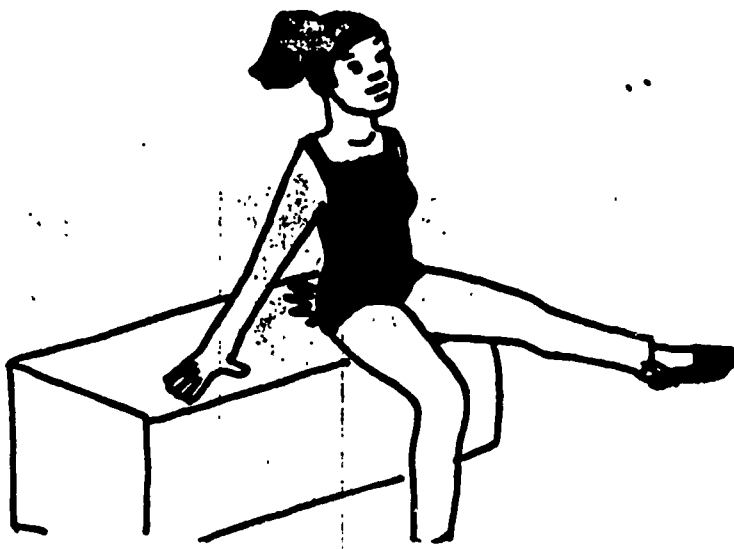

ADULT INSTRUCTOR'S AIDE

My name is Maria. I work in an Adult Learning Center. I help people learn the English Language. After I dropped out of high school, I could not find a good job. I went to the Adult Learning Center to work toward getting my high school equivalency diploma. Twice a week I went to the center to study. I did my work in a carrel because it was quiet. There were tables for doing group work, and counselors that students could talk to about problems. Sometimes a counselor referred a student to an agency for help. Other times a counselor helped a student to gain employment or enter a work training program.

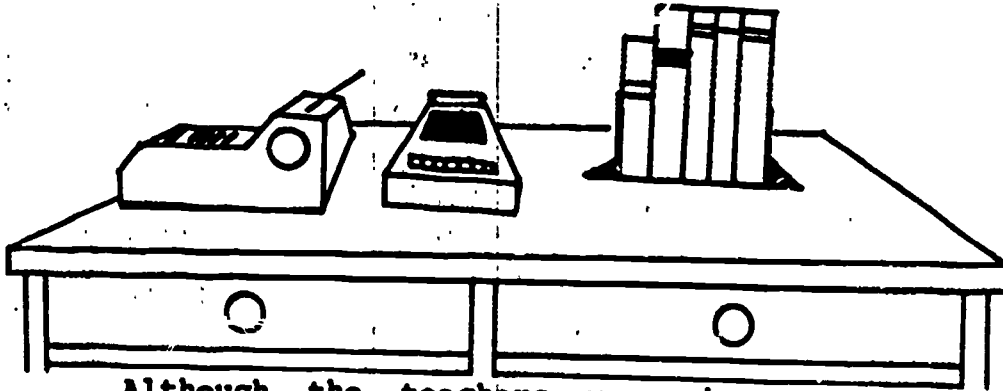

Although the teachers were nice, none were Hispanic. This caused a problem in understanding at times. Sometimes teachers asked me to help other Hispanic students. I have always taken for granted the fact that I am bilingual. This now enables me to get many good jobs. It also helps that I am willing to work hard!



After earning my equivalency diploma, I accepted a job at the center. I file student records in a file cabinet and arrange books. I also order ESL (English as a Second Language) materials and help people learn how to spend money wisely.

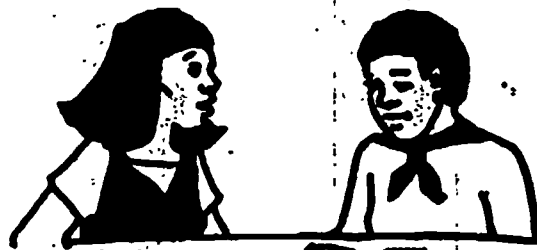

I was hired to work part time. I work on an hourly basis as an Instructor's Aide. Although the pay is low, it enables me to go to school and work toward a degree. I am taking dance classes as part of my studies, but my degree will be in Spanish. College study is hard work, even though I already speak Spanish. Perhaps someday I'll teach Spanish!

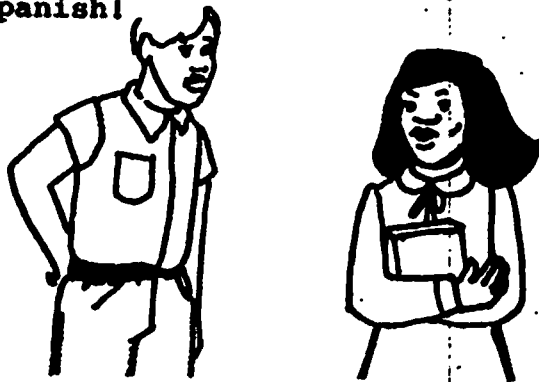

Once I've earned my degree, I will work full time as an Adult Education Instructor. Then I'll be giving and marking tests, and keeping student records. I will also counsel and make referrals. One of my duties will be teaching "Life Skills." Examples of life skills include reading want ads, filling out forms, and spending money wisely. The largest part of my job will be ABE (Adult Basic Education), which involves helping people learn to read on a seventh grade level.

I presently use some of the materials that I will use as an instructor. I use references, texts, and workbooks with the people I help. I also type, use a blackboard, a filing cabinet, and tape and film equipment.

I am sharing this story to tell Spanish-speaking people that being bilingual can be an advantage that they can use to make better lives for themselves.

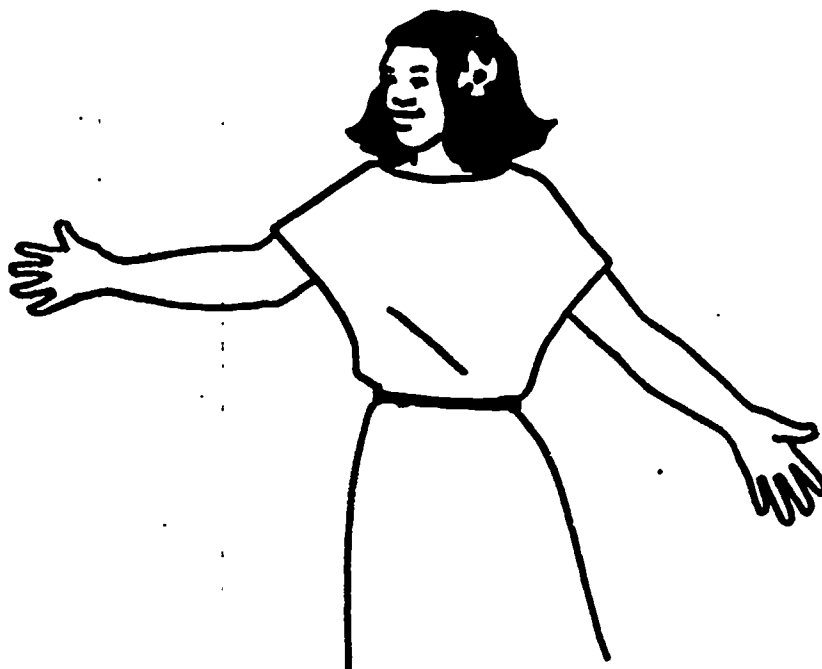

QUIZ YOURSELF: ADULT INSTRUCTORS' AIDE

Name three of my tools or pieces of equipment and one use for each.

Name one of my training places.



What are three of my on-the-job tasks or skills?

Name one of my work places.



WELDED METAL SCULPTOR

Lisa: Hello, Mr. Marks. I'm Lisa, from the City Middle School.

Mr. Marks: Come in, Lisa. You're right on time. I like that.



Lisa: Is this your studio? It's not what I expected. It looks like my father's garage, but it has more windows. He is a mechanic.

Mr. Marks: Is your father's garage fireproof, too? It is very important that the place I work in be as fireproof as possible. I covered the old wood floor with metal sheets. The walls are made from cinder block and the ceiling is asbestos. I keep a fire extinguisher, some sand, and water next to my welding table. All the windows are built to let fresh air come in the room at all times.

Lisa: Why is welding so dangerous?

Mr. Marks: It's not dangerous if you know what you are doing. Since sparks can fly and start a fire, I must keep the things that are not fireproof far away from my welding table. I always wear protective clothing when I do any welding. Since some metals give off toxic fumes when they are welded, I also may have to wear a gas mask.

Lisa: Is this space helmet part of your protective clothing?

Mr. Marks: Yes, it's called a welder's helmet. The face shield protects me from harmful rays when I am arc welding. Asbestos leggings and asbestos gloves also help protect my body from sparks and harmful rays. I always wear boots with steel toes so that if a heavy piece of metal falls on my foot while I'm working, I won't get hurt. When I am flame welding, I use protective glasses, leather gloves, and a leather apron. I always wear clothing with no cuffs or loose folds, and shirts with long sleeves.

Lisa: Are you a welder or a sculptor?

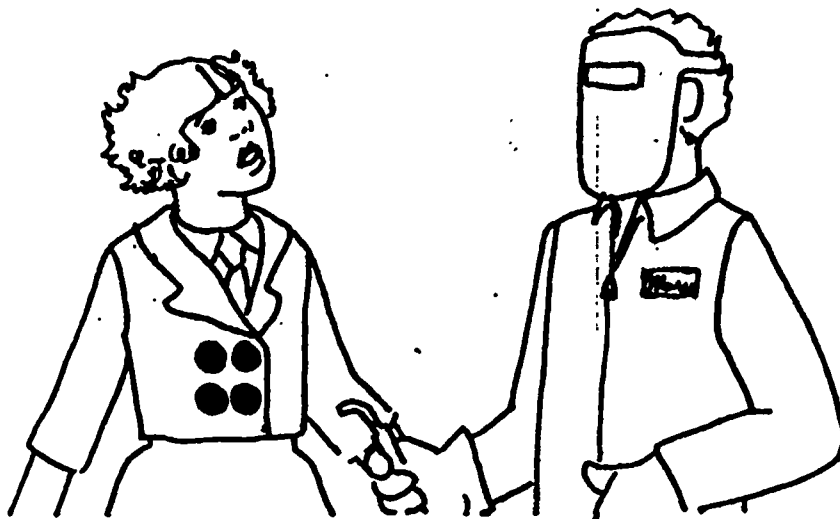

Mr. Marks: I am both. I run my own repair shop and weld metal sculptures when business is slow.

Lisa: When did you decide to become a sculptor?

Mr. Marks: Well, I began to make sculptures with metal when I was a kid. My father had a job at a scrap metal yard. Sometimes he would let me tag along with him and play around the yard. I loved to stack up pieces to make different designs and structures from them. Later, I learned to weld in vocational school while I was still a high school student. I enjoyed welding, so it was easy for me to become very good at it. After I had graduated, I opened up my repair shop. When business began to slow down, I "played" with the metal scraps I had lying around in the shop. It was just like what I had done in the scrap metal yard, except I was using my welding skills to make my designs and structures. It was fun, but I wanted to know more about drawing, designing, and welding metal sculptures. So, I took some courses at night in an art school. Now my repair shop also serves as my studio.

Lisa: How do you know what to make?

Mr. Marks: First I make a drawing, or design, of what I want to weld. Then I make a small model. I use math skills to measure and to build my model so that it will look like what I drew. Next, I test the metal I want to use to make sure it will hold up the way I want it to. Then I test different kinds of welds. When I am happy with my model, I plan what tools I'll need for my welding work. If I plan to use very thick metal, or heavy plate or structural steel, I take out my arc welding tools. For thinner metals I flame weld. For each method, I use different tools. This is an oxygen cylinder. I must be very careful with it. If it leaked, the gas would burn anything it touched. The cylinder would blast off like a rocket. Since I don't want any rockets in my shop, I must always check for leaks.

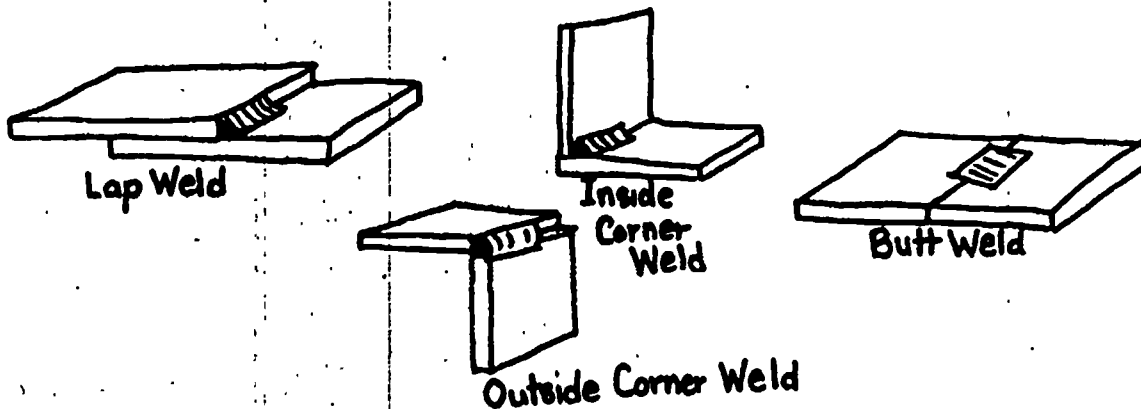

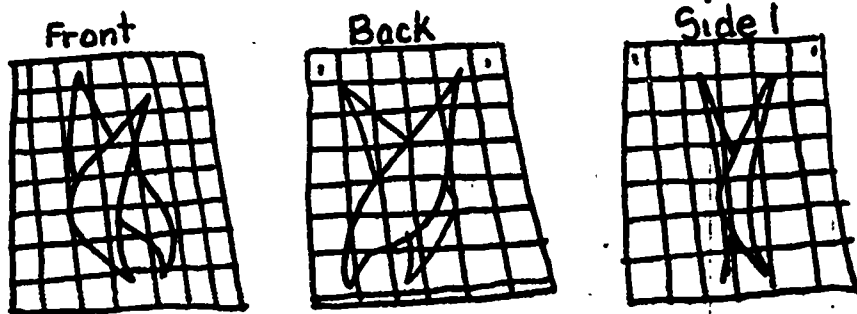

Lisa: What do you like best about being a metal sculptor?

Mr. Marks: Well, I get to use many different kinds of tools. I also can use different kinds of metals like gold, silver, copper, lead, iron, and steel. I can cut, bend, and weld the metal to look like my drawing, or I can change my plans. When I'm feeling very creative, I don't leave the shop at all. But other times, I may spend two weeks or so doing something entirely different from designing or welding. I think that's when I get some of my best ideas. Being a welded metal sculptor means I can be part technician, part artist, and part craftsman.

Lisa: Do you ever get tired of having to be so careful?

Mr. Marks: No, because it's all part of the job. I always read and understand the directions for using my tools safely. Once I have checked my tools, I can begin my work on a piece of sculpture without having to worry about my safety.

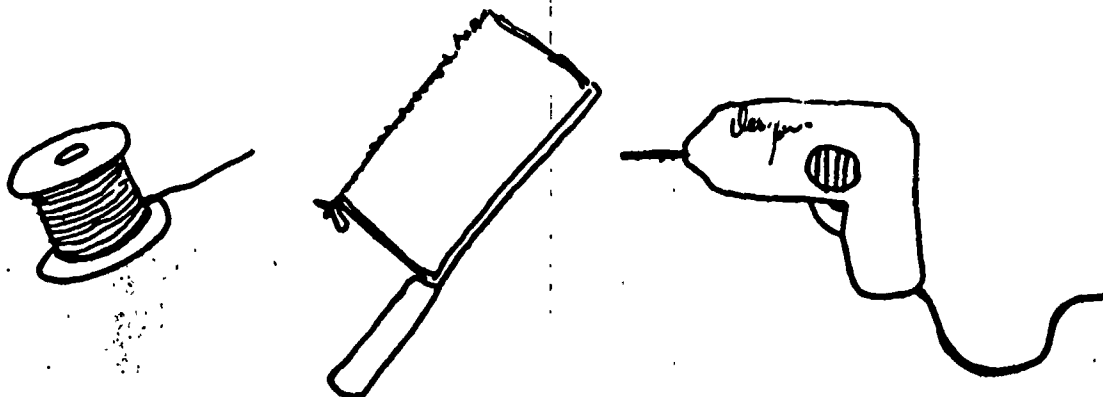

Lisa: Are there any other things you can tell me about your job?

Mr. Marks: Well, I am good at what I do, and I make good money. Sometimes I sell hardly anything, and sometimes I sell a lot. There are still many things I would like to learn. I am taking a course in anatomy now. I want to learn how and why the human body works, so that I can show more life in my sculptures. I'm also taking a course in metal finishing and plan to take a course in new specialized welding methods next fall. These courses will help to improve my work in repairing and making sculptures. This is not an easy job, but I enjoy it a lot.

Lisa: Thank you very much for this interview. Have a nice day!



Quiz Yourself:

SCULPTOR



Below are some questions about skills and tasks, tools and equipment, training places, and the work place of a sculptor.

If there are any questions you cannot answer, reread the interview and go back over these quiz questions until you know all the answers.

Name three tools or pieces of equipment used by a SCULPTOR.

What is one use for each tool or piece of equipment you have listed?

Name one training place for a SCULPTOR.

Name three skills and/or tasks of a SCULPTOR on the job.

Name one place where you might find a SCULPTOR at work.

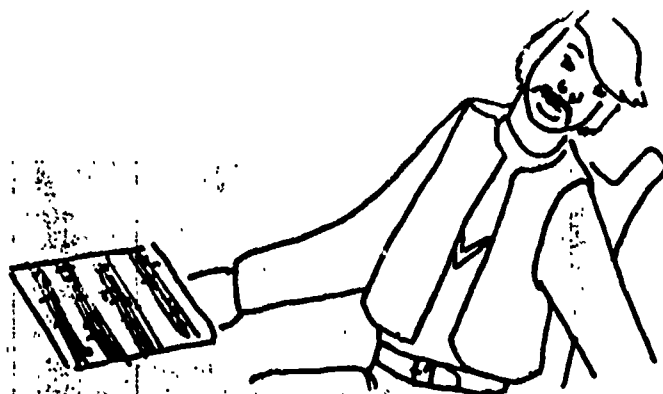

STUDIO MUSICIAN

As a studio musician, I've made it to the top.
With steady work through the grapevine, I'm skilled and I'm hot.
A union contact got me my first studio gig,
I played soulful blues bass for an album-cutting rig.
The union also sets up a minimum pay scale for beginners.
This helps musicians survive as they strive to be winners.

Before I was well-known, making a musical living was hard.
It was all part-time, and it was mostly in bars.
I worked fixing shoes during the day,
Building a musical reputation is filled with delay.

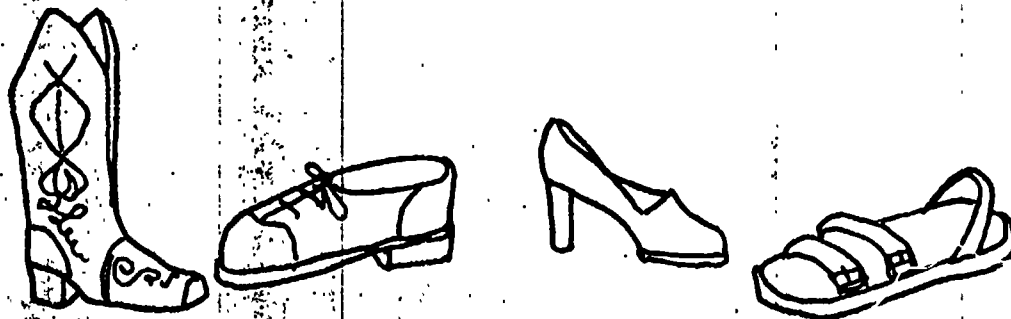

One clue, if you want to be tops in the trade,
Is versatility. Makes a difference in the money you're paid.
In one week, I might play country western, swing, jazz, or rock.
And as for working hours, we often play 'round the clock.
Since popular musicians play backup for many, we don't belong to any one band.

Patience is needed as we try and try again,
Till we get it right at each session.
As we play we listen with headphones to others playing the same,
Recording us all is multi-tracking (a descriptive name).
So while cutting disks, we don't have to do it all at one time.
If some players are away, well, we get them on the line,
And send a tape through the mail, it will arrive without delay.
Techniques and methods sure have changed, this is the modern way.

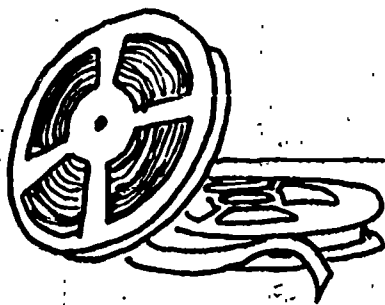
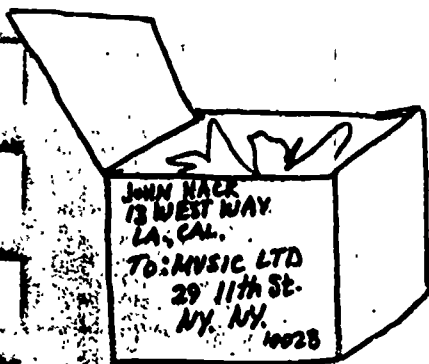

A studio's got tapes, sound equipment, and mikes,
Instruments from synthesizers to Illyan pipes.
I look carefully at musical arrangements and scores;
Outside noise can't interfere, for we've got floating walls and floors.
Working conditions are fine, but when I play loud rock or jazz,
I wear special ear plugs with flaps.
When the music gets loud, the flaps close by themselves,
And when it gets softer, they relax.

I get along with other musicians all right, though sometimes our egos clash.
Successful musicians know how to be cool; it helps them earn the biggest pile of cash.
One good thing about studio work you see, is I can earn enough money in a month,
To go on a vacation, for sweet relaxation.
Studio work's open to a few, but it's worth aspiring to.





QUIZ YOURSELF: STUDIO MUSICIAN

Name three tools or pieces of equipment and one use for each.

What are three on-the-job tasks or skills?

Name one training place.

Name one work place.

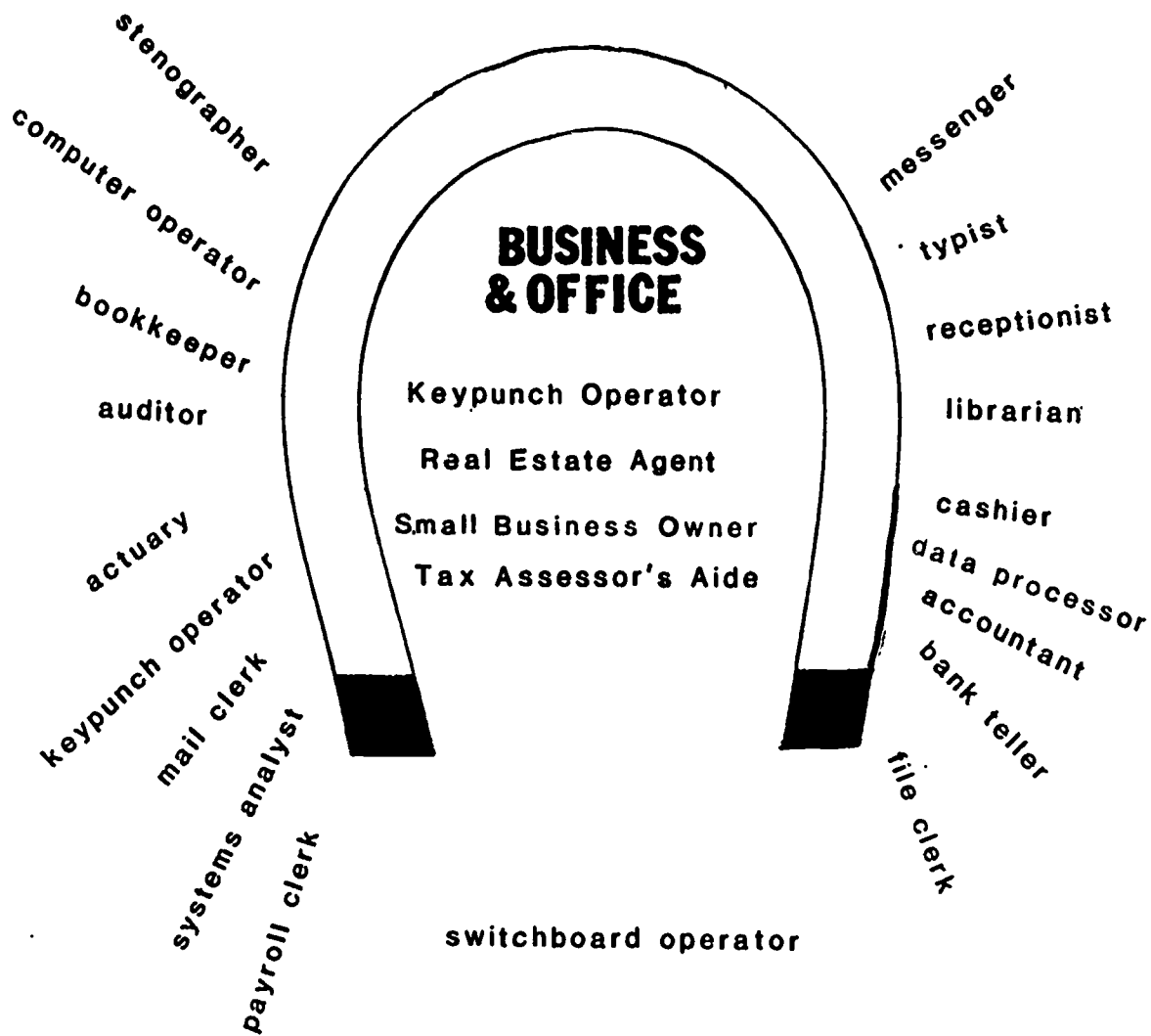

Workers from the Business and Office cluster usually work in office settings to record, store, and distribute information.

KEYPUNCH OPERATOR

My name is Dan Steele. I'm a keypunch operator. I use a typewriter-like machine to put information on cards by means of punched holes. Key punching is an entry level job in the data processing field. That means I need very little training other than typewriting which I learned in high school. Vocational schools, community colleges, and computer manufacturers offer courses in keypunch operation. They take from one to three months of study. I took a three month course in keypunch operation at the Birch Community College. The classroom resembled a computer operations center.



When I finished my training, I sent my resume to banks, insurance companies, manufacturing plants, hospitals, county offices and schools. These are places that use computers. I also sent it to the Birch Community College and they gave me a job. My "breaking in" time was easy because I already knew some of the people and the equipment.

My job changes very little; I do much the same thing over and over. First I read a "layout form" which tells how information or data should be coded on the computer cards. Next I read "input sheets." Input sheets give specific information to be punched on each card. It must follow the code described on the layout form.

LAYOUT FORM

INPUT SHEET

I must accurately type the data into the keypunch machine. The machine punches holes in each card according to what I typed. Later a computer operator will feed these punched cards into a computer. The computer will process the cards so the data is usable for many purposes. Some of them are payroll records, mailing labels, grade reports, and attendance records. Always my tasks stay the same. First I read carefully, then I type accurately, then I check for any errors.

I need a neat, clean workspace. The tools I need for my job are the keypunch machine, pencils, and paper clips. I have a manual for my machine. I use it to adjust or fix it if it isn't working well.

For each job I also need a program card. This program card tells the keypunch machine to perform a specific operation. For example, the machine may be programmed to punch numbers on the card. Again the layout forms tell me how the data should be organized. The input sheets tell me what data must be typed on each card.

As a keypunch operator I know exactly what I will be doing each day. I can go home and leave my work at the office. This is the kind of job I prefer. The work doesn't interfere with my family life. But while I work my complete attention is on the job I'm doing. Since I'm responsible for the cards punched on my machine I need to check my work carefully. A careless operator would be out of a job in no time.

There are many ways to advance. I can be promoted to senior keypunch operator. Next I could be promoted to supervisor of keypunch operations. Each promotion is based on things learned and length of time at the last job. I could get my Associate's Degree in computer science. The pay would be higher but I would have more responsibility. I like my job and feel secure in the growing computer field. Work will always be available for me in this field.

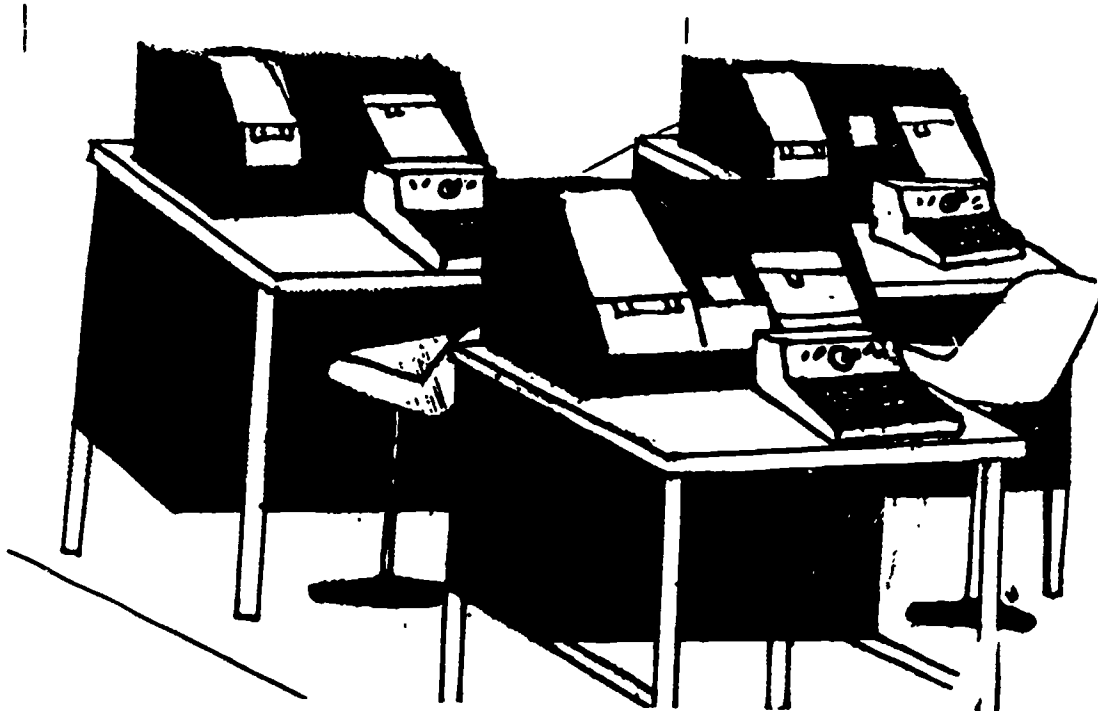

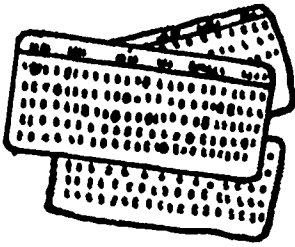

QUIZ
KEYPUNCH OPERATOR

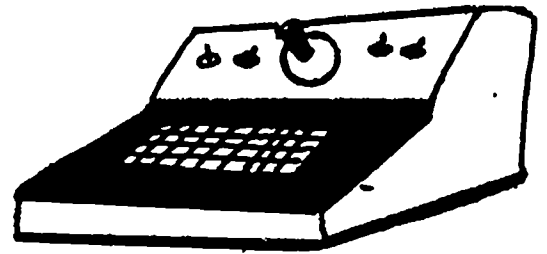

What are three of the tasks performed by key punch operators on the job?

Name two ways of getting the training needed to become a key punch operator.

What are some of the tools and equipment used by key punch operators on the job?

Name three places where key punch operators are hired.

Describe how a key punch operator might prepare for career advancement.

Name one course you can take in high school which would prepare you for work as a key punch operator.

Real Estate Agent

Maryanne: Good morning, Mrs. Potter. Thanks for seeing me today.

Mrs. Potter: You're welcome Maryanne. I like talking about my work as a real estate agent. What would you like to know?

Maryanne: Could you tell me what you do every day?

Mrs. Potter: I spend time driving around alone to look at houses and property to get to know neighborhoods. I also spend time driving people to see houses and property for sale mostly in the evenings and on weekends.



Maryanne: Do you sell property every day?

Mrs. Potter: No. Sometimes I don't sell anything for weeks or months. Winter is often a slow season, so I do a lot of looking around then. By spring I'm prepared to show people what's available.

Maryanne: I didn't know a real estate agent was that busy. You really need to know about the property for sale before you can show it.

Mrs. Potter: That's true, but I can plan my own work pace. I could work part-time or maybe just evenings, but I work whenever people have time to look at property.

Maryanne: I bet that the more you work, the more money you make.

Mrs. Potter: That's not quite true, since in my business I work on commission. The commission is a certain percentage of the selling price that the seller pays to the real estate agent. When my commission is 10%, I make \$5,000 on a \$50,000 sale no matter how long it takes me to sell the property.

Maryanne: Since there are houses and property all over, could you be a real estate agent anywhere?

Mrs. Potter: Yes; however, you will be able to sell more in an area where property is being bought and sold and where there are only a few real estate agents working.

Maryanne: Could you tell me how to become a real estate agent?

Mrs. Potter: I took a two year training program at my local college to earn my license. This license makes it possible for me to work at an agency as a real estate agent.

Maryanne: Why is it important to have a license?



Mrs. Potter: There are many real estate laws and local zoning laws (which vary from area to area). Each state gives a licensing examination covering their real estate laws.

Maryanne: How do you go about selling a piece of property?

Mrs. Potter: First I look at the property for sale. I try to determine its market value. That's the amount of money the seller can expect to receive. The market value is based on many things--size, materials, construction, near-by property, and demand. There may be some things a seller can do to make his property worth more. He might paint, or make minor repairs. Then, we decide on an asking price. Like many real estate agents, I take pictures of the property I have for sale. I write up a description of each piece of property. I put both in my booklet to show a buyer. I also advertise in newspapers and other real estate listing sheets.

Maryanne: Oh, I see. You can show the booklet to someone who needs to buy property. There will be a picture, a description and the cost.

Mrs. Potter: When a person comes to me looking for property, I find out what he needs. Then I try to help him determine how much money he can spend. I try to show him property he needs and can afford.

Maryanne: Suppose I want a house that costs more money than I want to pay. Say the buyer is asking \$40,000, but I want to pay only \$30,000?



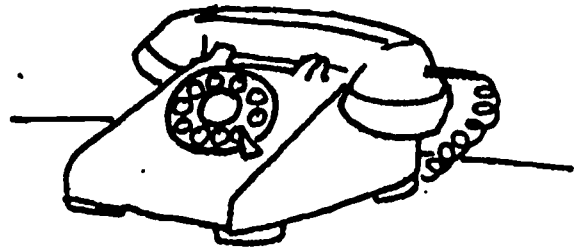
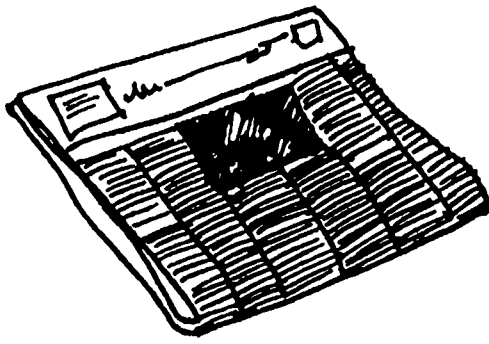

Mrs. Potter: I'll help you bargain with the owner. I will give the owner your offer. If he needs to sell quickly he may lower his price. You may find you can raise your offer. If you both agree on a price, I will help you with the legal documents. These are contracts, purchase agreements, and loan applications.

Maryanne: Does a real estate agent need special tools?

Mrs. Potter: Yes, but some of the tools you need are also used for other things. The necessary tools for a real estate agent are a car, a telephone, a typewriter, a camera, and a pen.

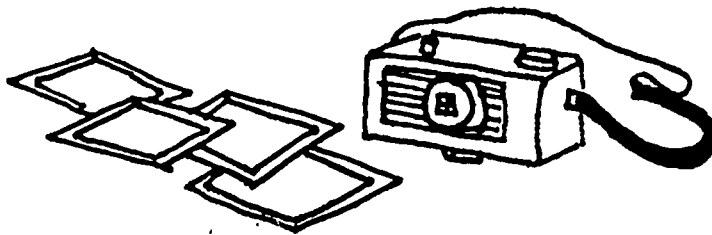
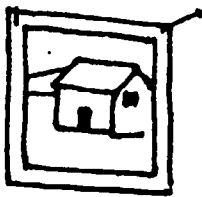

Maryanne: What kind of person would make a good real estate agent? What could someone do to prepare himself for the job?

Mrs. Potter: I'd advise learning basic business skills--typing, book-keeping, and the use of office machinery. In college you should take courses in law, contracts, and insurance. It is possible to take correspondence courses in these areas. You should also be an energetic person who enjoys people and working with them to help them.

Maryanne: Thanks very much for the time you spent with me. You have given me a good idea of what's important in your job as a real estate agent. You have been very helpful.

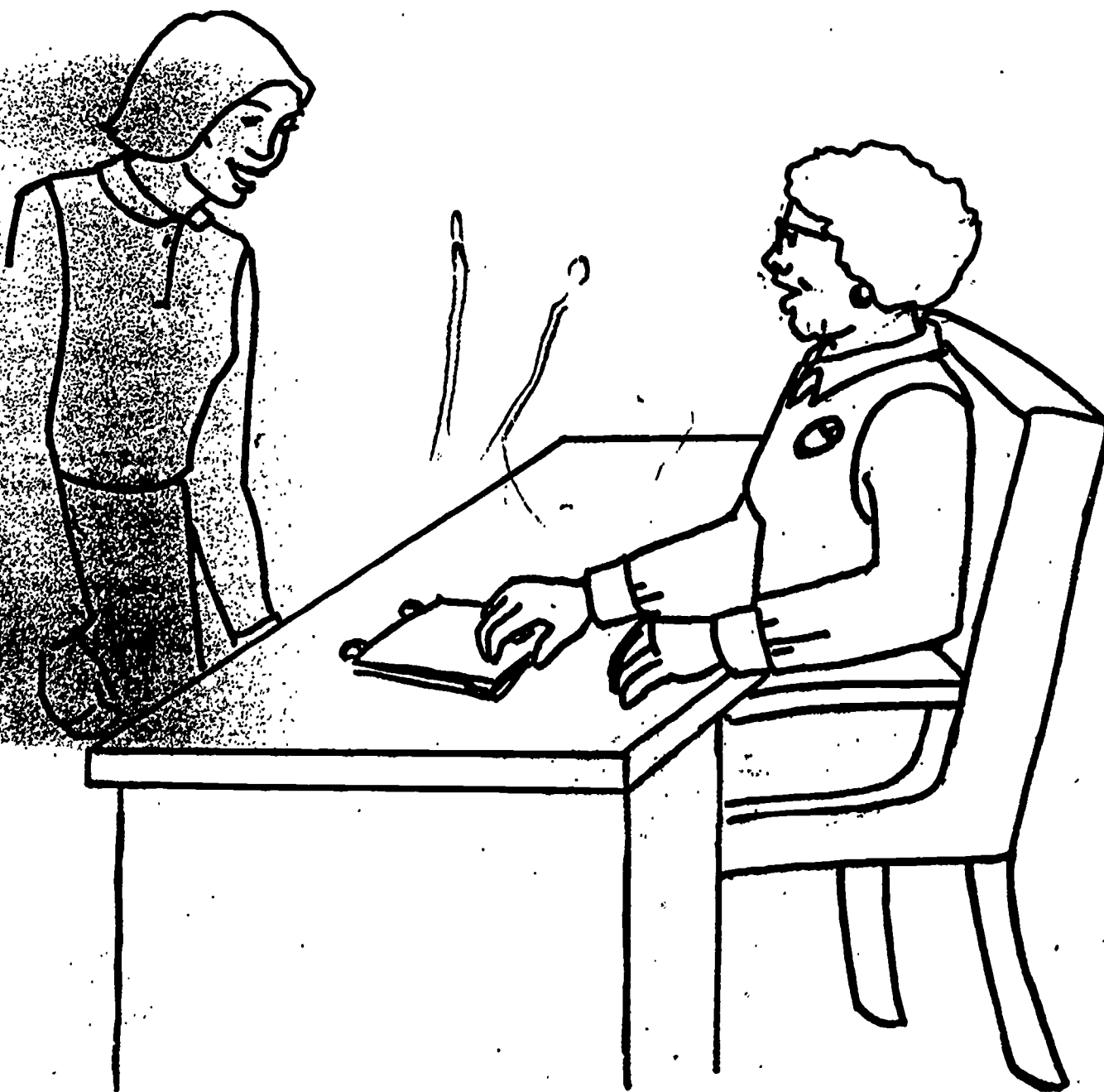

QUIZ YOURSELF:

Real Estate Agent

Below are some questions about the skills and tasks, tools and equipment, training and work places of a REAL ESTATE AGENT.

If there are any questions you cannot answer, reread the interview and go back over these quiz questions until you can answer all the questions.

Name three tools or pieces of equipment used by a REAL ESTATE AGENT.

What is one use for each tool or piece of equipment you named?

Name one training place for a REAL ESTATE AGENT.

Name three skills and/or tasks of a REAL ESTATE AGENT on the job.

Name one place where you might find a REAL ESTATE AGENT at work.



SMALL BUSINESS OWNER

Owning a small business is a big job, you see.
The success of the shop is my responsibility.
First I found a store location, put in counters and shelves,
Then I ordered attractive merchandise to please my clientele.

Talking to customers all day long takes a bit of a knack,
And with some hard-to-please consumers, I need a lot of tact.
For the motto of the shop keeper is, "The customer is always right."
So I try to be nice to everyone, and never get into a fight.

Another task of mine is to train the people I hire.
They must know merchandise and prices, to find what customers desire.
I teach them the things that I usually do
Like restocking shelves and taking inventory of items, old and new.

If you want to open a shop, what kind of training do you need?
Well, you can't be a shop owner based just on what you read.
Though schooling is helpful, experience is best,
And being business minded will "feather your nest."
Be good with numbers, be good with people too.
Merchandise, sales style and shop design are all left up to you.

It's handy for a shop keeper to have a variety of skills.
Being part-time carpenter, plumber, and electrician will lower your bills.

A shop owner is also a janitor, because a store must be kept clean.
Glass cases should be free from fingerprints, so items can be seen.

Reading is a skill you must be up to;
This way, you'll keep up with trends and everything that's new.
Pick up your pen for the forms you'll be filling out;
Tax forms, order forms, and business certificates you'll have to know
about.

Now we come to tools, and a shop owner needs plenty:
Assorted racks, and lots of shelves (I have over twenty);
A cash register or adding machine to fill obvious needs;
Paper, file cabinets, and catalogs to give you business leads.



Another important item that every shop owner considers
Is a burglar alarm turned on at night to keep out unwanted visitors.
Theft and vandalism can cost you quite a price;
Protection when you're not at work is something mighty nice.

Capital, if you don't already know,
Is the most important tool you need to make your business grow.
It's the money that you use at first to set up shop.
Yes, capital means money, and at first you need a lot.

An important factor that will help you to succeed
Is a good shop location. It's really what you need.
All the merchandise in the world may all go to waste
If the customers you might have had could never find your place.
That's where advertising comes in handy; it lets the public know
Where you are and what you sell, as your increased profits will show.

Now, you may be wondering how much a successful shop owner makes.
After seven years my salary's twenty grand, but I've had some lucky
breaks.

I must admit, that in my first year, I didn't make a cent.
The profits went into merchandise and paying monthly rent.

Obviously, a business of one's own isn't all peaches and cream.
Working day and night is par, and sometimes money's lean.
But the rewards of owning one's own business can be great,
Especially if working for another is what you hate.
You make your own hours, decide what to sell,
And if you're energetic and wise, all should go well.

QUIZ WHIZ

SMALL BUSINESS OWNER

Small business owners all work to succeed, not to flop.
The place of business is their own _____.

An owner tells of the skills and tasks which help the business to grow.
Name three of them now, and don't be slow.

Then describe the best training for this work in one word: _____

Name the tools and equipment that an owner seems to need.
It shouldn't be hard, just carefully read.

Small business owners all practice reading and math.
On the way to success, these skills help to form a path.
Describe how each skill comes in handy
In any business - from selling land to selling candy.

In order to answer this last rhyme,
Describe the working conditions in terms of on-the-job time.

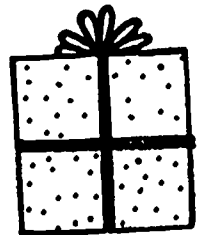

Tax Assessor's Aide

A Tax Assessor's Aide collects and files details about property (land and buildings). These details include the size and use of the land and buildings as well as where they are. The Aide uses these details to decide the value of the property, or how much it is worth. The Aide then decides how much tax the owners should pay. The tax is based on the value of the property.

The Aide works about ten percent of the time outside the office looking at land and buildings. The rest of the time, the Aide works in the office.

SKILLS AND TASKS

Gather details.

Take pictures of land and buildings.

Measure land and buildings.

Write down details about insides and outsides of buildings.

Organize details.

Code details to state rules and standards.

Figure out the size and number of acres. Write on property record cards.

Read property record cards to decide who owns the property and its size.

Store and keep track of details.

Draw lines on tax maps.

Put soil use on tax maps.

Put details in the computer.

Keep details up-to-date.

Read and file deeds.

Keep tax rolls up-to-date.



TOOLS AND EQUIPMENT

camera

tape measure

paper and pen

reference books:

State Manual for Assessors

State Cost Manual

calculator, paper and pen

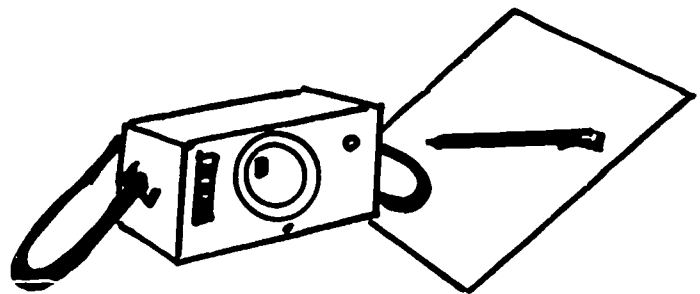
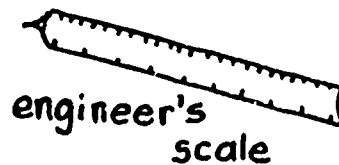
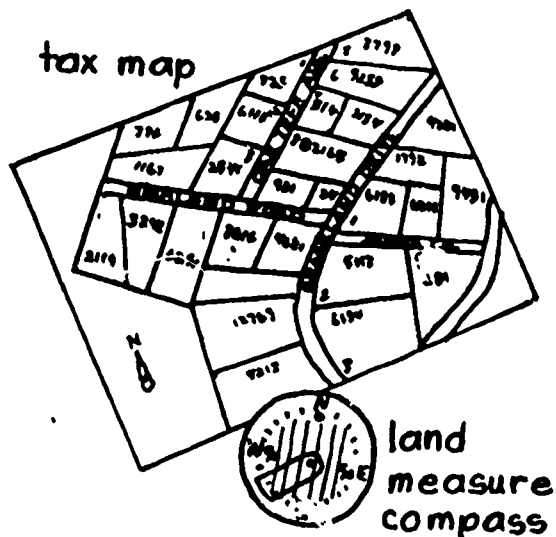

WORK CONDITIONS

Hazards: stress, lack of exercise, angry tax payers.

Advantages: meeting people, routine work, fringe benefits (vacations, sick time, health insurance, personal days).

READING AND MATH SKILLS NEEDED ON THE JOB

Reading: for letters, reports, deeds, law books, tax manuals.

Math: to measure and figure out the size of land and buildings, to keep tax books, to draw maps.

OTHER SKILLS NEEDED ON THE JOB.

Letter writing, public speaking, public relations (getting along with people, listening to complaints from irate taxpayers and not taking their anger personally), interpreting state laws to people, understanding of geography, geology, and local history (to interpret old landmarks).

TRAINING NEEDED

High school business classes.
On-the-job training.

CHART-A-QUIZ

Could you fill in a chart like this with correct information about a tax assessor's aide?

SKILLS AND TASKS		TOOLS AND EQUIPMENT	
1. _____		_____	
2. _____		_____	
3. _____		_____	
WORK PLACES			
1. _____		2. _____	
HAZARDS		WORK CONDITIONS	
1. _____		ADVANTAGES	
2. _____		1. _____	
		2. _____	
KINDS OF THINGS AN ASSESSOR'S AIDE READS ON THE JOB			
1. _____		2. _____	
MATH SKILLS NEEDED ON THE JOB			
1. _____		2. _____	
OTHER ON-THE-JOB SKILLS THAT CAN BE LEARNED IN SCHOOL			
1. _____		2. _____	
KINDS OF TRAINING			
1. _____		2. _____	

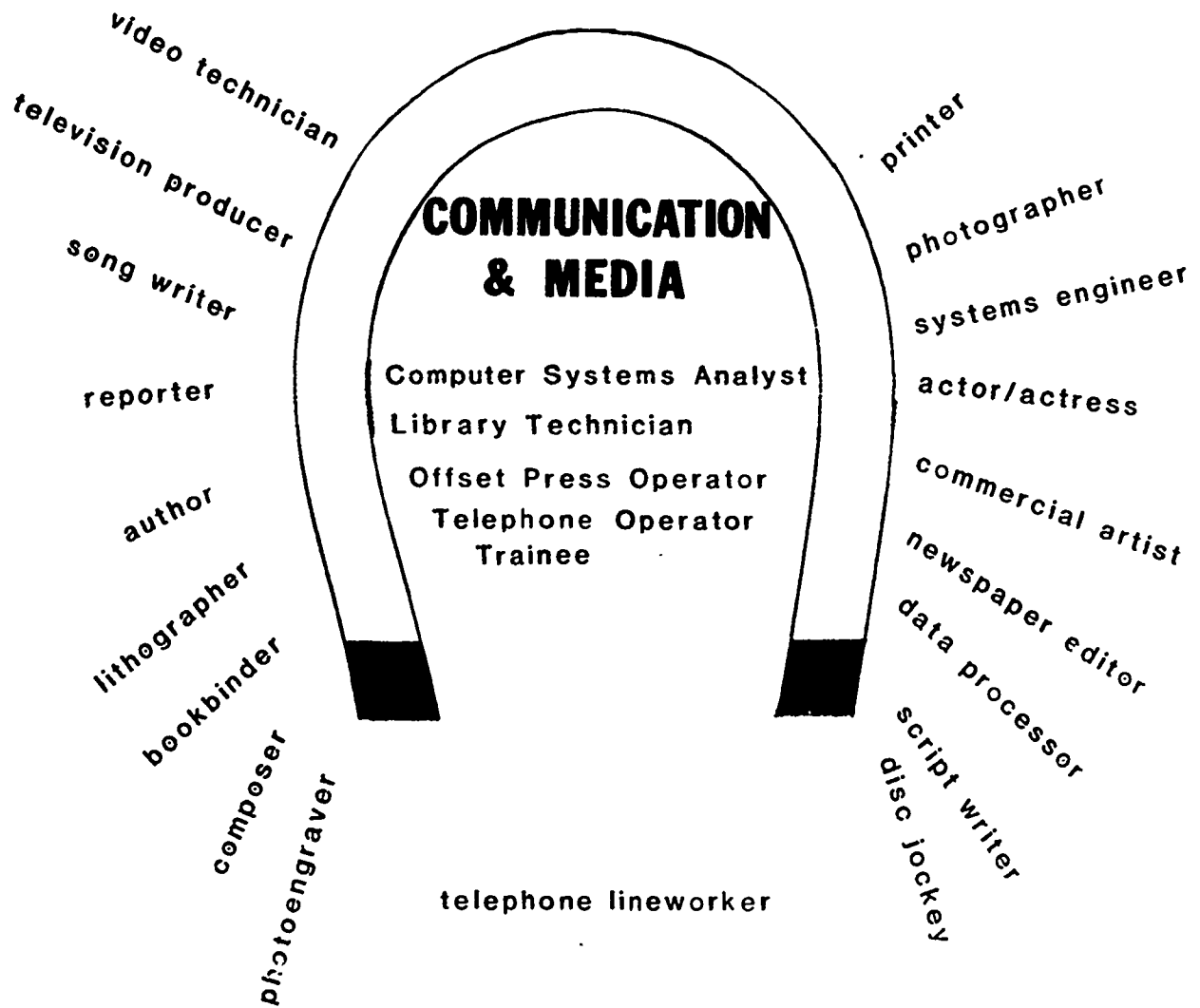

Workers from the Communication and Media cluster use various media to circulate information. They may work with telephones, radio, TV, books, magazines, film.

COMPUTER SYSTEMS ANALYST

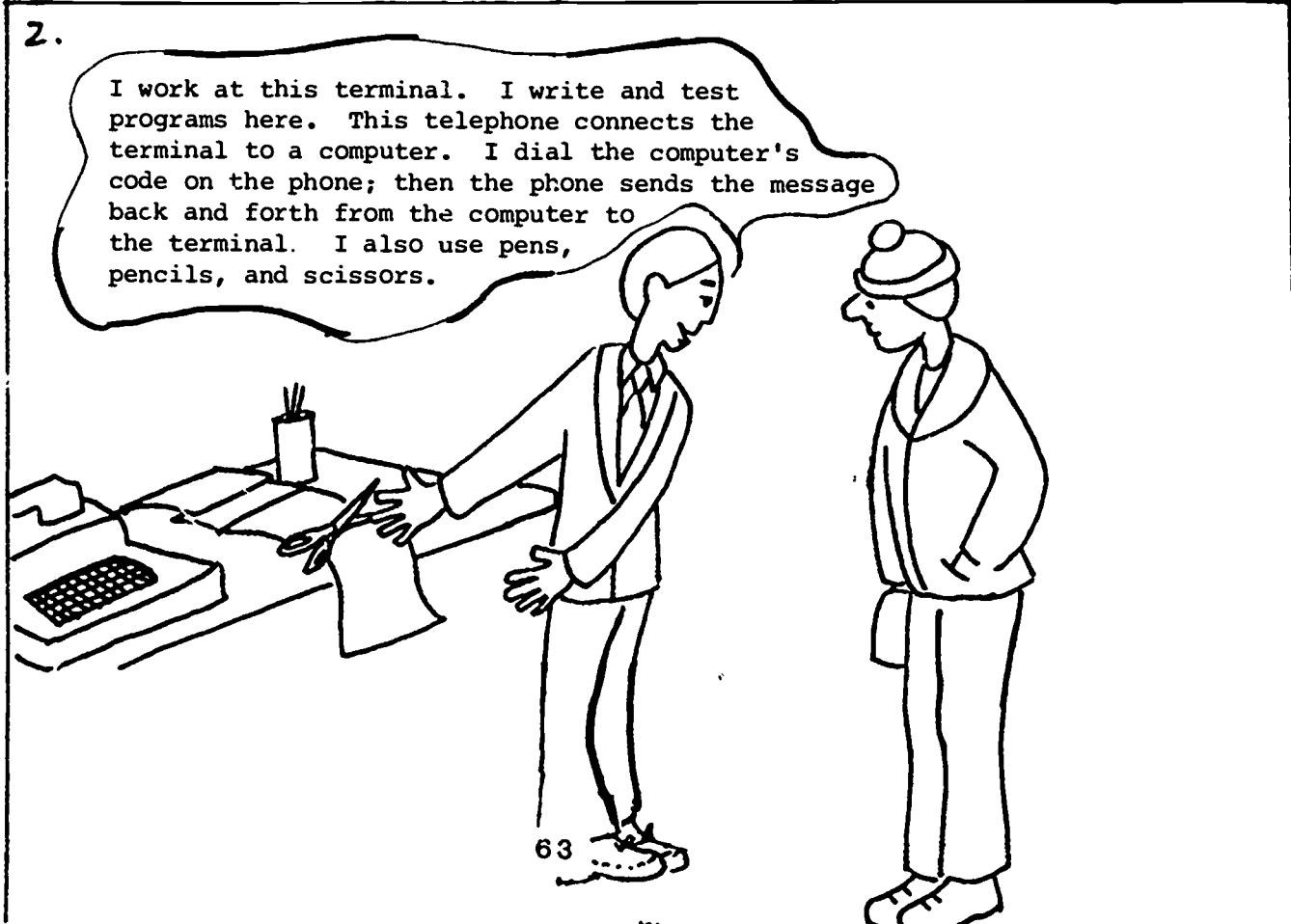
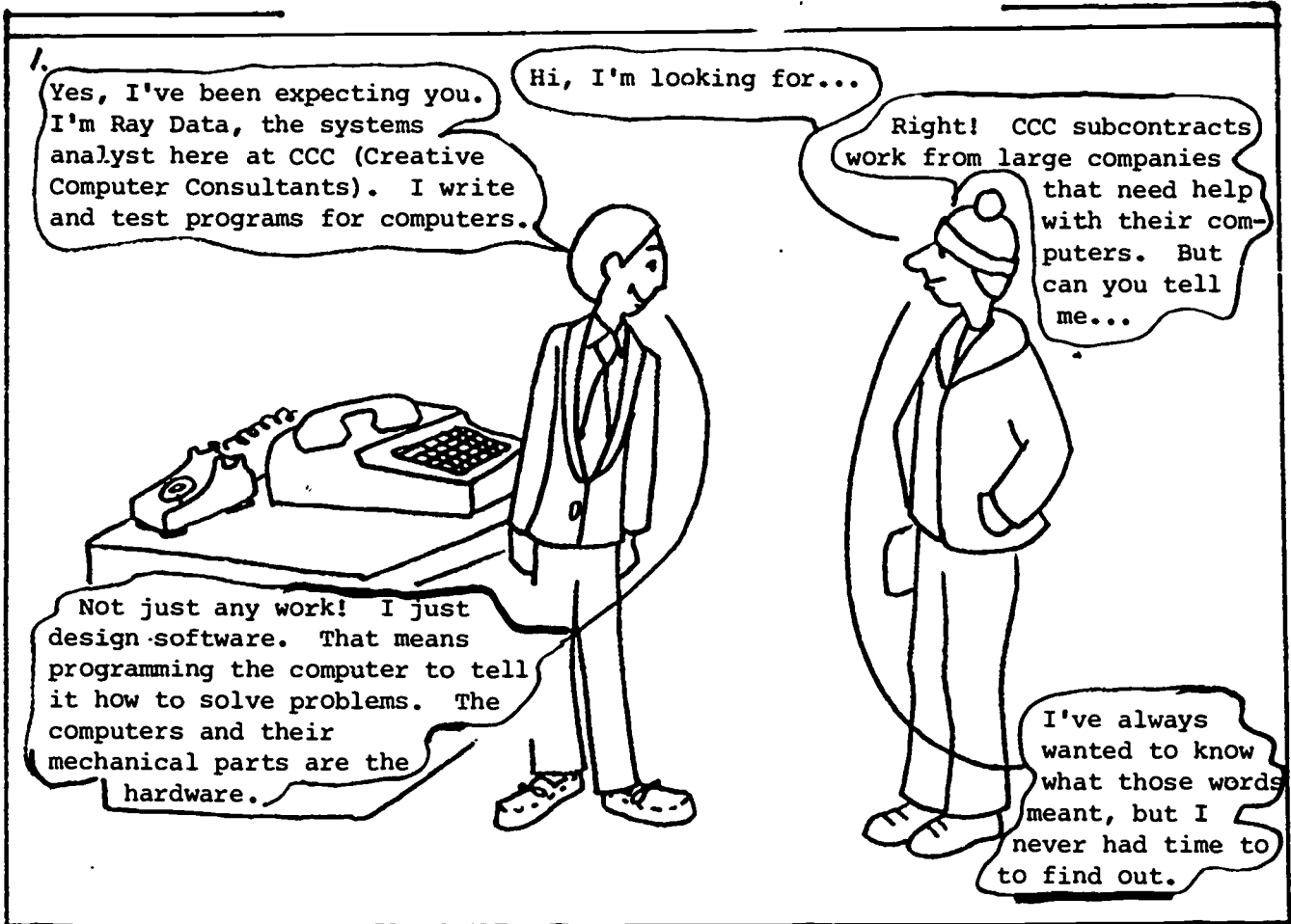

Please have a seat. I want to write perfect programs for the computers. When a program is perfect, the computer will give back correct information. When the program is perfect, I write up the documentation for the program.

Documentation is two things. First, it is a technical manual. This manual is written so a systems analyst can understand the internal make-up of the program. Second, it is a user's manual that tells the user how to get right answers from the computer.

Tell me about the documentation.

What if the computer doesn't give the right answers?

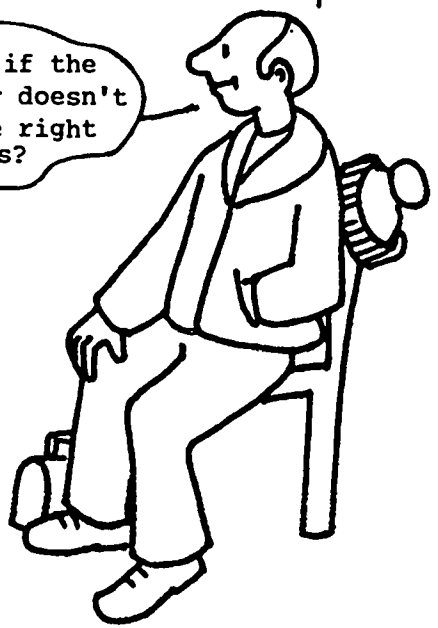

Please take your coat off. Make yourself comfortable. CCC offers support to clients. That means if there is a mistake in the system, we will fix it. That's part of our contract.

Who draws up the contract?

My client and I draw up the contract together. I estimate the cost of the job. The cost depends on the kind of program my client wants. It costs more if it takes a long time. I need good math skills to figure out the cost. Once we agree on a price, we sign the contract.

Tell me, how did you get to be a systems analyst?

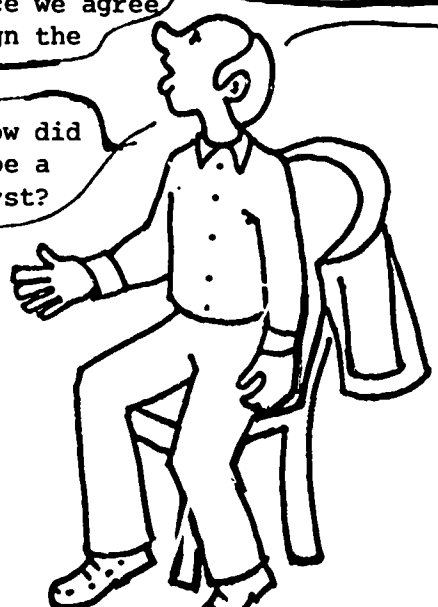
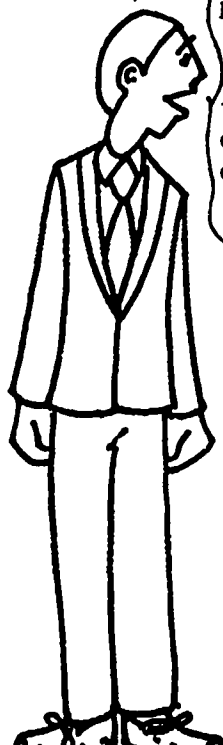

I went to college for four years. I studied science and mathematics. Computer science classes gave me the chance to learn how to use computers and terminals. I also practiced making programs.

That's classroom training. What about on-the-job training?

I have to attend a lot of workshops and seminars as part of my job. Since every program is different, I always have to learn new things.

Do you mind if I eat while you talk? I have a busy schedule today.

I don't mind. Go right ahead.

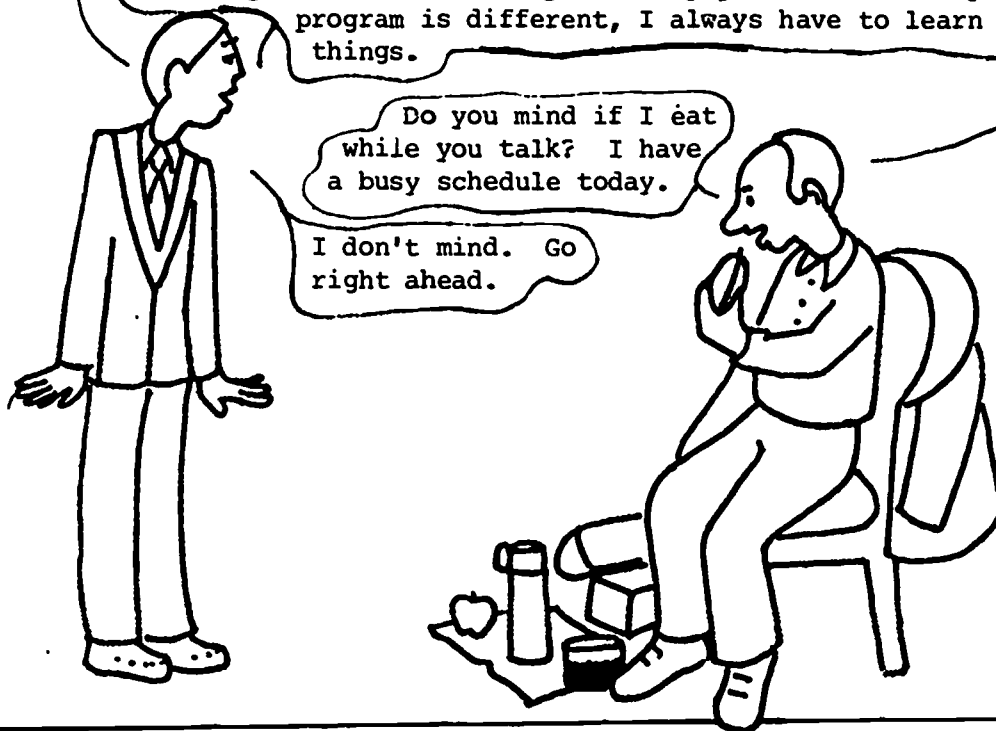

How are reading and writing important to your work?

I must read the manual for each computer I work with so that I can design the program correctly. I must read to keep up on all the newest findings in the computer field. Writing is also important. When I write up the documentation for a program I design, I must be able to write very technical information as clearly and as simply as possible. A manual which can't be understood is no good.

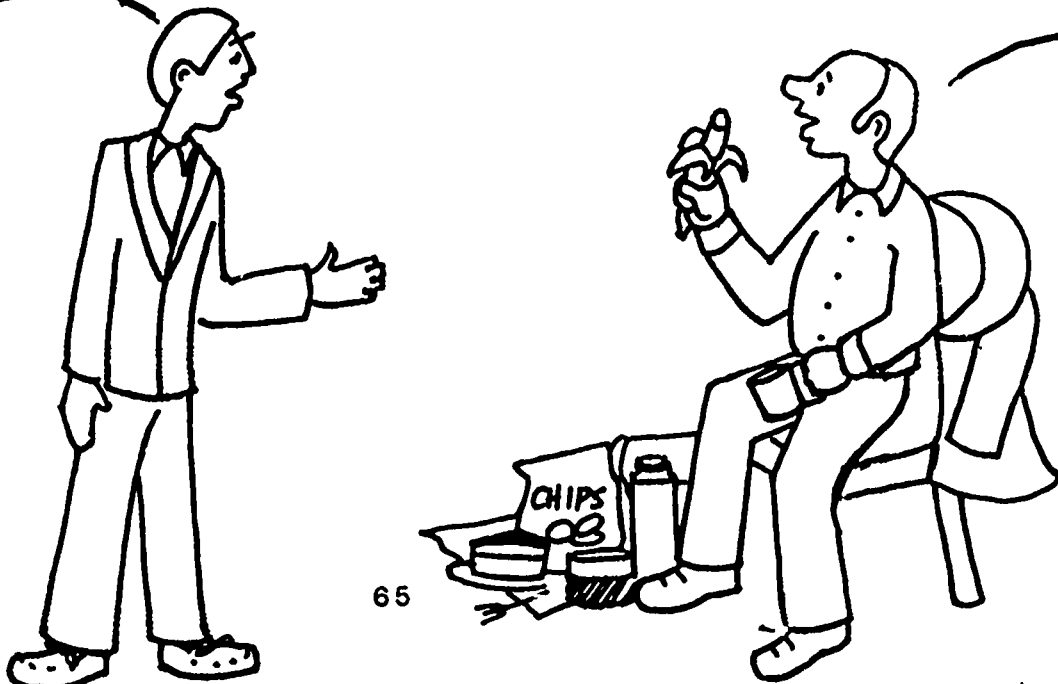

65

6

How's the pay as a systems analyst?

It depends on where you work. It may range from ten to sixty thousand dollars a year. Besides our salary here at CCC, we get a share of the profits. This job is never boring, either. I am always working with new people. Sometimes I travel to new places to meet clients. Now and then I work long hours because there are deadlines to meet.

I see. Listen, can you tell me where there's a bathroom on this floor? I want to wash up before I get back to work.

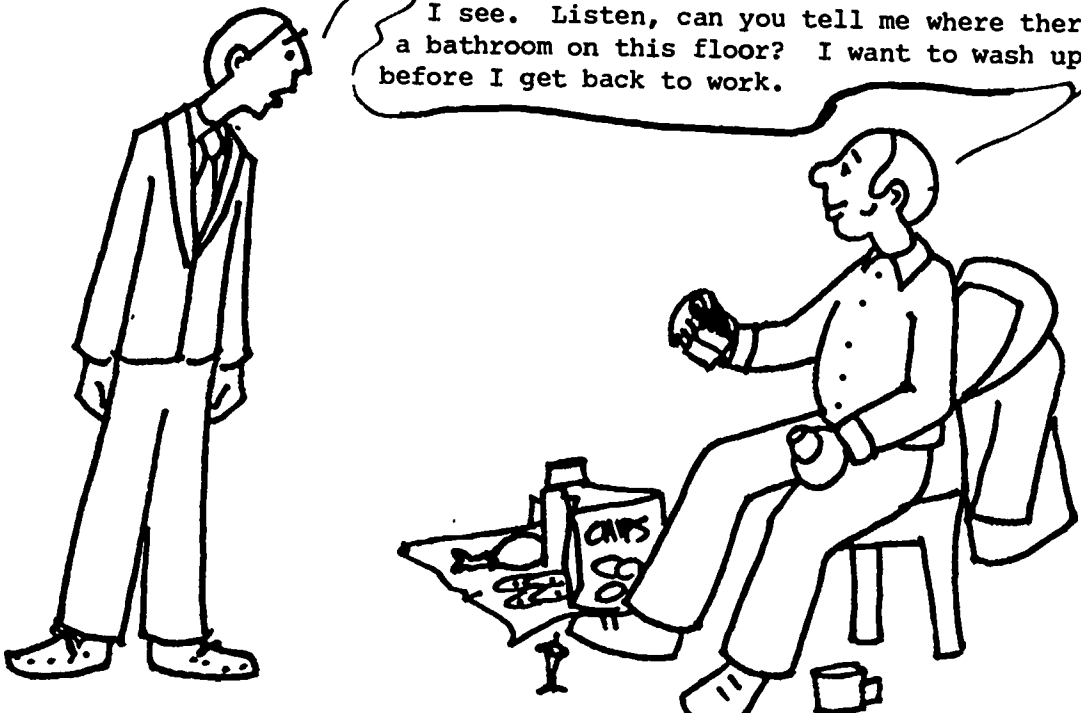

What do you mean "get back to work"? I thought you were Bob Lang. Didn't you come to discuss a contract on a new program for you OBM computer?

Are you kidding? I'm Milton Fitch. I'm a new janitor in the building. I was on my lunch break and stopped in here to ask you where the employee's cafeteria is.

Oh! The bathroom is next door, and the cafeteria is at the end of the hallway.

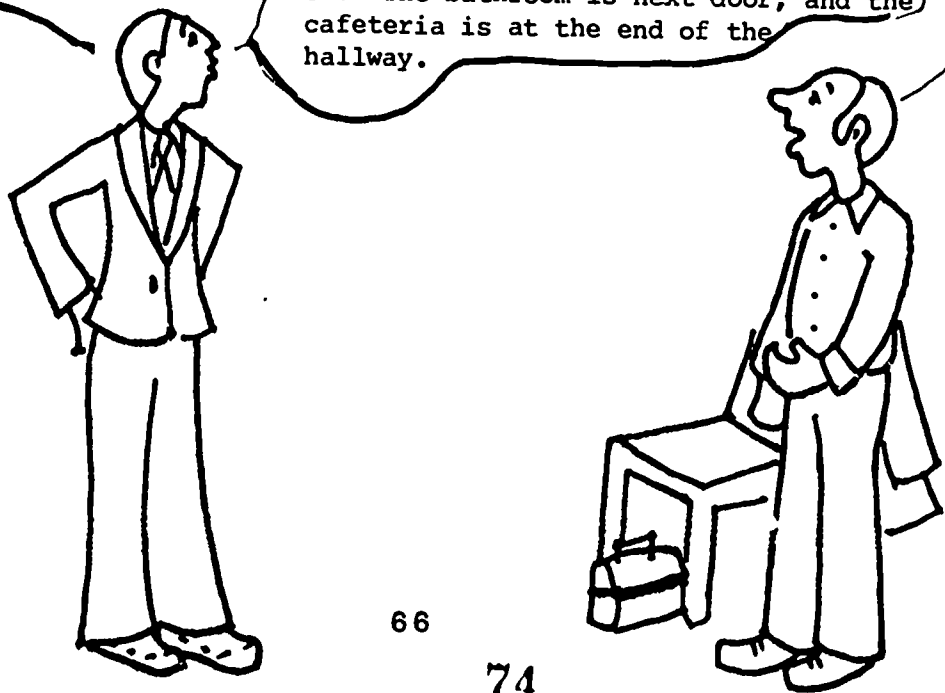



SYSTEMS ANALYST
HOW MUCH DO YOU REMEMBER?



Ray Data designs computer software.
What is software?
What is hardware?

Besides pens, pencils, and scissors, what
are Ray's two most important tools or pieces
of equipment?

Describe a systems analyst's work place.

How does Ray use math, reading, and writing
skills on the job?

What kind of training prepared Ray for his
work as a systems analyst?

Name one advantage and one disadvantage
to Ray's work.

Systems analysts can make lots of money,
depending on where they work. What's the
range of salaries which can be earned by
systems analysts?

Library Technician

SKILLS AND TASKS

Helps the librarian and directs the library aides.

TECHNICAL SERVICES

Gets things ready for use, such as putting the numbers on books.

Keeps files up to date.

Takes care of and runs audiovisual machines.

Adds new books to the card catalog.

Looks for damage on books and repairs them.

Keeps track of computer-based systems.

USERS' SERVICES

Answers questions asked by readers.

Helps readers find books and magazines.

Helps readers use the card catalogs, indexes and library machines.

Checks books in and out.

Sends notices of overdue books and collects fines.

Issues new library cards.

Tells users about the services and rules.

Arranges book displays.

Uses math skills to prepare and send overdue notices, and collects fines.

Uses reading skills to help patrons in finding books and periodicals, in using catalogs, indexes, and equipment such as microfilm, slide projectors, card catalogs, etc.



TOOLS AND EQUIPMENT

Audiovisual equipment—phonographs, slide projectors, microfilm viewers, televisions, and videotape recorders.

Computers.

Books, card catalogs, shelves, book trucks or carts (when loaded may contain 200 pounds or more of books).

Non-book media (maps, slides, artifacts, and special display items).

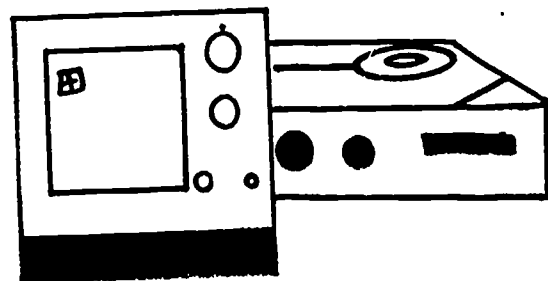

WORK ENVIRONMENT AND CONDITIONS

Public and private libraries.

Quiet, well-lit, neat rooms.

Stand a lot: must be strong to push loaded book carts.

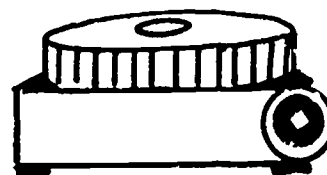

TRAINING

2-year college program in library technology.

On-the-job.

Helpful high school courses: English and literature, public speaking, and business classes.

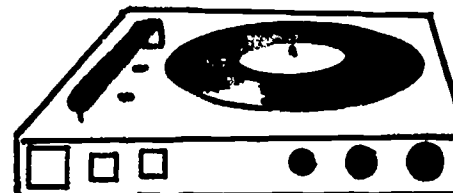

ADVANCEMENT

On-the-job experience can lead to technician's jobs at larger or special libraries.

More schooling can lead to a professional degree as a librarian.

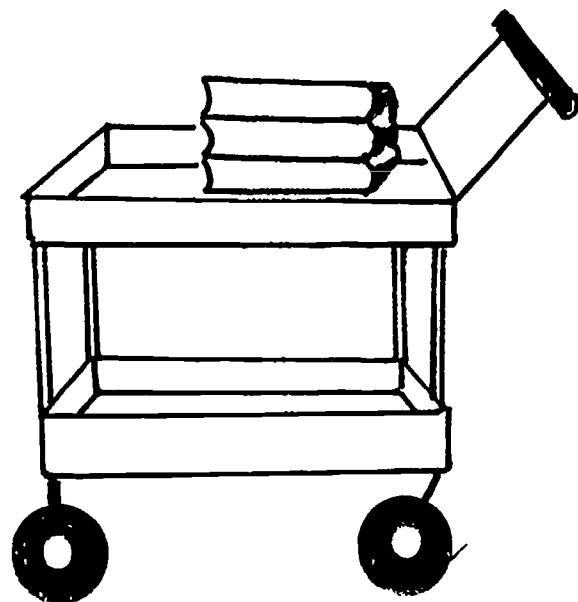

Living Yourself: Library Technician

Reread the fact sheet to find out any answers you don't know.

Name 3 tools or pieces of equipment and
1 use for each.

What are 3 on-the -job tasks and/or skills?

Name 1 training place.

Name 1 work place.

Offset Press Operator

Margie Green Reports for Work

Margie: Hi, I'm Margie Green; I'm here to work. Rita called me to say I have the apprenticeship position.

Frank: Have a seat, Margie, and welcome to the crew. My name is Frank Reynolds. We were impressed with your resume and interview. This type of work needs someone responsible and alert. Also, we're glad you had reading, art, math, and journalism in high school. The reading will help you find the mistakes in the printed copy. Also, it's important to know enough math to be able to estimate the cost of printing. And it helps to be mechanically inclined. You'll have no problem with these skills. Experience isn't necessary for an apprentice. On-the-job training is the way most people learn this trade, and there are technical training schools.

Margie: I don't know what I'll be good at doing yet.

Frank: In a small shop you can learn to do everything involved with running a print shop, from taking orders to running the press. In most large printing companies, employees are expected to do one task. As you become confident and skilled, you will move on to harder jobs. Since we have a small print shop, we train our people to do everything.

Margie: So I get a chance to do a lot. Just what is "everything?"

Frank: "Everything" means taking customers' orders, estimating the cost of jobs, and ordering materials. Also you will do layout and paste-up work and use the typeset. As a beginner, you'll work with the press for about four to six months.

Margie: I thought you wanted me to learn everything at once.

Frank: As you become confident and skilled, you will move on to harder jobs. There is plenty of room for advancement in the business; later you may be qualified to manage a small shop yourself. Now let me introduce you to Nellie, our offset press.

Margie: OK, I'd like that.

Frank: Let me explain the printing process to you. Problems can arise, and machines can be temperamental. Machines don't always want to cooperate. They have to be adjusted, cleaned, and oiled. Now let me explain about the plate. We use two kinds of plates: metal and paper plates. The plate is bendable, to fit onto the press. After the plate is put on the press, check the ink and water solution.

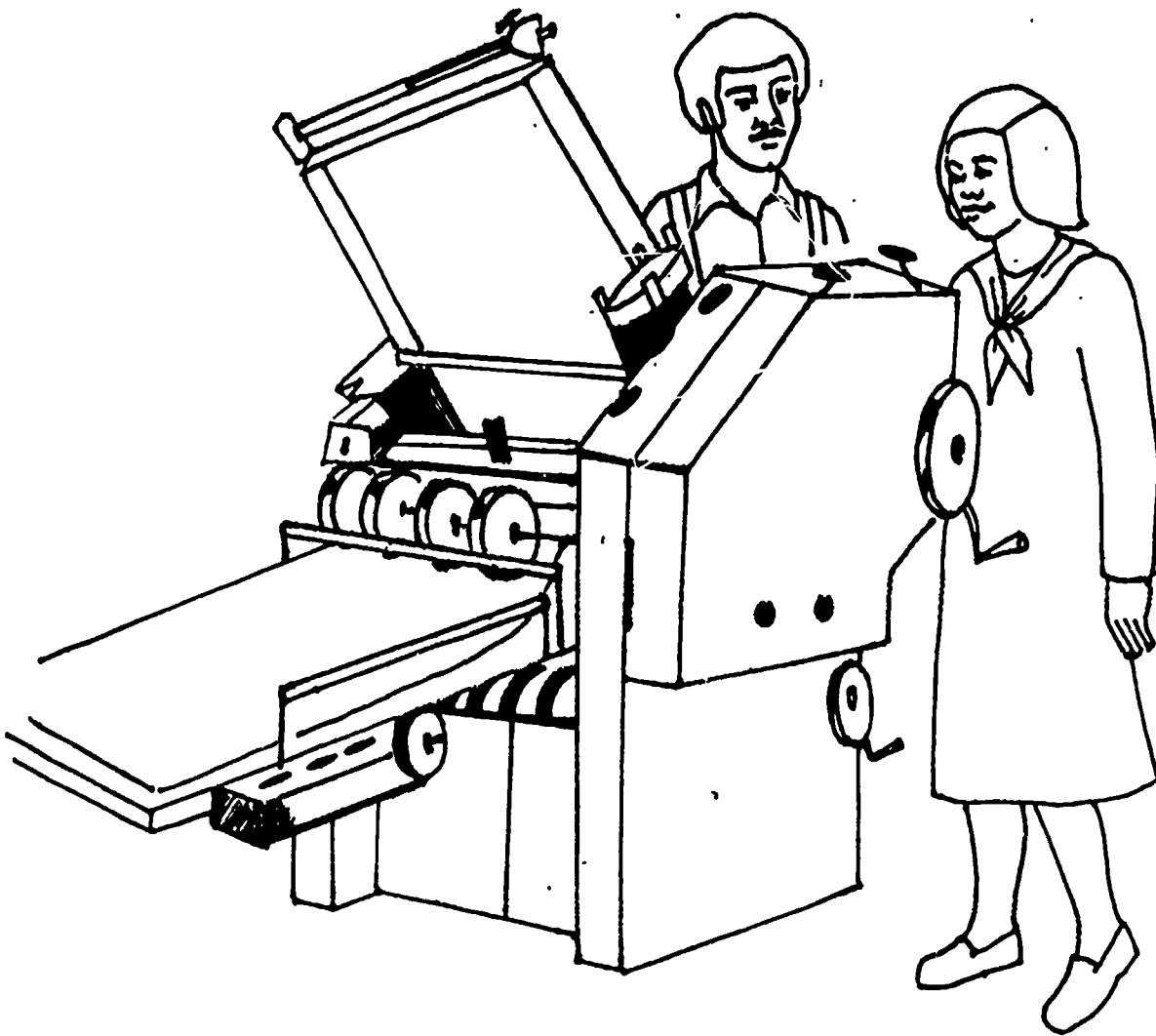

Margie: I understand ink and water don't mix. The water keeps the ink from sticking to the rubber blanket.

Frank: That's right. Next you're ready for the paper. It comes in different weights and thicknesses, and you have to know the number of copies you want to run off.

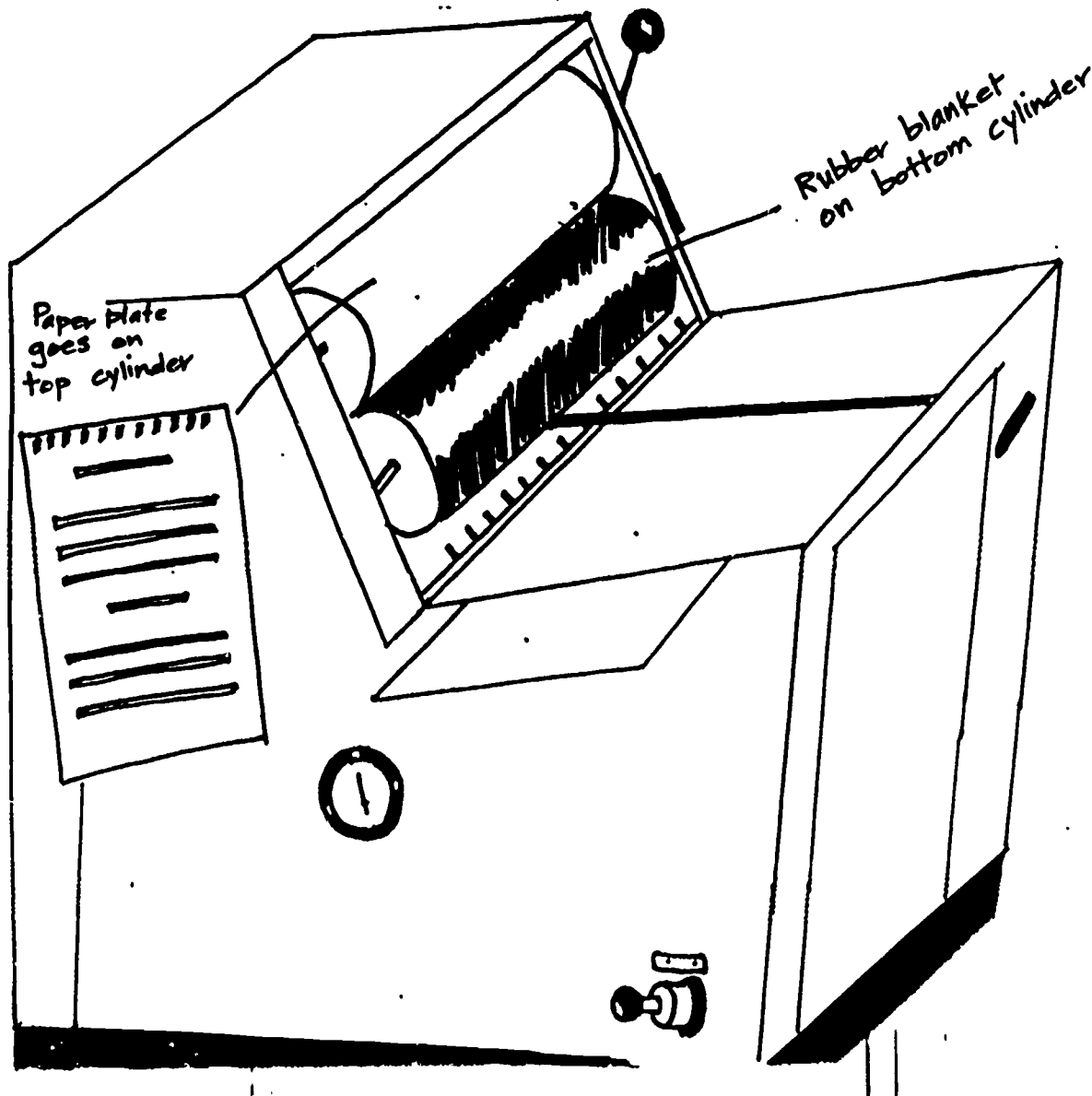

Margie: So I'll have to do a lot of planning before I start to print.

Frank: Yes. As you run the press, two problems could occur. The image could get blurry, or the machine could be taking more than one piece of paper at a time.

Margie: What else do I need to know?

Frank: Weather makes a difference. It causes changes in the thickness of ink and oil. In cold weather the ink and oil have to be thinned a little. You will have to adjust the ink solution according to the weather.

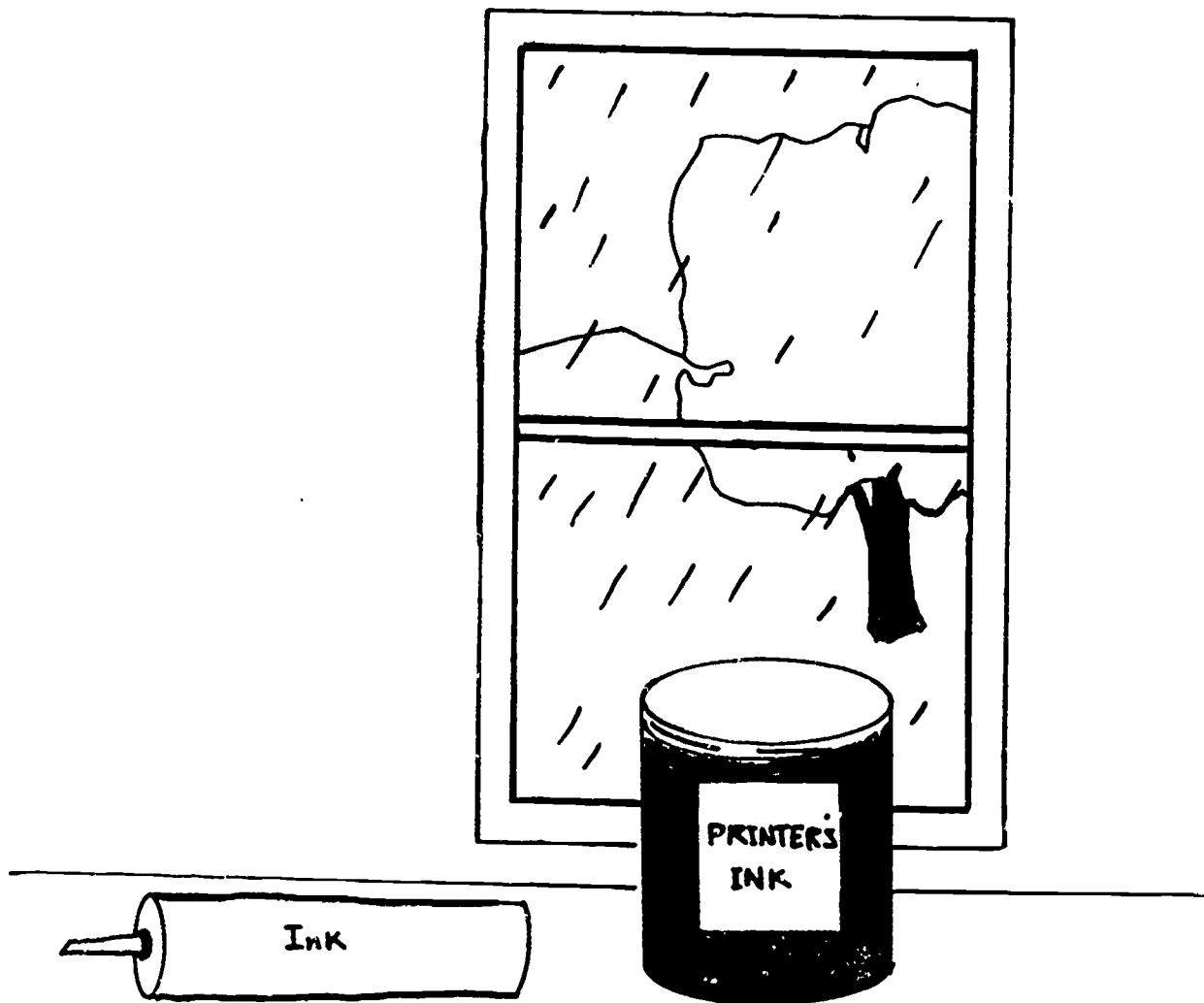

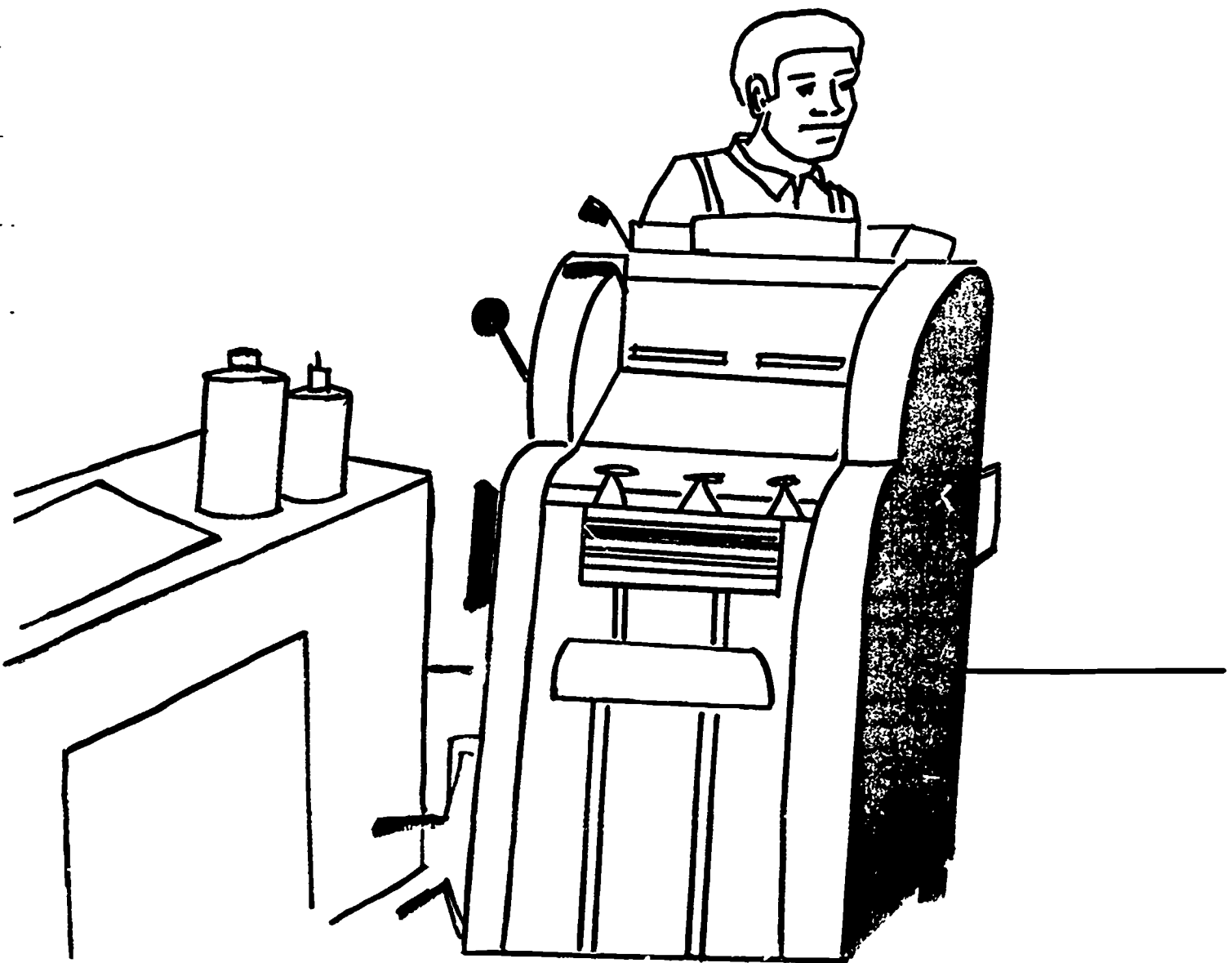

Margie: I think I'm going to like learning about the press.

Frank: You are going to learn skills that you can use in any town or city. Once you finish your apprenticeship, you will go on union wages. The union pay starts at about six dollars an hour.

Margie: I like that. I'm going to be involved in every step along the way. Should I wear clothes that I don't mind getting permanent ink stains on?

Frank: That's about the only problem on this job. The ink is permanent on paper and difficult to get out of clothing.

Margie: After I print, will I need to clean the machine?

Frank: Yes, you always clean it when you change the ink color. If you are using the same color ink, you clean the machine every three days. Cleaning and oiling are important maintenance work that keep the machine printing well. If the work we produce is high quality, then our customers come back. That is what keeps us in business. You have learned a lot already. When you come back from lunch, I'll show you how to oil the machine.

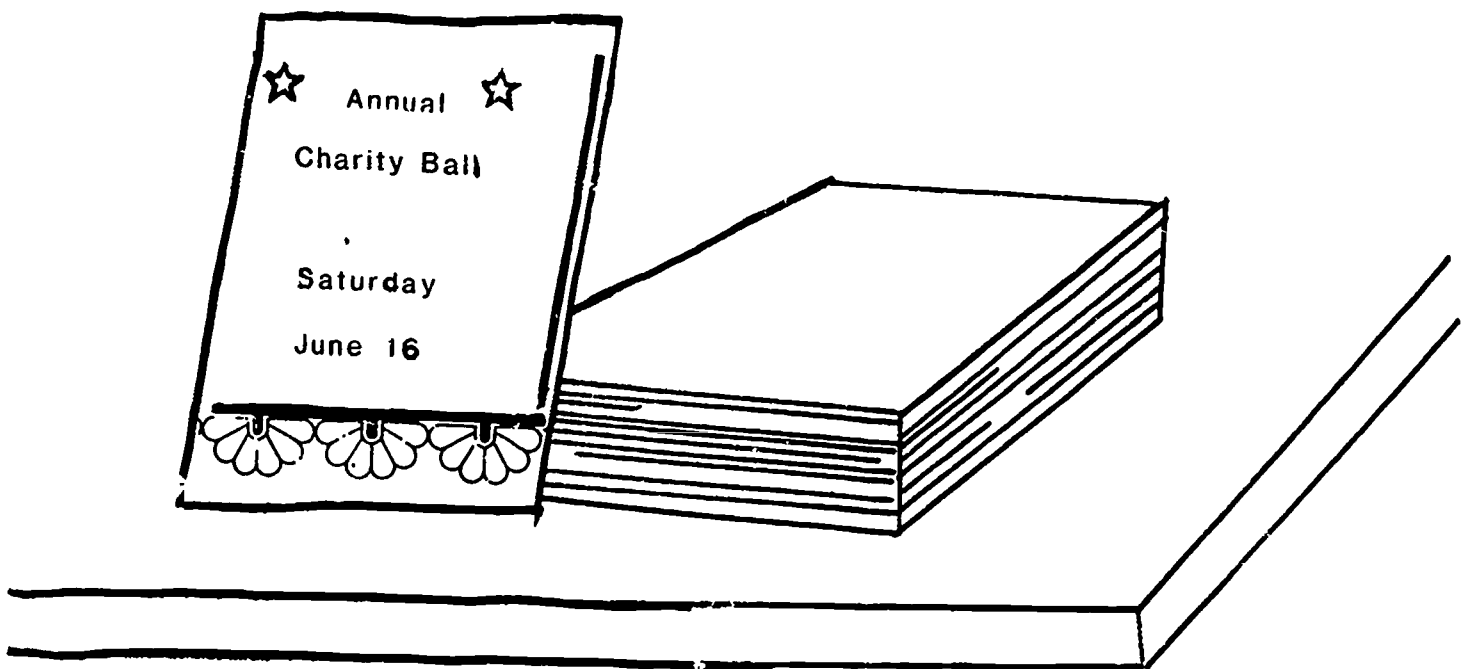

Margie: Thanks, Mr. Reynolds. What will my hours be here at the print shop?

Frank: Eight to four-thirty, with an hour off for lunch.

Margie: So, I'll see you in an hour.

Frank: Sure thing, Margie.

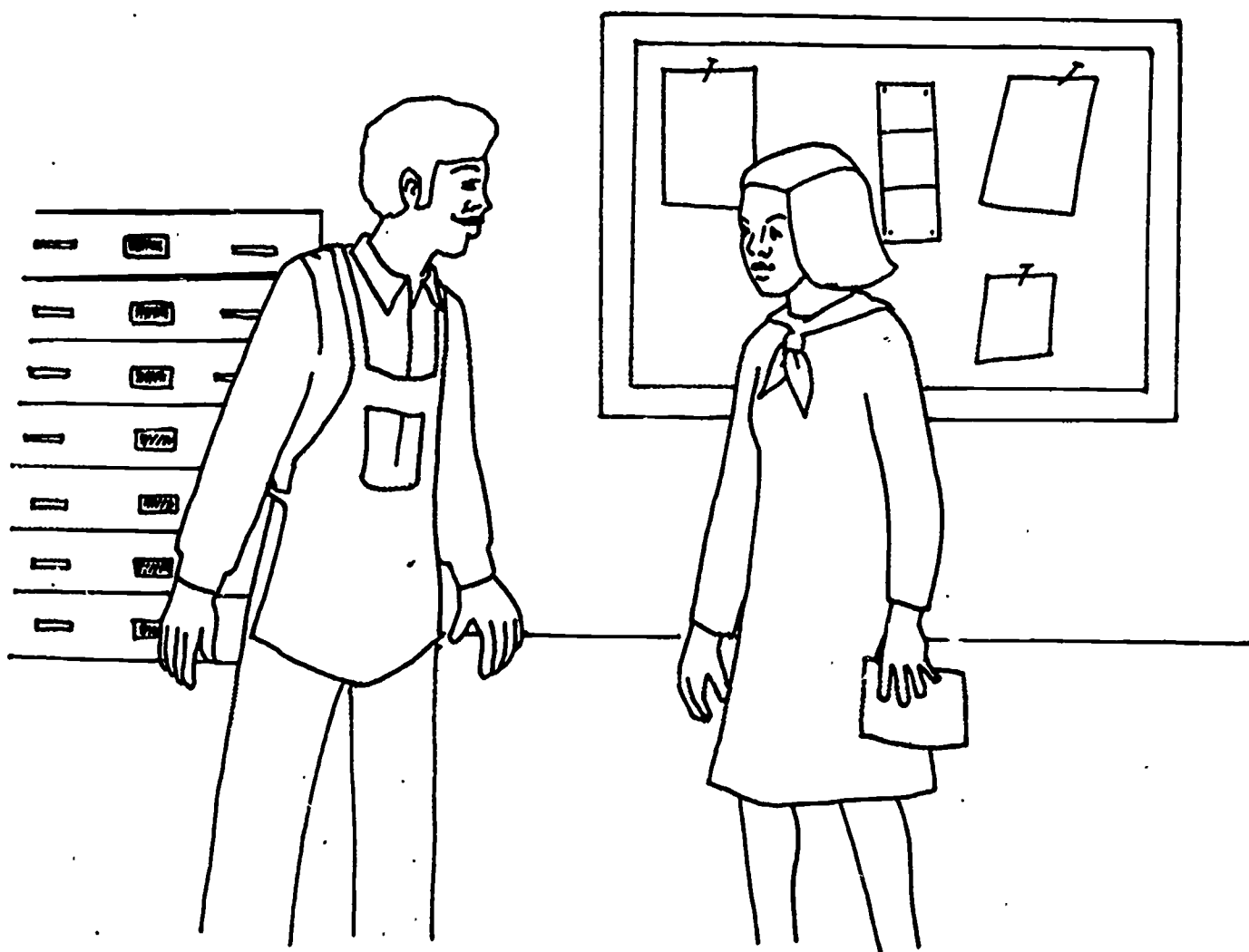

QUIZ YOURSELF:

Offset Press Operator

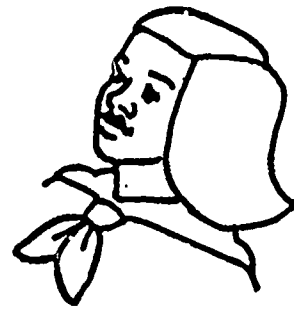

Name three skills and tasks that an offset press operator would perform at work in a small shop.

How is working at a small print shop different from working at a large printing agency?

Name four pieces of equipment or parts of an offset press which a press operator must be able to use.

Name three of an offset press operator's maintenance tasks.

Describe two ways of getting the training needed to become an offset press operator.

Name one advancement possibility for someone who has completed an apprenticeship at a small print shop.

LEROY AMES, TELEPHONE TRAINEE

My name is Leroy Ames. Last month I graduated from high school. Next week I'll finish my three-week training program. Then I will start working at the Concord Telephone Company full-time. As a trainee, after reading my training books, I test myself. I also use a model "toll call board" to practice what I've learned from reading.

I practice on a model toll call board helping customers who don't know how to dial. I also practice helping customers with emergencies. Sometimes I help complete long distance calls plus reverse charge, credit card, and pay phone calls.

I like getting paid while I learn and learning at my own pace. I don't have to wait for other trainees before I start reading the next training book. There are service assistants to help out. Even after training, they will continue to help us improve at our work. Operators must be able to work under close supervision.



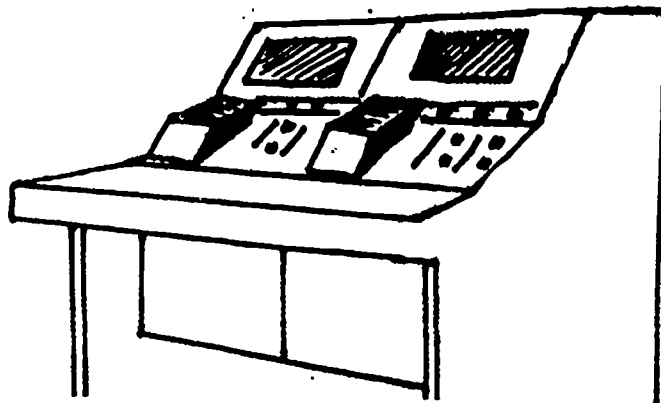

We need to speak clearly and to be polite. Now I'm learning to record information about the calls. I must be sure to mark the right spaces on the computer cards. Customer billing and company records are handled by a computer. I'm careful to mark the card without a mistake. Accuracy is an important skill for operators.

Another skill operators must have is reading, to be able to read the Bulletins. It lists the cost of calls and how to send them to any destination.

The toll call board must be answered 24 hours a day. Operators' schedules vary. Sometimes we work a late shift or an early morning shift. We do get breaks, and I work sitting down in a clean, well-lighted room.

Soon consoles will replace the toll call board. The console will automatically figure out and record charges. Fewer operators will be needed, but they won't be out of jobs. They can advance to other jobs in the company.

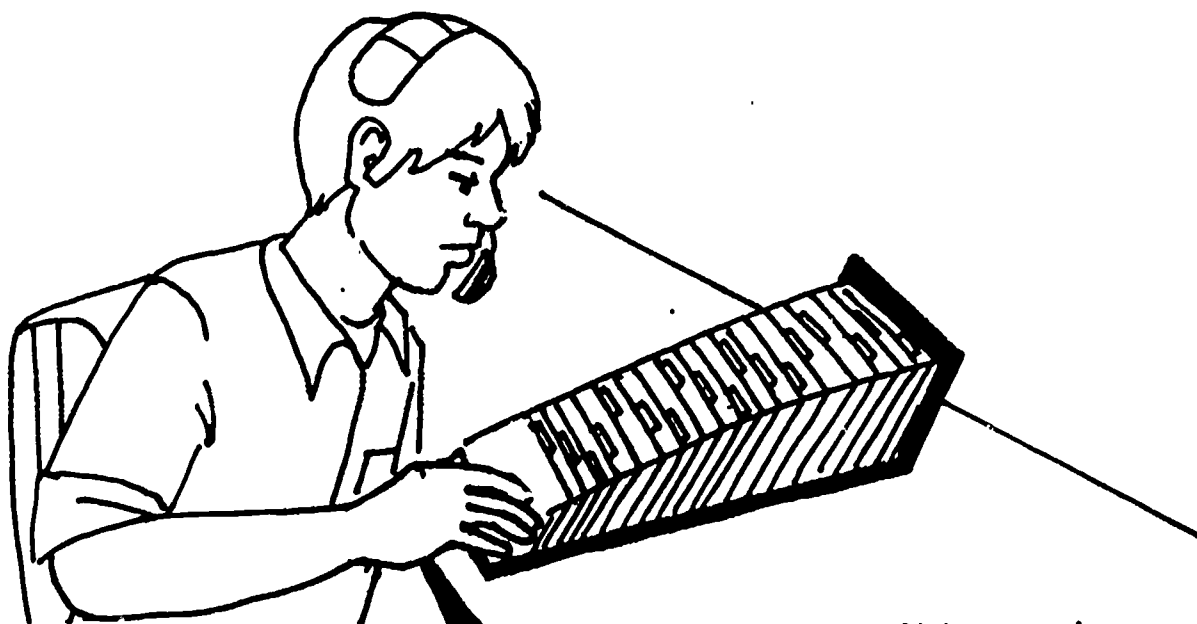

An operator who has worked six months can apply for other positions. If I qualify, I can use the company's tuition plan. It would help to pay for "business related" training courses. Typing and English are such courses. They are considered "business related."

Although employees do the same type of work each day, they must work according to strict instructions. Even so, there are advantages like paid holidays, sick leave, and a health plan. There are also disability, retirement, and saving plans.

Last month I graduated from high school. Next week I'll be a full-time operator. And next year--I'll be on my way to career advancement.



TELEPHONE OPERATOR:

TEST YOURSELF



Name four skills and/or tasks of a telephone operator.

Name three tools or pieces of equipment used by telephone operators. How is each used?

How does a telephone operator use reading skills on the job?

Describe a telephone operator's schedule and work conditions.

Describe the training needed to become a telephone operator.

How can a telephone operator advance to a higher paying position?

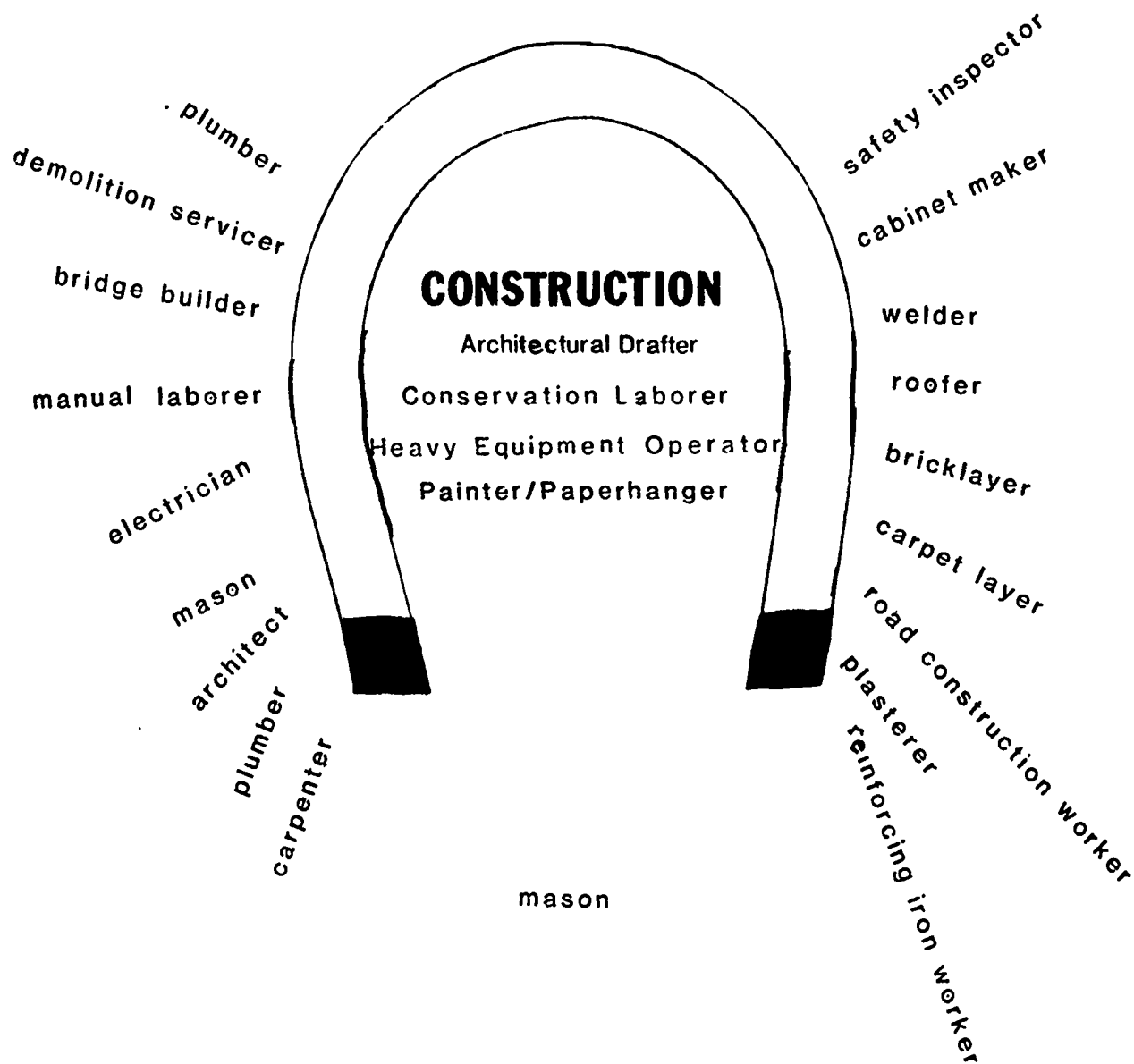

Workers from the Construction cluster are involved with designing, building, restoring, and demolishing structures.

ARCHITECTURAL DRAFTER

Architectural drafters work as part of a team in the business of construction. Drawing new plans for structures to be built, and renovation plans for structures which have met with some destruction. To start their work, drafters use sketches and "specs," (Guidelines for building) from engineers and architects. These specific instructions for a building's design help drafters draw plans, keeping form, use, and cost in mind. In renovation work (renewal), a drafter's tasks are listed below: Trace the existing plan, and use standard symbols to show what parts of the buildings must be added on, and which parts of the structure must go. All the parts of a structure are represented by lines, carefully measured for detail. Builders can see all the structural dimensions, since plans are always drawn exactly to scale.

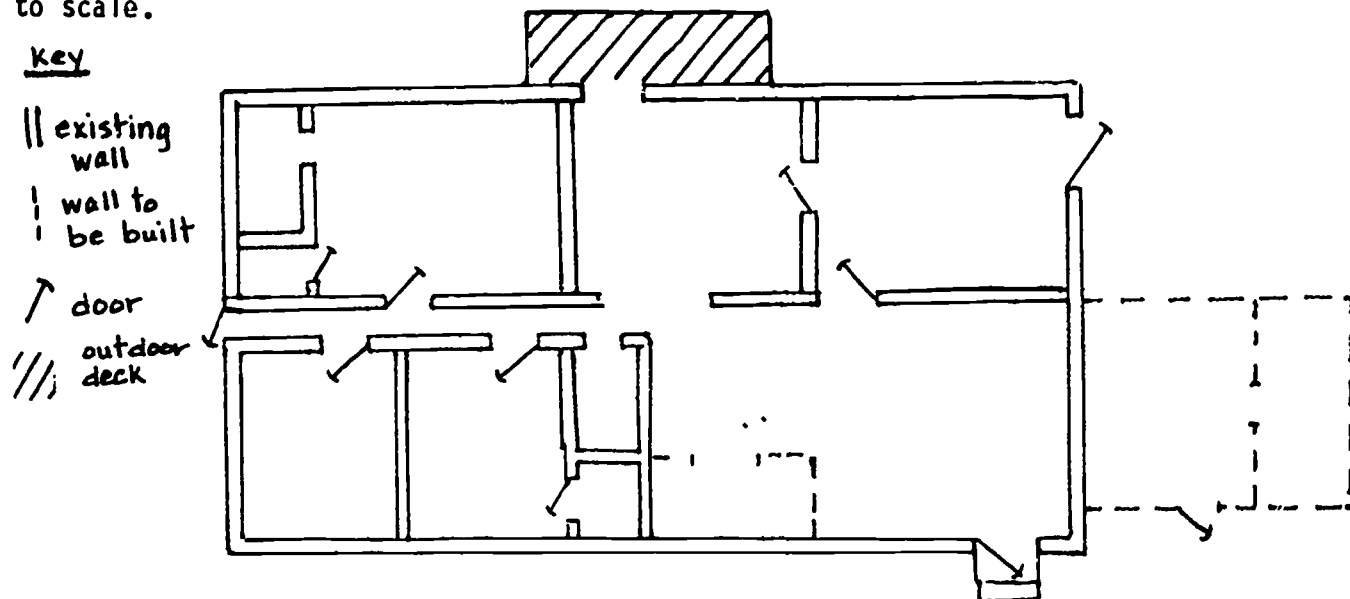

Though drafters draw on drafting film or special tracing paper, a machine turns these into blueprints used for every building caper. Drafters use engineering handbooks and calculators at length to figure out a structure's desired capacity and strength. Drafters also suggest the best materials for a job. To find the best at the lowest costs, they consult building catalogs. These materials are then listed in a detailed description. A drafter's blueprint is a builder's prescription.

Drafters' plans guide electricians, plumbers, and carpenters too. The blueprints tell these workers how and what to do. Members of this construction team then begin to communicate. Exchanging ideas and opinions, they find solutions that are first rate.

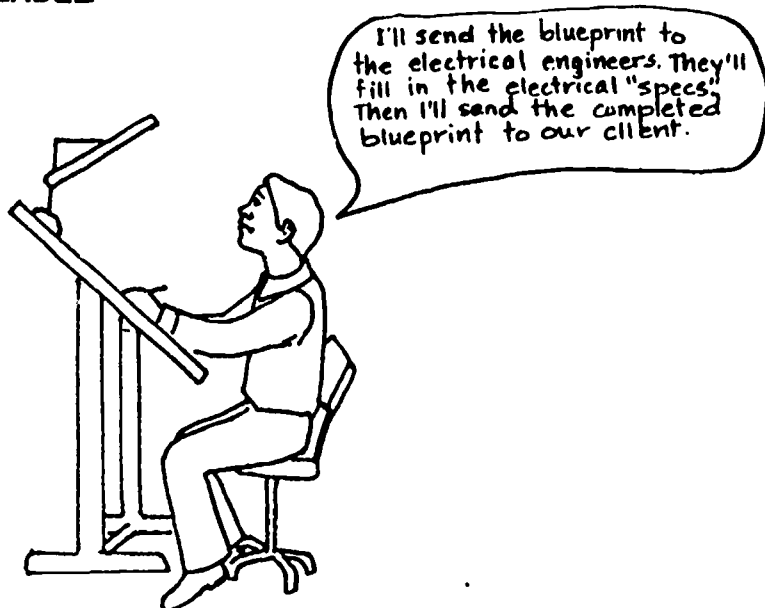

Drafters spend most of their time in quiet well-lit drafting rooms,
And must get benefits like paid vacations and medical insurance.
On-the-job hazards are stiff necks and sore backs,
And when you're always standing on your feet, it helps to have endurance.

Drafters work at large drawing tables with tools to measure and draw.
Adjustable triangles help them draw angles, needed for every drafting chore.
Drafters use geometry all the time, and must check their figures' dimensions,
So math is too important a skill for me not to mention.
Parallel edges and T squares help when drawing parallel lines,
And erasable pencil is the popular tool for drawing the drafter's designs.

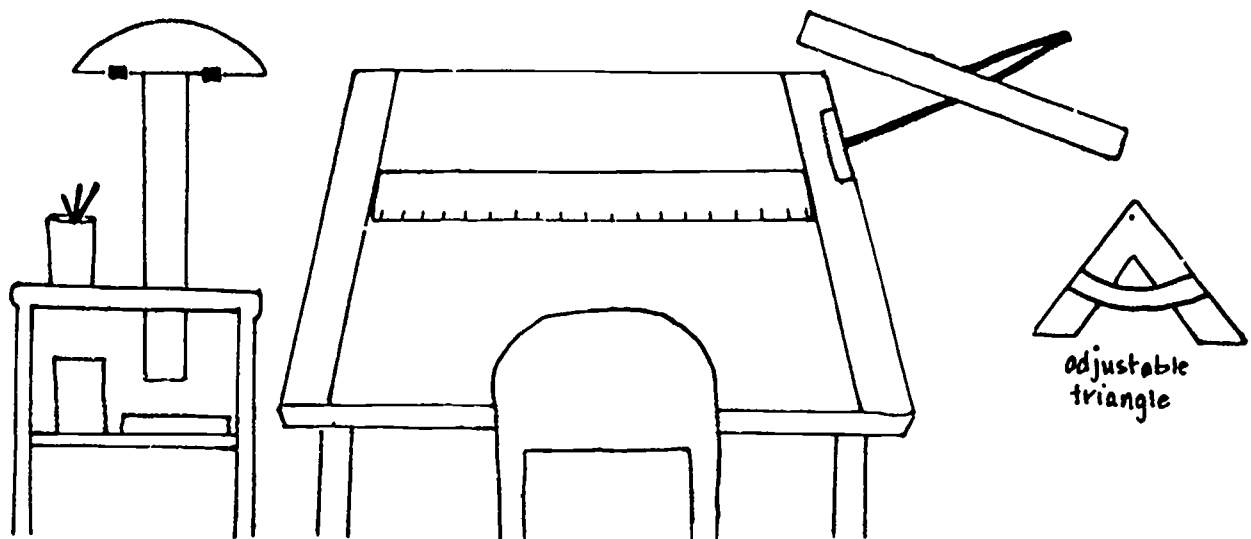

Drafters don't always work indoors, though, depending on secondhand news... They may want to look at and draw a structure from many different views. In this case, they'll visit "in the field" at the construction or renovation site, And get ideas about which steps to take next, and which materials will go just right.



Before apprenticeship (on-the-job) training, studies at college are key; Though high school graduates have a chance, most drafters have a college degree. In high school, you can prepare now by taking art courses, And in your free time, get a pencil and draw anything, from automobiles to horses. Physics comes in handy, and so do wood, electric, and metal shop. After two years of mechanical drawing, you can try a summer drafting job.

Engineering offices and architectural firms commonly employ drafters. Drafters also work in large building complexes, to help maintain structures From their basements to their rafters.

Advancement to "senior" means giving other drafters guidance and instruction. And an "architect's rep" often works in the field, overseeing construction. Drafters can move to jobs in other fields, like electric or sales engineers, "To be an architect one day" is many a drafter's aspiration, But being an architect takes many more years of school training, Which means lots of patience, and perspiration.

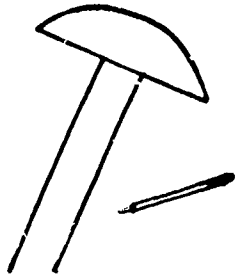

ARCHITECTURAL DRAFTER:
WHAT DO YOU KNOW?



What are three of an architectural drafter's work tasks?

Name three of a drafter's tools or pieces of equipment, and describe how each is used.

How do architectural drafters use reading and math skills on the job?

Name one advantage and one disadvantage of working as an architectural drafter.

Name two places where architectural drafters can be found at work.

Describe the training that architectural drafters need.

Name three advancement possibilities for architectural drafters.

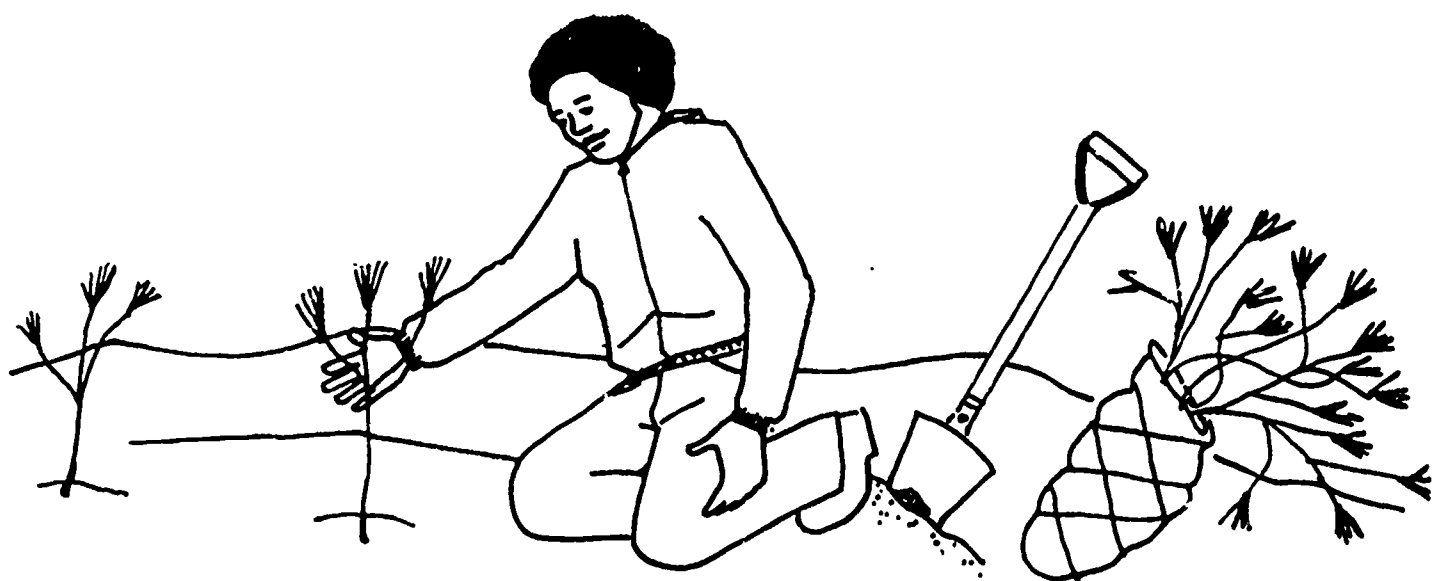

ENVIRONMENTAL CONSERVATION LABORER

Hi! My name is Micki Lane. I'm a laborer at the Department of Environmental Conservation. I like the outdoors, and luckily that's where I work most of the time. I work in all kinds of weather, so I am employed as a seasonal worker. A seasonal worker works in different places. Where I work depends on the time of the year and the job that needs to be done. If I want, I can become a permanent worker. Then I would work in one place all the time, doing just one job.

As you may have guessed, I like doing different things at work. So this type of work suits me fine. Sometimes I mow lawns in the hot summer sun; other times I clean out clogged ditches in the pouring rain. Once I had to help fight a forest fire. In the winter I plow snow from the roadways here at the regional office. I've moved and repaired office furniture. I've cleared brush and cut trees around fences and on forest roads and trails. Because my work is varied, I have to be prepared to do almost anything. I have a background in plumbing repairs, from when I took the BCCES training course in plumbing during high school. Whenever any plumbing repairs are needed, I do them.

Here are some of the tools I use. I'm proud to say I have a good working knowledge of each of these hand and small power tools. The Department of Environmental Conservation supplies these tools when I need them. Some of the small power tools I use are lawn mowers, chain saws, and sanders.

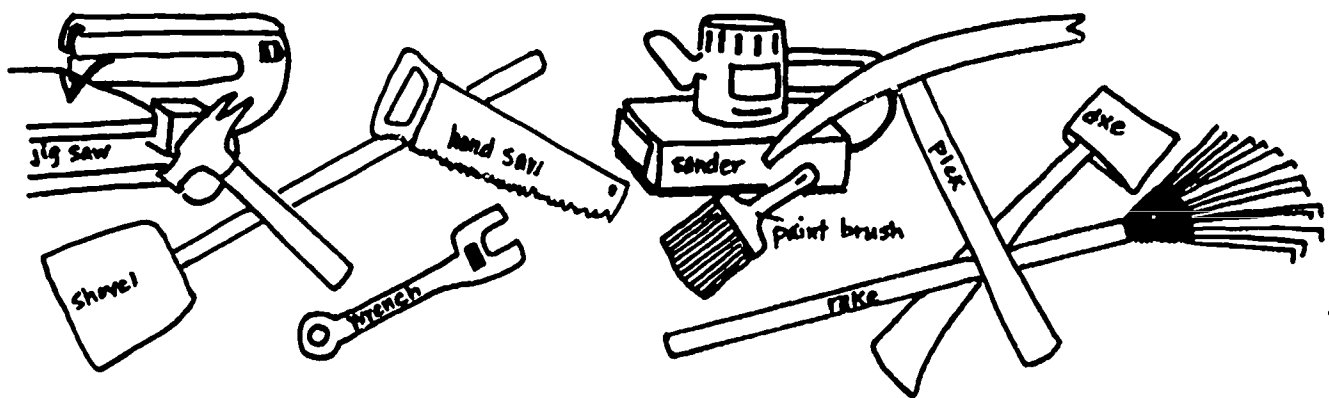

I must always be alert on the job. When cutting trees, I wear a hard hat to protect myself. I also wear earplugs when using a chain saw. When people practice safety, they're less likely to get hurt.

In high school I didn't like reading. But now I'm glad I stuck it out because reading is important at this job. I have to read directions so I will know how to put things together. I also read work orders to know where I'll be working and what my tasks are. Math is important, too, because I need to know how to figure out how many hours I've worked so I can fill out my time card. The average work day is from 8:30 A.M. to 5:00 P.M. with a half hour for lunch. Once in a while I might have to work longer. Then I get paid the overtime rate; that's pretty unusual. When I started out here I worked for the minimum wage. If I didn't know how to use math, I wouldn't be able to figure these things out. I also need to figure out ratios. When I fill the chain saw I put in a $\frac{2}{3}$ gas and $\frac{1}{3}$ oil mixture. So you see, math is a very important skill to know.

I also have to get along with people. I'm a representative of the Department of Environmental Conservation. The most important skill I use is common sense. Common sense helps me figure out how to do things that I've never had experience with before.

I am taking a class to learn how to drive large trucks now. Once I pass the test, I'll be able to drive the big trucks used by the Department. The Department hopes all of its employees will keep going back to school. The more skills we learn, the better it is for us. The skills we learn can help us to make more money. This is one of the reasons I like working here. There are lots of chances to move up. From laborer, I can move to a maintenance assistant, then to equipment operator, truck driver, or to operations or field supervision. Each of these jobs needs more experience and skill than mine does. I'm working to advance myself and I feel like I've got a real exciting future waiting for me!

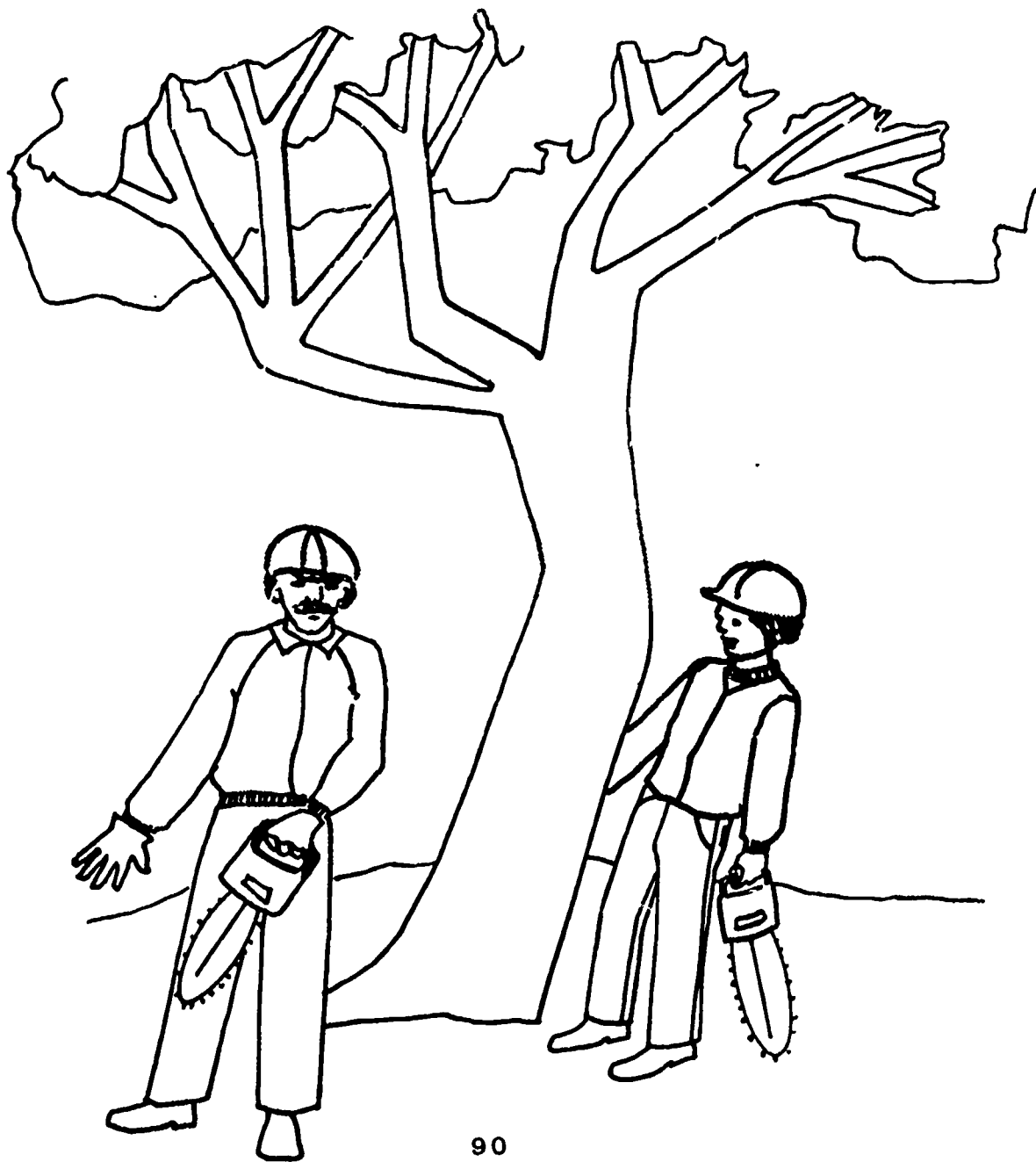

ENVIRONMENTAL CONSERVATION LABORER

QUIZ YOURSELF:

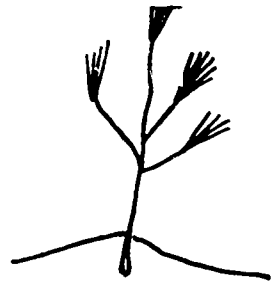
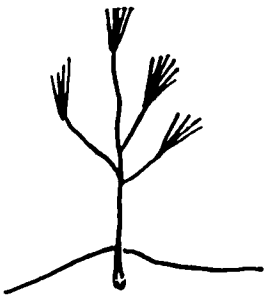

Micki's work tasks are varied. Name three of these tasks.

Name two hand tools and two power tools that Micki uses on the job.

Name some possibilities of advancement for environmental conservation laborers.

As a seasonal worker, Micki works at several different work places throughout the year. Describe three of these work places.

Describe how an environmental conservation laborer uses math and reading skills on the job.

What kind of training helped Micki to prepare for her job?

Name one on-the-job hazard and one advantage of Micki's type of work.

HEAVY EQUIPMENT OPERATOR: BUILDING A CAREER

My name is Hanna Debs, and this is where I work.

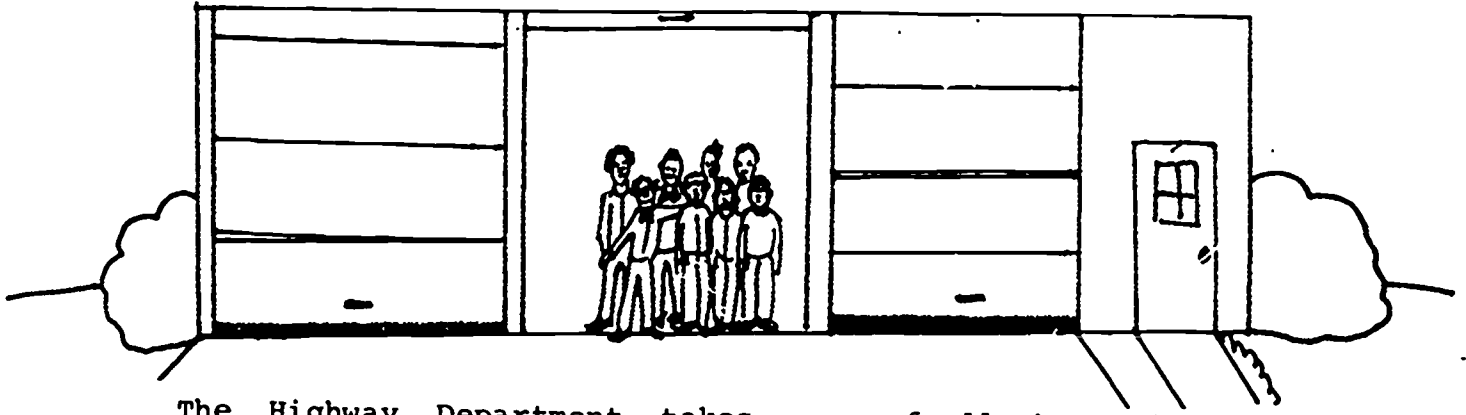

The Highway Department takes care of all the equipment and property owned by the town. Buildings, roads, sidewalks, curbs, and parks are some of the property owned by the town.

The people in the picture are Highway workers who are employed by the town of Newburgh. I am in the first row, on the right. The picture was taken two years ago, when I had just started working for the department. My first job was as a laborer. Most of my work was outdoors. I worked as a team member. We took care of the roads, sidewalks, and curbs. My training included using mowers and rakes. I used shovels to dig ditches and saws to cut any large limbs that fell. I also used hammers, screwdrivers, wrenches, and ladders to put up signs. Sometimes, I shoveled snow and used rock salt to melt the ice in the winter. The Highway Department supplied all the tools I needed. The department gave me a hard hat, a pair of gloves, a raincoat, and boots to wear on the job.

My work took lots of strength. I had to be well rested and in good health. I had to be "on call," which means I had to work when there was an emergency. I was "on call" some weekends, and often at night. I got paid double time for working "on call." This meant for each hour I worked, I got paid two times my hourly wage. The main hazards in my work were cuts and bruises.

I became interested in learning to operate heavy equipment. I wanted to learn how to drive and operate the dump truck, the roller, the backhoe, and the front end loader. But I didn't want to go to school. I thought of reading when I thought of going to school. I had a lot of trouble with reading in school, and I dropped out because of it. My boss, Henry, said he'd train me on the job.

My first training was in equipment maintenance. I made sure all the equipment was full of gas and oil each morning and the windshields were clean. I also reported if any repairs were needed. Then I learned how to do minor repairs, like fixing brakes. Next, Henry told me how to operate each piece of equipment. I went along with other equipment operators. I watched what they did, and listened to what they told me. I asked questions about what I didn't understand. I started driving equipment when I got my special license.

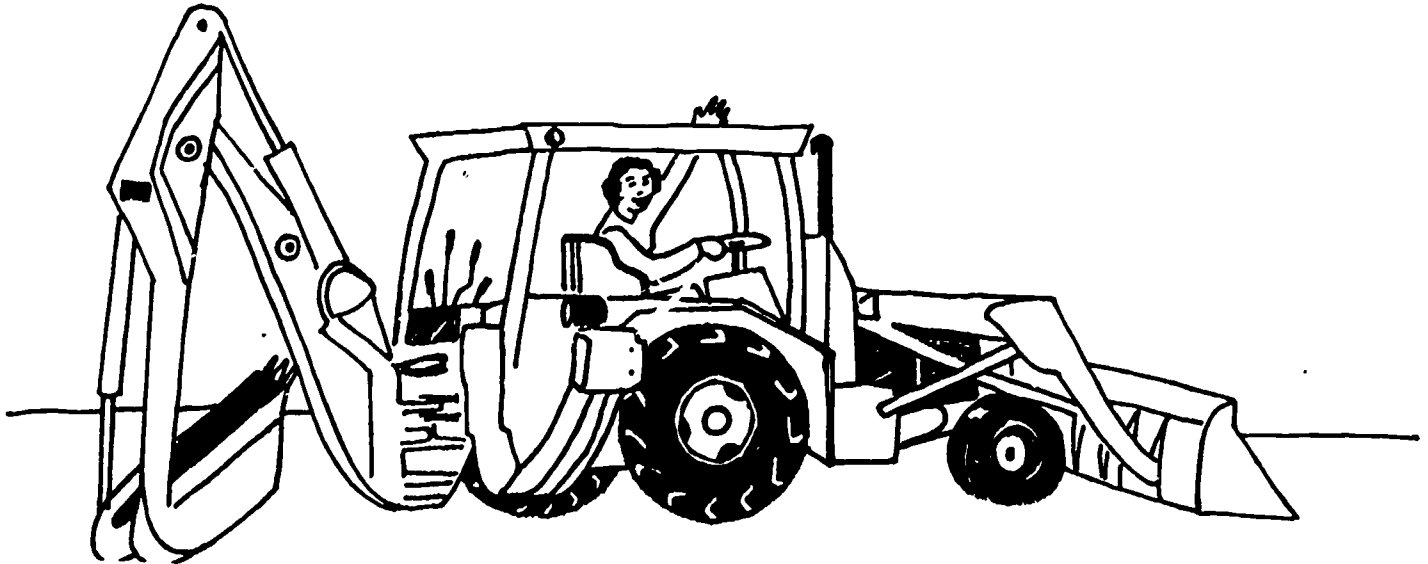

I make more money now as a heavy equipment operator. My working conditions haven't changed much. I still work outside most of the time and as part of a team. It can be dangerous, though, if I don't stay alert. Often I can dig ditches, while other times I put up signs and operate equipment.

The department needs a worker with plumbing skills. Henry said I should take a course at BOCES. I would love to learn to do plumbing, but I don't want to go to a vocational school. I want to learn the same way I learned to operate heavy equipment.

Henry told me I was a good worker. He said I was the best equipment operator he had trained. But, I had to take courses if I wanted to get paid for plumbing. That is the rule. It's in the department regulations.

I dropped out of school because of reading. Henry said a vocational course was not like school. He said I should give myself another chance to learn something I like.

What Henry says makes sense. I don't know yet if I'll take the training course. What would you do?

HANNA DEBS: EQUIPMENT OPERATOR

TEST YOURSELF



Name three work tasks Hanna performs as an equipment operator.

Name three pieces of equipment Hanna operates.

Why did it become important for Hanna to use reading skills?

Hanna got her training on the job. Name one other place where an equipment operator can get training.

What would Hanna have to do in order to earn more money on the job?

What did Hanna like best about her work conditions?

Painter / Paperhanger

Although painting and paperhanging are two separate skilled trades, many people do both types of work. The different On-the-Job Skills and Tasks, and Tools and Equipment used at each trade are listed separately next to the picture of the painter or the paperhanger.

Both jobs are similar in many ways. Information like Training and Advancement possibilities, Work Conditions, and On-the-Job use of Reading and Math, which are the same for both jobs, are listed only once on this page.

Training

On-the-job: Start out as a helper, and learn all the skills in four or five years.

Apprenticeship: Three years of planned activities including work experience and classroom training.

Work Site

Indoors or outdoors in new or existing buildings. Homes, offices, hotels and motels, schools, shipyards, manufacturing firms.

Self-employed painter/paperhangers may have own private offices.

Work Conditions

Hazards working indoors include allergic reactions to paint fumes.

Hazards working outdoors include falling from high ladders or scaffolds.

Advantages include a 40 hour work week with extra pay for overtime.

Union workers earn good wages and get lots of fringe benefits.

On-The-Job Use of Reading and Math

Reads work orders and directions on paint cans or other supplies.

Does math to compute cost estimates and amounts of paint or paper and other supplies needed.

Advancement

Workers with management ability can supervise and coordinate the activities of others.

Workers skilled in math can become estimators for large contracting companies.

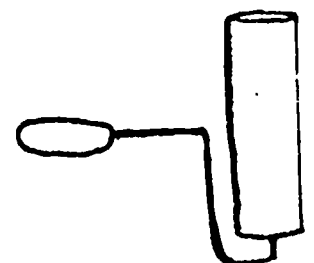
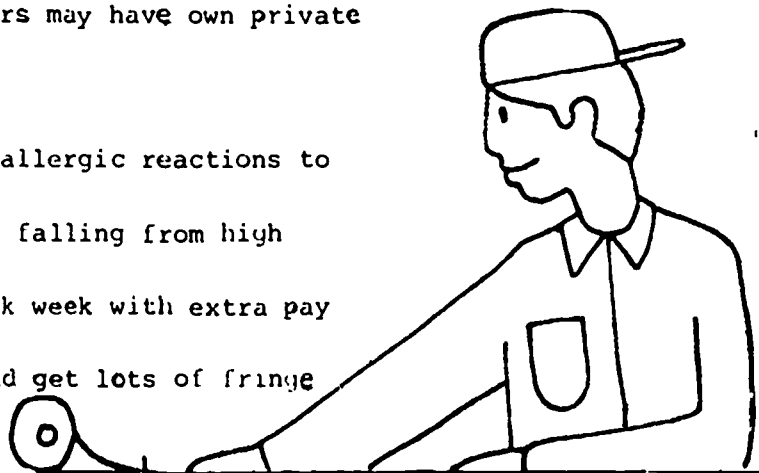
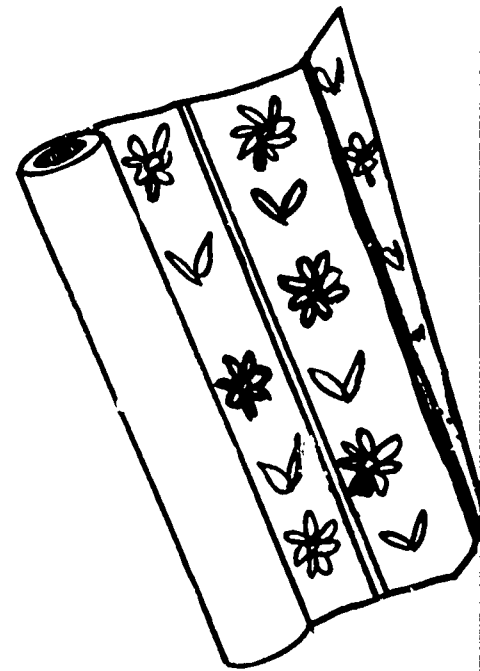

Tools and Equipment

- Scrapers
- Wire brushes
- Blow torch
- Paint remover
- Paint thinner
- Primer
- Paint
- Varnish
- Shellac
- Paint brushes
- Rollers and tray
- Spray gun
- Stepladder
- Extension ladder
- Scaffolds
- Drop cloths
- Face mask

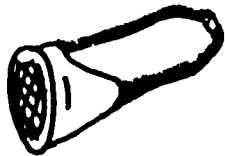
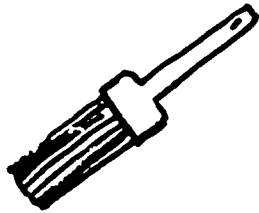

Other Skills

Must be neat and clean.
Must be able to talk to customers.

Skills and Tasks

Covers furnishings with drop cloths.
 Scrapes off old paint.
 Putties or plasters cracks or holes.
 Sandpapers rough spots and brushes them clean.
 Primes entire surface or touches up spots.
 Paints finish paint or top coat.
 On new walls:
 Applies prime coat, then,
 Applies 1 or 2 coats of paint.
 On old walls:
 Prepares surface,
 Checks for cracks or loose paint.

Smooths rough spots on walls.
 Fills holes and cracks.
 Removes grease, varnish, and old paint.
 Applies "sizing" to walls (a kind of glue that protects the wall when paper is removed).
 Cuts wallpaper to size needed.
 Spreads wheat paste or glue on back of paper.
 Puts paper on wall.
 Smooths out paper with a dry brush to remove air bubbles.

Tools and Equipment

- Scissors
- Knives
- Wood roller
- Dry brush
- Sizing
- Wheat paste
- Cutting table
- Ladders
- Plaster
- Trowel

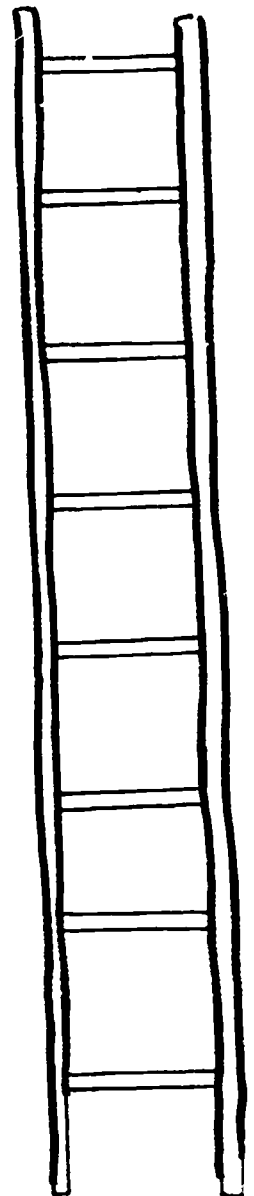
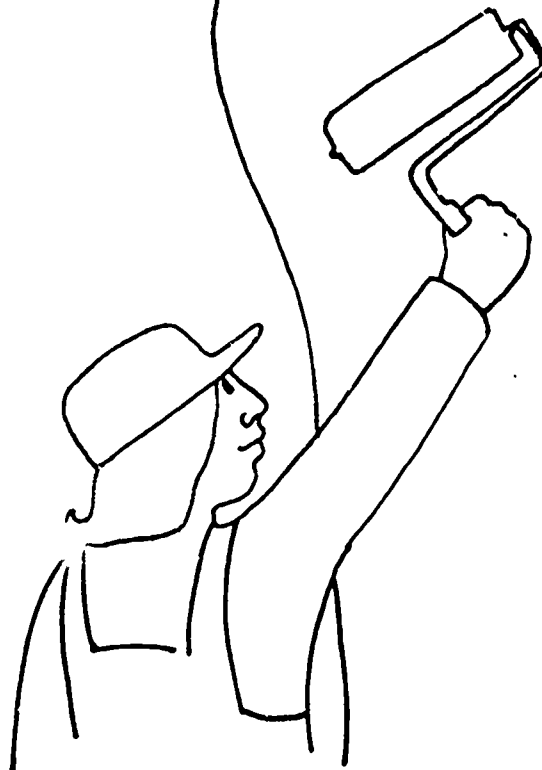

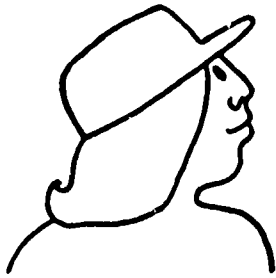

Painter / Paperhanger

How much do you remember?

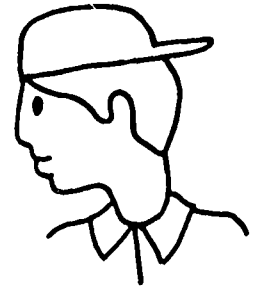

Name 3 of a painter's work tasks.

Name 3 of a paperhanger's work tasks.

Name 3 of a painter's tools.

Name 3 of a paperhanger's tools.

How do painter/paperhangers use reading and math?

What kind of training is required of painter/paperhangers?

Name one advantage and one disadvantage of working as a painter/paperhanger.

What are some of the possibilities of advancement for painter/paperhangers?

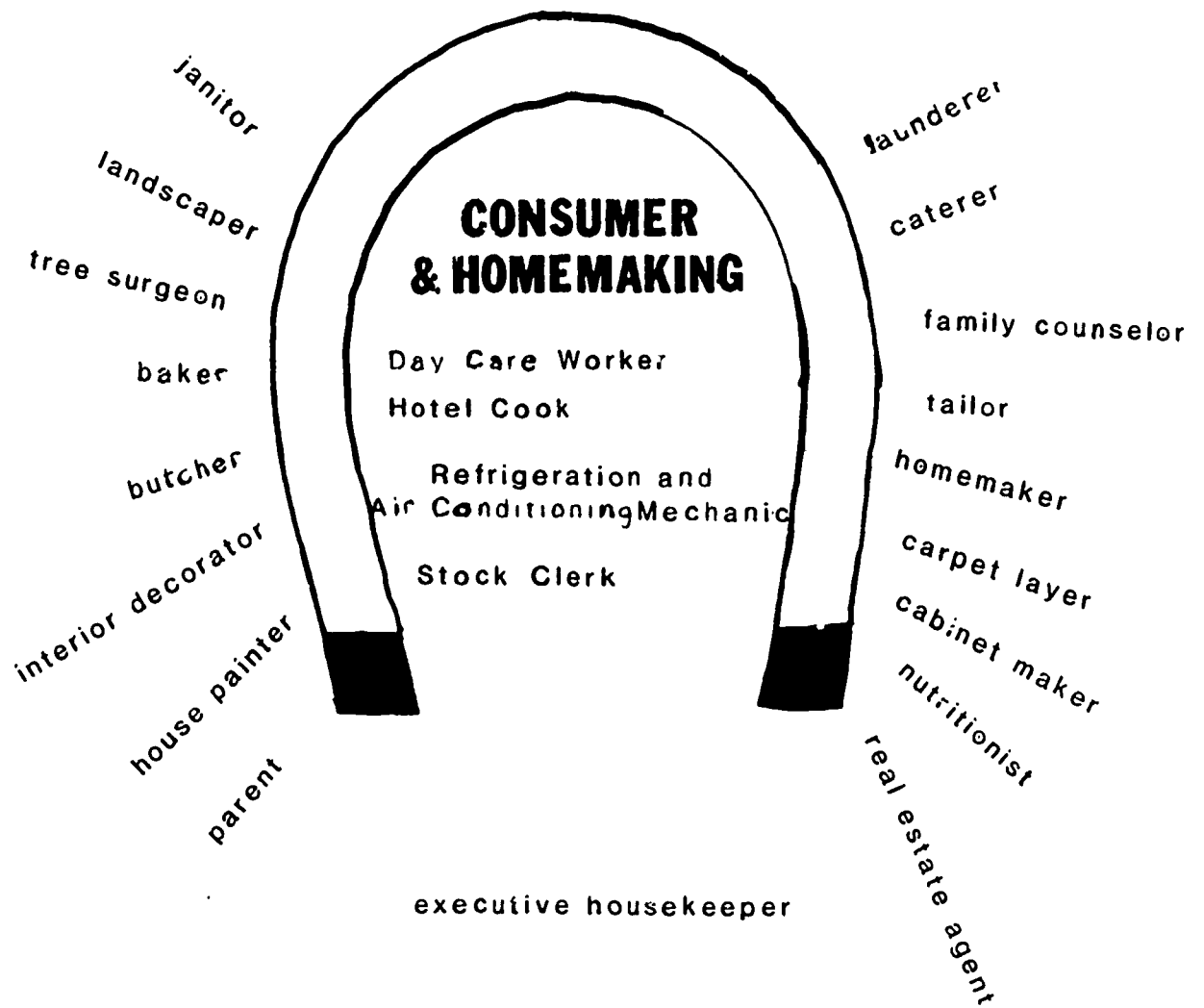

Workers from the Consumer and Homemaking cluster help to produce and improve food, clothing, home furnishings, and care of family members.

DAY CARE WORKER

Henry Jones is a student in the work-study program at City High School. Henry goes to school for half the day and works at the Child's Play Day Care Center for the other half.

When Henry started in the work-study program, he had an interview with Ben Wall. Ben Wall is the head or director of the Child's Play Day Care Center. Ben told Henry all about the center. Ben said, "A child's work is to play because children learn by playing. People who care for children need to make a happy, safe place for them for learn."

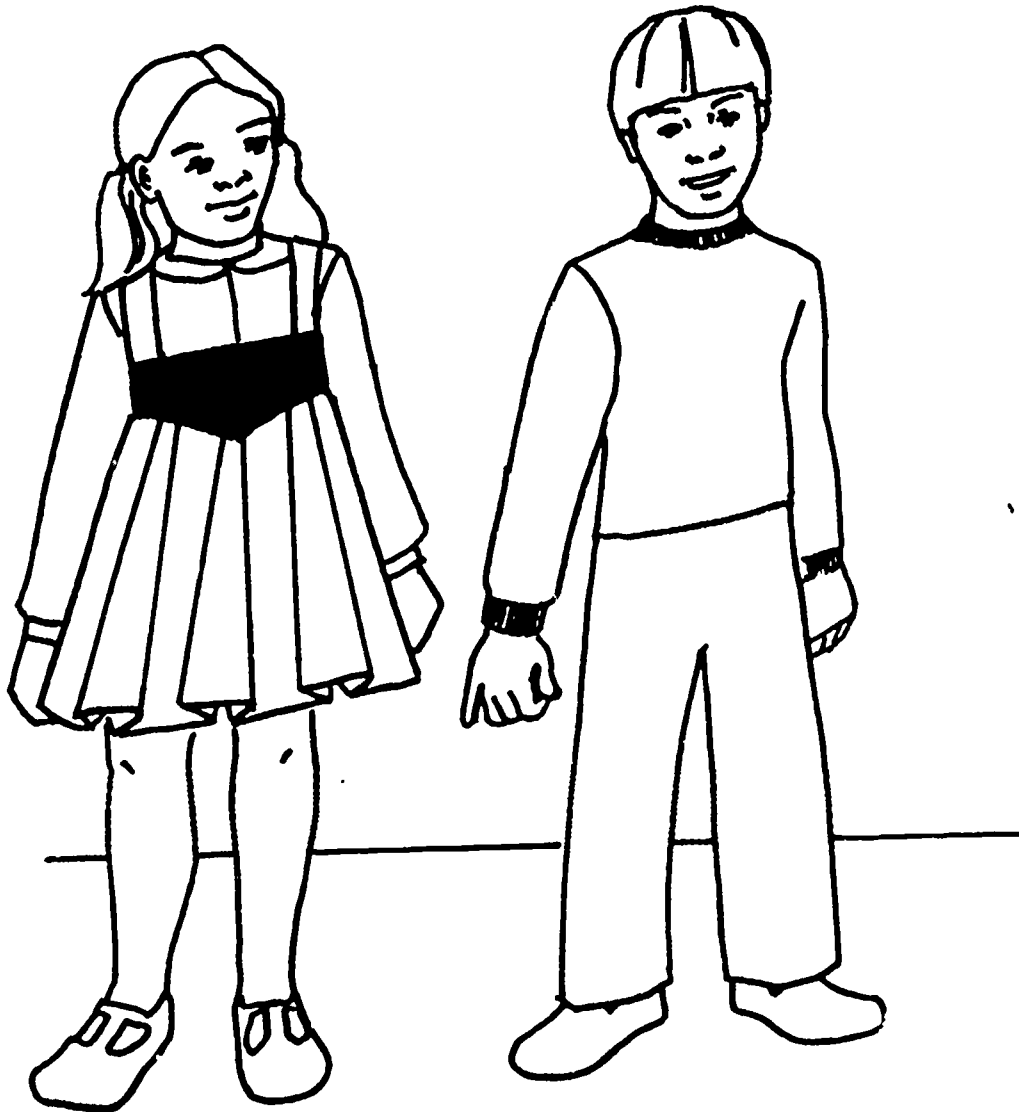

Henry asked Ben what he did to become the director. Ben said he always liked young children, perhaps because he had three younger brothers to care for when he was young. So, when he went to college, he took courses in early childhood education and got a teaching certificate. Next he worked in different day care centers for seven years. Following this experience, Ben felt he was ready to be a director. He applied for the opening at the Child's Play Day Care Center and was accepted because he had the best qualifications and background.

Henry knows that the children need quiet times as well as active times during the day. They need play areas with toys as well as quiet areas with books. In these surroundings they learn to share and get along with other children.

Day care workers, called aides, help the children learn about taking care of their bodies. For example, the aides help the children wash their hands and faces before they eat. Good, healthy snacks are given to the children every day. In some centers, one snack is a play-dough they make. An aide helps the children measure dry milk, honey, and peanut butter. This is a first lesson in basic math: measuring. The children mix these foods all up and use it like clay. When they get tired of playing, they can eat the mix. What fun!

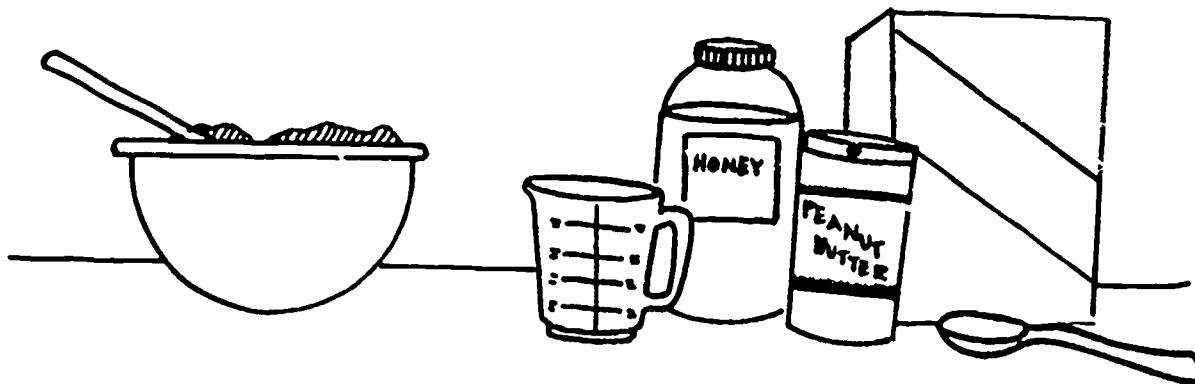

Some children climb on a jungle-gym. Others tumble on a mat on the floor. These activities help to keep muscles fit and are good for gross motor skills such as coordination. Gross motor skills means using the large muscles of the body. Fine motor skills use the small muscles of the body. For example, the fine motor skills of the hand muscles are needed to turn pages of books or to color pictures.

Rooms at the day care center have many things in them for the children to learn about. The children learn about living things by caring for plants and animals in the rooms. The children water the plants and feed and water the rabbits.

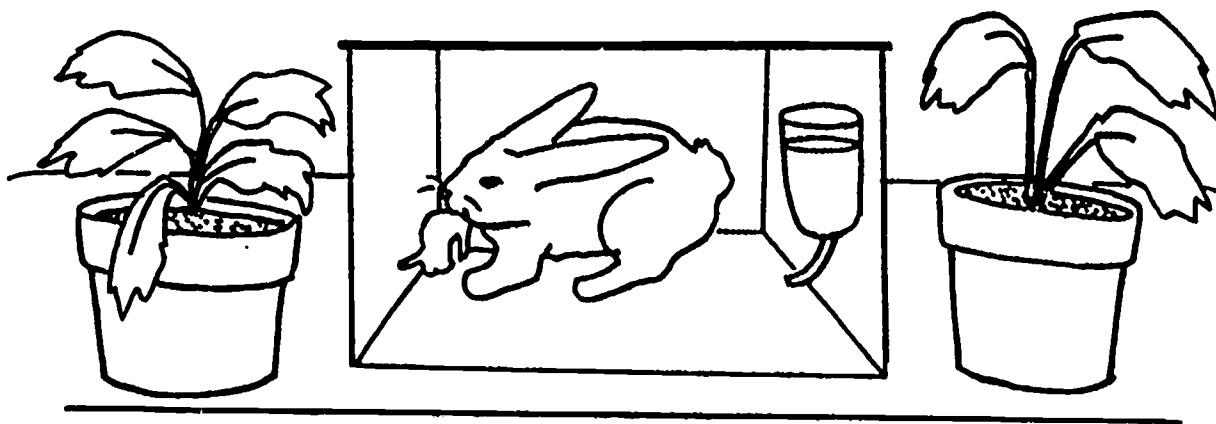

Sometimes an aide will read a story to a group of children or the children are encouraged to ask any questions they have. Sometimes the aide will ask the children questions. This helps the children to learn to express themselves and carry on conversations.

Some days the children and day care workers have no problems at all. The day goes as planned. Other days the time together must be carefully planned or it can be a disaster. Sometimes the problem is bad weather, but at other times it is because of problems in a child's home. Any "bad days" are the only disadvantage in this work.

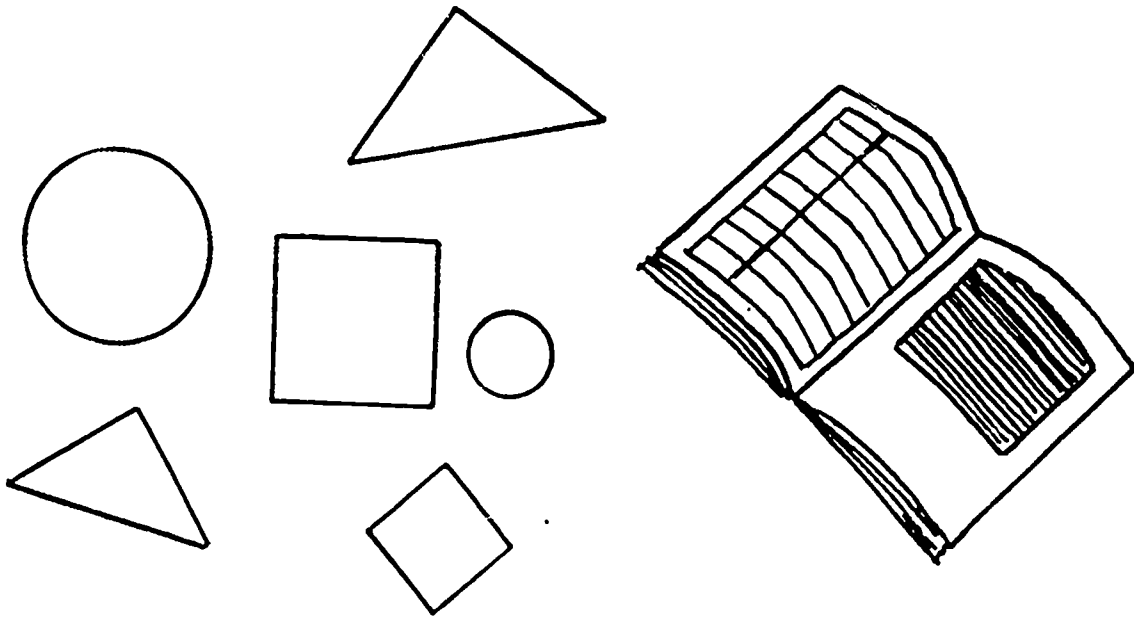

The advantage of this job is the delight of working with small children. You can watch them learn and see them grow. You help them with simple math and pre-reading skills. Pre-reading means activities leading up to reading. The children are shown colors and shapes and learn the names of these colors and shapes. The aides teach numbers, simple addition and subtraction skills, the alphabet letters, their names and other words.

Records are kept of each child's attendance and what he or she learns.

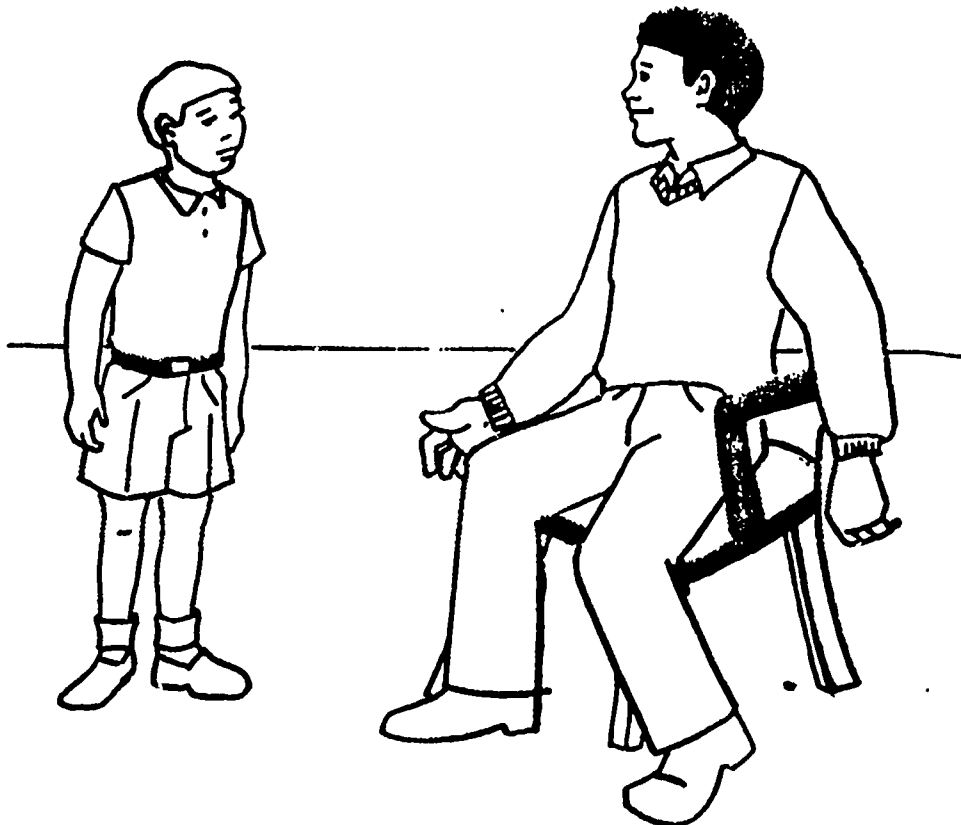

QUIZ YOURSELF:

DAY CARE WORKER

Name two places where you can get the training needed to become a director of a Children's Center.

What are three skills or on-the-job tasks of a day care worker?

Name two places where you might find a day care worker at work.

What are three tools or pieces of equipment that are used on the job? How is each used?

How does a day care worker use reading and math skills on the job?

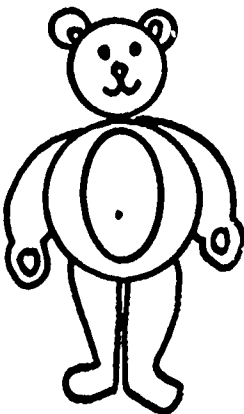



HOTEL COOK

I prepare and cook food for folks in large quantities.
After ten years of experience, I do it with ease.
Though I've always worked in kitchens, they've never looked the same:
Restaurants, cafeterias, or food serving chains,
For hospitals, or any institution you can name.
I've even fixed high-flying food for people in airplanes.
A galley cook works in a ship, far out at sea,
Wherever people gather, they must eat, and so, need me.

Well, there are plenty of ways to learn to cook up a storm,
Experience was my way, though it takes a little long.
In high school, I worked making heros and spreads.
Next year as cook's assistant, I earned a little more bread.
Then at a hamburger joint, I kept my grill clean,
But spent a lot of time the first few months, sifting French fries
through a screen.

I learned to make quick dinners, good chow with no frills,
That led me to a better job, a resort in the hills.
That's where I learned to do some fancy baking.
And you know, cooking for one hundred, there's no way of faking.
You've got to be quick and you've got to be good.
You must measure real well, and have a knack with food.
I follow directions and keep my workspace clean,
Board of Health Inspectors can get picky, it seems.
I multiply my recipes for banquets or a party,
I need my math when mouths are many and appetites are hearty.

Some tools of my trade may be familiar to you.
I use forks, spatulas, ladles, pastry blenders, and spoons.
I use special French knives with big blades for dicing,
Micro-wave ovens, and machines that do slicing,
Strainers, wire whisks, mixers for batters,
I measure with spoons and cups and scales, and arrange food on platters.
Believe it or not, it's especially new,
The way mashed potatoes are coming to you.
You push a button, they plop from a slot,
Made of powder and water, homemade they're not.



I prepare soups and gravies before each night begins.
I contact food wholesalers to get the biggest bargains.
My work is often under pressure, I can really feel the heat.
And waiters can get snappy from long hours on their feet.



If I were chef, I'd plan menus, and specialize in baking,
And supervise the other cooks and taste what they were making.
Although experience is one way to learn, as I've already said,
There are quicker ways to help ambitious cooks to get ahead.
Some two-year college courses can help you learn the trade,
But a culinary college is where a chef is made.

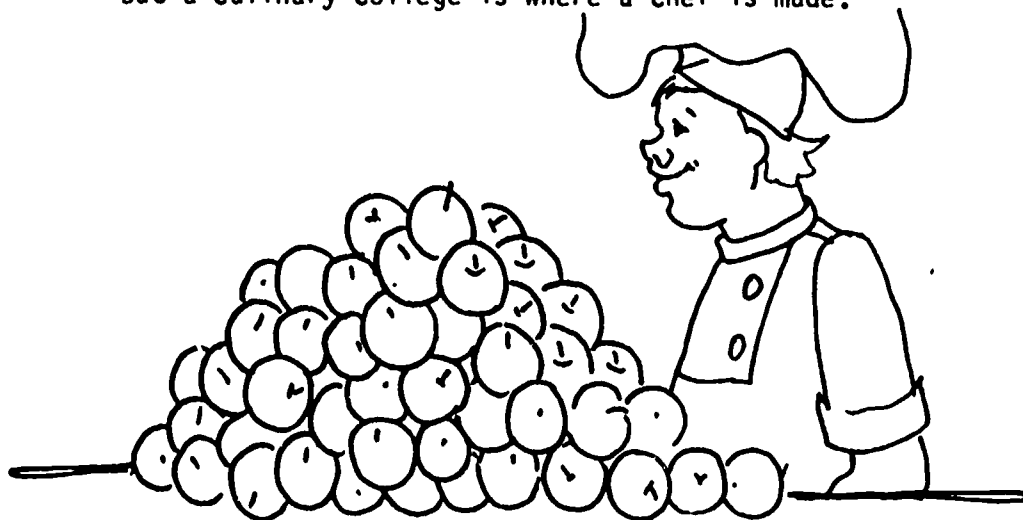

QUIZ YOURSELF: HOTEL COOK

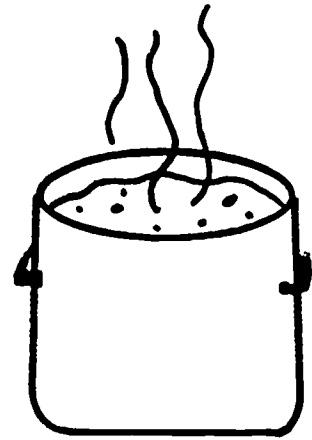

Name three on-the-job tasks and/or skills.

Name three tools or pieces of equipment and a use for each.

Name one work place.

Name one training place.

Refrigeration and Air Conditioning Mechanic

blueprints: detailed plans
or outlines

design specifications: detailed
descriptions of necessary parts

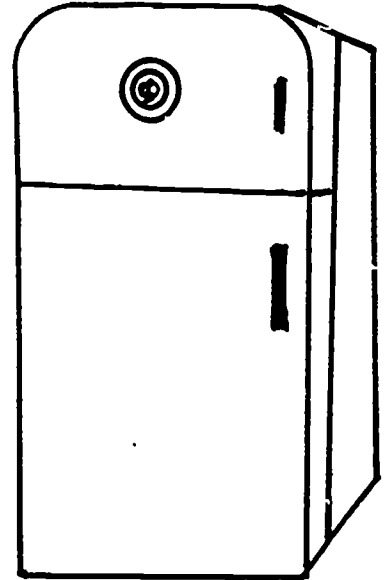
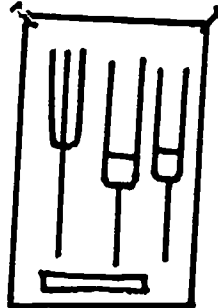

Skills and Tasks

Follows directions in blueprints and
design specifications
in order to install and
repair refrigerators,
freezers, and
air conditioners.

Installs electric circuits.

electric circuits: paths
that electricity flows

gas distribution: the amount of
gas/liquid in a refrigerator or
air conditioner

Adjusts balance of gas distribution and
gas pressure.

gas pressure: the amount
of force exerted by a gas

Charges equipment with refrigerant.

refrigerant: liquid that turns
to gas when it takes away heat

May weld or
solder in order to connect refrigeration pipes.

solder (say sod-der):
join or patch metal
parts with a melted
mixture of metals

Repairs the parts of refrigerators,
freezers, and
air conditioners by inspecting,
cleaning,
lubricating,
insulating,
changing filters, and
checking for leaks.

filters: remove moisture

Job Skills

Uses math skills to calculate temperatures and pressure, and to measure pipes.

calculate: to figure out

Uses reading skills to interpret specifications.

Uses orderly thinking. specifications: detailed lists of needed parts

Needs manual dexterity.

manual dexterity: skill in using tools, cutting and shaping pipes, putting things together and taking them apart.

Tools and Equipment

thermometer: measures temperature.

Refrigerant leak detector: finds leaks.

refrigerant: liquid that turns to gas when it takes away heat.

Ammeter or voltmeter: locates equipment breakdown by measuring electric current.

ammeter: measures the amount of electricity

voltmeter: measures the force that causes electricity to flow

electric current: the flow of electricity

Cooling units, which consist of:

1. compressors - squeezes refrigerating gases.
2. condensers - change gases to liquids.
3. metering devices - measure amounts.
4. evaporators - change liquids to gases.
5. piping.
6. relays - automatic switches.
7. thermostats - control temperature.
8. circulation fans - move air from one place to another
9. filters - remove moisture.

Small hand tools such as screwdrivers, wrenches, etc.

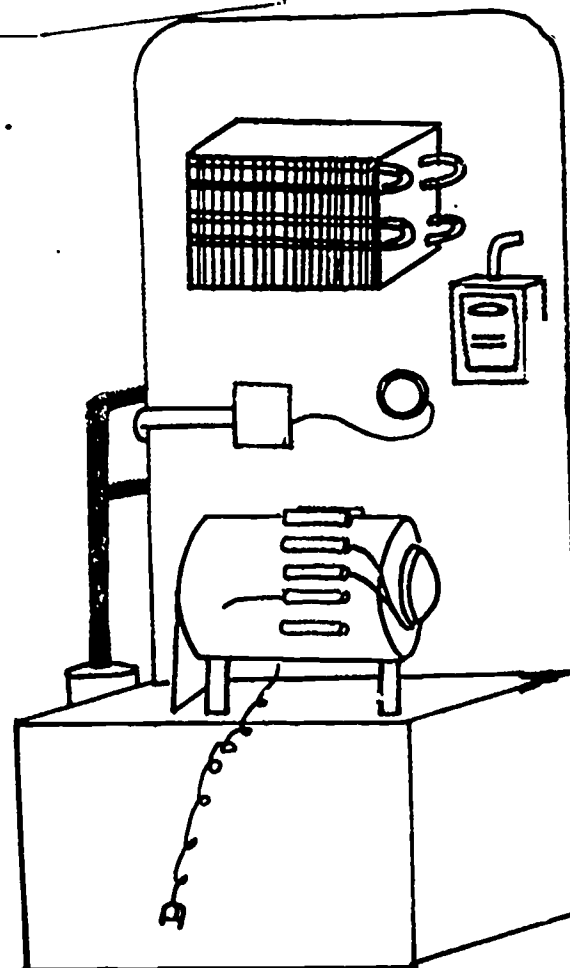

Training

Vocational school or college courses in physics, drafting, heating and refrigeration theory, heating, refrigeration, and air conditioning repair.

On-the-job training.

Periodic service clinics or factory schools, as part of ongoing training while employed.

Work Places and Conditions

Manufacturing plants, refrigerated trucks, planes, ships, railway cars, warehouses, stores, homes.

No office confinement, and often no direct supervision.

Usually works regular hours during the day, but may be called for emergencies at all hours.

Advancement

With increased efficiency and skill, can advance to foreman, estimator, manufacturer's service specialist, city or county inspector of work done by contractors, or open own business.

drafting: drawing up plans, like blueprints

theory: knowing the facts about gases and electricity in order to make refrigerators, freezers, and air conditioners work

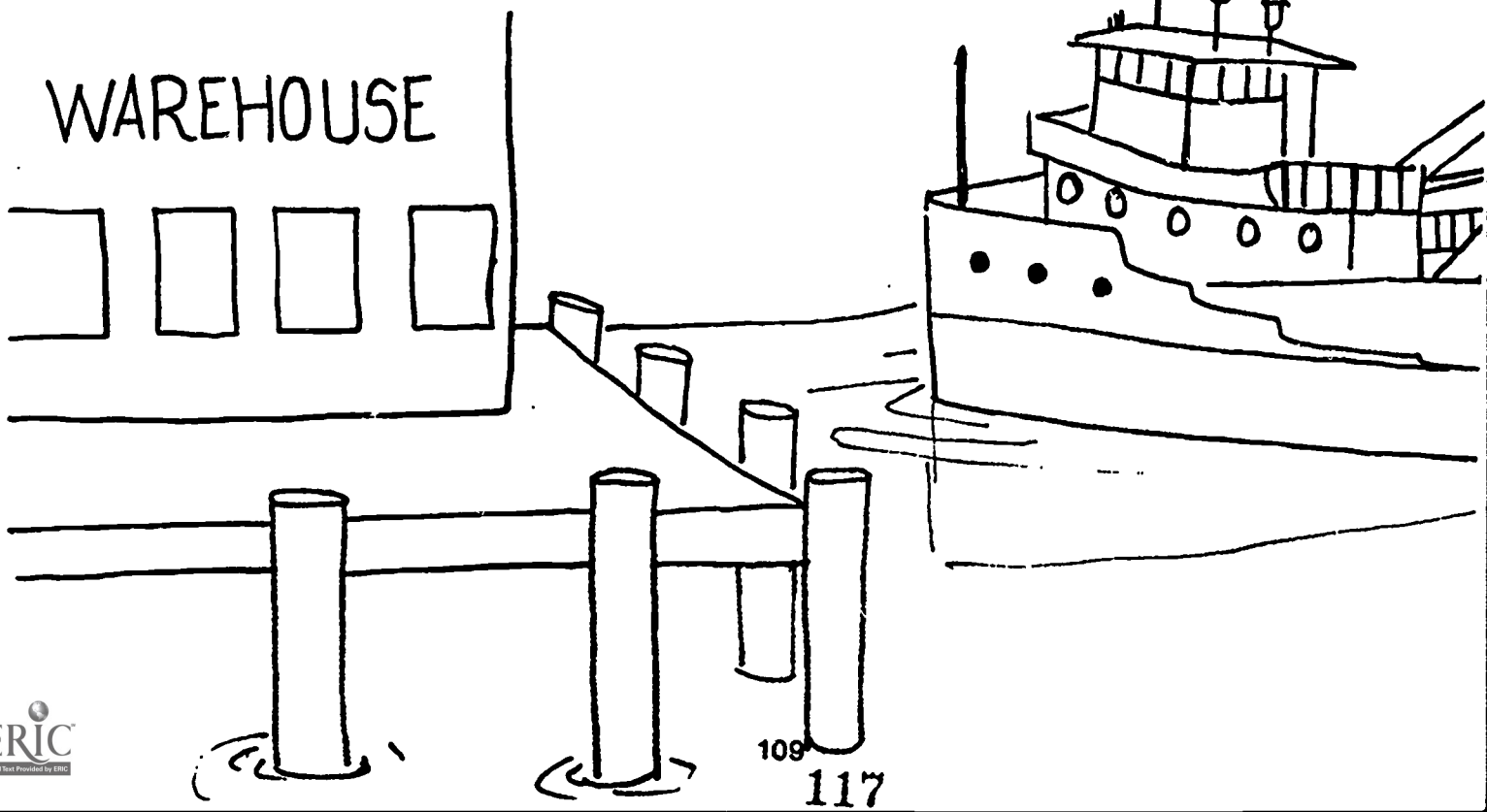
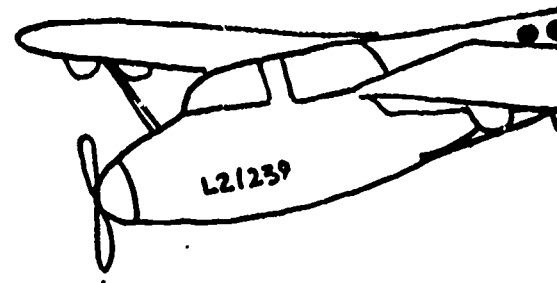

Quiz Yourself:

and Air Conditioning

Refrigeration

Mechanics

Koldspote

If there are any questions you can not answer, reread the fact sheet.

What are 3 on-the-job skills and/or tasks of a refrigeration and air conditioning mechanic?

Name 3 tools or pieces of equipment and a use for each one.

Name one work place of a refrigeration and air conditioning mechanic.

Name one training place.



STOCK CLERK

Shirley: Hi, I'm Shirley Lane. I called earlier to make an appointment for an interview. Are you Mr. Jesse Padern, the managing night stock clerk?

Jesse: Yes, I am, and I've been a stock clerk here for almost thirty years.

Shirley: Thirty years! Wow, you must have been my age when you began!

Jesse: Yes, I began working with the Good Foods Company when I was in high school. I started out then as a part-time stock clerk, and I am now the night crew stock clerk manager. Many people think a stock clerk's job is unimportant, pays poorly, and is only for high school kids. In some small stores this may be true, but we serve thousands of people daily. We have stock clerks working in shifts twenty-four hours a day; it's a big job. And if the pay wasn't good, I wouldn't be here.

Shirley: Can I ask you some questions about what a stock clerk does?

Jesse: Sure, and I'll take you on a tour of the store. Come this way; you'll see what the job is about. I'll show you the tools and equipment we use on the job. I'll also introduce you to some stock clerks.

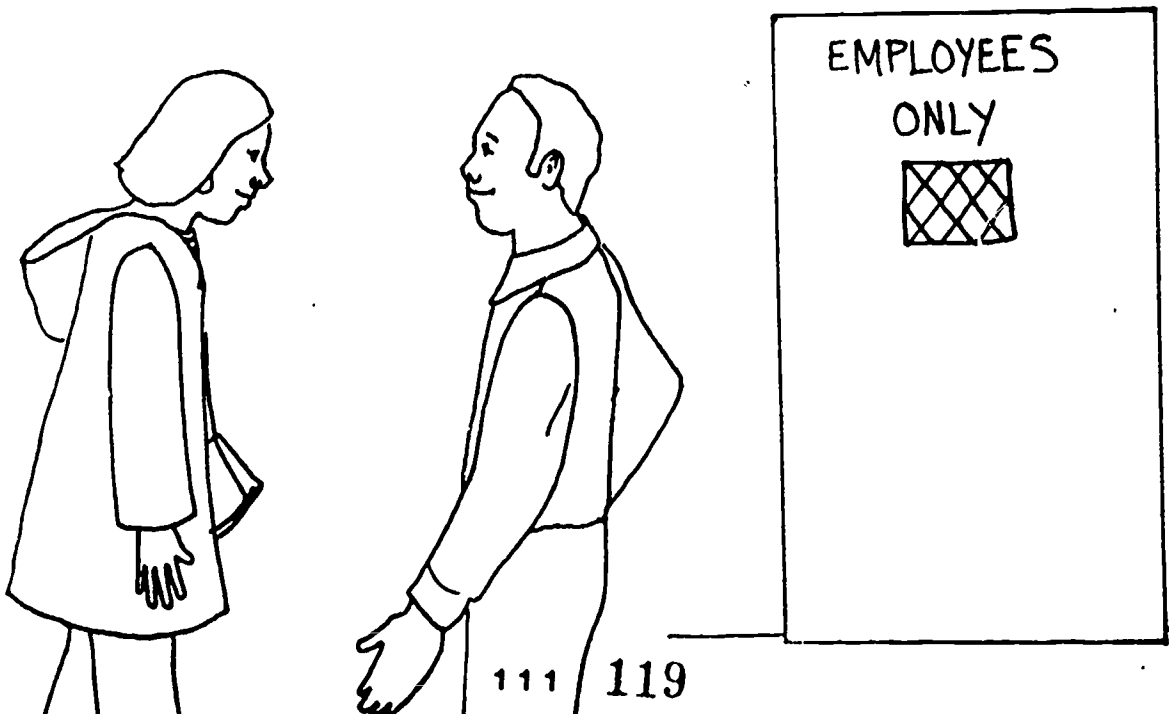

Shirley: What's this concrete landing we're standing on? Do you work out here?

Jesse: This is the loading dock, where the trucks come in every day from warehouses owned by Good Foods. These trucks deliver goods, which are taken into the aisles by the day crew. Then everything is ready for the night crew, who "pack out" the aisles.

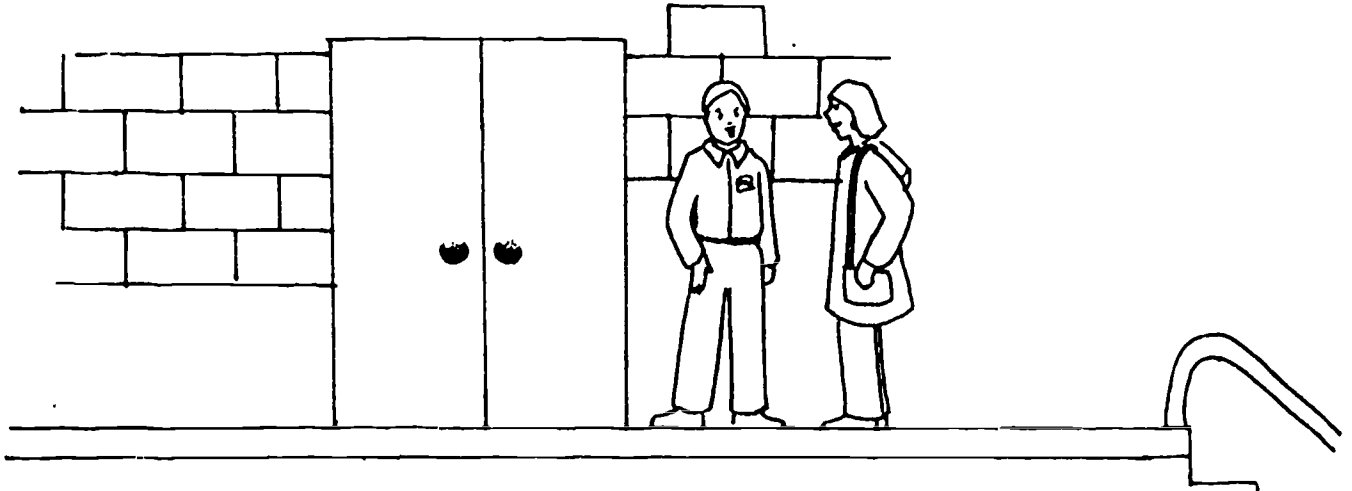

Shirley: "Packing out?" What does that mean?

Jesse: It means the merchandise is put on the shelves.

Shirley: What kind of tools and equipment do you use to "pack out" the aisles?

Jesse: See these low, wide crates? They are called "skids." Goods come stacked on the skids, and a jack is used to lift the goods onto a U-boat like this one here. It's called a U-boat because of its shape. It's made of metal and can hold a ton of merchandise. It takes strength to pull it. In small supermarkets, clerks may use dollies or hand trucks to move the cases, but a U-boat can move many more cases at once. When the U-boat is full, the merchandise is pulled to the correct aisles. Then the cases are taken off and put on "produce flats." The clerk must open the cases and price the items. We use a "cutter" to open the cases and a labeling gun to price the items.

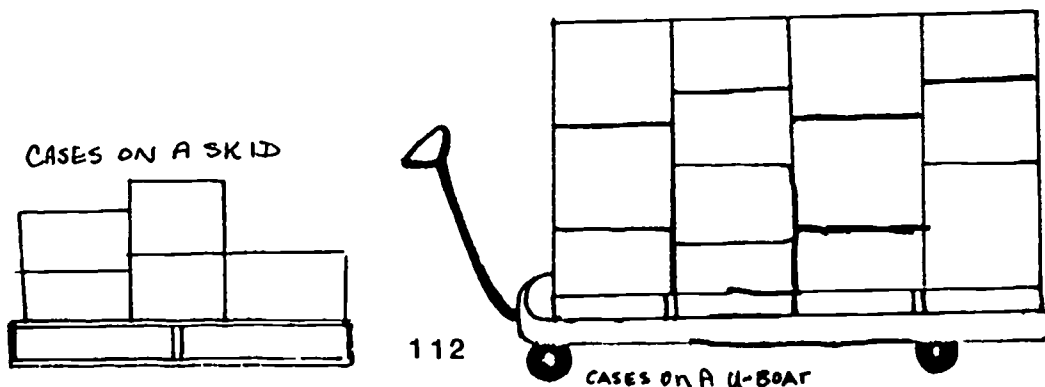

Shirley: Does a stock clerk have other kinds of work to do, too?

Jesse: Yes. A stock clerk has much more to do. Most of our day crew are part-time workers. A stock clerk must restock the shelves. This means making sure that there are always items on the shelves during the day and that they are kept in neat order. When the store is having a sale, a stock clerk must rebuild displays and set up carriages of stock (wire baskets filled with goods for the customer to buy). When the store gets too crowded, a stock clerk may be needed to do some of the packing at the checkout counter. After the sale has ended, prices have to be changed. The stock clerk uses a price-change cart to do this.

Shirley: Do you have full-time workers to do this too?

Jesse: Yes. All of our night crew are full-time. Night stock clerks have quotas to fill. That means we each have to move two hundred cases of stock in a night. Any stock clerk who cannot keep up with the quota after the first thirty days must look for a new job. Night clerks also have to do all the stock ordering. They must keep an inventory of what's "in stock," or in the store.

Shirley: How does a stock clerk know how much to order?

Jesse: Stock clerks need to look up how much of an item has been sold in the past. Then they need to figure out how much of that item will sell in a three-day period. Since we're ordering in advance, the stock clerks also need to do some basic arithmetic for this part of the job.

Shirley: Gee, there's more to this job than just stacking shelves! If a stock clerk has to order merchandise as well as stack it on the shelves, then a stock clerk is a pretty important person around here. Do only men do this sort of work?

Jesse: Oh, no. Both men and women can do this sort of job. Let me show you the inside of the store. This is Jane Rosen. She spends four hours in the snack aisles every night. She's seen more bags of potato chips than most people see in a lifetime. Her job is to stock these shelves and keep them neat. She keeps an inventory, and she orders all the items you see here. Every stock clerk can do any one of the tasks I've described to you. Most stock clerks specialize in one thing or work in one area of the store. Jane's responsible for this aisle, and it's a big job.



Shirley: I noticed outside that potato chips are on sale. Who sets up the displays? Does Jane, or is another person in charge of that?

Jesse: There's only one person in charge of displays, Frank Dobbs. He sets the displays up in front of the store. He's the best stock clerk I've ever had. Boxes of cookies, fresh vegetables, jars of jam...he'll stock them all neatly and fast.

Shirley: What kind of experience would people need to get a job here?

Jesse: People don't need any experience when they come in here for a job. In fact, sometimes it's best if they've never been stock clerks before. That way we can train them to fit the store. This is called on-the-job training. But people must be able to read so that they can do inventory and write orders. Math is also useful. They have to know how many items should go out on the floor, and how many to record. Let's face it, if you can't count, you can't be a stock clerk. And a stock clerk has to look neat and clean. You can wear blue jeans on the job here, but they must look neat. Safety-wise, you need to have closed shoes to protect your feet from falling cans and jars. That's the biggest hazard here: occasional squashed toes and pickle juiced pants every now and then!



Shirley: Do stock clerks who work here have a union?

Jesse: Yes. After thirty days, if full-time stock clerks are doing a good job, they can join the union. By joining the union they get benefits like medical insurance, maternity leave, sick days, holidays, and personal days. The union also covers employee grievances, which means it represents employees who have complaints against the management. The store provides for disabled employees. All in all, workers have it pretty good here. A worker who's been here six months gets a week's paid vacation. The longer people have worked here, the longer their paid vacations last. In the summer, the store is air conditioned and in the winter it's heated.

Shirley: This job is sounding better by the minute. How's the pay?

Jesse: The pay is good, too. A part-time stock clerk earns minimum wage to start, but after only a month, gets a raise. Part-time stock clerks can make up to \$7.50 an hour. Full-time stock clerks do even better: \$5.25 an hour to start, or \$5.50 on night crew. And a full-time night clerk who manages the floor can make as much as \$8.80 an hour. That's me!

Shirley: How does a person advance to a managerial or executive position?

Jesse: A person with ability can advance to almost any position in Good Foods. It's not so much formal education as it is experience that counts here. Of course, a person interested in managing a store would find business courses very helpful. However, the company doesn't require people to take these courses. Actually, the only thing I can think of that requires special training is computer work. More and more computers are being used in the food store business these days.

Shirley: Well, Mr. Padern, it sounds like you really like your job. Thanks so much for the interview and the guided tour. I've really learned a lot about how a supermarket runs, and just how important a stock clerk is.

Jesse: Yes, my job is pretty important, and I am happy here. Guess I'll keep this job. Besides, I have a month's paid vacation coming up!

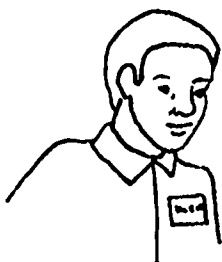

Can You Answer These?

STOCK CLERK

Describe three of a stock clerk's on-the-job skills and tasks.

Where can stock clerks be found at work?

Jesse describes quite a few of the tools and pieces of equipment used by stock clerks. Name three of these tools and describe one use for each.

What kind of training do stock clerks need?

How do stock clerks use math and reading skills on the job?

Toward the end of the interview, Jesse describes some hazards and benefits of being a stock clerk at Good Foods. Name one of each.

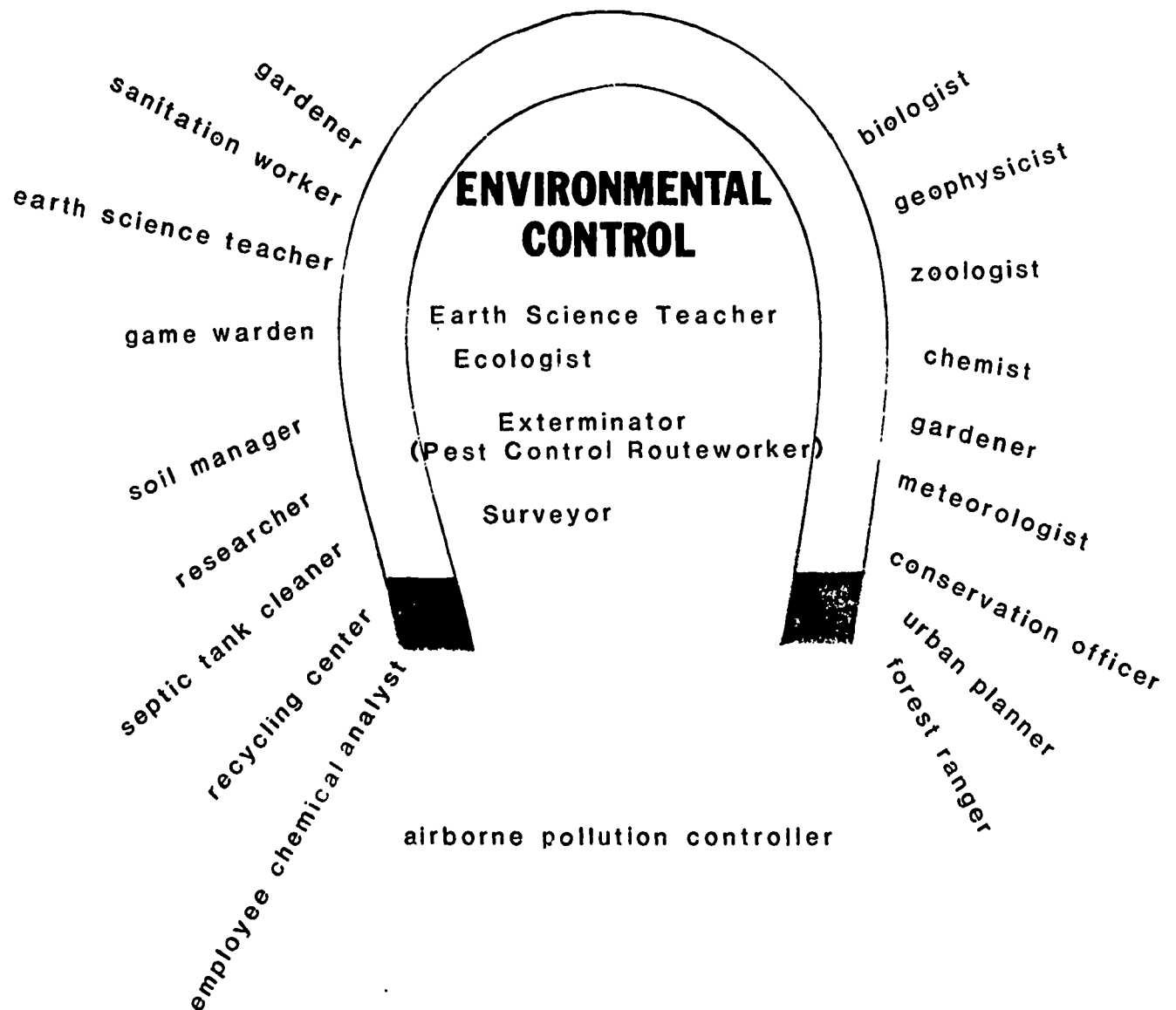

Workers from the Environmental Control cluster help to protect land, water, and air. They also encourage healthy physical relationships among all living things.

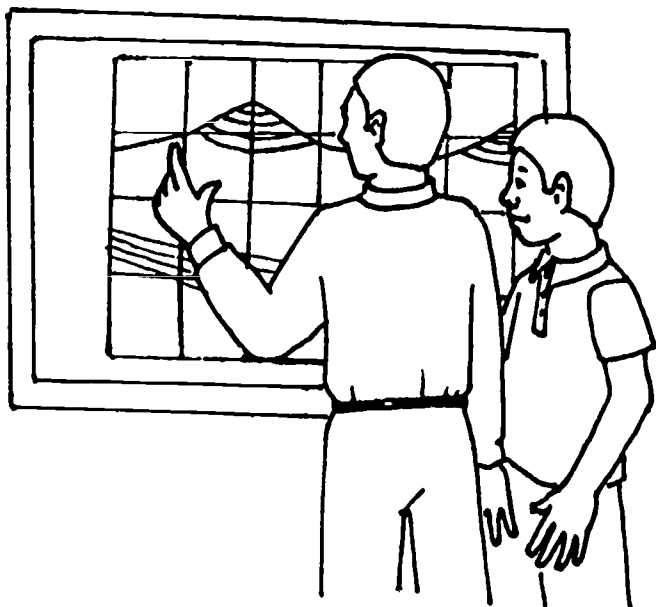

EARTH SCIENCE TEACHER

I teach earth science to five groups of students a day,
And the reward of seeing students learn is as important to me as the pay.
I help students learn about the structure of this earth,
Its place in the universe, and earth's history since its birth.
I teach respect for this planet's resources, a topic called "conservation,"
And I try to excite kids about the natural beauty abundant across the nation.
Some other topics I teach are "minerals," "astronomy," and "weather."
And since both "seasons" and "time" depend on the earth's movement,
I teach these two topics together.

When the school year begins, I plan lessons, and order the materials I'll use:
Films, mineral samples, and models of caves and mountains
Are some of the teaching tools I choose.
I describe each new topic, and I encourage questions, "Please ask."
Helping students understand what I'm teaching is a very important task.
I lecture. I draw diagrams and write words on the board.
And then I check each student's work so that no one is ignored.

I want students to do more than just listen to me, so I do more than just blab.
We go outside for earth and sky observation, and do experiments in the lab.
I introduce new words and ideas before I teach a lab subject.
And I give out supplies so students can practice using
Beakers, thermometers, bunsen burners, scales, and other scientific objects.

I make up lab experiments and tests, and then I grade them too.
And I put together groups of rocks for sample mineral kits.
I help students with special projects or problems after school.
I enjoy this, but discipline problems sometimes tax my wits.
When a student interrupts the class, acting like a clown,
I try to cool my temper, and calm the whole class down.

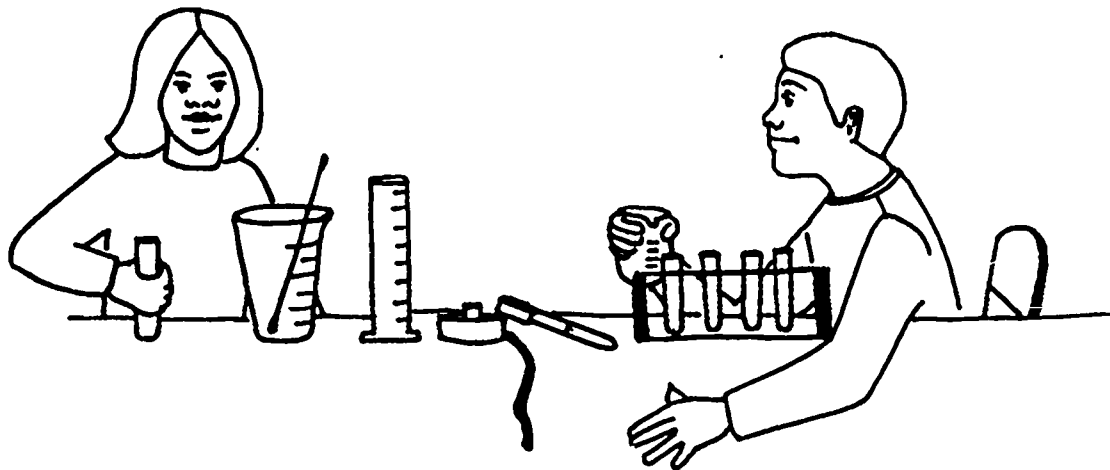

Many of my teaching skills are things I learned in school.
I use math for figuring proportions and equations, and I read a lot, as a rule:
Text books, lab instructions, maps and graphs of the sea and land.
My personality skills include patience, and flexibility with my plans.
It's important to be able to explain new ideas one step at a time,
And to know what each student is capable of.
Some kids need lots of special help; others work alone just fine.

My interest in earth science started for me when I was a child.
I was curious about the world around me, and I loved all things that grew wild.
But before I taught science, I was a mechanical engineer.
Then the fact that I wanted to work with people and the earth became very clear.
Though I had some college training, I'd never gotten a degree,
So I took science and education courses for years at night, you see.
Then, after teaching earth science for a few years, I went for my Masters degree.
Even though I've earned my M.S., education's an on-going thing with me.
During the long summer vacation that most teachers earn,
I take science courses in the field, my favorite place to learn.
The courses I take help me teach with enthusiasm.
It's easy to get excited about caves after a summer exploring underground chasms.



I work in the field, in classrooms, and in experimental labs.
Variety at work is one of the things that feels right
About this job of teaching science, which for me is prime.
Besides high school, earth science teachers can teach adult ed. courses at night,
Or with a Masters degree, at junior college, part time.
I can't imagine more fulfilling work than teaching, but...
Teaching jobs are hard to find now; school budgets are being cut.

The benefits at this job include hospital and dental insurance plans,
Sick time, and personal time, and chances to advance
To a school which pays better salaries, or is in a better location,
Or, if you're talented in management, maybe a job in administration.
But an advantage to this job which really helps me feel my worth
Is watching students get excited about studying the earth.

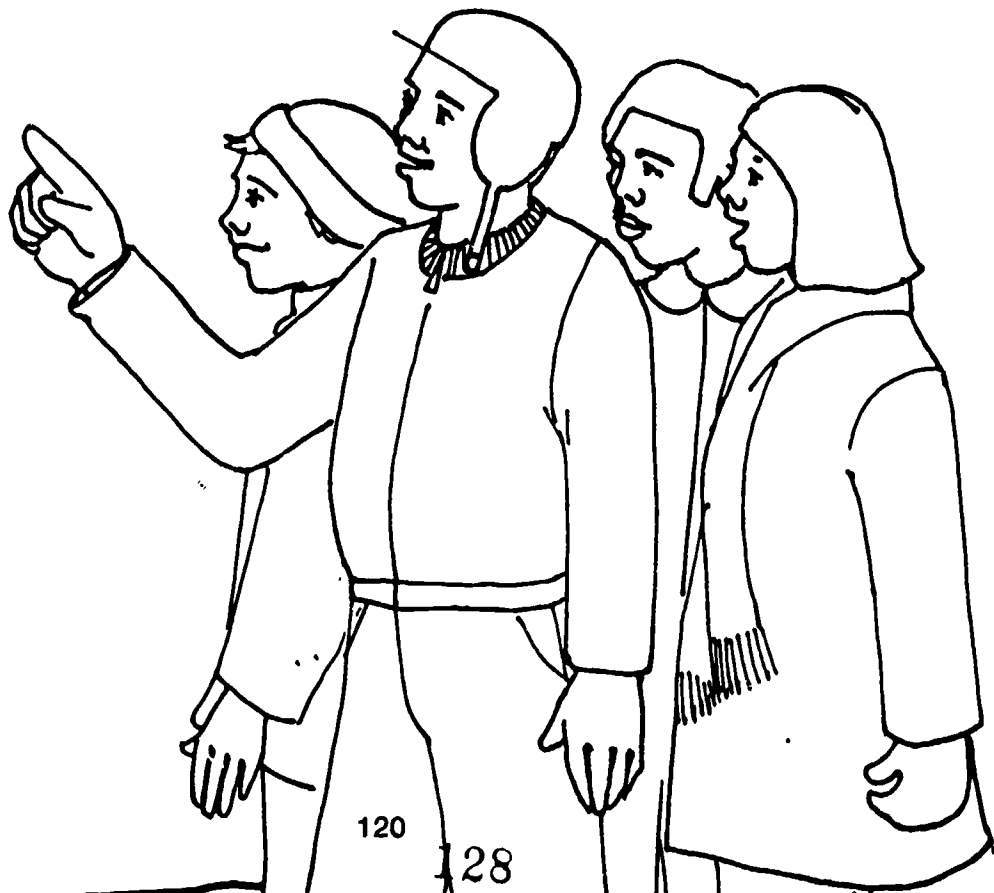



EARTH SCIENCE TEACHER:
TEST YOURSELF

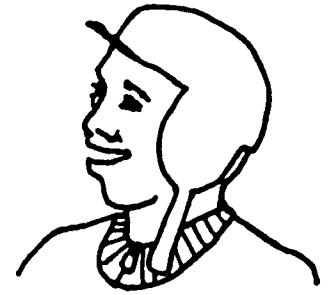

What are three on-the-job tasks of an earth science teacher?

Name four tools or pieces of equipment an earth science teacher might use on the job.

What kind of training will prepare someone to teach earth science?

Name three places where an earth science teacher works.

How do earth science teachers use reading and math skills on the job?

What other skills are important for success as an earth science teacher?

What's one possibility of advancement in the teaching field?

Name one benefit and one disadvantage that comes along with working in the teaching field.



ECOLOGIST

- Roy: Hello, Ms. Paz. I'm a reporter. My name is Roy Jones. You're the first ecologist I've met.
- Ms. Paz: Hello, Roy. Good to meet you.
- Roy: Is it true that ecologists fight pollution?
- Ms. Paz: Yes. I study living things, called the biosphere. I also study the non-living things that make up the environment of the biosphere. The environment includes weather, minerals, streams, marshes, forests, and other places where things live and grow.
- Roy: Who do you work for?
- Ms. Paz: I work for Dial Telephone Company. I help them find the best places to put underground cables.
- Roy: How do you do that?

Ms. Paz: I gather the facts I need to write an Environmental Impact Study. It takes months to find the facts I need. The study will tell about the effects of the underground cables on the living and non-living things in the environment. It will suggest the best way to lay the cable. We try to avoid damage to animal homes, tree roots, and streams. A stable environment is important.

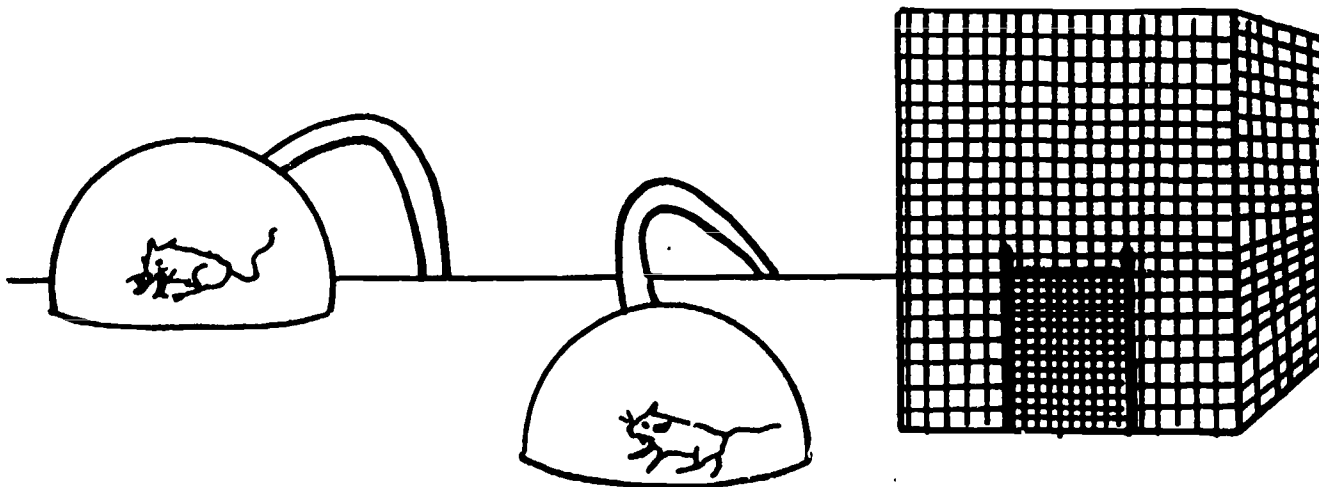

Roy: How do you find the facts for your study?

Ms. Paz: First I learn all I can about the geology of the area, the plant life, and the weather conditions in that area. Then, I use metal stakes to mark off the area I'm going to be studying. I use binoculars, a camera, a rain gauge, and other special equipment. Roy, this is Mr. Ross. He's working on an Environmental Impact Study, too. He'll find out how a nuclear power plant's cooling system will affect the fish in the bay.

Roy: What tools and equipment will you need for that, Mr. Ross?

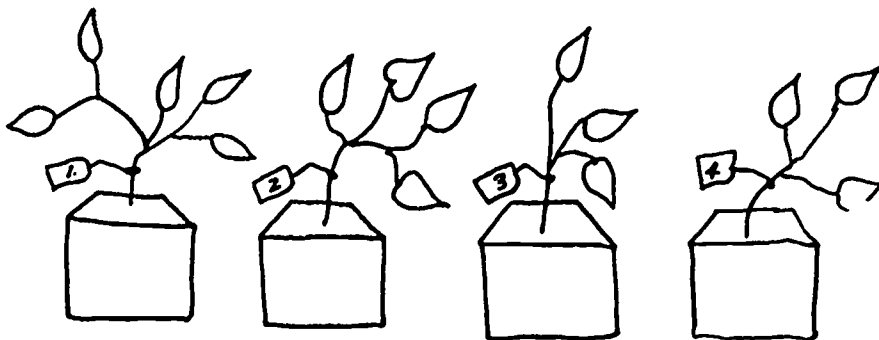

Mr. Ross: Well, right now I'm collecting plant and insect samples from the bay. I use plankton nets and sweep nets for this. I also use a seine net to crowd the fish together for doing a fish count. I use a Nansen bottle to collect water samples and a dredge scoop to collect samples of the bay floor. Sometimes I also need to measure the turbidity of the water. That means how far you can see through it.

Roy: Do you spend most of your time outdoors?

Mr. Ross: Yes, but there is office work to do, too. I need to look up information about laws and to identify plants, fish, and insects. In the laboratory, I do tests on the samples I collect in the field. Would you like to see my office? It's right next door.

Roy: Yes!

Mr. Ross: This is where I keep my maps and charts, and here's my library of plant and animal species key books. I also keep my tools here.



Roy: Do you use all these tools?

Mr. Ross: Yes. In the field I carry binoculars, a camera, tape measure, calipers, and a light meter. Sometimes I use a rain gauge to measure the amount of rainfall in a particular area.

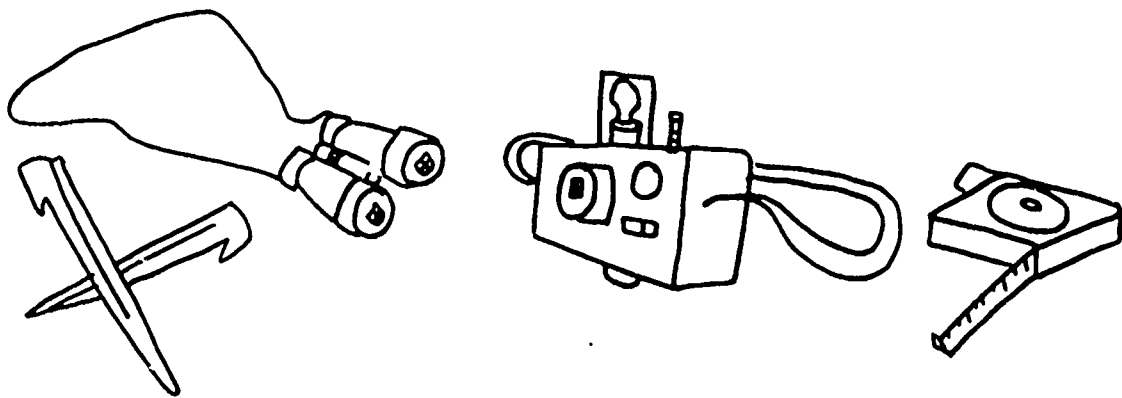

Roy: What's this?

Mr. Ross: That's an increment corer. It can tell the age of a tree.

Roy: Where else do ecologists work, Ms. Paz?

Ms. Paz: Plant nurseries, history museums, zoos, and aquariums are some other places. Some do all their work in toxicology labs. They measure the effect of toxins, or poisons, on living things. Ecologists can also work in colleges.

Mr. Ross: Sometimes, we get called by people who want to build shopping centers, hotels, or factories. They ask us to find the best place to build.

Roy: It sounds like you enjoy your work. How do you become an ecologist?

Ms. Paz: High school science is important. Those courses can teach you how to use laboratory equipment and to do experiments using the scientific approach. That's an orderly way to arrange observations and make hypotheses. It takes about six years of college study, too. That's how long it takes to earn a Master's degree.

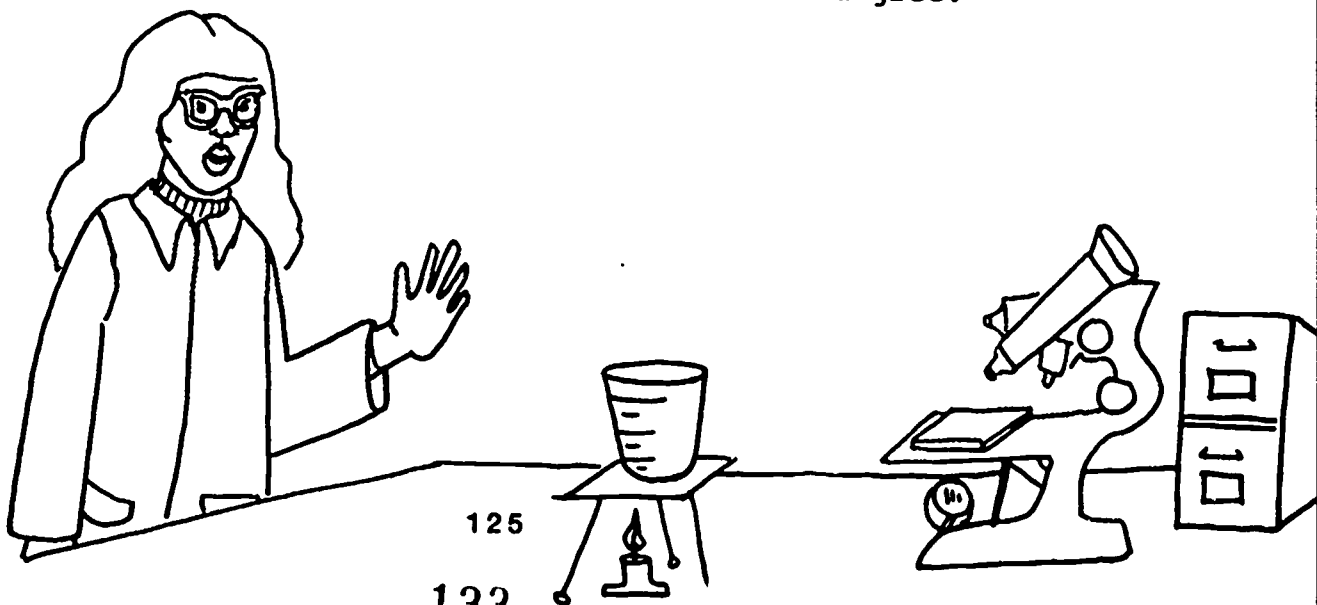

Roy: That sounds like a lot of work. How much money do you make?

Ms. Paz: Most ecologists earn between thirteen and sixteen thousand dollars a year.

Roy: Can you ever earn more?

Ms. Paz: Well, if I studied more and earned a Ph.D. I could. I might also be able to supervise other scientists in research projects, or I could teach at a college. But for now, I'm content with my work in the office, field, and lab. I really enjoy studying nature.

Roy: Are there any disadvantages?

Ms. Paz: Not many. Most days I work 9 to 5. Sometimes if I'm involved in a lab project, I have to work late to finish. In the field, I sometimes stay overnight for special projects. But I love my work, so I don't mind.

Roy: Thank you for the interview, Ms. Paz. I learned a lot.

Ms. Paz: Thank you, Roy. I've enjoyed telling you about my work. Good Luck!

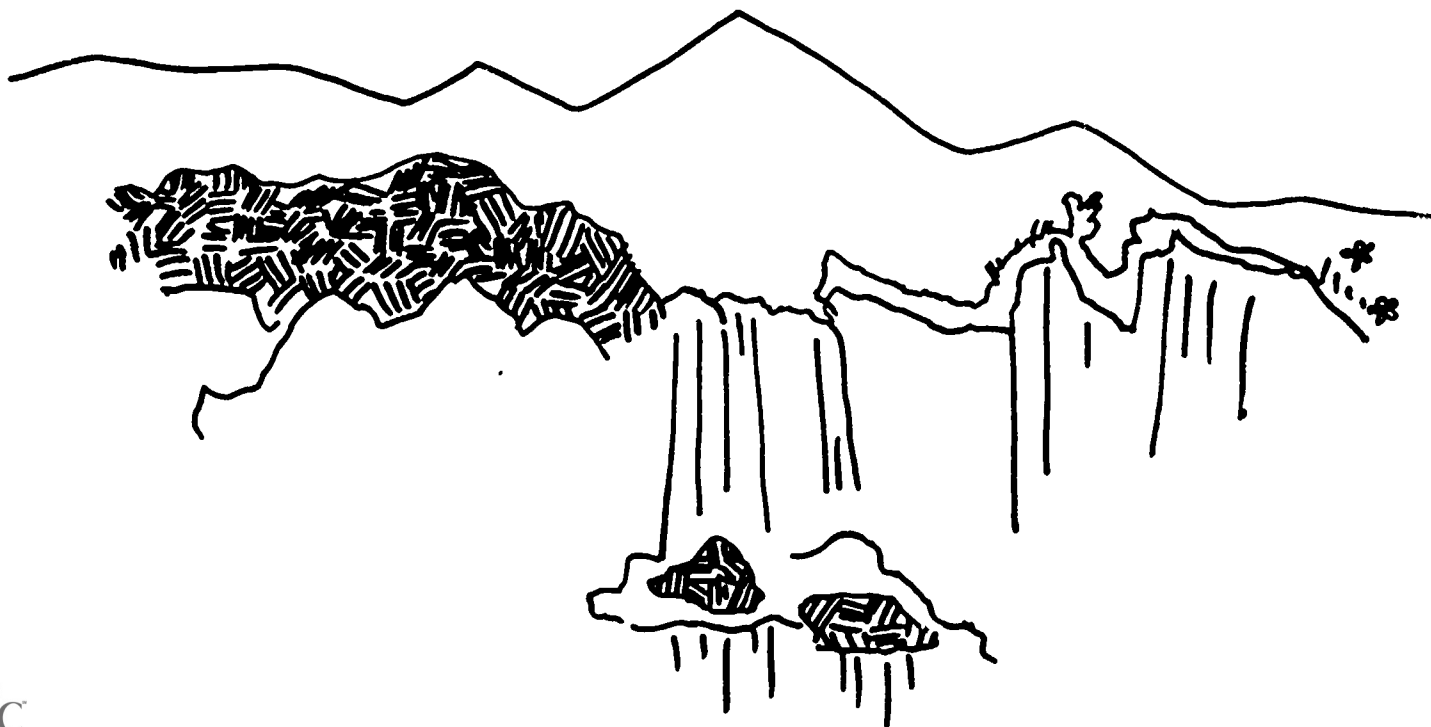



QUIZ YOURSELF:

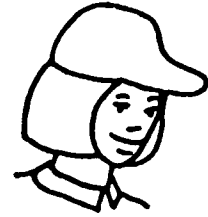

Ecologist

Below are some questions about the skills and tasks, tools and equipment, training places, and the work places of an ecologist. If there are any questions you cannot answer, reread the interview and go back over these quiz questions until you can answer all the questions.

Name three tools or pieces of equipment used by an ECOLOGIST.

What is one use for each tool or piece of equipment you have listed?

Name one training place for an ECOLOGIST.

Name three skills and/or tasks of an ECOLOGIST on the job.

Name one place where you might find an ECOLOGIST at work.



EXTERMINATOR or
PEST CONTROL ROUTEWORKER

My job is to free all kinds of places from pests.
I send termites, rats, fleas, and roaches to their final rest.
I tell folks how to correct the conditions that attract
The guilty rodents or bugs. I make life awful for rats.
Sometimes it means eliminating wetness, rot or cold.
I point out to people that they should paint wood that is old.
I build ditches around buildings where the poisons can go.
This kills the pests or keeps them from their food supply, you know.

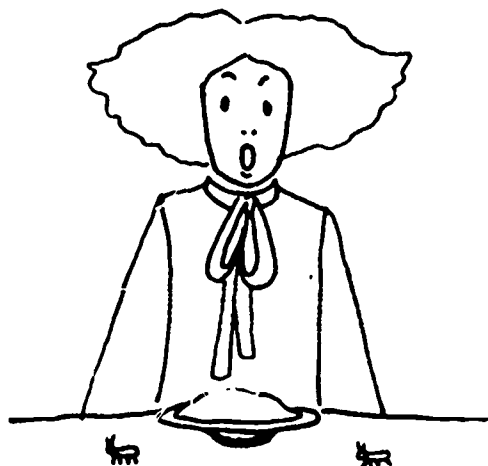

The skill that's most important at my job, you see
Is reading directions and following accurately.
These chemicals are very strong and if measured or mixed wrong,
They might kill much more than rats.
They could bore right through your hats
And your rubber welcome mats.
So each label is my instruction chart.
I read it twice before I start.

I wear a respirator, a type of safety mask
Before spraying or dusting powder or fogging with gas.
I must check to see if chemicals are safe where I spray...
Some types of pets, the foods you eat, must not be in the way.
There are two kinds of sprayers, a large, and a small portable.
A special pump builds pressure, and the nozzles make 'em squirtable.
I use dusting bulbs for powder, poison bait, and sticky traps.
The fogger's called a Microjen. A choice of methods I never lack.

A vehicle's important to carry my tools.
Sometimes I make six stops a day, but in restaurants or schools,
I may need to do my work at night when nobody is there.
The idea of bugs in eating places might give folks a scare.

You need a license for this type of work, must take a special test.
Reading and experience will help you do your best.
I find carpentry courses helpful, and general construction.
I recognize many types of wood, and mix concrete, need no instructions.
In high school, here's a chance to learn chemistry and math
For mixing things in good proportion, to give a bug its final bath.

We kill rats, roaches, termites, carpenter ants and fleas.
By killing rodents and their parasites, we cut down on disease.
Don't let carpenter ants or termites eat your homes for long.
I can help most everyone to keep their buildings strong.

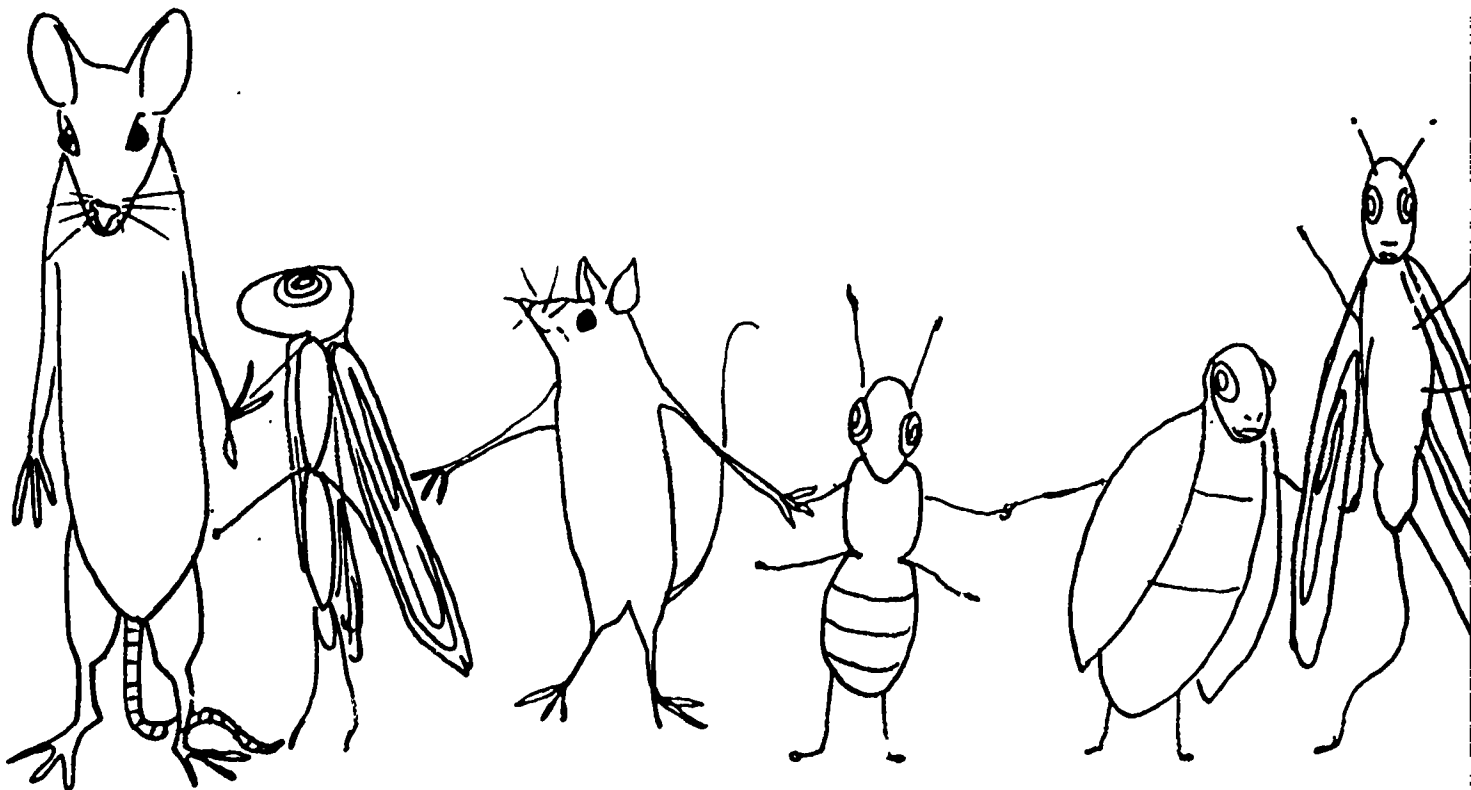

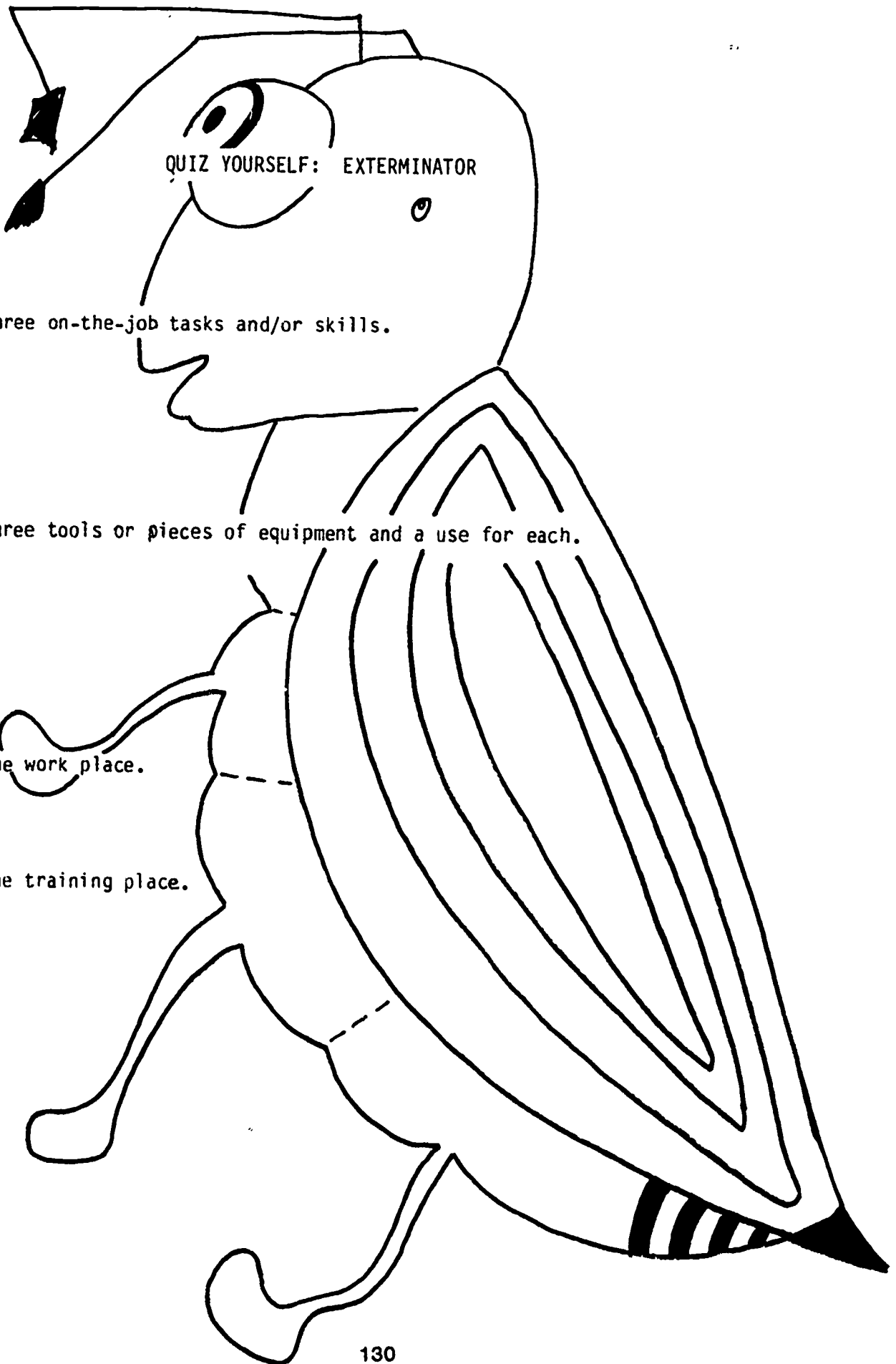

QUIZ YOURSELF: EXTERMINATOR

Name three on-the-job tasks and/or skills.

Name three tools or pieces of equipment and a use for each.

Name one work place.

Name one training place.

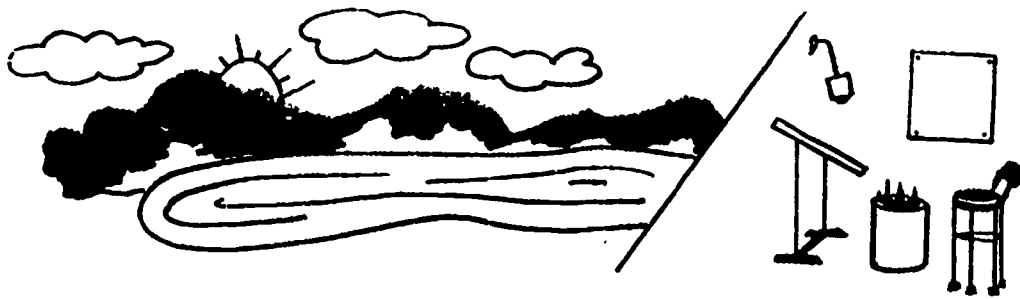

SURVEYOR: THE LAY OF THE LAND

My name is Bob, and I'm a surveyor. I use math skills in my job to calculate land areas, and measure elevations and contours. A good surveyor must be precise in measuring and drawing maps. I draw maps in my office.

I work outdoors to measure land and determine land borders. Part of my job is to take legal measurements for land sales. I also help when there is a problem over land boundaries in a will. Hence, my work helps solve some legal problems. My job begins before a contractor starts to build. I lay out foundations at building sites. My work also helps cartographers.

In high school, I wanted a summer job outdoors, so I got a job with a team of surveyors. I started by clearing brush. I also set markers, called range poles, in the ground. I liked working with a crew. One day the crew boss, Al, spoke to me about the land contours. He also showed me what drumlines, gullies, and anticlines are.

I really liked the idea of being a surveyor. I took a drafting course and all the math I could in high school. I decided to get an engineering degree in the field of surveying. It was four years of hard work, but I did it. My partner, Sue, is a good surveyor. She took a two year vocational program in surveying at a community college. Sue and I work steadily to keep qualified and well educated. We go to special meetings at least twice a year to keep up with the latest methods and equipment. And we read magazines devoted to finding out new developments about surveying here and abroad.

Surveyors measure short distances with chains or steel tapes. For longer distances, we use trigonometry. On very large jobs we use a special prism that sits on a tripod holder attached to a computer. A plumb bob is set up at the end of the distance to be measured. The plumb bob has a pointed tip and points to a precise spot. Light passes through the prism and a computer measures the length of time it takes (thousandths of a second) for the light to reach the tip of the plumb bob. That's how we measure long distances. Amazing, huh?

We measure angles with a tool called a theodolite (accent on od) with a kind of transit. Of course we use maps as well. In the office we use pads, pencils, and rulers as well as light tables and compasses.

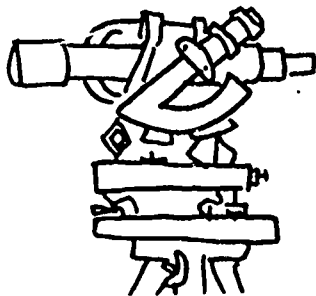

A TRANSIT THEODOLITE

Rocky land can be hard for a surveyor to work on. Some types of plant and animal life, like poison ivy and poisonous snakes, can be a hazard. But for me, work as a surveyor is great and I'm glad I stuck with it. I find it varied and challenging. Surveyors are hired by many different individuals and companies. With my skills, even as a one-man company, I'll almost always have work, and interesting jobs, too. By keeping in touch with new developments, I can advance in my field. When the amount of work requires that I hire others to help, I'm particularly happy because we work together to do a job right, therefore, we enjoy what we do!

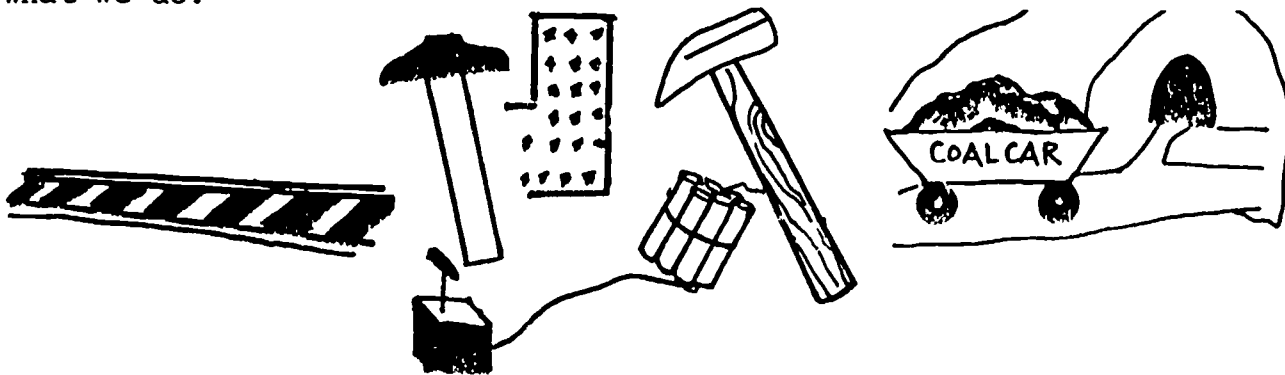

QUIZ YOURSELF:

SURVEYOR

Name three of my tools or pieces of equipment, and one use for each.

Name one of my training places.

What are three of my on-the-job tasks or skills?

Name one of my work places.

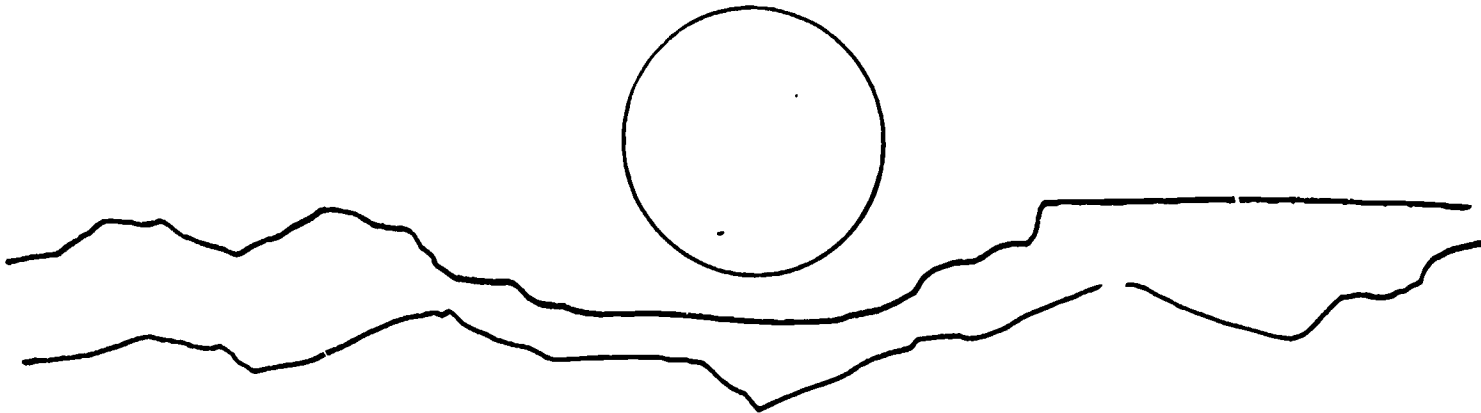

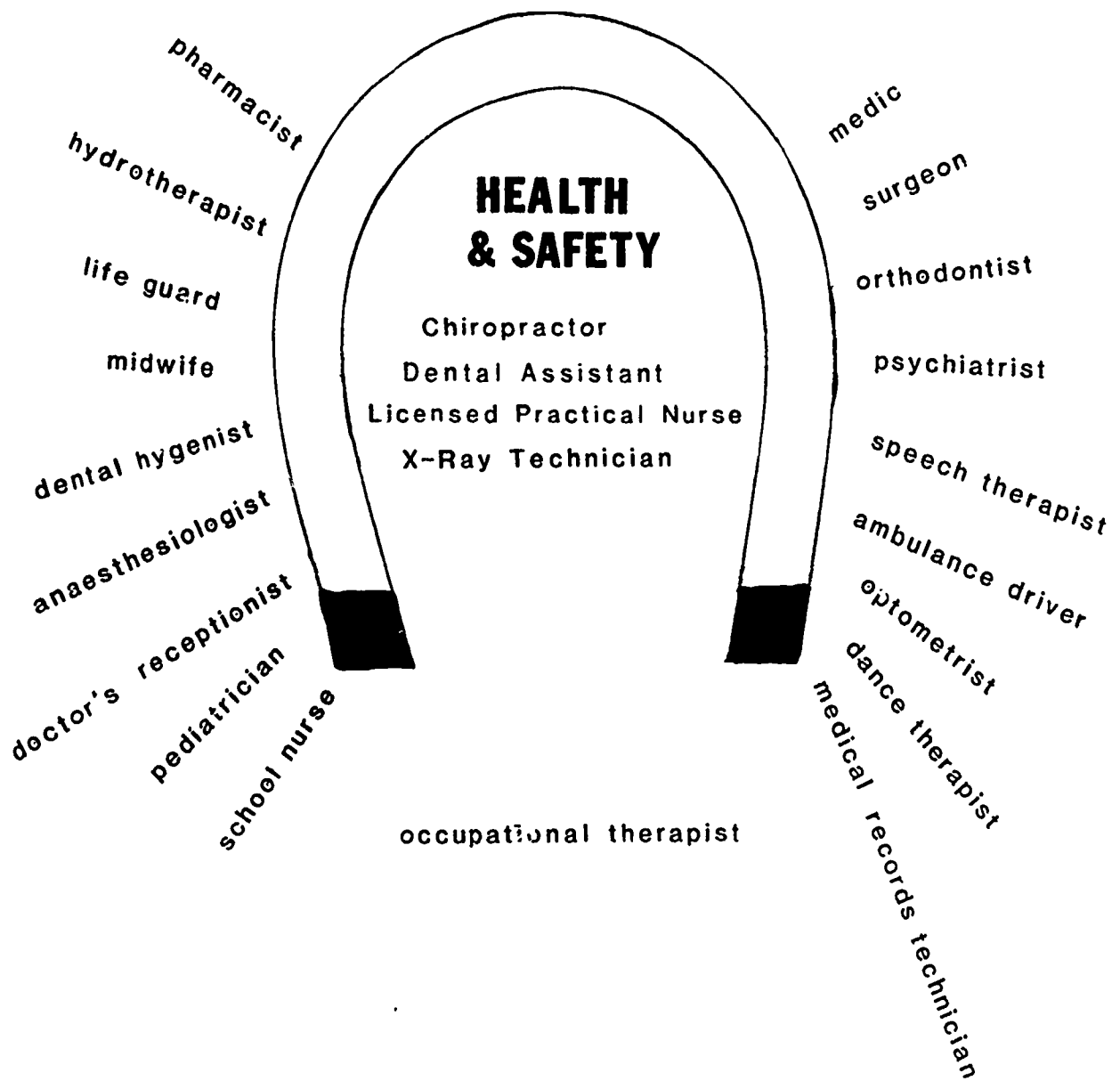

Workers from the Health and Safety cluster help care for and repair the human body and mind. Some workers care for animals, too.

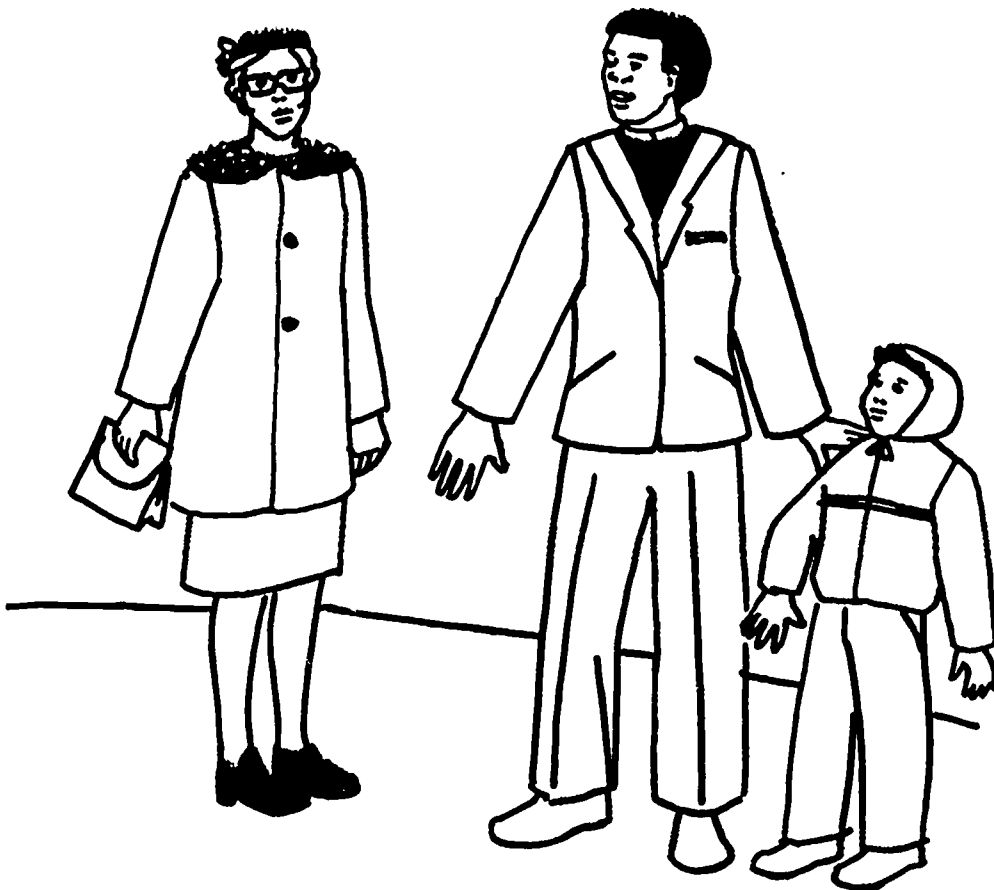

CHIROPRACTOR

An Interview with Doctor Jim Bollin

Nancy: Good morning, Dr. Bollin. I'm Nancy Dole from the High School. I'm glad to be here.

Doctor: I understand you want to learn about health careers, right?

Nancy: Yes, I want to know exactly what a chiropractor does.

Doctor: Well, I treat patients with all sorts of health problems by manipulating body parts, particularly the spinal column, or back bone. Adjustments can correct problems like poor circulation or pinched nerves. Many problems are caused by these two conditions alone!

Nancy: How did you become a chiropractor?

Doctor: That's a long story, Nancy. First I finished high school and went into the ministry. That took several years of college. When I was done, I became an assistant in a big city church. After five or six years I became more aware of the physical ills that people suffer. It was then that I realized that I wanted to help eliminate this suffering. It would be a different kind of ministry for me. I had a friend who was a chiropractor, and I knew a little about the work that she did. I was especially interested because no drugs are used. Aligning people's bodies so that they function at their best seemed to be a very natural way of healing. The only prescriptions chiropractors make are for rest, exercise, corrective supports, and diet changes.

Nancy: You must have gone to a special school then.

Doctor: Yes. I went to a four-year chiropractic college. There I learned a lot of the same things that doctors learn at medical school.



Nancy: Do you treat your patients the same way doctors do?

Doctor: Well, first my nurse writes down some personal data such as the patient's health history. We need this for our personal records. Then the patient and I discuss the problem that is bothering him or her. I can then begin an examination and manipulation of body parts which are out of place. Sometimes I need to "see" the patient's bones. If this is necessary, I send the person to the hospital for X-rays. Often, I need to see the person again. You see, muscles get used to holding the spine a certain way. But after the first few adjustments, a patient might not have to return for months.

Nancy: Dr. Bollin, what pieces of equipment do you use?

Doctor: My hands are most important. I use them to make all kinds of adjustments on patients. The adjustable table is also very important. Patients must lie on it. Because it moves, I can work on my patients at many angles. I also use a stethoscope to check hearts. I use an otoscope to check ears. Sometimes I use an ophthalmoscope to check eyes. I also use a precision hammer to check reflexes. In special cases I may use ultrasound or traction. Most of my tools are simple things that people can use at home, like hot packs or cold packs, steam, or a muscle massager. Also, braces for the spine or neck may help a person hold an adjustment and stop muscles from falling back into old habits.

Nancy: That's interesting. I see you have a nice private office. You keep evening hours, too.

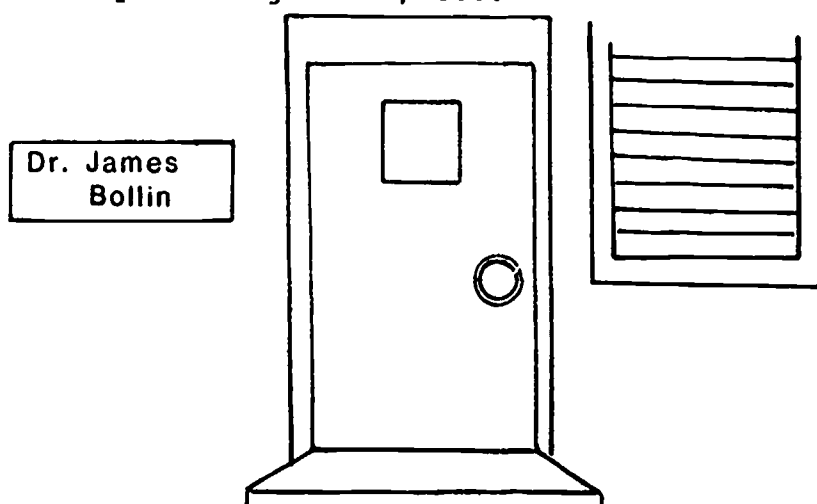

Doctor: Yes. I want to be sure working people won't have to take time off to be treated. I make my own hours here, and I like that. Some chiropractors work at clinics or industrial firms. These doctors have less freedom. They must set hours according to the establishment that they work for.

Nancy: I guess there are lots of things you like about this job.

Doctor: You're right. I like working on my own as a responsible person. Working conditions are very good. The office is clean and my assistants are friendly. I like using my hands to help people get well. Sometimes so many patients want to come to me that I have to be careful not to overwork myself.

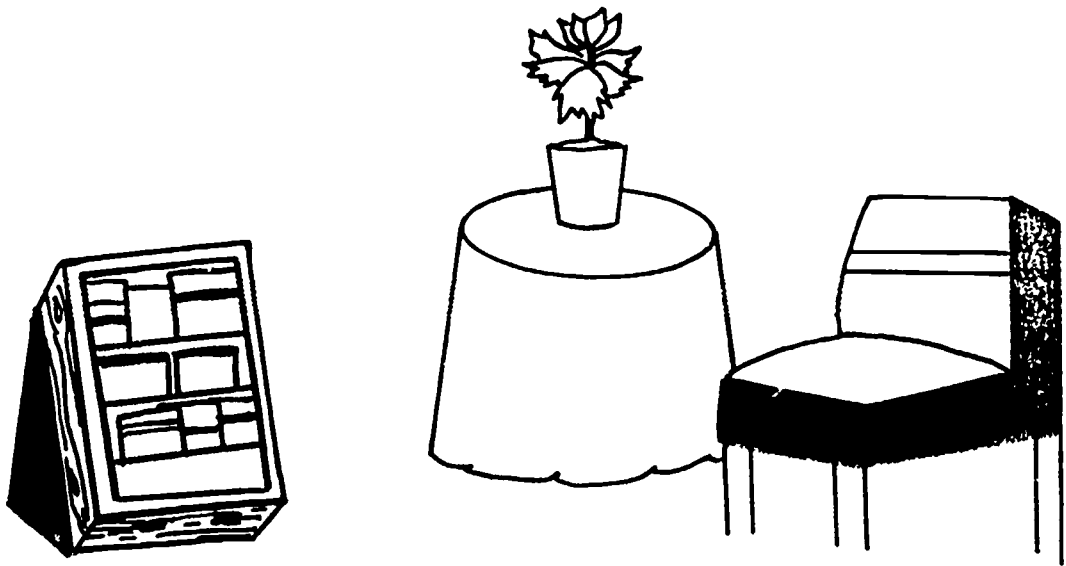

Nancy: Can you be promoted?

Doctor: I'm comfortable with the amount of money I earn. I support only myself because I'm single. My patients pay me according to what they can afford. I don't want to change this. If I do want to earn more, I can. I may study accupuncture, a Chinese method of healing without drugs. I could also study special massage techniques. In some states chiropractors are required to learn new skills each year in order to keep up with new practices.

Nancy: Thanks a lot, Doctor! Now I have a good idea of what you do. In fact, next time my mother gets a migraine headache, I'll tell her to come and see you!

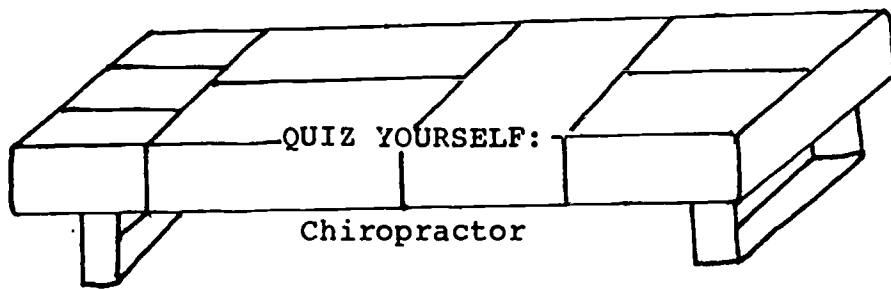

Below are some questions about the skills and tasks, tools and equipment, training and work places of a chiropractor. If there are any questions you cannot answer, reread the interview and go back over the quiz until you can answer all the questions correctly.

Name three tools or pieces of equipment used by a CHIROPRACTOR.

What is one use for each tool or piece of equipment you have listed?

Name one training place for a CHIROPRACTOR.

Name three skills and/or tasks of a CHIROPRACTOR on the job.

Name one place where you might find a CHIROPRACTOR at work.

Dental Assistant

Skills and Tasks

Prepares room for dental work:

- Cleans and sterilizes instruments for patients;
- Prepares materials for making impressions and restorations;
- Makes casts of teeth and mouth from impressions taken by dentist;
- Exposes X-rays and processes dental X-ray film.

Prepares patients for treatment:

- Makes patients comfortable in dental chair;
- Applies medicine to teeth and oral tissues;
- Removes excess cement used in filling process from surfaces of teeth;
- Places rubber dams on teeth to isolate them for individual treatment;
- Provides oral health instruction.

Helps dentist at the dental chair in treating patients:

- Sets up and hands dentist the proper instruments and materials;
- Keeps patient's mouth clear by using suction, rubber dams, and other devices;
- Writes clinical findings, as dictated by dentist, on patient's chart or record.

Uses reading and math skills to perform duties of receptionist and business secretary:

- Checks mail, types letters, answers telephone and makes appointments;
- Files treatment records, retrieves records for each appointment;
- Sends bills, receives payments, makes bank deposits;
- Orders dental supplies and materials;

Keeps office neat, straightens magazines, waters plants.



Tools and Equipment

X-ray machine, x-ray film, lead aprons.
Rubber dams, bibs, syringes, stool.
Patient's chart, telephone, appointment
book, insurance papers, financial records.
Slides, filmstrips (to show detailed health
care to patients), dental floss, toothbrush.

Work Places and Conditions

Private dental offices, dental schools,
hospital dental departments, state and
local public health departments,
private clinics, Public Health Service,
Veterans Administration, and
Armed Forces.

Training

Helpful high school courses:
biology, chemistry, health,
typing, bookkeeping.

One- and two-year programs
at junior and community colleges,
vocational and technical schools.

On-the-job.

Advancement

Experience and/or further training
may lead to employment as a dental
technician or hygienist.

The American Dental Association (ADA)
has accredited correspondence course
that takes two years to complete and
is equivalent to one year of
academic study.

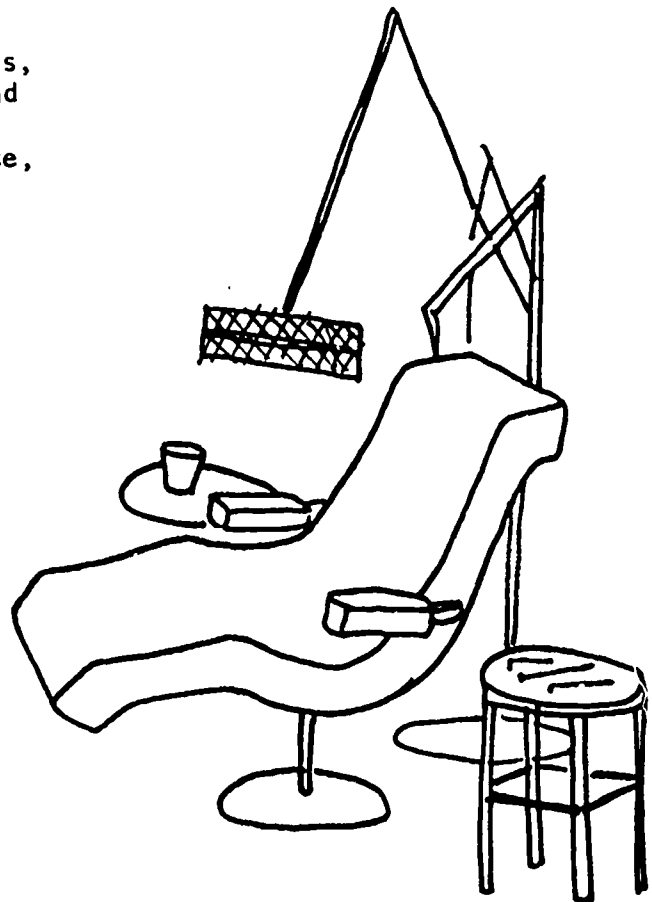

QUIZ YOURSELF: Dental Assistant

Answer the questions below. Reread the story to find answers you do not know.

Name 3 of my tools or pieces of equipment and one use for each.

Name one of my training places.

What are 3 of my on-the-job skills or tasks?

Name one of my work places.

LPN: Licensed Practical Nurse

My name is Paul Bey. I'm an LPN or Licensed Practical Nurse at the Olive County Hospital. I work with doctors and registered nurses to take care of sick or injured people called patients.

I do a lot of things at my job. I comfort patients when they are uneasy. I help change bandages, shave skin areas in preparation for surgery, give enemas, change bed linens, and help patients with their personal hygiene. Personal hygiene means bathing, brushing teeth, and combing hair. When patients are sick, they often need me to do these things for them. In some hospitals I give the medicine ordered by the doctors.

I work closely with other hospital staff. All staff must know how each patient is feeling and what is being done for the patient. Mostly we keep in touch by reading records or charts about each patient. Records and charts must be accurate and up-to-date. Then each shift can read the charts to find out what was done before and what is to be done next. Then before the next shift, all new information must be written on the charts.

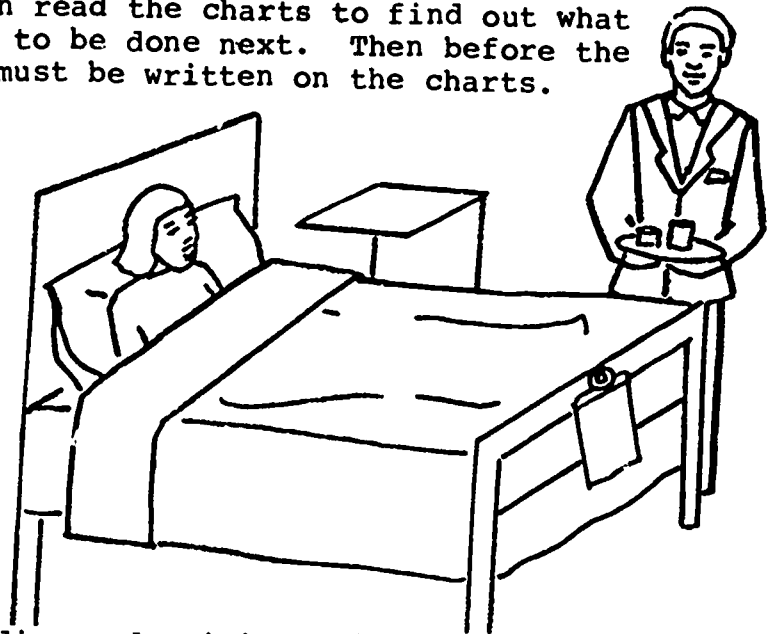

An LPN must have good reading and writing skills, for the charts tell what has been done to and for the patients and what needs to be done. Charts tell daily temperature and blood pressure. A thermometer shows the patient's temperature. Blood pressure is measured by a special instrument (tool) called sphyg-mo-ma-nom-e-ter. In addition to data, all care given the patients is reported on the charts. This includes changed bandages, removed stitches, bowel movements in certain cases, medicines taken, and pain complaints. We check eyes with an otoscope, heart beats with a stethoscope, a watch to time pulse beats. You can see that math skills are important on my job. I need to be able to count, measure, read instruments, and tell time accurately.

Some responsibilities are not recorded on the chart. Unless important in treatment, I do not record when I give bed pans or change bed sheets or when I put lamb's wool pads under patients. These lamb's wool pads help stop bedsores on patients who must spend all their time in bed.

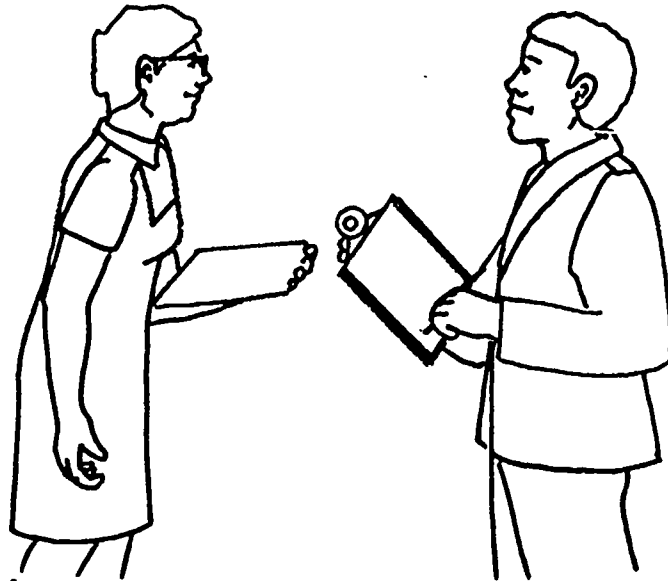

I rub backs and thereby massage sore muscles. This helps improve blood circulation. This is important for patients who are bedridden. Many times a warm smile and a friendly "hello" go far to cheer patients up.

After I got my high school diploma, I wanted to be a nurse. I became an LPN by taking an 18-month course here at the hospital. When the course was over, I had to pass a state test to get my license. I applied for work at health clinics, sanitariums, nursing homes, doctors' offices and at this hospital. I had three openings offered me but I decided I really wanted to work here because I like to take care of others and this staff really cares about its patients.

Now I would like a more responsible position. I start night courses next week at the Olive Community College. The courses are for the RN degree. RN stands for Registered Nurse. I had to make special plans with the hospital to release me from night shift duty for the two years the courses will take. When I become an RN I will have more responsibilities for the total patient care. Some things will stay the same. I will still have to work some weekends and nights which many consider a disadvantage. However, I will still enjoy helping and caring for sick or injured patients.

QUIZ YOURSELF:

LPN

Name three of my tools or pieces of equipment and one use for each.

Name one of my training places.

What are three of my on-the-job tasks or skills?

Name one of my work places.



X-RAY TECHNICIAN

I help doctors take X-ray pictures of internal body parts,
Being dense, bones are easiest to see.
Drinking a dense barium solution helps digestive organs show,
As it coats each part, glub, glub, down and out it must go.
A fluoroscopic screen is used when we take shots of organs.
This screen is where shadows are cast.
As barium traces the digestive tract,
We find reasons why some food isn't passed.

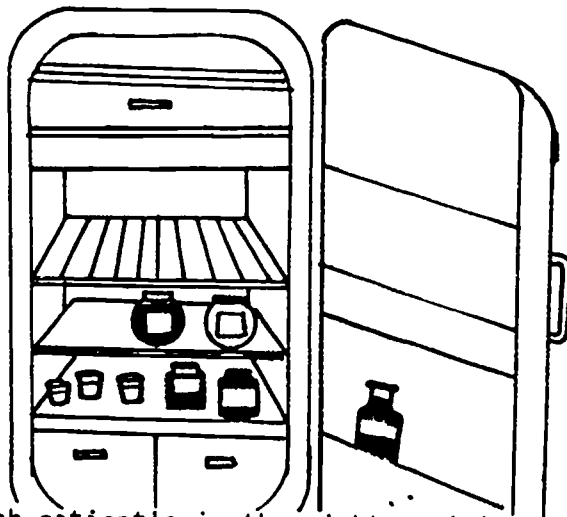

It's important that each patient's in the right position,
So I use a moving table with devices to restrain.
It's also my job to make folks feel safe,
So I make sure that they're comfy and I'm ready to explain.
An X-ray technician works in medical offices, labs, clinics, hospitals, and
schools,
Always under supervision of a doctor or a dentist,
With radiation, it's important that we follow safety rules.
In order to protect folks from extra radiation,
We use lead gloves, aprons, and gonadal protection.
Patients wear special white sheets or gowns.
Some X-ray machines are massive.
You've got to be strong to push them around,
But patients can't move, they must be passive.

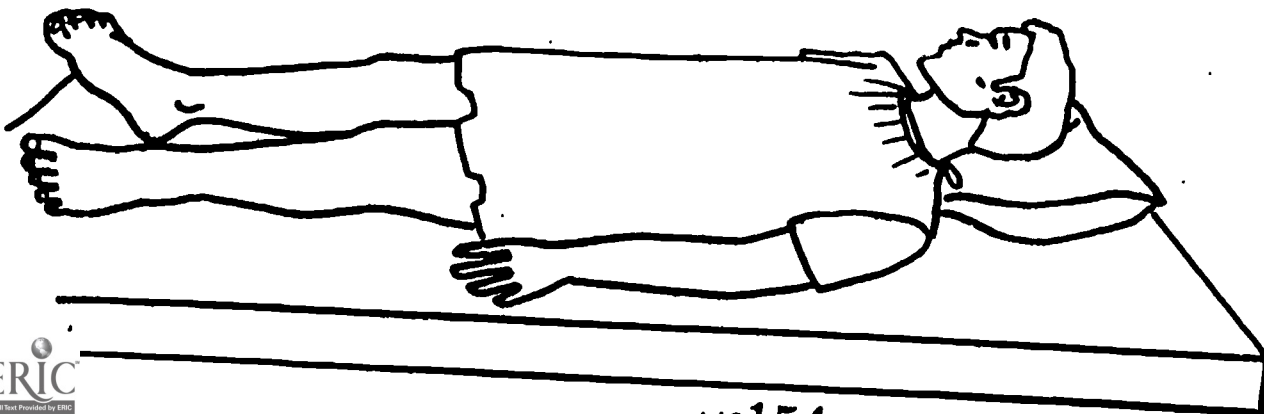

There are special machines which do "body sections,"
Taking body pictures layer by layer.
Tomography is the name of this process.
When I use these machines, I must work with care.

High school courses that have helped are science, math, and typing.
I'm glad I took them now, though then, I did a lot of griping.
They helped me get through Tech in two years, instead of three,
We learned all about equipment, and X-ray therapy.
I took courses at a college, but there are med school clinics, too,
And military service schools might be the route for you.
If I want to advance, I can take courses at my leisure,
To be a specialist or instructor in a special procedure.
If I want to be in charge of those who do what I do now,
I'll earn chief technologist's title by the sweat of my brow.

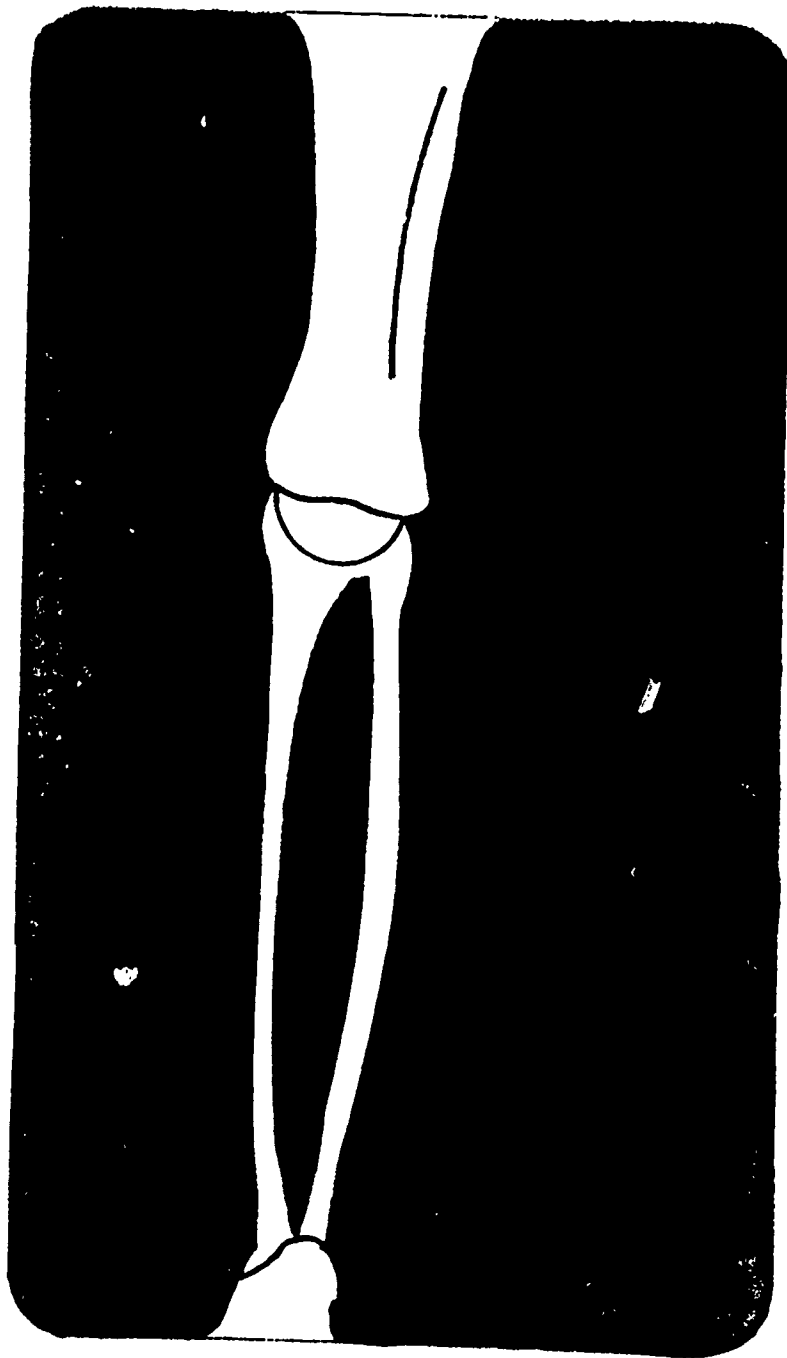

QUIZ YOURSELF: X-RAY TECHNICIAN

Name three on-the-job skills and tasks.

Name three tools or pieces of equipment and one use for each.

What is one training place?

What is one work place?

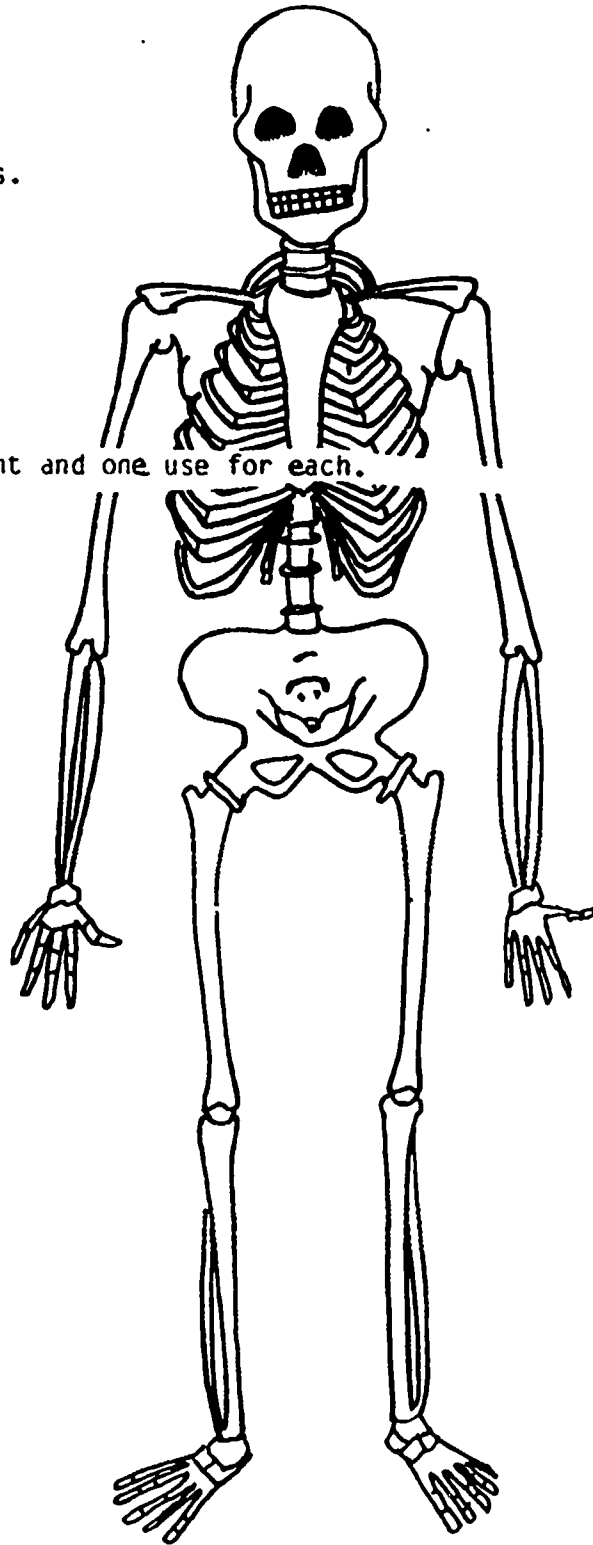

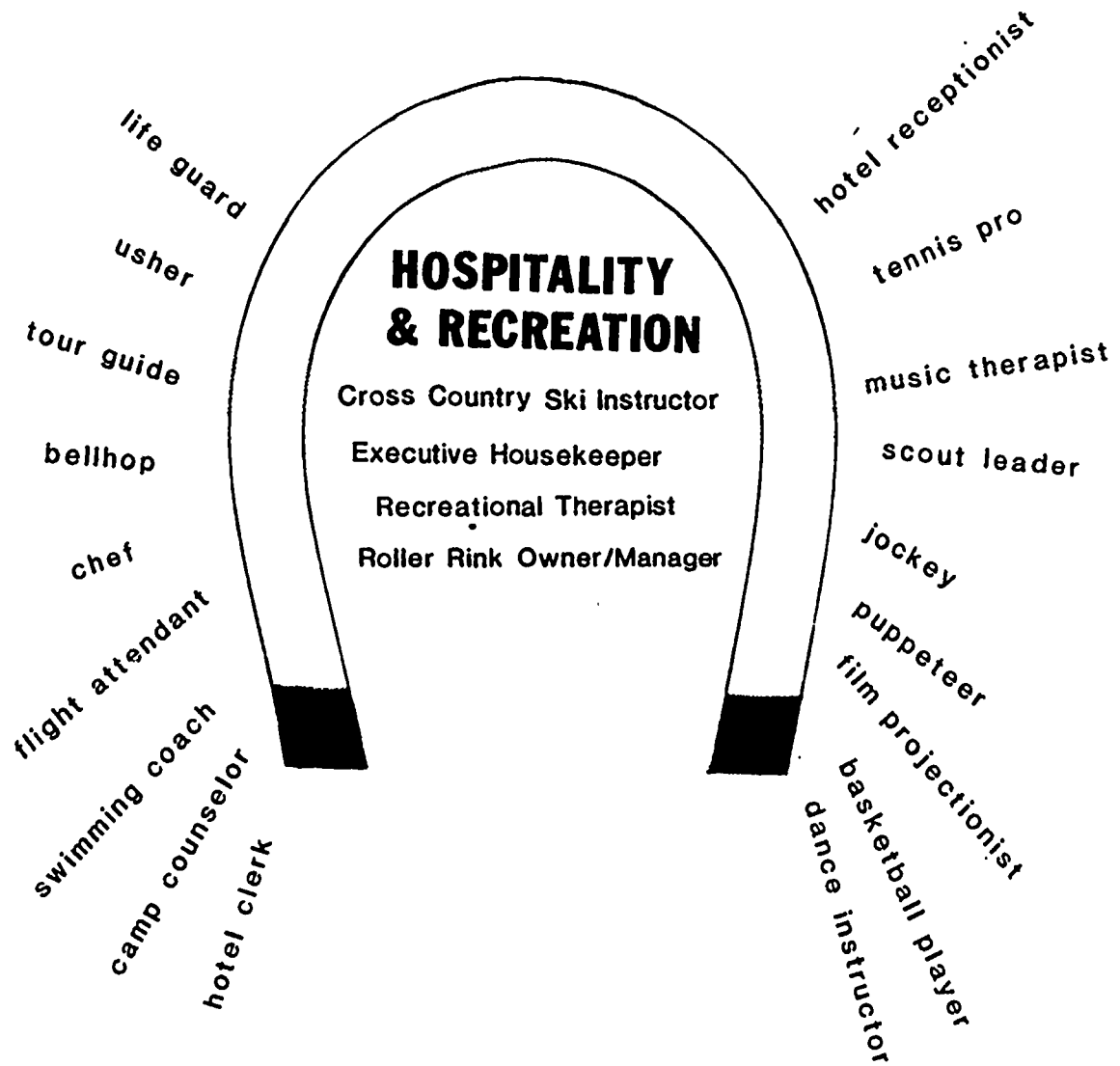

Workers from the Hospitality and Recreation cluster improve the quality of people's leisure time, or spare time, activities. Their work often involves sports, resorts, hobbies, or amusements.

Nieves at Work: A Cross-Country Ski Adventure

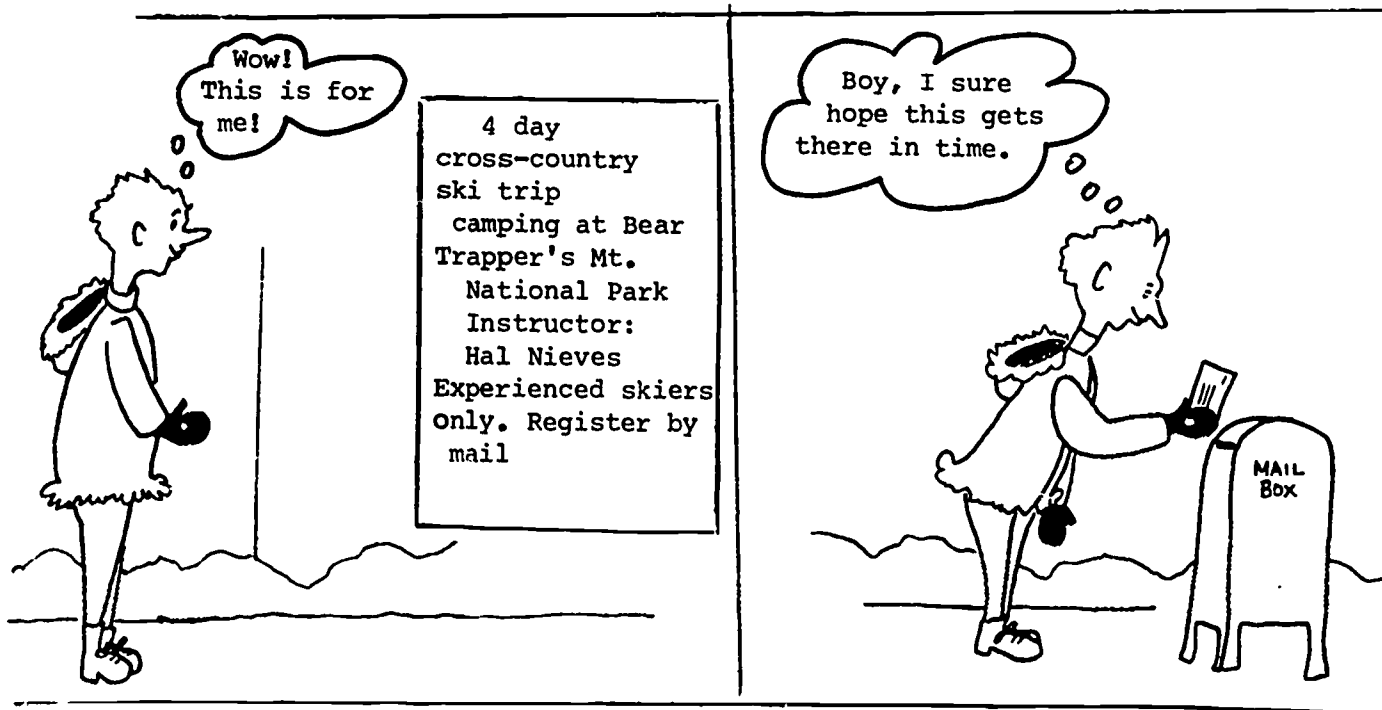
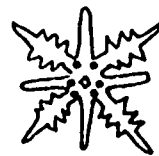

6 days later, Herman gets a list of tools and equipment he'll need on the trip.

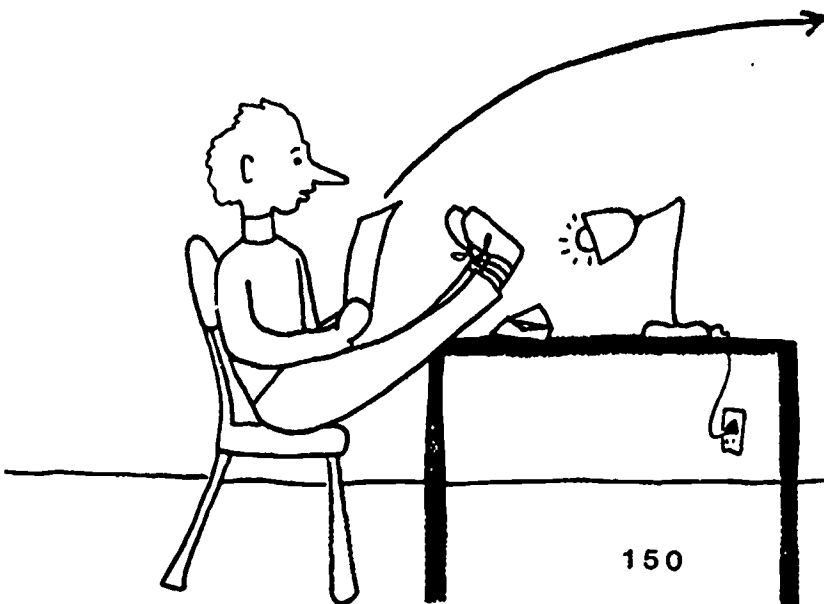

- Bring with you:
1. warm clothes
 2. skis, boots, and poles
 3. food for four days
 4. camping gear
 5. waxes and klisters if needed
- We Supply:
1. transportation
 2. tents
 3. maps of region
 4. first aid supplies

150

How are the ski conditions at Bear Trapper's Mountain?

Fantastic! There are 7 inches of crisp, powdery snow. Our course covers a mixed terrain of flat, sloped, and mountainous trails.

How much snow is required for cross-country skiing?

You need a minimum of 2 inches of snow.

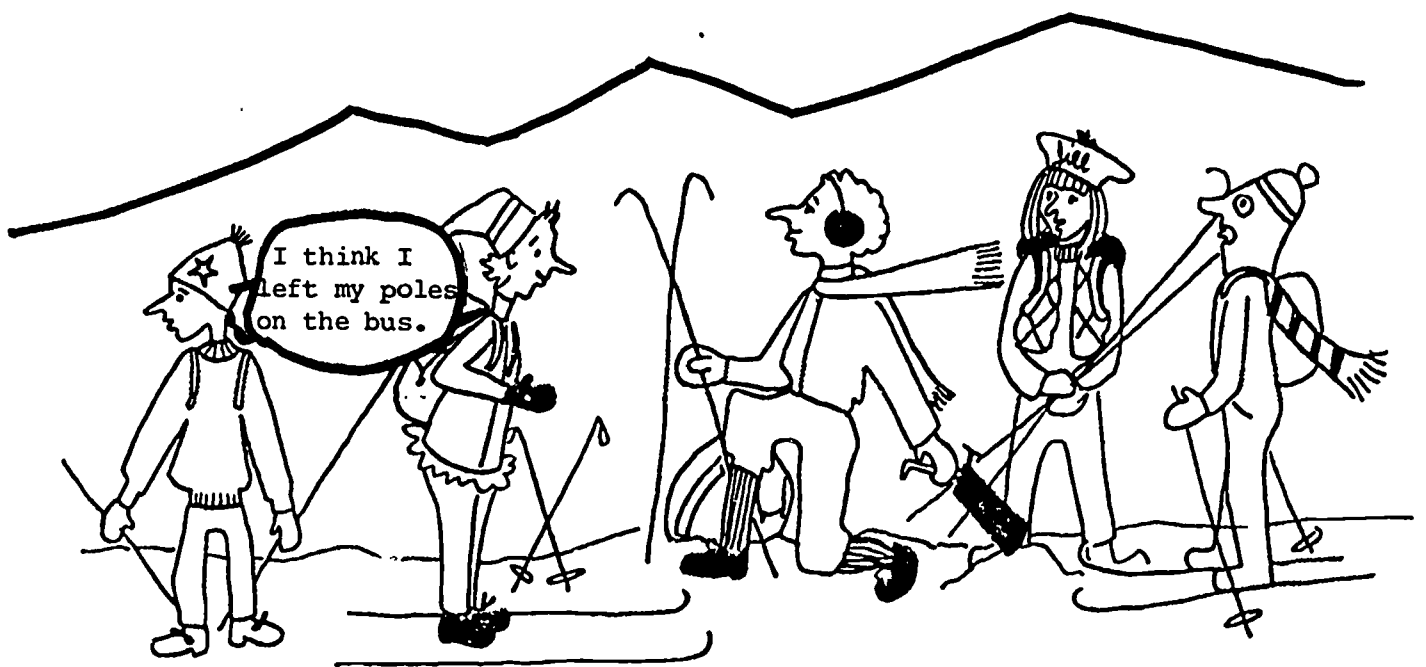

Herman: You're the instructor. What kind of wax should be used on our skis for this type of snow?

Hal: Well, Herman, there are several kinds of waxes. Different waxes are made to keep skis from sticking to the snow in different types of weather. I think a blue wax would be best for this type of snow and temperature. It will make your skis glide easily.

Jill: What's the torch for?

Hal: I use a torch to heat up my skis. The torch makes it easy to apply the wax. Sometimes I use a torch to remove the old wax, if I get a wax build-up. You can only use a torch on wood skis, because the heat might ruin a fiberglass ski.

Fred: I don't need wax for my skis.

Hal: The newer skis don't need wax. They have "steps," "fish scales," or mohair ridges to make the skis glide smoothly. I prefer the wooden skis that require waxing.

Both the traditional and newer skis work well. So it's just what you like best.

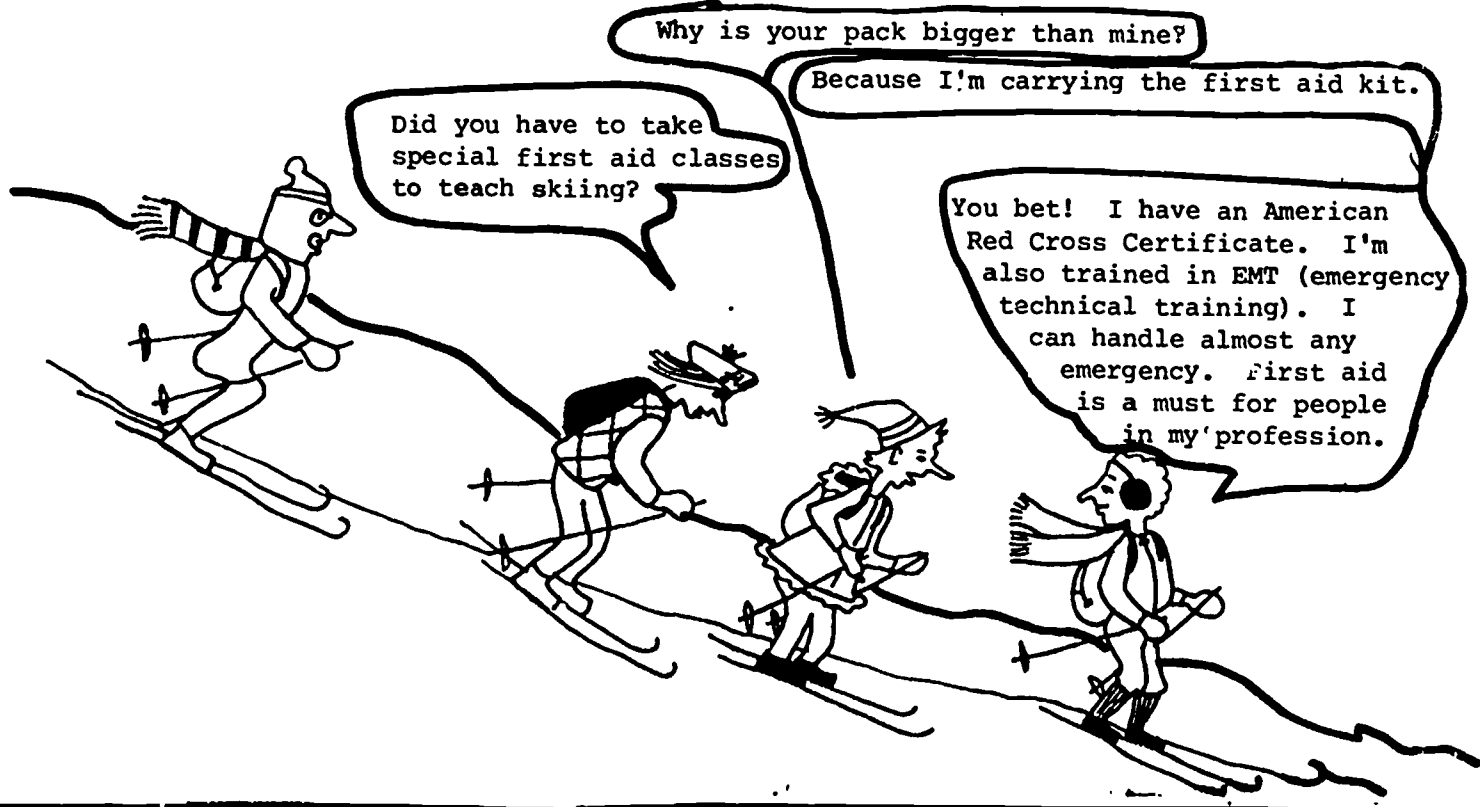

Did you have to take special first aid classes to teach skiing?

Why is your pack bigger than mine?

Because I'm carrying the first aid kit.

You bet! I have an American Red Cross Certificate. I'm also trained in EMT (emergency technical training). I can handle almost any emergency. First aid is a must for people in my profession.

Hal, earlier today you said you had first aid training to be a ski instructor. What other training does it take to be an instructor?

Well, Jill, first I have to be a good skier. I also have to be able to communicate my skills to folks. That's being a good teacher. Different places have different standards for their instructors. If I were working for a college, I'd need a Bachelor of Science degree. I might even need a degree in physical education. Some camps and resorts like professional certification. Others like you to have past experience as an instructor.

There are schools that offer courses in outdoor recreation. The certificate earned at these schools shows that you're qualified for the job. To be a recreational therapist, I might need a degree in social work or physical therapy. So you see, it depends on where you work. But a Red Cross First Aid Certificate is required everywhere.

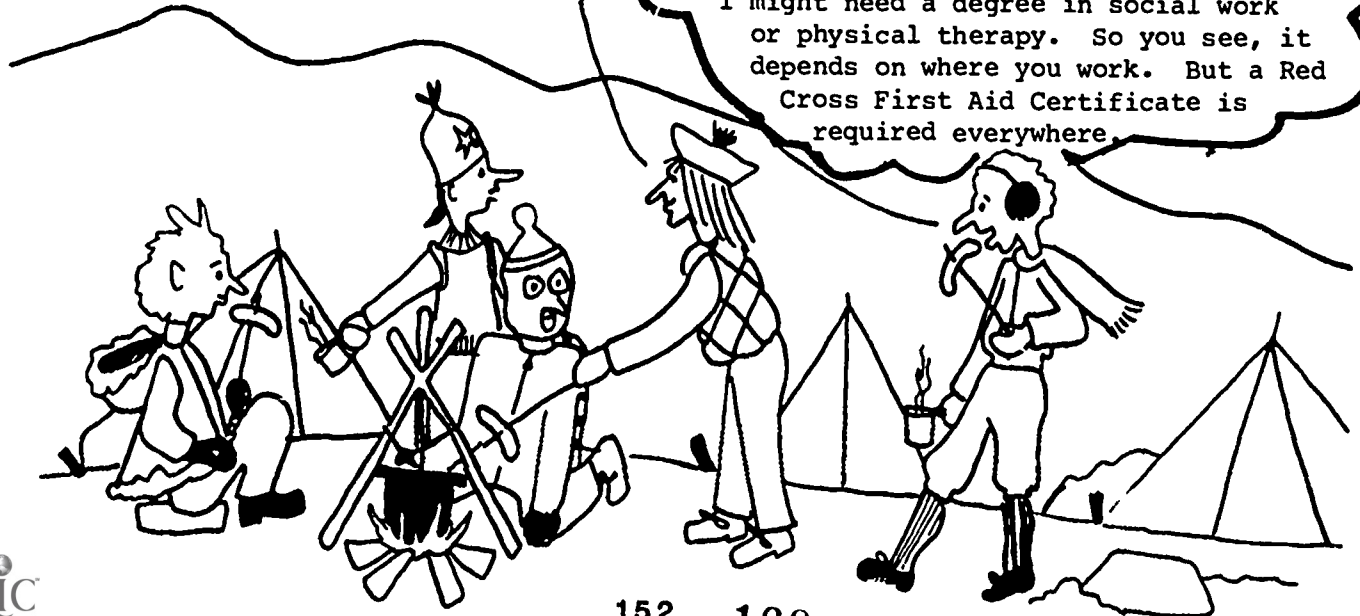

I'm still hungry; who's got another frozen hot dog?

Here, Herman.

Don't you need math skills for your job?

Yes, Frank, I almost forgot. Since I usually work for myself, I have to figure out the cost of a trip like this one plus figure out my own wage. Then I can decide what to charge my students. Often, a resort or camp will take care of all the math and just give me a wage. Other places, like colleges, may give the instructor a budget to work around. So, as you see, math is quite important.



Jake, since I'm the instructor, it's my job to help you with your form.

How did you know I was having trouble, Hal?

It's important for an instructor to be sensitive to a student's needs. Now, when you're going down a hill and want to slow down, bend your knees more and point your toes inward and your heels outward.

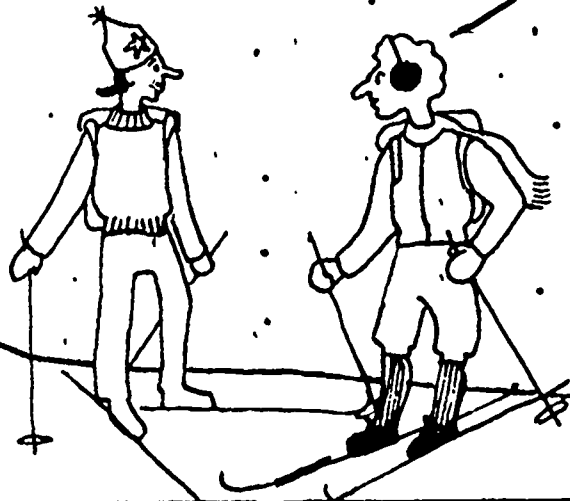

See that tree? That's called a scrub oak. Trees up this high on the mountain are short and scrubby because of the wind and lack of shelter.

Hal, how come you know so much about the environment?

I think it's important for a ski instructor to know the environment. So, I took courses in winter ecology, botany, and ornithology. This knowledge makes the trip more interesting for all of us. It also helps me when I'm looking for a job. It makes me more qualified.

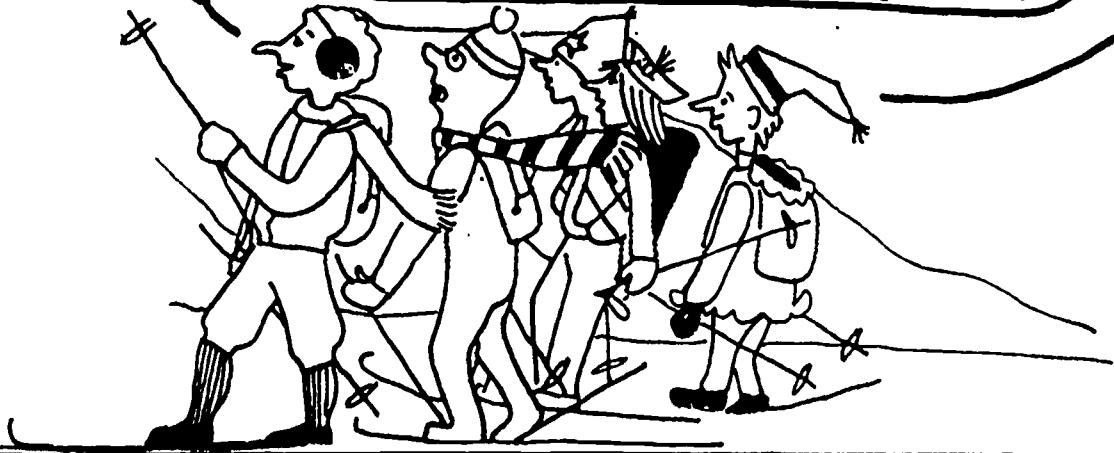

Jill: Boy, that was the greatest cross country ski trip I've ever been on!

Herman: I sure am glad it didn't get warm enough to melt the snow like they forecasted. Those weather people are wrong half the time.

Hal: You know, Herman, the weather is my biggest hazzard. No snow, no work. I moved to this area of the country just because we have snowy winters here.

Fred: I never thought of that. You can't be a ski instructor in Florida.

Hal: Not unless you want to teach water skiing.



Hal, you really seem to enjoy your job.

I do! It keeps me active, and the work is meaningful. Teaching people to do good things for themselves is important to me. My job is "Good for the body, good for the soul."

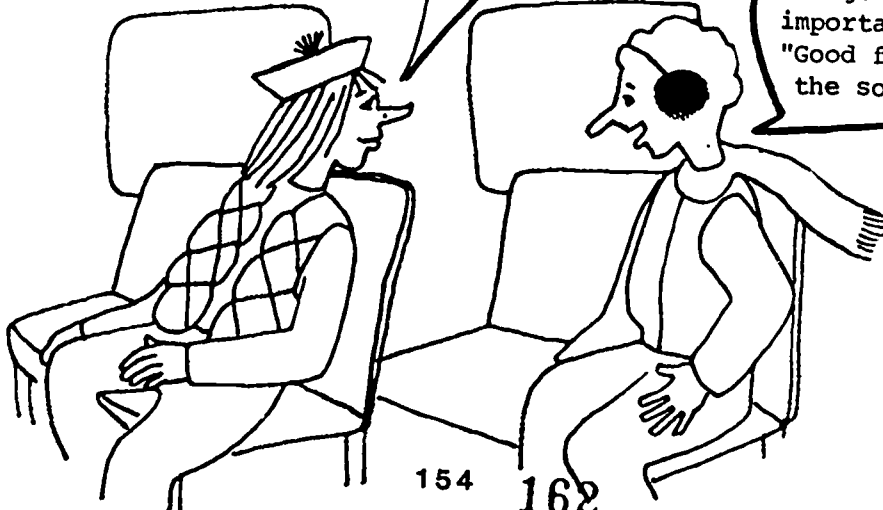

Well, Hal, it's been a wonderful four days and I've really improved a lot during this trip. Are you giving another long trip next weekend?

No, I don't think so. Long trips are very trying. Too many trips get too intense for me. Next week, I go on vacation. I'm going to read up on some new techniques, and then go on a solo trip to Chester Laurent Mountain. It's good for me to spend time developing my form and reading up on new equipment and techniques. Have a good time, and continue skiing.



QUIZ YOURSELF

Name 3 tools or pieces of equipment I use to do my job, and one use for each.

Name 3 places where you might find a ski instructor at work.

Name 2 kinds of training needed to be a ski instructor.

Name one academic course I found helpful in doing my job.

Describe how I use math and reading for my job.

Name 3 of my on-the-job tasks or skills.

What are the special weather conditions needed for me to do my job?

Name my biggest work hazard.

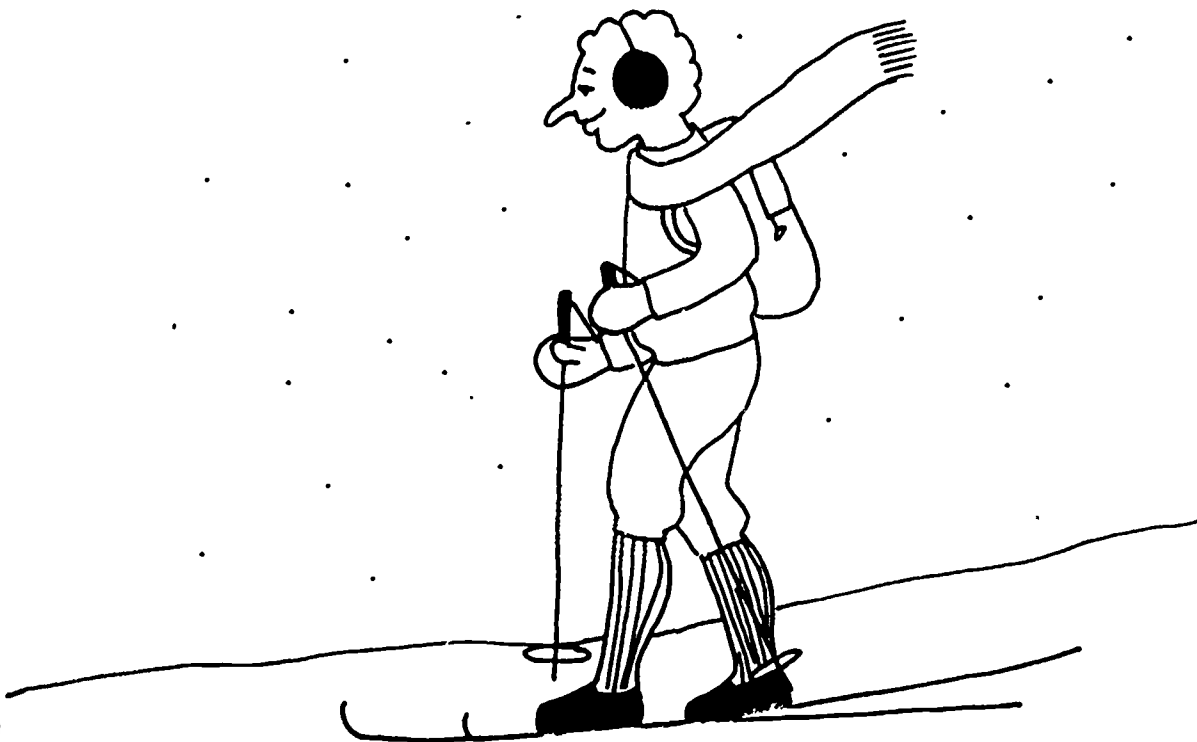
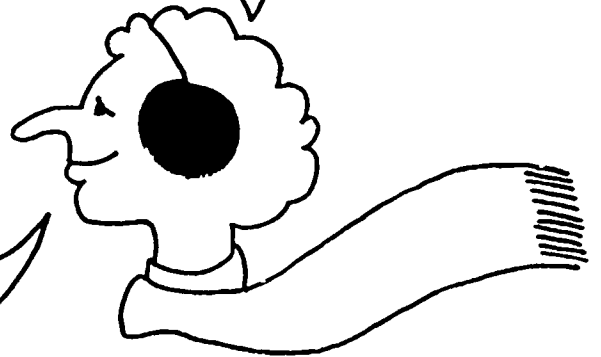

EXECUTIVE HOUSEKEEPER

My name is Ann and I work at the Four Star Hotel. I am an Executive Housekeeper. I am also the supervisor of the housekeeping department at the hotel. It's my job to make sure that the staff members carry out their housekeeping duties. I hire, train, and schedule the people that do cleaning, laundry, and maintenance work at the Star.

I keep records of when each housekeeping staff member comes and goes and what they do each day. Besides all this, I inspect rooms. I make sure that they are in order and completely clean. Actually, sometimes I even design rooms so that they are comfortable and beautiful. Then I decide what beds, chairs, tables, and other decorations belong in each room. Next, I choose the colors for the walls and drapes in each of these rooms. I also keep close track of all supplies that are bought and used by the hotel. That's my stock inventory.

I work closely with the hotel manager because I must report repairs that are needed. I order supplies and furniture for the hotel. The housekeeping department has its own budget, and I'm in charge of keeping the financial records. If I want to spend a large amount of money on hotel supplies, furniture, or repairs, I must ask the manager for special permission to use funds from the budget.



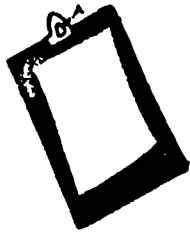

What does it take to do my job? Well, I tell people what to do and how to do it. I've got to know about the hotel inside and out. I have to be pleasant to work for, too. That way, my staff feels good about working hard. I don't get pushy when I tell them what must be done. However, I'm always firm with these people. I also need to find out about people when I interview them for jobs. I get them to talk about what they're like, what's important to them, and how they like to work.

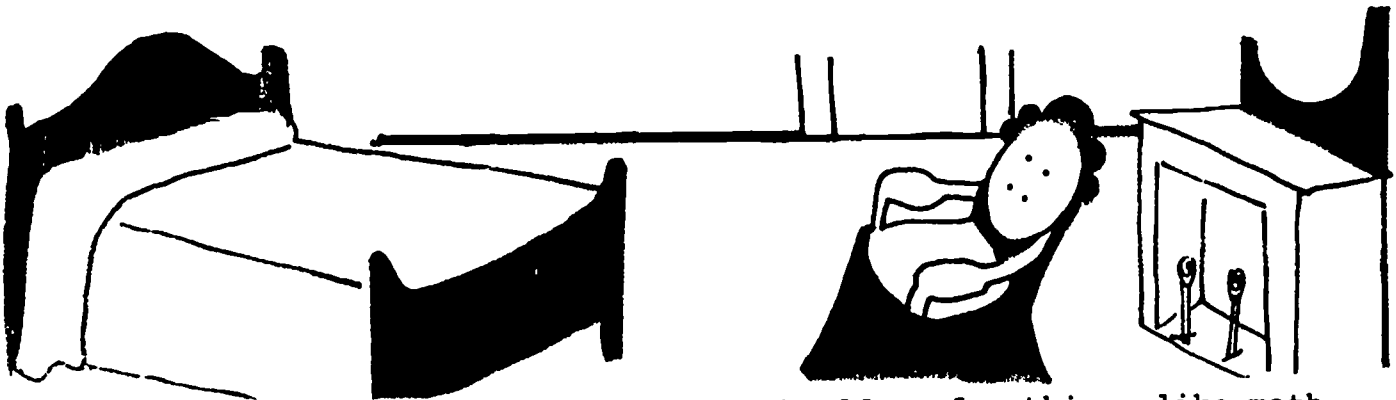

I need a good head on my shoulders for things like math because, when I order supplies, I have to get the best possible buys for the Star. I handle a lot of budget money for the hotel. Since I work alone, I must be honest and careful in doing my work. I don't need someone watching me to make sure that I finish my duties. I always do my best.



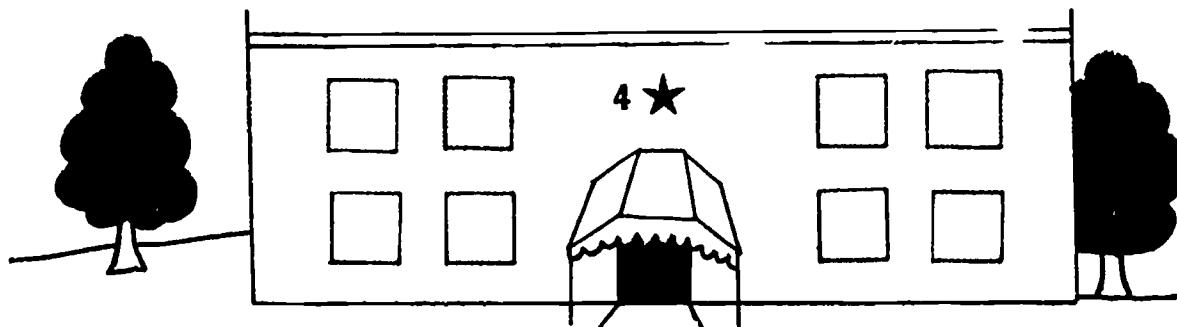

I use many tools to do my job. I need a floor plan of the hotel and the hotel job list to assign jobs to my staff. I use time cards and job schedules to keep track of staff. A clipboard is useful to take notes all day about what I see and hear. I use a phone to talk with people in other parts of the hotel to arrange interviews, to take calls from workers who are sick, and to order supplies, too. Since I plan work schedules, I need several calendars. On days when some of my staff are sick, I do their work. I use vacuums, cleansers, and mops to clean and put the rooms in order. I also train new staff to take care of hotel rooms and hallways.

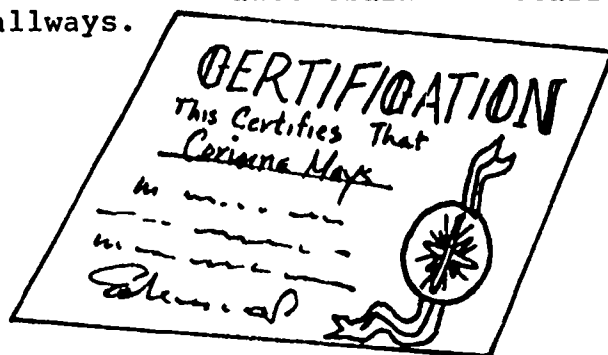

I was a housekeeper for many years. Then I decided that I wanted to use more of my own skills. I also wanted to be paid more money for my skills. Some hotels send their staff for special training to learn how the hotel wants jobs done. Some people go to state or local colleges to be executive housekeepers. But I sent away for a mail order course to learn to be an executive housekeeper. It took just a few months of hard work to earn my "degree." I took an 80-hour course and I passed it with flying colors. I learned a lot of things that help me do my job better.

Executive Housekeeper is an important job, and if it's not done right, the whole hotel suffers. I enjoy what I do, and I see the results of my good work when guests come back to the Four Star Hotel. They tell my boss how clean our staff keeps the rooms and hallways. Hearing this praise makes me feel good. I'll tell you something else. If all the hotels in the world closed tomorrow, I could still get a job in a hospital, college, store, or office building. Without Executive Housekeepers, the world would not be such a clean place to live in .

QUIZ YOURSELF: EXECUTIVE HOUSEKEEPER

Name three of my tools or pieces of equipment and one use for each.



Name one of my training places.

What are three of my on-the-job tasks or skills?



Name one of my work places.





RECREATIONAL THERAPIST

I'm Fred Hope, and I'm a student at Siftown High School. I did my shadowing at the Siftown Nursing Home. At the nursing home, I met a recreational therapist named Cora Williams. She was in her office planning a schedule of activities for the patients. Many different things were planned for the week. Some were cookouts, bingo, and sing-alongs.

"Old people should live with pride," said Cora. "They do this by using their spare time in meaningful ways. I try to help them as much as I can. Many patients need lots of medical care. Some feel abandoned by their families, and they get depressed. These folks need to be involved with other people. They also need to feel good about themselves. Some patients can be helped by hearing or telling a story; others benefit from making things to give as gifts. I'll try anything to get the patients involved in things that give them pleasure."

It was time for the first activity session. About twenty-five people came to the recreation room. Some built bird feeders and some made bead necklaces. Cora asked two aides to help those who were easily frustrated. She said, "All the aides know how to do all the activities well. They tried out all the activities blindfolded, with earplugs, bound to a chair. This way they learned how some of the patients feel. That's part of the in-service program I've developed."



"So part of your job is to train the aides?" I asked.

"Yes. Since I'm the recreational director here, I design the activities. Then I see that they're carried out properly, which includes helping the aides do their jobs well."

I took a look around the recreation room. Some tools that Cora used were books with large print, games, yarn, and a piano. The tools were stacked in different corners of the room, and the room was well lit and clean. I asked Cora how she organized everything.

"Each patient has different needs," she said. "See Joseph over there? He thinks making birdfeeders is for kids, so he won't build one. But he loves to help Angelo with his birdfeeder. Helping someone else is therapeutic for Joseph. Therapeutic means good for him. Ann Marie over there used to compare the number of pieces of jewelry she made to the number her friends made. She would cry whenever she thought someone might be making more than her. Part of the lesson she's learning is that she can enjoy herself while she's making something. Now she is relaxed enough to talk to Beverly and Don while she works. She feels so much better about herself, and that is progress."

"I'd never thought about working with old people as a job. I can see it's very different from working with children," said Fred.

"Oh yes," said Cora. "Each of these people has lived a full life and has a lot to share. It takes a lot of patience and caring to help these people. Helping old people get well is called 'geriatrics.' It is a very important job."

Later we met Phil Dawn, a physical therapist. Cora and Phil explained how all of the nursing home staff works together as a team. The therapists keep records of their patients' progress; the nurses and doctors keep records, too. All of the records are read aloud during "daily report" meetings. Cora and Phil always attend them. Once in a while, they also go to case meetings. At these meetings, staff members talk of how to help or treat each patient.

"You sure care about these people, don't you?" I asked.

"Oh, yes. It takes very special people to be recreational therapists. They have to be devoted and be able to see all the changes a patient goes through."

"Do all recreational therapists work in nursing homes?" I asked.

"No. Some work in hospitals and schools. Some spend their time planning programs for hospitals and treatment centers. Some might choose to teach people who want to be therapists. The teachers work in vocational schools and community colleges. If I took some classes, I could work at other jobs, like consultant."

"But you are happy directing the activities right here at the nursing home, right?"

"Yes, sir. I like being with my patients. It is a rewarding job."

When we finished talking, it was time for another activity session. I could hardly believe my eyes when I walked into the recreation room. Lora Ritt from the Daring Disco Band was sitting at the piano. She was playing an old song called "The Dawn is Breaking." I asked her what she was doing at the Siftown Nursing Home.

"I use music to help people," she said. "I'm going to college to get a music therapy degree. I spend a few hours a week here with the patients. This is my field work, or practical experience. I've learned more about music therapy here than in any class."

"Is music therapy a kind of recreational therapy?" I asked.

"Yes, Fred. Mine is the same kind of work as Cora's. But I use music in all my activities. It is important for people who don't talk or use their bodies much. Other kinds of recreational therapy are dance and art. I'm really happy with music therapy. I enjoy working with old people, so I'm thinking about working in geriatrics when I get out of school."

By this time the patients had entered the room. Everyone was given an instrument like drums and bells. As Lora played, everyone else played along. Cora and two aides walked around clapping and helping people who were having trouble.

Then we exercised, moving our heads and arms to the music. It was fun, it helped us listen, and it was exercise in coordination. Later, Cora brought out some song books with the words and music in large print. That's when the sing-along began. Some people sang and others just listened. Cora told me how much progress her patients made during the last year.

After the sing-along was over, Lora told me, "That sure went smoothly. It's not always so easy, Fred."

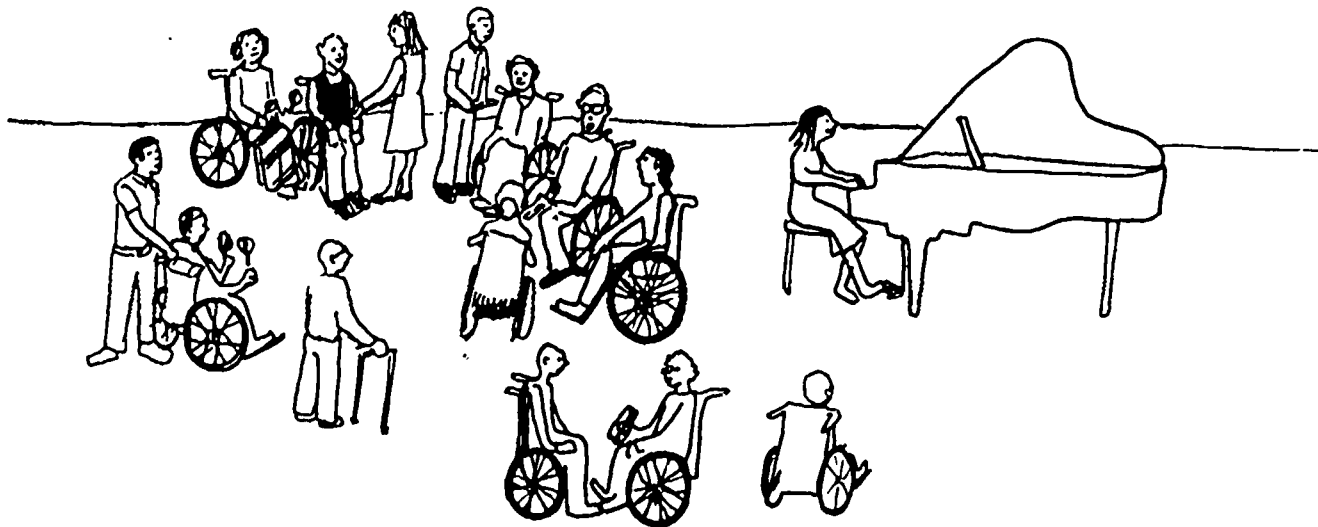

"That's very true," exclaimed Cora. "We often have to change our plans because our patients don't always like what we've planned."

"That's one of the things I had to learn here," Lora said. "If they all want to do something different, then I have to go along with it. Sometimes the new activity is good. Once Mrs. Feering started to sing old Irish songs for everyone. It turned into a talent show and nobody even needed the piano."

"Lora's right," Cora said. "We can't get hung up over our plans. We have to be flexible and patient."

Well, by this time my mind was really working. I'd begun to wonder if this sort of work might please me. I'd always liked older people, and I was the best piano player in my class. "Cora, how can I prepare for a job like this?" I asked.

"I suggest taking English courses. Reading and writing skills are used a lot with the patients. You must keep attendance records, plans, and daily progress reports, too. Good math skills help you find out the average number of people that attend the activities. But if I were you, I'd volunteer to work here first, to get some experience. Then if you're still serious about this kind of work, you should study geriatric recreation at a community college. When you get a degree, you'll need three more years of on-the-job experience. After that you'll be certified as a recreational therapist."

"Well, Cora, thanks for teaching me so much about your career. I've learned that it takes a special kind of person to do this work. I'd like to try it myself."

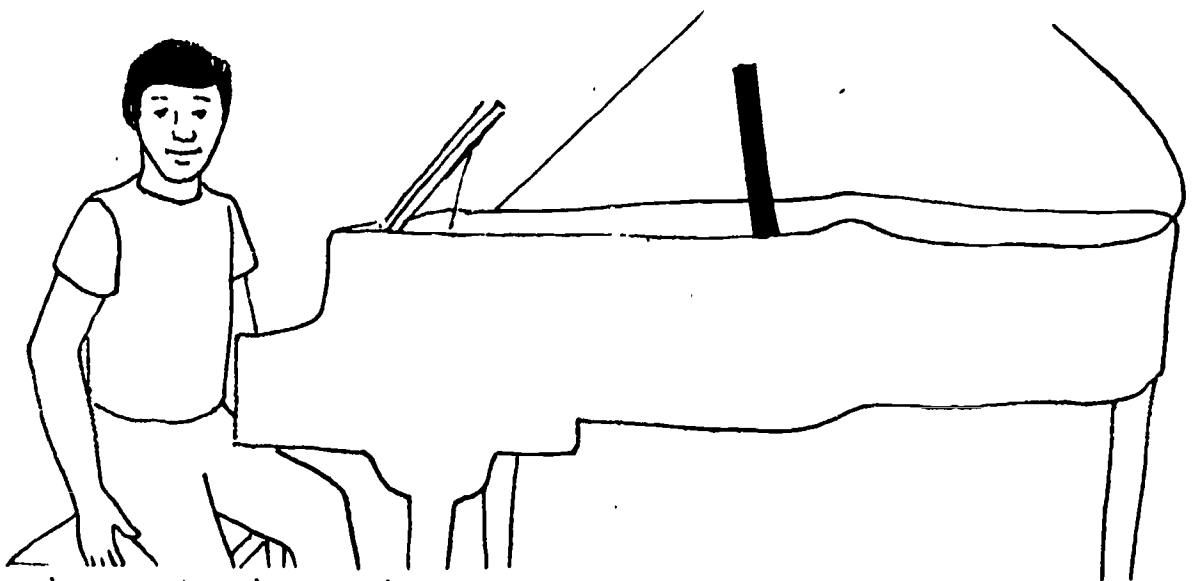

"I'm happy to hear that, Fred. It takes imagination, physical stamina, and other skills to deal with other people's needs and problems."

"I'm willing to try," I said eagerly. "Great," Cora exclaimed. "Maybe I'll see you here as a volunteer Fred."

"I hope so, Cora. It may be time for some brushing up on old time songs on the piano."

QUIZ YOURSELF:
RECREATIONAL THERAPIST



Name three of Cora's on-the-job tasks.

Fred describes some of Cora's tools. Name at least three, and describe how each is used.

When Fred looks around the room, he first sees Cora's tools. What else does he notice about the room?

Cora describes many places where recreational therapists can find work. Name two of these places.

Where can recreational therapists get the training they need to do their jobs?

Describe how Cora uses math and reading skills on the job.

Besides special training and practice using reading and math skills, what personal qualities should recreational therapists develop?

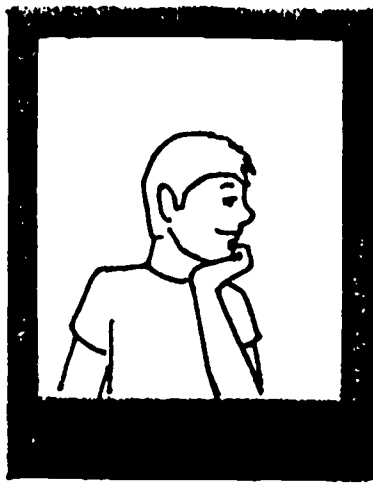

COAT CHECK

ROLLER RINK OWNER/MANAGER

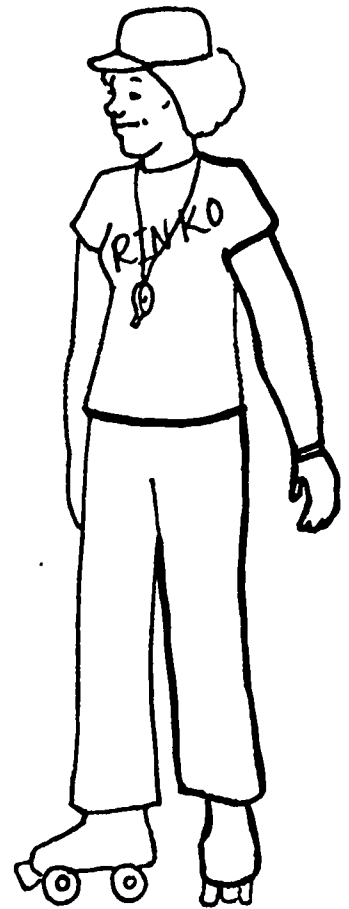

My roller rink is an inexpensive place to go for exercise and fun. All kinds of people enjoy the place---old folk, and young. I try to make this place appealing, a good business technique. I've hired many high school students, which makes this rink unique. They're flexible about hours, and they're energetic too; They earn money while they learn, and some earn credit at school.

As manager, to keep things running smoothly and fine,
I must hire coat-check, sales, and rental staff to work part-time,
And rink guards who work to enforce the skating rules.
I choose workers carefully; good employees are as valuable as precious jewels.

My responsibilities include offering music for every taste:
Salsa, disco, and old fashioned songs.
I also check our supplies, and prevent things from going wrong,
And I figure out ways to eliminate waste.

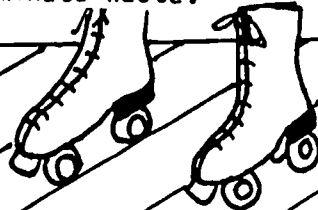



Economy is important, as all managers will agree.
 I watch the money closely, that's called "keeping the books."
 And I work closely with maintenance staff who repair and clean everything they see,
 Since business often depends on the way a place looks.
 The floor itself doesn't need much care;
 We use hard maple floorboard, and we leave it bare.
 My work is varied. Every night, I check out each work station.
 At each spot, I find out what I need to know through conversation.
 I cover the ticket booth, the rental booth, the grounds, and the rink.
 My job has more to do with people than you might think.
 I deal with customer complaints; I try to please them all.
 And first-aid skills come in handy if someone takes a bad fall.

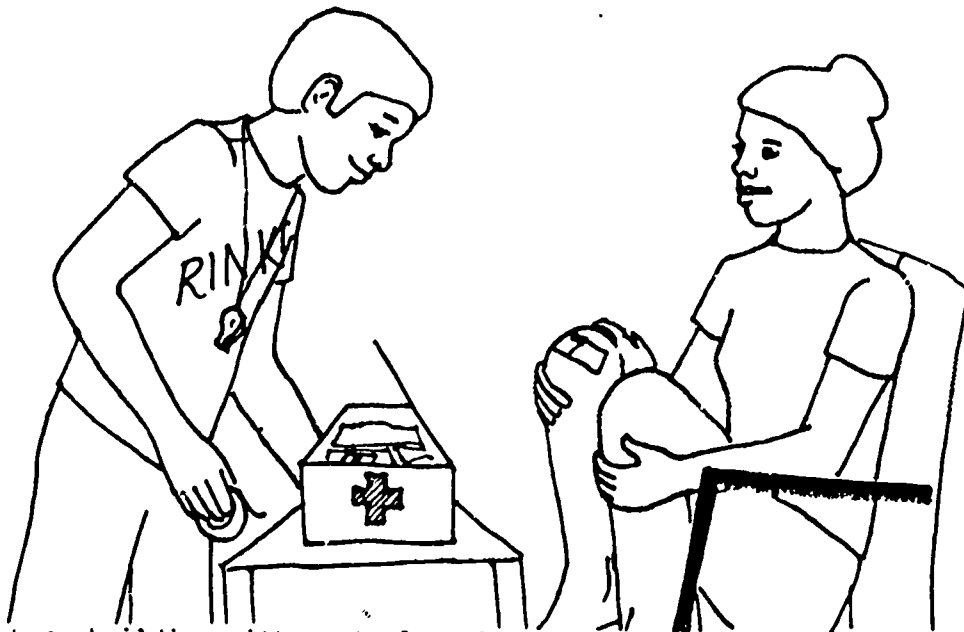

This is a huge building with central cooling and heat,
 Expensive stereo equipment, and snack food for skaters to eat.
 In two years, we've made the profit we've needed to pay
 For advertising, and to expand. It's a growing business today.

I had to take out loans before opening this place.
To start, I needed 500 pairs of rental roller skates.
This alone was a big investment at tremendous expense.
Then there were records, booths, benches, and pinball games, which the roller rink rents.

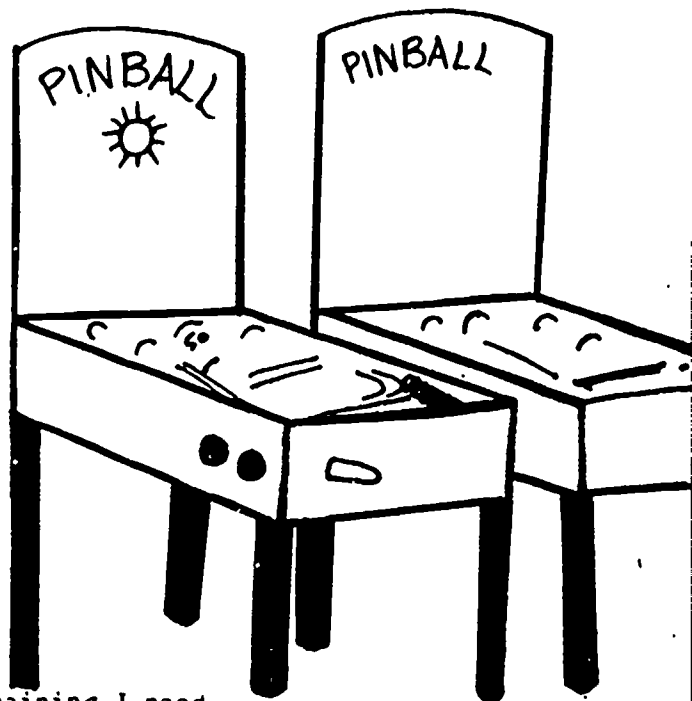
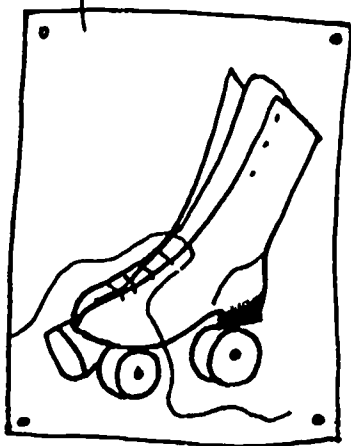

Keeping the books at restaurants helped me get the training I need.
Management and business magazines help too. I set aside time each night to read.
I keep up with skating trends through organizations of the "trade."
Roller Skating Rinks Of American is one, the RSROA.
Now, if you want to know how to get a management start,
Study management and business in high school. Take this advice to heart!



The hours here are unusual; I'm free during the day.
I work six or seven nights a week to earn my generous pay.
One drawback is the cost of a high-priced insurance policy;
We're considered quite a risk, as a sports facility.
But the benefits of this job are great, because as you can see,
I love to be around all kinds of people, and business is booming, indeed.

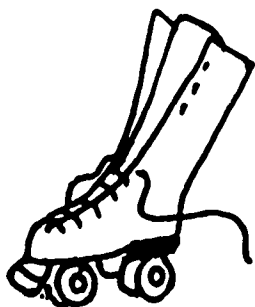

ROLLER RINK OWNER/MANAGER

ANOTHER WHIZ OF A QUIZ

The manager of a roller rink is responsible for more than you might think. Name at least four tasks you've read about in the poem.

This rink owner uses many tools, and some are expensive. Name at least three of these tools and their uses.

Roller rink managers contribute to the American scene of recreation. Name at least two of the manager's work stations.

Math and reading are both used on this job. Describe how.

Roller rink managers can get a start on their training as early as high school days. Mention two ways to get the training you'd need to help you start on your way.

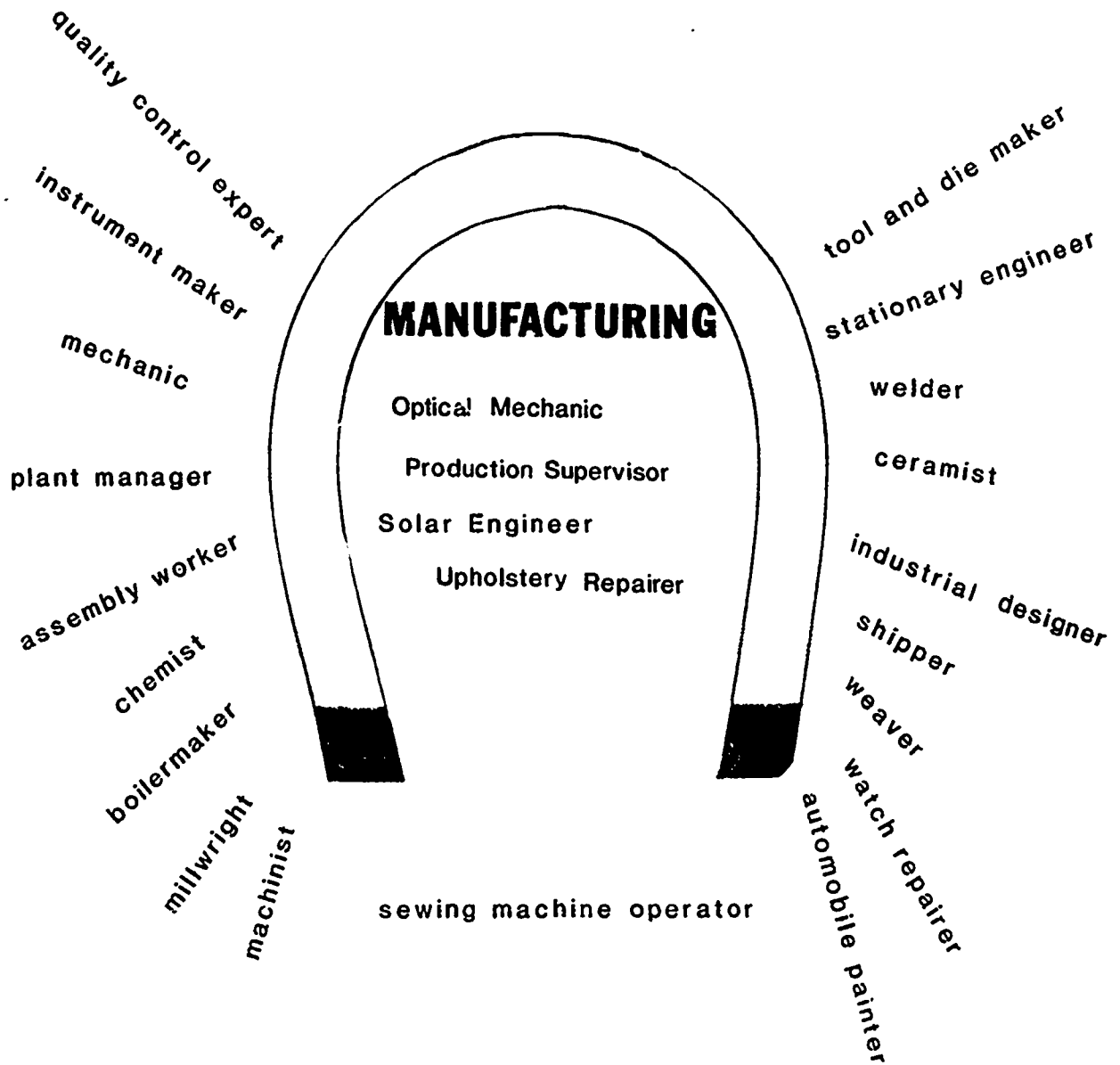

Workers from the Manufacturing cluster design, assemble, and produce processed goods which are not in their natural forms.

Optical Mechanic/Bench Technician

Skills and Tasks

An optical mechanic makes eyeglasses prescribed by eye doctors.

Orders lens from factory, where it is manufactured.

Puts lens in lensometer, which marks the center of the lens.

Puts lens in holder.

Selects "template," a pattern used to determine size and shape of lens which fits into the eyeglass frame.

Puts template and holder on a grinder, which cuts lens into the shape of the template.

Heats lens to smooth ground edges.

Cools lens with cold air from air hose.

Polishes lens.

"Pops" lens into frame.

Uses small pliers, screwdrivers, and glass drills to repair damaged eyeglasses.

Tools and Equipment

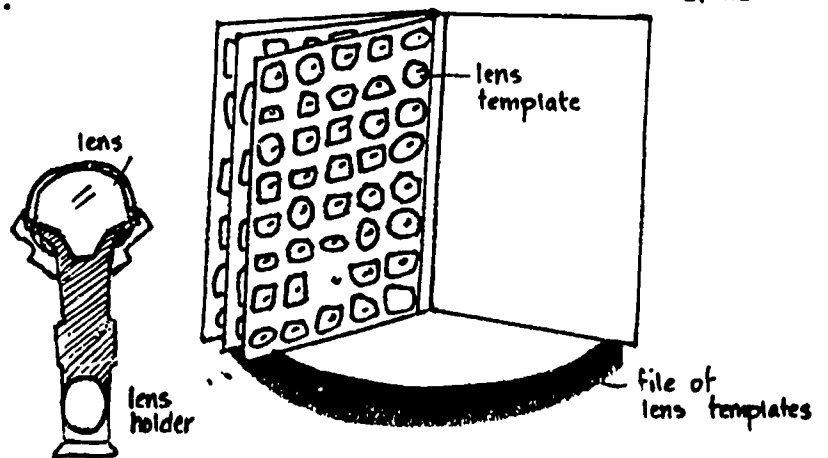
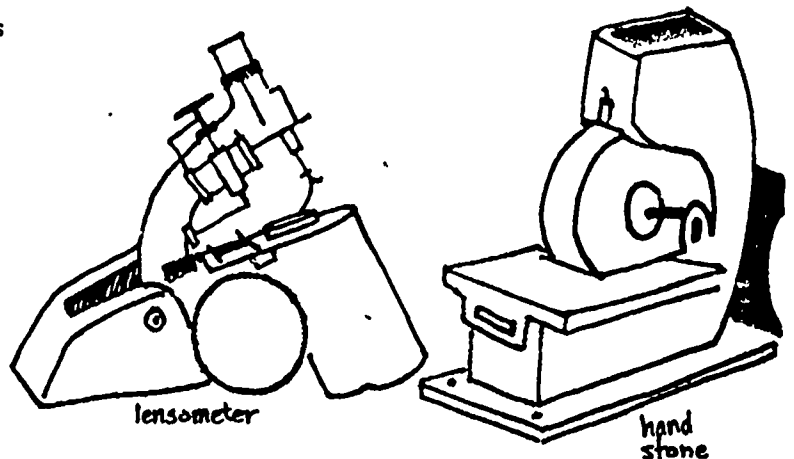

Other Skills

A bench technician must have good mechanical and fine motor coordination in order to do close precision work.

USES MATH
to calculate
prescriptions.

READS
doctor's
prescriptions

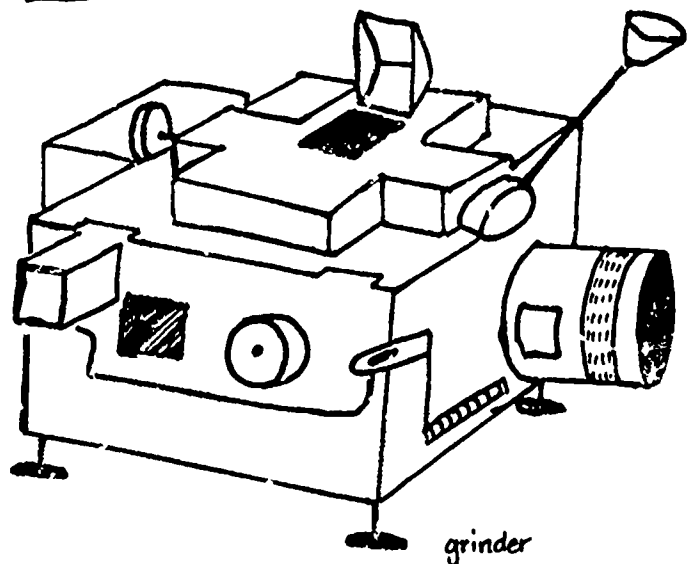

Work Places

1. Offices of eye doctors.
2. Laboratories.
3. Retail stores that sell prescription lenses.



Work Conditions

1. Work places are well ventilated, but may be noisy because of power grinding machines.
2. Bench technicians work a 40-hour week.
3. There are many employment opportunities for physically handicapped people with full use of their eyes and hands.
4. Insurance, vacations, sick time, and retirement plans depend on the work place.
5. Union membership may be chosen.

Training

1. On-the-job training, for 2-3 years.
2. Apprenticeship programs for 3-4 years.
3. Vocational schools, for 9 months full time plus on-the-job training.
4. Armed forces.
5. In some states, a bench technician must obtain a license before working in retail shops.

Advancement

1. In places that employ many bench technicians, supervisory or managerial positions are available.
2. With more training, a technician may become a dispensing optician or optometric assistant, who, in addition to making eyeglasses, fits the finished glasses on patients, and helps carry out tests for prescribing eyeglasses or contact lenses.



Bench Technician

Get The Facts



Name 3 work tasks a bench technician performs on the job.

Name 3 tools or pieces of equipment a bench technician uses on the job. Tell what each one is used for.

What does a bench technician have to read on the job?

How does a bench technician use math skills on the job?

Name 2 places where a bench technician can get training.

Name 2 positions a bench technician can advance to.

What appeals to you the most about a bench technician's work conditions?

SUE CROW,

PRODUCTION SUPERVISOR

My name is Sue Crow. I work in a factory that makes wooden toys. I'm a production supervisor in the assembly department where pieces of toys are put together. I have to be sure that there are enough parts to make the toys, and that the parts are put together so that each toy is strong and sturdy. I also train new workers on the job.

My work requires a lot of planning. Once a week I meet with the shop manager. He tells me what toys the company wants to put together, and I plan the work for the assembly department. The manager and I write up a "work order." Here is the place I use math skills. I have to see if we have enough parts to make the toys on the work order. If we don't have enough parts, I write a "request order." I send the order to the parts department, and they send me what I need. Once I have all the parts, the assembly line workers begin putting them together. I check to make sure that the parts are put together correctly. That's called quality control.

I began working at Toy Craft five years ago. I worked on the assembly line for two years. I got the job of production supervisor three years ago. First I had two months of on-the-job training. Since I help make adjustments and minor repairs to our machinery, my tools include gauges, wrenches, screw drivers, and the like. My reading skills are important when I fill out work and request orders, in using blueprints and checking specifications.

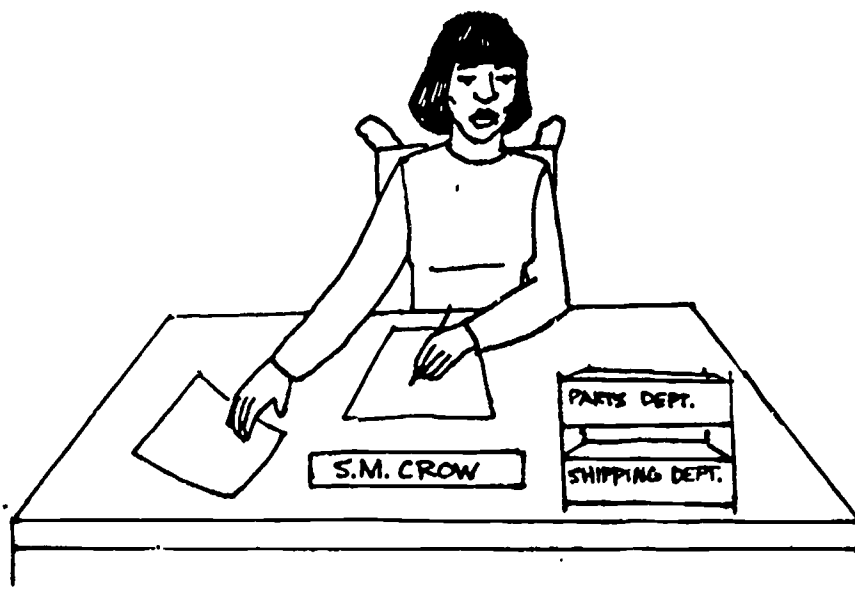

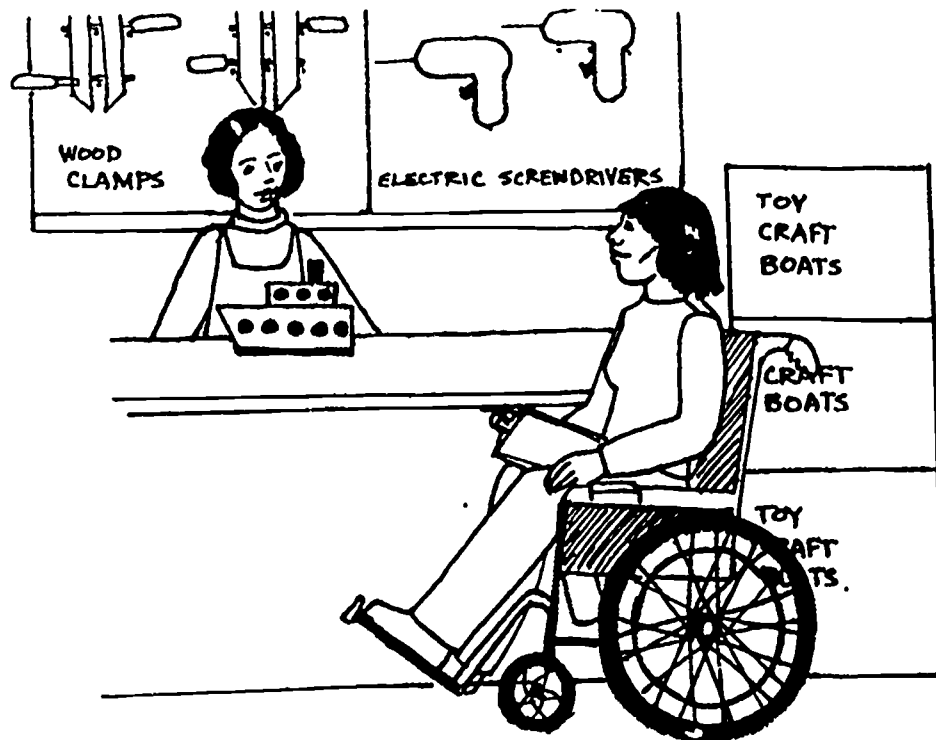

Toy Craft is the only company I've ever worked for. I like working here for lots of reasons. I work five days a week, eight hours a day. I have a half-hour off for lunch. We also get three ten-minute breaks during the day. Those breaks are important for workers in our department. Working around power tools or machines can be dangerous. For example, the noise of the power tools and always doing the same thing can make people careless so regular work breaks are good safety precautions. I like the two-week vacation I get every year, the paid sick days and personal leave days. We also are members in the company's health insurance plan. Toy Craft offers great opportunities for getting ahead, and I've applied for the job of shop manager. I know that I have a good chance of getting it. There are higher paying jobs in the company, too. I can get ready for these by going back to school or taking special company training courses.

There are plenty of factories I could work for, but I like working here. An important thing for me is that I work for a company that manufactures a very good product. The wooden toys I help make here at Toy Craft are the best on the market. Making sure the toys are the best on the market is part of my job.

PRODUCTION SUPERVISOR: GET THE FACTS

Name three skills and/or tasks of a production supervisor.

Where did Sue Crow get training to be a production supervisor?

Name three tools Sue uses on the job. Name a use for each.

What is Sue's work schedule?

What is one possible hazard for workers in an assembly department?

What are two advantages Sue appreciates in her work?

What training would Sue need to advance further on her job?

Name one work place for assembly workers.

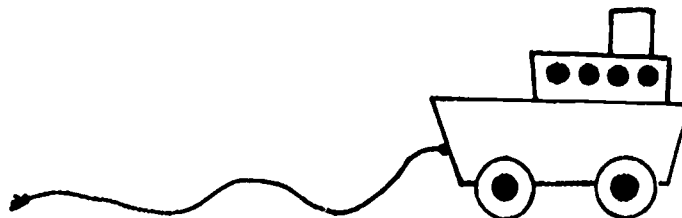

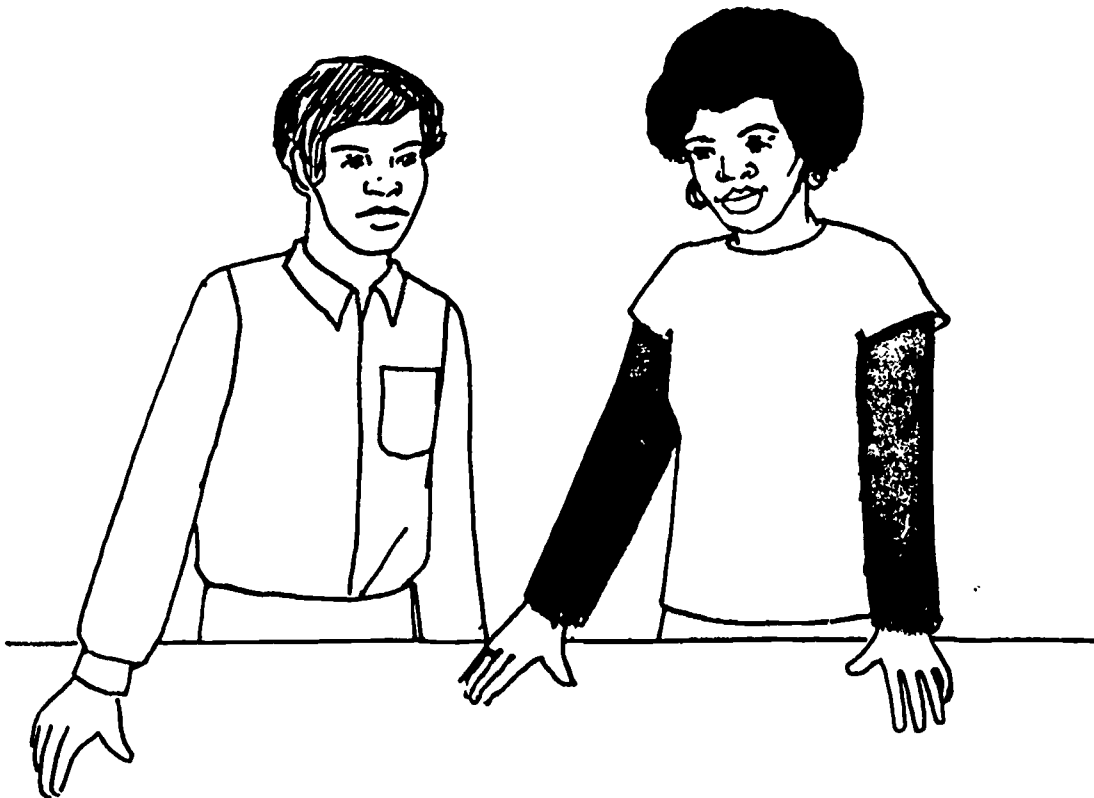

JESSICA ELDRIDGE

SOLAR RESEARCH ENGINEER

Hal: Hello, I'm Hal Adams, a student in the work study program at Uptown High School. I'm here for a meeting with Jessica Eldridge, to talk about what I'll be doing here at Sol-Products.

Jessica: Hello, Hal. I'm Jessica. I'm a solar research engineer, and your supervisor while you're here at Sol-Products.

Hal: I'm looking forward to learning about the work I'll be doing.

Jessica:

I like your spirit. Here's a drawing of a simple solar heating system made by Sol-Products. The solar collector collects heat energy from the sun, which is then transferred to a storage tank. The heat exchanger moves the heat from the storage tank to the place to be heated. The flow of air moves the heat in this system. Fans or pumps can be used to move air or liquid in our systems that are more complex. A big part of my job is conducting tests of effectiveness of the heating systems we are manufacturing.

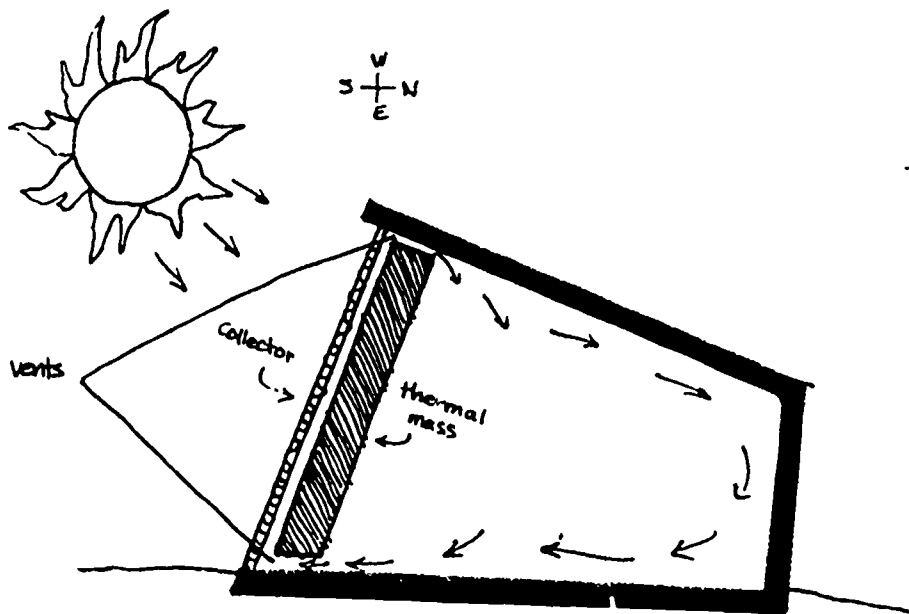

The thermal mass works as a storage tank.
The vents work as a heat exchanger.

Hal:

What things do you test?

Jessica:

I test all of the parts of the heating system, one at a time. If these meet our standards, I test all of the parts together as one system in a process called life-cycle testing.

Hal:

Does that mean testing to see how long a piece of equipment will keep running?

Jessica: Yes..sort of. Life-cycle testing tells me how long the materials used in constructing the collectors will last. Right now I'm running "quality control" tests, and you will be helping me with these.

Hal: It sounds like preparing for and running tests takes a lot of time. Do you do anything else?

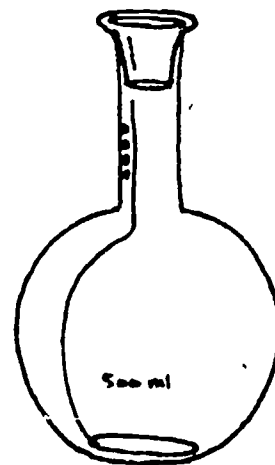

Jessica: Whenever a test is completed, I write a laboratory report, which summarizes information I've learned from the test. Since the reports will be read by potential customers, they must be presented in a way that is easily understandable.

Hal: What do you mean?

Jessica: The language of solar research engineering includes math and physics formulas. I use these formulas to make the tests. The data or information that I collect from the tests is also in formula language. I change the formulas into words that people who aren't scientists can understand.

Hal: What kinds of tools do you use in your work?

Jessica: Sometimes I work with containers containing chemicals. I must be very careful with the chemicals. Using chemicals in the wrong way is a big danger in any lab. My other tools are mostly measuring devices. For example, I use these gauges to measure pressure.

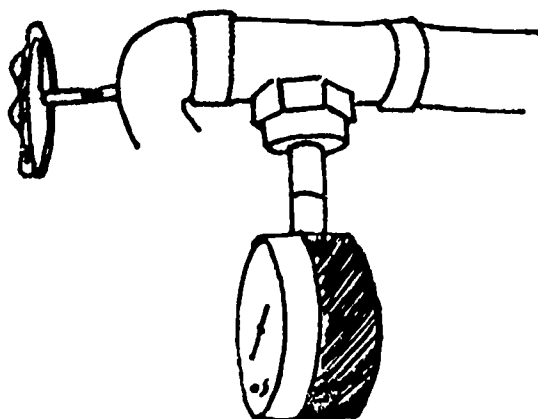

Hal: They look like the gauges used on our water heater at home.

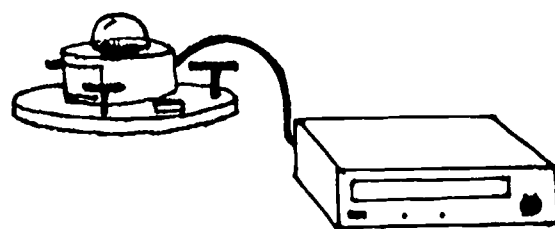

Jessica: Yes, they are similar, only these are much more precise. This is a useful tool called a periheliometer. It measures the strength of light, and this strip chart recorder makes a continuous second-by-second record. Such tools save time when we're running best and also in writing reports.

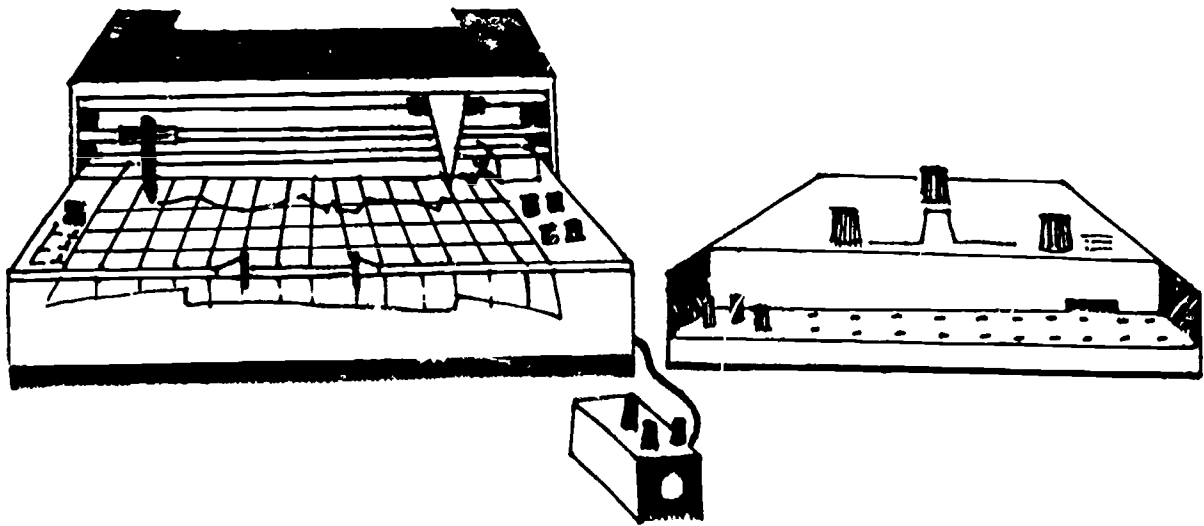

Hal: Learning how to use such tools must take a lot of training.

Jessica: I learned about many of them in college, others I learned how to use after I began working as an engineer.

Hal: How much education would I need to be a solar research engineer?

Jessica: You would need college physics, math, and engineering. Some places may want you to have an engineering degree. Many colleges offer courses in solar engineering. Soon many will offer solar engineering degrees. A person with the skills to work in the field of solar research will be able to find a job in almost any part of the country. It is also a good field for starting your own business.

Hal: What do you like best about your job?

Jessica: I like knowing that I'm in a new research area--Solar Energy. I could easily find a job anywhere in the U.S.A; I could start my own business or work for any number of new companies.

Hal: It sounds like a good field for a beginner.

Jessica: It is, for an enthusiastic young person, like yourself. I'm looking forward to working with you.

Hal: Thanks, Jessica. When do we start working?

Jessica: Right now. Bring that flask with you and we'll start running some quality control tests!



Solar Research Engineer: Quiz

Name three skills or tasks a solar research engineer performs on the job.

What is the "language" of solar research engineering?

Name one possible hazard in the work of a solar research engineer.

Name two tools or pieces of equipment a solar research engineer uses on the job. What is a use for each one?

What training would a person need in order to get a job as a solar research engineer?

Describe the career advancement possibilities for a worker in the field of solar research engineering.

Where can a solar research engineer expect to find a job?



UPHOLSTERY REPAIRER

Upholstery is the stuffing, covering, and other materials used to make furniture like sofas and chairs soft.

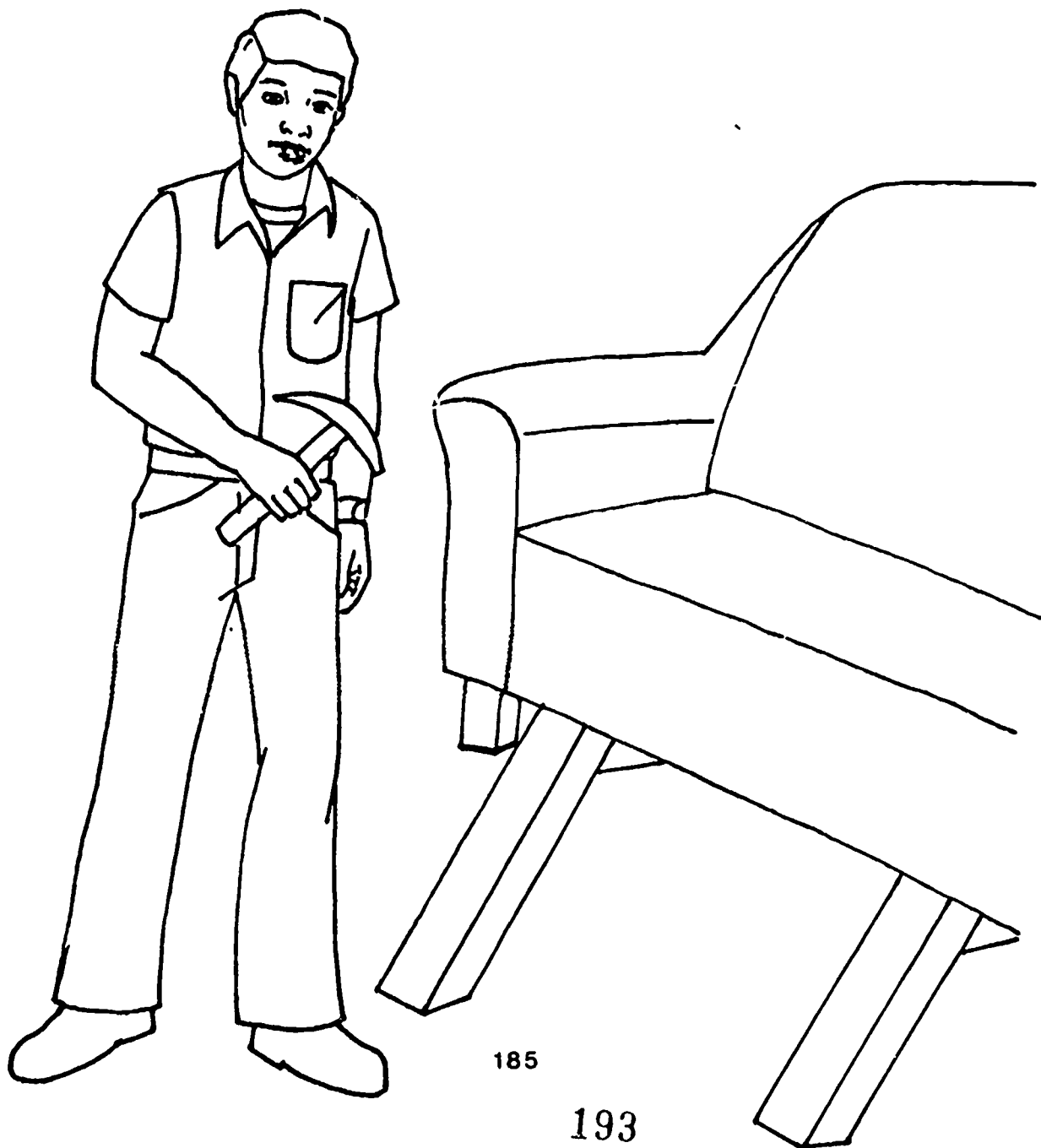

Upholstry Repairer

The workshop is well lit and ventilated.

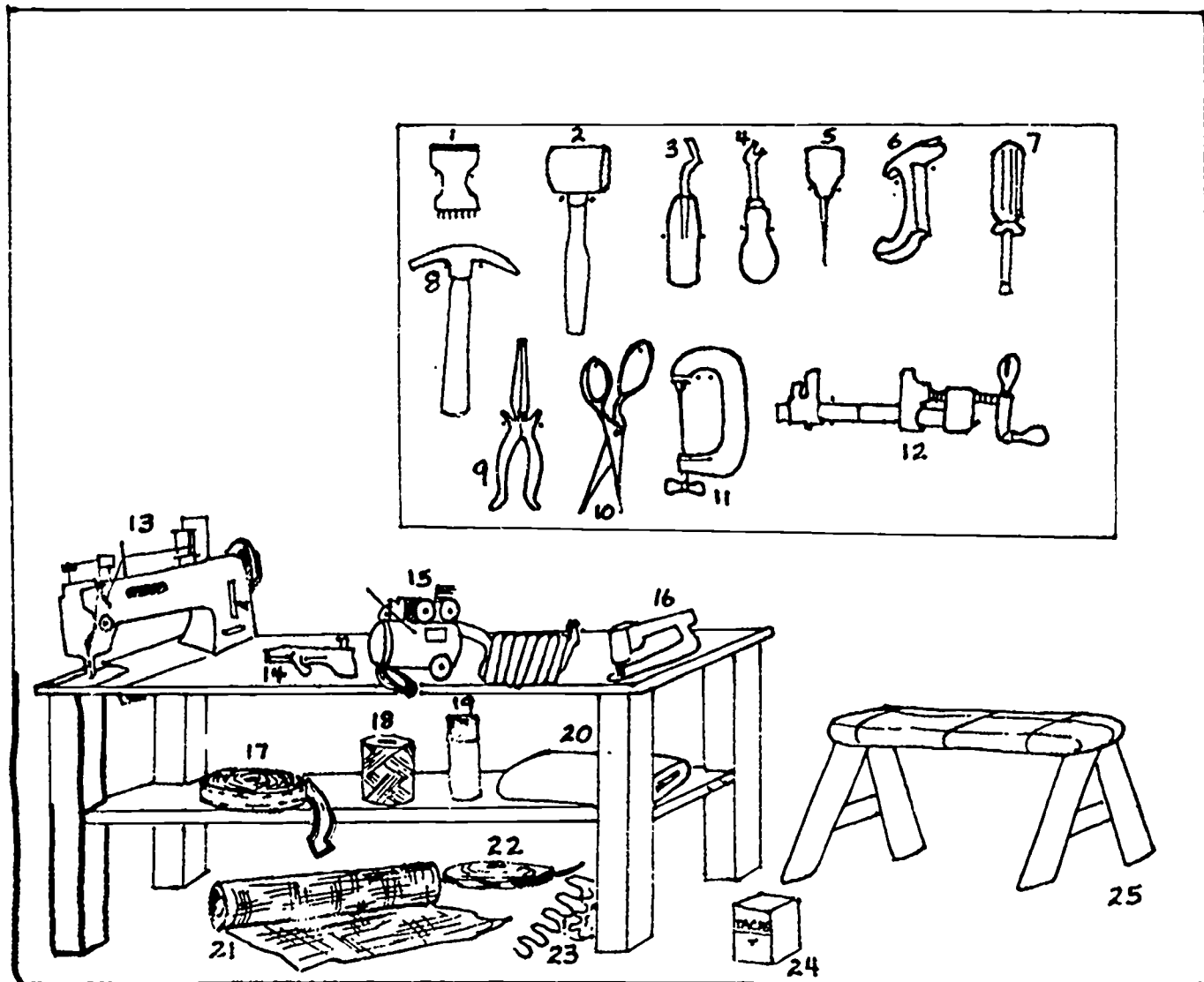

Tools and Equipment

- | | |
|-----------------------|-----------------------------|
| 1. webbing stretcher. | 13. sewing machine |
| 2. rubber mallet | 14. blo-gun |
| 3. ripping tool | 15. air compressor and hose |
| 4. tack puller | 16. staple gun |
| 5. awl | 17. webbing |
| 6. staple puller | 18. twine |
| 7. screwdriver | 19. spray paint |
| 8. hammer | 20. stuffing |
| 9. needle nose pliers | 21. burlap |
| 10. shears | 22. tack strips |
| 11. "C" clamp | 23. zig zag springs |
| 12. pony clamp | 24. tacks |
| | 25. padded wooden horse |

Skills and Tasks

TAKES FURNITURE APART:

1. Removes old material from springs or webbing.
2. Takes out bent or broken springs.
3. Rips out worn webbing.
4. Repairs wooden frames by regluing loose parts.
5. Replaces badly damaged wooden parts.

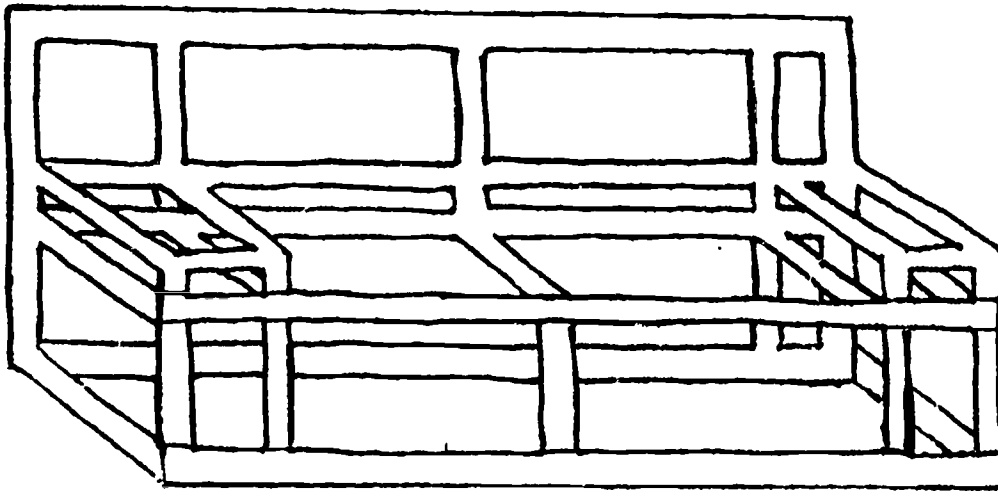

PUTS FURNITURE BACK TOGETHER:

1. Stretches and weaves strips of webbing on frame.
2. Tacks ends of strips to the frame.
3. Puts springs in place on top of webbing and ties them with twine.
4. Tacks burlap covering over springs to make a base for stuffing. (Stuffing pads the springs or webbing. It is often made of horsehair or foam rubber.)
5. Sews stuffing to burlap, using a long curved upholstery needle.
6. Covers stuffing with a cotton fabric called muslin.
7. Lays out pattern.
8. Cuts fabric and sews pieces together.
9. Sews finished fabric cover onto muslin-covered stuffing.
10. Polishes wooden parts that can be seen.

Upholstery repairers in large stores may do only one task over and over, like assembly workers. Upholstery repairers in small shops do many different tasks in a working day. Many upholstery repairers are self-employed, in their own shops.

Other Skills

1. Physical coordination and concentration, to stretch webbing and fabric with hand tools while using mouth to put tacks in place on magnetized end of hammer.
2. Physical strength, to lift and move heavy furniture.
3. Ability to pay attention to detail.
4. Math skills, to figure out fabric yardage and to figure prices.
5. Reading skills, to order tools and equipment from catalogs.
6. Writing skills, to fill out order forms.
7. Business management skills, to run own shop.

Training

High school, vocational school, and college, for courses like "Textile Fabrics" and "Furniture Making."

Apprenticeship programs, for 3-4 years.

On-the-job, as an aid or helper, for 2-3 years.

Furniture factories, as an assembly worker.

Work Places

Small repair shops (fewer than 10 workers).

Furniture factories and department stores.

Large universities.

Hotels, motels and theaters.

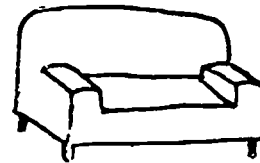

Advancement

Higher wages, as skills improve and increase.

Manager of upholstery department in a furniture store or factory.

Owner of an upholstery repair shop.

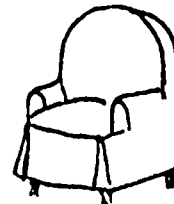

Hazards

Back strain, from lifting and moving heavy furniture, and from standing and bending in awkward positions while working.

Breathing dust, especially when old stuffing is removed.

Advantages

Membership in the trade union.

Maybe medical insurance, vacations, sick time, and retirement plan, depending on the size of the business.

Upholstery repairers who work in department stores get discounts on all their purchases.

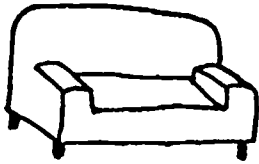

Quiz Yourself

UPHOLSTERY REPAIRER

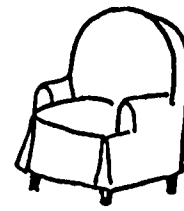

Name 2 tools or pieces of equipment you could find in an upholstery repairer's shop.

Name 2 tasks an upholstery repairer performs on the job.

Name one math skill an upholstery repairer needs on the job.

Name one thing an upholstery repairer might read on the job.

Name one other skill an upholstery repairer needs on the job.

Name 2 places a person can get training to become an upholstery repairer.

Name 2 places where you might find an upholstery repairer at work.

Name one hazard in an upholstery repairer's job.

Name one advantage in an upholstery repairer's job.

What are some possibilities of advancement for an upholstery repairer?

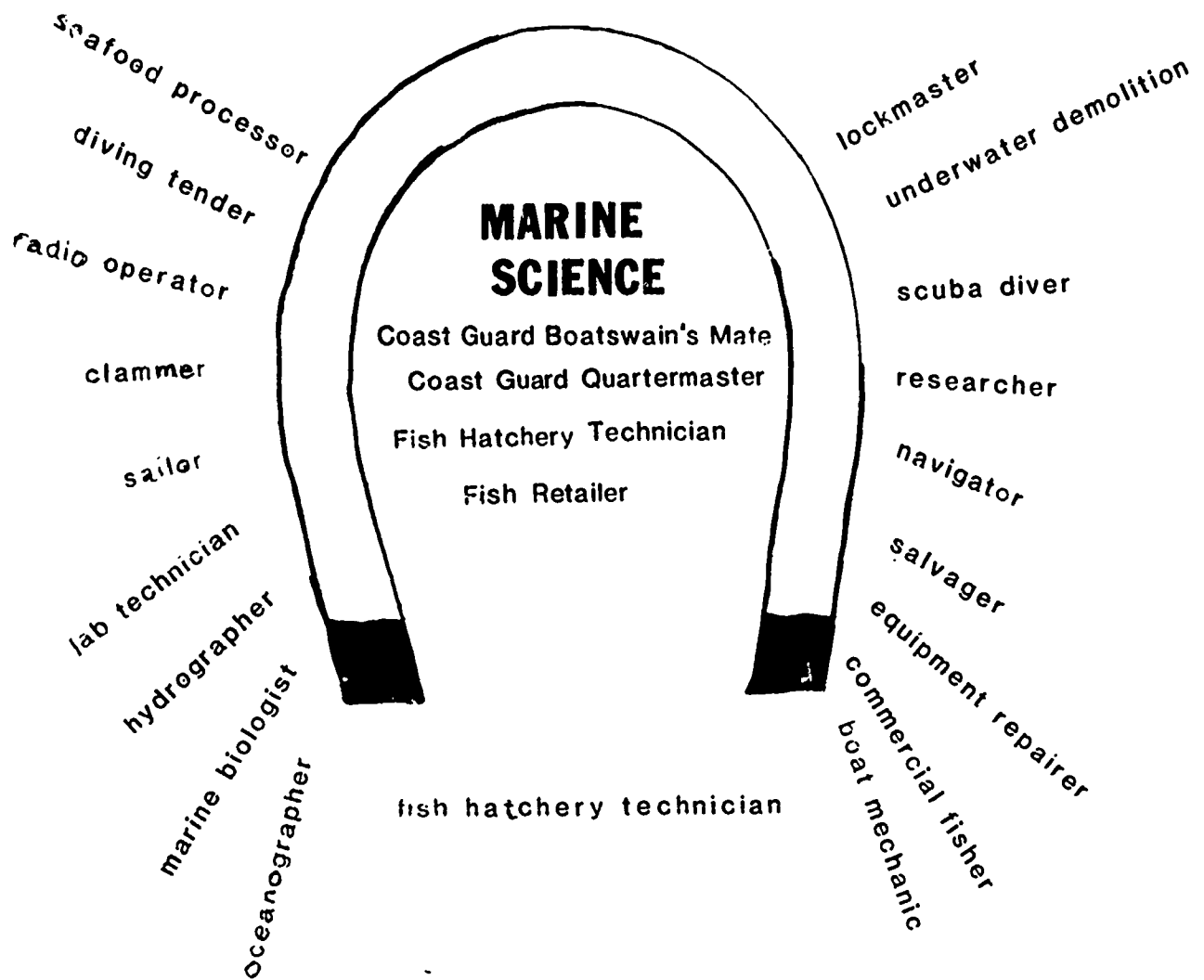

Workers from the Marine Science cluster study, grow, explore, harvest, and care for life and minerals in and around bodies of water.

Coast Guard Boatswain's (say bow'-suns) Mate

Sue: Hi, I'm Sue Green. I called you yesterday to ask for an interview.

Mike: I'm Mike Bodoin, a boatswain's mate.

Sue: I would like to learn about the Coast Guard. I have read that the Coast Guard's services include protecting the marine environment and making all marine transportation safe and lawful. What does that mean?

Mike: The Coast Guard is part of the United States Transportation System during peacetime, and during wartime it is part of the United States Navy.

Sue: I did not know that.

Mike: I can tell you a lot about the Coast Guard. It has a lot of different kinds of work.

Sue: How many people live at this station?

Mike: There are 11 of us here at this station.

Sue: What do all of you do every day?

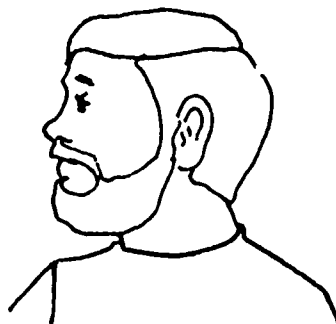

Mike: We are always on alert, and our radio is tuned in twenty-four hours a day so we can help anyone who needs us. We also make sure that everybody obeys the fishing and trade rules, but most of our work is taking care of buoys (say boo'-ees).

Sue: What is a buoy?



Mike: Buoys mark shallow areas in the water and are used as guides for the pilots of ships. Pilots steer clear of water that is too shallow for their ships. We call them navigational aides because they help the pilots of the ships.

Sue: How do you take care of buoys?

Mike: We fight rust, corrosion, and algae. We use sandblasting equipment, grinding wheels, wire brushes, chipping hammers, and special paint scrapers. We clean, paint, and number the buoys. We use special wire brushes and anticorrosive paints so that the buoys will not rust. We put new lighting and batteries in the buoys. As a boatswain's mate, I must know a lot about paints, brushes, scrapers, and chipping.

Sue: Gee, a lot of work has to be done on buoys, but how do you get buoys to the station?

Mike: Every boat is rigged with cranes to lift the buoys. These cranes work by wires, chains, ropes, and lines. This is the ship's rigging. As boatswain's mate, one of my jobs is to make sure the rigging is done every day.

Sue: Rigging is everything that helps you lift things?

Mike: Yes, our rigging helps us lift and tow things, too. Lifting and towing are very important to the Coast Guard. Because the rigging must be done the right way, tying knots and splicing ropes and lines on the rig are important skills.

Rigging for Single Boom

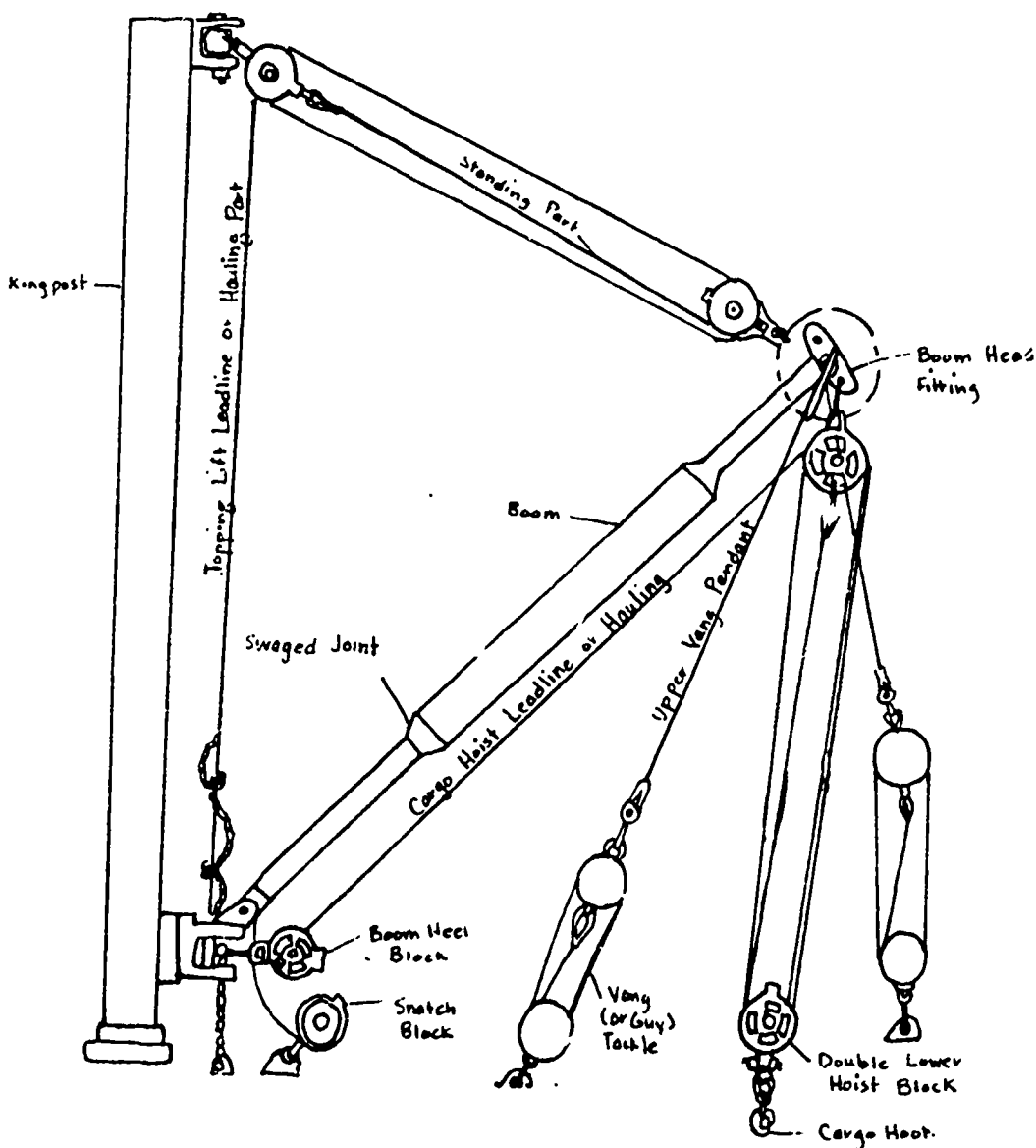

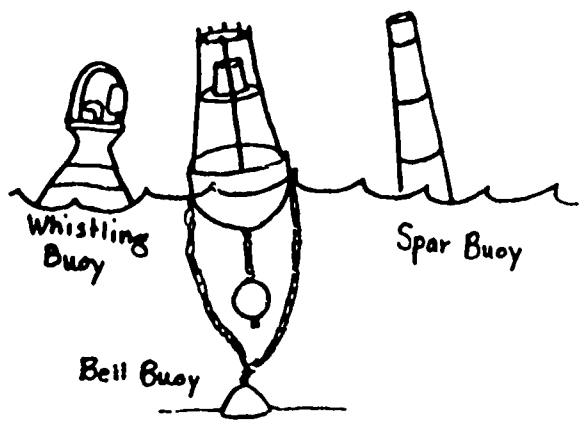

Wooden Fid

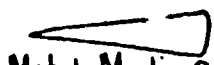

Metal Merline Spike

Sue: Do you do this work with your hands or with tools?

Mike: Making a rope can be done by hand, but when we splice a rope, we use a tool called a "wooden fid." Sometimes we use a tool called a "metal merline spike."

Sue: What is mooring?

Mike: Mooring is a type of anchoring. I take care of all deck duties. Sometimes I get to do a bit of navigating. "Navigating" means guiding the ship to where it has to go.

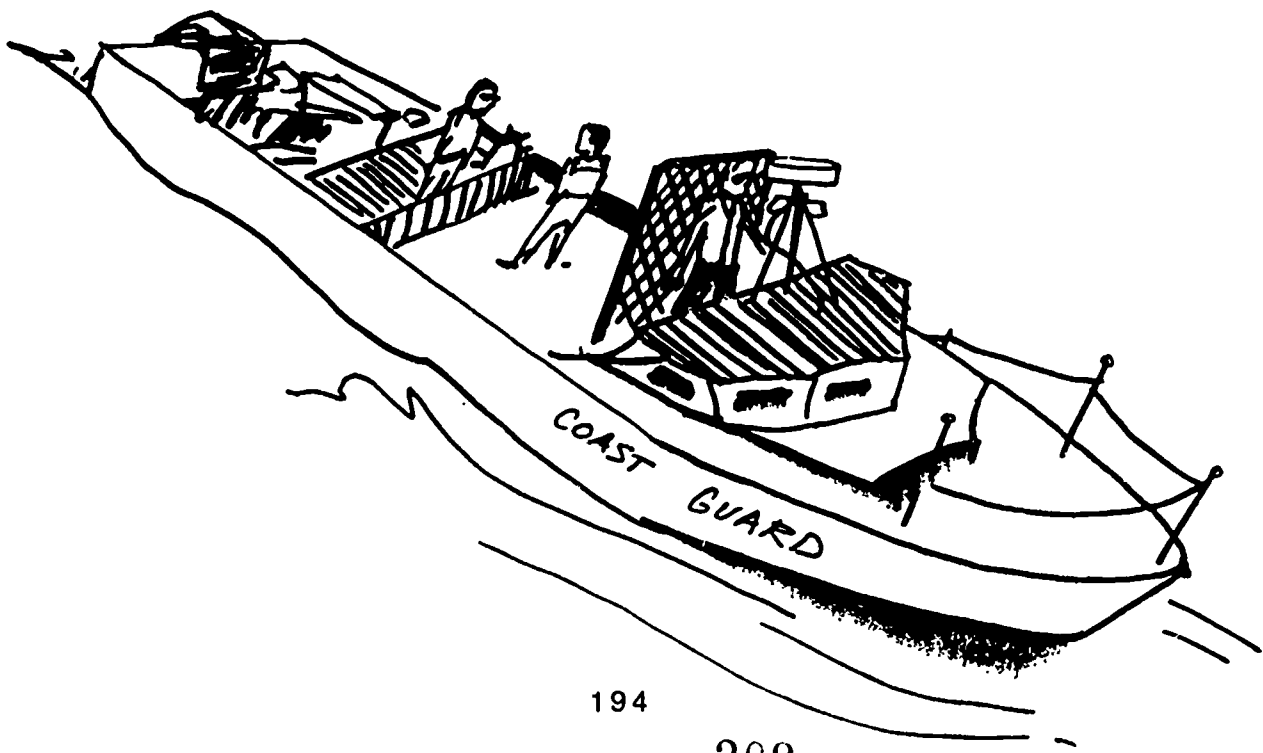

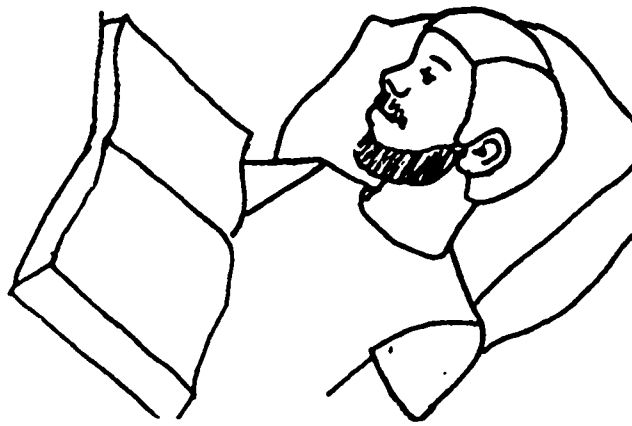

Sue: I have learned a lot from you, but where did you learn everything you know?

Mike: Most of us learn through on-the-job training, which is called "striking" for a position. "Striking" means having to go through an apprenticeship training. If you wanted a boatswain's mate position, you would have to learn while working with a boatswain. After getting experience from working with the boatswain, you would then take a test. I started out as a seaman's apprentice.

Sue: Can you get ahead in your job by going to school instead?



Mike: Some people go to the Coast Guard Academy for four years. All Coast Guard schools are on waterways, and you can get lots of experience there. Other schools take less time, like boatswain's school which only takes twenty weeks and gives you experience plus school studies.

Sue: School studies?

Mike: You bet! Reading is important in the Coast Guard. And we have to write about what we've done to the buoys. We use math to read charts and take careful measurements of where the buoys are at all times. Knowledge of longitude and latitude are useful for this. A buoy in the wrong place can be very dangerous.

Sue: I like the kind of work you do. I love water, and I would like to learn some new skills. Thank you for this interview.

Mike: You're welcome, and maybe I'll see you on deck someday!

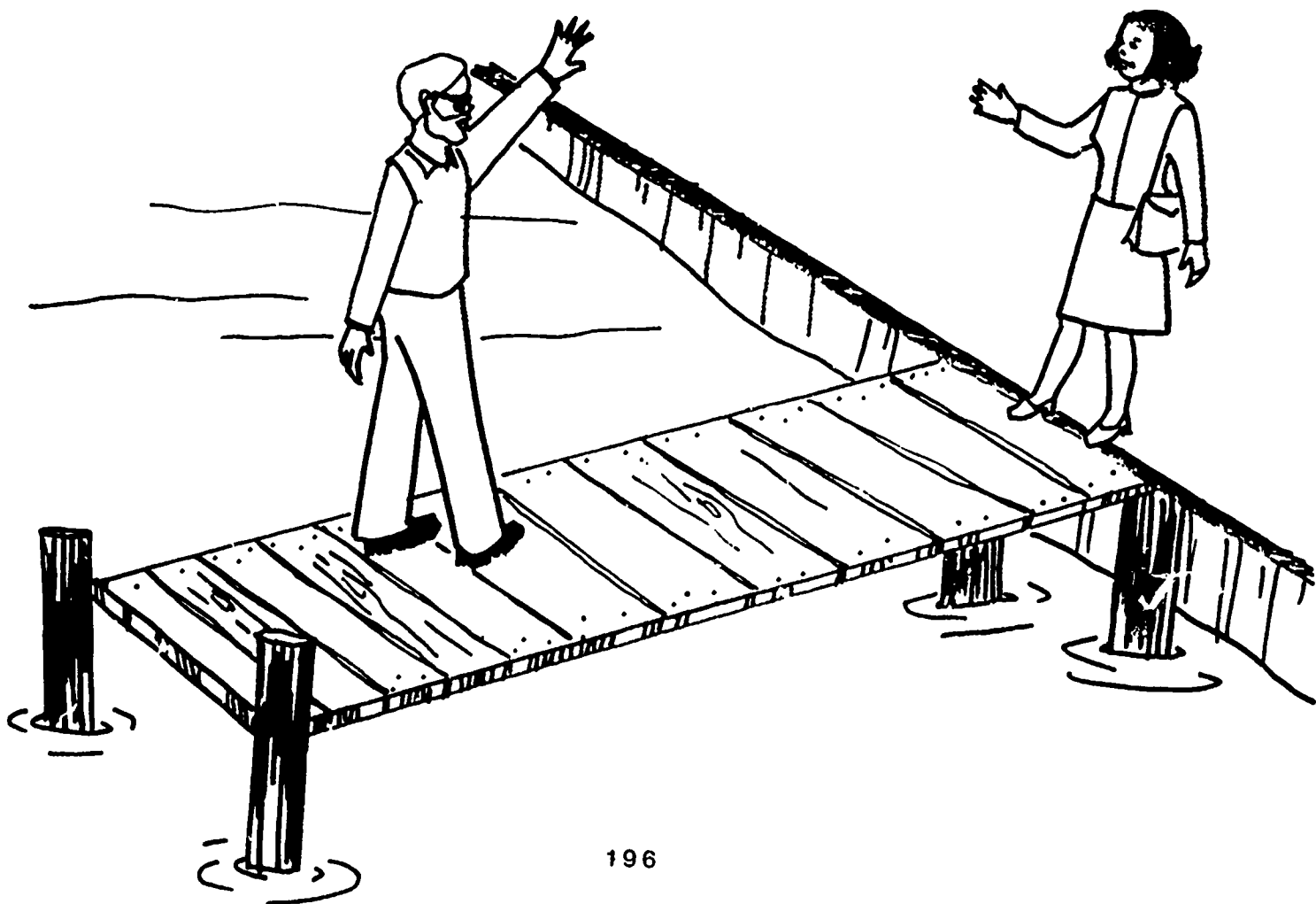

QUIZ YOURSELF:

Coast Guard Boatswain's Mate

What are three tasks or responsibilities of a Boatswain's Mate?

Name three tools or pieces of equipment used by a Boatswain's Mate on the job. What is each used for?

What is one way someone can get the training needed to become a Boatswain's Mate?

Where do Boatswain's Mates do their work?

How do Boatswain's Mates use math and reading skills on the job?

COAST GUARD QUARTERMASTER

The Coast Guard Quartermaster uses four different methods (Celestial Navigation, Dead Reckoning, Piloting, and Electronic Navigation) to NAVIGATE or GUIDE THE COURSE OF A SHIP. Navigation includes determining or figuring out:

- 1) the course or pathway of a ship,
- 2) the ship's position or "fix",
- 3) the distance to a ship's destination,
- 4) the distance traveled by a ship.

Read the definitions below; then enjoy this poem which describes life as a Coast Guard Quartermaster. Use a dictionary to look up the meanings of other unfamiliar words.

compass: a guage with a swinging needle which always points to the magnetic North Pole.

craft: a boat or ship.

E.T.A.: estimated time of arrival.

kingposts and beams: important supporting posts in a ships's "rigging" (system of useful chains, lines, and ropes).

starboard: the right side of a craft. The left side of a craft is called port.

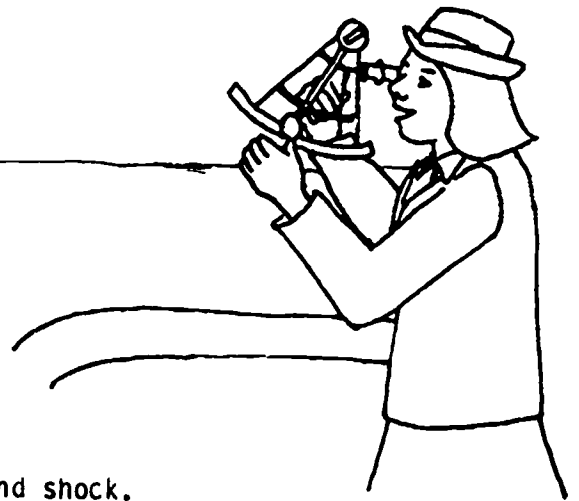

CELESTIAL NAVIGATION is an ancient way

To guide a ship by night or day.

I use a sextant to calculate the altitude of stars;

Other aides are the sun, the moon, and planets like Mars.

I use the sextant's mirrors, and I calculate and mix

The numbers on the sextant to determine our fix.

The sextant's used with a very accurate clock

Called a chronometer, protected from temperature, change, and shock.

It takes training, practice, and lots of skill in math

To let the heavenly bodies help you plot out your path.

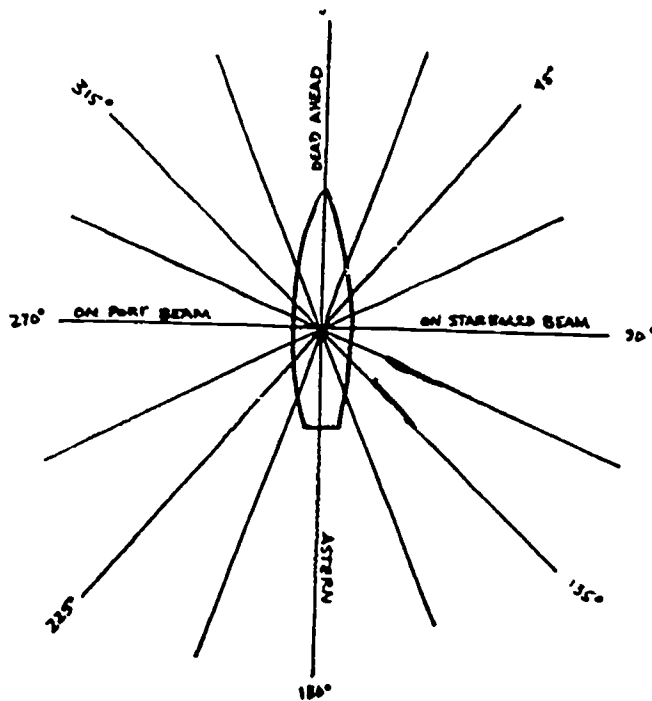

DEAD RECKONING is a way of using geometric degrees

To determine our fix, and get on the course we please.

Three hundred sixty degrees forms a circle; 0 degrees is "dead ahead."

Ninety degrees means "starboard beam," as you've already read.

The name of this system is "relative bearing";

It's more than handy for crafts which are seafaring.

When reckoning, I measure the distance between each fix with care,

And try to follow the course I set, precisely.

Using compasses which point north, I get to know where

South, east, and west are, very nicely.

I use charts which are maps of our shore and waterways,

So practice in map-reading skills really pays.



I use PILOTING aids like buoys, landmarks, and light
To help me navigate into harbors and inlets that are tight.
I measure the depth of the water with lead lines, or sound,
And an echo sounder keeps the ship from going aground.
You see, the time it takes for sound waves to reach the bottom and come back
Is measured by this Fathometer, which no large ship should lack.

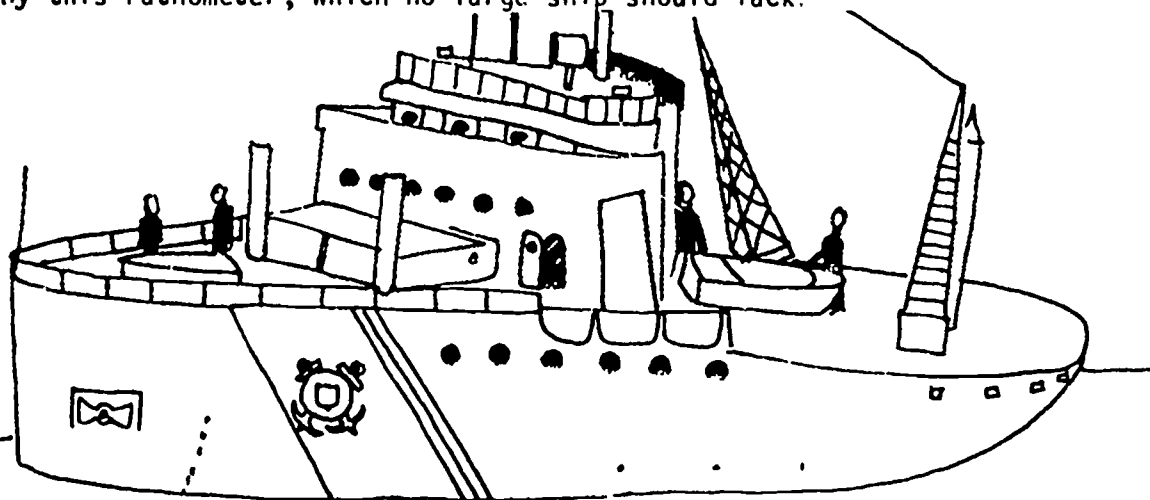

ELECTRONIC NAVIGATION uses Radar and Loran.
These systems help us determine our fix and our course, or travel plan.
Radar picks up radio waves reflected from objects at sea.
Using Loran, signals from outside stations help us find our fix, you see.
As quartermaster, I spend time on deck where the kingposts and beams are erected,
And in the control room and pilot house, with equipment that must be protected.
Though I work aboard ship most of the time, I've got one land-based working chore,
Using radio signals from the station house, I guide nearby craft to shore.

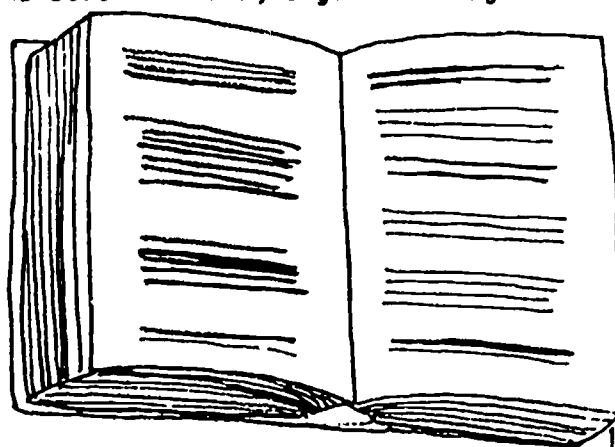

I keep a daily travel log, in which I write a review of each day.
I read tables and books describing the tides, and shorelines of ocean, and bay.
I do special problems, measure distance, time and speed;
To figure out an E.T.A., I use precise measurements, indeed.
For those who like the sea, and mathematics, I recommend this work.
I use math daily at most of my tasks, more than any sales clerk.
I "struck" for my position here, a kind of on-the-job training.
And between my studies, and my daily tasks,
There's no end to the knowledge I'm gaining.

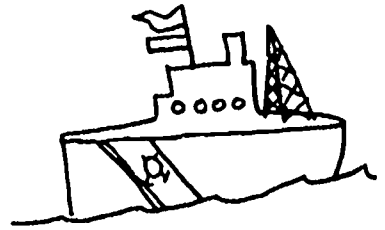

QUIZ YOURSELF:
COAST GUARD QUARTERMASTER

What are four different methods of navigating a ship?

Name one tool or piece of equipment for each method of navigation used by a Quartermaster. How is each used?

Where can someone get the training needed to become a Coast Guard Quartermaster?

Where does a Quartermaster work?

Name the ways a Quartermaster uses math and reading skills on the job.

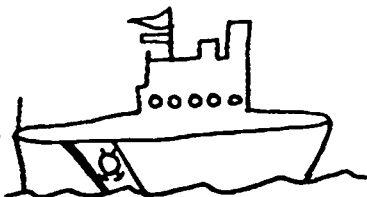

Fish Hatchery Technician

Fish Hatchery Technicians raise fish. The fish can be kept in man-made or natural areas. Much care is taken to control and manage the place where the fish are kept.

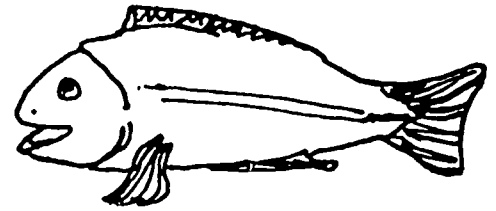

SKILLS AND TASKS:

Fish hatchery technicians clean and repair indoor and outdoor waterways, such as ponds. These ponds are built for raising and breeding fish. The technicians take care of the fish and fish eggs. They feed the fish, treat them for disease and keep the water clean and healthy. The technicians also hatch and raise broodfish, or large groups of young fish. Many times the fish are moved in order to stock ponds and lakes. They must help fish adapt to these new living conditions, too.

The technicians must keep careful records of their work and what they observe. These records may be used by other scientists who study the fish.

CHANCES FOR ADVANCEMENT:

With a lot of work experience, a technician may become a wildlife refuge manager or a fish hatchery manager. More advanced jobs like conservationist, game technician, or animal control biologist need college study.

TRAINING:

The training and experience needed vary according to the work place. High school studies are always needed. For some jobs college study of biology and environmental science is needed, too. Only those with college degrees will be considered for advanced positions. To work for the government you must pass a civil service test. In all cases a physical exam must be passed.

WORK PLACES:

Fish hatcheries — both private and government run.
May work with other scientists like biologists or conservationists to do field studies of natural bodies of water.

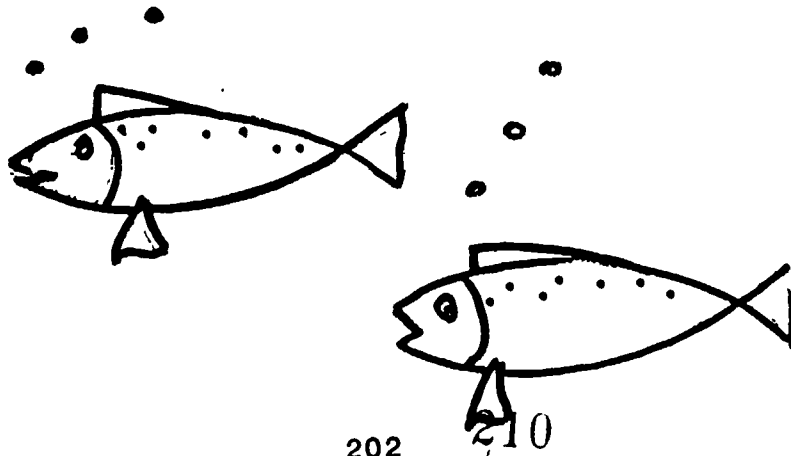

TOOLS AND EQUIPMENT:

Screens — to keep fish in certain places.

Screen-cleaning brushes.

Slurp gun — to catch small fish.

Long handled dip nets.

Seine — a long net pulled by a boat and used to catch large groups of fish.

Trap nets.

Hoop nets.

Shovels, hammers, screwdrivers, and saws to repair the places where fish are kept.

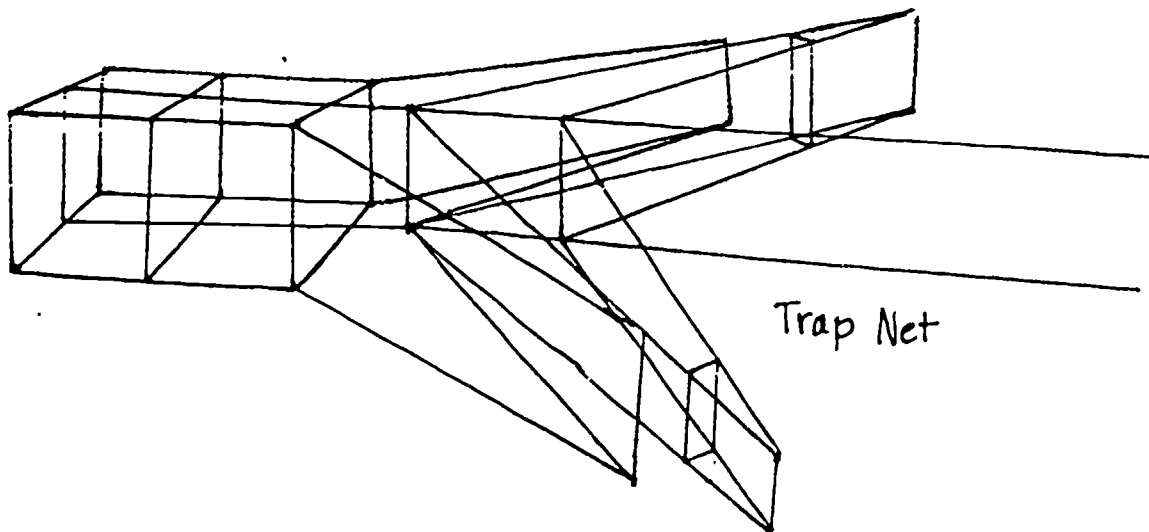
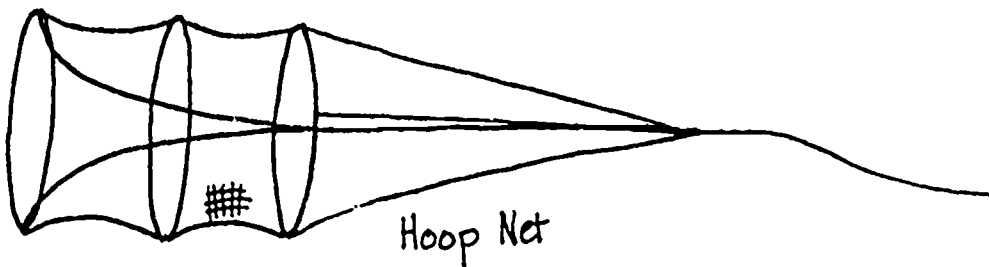
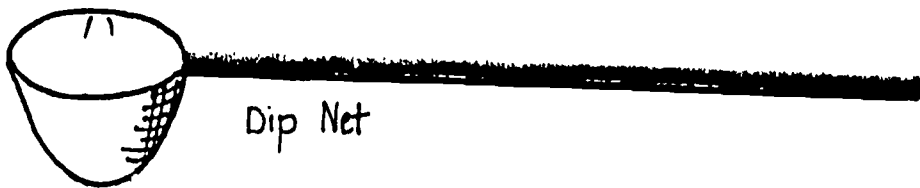

USE OF MATH AND READING SKILLS:

Math skills to keep records.

Reading skills to keep up to date with new information.

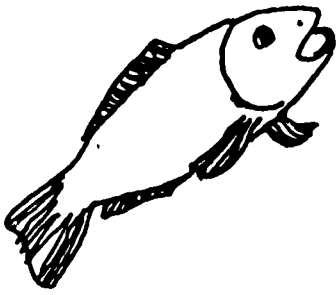

FISH HATCHERY TECHNICIAN QUIZ YOURSELF

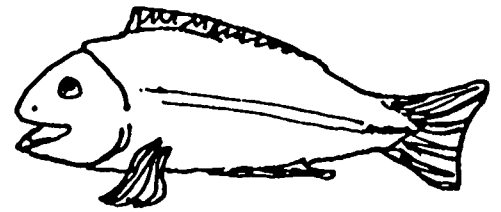

What are three on-the-job skills and tasks practiced by fish hatchery technicians?

Name three tools or pieces of equipment used by fish hatchery technicians, and one use for each.

Where do fish hatchery technicians work?

Describe the training needed by fish hatchery technicians.

How do fish hatchery technicians use reading and math skills?

Name one possibility of advancement for a fish hatchery technician.

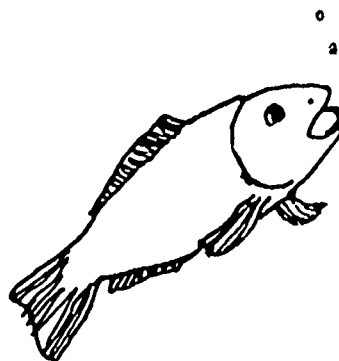



A FISH RETAILER TALKS ABOUT...



FISHY BUSINESS

Sea trout, sea bass, ocean perch and scrod,
Blue fish, red snapper, whitefish and cod.
All of these and many more,
Can be found in this fish store.

I work here cutting and cleaning each day
The fish that arrive from the ocean and bay.
Lakes, rivers, streams, and brooks,
Also hold fish prized by eaters and cooks.

Some people like their fish whole,
And some just like the fillet.
My job is to get either ready for them,
And do it without delay.

Fish is high in protein and minerals.
Each kind has its own special taste.
I know how to cut it correctly and fast,
With the least amount of waste.

Now cleaning a fish is not too hard,
But lots of practice it takes.
With knives, steel, and scrapers I must stay on my guard,
So I don't get cut or make mistakes.

During every working day, I work at gutting, scaling, filleting, and boning,
For each task there is a special knife which needs sharpening or noning.
For this, I use an oil stone or sharpening machine,
To keep my knives and my cleaver razor-sharp and clean.

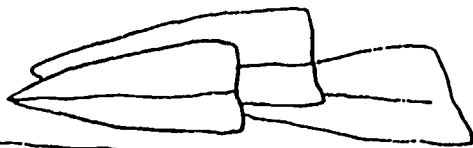

A clean cutting board and coolers, wrapping paper, and a sink
Help me do my work with the last amount of stink.
I use a large white apron to cover all my clothes,
So that when I go home, my wife doesn't have to hold her nose.



Working in the fish market is really quite pleasant,
Even though there is a fishy and salt water smell.
I get to meet all kinds of people,
Who see that I do my job quite well.

Being pleasant and helpful is part of my work;
Besides being a fish cleaner, I'm also a sales clerk.

I put math to work daily using cash register and scales,
And I must also be friendly if I expect to make sales.
I figure out wholesale and retail prices,
Based on the cost of fish to the store.
This includes a percentage plus profit.
After a big fish delivery, this can be quite a chore.

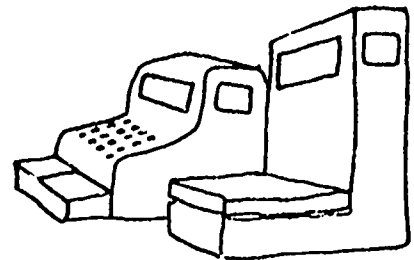

This work is learned through on-the-job training.
Once you master it, you have a good trade.
Learning may take anywhere from one month to ten,
But when you're good you have it made.

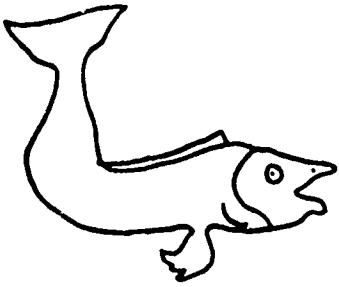

QUIZ YOURSELF:
FISH RETAILER

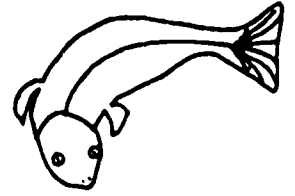

Name three on-the-job skills or tasks of a Fish Retailer.

Name three tools or pieces of equipment that are necessary for a Fish Retailer to do the job, and one use for each.

Name and describe one training place.

Name one place where a Fish Retailer works.

Since a Fish Retailer may not do much reading on the job, name two ways that math is used on the job.



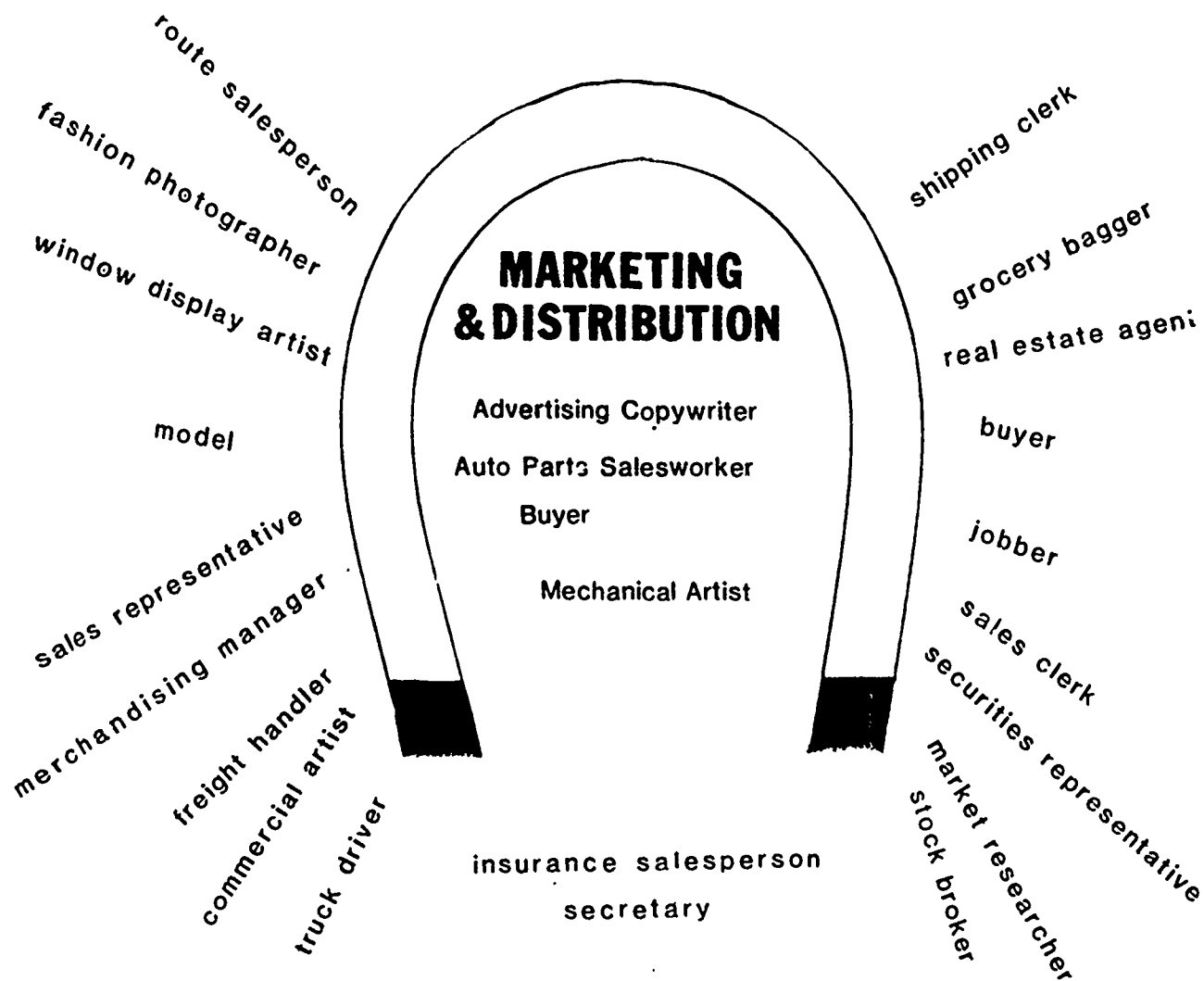

Workers from the Marketing and Distribution cluster package, advertise, and transport goods and services to make them available to customers.

Advertising Copywriter

Writes the words for advertisements. The "ads" help sell products and services for the clients of the advertising agency.

On-the-Job Tasks

Gets a job from a client or from the account executive. In a large ad agency the account executive gets all the jobs. The account executive gives the jobs to the ad copywriters.

Works with the client. Finds out what kinds of people the client wants to sell to. Does research on the possible buyers. Some copywriters specialize in selling one type of product or to one group of people.

Thinks about the product. "How does it help people?" "Why is it needed?"

Tries to find the "big idea." That is something that will make people want the product.

Decides what to say in the ad.

Writes many drafts. Each draft shows one way the item might be presented in an ad.

Meets with the art editor. The art editor does the picture layout for the ad.

Meets with the account executive to discuss final "draft." The account executive must approve the draft before it can be shown to the client.

Uses the approved draft and the artist's pictures to make a "storyboard." The storyboard shows the words and pictures as they will appear in the final ad.

Times the final script to check that it is not too long.



Training

College degree in liberal arts, business, or English.
Special college classes in copywriting or advertising and marketing.

READING AND MATH USED ON THE JOB

Reads for ideas:

magazines, books, microfilm, microfiche, library documents, and other ads.
Uses math to time ads and commercials.

Job Skills

Writing, with special attention to grammar and spelling

Imagination

Sales ability

Enthusiasm

Ability to meet deadlines under pressure

Advancement

Creative supervisor

Account executive (works closely with advertising managers of client firms)

Copy chief

Advertising manager

Work Conditions

Advantages:

Work is different each day.

Works both alone and with others, usually in pleasant office surroundings.

Medical insurance, vacation and sick time benefits are available to non-
full-time advertising copywriters.

Disadvantages:

Advertising deadlines cause a pressured work environment and often, irregular
work hours.

Tools and Equipment

Library called "information retrieval system," found in business libraries. (This system has information about products and industries.)

File index for information retrieval system.

Microfilm, microfiche.

Magazines, books, ad catalogs.

Slides.

Tapes.

Typewriter.

Stopwatch to time spoken ads or commercials.

Photos of models used for different commercials.

Video equipment for casting commercials.

Resume and a portfolio of written work.

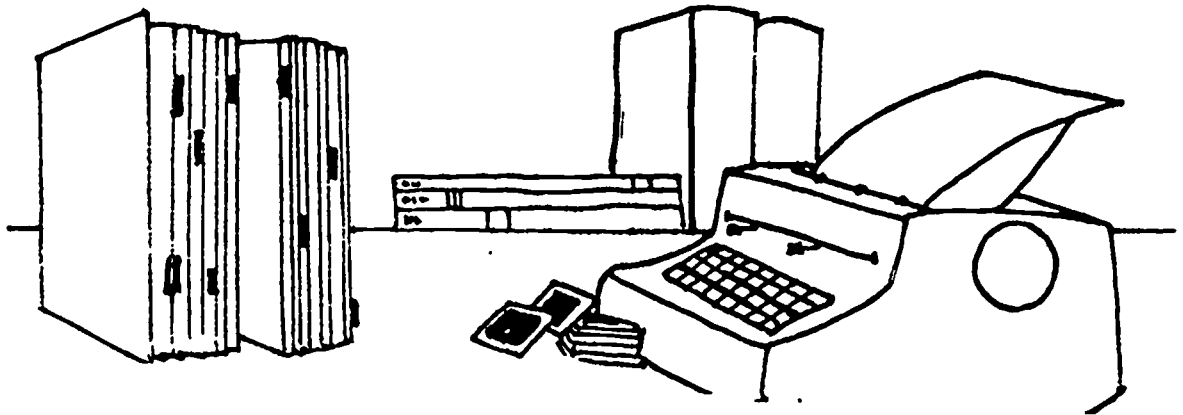

Work Places

Ad agencies pay highest salaries and include work in many other places such as:

offices of clients,

business libraries,

meetings out of town.

Department stores,

manufacturing companies, and

shopping centers also hire advertising copywriters to write their own ads.

Free lance copywriters may write at home.

COPYWRITER QUIZ

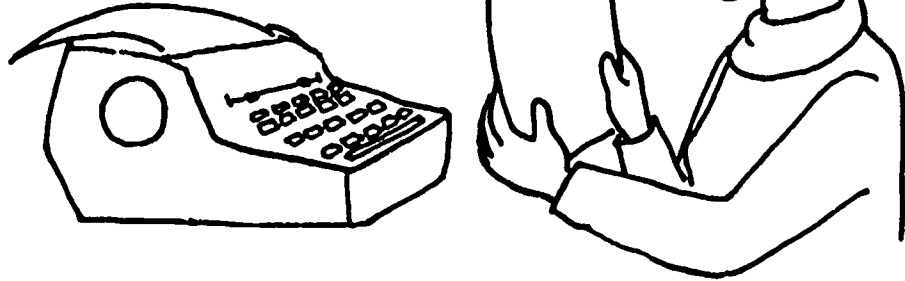

Name 3 skills and on-the-job tasks of an advertising copywriter.

Name 4 tools or pieces of equipment that advertising copywriters use on the job.

Name 3 places where advertising copywriters may be found at work.

Describe the training needed by an advertising copywriter.

Name 3 important skills needed by advertising copywriters.

Name one advantage and one disadvantage of working as a copywriter.

What are some of an advertising copywriter's chances for advancement?

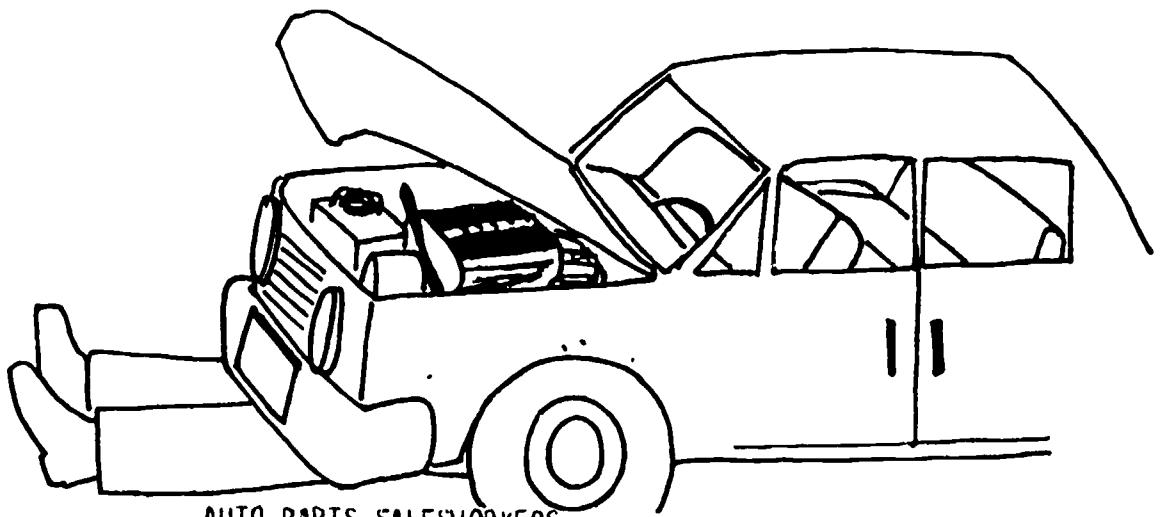

AUTO PARTS SALESWORKERS

We sell replacement parts and accessories for vehicles of all kinds, including cars, trucks, tractors, and boats. So we really use our minds. We must be familiar with the parts stocked in our store, so we do inventory. When we're out of something, we order more. We use parts catalogs, and tune-up "specs," and refer to lists of prices. We also keep records of the sales we make, and use the following devices: When auto service stations need work done on flywheels or brake drums, we use screwdrivers, wrenches, and lathes. So you see, we can't be all thumbs. When an auto part is not in stock, we might substitute another, using micrometers which measure very well. We use hand trucks to help us stock the shelves, and wrapping paper for items we sell. We also use spark plug testers, and machines to rivet brakes, fan belt measurers and calipers; while measuring, we can't afford mistakes.

We file technical bulletins and update catalogs, so we must know how to read. Being patient and polite with customers is another skill we need. We use math often for measuring parts; and to figure bills, we add. It's interesting work. We meet all kinds of folk, and working conditions aren't bad. The store is clean and well lighted, and there's always plenty to learn. And though we must often work 50 hours a week, that means overtime pay we can earn. In auto parts sales, there's so much to do with parts, books, vehicles, and people too.



One disadvantage to this work is long hours of standing,
And sometimes customers get impatient and very demanding.
We also have to spend some time each week "housecleaning" with a broom,
But this helps us to know the store better, and gives us more work room.

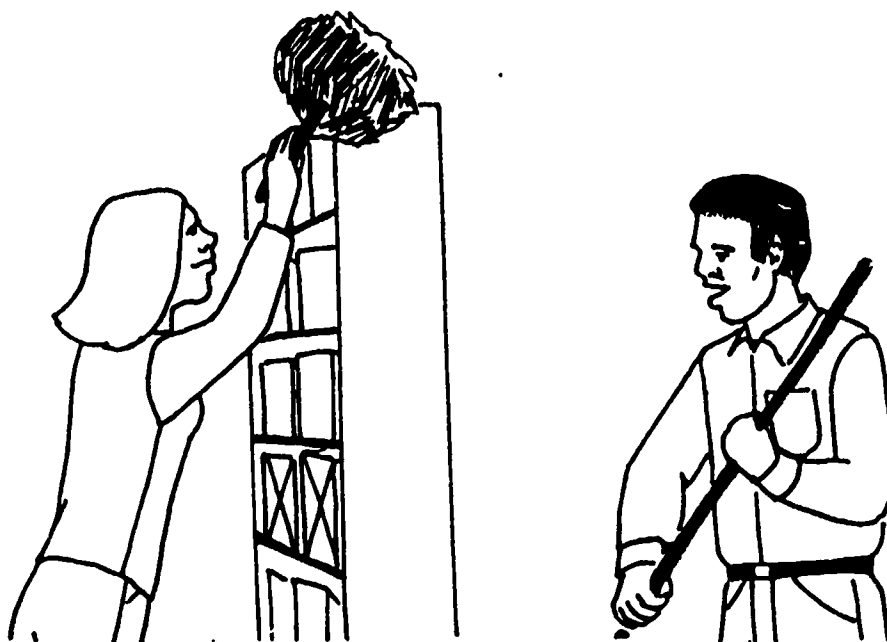

At most shops, there's medical insurance, holidays, and paid vacation,
And there are jobs for auto parts salesworkers all over the nation
At wholesale shops and retail stores,
Stores with automotive departments, auto dealers, and more.
In a city, you might work for a truck or bus line,
Or a warehouse parts distributor might suit you fine.

For this work, it helps to be familiar with the uses of auto parts.
Courses in auto mechanics, and work on your own car are good training starts.

Your shop may also sponsor a course in sales skills and attitudes.
This is important at any sales job, because you'll lose customers if you're
rude.
Business math comes in handy, and bookkeeping can help you advance.
And even if the first few months, you just deliver stock,
With sales skill and know-how, you'll have a chance
To manage an auto parts department, or a whole auto parts store,
Or be an on-the-road salesworker selling to garages door-to-door.
Getting really familiar with this work takes a year or two,
But auto parts saleswork has a good future,
And it just might be right for you.

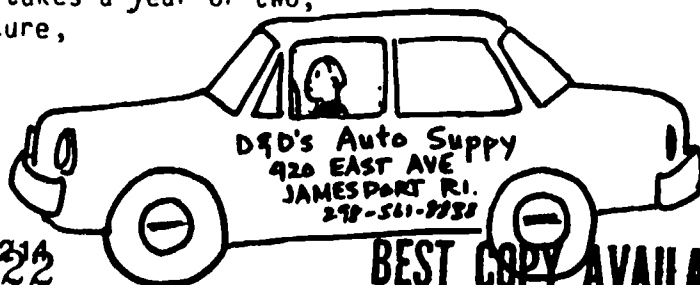

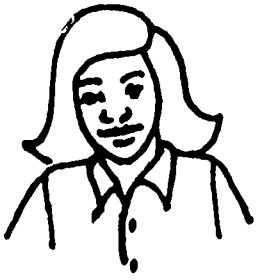

AUTO PARTS SALESWORKER:
QUIZ YOURSELF

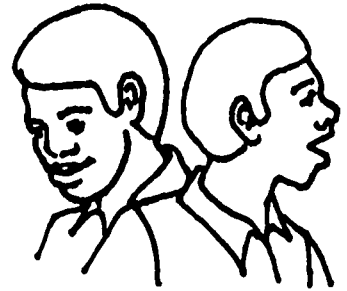

What are some of the on-the-job skills and tasks practiced by auto parts salesworkers?

What are some of the tools or pieces of equipment that auto parts salesworkers use on the job? Name one use for each.

Name two places where auto parts salesworkers can be found at work.

Where can auto parts salesworkers get the training they need?

Describe how auto parts salesworkers use math and reading skills on the job.

Name one on-the-job hazard and one advantage of this type of work.

What's one possibility of advancement for auto parts salesworkers?

Hi, I'm Francis George and I'm here to see Ruth Romano, the buyer.

Hello, Frank, I'm Ruth Romano, the Clothes Town buyer. I'm happy to tell you about my work here. It is my job to keep the store stocked with the styles, colors, and quantities of dresses, skirts, blouses, jackets, and undergarments at prices it can retail. Before placing my orders, I visit the show rooms and talk to wholesalers to learn what will be available.

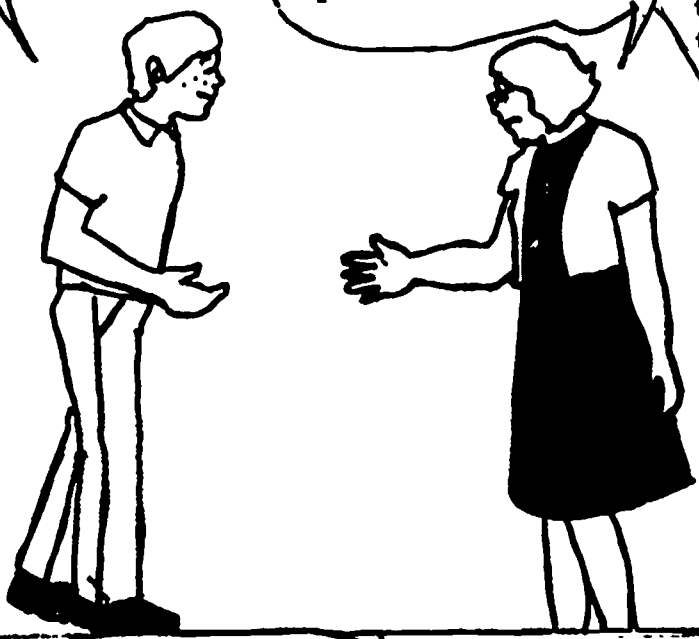

Wholesalers are people who sell things in large quantities. For instance, I can't buy just one blouse from a wholesaler. I buy a lot of them. However, I pay less for each one because I buy a lot. Retail means to sell one of the blouses to a customer. The customer pays more for the blouse than I paid the wholesaler for it. That's how stores make money.

Who are wholesalers, and what does retail mean?



You use math skills a lot in your work, don't you?

Yes. I especially use multiplication and division skills to calculate costs, income profit and losses, and percent is important too.

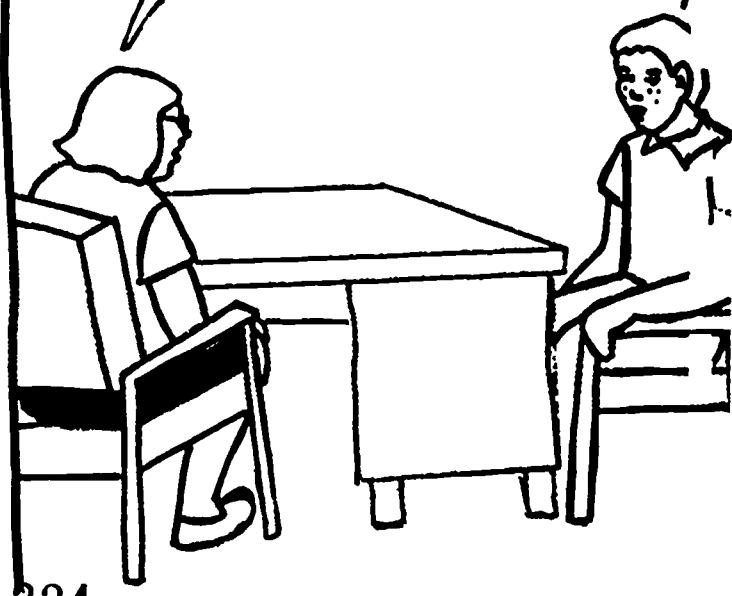

Do you do all the math in your head?

Not very often because I usually use this hand calculator. Sometimes I use paper and pencil. But paper and pencils are most useful to me for making lists of people's names, addresses, and phone numbers, noting what items are being wholesaled, and what kinds of clothing our customers request.

Your work requires a lot of attention to details, doesn't it?

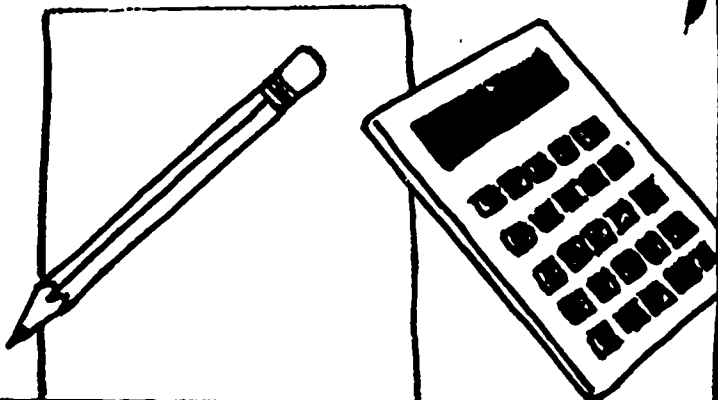

Yes. And it takes a lot of reading, too. I read catalogs, brochures, and fashion magazines to know what styles of clothing experts suggest should be bought.

You really do a lot of different things on the job. What do you like to do the most?

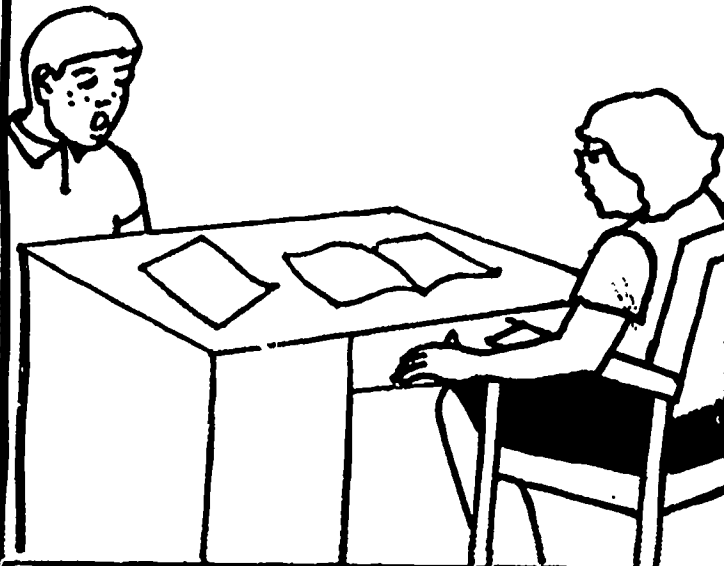

Well, I like to travel to showrooms to see all the goods they have on display, then I can select the merchandise for the store. Most showrooms I visit are in New York City. The best part of this job is called merchandising. It is the creating of advertising and the planning and setting up of clothing displays. I put my sense of color and form to work to create attractive, beautiful advertisements, window displays, and in-store exhibits.

Where did you learn how to be a buyer?

I took a home economics course in high school. I learned about buying careers. I took art courses in college to learn about design and color. Business courses were an important part of college, too. I also studied how to organize a wardrobe. The best place to learn is right here on the job. I learn new things every day.

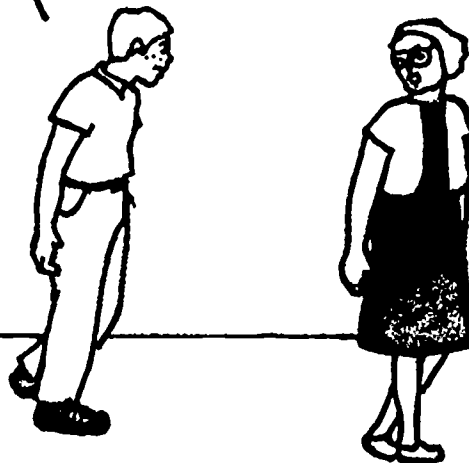

It sounds like you really enjoy your work. Is there anything you don't like about being a clothing buyer?

Well, when I have to work standing up all day, my feet hurt, but that doesn't happen often. Nearly all the time I find my work interesting, challenging, and fun. There are good opportunities for advancement too; for example, into a larger store with a greater variety of merchandise.

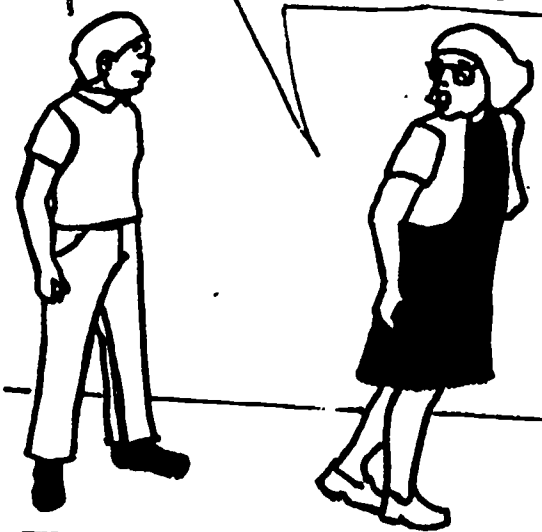

Do you possibly need a beginning buyer's assistant?

Why, are you looking for a job? Hmm . . . maybe. Let's sit down in my office and talk about it.



QUIZ YOURSELF: BUYER

Answer the questions below. Reread the story to find answers you do not know.

Name 3 of my tools or pieces of equipment and one use for each.

Name one of my training places.

What are 3 of my on-the-job skills or tasks?

Name one of my work places.

LENA ROSS, MECHANICAL ARTIST:

ADVERTISING BEHIND THE SCENES

Hi. My name is Jerry and I am interested in an artistic career which will give me an opportunity for advancement. I talked to my guidance counselor about what I want. He said I should make an appointment to speak with Lena Ross. She is a mechanical artist who does "layout and paste-up" at a small print shop. I didn't know about layout or paste-up, so I asked about those first.

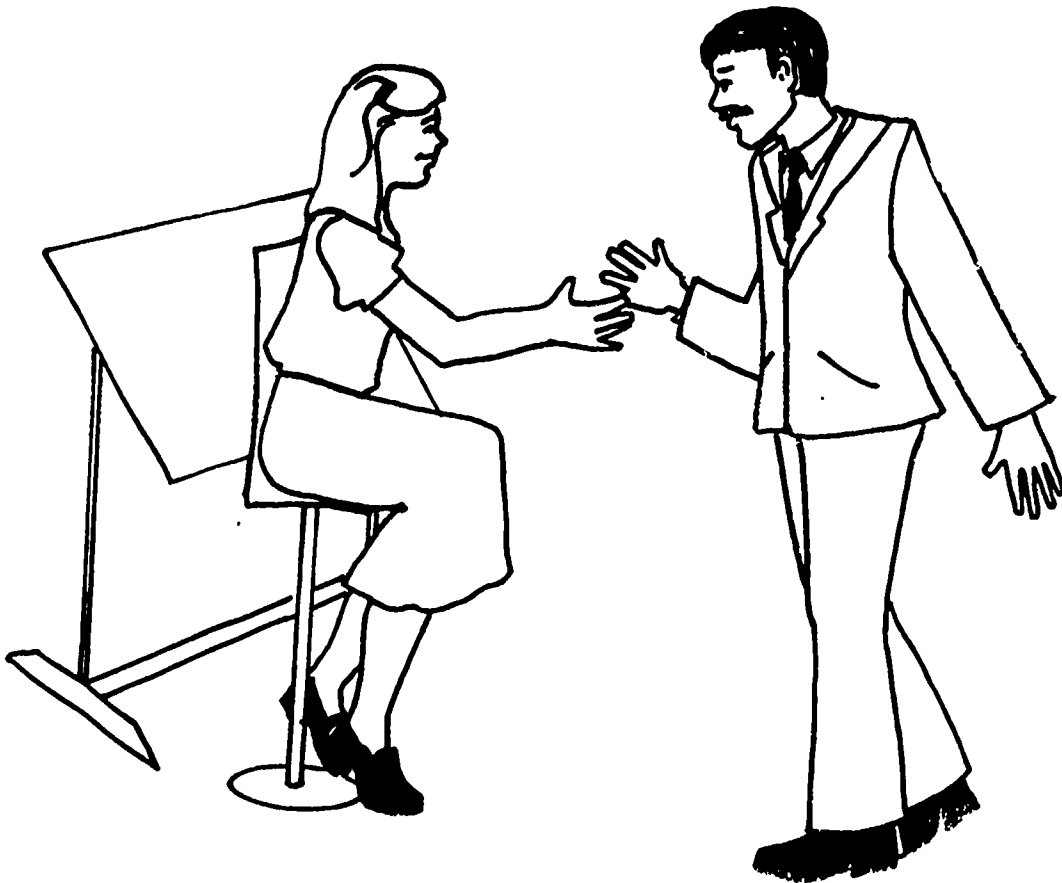

"Lena, what is layout and paste-up?"

"Layout is placing copy and pictures on paper. When an artist does 'paste-up,' she is pasting the words and pictures on a piece of paper. A finished product is called 'camera ready copy.' This means that the work is ready for the printer."

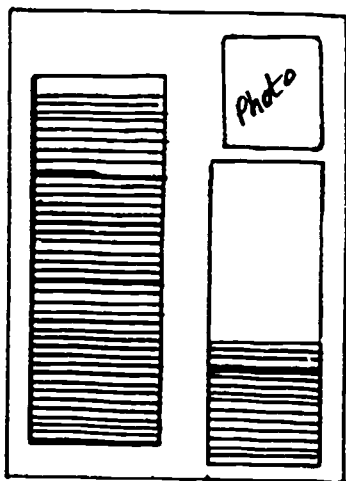

"What kind of words and pictures do you design?"

"Here at the shop I design business cards, newsletters, and advertising flyers."

"Lena, I've been reading. The Marketing and Distribution work cluster involves advertising. How does your work fit into Marketing and Distribution?"

"Advertising means getting people interested in what you have to say. I work hard to make my copy look attractive so that people will be interested in my client's product."

"I know that photographers and copywriters are advertising workers. I never really thought about the people who arrange the pictures and words."

"Mine is a behind-the-scenes job. I work alone. I use a light table, typesetting machine, and other tools. If you have time to watch me do my job from beginning to end, you can see what tools I use."

"First I read the 'specs' (specific instructions for the layout) and copy. These both come from the client. There are times when a drawing or photograph is included in the 'specs.' Other times, I draw a picture or choose a photograph from a special catalog. The next step is drawing the mechanical."

"The mechanical?" I said.

"Yes, that's the outline I'll use when laying out the pictures and copy. Before I draw a mechanical, I must divide the paper into sections. I want the copy and pictures to be well designed, and that means having an ad, for example, well spaced so that the layout won't look crowded."

"Lena, do you have to measure the page, copy and pictures first?"

"Oh, yes. I use basic math skills often. I divide the mechanical into units called 'picas.' I choose the size print that fits into the picas. Then I choose the style of print that seems appropriate. Next, I use a typesetting machine or, what we call at the print shop, a composer, which is like a typewriter. It spaces the words in the size and style I choose. The words must be typed on a special film paper. The paper is developed and is then ready for paste-up."

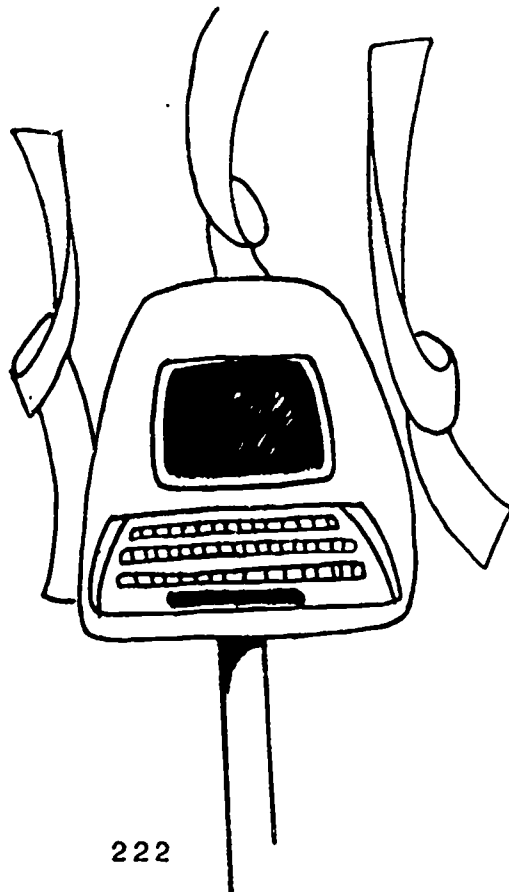

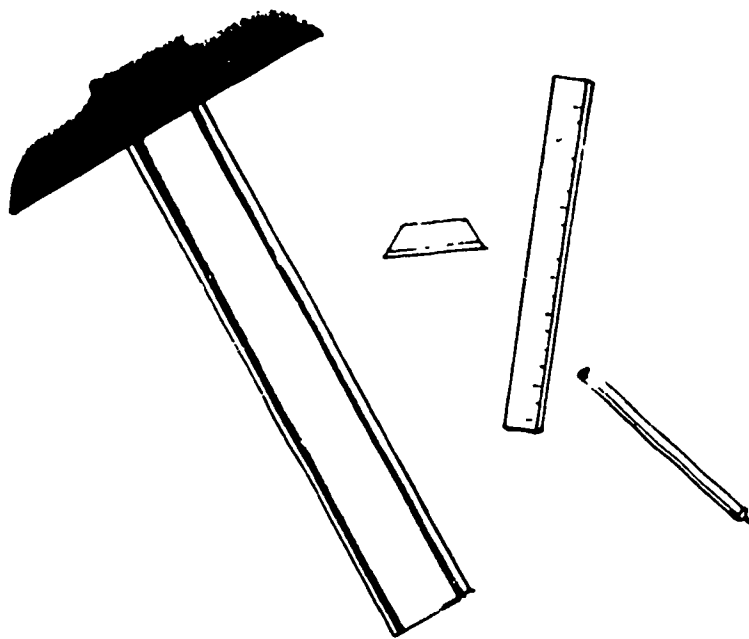

"Do you use paste or glue for paste-up?"

"At the ad agency I used rubber cement, but here I use wax. I prefer to use wax because it can be easily removed. If I see a mistake or change my mind about something that I've just pasted up, I can peel it off. The wax machine melts the wax and applies it to the paper evenly."

Near the light table I saw rulers, razors, and other tools. Lena used scissors to cut out printed copy so it would fit on the mechanical. She used a T-square to make sure the lines of the copy were straight. She drew a border with a fine-point ruling pen. Lena then carefully read the copy she made.

"I do proofreading, and so I use my reading skills. A mistake in one word can lead to all kinds of trouble. Clients may refuse to pay for work that has a mistake in it. This could be bad for the print shop, so I have to be really careful."

"Lena, what about art and other skills?"

"Well, it helps to be artistic. A mechanical artist should enjoy designing pictures, and copy should look attractive. After five years of this work, I have developed a 'good eye.' A good eye helps me to center the copy and line things up just by looking at them. Since I do lots of jobs every day, speed is important."

"Lena, I want a career with many opportunities for advancement. Would you say that a mechanical artist has a good chance at this?"

"Jerry, that's one of the advantages in my work. A mechanical artist can find employment at print shops, newspaper and book publishers, and ad agencies, to name a few places. You can start a career at a print shop or agency. There you can get on-the-job training as a paste-up assistant. As you learn new skills, you'll take on more responsibilities. In a few years you may become responsible for all the layout and paste-up work at the shop. Also, you can get training for this type of work at community colleges."

"Lena, how long would a person have to go to college?"

"A program lasts two years. As a mechanical artist, I learn new skills and shortcuts daily. At this type of job, you never stop learning."

"Do you have plans for advancement, Lena?"

"Yes, one day I'd like to supervise the art department at an ad agency or large print shop. I'm preparing myself to become an art director by working hard and reading the trade magazines. Trade magazines help me keep up with new trends in my field. These magazines also help me to find out about other jobs and their requirements. When I see a job that I'm interested in, I send a cover letter and resume to the employer."

"You seem to be well informed about your field. What are some of the hazards or disadvantages of this type of work?"

"Well, I have to watch out for sharp objects like razors or scissors. Doing such close work, my eyes can get tired. I also spend most of the day bent over this light table. It's very tiring work. It's not the type of work for someone with a bad back. But, it's a clean, well-lit place to work. Another benefit of this job is the paid holidays, sick time, and medical insurance. But most of all I love this work because every day is different. As long as there is work to do, I never get bored. The pride I take in my work makes me feel good about myself. Designing copy and pictures is my reward."

"Gee, Lena, I've learned a lot today. Thanks. Do you know of any place that's looking for a paste-up assistant?"

"Try Broadway Printing. You can earn while you learn there, if they're hiring. It was smart of you to meet someone in the field of your interest. Good Luck!"

"Thanks again."

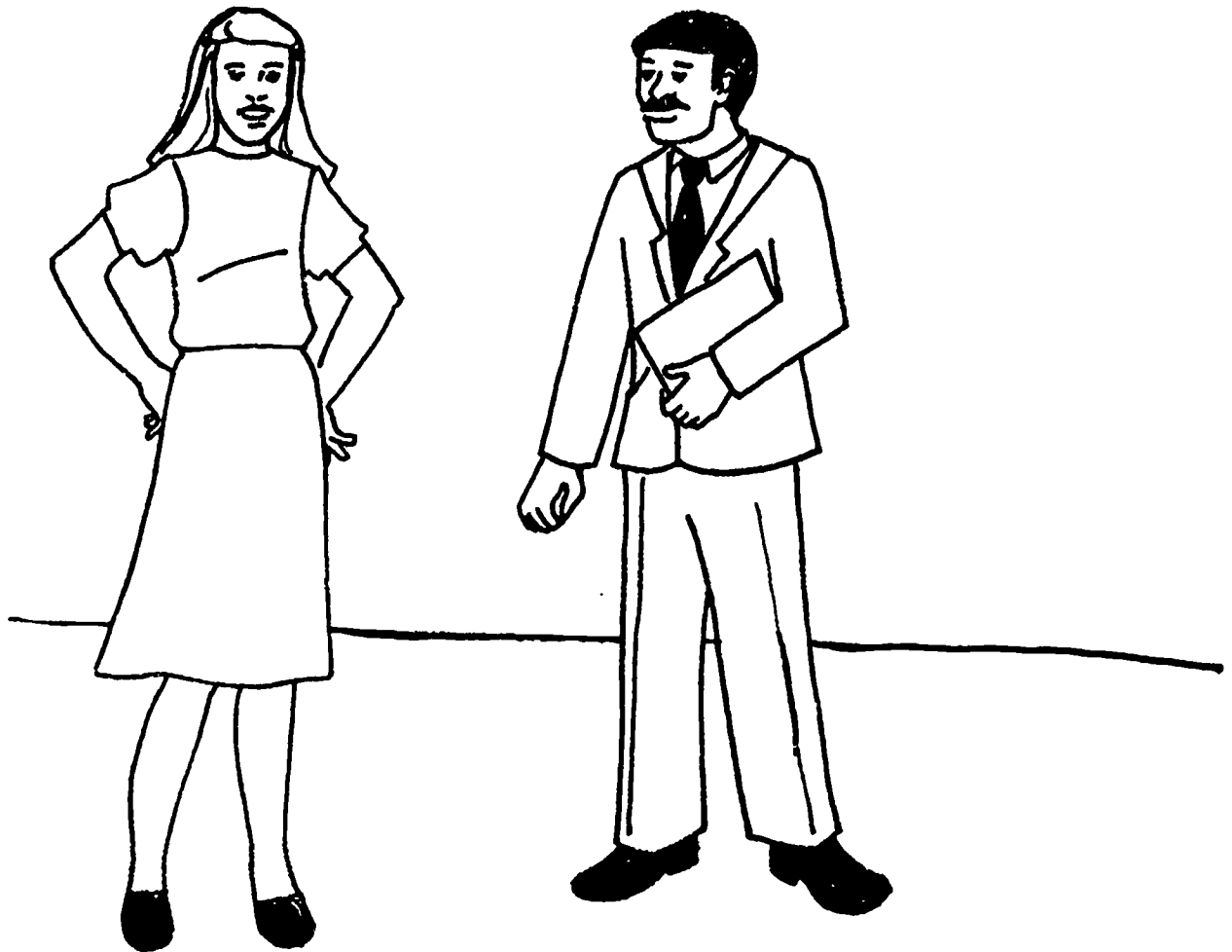

QUIZ YOURSELF:
MECHANICAL ARTIST

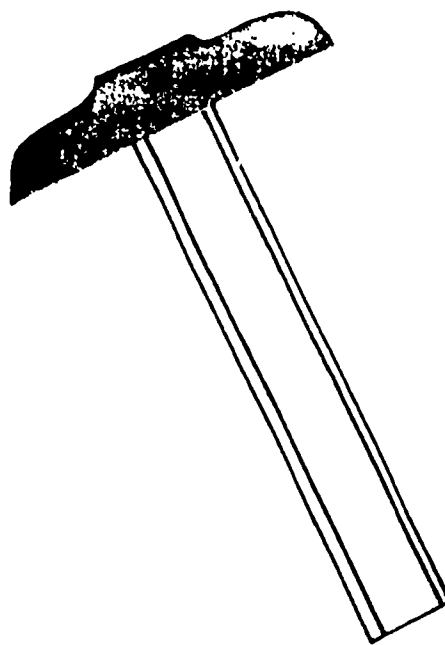

What does "layout" mean?

What does "paste-up" mean?

Name three of a mechanical artist's on-the-job tasks.

Name three tools or pieces of equipment that Lena uses on the job, and describe how each is used.

How do mechanical artists use reading and math skills at work?

Describe two ways of getting the training needed to be a mechanical artist.

Name three places where a mechanical artist might work.

What are two advancement possibilities for a good mechanical artist?

Name one benefit and one on-the-job hazard that Lena mentions when she talks about working conditions.

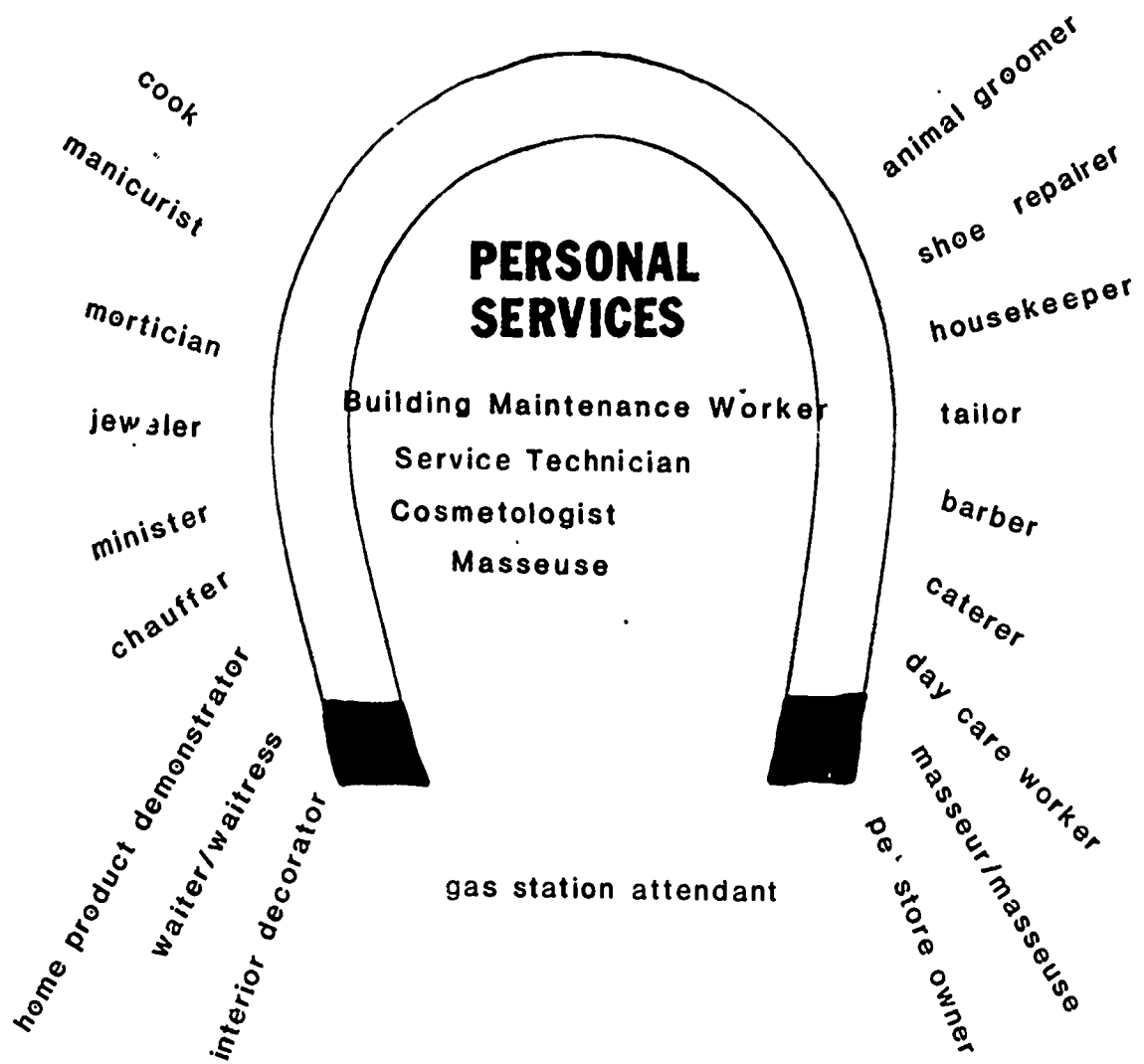

Workers from the Personal Services cluster perform a wide variety of tasks, from drycleaning to dog grooming, in order to make life more comfortable for individuals.

Building Maintenance Worker

OTHER WORKERS WITHIN THE CUSTODIAL SERVICES UNION INCLUDE:

upholsterers, carpenters, cleaners, security personnel, movers, grounds keepers, heating personnel, plumbers, electricians, utility shop personnel, paint shop personnel, locksmiths, door closers, specialty crews (research supplies, update chemicals, purchase equipment, answer emergency telephone calls, keep records, use computers).

POSITIONS:

Grade 1 Domestic

Grade 4 Cleaner

Grade 6 Janitor

Civil Service Exam necessary
for advancement to:

Grade 9 Supervising Janitor

Grade 12 Head Janitor

Grade 16 Chief Janitor

Grade 26 Supervisor

READING SKILLS NECESSARY TO:

Read and follow directions on containers, take the tests required for advancement to supervisory positions.

MATH SKILLS NECESSARY TO:

Dilute cleaning chemicals to proper strength.

Tools and Equipment

Rags, sponges, squeegees, wet and dry mops, dust mops, buckets, chemical cleaners, automatic scrubbers and sweepers.

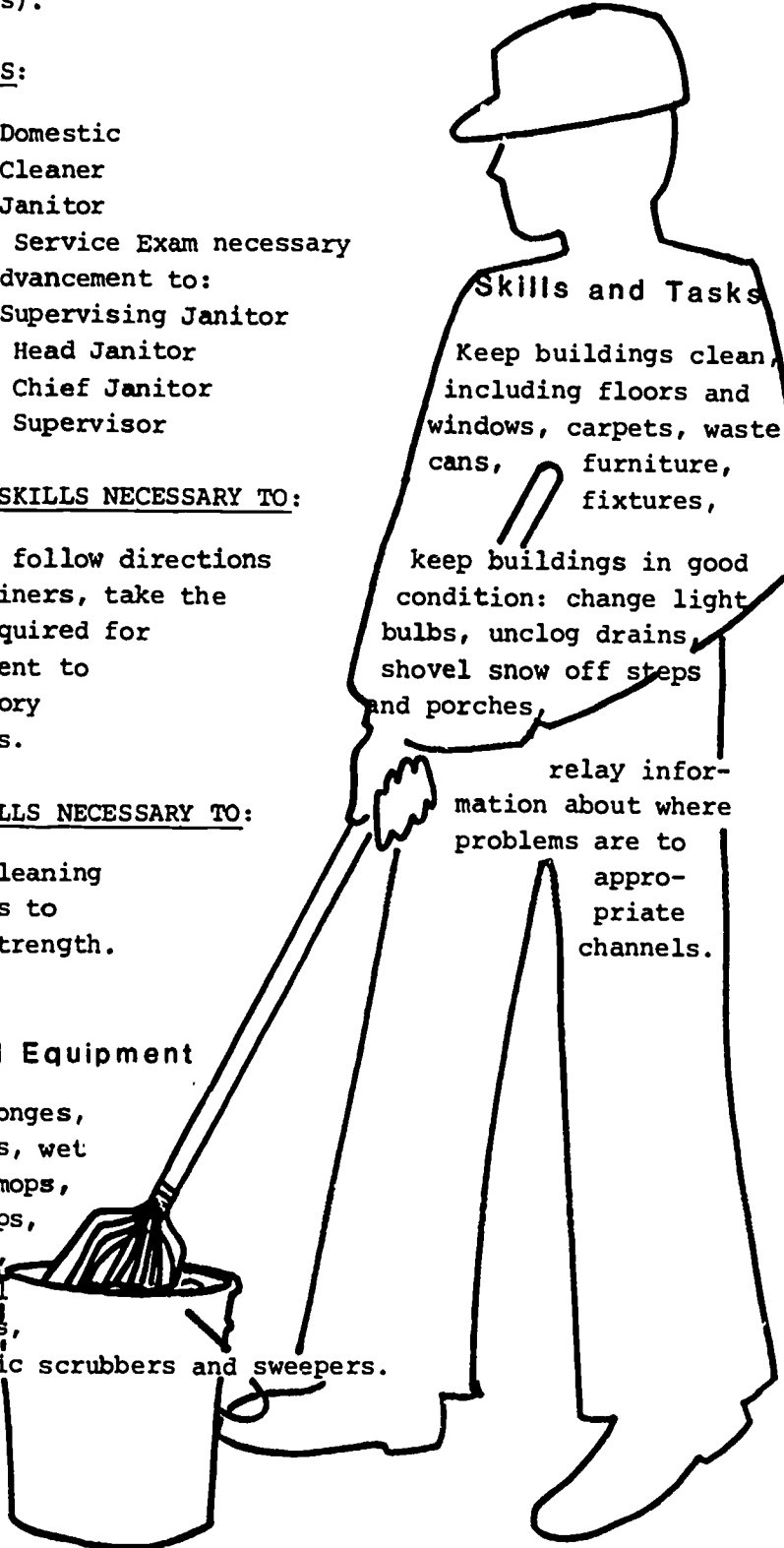

Skills and Tasks

Keep buildings clean, including floors and windows, carpets, waste cans, furniture, fixtures,

keep buildings in good condition: change light bulbs, unclog drains, shovel snow off steps and porches,

relay information about where problems are to appropriate channels.

Training

Minimum qualifications: physically able to do manual labor, high school diploma preferred.

All training can be acquired on-the-job through courses in a wide variety of subjects, from basic writing, use of computers, to air conditioning repair.

Work Places

Indoors and outdoors around apartment houses, hospitals, office buildings, manufacturing plants, factories, schools, churches private businesses.

Both part- and full-time work available.

Business Machine Service Technician

Hi! I'm George Lane. For as long as I can remember, I've been fixing broken machines. I fix toasters, clocks, record players, and radios for my friends and family members. In the Work Study Program at my high school I wanted to start right in repairing machines. But, my first assignment was to shadow a business machine service technician named Jean Gallow. I thought I'd be bored just watching somebody else work. I went to Jean Gallow's office, which is at the IOM Building. The first day of "shadowing" didn't turn out badly at all. Here's what happened.

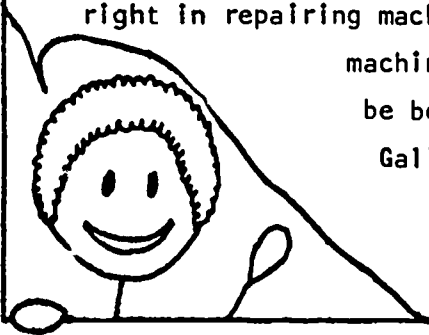

Good morning, George. You're right on time.

G'morning, Ms. Gallow.

Call me Jean.

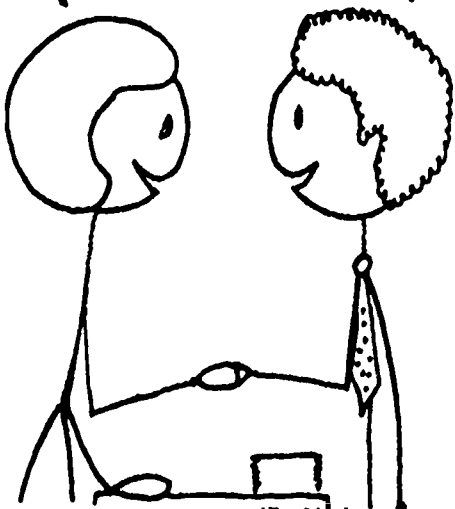

What a nice office! It doesn't look anything like a repair place. Where are the machines you fix?

They're in people's places of business.

Oh! Who brings them here for you to fix?

No one. I go to where the machines are and fix them there.

Oh, so you have to bring along your work clothes?

I'm wearing my work clothes.

Oh!

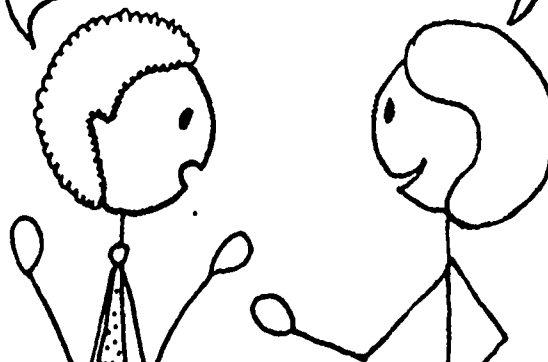

None of this is what I expected!

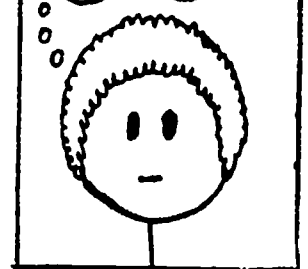

Before you got here I was looking over the list of people who need machines repaired. Legal Aid is having difficulty with a typewriter, and County Bank needs two typewriters fixed. City Hospital has a problem with one typewriter, and the State College has one typewriter broken.

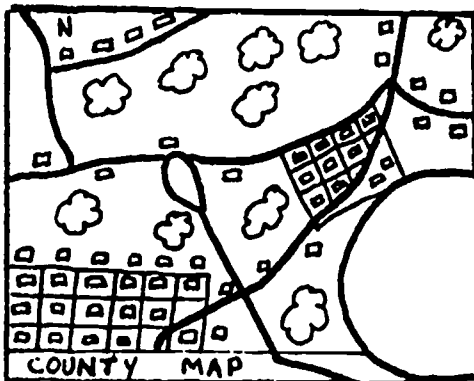

Only typewriters today? I was hoping to see a computer being repaired. Do you ever work on computers?

Not yet. You see, all 10M repair technicians start out fixing typewriters. After 2 years or so, technicians can ask to be trained to repair more complicated machines, like computers. There'll be an opening for a computer trainee soon. I plan to apply for it. Right now I have my customers to take care of. Let's see...County Bank, City Hospital, and State College have other typewriters they can use. Legal Aid has only one, and it is not working. That's where we'll go first. It is important to plan your route carefully because you should take care of the customers who need the most help first. It is part of what we call "customer satisfaction." Let's get in my car and go to my clients' places of business.

I thought business machine service technicians just fixed broken machines. "Customer satisfaction" means getting along with people, doesn't it?

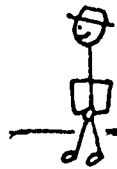

FURNITURE

1 HOUR CLEANER

FOOD



Yes. In my job, it's just as important as being able to fix typewriters. You'll see.

Hi, Pat. What's the problem?

I'll never have this legal brief typed by 10:30! I have a lot of typing left to do!

Pat, I will fix your typewriter in no time! You'll have plenty of time to complete your typing. Now, show me what the problem is with the machine.

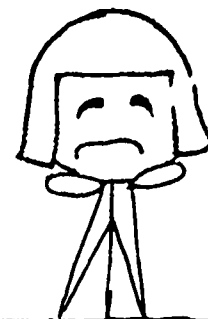
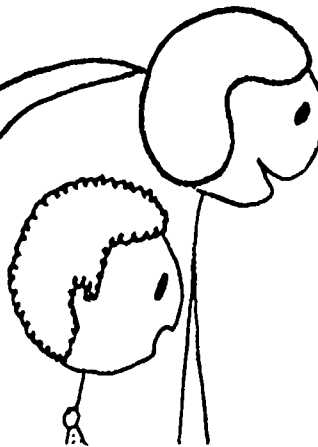

10M

The typewriter tends to skip--like that!

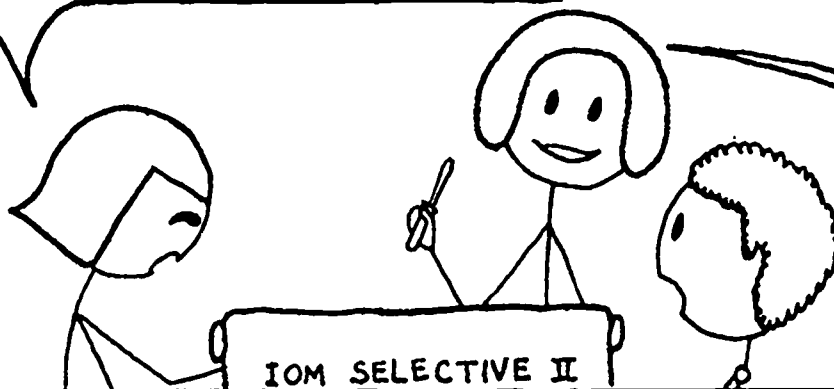

It sure bugs me when machines don't work. This is an easy problem to fix. A simple adjustment with the screwdriver, and it is fixed. You have lots of time to type your legal brief.

Jean is wonderful!

This is not what I expected!

I was sure surprised when you took that screwdriver from your purse.

Looks like a purse to you, huh? I have a surprise for you. That's my tool box. Take a look inside.

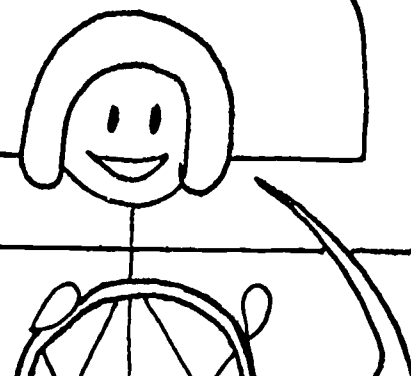
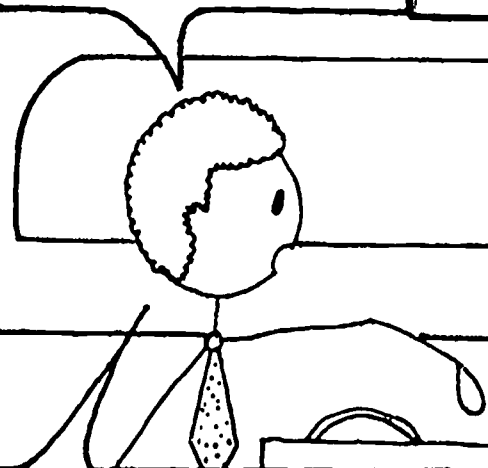
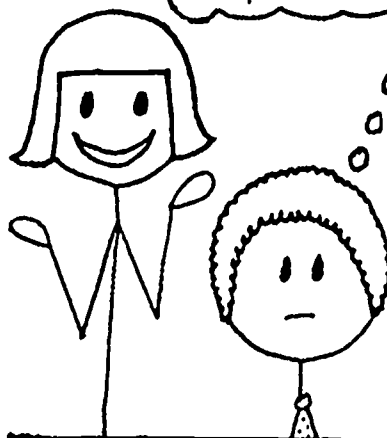

Let's see...you have lots of tools: pliers, screwdrivers, and wrenches. I don't know the names of all these tools.

Those are special tools for the IOM typewriter. I learned to use them in my training course. Here we are at County Bank.

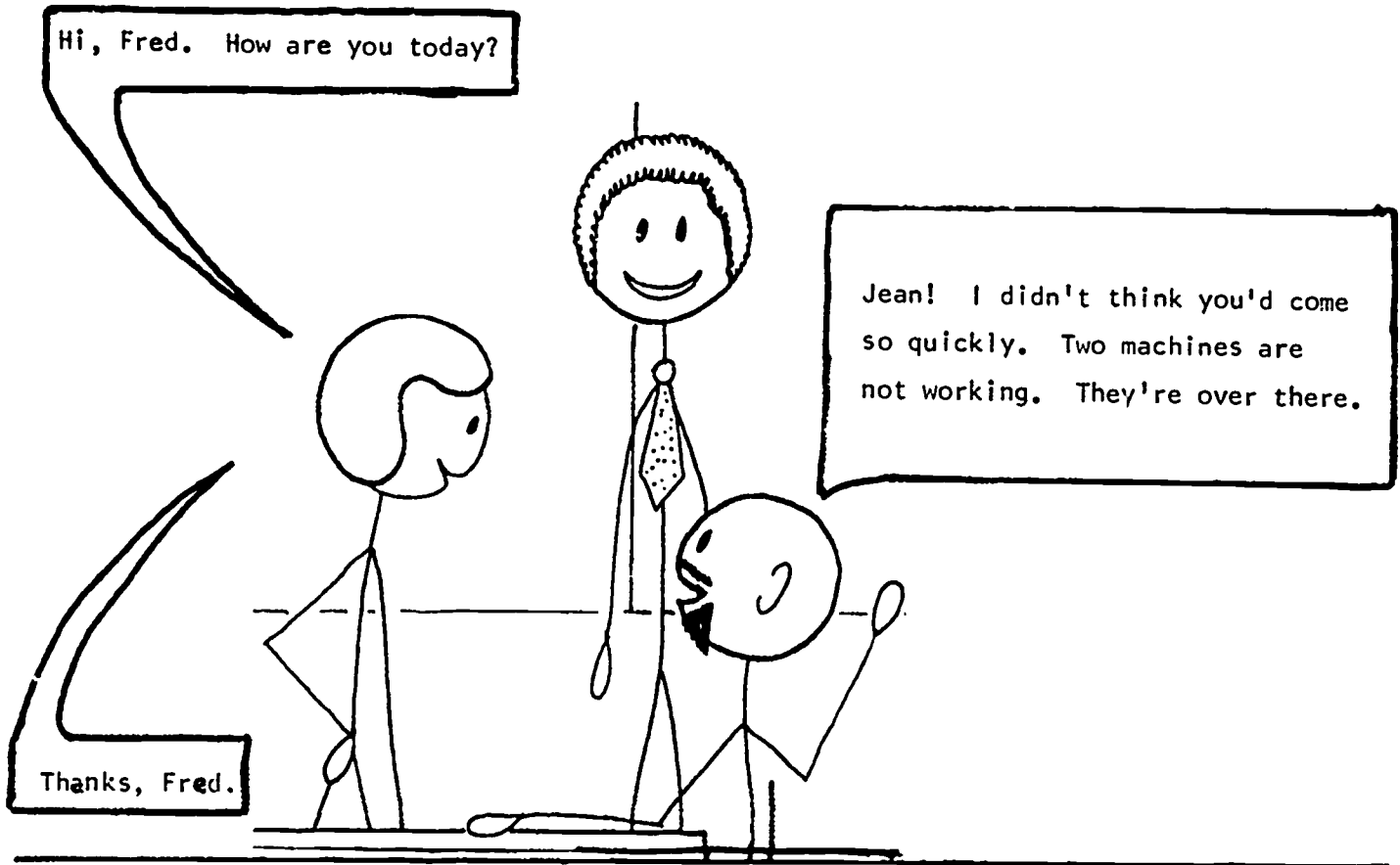

Hi, Fred. How are you today?

Jean! I didn't think you'd come so quickly. Two machines are not working. They're over there.

Thanks, Fred.

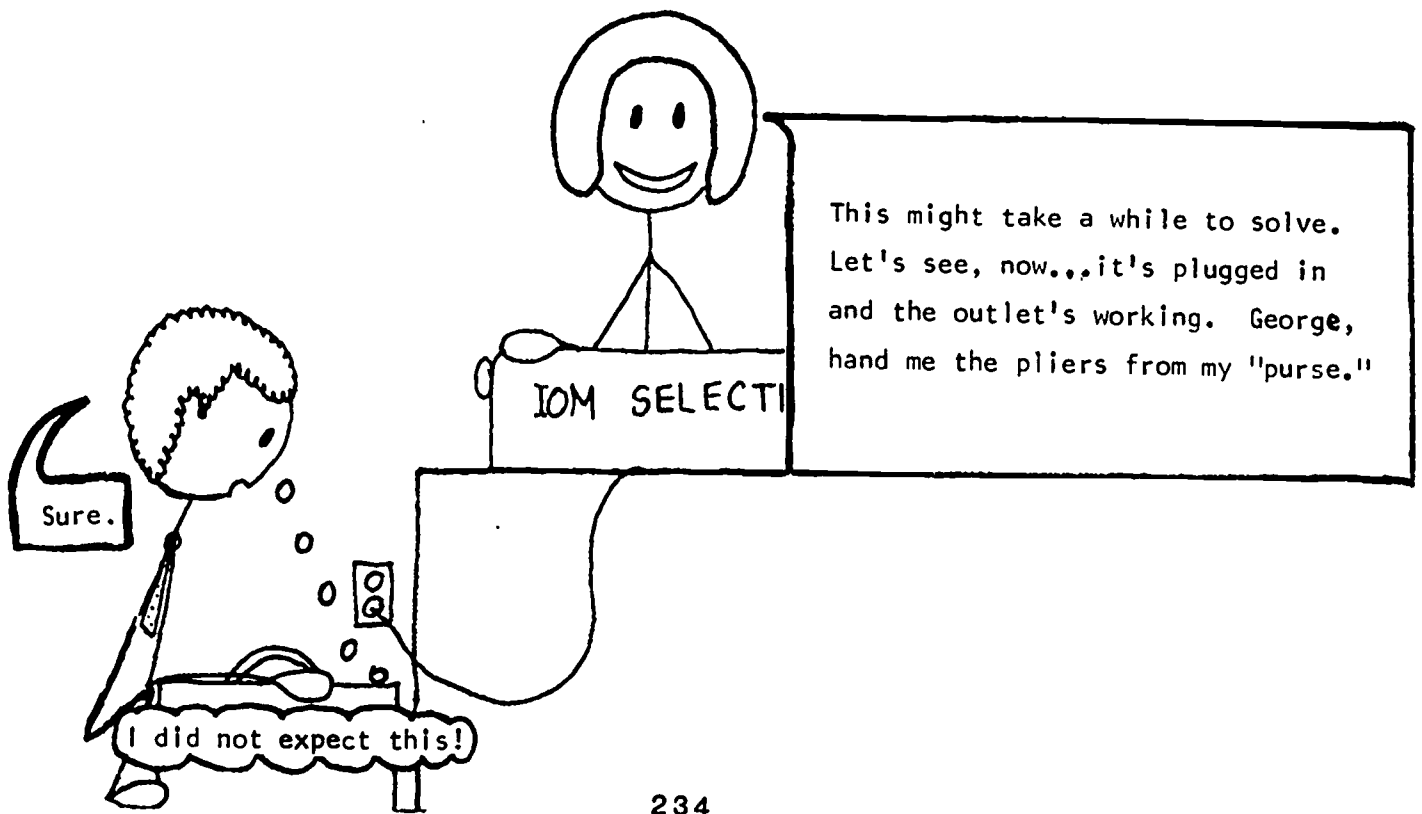

This might take a while to solve. Let's see, now...it's plugged in and the outlet's working. George, hand me the pliers from my "purse."

Sure.

I did not expect this!

I was sure the typewriters were not plugged in. Does that happen when you answer calls?

No, that would make a customer feel uncomfortable. We do not want that to happen, so when they call us, we tell them to be sure the machine is plugged in.

City
Hospital

PARKING

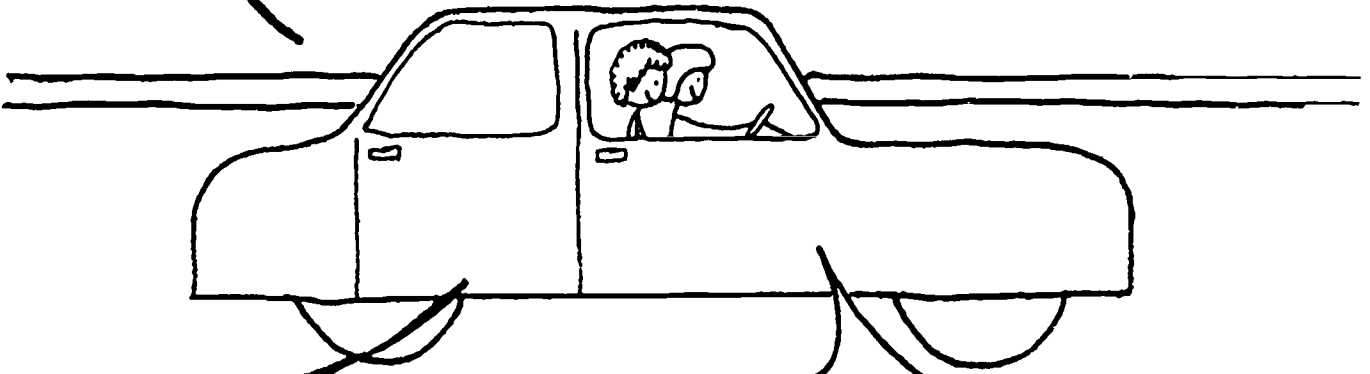

Good idea.

Here's City Hospital. We go to the records office.

Hello, Jeff. How's business?

Not so good, Jean.

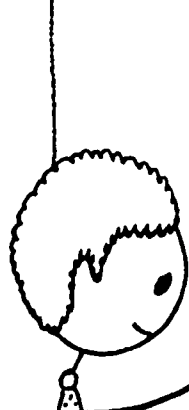

Show me what's wrong, and I'll get to work on it right away.

When I strike a key, nothing happens. It does not type at all, and the position indicator fell off, too.

Thanks, Jeff. The first thing I'll do is turn the machine on and listen for unusual sounds. Then, I will take it apart and look at the parts to check for wear and tear. It may need a new part.

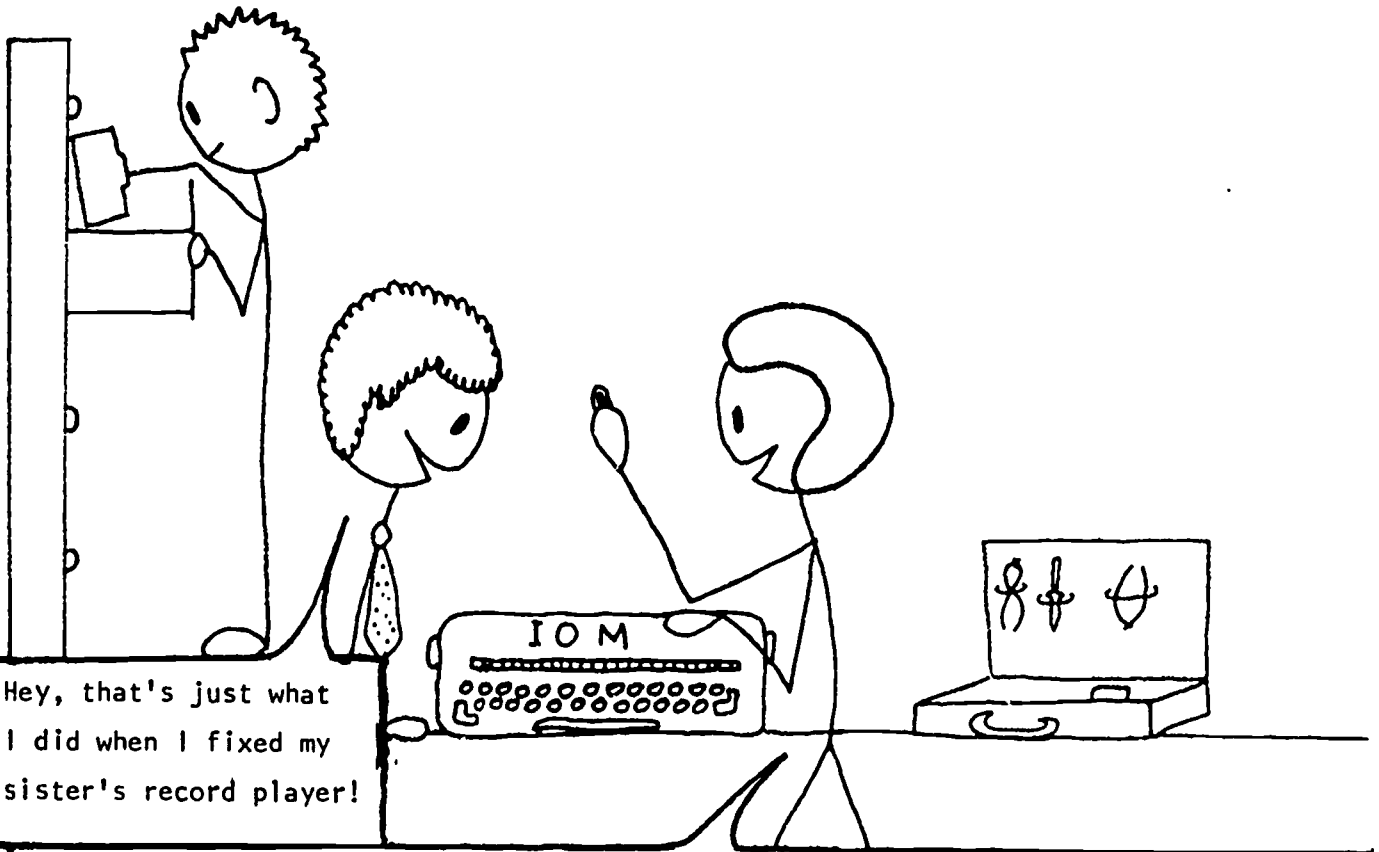

Hey, that's just what I did when I fixed my sister's record player!

I have found the problem--a loose nut! I'll tighten it up, and now it types fine. The indicator needs to be changed, but I don't have a spare one with me. I can bring one Tuesday, but in the meantime I'll rig something. Hmm...think I can make one out of a paper clip?

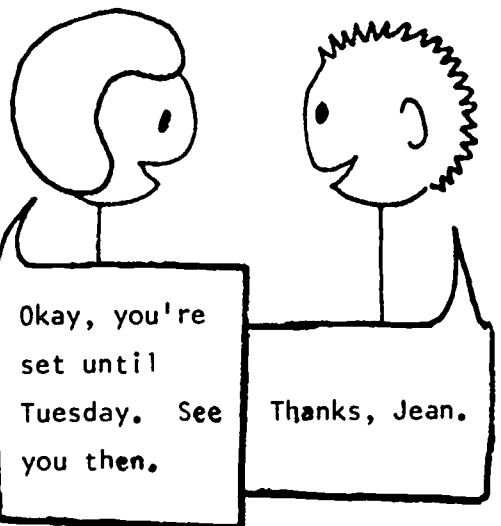

Okay, you're set until Tuesday. See you then.

Thanks, Jean.

That was great when you used a paper clip. Was that part of your training?

Not really. I never had any real training in parts. Even before high school, I liked fixing things, just like you. I took mechanical shop courses in high school, and for a year I studied electronics at the State College. We are going to stop there next. Then I got a job at IOM and passed the tests, which showed that I had the right qualifications for their 2-month training course.

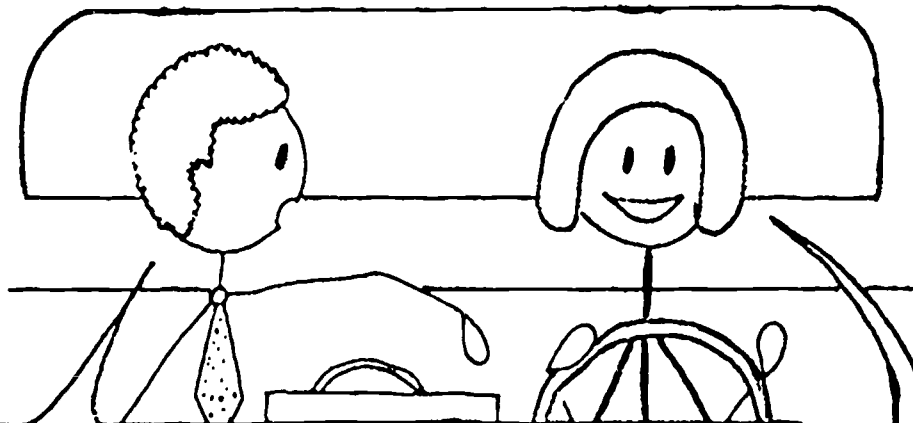

Do you need a lot of math and reading for your work?

Well, I have to read and write to pass tests and write up bills. I also read schematics, which are plans. I use math skills all the time when I write up bills. I also drive a car and have to be nice to people. Here's the State College.

Marie! How are you?

I'm fine. The spacing on the typewriter is broken again.

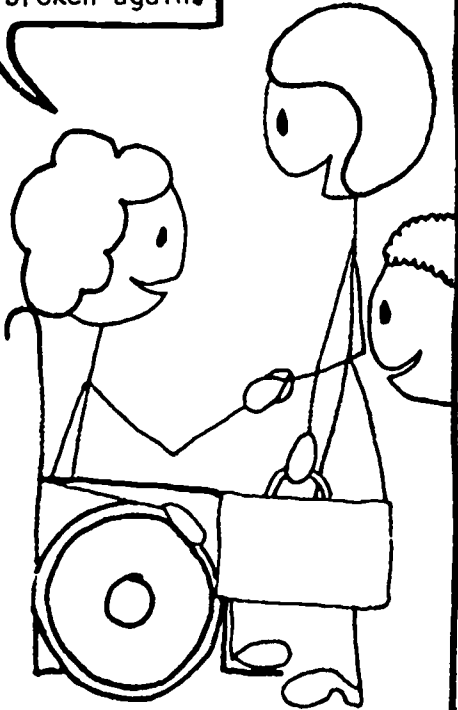

Okay. I'll fix it up again, but you may want to get a new typewriter because this one is getting old.

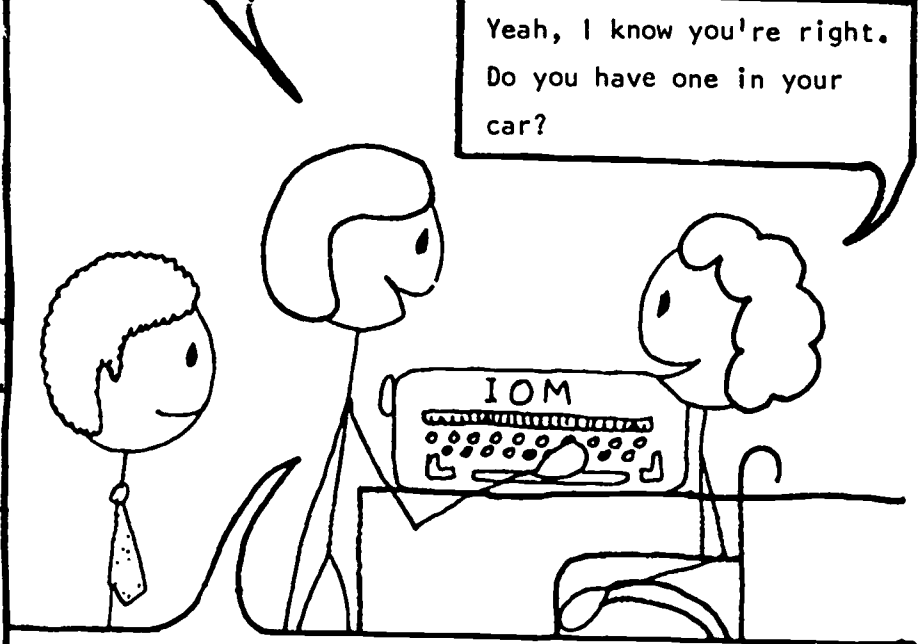

Yeah, I know you're right. Do you have one in your car?

Ha, ha! No, I don't sell them; I repair them. But I'll tell our sales representative that you want to buy a new machine, and I'll sell you a contract to have it fixed.

This typewriter is fixed. I'll be seeing you, Marie.

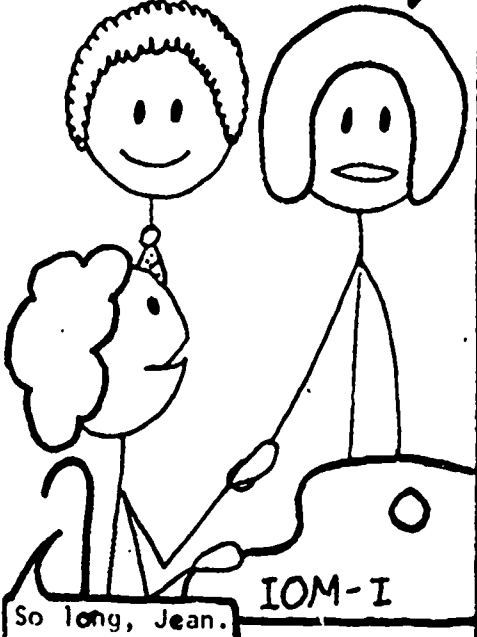

So long, Jean.

Okay, George. Let's get back to IOM where you can sit in on a company training class for business machine service technicians.

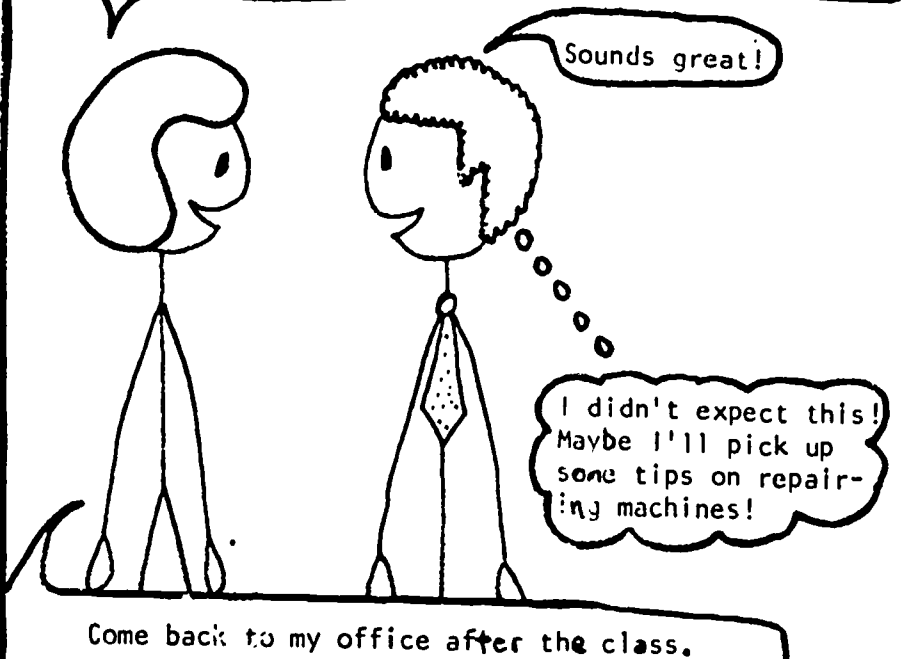

Sounds great!

I didn't expect this! Maybe I'll pick up some tips on repairing machines!

Come back to my office after the class.

Well, what did you think?

The whole training class was about customer satisfaction. I thought it would be about repairing machines. I am finding out that in a technician's work, people are as important as machines.

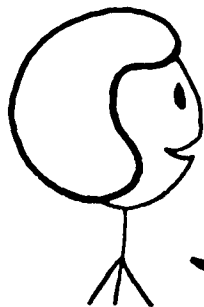

They are.



I did not know that until today. That makes a technician's job nicer, since I would get to travel, meet people, plus fix machines. Thanks, Jean. I hope you'll be here when I get my job.

Yes, I'll be here.

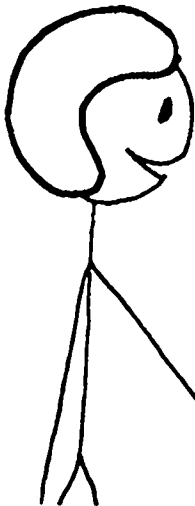

Thanks, Jean.
Take it easy.

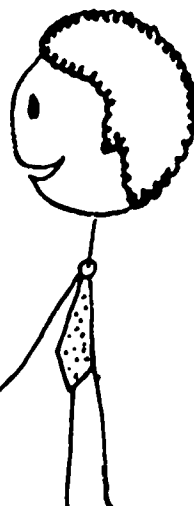

Bye.

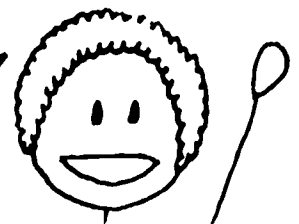

Check Out the Facts: Business Machine Service Technician

What would Jean say?



Hello, Jean! This is George.

Hello, George.



I'm writing up my Shadow Report and I want to check my information with you. Can you tell me 3 of your on-the-job skills and tasks?

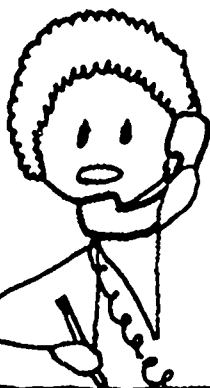

Sure.

Thanks. Now can you tell me 2 places where you do your work?

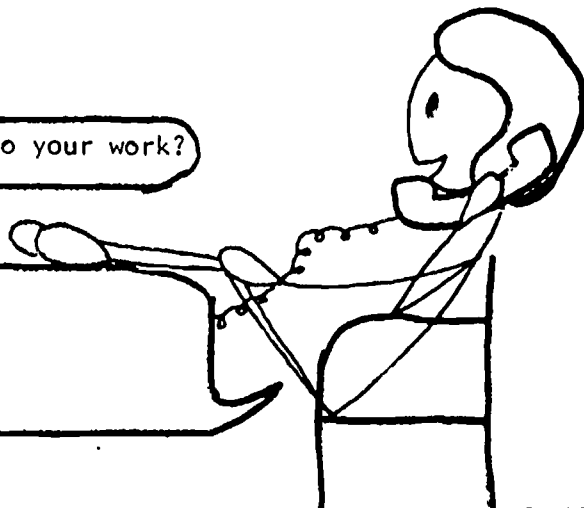

Good. Will you tell me 3 tools or pieces of equipment you use and what you use each one for?

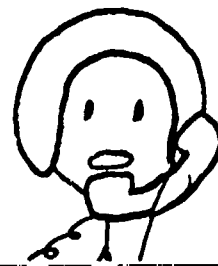

COSMETOLOGIST

"BEAUTY IS HER BUSINESS"

My name is Georgia Rose Williams, and beauty is my business. I am a "cosmetologist," but some call me a "beautician." Others call me a "hair cutter," "stylist," or "hairstylist." By any name, my work is to take care of people's hair, skin, and nails. The people who pay me for these services are called "customers."

My work takes special skill, and I use many tools. I use plastic capes and towels to keep my customers' clothes clean. The water, soap and chemicals I use might splash on them. I wash hair with shampoos and rinse hair with conditioners. I use scissors, razors, and clippers to cut hair, and rollers, clips, and spray to style hair. Sanitation is important, so I keep my tools clean. I use chemicals to wave or straighten hair, and rinses, dyes or bleaches to make hair lighter or darker. Eyebrows are shaped with tweezers, and fingernails or toenails are cut with nippers. I use creams and lotions to give facial treatments. I use nail polish to protect and color the nails. I do what my customers ask and try to keep my customers satisfied. Customer satisfaction is a major part of my work.

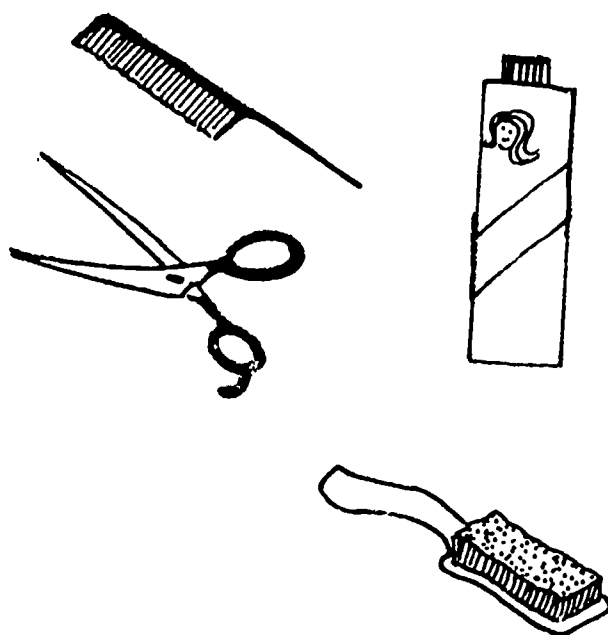

For all my work I need good finger dexterity and good hygiene too. Sometimes I stand on my feet for hours. I'm glad that I don't have allergies. Many of the products I use can irritate people's skins and make them sick.

I began cutting hair when I was about ten years old. It all started when my little brother and I were making mud pies one day. I decided to make a fancy mud pie on his head. However, his hair looked too long to me, so I quickly got the scissors from the house. I proceeded to give him a haircut and gave him a fancy mud pie hair-do. I thought he looked beautiful. I felt very proud! My mother was horrified when she saw the huge pile of mud on his head. She scolded me for it and immediately washed his hair. When his hair was clean, she noticed his haircut. I expected her to be upset about it, too. Instead, although she was surprised, she liked it a lot and asked me to cut her hair. That's how I started cutting hair. After a short time, I was cutting hair for my friends, too. This talent was mine for sure!

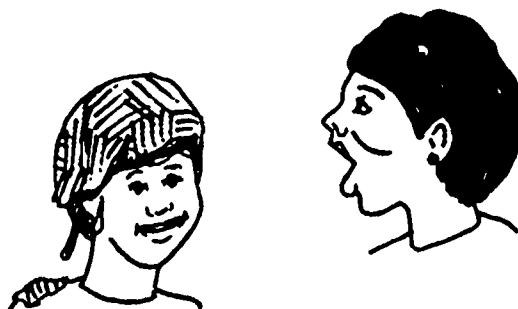

I had to finish 8th grade and be at least sixteen years old, the legal age, before I could go to cosmetology school. Even though I did not enjoy school much, I stayed in till I passed 8th grade. That way I could become a cosmetologist. Many years later I chose to go into business for myself. I lacked the math skills I should have learned in high school. I went back to school to study and learn those math skills.

Formal training is important in my profession. Training requirements are not the same in all states. New York requires 1,000 hours of training. It took me seven months to complete the American Cosmetology School. I had to take out a loan to pay for my education. I could have learned my trade at a vocational school. I took many courses and learned how to care for hair, skin, and scalp. Hair cutting, styling, and safety practices were part of my studies, too.

For the first 500 hours, students practiced on mannequins and on each other. Then they worked on customers who came to the school because of the low fees. Training was fun since I learned how to make money at what I loved to do.

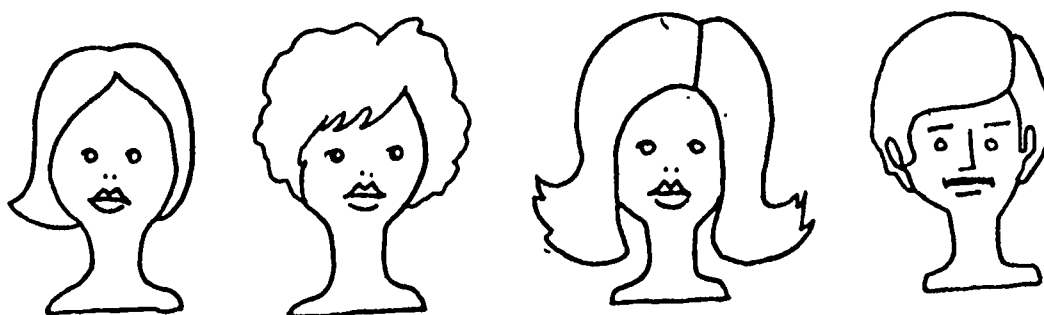

After I completed my training, I passed the state exam and got my license from the State Cosmetology Board. Cosmetologists can work at many different places like large and small commercial shops, in stores, or on cruise ships. I went to work in Ron Wells' store. He was an expert at hair cutting and styling. I learned a lot from him. Soon I was a specialist and customers began to ask for me. Ron saw I was good for his business and told me about a job on a cruise ship. I was excited to take that job. I was able to pay off my loan in two years. Then I decided to go back to school and learn the math and other business skills needed to run a business. School was at night. I worked part-time while I studied.

Now I have my own shop. I am a business woman. I also have what are called "managerial duties." That means I hire, train, and supervise the beauticians who work for me. My specialty is hair cutting and styling. That's what I train some of my employees to do. Other specialists in bleaching, dyeing, hair straightening, and permanent waving work for me too! A new cosmetologist out of school can get training in my shop in any of these areas. While they complete training they give shampoos, answer the phone, make appointments and collect fees from customers.

I keep records and order supplies, so I use my math skills a lot. I also use them to make up payrolls, pay bills, and keep information on hair color formulas. Math skills are also used when I mix chemicals for a hair color. I must measure the chemicals correctly to get the right color.



I use my reading skills too. I have to read instructions in order to mix up hair color formulas. It is important for me to read magazines in my profession to keep up with the new styles coming out. Looking at pictures is not enough. I have to read about how to make my customers' hair look like the hair styles in the pictures. By going to training conventions I can keep up with new styles and techniques.

I always have something new to learn in my field. For me that is the beauty of it...and beauty is my business.



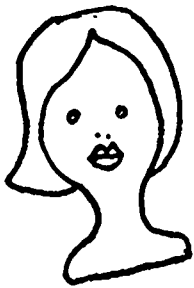

QUIZ YOURSELF:



COSMETOLOGIST

What are three skills or tasks Georgia performs on the job?



Name three tools or pieces of equipment that Georgia uses on the job. What are they used for?

Name two places where Georgia has worked.

Name two places where Georgia got training for her profession.

Name two math skills and one reading skill that is important for Georgia's work.

ELLA STOVER, MASSEUSE

Did you ever feel tense or feel like having your neck or back rubbed to help you relax? Well, that's what I do, and more! I rub people's heads, necks, arms, legs, feet, and bodies in order to relieve tension and relax them. If you've never had a massage, you don't know what you're missing. And if you have, then you know how good it makes you feel. A lot of people with high pressure jobs find it difficult to relax. People who are just tense, who have poor circulation, or who use their bodies to do a lot of strenuous athletic work need a good massage or rubdown to help them feel their best.

I work hard. It takes a lot of strength to rub and knead and pummel people's muscles until they are relaxed. It's even harder if they're big or musclebound. My hands have to be strong. It takes strength and endurance to massage eight or ten people a day. Sometimes I can use my weight to apply pressure, so I don't have to use my strength for every stroke. Some strokes are even relaxing for me. One of the reasons I started doing massage was because it made me feel good.

I really enjoy my work now. When I started out, I had no license so I couldn't work at a hotel or spa. I had to rely on word-of-mouth to get clients. Using my own car, I took my massage table, towels, and oils with me. I kept records on every client--where they were sore, what strokes they liked, things like that. That way I could check their progress, too.

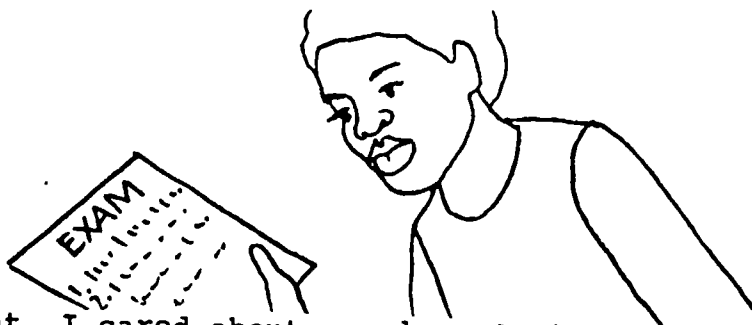

Word spread that I cared about people and did a good job. My friends and clients encouraged me to get a license. Each state has its own laws, and in New York there is an exam. The only accredited place to learn massage in this state is the Swedish Institute of Massage. They have a two-year course, and I took it. I studied anatomy and physiology, and I did practical work, too. I have my license now, but I still go to workshops to learn new techniques and skills.

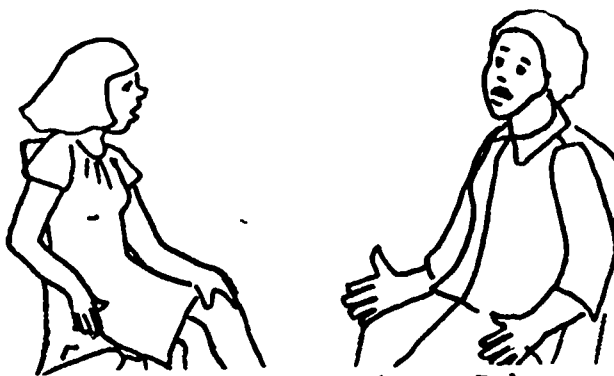

These days I work at the YMCA, where I have a nice clean studio. I still have to get my own clients. The Y doesn't pay me much. Most of my income is directly from my clients. The Y benefits from the new clients I bring in, and I get a nice studio in return.



When a client comes in, we decide on a thirty or forty-five minute massage. Then we talk about specific soreness or general health problems. Warm towels keep a client from feeling cold or embarrassed. I rub oil on my hands and begin. I'm systematic, but I seldom give the same massage twice. That way I don't get bored. I get to know each person's body type and musculature. I may even play soothing music from my tape collection.

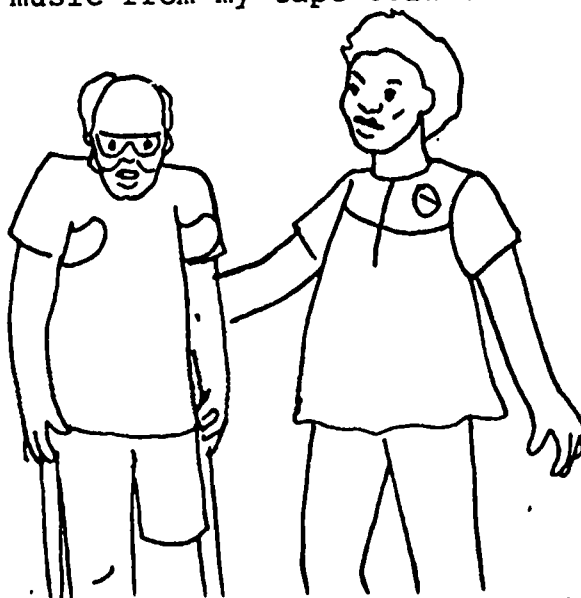

I could work in a hotel or spa if I wanted a change of pace. I would get paid by the day and only handle clients sent to me. Some days might be busy, some would be slow. Since I enjoy the control I have over my own life, I stay in business for myself. When I'm ready for a change, I'll probably go back to school. I'd like to become a physical therapist. I've been thinking a lot about that lately. I would be a professional and work in a hospital or clinic. I would still give massages, plus I would gain more respect. It's expensive, though, so I'm saving my money now. I may even need a loan, but I know I could do it! For right now, I'm doing the best I can and I have a lot of satisfied clients. That's the important thing! 248



QUIZ YOURSELF: MASSEUSE



Name three of my tools or pieces of equipment, and one use for each.

Name one of my training places.

Name one of my work places.

What are three of my on-the-job tasks and/or skills?

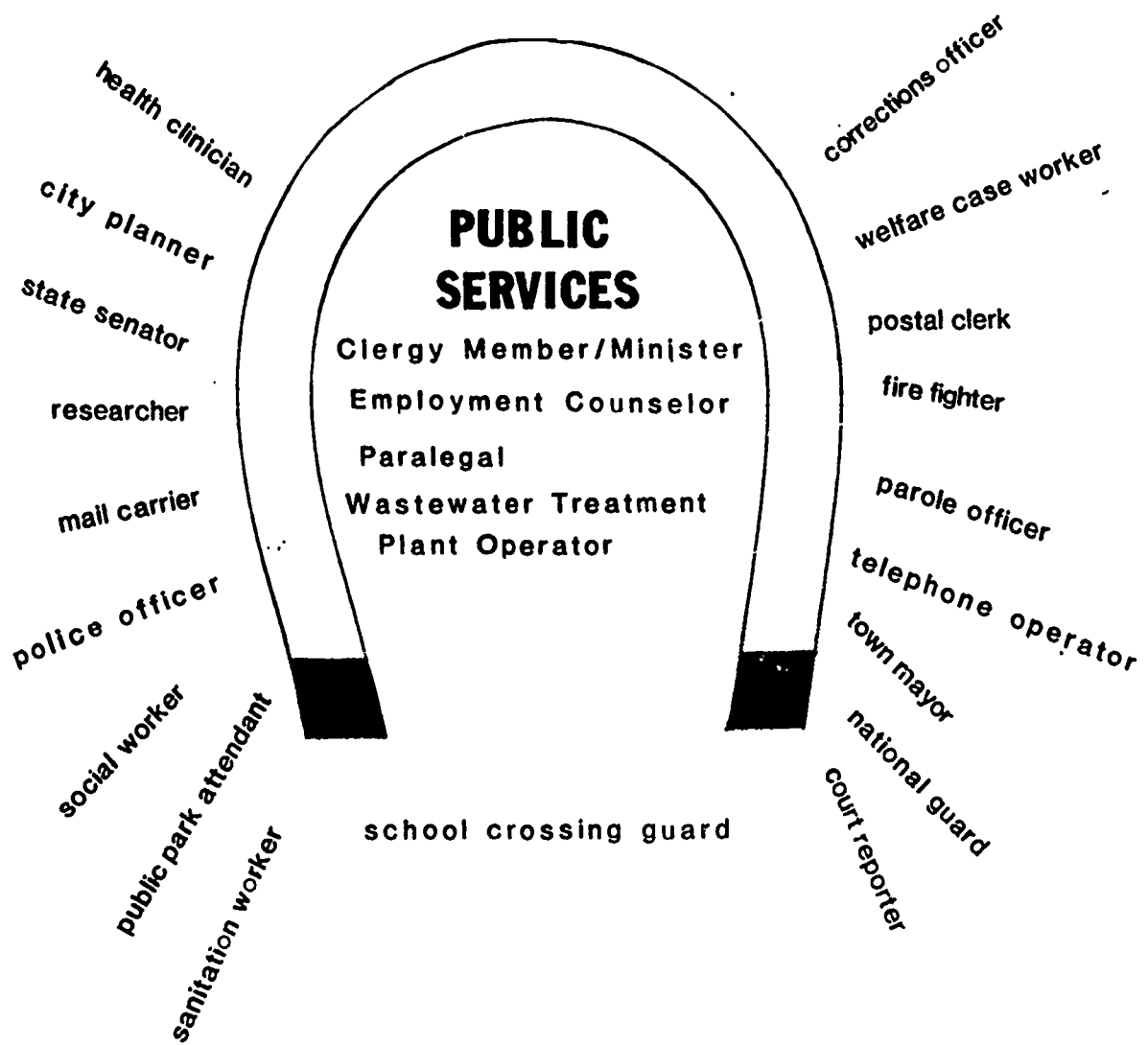

Workers from the Public Services cluster protect the rights, property, and general well-being of community members.



Clergy Member (Minister)

Karen: Hello, are you Reverend March? I'm Karen Palen.

Rev. March: Hello, Karen. Yes, I'm the Reverend, but you can call me Mr. March.

Karen: Okay, Mr. March, and I thank you for seeing me today. I really appreciate it when adults are willing to answer questions I have about their jobs. I think I explained that I need this information to help me with some workbook activities I'm doing in school.

Rev. March: Well, why don't you start by asking me some of those questions you have on your note pad?

Karen: Okay, I know that this is a public service job, but why? What do you do on the job?

Rev. March: My job is a public service because I take care of the people in my congregation. A congregation is a group of people who come together to worship. I take care of their spiritual and moral needs. I conduct their weekly worship and special services like weddings, funerals, and baptisms. Much of my time is spent talking with people. I visit the sick in hospitals and at home. I also visit and help people who have lost loved ones. When people come to me with problems, I counsel them. I must plan and write sermons, a monthly column for the church newsletter, and I often write a column for the local newspaper.

Karen: Wow, you really keep busy! I noticed you have three walls full of books. That's quite a library! Do you find time to read, too?

Rev. March: I read whenever I can. I use what I read to help me prepare my sermons or counsel those who come to me needing help. As I'm reading, I guess you could say I'm also studying, because I remember what I've read and use it to help me in my work.

Karen: Would you say books are your tools?

Rev. March: Yes, Karen. These books include theology (the study of God), histories, dictionaries, newspapers, and especially the Bible. Other tools are my robes for worship, baptismal font, pulpit, and hymn books.

Karen: Mr. March, could you tell me what you wear?

Rev. March: For some churches, robes are important and used at all worship. In other churches they are used for special worship. Most of the time I wear a suit and white collar for church services. In the city I'd wear the collar more often. Then I'd look like a minister when I went to hospitals or homes to visit.

Karen: Would you say that the church, hospitals, and homes are your work places?

Rev. March: Yes, Karen. Ministers work in many places. In fact, I think of the church classrooms and this office as being work places. Sometimes I attend meetings with other ministers or town groups at restaurants or the town hall. I think of those places as work places, too! Some ministers work in missions overseas or as chaplains in the armed forces. Some teach in colleges or seminaries.

Karen: Mr. March, did you need a lot of training to become a minister?

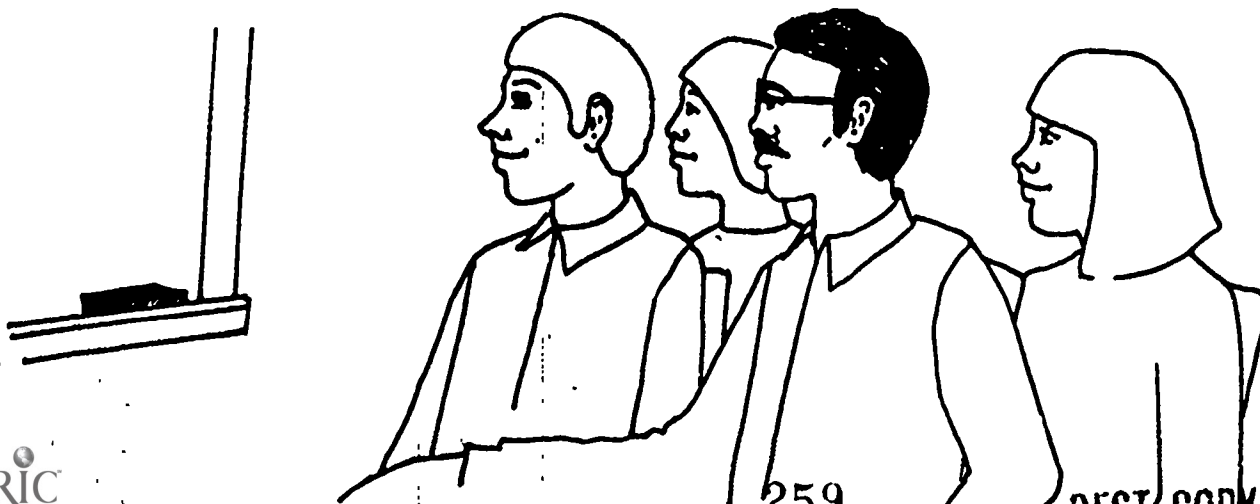

Rev. March: Yes. First I graduated from a four-year college. Then I went to a theological seminary. This is a special school for ministers. There, I learned about the Bible, and how to be a minister. My seminary studies included on-the-job training under an experienced minister.

Karen: How did you first decide to go into the ministry?

Rev. March: Well, Karen, I always liked church and joined in church groups. Also, I have some relatives who are ministers. But during high school I also liked science. I studied science when I went to college. I got a degree in chemistry and worked for a chemist. I met my wife while attending college. After college we got married and both worked. We both enjoyed our work, but something was missing.



Karen: What did you do?

Rev. March: After five years of working as a chemist, I decided to go back to school. I felt a special calling for the ministry. I decided on a theological seminary. My wife was very supportive; she continued to work, and I was able to use my time to study. I spent three years at the seminary. Then I spent one year working for a master's degree. At that point I was ready for a congregation.

Karen: How do ministers get placed at a church?

Rev. March: The seminary has a placement office that keeps a listing of churches that need ministers. Then, it's just a matter of meeting with the different church congregations. You wait until a congregation offers you a position which you decide to accept.

Karen: How long do ministers stay in one place?

Rev. March: Well, Karen, it is hard to say. I've known some ministers who have stayed in a place for only two years. Then there are other ministers who stay in one place for 28 years. There is no average length of time, and some movement from congregation to congregation helps keep you from getting in a rut.

Karen: Mr. March, what are your working conditions like?

Rev. March: The working conditions here are pleasant. I try to be a loving, helpful person at all times. I spend a lot of time talking with people, especially when I counsel and attend meetings. But the hours are often long and irregular. I don't work an average week, and I'm on call all the time. Most nights I have meetings to attend, so I'm not home a good portion of the time. Sometimes this is difficult for my family.

Karen: Your job sure seems demanding! Is it true you're supported by the church?

Rev. March: Yes, the church provides a home for me and my family. In some other churches, a car would be given also. A minister's salary is low, but the things supplied by the church sometimes make up for that. When special services are performed, such as weddings or funerals, the family might give the minister a money gift.

Karen: It sounds to me like it takes a special kind of person to be a minister. Someone who cares more about people than about money.

Rev. March: That's right, Karen. And you know, even after ministers retire, they remain active by helping out as guest speakers in nearby churches. It's a way of life, not just a job.

Karen: I have just two more questions. I know that reading is a necessity. But how important is math, and what other academic skills do you use?

Rev. March: Math is important because I use it to balance the church budget. But you're right. Reading is still most important. As for other skills, public speaking and writing are also very important on this job. I have to be able to speak well in front of my congregations and church committees. I write my sermons and articles for the paper. And I've got to be an understanding person. Being a good listener might be the most important skill of all.

Karen: Well, Mr. March, you've really given me a lot of information and a good understanding of what it's like to be a minister. Thank you very much!

Rev. March: I'm glad I could be of help, Karen. It was fun! So long now.

Karen: Goodbye, Mr. March. Hope to see you again sometime.

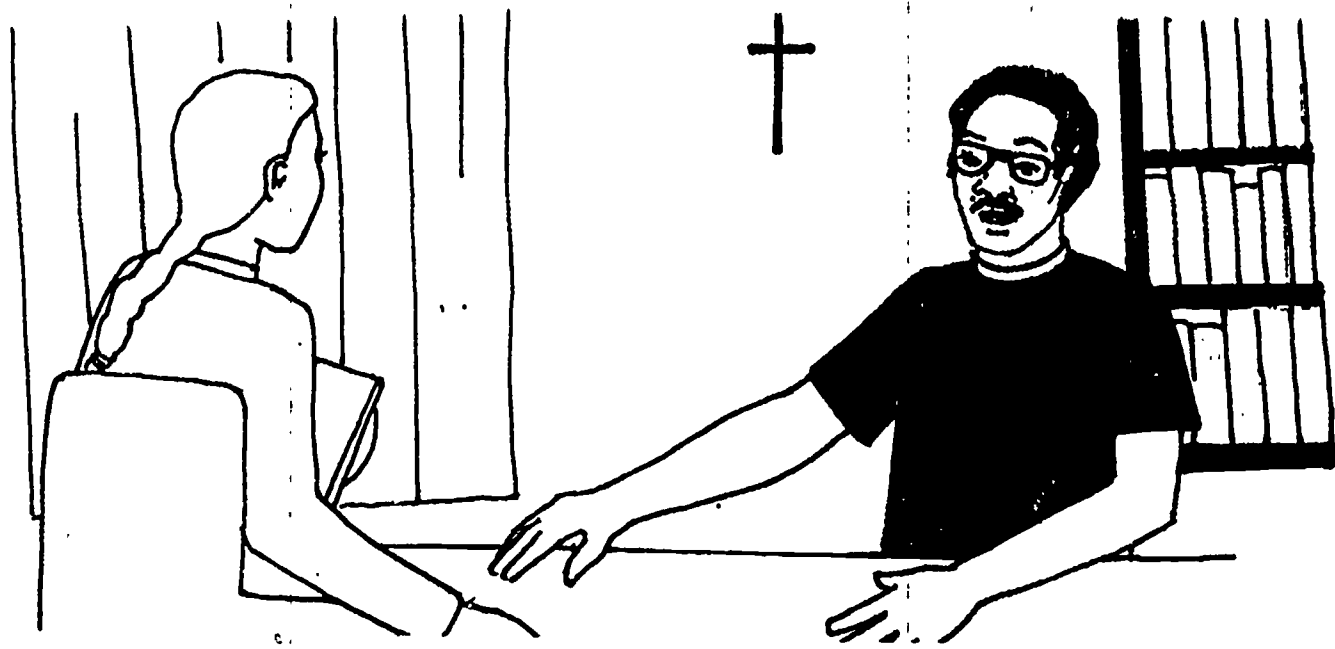

Clergy Quiz

Name three of the services that clergy members perform for their congregations.

What are three tools that Reverend March uses on the job?

Name three places where a clergy member might be found at work.

What kind of training prepared Reverend March for the ministry?

How do clergy members use reading and math skills on the job?

Besides reading and math, what other skills or personal qualities do clergy members use on the job?

Name one benefit and one disadvantage that comes along with being a clergy member.



Employment Counselors

Employment counselors must know everything about jobs. This means that they are always up-to-date on the job market. Their work includes finding out about all kinds of jobs and then telling others about the jobs. They must know what jobs are open. They must know what training is needed for different types of jobs. They must know about salaries, wages, and the working conditions of different jobs. They learn these things in college or on the job. Counselors always have to read a lot to keep their information up-to-date. To do this they read newspapers, magazines and government pamphlets.

Employment counselors use this information to help people plan, prepare for, and find work. (The people they help are called "counselees.") Counselors must be able to work well with different kinds of people. They must be able to understand points of view different from their own. They must be flexible when they deal with people.

When there is a job opening, the counselors must be ready to make quick decisions based on what they know about the job and the person to fill it. Both the counselees and employers must trust the counselors to know the "right person for the right job." The outline on the next page shows how counselors find the "right person for the right job."

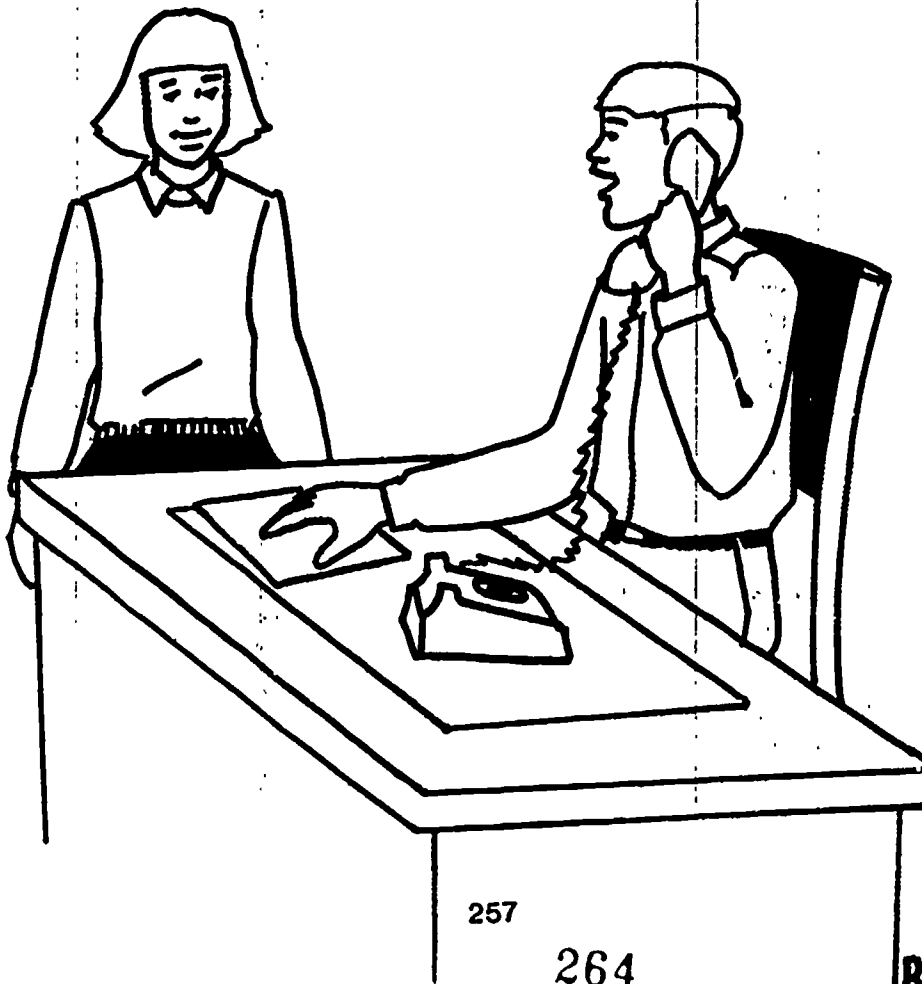

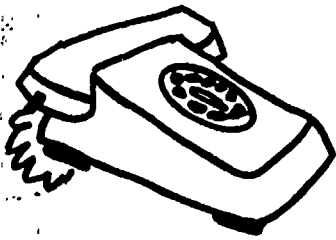
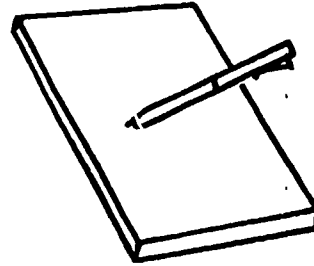
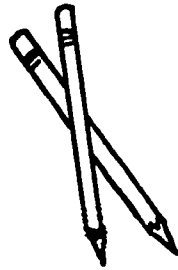
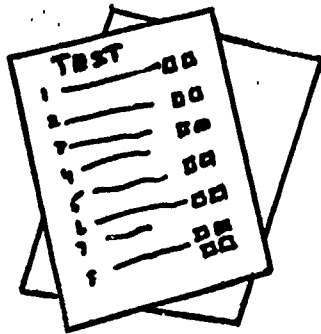
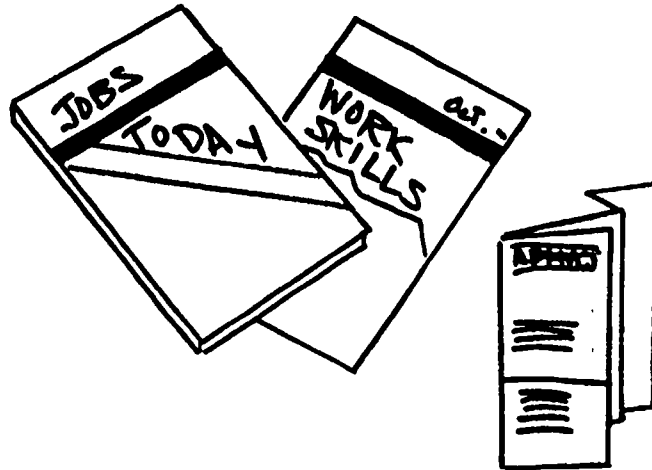
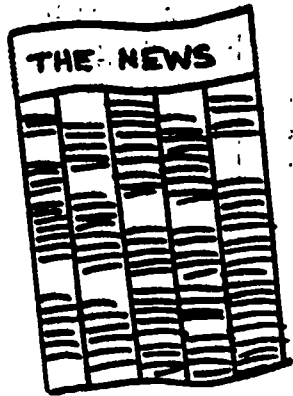

Tools and Equipment

newspapers

interest and aptitude tests

magazines

resumes

government pamphlets

telephone

paper, pencils, and pens

MORE FACTS ABOUT EMPLOYMENT COUNSELORS

- I. To help counselees find satisfying work, employment counselors:
 - A. Interview counselees.
 1. Explain the job-finding services available at the employment agency.
 2. Find out what kind of help the counselees are looking for.
 3. Find out how counselees approach problem solving.
 4. Discuss the counselees' personalities, interests, skills they think they have, skills they think need strengthening.
 - B. Test counselees.
 1. Give interest and aptitude tests.
 2. Score and interpret tests.
 - C. Research counselees.
 1. Obtain records of counselees' training and work experience.
 2. Contact counselees' former employers, usually by telephone.
 - D. Offer guidance to counselees.
 1. Help counselees evaluate their abilities and interests.
 2. Help counselees decide for themselves on the best career plans for them.
 3. Help counselees prepare their resumes.
 - E. Refer counselees to employers.
- II. To help employers find satisfactory workers, employment counselors:
 - A. Talk on the telephone to employers.
 1. Find out about job openings employers have.
 2. Find out about job openings employers expect to have.
 3. Find out what kinds of workers the employers prefer.
 - B. Suggest appropriate counselees to fill job openings.
 1. Send counselees' resumes to employers.
 2. Arrange employer-counselee interviews.

Other important skills for employment counselors are writing reports and organizing information.

STILL MORE FACTS ABOUT EMPLOYMENT COUNSELORS

Employment counselors work for private agencies, for private industry, or for tax-supported agencies. Depending on the work place, employment counselors' training requirements, advancement possibilities, and working conditions are different. The chart on the next page shows the differences.

THE CHART BELOW SHOWS SOME IMPORTANT DIFFERENCES AMONG:

WORK PLACES**	TRAINING NEEDED	ADVANCEMENT	WORK CONDITIONS
Private employment agencies.	High school. About three months of formal instruction. Sales experience can be helpful.	After about five years of on-the-job experience, counselors with initiative and ability can expect to earn more money. Counselors may set up their own agencies.	Highly competitive. Salary is on commission. Overtime may be necessary. Depending on size of agency, there may be health insurance, pension plans, paid vacations, sick leave.
Private industry.	B.A. in one of the following: sociology, psychology, or educational guidance and counseling.	After several years of on-the-job experience, counselors willing to give up working directly with counselees can advance to supervisory or administrative work.	Assistance from a secretarial staff. Paid vacations, sick leave, pension plans, insurance coverage. Little or no overtime.
Tax-supported agencies. For example: public employment agencies, community agencies, prisons, training schools for delinquent youth, mental hospitals, Veterans Administration, Bureau of Indian Affairs. Colleges and Universities.	M.A. in one of the following: social work, personnel work, psychology, guidance and counseling, or public administration. Must pass qualifying exam, and sometimes a Civil Service Exam, before working in any tax-supported agency.	After several years of on-the-job experience, counselors willing to give up working directly with counselees can advance to supervisory or administrative work.	Assistance from a secretarial staff. Paid vacations, sick leave, pension plans, insurance coverage. Little or no overtime.

260

BEST COPY AVAILABLE

Employment counselors do most of their work in well-lighted, well-heated (or air conditioned) offices. Some Employment Counselors visit employers at their work sites.

EMPLOYMENT COUNSELOR:

QUIZ



Name 4 of an employment counselor's work tasks.

Name 3 tools or pieces of equipment which employment counselors use on the job.

Name 3 different places where employment counselors can be found at work.

How do training requirements differ for employment counselors working at private and at tax-supported agencies?

What are 3 skills which employment counselors practice on the job?

Describe an employment counselor's work conditions.

Name the advancement possibilities for employment counselors working at private and at tax-supported agencies.

KAREN FRYE, A PARALEGAL WITH INITIATIVE

Hi! My name is Karen Frye. I work as a paralegal at Legal Services in Powell City. Legal Services represents people who can't pay private lawyers. People come to Legal Services about their problems with landlords, welfare payments, job discrimination, and marriage. They know they can depend on us for help. We serve the community.

Some of my work is like a lawyer's. I represent clients at pretrial hearings, where many cases are settled. To prepare myself for the hearings, I review the history of the case, and I research similar cases. I use a law encyclopedia, a legal dictionary, and legal documents when I prepare a case. I talk with a lawyer about each case so I can know how to be most helpful. Since I must speak for my clients, I review the procedures used at pretrials.

Other times my work is like a secretary's. In the office I do a lot of paperwork for the lawyers. I organize and file documents, and I sort mail. I add inserts to our files as laws change. I prepare tax returns or inheritance forms. I even order office supplies. I also use the phone to schedule clients on the appointment calendar. When clients call for help, I set up interviews with them. Sometimes we meet in their homes. I get to see how they live. This helps me to learn more about their problems.





Helping people has always been important to me. Lawyers and paralegals work together to help people. We help people with specific problems. We also offer workshops in the community to supply them with information they need to work out their problems. We help people learn about things like welfare and landlord-tenant relations.

I never liked school too much, but I've always been a reader. I enjoy all kinds of books. Being a reader sure comes in handy on this job. I refer to consumer manuals and law books often. When I started this job, I didn't know many legal terms. Now I use them all the time. I've learned so much just by reading on my own!

Although reading is an important skill, initiative is even more important. Initiative is the willingness and ability to start things, to do what needs to be done without waiting to be told. Of course, I follow directions, but no one tells me exactly how to spend my time. For me, initiative means taking the important steps to do my job well. It also means using my own judgment. I research thoroughly and do good work because my clients depend on me. I want to help my clients the best way I can. There are other skills that help me on this job, too! Typing is one. There are always lots of forms to be typed up. I also need to know math, to help me figure out the welfare budgets and rents.

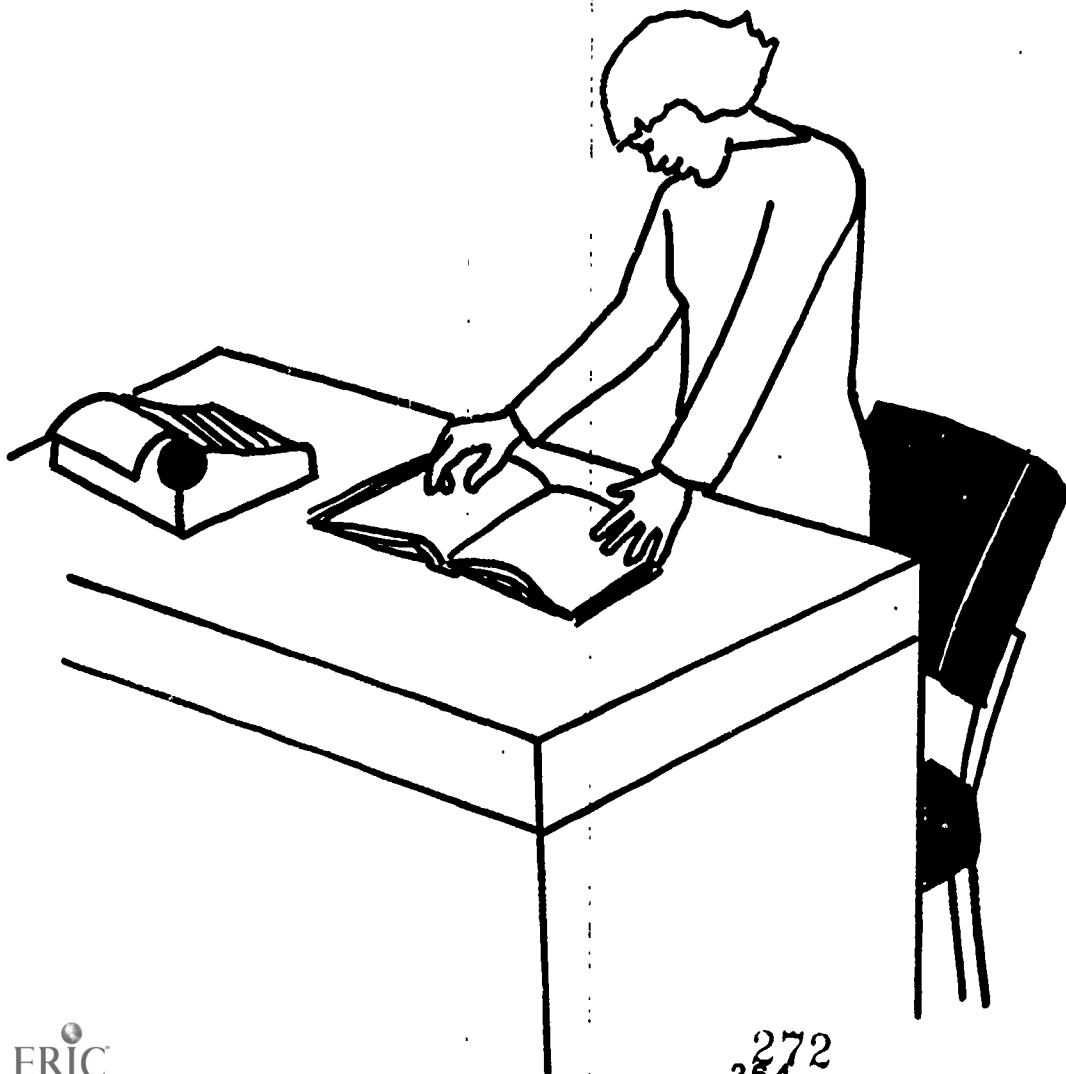

I like being a paralegal, and I like helping people. I've learned a lot about the American legal system. I've learned a lot about the many people of our world. I've also learned many skills, and I feel prepared for many kinds of jobs.



PARALEGAL:

QUIZ WHIZ



Name three of a paralegal's work tasks.

Name four tools or pieces of equipment used by paralegals on the job.

Where do paralegals do their work?

How do paralegals use reading and math skills on the job?

Name a personal skill that's important for paralegals to develop.

What kind of training is required of paralegals?

Name one advantage and one disadvantage of paralegal work.

What are some of the possibilities of advancement for a paralegal?

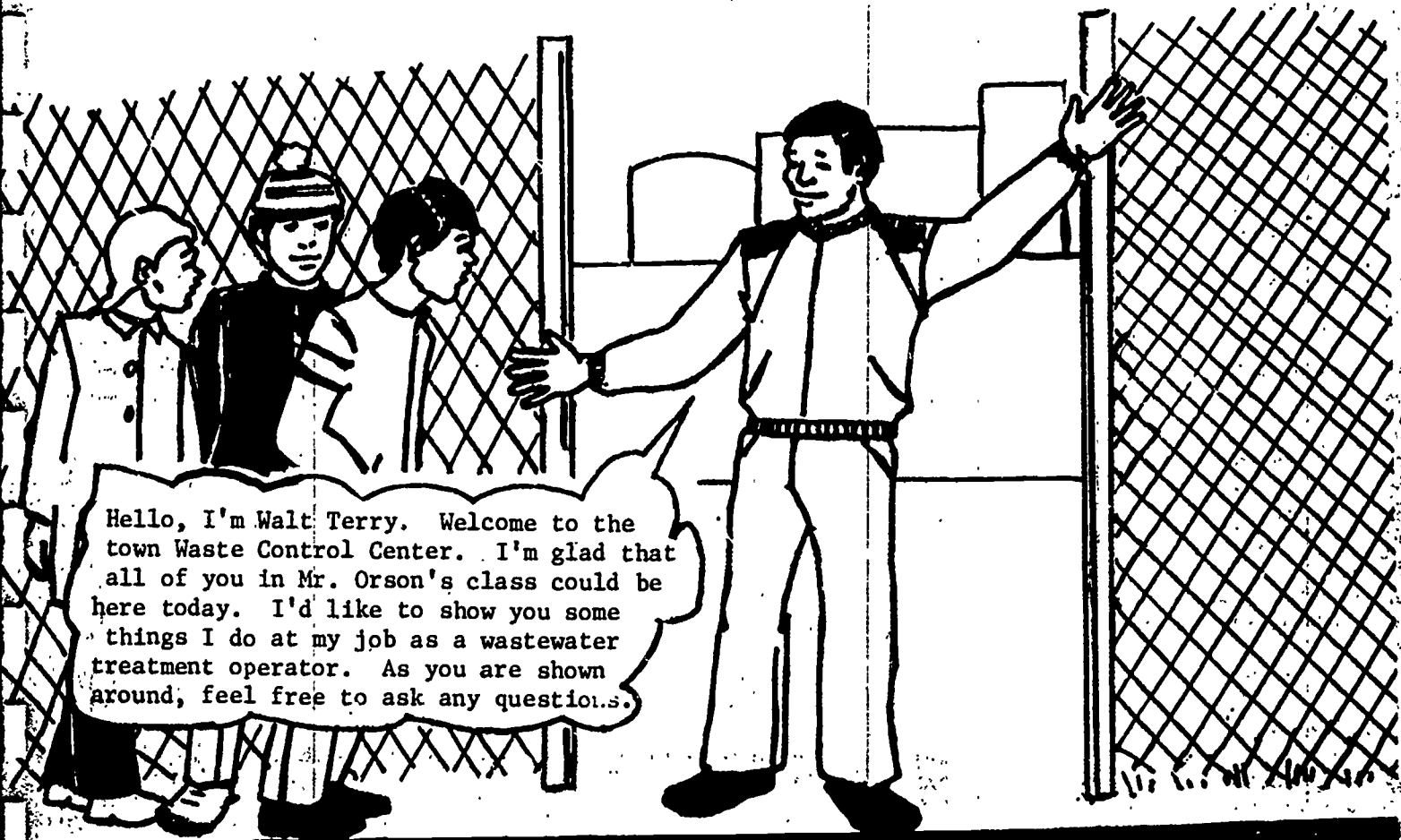

Hello, I'm Walt Terry. Welcome to the town Waste Control Center. I'm glad that all of you in Mr. Orson's class could be here today. I'd like to show you some things I do at my job as a wastewater treatment operator. As you are shown around, feel free to ask any questions.

My job is important because it helps to clean up the sewage and other liquid discharges from homes, businesses and industry. I also help keep our town a healthy place to live. There is one hazard in my job. I have to be careful because of the disease causing bacteria that may be around. Meters and gauges like these let me know what's going on at each step of the waste treatment process. An important part of my job is reading these meters and gauges to keep track of what's going on. I must keep careful records of meter readings and I use math skills to do it.

Is math hard?

No, addition, subtraction, and multiplication are all that's required, and I like math.

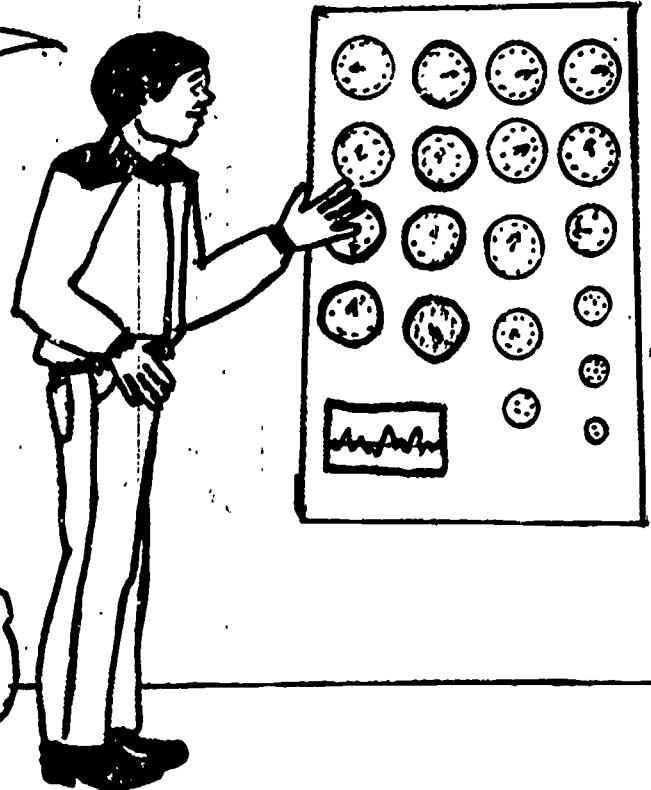

This is where the untreated wastewater comes into the plant through pipes and enters tanks where treatment begins.

What happens if a pipe gets a leak?

We have the tools and spare parts to repair leaky pipes. This depth finder here is one of the tools we use. The depth finder is used to make repairs in hard-to-reach places.

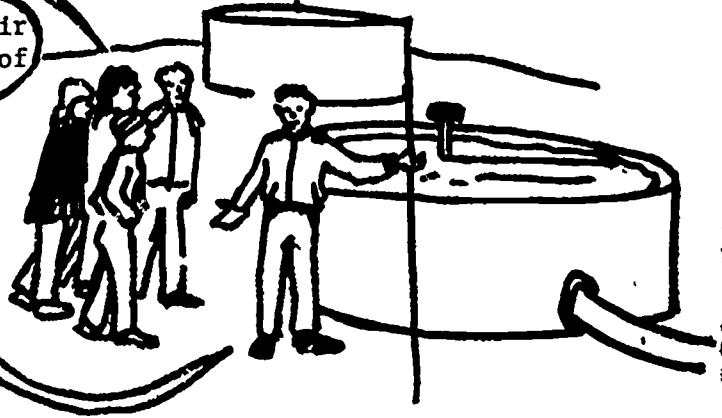

Untreated wastewater is piped into tanks, which are a suitable place for bacteria to grow. We want this to happen because the bacteria digest the waste matter and decomposes it into simpler parts. Aeration is done at this step in the process.

What is aeration?

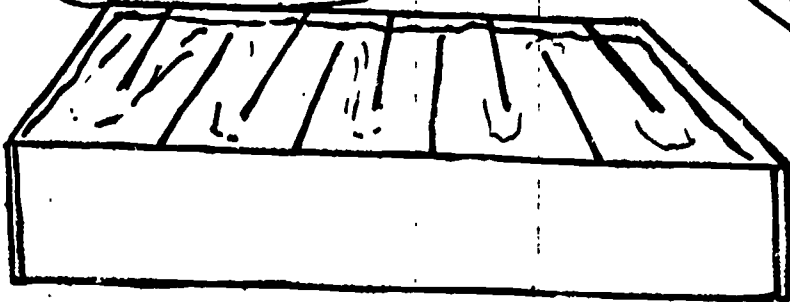

Like most living things bacteria which decompose waste need oxygen to grow and reproduce. Aeration means mixing in air with the waste matter so bacteria can thrive. I regulate the air mix by using meters and gauges which tell me if the amount of air is enough, or too much, or just right.

Bacteria growth is the most important part in the treatment of wastewater. When the digestion ends the relatively small amount of non-water residue is divided into sludge cakes. Then the sludge cakes can be burned in the incinerator. I need to keep accurate records of meter readings that tell me what's happening inside the incinerator.

It sounds like on your job you must keep good records. You keep track of things inside of pipes, tanks, and the incinerators.

That's right!



Did you learn how to be an operator here at the town Waste Control Center?

I studied about wastewater treatment at vocational school where I learned about sludge digestion, aeration, odor control, and chlorination. Some other workers here took training put on by the state Health Department.

Can you advance on your job?

Sure. If I take in-service or college level courses, I can learn more and advance to a more responsible position at the plant. If I show my boss I do good work, and that I have had good experience, that helps with advancement, too.

At what kinds of places can waste-water treatment operators find work?

Any place wastewater needs to be disposed of, that's where I can work. There are local, state, and federal installations as well as treatment plants run by private industry.

We appreciate your taking time today to show us the plant because we learned a lot about your work.

I enjoyed it.



QUIZ YOURSELF:

WASTEWATER TREATMENT OPERATOR

Answer the questions below. Reread the story to find answers you do not know.

Name three of my tools or pieces of equipment and one use for each.

Name one of my training places.

What are three of my on-the-job skills or tasks?

Name one of my work places.

merchant marine
station master
school bus driver
ship's captain
railroad mechanic
railroad engineer
security agent
flight attendant
signals operator

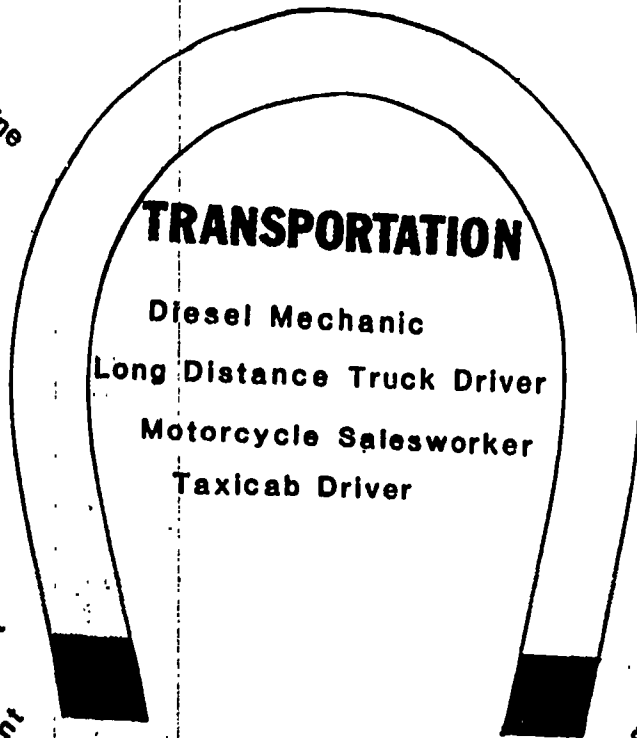

lockmaster
truck driver
reservationist
estimator
equipment operator
auto mechanic
airplane pilot
aircraft mechanic
freight handler

inspector
dispatcher
driver

Workers from the Transportation cluster help to move people and goods from one place to another.

DIESEL MECHANIC

Trina: Hi. I'm Trina Parks from North Pass High School. I called last week to make an appointment with Paul Spratt, the service manager.

Paul: I'm Paul Spratt, and I'm glad to meet you. I understand you want to learn about what diesel mechanics do at work, right?

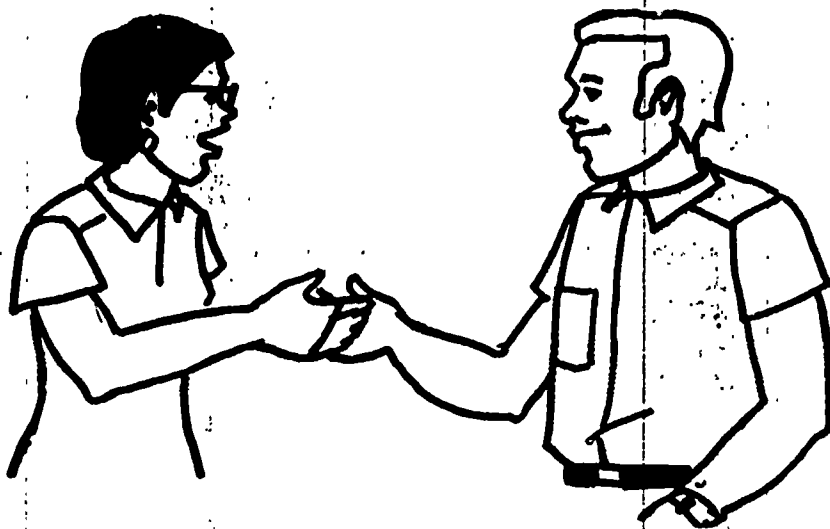

Trina: Yes, please tell me everything you can.

Paul: Well, let's start at the beginning. Do you know how a diesel engine differs from a gas engine?

Trina: I know that diesel engines take special fuel, which is thicker than gasoline. Spark plugs aren't used to burn the fuel in diesel engines either. Instead, in the cylinders, a mixture of air and fuel is squeezed. This generates heat, which ignites the fuel.

Paul: Yes, I see you know the basics of diesel theory.

Trina: I did some research before I came. Besides, I love to work on engines. I want to know about diesels because they get such good gas mileage. I understand that diesel engines are even used on small cars now, so a mechanic can find work in many places.

Paul: Yes, I believe you're right. In European countries passenger cars are run by diesel engines. There are lots of advantages in using diesel fuel. We figure sixteen gallons of diesel fuel are used for every forty gallons of gasoline on most big trucks. It is the best fuel for engines that idle for long periods of time. The only disadvantage is that diesels are hard to start in winter because the fuel is so thick.

Trina: Other than trucks, what types of vehicles use diesel fuel?



Paul: Now, in this garage, we only service trucks. At other diesel service centers, you might see cranes or tractors. You may see boats, trains, or oil drilling rigs. A diesel mechanic might find work in lots of places. There's always work at a bus or railroad line or even a construction company. One might possibly find work at a power plant, a shipping firm, or even a mining or drilling company. Wherever big, heavy equipment uses fossil fuel, chances are diesel engines are doing the work.

Trina: Well, it sure seems like a good field to go into. Tell me about this shop. When a truck is brought in for repairs, does one mechanic work on it, or do the mechanics all work together?

Paul: It depends on what's wrong with the truck. Most mechanics here are really good in one area of repair. Some specialize in front-end and brake work. Some work on fuel injectors, pumps, and nozzles. Still others are great at fixing rear-end and transmission problems. Two people here do just electrical work and tune-ups. Only one person besides myself is equally good at everything. But all the mechanics here are very good at what they do. Plus, they all work very well with each other. These are the things that matter to me. I trust them all to do their best work all the time. It doesn't matter if they are working alone or with others, or whether or not someone is watching them.

Trina: The way I see it, a mechanic's job includes three things:

1. routine repair jobs
2. determining problems, and
3. repairing and replacing parts.

Do you agree?

Paul: Yes, a good mechanic should be able to do those three things. Mechanics here do maintenance work to stop things from going wrong on the road. Drivers like this service, though they sometimes wait till it's too late.

Trina: Do the drivers diagnose most of the problems themselves? Do they usually tell you what they think is wrong with their trucks?

Paul: Well, most drivers know what might be wrong with their trucks. But as a manager, I know exactly what's done to each truck. I give each truck a test drive, look it over, and diagnose the problem. Next, I give the work to the mechanic who can do the best job. Of course, all the mechanics do some diagnosing while they work; they watch for strange sights, noises, and smells. Sometimes a job is bigger than I expected. I really trust each mechanic to be alert.



Trina: What else do you look for in a mechanic?

Paul: A diesel mechanic must often lift as much as 100 pounds. His strength is important. He must be able to read micrometers and gauges. Also, he must figure out problems like how much fuel is going through a pump while under a certain amount of pressure. You see, a high school background in math and science really comes in handy. Of course, special school training is just as important. Mechanical experience counts, too! Reading is also an important skill for this job. Mechanics must know how to use the manuals and read diagrams. Don't get me wrong. Reading isn't everything. I have fired mechanics who understood engines described in books, but when faced with a real engine, just couldn't manage. When I am hiring, I look for a person with practical experience and a desire to learn.

Trina: Would you hire someone straight out of high school?

Paul: Well, it depends. These days, technical schools and community colleges offer good two-year programs. They offer courses in hydraulics, welding, and blueprint reading. Of course, they give courses in actual repair. You can see why I like to hire someone with that kind of experience. I would consider someone who is willing to spend two years as an apprentice here. An apprentice is trained on the job and gets paid less than other mechanics. This is because he is still learning the trade.

Trina: I have noticed that the hand tools around here look new. Do you give your mechanics new tools once in a while?

Paul: No, each set of tools belongs to a mechanic. Each person owns about \$1,000 worth of tools, bought over years. That's a big investment, so mechanics take care of their tools and keep them clean. Besides, grease or dirt can wreck a mechanical job.

Trina: What tools and equipment do the mechanics use on a typical day?



Paul: Mechanics use many tools. They use pliers; screwdrivers; ratchet, box, and open-ended wrenches; surface and pressure gauges; and feelers. They also use micrometers which measure up to .0001 of an inch. Some equipment they use belongs to the shop. These are things like a valve grinding or resurfacing machine and a pin-fitting machine. There are also an electronic engine tester called a dynamometer, hydraulic lifts, jacks, welding equipment, and safety goggles. Powered hoists and cranes help lift heavy parts. Of course, each mechanic has a creeper.

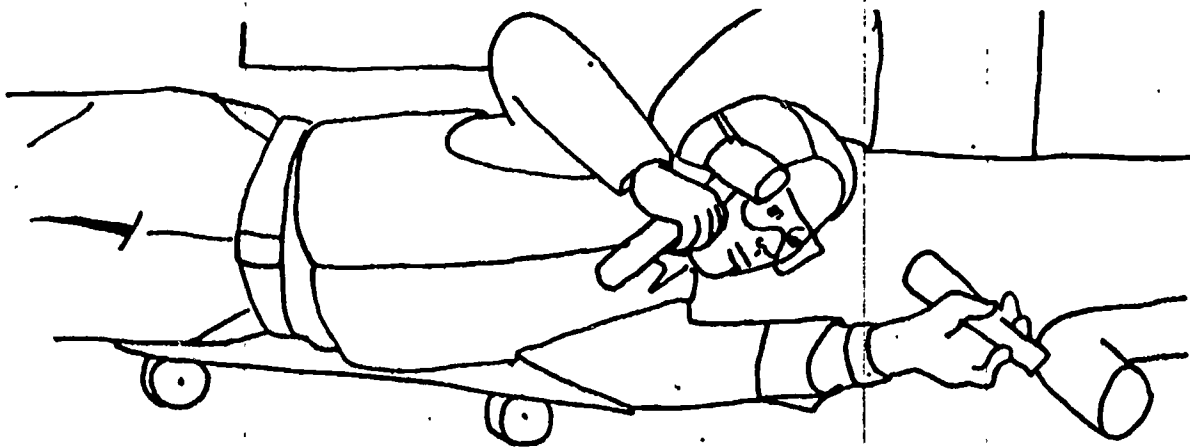

Trina: A creeper?

Paul: Yeah, it's a board with wheels. You use it to get to hard-to-reach places under trucks.

Trina: What is in the future for a mechanic? Is there room for advancement?

Paul: Well, a careful mechanic who learns everything about diesel repair can become a service manager. That is what I did. A mechanic could also become a shop supervisor, with enough experience and knowledge. There are chances to learn outside of the shop, too. Engine manufacturers offer special classes to teach new techniques. They also teach mechanics about new designs and equipment. I go to these classes myself when I can.

Trina: Hmm. I certainly have learned a lot here. I think I'll start lifting weights so that I can meet the strength requirement. I'm really interested in this career. At home, I've been working on the family car. Soon I hope to get some diesel experience.

Paul: Well, give me a call when you get some more schooling and experience. If you're willing to work hard, you may have a job!

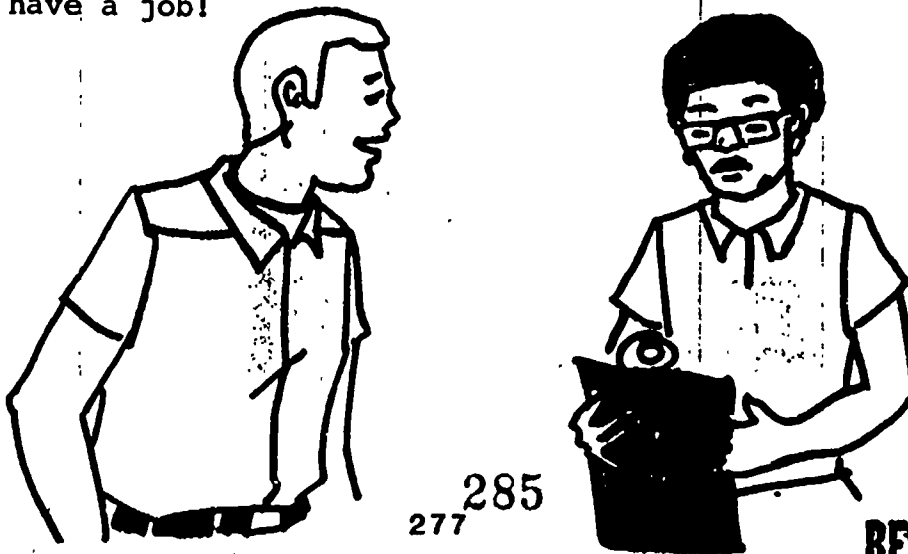



QUIZ YOURSELF:

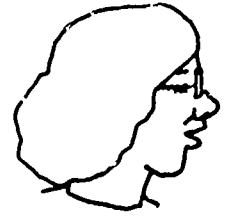

DIESEL MECHANIC

What are three skills every Diesel Mechanic must practice on the job?



Name two hand tools and one shop tool used by a Diesel Mechanic on the job. What is each used for?

Besides on-the-job garage training, where can someone be trained to become a Diesel Mechanic?

Name two places you might find Diesel Mechanics at work.

How do Diesel Mechanics use math and reading skills on the job?

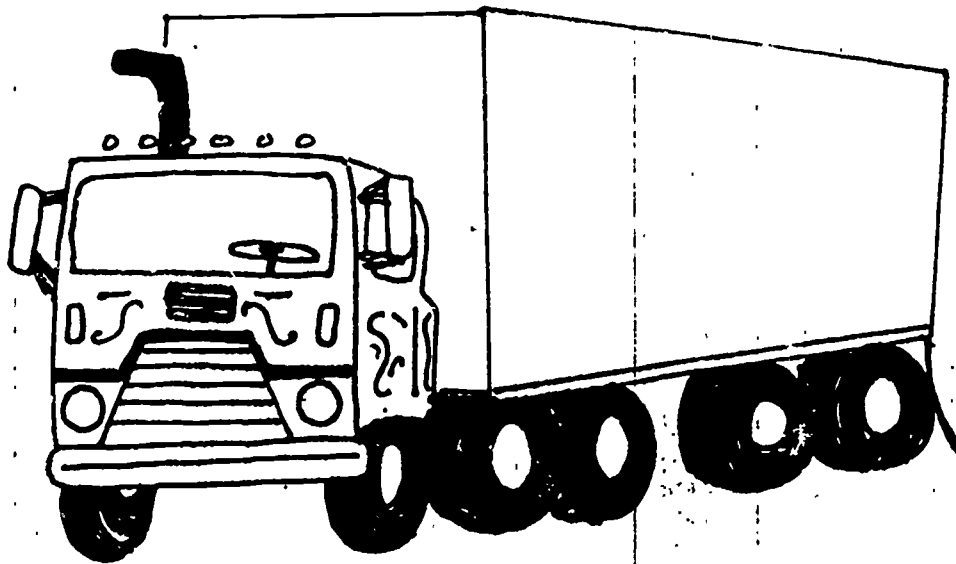

JOHN MARSH: LONG-DISTANCE TRUCK DRIVER

I drive a tractor trailer; in this business we call it a "rig."
It's a multi-axled vehicle; at fifty-five feet long, it sure is big.
My truck has over a dozen gears, so driving this rig takes training and skill.
Shifting gears keeps me occupied; it takes experience to climb a really steep hill.

I got driving experience growing up on a farm, and more training in the armed forces.
But besides these types of experience, there are other training sources:
Tractor trailer driving schools teach students for a fee by night or by day.
And if you learn through the union as a driver's aide,
You can learn on the job and earn some pay.

Truckers must pass a tough road test,
So among motorists on the highway, we're probably the best.
Incidentally, if it's about our health you're quizzical,
Every two years, truckers must pass an in-depth physical.

Since the government guides the weight of a safe truck load,
There are weighing stations set up on the sides of major roads.
And the government regulates the number of hours a trucker may drive,
To insure that we take needed breaks to stay awake and alive.
The most important thing for a trucker is to stay alert,
To avoid accidents on highways so that no one is hurt.

Some truckers take pills to stay awake
So they can work longer hours without stopping for a break,
But if these drivers are caught, their licenses may be revoked.
Besides, the chances are that their lives will soon go up in smoke.

BEST COPY AVAILABLE

When you work for yourself as I do,
You have lots of tasks, you're a one-person crew.
You're the businessman or woman who arranges every job.
You also load and unload the goods which could be coal, furniture, or corn on the cob.
I also make connections to buy commodities (goods) that sell,
Which means I'm also a salesman, who needs a reliable clientele.

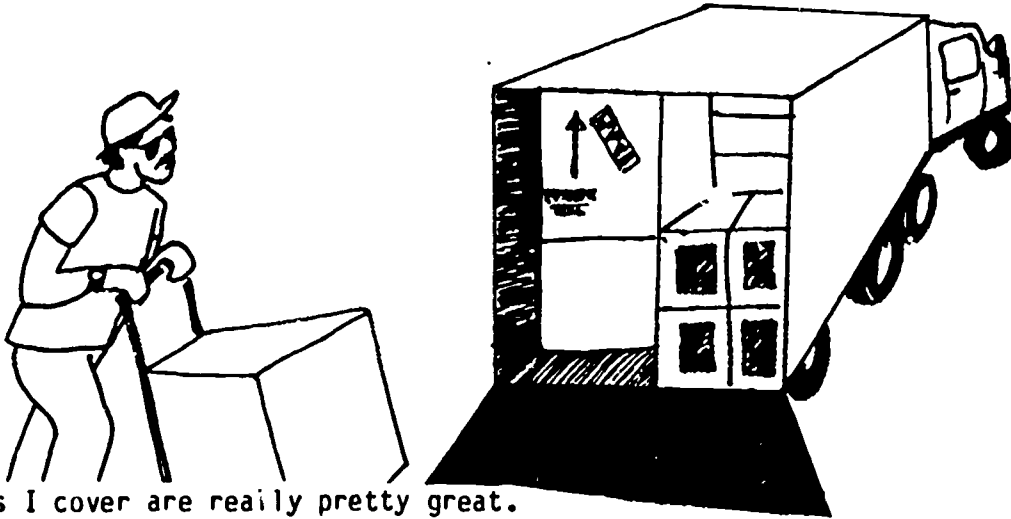

The distances I cover are really pretty great.
It's not the miles that get to me; it's gas prices that I hate.
I cover four miles of road to every gallon of fuel,
So driving directly to my destination becomes my "golden rule."

Now, if you want to be a trucker and your own best friend,
It's important to learn mechanical skills on which you can depend.
But of course, when you break down too far from your garage or home,
You use your C.B. radio for help; it's a trucker's telephone.

But the tools of my trade are more than a C.B. radio and tool box.
I need maps, chains, jumper cables, and to wake me, an alarm clock.
I need a loading ramp, ropes, crowbars, and a dependable flashlight,
And reflectors and flares are needed, in case my truck breaks down at night.

Wondering if truckers need reading and math?
It's like asking if a flea-ridden dog needs a bath.
We read exit signs to avoid parkways and private roads.
And math is needed to calculate the weight and volume of our loads.

Nothing is more important than knowing how to add;
Ignoring bridge and tunnel elevations causes accidents which are bad.
And you need to keep your records straight
When making out bills and receipts, when exchanging freight.

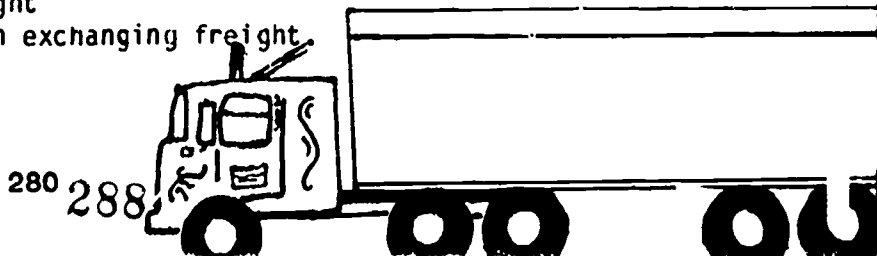

If you run your own business, math is more important still;
You'll have to pay a special fuel tax and vehicle repair bills.
Being a mathematical genius isn't needed.
But you'll do better if your current math instructor is heeded.

If you like to be alone a lot, and traveling's your thing,
Consider being a trucker;
Bring some tapes, and sing!



QUIZ

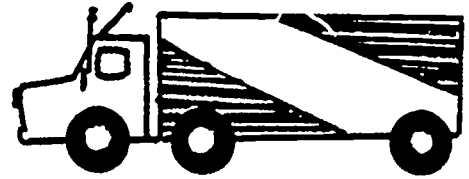

LONG DISTANCE TRUCK DRIVER

Describe three of John Marsh's work tasks.

Name four tools or pieces of equipment used by long distance truck drivers.

Describe two ways that truckers use math skills on the job.

Name three ways of getting the training needed to drive a tractor trailer.

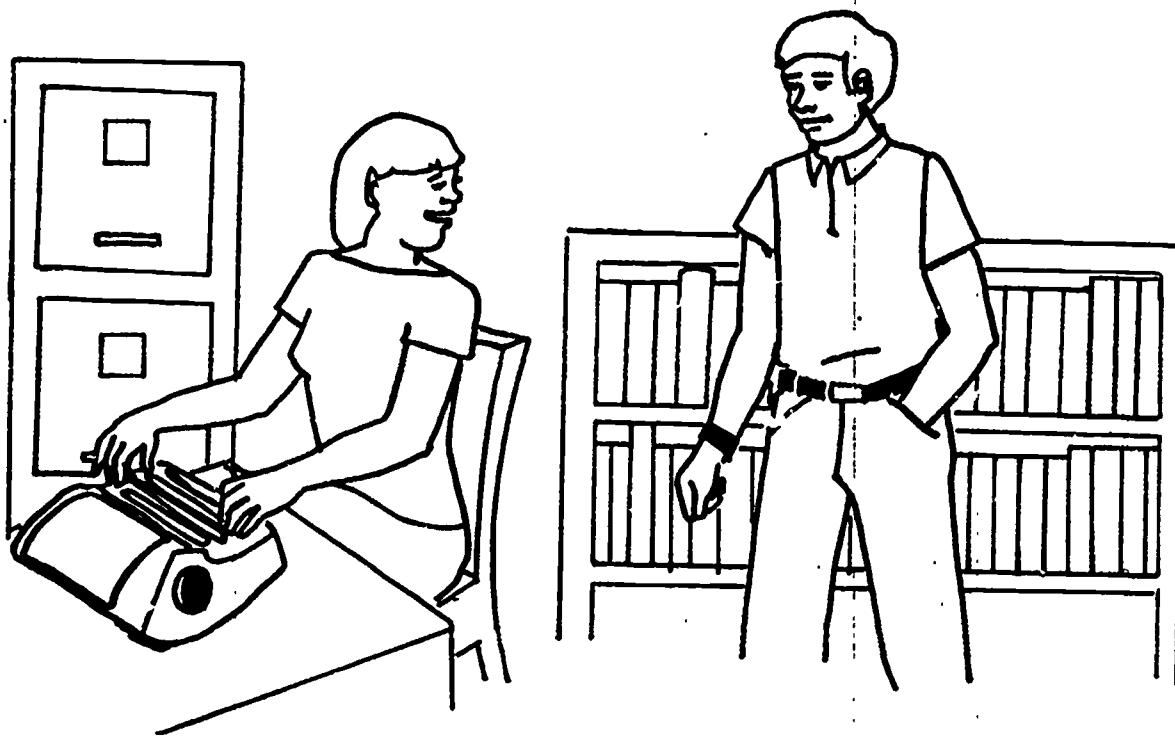

SELLET'S "CYCLE" WHEELS

Hi, my name is Jordan Moore. Last week I was a "shadow" at Sellet's Wheels, a retail motorcycle shop. My friends and I have been going there for years to look at new bikes. I thought I knew all there was to know about the shop, but I was wrong. My first surprise was Kate Star. I always thought she was a secretary; every time I saw her, she was talking on the phone or typing. One day I was Kate's shadow; I went with her and saw how she did her work. I found out that Kate is the top salesworker in the store. A good motorcycle salesworker has many duties.

Kate hunts for customers by phone and mail. She spends two hours a day in her office following up on leads. She looks at driver registrations and service records of people in our city. When Kate hears about people with old bikes, she calls them. She asks them if they want to trade their used bikes for new ones. Her office is filled with catalogs and brochures about different motorcycle models. She has a file cabinet full of service histories of former customers. One bookshelf is filled with contracts for bank loans. Kate knows a lot about motorcycles and managing money. She gets manufacturer's bulletins daily. She always reads these pamphlets.

In the winter, a slow time for sales, some salesworkers are laid off. Kate is not! She has office work. Talking to customers is important. Kate knows what people are looking for and can talk about bikes in terms that people understand.

Later in the day Kate had an appointment with a man who might want to buy a bike. I thought Kate would try to sell him the biggest bike right away, but I was wrong. Kate asked him a lot of questions. What is the bike going to be used for, how often would he ride it, and how much money did he want to spend? Kate listened as much as she talked. She showed him three bikes that were all in his price range and gave him brochures that told him about each bike. Kate said, "Don't rush! Call me when you want to talk more."

"You don't push people, do you?" I asked later.

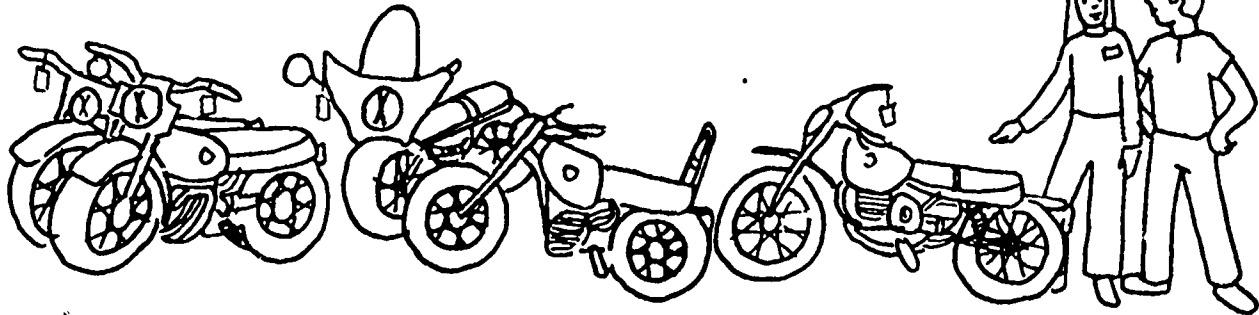

"Most people want to think and make a good decision before spending over \$1,000. My job is to help people decide what's best for them to buy. I don't want to make people spend more than they want to. I want to be a resource person so that my customers will trust me and will come back again. What makes me a good salesworker is my attitude!"

I thought about what she said. Never before had I thought of salesworkers as resources.

I watched Dan White, junior salesworker at Cycles, trying to sell a bike to a young couple. He asked his customers the same kinds of questions Kate had asked. I saw that Dan and Kate had three things in common. They were both friendly and polite, and they both spoke clearly. I asked Dan how important he thought these things were.

"Soon after I got this job I took a public speaking class. It's important to know how to talk to people. That public speaking class helped me with my sales."

I asked him, "How can a student prepare for a motorcycle sales career?"

"Sell anything, and get used to talking to people," he said. "It's also important how you dress. Mechanical experience helps also. A motorcycle salesworker should be a bike rider too!"

"What about finance papers and contracts?" I asked. "How could I prepare for that?"

"You could learn on the job. Good reading skills are important. They help you understand contracts. Finance and insurance forms go along with every sale, so business math helps salesworkers too. The most important part of sales is personality. That means being polite, knowing what customers like, and dressing neatly."

"You've told me many things I can work on now," I said. I thought, "There is more to sales than meets the eye!"

"Oh," Dan added, "one other thing that helps me is that I'm able to change. In the winter I sell snowmobiles, snowblowers, and other things. I'm willing to improve myself and learn about new products. If it's at Cycles, I'll sell it!"

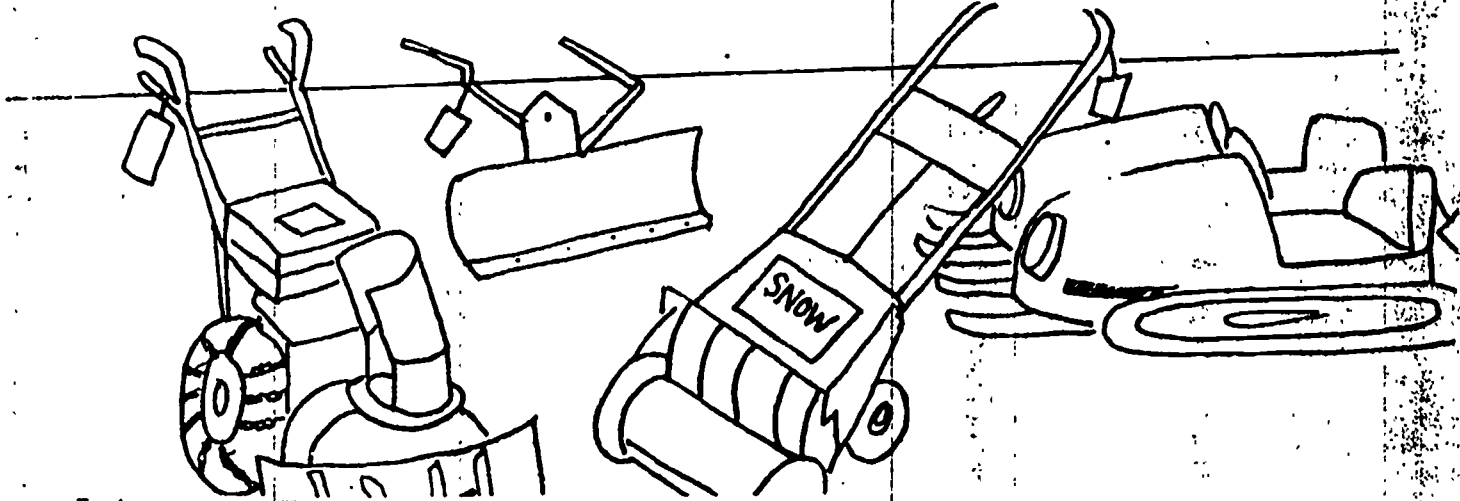

Later on, Kate met with a customer who wanted to buy a bike. At Cycles, making a sale is called "closing" a sale. We all went into her office. Kate explained many things to her customer. She explained insurance rates, special loans, and financing policies to him. Kate prepared the order forms and talked about the warranty. The customer read and signed the papers and then the sale was closed. Kate would deliver the bike after it came to the store.

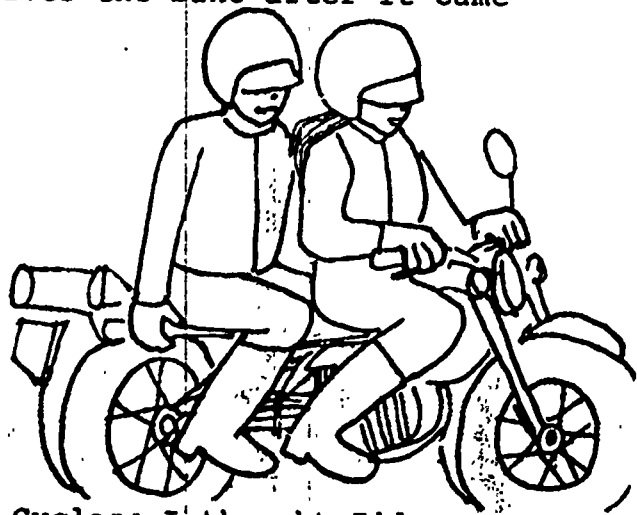

I felt good about my day at Cycles; I thought I'd seen everything! But when Kate took a customer on a test drive, I thought about all the many different things Kate might do in one day. I asked her about it when she came back.

"Well, you came on a very busy day. Weeks can go by when I don't leave the shop. There are real benefits to this work. The showroom is always clean, with plenty of light, and I have my own place to work. These things are important to me. I also get a paid vacation, a life insurance policy, and good medical and hospital plans. But it took me a long time to learn good sales techniques. Even though my job is secure, I'm still learning. I go to classes that motorcycle manufacturers give because I want to know all I can about what I sell. You see, Jordan, I like adding to my skills."

"Then it wasn't always as easy as it is now for you! Did you become a good salesworker little by little?"

"That's right, just like Dan. He does well because he tries to get better. I was a junior salesworker for two years. Then I worked myself up to this job. At first, it was hard. You see, we earn small salaries so we really depend on our commissions. Commissions are a part of the money we make from each sale, so we have to build up our clientele to make good money."

"Clientele?"

"Yes, that is a word for groups of customers. After two years I have a large clientele, so now I feel secure here. The many things I do each day make my work interesting, and they sure help the day go fast!"

I've learned so much at Cycles that I want to see if I can be good at sales. This weekend I'll take my bike to the flea market. HMMMMMMMMMMMM. I think my jogging outfit will please the athletic people!

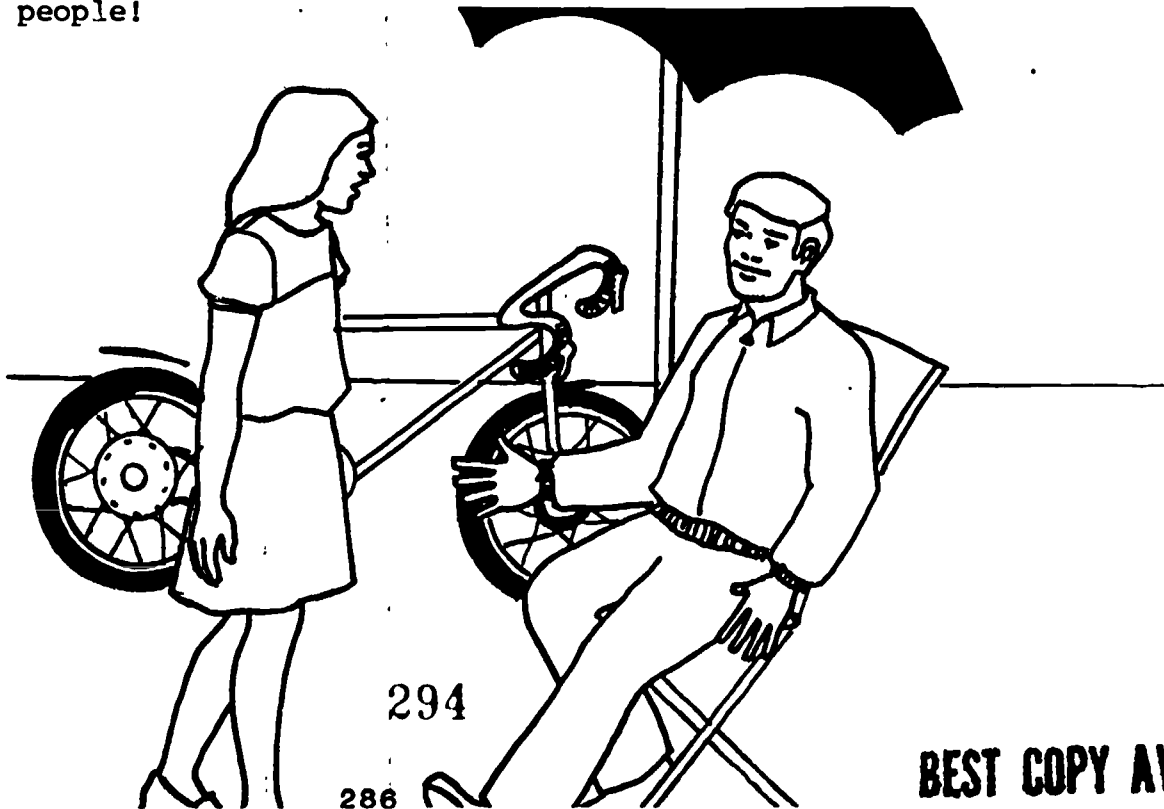

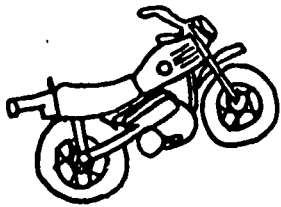

QUIZ YOURSELF:

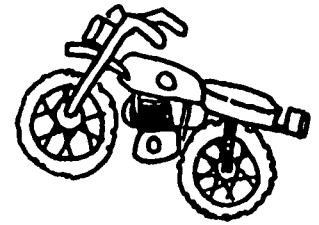

RETAIL MOTORCYCLE SALESWORKER

Name three tasks Kate performs on the job.

Name three tools or pieces of equipment Kate uses on the job. How is each used?

Where does Kate do her work?

What should someone do to prepare for a career as a Motorcycle Salesworker?

How do Motorcycle Salesworkers use math and reading skills on the job?

Taxicab Driver

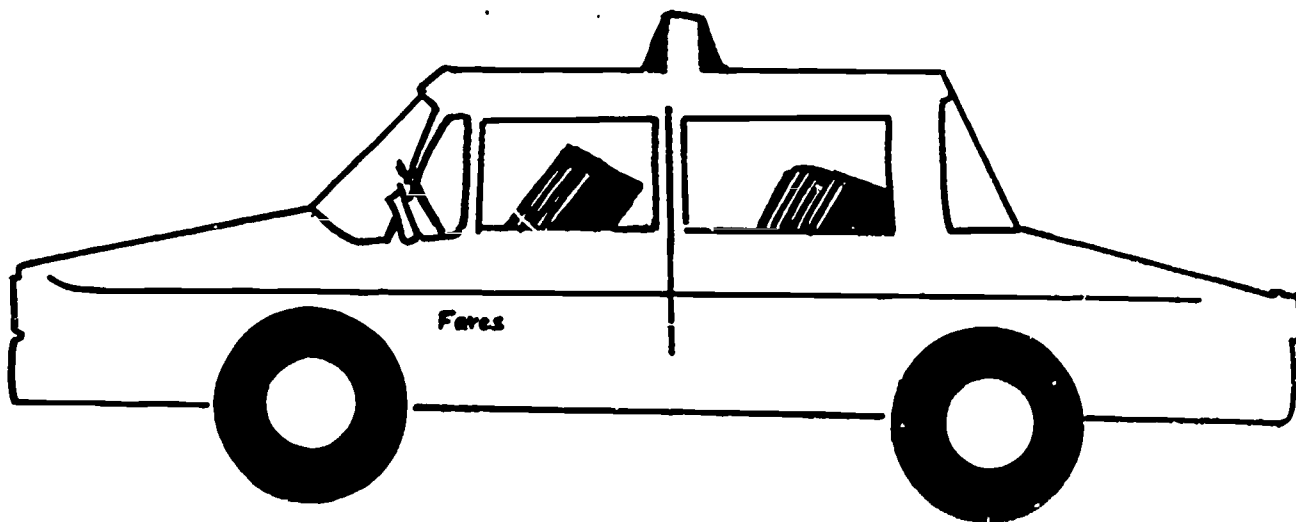

JOB DESCRIPTION: Off : personal transportation to people in city (urban) and country (rural) areas. That means that taxi drivers take people WHERE they want to go, WHEN they want to go.

"Cabbies" work a day shift or a night shift. Drivers who have their own cabs can work when they want to. They make as much money as they collect from the people who ride with them. The money for a ride is called the fare. Most drivers work for a company. They earn 40-50% of the fares they collect, PLUS tips.

ON-THE-JOB TASKS AND SKILLS:

- 1) Gets call from dispatcher on a two-way radio or on a phone at the taxi stand. (People who need a ride call the dispatcher.)
- 2) Picks up people and takes them where they want to go.
- 3) Collects the fare. The fare is based on how far the people go and sometimes how long it takes to get there.
- 4) Helps people carry luggage.
- 5) Makes change.
- 6) Keeps records of each day's work. This includes when and where each person was picked up and left and how much fare was collected.
- 7) May show people the "sights" of an area. This means that the cabbie must know the area very well.
- 8) Must be polite.
- 9) Must be a good driver.

WORK PLACES:

- 1) In cab: on the road, at taxi stands, in front of busy places like hotels, airports, and bus and train stations.
- 2) A good living can be made in urban areas. In rural areas, cab driving is a good source of part-time or extra income.

TOOLS AND EQUIPMENT:

- 1) Cab (owned by a cab company, or by the driver).
- 2) Two-way radio used to take calls from dispatching office, and to call in one's destination.
- 3) Record sheets or log book to record all trips and prices.
- 4) Taximeter (always in urban areas, sometimes not used in rural areas) which tells how many miles are traveled or how much the fare is.
- 5) Cash box.

TRAINING REQUIREMENTS:

- 1) Drivers must be 21 years old.
- 2) A good driving record.
- 3) A chauffeur's driving license. Besides this, taxi drivers must often take a separate written test. The test includes questions about accident reports, traffic insurance, and street locations.

WAYS THAT READING, WRITING, AND MATH ARE USED ON THE JOB:

- 1) Reading, to pass chauffeur's license tests and other tests.
- 2) Drivers must be able to read street signs, and must read maps when getting to know an area.
- 3) Writing, to keep records of all their trips.
- 4) Math, to make the correct change, and to keep records of fares.

CHANCES FOR ADVANCEMENT:

- 1) Drivers may become dispatchers.
- 2) Drivers may buy their own cabs.
- 3) Experienced drivers with business training may start their own cab company.

Quiz Yourself

TAXICAB DRIVER

- I. What are 3 tasks a Taxicab Driver performs during a working day?



- II. Name 2 busy places where cabs can be found waiting for riders.



- III. What are 3 tools or pieces of equipment used by Taxicab Drivers? What are they each used for?

- IV. What is 1 way to prepare or train for a job as a Taxicab Driver?

- V. How can reading and math skills come in handy on the job?



Contents developed at:
MID-HUDSON MIGRANT EDUCATION CENTER

CHOICE
PO BOX 250
NEW PALTZ, NY 12561

(914) 257-2185

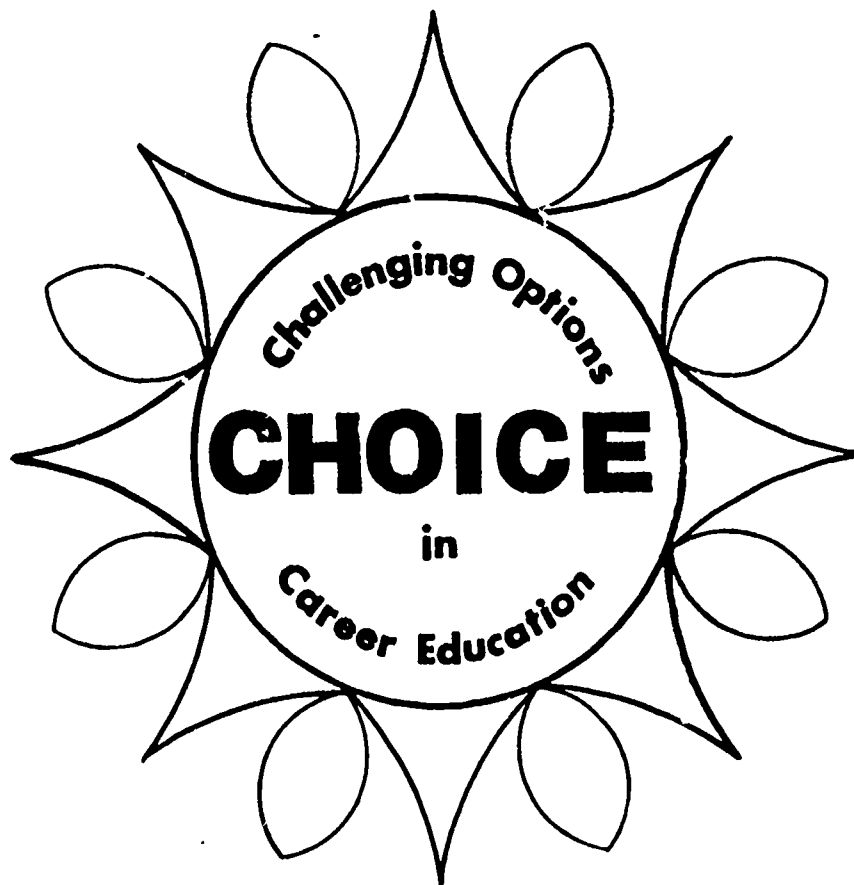

1983

Work on this curriculum is performed pursuant to project #28-84-0023 with the United States Department of Education. Funds were obtained through Title I ESEA Migrant Education Funds public law 95-561 section 143. The opinions expressed do not necessarily reflect the position or policy of the United States Department of Education and no official endorsement should be inferred.