

DOCUMENT RESUME

ED 268 336

CE 044 218

**AUTHOR** Thompson, Joselyn H.  
**TITLE** Medical Laboratory Technician--Microbiology (AFSC 90470).  
**INSTITUTION** Air Univ., Gunter AFS, Ala. Extension Course Inst.  
**PUB DATE** 28 Nov 83  
**NOTE** 644p.; Supersedes ED 224 892.  
**PUB TYPE** Guides - Classroom Use - Materials (For Learner) (051)

**EDRS PRICE** MF03/PC26 Plus Postage.  
**DESCRIPTORS** \*Allied Health Occupations Education; Behavioral Objectives; Biomedical Equipment; Correspondence Study; Distance Education; Laboratory Procedures; \*Laboratory Technology; Learning Activities; \*Medical Evaluation; Medical Services; \*Medical Technologists; \*Microbiology; Military Personnel; \*Military Training; Postsecondary Education

**IDENTIFIERS** Air Force

**ABSTRACT**

This four-volume student text is designed for use by Air Force personnel enrolled in a self-study extension course for medical laboratory technicians. Covered in the individual volumes are laboratory procedures in clinical bacteriology (the history of bacteriology; aseptic techniques and sterilization procedures; bacterial morphology and physiology; inoculation of media for isolation of bacteria; antimicrobial agents, drug resistance, and susceptibility testing; gram-positive organisms, gram-negative cocci, coccoid forms, and bacilli; enteric organisms, mycobacterium and spirochetes); clinical parasitology (medical parasitology and protozoa, platyhelminthes, and nematodes infecting man); and laboratory procedures in clinical mycology (medical mycology, yeastlike fungi and monomorphic molds, pathogenic dimorphic fungi, saprophytic fungi, and laboratory diagnosis of viral rickettsial and chlamydial diseases. Each volume in the set contains a series of lessons, exercises at the end of each lesson, a bibliography, and answers to the exercises. Supplementary volume review exercises, a foldout, and a change supplement are also provided. (MN)

\*\*\*\*\*  
 \* Reproductions supplied by EDRS are the best that can be made \*  
 \* from the original document. \*  
 \*\*\*\*\*

ED 268 336

MEDICAL LABORATORY TECHNICIAN--  
MICROBIOLOGY

(AFSC 90470)

EXTENSION COURSE INSTITUTE

AIR UNIVERSITY

U.S. DEPARTMENT OF EDUCATION  
NATIONAL INSTITUTE OF EDUCATION  
EDUCATIONAL RESOURCES INFORMATION  
CENTER (ERIC)

This document has been reproduced as  
received from the person or organization  
originating it

Minor changes have been made to improve  
reproduction quality

• Points of view or opinions stated in this docu-  
ment do not necessarily represent official NIE  
position or policy

81244218

## ECI COURSE MATERIALS SHIPPING LIST

COURSE NUMBER	COURSE TITLE	EFFECTIVE DATE
90412	MEDICAL LABORATORY TECHNICIAN--MICROBIOLOGY (AFSC 92470)	28 Nov 83

INSTRUCTIONS The following materials are needed to complete this course. Check this list immediately upon receiving your course package, and if any materials are missing or incorrect (numbers don't match) notify ECI immediately. Use the ECI Form 17 for this purpose, and be sure to include your identification number, address, course and volume number, and VRE form designation (if a VRE is involved). Send all correspondence separately from your answer sheet.<sup>1</sup>

ITEM	TYPE	DESIGNATION OR TITLE	INVENTORY CONTROL NUMBER	VRE ANSWER SHEET IDENTIFICATION
1	ENV	ECI RETURN ENVELOPES (4 EACH)		
2		YOUR KEY TO A SUCCESSFUL COURSE	M-140	
3	VOL	VOL 1, Laboratory Procedures in Clinical Bacteriology (Part I)	90412 01 7809	
4	VRE	VOLUME REVIEW EXERCISE (VOL 1)	90412 01 22	90412 01 22
5	VOL	VOL 2, Laboratory Procedures in Clinical Bacteriology (Part II)	90412 02 7910	

7	SUPP	SUPPLEMENTARY MATERIAL (VOL 2)	90412 02 S02 7910	
8	VRE	VOLUME REVIEW EXERCISE (VOL 2)	90412 02 22	90412 02 22
9	VOL	VOL 3, Clinical Parasitology	90412 03 8007	
10	VRE	VOLUME REVIEW EXERCISE (VOL 3)	90412 03 22	90412 03 22
11	VOL	VOL 4, Laboratory Procedures in Clinical Mycology	90412 04 8201	
12	SUPP	SUPPLEMENTARY MATERIAL (VOL 4) (Foldouts 1-3)	90412 04 S01 8201	
13	VRE	VOLUME REVIEW EXERCISE (VOL 4)	90412 04 22	90412 04 22

NOTE: DIRECT ANY QUESTIONS OR COMMENTS RELATING TO ACCURACY OR CURRENCY OF TEXTUAL MATERIALS TO AUTOVON 736-2809.

SPECIAL NOTE: DISREGARD THE AFSC 90412 PRINTED ON THE COVER OF THE TEXTS. THIS CDC IS FOR AIRMEN ON UPGRADE TRAINING TO AFSC 92470 ONLY.

<sup>1</sup>SEE REVERSE SIDE FOR ADDITIONAL INSTRUCTIONS.

## LIST OF CHANGES

COURSE NO.  90412	CAREER FIELDS, POLICIES, PROCEDURES AND EQUIPMENT CHANGE. ALSO ERRORS OCCASIONALLY GET INTO PRINT. THE FOLLOWING ITEMS UPDATE AND CORRECT YOUR COURSE MATERIALS. PLEASE MAKE THE INDICATED CHANGES.
EFFECTIVE DATE OF SHIPPING LIST 28 Nov 83	

NOTE: YOU ARE NOT REQUIRED TO POST ANY CHANGES LISTED IN THIS SHIPPING LIST WHICH CORRECT TYPOGRAPHICAL ERRORS, UNLESS SUCH ERRORS CHANGE OR OTHERWISE AFFECT THE MEANING OF THE MATERIAL.

SPECIAL NOTE: THROUGHOUT THE VOLUMES, WHEREVER IT APPEARS, CHANGE THE FIRST 3 DIGITS OF ALL AFSC REFERENCES FROM 904 TO 924.

1. CHANGE FOR THE TEXT: VOLUME 2

Preface, page *iii*, line 9: Change to read: "Foldouts 1 and 2 are printed as separate enclosures. Foldout 3 appears in the back of the volume."

2. CHANGE FOR THE TEXT: VOLUME 3

Page 20, col 1, line 11: Change "419" to "417."

3. CHANGES FOR THE TEXT: VOLUME 4

a. Page 10, col 2, line 18 from bottom: Change "muslce" to "muscle."

b. Page 21, Exercises (612)-6: Change "macroscopically" to "microscopically."

c. Page 52, col 1, line 5 from bottom: Change "en" to "an."

d. Page 90, col 1, line 3 from bottom: change "Macroscopically" to "Microscopically."

e. Page 92, Table 5-1, under "Group" column: Change "PAPOVARIVUSES" to "PAPOVAVIRUSES" and change "POX VIRUSES" to "POXVIRUSES."

f. Page 98, col 1, line 9: Change "comoplete" to "complete."

g. Page 100, col 1, line 12 from bottom: Change "Burkett's" to "Burkitt's."

4. CHANGE FOR THE VOLUME REVIEW EXERCISE: VOLUME 2

Cover page, line 6: After "Bacteriology" add "(Part II)."

5. CHANGES FOR THE VOLUME REVIEW EXERCISE: VOLUME 3

a. Page 3, question 10: In the stem of the question, change "Whih" to "Which." Question 14: In the stem of the question, delete "of infection."

b. Page 6, question 34, choice c: Change "Gingitis" to "Gingivitis."

c. Page 7, question 38, choice c: Change "chromoloidal" to "chromotoidal." Question 39, choice c: Change "hartamanni" to "hartmanni."



## LIST OF CHANGES

COURSE  
NO.

90412

CAREER FIELDS, POLICIES, PROCEDURES AND EQUIPMENT CHANGE. ALSO ERRORS OCCASIONALLY GET INTO PRINT. THE FOLLOWING ITEMS UPDATE AND CORRECT YOUR COURSE MATERIALS. PLEASE MAKE THE INDICATED CHANGES.

EFFECTIVE DATE  
OF SHIPPING LIST

28 Nov 83

### 5. CHANGES FOR THE VOLUME REVIEW EXERCISE: VOLUME 3 (Continued)

d. Page 9, question 55: In the stem of the question, after "parasite" add "consists of two series of events which" and change "takes" to "take."

e. Page 10, question 59, choice b: Change "flaciparum" to "falciparum."

f. Page 15, question 92: In the stem of the question, change "kateral" to "lateral." Question 96: In the stem of the question, change "American ?" to "America?"

g. Page 16, question 101: In the stem of the question, change "thenubmer" to "the number."

h. Page 17, question 108: In the stem of the question, add "that" after "the."

### 6. CHANGES FOR THE VOLUME REVIEW EXERCISE: VOLUME 4

a. Page 2, question 6, choice c: Change "6.5" to "7.5" Choice d: Change "6.8" to "8.5."

b. Page 3, question 11, choice c: Change "Nocarida" to "Nocardia."

c. Page 5, question 21: In the stem of the question, change "microscopically" to "macroscopically."

d. Page 6, question 28: In the stem of the question, change "Candidablicans" to "Candida albicans." Question 32, choice c: Change "xylose" to "maltose."

e. Page 7, question 36, choice d: Change "incased" to "encased." Question 37, choice a: Change "arthnospires" to "arthrospores."

f. Page 8, question 42: In the stem of the question, change "antibotics" to "antibiotics." Question 43: In the stem of the question, change "M. gyseum" to "M. gypseum."

g. Page 10, question 56: In the stem of the question, change "nocordiosis" to "nocardiosis."

h. Page 11, question 57, choice d: Change "subjeced" to "subjected." Question 60, choice a: Change "Ceserin" to "Casein."

i. Page 13, question 70, choice c: Change "sensitie" to "sensitive."

j. Page 16, question 88: In the stem of the question, change "revese" to "reverse."

## LIST OF CHANGES

COURSE  
NO.

90412

CAREER FIELDS, POLICIES, PROCEDURES AND EQUIPMENT CHANGE. ALSO ERRORS OCCASIONALLY GET INTO PRINT. THE FOLLOWING ITEMS UPDATE AND CORRECT YOUR COURSE MATERIALS. PLEASE MAKE THE INDICATED CHANGES.

EFFECTIVE DATE  
OF SHIPPING LIST

28 Nov 83

### 6. CHANGES FOR THE VOLUME REVIEW EXERCISE: VOLUME 4 (Continued)

k. Page 17, question 97, choice a: Change "growth rate" to "growth at 42°C." Question 99: In the stem of the question, change "mononucleosis" to "mononucleosis." Choice c: Change "herpesviruses" to "Herpesviruses."

l. Page 18, question 105, choice b: Change "nucleocapsid" to "nucleocapsid."

m. Page 19, question 111: In the stem of the question, change "mononucleosis" to "mononucleosis."

n. Page 20, question 117, choice a: Change "arthopod" to "arthropod." Choice c: Change "sperical" to "spherical."

o. Question 17 is no longer scored and need not be answered.

NOTE: Change the currency date on all volumes to "May 1983."

90412 01 7809

CDC 90412

**MEDICAL LABORATORY TECHNICIAN—  
MICROBIOLOGY**

(AFSC 90470)

**Volume 1**

*Laboratory Procedures in Clinical Bacteriology  
(Part I)*



**Extension Course Institute**

**Air Training Command**

Prepared by  
SMSgt Joselyn H. Thompson  
School of Health Care Sciences (ATC)  
Sheppard AFB, Texas 76311

Reviewed by  
Elmore C. Hall, Education Specialist  
Extension Course Institute (ATC/AU)  
Gunter AFS, Alabama 36118



PREPARED BY  
SCHOOL OF HEALTH CARE SCIENCES, USAF (ATC)  
SHEPPARD AIR FORCE BASE, TEXAS

---

EXTENSION COURSE INSTITUTE, GUNTER AIR FORCE STATION, ALABAMA

THIS PUBLICATION HAS BEEN REVIEWED AND APPROVED BY COMPETENT PERSONNEL OF THE PREPARING COMMAND  
IN ACCORDANCE WITH CURRENT DIRECTIVES ON DOCTRINE, POLICY, ESSENTIALITY, PROPRIETY, AND QUALITY.

## PREFACE

MICROBIOLOGY HAS undergone many significant changes within the second half of the twentieth century, during which time tremendous scientific progress has been achieved. Such progressive changes are continuous and require the updating and revising of this course. Thus, in this and in subsequent volumes, we have attempted to introduce the latest applied literature in the field to the bacteriology student and the technologist with the ultimate goal of meeting the professional training of both.

This volume enables the student to review the fundamentals of diagnostic bacteriology. The opening chapter briefly traces the historical development of current bacteriological procedures. The second chapter instructs on laboratory techniques and equipment necessary for the safe handling of infectious microorganisms. Chapters 3 and 4 explain how knowledge of bacterial morphology and physiology permits the technician to isolate and cultivate pathogenic microbes in the laboratory. Lastly, Chapter 5 discloses the basis for antimicrobial sensitivity testing and drug assays.

In total, much emphasis has been made upon the ongoing need for and application of quality control principles and techniques. A brief section has been included on quality control guidelines for the disc agar diffusion method of susceptibility testing in relationship to the standardized modified Kirby-Bauer procedure.

A glossary is included at the end of this volume to assist you in understanding a number of terms with which you should become familiar.

Please note that in this volume we are using the singular pronoun *he, his, or him*, in its generic sense, not its masculine sense. The word to which it refers is person.

If you have questions on the accuracy or currency of the subject matter of this text, or recommendations for its improvement, send them to the School of Health Care Sciences /MSTW, Sheppard AFB TX 76311. NOTE: Do not use the suggestion program to submit corrections for typographical or other errors.

If you have questions on course enrollment or administration, or on any of ECI's instructional aids (Your Key to Career Development, Behavioral Objective Exercises, Volume Review Exercise, and Course Examination), consult your education officer, training officer, or NCO, as appropriate. If he can't answer your questions, send them to ECI, Gunter AFS AL 36118, preferably on ECI Form 17, Student Request for Assistance.

This volume is valued at 63 hours (21 points).

Material in this volume is technically accurate, adequate, and current as of June 1978.

## Acknowledgment

Figure 2-8 and table 2-3 were furnished through the courtesy of American Sterilizer Company, Erie, Pennsylvania.

## Contents

	<i>Page</i>
<i>Preface</i> .....	iii
<i>Acknowledgment</i> .....	iv
 <i>Chapter</i>	
1 A Brief history of Bacteriology .....	1
2 Aseptic Techniques and Sterilization Procedures .....	5
3 Bacterial Morphology and Physiology .....	48
4 Inoculation of Media for Isolation of Bacteria .....	87
5 Antimicrobial Agents, Drug Resistance, and Susceptibility Testing .....	123
 <i>Bibliography</i> .....	 147
<i>Glossary</i> .....	149
<i>Answers for Exercises</i> .....	151

**NOTE:** In this volume, the subject matter is developed by a series of Learning Objectives. Each of these carries a 3-digit number and is in boldface type. Each sets a learning goal for you. The text that follows the objective gives you the information you need to reach that goal. The exercises following the information give you a check on your achievement. When you complete them, see if your answers match those in the back of this volume. If your response to an exercise is incorrect, review the objective and its text.

## A Brief history of Bacteriology

**BACTERIOLOGY**, as we know it today, is a science which demands an understanding of the basic morphology and physiology of bacteria. You must have a keen sense of perception to be able to observe bacterial growth, make intelligent interpretations of this growth, and record what you observe. As a laboratory technician working in bacteriology, you must be a "detective" ready to analyze clues gathered from your efforts in the laboratory as to the identity of a particular disease-associated microorganism. This analysis is fairly routine today, but it has not always been this way.

Sanitary practices and devices to improve ventilation and dispose of human wastes were in use as far back in history as the Knossian or Minoan period (1850–1400 B.C.). Some of these sanitary methods were far better than anything in use before the 19th century. There were no bacteriologists during this time period, so we must conclude that aloof, intelligent, logical minds prevailed in the hierarchy of the day.

Investigators of long ago were not aware of anything smaller than what was visible to the unaided eye. Belief in the supernatural, fear of reprisal, and religious practices did not help to stimulate research. The invention of the microscope was an important stimulus to learn about the tiny world of *animalcules*. Through a slow and gradual process, knowledge about bacteria was sought and diseases associated with them were documented. The world began to realize that small microscopic matter was important in health and disease.

Recent history of medical bacteriology is largely that of the foundation of techniques for isolation and identification of specific disease-causing microorganisms. Conscientious experimentation and careful recording of observations have led to the present status of bacteriology as a science and as a useful tool in fighting the diseases of man.

By being aware of some of the historical high points in the development of bacteriology as a science, you will better appreciate the vast obstacles which had to be overcome. Hopefully, you will be stimulated to add to the progress in this science. Before we go into our discussion of present-day laboratory techniques, we will look at some of the events which helped to shape the destiny of bacteriology.

### 1-1. Major Contributions in the Discovery of Bacteria

Hippocrates (460–377 B.C.), the father of medicine, was not a bacteriologist, but his observations and writings gave a foundation to the field of bacteriology, even though bacteria as such were still unknown. He attributed diseases to changes and disorders in the "vital fluids" of the body. He stressed the use of boiled water for irrigating wounds and called attention to the importance of clean hands and fingernails of the "surgeon." He coined such terms as "acute," "chronic," "endemic," and "epidemic"—terms which are still with us today, although we may use them in a slightly different context. Let's briefly discuss some of the significant major contributions in the discovery of bacteria.

**001. Indicate whether given statements correctly reflect major contributions in the discovery of bacteria.**

**Concept of Contagion.** As the Dark Ages replaced the progressiveness of the Romans and Greeks with mysticism and fear, witches were boiled instead of water. Filth, pestilence, and plague covered Europe. This situation prevailed



until the 18th century. Changes were made, but their acceptance was slow.

The discovery of infectious agents was long preceded by the concept of contagious disease. This contagious disease was initiated by contact with a diseased person or with objects contaminated by him.

It was during the Renaissance (1453-1600) that bacteriology probably had its real beginning. In 1546 Girolamo Fracastoro, father of the germ theory of disease wrote, "Contagion is an infection that passes from one thing to another." He recognized that basically there were three sources of contagious material: (1) by contact, (2) by fomites, and (3) from a distance. This typified the level of scientific knowledge at the beginning of the 17th century, and from this level, science began to emerge as a systematic method of investigation. It was Fracastoro who should probably get credit for giving the venereal disease "syphilis" its name. Fracastoro published a poem which recounted the legend of the shepherd Syphilus who had been afflicted with the disease. The name is still with us.

**The First Microscopic Observations.** Development of the microscope was probably the most significant occurrence in the field of bacteriology. The first simple lens was made by Roger Bacon. This invention was followed by the compound lens of Zacharias Janssen in Holland. The world of microbes was now visible to all who were interested. The first notable observation of microbes was recorded by Anton van Leeuwenhoek in 1675. With his crude microscope, composed of a biconvex lens, Leeuwenhoek discovered bacteria in water and body fluids, as well as yeast in beer. He

saw different shapes and observed that certain bacteria could move from one place to another under their own power. His drawings of these organisms, one of which is shown in figure 1-1, formed a foundation of the modern-day classification of bacteria. Invention of the microscope provided a means to study the causes of fermentation and disease. Naturally, knowledgeable men of the day wanted to learn more about the identity and functions of microbes. However, they were handicapped in their efforts because Leeuwenhoek jealously guarded the secret of his microscope until his death.

After the death of Leeuwenhoek, with the aid of this new instrument and with the information in the more than 200 letters which Leeuwenhoek wrote to the Royal Society of London about his experiments and observations, the science of microbiology was started.

**Exercises (001):**

Indicate whether each of the following statements is true (T) or false (F), and correct those that are false.

- T F 1. The discovery of the concept of contagious disease was long preceded by the discovery of the infectious agents.
- T F 2. It was during the Dark Ages when filth, pestilence, and plague covered Europe that bacteriology probably had its real beginning.
- T F 3. Hippocrates is considered to be the father of the germ theory.
- T F 4. The father of the germ theory recognized that the three sources of contagious material were (1) by contact, (2) fomites, and (3) from a distance.
- T F 5. From the basic concept of contagion, science began to emerge as a systematic method of investigation.
- T F 6. The first simple lens was made by Zacharias Janssen in Holland.

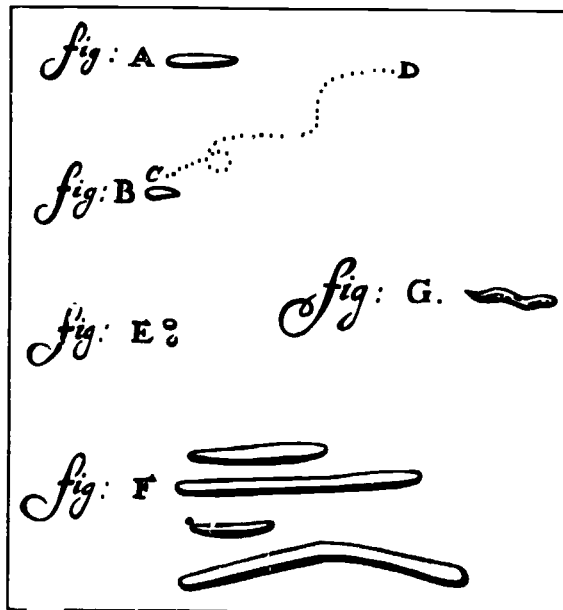

Figure 1-1. Leeuwenhoek's drawing of bacteria.

T F 7. The first notable observation of microbes was recorded by Anton van Leeuwenhoek in 1675.

T F 8. During his lifetime, Leeuwenhoek generously exposed his new instrument and the information about his experiments and observations to his knowledgeable contemporaries, thus starting the science of microbiology.

### 1-2. Contributions of Important Bacteriologists

Belief in the theory that living organisms could originate from nonliving matter made it easy to explain the presence of biological beings, but hampered research for scientific truths. In fact, *spontaneous generation* was so commonly accepted that one could purchase a recipe book which contained a formula for producing mice by simply placing a pair of old trousers, an old shoe, and a few crumbs of food in a quiet, dark corner. In a few days or so mice would indeed be found in the corner or at least evidence that they had been there. Fortunately, there were individuals who would not accept such examples as truths.

002. Identify the contributions made by early bacteriologists in terms of their significance to scientific truths.

**Francesco Redi.** Francesco Redi (1626-1697) wanted to disprove once and for all the theory that putrefying meat gave rise, spontaneously, to living worms or maggots. His simple and classical experiment consisted of three jars into which he placed pieces of fresh meat. He left one jar open, thus exposing the meat to air and flies. Another he covered with gauze; while still another he sealed with a tight-fitting lid. He noticed that flies visited the jars which were exposed to the air, and indeed observed that white worms began forming on the meat in the jar left uncovered. White worms were also found on the gauze which covered one of the jars. No worms were found in the tightly sealed jar although putrefaction was evident.

Redi's experiment started the beginning of the end for the theory of spontaneous generation. This experiment was scientific proof for the day. The worms or maggots were simply fly larvae, which eventually turned into flies. Of course, advocates of spontaneous generation tried to disprove this evidence, but their efforts were to no avail.

**Lazzaro Spallanzani.** Lazzaro Spallanzani (1729-1799), interested in the work of Redi and others, approached the problem of spontaneous

generation in another way. He boiled beef broth for an hour and sealed the flasks in which they were boiled. He noticed that no putrefaction or other apparent changes occurred in the broths even after long periods of time. This experiment was discredited by the spontaneous generation advocates who claimed that the heat had destroyed the air. Other scientific minds would later apply Spallanzani's principle to preserve foodstuffs, resulting in benefits we still enjoy today.

**Schroeder and Von Dusch.** To further disprove the theory of spontaneous generation, two scientists, Schroeder and Von Dusch, followed up the experiments of boiled infusions. However, instead of sealing, they closed the containers with gauze plugs, allowing air to enter the vessels. Eventually some decomposition took place in the broths naturally. This led Schroeder to wonder if the broth changes were caused by organized microscopic germs or some unknown chemical substance. The decomposition was later attributed to oxygen. The cotton plugs had kept bacteria, flies, and other particles out of the broth and are still used to great advantage in modern-day bacteriology.

**Edward Jenner.** The 18th century saw many innovations and scholarly contributions to the science of microbiology. Particularly important were the discoveries of Edward Jenner (1749-1823) regarding immune principles. His classical experiments in developing and administering vaccines are known worldwide.

**Joseph Lister.** The 19th century saw the use of antiseptics in surgery. The use of antiseptics in surgery was advocated by Lord Joseph Lister (1827-1912). He proposed the theory that "infection was due to passage of minute bodies capable of self-multiplication from infector to infected." He soaked ligatures in disinfectants and even went to the extreme of performing operations under a spray of phenol in an effort to destroy and/or prevent these minute bodies from infecting the patient. Because of his many contributions, the title, "Father of Aseptic Surgery" was bestowed upon him. One of his least-known credits, although questionable, is that of being the first person to obtain a pure culture of a microorganism.

**Louis Pasteur.** Probably the greatest blow to the theory of spontaneous generation was dealt by Louis Pasteur (1822-1895). Pasteur's simple experiment, using flasks with long, swan-neck, tubular openings revealed that contamination of nutrient material could only take place when the material has access to air laden with living microorganisms. As the air passed through the tubular neck, the lack of air currents prevented the organisms from rising up the tube and gaining access to the nutrient material within the flask. Consequently, the flasks remained uncontaminated.

Louis Pasteur is well known for his work on fermentation, rabies, and anthrax. Pasteurization of many of our foodstuffs is a result of his experiments and observations. A major contributor to the "Golden Age of Bacteriology," Pasteur is recognized as the father of bacteriology. In disproving the theory of spontaneous generation, he developed procedures which are basic in microbiology today.

**Robert Koch.** Knowledge of bacteria is important, and bacteriological techniques are of prime concern to clinical bacteriologists. The work of Robert Koch (1843-1910) provided a firm foundation for modern-day techniques. He discovered and developed the use of culture media, was able to isolate pure cultures of microorganisms, and introduced the rapid-air drying of thin bacterial films for staining. In laboratory research and development of bacteriological techniques, he established valid criteria for determining the cause of infectious disease. These criteria are known as "Koch's Postulates" and form the basis for the identification of many bacteria. His classic work with tuberculosis stands as a tribute to these problems. These postulates, briefly stated, are:

- A specific organisms must always be associated with a specific disease.
- The organism must be isolated in a pure culture.
- The organisms must cause the specific disease in a susceptible animal.
- The organism must, in turn, be isolated in a pure culture from the diseased animal.

Improved bacteriological techniques make it unnecessary to go through each step of Koch's postulates in laboratory diagnosis of most disease agents. There are many organisms which do not produce disease in experimental animals. Furthermore, certain organisms in pure culture require close association with another organism in order to produce infection. These postulates have made a science out of microbiology and are required for successful investigation of certain diseases.

Through careful observation and recording of experimental results, you can make valid conclusions in the bacteriology laboratory. It requires practice, perseverance, and astuteness to become a successful clinical bacteriologist upon whom the physician and patient rely for determining the cause of an infectious disease. You, as a medical laboratory technician, must be constantly alert to new discoveries and concepts which improve medical bacteriological techniques. The words of Pasteur (1854) admirably illustrate

this point: "Without theory, practice is only routine; governed by the force of habit. Only theory can breed and develop the spirit of invention." Perhaps in this course, we can stimulate and develop the spirit of invention in you.

#### Exercises (002):

Match each of the early bacteriologists in column B with the statements in column A by placing the letter of the column B item beside the number of the column A item that most nearly describes it. Each element in column B may be used once, more than once, or not at all.

<i>Column A</i>	<i>Column B</i>
— 1 His experiment started the beginning of the end for the theory of spontaneous generation.	a. Lazzaro Spallanzani.
— 2 He wanted to disprove once and for all the theory that putrefying meat gave rise, spontaneously, to living worms or maggots.	b. Louis Pasteur.
— 3. He boiled beef broth for an hour, sealed the flasks, and observed no formation of microbes.	c. Francesco Redi.
— 4. Other scientific minds later applied his principle to preserve foodstuffs.	d. Robert Koch.
— 5. Instead of sealing, the experiment involved containers closed with gauze plugs	e. Edward Jer. jr.
— 6. His classical experiments in developing and administering vaccines are known worldwide.	f. Joseph Lister.
— 7. One of these investigators wondered if the changes in the plugged broth container were caused by organized microscopic germs or some unknown chemical substance.	g. Schroeder and Von Dusch.
— 8 He proposed the theory that infection was due to passage of minute bodies capable of self-multiplication from infection to infection.	h. Franz Schulze.
— 9. He is recognized as the father of bacteriology.	i. John Tyndall
— 10. Although questionable, he is said to have been the first person to obtain a pure culture of a microorganism	
— 11 He discovered and developed the use of culture media.	
— 12. In laboratory research and development of bacteriological techniques, he established valid criteria for determining the cause of infectious disease.	

## Aseptic Techniques and Sterilization Procedures

**SAFETY OF PERSONNEL** is of prime concern in any task we do. It is a major concern in microbiology because of the nature of the material we work with. Every specimen sent to the laboratory is a potential carrier of disease-producing organisms, and as you become more proficient you might become careless. Through your carelessness you can infect yourself with a disease-producing organism, or worse yet, become a walking carrier of a disease and spread the disease to unsuspecting persons.

You must know and use proper safety procedures in collecting, handling, and processing specimens to protect yourself and the patient from further disease. You must be able to handle the specimen within the laboratory without causing contamination of your co-workers. Also, you must be able to decontaminate a contaminated area, give first aid in case of accidental contamination of yourself or a co-worker, and take the right steps to report accidents.

Specimens are received in the laboratory in a variety of containers and by many different means. You must know the various types of containers in use, their advantages, disadvantages, and methods of sterilizing them before and after use. You must know how to properly dispose of materials after you have finished with them. Also, you must know how to ship a specimen properly to avoid breakage and contamination. As we go along, we will discuss pertinent safety precautions as they apply to individual procedures.

### 2-1. Procedures for Receiving and Collecting Specimens

Before a specimen is processed in your microbiology laboratory, you must either receive it or collect it. Most often, it is sent to you after it has been collected by a physician or nurse. On other occasions, the patient comes to the laboratory and you collect it yourself. Let's briefly review the process of receiving specimens.

**003. Briefly state guidelines for receiving bacteriological specimens.**

**Receiving Specimens.** All specimens received in the laboratory must be properly labeled and accompanied by the correct laboratory requisition. Currently, Standard Forms 553 and 554, Microbiology I and II, respectively, are used. More often, they are prepared from the doctor's orders by the ward nurse, the senior medical service technician, or similar personnel in the clinic area. If the physician has signed the AF Form 3066, Doctor's Orders, he does not need to personally sign the laboratory request.

All forms accompanying the specimens should have the appropriate blocks filled in with the pertinent information. Properly completed forms, with attention paid to possible diagnosis and antibiotic therapy, will aid you in isolating pathogenic bacteria with a minimum loss of time and greater efficiency.

Each specimen container should be labeled in such a way that if the request form is separated from the specimen, the two can be quickly identified as belonging to each other. The label should be completed by ward or clinic personnel and should show the name of the patient, the register number, the ward location and bed number, the patient status, and any other significant data. It is possible to have patients on a ward who have the same first names, last names, and middle initials. If the other data is incomplete or incorrect, a mixup can occur, and you will not be able to tell which specimen belongs to which patient. This can be of serious concern to the physician who is trying to make a positive diagnosis, and to the patient he is treating. You, the laboratory technician, should always check the container label to assure yourself that the container and its contents do go with the request form.

The examination desired should be indicated by a check in the appropriate blocks on the form or by writing in any special requests. When a specimen is received in the laboratory, check the request form to insure that you know exactly what is requested. To aid you, and for future reference, the anatomical site from which a specimen has been taken should be adequately described. For example, you would want to know if it is a specimen of "pus

from wound of right thigh," "purulent pleural fluid from the right side of thorax," or "fluid from abdomen." If you know the source, you can decide what steps to take to isolate and identify the disease-causing organism.

**Exercises (003):**

Complete the following statements:

1. All specimens received in the laboratory must be properly \_\_\_\_\_ and accompanied by the correct laboratory requisition.
2. Currently, Standard Forms \_\_\_\_\_ and \_\_\_\_\_ are used.
3. If the physician has signed the \_\_\_\_\_, he does not need to personally sign the \_\_\_\_\_.
4. Properly completed forms with attention paid to \_\_\_\_\_ and \_\_\_\_\_ will aid you in isolating bacteria with a minimum loss of time and greater efficiency.
5. The label should show the patient's \_\_\_\_\_, the \_\_\_\_\_ number, the ward location and \_\_\_\_\_ number, and \_\_\_\_\_ status.
6. If other data on the patient is incomplete or incorrect, if a mixup occurs, you \_\_\_\_\_ be able to tell which specimen belongs to which patient.
7. Always \_\_\_\_\_ the container and its contents to go with the \_\_\_\_\_.
8. When a specimen is received in the laboratory, \_\_\_\_\_ the request form to insure that you know \_\_\_\_\_.
9. The anatomical site from which a specimen has been taken should be \_\_\_\_\_.

10. If you know the \_\_\_\_\_, you can decide what steps to take to \_\_\_\_\_ and \_\_\_\_\_ the disease-causing organism.

**004. Specify whether given rules for collecting and processing specimens are in agreement with accepted guidelines.**

**Rules for Collecting and Processing Specimens.** Collecting a specimen can often be your responsibility. At other times, you may have to give instructions for proper collection. Improper collecting and processing of bacteriology specimens have been definite factors in the failure to isolate and identify the bacterial agent of a disease. The following are some simple rules for collecting and processing bacteriological specimens:

- a. A sufficient quantity of specimen must be provided to permit thorough study.
- b. The sample should be representative of the infectious process; for example, sputum, not saliva; pus from the underlying lesion, not from its sinus tract; a swab from the depth of the wound, not from its surface.
- c. Instruments, containers, and other equipment coming in direct contact with most specimens must be *sterile* (the stool specimen is one exception). Material for culture must not come in contact with chemicals, disinfectants, or germicides.
- d. Material for culture should be obtained before the patient receives antibiotic or sulfonamide therapy. If he has received some type of therapy, it should be written on the request form.
- e. Specimens should be properly labeled and dated.
- f. Specimens should be delivered to the microbiology laboratory immediately after collection.
- g. Specimens should be inoculated to media immediately after delivery to the microbiology laboratory.
- h. Anaerobic culture specimens should be placed under anaerobic conditions immediately after collection for transport to the laboratory since some anaerobes are quite oxygen sensitive and will die in an aerobic environment. As a very minimum procedure, the material can be placed in a medium containing a reducing agent such as cysteine or thioglycollate at room temperature for a period not exceeding 2 hours.
- i. To avoid contamination, culture the specimen before making smears or performing special tests.

**Exercises (004):**

Indicate whether each of the following statements is true (T) or false (F), and correct those that are false.



T F 1. A specimen of saliva submitted for a sputum culture will provide just as accurate results as a sputum specimen.

T F 2. Instruments, containers, and other equipment coming in direct contact with most specimens must be sterile, with one exception, the sputum specimen.

T F 3. Antibiotic or sulfonamide therapy should be started before the material for culture is obtained.

T F 4. Specimens for anaerobic cultures, as a very minimum, should be placed in a medium containing sodium desoxycholate and salicin, NF.

T F 5. To avoid contamination, make smears or perform all special tests before culturing the specimen.

T F 6. Anaerobic specimens which have been placed in a medium containing a reducing agent should not exceed 4 hours at room temperature.

005. Cite the significance of collecting and processing blood culture, body fluid, and exudate specimens in terms of the organisms most frequently isolated, sources, optimum time for collection, and basic guidelines for processing.

**Blood Specimens.** Isolation of microorganisms from blood can help the physician to diagnose and treat various infections. Invasion of the blood may be transitory or fulminating. It depends upon the disease agent, the primary focal point of infection, and the resistance of the host. The terms *bacteremia* and *septicemia* are often used to describe these conditions.

Many blood cultures yield negative results because samples are not collected at the proper stage of the disease. Specimens of blood should be drawn when symptoms indicate circulatory involvement such as chills, fever, or convulsions.

Negative results from a single blood culture do not rule out septicemia.

You can use many methods to culture blood. Regardless of the method that you choose, the blood should be drawn by venipuncture, using strict aseptic technique. You may immediately inoculate blood into broth at the bedside of the patient, or collect it and take it to the laboratory in sterile, capped test tubes containing sterile anticoagulant.

**Body Fluid Specimens.** Body fluids include spinal, synovial, pleural, pericardial, and peritoneal fluid. Examination of spinal fluid is important in determining bacterial meningitis. In many cases, emergency chemotherapeutic agents are administered on the basis of results from a microscopic examination (gram-stained smear) of centrifuged spinal fluid. The genera of microorganisms most frequently responsible for meningitis are *Neisseria*, *Streptococcus*, *Staphylococcus*, *Hemophilus*, and occasionally *Mycobacterium*. One of the fungi chiefly responsible for a type of meningitis is *Cryptococcus neoformans* (*Torula*). *Neisseria* may be found in specimens of synovial fluid from arthritic patients.

Body fluids are aspirated by a physician and transported to the laboratory in sterile, screw-capped test tubes. You should not waste any time between collecting and culturing body fluids. These fluids contain enough fibrinogen to coagulate the fluid if we delay. Always practice extreme care when handling body fluids, for these fluids often contain highly infectious organisms.

**Exudate Specimens.** An exudate is material that has passed through the walls of vessels into nearby tissues or areas of inflammation. Exudates may come from boils, wounds, ear or mastoid infections, eye infections, and skin lesions.

A great variety of microorganisms may be isolated from such areas. Boils may yield *Staphylococcus* spp, *Streptococcus* spp, and occasionally Gram-negative bacilli such as *Escherichia* spp, *Pseudomonas* spp, or *Proteus* spp. Deep wounds, especially puncture wounds, provide ideal living conditions for anaerobes, especially *Clostridium* spp. An infected wound that exhibits a greenish or bluish purulent discharge may be a *Pseudomonas* infection. Exudates from surgical or postoperative infections may reveal anaerobic *Streptococcus* spp. Ear and mastoid infections are often caused by *Pseudomonas*, *Staphylococcus*, or *Streptococcus* spp. Eye infections may yield *Hemophilus* or possibly *Neisseria* spp. Purulent discharges from the urethra frequently reveal *Neisseria gonorrhoeae*. A Gram-stained smear of exudate from a chancroid or soft chancre, usually reveals small Gram-negative rods of *Hemophilus ducreyi*.

You may collect exudate material in the form of purulent drippings from causes of urethritis in male patients on sterile, cotton-tipped swabs or on

sterile wire bacteriological loops and inoculated directly into culture media. If you collect the urethral discharge for examination for gonorrhea, use the utmost discretion and tact and give the patient privacy. Collect the specimen with the least amount of embarrassment and talk. When you see the request, do not broadcast it for all to hear. Remember always that laboratory requests and results are privileged, confidential information and this information is between you and the physician only.

**Exercises (005):**

1. Give one reason why many blood cultures yield negative results.
2. Upon what three factors does the invasion of the blood by microorganisms depend?
3. What genera of organisms are most frequently responsible for meningitis?
4. One of the fungi chiefly responsible for a type of meningitis is \_\_\_\_\_.
5. What genera of microorganisms is most likely to be found in specimens of synovial fluid from arthritic patients?
6. What can happen if there is a delay between the culturing and collecting of body fluids?
7. Why should extreme caution be practiced when handling body fluids?
8. What is an exudate?
9. What anaerobe is most likely isolated from deep wounds?

10. What three organisms often cause infections of the ear and mastoid?
11. What three practices may be observed when you collect the urethral discharge for examination for gonorrhea?

**006. Indicate whether given statements correctly reflect the significance of fecal and sputum specimen examinations, organisms frequently isolated, basic types of media used, and methods of collection.**

**Fecal Specimens.** Bacteriological examination of fecal specimens aids diagnosis of gastrointestinal infections manifested by diarrhea and/or dysentery. Stool cultures, along with blood and urine cultures, are important aids in diagnosing typhoid and paratyphoid fevers. Many diseases are spread by human carriers through food and drink. Stool cultures are required on food handlers only in areas where the frequency of *Salmonella*, *Shigella*, or staphylococcal food poisoning is a potential threat. This is required to supplement Environmental Health Services control measures.

The organisms most frequently involved in enteric infections are the *Salmonella* and *Shigella* spp. *Arizona arizonii* has been implicated to a lesser degree. The normal intestinal flora of the adult are primarily *Escherichia coli* (*E. coli*), *Citrobacter* spp, *Enterobacter cloacae*, *Klebsiella pneumoniae*, and *Providencia* groups. *Pseudomonas aeruginosa*, *Alcaligenes faecalis*, and *Proteus* spp are sporadically present and may be called transient saprophytes. Saprophytic organisms, including *Proteus morganii* and the *Providencia* group, have been implicated as etiologic agents of infant diarrhea, as has pathogenic *E. coli*.

In culturing specimens of intestinal origin, the basic problem is to isolate pathogenic agents from specimens which may contain large numbers of saprophytic organisms. To do this, we use special, differential, selective, and inhibitory media.

Fecal specimens should be collected in clean, widemouthed containers with tight-fitting lids. Cardboard or plastic half-pint containers with tight-fitting lids are generally used. The advantage of their use is that the containers and contents can be incinerated. Stool collection containers do not have to be sterile, but they should always be clean. You should never mix specimens with body fluids, or collect them from from bedpans or commodes.

If you use rectal swabs for a specimen, they should be sent to the microbiology laboratory in clean, cotton-plugged test tubes. Rectal swabs are useful to collect cultures from infants or large numbers of patients. You should culture fecal material as soon as possible after collection. If culturing is delayed, you may not isolate causative agents, particularly *Shigella* spp, since they die off rapidly after collection.

**Sputum Specimens.** Sputum specimens are usually from true or suspected cases of pneumonia or tuberculosis. We examine the sputum for bacteria causing the pneumonia with a different method than that used to examine for the tubercle bacillus. You must be sure the request clearly states the type of examination to be performed. If in doubt, check with the physician.

You should collect sputum for bacteriological examination in a sterile container. A sterile plastic specimen container prepacked in a plastic bag is commercially available. Another sputum collection system consists of a funnel with hinged lid. This sterile unit allows sputum to be collected and transported to the laboratory without personnel touching contaminated parts. The sputum goes directly into a detachable 50-ml tube. In cases of pneumonia, one sputum specimen is usually enough for the examination. Collect the specimen as soon as the patient awakens in the morning. You should explain to the patient the difference between sputum and spittle. Sputum is a secretion brought up from the lungs and bronchial tree, and is usually associated with a cough. Spittle is nothing more than an accumulation of saliva in the mouth. Spittle will not show the bacteria infecting the deeper regions of the respiratory system.

#### Exercises (006):

Indicate whether each of the given statements is true (T) or false (F), and correct those that are false.

T F 1. All food handlers must submit stool specimens for examination.

T F 2. The organisms most frequently involved in enteric infections are *Escherichia coli* and *Citrobacter* spp.

T F 3. To isolate pathogenic agents from a large number of saprophytic organisms of the intestinal tract, we need a selective media only.

T F 4. Stool collection containers should always be sterile.

T F 5. If culturing of the stool specimen is delayed, you may not isolate causative agents, particularly *Salmonella* spp.

T F 6. We examine the sputum for bacteria causing the pneumonia with the same methods used to examine that for the tubercle bacillus.

T F 7. If the patient is unable to collect a sputum specimen, an accumulation of saliva will adequately suffice.

**007. Specify the purpose of throat and nasopharyngeal cultures, state some potential pathogens isolated, and briefly cite the procedure for taking throat cultures.**

**Throat and Nasopharyngeal Specimens.** Throat and nasopharyngeal cultures help diagnose infections such as streptococcal sore throat, scarlet fever, diphtheria, and whooping cough. They can determine the focal point of infection in diseases such as rheumatic fever and acute glomerulonephritis. In epidemiological studies, these cultures can detect carriers of beta hemolytic *Streptococcus*, hospital *Staphylococcus* spp, *Corynebacterium diphtheriae*, and other potential pathogens.

Collect throat specimens under good lighting with a dacron, cotton, or calcium alginate swab by vigorously swabbing both tonsillar areas, the posterior pharynx and any areas of inflammation, ulceration, exudation, or capsule formation. A rayon-tipped swab, with an ampule containing 0.5 ml of modified Stuart's transport medium, is shown in figure 2-1,A. This swab is stock listed as Tube, Biological Culture Sampling, NSN 6640-00-518-5462, and is frequently used when the culture is to be taken and transported to the laboratory. The swab may be used for collecting and holding biological cultures moist for 72 hours. Another swab commonly used is shown in figure 2-1,B, and is stocklisted as Tube, Biological Culture Sampling, NSN 6640-00-729-6484.

In figure 2-2, note the nasopharyngeal calcium alginate applicator. They may be used in the taking of specimens, either orally (from the nasopharynx) or through the pernasal route (from the posterior nasopharynx). The 0.035" aluminum shaft is for strength and flexibility. The bud of calcium alginate fibers is soaked in sodium salts solutions of numerous organic acids to provide maximum recovery of organisms.



**Exercises (007):**

1. What diagnostic purposes do throat cultures serve?
2. In epidemiological studies, carriers of what organisms may be detected from throat cultures?

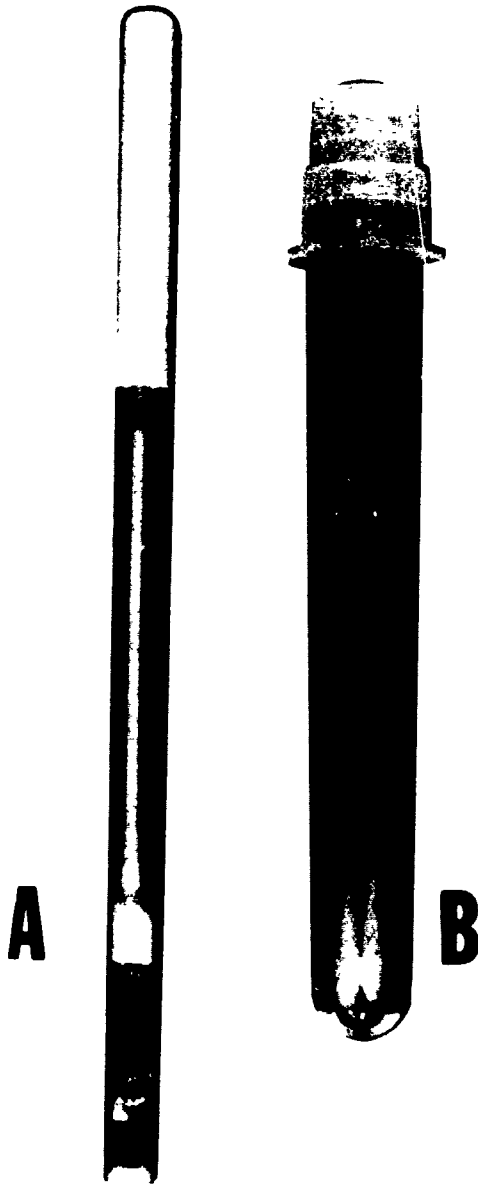

Figure 2-1. (A) Culture sampling tube with Stuart's media and (B) culture sampling tube without transport media

In figure 2-3, we show how to depress the tongue with a tongue blade and pass the swab gently past the crypts and tonsils (A) across to the back surface of the pharynx (B). Do not touch the swab to the tongue, cheek, or teeth. The tongue, cheek, and teeth harbor a variety of organisms unrelated to the disease organisms which may be pathogenic and significant if isolated from the proper site. A swab contaminated by contact with the tongue, cheek, or teeth may add many confusing organisms and make isolation of the pathogen difficult.

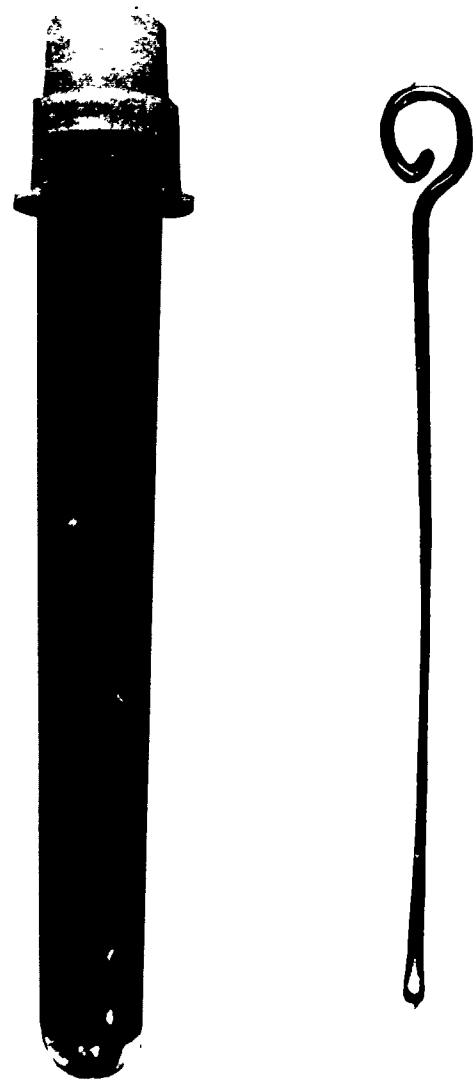

Figure 2-2. Calcium alginate applicator swabs for collecting nasopharyngeal specimens.

3. How long will the biological cultures be kept moist by using the rayon-tipped swab with an ampule containing 0.5 ml of Stuart's transport medium?
4. What two ways may be used to obtain nasopharyngeal cultures?
5. What process of preparation enables the calcium alginate fibers to provide maximum recovery of organisms?
6. When taking a throat culture, after depressing the tongue with a tongue blade, from what areas is the specimen taken?
7. What effect, if any, will a swab contaminated by contact with the tongue, cheek, or teeth have on the results of the test?

008. Specify whether given statements about processing cultures and smears and discarding of contaminated swabs are in agreement with accepted guidelines.

**Culture and Smear Technique.** When you receive a cotton-tipped swab for culture and smear, you must remember to make cultures before making the smear. Otherwise, bacteria may be transferred from the smear slide to the culture media and we have contaminated the culture. You should discard the swabs into a solution of disinfectant. A plastic autoclave bag may be used to hold all contaminated swabs, specimens, and platelets until sterilizing is accomplished. The addition of swabs to the disinfectant tends to dilute the disinfectant, thereby lessening its effectiveness, and some spores are not destroyed.

Therefore, you should sterilize the swabs and container in the autoclave and *not* discard them directly into a trash can. Remember, all material received for bacteriological examination is a potential hazard and can infect you and all others who may contact the material. Use caution when disposing of such material.

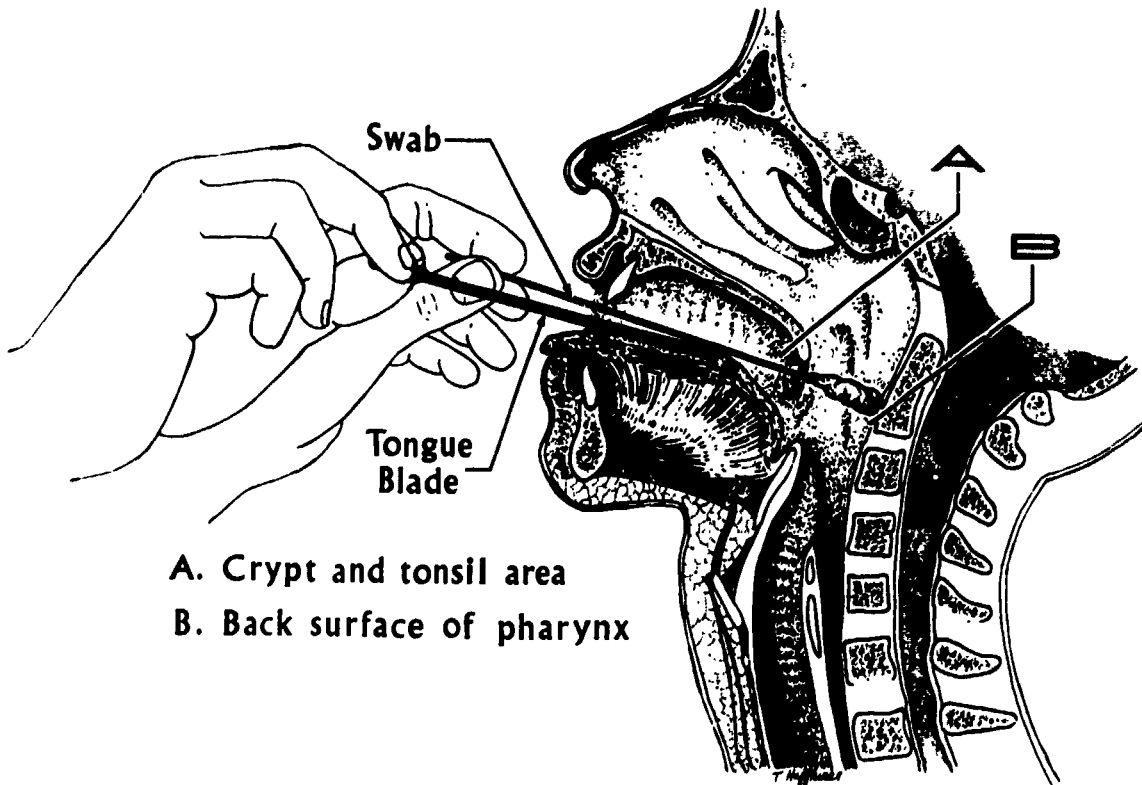

Figure 2-3. Collection of throat swab cultures.

**Exercises (008):**

Indicate whether each of the following statements is true (T) or false (F), and correct those that are false.

- T F 1. When you receive a cotton-tipped swab for culture and smear, you must remember to make smears before making the culture.
  
- T F 2. If smears are made first, bacterial contamination will be reduced.
  
- T F 3. The addition of swabs to the disinfectant tends to dilute the disinfectant, thereby lessening its effectiveness.
  
- T F 4. If time does not permit, the swabs and container should be discarded directly into a trash can.

T F 5. All material received for bacteriological examination is a potential hazard and can infect you and others.

**909. Point out the value of urine cultures; list some of the organisms frequently found in "normal" and "infected" urine; cite some guidelines for collecting and processing urine cultures; and state the types of specimens collected and their significance.**

**Urine Specimen.** Urine cultures are of value in diagnosing primary infections of the urethra (urethritis), bladder (cystitis), and kidneys (nephritis). They are also important in diagnosing certain systemic infections caused by bacteria excreted via the urinary tract. Since specimens of urine, either clean voided or catheterized, are frequently contaminated on collection, the recovery of organisms, even known pathogens, does not necessarily establish the diagnosis of a urinary tract infection.

In most cases, quantitative bacterial cultures allow differentiation of true urinary tract infections

Normal Urine	Infected Urine
<p>Staphylococci, coagulase negative                      Diptheroid bacilli                      Coliform bacilli                      Enterococci  <u>Proteus</u> species                      Lactobacilli                      Alpha and beta hemolytic streptococci                      Saprophytic yeasts  <u>Bacillus</u> species</p>	<p><u>Escherichia coli</u>, <u>Kebsiella-Enterobacter-Serratia</u> division  <u>Proteus mirabilis</u> and other <u>Proteus</u> species, <u>Providencia</u> species  <u>Pseudomonas aeruginosa</u> and <u>Pseudomonas</u> species                      Enterococci (<u>Streptococcus faecalis</u>)                      Staphylococci, coagulase positive and negative  <u>Alcaligenes</u> species  <u>Acinetobacter (Herellea)</u> species  <u>Haemophilus</u> species (probably <u>Corynebacterium vaginalis</u>)  <u>Candida albicans</u>, <u>Torulopsis glabrata</u>, other yeasts                      Beta hemolytic streptococci, usually Groups B and D  <u>Neisseria gonorrhoeae</u>  <u>Mycobacterium tuberculosis</u>, other mycobacteria  <u>Salmonella</u> and <u>Shigella</u> species</p>

Figure 2-4. Microorganisms frequently occurring in "normal" and "infected" urine

from contamination of the urine by bacteria from the urethra and the external genitalia. Note that in figure 2-4, the bacterial flora of "normal" voided urine differs from that of "infected" specimens. Because it is necessary to distinguish contaminating from etiologically important organisms, only quantitative urine examination can yield meaningful results.

**Collection of Urine Specimens.** Urine collection for culture by urethral catheterizations is seldom indicated, except in those cases in which catheterization must otherwise be done for diagnostic or therapeutic reasons. Because of the danger of introducing microorganisms into the bladder, catheterization is to be avoided whenever possible.

Where male patients are concerned, following proper cleansing of the glans penis, it is permissible to collect a clean midstream voided urine specimen. Satisfactory midstream specimens from females can sometimes be obtained after cleansing the vulva and spreading the labia, but sometimes catheterization is unavoidable. Urine should be collected in a sterile widemouthed, screw-capped jar. Generally, urine will support the growth of most urinary pathogens as well as do routine media. It is absolutely essential for culture purposes that urine be processed within an hour of collection or stored in a refrigerator at 4° C until it can be cultured. During the course of the laboratory workday if specimens are received at various times, they may be placed in a refrigerator as received, then set up together at some designated hour in the afternoon.

**Types of Specimens.** Urine, unless catheterized, should be collected by the patient himself. This may be done on the ward, or the patient may be sent to the laboratory with the proper request form. The physician will state whether he wants a clean-voided, midstream, two-glass, or three-glass urine specimen, depending upon what specific information he is seeking. You must have knowledge of these terms and know what is meant by them if the proper collection is to be made.

**Clean-voided.** To collect a *clean-voided* urine specimen, the patient is instructed how to wash the genitalia with a suitable cleansing solution. He should void directly into a sterile, screw-capped or suitable container without contaminating the inside of the container.

**Midstream.** When the physician orders a *midstream* urine specimen, the patient is instructed how to wash the genitalia with a suitable cleansing solution and to void—discarding the first part of the urine stream. He is told to collect, in a sterile container, that part of the urine stream which, in his opinion, is the middle third. The last part of the urine is also voided and discarded. The patient must understand that it is the middle third of the urine stream that is desired.

**Two- or three-glass.** Sometimes the physician will order a *two-glass* or *three-glass* urine specimen. When either of these is ordered, the patient is instructed how to wash the genitalia with a suitable cleansing solution and to collect the urine in two or three sterile, screw-capped containers. The patient is given numbered bottles and told to collect the specimens in the order the bottles are numbered. The volume in each bottle does not matter; no attempt should be made to adjust the volumes by pouring urine from one bottle to another. The volumes should be left as collected.

To avoid embarrassment to yourself and the patient it is best to have a printed set of instructions for each of the collections. When the patients hands you a request form, all you need to do is see that the patient has access to containers, cleansing material, and a private place to collect the specimens. If the patient is a child, give the instructions to the accompanying adult, who in turn can see to it that the specimen is properly collected.

There are valid reasons for collecting the urine specimen as described above. A clean-voided urine can indicate an infection in the urethra or the anterior section of the bladder. The midstream collection helps to pinpoint an infection in the bladder. The three-glass urine divides the urine as coming from three separate anatomical sections of the urinary system. The first is the urethra, the second is the bladder, and the third is the anterior part of the bladder, or possibly the ureters and kidney, as some urine may drain into the bladder when it empties.

Other methods of urine collection are done by the urologist. These methods include catheterization of the bladder, the ureters (such urine comes to the laboratory in marked containers, *right ureter* and *left ureter*), and possibly the kidney itself. You must remember to handle each specimen carefully and to avoid mislabeling your cultures.

#### Exercises (009):

1. Urine cultures are of value in diagnosing primary infection of what organs of the body?
2. Why does the recovery or presence of pathogens in the urine not necessarily establish diagnosis of a urinary tract infection?
3. What process allows differentiation of true urinary tract infections from contamination?

4. List some organisms which are found both in "normal" and "infected" urine specimens.
5. How soon should the urine specimen be processed after collection? Why?
6. Where should the urine specimen be stored until the culture is set up and at what temperature?
7. How does the patient collect a *clean-voided* urine specimen?
8. In which type of urine specimen collection is the patient given numbered bottles or containers and told to collect the specimens in the order the bottles are numbered?
9. What is the purpose of a three-glass urine collection.
10. What anatomical section of the urinary system does the second glass or container represent?

## 2-2. Quality Control in Handling Microbiology Specimens

All specimens received in the laboratory should be monitored and controlled in a systematic fashion. If this is done, the safety of laboratory personnel will be possible. As a laboratory technician, you should remember that the safety of patients and laboratory personnel must be a prime concern in microbiology. Where else could safety begin, but with the collection of the specimen? The approach is not only to protect the specimen from contamination, but also to protect laboratory and other personnel. Remember, good bacteriological techniques protect the specimen and the worker.

**010. State guidelines for safety in handling and processing bacteriological specimens in terms of the use of laboratory supplies, equipment, and instruments.**

**Safety in Handling Specimens.** Specimens should be collected in sturdy containers with adequate

closures to prevent spillage or leakage. Clinical information must be available for instituting adequate precaution and for proper handling, such as specimens from isolation patients. Specimens suspected of containing highly infectious agents should not be placed in a container with numerous routine specimens. Nevertheless, the laboratory worker must treat each specimen as a potential hazard to his health.

All specimens received in the laboratory should be in containers which have a clean, uncontaminated exterior surface. It is possible that during delivery of the specimen from the ward, place of collection, or within the laboratory itself, splashing of the contents may occur. If the container does not have a tight-fitting lid, some of the contents may seep around the cover and contaminate the outer surface. This contaminated surface is a source of infection to you or anyone else in the laboratory. Do not accept any specimen that shows evidence of a contaminated outer surface.

Wrapped specimens (a common practice with outpatients) should be unwrapped and removed from their wrappers by the person bringing the specimens to the laboratory. Do not let the person leave until you are sure that a request slip has accompanied the specimens and that the specimens are properly identified.

A diaper is sometimes brought to the laboratory for bacteriological examination of its contents. Check the request form to see if the physician is interested in enteric bacteria; then the diaper contents are acceptable if the specimen is fairly fresh. If the physician wants a check for bacteria other than enteric organisms, another fresh specimen should be collected in a sterile container or on a rectal swab. Do not rinse the diaper, as this subjects you to a source of contamination.

*Safety cabinets (hoods).* As an added safety precaution, it is wise to use a fume hood when working with highly contagious material. You should also wear a face mask and rubber gloves to prevent contaminating yourself. Perform all bacteriological work on a nonabsorbent surface. You should place a disinfectant-soaked paper towel or similar absorbing material directly on your working surface. This will minimize contamination caused by droplets or spillage of specimen. When you are finished with your work, the entire area should be wiped down with a disinfectant.

When you mix liquid specimens or serially dilute broth cultures, **BE VERY CAREFUL.** The aerosol produced during these procedures is a source of danger and can very easily spread a "fog" of bacteria throughout the immediate area. The aerosol can infect you or another person through the natural process of breathing. The bacteria may not settle until after you have cleaned up and left the area.

**Centrifuges.** Occasionally, you may centrifuge a specimen or culture to concentrate the material. To do this, you use tightly fitted screw-capped tubes to prevent contamination of the material as well as the atmosphere. However, you must be careful in the choice and care of glassware. Check it before use for cracks and chips. Make sure one tube is balanced with another tube before spinning. Also, it is important to check your centrifuge for balance. Unbalanced, the tubes may get broken, spreading dangerous biological material all over the laboratory, or centrifugal force may tear the head from the motor shaft. Do not exceed the recommended speeds set by the manufacturer of the centrifuge or the glass maker.

**Pipettes.** No infectious or toxic materials should be pipetted by mouth, and no infectious material should be blown out of pipettes or mixed by pipetting. Sterile cotton-plugged pipettes, obtainable through normal supply channels, should be used for pipetting of infectious or toxic materials.

A commercial rubber suction bulb which is easily controlled with the hand should be used with pipettes. Here again, you must exercise care and not contaminate the bulb.

Remember, the steps you take to prevent contamination of yourself, other persons, and the laboratory are worth the effort. It takes less time to prevent contamination than it does to treat a person who becomes infected.

#### Exercises (010):

1. What should be done to identify specimens suspected of containing highly infectious agents?
2. How should the laboratory technician treat each specimen received in bacteriology?
3. If you are interested in identifying the organisms contained in a specimen, why then must you also be concerned with the condition of the outer surface of the specimen container?
4. If the pediatrician wants to check for bacteria other than enteric organisms, what type of specimen would you accept or obtain?
5. When is the use of a fume hood or safety cabinet a must in bacteriology?

6. How does working on an absorbent surface, such as a disinfectant-soaked paper towel, provide safety in the bacteriology laboratory?

7. When you are finished with your work area, what should be done?

8. What three checks should you make when using the centrifuge in bacteriology?

9. What is the best way to pipette infectious or toxic material by mouth?

011. List five factors to be considered when choosing a container for a bacteriology specimen, and cite examples which reflect the significance of these factors.

**Types of Containers.** There are many factors to consider when choosing a container for a bacteriology specimen. The type of specimen, source of specimen, analysis desired, time lapse between collection and media inoculation, and the final disposition of the container are important factors. Each laboratory, including the one in which you are now working, has an established procedure for selecting containers used to collect the various specimens. Learn and use them only as directed. Remember to consider the above points in choosing containers for specimens.

**Type of specimen.** The type of specimen will be our first dictate in choosing a container. A variety of sterile disposable containers are available for the collection of urine, stool, pleural fluid, and other body fluids. These containers have been designed to provide personnel protection while facilitating the easy handling and protection of the specimen. They are graduated in ounces and milliliters to provide convenient, single-use, time-saving containers for collection, transportation, and storage of a wide variety of specimens. They are molded of rugged polypropylene; are biologically inert and chemically resistant to many laboratory reagents at room temperature.

Certain body fluids may coagulate before they get to the laboratory. In this case, you would use a sterile, screw-capped container. You would culture the whole clot, because as the clot forms, bacteria along with cellular structures, such as white blood cells, red blood cells, and epithelial cells, will be caught in the fibrin clot. If you want to inhibit



clotting, you can use anticoagulants. They must be sterile, compatible with bacterial life, and used according to the manufacturer's directions. You can avoid clotting by inoculating the culture media directly at bedside as the specimen is collected.

A needle with a large eye is easier to thread than a needle with a small one. Likewise, a wide-mouthed container to collect a sample is easier to use than a narrow-mouthed container.

*Source of the specimen.* We must consider the source of the specimen. Urine, sputum, tissues, exudates, or specimens of large quantity should be collected in various sizes of screw-capped, wide-mouthed containers. Spinal fluid, small quantities of urine, and cavity fluids can be collected in small, screw-capped tubes.

If you catheterize to obtain the urine, use a sterile, screw-capped test tube. Test tubes are easy to centrifuge, so the specimen need not be transferred to a tube for centrifugation, thereby eliminating a step which could introduce a source of contamination. Spinal fluid should also be collected in sterile, screw-capped test tubes, because of its usual small volume.

*Type of analysis.* The type of analysis requested should be considered before choosing the type of container. Again, we refer to stool examination. Normally, we use a clean, waxed cardboard box or plastic disposable container. However, you must use a sterile container to collect stools if you are interested in other than enteric organisms. The study of various body fluids for virus and rickettsial-like organisms may require that you collect two or more specimens a few weeks apart. This means storing one specimen until you receive the second one.

If a suitably sized container is not selected, we may quickly run out of storage space for sterile and nonsterile containers. A minimum of three early morning voided "clean catch" or catheterized urine specimens is recommended to check for tuberculosis. The entire volume of each voiding is collected in a sterile container. Storage of containers large enough for a 24-hour volume can pose a problem to both the ward and the laboratory. Selection of suitable containers is based on intelligent forethought as to storage space.

*Time lapse.* Another important factor is the time lapse between getting the specimen and culturing it. It is desirable to transfer the clinical material to a suitable growth environment as soon as possible after collection, but it is possible to hold some material for a relatively long period of time. As an example, outpatient clinics collect throat and nasopharyngeal culture swabs. Good practice dictates that these swabs be delivered to the laboratory as promptly as possible after collection.

The use of a rayon-tipped swab (cultures) with an ampule containing modified Stuart's transport

medium prevents drying and can keep the culture moist for 72 hours.

In addition to preventing drying, there is the advantage of giving the bacteria a headstart in their growth. In turn, this means that the physician gets his report back quicker and the patient is assured of faster treatment.

Do not allow a specimen to stand a great length of time before starting the necessary studies. Some fluids, if allowed to stand, will change in their state of acidity or alkalinity. This change may cause some bacteria to die while other bacteria grow and multiply faster. This means that a more pathogenic organism with a slow growth rate may be overgrown by a fast-growing nonpathogen. Some researchers believe that cotton used for applicators may contain fatty acids which may be detrimental to microbial growth. An excellent substitute may be found in calcium alginate wool. Since this technique is not part of this section, we will not discuss this work here. It is important to start the identification procedures as soon as possible. We must impress our ward and clinic personnel with the idea that the specimens must get to the laboratory with the least amount of delay.

*Final disposition.* After all is said and done, we have to dispose of the biological material. By final disposition we mean—"What will happen to the container and the contents when we are finished with it?" Do not discard any contagious material into a common trash can.

Stainless steel or porcelain containers with snug-fitting tops are needed for the discard of contaminated glassware. Food serving insert pans, which can be obtained from the food service department, are quite good. For pipettes you can use cylindrical jars or rectangular pans containing disinfectant. Once the item is discarded, it should never be removed from the discard pan until the pan and its contents have been autoclaved. Bags of autoclavable plastic are now available and are very convenient for disposal of contaminated material.

Specimen castors, tongue depressors, applicator swabs, cotton, and similar materials should be autoclaved as soon as possible, rather than incinerated before they are discarded.

Your laboratory should have a standard procedure for discarding contaminated containers and material. Know and follow it to the letter!

#### Exercises (011):

1. List at least five factors that you should take into consideration when selecting a specimen container.

2. Describe three techniques which you can use to culture body fluids since you know that they may coagulate after being withdrawn from a patient.
3. When would you be required to collect body fluid specimens a few weeks apart?
4. What type of specimen is recommended for collection to check for tuberculosis of the kidneys?
5. In addition to preventing drying, what other basic advantage do the culturettes provide?
6. When some fluids are allowed to stand a great length of time, a change in acid or alkalinity will have what effect on bacterial growth?
7. Some researchers believe that the cotton used for applicators may produce what effect on bacterial growth?
8. For final disposition, how would you process contaminated tongue depressors, applicator swabs, cotton, and similar materials?

012. Indicate whether given statements correctly reflect the methods for preservation of microbial organisms.

**Preservation.** As a bacteriology technician, be certain that you have performed all the procedures the physician requested. Be absolutely certain that you start all procedures as soon as the specimen is received in the laboratory. Only after you are assured that you have done all that is required may the specimen be discarded. However, you may find it necessary to preserve the specimen for future reference, or there may be occasions to submit specimens to a reference laboratory under properly preserved conditions. There are several methods of preservation; however, the suggestions here are, for the most part, practical in laboratories where highly

specialized equipment, such as freeze-drying apparatus, does not exist.

*Freeze-drying (lyophilizing).* The method of freeze-drying depends upon extreme cold, rapid evaporation of water, and the use of a vacuum to eliminate any water which may crystallize. First, mix the bacteria in a suitable fluid medium and dispense the bacteria in small aliquots to glass ampules. Put the ampules into a bath of carbon dioxide ice and alcohol or acetone to reduce the temperature to near  $-76^{\circ}$  C. The contents will freeze immediately. The contents are dried while they are in the frozen state by using a high vacuum which will sublimate the water. The ampules are heat sealed while still under vacuum. To reconstitute this powder, you need only add a sterile broth medium or other sterile fluid. Lyophilization and desiccation are not routinely done in most bacteriology laboratories.

*Desiccation.* This method means removing water by drying, and can be used to preserve certain bacteria. Once preserved in this manner, they can survive for long periods of time. It must be recognized that some species of bacteria, however, are readily killed by desiccating procedures, and the choice of this method of preservation must be carefully made. Desiccated cultures are convenient because a larger number of them may be stored in a small area. Maintained in this manner, those bacteria which survive drying do not produce mutations upon being reconstituted. The simple addition of sterile medium will reconstitute the bacteria. *Corynebacterium diphtheriae* have survived as long as 15 years, *Mycobacterium tuberculosis* as long as 17 years, and pathogenic beta *Streptococci* for 25 years.

*Refrigeration.* Clinical specimens likely to contain abundant microbial flora may, in most instances, be held at  $5^{\circ}$  C in a refrigerator for several hours before culturing if they cannot be processed right away. This is essentially true with such specimens as urine, feces, and sputum samples and material on swab sticks taken from a variety of sources, with the exception of wound cultures that may contain oxygen-sensitive anaerobes. These are best kept at room temperature until inoculation. Refrigeration at 4 to  $5^{\circ}$  C will not only prevent the viability of most pathogens, but also prevent overgrowth of commensals, organisms which, in increased numbers, could make the isolation of a significant microbe a more difficult task.

*Freezing.* It may be necessary to submit specimens to a reference laboratory for vital studies. These specimens should be shipped in a frozen state to preserve the viability of the organisms suspected. This is quite true of virus-containing material, such as cerebrospinal fluid, throat and rectal swabs, stools, and tissue, which should be frozen immediately and shipped in DRY



ICE. It must be remembered here that freezing and thawing of blood would result in extensive hemolysis, rendering the serum unsuitable for serological testing.

**Chemicals.** Straight chemical preservatives should not be used to preserve bacteria. A chemical preservative can alter the bacteria metabolism and, in many instances, cause death. Consequently, the chances of isolating bacteria from these specimens are not good. If you use a container that has held a chemical preservative, you must clean and sterilize it before using it to collect specimens for microbiological examination.

When fecal specimens must be shipped in the unfrozen state, or when such specimens must be held for some time before culturing, it is recommended that they be placed in a preservative solution. The buffered glycerol saline solution of Sachs has proved satisfactory. The final pH of this solution should be 7.4 and should be discarded if it becomes acid.

**Holding media.** A holding or transport medium should be used to preserve the viability or maintain the original number of bacteria in material of human origin. A medium such as that devised by Stuart works well. A good holding medium should contain a nonnutrient, *soft agar to prevent overgrowth; charcoal to neutralize certain bacterial inhibitors; and a reducing agent to prevent oxidation of the medium components.* A holding medium is not necessarily a long-term means of preserving bacteria. Eventually, most bacteria die due to a change in the medium caused by moisture loss. Holding medium lends itself well for shipping bacteria to reference laboratories for confirmation and for use as a transit medium pending inoculation to other media which may be used for quality control stock cultures.

#### Exercises (012):

Indicate whether each of the following statements is true (T) or false (F), and correct those that are false.

T F 1. The method of freeze-drying depends upon extreme cold, rapid evacuation of water, and the use of a liquid dehydrating reagent.

T F 2. Reconstitution of dehydrated cultures is done by adding a sterile broth medium or sterile fluid.

T F 3. The choice to use desiccation for preservation can depend significantly upon the type of bacteria.

T F 4. After preservation by desiccation, bacteria will produce mutations upon being reconstituted.

T F 5. Material on swab sticks from sputum cultures may contain oxygen-sensitive anaerobes and are best kept at room temperature than refrigerator temperature until inoculation.

T F 6. Virus-containing material such as cerebrospinal fluid, throat and rectal swabs, stools, and tissue should be frozen immediately and shipped in DRY ICE.

T F 7. Freezing and thawing of blood resulting in extensive hemolysis renders the serum unsuitable for serological testing.

T F 8. Fecal specimens that must be shipped in an unfrozen state and which may be held for some time before culturing may be placed in buffered glycerophosphate solution.

T F 9. Charcoal in the Stuart transport medium is used to neutralize certain bacterial inhibitors.

**013. Identify the holding media used in the shipment of bacteriological specimens in terms of their components and usefulness with specific organisms.**

**Transport Media.** Many laboratories ship bacterial specimens to reference laboratories for initial analysis or for confirmation studies. All specimens shipped must be accompanied by the properly completed request form.

Bacteriological specimens collected in hospital wards, as well as those obtained under field conditions, are subjected to considerable delays in transit before they can be inoculated to appropriate culture media. Several transport or holding media have been devised to prolong the survival of microorganisms when a significant delay occurs in collection, shipment, and definitive culturing.

You should know the most appropriate holding or transport media for the specimens obtained. A suggested outline for processing and shipment of various bacteriological specimens is presented in table 2-1. Some media suggested may be obtained from BBL, Baltimore Biological Laboratories; however, they may be available from many other commercial sources.

The following transport media are available. It is your responsibility to know the specific requirements of the reference laboratories you use. Write or call them for their guide or handbook concerning shipment of bacteriological specimens.

*Transport medium (Stuart, Toshach and Patsula).* This nonnutritive semisolid medium, containing sodium thioglycollate to suppress oxidative changes, was originally designed to

facilitate transportation of swab specimens for cultures of gonococci. The medium is valuable for maintaining delicate organisms such as *Neisseria*, *Tricholmonas*, *Haemophilus*, and *Shigella* species. Upper respiratory tract and enteric pathogens have been reported to survive storage up to 8 to 12 weeks at room temperature. Transport medium has also been reported as neutralizing the bactericidal effect exerted by some commercial swabs.

*Transport charcoal medium.* Transport charcoal medium is similar to transport medium but contains 0.2 percent charcoal to remove inhibitory substances present in some agars and further reduce the toxic effects of some commercial swabs.

*Cary and Blair transport medium.* The Cary and Blair transport medium was introduced for the collection and shipment of stool specimens in order

TABLE 2-1  
PROCESSING AND SHIPMENT OF SPECIMENS

Processing and Shipment of Specimens			
Specimen	Suggested Media of Initial Inoculation	Transport Media	Remarks
Blood	Taken with culture bottles containing trypticase Soy Broth or Thioglycollate Medium-135C	Same as growth medium	Prior to shipment incubate specimens for 12 to 24 hrs.
Urine	Blood Agar, Desoxycholate Agars, Losin Methylene Blue Agar, Thioglycollate Medium-135C	Thioglycollate medium-135C	
Feces	XLD Agar, Salmonella-Shigella Agar, Losin Methylene Blue or MacConkey Agars, Selenite Cystine, Selenite or G <sub>1</sub> Broths	Cary and Blair Transport Medium, Specimen Preservative (SP Hajna), or Enrichment Broths (Selenite Cystine, Selenite-I or G <sub>1</sub> )	In food poisoning outbreaks, feces should be collected from patients with diarrhea and all food handlers associated with the outbreak.
Sputum	Petragnani, Lowenstein-Jensen, ATS or Petroff Medium, Blood Agar, Mycosel or Phytone Yeast Extract Agar, Thioglycollate Medium-135C	Cary and Blair Transport Medium	
Cerebrospinal fluid	Blood Agar + CO <sub>2</sub> , Chocolate Agar + CO <sub>2</sub> , Thayer-Martin Selective Agar + CO <sub>2</sub> , Desoxycholate Lactose Agar, Mycophil Agar, Lowenstein-Jensen Medium, Thioglycollate Medium-135C	Thioglycollate Medium-135C	Where tuberculosis is suspected, see directions for processing such specimens. Retain broth culture under incubation 12 to 24 hours prior to shipment.
Throat and Vaso-pharynx	Blood Agar + CO <sub>2</sub> , Chocolate Agar + CO <sub>2</sub> , Serum Tellurite Agar, Thayer-Martin Selective Agar + CO <sub>2</sub>	Serum Tellurite Agar, Thioglycollate Medium, Thayer-Martin Selective Agar + CO <sub>2</sub>	
Eye	Blood Agar, Chocolate Agar + CO <sub>2</sub> , Serum Tellurite Agar, Pseudosei Agar, Trypticase Soy Broth, Thioglycollate Medium-135C	Serum Tellurite Agar, Thioglycollate Medium-135C	
Lar	Blood Agar, Chocolate Agar + CO <sub>2</sub> , Phenylethyl Alcohol Medium, Desoxycholate Lactose Agar, Mycosel Agar, Pseudosei Agar Trypticase Soy Broth, Serum Tellurite Agar, Thioglycollate Medium-135C	Serum Tellurite Agar, Thioglycollate Medium-135C	
Genital Tract	Blood Agar + CO <sub>2</sub> , Chocolate Agar or Thayer-Martin Selective Agar + CO <sub>2</sub> , Desoxycholate Lactose or Losin Methylene Blue Agars, Serum Tellurite Agar, Thioglycollate Medium-135C	Cary and Blair Transport Medium, Stuart Transport Medium, Thioglycollate Medium-135C	
Wounds and Operative Sites	Blood Agar, Pseudosei Agar, Thioglycollate Medium-135C	Stuart Transport Medium, Cary and Blair Transport Medium, Thioglycollate Medium-135C	
Gastrointestinal Tract	XLD Agar, Salmonella-Shigella Agar, Losin Methylene Blue Agars, or MacConkey Agars, Selenite Cystine, Selenite-I or G <sub>1</sub> Broths	Cary and Blair Transport Medium, Specimen Preservative (SP Hajna), or Enrichment Broths (Selenite Cystine, Selenite-I or G <sub>1</sub> )	

to overcome the difficulties encountered with overgrowth by Gram-negative rods such as *Citrobacter freundii*, *Klebsiella pneumoniae*, *Enterobacter* spp, and *Escherichia coli*. The overgrowth by Gram-negative rods was reported in specimens transported by Stuart transport medium. Authorities report that *Salmonella* and *Shigella* can be recovered for as long as 49 days, *Vibrio cholerae* for 22 days, and *Yersinia pestis* for at least 75 days from clinical specimens carried in this medium. Recoveries of *Shigella*, *Salmonella*, cholera vibrios, other enteric pathogens, *Pseudomonas*, and *Mycobacterium tuberculosis* have been made from clinical specimens transported in this medium.

**Serum Tellurite agar.** Serum tellurite agar has proven especially useful for the transportation and examination of nose and throat cultures suspected of containing *Corynebacterium diphtheriae*. It is recommended for the isolation of streptococci, *Listeria* and *Candida albicans* from throat specimens, vaginal swabs, and exudates, and particularly from specimens which also contain many Gram-negative bacilli.

**Selective enrichment broths.** Selective enrichment broths such as selenite cystine, selenite-F, or GN broths are recommended for enhancing detection of *Salmonella* and *Shigella*. They are suitable for short transportation.

**Specimen preservative (S P Hajna).** Specimen preservative Hajna is a buffered solution that contains desoxycholate and citrate. It is a highly selective holding medium for recovery of *Salmonella*, *Shigella*, *Klebsiella*, and other Gram-negative bacilli from stool specimens, rectal swabs, sputum, and other materials.

A number of modifications with different buffer systems and the inclusion of charcoal to adsorb toxic substances are available. Amies is one such modification of Stuart's transport medium.

### Exercises (013):

Match each of the holding media in column B with the statements in column A by placing the letter of the column B item beside the number of the column A item that most nearly describes it. Each element in column B may be used once or more than once.

Column A	Column B
— 1. Contains sodium thio-glycolate to suppress oxidative changes and was designed to facilitate transportation of swab specimens for cultures of gonococci.	a. Serum tellurite agar.
— 2. Reports indicate that pathogens from the respiratory and enteric tract have survived storage up to 8 to 12 weeks.	b. Transport charcoal medium.
	c. Selective enrichment broths.
	d. Stuart transport medium.
	e. Cary and Blair transport medium.
	f. Specimen preservative Hajna.
	g. Amies.

- 3. Removes inhibitory substances present in some agars and reduces the toxic effect of some commercial swabs.
- 4. Overgrowth of Gram-negative organisms reported in this medium.
- 5. This medium was introduced for the collection and shipment of stool specimens.
- 6. Has proven especially useful for the transportation and examination of *Corynebacterium diphtheriae*.
- 7. Overgrowth encountered by Gram-negative rods such as *C. freundii*, *Klebsiella pneumoniae*, *Enterobacter* spp, and *E. coli* has been diminished by the use of this medium.
- 8. Recommended for the isolation of streptococci, *Listeria* and *Candida albicans* from throat specimens, vaginal swabs, and exudates.
- 9. Are suitable for short-term transportation.
- 10. Contains desoxycholate and citrate.
- 11. A high selective holding medium for recovery of *Salmonella*, *Shigella*, *Klebsiella*, and other Gram-negative bacilli from stool specimens, rectal swabs, and sputum.
- 12. A modification of Stuart's.

### 014. Cite guidelines and their source for shipping, packaging, and labeling of bacteriological specimens.

**Shipment of Specimens.** Shipping specimens requires not only a knowledge of the specimen itself, but also current directives and postal regulations concerning shipment. The Department of Health Education and Welfare publishes detailed instructions on the collection, handling, and shipment of diagnostic specimens. The publication is entitled *Collection, Handling and Shipment of Microbiological Specimens*, DHEW Publication No. (CDC) 75-8263.

**Packaging of specimens.** Package specimens properly to protect them in transit and the personnel handling them. Never mail specimens in Petri plates. Do not place dry ice inside the thermos, or enclose in hermetically sealed containers. Pressures building up as CO<sup>2</sup> are liberated and will explode the thermos or

containers. Federal Regulation 72.25 of part 72, Title 42, Code of Federal Regulations, defines etiologic agents and provides guidelines for transportation of such specimens. This information is included in detail in the DHEW's collecting, handling, and shipping manual. You should have the most recent edition of this information in the laboratory.

Since most bacteriological specimens are shipped in volumes less than 50 ml, the rules for such quantity are as follows:

*Volume less than 50 ml.* Material shall be placed in a securely closed, watertight container (primary container—test tube, vial, etc.) which shall be enclosed in a second, durable watertight container (secondary container). Several primary containers may be enclosed in a single secondary container, if the total volume of all the primary containers so enclosed does not exceed 50 ml. The space at the top, bottom, and sides between the primary and secondary containers shall contain sufficient nonparticulate absorbent material to absorb the entire contents of the primary container(s) in case of breakage or leakage. Each set of primary and secondary containers shall then be enclosed in an outer shipping container constructed of corrugated fiberboard, cardboard, wood, or other material of equivalent strength.

Detailed instructions for shipping different types of specimens are included in the DHEW's publication and AFM 160-52, *Laboratory Procedures in Clinical Bacteriology*. A cross section of a properly packed container is shown in figure 2-5.

*Labels.* Mailing containers should have affixed on the outside a label which reads as shown in

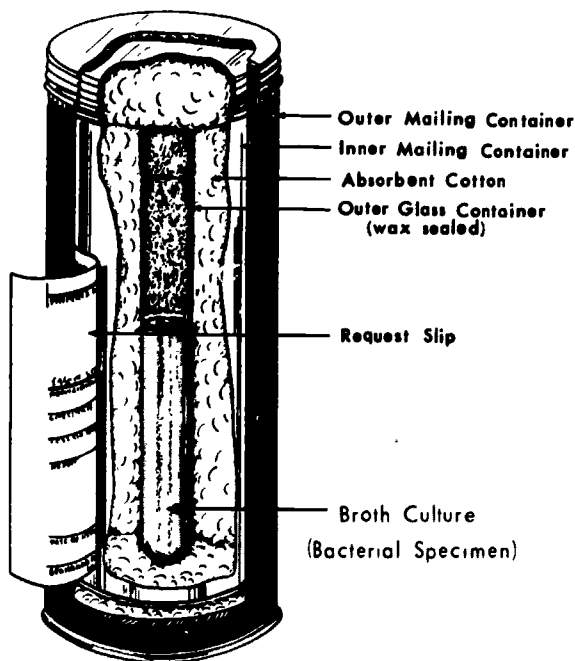

Figure 2-5. Infectious specimen for shipment (cross section).

A



BIOMEDICAL  
MATERIAL

B

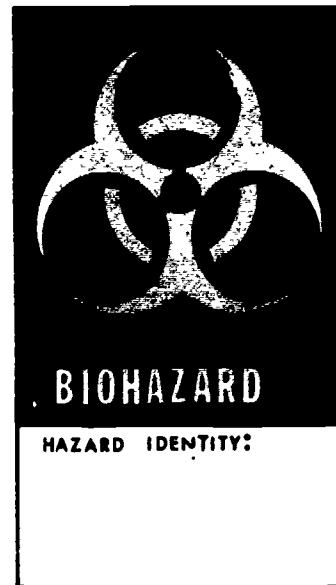

Figure 2-6. Biological hazard labels: (A) Biomedical Material shipping label and (B) Biohazard label.

figure 2-6,A. The label conforms to specifications published in Code of Federal regulations, Regulation 72.25 of Part 72, Title 42, required on shipments of etiologic agents. For additional information, the label shown in figure 2-6,B, enables you to include the hazard identity.

**Exercises (014):**

1. What manual published by HEW governs handling and shipment of all infectious specimens?
2. Specimens should be packaged properly for what two brief reasons?
3. What could happen if dry ice is placed inside the thermos or enclosed in hermetically sealed containers?

4. What Federal regulation defines etiologic agents and provides guidelines for transportation of such specimens?
5. Fill in the words as they appear on the biological hazard label:

\_\_\_\_\_ AGENTS

\_\_\_\_\_

MATERIAL  
IN CASE OF \_\_\_\_\_

OR \_\_\_\_\_

\_\_\_\_\_ Director CDC  
ATLANTA, GEORGIA  
404/633-5313

**015. Point out some precautions used against contamination, and state the usefulness of disinfectants for decontamination of work areas.**

**Precautions Against Contamination.** In any highly technical field, you need to be very careful and know the hazards that exist. In microbiology, you need to use more than ordinary care to avoid trouble. You can become infected or infect others with sloppy techniques or through carelessness.

At times your work areas will become contaminated with pathogenic organisms. This occurs as a result of human carelessness and accidental breakage of containers due to flaws or aerosol sprays. To prevent the spread of a disease agent from the contaminated area, it is essential that you start decontamination procedures immediately. Knowledge of these procedures is a necessary part of your job.

As practical chemical disinfectants for table tops and instruments, 5 percent Lysol or other phenolic compounds have been recommended as maintaining the maximal usefulness and effectiveness. However, you should be aware of properties of these disinfectants, such as cause of corrosiveness and skin irritation. Phenol compounds are absorbed as a thing, fairly durable film on surfaces to which they are applied. This film creates a residual effect and besides destroying bacteria already present on the surface, serves to destroy bacteria that land on the surface for several hours after it is applied. Halogens, such as iodine and chlorine, heavy metals, synthetic detergents, and alcohols work well for the first decontamination, but as a rule, lack the ability to remain potent for any period of time.

If you fail to decontaminate an area immediately, or as soon as possible after contamination, this may result in contaminating a much larger area,

yourself, your work, and everyone in the vicinity because of air currents caused by movement of equipment and personnel within the laboratory. If you think that an area has become contaminated, decontaminate immediately. Do not wait until you have finished with your work; it may then be too late.

**Exercises (015):**

1. How soon should decontamination be started after your work area has become contaminated with pathogenic organisms?
2. As practical chemical disinfectants for table tops and instruments, which disinfectants have been recommended as having maximal usefulness and effectiveness?
3. What other properties of 5 percent Lysol or phenolic compounds should you be aware of?
4. How does phenol compound maintain its residual effect?
5. List some disinfectants that work well for the first decontamination, but as a rule, lack the ability to remain potent for any period of time.
6. If you fail to decontaminate an area immediately, how can this result in contaminating a much larger area, yourself, your work, and everyone in the vicinity?

**016. Indicate whether given statements correctly reflect some first aid procedures in the bacteriology laboratory.**

**First Aid Procedures.** First aid procedures in a bacteriology laboratory should be limited to those procedures which will prevent infection and preserve life before you can see a physician. You must know the methods of artificial respiration, the pressure points, how to stop hemorrhage, and how to treat shock. In this course, we will not discuss these topics since they were included in a prerequisite CDC. However, you should attend any and all first aid or disaster preparedness courses to



increase your knowledge and proficiency in these areas.

Most accidents are not serious and include lacerations, needle punctures, spillage of contaminated materials, and the improper use of pipettes. In all instances, you need to take first aid steps immediately. After you have taken these steps, refer the individual to a physician and complete an accident report. Ground safety regulations will help you in the proper procedure. Be sure you report all accidents to your NCOIC or OIC.

*Lacerations.* Lacerations of the fingers and hands occur frequently, particularly when handling chipped or cracked glassware. If you do cut yourself, you will usually have some bleeding. This flow of blood flushes any bacterial contamination out of the wound. However, you can still become infected because some pathogenic bacteria may enter the bloodstream, where conditions are quite favorable for optimum growth. First aid for a laceration injury is to immediately cleanse the wound with running water, then wrap the wound with sterile material. Proceed to the treatment room to see a physician. It would help the physician to know what organism was on the glassware causing the laceration, or the source of the specimen with which you were working. The physician will be able to better treat the wound and prescribe medications.

*Puncture wound.* While working with a needle and syringe, it is very easy to stick yourself with the contaminated needle. A puncture wound is a greater danger than a laceration because little or no bleeding occurs with a puncture wound. Pathogenic organisms are forced deep into the tissues. This deeper penetration gives the bacteria an environment where good growth can occur. Don't disregard the fact that you received a needle puncture. See a physician at once, before the signs and symptoms of a disease show themselves.

*Skin contact with contaminated fluid.* Careless spilling of a contaminated fluid can very easily infect you with pathogenic organisms. Although a laceration or puncture does not usually accompany spillage, there is a good chance of contacting a local skin infection because of large numbers of bacteria in a fluid medium, particularly if the material has been incubating for some time. You may have an old laceration and the bacteria can penetrate the healing tissue.

First aid for spillage is to immediately wash the affected area with a disinfectant-type detergent soap, then rinse with large amounts of running water. You should wash and rinse as soon as possible after spillage, and before you clean up the bench or floor area. Clean and decontaminate the spillage area after you have rinsed the contaminated material off your person. Again, seek the advice of a physician.

#### Exercises (016):

Indicate whether each of the following statements is true (T) or false (F), and correct those that are false.

T F 1. Since most accidents are not serious and include lacerations, needle punctures, spillage of contaminated materials, first procedures may be delayed.

T F 2. The flow of blood flushes any bacterial contamination out of the wound and prevents all infection of pathogenic bacteria.

T F 3. First aid for a laceration is to immediately cleanse the wound with a mild antiseptic.

T F 4. It would help the physician to know what organism was on the glassware causing the laceration.

T F 5. A puncture wound is a lesser danger than a laceration because little or no bleeding occurs.

T F 6. Careless spilling of a contaminated fluid can easily infect you with pathogenic organisms.

T F 7. You may have an old laceration and the bacteria can penetrate the healing tissue.

T F 8. First aid for spillage is to immediately wash the affected area with large amounts of running water; then rinse with a disinfectant-type detergent soap.

017. State the most frequent causes of laboratory infection, the purpose of the Occupational Safety and Health Act (OSHA), and reasons for reporting of laboratory accidents in bacteriology.

**Causes of Laboratory Infection.** The most frequently recognized causes of laboratory infections are accidental oral aspiration of infectious material through a pipette, accidental inoculation with syringe needles, sprays from loose needles on syringes, centrifuge accidents, and animal bites. To prevent oral aspiration of etiological agents, mouth pipetting must be forbidden and replaced by the use of safe pipetting devices. When inoculating etiological agents, only syringes to which the needle is firmly fixed by threads (Luer Lok or equal) should be used. Screw-capped safety cups should be used when centrifuging etiological agents in an open laboratory area. Small, tabletop model centrifuges without safety cups can be used to process etiological agents if the centrifuge is operated in a closed box, if the box is under negative air pressure, and if exhausted air is filtered or incinerated. Neither smoking nor the consumption of food and drink shall be permitted in areas in which etiological agents are handled.

Contamination of the hands is another source of infection. For this reason, you should always wash your hands before leaving the area. This is a time-consuming procedure, but it is a necessary one if you wish to eliminate a source of danger to everyone you contact. Many technicians will lay their cigarette, cigar, or pipe on the edge of a bench instead of an ashtray. The subsequent insertion into the mouth can be a source of contamination. Remember, do not smoke, eat, or drink in the procedures area of the laboratory.

**Occupational Safety and Health Act.** The Occupational Safety and Health Act (OSHA) of 1970 (Public Law 91-596) establishes minimal safety standards for many work situations. These standards are not specific for a particular work area, such as diagnostic laboratories. They do define standards for particular hazards, such as storing compressed gases and flammable solvents, allowable airborne amounts of various pollutants, and wearing of safety equipment. The Center for Disease Control (CDC) is attempting to identify those OSHA standards that will apply to laboratories and, when requested (Office of Biosafety, Center for Disease Control (CDC), Atlanta, Georgia 30333), will provide these citations.

The CDC has also published two larger books dealing with infectious agents and with laboratory safety: *Classification of Etiologic Agents on the Basis of Hazard* and *Lab Safety at the Center for Disease Control*.

**Report of Accident.** Every laboratory has, or should have, in existence a standard procedure to follow in the event it becomes necessary to report an accident. If you become ill after contamination due to an accident and the illness is attributed to the same organism with which you were previously

exposed, diagnosis, treatment, and prognosis of the infection is made easier. This also makes the analysis of your health records for future disability claims easier to interpret and evaluate. Accident reporting protects you, so don't neglect it. Do not let your co-workers forget it, either. You are in a field where occupational diseases are as numerous as the number of pathogenic bacteria. Only by being careful with your techniques can you hope to prevent injury to yourself and your co-workers.

**Exercises (017):**

Complete the following statements.

1. The most frequent causes of laboratory infections are:
  - a. Accidental \_\_\_\_\_ of infectious materials through a \_\_\_\_\_.
  - b. Accidental inoculation with \_\_\_\_\_.
  - c. \_\_\_\_\_ from loose \_\_\_\_\_ on \_\_\_\_\_.
  - d. \_\_\_\_\_ accidents.
  - e. Animal \_\_\_\_\_.
  
2. To prevent oral aspiration of etiological agents, mouth pipetting must be \_\_\_\_\_ and \_\_\_\_\_ by the use of \_\_\_\_\_ devices.
  
3. When inoculating etiological agents, only syringes to which the needle is \_\_\_\_\_ by \_\_\_\_\_ should be used.
  
4. Contamination of the \_\_\_\_\_ is another source of infection.
  
5. Do not \_\_\_\_\_, \_\_\_\_\_ or \_\_\_\_\_ in the procedures area of the laboratory.
  
6. The Occupational Safety and Health Act (OSHA) of 1970 establishes \_\_\_\_\_ for many work situations.
  
7. If diagnosis, treatment, and prognosis have been made of illness after contamination due to an accident, it also makes the analysis of your health records for future disability claims \_\_\_\_\_ to \_\_\_\_\_ and \_\_\_\_\_.

8. You are in a field where occupational \_\_\_\_\_ are as numerous as the number of pathogenic \_\_\_\_\_ .

### 2-3. Sterilization and Disinfection

Bacteriological identification requires that pure cultures of microorganisms be studied. Since microorganisms are everywhere, all materials that you use to cultivate bacteria must be sterile. It is important that you, as a bacteriology technician, know the methods of removing, killing, or preventing (inhibiting) the growth of microorganisms. The many different kinds of organisms vary in the manner by which they can be destroyed. Therefore, no single method of sterilization is suitable for all organisms or all situations. Certain facts can guide you to select the best method of sterilization.

#### 018. Define sterilization and cite some major uses of sterilization.

**Sterilization.** Sterilization means the freeing of an article from all living organisms, including virus, bacteria and their spores, and fungi and their spores, both pathogenic and nonpathogenic. Sterility then is an absolute state; thus an article is either sterile or unsterile and must not be described as being "relatively sterile."

Sterilization is required for culture media, suspending fluids, reagents, containers, and equipment used in microbiology. It is also required for medical and surgical instruments and materials used in procedures that involve penetration into the blood, tissues, and other parts of the body that are normally sterile. Examples of these are such as those used in surgical operations, intravenous infusions, hypodermic injections, and diagnostic aspirations.

#### Exercises (018):

1. Define sterilization.
2. Why should an article *not* be described as "relatively sterile"?
3. What are some uses of sterilization?

#### 019. Define disinfection, cite some uses of disinfectants, and state the meaning and use of an antiseptic.

**Disinfection.** Disinfection means the freeing of an article from some or all of its contamination with live pathogenic bacteria which might cause infection during use. The term is relative, and disinfection may be described as being partially or highly effective according to the proportion of the pathogenic organisms killed or removed. Generally, disinfectants will kill the living vegetative forms of microorganisms, but not the heat-resistant spores. Synonyms for disinfectant are germicide and bactericide, both of which are used quite extensively.

Under circumstances in which sterility is unnecessary or sterilizing procedures are impractical, disinfection rather than sterilization is attempted. There is still some merit in obtaining a partial or complete removal of nonsporing pathogens. For example, it is impractical to apply sterilizing procedures to laboratory furnitures, counter tops, equipment, eating utensils, washbasins, bedclothes, and other fomites that might spread infection in a hospital or laboratory. However, since potential pathogens, not including those that form spores, present on these articles are capable of causing infection, it is useful to disinfect the articles by procedures lethal only to vegetative organisms. It is also impractical to apply sterilizing procedures to the skin.

**Antiseptic.** An antiseptic is a substance which can inhibit the growth of microorganisms without actually killing them. Antiseptics are generally used to inhibit organisms which come in contact with the body. Although the terms "bacteriostasis" and "antibiotic" have the same definition as antiseptic, they have a different significance.

The suffix of bacteriostasis, *stasis*, means "to stand still." Bacteriostatic agents do not cause the immediate death of microorganisms, but instead prevent multiplication. The microorganisms will eventually die without a significant increase in their number. Good examples of a bacteriostatic agent are low temperature, desiccation (of some organisms), and antibiotics.

An antibiotic, literally translated, means "antigrowth substance" or "growth inhibitor." Its effects are similar to bacteriostasis and, in fact, act as a bacteriostatic agent.

#### Exercises (019):

1. What does disinfection mean?
2. Disinfection may be described as being partially or highly effective according to what factor?



3. Generally, disinfectants will kill the living vegetative forms of microorganisms, but not what other forms?
4. What are two synonyms for disinfectant?
5. Under what circumstances would disinfection be used?
6. What is the main difference between sterilization and disinfection?
7. What is an antiseptic?
8. What is a bacteriostatic agent?
9. List three examples of a bacteriostatic agent.
10. An antibiotic, literally translated, means "\_\_\_\_\_ substance" or "growth \_\_\_\_\_."

**020. Define viability of organisms and list factors responsible for the variations in susceptibility of microorganisms to various methods of sterilization.**

**Viability of Organisms.** Viability means "ability to live." To remain viable, organisms must be able to propagate over an extended period when placed in a suitable environment. To do this, bacteria must carry out the vital processes of life. They need water to maintain the proper cytoplasm consistency and osmotic stability. They need food, oxygen or carbon dioxide, a proper temperature, and the correct acid-base environment. If these are available, the metabolism of the organism takes place within the cell and multiplication results. Removal of the water or altering the physical conditions that control the chemical metabolism can cause the organism to die. There are, however, certain bacteria which can survive this alteration. To destroy them, it is necessary to act on their internal metabolic processes.

The variations in susceptibility of microorganisms to various methods of sterilization are very important when choosing a means of sterilization and the conditions under which sterilization can take place. There are essentially six considerations to be investigated:

- Related genus.
- Growth curve (stage of organism).
- Presence of organic matter.
- Temperature.
- Time.
- pH.

Microorganisms vary to a great extent in their resistance to adverse physical and chemical conditions. Some are unable to survive minor environmental changes, whereas others are difficult to kill. Spore-forming species are most durable. Spores have the physical protection of their thick coats. Their metabolic needs are minimal, and since they do not divide, they avoid the increased susceptibility of the dividing cells to various harmful metabolic agents. Thus, the selection of an appropriate procedure or agent to destroy harmful organisms is determined by the specific situation and whether it is necessary to kill all microorganisms or whether it is necessary to kill only certain species. Approximately 95 percent of all sterilization is done by steam under pressure in the autoclave. Chemical sterilization is less reliable.

**Exercises (020):**

1. Define viability.
2. How can we destroy viable organisms?
3. List the factors responsible for variations in the susceptibility of microorganisms to various methods of sterilization.
4. Why are spore-forming species more difficult to destroy than non-spore-formers?
5. What factors may determine the selection of an appropriate procedure or agent for destroying harmful microorganisms?

021. Identify the phases of bacterial growth in terms of their given characteristics, the chemical and physiological activities of organisms during these phases, and the significance of these phases in the *in vitro* identification and destruction of bacterial organisms.

**Phases of Growth.** Numerous laboratory studies of bacteria depend upon introducing them into or onto sterile culture media where they can multiply. Many experiments have been worthless because the experimenter failed to appreciate some of the factors determining subsequent rate of multiplication of these organisms. Each bacterial strain has its own maximal rate which it can reach under optimal conditions, but it does not necessarily begin to reproduce at this rate straight away.

Figure 2-7 shows a typical growth curve of bacterial culture in broth. The exact shape of the curve depends on many factors including the nature of the organism, the size of the inoculum, the age of the culture from which it was taken, the composition of the medium, and the conditions of incubation; but all microorganisms go through four phases during their life cycles or growth curves. They are lag phase, logarithmic or exponential phase, stationary phase, and senescent or phase of decline.

**Lag phase.** The lag phase represents a period during which the cells, depleted of metabolites and enzymes resulting from the unfavorable conditions obtained at the end of their previous culture history, adapt to their new environment. The phase represents a period during which the dormant organisms used as inoculum are probably imbibing water. In addition, these cells are restoring RNA (chiefly ribosomal) essential for synthesis of new proteins and possibly producing inducible enzymes to cope with new nutrient substances. During this phase, they are swelling and otherwise becoming adjusted to the new environment.

If these cells are taken from an entirely different medium, it often happens that they are genetically incapable of growth in the new medium. In such cases, the lag represents the period necessary for a few mutants in the inoculum to multiply sufficiently for a net increase in cell number to be apparent. There is growth in size of cells, but no immediate increase in number.

**Logarithmic or exponential phase.** In this phase the bacteria reproduce at a logarithmic rate; that is, one becomes two, two become four, four become eight, etc. The colonies increase in size and gain their characteristics during this stage. Fission may become so rapid that the number of organisms doubles within each 10 minutes.

Number of viable organisms per ml.

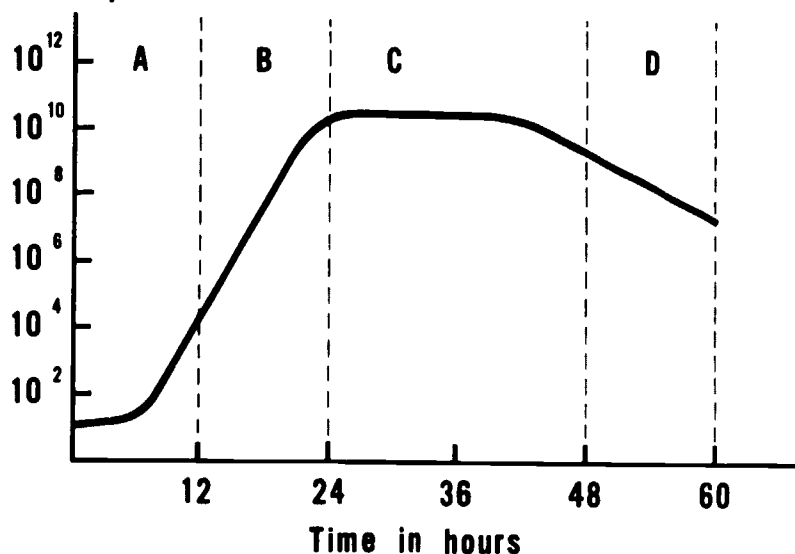

A. Lag Phase                      C. Stationary Phase  
 B. Logarithmic Phase          D. Senescent Phase

Figure 2-7 Typical growth curve of a bacterial culture in a liquid medium

During this phase, most of the cells are physiologically young and biologically active. If a subculture is made from the flask to a new flask of the same sort of warm, sterile broth, growth continues at the logarithmic rate; there is no lag or dormant phase. Biochemical and physiological properties that are commonly used for identification of organisms are usually manifested during the logarithmic phase.

**Stationary phase.** At this point of growth there are about as many bacteria dying as there are being produced. The number of viable organisms have reached a maximum. In this phase, food begins to run out, poisonous waste products accumulate, pH changes, hydrogen acceptors are used up, energy transfers are diminished, and the cells interfere with each other.

**Senescent of phase of decline.** In this stage, the number of living bacteria slowly decreases. Eventually the number of cells dying balances the rate of increase, and the total viable population remains unchanged for a time. This change is influenced by such factors as the time depending on the temperature, the size of the tube and volume of fluid, and the composition of the medium. The speed and shape of this decline depends upon the susceptibility of the organisms to their own waste product; some delicate species are extinct within a few days, whereas cultures of others may continue to yield survivors for years. The total number of bacteria, living and dead, in a broth culture remains constant for a long period after the stationary phase, unless the organism is autolytic, producing enzymes that destroy its own cells.

During the first two phases and through part of the third phase, the organisms are young and growing. Their enzymatic functions are fairly rapid and their cell walls are vulnerable to the effects of the various sterilization techniques.

One reason why it is important to know about these phases of growth is that the rapidly multiplying bacteria of the logarithmic phases are particularly susceptible to damage by antiseptics and antibiotics. They are also able to multiply at maximal speed immediately, without a lag phase, if transferred to suitable fresh medium. Therefore, many *in vitro* comparisons between organisms are meaningless because the inocula are taken from cultures in different phases of growth.

As the bacteria become old, their functions slow down, and those that can begin to go into a resting stage. At this point, killing the organism becomes more difficult. It is easier to destroy a young growth of bacteria than an old one. You will easily recognize which phase the bacteria are in as you work with cultures. Review the four phases shown in figure 2-7. It will be easy for you to select sterilization and decontaminating procedures.

### Exercises (021):

Match each growth phase in column B with the statement in column A by placing the letter of the column B item beside the number of the column A item that most nearly describes it. Each element in column B may be used once or more than once.

#### Column A

#### Column B

- |   |   |
|---|---|
| <ul style="list-style-type: none"> <li>— 1. Depends upon the nature of the organism, the size of inoculum, the age of the culture from which it was taken, the composition of the medium, and condition of incubation.</li> <li>— 2. During this phase, the dormant organisms are probably imbibing water, restoring ribosomal RNA essential for new protein synthesis.</li> <li>— 3. This phase represents the period necessary for a few mutants in the inoculum to multiply sufficiently for a net increase in cell number to be apparent.</li> <li>— 4. During this stage, most of the cells are physiologically young and biologically active.</li> <li>— 5. Biochemical and physiological properties that are common for identification of organisms are usually manifested during this phase.</li> <li>— 6. Food begins to run out, poisonous waste products accumulate, pH changes, hydrogen acceptors are used up, energy transfers are diminished, and the cells interfere with each other.</li> <li>— 7. The number of living bacteria slowly decreases.</li> <li>— 8. The speed and shape of this phase depends upon the susceptibility of the organisms to their own waste products.</li> <li>— 9. During these two phases, the organisms are considered to be young and growing.</li> <li>— 10. During this phase, bacteria are more susceptible to damage by antiseptics and antibiotics.</li> <li>— 11. If transferred to suitable fresh medium from the logarithmic phase, the stage at which the organisms would most likely continue to grow.</li> <li>— 12. Killing the organisms is most difficult at these stages.</li> </ul> | <ul style="list-style-type: none"> <li>a. Senescent or phase of decline.</li> <li>b. Logarithmic or exponential phase.</li> <li>c. Lag phase.</li> <li>d. Stationary phase</li> </ul> |
|---|---|

**022. Specify the basic principle of sterilization by moist heat, state the factors that affect the effectiveness of boiling, and cite the principle of sterilization by free-flowing steam.**

**Physical Agent Sterilization.** There are many physical means of killing or inhibiting the growth of microorganisms. Methods in common use include:

- Moist heat.
- Steam under pressure.
- Dry heat.
- Incineration (open flame).
- Ultraviolet radiation.
- Mechanical (filtration).

In the following paragraphs, we will discuss each of these methods separately and give you a working knowledge of the principles on which they work.

**Moist heat.** Moist heat (boiling in water and steam) will coagulate the protein within the bacterial cell. This occurs in two stages: (1) the water reacts with the protein (denaturation) and (2) the altered protein separates out as particles (flocculation). Coagulation of the protein is directly related to time and temperature. Different genera of microorganisms vary in their susceptibility to heat.

**Boiling water.** Using boiling water for disinfecting purposes is a simple procedure. You can use it almost any place where water and a container to boil the water are available. Boiling is a good method for disinfecting; however, it can never be depended upon for complete sterilization, especially at elevations above sea level. Ordinarily a 5-minute boiling procedure in New York City, which is at sea level, would be sufficient to sterilize water. However, it would take much longer time to sterilize water at Tahoe, Nevada, where the altitude is 6,225 feet.

If boiling is used for sterilization, as might be the case with outpatients for sterilizing their own containers, sufficient time must be allowed to compensate for the difference in altitude and the change in the boiling point. Remember also that spores may remain alive after hours of boiling. Use boiling as a means of sterilization under carefully controlled conditions.

**Free-flowing (live) steam.** To get free-flowing steam, you use a covered container to hold steam without building up pressure. You should remember that free steam, as with boiling water, does not reach a temperature above 100°C or 212° F. In higher elevations the temperature would be even less.

A British scientist, Tyndall, noticed that after boiling and standing for a period of 24 hours at room temperature, the dormant and heat-resistant spores in a solution would germinate and grow. Reboiling would then kill these forms.

Thus, free steam is sometimes used to accomplish *fractional sterilization* or *tyndallization*. Tyndall devised a process of sterilization by steaming for a few minutes at 100° C on three or four successive occasions separated by 24-hour intervals at room temperature. The intervals permit the dormant, resistant spores to become active, vulnerable vegetative cells, readily destroyed by 100° C. This process renders an infusion sterile, whereas one single continuous boiling for 1 hour may not, since many spores can remain in their dormant and resistant state during this time. An advantage is that it requires no special apparatus. A disadvantage is that it is time-consuming and in some fluids, such as water, spores may not grow out promptly. Also, if the material is freely exposed to air, anaerobic spores may not germinate and may survive the process. If not freely exposed to air, aerobic spores will not grow out.

You may sterilize certain media, such as gelatin, sugars, and potatoes used for bacteriological procedures by this procedure.

#### **Exercises (022):**

1. The process of destroying bacteria by moist heat such as boiling and steam is accomplished in two stages by what principles?
2. Coagulation of the protein (bacteria) is directly related to what two factors?
3. What two factors affect the effectiveness of boiling as a means of sterilization, and to what other key factor are they both related?
4. What is the principle of fractional sterilization with free-flowing steam?
5. What are some disadvantages of the free-flowing steam?

**023. Point out briefly the principle of sterilization by the autoclave; the effective lethal agents in this process; the time, temperature, and pressure routinely used; and guidelines in the process of autoclaving laboratory materials.**

**Steam Under Pressure.** If you are familiar with the operation of a home pressure cooker, then you

should understand the principle of an *autoclave*. The autoclave will kill microorganisms, including heat-resistant spores, with heat at temperatures above that of boiling water. Water boils when the vapor pressure is equal to the pressure of the surrounding atmosphere. Hence, if the pressure is increased in a sealed vessel, the boiling point will rise above 100° C. In a closed system, the exact temperature at which water will boil depends upon the pressure employed. Since it is not the pressure, but the temperature and moisture which are the effective lethal agents, the autoclave is equipped with a thermometer as well as a pressure gauge. The exposure time should be based on the temperature reading rather than the pressure reading, because air trapped in the chamber may cause the pressure to build up before the desired temperature is reached. The maximum temperature corresponding to any given pressure can only be obtained when the interior of the vessel is saturated with steam. In table 2-2, the temperature attained at different pressures of saturated steam is given. Only culture media, solutions, or materials which are not destroyed or altered by excessive heat should be subjected to autoclave sterilization.

An autoclave temperature of 121° C at 15 pounds pressure for 15 minutes or longer is required for the sterilization of most of the materials routinely used in the bacteriology laboratory. Figure 2-8 illustrates the parts of the autoclave and the flow of steam through the autoclave.

**Process of Autoclaving.** In order to achieve desired results through autoclave sterilization, you must observe the following principles:

a. The autoclave should never be overlooked.

b. Tubes should be packed loosely in baskets or racks and never placed in containers capable of trapping air.

c. Large quantities of media in single containers should be preheated to avoid undue time lag. If possible, distribute media to several smaller containers to effect complete heating and sterilization. The pressure must be allowed to subside slowly after heating is completed or the superheated fluids in open (cotton-plugged) vessels will boil over. *Tightly sealed vessels may explode.*

d. All air must be exhausted from the autoclave and the temperature reached before timing the sterilization cycle.

e. Media should never be overautoclaved or reautoclaved.

f. Flasks and tubes should never be filled to more than two-thirds capacity (one-half capacity is better).

g. All media should be removed from the autoclave as soon as possible after sterilizing.

**Exercises (023):**

1. How does the autoclave destroy microorganisms?
2. What are the two effective lethal agents in the process of sterilization by the autoclave?
3. What time, temperature, and pressure are routinely used to sterilize bacteriology laboratory materials?

TABLE 2-2  
PRESSURE TEMPERATURE RELATIONSHIPS IN THE AUTOCLAVE

<i>Temperature in Degrees Centigrade</i>	<i>Steam Pressure in Pounds</i>
108	5
116	10
121	15
127	20
131	25
134	30

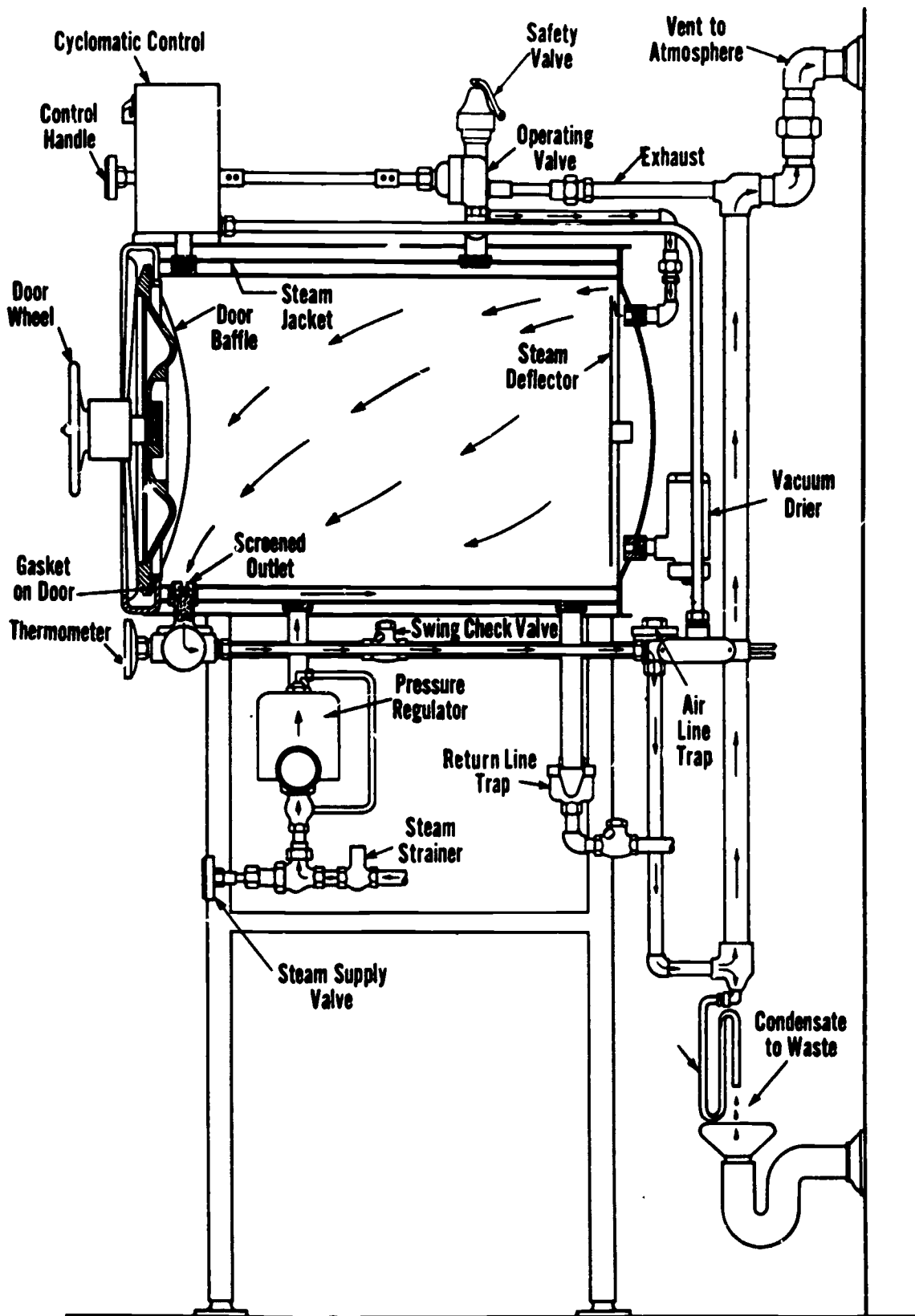

Figure 2-8. Autoclave (Courtesy of American Sterilizer Company, Erie, Pennsylvania)



4. If the autoclave pressure is not allowed to subside slowly, what could happen to tightly sealed vessels?
5. What could happen to the superheated fluids in open (cotton-plugged) vessels if the autoclave pressure is not allowed to subside slowly?
6. To what capacity should flasks and tubes be filled?
7. How soon after sterilizing should all media be removed from the autoclave?

024. Identify given physical agents of sterilization in terms of their uses and methods for destruction of bacteria.

**Dry Heat.** This method is used when direct contact of saturated steam to all surfaces of a material is impractical. Sterilization by dry heat requires higher temperatures and a longer period of heating than does sterilization with steam. Its use is limited primarily to the sterilization of glassware and such materials as oils, jellies, and powders that are impervious to steam. The lethal action results from the heat conveyed from the material with which the organisms are in contact and not from the hot air that surrounds them. As a result, the importance of uniform heating of the whole of the material to be sterilized is stressed in this method. The hot air oven is the most widely used to provide dry heat. Sterilizing times of 2 hours at 180° C are adequate even for spore-forming organisms.

When loading the dry-heat sterilizer, observe the following rules:

- Do not load the chamber to capacity.
- Do not pack containers close together. Allow space between them so that the hot air can circulate.
- Do not stack articles against side walls. The hot air must circulate freely.



Figure 2-9. Seitz filter.

All items to be sterilized by the dry-heat method must be thoroughly cleansed before exposure. Otherwise, heat will fix the grease, dirt, and other material to the equipment.

**Incineration.** Incinerating is a method to assure complete destruction of contaminated materials. You should use common sense when deciding what may be burned, and take caution to assure complete burning of the discarded material. Always observe local practices in the use of the incinerator.

**Ultraviolet Radiation.** This method of sterilization has come about after prolonged investigation. There is no doubt that light and electromagnetic rays of short wavelength exert an effect when absorbed by the bacteria. Its use is limited, however, in that it must be applied directly to the surface being sterilized. It cannot penetrate glass, and exposure must be prolonged. Eyes must be protected from the X-rays. It can be used to sterilize rooms in a hospital, such as the operating room. It is quite effective in killing microorganisms on the floor, walls, instrument tables, and in the air. The treatment of certain biological materials, such as vaccines and plasma, to kill any contaminating viruses is becoming common practice. In every case, it is the radiation and energy absorbed by the bacterium which bring about its destruction with resultant damage to the DNA, and not the energy applied. The most effective bactericidal wavelength is the 240- to 280-nm range with the optimum at about 260 nm which corresponds with the absorption maximum of DNA.

**Mechanical (Filtration).** Filtration is a mechanical means of sterilization. It removes rather than destroys microorganisms from the material to be sterilized. Certain types of media are destroyed or altered by heat. Materials such as carbohydrates, serum, ascitic fluid, urea, potassium, and tellurite are thermolabile. These substances in solution are passed through a filter of fine porosity to remove all bacteria. Examples of different types of filters are listed below.

**Seitz.** Seitz filters consist of compressed asbestos pads of the K (germicidal) porosities, as shown in figure 2-9. All the filters discussed, except the Seitz, are permanently mounted in a funnel. The Seitz has filter pads which are clamped in the base of a metal funnel.

**Berkefeld.** Candle filters, which are thick-walled tubes made of diatomaceous earth, are Berkefeld filters. They can be obtained in three porosities, namely, the *V* (coarse), *N* (normal), and *W* (fine). Only the *N* and *W* filters of this type should be used for sterilization.

**Pyrex brand.** Pyrex brand filters consist of pulverized glass (fritted ware) available in UF or ultrafine porosity for bacterial sterilization. This type is shown in figure 2-10.



Figure 2-10. Pyrex fritted glass filter.

**Chamberland.** Chamberland filters are made of unglazed porcelain in graded porosities designated L-1, L-2, L-3, etc. The filter gradations ranging from L-5 to L-7 are bacteria-proof.

**Cleaning and Operation of Filters.** Clean the Berkefeld filter by successive boiling in 2 percent sodium carbonate and distilled water, then rinsing with water. Pyrex filters are cleaned by immediately flushing with water under pressure, placing in hot, hydrochloric acid, and thoroughly rinsing with distilled water. Clean Chamberland or porcelain filters in standard chromic acid washes, flush thoroughly with water under pressure, and rinse with distilled water. The Seitz filter pads are disposable. You must wash the metal funnel parts in good detergent and rinse thoroughly.

The sterilizing effect of filters is achieved mostly by adsorption of the microorganisms to the surface of the filter and filter funnels rather than by sieve action. All equipment used for filtration must be sterilized prior to use. The filter will absorb those

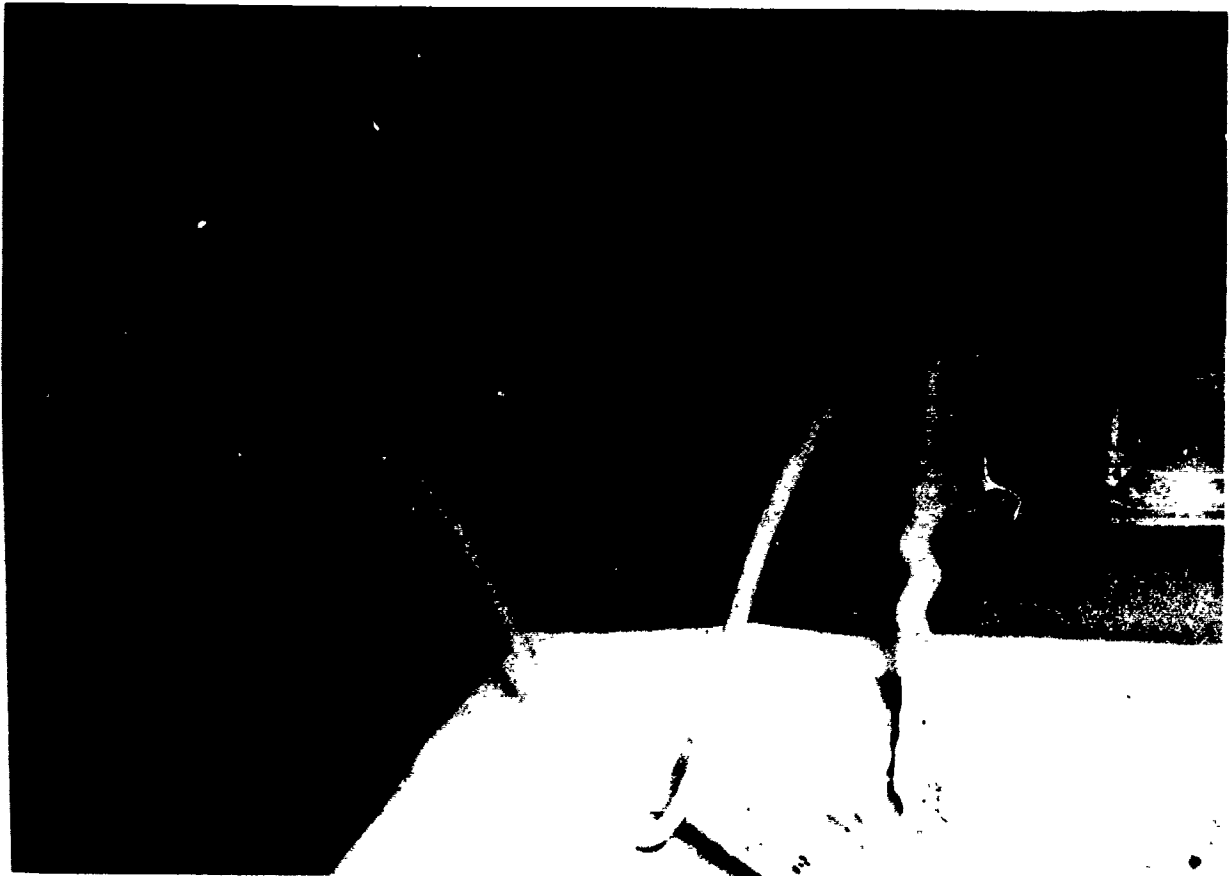

Figure 2-11. Filter attached to suction

microorganisms from the fluid coming through the filter but, naturally, cannot remove those organisms below the filter. Figure 2-11 is an example of the setup used for filtration.

Another means of filter sterilizing is a filter attachment on a syringe. This allows the filter sterilization of small amounts of fluids. One example of this equipment is that produced by the Millipore Filter Corporation. Individual syringes with the filter attachment are autoclaved and stored in a sterile condition until needed. You fill the syringe by removing the plunger and pouring the fluid into the barrel. Insert the plunger and apply steady pressure. This will force the fluid through the filter into a sterilized tube or tubes. This method offers the advantage of using less medium and will save on storage space and resources.

**Exercises (024):**

Match each of the given physical agents of sterilization in column B with the statements in column A by placing the letter of the column B item beside the number of the column A item that most nearly describes it. Each element in column B may be used once, more than once, or not at all.

*Column A*

*Column B*

- |  |   |
|--|---|
| <ul style="list-style-type: none"> <li>— 1. This method is used when direct contact of saturated steam to all surfaces of a material is impractical.</li> <li>— 2. Requires higher temperatures and a longer period of heating than does sterilization by steam.</li> <li>— 3. Use is limited primarily to the sterilization of glassware and such materials as oils, jellies, and powders that are impervious to steam.</li> <li>— 4. A method to assure complete destruction of contaminated materials.</li> <li>— 5. It cannot penetrate glass, and its exposure must be prolonged.</li> <li>— 6. Sterilizing times of 2 hours at 180° C are adequate even for spore-forming organisms.</li> <li>— 7. In every case, it is the absorption of energy and this agent by the bacterium which result in damage to the DNA.</li> </ul> | <ul style="list-style-type: none"> <li>a. Incineration.</li> <li>b. Seitz filter.</li> <li>c. Pyrex brand filter.</li> <li>d. Ultraviolet radiation.</li> <li>e. Dry heat.</li> <li>f. Chamberland filter.</li> <li>g. Berkefeld filter.</li> <li>h. Steam under pressure.</li> </ul> |
|--|---|

- 8. The most effective bactericidal wavelength is the 240- to 280-nm range.
- 9. Consists of compressed asbestos pads of the K (germicidal) porosities.
- 10. Types are candle filters which are thick-walled tubes made of diatomaceous earth.
- 11. Consists of pulverized glass (fritted ware) available in ultrafine porosity for bacterial sterilization.
- 12. Made of unglazed porcelain in graded porosities.
- 13. Is cleaned by successive boiling in 2 percent sodium carbonate and distilled water, then rinsing with water.
- 14. May be cleaned by immediately flushing with water under pressure, placing in hot, hydrochloric acid, and thoroughly rinsing with distilled water.
- 15. Filter pads are disposable.

**025.** Point out the sites in the bacterial cell that are susceptible to chemical sterilization, and specify the mechanism by which chemical agents kill or inhibit the growth of the cell.

**Chemical Sterilization.** There are three sites in the bacterial cell that are susceptible to the action of chemical agents. These are surface layer, nuclear material, and enzyme systems. Chemical agents perform their disinfecting and sterilizing action on these sites by coagulation of proteins as surfactants, by specific chemical combinations, and by nonspecific chemical combinations. Action by chemical agents may be by one or more of the above methods. A brief discussion of each of these methods follows.

*Coagulation of proteins by surfactants.* The coagulation of proteins is similar to that of cooking an egg. The protein (albumin or white) of the egg coagulates and turns white. Any agent that can induce coagulation is lethal to a living cell.

Surfactants are chemical agents which coat the surface of the organism and/or the surface of certain enzyme systems to prevent the microorganism from absorbing or utilizing nutritional substances. This will cause the organism to die. Certain chemical agents injure or destroy the cell wall, causing immediate lysis of the cell or changes in the cell membrane permeability. Polymyxin, an antibiotic, works in this manner.

*Specific chemical combinations.* In low concentrations, these enter the cell of the microorganism and stop or interfere with enzyme

groups. This will lead to bacteriostasis or death, depending upon the type of cell and chemical agent. The sulfonamide drugs and many antibiotics are effective in this manner.

*Nonspecific chemical combinations.* These chemicals will combine indiscriminately with the protein and other compounds within a bacterial cell. These substances are nonspecific in their action and will combine readily with feces, blood, body tissue, and mucus as well as the protein of the microorganisms. Chlorine, iodine, formaldehyde, and phenol are examples.

#### Exercises (025):

1. Chemical sterilization is achieved by attacking what three sites of a bacterium?
2. How do surfactant chemical agents affect the cell?
3. How is the cell affected by nonspecific chemical combinations?

**026.** Identify given chemical agents used in sterilizing or as disinfectants in terms of their applications, properties, effectiveness, and manner in which they work to destroy microorganisms.

**Chemical Agents.** Now that you have a brief understanding of the way in which chemical agents affect microorganisms, we will discuss these chemical agents: chemical agents:

- Halogens (oxidizing agents).
- Heavy metals.
- Synthetic detergents.
- Organic solvents.
- Gaseous agents.
- Phenols.

*Halogens.* Halogens used as disinfecting agents are chlorine and iodine. These are used frequently and are known to be effective disinfectants.

*a. Chlorine.* Chlorine is the form of calcium or sodium hypochlorite has a high bactericidal property. It is commonly purchased as a 5-percent bleach solution in most grocery stores. Although chlorine is quite effective as a disinfectant, it has certain disadvantages which we must consider before using it. These are:

- (1) It is readily neutralized by protein and other organic material (nonspecific).
- (2) It is poisonous.
- (3) It tends to evaporate from the container.

(4) In aqueous solution it is unsuitable for polished surfaces, since it does not spread evenly over the surface.

(5) It attacks metals.

Chlorine is probably the most effective agent for use in disinfecting water. It can be used as a 1.0-percent solution for cleaning hands; however, the hands may develop a bad odor. (A thiosulfate solution will remove the odor.)

*b. Iodine.* Iodine is the most active halogen in its antimicrobial effect. As a 1.0-percent solution in 70 percent ethanol or in a potassium iodide solution it is a good disinfectant for the skin. However, iodine is not used very often for large-scale disinfecting procedures, because it has most of the disadvantages of chlorine. Solutions of iodine combined with a surfactant carrier (iodophor) are available commercially and may be used for a variety of purposes, including sanitizing dishes and sterilizing thermometers. Examples of products available commercially are Wescodyne, Tincture of Iodine, and Betadine.

*Heavy metals.* Compounds of the heavy metals mercury, silver, and copper have a definite but limited use as disinfectants. Their action is more bacteriostatic than bactericidal. In high concentrations they act on the bacterial cell to coagulate the protein, but in low concentrations they interfere with certain enzyme systems.

The more common heavy metal compounds in use include mercury bichloride, copper sulfate, and silver nitrate. Merthiolate (Thimerosal), Mercurochrome, Argyrol, and Protargol are familiar names for commercially prepared solutions of the compounds of mercury and silver. Solutions of copper sulfate are used mostly as fungicides.

*Synthetic detergents.* These are often used for sterilization. The word "detergent" is derived from Latin and means "to cleanse." Detergents including household detergents are strong, surface active agents. They are essentially nonirritating to raw surfaces, and in dilutions varying from 1/100 to about 1/15000, destroy vegetative forms of bacteria. Some of the synthetic detergents will precipitate various proteins, agglutinate bacteria, and are toxic to white blood cells (leukocytes). For vegetative forms of microorganisms on the skin, detergent action is more bacteriostatic than bactericidal. Their action is decreased by the presence of organic matter and saline, but not by distilled water. Generally, the Gram-positive bacteria are affected more readily than the Gram-negative organisms. Detergents are essentially of three types—anionic, cationic, and nonionic.

*a. Anionic.* Anionic detergents consist of soaps and fatty acids which yield a negatively charged ion when mixed with a suitable solvent. This type of detergent is more active at an acid pH and is more effective against Gram-positive organisms. Its lack

of effectiveness against Gram-negative organisms is thought to be due to lack of phospholipid material at their surface. When the detergent reacts with this phospholipid in Gram-positive organisms, salts are formed and death results.

*b. Cationic.* The cationic group of detergents has a water-soluble group of particles which will dissociate to form positively charged ions. These ions will be absorbed on the surface of the negatively charged bacteria, causing a loss of semipermeability with a resultant leakage of phosphorous, nitrogen, and other substances important to bacterial metabolism. Cationic detergents, also considered quarternary ammonium compounds, are more active at an alkaline pH. Zephiran or *Roccal Cetrimide* and hexachlorophene are examples of cationic detergents.

*a. Anionic.* Anionic detergents consist of soaps and fatty acids which yield a negatively charged ion when mixed with a suitable solvent. This type of detergent is more active at an acid pH and is more effective against Gram-positive organisms. Its lack of effectiveness against Gram-negative organisms is thought to be due to lack of phospholipid material at their surface. When the detergent reacts with this phospholipid in Gram-positive organisms, salts are formed and death results.

*b. Cationic.* The cationic group of detergents has a water-soluble group of particles which will dissociate to form positively charged ions. These ions will be absorbed on the surface of the negatively charged bacteria, causing a loss of semipermeability with a resultant leakage of phosphorous, nitrogen, and other substances important to bacterial metabolism. Cationic detergents, also considered quarternary ammonium compounds, are more active at an alkaline pH. Zephiran or *Roccal Cetrimide* and hexachlorophene are examples of cationic detergents.

*c. Nonionic.* Nonionic detergents do not ionize or dissociate in water and are therefore pH independent. They are relatively nontoxic and are often used as additions to commercial detergents. Tween 80, which may even facilitate bacterial growth, is an example of a nonionic detergent. Triton X-100, another nonionic detergent, has a specific solubilizing effect on the cytoplasmic membrane, selectively separating the proteins of the cell wall and membrane.

You cannot use synthetic detergents at random. Your choice must be made intelligently so that maximum benefit can be achieved. Do not mix anionic and cationic detergents because the negative and positive charges will combine and neutralize each other and cancel out the antiseptic or disinfectant effect desired.

*Organic solvents.* Alcohol, the most used of the group known as organic solvents, is a good example of this type of disinfectant. You already know that ethyl alcohol (ethanol) has an optimum



disinfectant quality at a strength of from 50 to 70 percent. A point to remember is that this percentage refers to the final dilution of alcohol. To illustrate—to disinfect dry bacteria, a solution of 50 to 70 percent ethanol is best and can be used directly; but if you wish to disinfect a tube of broth containing viable organisms, it is best to add absolute ethanol to the broth so that a final dilution of the alcohol in the broth represents 50 to 70 percent. The addition of diluted alcohol to the broth tends to dilute the alcohol further, and as a result, it is less effective. To disinfect the hands, 70 to 80 percent alcohol is best if the hands are dry, and 80 to 96 percent alcohol if the hands are wet.

*a. Ethyl alcohol.* Ethyl alcohol in the proper strength works well to destroy the vegetative stage of bacteria. It takes longer to kill dry bacteria than wet bacteria. To destroy spore forms, the addition of sulfuric acid to 70 percent alcohol (1.0 percent final volume of sulfuric acid) works effectively. You can use also sodium hydroxide instead of sulfuric acid.

*b. Isopropyl alcohol.* Isopropyl alcohol (80 percent) is useful as a skin disinfectant. It is a better fat solvent and more bactericidal than ethyl alcohol. Both have the disadvantage in that they are rendered rather inactive by the presence of mucus or pus. In this respect, to be effective in disinfecting thermometers, you must wipe them clean before placing them in the alcohol solution, or in any disinfectant solution where its action is based on the coagulation of protein.

*Gaseous agents.* These agents include formaldehyde, ethylene oxide, and beta-propiolactone. Each has certain limitations, and most clinical laboratories have little use for gaseous agents as a means of sterilization.

*a. Formaldehyde.* Formaldehyde is used very little. It has a very low penetrating ability and is affected by the presence of protein matter. It is most effective in destroying vegetative forms of bacteria in a concentration of 1 to 2 mg per liter of air at 80 percent relative humidity. Its chief advantage is in the disinfecting of smooth surfaces. To penetrate and disinfect blankets and the like, the formaldehyde should be mixed with steam. You should not use formaldehyde on good furniture, because the formaldehyde will convert to paraldehyde and form a white film which is hard to remove. Formaldehyde cannot be relied on to destroy spores or acid-fast bacilli.

*b. Ethylene oxide.* You will come in contact with material sterilized by the gaseous agent ethylene oxide. Practically all disposable, plastic materials are sterilized by this gas. Ethylene oxide is very effective and kills bacterial spores. The gas is highly explosive at certain concentrations, and its use is generally limited to a closed system similar to an autoclave. It has an advantage over formaldehyde in that ethylene oxide is highly diffusible and can

be used to sterilize fabrics, catheters, cryoscopes, and other equipment.

*c. Beta-propiolactone (BPL).* Beta-propiolactone is a good sterilizing agent in that it kills both the vegetative and spore forms of microorganisms. It acts by combining with the sugars, cellular proteins, and fats of bacteria. It can be used to sterilize tissues for grafting and for sterilizing vaccines which could not be sterilized in any other way. It does not leave a residue as does formaldehyde. It is several thousand times more active than ethylene oxide.

*Phenol and creosol products.* Phenol (carbolic acid) and creosol products are obtained by the destructive distillation of coal tar. Phenol and its many derivatives are surfactants. The lethal effect of the phenols is due to their ability to orient themselves at interfaces, causing membrane damage, release of cell contents, and lysis. Low concentrations of phenol precipitate proteins. Membrane-bound oxidases and dehydrogenase are irreversibly inactivated by concentrations of phenol that are rapidly bactericidal for the organism. They have a sterilizing effect in that they can kill both the vegetative and spore forms of bacteria. Creosols mixed with green soap are sold under the trade names Lysol and Creolin and are four and ten times more effective than phenol respectively. The addition of sodium chloride to the commonly used 5-percent solution of phenol increases its effectiveness. The addition of ethyl alcohol reduces its effectiveness considerably. Certain of the coal tar derivatives known as bis-phenols are incorporated in solution with other surfactants or detergents to produce the surgical soap and hand wash Gamophen and Phisohex.

#### Exercises (026):

Match each chemical agent in column B with the statements in column A by placing the letter of the column B item beside the number of the column A item that most nearly describes it. Each element in column B may be used once or more than once.

Column A	Column B
— 1. Is probably the most effective agent for use in disinfecting water.	a. Anionic detergent (synthetic).
— 2. In the form of calcium or sodium hypochlorite, it has a high bactericidal property.	b. Isopropyl alcohol (organic solvent).
— 3. The most active halogen in its antimicrobial effect.	c. Formaldehyde (gaseous agent).
— 4. In high concentrations, they act on the bacterial cell to coagulate protein, but in low concentrations, they interfere with certain enzyme systems.	d. Phenol and/or creosol products.
— 5. They include such compounds as mercury bi-	e. Beta-propiolactone (gaseous agent).
	f. Ethylene oxide (gaseous agent).
	g. Ethyl alcohol (organic solvent).
	h. Nonionic detergent (synthetic).



Column A

- chloride, copper sulfate, silver nitrate, also commercial solutions such as Merthiolate, Argyrol, and Protargol.
- 6. Consists of soaps and fatty acids which yield a negative charged ion when mixed with a suitable solvent.
  - 7. Is more active at an acid pH.
  - 8. When this detergent reacts with a phospholipid material at the surface of Gram-positive organisms, salts are formed and death results.
  - 9. Has a water-soluble group of particles which dissociate to form positively charged ions.
  - 10. These ions will be absorbed on the surface of the negatively charged bacteria, causing a loss of semi-permeability with a resultant leakage of substances necessary for bacterial metabolisms.
  - 11. More active at an alkaline pH.
  - 12. Do not ionize or dissociate in water and are therefore pH independent.
  - 13. Tween 80 and Triton X-100 are commercial examples.
  - 14. If both of these detergents are mixed they will neutralize each other and cancel out the antiseptic or disinfectant effect desired.
  - 15. It is a better fat solvent and more bactericidal than other closely related organic solvent in that group.
  - 16. It has a very low penetrating ability and is affected by the presence of protein matter.
  - 17. It is most effective in destroying vegetative forms of bacteria in concentrations of 1 to 2 mg per liter of air at 80 percent relative humidity.
  - 18. Practically all disposable, plastic materials are sterilized by this gas; it is very effective and kills spores.
  - 19. It acts by combining with the sugars, cellular proteins, and fats of bacteria.
  - 20. It can be used to sterilize tissue for grafting and for sterilizing vaccines which could not be sterilized in any other way.

Column B

- i. Cationic detergent (synthetic).
- j. Heavy metals
- k. Iodine (halogen)
- l. Chlorine (halogen)

- 21. Are obtained by the destructive distillation of coal tar
- 22. The lethal effect is due to their ability to orient themselves at interfaces, causing membrane damage, release of cell contents, and lysis
- 23. The addition of sodium chloride to the commonly used 5 percent, increases its effectiveness
- 24. A practical means of sterilizing plastic articles is by the use of this agent

027. Point out how given factors directly relate to the effectiveness of disinfectants.

**Factors Affecting Disinfectant Potency.** Most disinfectants have a general affinity for the protein and protoplasm of the bacteria. Consequently, the presence of extraneous quantities of blood serum, mucus, or feces may protect the organisms by combining with the disinfectant before the disinfectant has a chance to affect the bacterial cell. Because of this, culture growths are easier to sterilize than body fluids.

No routinely used disinfectant acts immediately. It takes time for a disinfectant to act, and this depends upon several factors, four of which are:

- Concentration of organisms.
- Concentration of disinfectant.
- Temperature.
- Presence of cells in the culture having varying susceptibilities.

The true concentration can refer to the dilution of the disinfectant or to the number of organisms in the culture. The more concentrated the disinfectant (within limits), the more effective it will be. The relation of concentration to effectiveness is shown in figure 2-12. The concentration of most disinfectants is stated on the label. You should always follow the manufacturer's instructions for using and diluting any disinfectant. The concentration at which a disinfectant is used determines how effective it will be. Any disinfectant has an optimum dilution where it will do the best job.

The warmer the disinfectant, the more effective it is and the quicker it will react. A higher temperature generally increases a disinfectant's effectiveness by decreasing the viscosity, increasing the acidity of the bacterial surroundings, and lowering the bacterial surface tension. Heating too much can decrease the disinfectant's effectiveness by diminishing adsorption to the cell wall. We can say that the temperature effect in this type of reaction

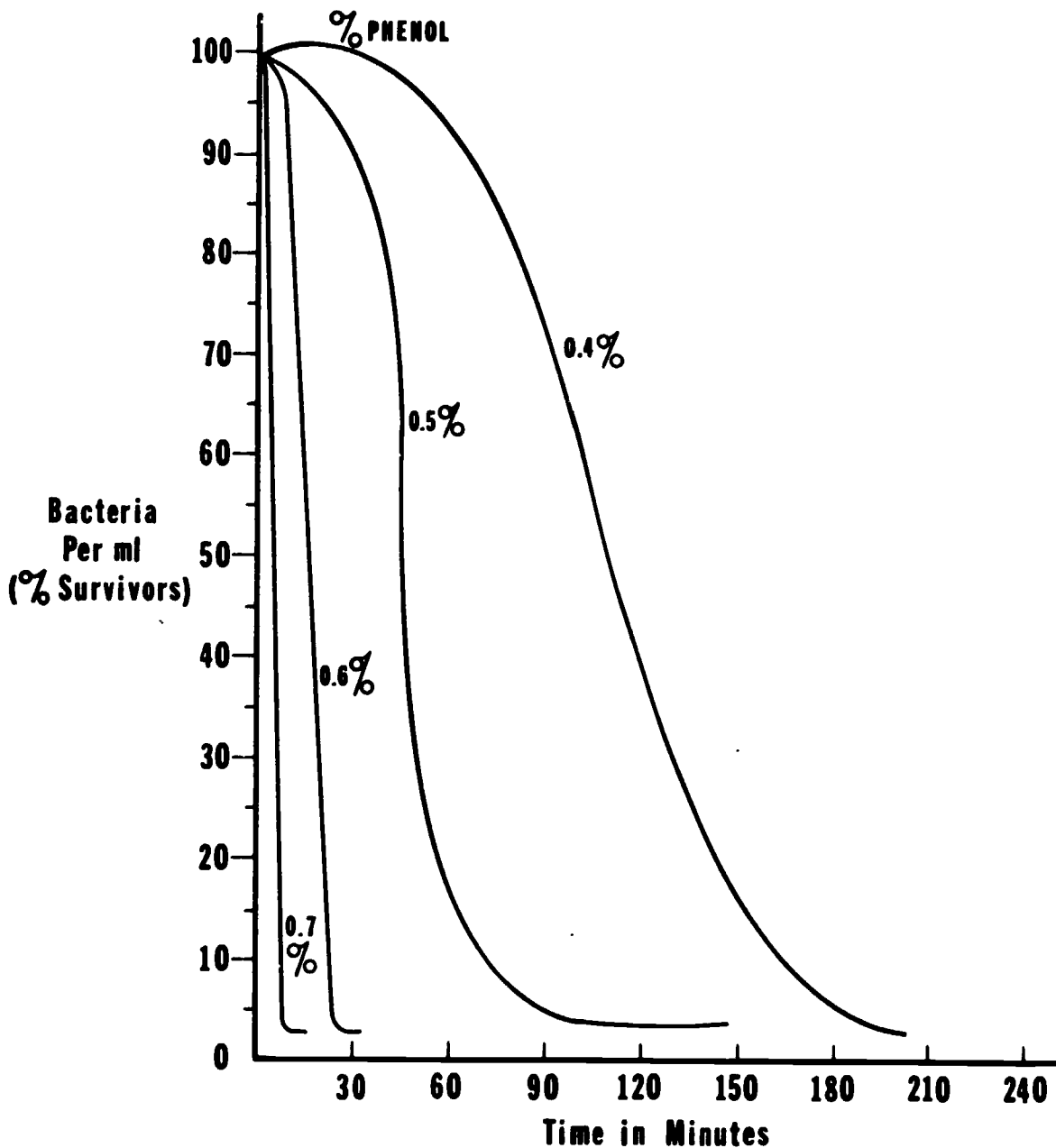

Figure 2-12. Chart—concentration vs effect.

is similar to that created in a chemical reaction: the temperature increases arithmetic progression, while the speed of the reaction proceeds in a geometrical progression. The temperature and reaction speeds are diagrammed in figure 2-13. Keep in mind, however, that high temperatures may destroy the disinfectant; therefore, heating disinfectants should be done carefully.

Disinfectants are most active at different pH. Heat as used for sterilization increases the acidity of the solution surrounding the cells. This change in

pH affects some of the metabolic processes of the bacterial cell. As a result, the bacteria may die.

**Exercises (027):**

1. How may extraneous quantities of blood serum, mucus, or feces protect the organisms before the disinfectant has a chance to affect the bacterial cell?

2. Since disinfectants do not act immediately, the speed with which they react depends mainly on what four factors?
3. How does a higher temperature increase the effectiveness of a disinfectant?
4. How can heating too much decrease the effectiveness of the disinfectant?
5. How does heat used for sterilization affect the solution around the cells in terms of a pH change?

028. List some characteristics of a good disinfectant; state the necessary conditions when culturing the organisms to test the effectiveness of a disinfectant; and cite the principle of the Food and Drug Administration method for determining phenol coefficient.

**Characteristics of a Good Disinfectant.** To be effective, a disinfectant must possess the following qualities:

- a. Solubility.
- b. Stability.
- c. Noncorrosiveness.
- d. Nonbleaching.
- e. Effective power of penetration.
- f. Ease of application.
- g. Cheap in cost.
- h. Nontoxic to animals.
- i. High coefficient of disinfection.
- j. Deodorization.

All of the above qualities, with the possible exception of high coefficient of disinfection, are easy to understand in that you use them every day. We discuss this quality in the following paragraphs.

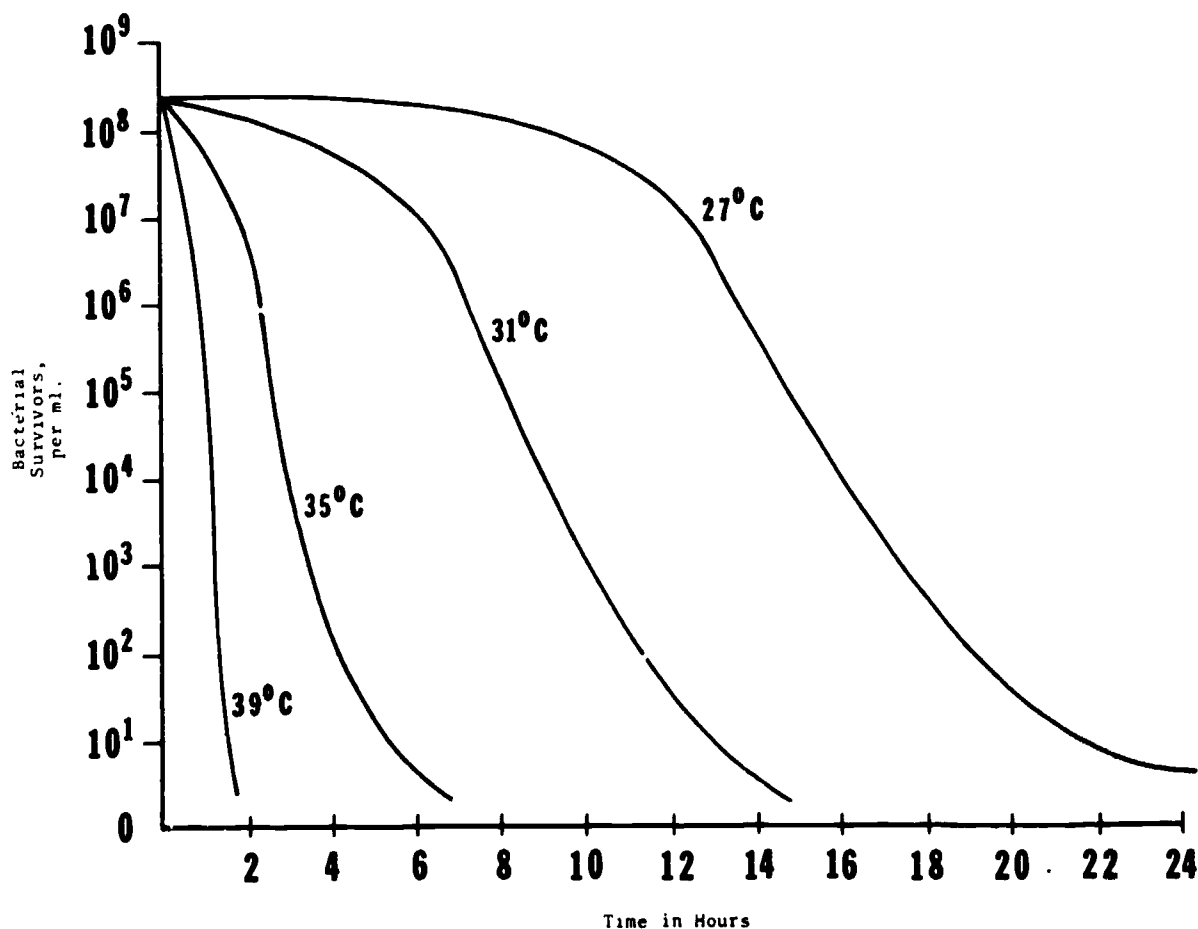

Figure 2-13. Temperature vs disinfectant effect.

To test the relative efficiency of disinfectants, some disinfectant had to be selected as a standard and all others tested in relation to this standard. The disinfectant chosen was phenol (carbolic acid).

Principles which govern the estimation of the disinfecting power must be strictly adhered to.

a. The media used in all cases of standardization must be alike in composition and pH.

b. The organism used must always be grown and treated under the same conditions.

c. Temperature should remain constant.

Although the standard methods employ constant factors as listed above, you must remember that even though a high proportion of organisms are killed before sterilization is complete, a few organisms may resist the disinfectant action for a long period of time.

**Phenol Coefficient Method.** A method that has been used for a long time and that appears to be suitable for most purposes is called the phenol coefficient method. This method tests the effectiveness of an unknown disinfectant only if conditions are carefully controlled.

There are in general use several methods of determining the phenol coefficient of a disinfectant. Three of these are:

a. The U.S. Hygienic Laboratory method.

b. The Rideal-Walker method.

c. The Food and Drug Administration method.

The Food and Drug Administration method is generally the method used in testing many of the disinfectants on the market. The method compares the ability of phenol against an unknown disinfectant, when diluted to kill the Hopkins strain of *Salmonella typhosa*. The figure representing the dilution of phenol that kills the organism in 10 minutes is divided into the dilution figure of the unknown disinfectant which killed the organism in 10 minutes. For an illustration: Phenol at a dilution of 1:100 killed the organism in 10 minutes. The unknown disinfectant killed the organism in the same time, but at a dilution of 1:250. Dividing 100 into 250 gives a phenol coefficient of 2.5.

The significance of the phenol coefficient has limitations. For example, a disinfectant may be found to have a phenol coefficient of 40 when tested in distilled water. The compound may be quite ineffective when applied in the presence of organic matter, pus, saliva, feces, or milk. Then again, when tested against some other organism such as *Staphylococcus aureus* it may have a much lower coefficient. Disinfectants are often diluted to offer a concentration roughly 20 times the phenol coefficient. This "use dilution," though considered unreliable, is the dilution in which disinfectants are used.

#### Exercises (028):

1. List five qualities a disinfectant must possess to be effective.
2. To offer standardization in measuring the effectiveness of disinfectants, which agent is used as the standard?
3. If we wanted to test the effectiveness of a disinfectant, what three conditions must we observe in culturing the organisms to be used in the test?
4. When can we consider a phenol coefficient valid?
5. How does the Food and Drug Administration method determine the phenol coefficient?
6. Using the FDA method for phenol coefficient, what would be the phenol coefficient of an unknown disinfectant with a dilution of 1:450, that killed the organism at the same time as the standard?
7. What limitations does the phenol coefficient have?

029. Indicate whether given statements correctly reflect guidelines for sterilization.

**Sterilization Guidelines.** To aid you in your use of disinfection and sterilization techniques, you can follow these guidelines:

a. The vegetative form of the microorganisms is easier to kill than the spore form.

b. Spores and acid-fast bacilli are best killed by heat. (Liquid disinfectants are fairly ineffective because of the lipid material surrounding the acid-fast bacilli.)

c. Bacteria suspended in a nonprotein-type medium are easier to destroy than those suspended in a protein-type medium. It is more difficult to destroy bacteria in protein-type media if the media are also nutrient in nature.

d. The addition of an acid or a base to protein media increases the effectiveness of the disinfectant. A given concentration of H<sup>+</sup> ions is more effective than the same concentration of OH<sup>-</sup> ions.

e. The sterilization process can be increased by raising the temperature of the disinfectant.

f. Dissolving certain germicidal chemicals in alcohol may either decrease or increase the effectiveness of the solution.

g. The presence of organic matter usually lowers the effectiveness of liquid disinfectants.

h. An emulsified disinfectant and/or a liquid disinfectant containing a wetting agent is best for sterilizing smooth surfaces.

i. Powder disinfectants must be placed in solution to be effective; otherwise, they act only as deodorants.

#### Exercises (029):

Indicate whether each of the given statements is true (T) or false (F), and correct those that are false.

T F 1. The vegetative form of the microorganism is easier to kill than the spore form.

T F 2. Spores and acid-fast bacilli are best killed by chemical sterilization.

T F 3. Bacteria suspended in a nonprotein-type medium are less susceptible to destruction than those suspended in a protein-type medium.

T F 4. The addition of an acid or a base to protein media increases the effectiveness of the disinfectant.

T F 5. The sterilization process can be increased by decreasing the temperature of the disinfectant.

T F 6. An emulsified disinfectant and/or a liquid disinfectant containing a wetting agent is best for sterilizing smooth surfaces.

T F 7. Powder disinfectants need not be placed in solution to be effective, and they act as good deodorants.

030. Define asepsis; cite techniques, organisms used, and sequence for sterility testing.

**Asepsis Testing.** Asepsis is briefly defined as the absence of septic matter, or freedom from infection. As a bacteriology technician, you will be testing the effectiveness of hospital aseptic techniques and practicing aseptic techniques in much of your routine daily work. This section will deal primarily with the laboratory's responsibility (consequently yours) toward preventing the spread of hospital-borne diseases.

There are many behind-the-scene activities in a hospital. One of these is the prevention of the spread of disease within the hospital. There are many different facets to this particular activity, and you will be required to lend support to this extremely important program. The Hospital Infection Committee with the approval of the commander makes recommendations for the prevention and control of infections. The following paragraphs will inform you about aseptic techniques and in-house infections.

**Sterility Testing.** This refers to those procedures which test the effectiveness of the various methods of sterilization, more specifically, the autoclave and room disinfection.

You can use the autoclave to sterilize medical equipment. To assure sterility of this equipment, it must be tested at regular intervals. You can do this testing in three ways.

- (1) Testing the equipment itself by culturing.
- (2) Using heat sensitive dye indicator strips.
- (3) Using spore strips.

First, you must test the equipment. In this method, you open the packs containing the equipment. Swab the various articles using a sterile, cotton-tipped applicator and then place the swab into a suitable culture medium and incubate it. Check the broth for growth. A disadvantage of this method is that one can only assume that if no growth occurs from a particular article that specific article was sterilized by the autoclave. However, it is possible that the article was sterilized when being cleansed. The other articles in the pack may not be sterile. This method is a fairly reliable substitute when heat-sensitive dyes or spore strips are not available. If the piece of equipment is small, you can place the entire article in a suitable culture medium to check for sterility.

If you are operating the autoclave, the use of a dye-indicator strip is a quick means to test the equipment for proper operation. The indicator is a

TABLE 2-3  
RESISTANCE DATA--SPORODEX SPORES\*

ORGANISMS	Moist Heat		Dry Heat		Ethylene Oxide	
	Survives	Killed	Survives	Killed	Survives	Killed
<u>Bacillus subtilis</u> <u>(globigii)</u>	215°F.-5 min.	220°F.-15 min.	250°F.-30 min.	300°F.-60 min.	15 min.	2 hours (600-620 mg/L ETO at 130°F. and 50% R.H.)
<u>Bacillus</u> <u>stearothermophilus</u> <u>250°F.</u>	250°F.-5 min.	250°F.-12 min.	250°F.-30 min.	250°F.-120 min.		
<u>Bacillus</u> <u>stearothermophilus</u> <u>270°F.</u>	270°F.-20 sec.	270°F.-2 min.				
<u>Bacillus subtilis (globigii)</u>	Specifically for dry heat and Ethylene Oxide; acceptable for 250°F steam. Incubation at 37°C.					
<u>Bacillus stearothermophilus</u>	(250°F.) Population stabilized for 250°F. steam. Recommended standard for hospital use with 250°F. steam. Requires incubation at 55°C.					
<u>Bacillus stearothermophilus</u>	(270°F.) Population adjusted for 270°F. steam. Specifically for vacuum high temperature cycles. Require incubation at 55°C.					

\*Courtesy of American Sterilizer Company.



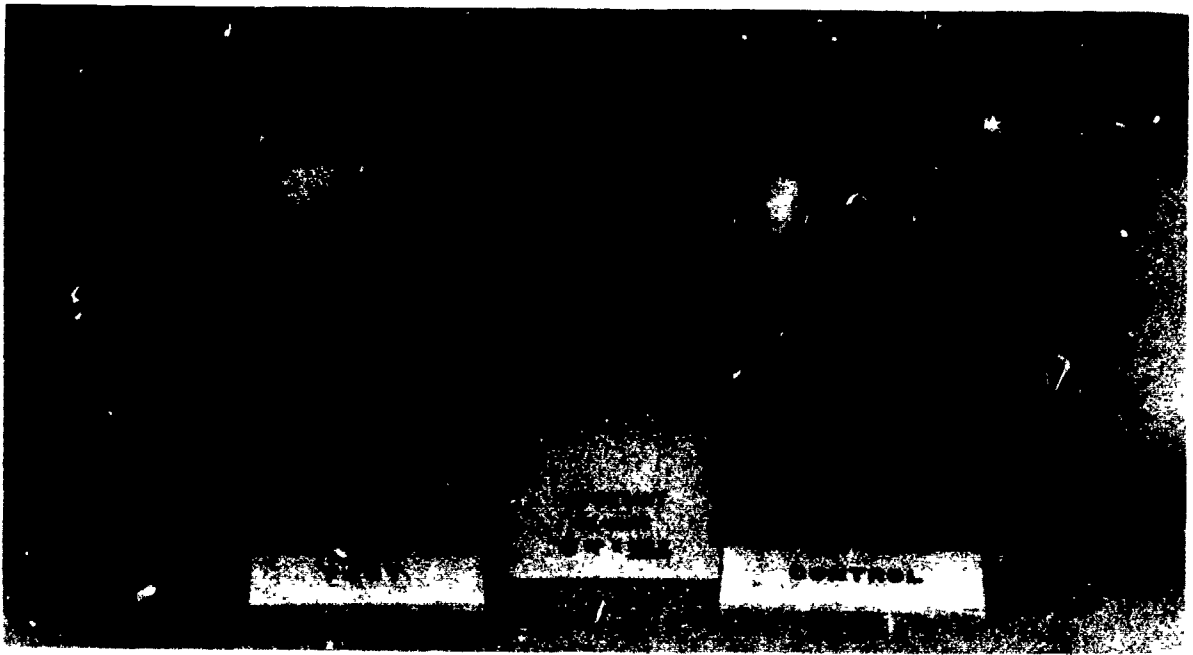

Figure 2-14. Biospore autoclave controls.

thermolabile dye on paper strips, or wrappers, or on tape; or it may be applied to thread or gauze. The dye turns a specific color if the contents have been sterilized at the correct temperature for a sufficient length of time. You need only to observe these color changes to assure sterility.

You can make a more direct, though more time-consuming, check on sterilization by the use of spore strips. A spore-impregnated strip of filter paper enclosed in a sterile envelope is placed in the center of the package to be sterilized. For autoclave testing, the spores of *Bacillus stearothermophilus* are most often used; and for dry heat and ethylene oxide the spores of *Bacillus subtilis (globigii)* are preferred. Table 2-3 shows the various time and heat combinations.

After sterilization, remove the strip from its envelope (using sterile forceps), place it in a suitable culturing medium, and incubate. If growth occurs within 7 days, sterilization has not been complete. The absence of growth indicates that sterilization has been complete. To assure yourself that sterility is the reason for the spores not germinating and growing, you must also use a control strip. This control strip is not autoclaved, and should grow organisms when cultured. You can see biospore controls in figure 2-14.

Sealed ampules containing culture media and spores of *Bacillus stearothermophilus* are also available on the market. After sterilization, the ampules are incubated at 55° C. As *B. stearothermophilus* is a strict thermophile, lack of sterility will be indicated by growth of the organism in the control ampule, as shown in figure 2-15. As

*B. stearothermophilus* is one of the most heat-resistant organisms known, its use offers a good indication of sterility.

#### Exercises (030):

1. What does asepsis mean?
2. How do we prevent hospital-borne infections?
3. Who coordinates activities within USAF hospitals for the prevention and control of hospital-borne infections?
4. What are three main techniques used for testing the sterility of the autoclave?
5. What is a disadvantage of testing equipment by swabbing various articles?
6. In using spore strips for sterility testing, where is the strip initially placed?

7. What spores are most often used for autoclave testing?
8. What spores are preferred for dry heat and the ethylene oxide test for sterilization?
9. What is done with the spore strip after sterilization?
10. What does the presence of growth within 7 days indicate?
11. If the control strip is not autoclaved, what should happen when the strip is cultured?

**031. State reasons for periodic culturing of selected patient areas and areas of the hospital where bacterial infections are most susceptible; point out some of the sites and areas for sampling and the frequency of cultures taken from those given areas.**

**Cultures of Hospital Environment.** Hospital-acquired (or nosocomial) infections and the areas of the hospital where bacterial infections are most susceptible are related to the extent that it is

theoretically beneficial to reduce the patients' exposure to bacteria present in the hospital environment. Thus, periodic culturing of selected patient areas of the hospital is of value for the following reasons:

- a. To provide technical experience in hospital surveillance programs before a hospital epidemic occurs.
- b. To educate and motivate personnel to strive to reduce nosocomial infections.
- c. To evaluate sterilization, disinfection, and housekeeping procedures.
- d. To monitor sterile equipment, medication, intravenous fluids, and instruments.
- e. To establish acceptable baselines and limits of bacterial contamination of critical areas such as operating rooms, recovery rooms, burn units, delivery rooms, intensive care sections, isolation units, and nurseries.
- f. To keep records of changes in the hospital flora and in bacterial sensitivities and to report such changes to the infection committee.
- g. To comply with the standards set by the Joint Commission on Accreditation of Hospitals.

**Areas and Sites for Sampling.** Cultures are taken by designated personnel. Cultures are taken from areas such as operating rooms, recovery rooms, burn units, intensive and coronary care sections, isolation units, and nurseries. It is suggested that cultures be taken from the following sites:

- a. Floors in strategic areas only.
- b. Air in strategic areas only.
- c. Sinks, air and water inlets, faucet aerators, steam humidifiers, inhalation therapy equipment,



**CONTROL**



**TEST**

Figure 2-15. Kilit ampules (autoclave controls).

anesthesia equipment, Isolettes, formulas, and catheters.

d. Mops and buckets used in housekeeping.

e. Respirators and suction devices.

f. Ice machines and freshly washed eating utensils.

g. Sterile solutions, equipment, instruments, spore strips of autoclaves and prepackaged sterile material, solutions, surgical sutures, and gloves.

**Frequency of Cultures.** It is suggested that the environmental cultures be taken (1) biweekly: spore strips, all sterilizers; (2) weekly: sterile fluids, instruments, medication, anesthesia masks; (3) bimonthly: equipment used in inhalation therapy, catheters, and aspirators; (4) monthly: Isolettes, soap spouts, formulas, faucets in operating rooms, nebulizers, and vaporizers; (5) on request only: isolation rooms, floors, beds, tables, walls, and curtains.

**Exercises (031):**

1. What are nosocomial infections?
2. List four reasons for infection surveillance and control by periodic culture sampling.
3. From what areas are these cultures taken?
4. How frequently are cultures obtained for check of sterile fluids, instruments, medication, and anesthesia masks?
5. Once a month, culture sampling for infection surveillance and control is done of what items?

**032. Indicate whether given statements correctly reflects procedure in testing for carriers of staphylococcal infections.**

**Testing for Staphylococci Infection.** Staphylococci can be carried from the hospital to the patient's family and friends who, in turn, can become infected. Besides the routine precautions observed in isolating patients with known staphylococcus infections and the complete sterilization of the rooms and equipment with

which they come in contact, hospitals are vitally concerned with controlling the transmission of this organism by identifying and treating carriers on its own staff. One of your duties as a laboratory technician will be to culture staff members and determine who might be carrying the staphylococcal organism.

To culture this organism, you generally use three sites. They are the nose, throat, and lesions. We have already discussed the isolation of organisms from these sources; however, it is pertinent to add here that in order to isolate the staphylococcus organism from the nose, it is not necessary to insert the cotton-tipped or calcium alginate wool-tipped swab to the posterior part of the nose. A more realistic approach is to obtain the specimen from the area of the nostril which is exposed to the air. That is, culture the first one-fourth or one-half of the nose. This area has the hairs which filter the air going in and out; therefore, chances of isolating organisms are greater if you culture this area.

**Testing Food and Water.** Although primarily a duty of the veterinary personnel, an occasion may arise where you may have to examine water, dairy products, and foods for contamination. Since these products are consumed by everyone, they must be free of infectious agents. If you should need to examine these products, the procedures are outlined in AFM 160-52, *Laboratory Procedures in Clinical Bacteriology*.

**Exercises (032):**

Indicate whether each of the following statement is true (T) or false (F), and correct those that are false.

- T F 1. A patient's family and friends can become infected with staphylococci carried from the hospital.
- T F 2. Hospitals are vitally concerned with controlling the transmission of staphylococci by identifying and treating carriers on its own staff.
- T F 3. Three sites generally used for staph cultures are the nose, throat, and ear.
- T F 4. To isolate the staphylococcus organism from the nose, it is necessary to insert the cotton-tipped or calcium alginate wool-tipped swab to the posterior part of the nose.

T F 5. Since dairy products and prepared food are consumed by everyone, they are free of infectious agents.

**033. State practices of aseptic techniques.**

**Practicing Aseptic Techniques.** Besides evaluating the aseptic techniques of others, you should be aware of the techniques that you perform routinely. While performing venipunctures, do you use the correct strength alcohol to disinfect the site of puncture? Are your needles sterile? In bacteriology, do you wipe your benches with a good disinfectant when you finish for the day? Do you wash your hands before leaving the laboratory? Do you exercise the proper care when handling specimens and culture material? Do you perform sterility checks with diligence? These are your individual responsibilities.

As a laboratory technician, you will come in contact with many patients. Some will have contagious disease and may be in isolation. That is, they are in an area by themselves and so situated that microorganisms stand very little chance of getting out of the area if proper precautions are taken. In another situation, disinfection material will be available to prevent the transfer of organisms from one environment to another.

In those instances where isolation techniques must be practiced, they must be practiced by everyone to be effective. Although time-consuming, it is necessary to wash your hands in a disinfectant solution, and wear a mask, a cap, and a gown, when required. It is also important that you properly dispose of these items. If you must go into a room where there is a contagious disease, take only those materials which you can leave behind. Anything that you remove, such as a tube of blood, must have its external surface decontaminated. Do not take your tray inside. You can very easily contaminate it, and by carrying it through the hospital, contaminate every place you set the tray

down. You cannot see microorganisms, so exercise care in everything you do. A good technician does.

**Exercises (033):**

Complete the following statements:

1. You should be aware of the techniques that you perform \_\_\_\_\_ .
2. You should wipe your benches with a good \_\_\_\_\_ when you finish for the day.
3. Exercise the proper \_\_\_\_\_ when \_\_\_\_\_ specimens and culture materials. \
4. Perform sterility checks with \_\_\_\_\_ .
5. In those instances where isolation techniques must be \_\_\_\_\_ , they must be \_\_\_\_\_ by \_\_\_\_\_ to be effective.
6. Although \_\_\_\_\_ , it is necessary to \_\_\_\_\_ your hands in a disinfectant solution, and \_\_\_\_\_ a mask, a cap, and a gown, when required.
7. Anything you remove from a room where there is contagious disease, such as a tube of blood, must have its \_\_\_\_\_ surface \_\_\_\_\_ .
8. Exercise \_\_\_\_\_ in everything you do.

## Bacterial Morphology and Physiology

TO THIS POINT, you have studied the basic art and science of bacteriology. You should have definite awareness of how to handle and process specimens. Certainly, you should know how to do your work safely, sterilize media and equipment, and use precise aseptic techniques. Without the constant application of this knowledge, your work in the study of microbes is useless, because diagnostic tests in bacteriology usually depend upon isolating the agent of an infectious disease from other organisms present in most clinical specimens and in the laboratory environment. In this chapter we will discuss the classification of bacteria, cellular morphology, culturing of bacteria, and the various media that we can use to cultivate bacteria.

One of the new areas in your studies is the classification of bacteria. Biologists have for some time been accustomed to assigning every form of life to one or two kingdoms: animal kingdom, containing the motile, nonphotosynthetic forms; and the plant kingdom, consisting of the nonmotile photosynthetic members. Because the taxonomic position of microorganisms is not clear-cut, the establishment of a third kingdom call *Protista* by Haeckel in 1866 seemed logical. From this point, we will discuss the further breakout in the naming and grouping system until we have finally classified a typical organism.

Bacteria are no different from other living organisms with respect to their ability to carry out specific functions in order to maintain their life processes. From close observation, you will be able to identify bacteria by knowing their structures, size, shape relationships, and variations from normal appearance and behavior.

### 3-1. Classification of Bacteria

A bacterium should have a name which describes it and conveys a definite idea about the organism. You will work with many different bacteria and use their names in written and oral communication. The names are fairly standard (there are a few exceptions) throughout the scientific field and will convey certain information to your co-workers. In order for you to develop a basic knowledge about

the classification and nomenclature of bacteria, we will discuss:

- Taxonomy.
- International method of classification.
- Techniques of classification—morphology and physiology.
- Means of distinguishing species.

**034. Define "taxonomy" with reference to microorganisms; state why attempts for a clear, concise definition of bacteria encounter difficulties; and indicate whether given statements correctly reflect the characteristics of *Protists*.**

**Taxonomy.** An arrangement of organisms is called a "taxis," so the term "taxonomy" refers to the arrangement and classification of bacteria. Classification systems are somewhat arbitrary and do not directly reflect evolutionary relationships between different groups of bacteria. This fact has made complete understanding and agreement in the naming of bacteria difficult. After all, bacteria lack many attributes enjoyed by other plants and animals.

Although there are reports that indicate discovery of bacterial fossils some 3.5 billion years old, the bacteriologists can only theorize as to the evolutionary and the phylogenetic history of these organisms.

Methods of establishing relationships between species on a genetic basis have been found only recently. We now know that certain groups of bacteria, as in the higher plants and animals, have a precise sexual mechanism which involves an exchange of cellular material. Moreover, there are a number of other means by which genetic traits from one bacterial strain can be introduced into closely related organisms. Thus, as progress is made in exploring hereditary mechanisms and relationships, new concepts are being proposed which go far beyond the older ideas of grouping bacteria together on the basis of morphological or cultural similarities. However, the taxonomic position of microorganisms is not clear-cut. Some organisms possess certain characteristics commonly associated

with animals, and still others possess characteristics of both animals and plants. For these and other reasons, the taxonomic position of microorganisms has been the subject of considerable debate and disagreement.

**Protists.** The *Protista*, which are distinguished from animals and plants by their relatively simple organization, became recognized as the third kingdom. Further division of the *Protista* is based on the complexity of cellular structure. The Protists include two types of cells: the procaryotes (pro- indicating a primitive nucleus) and the eucaryotes (from the Greek *eu*-true, and *caryote*-nucleus), which are differentiated on the basis of nuclear structure and cellular organization. The bacteria and blue-green bacteria (algae) are procaryotic cells which divide amitotically by binary fission and are generally characterized as having naked, nonmembrane-bound nuclear deoxyribonucleic acid (DNA), without associated basic protein and a semirigid cell wall of unique composition. In contrast, eucaryotic cells have a true, membrane bound nucleus, containing multiple apparatus, a well-defined endoplasmic reticulum and mitochondria. Eucaryotic protists include fungi; the red, green, and brown algae; and protozoa.

Consideration of the variety and breadth of the many differences between the two groups allows the suggestion that a multiplicity of life forms evolved simultaneously in several directions from a variety of primitive forms ancestral to the presently known procaryotes. As a result, the procaryotes and their hypothetical ancestral forms are now grouped together in the kingdom Procaryotae.

#### Exercises (034):

1. What is a taxis?
2. With reference to bacteria, what is taxonomy?
3. Why is complete understanding and agreement in the naming of bacteria difficult?
4. Even though there has been discovery of bacterial fossils some 3.5 billion years old, how specific can bacteriologists classify these microorganisms?
5. Upon what classification schemes do we commonly rely and use in bacteriology?

In questions 6 through 11, indicate whether each of the following statements in true (T) or false (F), and correct those that are false.

- T F 6. Protists include two types of cells, the red and brown algae.
- T F 7. The two divisions of protists are differentiated on the basis of nuclear structure and cellular organization.
- T F 8. Procaryotic cells have a true membrane-bound nucleus containing multiple apparatus.
- T F 9. The bacteria and blue-green bacteria (algae) are eucaryotic cells.
- T F 10. Procaryotic protists include fungi, the red, green and brown algae, and protozoa.
- T F 11. The procaryotes and their variety of primitive ancestral forms are now grouped together in the kingdom Procaryotae.

035. Cite the system of classification and nomenclature of bacteria used; state the two divisions of the kingdom Procaryotae and the properties upon which Bergey's classification is based; define suffixes used to denote groups of organisms at various levels of the classification system.

**Bacterial Classification.** Based upon the Linnean scheme of classification used for higher plants and animals, bacteria may be classified as to kingdom, class, order, family, tribe, and a specific name comprised of a binomial for *genus* and *species* designations. The concepts useful in describing relatedness in higher eucaryotic life form have not been adequate for procaryotic cells; thus, attempts to set up traditionally ordered schemes of relationships among diverse bacterial groups have failed for lack of information. For this reason, the current trend is to use a pragmatic approach in describing larger groups of bacteria without implying degrees of relatedness between them. This approach is used in the Eighth Edition of *Bergey's*



*Manual of Determinative Bacteriology*, published in 1974. The classification and nomenclature system is widely followed in the United States. Commonly called *Bergey's Manual*, the work represents the collaborative effort of over 100 of the best-qualified bacteriologists at the time it was brought together. For example, the kingdom Procaryotae is recognized as containing two major divisions, the Cyanobacteria, or blue-green bacteria (algae), and the Bacteria. The latter division includes some 19 parts or bacterial groups which are given vernacular descriptions. The classification of the organisms is based on numerous properties, morphological, cultural, nutritive, biochemical, physiological, serologic, bacteriophage susceptibility, and pathogenic and genic properties of the organisms. It is based on the *International Code of Nomenclature of the Bacteria and Viruses* established by the International Committee on Bacteriological Nomenclature in 1947. Our discussion of some of these properties a little later on will show that they fall roughly into three categories: morphology; the physiology of life processes; and a miscellaneous group of characteristics which often serve to differentiate between two organisms that are otherwise indistinguishable.

There are certain endings affixed to some of the taxonomic names. Becoming familiar with these suffixes will help you identify a particular group. The following endings denote groups of organisms at various levels of the classification system:

Name	Ending	Example
Order	ales	<i>Pseudomonadales</i>
Suborder	ineae	<i>Rhodobacteriineae</i>
Family	aceae	<i>Thiorhodaceae</i>
Tribes	cae	<i>Escherichiae</i>

#### Exercises (035):

1. What system of classification and nomenclature is used for classifying bacteria?
2. Into what two divisions is the kingdom Procaryotae divided?
3. Which of the two divisions includes some 19 parts or bacterial groups which are given vernacular descriptions?
4. List some of the properties upon which the classification system is based.

5. The suffix *ales* refers to what level of classification?
6. The ending *eae* refers to what level of classification?
7. The suffix *aceae* refers to what level of classification?

036. State the order of classification used by the Linnean system for higher plants and animals, and cite the reason for the inadequacy of the system; state the new order of classification recommended by the Eighth Edition of *Bergey's Manual*.

**Classification Ladder.** According to the Linnean system of classification, the higher plants and

KINGDOM PROCARYOTAE	
DIVISION II	THE BACTERIA
PART 8	GRAM-NEGATIVE FACULTATIVELY ANAEROBIC RODS
ORDER	-
FAMILY I	ENTEROBACTERICAE
GENUS IV	<i>Salmonella</i>
SPECIES	<i>enteritidis</i>
VARIETY OR SEROGROUP	<i>paratyphi A</i>

DIVISION II	THE BACTERIA
PART 1	PROTOTROPHIC BACTERIA
PART 2	GLIDING BACTERIA
PART 3	SHEATHED BACTERIA
PART 4	BUDDING AND/OR APPENDAGED BACTERIA
PART 5	SPIROCHETES
PART 6	SPIRAL AND CURVED BACTERIA
PART 7	GRAM-NEGATIVE AEROBIC RODS AND COCCI
PART 8	GRAM-NEGATIVE FACULTATIVELY ANAEROBIC RODS
PART 9	GRAM-NEGATIVE ANAEROBIC BACTERIA
PART 10	GRAM-NEGATIVE COCCI AND COCOCILLI
PART 11	GRAM-NEGATIVE ANAEROBIC COCCI

Figure 3-1. Classification scheme—*Bergey's Manual*.

animals may be classified as to kingdom, phylum, class, order, family, tribe, and a specific name made up of a binomial for *genus* and *species* designations. Concepts used to describe higher order or complex organisms were used to describe bacterial groups. The traditional ordered schemes of relationships among bacterial groups have failed because of lack of information concerning accurate evolutionary record of bacterial life forms. A practical and meaningful approach is used in the Eighth Edition of *Bergey's Manual*.

Figure 3-1 briefly describes the simple classification systems used in the *Bergey's Manual*. Figure 3-2 shows the structure of the ladder of classifications for the old scheme and new schemes. Compare them and note the information provided in the new scheme which will assist you better in identifying and classifying bacterial organisms.

**Exercises (036):**

1. State, in descending sequence, the taxonomic categories of the Linnean system used for classification of higher plants and animals.
2. Why have the traditional ordered schemes of relationships among bacterial groups been considered inadequate?

3. State in descending sequence the order of classification described in the Eighth Edition of *Bergey's Manual*.
4. Under what division and part, respectively, is the family *Enterobacteriaceae* found?
5. Under Division II, The Bacteria, Part 11 is listed to contain information on what group?

037. Cite the morphological characteristics and physiological properties used for classification of bacteria.

**Characteristics Used for Classification.** We cannot use any one set of characteristics to differentiate all pathogenic bacteria. Classification, based on many characteristics which we noted before, falls into three general categories: morphological characteristics, physiological properties, and other miscellaneous factors which aid in identification.

*Morphological characteristics.* These include size, shape and arrangement of cells, and internal cellular structures. You can see the three principal

<u>OLD</u> (1957)	<u>NEW</u> (1974)
<u>PLANT KINGDOM</u>	<u>KINGDOM PROCARYOTAE</u>
Division I Protophyta	Division II The Bacteria
Class II Schizomycetes	Part 8 Gram Negative Facultatively
Order IV Eubacteriales	Aerobic Rods
Family IV Enterobacteriaceae	Family I Enterobacteriaceae
Tribe I <u>Escherichiae</u>	Genus I <u>Escherichia</u>
Genus <u>Escherichia</u>	Species <u>coli</u>
Species <u>coli</u>	

Figure 3-2. Classification ladder—old and new.

shapes of bacteria and their average sizes in table 3-1. Bacteria vary considerably in size, as the factor of ten times between the average diameter of a coccus and the length of a spiral form shows.

*Physiological properties.* Classification according to physiological properties is based on growth requirements, primarily the need for an inorganic or an organic source of carbon.

*Autotrophic bacteria* obtain energy and grow on inorganic media employing carbon dioxide (CO<sub>2</sub>) as their sole source of carbon. They begin with CO<sub>2</sub> and ammonia (NH<sub>3</sub>) and build an entire protoplasmic structure of protein, fat, and carbohydrates by oxidizing ammonia to obtain energy for their other life processes.

*Heterotrophic bacteria* obtain energy from organic carbon sources. Heterotrophs require the addition of sugars, amino acids, purines, pyrimidines, and vitamins to their culture medium. They ferment sugars as their primary source of energy.

Disease-producing bacteria are usually heterotrophs. They have adapted to an environment in which many kinds of organic materials are normally available. In many cases such organisms have lost their ability to synthesize certain complex organic substances needed for growth from simple compounds.

Parasitic bacteria (pathogens) require organic matter from a living host for nutrients. Saprophytic bacteria are heterotrophs which use decaying organic matter for nutrients and usually do not cause disease.

By preparing artificial media containing various nutrients needed for growth and reproduction, bacteriologists are able to study the growth characteristics of bacteria. Growth requirements associated with a parasitic or saprophytic existence in man include optimum temperature, the right concentration of oxygen, proper pH, and suitable nutrients.

#### Exercises (037):

1. What features do we generally include under the term "morphological characteristics"?
2. What are the three principal shapes of bacteria?
3. What type of bacteria obtain their energy from inorganic material and their carbon from carbon dioxide?
4. Those organisms that require or obtain energy from organic sources are called \_\_\_\_\_ bacteria.
5. Disease-producing bacteria are usually \_\_\_\_\_.
6. Bacteria that use decaying organic matter for nutrients and do not usually cause disease are called \_\_\_\_\_.

#### 3-2. Cellular Morphology

Bacteria possess complex cell structures which can be divided into two types: general cell structures possessed by all bacteria and special cell structures possessed in various combinations by some, but not all bacteria. These should be considered in the following discussion of cell size, shape, grouping, and variation.

Although the study of size, shape, and structural parts is an important aid to identification,

TABLE 3-1  
MORPHOLOGICAL CHARACTERISTICS

<u>Shape</u>	<u>Terminology</u> <u>(singular &amp; plural)</u>	<u>Average Size</u> <u>(microns)</u>
spherical	coccus, cocci	1.0
rod-shaped	bacillus, bacilli	0.5 X 2.0
spiral-shaped	spirillum, spirilla	0.2 X 10

(Coccobacillary forms are intermediate between spheres and rods)

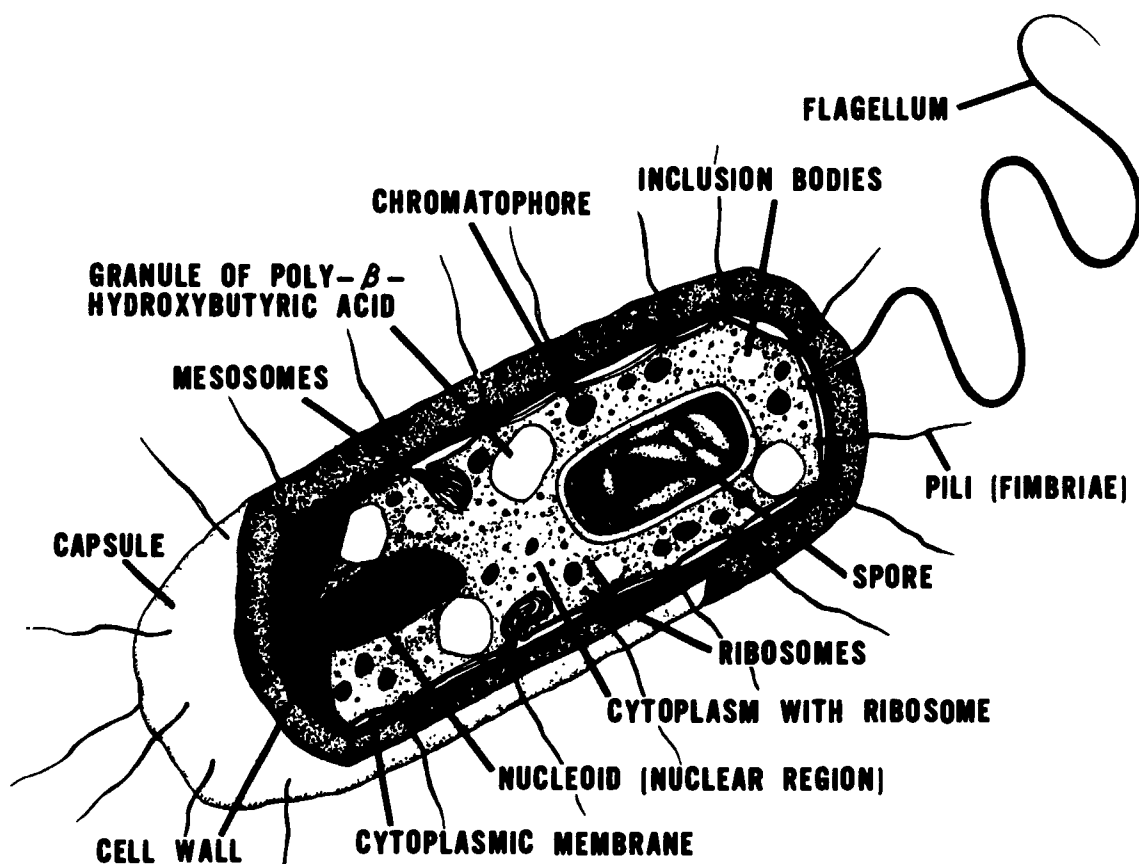

## GENERAL

### CELL WALL

A thin complex covering of proteins, lipids, and polysaccharides that encloses the protoplasm of the cell, giving rigidity to bacteria.

### CYTOPLASMIC MEMBRANE

A semipermeable membrane governing osmotic activity; located directly beneath the cell wall.

### CYTOPLASM WITH RIBOSOME

The protoplasmic or vital colloidal material of a cell exclusive of that of the nucleus.

### NUCLEOID (NUCLEAR REGION)

Mostly DNA. Diffused chromatin material responsible for genetic control of growth and reproduction of the cell.

## SPECIAL

### CAPSULE

An accumulation of high molecular weight, excretory substances (slime layer) around a single bacterium or clump of bacteria. A capsule serves as a defense against phagocytosis. Usually, the presence of a capsule is a sign of virulence.

### FLAGELLUM

A protoplasmic strand of elastic protein originating in the cytoplasm and extending from the body of the cell. A flagellum serves as an organ of locomotion. The arrangement of flagella is characteristic of the species.

## CELL STRUCTURES

### SPORE

A metabolically inactive resistant body formed by a vegetative bacterium to withstand an unfavorable environment. Only bacilli form spores. The position and size of the spore within a bacillus is peculiar to the species.

### INCLUSION BODIES

Vacuoles of reserve or waste materials contained within the cytoplasm.

### PILI (FIMBRIAE)

Provides conjugation, possible attachment to certain surfaces.

### MESOSOMES

In some, may involve separation of nuclear material during cell division; other roles less clear.

### CHROMATOPHORE

Site of photosynthesis.

### RIBOSOMES

Synthesis of proteins and mostly composed of RNA and protein.

### GRANULE OF POLY- $\beta$ -HYDROXYBUTYRIC ACID

Granules of inert stored food substances.

NOTE: No single species is expected to exhibit all of these structures.

Figure 3-3. Composite drawing showing various bacterial structures, some of which are present only in certain groups of bacteria.

**COCCUS (Spherical)**



**COCCI**



**DIPLOCOCCI**  
(in pairs)



**STREPTOCOCCI**  
(in chains)



**STAPHYLOCOCCI**  
(in clusters)



**COCCI IN TETRADS**



**COCCI IN CUBES**

**SPIRILLA and SPIROCHETES**  
(Spirals)

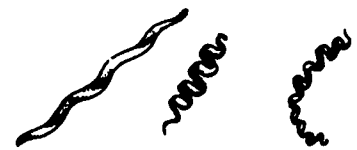

**BACILLUS (Rod Shaped)**



**BACILLI**



**DIPLOBACILLI**  
(in pairs)

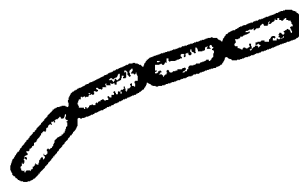

**STREPTOBACILLI**  
(in chains)



**PALISADES**



**BACILLUS ENCAPSULATED**

**SPORES**



**TERMINAL**



**SUBTERMINAL**



**CENTRAL**

**FLAGELLA**



**MONOTRICHOUS**



**LOPHOTRICHOUS**



**AMPHITRICHOUS**

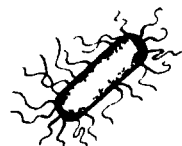

**PERITRICHOUS**

Figure 3-4. Cell structures.

similarities in cell structure generally make it impossible to classify bacteria on the basis of morphology alone.

**038. State the unit of measure for bacteria; identify bacterial structures and their functions, terms used to describe bacterial spores and flagella, and terms used to identify bacilli by cell grouping.**

**Cell Size.** Note that the general cell and special cell structures are shown and defined graphically in figure 3-3. In our work we use a unit of measure to compare the size of cells. In the comparisons of bacteria to other cells, we use the micron ( $\mu$ ). A micron is 1/1000 of a millimeter (mm), or 1/25400 of an inch. Occasionally, the angstrom unit (A), equivalent to  $10^{-7}$  mm, or 1/10000000 of an mm, is used for very small organisms. Although there are exceptions, most bacteria range from 0.2 (width) to 5 microns (length) in dimension. A size relationship can be made using human erythrocytes (red blood cells) which average about 7.5 microns in diameter. As you become familiar with your microscope, the size of an erythrocyte in the oil immersion field will give you an idea of the dimension of any given organism, and indeed, many measurement references are made in relation to the erythrocyte.

**Shape of Cells.** As you can see in table 3-1, there are essentially three different shapes of bacteria. They are spherical, rod-shaped, and spiral-shaped. Figure 3-4 illustrates the variations in arrangement which these three basic shapes may take. Notice, too, the terminology and position of the bacterial spores and flagella. These descriptive terms are used frequently, and from them you should be able to picture a particular bacterial cell.

**Grouping of Cells.** Cell grouping, as well as the shape, can aid in identifying bacteria. The grouping results from the manner in which cell multiplication takes place. Bacteria reproduce by binary fission; by this we mean the bacteria split (divide) at right angles to their long axis. One organism becomes two, two become four, four become eight, and so forth. In the case of binary fission in the rod-shaped bacteria, a cell first increases in length. Then a constriction develops across the narrow width of the cell about midway between the two ends. This is the location at which cleavage (fission) takes place to give us two cells in the place of one. Cell division in the rod forms often gives rise to chains of organisms which break up into single cell masses. However, if individual cells do not separate cleanly, and there is post-fission whipping of bacilli, the side-by-side palisade arrangement shown in figure 3-4 can result.

Among the spherical forms (cocci), cell division can occur in more than one plane, and the distinctive grouping of cells which follows reproduction is characteristic of certain genera. To

picture this clearly, imagine that we place an orange on a table and slice through the center of the fruit with a knife. The slice can be made from top to bottom (one plane), or laterally from side to side (a second plane), or even on the diagonal (a third plane). Also, suppose that each half grows into a whole orange, to be sliced again. A series of orange slices each time from top to bottom (only one plane) will yield a chain extending along the surface of the table. This grouping is typical of the streptococci. Similarly, if an orange is sliced first from top to bottom, and the resulting two oranges are sliced in a different plane, the result will be a packet or cluster of fruit rather than a chain.

In this manner, the grapelike clusters typical of the staphylococci are built up by cell division, first in one plane and then another as reproduction proceeds. In table 3-2 note that spherical organisms are found in pairs, tetrads (groups of four cells), cubes, and clusters, depending upon the number of planes in which cell division takes place. Incidentally, you can best observe these characteristics groupings in a broth culture rather than in colonies on solid media.

**Exercises (038):**

Complete the following statements:

1. The unit for measuring bacteria is the \_\_\_\_\_.
2. The structure of a bacterial cell which contains diffused material responsible for the reproduction of the cell is the \_\_\_\_\_.
3. The structures within the bacterial cells responsible for protein synthesis are called \_\_\_\_\_.
4. The \_\_\_\_\_ serves as a defense phagocytosis, is a sign of virulence, and is an accumulation of high molecular weight, excretory substances (slime layer) around a single bacterium or clump of bacteria.
5. The \_\_\_\_\_ is a metabolically inactive resistant body formed by a vegetative bacterium to withstand an unfavorable environment.



6. The term used to represent the forms that are intermediate between spheres and rods is \_\_\_\_\_ .
7. A bacillus with flagella completely surrounding the cell is termed \_\_\_\_\_ .
8. A bacillus with the spore located between one end and the center is said to contain a \_\_\_\_\_ spore.
9. The post-fission whipping of bacilli results in the arrangement referred to as \_\_\_\_\_ formation.
- As a result of binary fission, bacilli are seen in various groupings. The following statements describe the appearance of the bacilli microscopically.
10. Bacillus occurs \_\_\_\_\_ .
11. Diplobacillus occurs in \_\_\_\_\_ attached end to end.
12. Streptobacillus occurs in \_\_\_\_\_ attached end to end.
13. Palisades occur as rows of bacilli \_\_\_\_\_ by \_\_\_\_\_ .

TABLE 3-2  
ARRANGEMENT OF BACTERIAL CELLS

Arrangement	Terminology	Type of Division
<b>SPHERICAL FORM</b>		
Single	coccus	--
Pair	diplococcus	in one plane
Chain	streptococcus	in one plane
Cluster	staphylococcus	in many planes
Four	tetrad	two or more planes
Eight	cube	two or more planes
<b>ROD FORM</b>		
Single	bacillus	
Pair	diplobacillus	in one plane
Chain	streptobacillus	in one plane
Palisade	palisade	in one plane (post-fission whipping)
<b>SPIRILLUM, always occur singly</b>		
<b>COCCOBACILLUS, same as for spherical forms</b>		

039. Define variation; specify the two types of variation; and cite examples and forms associated with a given type.

**Variation.** If we cultivate bacteria under carefully controlled laboratory conditions, we can reasonably expect these organisms to reproduce their typical morphological features from one generation to the next. Likewise, we expect that manifestations of life processes will remain fairly constant from culture to culture of the same organism. Now and then we encounter altered growth patterns in laboratory cultures, or morphological changes that make identification of bacteria difficult. These departures from normal or "typical" growth of a species are called *variation*. Variation is found in form and structure of the cell or colony, metabolic processes, immunological character, and ability to produce disease.

Variation in bacteria introduces an element of uncertainty which, coupled with the complexity of working with living biological systems, makes the positive identification of microbes one of the most challenging and time-consuming procedures in the clinical laboratory. Fortunately, we ordinarily find sufficient properties that are characteristic of a given genus or species (cellular and colonial morphology, nutritional requirements, immunological components of the cell) to form a composite picture that enables us to establish identity.

Variation generally arises from either of two causes: a change within the genetic structure of cells in a culture (a mutation); or a noninherited modification in appearance or behavior (an adaptation) brought on by environmental influences as a laboratory culture of organisms grows and reproduces. This second form of change sometimes occurs despite our best efforts to supply a pathogenic bacterium with the same growth conditions it enjoyed in the human host from which it was isolated.

**Mutations.** Mutations of many kinds occur spontaneously in the genes of the bacterial nucleus. A *gene* is a self-duplicating, biological unit which carries an inherited trait from generation to generation during reproduction. Many mutations are lethal to the organisms in which they occur, but others are not. If environmental conditions favor the growth of a mutant cell, the culture will soon contain a mixture of both typical bacteria and mutants. Resistance to antibiotics is a prime example of a spontaneous mutation among pathogenic bacteria. You can demonstrate this mutation very easily by plating a heavy suspension of organisms to a culture medium containing an antibiotic. A few isolated colonies of the drug-resistant mutant will usually appear, since the inhibitory medium permits survival of only the resistant forms present in the inoculum. The

physician must contend with this phenomenon of drug resistance in treating a patient for a bacterial infection. The infectious microorganisms, if not already resistant to one more antibiotics, may develop resistance by mutation during the course of antibiotic therapy.

**Adaptations.** The second form of variation we spoke of, that is a noninherited modification, or adaptation, of the cell, is perhaps best exemplified by changes in size, shape, or structure of bacteria during cultivation in the laboratory. A stained slide prepared from a patient's specimen at the time the specimen is collected for culture will quite often reveal microbes greatly different in morphology from those which grow out on laboratory media. For instance, a coccuslike form found in body tissues may emerge as a short rod in the colonies growing on a blood agar plate. Capsules, or a slime layer, are often formed around an organism in the body, only to be lost during cultivation on artificial media. This loss is usually accompanied by a change in colony texture from smooth (S) to rough (R). To cite another example, the bacillus causing the disease anthrax in animals and man tends to remain in the vegetative (nonspore) state during reproduction in the host. Spore formation characteristically takes place only outside of host tissues, or in laboratory media.

There are two other terms which you should become familiar with because they are often used in discussions of microbial morphology and variation—*involution forms* and *pleomorphism*. *Involution forms* are abnormal, bizarre shapes assumed by bacteria in aging cultures, or under highly unfavorable environmental conditions. These forms may bear no clear resemblance to the usual morphological features of the genus to which they belong. For instance, after exposure to antibiotics a short rod may produce, in culture, extremely long filamentous forms because the action of the antibiotic has interfered with the process of cell division.

Some genera of bacteria are more prone than others to grow in a variety of shapes that can make identification difficult—even in a favorable cultural environment. Species of the genus *Actinomyces*, pathogens of man and animals, are good examples. They have morphological properties akin to those of the molds and higher fungi. *Actinomyces* are said to be *pleomorphic* in that they occur naturally in several forms: as short cocc' forms, bacillary fragments, club-shaped rods, and branched structures which, to the inexperienced bacteriologist, seem to represent a mixed culture.

**Exercises (039):**

1. What is meant by variation?

2. In what characteristics is variation found?
3. Explain the two types of variation.
4. Mutation from penicillin-sensitive to penicillin-resistant is an example of what type of mutation?
5. Cultures can contain a mixture of typical and mutant bacteria. If you grew a culture on a medium which contained an antibiotic to which the typical bacteria were susceptible, what would you be apt to see after incubation?
6. Change from "S" colonies to "R" colonies is an example of which type of variation?
7. Capsules, or a slime layer, often formed around an organism in the body, only to be lost during cultivation on artificial media, is an example of which type of variation?
8. In terms of microbial morphology and variation, abnormal, bizarre shapes assumed by bacteria in aging cultures or under highly unfavorable environmental conditions are called \_\_\_\_\_ forms.
9. What is pleomorphism?

### 3-3. Cultivation of Bacteria

Any plant or animal will flourish or die, depending on its environment. Given ample food, water, and the proper atmosphere, abundant growth will follow; however, let the opposite be true and death ensues. Bacteria are no different in this regard. They will flourish and reproduce in the laboratory if carefully cultivated.

You can conclude from our discussion so far that bacteria cannot be identified as to species, and usually not to genus, on the basis of morphology and staining reactions alone. Therefore, you must supplement your microscopic examination by studying the appearance and growth characteristics

of bacteria on laboratory media. But in order to set up the proper conditions for microorganisms to survive and multiply on artificial media you must first learn something about microbial growth requirements.

**040. List five factors to be considered in cultivating bacteria and specify how constituents of these factors aid in bacterial growth.**

**Growth Requirements.** To cultivate bacteria in the laboratory you must consider several important factors. These factors are very similar to those involved in the life processes of other plants, animals, and humans. These are:

- Nutrition (proper food).
- Moisture.
- Acidity/alkalinity (pH).
- Temperature.
- Gas exchange.

**Nutrition.** The proper foods include a source of carbon (organic or inorganic), nitrogen, inorganic chemical salts, and other growth-promoting substances. Most media contain peptone, a breakdown product from protein, which provides an available source of carbon and nitrogen. Certain pathogens need serum or blood in order to reproduce on culture media. Carbohydrates are needed by some organisms as a source of energy, but not by others. You may add calcium, magnesium, potassium, and sodium salts, as well as certain other minerals, and even dyes, to culture media to either assist or inhibit bacterial growth, depending upon your purpose in cultivation.

**Moisture.** Moisture is essential for growth. There is usually sufficient moisture in a culture medium, particularly in a broth. You can add moisture to closed containers, such as candle jars, by soaking a piece of gauze or cotton with water and placing the dampened material in the container beside the plates of medium.

**Acidity/alkalinity (pH).** The proper pH must be maintained during the life of the bacteria. Just as you would die if your body pH changed very much, so will bacteria. Media are usually prepared to a specific pH in the range of 6.8 to 7.2. However, as bacteria grow they utilize the food available to them, and in so doing, change the pH of the medium because of the accumulation of their waste products. To counteract this change, buffering agents are incorporated into culture media. Buffer substances retard changes in the pH of the growing culture, thus permitting more abundant growth before a limiting acidity or alkalinity is reached.

**Temperature.** Bacteria vary considerably with respect to their temperature requirements for

growth. We classify all bacteria into three broad temperature groups: psychophilic, mesophilic, and thermophilic. Psychophilic or cold-loving forms grow more readily at lower temperatures,  $-5^{\circ}$  to  $30^{\circ}$  C (optimum,  $10^{\circ}$  to  $20^{\circ}$  C); mesophilic,  $10^{\circ}$  to  $45^{\circ}$  C (mesophilic forms grow best at  $20^{\circ}$  to  $40^{\circ}$  C); and thermophilic or heat-loving,  $25^{\circ}$  to  $80^{\circ}$  C (these forms grow best at  $50^{\circ}$  to  $60^{\circ}$  C). The majority of human pathogens are mesophilic, growing best at  $35^{\circ}$  C. A constant temperature incubator adjusted to  $35^{\circ}$  C satisfies the temperature requirement for most pathogens.

**Gas exchange.** Gas exchange between bacteria and their environment is vital. While most of the bacteria encountered in medical bacteriology will grow under conditions of normal atmospheric oxygen, certain others need more carbon dioxide than is found in air. Still others can obtain their oxygen only from chemicals incorporated in the medium. Since some pathogenic forms can use only one of the several different systems of respiration found among bacteria in general, you must furnish the specific atmospheric environment which those disease agents require. Otherwise, your isolation attempts will almost always result in failure. We will take a closer look at some of the types of respiration found in bacteria, along with other physiological principles important in cultivating microorganisms.

#### Exercises (040):

1. List five factors that you must consider in cultivating bacteria.
2. What do some of the proper food providing bacterial nutrition include?
3. Most media contain what essential nutrition and what does it provide?
4. Serum or blood is needed by certain pathogens for what purpose?
5. What purpose do buffering agents serve when incorporated into culture media?
6. The majority of human pathogens grow best at  $35^{\circ}$  C and are called what type of form, in terms of growth temperature?

7. Which forms of bacteria grow best at a temperature range of  $50^{\circ}$  to  $60^{\circ}$  C?
8. Gas exchange between bacteria and their environment is \_\_\_\_\_.

041. State basic principles of bacterial respiration, and define the four categories of bacteria on the basis of their requirement for atmospheric oxygen as the hydrogen acceptor.

**Physiology.** Respiration is a process by which bacteria generate energy for growth. You learned in basic chemistry that energy is released through a coupled reaction in which one compound is oxidized while another compound is simultaneously reduced. You will recall that oxidation represents a loss of electrons, and reduction a gain of electrons. In bacterial respiration, electron transport is accompanied by the transfer of hydrogen atoms. So, for all practical purposes the energy-yielding, oxidation-reduction reaction can be pictured as a transport of hydrogen atoms from one compound to another. In other words, an oxidized compound within the cell (hydrogen donor) gives up one or more hydrogen atoms to a second compound (hydrogen acceptor), which is thereby reduced by its acceptance of these same hydrogen atoms.

Bacteria can utilize a wide assortment of organic and inorganic compounds in generating energy for cell functions. In general terms, if members of a given species can couple hydrogen atoms with atmospheric oxygen (the hydrogen acceptor) as the final link in a chain of oxidation-reduction reactions, then we speak of this process as "aerobic" respiration. If some chemical substance other than free oxygen serves as the hydrogen acceptor, we term this respiration "anaerobic." In bacterial classification, microorganisms can be divided into four major categories on the basis of their requirements for atmospheric oxygen as the hydrogen acceptor:

- (1) Aerobes.
- (2) Facultative anaerobes.
- (3) Obligate anaerobes.
- (4) Microaerophils.

**Aerobes.** An aerobic growing on solid medium must have oxygen gas in the atmosphere surrounding the culture. Broth cultures must contain dissolved oxygen throughout the liquid in order for aerobic respiration to proceed. Quite often the diffusion of oxygen into the broth is accelerated by agitating (shaking) the medium during incubation. In most aerobic organisms the hydrogen atoms arising from oxidation-reduction

reactions in the cell are joined to atmospheric oxygen to form hydrogen peroxide ( $H_2O_2$ ) as the end product in respiration. Since  $H_2O_2$  is toxic to biologic systems, the aerobes produce an enzyme, catalase, to break down the harmful compound into water and oxygen.

**Facultative anaerobes.** This type of bacterium is able to use either atmospheric oxygen or some other substance as a hydrogen acceptor. By this process, a facultative organism can adapt to grow in either an aerobic or an anaerobic environment. Many of the bacteria which normally live in the human intestine are facultative anaerobes which show rapid growth aerobically on laboratory media. They can adapt to anaerobic conditions when the supply of oxygen in the culture is exhausted. Most of the pathogenic organisms we will study are facultative anaerobes.

**Obligate anaerobes.** An obligate anaerobe will not grow in a culture exposed to atmospheric oxygen. Free oxygen is toxic to the anaerobe's respiratory mechanism, and hydrogen atoms are usually transferred only between certain organic compounds fabricated by the cell from constituents of the culture medium. In effect, the anaerobic forms do not possess the respiratory enzymes necessary to couple hydrogen atoms with oxygen, the hydrogen acceptor commonly used by the aerobes and facultative anaerobes. Many of the obligate anaerobes of interest to us in the clinical laboratory, such as certain gangrene organisms of the genus *Clostridium*, survive an oxygen atmosphere by forming resistant spores. These spores remain metabolically inactive until an environment free of oxygen stimulates their germination.

**Microaerophils.** Between the strict aerobes and the obligate anaerobes we find some interesting gradations among bacteria with respect to requirements for atmospheric oxygen. For example, the *microaerophils* are forms for which oxygen is toxic in normal atmospheric concentration. These bacteria are not true anaerobes because a need for oxygen does exist, although the amount required is extremely small. Then, again, there are so-called indifferent microbes which can grow either in the presence or absence of oxygen. The gas is not toxic to these anaerobic organisms, but atmospheric oxygen is not used as a hydrogen acceptor in respiration.

#### Exercises (041):

1. In bacterial respiration, electron transport is accompanied by the transfer of what type of atoms?
2. When an oxidized compound within the cell (hydrogen donor) gives up one or more hydrogen atoms to a second compound

(hydrogen acceptor), in what manner is this second compound affected by its acceptance of these same hydrogen atoms?

3. In most aerobic organisms the hydrogen atoms arising from oxidation-reduction reactions in the cell are joined to atmospheric oxygen to form what substance as the end product in respiration?
4. What enzyme do the aerobes produce to break down the harmful compound into water and oxygen?
5. What is a facultative anaerobe?
6. What effect does oxygen have on the respiratory mechanism of obligate anaerobes?
7. What essential ability do the aerobes and facultative anaerobes have that the obligate anaerobes do not possess that enables them to survive the presence of oxygen?
8. What sort of structures are produced by obligate anaerobes, such as certain organisms of the genus *Clostridium*, that enable them to survive an atmosphere of oxygen?
9. Define a microaerophil.

**042.** Point out the factors used in the macroscopic examination of bacterial morphology, and state conditions responsible for given patterns of these factors.

**Colony Morphology.** In a suitable environment, a bacterium will grow and multiply. As a result, where originally there was one organism, descendants (progeny) of that organism begin to build up around the original cell. Within a short period of time there are enough organisms in one area to be seen macroscopically. As these organisms



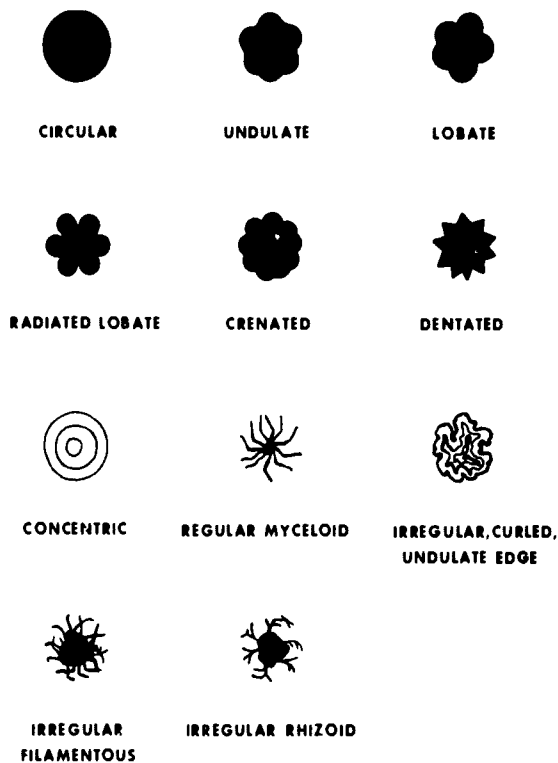

Figure 3-5. Colony shape

reproduce, they form groups, or colonies, which possess qualities that aid in their identification. The qualities are referred to as colony shape, size, and texture. Recognition of typical colonies of each genus is essential as a step to identification.

**Colony shape.** Colony shape refers to the outline of the colony, along with its elevation above the medium. When examining colony growth, you must observe individual colonies which have not been distorted or influenced by colonies growing in close proximity. Certain terms are used to describe colonial shape in relation to its outer edge, such as circular, undulate, lobate, crenated, etc. Some colonies may be irregular and appear spread out. You can see examples of colony shape in figure 3-5.

The more motile an organism, the greater will be the area of the colony. For example, *Proteus vulgaris* may produce spreading colonies which will cover the entire plate and give the appearance of a thin film of bacteria on the plate—H-type colonies. *Proteus* may also grow as a small discrete colony—O-type colonies. The H and O designations were derived from the German words, Hauch and Ohnehauch, denoting spreading and nonspreading forms. The H-type colony is due to active flagellar motion, and the O-type colony indicates a nonflagellated and, therefore, nonmotile organism. It is significant that the presence of flagella correlates with the antigenic properties of the organism. *Antigens* are chemical components of the bacterial cell which

stimulate the formation of specific protective substances, "antibodies," in the bloodstream of man and animals. You will learn later how to capitalize on this phenomenon by using serological techniques to detect differences in antigenic structure of closely related microorganism. Sometimes you can distinguish morphologically identical species only by means of analysis of their antigens.

Colony elevations are described by such terms as flat, convex, umbilicate, raised, umbonate, papillary, and convex rugose, as we have illustrated in figure 3-6. To best view these characteristics, you should use oblique light and a hand lens to see shadow effect. Older colonies may tend to flatten and yield nontypical features. Be aware of the time element.

**Colony size.** The size of a colony is labeled as pinpoint, small, discrete, large, or spreading. Under normal cultural conditions, size is an aid in identification. Significance is often attached to minute (dwarf) colonies in that these are apt to be variant colonies having a degree of virulence different from that of larger colonies of the same organism. As with the shape of the colony, size can be affected by factors of motility. Distortion in size may also be caused by the presence of too much moisture on the medium surface. This is one reason why you should not inoculate media surfaces with bacteria while water droplets, arising from condensation, are still present on the culture plate. The resulting growth may not take the form of isolated colonies needed as an aid in identification.

You can gather other information from tube cultures. In figure 3-7, you can see the different growth pattern of organisms on a slant culture. For certain identification procedures, you may do a stab culture to examine the growth of organisms within a solid medium. Figure 3-8 shows the growth patterns in a solid medium. The pattern obtained aids in identification. We will discuss the preparation of these cultures in Chapter 4.

**Colony texture.** Another useful aid to identification is the texture of the colony. Texture is described by such terms as rough, smooth, glistening, mucoid, and heaped. Some colonies are so mucoid that, if you touch them with a metal loop, you will see a long string of sticky material adhering to the loop as you withdraw it. Mucoid colonies can result from heavy capsule formation by individual cells or by secretions produced by bacteria in response to an external stimulus, such as phenol in a medium.

Smooth (S) and rough (R) colonies are frequently encountered. Many bacteria produce both the S- and R-type colonies. The S-type colony is generally smooth, translucent, convex, glistening (moist), circular, and "butterlike" in consistency. The S-type bacteria are usually encapsulated and, as a rule, will produce a smooth growth in a liquid medium or broth.





**FLAT (EFFUSE)**



**RAISED**



**CONVEX**



**UMBILICATE**



**UMBONATE**



**PAPILLARY**



**CONVEX RUGOSE**

Figure 3-6. Colony elevations.



**Effuse**



**Beaded**



**Spreading**



**Filiform**



**Echinate**



**Rhizoid**



**Villose**

Figure 3-7. Slant streak culture.

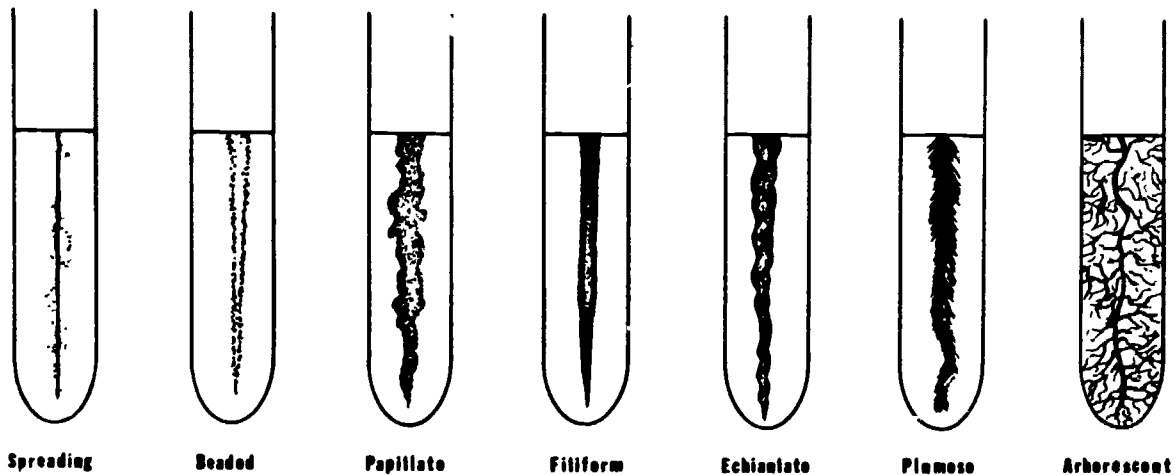

Figure 3-8. Tube stab culture.

Loss of virulence or capsule may cause the bacteria to show a variation in colonial growth; that is, instead of an S colony, an R colony is produced. An R colony is generally dull in appearance, less translucent (more opaque) than the S colony, and may have an irregular circumference and a wrinkled or rough surface. Bacteria from R colonies, when grown in broth, may form flakes or granules. They may settle to the bottom or form a surface scum or pellicle. Stained slides made from the broth, or from surface colonies from the plated medium, will usually reveal long, filamentous organisms.

**Exercises (042):**

1. In examining colonies of bacteria, what physical microscopic characteristics should you observe?
2. What are some terms used to describe colony shape in relation to its outer edge?
3. Colony shape refers to the outline of the colony along with what other characteristic?
4. An H-type colony is the result of active flagellar motion. You would expect this type of colony to be (spread out/pinpoint).
5. Colony elevations are described by what terms?

6. What are two possible causes of colony size differences of the same organism?
7. The terms "rough," "smooth," "heaped," and "muroid" refer to which characteristic of the colony?
8. What two conditions can result in the production of muroid colonies?
9. Loss of virulence or capsule may cause the bacteria to show what type of colony texture?

**043. List some factors which may influence the production of bacterial pigment; cite and define the two major groups of bacterial pigments; and state three types of bacterial pigments and the genera with which they are closely associated.**

**Bacterial Pigments.** In addition to shape, size, and texture, bacterial colonies can develop certain characteristic colors or pigmentation or cause the surrounding medium to become pigmented. Although we don't know exactly how these pigments are formed, they often give us a hint as to the identity of organisms growing on plated media or in a culture tube. Colors are produced in a wide range, depending upon the type of medium used, time and temperature of incubation, age of culture, and other environmental factors. On a dye-free medium the colonies of most bacteria are white

TABLE 3-3  
BACTERIAL PIGMENTS

<u>Type Pigment</u>	<u>Color</u>	<u>Representative Genera</u>
Carotenoid	Red, yellow, orange	Sarcina Micrococcus Staphylococcus
Anthocyanins	Blue, red, intermediate colors	Pseudomonas
Melanins	Red, brown, orange, black	Bacillus

to gray and range from opaque to translucent, but with the pigmented media, a colony may be a bright yellow on one medium, and a dull yellow, orange, or white on another.

The two major groups of pigment that you may encounter are *leukobases* and *lipochromes*. Leukobases are compounds which, after being excreted by the bacteria, are oxidized to form a colored product. An example of this reaction is found in *Pseudomonas aeruginosa*. The organism produces a blue pigment, pyocyanin, which gives us the term "blue pus" that is descriptive of certain wound infections. Lipochrome pigments are red, yellow, and orange; they are similar to those produced by flowers and to pigments seen in butter and egg yolk.

Pigments vary a great deal in color intensity, even with the same organism. Moreover, they are unstable substances. Only if you interpret pigmentation with certain considerations in mind, for example, the conditions of cultivation, can pigment formation be used as an identifying characteristic. There are three types of pigments of interest to you, based on solubility differences in common laboratory solvents. They are (1) carotenoids, (2) anthocyanins, and (3) melanins. In table 3-3, we have listed the types of pigments, their colors, and some of the organisms which produce them. These bacterial genera are often found as isolates from clinical specimens.

#### Exercises (043):

1. Color production is dependent upon what factors?
2. What are the two major groups of pigments that you may encounter when studying bacterial pigments?

3. Which of the major groups of pigments are compounds which, after being excreted by the bacteria, are oxidized to form a colored product?
4. Which of the major groups of pigments are red, yellow, and orange, and are similar to those produced by flowers and to pigments seen in butter and egg yolk?
5. The blue pigment produced by the organism *Pseudomonas aeruginosa* is an example of the reaction resulting from which group of pigments?
6. What are the three types of pigments?
7. A red, yellow, orange color or carotenoid pigment is most likely produced by which genera?

**044. Cite important considerations in the cultivation of anaerobic bacteria and proper collection and transport techniques; and state basic guidelines for the isolation of anaerobes.**

**Anaerobic Cultures.** In recent years, increased awareness of the role played by anaerobic organisms in disease has inspired the development

of techniques for the recovery of these organisms from clinical specimens. As you may recall, the toxic effects of O<sub>2</sub> (oxygen) on anaerobes require the production and maintenance of a reduced O<sub>2</sub> environment for successful cultivation. Previously, most of the methods available were cumbersome, inadequate, and difficult. Currently, there are a number of culture systems available, but certain basic principles common to all are essential for optimal recovery of anaerobic bacteria from clinical specimen.

**Isolation from Clinical Specimen.** The anaerobic bacteria can be isolated and studied quite readily, provided certain cardinal principles of anaerobic bacteriology are rigidly applied. Four of the most important considerations in the cultivation of anaerobic bacteria are:

- a. Proper collection and transport of the material to be examined.
- b. Culture of the material as soon as possible after collection.
- c. Use of freshly prepared and properly reduced media.
- d. Proper anaerobic conditions.

**Proper collection and transport.** Proper collection and transport of clinical specimens is of primary importance in recovery of anaerobes. The sample should be collected from the active site of infection and precautions should be taken to exclude surface contaminants and aeration of the sample. Whenever possible, tissue samples or fluid aspirates should be collected rather than swab samples. The material on swabs should never be allowed to dry out. Specimens should be placed under anaerobic conditions immediately after collection for transport to the laboratory, since some anaerobes are quite oxygen sensitive and will die rapidly in an aerobic environment.

Sterile rubber transport vials and tubes containing an oxygen-free CO<sub>2</sub> atmosphere are available commercially. These items may be available from commercial sources such as Scott Laboratories, Fiskeville, Rhode Island; Hyland Laboratories, Costa Mesa, California; and McGaw Laboratories, Glendale, California.

Specimens aspirated with a needle and syringe can be injected directly into the transport bottles; care must be taken to exclude any air. If necessary, a specimen tube can be opened in an upright position, the specimen or swab added, and the tube closed for transport to the laboratory. Since CO<sub>2</sub> is heavier than air, the CO<sub>2</sub> atmosphere is maintained in the transport tube. As a very minimum procedure, the material can be placed in a medium containing a reducing agent such as cysteine or thioglycollate at room temperature for a period not exceeding 2 hours. Samples should not be refrigerated since chilling is detrimental to some anaerobes, and oxygen absorption is greater at lower temperatures.

**Isolation of anaerobes.** All clinical material except specimens likely to be contaminated with normal flora should be routinely cultured for anaerobes. Specimens that should not be cultured include nasal swabs, throat swabs, sputum, gastric contents, skin, feces, voided or catheterized urine, and vaginal swabs.

For isolation of anaerobes from blood specimens, 5 to 10 ml of blood should be inoculated into 50 to 100 ml of liquid media (10% V/V) and the blood cultures incubated up to 14 days. Broth media containing 0.025 percent sodium polyanethol sulfonate (liquoid) and an anaerobic or partial CO<sub>2</sub> atmosphere are commercially available. Tryptic soy broth, trypticase soy broth, thioglycollate medium, and prereduced brain heart infusion broth designed for anaerobic blood culture all appear to be equally satisfactory. Liquoid may prevent the growth of some anaerobic cocci and slow the growth of some strains of *Bacteroides melaninogenicus*. Blood cultures should be subcultured to plating media whenever there is any obvious growth and blind subcultures made at least after 48 hours incubation and at the end of 14 days. In addition to plating on blood agar plates, it has been shown that subculturing to a selective plating medium will allow detection of anaerobes mixed with aerobic organisms in bacteremic infections.

**Immediate culturing.** Ideally, specimens should be cultured as soon as possible after collection, and every effort should be made to prevent exposure of culture media to molecular oxygen. Plating media for primary isolation should be prepared on the day it is used, or freshly prepared media should be placed under anaerobic conditions for a period no longer than 2 weeks. Plating media can be stored in an anaerobe jar, glove box, or in an airtight cabinet containing an oxygen-free CO<sub>2</sub> atmosphere. Liquid media containing reducing agents should be stored in the dark at room temperature in tightly capped tubes for not longer than 2 weeks. Provided the media is fresh and properly reduced, successful cultivation of anaerobes can be obtained by use of the GasPak anaerobe jar by use of an anaerobe jar with a gas replacement method. Two excellent methods for the cultivation of anaerobes are the glove box system and the roll-streak tube system in which prereduced anaerobically sterilized (PRAS) media are used as recommended by authorities.

All specimens except blood should be Gram stained and cultured by both direct plating and enrichment procedures. All liquid or semisolid media stored in an aerobic environment should be prereduced by heating the media for 10 minutes in a boiling water bath and cooling before inoculation.

#### Exercises (044):

1. What are four important considerations in the cultivation of anaerobic bacteria?

2. From what site should the sample be collected?
3. What specific precautions should be taken during collection of the specimen?
4. Instead of swab samples, what type specimens are preferable if possible?
5. As a very minimum procedure, the material can be placed in a medium containing what reducing agent, at what temperature, and for how long?
6. Why should samples not be refrigerated?
7. List specimens which should NOT be cultured routinely for anaerobes.
8. Why should the above specimens NOT be cultured?
9. For isolation of anaerobes from blood specimens, how many mls of blood should be inoculated into 50 to 100 mls of liquid media?
10. How does liquor affect the growth of some anaerobic cocci and the growth rate of *Bacteroides melaninogenicus*?
11. Freshly prepared media should be placed under anaerobic conditions for what maximum recommended length of time?
12. What basic procedures are recommended for all specimens except blood?

045. State the three primary types of anaerobic culture systems currently used; cite the principle of given anaerobic culture systems; and point out the two types of this system in terms of the reagents, procedures, and related precautions.

**Anaerobic Culture Systems.** Systems currently used for isolation of anaerobic bacteria include anaerobic jars, the Hungate roll-tube or roll-streak tubes of prereduced anaerobically sterilized (PRAS) media, and anaerobic glove boxes. Although there are advantages and disadvantages to each system, recent studies have shown that all of the systems are suitable for isolation of the commonly encountered anaerobes responsible for human infections if certain principles of anaerobic bacteriology are followed.

a. Specimens must be properly collected and handled to exclude atmospheric oxygen.

b. Fresh or prereduced media must be used.

c. The anaerobic system must be properly used by providing an active catalyst in the system to allow effective removal of residual oxygen.

*The anaerobic culture jar.* There are a number of anaerobic culture jars, such as the Brewer, Torbal, and GasPak, commonly used which rely on the same general principle for the removal of oxygen. Addition of hydrogen allows reduction of oxygen to form water as follows:



Each system uses a catalyst to accelerate the rate of oxygen reduction. The palladium catalyst in the lid of the Brewer jar requires heating with an electric current to be fully active, but the catalysts used in the more modern jars do not require heating.

It is important to keep the lids of anaerobe jars clean and dry when not in use to prevent inactivation of catalyst. The catalyst (palladium-coated alumina pellets) used with the GasPak system is known to be inactivated ("poisoned") by hydrogen sulfide, chlorine, and sulfur dioxide gases. Therefore, the pellets must be replaced at frequent intervals (preferably each time the jar is used) with new or "rejuvenated" pellets. The activity of used catalysts can be restored ("rejuvenated") by heating the pellets in a dry-heat oven at 160° to 170° C for 2 hours. After rejuvenation, store the pellets in a clean, dry container away from contaminating gases until they are used.

*The Brewer jar.* In the Brewer jar, the oxygen is removed by means of an electrically heated platinized asbestos catalyst with the electric connection outside the jar in order to eliminate the danger of explosion. The Brewer anaerobic jar is shown in figure 3-9.

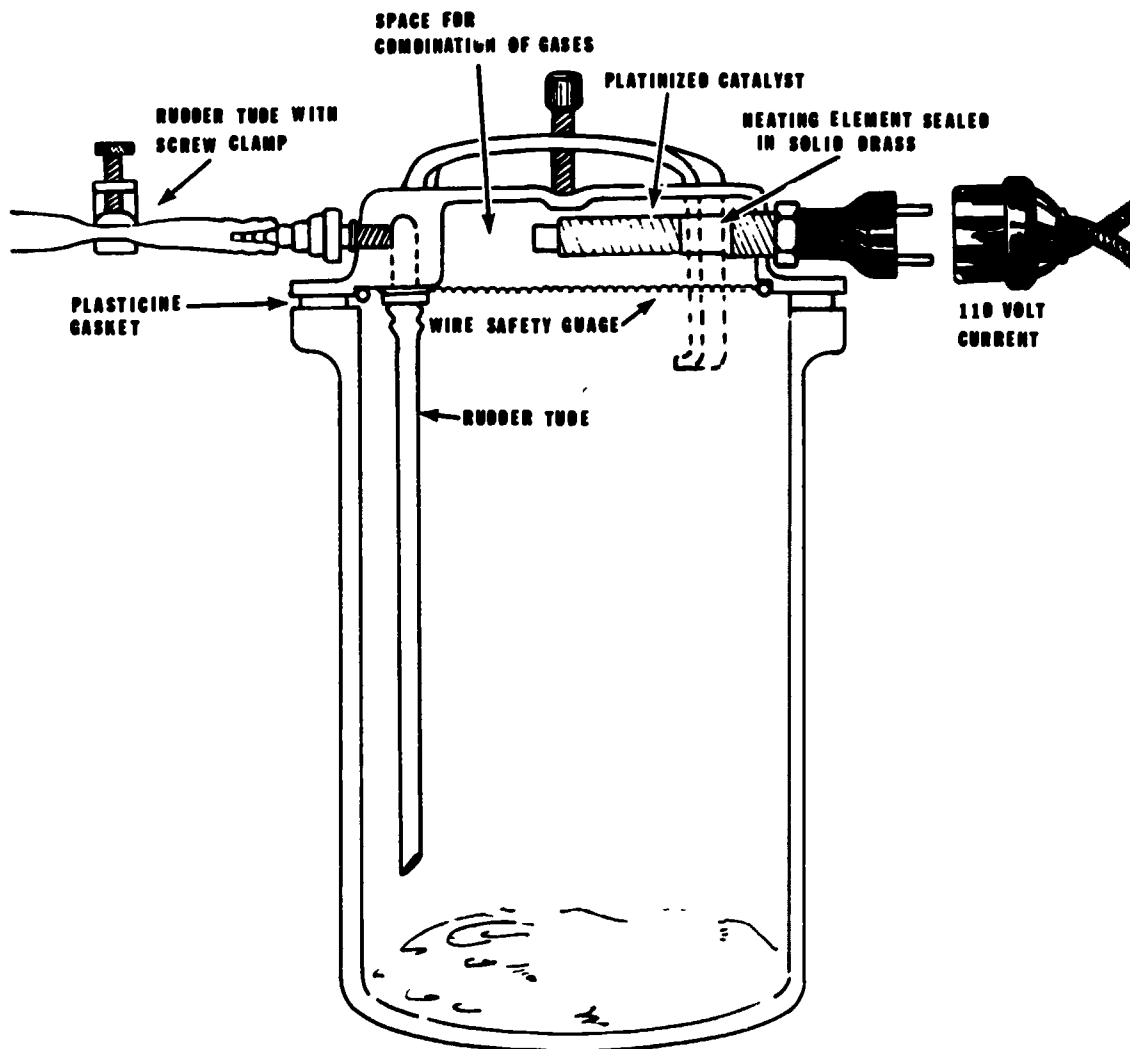

Figure 3-9. Brewer anaerobic jar.

After the jar is evacuated by a vacuum, it is slowly filled with a gas mixture containing 10 percent hydrogen, 10 percent carbon dioxide, and 80 percent nitrogen. After repeated evacuation and filling, the electrical element is connected and allowed to heat for 10 minutes. The unit is then disconnected and placed in the incubator.

*The GasPak jar.* The GasPak jar is about the simplest of the anaerobic jars. The GasPak jar is shown in figure 3-10. The unit is used with a disposable hydrogen and carbon dioxide generator envelope, and a disposable anaerobic indicator. This polycarbonate plastic anaerobic jar, used with the disposable hydrogen generator, has no external connections, thereby eliminating the need for manometers and the like. It uses a room temperature catalyst, palladium-coated alumina pellets, which eliminate the need for an electrical connection to heat the catalyst.

The inoculated media or tubes are placed in the jar, along with one hydrogen generator envelope with a top corner cut off and a methylene blue anaerobic indicator. Ten ml of water is introduced with a pipette into the envelope; then the cover containing the catalyst in a screen is immediately placed in position. The clamps are screwed handtight. The hydrogen reacts with the oxygen in the presence of the catalyst. An anaerobic condition is thus produced. As the anaerobic atmosphere is achieved, condensed water will appear as a visible mist or fog on the inner wall of the jar, and the lid over the catalyst chamber will become warm. The methylene blue indicator should appear colorless and the jar will be under a slight positive pressure after incubating overnight.

Every precaution must be taken to prevent a laboratory accident when using the GasPak unit and the Brewer anaerobe jar, because hydrogen is an explosive gas. Observe the following:



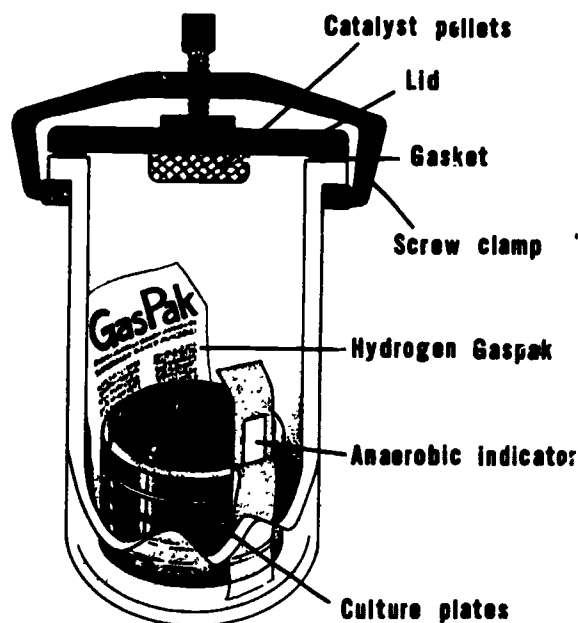

Figure 3-10. GasPak anaerobic jar.

- a. Any open flame within proximity must be extinguished.
- b. Inspect all jars for cracks and discard if faulty.
- c. Make sure that the metal screen inside a Brewer jar is intact.
- d. Whenever the catalyst is activated electrically, a wooden or metal safety shield should be used.

**Exercises (045):**

1. What are the three systems currently used for isolation of anaerobic bacteria?
2. What is the basic principle of the anaerobic culture jars?
3. Why is it important to keep the lids of anaerobic jars clean and dry when not in use?
4. What is the catalyst used with the GasPak system?
5. How can the used catalyst be restored or "rejuvenated"?

6. In the Brewer anaerobic jar, what type of catalyst is used to remove the oxygen?
7. After the jar is evacuated by a vacuum, it is filled with gas containing what percentages of hydrogen, carbon dioxide, and nitrogen?
8. In the GasPak jar, where is the hydrogen and carbon dioxide produced?
9. What must the temperature be before the palladium-coated catalyst becomes activated in the GasPak?
10. In the GasPak jar, as the anaerobic atmosphere is achieved, what two conditions may be noted?

11. What color will the indicator show and what type of pressure is noted after the GasPak is incubated overnight after a complete anaerobic atmosphere has been achieved?

Complete the following statements:

12. Hydrogen is an \_\_\_\_\_ gas.
13. Any open flame within the proximity of an anaerobic jar or GasPak unit must be \_\_\_\_\_.
14. Whenever the catalyst is activated electrically, a \_\_\_\_\_ or \_\_\_\_\_ should be used.

**046. Cite the roll-streak tube and anaerobic glove box technique for anaerobic cultures; specify the reagents used and advantages of both techniques.**

**Roll-Streak Tube Technique.** This system uses enriched media that have been prepared, sterilized, and stored under oxygen-free gas in order to maintain a low oxidation-reduction potential and

prevent oxidative changes. The media are known as prereduced anaerobically sterilized media (PRAS). During inoculation, the media are kept anaerobic either by needle injection through the oxygen impermeable stopper without introducing air or by passing a gentle stream of oxygen-free gas into the tube by way of a sterile cannula when the stopper is removed. Each tube has its own anaerobic atmosphere and can be incubated in a standard incubator and observed at any time for growth.

**Anaerobic Glove Box Technique.** An anaerobic glove box is a self-contained anaerobic system. It consists of a closed chamber usually made of flexible clear plastic and fitted with gloves for manipulations within the enclosed space.

After the glove box is assembled and sealed, the chamber is partially evacuated and filled 10 times with technical grade nitrogen and 10 times with a gas mixture of 5 percent CO<sub>2</sub> (bone dry), 10 percent H<sub>2</sub>, and 85 percent N<sub>2</sub>. Approximately 1 pound of catalyst pellets in each of the catalyst diffusion boxes aids in the removal of residual oxygen.

The relative humidity of the chamber is regulated with a drying agent, "Tel-Tale" silica gel, desiccant grade H type IV, which is reusable by heating in a dry-heat oven at 160° C to remove moisture. Anaerobic conditions are maintained in the glove box by replacing the catalyst pellets with new or "rejuvenated" catalysts at frequent intervals (at least once per week).

When material is passed into the chamber, the lock is evacuated and replaced two times with nitrogen and once with the gas mixture (5% CO<sub>2</sub>, 10% H<sub>2</sub>, 85% N<sub>2</sub>) before the inner door is opened. The same procedure in reverse is used when removing materials from the chamber. Media prepared in the usual manner are passed into the chamber and reduced 48 hours before they are used. PRAS media can also be used in the glove box if desired. Cultures are incubated within the chamber and can be inspected and subcultured at any time without exposure to air.

The use of an anaerobic glove box has several advantages:

a. Either conventional media (prereduced in the chamber) or prereduced anaerobically sterilized media can be used.

b. Clinical specimens are not exposed to aerobic conditions during culture procedures.

c. The need for boiling liquid media just before use is eliminated.

d. Conventional plating techniques can be used.

e. Cultures can be incubated under anaerobic conditions, inspected and subcultured at any time without exposing the bacteria to air.

f. Using the system is quite economical. The only major operating cost is for gases that are used when materials are passed into and out of the chamber.

#### Exercises (046):

1. Briefly describe the roll-steak tube technique anaerobic system.
2. What is the media used in the roll-steak tube technique called?
3. The media is kept anaerobic by what two possible ways during inoculation?
4. What are two advantages of the roll-streak tube technique?
5. Briefly describe the anaerobic glove box technique.
6. After the glove box is assembled and sealed, the chamber is partially evacuated and filled 10 times with what technical grade gas and 10 times with what other gas percentage mixture?
7. With what agent is the relative humidity of the chamber regulated?
8. Can PRAS media be used in the glove box?
9. What is the key advantage with reference to the incubation, inspection, and subculturing of cultures using the glove box technique?
10. During what step is it necessary to boil liquid media just before use with the glove box technique?
11. What is the only major operating cost of the glove box technique?

047. Indicate whether given statements correctly reflect the purpose and procedure for the use of the candle jar and thioglycollate medium, and guidelines for incubation temperature.

**Candle Jar Method.** Most organisms grow better when CO<sub>2</sub> tension is slightly increased. Some organisms require increased CO<sub>2</sub> tension. You can produce an atmosphere containing 2 to 3 percent carbon dioxide by incubating cultures in a candle jar, as shown in figure 3-11.

Any widemouthed vessel with an airtight lid will suffice, provided it is large enough to accommodate several cultures. Place the inoculated tubes or plates of media in the vessel; then place a lighted candle in the container above the cultures, and securely tighten the lid. The burning candle will be extinguished when about 2 to 3 percent carbon dioxide has accumulated. Be certain to place the candle as high as possible in the candle jar to permit accumulation of CO<sub>2</sub> which extinguishes the flame. (The CO<sub>2</sub> is heavier than air and fills the bottom first.)

**Thioglycollate Broth.** This is a medium which contains a small amount of agar in a liquid medium. It is excellent for cultivating strict anaerobes as well as aerobes. The sodium thioglycollate in the medium acts as a reducing

agent and methylene blue as an indicator of the degree of oxidation. Thioglycollate broth is stored at room temperature in the dark, since at refrigerator temperature it absorbs more oxygen. Oxidation of the medium, which begins at the surface, is seen by a blue-green color change. If the color change involves 20 percent of the column, the medium should be boiled once, cooled, and used. The medium is destroyed by repeated boiling. Tubes that have been boiled and not used should be discarded.

Complete anaerobiosis is produced in all but the very upper portion of the medium. Thioglycollate fluid medium is widely used as a routine broth medium for most bacteriological analyses.

**Incubation.** Incubation temperatures must be set between 35° C and 37° C. Authorities have found that 35° C is adequate for most pathogens. A daily check of incubator temperatures should be made and records kept. In addition, it is important that the atmosphere inside the incubators be moist. Disc susceptibility testing utilizing the Kirby-Bauer method should not be done in a CO<sub>2</sub> atmosphere for most organisms because the pH of the surface of the agar will be too low, producing an increase or decrease of antimicrobial activity.

**Exercises (047):**

Indicate whether each of the following statements is true (T) or false (F), and correct those that are false.

- T F 1. Most organisms grow better when the CO<sub>2</sub> tension is slightly increased.
  
- T F 2. The candle jar produces an atmosphere of approximately 20 to 30 percent CO<sub>2</sub>.
  
- T F 3. After placing inoculated tubes and plates of media in the vessel, a lighted candle is placed in a container at the bottom of the vessel, and the lid is securely tightened.
  
- T F 4. The burning candle will be extinguished when about 20 to 30 percent carbon dioxide is accumulated.
  
- T F 5. Be certain to place the candle as low as possible in the candle jar to permit accumulation of CO<sub>2</sub>.

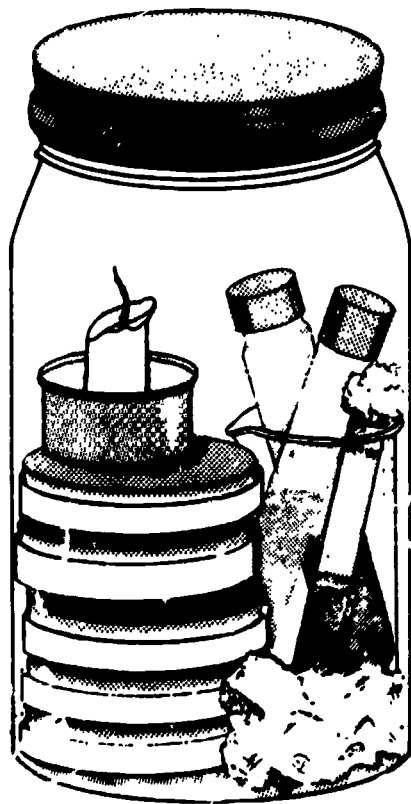

Figure 3-11. Candle jar.

- T F 6. The CO<sub>2</sub> is heavier than air and fills the bottom first.
- T F 7. Thioglycollate medium is excellent for cultivating strict anaerobes as well as aerobes.
- T F 8. In the thioglycollate medium, the methylene blue acts as a reducing agent in the medium.
- T F 9. Thioglycollate broth stored at refrigerated temperature will absorb more oxygen than when stored at room temperature.
- T F 10. Oxidation of the medium, which begins at the surface, is seen by a blue-green color change.
- T F 11. Tubes that have been boiled and not used thereafter may be stored indefinitely.
- T F 12. Incubation temperatures must be set between 25° C and 27° C.
- T F 13. Authorities have found that 37° C is adequate for most pathogens.
- T F 14. It is important that the atmosphere inside the incubator be dry.
- T F 15. Sensitivity testing using the Kirby-Bauer method is unaffected in the CO<sub>2</sub> atmosphere.

### 3-4. Culture Media and Environment

Bacteria had been grown in culture broths for some time before Robert Koch, the German physician, began experimenting with solid media in

the 1800s. He first used 2 to 5 percent gelatin, which worked well in cool temperatures or when the bacteria did not hydrolyze the gelatin. Frau Hesse, wife of one of his investigators, suggested agar-agar, a seaweed preparation commonly called agar. Agar had come to European kitchens from Java and was used in preparing jellies. This new material seemed inert to the action of bacteria. It launched a whole new era in the study and isolation of bacteria.

Since Robert Koch's introduction of solid culture media for growing and isolating bacteria, the field of bacteriology has expanded and prospered. A great deal of research has been done to prepare an artificial medium which is similar to the environment each organism prefers in nature. In order for bacteria to build up their cells and reproduce, the elements necessary for the various cell structures and functions must be supplied in the immediate environment.

**048. Indicate whether given statements correctly reflect the constituents and the percentage of agar present in media and the effects that prolonged heating can have on media.**

**General Classes of Media.** No single culture medium is satisfactory for cultivating all bacteria. A general-purpose or basal culture medium has sources of carbon, nitrogen, and inorganic salts; but the addition of other substances, such as blood, serum, amino acids, or vitamins may be required for growth of pathogenic organisms. The basic energy sources are supplied by water extracts or infusions of meat, vegetables, or yeast. Other complex energy sources include hydrolysates or digests of protein which yield the nitrogen-containing amides, amino acids, peptides, peptones, and proteoses.

Additional energy sources may be supplied by carbohydrates, alcohols, organic acids, glucosides, or similar materials. Carbohydrates, especially glucose, are often incorporated into media for the primary isolation of pathogens. When studies for hemolysis are to be performed, however, carbohydrates should be excluded from blood agar, for they tend to inhibit the bacterial production of certain hemolysins.

Culture media may be liquid or solid. You can prepare a solid medium by adding agar to a liquid nutrient medium. As previously mentioned, agar is an inert, purified extract of *Gelidium*, a type of seaweed, which is not metabolized by bacteria. Heat a liquid medium with added agar powder or flakes to melt the agar and then sterilize it. At a temperature of 96° to 98° C agar melts and goes into solution. Upon cooling to 40° C, the agar solidifies and congeals the medium. You generally use agar in 1.5 to 2.0 percent concentrations in

preparing solid media. Lower concentrations of 0.5 to 1 percent give a semisolid medium which is ideal for performing motility checks of pure cultures.

Your main purpose in culturing bacteria is to produce pure cultures on a solid medium. Therefore, a very important factor in media preparation is sterility. Media must be free of bacteria before inoculation so that growth of the organism from a clinical specimen will not be masked or inhibited by contaminant. The most common means of sterilizing media is by the autoclave in which steam under pressure is used to reach the necessarily high temperature of about 121° C.

Prolonged heating at high temperatures can change the composition of a medium. For example, excessive heat can chemically break down lactose broth, and may demonstrate a positive lactose fermentation (false positive) by organisms which do not ferment lactose. Increased heat may also make a medium more acid than desired or form an undesirable precipitate which will be visible in the medium. The gelling ability of the medium may also be destroyed.

When you prepare media from commercial sources, follow the manufacturer's direction very carefully as to time and temperature of sterilization. Much of the media used today is commercially prepared and available in powdered, dehydrated form. This powder contains the ingredients necessary to grow the bacteria for which it was specifically designed and needs only to be reconstituted with a fluid and sterilized before use.

#### Exercises (048):

Indicate whether each of the given statements is true (T) or false (F), and correct those that are false.

T F 1. A basal culture medium has sources of carbon, nitrogen, and inorganic salts.

T F 2. Carbon, nitrogen, and inorganic salts may be required for growth of pathogenic organisms.

T F 3. Basic energy sources are supplied by water extracts or infusions of meat, vegetables, or yeast.

T F 4. When studies for hemolysis are to be performed, carbohydrates should be included in blood agar since they tend to enhance bacterial production of certain hemolysins.

T F 5. Agar is an inert, purified extract of *Gelidium*, a type of seaweed, which is metabolized by bacteria.

T F 6. Concentrations of 1.5 to 2.0 percent of agar are used in preparing solid media.

T F 7. A very important factor in media preparation is sterility.

T F 8. Excessive heat can chemically break down lactose broth, and may show a false negative result by organisms which do ferment lactose.

T F 9. The gelling ability of the medium may be enhanced by excessive heat.

049. Cite some factors which may influence the type of media to be used, and identify four types of media in terms of their given purpose, constituents, and examples.

**Selection of Media.** In order to select and prepare cultures for various bacteriological analyses, it is necessary for you to become familiar with the many and varied types of media. It is important that laboratory personnel keep their selections of media to a minimum to avoid costly duplication of purpose. The number of media available for initial plating is endless, and the choice should be based on the judgment of an experienced technician. The choice may be influenced by factors such as cost, preference, and commercial availability. Culture media may be selected for general and specific purposes.

**Basic nutrient media.** There are a number of this kind of media. Initially, basic nutrient media in broth or solid form will support the growth of many organisms. Most basic nutrient media are used for growing nonfastidious organisms which comprise the majority of bacteria. Trypticase soy broth is a good general medium, but has limitations. Some fastidious organisms will not grow in it, and due to its glucose content, which is metabolized to acid end products by certain bacteria such as pneumococci, growth may be retarded. Fluid thioglycollate medium may support the growth of a wide variety of anaerobes.



However, it should not be relied upon too strongly, especially in the area of anaerobic bacteriology. When the basic nutrient media are modified to promote or inhibit growth by addition of substances, enrichment, differential, and selective media are produced.

**Enrichment media.** It is frequently necessary to use an enrichment medium in the examination of fecal material for the presence of pathogenic bacteria. *Enrichment* media, because of their chemical composition, will inhibit or destroy the normal intestinal flora such as the coliforms (commensals), and will promote the growth of *Salmonella* and *Shigella*. These organisms, if present in small numbers, are allowed to grow almost unrestrictedly, thus enriching the population of such forms. Example of enrichment media are Tetrathionate broth, selenite broth, and GN broth which are used primarily in enteric bacteriology. In contrast, *enriched* media contain an added nutritive supplement. They are usually prepared by adding blood, serum, or other nutrients to the basic nutrient medium for the primary isolation and subculture of fastidious organisms, usually pathogens.

**Differential media.** Differential media are designed to separate various organisms depending upon carbohydrate utilization, fermentation or oxidation, or enzyme activity. Some media are both differential and selective, such as EMB agar, MacConkey agar, and XLD agar. For example, xylose lysine desoxycholate (XLD) agar contains the carbohydrate, lactose and indicator, phenol red. On this medium, *Salmonella* will produce red, black-centered colonies. *Shigella* and *Providencia* will produce red colonies, and *Escherichia*, *Citrobacter*, *Klebsiella*, *Proteus*, and *Enterobacter* will produce yellow colonies. The lactose and phenol red is used to differentiate between lactose and nonlactose fermenters. If the lactose is fermented, an acid byproduct is produced which will give a visible (yellow) color change to the medium.

**Selective media.** Selective media inhibit the growth of certain organisms while permitting others to grow. Examples are *Salmonella* and *Shigella* (SS) agar and desoxycholate citrate, as well as Mannitol salt agar and Phenylethyl alcohol agar used for growing staphylococci and Gram-positive cocci respectively. It must be remembered that these selective media are relative in their action and may suppress what they are designed to show. Phenylethyl alcohol does slightly suppress Gram-positives, and Lestrin medium or Transgrow does suppress gonorrhea. Thus, after initial growth on selective media, the organism must be transferred to more compatible media.

In some cases, a selective medium can distinguish between genera. SS agar will grow *Salmonella* and

*Shigella* species, but brilliant green agar will grow *Salmonella* and inhibit *Shigella*.

#### Exercises (049):

1. Why is it important that personnel keep their selection of media to a minimum?
2. What factors may influence the type of media used?
3. What is the purpose of basic nutrient media?
4. What reaction may cause the retarding of growth in fastidious organisms when Trypticase soy broth is used as a basic nutrient medium?
5. For what purpose is enrichment media used in enteric bacteriology?
6. What are some examples of enrichment media?
7. How does an enriched medium differ from an enrichment medium and how is the enriched medium prepared?
8. List three examples of enrichment media used primarily in enteric bacteriology which are designed to suppress normal flora and to promote the growth of *Salmonella* and *Shigella*.
9. What is the purpose of the differential media?
10. List three examples of differential media.
11. What constituents are incorporated in the XLD agar to differentiate between the lactose and nonlactose fermenters?



12. What is the purpose of the selective media?
13. What two selective media may be used for growth of staphylococci and other Gram positive cocci?
14. Why must organisms grown on selective media such as Phenylethyl and Transgrow be transferred after initial growth to a more compatible media?

**005. State procedures for rehydrating media and preparing liquid media.**

**Preparation of Media.** The proper preparation of a medium is as important as its selection. We should reemphasize here that in preparing any medium from commercially manufactured ingredients, you should always follow the manufacturer's directions explicitly.

**Rehydrating media.** In rehydrating the media, you should use water meeting the USP definition of purified water. Purified water is water obtained by distillation or by ion-exchange treatment. Fresh, distilled water is best because water that has been stored in an open container for long periods of time can absorb enough gases to alter the final pH of the medium. Carefully weigh the dehydrated powder on weighing paper according to the directions on the container label. Slick paper is preferred over filter paper when weighing, because some of the powder may be lost by adhering to the filter paper. You should then place the powder in a dry flask of a size suitable to hold twice the final volume of medium desired. For example, 1 liter of broth should be prepared in a 2-liter flask. You should add water to the dehydrated medium slowly at first to make sure that it will be completely dissolved. Add a little water and make a thick slurry. Then, you can add the remaining water. If you dissolve dehydrated media in this way, there will be no lumps and you will prevent burned agar when heat is applied.

In preparing an agar-type medium, you must apply heat and bring the solution to the boiling point. Agitate and swirl the flask to prevent burning and sticking of the medium to the flask. Use caution while heating solutions over the burner, since the medium may boil over the top and onto your hands, causing serious burns. Watch the flask carefully and hold it with tongs or asbestos gloves. Keep the opening of the flask pointed away from your face. If you notice that the material is about to boil over, immediately set the

flask down on the counter top. Do not attempt to carry the flask to the sink. You can clean up a mess and make more media a lot easier than you can treat burned hands and fingers.

**Using liquid media.** You do not need to heat most liquid media to boiling because they are usually soluble in water at room temperature. You can best dissolve a medium containing gelatin by heating it to a temperature of 50° C in a water bath.

We cannot overemphasize the importance of exercising extreme care in media preparation and also the necessity of using chemically clean glassware. Detergents or other contaminating chemicals may act as disinfectants or alter the pH of a medium. The medium will not have the proper environment for the bacteria we are trying to identify.

**Exercises (050):**

1. What type of water is recommended for rehydrating media?
2. How is the water obtained?
3. What size flask is recommended for the powder after the desired quantity is weighed?
4. How can you prepare the dehydrated media so that there will be no lumps and burned agar when heat is applied?
5. Why must caution be observed while heating solutions over the burner?
6. If you were heating the medium on a burner and noticed that the material was about to boil over, what should you do?
7. Why isn't it necessary to heat most liquid media to boiling?
8. How can you best dissolve a medium containing gelatin?

9. Why is it important to use chemically clean glassware in media preparation?

**051. Cite recommendations for preparation of media in terms of processing set quantities, filtering, enriching, and checking of the pH.**

**Quantity of Media.** The larger the volume of material to be sterilized, the longer it takes to sterilize completely. As a general rule, however, the quantities of media you will be preparing in the laboratory can be sterilized in 20 to 30 minutes at 121° C. Media containing carbohydrates are probably best autoclaved at a temperature not exceeding 116° to 118° C. During autoclaving there is considerable bubbling. Allow extra space in the flask for this bubbling effect to prevent overflow and loss of medium. As the medium begins to boil during heating, it tends to expand. An Erlenmeyer flask is tapered toward the top, so this constriction speeds up the rate at which the medium can bubble over. Using a larger flask will eliminate this problem, as we noted in the example of a 2-liter flask to hold 1 liter of medium.

**Filtering Media.** When you sterilize media by filtration, if heating is recommended, you must dissolve the ingredients slowly over low heat to prevent the breakdown of constituents and formation of lumps which would clog the filter. Many formulae which do not contain agar, gelatin, or cysteine will dissolve without heating, but heat is required to dissolve others. Filtration is necessary because some of the ingredients would be destroyed at autoclave temperature. It is important that all equipment and tubes be sterile when using filtration and that you use aseptic techniques to maintain sterility of the filtrate.

**Enriching Media.** When you need to add enrichment to a medium, you must cool the medium to a temperature which will not alter or destroy the additives. As a rule, after the medium has been autoclaved, it should be cooled to 45° to 50° C before adding substances such as whole blood, ascitic fluid, albumin, or any material which can coagulate or be destroyed by high temperatures.

**Checking the pH of Media.** It is not usually necessary to adjust the pH of a sterilized medium when using the commercially prepared powder, provided that you have carefully followed the manufacturer's directions. The final pH will be as stated on the label. When you are preparing your own medium from a formula and stock chemicals, however, you should check the pH with a pH meter and add a small amount of a weak base or acid as indicated by whether the medium is too acidic or too alkaline respectively.

To use media for cultures, you must have them in small, usable portions or aliquots. These aliquots are dispensed into sterile containers suitable to whatever purpose that is needed. The containers may be Petri dishes, test tubes, bottles, or glassware of some special design. Most important, you must dispense the culture material into the sterile containers (glass or plastic) in such a way as to prevent contamination of the medium, bubbles on the medium surface, and lumps in the medium.

**Exercises (051):**

1. As a general rule, the quantities of media prepared can be sterilized for how long and at what temperature?
2. Media containing carbohydrates may be autoclaved between what temperatures?
3. Besides definite aseptic techniques to maintain sterility of the filtrate, what other essential items must be sterile in filtering media?
4. As a rule, after the medium has been autoclaved, to what temperature range should media be cooled before adding whole blood, ascitic fluid, albumin, or carbohydrates?
5. Why is it not usually necessary to adjust the pH of a sterilized medium when using the commercially prepared powder?

**052. Indicate whether given statements correctly reflect methods for preventing contamination and bubbles when pouring media.**

**Preventing Contamination.** To prevent contamination of the medium, be certain that the bench area is disinfected. It should be wiped clean with any of several disinfectants kept in the laboratory for this purpose. Leave the Petri dishes covered until you are ready to pour the medium; then remove the tops only enough to add the medium. Pouring should take place in an area free of air currents and away from other laboratory activities which might cause dust in the air.

**Preventing Bubbles.** Bubbles on the surface of the medium can be dangerous to you. They also create a problem in trying to obtain isolated

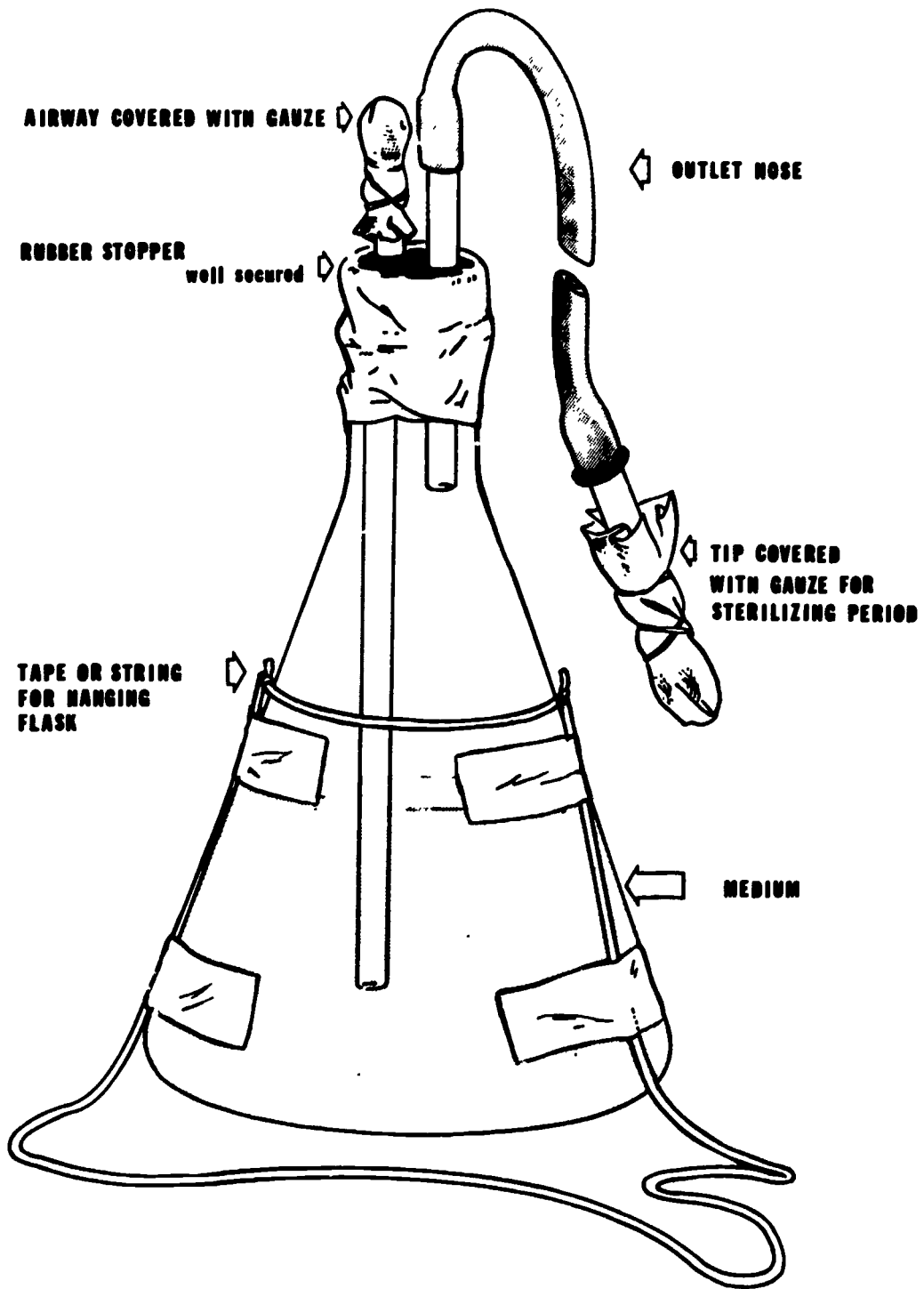

Figure 3-12. Flask of sterilized medium.

colonies. Bubbles will catch and "spring" a wire loop as it passes over the medium. This spring or snapping effect may cause an aerosol, that is, an airborne cloud of particles or droplets containing infectious bacteria. It is also possible for the wire loop to cut into the medium around the bubble and in so doing be wiped free of most bacteria. Very few bacteria will be left on the loop to streak out for isolation as individual colonies.

To prevent bubbles in the medium, you can use a sterile gauze over the opening of the pouring flask. As you pour the medium through the gauze, the bubbles are blocked and broken up. When pouring, it helps to have the mouth of the flask close to the Petri dish to avoid splashing and aeration bubbles.

Another good method to prevent bubbles from accumulating on the medium surface, prevent contamination, and make distribution of the aliquots easier is to use an Erlenmeyer flask setup, as shown in figure 3-12. This device allows for a

one-man operation, and more media can be poured at any given time because many Petri dishes can be placed in position near the operator. You can sterilize the flask and its contents as an intact unit before pouring the medium. In figure 3-13, we show the flask hung for dispensing medium to containers.

The most common method to break up bubbles on an agar medium surface is to gently pass a Bunsen burner flame over the medium before it hardens to burst the bubbles and allow the medium surface to smooth out. Take care, however, not to melt plastic Petri dishes with the flame. If the plastic bottom lip gets soft and you lower the top, the two parts may adhere to one another making it difficult to separate them later on.

#### Exercises (052):

Indicate whether each of the given statements is true (T) or false (F), and correct those that are false.

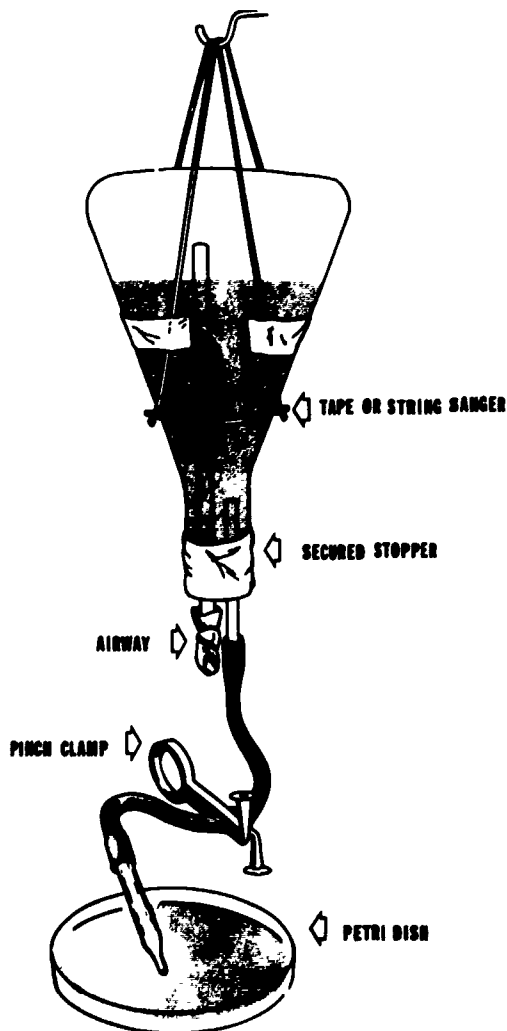

Figure 3-13. Flask set up for dispensing media

T F 1. Before pouring media, the bench area must be disinfected to prevent contamination.

T F 2. The Petri dishes must be left uncovered until you are ready to pour the medium.

T F 3. Pouring should take place in an area with ample air currents for cooling media and away from other laboratory activities.

T F 4. Bubbles on the surface of the medium can create a problem in trying to obtain isolated colonies.

T F 5. In a method to prevent bubbles in the medium, you can use a sterile gauze over the opening of pipette tip leading from the outlet hose of the flask.

T F 6. The most common method to break up bubbles on an agar medium surface is to gently break each one with a sterile needle before it hardens.

T F 7. Take care not to melt the medium with the flame.

053. Point out the cause of lumps in medium, the disadvantages, and the way to prevent them; and state the method for preparing slants.

**Preventing Lumps.** Lumpy medium results from allowing the medium to cool too much before pouring—that is, to the point at which the agar begins to solidify. A lumpy medium, although suitable for bacterial growth, does present some of the hazards described for a medium that bubbles on its surface. A lumpy medium does not usually have an even distribution of nutrients. This gives problems when you try to interpret the results of your isolation technique, because the same organism may give a different colony appearance on various parts of the plate, and it is difficult to streak the plate. Do not allow the medium to cool to the point of solidifying before pouring your aliquots.

The use of test tubes to hold media is universal. You can use test tubes to hold liquid, semisolid, and solid media. You may allow solid media to solidify in the tube standing upright or tilt the tube before hardening to give a solid medium with a slanted surface. All test tubes must be sterile and chemically clean. They must be stoppered with cotton, gauze plugs, or plastic plugs or covered with metal lids. You may also use screw-capped tubes. Choose the tubes according to the type of medium being prepared and the purpose of its use. Thrift should not be the main reason for using small test tubes to dispense media; however, use the smallest tube which will serve the purpose. Some media making instructions list the size tube in which the medium should be dispensed to obtain best results.

**Preparing Slants.** To prepare slants, dispense the heated medium into test tubes and autoclave it. After that, tilt the tubes by some means to offer the proper slant area. Once slanted, do not disturb the tubes until the medium is completely gelled. In

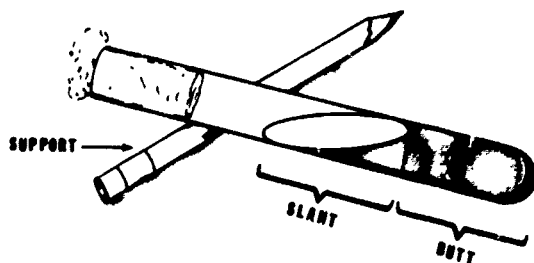

Figure 3-14. Diagram of typical slant culture.

figure 3-14, we have shown a correctly slanted tube. There should be an adequate butt and slant area if this form of medium is to be technically useful. It is commonly used in the identification of enteric organisms. It provides both an aerobic condition on the surface of the slant and anaerobic conditions in the butt. Depending on the specific medium used, the size of the butt can vary. A butt one-half the length of the slant is usually satisfactory.

**Exercises (053):**

1. How are lumpy media caused?
2. What are disadvantages of a lumpy medium?
3. How can you prevent a lumpy medium?
4. The choice of tubes used for solid or semisolid medium may be made based upon what two factors?

Complete the following statements:

5. To prepare slants, \_\_\_\_\_ the \_\_\_\_\_ medium into test tubes and \_\_\_\_\_ .
6. After completing the above step, \_\_\_\_\_ the tubes by some means to obtain the proper \_\_\_\_\_ area.
7. Once \_\_\_\_\_, do not disturb the tubes until the medium is completely \_\_\_\_\_ .
8. In a correctly slanted tube, there should be adequate \_\_\_\_\_ and \_\_\_\_\_ area if this form of medium is to be technically useful.
9. It provides both \_\_\_\_\_ conditions on the surface of the slant and \_\_\_\_\_ conditions in the \_\_\_\_\_ .

10. A butt \_\_\_\_\_ the length of the slant is usually satisfactory.

054. Point out other equipment used for dispensing media; cite the system available for dispensing and sterilizing media, their features, and factors which can influence the purchase of such equipment.

**Dispensing Media.** You can dispense a medium into test tubes or plates by several methods. Pipetting sterile media and seeded agar for antibiotic assays may be best accomplished with the use of automatic pipetting machines. You may obtain a pipetting machine from a commercial source to cope with the demands of an increased workload. Figure 3-15, A and B, illustrates such automatic devices. Glass or stainless steel syringes are employed in the pumping mechanisms in figure 3-15,A. The delivery tip is connected to a rubber

tubing and can be carried to a container to be filled; the intake tubing features the same mobility for connecting to the fluid reservoir. In figure 3-15,B, water and dehydrated media are added. The unit sterilizes the medium. After sterilization, the unit automatically adjusts to a preset dispensing temperature until you are ready to use it. All types of agar and nutrient broth can be sterilized under perfectly controlled conditions.

At present, complete systems for culture media preparation are available and are designed for efficient independent operation. They are closed systems which prepare, sterilize, and hold media at desired temperature, then fill as many as 500 Petri dishes an hour fed from a carousel module into a UV sterilized filling chamber. The dishes are automatically stacked and conveniently positioned. An automatic device is recommended because it is quicker, and consistent volumes are dispensed.

How you distribute medium aliquots will depend upon the use to which you put the aliquots. Petri

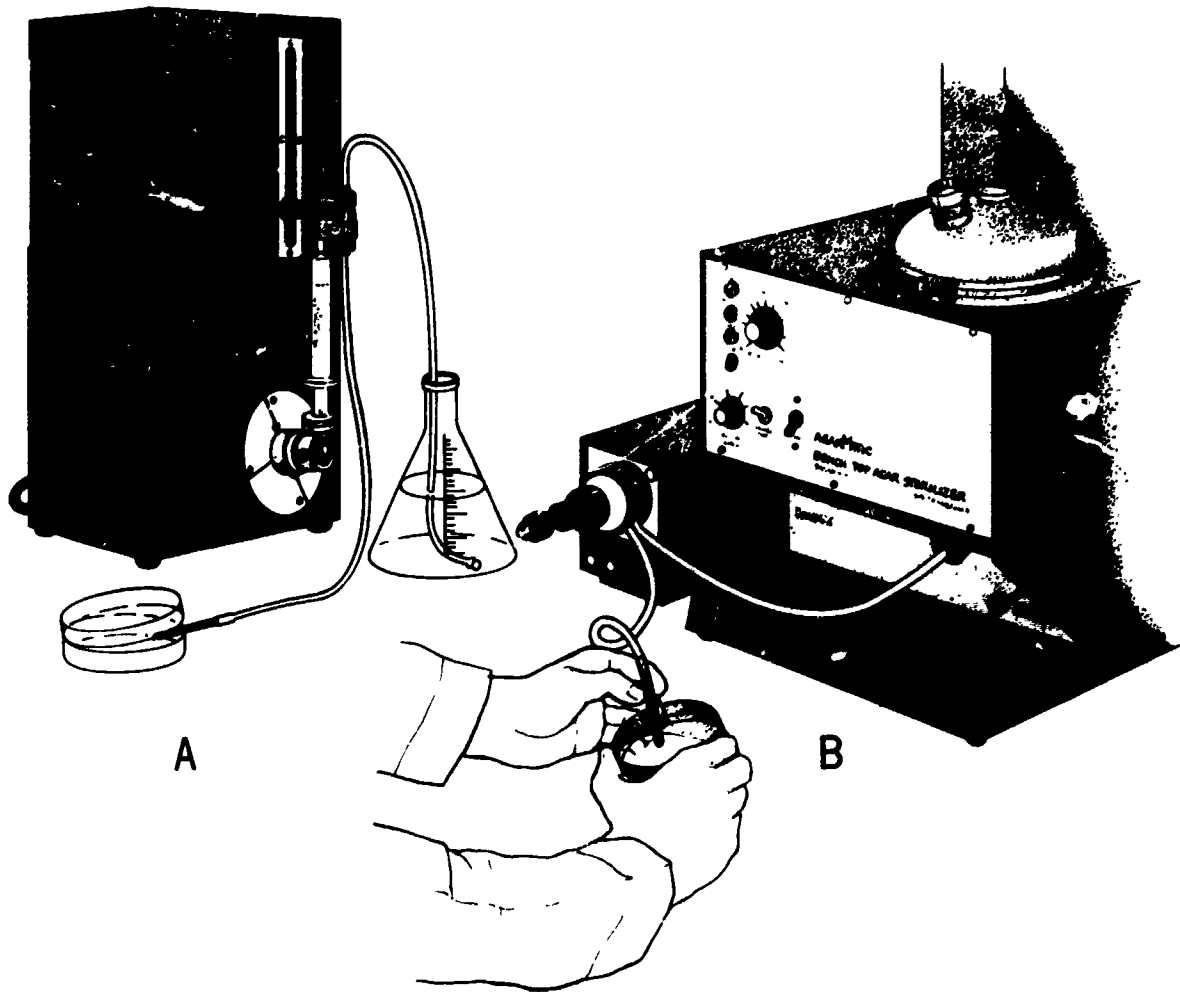

Figure 3-15. (A) Pipetting machine and (B) bench-top agar sterilizer/dispenser.



dishes give a large surface area on which to spread a clinical specimen so that you can get isolated colonies and pure cultures. Test tubes allow a small amount of medium to be used for such studies as motility, biochemical, and physiological testing. The purchase of tube media may be dependent upon such factors as increase in your workload, cost-saving and time-saving elements, and the interest of good quality control

After using a dehydrated medium, make sure that you have replaced the cap tightly on the stock bottle. This tight closure prevents absorption of moisture from the air and keeps the medium in powdered form. Store the bottles in a cool, dry place away from windows and heating equipment.

#### Exercises (054):

1. What equipment is best recommended for pipetting sterilized media and seeded agar for antibiotic assays?
2. What types of syringes are employed in the pumping mechanism of the given automatic pipetting machine?
3. How is the container filled using the automatic pipetting machine?
4. After sterilizing, the bench top agar sterilizer automatically does what other function?
5. What is one advantage of the bench-top agar sterilizer?
6. List some features of the complete systems presently available.
7. Before obtaining most tubed media from commercial sources, what are a few factors to consider?

055. Specify whether given statements correctly reflect rules for prepared media.

**Rules for Prepared Media.** Once you have prepared and poured the medium and it is ready for storing, you must observe the following rules:

a. Most commonly used media should be refrigerated.

b. Thioglycollate broth and semisolid media should be stored at room temperature. If the thioglycollate broth shows a pink or red layer at the surface, heat the tubes of media in a hot water bath before inoculation to drive off the excess oxygen before use. Heat the tubes only once; additional heatings make the broth unsuitable for bacterial growth.

c. All plates should be incubated at room temperature in an averted position for at least 18 hours or overnight to check for sterility.

d. When removed from the refrigerator, plates should be allowed to warm to room temperature before use. Inoculation of a cold medium lengthens the lag phase of the growth curve and may even kill some organisms.

e. Media containing a dye should be protected from light during storage because some dyes break down under strong light.

f. Consideration of moisture on tubes and Petri dishes due to refrigeration is likely to increase the chance of contamination of the medium in those particular tubes and dishes. Surface areas of media should be moist (not wet or dry) for best results. A wet surface makes it difficult to obtain isolated colonies and heightens the chances of contaminating an area of the laboratory while you are streaking the plate with a wire loop.

g. If media are to be stored for more than 5 days, they must be protected from dehydration by enclosing them in suitable containers such as plastic bags. A dried medium, as manifested by the medium retracting from the edge of the tube or plate, or by a dry, dull surface, should not be used because inaccurate results and abnormal growth will result.

#### Exercises (055):

Indicate whether each of the statements is true (T) or false (F), and correct those that are false.

T F 1. Most commonly used media should be refrigerated.

T F 2. Thioglycollate broth and semisolid media should be also stored at refrigerated temperature.

T F 3. Additional heating of thioglycollate tubes makes the broth quite stable for bacterial growth.

- T F 4. All plates should be incubated at 35° C in an inverted position for at least 18 hours or overnight to check for sterility.
- T F 5. Inoculation of a cold medium lengthens the lag phase of the growth curve and may kill some organisms.
- T F 6. Dyes in media are not affected under light and are quite stable.
- T F 7. Surface areas of media should be moist, not wet or dry, for best results.
- T F 8. A wet surface can often make it easier to obtain isolated colonies.
- T F 9. If media are to be stored for more than 5 days, they must be protected from dehydration by enclosing them in suitable containers.

**056. Identify given media additives in terms of their general applications and special purposes.**

**Media Additives.** There are many different reagents which have been added, or you may add to media for special purposes. Some reagents neutralize antibiotics which might be present in the specimen from a patient being treated for an infection; others promote growth of specific organisms having unusual nutritional needs; still others give instant identification of bacteria by color. We will take a look at some examples that you may run across in your work in bacteriology.

**Para-aminobenzoic acid.** This substance neutralizes the bacteriostatic effect of sulfonamides in culture media. Any medium that is inoculated with a sulfonamide-containing specimen may require the addition of 0.0002 percent paraaminobenzoic acid (PABA). If para-aminobenzoic acid is not available, you may use a similar concentration of procaine hydrochloride. This requirement for PABA particularly pertains to urine, blood, and fecal cultures from patients who may have received sulfonamide therapy.

**Sodium thioglycollate.** This is incorporated in media not only to permit the growth of anaerobic bacteria (because of its reducing action) but also to neutralize the bacteriostatic effect of mercurial and silver disinfectants. Mercury compounds are often used as preservatives in plasma, serum, biologicals, and pharmaceuticals intended for parenteral injection. You should use thioglycollate media to test the sterility of such products.

**Antibiotic inhibitors.** These are substances which neutralize the activity of antibiotics. They are added to culture media when clinical material is suspected of containing the corresponding antibiotics. For instance, you use the enzyme penicillinase to inactivate penicillin, and also to inactivate streptomycin to some degree. In culturing blood or other body fluids containing penicillin, you should add 1 ml of penicillinase to each 100 ml or less of sterile medium. This amount of the enzyme will inactivate 50,000 units of penicillin, the highest level of antibiotic that could be expected in 10 ml of blood or other body fluids. One ml also inactivates up to 1,000 units of streptomycin. Penicillinase does not interfere with the sulfa-inactivating action of para-aminobenzoic acid which may also be added to the medium. Keep penicillinase refrigerated during storage, because this reagent, like many enzymes, loses activity at room temperature.

**Dyes.** Dyes that are incorporated in media have selective bacteriostatic effects, but they are generally more active against Gram-positive bacteria. Crystal violet, brilliant green, and basic fuchsin are used in well-known selective media. Thionin and basic fuchsin are used in differentiating species of *Brucella*. If you are trying to isolate streptococci in the presence of staphylococci, the latter can be effectively inhibited if you add a 1:500,000 dilution of crystal violet to the broth or agar medium. Add one milliliter of autoclaved aqueous 1:25,000 solution of the dye to each 20 ml of medium.

**Sodium desoxycholate and other bile salts.** In proper combination with other substances in the media, bile salts inhibit the growth of Gram-positive bacteria. The addition of this inhibitor is useful when we try to isolate Gram-negative bacteria from clinical material in which both Gram-positive and Gram-negative bacteria are present. On desoxycholate agar, the motility of all flagellated bacteria is temporarily suppressed, and the swarming of certain species of *Proteus* is considerably inhibited. If citrates are also present, as in desoxycholate-citrate agar or SS agar, the bacteriostatic effect extends to some of the Gram-negative bacteria, notably the nonpathogenic enteric bacilli. Bile salts are not used successfully in media to isolate the gonococcus, meningococcus, or species of *Hemophilus*.

**Potassium tellurite.** When added to culture media in a final concentration of 0.01 percent, potassium tellurite retards the growth of most

Gram-negative bacteria also permits the growth of *Streptococcus* species and other Gram-positive organisms. A 0.03-percent concentration of tellurite will inhibit most *Streptococcus* species, but *Staphylococcus* species and the Corynebacteriae are still able to grow. Potassium tellurite is most useful in agar for the isolation of *Corynebacterium diphtheriae*. You can add it to broth to isolate Gram-positive bacteria, notably *Staphylococcus* species from mixed culture material overgrown by species of *Proteus* or other rapidly growing Gram-negative bacilli.

**Chloral hydrate.** If added to nutrient agar in a final concentration of 0.1 percent, chloral hydrate has little or no inhibitory effect on either Gram-positive or Gram-negative bacteria. It does, however, prevent the swarming of species of *Proteus*, rendering them temporarily nonmotile. Unlike bile salts and tellurite, chloral hydrate does not "lake" blood (lyse red blood cells), and so you may use it in blood agar plates without interfering with the development of characteristic zones of hemolysis by streptococci and other organisms.

**Media containing antibiotics.** In appropriate concentrations, these media are inhibitory to some organisms and noninhibitory to others. Antibiotic media may be used in the selective isolation of certain pathogens from specimens containing many contaminating microorganisms. For example, you may incorporate penicillin in Bordet-Gengou agar in a concentration of 1 unit per ml of medium. The antibiotic will restrict growth of some Gram-positive organisms of the throat and allow isolation of *Bordetella pertussis*, the cause of whooping cough. Penicillin and streptomycin in combination, or chloramphenicol alone, may be incorporated in media for the isolation of certain fungi from bacteria-contaminated specimens.

**Sodium azide.** This additive, which inhibits the growth of Gram-negative organisms, is also used in culture media to help isolate hemolytic *Streptococcus* species from the respiratory passages. Azide blood agar base is a selective medium for isolation of streptococci and staphylococci from materials of sanitary importance such as sewage, swimming pool waters, food, and other sources containing a mixed flora.

For details, you should consult catalogs such as the *BBL Manual of Products and Laboratory Procedures* and *Difco's Supplementary Literature*. They list many kinds of culture media for various purposes.

#### Exercises (956):

Match each media additive or related item in column B with the statements in column A by placing the letter of the column B item beside the number of the column A item that most nearly

describes it. Each element in column B may be used once, more than once, or not at all.

#### Column A

#### Column B

- |   |  |
|---|--|
| <ul style="list-style-type: none"> <li>— 1. This substance neutralizes the bacteriostatic effect of sulfonamides in culture media.</li> <li>— 2. This is incorporated in media not only to permit the growth of anaerobic bacteria but to neutralize the bacteriostatic effect of mercurial and silver disinfectants.</li> <li>— 3. This substance is used to inactivate penicillin, and also to inactivate streptomycin to some degree.</li> <li>— 4. Does not interfere with sulfa-inactivating action of para-aminobenzoic acid.</li> <li>— 5. Those incorporated in the media have selective bacteriostatic effects, but are generally more active against Gram-positive bacteria.</li> <li>— 6. Are used in differentiating species of <i>Brucella</i>.</li> <li>— 7. This salt inhibits growth of Gram-positive bacteria and will also suppress the motility of flagellated bacteria.</li> <li>— 8. Retards growth of most Gram-negative bacteria and is especially useful when trying to isolate <i>C. diphtheriae</i>.</li> <li>— 9. Prevents the swarming of species of <i>Proteus</i>, rendering them temporarily nonmotile.</li> <li>— 10. May be used in blood agar plates without interfering with the development of characteristic zones of hemolyses of streptococci and other organisms.</li> <li>— 11. May be incorporated in Bordet-Gengou agar in a concentration of 1 unit per ml on medium.</li> <li>— 12. May be used alone, incorporated in media for the isolation of certain fungi from bacteria contaminated specimens.</li> <li>— 13. This additive inhibits the growth of Gram-negative organisms and is also used in culture media to help isolate hemolytic <i>Streptococcus</i> species from the respiratory passages.</li> <li>— 14. May be consulted for details of the kinds of culture media for various purposes.</li> </ul> | <ul style="list-style-type: none"> <li>a. Dyes.</li> <li>b. Crystal violet.</li> <li>c. Penicillinase.</li> <li>d. Sodium desoxycholate.</li> <li>e. Chloral hydrate.</li> <li>f. Potassium tellurite.</li> <li>g. Sodium azide.</li> <li>h. Penicillin.</li> <li>i. Chloramphenicol.</li> <li>j. <i>Bergey's Manual of Determinative Bacteriology</i>.</li> <li>k. <i>BBL Manual of Products and Laboratory Procedures</i>.</li> <li>l. Para-aminobenzoic acid.</li> <li>m. Sodium thioglycollate.</li> <li>n. Thionin and basic fuchsin.</li> <li>o. Sodium chloride.</li> </ul> |
|---|--|

057. Point out the reasons for using biochemical media, the carbohydrates used, and the organisms producing specific reactions; and cite examples of the differential carbohydrate and carbohydrate fermentation media.

**Biochemical Media.** There are a wide variety of media to test for biochemical reactions. These reactions are valuable tools for getting more specific identifying information on an organism isolated in pure culture. We will point out the reasons for using biochemical media and cite examples of differential carbohydrate and carbohydrate fermentation media.

**Differential carbohydrate media.** Carbohydrates, including many of the 6-carbon and 12-carbon sugars such as glucose and sucrose, respectively, are excellent sources of energy for microorganisms. However, there are great differences in the ability of bacteria, though closely related taxonomically, to use one or more of these numerous compounds for energy and growth. This feature is particularly helpful to you in distinguishing among the morphologically similar facultative anaerobes which inhabit the human intestinal tract—for example, the enteric bacilli, especially *Salmonella typhi*, and the *Salmonellae* of food poisoning. For example, differentiation of enteric bacteria is achieved through the incorporation of lactose and sucrose in some brands of eosin methylene blue (EMB) agar, since the organisms that attack lactose will form colored colonies, whereas those that do not will appear as colorless colonies. Such media as EMB agar and MacConkey agar contain carbohydrates and chemicals that are inhibitory to many Gram-positive bacteria. The ability of an unknown organism to ferment glucose, but not lactose, provides valuable information. The breakdown of sugars is usually accompanied by the formation of identifiable byproducts. That is, you can test for the production of organic acids and certain gases which form in the culture during breakdown of a carbohydrate medium.

Two other examples of differential media commonly used to distinguish between closely related organisms are Kligler's iron agar (KIA) and triple sugar iron agar (TSI). These media are useful because they take advantage of fundamental differences in the physiology of bacteria that seem identical from outward appearance.

KIA contains lactose, dextrose, nutrient agar, and phenol red indicator. TSI contains sucrose in addition to lactose and dextrose. Color changes in these media, caused by selective fermentation of the carbohydrates, form the basis for genus and species identification. KIA and TSI also contain an iron compound which indicates whether or not an organism can produce hydrogen sulfide ( $H_2S$ ). As fermentation proceeds, the medium is blackened

through the reaction of  $H_2S$  and iron to form iron sulfide.

The study of reactions in KIA and TSI differential media usually leads only to tentative or presumptive identification of an organism. Identity must be confirmed by other means such as the fermentation of additional sugars and sugar alcohols, amino acids, or by serological procedures. This situation comes about because bacteria belonging to related but different genera sometimes give identical results in one or more of the reactions seen in KIA and TSI media. For example, *Enterobacter cloacae*, *Escherichia coli*, and *Klebsiella pneumoniae* yield both a yellow (acid) slant and butt in a TSI culture tube. The presence of gas bubbles and  $H_2S$  production can often be used as distinguishing characteristics, but in general, reaction on differential carbohydrate media serves as a preamble to further steps in identification.

**Carbohydrate fermentation media.** To study carbohydrate fermentation you must choose a proper basal medium. One such medium is trypticase agar base. Trypticase agar base permits accurate fermentation determinations. Since small amounts of acids are not readily dispersed throughout the medium, positive reactions may often be determined more quickly than in liquid media. Carbohydrate taxo discs or appropriate carbohydrates may be added for fermentation studies. This medium is particularly recommended for use with clostridia, bacilli, common micrococci, enteric bacilli, and other organisms not generally considered to be nutritionally fastidious. Cystine trypticase agar is another such medium for detection of motility. With added carbohydrates, for fermentation reactions of fastidious organisms, including *Neisseria*, *Pasteurella*, streptococci, *Brucella*, *Corynebacteria*, and vibrios, may be readily cultivated on CTA medium. Carbohydrates may be in the medium, or carbohydrate taxo discs can be conveniently selected and added as needed to tubes of plain CTA medium. Both CTA and trypticase agar base contain phenol red as the indicator. CTA contains sodium chloride, and trypticase agar base does not. These media have a pH of about 7.3 to 7.4 to detect carbohydrate fermentation.

In the presence of an indicator, a change of pH due to accumulation of metabolic products gives a visual indication of fermentation. Specific reactions on differential and carbohydrate media will be shown later in our study of individual genera of the pathogenic microorganisms.

#### Exercises (057):

1. How can you use carbohydrate fermentation studies as an aid in identifying genera and species of bacteria?



1. How can you use carbohydrate fermentation studies as an aid in identifying genera and species of bacteria?
  2. What two carbohydrates are incorporated in some brands of EMB for differentiation of enteric bacteria?
  3. Why are different media such as KIA and TSI useful in the identification of enteric organisms?
  4. What sugars does TSI medium contain?
  5. Which of the sugars contained in TSI medium is lacking in KIA medium?
  6. As fermentation proceeds, TSI may be blackened through the reaction of H<sub>2</sub>S and iron to form what other compound?
  7. What genera of organisms commonly produce both yellow (acid) slant and butt in a TSI tube?
  8. What other characteristics of TSI are often used as distinguishing characteristics?
  9. What two basal media may be used for nonfastidious and fastidious organisms respectively?
  10. Why can positive reactions on trypticase agar base be more quickly determined than in liquid media?
  11. What are some organisms for which the use of Trypticase agar base is recommended?
  12. What are some organisms which may readily be cultured on CTA medium?
  13. What causes the change in pH and subsequent visual indication of fermentation on the medium?
058. Identify the given media or biochemical reactions in terms of their principles, reagents, interpretation, and procedures.

**Biochemical Tests.** Over the years, many techniques have been developed to give information beyond that gained by observing growth on differential carbohydrate media such as Kligler's and triple sugar iron agar. For the most part, however, these techniques still depend on the detection of breakdown products of protein and carbohydrate metabolism, or oxidation-reduction reactions and fermentation patterns typical of some bacteria but not others. These are the classical IMVIC reaction coupled with the identification of various enzymatic capabilities and certain fermentative reactions to achieve an identification. Media capable of displaying these reactions are now readily available commercially, as individual tubed media, various kits, and in some instances, paper strip indicators. Reliability varies, but when used with control organisms, they may be used with assurance. The procedures discussed in the following paragraphs are representative of the special tests commonly used.

**Indole production.** This procedure is based on the ability of certain organisms to split the amino acid tryptophan to alanine and indole. You can detect the liberated indole by adding Kovac's reagent (para-dimethyl-amino-benzaldehyde). A red color indicates positive indole production. There are several media available for this purpose, but in all cases, be certain that tryptophan (in the form of peptone) is present in the medium.

Tests for indole production with Ehrlich's or Kovac's reagents may be made after 24-hour incubations, but all negative tests should be repeated on a separate 48-hour broth culture.

**Methyl red and Voges Proskauer (MR-VP) tests.** These reactions are used frequently to differentiate certain bacteria of the enteric groups. The methyl red test is used to identify organisms that ferment dextrose and produce acids as final end products. The test is based upon a change in the pH of Clark and Lub's broth. An indicator dye, methyl red, turns the broth a yellow color when the pH is greater than 4.5. This is a negative MR test. A pH of 4.5 or less will turn the solution a distinct orange-red or red. This is a positive test.

The Voges Proskauer test is based on the ability of some organisms to produce a neutral end product, acetyl-methyl-carbinol, from an acid resulting from dextrose fermentation. Dextrose is fermented to pyruvic acid to acetaldehyde to acetyl-methyl-carbinol. A few drops of 5 percent alpha-naphthol in absolute alcohol and 40 percent potassium hydroxide are added to a broth culture. A positive test develops a copper or red color. A yellow color is regarded as a negative test.

*Escherichia* is V-P negative; *Enterobacter* and *Klebsiella* are V-P positive. These organisms may be used as positive and negative controls.

*Simmon's citrate*. Simmon citrate agar is a synthetic medium that incorporates citrate as the only source of carbon. Some of the Gram-negative bacilli are able to utilize carbon in this form and can thus survive and grow well on this medium. As growth continues, they break down the inorganic ammonium and citrate salts and produce alkaline products, thus giving the blue color (alkaline) reaction in the medium. Those organisms that are unable to utilize carbon in the form of citrate do not survive on the medium, and it retains its normal green color. The pH indicator used is bromthymol blue, range 6.0 (green) to 7.6 (blue). The appearance of visible growth is accompanied by an alkaline (blue) change of the indicator.

*Nitrate reduction test*. Some organisms can reduce nitrate beyond the nitrite stage to nitrogen or ammonia. Incubation will frequently produce frothing in the broth medium and cracks in the agar as a result of nitrate reduction and subsequent nitrogen gas production. Add equal amounts of sulfanilic acid and dimethyl-alpha-naphthylamine to develop the pink or red color which indicates the presence of nitrites. A negative test for nitrite, therefore, should not be construed necessarily as a negative nitrate reduction test without first testing for the presence of unreduced nitrate. This may be done by adding a minute amount of zinc dust to the tube. The development of a red color indicates the presence of unreduced nitrate.

*Proteolytic activity*. This activity of bacteria is another aid to their individual identification. Some bacteria produce enzymes which break down protein and protein derivatives. For example, they can liquefy gelatin and cause coagulated egg albumin to become fluid again. You can use gelatin liquefaction to detect this proteolytic activity in the laboratory, but you can also use coagulated serum as a test medium. Gelatin liquefaction is frequently used to distinguish the genus *Enterobacter* from other members of the family *Enterobacteriaceae*, primarily the genus *Klebsiella*. Coagulase-positive *Staphylococcus* species usually liquefy gelatin.

*Oxidation-fermentation medium*. The oxidation-fermentation medium distinguishes oxidative acidity from fermentative acidity. One tube for each test contains added carbohydrates such as dextrose,

lactose, and sucrose and an indicator of acid production (bromethymol blue).

a. To determine the oxidation fermentation characteristics of a pure culture, inoculate two tubes of O-F basal medium containing 1 percent dextrose. Overlay one of the tubes with sterile petrolatum jelly. Incubate at 35° to 37° C for 48 hours or longer.

b. Acid formation in the open tube only indicates oxidative utilization of dextrose. Acid formation in both the open and closed tubes indicates fermentative utilization of dextrose. No acid in either tube indicates the nonutilization of dextrose.

The O-F medium is useful in identification of *Pseudomonas*, *Acinetobacter*, and *Alcaligenes*. Remember to use controls of known bacterial cultures with each test: oxidation, *Pseudomonas* (oxidizer, nonfermenter); fermentation, *Escherichia coli* (fermenter, aerogenic); inactive, *Alcaligenes faecalis* (nonoxidizer, nonfermenter).

There are many types of media, each with a variety of uses. The preceding paragraphs have given you a basic explanation of how certain reactions take place and their role in identification of bacteria. As we proceed with the discussion of various bacteria and their growth and identifying characteristics, we will discuss other special media or additional tests as they are needed. For you who are interested, there are many text books available to you in medical libraries and clinical laboratories which detail the biochemistry and metabolism of bacteria in various environments.

#### Exercises (058):

Match each medium or related biochemical reaction in column B with the statements in column A by placing the letter of the column B item beside the number of the column A item that most nearly describes it. Each element in column B may be used once or more than once.

#### Column A

#### Column B

- |  |   |
|--|---|
| <ul style="list-style-type: none"> <li>— 1. A positive test is detected by the addition of Kovac's reagent and is indicated by a red color.</li> <li>— 2. The test is based upon a change in the pH of Clark and Lub's broth.</li> <li>— 3. In this test, the indicator dye turns the broth a yellow color when the pH is greater than 4.5.</li> <li>— 4. This test measures the ability of an organism to produce acids from dextrose.</li> </ul> | <ul style="list-style-type: none"> <li>a. Voges Proskauer test.</li> <li>b. Proteolytic activity.</li> <li>c. Nitrate reduction test.</li> <li>d. Methyl red.</li> <li>e. Indole production.</li> <li>f. Oxidation-fermentation medium.</li> <li>g. Simmon citrate agar.</li> <li>h. Oxidation reaction.</li> <li>i. Fermentative utilization of dextrose.</li> </ul> |
|--|---|



Column A

- 5. This test is based on the ability of some organisms to produce a neutral end product, acetyl-methyl-carbinol, from an acid resulting from dextrose fermentation.
- 6. The given method of this procedure requires the use of 5 percent alpha-naphthol in absolute alcohol and 40 percent potassium hydroxide added to a broth culture.
- 7. The pH indicator used this medium is bromthymol blue, and as growth continues, bacteria break down inorganic ammonium and related salts to produce alkaline products with the appearance of a blue color.
- 8. A positive test is indicated by the addition of equal amounts of sulfanilic acid and dimethyl-alpha-

Column B

- naphthylamine to develop a pink to red color.
- 9. A minute amount of zinc dust is added to the tube to confirm negative test results; the development of a red color indicates the presence of this unreduced substance of this test
- 10. Gelatin liquefaction is used to detect this reaction
- 11. To determine the test using this medium of 1 percent dextrose, inoculate two tubes with pure cultures. Overlay one tube with sterile petrolatum jelly; and incubate at 35° to 37° C for 48 hours.
- 12. This reaction is indicated by utilization of dextrose and acid formation in the open tube.
- 13. This reaction is commonly produced by *Escherichia coli*.
- 14. This reaction is indicated by acid formation in both the open and closed tube.

## Inoculation of Media for Isolation of Bacteria

PURE CULTURES are essential to the study of colony characteristics, biochemical properties, morphology, staining reaction, immunological reactions, and the susceptibility of a microbial species to antimicrobial agents.

Our major problem in diagnostic bacteriology is to effectively separate pathogenic microbes from harmless organisms with which they are closely associated in nature. From the moment of birth the human body is heavily populated with bacteria representing many different genera. Some of these microbial populations are *transient*, but others are *resident* in the sense that they can almost always be recovered in large numbers from the skin, the body orifices, and the intestinal tract—the so-called normal flora.

Once we can immobilize a single-celled microorganism on a solid culture media suitable for growth and reproduction, its progeny provide us within the space of a few hours the material needed for cultural studies—an isolated colony visible to the naked eye.

Beyond this point, different procedures developed over the years for subculturing the colony enable us to select the condition of growth best suited to bring out the morphological and physiological characteristics which experience has shown will establish the identity of unknown organisms.

### 4-1. Isolation and Cultivation of Bacteria

In almost every case the pus, urine, stool, or other clinical specimen submitted to the laboratory contains more than one kind of organism. The organisms may all be pathogens, or one or more pathogens may be found among several saprophytes. There are several ways of obtaining pure cultures from mixed populations, although more than one method may have to be used in processing a single specimen.

The choice of methods, or combination thereof, depends upon the nature of the specimen. These are the commonly used procedures:

- Plating (streak or pour plates).
- Subculturing.
- Dilution.

**059.** Cite the purpose of the streak plate technique, arrange in the proper order the given technique for streak plate, and state reasons for procedures after completing streak plate.

**Streak Plate.** The streak plate technique, if effectively performed, is probably the most practical and most useful method for obtaining discrete colonies and pure cultures. Methods of streaking may vary from one laboratory to another, but the following technique may be used for inoculating any type of agar plate. Streaking may be accomplished in the sequence of steps shown in figure 4-1. Although this procedure has been designed for broth cultures, it may be used for cultures from agar plates and agar slants.

Collect a loopful of inoculum on a flame-sterilized wire loop needle and proceed as indicated in Figure 4-1.

a. Place a loopful of the inoculum near the periphery of the plate and streak back and forth over the area.

b. With the loop, spread the inoculum until one fourth of the plate surface is covered.

c. Cut deeply or stab the loop into the agar and continue streaking to cover the second quarter of the plate overlapping the previous streak.

d. Stab the loop as before and continue streaking.

e. Flame the loop, allow it to cool, then overlap the previous streak and complete your streaking.

f. Lift your loop and streak the center of the plate in a zigzag motion.

As you continue the streaking, fewer and fewer cells are dispersed by the loop, and finally single cells are spread across the agar. Each cell will grow into a visible colony under suitable environmental conditions. If you are culturing clinical material on a cotton swab, you can roll the swab over a small area of the agar surface at the edge of the plate. Then, spread the inoculum with a wire loop as just described.

After completing the above procedure, turn the plate upside down to prevent contamination by

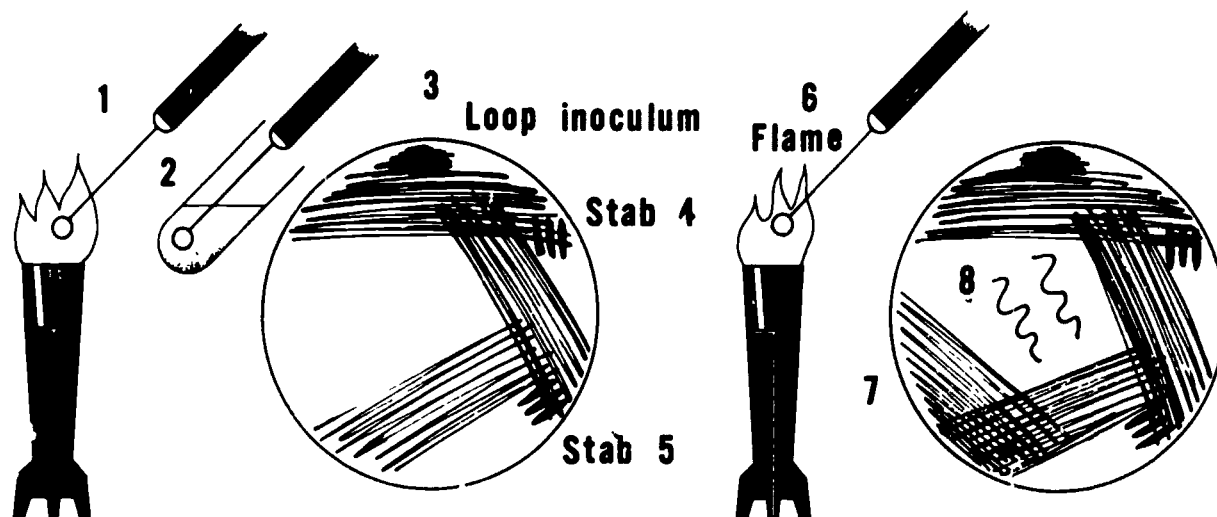

Figure 4-1. A procedure for streak plate.

water condensation. Incubate at 35° to 37° C. You may notice distinct colonies in the central portion of the plate. However, additional information concerning hemolytic activity may be obtained from the effect of reduced oxygen tension of the organisms stabbed into the agar. In some instances, beta hemolytic streptococci may appear to be alpha hemolytic on the surface. The "O" hemolysins of beta hemolytic streptococci are active only under reduced oxygen tension such as those provided the organisms stabbed into the agar. However, in cases where different types of media are used and the atmospheric growth condition consists of reduced oxygen tension, the stabbing, as shown in figure 4-1, may be omitted.

As a routine matter, after incubation at 35° to 37° C for 18 to 24 hours in the inverted position, isolated colonies are examined grossly and microscopically for characteristics of various genera and species. You can "pick" pure cultures by touching the center of a colony with a wire needle and subculturing the material to suitable broth or agar media for additional tests.

#### Exercises (059):

1. The streak plate technique is practical and most useful for what reasons?
2. How does this surface streaking technique used on plate cultures help in the isolation of a bacterium?

3. Arrange the following steps in the proper order. In performing the streak plate technique, the technician must first begin with the following steps and proceed accordingly:
  - a. Place a loopful of inoculum near the periphery of the plate.
  - b. Stab the loop as before and continue streaking.
  - c. With the loop, spread the inoculum until one fourth of the plate surface is covered.
  - d. Collect a loopful of inoculum on a flame-sterilized wire loop needle.
  - e. Stab the loop into the agar and continue streaking to cover the second quarter of the plate overlapping the previous streak.
  - f. Lift your loop and streak the center of the plate in a zigzag motion.
  - g. Flame the loop, allow it to cool, then overlap the previous streak and complete the streaking.

4. Why are the plates turned upside down after streaking?
5. At what portion of the plate would you *most* likely find information concerning the hemolytic activity of beta hemolytic streptococci and why?
6. How can you "pick" pure colonies from the culture?

**060.** State the purpose of pour plates, their uses, procedures, and reporting methods; cite the meaning of the results of the reports of urine colony counts.

**Pour Plates.** Pour plates are normally used to determine the approximate number of viable organisms in a liquid medium such as water, milk, urine, or broth culture. They are reported as the number of colony-forming units per milliliter of inoculum. Pour plates are frequently used to determine the hemolytic activity of deep colonies of some bacteria such as streptococci, by using blood agar. The pour plates also provide excellent study of pure cultures, especially when the components of a mixed culture are to be separated. Distinctive features such as size, shape, and color of the colonies are recognized.

The method requires the preparation of serial dilutions of the specimen in sterile water or saline. These dilutions are pipetted into sterile Petri dishes. Melted agar medium is added and evenly distributed by tilting plate and cooling. After incubation at 35° to 37° C, the colonies may be examined as surface or subsurface colonies for differences, or they may be counted. The melted agar medium should not exceed 50° C and the dilution should be adequately mixed.

**Diluting.** In the description of a pour plate technique we touched on the advisability of diluting the inoculum from a clinical specimen to insure that well-isolated colonies would grow out on the plate. You can also use dilution cultures to estimate the number of bacteria in a specimen. A urine sample, for instance, may contain so many bacteria that it would be impossible to obtain separate and pure colonies by plating the undiluted urine. Diluting this specimen, say 1:100 and 1:1000 in saline, not only assures isolation of colonies, but allows you to make a colony count. Multiplying the number of colonies on the plate by the dilution factor tells the physician the number of bacteria per ml of urine. In this calculation, each colony is assumed to be the progeny of a single bacterium present in the original specimen.

In many laboratories the calibrated loop-direct streak method is commonly used and has virtually replaced the dilution of urine with saline. However, after proper incubation, the number of colonies present is estimated and reported as a measure of the degree of bacteria.

**Exercises (060):**

1. For what purpose are pour plates used?
2. What are some examples of specimens from which pour plates might be made?

3. How are they reported?
4. For what purpose would pour plates be used in relationship to streptococci studies?
5. When pour plates are used to separate components of mixed cultures, what distinctive features may be recognized?
6. The pour plate method may require preparation of serial dilutions in either of which two substances?
7. The melted agar should not exceed \_\_\_\_°C and the dilution should be \_\_\_\_\_.
8. What two dilutions may be used for urine samples to assure isolation of colonies for counting by the given method?
9. How is the colony count reported?

**061.** State reasons for subculturing with the use of liquid broth, slant, and stab cultures, and cite given techniques.

**Subculturing.** After you have obtained isolated colonies by the streak plate or pour plate technique, you usually need to transfer (subculture) them to tubed media for further study. Restreaking from one plate to another is one form of subculturing to obtain isolated growth of mixed flora. There are several different configurations in tubed media, each developed for a specific purpose, but we will limit our discussion to the following

- Liquid broth cultures.
- Slant cultures.
- Stab cultures.

**Liquid broth cultures.** These are used to maintain the viability of an organism by successive transfers to fresh medium; to grow a large volume of liquid culture for inoculation to differential or fermentation media. To inoculate a broth culture,

use a wire loop to pick a colony from a plate. Emulsify this material on the moist wall of the tube just above the liquid level, and wash down the solid matter by tilting the tube. If the inoculum is liquid instead of growth from a colony, simply place a loopful in the broth and disperse it by gentle agitation. A word of caution, though: if you swirl the loop too vigorously, droplets will escape from the tube and contaminate the surrounding air. The resulting aerosol can infect you and your fellow workers.

**Slant cultures** Slant cultures are used for biochemical tests as well as to maintain stock cultures in the laboratory. We learned earlier in Chapter 3 that "slants" are tubed agar media that have been allowed to harden in a near-horizontal position to give a large surface area for bacterial growth. You prepare them by streaking an inoculum over the slant surface from bottom to top. If the slant contains water of condensation at its base, drain the moisture out by inverting the tube before inoculation. Do not spread the water over the surface of the slant because the resulting growth will not give a characteristic appearance.

**Stab cultures.** These are also used in biochemical tests. You can make stabs with a straight needle into tubes of solid or semisolid medium (not slanted) which hardened in a vertical position to give great depth and a small surface area. You should center the stab line and extend it approximately two-thirds of the depth of the medium. Insert the inoculating wire straight and evenly to avoid tearing the medium and creating bubbles. Later, these bubbles could be mistaken for gas production. In some instances, the features of stab and slant cultures are combined. For instance, the differential medium, triple sugar iron agar, described in the preceding chapter is both a slant and stab culture. It is used to detect sugar fermentation as well as H<sub>2</sub>S production in the same tube.

#### Exercises (061):

1. List some uses of broth cultures.
2. What technique may be used to inoculate a broth culture with a colony from a plate?
3. What can happen if you swirl the loop too vigorously in inoculating a broth?
4. What are two uses of slant cultures?

5. What would result if the condensed water over the slant surface is not allowed to drain before inoculation?
6. For what general purpose are stab cultures used?
7. How should the stab be made in stab cultures?

#### 4-2. Initial Isolation Procedures

Specimens from many sources containing a wide spectrum of bacteria constitute the workload of a bacteriology section. In setting up cultural conditions favorable to isolation of the diverse species found in clinical material, you should keep in mind the growth parameters that we discussed in the previous chapter. Incubation temperature, pH, moisture, the proper gaseous atmosphere, and suitable nutrients all come into play in establishing an ideal environment for propagation of pathogens. Specific reactions for identifying the organisms will be discussed in greater depth in a later chapter of this volume and in Volume 2.

**062. State pathogenic organisms most often found in throat and nasopharyngeal cultures; cite media recommended for use when specific conditions are suspected; and specify the significance of characteristic growth of thioglycollate media.**

**Throat and Nasopharyngeal Swabs.** The selection of media for culturing throat and nasopharyngeal specimens must be broad because so many different genera may be involved. The pathogenic organisms most often found in the throat and nasopharyngeal area include species of beta hemolytic streptococci, *Staphylococcus aureus*, *Corynebacterium diphtheriae*, *Borrelia vincentii*, *Hemophilus*, and *Bordetella* species.

For routine cultures, inoculate a blood agar plate by either the streak or pour plate method, generally the former. Blood agar differentiates between the several types of hemolysis (lysis of red blood cells around the colony) and furnishes the nutrients required by many fastidious pathogenic bacteria.

When further study is required, pour plates are useful in revealing certain strains of group A streptococci that may appear to be non-hemolytic when grown on the surface because only streptolysin "O" is produced by these strains, which are active under microaerophilic conditions. However, most strains of group A streptococci show beta hemolysis around surface colonies due to



their production of streptolysin S, which is oxygen stable.

Incubate all throat and nasopharyngeal cultures at 35° to 37° C in a candle jar or a 10-percent carbon dioxide incubator for 12 to 24 hours. The increased CO<sub>2</sub> is not harmful to the other pathogens and is required for isolating *Neisseria meningitidis*, the agent of epidemic meningitis. Chocolate agar or Thayer-Martin medium is preferred by some strains of *N. meningitidis*, so in addition, streak a plate of chocolate agar or Thayer-Martin in cases of suspected meningitis.

It is a good idea to make two or three cuts in the agar with a loop in the heavily inoculated area of the streak plate. This will allow subsurface growth of streptococci which produce the "O" hemolysin under microaerophilic conditions. Another technique to detect the hemolysin is to place a sterile coverslip on the surface of the streaked plate. The medium beneath the coverslip is devoid of atmospheric oxygen, permitting the "O" hemolysin to form.

Dependent upon the extent of studies required, a part of the specimen may be inoculated to thioglycollate broth. It should be noted that the results obtained from throat cultures on blood agar depend to a great degree on the type of blood used in preparing the plates. Sheep blood agar plates are best recommended for these cultures. It produces an inhibitory action on the growth of *Hemophilus hemolyticus*, a normal throat commensal whose beta hemolytic colonies may be confused with those of beta hemolytic streptococci. When in doubt, a Gram stain of the suspected colonies will rapidly differentiate Gram-positive cocci from Gram-negative bacillary forms of *H. hemolyticus*. Outdated human blood is not recommended for preparation of blood agar because of its content of possible inhibition factors such as antibacterial substances, antibiotics, or an excess citrate ion.

The type of growth in the thioglycollate medium (sediment, pellicle, floccules) gives a hint of the next step to take in identification. You should then subculture organisms seen in the broth and incubate them further under aerobic or anaerobic conditions, depending on the level at which the growth appeared within the thioglycollate medium. A pellicle on the surface shows the presence of an aerobe. Conversely, growth deep in the tube must have been formed by an anaerobe, so you should incubate subcultures anaerobically in this instance. The Gram reaction and morphology on a stained slide of the bacteria in thioglycollate medium will suggest the type of medium and atmospheric environment to be used in subculturing.

Inoculate a part of the throat or nasopharyngeal specimen to a slant of Loeffler's serum medium and chocolate tellurite agar if *Corynebacterium diphtheriae* is suspected. The organism grows out on Loeffler's in 18 to 24 hours at 35° to 37° C.

You should allow the chocolate tellurite agar to incubate at 35° C for 24 to 48 hours to allow the formation of the gray to black colony pigment characteristic of *C. diphtheriae*. If the physician wants to rule out whooping cough, he may ask for a "cough" plate of Bordet-Gengou medium. By this technique, the patient coughs directly onto the surface of the plated medium, and *Bordetella pertussis* expelled in saliva droplets appears as isolated colonies on the surface of the selective medium.

One of the enteric media such as eosin methylene blue or MacConkey will aid in isolating Gram-negative bacilli that may be present in the throat. Recovery of *Proteus* spp and *Escherichia coli* from throats of young children is common.

As part of the initial processing, make a direct slide smear from the specimen, particularly if Vincent's angina is suspected. It is a pseudomembraneous or ulcerative infection of the gums, mouth, or pharynx. It is caused by a Gram-negative spirochete, *Borrelia Vencentii*, and a straight or slightly curved, anaerobic Gram-negative rod with sharply pointed ends, *Fusobacterium fuseforme*, in symbiotic association with other oral organisms. Because these organisms are frequently present in the normal mouth and gums, to be of diagnostic significance their presence in smears must be correlated with the clinical findings.

If you are looking specifically for staphylococci, it helps to streak a medium containing mannitol and a high concentration of sodium chloride in an effort to isolate pathogenic *Staphylococcus aureus* in minimum time. A medium such as Mannitol salt agar is selective in this respect. Colonies that produce a yellow discoloration of the medium are mannitol fermenters. The fact that growth has occurred in a high salt concentration is presumptive evidence that the organism belongs to the genus *Staphylococcus*. You must necessarily follow with confirmatory tests as to species.

#### Exercises (062):

1. List some pathogenic organisms most often found in the throat and nasopharyngeal areas.
2. As a medium used for routine cultures, what two advantages does blood agar have?
3. What type of hemolysins are produced by most strains of group A and under what atmospheric conditions are they grown?



4. What two media may be used when *Neisseria meningitidis* is suspected?
  5. Why is it a good idea to make two or three cuts in the agar with a loop in the heavy inoculated area of the streak plate?
  6. The results obtained from throat cultures on blood agar depend to a great degree upon what factor?
  7. Give one important reason why sheep blood agar plates are best recommended for throat cultures.
  8. Why is outdated human blood NOT recommended for preparation of blood agar?
  9. If you noted a deep growth in the thioglycollate medium, under what atmospheric condition would you recommend subculturing for the most likely recovery of the organism?
  10. If *Corynebacterium diphtheriae* is suspected, what media would you inoculate for possible isolation of the organism?
  11. If a "cough" plate was requested when *Bordetella pertussis* is suspected, what medium would you recommend?
  12. Why would one wish to use enteric media for throat culture?
  13. What should be done as part of the initial process with the specimen when Vincent's angina is suspected from a throat swab?
  14. What two organisms may be observed in Vincent's stomatitis?
  15. What medium would you use in an effort to isolate *Staphylococcus aureus*, and what colony reaction do the organisms produce on the media?
- 063. Cite some organisms commonly isolated from sputum and other related specimens, media used for inoculation, and the significance of the Gram stain in the processing procedure.**
- Sputum, Bronchial, and Gastric Washing for Acid-Fast Bacteria (AFB). You can find a wide variety of organisms, some of them highly infectious, in cultures of these specimens. In figure 4-2, we have presented a suggested scheme for successfully isolating representative microorganisms. The specimen is usually derived from a true or suspected case of pneumonia or tuberculosis. Generally, the physician will specify that he wants "acid-fast" or tuberculosis studies. Otherwise, you set up routine procedures that will grow out bacteria other than *Mycobacterium tuberculosis*, which requires special processing steps. Organisms most likely to be isolated from sputum and other specimens in this category are *Staphylococcus aureus*, *Streptococcus* spp, *pneumoniae*, *Klebsiella pneumoniae*, *Hemophilus* spp, *Bordetella pertussis*, the *Candida* spp, and *Mycobacterium tuberculosis*.
- You can do practical and efficient isolation of these organisms, except for the tubercle bacillus, by inoculating blood and chocolate agars, enteric media, and thioglycollate broth in accord with the cultural conditions we suggested for throat and nasopharyngeal swabs. You should also prepare a smear to check visually for bacteria in the specimen. Remember, a stained smear gives only a rough indication of the number and kind of organisms present. If the stain is done properly, however, the size, shape, and Gram reaction of the microbes will serve as a guide to subsequent culture procedures.
- Exercise (063):**
1. Name some organisms most likely to be isolated from sputum and other related specimens.
  2. Which media may be inoculated from sputum specimens for isolation of organisms other than the tubercle bacillus?
  3. If properly done, the size, shape, and Gram stain of the organisms in the specimen will provide what advantage?

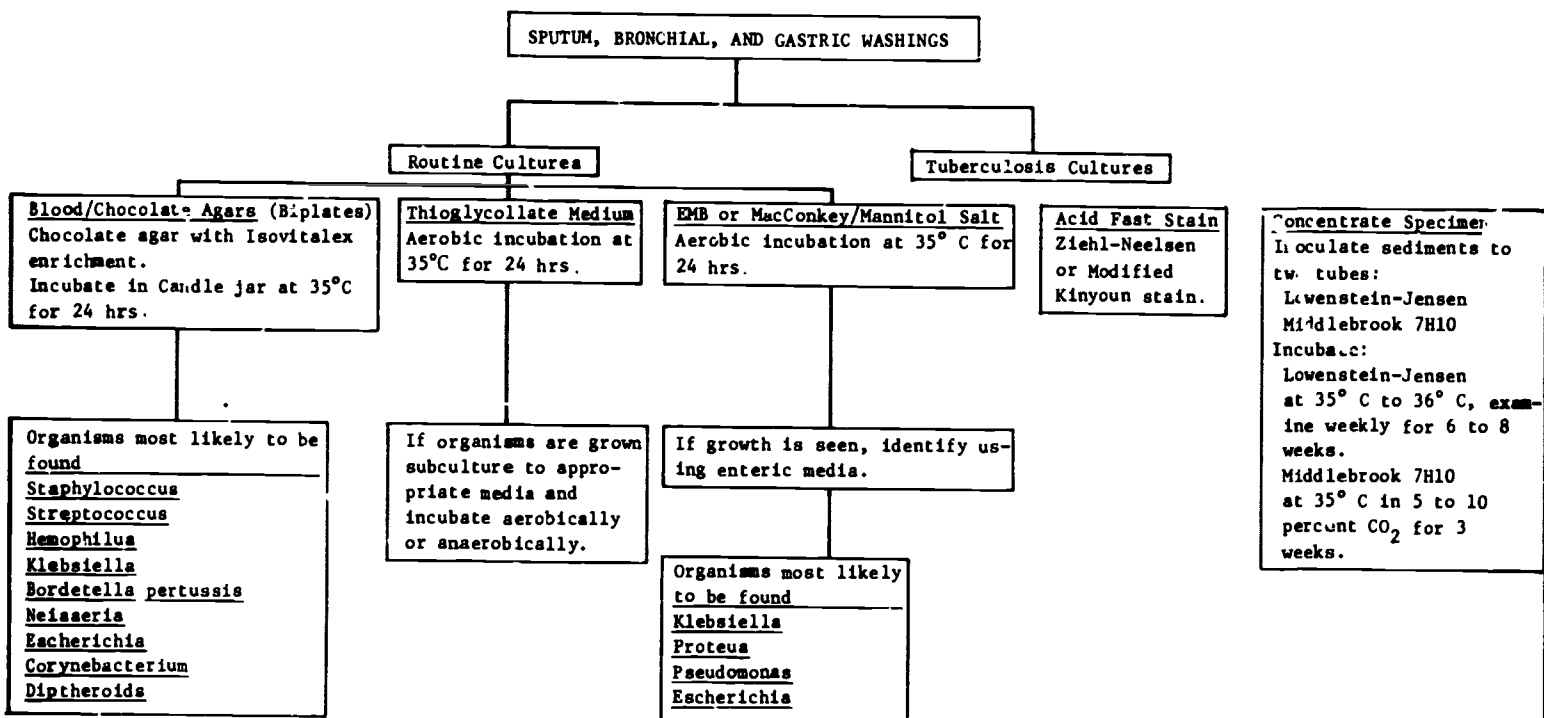

Figure 4-2. Flowchart for processing sputum, bronchial, and gastric washings

064. State the order of processing sputum specimens for routine and acid fast cultures; the method of choice for sputum and urine collection; and the procedure recommended when specimens of gastric washings are sent by mail.

**Acid-Fast Studies.** For acid-fast studies (AFB) you need special media, and the sputum specimen itself is handled differently. If a routine culture is requested in addition to a culture for tuberculosis (TB), you should set up the routine work before you start TB processing, or else you must use two separate specimens. This is necessary because the digestion and concentration technique for isolation of the tubercle bacillus destroys other microorganisms in the sputum.

Successful culture requires getting the freshest possible specimens. A good sputum specimen is 5 to 10 ml of recently discharged material from the bronchial tree, with minimal amounts of oral or nasal contaminants. Three such small specimens, kept refrigerated until processed, are better than a pooled 24-hour sample of equal total volume. Pooling of sputum for several days is not desirable because sputum may become toxic to tubercle bacilli and contamination may increase. The urine specimen of choice is the early morning clearly voided midstream portion. Again, multiple specimens of this kind are superior to a 24-hour pooled specimen. Keep refrigerated prior to processing. Gastric washings are collected in the morning after the patient has fasted. You must process stomach washings without delay because the highly acid gastric juices will inactivate the tubercle bacilli. Bronchial and gastric washings are collected by a physician or other qualified personnel. Direct smears and concentration procedures should be instituted as soon as possible after collection of the specimens to insure recovery of viable acid-fast bacilli. If the specimen is to be sent through the mail, try to neutralize the acidity with buffering tablets or sodium carbonate.

**Exercises (064):**

1. In what sequence of processing steps should a sputum submitted for both routine and AFB cultures be handled?
2. Why must the processing be done in this order?
3. What type of sputum specimen is considered to be good AFB studies?

4. Why is pooling of sputum for several days not desirable?
5. What type of urine collection is considered to be the urine specimen of choice for AFB studies?
6. When is the specimen of gastric washings collected?
7. Why must stomach or gastric washings be processed without delay?
8. If the gastric specimen is to be sent through the mail, what must be added and why?

065. Indicate whether given statements correctly reflect the purpose of the direct smear for AFB, the methods used, and advantage of the fluorochrome technique over conventional techniques.

**Direct Smear.** Tubercle bacilli from an active case are highly infectious. The demonstration of acid-fast bacilli in stained smears of sputum or other chemical material is only presumptive evidence of tuberculosis infection. However, the speed and ease of performance make the stained smear an important diagnostic aid, since it may be the first evidence of a mycobacterial infection. In examining a sputum specimen select purulent, bloody, or caseous material to prepare direct smears. Since mycobacteria stains poorly by the Gram method, the conventional Ziehl-Neelson or Kinyoun carbolfuchsin stains or fluorochrome staining technique, using auramine and rhodamine, is a required procedure. In the fluorochrome staining technique, smears may be screened at 100 × magnification, allowing a larger area of the slide as compared to 1,000 magnification using the conventional technique. It uses a fluorescent optical system. An antibody-antigen reaction is not involved in the fluorochrome procedure. Thus, the procedure is not an FA or immunofluorescence test. The method is also known as a Truant fluorochrome method. Studies have shown that at least 100,000 bacilli per ml of sputum must be present if we expect to find TB organisms microscopically. Regardless of whether acid-fast forms are seen on the slide, you should concentrate

the sputum to increase your chances of isolating the tubercle bacillus in the culture.

**Exercise (065):**

Indicate whether each of the following statements is true (T) or (F) false, and correct those that are false.

- T F 1. Demonstration of acid-fast bacilli in stained smears of sputum on other clinical material is conclusive evidence of tuberculosis infection.
- T F 2. The Gram method of staining may be efficiently used for staining mycobacteria.
- T F 3. The Kinyoun method of staining also uses the auramine and rhodamine stains.
- T F 4. In the fluorochrome staining technique, smears may be screened at 100 X magnification, allowing a larger area of the slide as compared to 1,000 magnification using the conventional technique.
- T F 5. An antibody-antigen reaction is involved in the fluorochrome procedure.
- T F 6. The procedure is NOT an FA test but an immunofluorescent test.
- T F 7. Studies have shown that at least 100,000 bacilli per ml of sputum must be present if we expect to find TB organisms microscopically.

**066. State the purpose of the concentration technique; cite acceptable methods for digestion and decontamination of sputum and bronchial and gastric washings in terms of their principles, reagents used and purposes; point out the stains used for concentrated sediments of acid-fast bacilli and some advantages of the staining method of choice.**

**Concentration Techniques.** There are several good concentration techniques which do not destroy the tubercle bacillus and which also reduce the risk of infection to the technician. These techniques are based on the principle of breaking down tissue in which *Mycobacterium tuberculosis* is trapped, while at the same time destroying other, less resistant microbes which might later overgrow the tubercle bacillus during cultivation on isolation media. We are using sputum as a typical specimen in this discussion; however, the digestion and concentration techniques are equally applicable to bronchial and gastric washings.

Conventional chemical methods of digestion and decontamination of sputum for cultivation of tubercle bacilli result in the destruction of a large percentage of these organisms. Thus, there is a need for a milder decontamination and digestion procedure using a good mucolytic agent.

*N-acetyl-L-cysteine-sodium hydroxide (NALC) method.* The mucolytic agent, N-acetyl-L-cysteine (NALC), provides a mild decontamination and digestion process for tenacious sputum. The procedure, considered by many authorities a method of choice, was advocated at the National Communicable Disease Center.

Mucoproteins in sputum and mucus specimens are readily dissolved by NALC in weak NaOH solution. The main advantage of the NALC technique is greater survival of the tubercle bacillus during the digestion process because of the lower concentration of alkali present. Add an equal volume of the digestant solution to the sputum in a tube and wait until the specimen clears (5 to 30 seconds). Caution: Digestant should be dispensed with a fresh, sterile pipette for each specimen. Take every precaution to avoid contaminating the digestant.

After digestion is complete, neutralize the NaOH with M/15 sterile phosphate buffer and centrifuge. Pour off the supernatant fluid into a disinfectant solution such as 5 percent phenol, being careful not to disturb the sediment. To this sediment add 1.0 ml of sterile 0.2 percent bovine albumin Fraction V to serve as a buffer against pH change during growth of the culture. Mix well, inoculate culture media, and prepare slide for staining.

*Sodium hydroxide procedure.* The sodium hydroxide is a simple procedure which involves: *first*, adding 4 percent NaOH in a volume equal to that of the specimen and shaking the mixture, preferably on a mechanical shaker, to homogenize the specimen. The *second* step consists of centrifuging the sediment and decanting the supernatant liquid into 5 percent phenol disinfectant. No later than 30 minutes after adding the NaOH, you should titrate the sediment to a neutral end point with hydrochloric acid (HCl). Portions of the sediment are then ready for preparation of additional slides, and culturing.

Sodium hydroxide, the most commonly used digestant will serve to liquefy secretions and control contaminants. The stronger the alkali, the higher its temperature is, and the longer it is allowed to act, the greater is its killing action on both contaminants and mycobacteria.

*Trisodium phosphate-benzalkonium chloride method.* Trisodium phosphate-benzalkonium chloride method requires digestion with trisodium phosphate for only 1 hour, as opposed to a 12- to 24-hour exposure method, which no longer is an acceptable procedure, due to the low survival rate of mycobacteria after lengthy exposure to the digestant.

You begin the process by mixing the specimen with an equal amount of trisodium phosphate-benzalkonium chloride in a 50-ml disposable leakproof centrifuge tube. Shake in a mechanical shaker for 30 minutes. Allow to stand at room temperature for 20 to 30 minutes; then centrifuge for 20 minutes. Decant the supernatant fluid into a disinfectant, observing necessary precautions. Resuspend the sediment into 10 to 20 ml of M/15 sterile phosphate buffer, pH 6.6, and recentrifuge for 20 minutes. Decant the supernatant once more and inoculate the sediment on egg media.

Trisodium phosphates liquefies sputum rapidly, but requires long exposure for decontamination of the specimen when used alone. Benzalkonium chloride (Zephiran) as used with trisodium phosphate in the method shortens the required period and selectively destroys many contaminants with minimal bactericidal action on tubercle bacilli.

The best yield of tubercle bacilli may be expected to result from the use of the mildest digestion which gives sufficient control of contaminants.

*Smear of concentrate.* You should examine air-dried heat-fixed smears of the specimen and of the concentrated sediments for acid-fast bacilli. The previously mentioned Ziehl-Neelsen and Modified Kinyoun stains are widely used. Both use basic dyes in conjunction with other constituents that increase penetrability of the dyes. In the Ziehl-Neelsen method, heat is applied to drive the stain into the cell. The Modified Kinyoun method uses a wetting agent, Tergitol 7, for the same purpose. Once the cell is stained, acid-alcohol will not remove the light pink (acid-fast) color from the stained cell. The background is stained with methylene blue and serves as a color contrast for the pink tubercle bacilli.

Fluorochrome staining may be used if available to provide the advantage of ease, speed, and thoroughness of observation. As previously indicated, low-power objectives may be used, permitting inspection of a large area in a short period of time. Other advantages are better contrast, minimal eye strain, and relative unimportance of the color acuity of the technicians.

#### Exercises (066):

1. What is the purpose of the concentration technique in processing sputum for TB isolation?
2. How is digestion of sputum accomplished by the N-acetyl-L-cysteine-sodium hydroxide method?
3. What is the main advantage of the NALC technique?
4. After the process of digestion is completed in the NALC method, what reagent is used for neutralizing the sodium hydroxide specimen mixture, and what process follows?
5. In the sodium hydroxide procedure, what is the main purpose of the sodium hydroxide?
6. In the sodium hydroxide technique, after centrifugation in the second step, the supernatant is decanted into what disinfectant?
7. Compared with the 12- and 24-hour Trisodium phosphate exposure method, how long is the exposure necessary with the Trisodium phosphate benzalkonium method?
8. Why is the 12- to 24-hour Trisodium phosphate no longer considered an acceptable procedure?
9. What purpose does the benzalkonium chloride serve in the Trisodium phosphate benzalkonium chloride method?
10. What two conventional staining methods are used for staining concentrated sediments and air-dried, heat-fixed smears for acid-fast bacilli?

11. What are some advantages of the fluorochrome staining over the conventional methods?

**067.** Point out the media commonly used for culture of acid-fast bacilli; the temperature ranges and lengths of incubation, characteristics and properties used for identification and mycobacteria pathogens, and the use of animal inoculation as a final criterion of pathogenicity.

**Culture Methods.** You can culture the sediment on a variety of media, but Lowenstein-Jensen, Petragani's, and Middlebrook 7H10 agar are commonly used. The first two are egg-base media which require a prolonged incubation period (up to 8 weeks). The Middlebrook medium is solidified with agar and grows tubercle bacilli more rapidly (about 3 weeks).

Incubate the Lowenstein-Jensen slants in a horizontal position for 1 to 2 days at 35° to 36° C in the dark, and examine weekly for 6 to 8 weeks. Incubate the Middlebrook 7H10 plates right side up in sealed permeable polyethylene bags in the dark in a carbon dioxide incubator at 35° C for 3 weeks.

Positive cultures are reported as soon as noted and the final report is made after 6 to 8 weeks' incubation of both 7H10 plates and L-J slants. Petragani medium is a glycerolated egg-potato medium made with a milk base and contains malachite green in a concentration of about .045 percent. The medium is somewhat more inhibitory than Lowenstein-Jensen because of the higher dye content. Consequently, Lowenstein-Jensen medium would be expected to give a higher proportion of positive findings. A higher percentage of contaminants might also be anticipated, but researchers reported fewer contaminants as well as more positives in an examination of 7,362 specimens, and concluded that Lowenstein-Jensen medium is the most satisfactory for routine diagnostic use, and obtained more positive results by culture than by examination of smears.

Most mycobacterial pathogens may be identified by rate of growth, pigmentation, colony morphology, and one or two other properties of chemical reactions.

**Animal Inoculation.** The inoculation of a laboratory animal, generally the guinea pig, has been accepted in the past as the final criterion of pathogenicity of an acid fast bacillus. This is no longer correct for human isolates, since some organisms, notably the mycobacteria other than tubercle bacilli and some isoniazid-resistant strains of *Mycobacterium tuberculosis*, do not produce progressive disease in the injected animal.

In addition, the merit of cultural procedures presently available and the more frequent use of multiple specimens from a suspected case of

tuberculosis makes it unnecessary for the hospital laborator to inoculate laboratory animals.

**Exercises (067):**

1. What media are commonly used for culturing suspected sediments of tubercle bacilli?
2. Initially, how should the Lowenstein-Jensen slants be incubated and at what temperature?
3. How often are the L-J cultures examined and for how long?
4. Under what atmospheric conditions should the Middlebrook 7H10 cultures be incubated, at what temperature, and for how long?
5. When are positive cultures reported?
6. When is the final report made?
7. Why is Petragani medium more inhibitory than Lowenstein-Jensen medium?
8. Which of the two media is said to give a higher percentage of positive findings?
9. By what characteristics and properties are most mycobacterial pathogens identified?
10. Why is animal inoculation no longer accepted as the final criterion of pathogenicity of an acid-fast bacilli?

**068.** List some organisms frequently encountered in body fluids, and cite procedures for handling such specimens.

**Body Fluids.** Specimens that you will be asked to culture include spinal, synovial, pleural, pericardial,



and peritoneal fluids. These specimens are collected by the physician from the spinal column, joints, and cavities of the lungs, heart, and abdomen. Among the organisms which you may encounter frequently in these body fluids are the following:

*Staphylococcus aureus*

*Streptococcus pyogenes*

Enteric bacilli (from lower half of body)

*Bacteroides* species and other anaerobic nonsporing Gram-negative and Gram-positive rods.

Anaerobic cocci (*Peptococcus*, *Peptostreptococcus*), Enterococci.

*Hemophilus* species.

*Neisseria* species.

You may occasionally encounter *Mycobacterium tuberculosis*. One of the fungi chiefly responsible for meningitis is *Cryptococcus neoformans* (torula). You must consider whether to use routine or acid-fast techniques, and this is usually determined by the type of test requested on either Standard Forms 553 or 554, Microbiology I or II respectively.

Since clotting is a factor to be considered in specimens of this type, you should usually add sterile heparin to prevent clotting while processing is underway. If the volume of fluid is small, you can culture the entire specimen.

Since infection of these anatomical spaces may be due to anaerobes, it is recommended that fluid on pus be collected with a sterile syringe and needle. The air bubbles present in the syringe should be expelled, and the material injected directly into an anaerobic transport "gassed out" tube or vial containing CO<sub>2</sub>.

You should centrifuge clear and slightly cloudy fluids and examine carefully Gram-stained smears of the sediment. Nevertheless, purulent material should be smeared directly and examined after it has been stained for the presence of bacteria.

Despite the fact that anaerobic procedures are not more difficult to follow than those used for aerobic bacteriology, a degree of patience and a strict adherence to basic principles will insure successful recovery of these pathogens.

#### Exercises (068):

1. List some organisms frequently encountered in body fluid specimens for culture.
2. When processing body fluids, what anticoagulant is added to prevent clotting?

3. What should be done when air is noted in the syringe when collecting fluid and pus for anaerobic cultures and into what container should the specimen be injected immediately after collection?

4. Before smears for Gram stains are made for examination, what should be done with clear and slightly cloudy specimens?

069. Briefly cite some clues for clinical materials likely to contain anaerobes, and state inoculation and incubation procedures in terms of the media, length of inoculation, incubation temperature, and additional procedures.

**Specimens likely to Contain Anaerobes.** There are certain clues that should prompt the bacteriology technician to carry out anaerobic culturing of selected clinical materials. Some of these specimens include:

- a. Pus from any deep wound or aspirated abscess.
- b. Necrotic tissue from suspected gas gangrene.
- c. Uterine cultures from post abortal sepsis.
- d. Material from abscesses of the brain, lung, or liver or from intra-abdominal, perirectal, or subphrenic sites.
- e. Aspirated fluids such as blood, peritoneal, pleural, synovial, or amniotic fluids.

Methods for providing an anaerobic environment have been previously discussed in this chapter. However, the use of the anaerobic jar with a catalyst and hydrogen or nitrogen gas plus 5 percent CO<sub>2</sub> offers the most practical and satisfactory method for achieving an anaerobic environment in the clinical laboratory.

**Inoculation and Incubation of Cultures.** There are a variety of liquid and solid media available for primary inoculation of specimens. The following media should be inoculated as soon as possible according to the flowchart shown in figure 4-3. Inoculate the sediment on a portion of the specimen to:

- a. Thioglycollate medium.
- b. Two blood agar plate.
- c. One enriched chocolate agar plate.
- d. One EMB plate.
- e. One Mannitol salt agar (if indicated).

Incubate one BA plate anaerobically in a GasPak Jar. Then incubate the second BA plate and chocolate plate in a candle jar (approximately 3% CO<sub>2</sub>), or CO<sub>2</sub> incubator. Incubate the EMB, Mannitol salt, and thioglycollate aerobically.

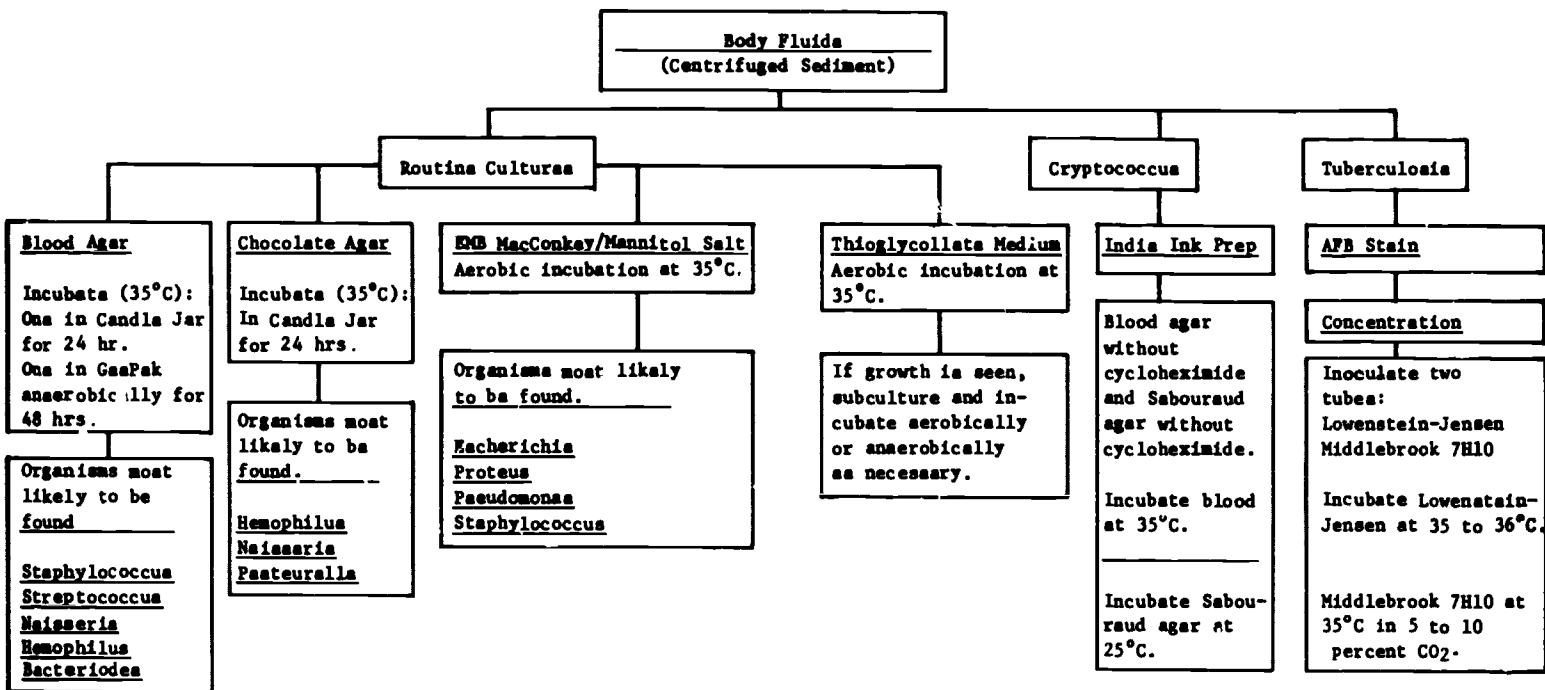

Figure 4-3. Flowchart for processing body fluids.

Plates in the candle jar are used for comparison with anaerobic plates. All plates are incubated at 35° to 36° C. Anaerobic plates are incubated for a minimum of 48 hours. The aerobic plates and thioglycollate are examined after overnight incubation, then subcultured. Organisms isolated are identified and sensitivity tests are set up. The thioglycollate medium is incubated and subcultured as previously described. If acid-fast studies are indicated, you should prepare on acid-fast stain and follow the protocol for concentration and inoculation of TB organisms.

In addition to the usual Gram stain, when indicated, do an India ink preparation of the sediment to rule out infection with *Cryptococcus neoformans*, or one of the other pathogenic fungi. Mix a small drop of India ink with a drop of the sediment on a microscope slide. If *C. neoformans* is present, a clear area—or capsule—or capsule—will be outlined surrounding the individual or budding cell. In the case of a positive smear, the fungus media listed in figure 4-3 should be inoculated with the specimen for incubation at 35° C and room temperature. Most fungi have an optimum temperature for growth lower than the 37° C body temperature.

Cycloheximide (acidione) is an antibiotic commonly added to media to inhibit bacteria and saprophytic mold growth in fungus cultures. *Cryptococcus neoformans*, however, is one of the few pathogenic fungi sensitive to the additive. In figure 4-3 we have specified blood agar and Sabouraud's agar *without* cycloheximide; but if the stained smear suggests a pathogenic fungus other than *C. neoformans*, you should add the inhibitor to the isolation media.

#### Exercises (069):

1. Briefly list some clinical materials that should prompt the bacteriology technician to carry out anaerobic culturing.
2. When setting up the anaerobic cultures, which plate is placed in the GasPak jar?
3. At what temperature range should the plates be incubated?
4. How long should all anaerobic plates be incubated?
5. What should be done if acid-fast studies are required on body fluids?
6. In addition to the usual Gram stain, when indicated, the India ink preparation can be used to outline the capsule of what pathogenic fungi?
7. What is cycloheximide?
8. When *Cryptococcus neoformans* is suspected, why is the use of blood and Sabouraud's agars specified without the use of cycloheximide?

**070. Define exudate; list areas from which wound cultures might be obtained and organisms frequently isolated from wounds and those rarely isolated; and cite swab specimens not normally cultured anaerobically.**

**Exudates.** In Chapter 2, we defined an exudate as "material . . . passed through the walls of vessels into nearby tissues or areas of inflammation." Dorland expresses it this way: ". . . any adventitious substance deposited in or on a tissue by a vital process or a disease." The bacteriologist usually pictures an exudate as fluid or semiliquid material collected from wounds, skin lesions, tissue abscesses, infections of the eye or ear, and similar pathologic conditions.

**Wounds.** The definition of wound may be expanded beyond the usual meaning of superficial and deep sinus tract produced by an operation or secondary, to include various kinds of trauma. Thus, we may include the following areas when we speak of wound culture specimens:

- a. Cutaneous ulcers.
- b. Bone fragments.
- c. Abscesses of any kind.
- d. Any fluid obtained from a body cavity, such as from empyema, peritonitis, or pericarditis.
- e. Tissue fragments from an operation or autopsy.
- f. Cervical or vaginal cultures, not specifically for gonorrhea.
- g. Various miscellaneous culture types such as eye, ears, joint fluid, gall bladder contents, and bone marrow.

*Organisms frequently isolated.* Among the organisms which you may frequently isolate from wounds are the following:

*Staphylococcus aureus*

*Streptococcus pyogenes*

Enteric bacilli (from the lower half of the body)

*Bacteroides* species and anaerobic nonsporing Gram-negative and Gram-positive rods

*Pseudomonas* species.

*Clostridium* species

Anaerobic cocci (*Peptococcus*, *Peptostreptococcus*).

*Organisms rarely isolated.* Organisms considered to be rarely isolated from wounds include the following:

*Clostridium tetani*

*Francisella tularensis*, *Pasteurella multocida*

*Mycobacterium tuberculosis*, *M. marinum*, and other mycobacteria

*Corynebacteria diphtheriae*

*Bacillus anthracis*

Systemic fungi (*Sporothrix schenckii*,

*Actinomyces*),

*Nocardia*

*Erysipelothrix insidiosa*

*Culture methods.* As a matter of routine practice, culture media are selected which will support growth of most of the commonly found aerobes and anaerobes. Note the flowchart illustrated in figure 4-4. Anaerobic organisms are part of the normal flora of body sites which include the skin, oropharynx, intestinal tract, or external genitalia. The following type specimens are not cultured anaerobically:

a. Swabs from the throat, nose, eye, ear decubiti, superficial wounds, urethra, vagina, cervix, or rectum.

b. Expectorated sputum, bronchial secretions, voided urine, feces, and gastric contents.

The anatomical origin of the exudate and the morphology of organisms seen in direct smears of the specimen often serve as a guide to the choice of isolation media. For instance, Gram-positive rods found microscopically in a stained exudate from a deep wound would suggest infection with species of *Clostridium*, the anaerobes associated with gangrene and tetanus. In this case you would emphasize anaerobic procedures by incubating a streak plate in a Brewer or GasPak jar, in addition to inoculating thioglycollate broth. Similarly, if an exudate reveals yeastlike forms or branching structures typical of fungi, we would watch closely for growth on Sabouraud's agar or one of the other media designed for isolating the pathogenic fungi.

#### Exercises (070):

1. What is an exudate?
2. Briefly list some areas from which wound cultures may be obtained.
3. List some organisms frequently isolated from wounds.
4. List some organisms rarely isolated from wounds.
5. List some types of swab specimens that are not cultured anaerobically.
6. Gram-positive rods found microscopically in a stained exudate from a deep wound would suggest infection with species of \_\_\_\_\_.
7. What type of atmosphere would you use for culturing the organism suggested in exercise 6?

071. Cite the points of the urinary tract where infections may occur and the criteria used to determine significant bacteria when culturing urine; specify the counting techniques and advantages of each.

*Urine Cultures.* The urinary tract can play host to a bacterial infection at a number of different points: the *kidney*; the *ureters*, which transport urine to the *bladder*; the *bladder* itself; and the *urethral passage* leading to the external orifice. While one might expect the urinary tract to be free of microbes in a normal individual, samplings have shown that apparently healthy persons often void thousands of organisms per ml of urine without clinical evidence of disease.

The finding of bacteria in "normal" urine has raised controversy as to the significance of a qualitative urine culture in detecting disease. Most physicians feel that the quantitative aspects are more significant than just the presence or absence of microorganisms, per se. Consequently, there is a

EXUDATES

ABSCESS

Inoculate:  
 Sheep Blood Agar, Mannitol  
 Salt Agar, EMB or MacConkey  
 Agar and Thioglycollate

Incubate (35°C):  
 SBA in increased CO<sub>2</sub>

Gram Stain:  
 Examine immediately

ORGANISMS MOST LIKELY  
 TO BE FOUND

*Staphylococcus*  
*Pseudomonas*  
*Streptococcus*  
*Bacillus*

EAR DRAINAGE

Inoculate:  
 Sheep Blood Agar  
 Chocolate Agar  
 EMB or MacConkey  
 Thioglycollate

Incubate (35°C)  
 Sheep Blood and  
 Chocolate Agar in CO<sub>2</sub>

Gram Stain:  
 Examine immediately

ORGANISMS MOST LIKELY  
 TO BE FOUND

*Pseudomonas*  
*Staphylococcus*  
*Streptococcus*  
*Proteus*  
 Coliforms

EYE

Inoculate:  
 Sheep Blood Agar  
 Chocolate Agar  
 EMB or MacConkey  
 Thioglycollate

Incubate (35°C):  
 Sheep Blood and  
 Chocolate Agar in CO<sub>2</sub>

Gram Stain: Examine  
 immediately.

ORGANISMS MOST LIKELY  
 TO BE FOUND

*Staphylococcus*  
*Haemophilus*  
*Neisseria*  
*Moraxella*  
*Corynebacterium*  
*Pseudomonas*

IF GONORRHEA IS  
 SUSPECTED

Inoculate:  
 Thayer-Martin Agar

Incubate (35°C)  
 Increased CO<sub>2</sub>

Confirm:  
 Oxidase Test

URINARY AND VAGINAL

Inoculate:  
 Sheep Blood Agar  
 Thayer-Martin Agar  
 EMB or MacConkey Agar  
 Thioglycollate

Incubate (35°C):  
 Sheep Blood and  
 Thayer-Martin in CO<sub>2</sub>

Gram Stain:  
 Examine immediately

ORGANISMS MOST LIKELY  
 TO BE FOUND

*Neisseria*  
*Staphylococcus*  
 Coliforms

Figure 4-4 Flowchart for processing exudates

trend toward reliance on colony counts as an aid to diagnosis.

It is now generally accepted that a bacteriuria (bacteria in the urine) of less than 10,000 organisms per ml of a "clean catch" or "midstream" voided urine has little significance as an indicator of disease. Counts ranging from 10,000 to 100,000, however, suggest an infection; and colony counts larger than 100,000 per ml indicate a disease state. Since bacteria can multiply in urine allowed to stand at room temperature, speedy processing of specimens is essential in performing colony counts. To demonstrate this point, let's assume that freshly voided urine contains only 1,000 organisms per ml. With a generation time of about 20 minutes—not at all unusual among microorganisms—these 1,000 cells can reproduce to a level of 130,000 per ml within 2 hours and 20 minutes.

**Counting Techniques.** Of the several techniques available for counting bacteria in the urine, two will be described here: pour plate method and calibrated loop technique.

**Pour plate method.** Although the pour plate method has been criticized as not entirely reflecting the true bacterial count of a urine specimen, it still remains the most accurate procedure for measuring the degree of bacteriuria.

First, three tenfold dilutions of well-mixed urine are made with sterile distilled water in screw-capped tubes 1:10, 1:100, and 1:1000 respectively. One ml of each dilution is placed in appropriately labeled sterile Petri dishes. Each dilution is then overlaid with 15 to 20 ml of melted and cooled nutrient or infusion agar at 50° C, then mixed well by carefully swirling the dishes. After the plates are solidified, they are inverted and incubated overnight at 35° to 37° C. The number of colonies in the plate yielding 30 to 300 colonies is counted with the use of a Quebec colony counter and calculated. The number of colonies is multiplied by the dilution to obtain the total number of microorganisms per ml of urine.

**Calibrated loop plating.** The second technique, calibrated loop plating, is more convenient in that it avoids the time-consuming act of preparing dilutions of the urine in distilled water. Wire loops are available which hold a measured volume of urine, for example, 0.01 or 0.001 ml. A dip of the flame-sterilized loop into the specimen picks up a reasonably accurate volume of urine to be streaked on an agar surface. If you multiply the number of colonies by the dilution represented in the calibrated loop, the result gives you the number of bacteria present per ml of specimen.

**Exercise (071):**

1. What four areas of the urinary tract may play host to a bacterial infection?

2. What disease condition does a bacterial count of less than 10,000 organisms per ml of a "clean catch" or "midstream" voided urine signify?
3. What range of bacterial organisms per ml suggests an infection?
4. What range of bacterial organisms per ml isolated from a "clean" or "midstream" voided urine indicates a disease process?
5. What are two methods for bacterial colony counts?
6. Despite criticism concerning the pour plate method for reflecting the true bacterial count of a urine specimen, how accurate is it when compared with the calibrated loop plating?
7. What is a major advantage of the calibrated loop plating?

**072.** Cite methods of processing urine cultures in terms of the given disadvantages and advantages and, methods of reporting; and point out the type specimen of choice for AFB urine cultures.

**Isolation and Identification.** It has been a common practice in a number of laboratories to inoculate either liquid or solid media with the sediment of the centrifuged specimen or to inoculate the urine directly into a tube of broth. Although situations may arise that may require these methods of handling, questions concerning the accuracy of such methods have been brought up. For example, centrifugation will concentrate contaminants as well as pathogens. The introduction of only a few contaminating bacteria by directly inoculating broth on solid media for isolation will invariably result in a positive culture. In addition, most routine urine cultures are not catheterized, and the chance of contaminants is more likely. Thus centrifugation could concentrate contaminants if many are present.

The calibrated loop method is used most successfully as a screening procedure. When compared with actual plate counts, its confidence



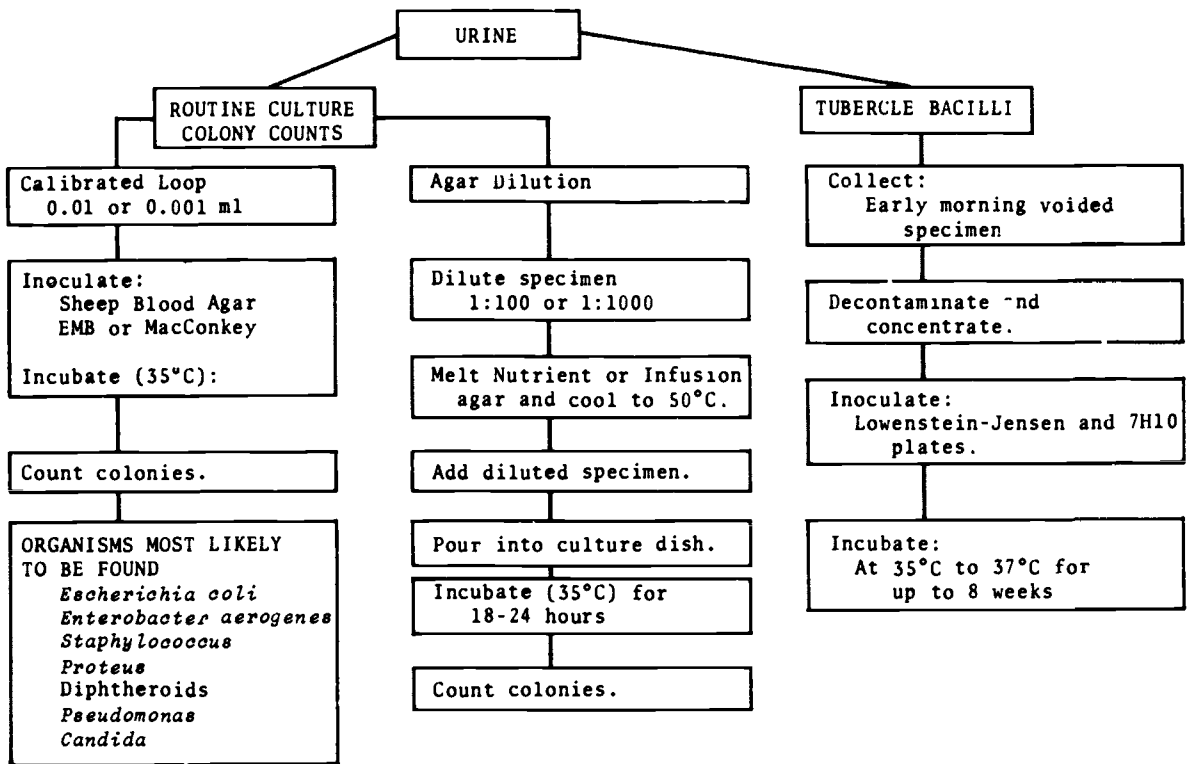

Figure 4-5. Flowchart for processing urine specimens.

level is highest when counts of  $10^5$  (and greater) bacteria per millimeter are observed.

The procedure requires the use of a well-mixed uncentrifuged specimen which is inoculated to a blood agar plate and EMB or a MacConkey agar plate (fig. 4-5). The plates are incubated overnight at 35° C and read the following morning. After determining the plate count as previously discussed, proceed with the identification of the organisms present and determine their susceptibility to antibiotics. If no growth occurs within 24 hours, hold the plates for another day. If there is still no growth, report as "No growth after 48 hours."

**Urine Culture for AFB.** Urine specimens suspected of harboring the tubercle bacillus require a special decontamination and concentration technique. The early morning, clean-voided specimens are preferred. These specimens are processed as follows:

a. Pour about 50 ml portions into one or more centrifuge tubes; centrifuge at 3,000 rpm. for 30 minutes.

b. Aseptically decant supernatant fluid; resuspend sediment into 2 to 5 ml of sterile water.

c. Add an equal volume of NALC-NaOH reagent and proceed as with sputum (fig. 4-5).

**Exercises (072):**

1. What is the disadvantage of the routine practice to inoculate the centrifuged urine sediment to either liquid or solid media?
2. What is the advantage of directly inoculating the broth or solid media with urine sediment?
3. The calibrated loop method has been successfully used as what type of procedure?
4. When compared with actual plate counts, when is the confidence level of the calibrated loop method highest?
5. If no growth has occurred on the urine culture plates after 48 hours of incubation, what is reported?

6. What type of urine specimen is prepared when the tubercle bacillus is suspected?

073. Cite enteric diseases caused by Gram-negative bacilli and Gram-positive cocci and the normal inhabitants of the intestinal tract; identify enrichment media in terms of their purposes, significance, and the media of choice when a single enrichment medium must be selected for general purposes.

**Fecal Specimens.** The complex, interrelated flora of the intestines comprise representatives of many Gram-positive and Gram-negative genera. Certain of the Gram-positive forms are capable of causing disease, as in the case of staphylococcal food poisoning; but our foremost concern in fecal cultures is with the Gram-negative microbes which give rise to some of mankind's most prevalent and debilitating infections. We have reference here to the enteric diseases: typhoid and paratyphoid fevers, bacillary dysentery, food infections, and a variety of other gastrointestinal disturbances.

Among those organisms found as normal inhabitants of the intestinal tract are *Escherichia*, *Klebsiella*, *Enterobacter* (*Aerobacter*), *Proteus*, *Clostridium*, *Bacteroides*, *Staphylococcus*, *Pseudomonas aeruginosa*, and yeasts, as well as aerobic and anaerobic streptococci.

The bacteriologist must distinguish between normal intestinal inhabitants and the etiologic agent of disease as in cases of enteric infections when such pathogens as *Salmonella* and *Shigella* may be present.

As a bacteriologist, your job is to carry out a series of isolation procedures which will successfully sort out the pathogens from the morphologically identical and taxonomically related saprophytes whose numbers predominate. Success calls for ingenuity in your choice and use of assorted enrichment, selective, and inhibitory media. Our procedural steps generally take the following sequence:

- (1) Enrichment media.
- (2) Plating media.
- (3) Primary differentiation media.

**Enrichment Media.** Enrichment media are used to increase the relative number of pathogens at the expense of the enteric saprophytes so that the pathogens will not be overgrown on a primary plating media. Two such media have been employed extensively and may be recommended for general use. These are Mueller tetrathionate medium and Leifson selenite broth.

Tetrathionate broth may be employed with all specimens, since salmonellae including *S. typhi*

generally are greatly increased in numbers in this medium. Some *Shigella* also may be recovered from it. Many persons prefer selenite broth for general use since *Shigella* and *S. typhi* usually are inhibited when tetrathionate broth is used in conjunction with brilliant green agar. Selenite broth was designed for enrichment of *Salmonella* including *S. typhi*, not for *Shigella*. However, slight modifications have been made by most commercial sources, and some shigellae may be recovered after plating from it.

Increased numbers of *Salmonella* and *Shigella* have been noted with the use of GN broth medium, and it has been used successfully in the study of outbreaks of shigellosis bacillary dysentery.

Selenite broth is the medium of choice if a single enrichment must be selected for general purposes. Inoculate the medium with approximately 1 g (or 1 ml of fluid specimen of feces) and emulsify thoroughly. After 18 to 24 hours' incubation at 35° to 37° C, cultures in enrichment media should be streaked or subcultured to one or more plating media shown in figure 4-6. A battery of noninhibitory and only slightly inhibitory plating media are used along with enrichment media for primary culture of feces.

Since primary plating media support the growth of most enteric disease producers, as a technician you will often streak one or more of these media directly from the stool specimen at the same time you inoculate the enrichment broth. If you get a positive isolation on a streaked plate, you will have saved 18 to 24 hours in identifying the causative organism.

#### Exercises (073):

1. What are some enteric diseases caused by Gram-negative bacilli?
2. List some normal inhabitants of the intestinal tract.
3. For what basic purpose are enrichment media used?
4. When brilliant green agar is added to tetrathionate broth, what two organisms are usually inhibited?
5. What organisms was selenite broth designed to recover?

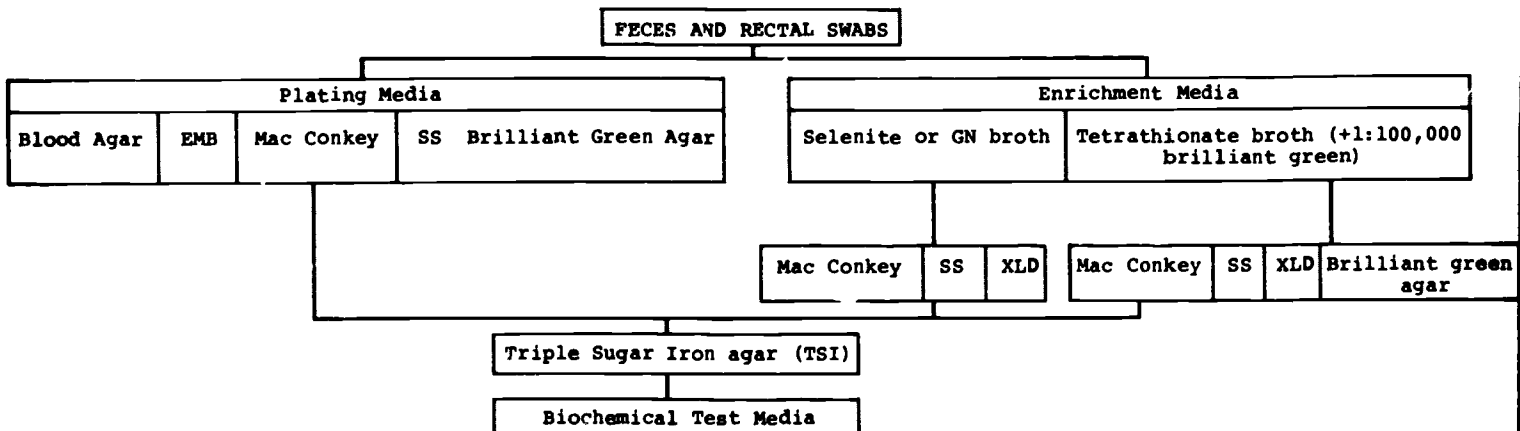

Figure 4-6. Flowchart for processing fecal specimens.

6. How has it been possible for some *Shigella* to be recovered from the use of selenite broth after plating?
7. Increased number of *Salmonella* and *Shigella* have been noted and successful results have been obtained in the study of shigellosis outbreaks with which enrichment medium?
8. Which enrichment medium is recommended as the medium of choice if a single enrichment must be selected for general purpose?
9. A battery of what type of plating media is used along with enrichment media for primary plating of feces?

**074. Identify plating media used in enteric bacteriology in terms of their general purpose, constituents, and classification.**

**Plating Media.** The choice of a primary plating medium depends to some extent on what organisms the physician suspects of causing the disease in his patient. As a matter of routine, however, it is best to inoculate several of the available plating media in order to increase the probability of a positive isolation. These media differ sufficiently in nutrient constituents, selectivity, and inhibitory effects so that no one of them can be said to serve as a completely satisfactory medium for all enterics.

The media listed in figure 4-6, blood agar, eosin methylene blue (EMB) agar, MacConkey agar, *Salmonella-Shigella* (SS) agar, xylose-lysine-deoxycholate (XLD) agar, and brilliant green agar serve as primary media. Blood agar allows you to recognize staphylococci, yeast, and Gram-negative organisms. The Gram-negative growth usually produces shiny, convex, opaque colonies, some of which may be completely hemolytic. Blood agar serves as a noninhibitory plating medium. EMB, MacConkey, XLD, and SS contain Gram-positive bacteriostatic agents and a fermentable carbohydrate, usually lactose (XLD has additionally xylose and sucrose), as well as an indicator dye to differentiate lactose-fermenting organisms. Plating media may be classified as:

- a. Slightly selective:  
EMG agar.  
MacConkey agar.

- b. Moderately selective:  
SS agar.  
XLD agar.
- c. Highly selective:  
Bismuth sulfite agar for *Salmonella*.  
Brilliant green agar for *Salmonella*.  
Thiosulfate citrate bile salts sucrose (TCBS) agar for cholera vibrios.

Occasional strains of shigellae may not grow on MacConkey, SS, or deoxycholate-citrate agar, or a particular *Salmonella* may not appear on brilliant green agar. It is therefore advisable to use a variety of media whenever possible. However, remember that the procedure to be followed in any laboratory is dictated by the facilities, the personnel, and the time available for enteric bacteriology.

**Exercises (074):**

1. How can knowledge of the patient's clinical diagnosis benefit the bacteriology technician when culturing a stool specimen?
2. List some primary plating media.
3. What three purposes does blood agar serve as a noninhibitory plating medium?
4. What three basic constituents for differentiation of enteric organisms do EMB, MacConkey, XLD, and SS contain?
5. What essential purpose does the indicator serve?
6. What two media may be classified as moderately selective?
7. Occasional strains of *Shigella* may not grow on which media?

**075. Identify media used for primary differentiation in terms of the method of inoculation, and cite other systems used in terms of the composition and significance of their results.**

**Primary Differentiation Media.** Colonies of suspected pathogens (nonlactose fermenters) on primary plating media are usually picked and restreaked to MacConkey's EMB or one of the other formulations listed in figure 4-6 to provide a source of pure cultures for study on differential media. In some cases, of course, you can circumvent this purification plating step in well-isolated colonies of pathogens appear on the primary plating medium. The bacteriologist can then proceed directly to the inoculation of tubed differential agar, such as Kligler's or triple sugar iron (TSI) agar, to expedite species identification.

As you may recall, the butt of the medium first is stabbed to the bottom of the tube, and then the slant is streaked carefully over the entire surface. Atypical reactions may result if good growth does not occur in the butt or on the slant of these media. Many bacteriologists use lysine-iron agar (LIA) and motility-indole-ornithine (MIO) medium in conjunction with TSI (or KI) agar.

Another system for primary differentiation of enteric Gram-negative bacteria involves the use of TSI, LIA, Christensen's urea agar, Simmons citrate, motility-indole-ornithine (MIO), and peptone broth media (MIO). This method, or slight modifications of it, is known to be employed in a number of well-established laboratories.

Several other systems are available which have been evaluated. Results have indicated that, if used and interpreted properly, these systems yield good results, especially with typical cultures. Some of these are Auxotab, the Enterotube, and the R-B Systems. Another device that should be mentioned here is the API (Analytab Products Inc.) A commercially available set of biochemical reactions, API 20 Enteric, is a diagnostic kit that utilizes 21 different biochemical tests for the diagnosis of *Enterobacteriaceae*. The biochemical reactions are read as positive or negative at 18 to 24 hours. Using the plastic API Coder, these 21 test results are reduced to a unique seven-digit profile in the Profile Register which lists the genus and usually the species corresponding to the observed pattern of test results. Along with the Profile Register, the manufacturer supplies a percent chart showing the expected frequency of positive results for each biochemical test for each of 31 diagnostic categories. The API Anaerobe System (API 20A) is also available and allows rapid and reliable performance of 21 biochemical tests for the identification of anaerobic bacteria conveniently and economically. Evaluations have indicated that good results can be obtained with the API system.

**Exercises (075):**

How is the TSI medium inoculated?

2. If good growth does not occur in the butt or slant of these TSI or Kligler's media, what reactions may result?
3. What other two such media are used by some bacteriologists in conjunction with TSI (or KI) agar?
4. What other given system for primary differentiation of Gram-negative enteric bacteria is known to be used in a number of well-established laboratories?
5. How are the biochemical tests for the API 20 Enteric read, and approximately how long after inoculation?
6. After the biochemical reactions are read, what apparatus is used to reduce these 21 test results to a unique seven-digit profile in a Profile Register?
7. What information concerning the organism is listed in the Profile Register?

076. Indicate whether given statements correctly reflect other pathogens isolated from the intestinal tract in terms of their sources and selective media used.

**Other Organisms Isolated.** Much of our discussion of stool cultures has focused on means of separating lactose-positive (fermenters) from lactose-negative (nonfermenters) microbes among the Gram-negative genera. Those which utilize lactose as a source of energy, for example, *E. coli*, can always be found in stool specimens. They hold little clinical significance except in occasional outbreaks of infant diarrhea.

*Enteropathogenic Escherichia coli*. Enterocolitis in newborns, infants, and children under 2 years of age may be produced by a group of *E. coli* called enteropathogenic *E. coli* (EPEC). They may also be found in adult carriers. We will discuss laboratory diagnosis and identification of EPEC in another section.

**Pathogenic staphylococci.** Broad-spectrum antibiotics administered to patients may result in a disturbance of the normal microflora of the lower intestinal tract. As a result, a large number of *Staphylococcus aureus* may be isolated in this area along with symptoms characterized by lower abdominal pain, and a fulminating diarrhea.

One of several antigenically different enterotoxins may be produced by strains of *Staphylococcus aureus* when they grow in a food prior to consumption. Foods suspected of involvement customarily are examined for *S. aureus*.

Pathogenic staphylococci may be isolated from the stool through the use of a selective medium containing a high concentration of sodium chloride, such as Staphylococcus medium 110 or Mannitol salt agar. A laboratory report of considerable clinical significance is the result indicating isolation of large numbers of *S. aureus* from stools employing a medium such as Phenylethyl alcohol agar and a Gram stain of a direct smear of the fecal specimens that reveals large numbers of Gram-positive cocci in clusters.

#### Exercises (076):

Indicate whether each of the following statements is true (T) or false (F), and correct those that are false.

T F 1. Enteropathogenic *E. coli* causes enterocolitis in adults and children under 5 years of age.

T F 2. *E. coli* uses lactose as a source of energy.

T F 3. Large numbers of *S. aureus* may be isolated as a result of a disturbance in normal microflora of the lower intestinal tract due to low spectrum antibiotics.

T F 4. Foods suspected of involvement with food poisoning are examined for *S. aureus*.

T F 5. Pathogenic staphylococci may be isolated from the stool through the use of a selective medium containing calcium chloride.

T F 6. Staphylococcus medium 110 or Mannitol salt agar may be used for isolation of *S. aureus*.

T F 7. A Gram stain of a direct smear of the fecal specimen revealing large numbers of Gram-positive cocci in clusters and large numbers of *S. aureus* isolated from stool using Phenylethyl alcohol agar constitute a report of little clinical significance.

**077. Define terms associated with blood infections; point out the types of bacteremias and diseases associated with these types of terms of the conditions most suitable for collection of blood cultures; specify procedures for collection of blood cultures.**

**Blood Cultures.** In some microbial infections a *bacteremia* occurs as one phase of the disease process. "Bacteremia" simply means that bacteria are present in the blood stream. Septicemia is a term used to characterize a bacteremia with serious pathological manifestations—a so-called blood poisoning caused by pathogenic microorganisms and their toxic products. Regardless of whether organisms circulating in the blood entered from the intestine, a skin lesion, the lungs, the urinary tract, or some other site, the bacteriologist can aid in diagnosis by culturing a blood sample and identifying the microorganisms he finds there.

Specimens should be taken before initiation of antimicrobial therapy. In diseases such as endocarditis or endarteritis, uncontrolled infections, typhoid fever, and brucellosis, the bacteremia is considered to be continuous. Timing in the collection of cultures in endocarditis, for example, is therefore not critical; however, in other cases, timing of collection presents a problem because bacteremia is usually intermittent and precedes the onset of fever or chills by as much as an hour.

In patients with suspected bacterial endocarditis, three blood cultures collected at hourly intervals within a 24-hour period are shown to be sufficient. In intermittent bacteremias, three separate blood cultures within 24 to 48 hours are usually sufficient to isolate the etiologic agent. The time interval between cultures is determined by clinical circumstances and the urgency to initiate antimicrobial therapy.

**Blood Culture Procedures.** Since skin bacteria are possible contaminants, care must be exercised in preparing the site for venipuncture. This procedure is done by first cleansing the skin with 70 to 95 percent alcohol and secondly, by applying 2 percent iodine in concentric fashion to the venipuncture site. "Instant" antiseptics never occurs, and the iodine or iodophor (may be used because of lower skin sensitivity) should remain intact on the skin for at least a minute. After allowing the iodine to dry, remove the residue with another alcohol sponge. The venipuncture site should not be



touched unless the fingers used for palpation are similarly disinfected.

A large volume of specimen, usually 10 ml of blood, increases the possibility of isolating the bacterial agent. The blood is withdrawn by a sterile 21-gauge needle on a 20-ml syringe or with a commercial blood collecting unit, if vacuum bottles are used. In infants and children, collection of 1 to 5 ml appears to be satisfactory. The blood should be diluted at least one part blood in nine parts of broth to insure the best yield. Culture of a lesser volume may be responsible for lower recovery rates because of the low order of magnitude of most bacteremias. A 10-percent vol/vol basis for inoculation of blood into culture media counteracts the normal bactericidal activities of chemical and cellular mediators of immunity. The problem of clotting has been reduced substantially by the presence of 0.05 and 0.025 percent sodium polyanethol sulfonate (SPS). This substance appears to increase the yield of organisms isolated from blood by preventing clotting and inactivating leukocytes, complement, and certain aminoglycoside and polypeptide antibiotics.

**Exercise (077):**

1. What is *bacteremia*?
2. To what does *septicemia* refer?
3. Blood culture specimens should be taken at what time of antimicrobial therapy?
4. In which type of bacteremia is the collection timing NOT critical?
5. What are some examples of diseases in which continuous septicemia is manifested?
6. In a continuous bacteremia such as bacterial endocarditis, how many blood cultures would be sufficient and at what intervals should they be taken within a 24-hour period?
7. Prior to taking the blood culture, the skin should be cleaned with what two antiseptics?

8. Since "instant" antiseptics never occurs, about how long should the iodine or iodophor remain on the skin?

9. To obtain the best recovery of organisms, what dilution of blood and broth is recommended in the culture bottle?

10. How does the presence of 0.05 and 0.025 percent sodium polyanethol sulfonate (SPS) appear to increase the yield of organisms isolated from blood?

**078. List media used for blood cultures; state the justification for routine use of penicillinase in blood culture media, media used for isolation of *Brucella*, and techniques used for incubation and examination of blood culture specimens.**

**Blood Culture Media.** Any general-purpose commercially available nutrient broth medium may be used for the blood culture. Soy bean casein digests, such as Tryptic (Difco) or Trypticase (BBL) soy broth, Columbia broth, and Brain Heart Infusion broth have been found to be satisfactory. Commercially available liquid media are generally bottled under vacuum with CO<sub>2</sub> and contain 0.025 percent SPS. To this extent, they are satisfactory for cultivation of anaerobes from blood. Bottles containing 50 to 100 ml of media should be employed.

If only one blood culture bottle is used, it should not be vented. However, it is desirable to use two bottles; one should not be vented and the other may be vented. The routine addition of penicillinase to blood culture media does not appear to be justified, except in selected cases which are receiving high doses of a penicillin or cephalosporin at the time of collection.

The isolation of *Brucella* may be performed by inoculation of the blood into Castaneda's double medium or into *Brucella* broth which must be subcultured at least twice weekly. Retain cultures for 21 days before reporting them as negative.

**Incubation and Examination of Cultures.** A brief flowchart for processing a blood culture specimen is outlined in figure 4-7. Cultures are incubated at 35° C and are inspected on the same day of their collection and daily thereafter for at least 7 days for evidence of turbidity, hemolysis, gaseousness, and pellicle or discrete colonies. They may be further examined several times a week thereafter for any of the characteristic appearances. Prepare Gram-stained smears and subcultures of suspected positive

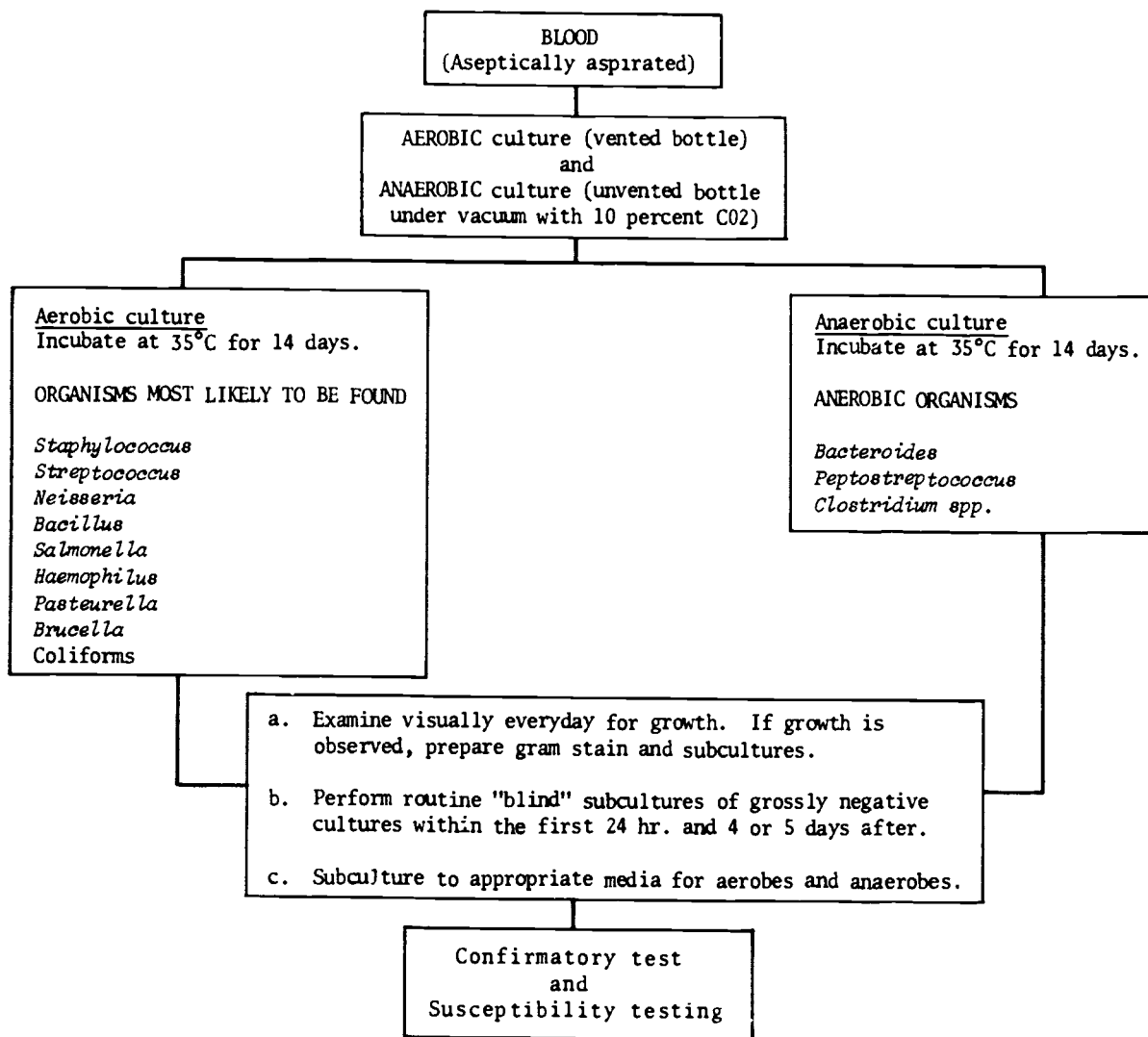

Figure 4-7 Flowchart for processing blood culture specimens.

cultures immediately and report the microscopic examination of the smear by phone and in writing to the patient's physician as quickly as possible.

Perform routine "blind" subcultures of grossly negative cultures within the first 24 hours after collection and after 4 or 5 days of incubation. For a "blind" subculture from aerobic bottles, place the inoculum onto quadrants of chocolate agar plate and incubate in 10 percent CO<sub>2</sub> for 48 hours. For the anaerobic "blind" culture, inoculate quadrants of a prerduced blood agar plate and incubate at 35° C in a GasPak jar or anaerobic chamber for 48 hours before opening.

After 14 days of incubation, repeat subculture procedures. If all cultures, subcultures, and Gram-stained smears are negative, the blood culture may be reported as "No growth aerobic or anaerobic after 14 days incubation."

#### Exercises (078):

1. List some media used for blood cultures.
2. If one blood culture bottle is used in the procedure, under what atmospheric condition should the culture be grown?
3. Under what condition does the routine addition of penicillinase to blood culture media appear to be justified?

4. For isolation of *Brucella*, what media may be used and about how long is the culture usually retained before reporting as negative?
5. After blood culture specimens are taken and incubated at 35° C, at what times are they normally inspected for growth?
6. What characteristics must be observed to indicate evidence of growth in the blood culture media?
7. What must be done in processing suspected positive cultures?
8. In processing a "blind" subculture from the anaerobic culture bottle, what medium and atmospheric growth conditions are recommended?

079. Cite three areas of the genitourinary tract which usually harbor microorganisms; specify organisms commonly associated with specific areas of the genitourinary tract and two factors that influence variation of vaginal flora.

**Genitourinary Tract Secretions.** There are a number of bacterial genera which give rise to infections of the lower urinary tract and the urethra. These infections are sometimes revealed by secretions from the external genitalia. Aside from the gonococcus which causes a venereal disease, gonorrhoea, or specific urethritis as it is often labeled, enteric organisms can find their way into the genitourinary passages and incite a pathological response. Moreover, microbes that are usually considered normal flora on and within the genitals occasionally become pathogenic when their environment is altered, as by a change in the state of the host's mucous membranes. Such infectious processes are sometimes referred to as nonspecific urethritis.

**External Genitalia.** The external genitalia are vulnerable to the same infections as other areas of the skin. The following organisms have been frequently isolated from the surface of the genitalia:

*S. epidermidis*  
*Streptococcus mitis*  
 enterococci  
 peptostreptococci

corynebacteria  
 mycobacteria  
 various members of *Enterobacteriaceae*  
*Bacteroides* spp  
*Fusobacterium* spp  
*Mycoplasma* spp  
*C. albicans*, and other yeasts

The distinctive lesions of the external genitalia are venereal in nature and include the lesions of syphilis, chancroid or soft chancre, and granuloma inguinale, which is widespread in the tropics and is caused by an agent variously thought to be a *Klebsiella* variant or a separate pathogenic organism *Donovania granulomatis*.

**Anterior Urethra.** A significant variety and number of organisms can usually be isolated from this region in normal healthy individuals of both sexes. They are as follows:

*S. aureus*  
*S. epidermidis*  
 enterococci  
 various nonpathogenic neisseriae  
 aerobic corynebacteria  
 rarely certain mycobacteria  
 the various enteric gram negative rods  
*Acinetobacter lwoffii* (*Mima*)  
*Haemophilus vaginalis*  
*Mycoplasma*  
*Candida* spp, including *C. albicans*  
*Trichomonas vaginalis*

When the disease is present, it is difficult to determine exactly where the anterior portion of the urethra ends. It is indicated to consider the entire urethra in the male. Urethritis may be caused by gonococcus, and nonspecifically by a variety of bacteria which include *S. aureus*, the Gram-negative rods, and *Listeria*. In the female, it is difficult to avoid contamination of the anterior portion of the urethra by vaginal-labial disease. At times when detection in the vagina has failed, it is perhaps correct to maintain that *Neisseria gonorrhoeae* can be recovered from the anterior urethra of the female.

**Vagina.** In normal females the vaginal flora varies considerably with the pH of the secretions and the amount of glycogen present in the epithelium; these factors, in turn, are influenced by the ovarian function. The usual microflora of this organ is dominated by microaerophilic lactobacilli, designated as Doderlein bacillus and actually *L. acidophilus*. Other organisms cultured from vaginal samples of healthy women include:

*S. aureus*  
*S. epidermidis*  
*Streptococcus mitis*  
 enterococci  
 peptostreptococci  
 group B streptococci

some actinomycetes  
members of the family *Enterobacteriaceae*  
*Acinetobacter* spp  
*H. vaginalis*  
occasionally clostridia and other anaerobic rods  
*Mycoplasma*  
*C. albicans*, and other yeasts  
*Trichomonas vaginalis*

The venereal diseases syphilis and gonorrhea are the major infectious diseases of the female pudenda. Candidiasis, trichomoniasis, and nonspecific vaginitis caused by a variety of organisms may act as opportunistic secondary invaders. *Haemophilus vaginalis* infection ranks high among the so-called nonspecific vaginitides.

#### Exercises (079):

1. What are three areas of the genitourinary tract that usually harbor microorganisms?
2. What is the nature of distinctive lesions of the external genitalia?
3. List some Gram-positive cocci frequently isolated from the surface of the external genitalia.
4. List two Gram-negative coccoid, diplococcoid, cocobacillary, or plump bacillary rods usually isolated from the anterior urethra.
5. When is urethritis considered to be nonspecific?
6. Variation in the vaginal flora of normal females is dependent upon what two conditions?
7. What organisms are considered to be the usual microflora of the vagina?
8. What organism ranks high among the organisms causing nonspecific vaginitis?

080. State cultural criteria and techniques for diagnosis of gonorrhea in terms of specimen sources, media used, the preparation of smears, and microscopic report.

**Cultural Criteria and Techniques for Diagnosis of Gonorrhea.** Figure 4-8 suggests the cultural conditions you should provide in attempting to isolate bacteria from genitourinary secretions. A stained slide prepared from the specimen is helpful in guiding you to a choice of media, although the slide often discloses a mixed population of microbial cells. However, to diagnose gonorrhea in women, culture specimen should be obtained from the cervix and anal canal by the physician. The specimen is inoculated on separate Thayer-Martin (TM) culture plates or in separate Transgrow bottles. The combination of a positive oxidase reaction of colonies and Gram-negative diplococci grown on either medium provides sufficient criteria for diagnosis of gonorrhea.

In male, microscopic demonstration of Gram-negative, intracellular diplococci on the smear of a urethra discharge constitutes sufficient basis for a diagnosis of gonorrhea. Prepare the smear by rolling the swab on a slide. Do not rub the swab on the slide because microscopic morphology will be distorted.

When Gram-negative diplococci cannot be identified on a direct smear of a urethral exudate, a culture specimen should be obtained from the anterior urethra and inoculated on Thayer-Martin (TM) or Transgrow medium. The combination of a positive oxidase reaction of colonies and Gram-negative diplococci grown on either medium provides sufficient criteria for a diagnosis of gonorrhea. If it is known or suspected that homosexuality exists, additional culture specimens should be obtained from the anal canal and oropharyngeal areas and inoculated on TM or Transgrow medium, and interpreted according to the usual biochemical reaction and demonstration of Gram-stained smear of culture as indicated for the cultures previously described.

**Media Selection.** On occasions, selection of appropriate media will depend upon the findings of the Gram stain and upon the tentative clinical diagnosis. A wide variety of broad spectrum as well as selective media are recommended to cover as far as possible the etiologic agents generally expected in genital tract infections.

The following media may be inoculated for isolation of pathogens from genitourinary tract secretions: blood agar plate, EMB agar, chocolate agar, Mannitol salt agar, Thayer-Martin medium, and Thioglycollate medium. Again, note that figure 4-8 suggests specific cultural conditions and incubation times for these media.

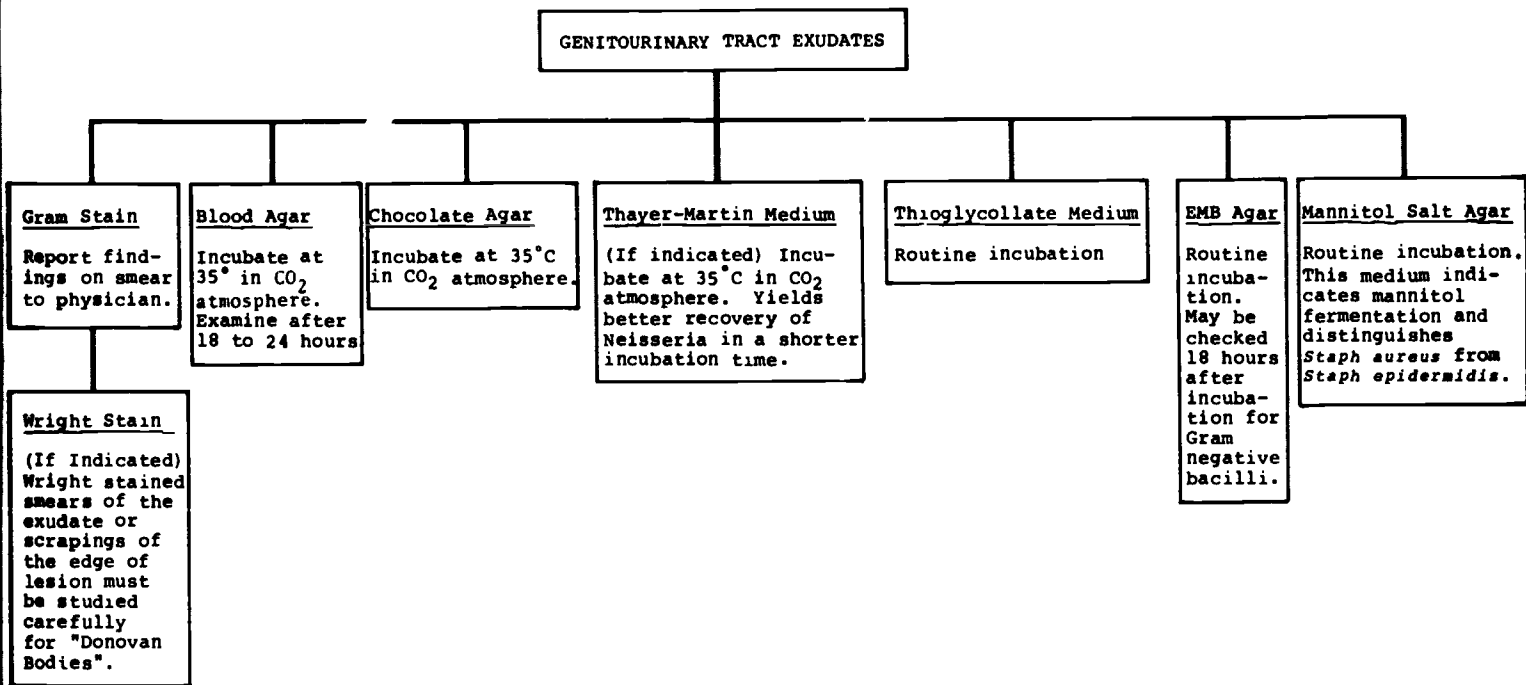

Figure 4-8. Flowchart for processing genitourinary tract exudates.

### Exercises (2<sup>nd</sup>):

1. To diagnose gonorrhea in women, culture specimen taken by physicians are obtained from what two sources?
2. What two media are suggested for culture of gonorrhea?
3. What results constitute sufficient criteria for diagnosis of gonorrhea in females?
4. In males, what results provide sufficient bases for diagnosis of gonorrhea?
5. How is the smear prepared on the slide and why?
6. What further actions should be taken when Gram-negative diplococci cannot be identified on a direct smear of a urethral exudate?
7. On occasions, the selections of appropriate media will depend upon what two factors?
8. List some media which may be inoculated in various combinations for isolation of pathogens from genitourinary tract secretions.

### 4-3. Stain Technology

It is almost axiomatic that microscopic examination of a stained slide is the first task we undertake in identifying bacteria. Staining is necessary because most of the smaller internal and external structures of the cell are otherwise invisible. Indeed, certain of these structures become visible only after stains are applied in conjunction with intense heat or strong chemicals.

It is not surprising, then, that most staining procedures prove lethal to bacteria. So-called vital or supravital dyes are available to stain cells internally without destroying life functions, but these days have only limited usefulness in routine work. The staining techniques you most frequently use begin with a fixation process that quickly kills

all cells on the slide. Fixation not only makes the cells adhere to the slide during staining, but it also reduces the hazard of handling exposed smears of living pathogenic organisms.

There are a few circumstances which require you to observe bacteria in the living state. The circumstance most often encountered in clinical laboratory practice is detection of motility. Later in this section, we will describe the wet mount or hanging drop technique of studying unstained bacteria. But first we must review some precautions in the proper preparation of smears, discuss certain fundamentals of stain technology, and explain some of the routine and special staining procedures performed daily by the bacteriologist.

**081. State significant points to remember when preparing slides for staining; specify the procedures for preparation of smears in terms of air-drying, heat-fixing, and transferring of pus, exudates, and broth cultures to slides.**

**Smear Preparation.** There are three important points to keep in mind when you prepare smears for staining:

- a. Always use clean slides.
- b. Make more than one slide of a specimen.
- c. Air-dry the smear completely.

It is essential to use only clean, unmarred glass slides because oily deposits, scratches, and residues of previous smears lower the quality of the stained slide.

You should generally make two or more smears from the same specimen for a number of reasons: the first slide might stain imperfectly; a special stain could be called for after initial microscopic observation; and multiple smears give a more representative picture of the bacteria present in the specimen.

**Air-drying.** Complete air drying of the smear lays the groundwork for a uniform stain. It is always tempting to hasten the drying process by heating the wet slide with a Bunsen burner, but the risk of "cooking" the smeared cells so that they do not stain typically dictates against the application of a flame. It is permissible when time is short to place the wet slide on the laboratory bench near the base of the Bunsen burner so that heat radiating downward from the flame will accelerate drying. An alternative is to place the slide on a warm microscope lamp, but determine beforehand that the lamp is merely warm and not hot to the touch.

**Transferring specimen.** There are also several things to remember in transferring a specimen to the slide. Pus and serous exudates take the stain better if you spread them as a thin film over a large area of the slide. Moreover, masses of leukocytes and red cells are apt to obscure any bacteria



present if the smear is too thick. For smears of sputum or feces, select small flecks of mucus or blood-stained particles. These elements are more likely to yield organisms on microscopic examination. You must first emulsify swabs containing dried material or meager specimens in a drop of sterile saline on the slide before spreading the film.

We have already noted that specimens of urine, spinal fluid, and other body fluids yield positive results more often if sediments are collected from the liquids by centrifugation. Transfer some of the sediment to a slide, using a loop or a clean wooden applicator stick. Spread the sediment to make an even film. In working with sediment and other specimens (except those in which blood and tissue cells present a complicating factor), make a thicker smear as a rule than you ordinarily would in staining bacterial cells from broth or solid media. The concentration of microbes in clinical material is generally much lower than in laboratory cultures.

**Preparing liquid smears.** Smears of liquid (broth) cultures are prepared by depositing a loopful of the medium on a glass slide. If the broth is highly turbid, spread the droplet over an area slightly smaller than the size of a dime. When growth is scant, you may find it necessary to use 2 or 3 loops of broth to prepare a concentrated film. Bacterial growth on solid media presents a different problem. Pick a minute amount of material from a pure colony and emulsify it in a drop of fresh (bacteria-free) water on a glass slide. Picking is best done with a straight inoculating needle. The suspension of organisms should be only slightly cloudy; otherwise the smear will be too thick for microscopic observation of individual cells.

**Heat-fixing.** After you have made smears and allowed the slides to dry in the air, you must "fix" them by passing the slide through a Bunsen burner flame, smear side up, two or three times. The slide will feel slightly warm but not hot when you touch it to the back of your hand. If the slide gets too hot, the bacteria will be charred and altered in morphology. Heat also tends to modify the pH of the cellular material, a change that will consequently affect staining properties. Heat-fixing causes the smear to adhere so that it will not be washed off the slide during the staining process. When the slide has cooled, the smear is ready for staining. If a number of routine cultures are to be examined using the same kind of stain, it is a practical idea to prepare several smears on a single slide.

#### Exercises (081):

1. What are three important points to remember when you prepare smears for staining?

2. Why is it not advisable to hasten the process of drying the wet slide by heating with the flame of a Bunsen burner?
3. In transferring pus and serous exudates, why should they be spread as a thin film over a large area of the slide rather than making the smear too thick?
4. What portions of the sputum or feces should be most favorable for the smear and why?
5. How should the smear of urine, spinal fluids, and other body fluids be made?
6. When preparing smears of broth cultures if the growth is scant, how can a concentrated film be made?
7. How should smears from bacterial growth on solid media be prepared?
8. When heat-fixing the slide, what can happen if the slide gets too hot?

**082.** Cite the purposes of the dye in the staining process and basic characteristics of the dye used in staining; state the purposes of other reagents used in the staining process.

**Description of Staining Procedures.** Bacteria are colorless and transparent in their natural state. For the most part, fine structures are not visible unless you accentuate them by imparting a color to the cell. The staining process serves a dual purpose. The dye in the stain provides a visual contrast between various components of the cell or between the cell and its background; secondly, the dye coating expands the dimensions of the smaller structures and thus improves the resolution of the light microscope.

From the chemical standpoint a dye is an organic compound, usually structured of benzene rings and side groups which are specific for each dye. One such chemical group, the *chromophore*, gives the

dye molecule its characteristic color. If the chromophore is an anion (negatively charged) in solution, the dye is said to be an acid dye. Conversely, a cationic chromophore (positively charged ion) denotes a basic dye. Eosin, one of the dyes incorporated in the familiar EMB agar for coliforms, is typical of the acid dyes. Methylene blue, crystal violet, basic fuchsin, and safranin are commonly used basic dyes.

In addition to the application of a *dye* to the smeared specimen, other reagents are usually employed as adjuncts in the staining process. A *mordant* is a substance that fixes a dye to the cell and thereby prevents the dye from being removed by decolorizers. The iodine reagent in the Gram stain is a prime example of a mordant. Iodine combines with the crystal violet to prevent washing out of the dye during decolorization of Gram-positive organisms with acetone-alcohol solution. A *decolorizer*, in this instance acetone-alcohol, is a chemical solvent used deliberately to remove a dye from the material being stained. A *counterstain* refers to a secondary dye which follows in sequence the application of (or removal of) the principal dye in a staining procedure. Counterstains are useful in developing a color contrast as in highlighting special structural features of a cell.

#### Exercises (082):

1. What two purposes does the dye serve in the staining process?
2. Describe the dye used from a chemical standpoint.
3. A chemical group that gives the dye molecule its characteristic color is called a \_\_\_\_\_.
4. List some basic dyes.
5. A substance which fixes (intensifies) a dye to a cell, thereby minimizing the dye's removal from the cell, is referred to as a \_\_\_\_\_.
6. The iodine reagent in the Gram stain is a prime example of a \_\_\_\_\_.

7. What is the essential purpose of counterstains?

083. Define given categories of stains and cite examples; specify the mechanism of dye action and its effect on varied cultures.

**Categories of Stains.** For the sake of convenience, staining procedures can be classified into these four different categories:

- (1) Direct stains.
- (2) Indirect stains.
- (3) Differential stains.
- (4) Selective stains.

In *direct* staining, a dye is applied to bacteria to bring into view the general characteristics of cell morphology, such as shape, size, and groupings. *Indirect* stains color the background so that the cells stand out in contrast, but the bacteria, themselves, do not take the dye. India ink preparations exemplify this type of staining. *Differential* stains are used to distinguish between morphologically similar organisms on the basis of the relative affinity of cells, or cellular components, for a given dye. The Gram stain, which we will discuss shortly, is perhaps the best known example of a differential bacteriological stain. "Selective" stains, as the term implies, bring out specific structural features such as flagella, capsules, or spores.

**Mechanism of Dye Action.** The exact mechanism of dye action is not fully understood in each case, but we do know that some dyes undergo a firm chemical union with cellular components. With other dyes, the staining involves only a physical absorption or simple coating action at the cell surface. In general, the acid dyes combine with basic elements of the cytoplasm to give an evenly stained appearance. But many bacteria, and notably the genus *Yersinia*, exhibit "bipolar" staining because cellular constituents concentrated at both ends of the cell stain more intensely or accumulate dye to a greater extent than other areas. Basic dyes tend to combine with the nucleic acid components of the cell; but since the nuclear material in bacteria is diffused throughout the cell, the basic dyes demonstrate gross morphology as well as certain internal structures.

Reagents used to stain bacteria can be a source of error if not properly prepared or applied. The concentration of the dye, the concentration of bacteria, and the time during which the dye is in contact with the microorganisms determine what the final color pattern will be. You must check each set of stains for the proper timing sequence if you are to achieve optimum results. And, too, a

knowledge of culture conditions will often aid you in interpreting staining reactions. As an example, old cultures, particularly broth cultures, contain dead, dying, or atypical cells which will not stain uniformly. Bacteria grown in a carbohydrate broth may not yield typical results, particularly if the carbohydrate has been fermented with the production of acid.

With the foregoing information of a general nature as background, we can touch on several of the more important differential and selective stains. Two of these, the Gram and acid-fast staining procedures, are performed several times daily in a busy medical laboratory. Capsule and spore stains, while not done routinely, illustrate the technically complex selective staining procedures that the bacteriologist is called upon to perform from time to time.

#### Exercises (083):

1. What is direct staining?
2. What is the difference between a direct and an indirect stain?
3. The India ink preparation is an example of what type of staining?
4. What type of stain does the Gram stain exemplify?
5. What category of stains is used to bring out specific structural features such as flagella, capsules, and spores?
6. How do acid dyes result in an evenly stained appearance of the organism?
7. Bipolar staining shows what feature of an organism?
8. Basic dyes combine with what components of the cell?
9. Why do basic dyes demonstrate gross morphology?
10. What are three major factors that influence the final color pattern on a properly stained smear?
11. Why is it possible that bacteria grown in a carbohydrate broth may produce atypical staining result?

084. Indicate whether given statements correctly reflect the principle, technique, and sources of errors of Gram staining.

**Gram Staining.** Most bacteria can be classified into one of two categories on the basis of the Gram staining reaction: Gram-positive or Gram-negative. If the cells of a culture retain a crystal violet dye (cells are purple or blue) after washing with alcohol or acetone-alcohol mixture, these bacteria are said to be Gram-positive. Cells which release crystal violet under treatment with decolorizers and subsequently stain red with a safranin counterstain are termed "Gram-negative." The knowledge of whether an organism is Gram-negative or Gram-positive is critically important because this information limits the number of genera which must be considered in identifying an unknown bacterium.

The mechanism of the Gram stain is not fully known. The property of being Gram-positive appears to be associated with a ribonucleic acid component of the cytoplasmic membrane. This region of the bacterial cell has an affinity for the crystal violet-mordant (iodine) complex formed during the staining procedure. Gram-negative organisms do not show this affinity. It is true that crystal violet and iodine penetrate both Gram-positive and Gram-negative cells, but these reagents only form a stable compound in the Gram-positive cells. Bacteria which lack specific cellular substances responsible for binding the crystal violet-mordant fail to retain the violet stain when decolorizers are applied. The Gram-negative forms are, therefore, stained red by the safranin counterstain which follows the decolorizing step.

Although most bacteria are clearly either Gram-positive or Gram-negative, there are some species that exhibit a definite tendency to display both positive and negative cells in a stained preparation. These organisms are called Gram-variable. But whether positive, negative, or variable, the Gram reaction is species specific when properly performed and interpreted.

The Gram staining procedure is not unduly sensitive to variations in technique, but there are certain precautions you must watch in order to get a good stain consistently. One of these is the age and condition of the specimen to be stained. Gram-positive organisms may become Gram-negative as a result of autolysis, aging, acidity of the culture medium, improper temperature of incubation, or the presence of toxic substances (drugs, metabolic wastes). For best results, you should prepare Gram stains on cultures 18 to 24 hours old. Use a known Gram-positive organism as a control.

The quality of the smear is equally important. If you prepare films unevenly or too thickly, dense deposits of material will retain crystal violet upon decolorization regardless of the Gram reaction. Under these conditions, falsely Gram-positive clumps of bacteria will be seen in an otherwise Gram-negative smear. Smears should be completely dry before heat-fixing, or else protein carried over into the smear from culture media or specimens will be precipitated. The background of the smear will then be difficult to decolorize and may contain debris and misleading artifacts.

Decolorization of Gram-positive cells can result if you use an iodine (mordant) solution which has deteriorated. Gram's iodine solution will remain stable for long periods of time when protected from light by storage in a dark bottle. When the iodine solution fades in color from brown to light amber or yellow, it is no longer suitable for use. Overly enthusiastic treatment with the decolorizing solution also results in a false Gram-negative reaction. *Immediately* after the washings become clear during treatment of the smear with alcohol or acetone-alcohol mixture, you must rinse the slide with water to prevent overdecolorization.

#### Exercises (084):

Indicate whether each of the following statements is true (T) or false (F), and correct those that are false.

- T F 1. Whether an organism is Gram-negative or positive is critically important because this information limits the number of genera in identifying an unknown bacterium.
- T F 2. The property of being Gram-positive appears to be associated with a deoxyribonucleic acid component of the nuclear membrane.
- T F 3. In Gram-positive organisms, a specific component of the bacterial cell has an

affinity for the crystal violet-mordant (iodine) complex formed during the staining procedure.

- T F 4. Crystal violet and iodine penetrate both Gram-positive and Gram-negative cells, but these reagents only form a stable compound in the Gram-negative cells.
- T F 5. Cells that display both negative and positive in their staining are called Gram-reversible.
- T F 6. Gram-negative organisms may become Gram positive as a result of autolysis, aging, and improper incubation temperature.
- T F 7. If you prepare films unevenly or too thick, dense deposits of material will retain crystal violet upon decolorization regardless of Gram reaction.
- T F 8. Smears should be completely dry before heat-fixing, or else protein carried over into the smear from culture media or specimens will be precipitated.
- T F 9. When the iodine solution fades in color from brown to light amber or yellow, it has aged and is highly suitable for use.

**085. Point out the substances in acid-fast organisms which prevent staining by ordinary methods, the reagents used to allow penetration and staining, and the major differences between the two given acid-fast techniques.**

**Acid-Fast Staining.** Members of the genus *Mycobacterium* and certain *Nocardia* spp possess relatively large amounts of lipids, fatty acids, and waxes within their cell wall. Such substances withstand penetration and staining of the cytoplasm by ordinary methods. When these resistant forms

are heated during exposure to a high concentration of a basic dye in phenol, staining is more readily accomplished. Phenol serves as a carrier for the dye in penetrating the lipid layer. Once stained, the organisms resist decolorization with acid-alcohol even upon prolonged exposure. They are thus said to be acid-fast. Although all bacteria may be stained in this manner, only the aforementioned organisms, with rare exceptions, will resist decolorization with the acid-alcohol solution. The tubercle bacillus in a stained smear will appear pink to red because of the absorption of the carbol-fuchsin. The nonacid-fast bacteria, having been decolorized by acid-alcohol, will show up as blue from the methylene blue counterstain.

You will routinely use the Ziehl-Neelsen or Modified Kinyoun techniques in examining specimens or cultures for the presence of acid-fast bacilli. In the Ziehl-Neelsen procedure, time and temperature of heating the smear are somewhat critical. Overheating diminishes the color of the organisms to a pink or brown, or may even distort the shape of the cell. Tergitol is incorporated in the Modified Kinyoun to reduce the surface tension between the cell wall of acid-fast organisms and the carbol-fuchsin stain. This is the role played by heat in the Ziehl-Neelsen stain. The heatless tergitol method is more advantageous in that it is less cumbersome and requires less time.

#### Exercises (085):

1. What substances present in the cell wall of the genus *Mycobacterium* and certain *Nocardia* spp enable them to withstand penetration and staining?
2. What is the action of phenol in the carbol-fuchsin solution as employed in an acid-fast stain?
3. What causes the bacillus in a stained smear to appear pink to red?
4. What is the major difference between the Ziehl-Neelsen and the Modified Kinyoun acid-fast staining techniques?

**086.** Cite given fluorochrome staining technique in terms of the dyes and reagents used; arrange in the proper order the procedure for staining; and state some of the advantages of this technique over the carbol-fuchsin techniques.

**Fluorochrome Stain.** The fluorochrome staining procedure requires the use of fluorescent dyes, such as Auramine O and Rhodamine B. Examination by fluorescence microscopy using an ultraviolet light source will demonstrate acid-fast bacilli showing a glow with an orange to red color.

**Reagents.** In addition to auramine (1.5g) and rhodamine (0.75g), glycerol (75 ml), phenol (10 ml), and distilled water (50 ml) are combined and heated until warm then vigorously mixed for 5 minutes. The solution is filtered through glass wool and may be stored for several months in a dark bottle at 4° C.

**Procedure.** Smears are prepared using new slides. The slides are heat fixed on a slide warmer for 2 hours at 65° C or overnight. They are then flooded with fluorochrome stain solution and allowed to stand for 15 to 20 minutes at room temperature, then rinsed with tap water. Further, they are decolorized with 0.5 percent HCL in ethyl alcohol (acid alcohol) and again rinsed thoroughly in distilled water. The smears are then flooded with counterstain, a 0.5-percent solution of potassium permanganate, rinsed, dried, and examined. Smears are examined under a binocular microscope using an ultraviolet light source, with a dark field condenser 200-watt arc lamp, blue exciter filter (BG-12 or equivalent) and orange barrier filter (EK-15 or equivalent).

Under low power, tubercle bacilli appear as self-luminous, golden-yellow rods. All positive smears should be confirmed with a Kinyoun or Ziehl-Neelsen stain. This procedure allows rapid scanning of smears magnified 100 times. Patients on drug therapy may discharge organisms that stain by fluorescent methods but not by the conventional acid-fast stains. Specimens may be screened with less eye fatigue, and the method provides a substantially greater yield of positive results than the carbol-fuchsin techniques. It is further recommended for laboratories that handle a considerable quantity of clinical specimens and in which adequate equipment can be made available.

#### Exercises (086):

1. What two fluorochrome dyes are used in the fluorochrome staining procedure?
2. Besides the dyes used, what other reagents are components of the staining solution?
3. Prior to staining, how is the slide heat fixed and for how long?



4. Rearrange the following steps in the proper sequence. After heat-fixing the slide, for staining procedure, the technician must:
  - a. Decolorize with 0.5 percent HCL in ethyl alcohol (acid alcohol).
  - b. Flood smear with counterstain, a 0.5-percent solution of potassium permanganate.
  - c. Rinse, dry, and examine.
  - d. Flood slide with fluorochrome stain solution and allow to stand for 15 to 20 minutes at room temperature.
  - e. Rinse with tap water.
  - f. Again rinse thoroughly is distilled water.
  
5. With what other staining technique should all positives smears be confirmed?
  
6. List four advantages of this technique over the other carbolfuchsin techniques.

087. Identify selective staining techniques in terms of their purposes, contents, use of additional reagents, and appearances of the organisms with each; identify wet unstained preparations in terms of their purpose and techniques.

**Selective Staining.** Selective stains, as we defined them earlier, aid you in establishing the identity of an organism by highlighting structures that usually can't be observed clearly with conventional stains. Capsules and spores are typical of these specialized structures. The *capsule* may be demonstrated by either negative or positive staining. You will see capsules most often in young cultures 4 to 6 hours old. Negative staining provides a dark background (usually black) against which the unstained organism and capsule contrast. The capsule is visible only because of the space it occupies. The dye nigrosin or India ink is most often used, but not all brands of India ink are satisfactory for demonstrating capsules. Brands containing very finely divided carbon particles yield the best results. Inks should be free of bacterial contamination. They can be protected against contamination by adding phenol in 0.5 percent concentration by volume.

**Hiss stain.** The Hiss stain is useful in imparting color to the capsule itself; for example, positive staining. For best results, it is necessary to grow the test organism in a liquid medium containing serum or ascitic fluid for full development of the capsule. As an alternative you can mix blood serum and bacteria grown on solid media prior to air drying

and heat-fixing the slide. Bacterial capsules are composed of a polysaccharide which does not stain well by ordinary means. This capsule, however, can be caused to swell when mixed with normal serum. The serum allows the dye to penetrate. The combination of capsular swelling and dye impregnation is the basis of the Hiss stain. Use a copper sulfate solution instead of water to wash the stain from the slide, since water tends to act as a decolorizer.

**Spore staining.** Spores are developed in *Clostridium* and *Bacillus* species as a means of survival during unfavorable environmental conditions. In the laboratory, spores may form during routine culturing, and the presence of these bodies is a clear indication that you are dealing with one or the other of these genera. The bacterial spore is characterized by three distinct properties of interest to you in staining: (1) a high degree of heat resistance, (2) resistance to penetration by dyes, and (3) highly refractile when viewed microscopically. These properties account for the clear "hole" you see while examining sporeformers stained with the Gram stain, methylene blue, or similar stains. The spores appear colorless with these stains, so in order to study a spore in detail, it is necessary to alter at least one of the three properties mentioned above. The Wirtz-Conklin spore stain is typical of the techniques available to you. Using this technique, you must steam the dye-covered smear for a brief period, utilizing the heat to drive the dye into the spore coat. Once the spore is stained, the dye is retained during rinsing, and the vegetative cell is then counterstained with a dye of contrasting color.

**Wet Unstained Preparations.** Occasionally, the microscopic examination of wet, unstained preparations can aid bacterial identification by revealing whether or not the organisms possess flagella. The most commonly used method is the hanging drop to detect motility of living bacteria in pure culture. The technique for preparation and microscopic observation of hanging drop mounts is illustrated in figure 4-9. Deposit a drop of broth culture containing the cells on a coverslip and invert it over a depression slide. You can see flagellar motion as directional movement of individual cells. Do not confuse motility with Brownian movement which is a vibratory type of motion of the bacterial cells due to molecular bombardment. An alternate method is the wetmount method which uses a plain glass slide and a vaseline "ringed" coverslip inverted over it. Although not as good as the hanging drop technique because of limited space between slide and coverslip, this method offers a quick way of examining bacterial growth when the concave depression slide is not available. This method may be essential with such microorganisms as the



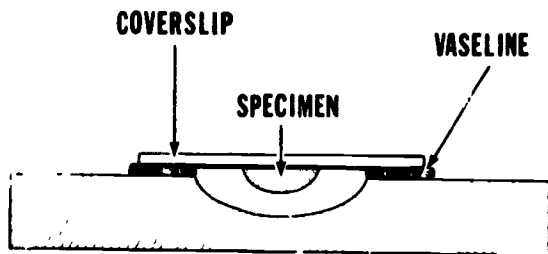

Figure 4-9. Hanging drop slide.

treponeme of syphilis and in this instance is examined by dark-field microscopy.

**Exercises (087):**

Match each of the following items in column B with the statements in column A by placing the letter of the column B item beside the number of the column A item that most nearly describes it. Each element in column B may be used once or more than once.

- | <i>Column A</i>  | <i>Column B</i>             |
|--|-----------------------------|
| — 1. Is visible only because of the space it occupies.   | a. Brownian movement.       |
| — 2. Certain brands containing finely divided carbon particles are used for demonstrating capsules.  | b. Hiss stain.              |
| — 3. Can be protected against contamination by adding phenol in 0.5 percent concentration by volume. | c. Wirts-Conklin stain.     |
|  | d. India ink.               |
|  | e. Copper sulfate solution. |
|  | f. Hanging drop.            |
|  | g. Wet-mount.               |
|  | h. The bacterial spore.     |
|  | i. The bacterial capsule.   |

- 4. Is useful in imparting color to the capsule. j. Serum.
- 5. In this procedure it is necessary to grow the test organism in a liquid medium containing serum or ascitic fluid for full development.
- 6. Allows the dye to penetrate in the Hiss staining process.
- 7. The combination of capsular swelling and dye impregnation is the basis of this stain.
- 8. Is used instead of water to wash the stain from the slide, since water tends to act as a decolorizer.
- 9. They are characterized by a high degree of heat resistance, resistance to penetration by dyes, and are highly refractile when viewed microscopically.
- 10. This technique requires steaming the dye-covered smear for a brief period utilizing heat to drive the dye into the spore coat.
- 11. Most commonly used to detect motility of living bacteria in pure culture.
- 12. Is a vibratory type of motion of the bacterial cells due to molecular bombardment.
- 13. This method uses a plain glass slide and a vaseline "ringed" coverslip inverted over it.
- 14. Is examined by dark-field microscopy for such microorganisms as the treponeme of syphilis.

## Antimicrobial Agents, Drug Resistance, and Susceptibility Testing

IN CHAPTER 2 of this volume, you studied some of the principles of disinfection and sterilization. You learned that microbes are susceptible to a wide variety of chemical compounds commonly referred to as "antiseptics" and disinfectants or "germicides." You also found that physical energy in the form of heat and radiation can be used to decontaminate materials in our environment which harbor pathogenic microorganisms.

But when we attempt to counter the pathogenicity of bacteria within the human body, the choice of antimicrobial agents is severely restricted. It is a biological fact that life processes in bacteria and man are so similar at the cellular level that most physical and chemical agents potent enough to destroy a bacterium inside the body are also toxic to the human host. It is not surprising, therefore, that until recent years few drugs (chemotherapeutic agents) were available to combat deep-seated infections in man safely and effectively.

With the discovery of a hitherto unrecognized class of biological substances, the antibiotics, an array of new therapeutic weapons became available to the physician. In this chapter we will show how representative antimicrobial agents act against bacteria, and examine some of the resistance mechanisms displayed by microorganisms.

We will proceed to discuss a relatively new disc method for determining antimicrobial susceptibility—that of Kirby and Bauer—and procedures to assess the effectiveness of antibiotic therapy. Finally, we will discuss briefly recommendations for quality control procedures in susceptibility testing.

### 5-1. Antimicrobial Agents

For our purposes, the term "antimicrobial agent" embraces an assortment of therapeutic organic chemicals, including substances synthesized in the laboratory and those derived from living organisms. The widely prescribed sulfonamides typify drugs of the synthetic group. By common usage the term "antibiotic" is reserved for chemical substances produced by living forms—compounds like the

penicillins—which in low concentration suppress the growth of microbes, or actually kill them outright. But since the underlying principle of sensitivity testing and assay is identical for most synthetic and naturally occurring chemotherapeutic agents, we will not emphasize the differences in the source of the drug. We will exclude those antiseptic and germicidal compounds mentioned in Chapter 2 that are limited by toxicity to topical application or to disinfection of inanimate objects.

**088.** Define an antibiotic; cite the genera of organisms from which most antibiotics are derived; identify the terms bacteriostatic and bactericidal as to their contrasting effects; and state the major categories in which the cell functions are affected by the action of antibiotics.

**General Characteristics of Antibiotics.** An antibiotic is a chemical substance, derived from or produced by various species of microorganisms, which is capable in minute concentrations of inhibiting the growth. Antibiotics are widely distributed in nature and play a significant part in regulating the microbial population of soil, water, sewage, and compost. They differ significantly both chemically and in their modes of action. Thus, there exists little or no relation between the antibiotics other than their ability to adversely affect the life processes of certain microorganisms. Several hundred antibiotics have been purified, but only a few have been sufficiently nontoxic to be of use in medical practice. The ones that are currently of greatest use have been derived from a relatively small group of microorganisms belonging to the genera *Bacillus*, *Penicillium*, and *Streptomyces*.

**Desirable Properties of Antibiotics.** An essential property of a chemotherapeutic agent is selective toxicity. The pathogen must be destroyed or inhibited without injury to the host. The ideal antibiotic is one that is bactericidal rather than bacteriostatic in its effect.

Antimicrobial substances are usually characterized as either *bacteriostatic* or *bactericidal*,

although some of them possess both bacteriostatic (inhibitory) and bactericidal (lethal) properties, depending upon drug concentration and the type of bacterial pathogen involved. This difference in effect is understandable if we examine the nature of the cell function that is altered. For instance, an agent is clearly bactericidal if its action so weakens the main supporting structure—the cell wall—that the high internal osmotic pressure of the cytoplasm causes lysis of the cell. On the other hand, a drug that upsets nucleic acid synthesis may prevent the cell from reproducing even though the functions of respiration and growth remain intact. The end result of this inhibitory, or bacteriostatic, effect is that multiplication of the pathogen is suppressed, and the natural defenses of the host are given an opportunity to overcome the infection.

If we group antimicrobial substances in terms of their effect on cell functions, five major categories can be recognized. They interfere with:

- Cell wall synthesis.
- Cytoplasmic membrane function.
- Protein synthesis.
- Nucleic acid metabolism.
- Intermediary metabolism.

#### Exercises (088):

1. What is an antibiotic?
2. Antibiotics differ in terms of what two characteristics?
3. Most antibiotics currently used are derived from which three genera of organisms?
4. What is meant by selective toxicity of a chemotherapeutic agent?
5. An antimicrobial substance which inhibits the growth of an organism may be considered as \_\_\_\_\_.
6. An ideal antibiotic is one that is \_\_\_\_\_ rather than \_\_\_\_\_ in its effect.
7. In what five major categories are cell functions affected by the action of antibiotics?

#### 5-2. Mode of Drug Action

Beginning with the bacterial cell wall and proceeding deeper into the cell, we will follow the functional classification of antimicrobial agents set forth above to show how representative chemotherapeutic drugs react at the molecular level.

089. Cite the structural composition of the bacterial cell wall, the function of peptide linkage, and the functions of given antimicrobial agents in terms of their adverse effects upon the bacterial cell wall.

**The Cell Wall.** The bacterial cell wall is a complex structure containing various combinations of lipids, carbohydrates, and proteins. But chemical substances known as *mucopeptides* comprise the main building blocks from which the cell wall is constructed. Each building block is fashioned from long chains of a polysaccharide held in place by cross links formed by amino acids. A polysaccharide is a form of carbohydrate containing four or more molecules of the simple sugars or their derivatives.

You will recall the amino acids (the main constituents of protein) are carbon compounds having at least one free amino (NH<sub>2</sub>) group and one or more carboxyl (COOH) groups. The amino acids that keep the polysaccharide chains in proper position are themselves bound together by a so-called "peptide linkage" in which the NH<sub>2</sub> group of one amino acid combines with the COOH group of another, as shown in figure 5-1. The union of two amino acids yields a peptide, and a molecule formed by several peptides is called a polypeptide. We can thus visualize the mucopeptide building block of the cell wall as a lattice-like structure in which parallel strands of polysaccharide are held in

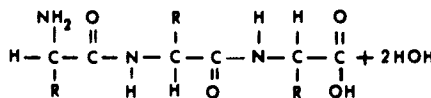
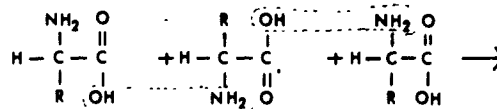

Three amino acid molecules combine to form a polypeptide chain. "R" indicates the remainder of the amino acid molecule not shown in the drawing.

Figure 5-1. Illustration of peptide.

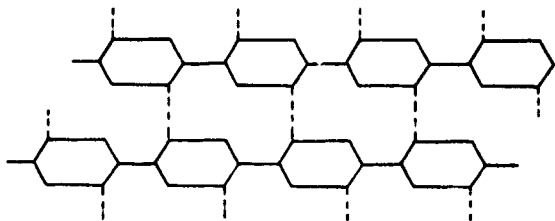

Horizontal chains represent the polysaccharide component.

Vertical links are formed by polypeptides.

Figure 5-2. Sketch of mucopeptide unit.

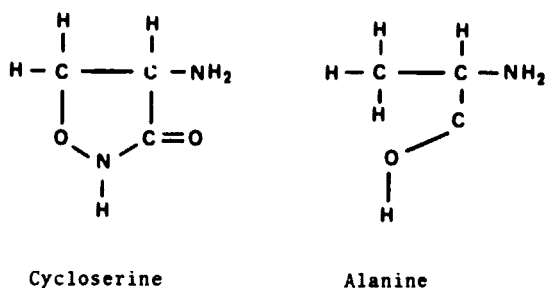

Figure 5-3. Structural formulas of cycloserine and alanine.

their respective positions by lateral bridges formed between the strands by the polypeptides. This structure is illustrated in figure 5-2.

The rigid cell wall gives shape to the bacterium, protects the cell from mechanical injury, and provides structural support for the underlying cytoplasmic (protoplast) membrane which regulates the flow of nutrients into and out of the cell. Because of the great difference in the concentration of solutes within the cell (as opposed to the external medium), the osmotic pressure inside the cytoplasmic membrane is high. Without an intact cell wall, the membrane cannot maintain the proper osmotic relationship for normal functioning. As we pointed out in our earlier discussion of a bactericidal agent, the pressure differential may also lead to lysis and death of the cell.

There are several antimicrobial agents that in one way or another adversely affect the cell wall. We will talk about bacitracin produced by *Bacillus licheniformis*, cycloserine (*Streptomyces spp*), the penicillins (*Penicillium spp*), and the synthetic nitrofurans compounds.

**Bacitracin.** Bacitracin, a mixture of polypeptides, blocks the integration of mucopeptide units into the wall structure. We think that bacitracin interferes with the orderly linking of the polypeptide side chains that bridge the polysaccharide strands.

**Cycloserine (Oxamycin).** Cycloserine is an antibiotic that is active against many Gram-positive and Gram-negative organisms. It is produced by *Streptomyces orchidaceous*. Clinically, it has been useful in patients with tuberculosis when organisms are resistant to other antituberculous agents. It is structurally similar to the amino acid alanine. (See fig. 5-3.) When the antibiotic is present, the enzymes that control synthesis of the peptide component randomly select a molecule of cycloserine, a "competitive analog," instead of the natural alanine. The antibiotic, although sufficiently similar to alanine to engage the enzyme, cannot be fitted into the peptide portion of the building block. As a result, the mucopeptides function imperfectly because the sequence of amino acids within them is abnormal.

**Penicillins.** There are several different penicillins. The nucleus common to all of them is a cyclic dipeptide of cystine and valine. (Study fig. 5-4.) Note that it is the side chain, attached to the nucleus at the point "R" (radical in the diagram, that gives the various penicillins their distinctive actions against different groups of microorganisms. Several representative side chains are shown in this figure. The penicillins are thought to affect the bacterial cell at more than one site, although the exact nature of the reactions is still not clear. Laboratory experimentation has disclosed three main effects on susceptible organisms: a blocking of amino acid uptake from the external environment; inhibition of the synthesis of certain enzymes by the cell; and interference with cell wall formation. With regard to the cell wall, the effect is believed to be either an interruption of the process in which the mucopeptide building block is fabricated from its component parts, or disruption of the polypeptide cross links between the strands of polysaccharide in the mucopeptide.

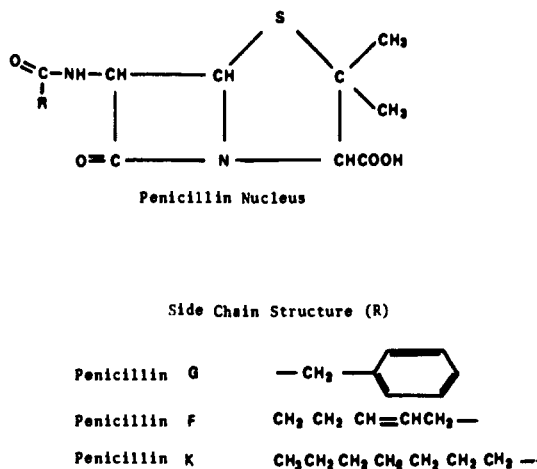
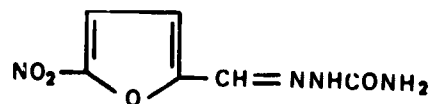

Figure 5-4. Structural formula of penicillins.

**Synthetic nitrofurans compounds.** Among the bacteriostatic and bactericidal drugs synthesized in the chemical laboratory are the nitrofurans compounds. Figure 5-5 illustrates these compounds, which are useful in treating urinary tract infections by Gram-positive and Gram-negative forms. As in the case of the penicillins, there seem to be multiple sites of drug action—that is, intracellular enzyme systems, the cytoplasmic membrane, and the cell wall. Because mucopeptide precursors (raw materials) accumulate in culture media containing the nitrofurans, there is speculation that the drugs inhibit fabrication of the mucopeptide unit in its finished form.

**Exercises (089):**

1. The cell wall building block of bacteria is composed primarily of what substances?
2. What is the primary function of peptide linkage in the bacterial cell?
3. The osmotic pressure inside the bacterial cytoplasmic membrane is (lower/higher) than the outside pressure.
4. How does bacitracin affect bacterial cell wall function?
5. Briefly explain why the cell wall mucopeptides function imperfectly when a cell is subject to an environment containing cycloserine.
6. Most penicillins, although similar chemically, differ in what aspect of their molecular makeup?
7. Penicillins are thought to affect the bacterial cells in what three ways?
8. As in the case of the penicillins, the synthetic nitrofurans compounds seem to have \_\_\_\_\_ of drug action.



Furacin

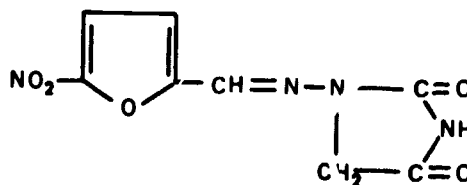

Furdantin

The side chains on the nitro furan ring nucleus give the compounds their antimicrobial specificity.

Figure 5-5. Structural formula of nitrofurans compounds.

**090.** Specify the role of the cytoplasmic membrane in the bacterial cell; the action of an antimicrobial agent on the cytoplasmic membrane; and the reason why some antimicrobial agents are effective against pathogenic fungi and not bacteria.

**The Cytoplasmic Membrane.** A thin membrane located directly beneath the cell wall encases the bacterial protoplasm. This cytoplasmic or protoplast membrane provides a barrier against the indiscriminate flow of fluids and metabolites into and out of the cell and maintains the proper interior osmotic pressure for life functions. The structure houses the enzymes that mediate the selective transport of sugars, amino acids, and essential ions across the membrane into the cell. In addition, there is evidence that the cytoplasmic membrane participates in the synthesis of other structures, such as the cell wall and appendages, for example, flagella.

More than half of the membrane is protein in nature, but lipids and carbohydrates are present in significant amounts and in chemically complex molecular arrangements. The action of antimicrobial agents is generally manifested in one of two ways. First, combining of the agent with a vital component of the membrane can impair the transport of materials into or out of the cell. Second, the union of agent and membrane can result in a loss of selective permeability so that essential constituents "leach" out of the cell into the exterior environment.

Several antimicrobial agents active against the pathogenic fungi (but not against bacterial



pathogens) owe their effect specifically to a joining of the agent with sterol components of the cytoplasmic membrane. Bacteria are resistant because they lack the sterols (cyclic alcohols) with which the antibiotics combine. Amphotericin B (*Streptomyces nodusus*), filipin (*Streptomyces filipinensis*), and nystatin (*Streptomyces noursei*) are members of this group of antifungal substances whose action disorganizes membrane permeability and permits vital intracellular elements to be lost.

Among the antibacterial drugs affecting the cytoplasmic membrane are the polypeptides polymyxin and tyrothricin. *Bacillus polymyxa* produces several polymyxins, each differing in amino acid content, but the basic molecular configuration is the same. It is believed that the polymyxins apparently form a complex with phospholipids of the lipoprotein present in the cytoplasmic membrane of Gram-negative organisms.

The *in vivo* and *in vitro* activity of polymyxin is restricted to Gram-negative organisms. This union causes a breakdown in the membrane's capacity to regulate permeability, and cell constituents diffuse to the exterior.

Tyrothricin is a mixture of cyclic polypeptides, labeled gramicidins and tyrocidins, elaborated by *Bacillus brevis*. Tyrothricin and bacitracin are effective against Gram-positive bacterial infections. These antibiotics interfere with the energy-yielding phosphate reactions that are necessary to cell respiration. Beyond this, the polypeptide agents from *B. brevis* exhibit properties similar to the polymyxins in disrupting the normal control of permeability.

#### Exercises (090):

1. What is the role of the cytoplasmic membrane in the bacterial cell?
2. What explanations have been given for the action of an antimicrobial agent on the cytoplasmic membrane?
3. Why are some antimicrobial agents effective against pathogenic fungi and not bacteria?
4. The *in vivo* and *in vitro* activity of polymyxin is restricted to what type staining organisms?
5. How does the union of the polymyxins affect the cytoplasmic membrane?

6. What given antibiotic mixture, effective against Gram-positive bacterial infection, interferes specifically with the energy-yielding phosphate reactions that are necessary to cell respiration?

091. Identify the functions and purposes of given ribonucleic acid (RNA) components and the antimicrobial agents that inhibit protein synthesis.

**Protein Synthesis.** Before we learn how antimicrobial drugs exert their effect on bacterial protein synthesis, we should review briefly the major steps in the manufacture of protein by the cell. These steps are carried out by ribonucleic acid (RNA) components acting under the genetic influence of deoxyribonucleic acid (DNA) found in the nuclear portion of the cell.

Actually, we are concerned here with three distinct forms of ribonucleic acid:

- Ribosomal RNA.
- Soluble RNA.
- Messenger RNA.

**Ribosomal RNA.** The preponderance of the RNA occurs in the *ribosomes*, which are free particles, or aggregates of particles (polyribosomes) that combine individual amino acids into peptides, the building blocks of the new protein. The ribosomes can be looked upon, then, as the cell's manufacturing plant for protein.

**Soluble RNA (sRNA).** This constitutes 10 percent or less of the total RNA. Soluble RNA molecules select specific amino acids from the intracellular pool of these compounds and deliver them to the ribosomes for fabrication into protein. Soluble RNA thus performs a transport function between raw materials and the protein manufacturing site of the cell.

**Messenger RNA (mRNA).** Messenger RNA, which comprises the remaining small fraction of the total RNA, can be pictured in the role of the plant production chief, since mRNA transmits from the nuclear DNA (the plant manager) to the ribosome instructions on the makeup of the new protein that is to be synthesized. This mRNA information, or genetic code, is read by the ribosome as the latter links together in proper sequence the amino acid molecules supplied by sRNA.

The intricate process of protein synthesis, greatly simplified here for our purposes, can be disrupted at many points in the chain of events. First, there are antimicrobial agents that in therapeutic concentration cause destruction or gross impairment of major systems in the cell. For instance, exposure to streptomycin (*Streptomyces griseus*) results in a general breakdown of DNA, while ribosomes formed in the presence of



chloramphenicol (*Streptomyces venezuelae*) are intact, but so structurally disorganized that the protein they synthesize is imperfect and nonfunctional.

Usually, however, you will find that the adverse effect of the agent is more subtle. It is apt to be focused on one of the reactions carried out by components of the sRNA—ribosome—mRNA complex as they actively produce new protein. In the next paragraph we will show some examples of postulated mechanisms that may account for the action of antimicrobial agents in protein synthesis. These assumptions are based on research conducted with a variety of experimental systems.

Lincomycin from *Streptomyces lincolnensis* is believed to interfere with the activation or transfer of amino acids from the pool of these raw materials. Chloramphenicol and the tetracyclines, as shown in figure 5-6, apparently block the release of amino acids from the carrier, sRNA, to the ribosome. Similarly, by combining with the ribosome at one specific point on that organ, erythromycin (*Streptomyces erythreus*) blocks the attachment of the incoming sRNA molecule and its amino acid. Streptomycin binds the ribosome at still another point to retard the attachment or movement of the mRNA molecule. In this instance the result is a misreading of the genetic code for the makeup of the protein that is manufactured on the ribosome. In the final stage of protein synthesis, cycloheximide (*Streptomyces griseus*), also shown

in figure 5-6, and puromycin (*Streptomyces alboniger*) in some way prevent the correct placement of amino acids in their respective positions in the developing peptide molecule.

#### Exercises (091):

Match each item in column B with the statements in column A by placing the letter of the column B item beside the number of the column A item that most nearly describes it. Each element in column B may be used once or more than once.

#### Column A

#### Column B

- 1. Constituents function to combine individual amino acids into peptides, which are the building blocks of the new protein.
- 2. Serves as a transport medium between raw materials (amino acids) and the protein manufacturing site of the cell.
- 3. Transmits from the nuclear DNA to the ribosome the necessary genetic coding instructions for making protein.
- 4. Can be pictured in the role of plant production.
- 5. Exposure to the cell results in a general breakdown of DNA.
- 6. Ribosomes formed in the presence of this antibiotic will be intact, but so structurally disorganized that the protein they synthesize is imperfect and nonfunctional.
- 7. Is believed to interfere with the activation or transfer of amino acids from the pool of these raw materials.
- 8. Apparently block the release of amino acids from the carrier, sRNA, to ribosome.
- 9. Blocks attachment of the incoming sRNA molecule and its amino acid by combining with the ribosome at one specific point on that organ.
- 10. Binds the ribosome at another point to retard the attachment or movement of the mRNA molecule.
- 11. In some way prevents the correct placement of amino acids in their respective positions in the developing peptide molecule.

- a. Chloramphenicol.
- b. Erythromycin.
- c. Ribosomal RNA.
- d. Messenger RNA.
- e. Lincomycin.
- f. Soluble RNA.
- g. Streptomycin.
- h. Cycloheximide.
- i. Tetracyclines.

Cycloheximide

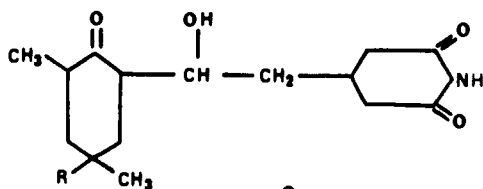

Chloramphenicol

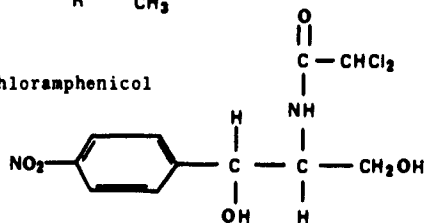

Tetracycline

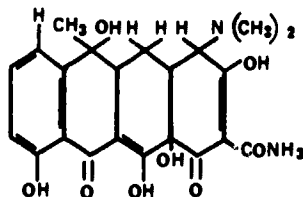

Figure 5-6. Compounds affecting protein synthesis.

092. Cite the two primary roles to which the DNA molecule is related; the mechanisms employed in altering the structure or function of DNA; point out given antibiotics in terms of their effects upon nucleic acid metabolism.

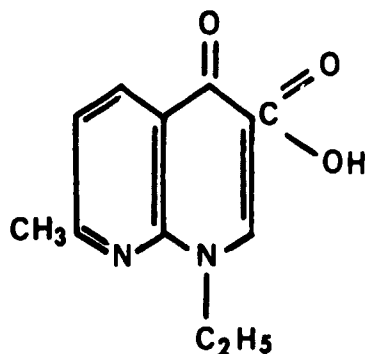

Figure 5-7. Structural formula for nalidixic acid.

**Nucleic Acid Metabolism.** Although many compounds have been discovered that upset functions in the nuclear elements of the microbial cell, few are suitable for therapeutic purposes. Nucleic acid metabolism in all species is so similar that an agent toxic to one form is generally poisonous to all. The structure of the deoxyribonucleic acid (DNA) molecule is intimately related to its two primary roles, duplication and transcription. When an agent disturbs the structure of the organized double helix of DNA, it is potentially capable of causing profound effects on all phases of cell growth and metabolism. Drugs used for altering the structure or function of DNA employ the mechanisms of cross-linking and intercalation between the stacked bases of the double helix.

**Nalidixic acid.** Nalidixic acid, shown in figure 5-7, is a synthetic drug useful in treating urinary tract infections by Gram-negative rods. The antimicrobial agent inhibits DNA synthesis, which in turn, retards the production of RNA and protein. The specific nature of the bactericidal reaction has not yet been determined.

**Novobiocin.** Novobiocin is bactericidal for Gram-positive organisms. Its range of activity is similar to that of penicillin and erythromycin. (Note fig. 5-8.) Presently, the mode of action of novobiocin cannot be explained by any single hypothesis. Its primary

effect probably is on DNA synthesis, although numerous secondary effects are involved. DNA polymerase activity is inhibited immediately. Cell wall synthesis and protein synthesis are inhibited later. It also affects the integrity of the protoplast membrane and causes a leakage of nucleotides into the medium.

**Griseofulvin.** Griseofulvin is a fungistatic agent specific for fungi whose walls contain chitin. (Note fig. 5-9.) It has been used successfully in the treatment of infections caused by the dermatophytes. It inhibits mitosis in the metaphase, causing multipolar mitosis and abnormal nuclei.

**Exercises (092):**

1. The structure of the deoxyribonucleic acid molecule is intimately related to which two of its primary roles?
2. What mechanisms are employed by drugs used to disturb the functions or structure of DNA?
3. How does the antibiotic nalidixic acid affect DNA metabolism?
4. What effects does novobiocin have on DNA metabolism?
5. Griseofulvin is a fungistatic agent specific for fungi whose walls contain what substance?
6. How is DNA function affected by the use of Griseofulvin?

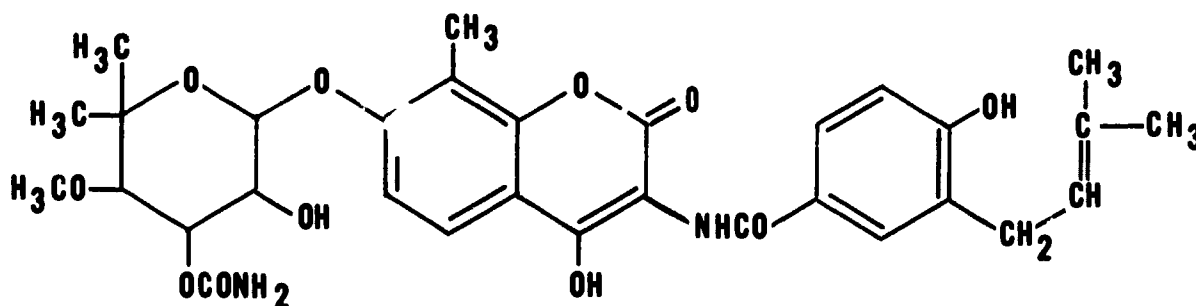

Figure 5-8. Structural formula for novobiocin.

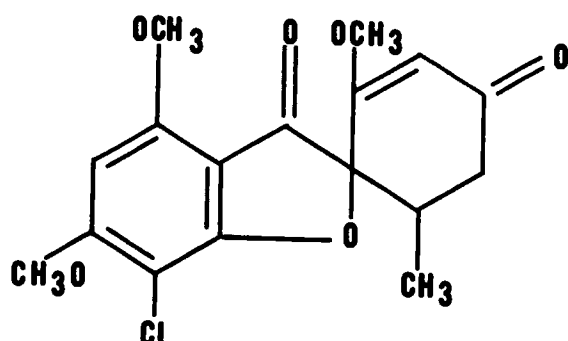

Figure 5-9. Structural formula for griseofulvin.

093. Indicate whether given statements correctly reflect the functions of intermediary metabolism, the drugs affecting such functions, and their mechanisms of action.

**Intermediary Metabolism.** The term "intermediary metabolism," in its broadest context, can be used to include the energy-yielding reactions taking place in the cell (respiration), the breakdown of complex nutrients to simplified usable form (catabolism), and the buildup of cell constituents from these simpler substances (anabolism). Para-aminosalicylic acid (PAS), active only against the mycobacteria, and the sulfonamides, useful in treating infections caused by the cocci and the Gram-negative rod forms, exemplify drugs that derange metabolic patterns in the bacterial cell.

Both of these drugs are involved in para-aminobenzoic acid (PABA) metabolism, although the inhibitory mechanism is probably not identical. PABA is an essential metabolite (required for growth) for several genera of organisms. In still others, it forms a part of the folic acid molecule. Folic acid is a growth factor associated with coenzymes that assist in transferring single carbon units.

In figure 5-10 note the structural resemblance of PABA, PAS, and the sulfonamides. We can look upon PAS and the sulfonamides as "pseudometabolites" or "competitive analogs" which the cell mistakenly builds into various molecular structures that require PABA for normal functioning. The result is a blocking of metabolic pathways when the faulty molecules enter into cellular reactions.

**Exercises (093):**

Indicate whether each of the following statements is true (T) or false (F), and correct those that are false.

T F 1. Respiration, the breakdown of complex nutrients to simplified usable forms (anabolism), and the buildup of cell constituents from these simpler substances (catabolism) are inclusive of intermediary metabolism.

T F 2. The sulfonamides are active only against the mycobacteria.

T F 3. Para-aminosalicylic acid (PAS) and the sulfonamides exemplify drugs that derange the metabolic patterns in the bacterial cell.

T F 4. Para-aminosalicylic (PAS), but not the sulfonamides, is involved in the para-aminobenzoic acid (PABA) metabolism.

T F 5. PABA is an essential metabolite required for growth of several genera of organisms.

T F 6. When the cell mistakenly builds various molecular structures that require PABA from PAS or sulfonamides, the result is a more sound metabolic pathway.

**5-3. Mechanism of Antibiotic Resistance**

Soon after the introduction of sulfonamides and penicillin, a new era in clinical medicine was opened, and their effectiveness stimulated a wave of optimism in the fight against infectious disease. Early in the use of these drugs, however, it was

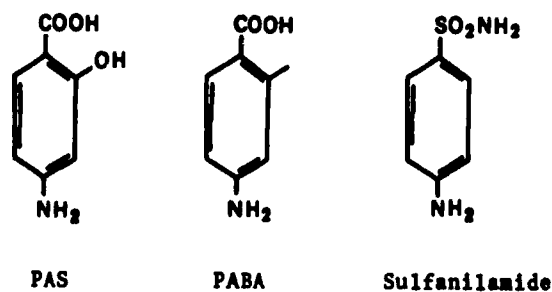

Figure 5-10. Structural formula for PAB, PAS, sulfanilamide.

realized that even though devastating epidemics had been curbed, disease caused by infectious organisms remained a major problem. A significant factor contributing to the persistence of disease is the enormous capacity of microorganisms to circumvent the action of inhibitory drugs. For example, soon after penicillin came into wide use in the 1940's, it was recognized that some strains of *Staphylococcus aureus* were developing resistance to drug concentrations that were formerly lethal. Resistance was attributed to production of an enzyme, "penicillinase," that degraded the penicillin molecule into harmless fragments.

The ability of many microorganisms to develop resistance to the antimicrobial drugs offers a serious threat to their future usefulness and ingenuity of the bacteriologist in meeting and counteracting the problem. It is becoming increasingly important, therefore, to understand the genetic and cellular mechanisms that account for enhanced tolerance to therapeutic agents.

**094. Indicate whether given statements correctly reflect the characteristics of drug-resistant mutants and the frequency rate of spontaneous mutation of microorganisms.**

**Origin of Drug-Resistant Strains.** There are two major mechanisms by which increased resistance to antibiotics and other drugs used in clinical practice may arise. They are by (a) spontaneous mutation and (b) the exchange of genetic material between cells. Both mechanisms have a genetic basis.

**Drug-Resistant Mutants.** Much effort has been directed toward determining whether resistant cells represent the product of adaptation with visible characteristics resulting from some interaction of the drug with the organism or whether they are mutants arising independently of the antibiotic by mutation.

It is now firmly established that drug resistance arises by the latter mechanism. An example of this is a random mutation that results in an altered susceptibility to the drug. The drug serves only as a selective agent favoring the survival of resistant over sensitive organisms after the genetic change has taken place and visible characteristics appear. We know that mutants arise naturally in bacterial cultures with a frequency that can be predicted accurately in many cases.

Mutations generally occur at a frequency of about 1 in  $10^5$  to  $10^{10}$  cell divisions. As would be anticipated, the frequency rate of spontaneous mutation to resistance varies with the bacterial species and antimicrobial drug. For example, the rate of mutation by *M. tuberculosis* to streptomycin is approximately  $10^{-10}$  and to isoniazid,  $10^{-6}$ . Knowledge of the mutation rate as well as the site of attack of the various drugs is significant in a sound approach to chemotherapy.

**Exercises (094):**

Indicate whether each of the given statements is true (T) or false (F), and correct those that are false.

T F 1. Two major mechanisms by which increased resistance to antibiotics may result are by spontaneous mutation and genetic exchange.

T F 2. It is now firmly established that drug-resistant mutants arise through interaction of the drug with the organism showing adaptation through change in visible characteristics.

T F 3. In a random mutation that results in an altered susceptibility, the drug serves only as a selective agent favoring the survival of resistant over sensitive organisms.

T F 4. Mutations generally occur at a frequency of about 1 in  $10^{10}$  to  $10^{20}$  cell divisions.

T F 5. The frequency rate of spontaneous mutation to resistance varies with the bacterial enzymes and growth environment.

**095. Cite the methods through which resistance may be accomplished by genetic exchange, and define the genetic units involved in this process; point out the genetic elements that control multiple drug resistance and their purposes; state the methods by which the plasmids function in accomplishing resistance in a staphylococcal cell by transduction.**

**Resistance Accomplished by Genetic Exchange.** Genetic information that controls bacterial drug resistance occurs both in the bacterial chromosome and in the DNA of extrachromosomal plasmids. Episomes are extrachromosomal genetic units which are capable of replicating either autonomously or as an integral part of the host chromosome. Plasmids are other types of extrachromosomal genetic units that can be transferred by transduction as will be discussed later. The resistance trait may be transmitted from these loci by the transfer of genetic material from a

resistance cell to a sensitive one.

**Infectious drug resistance.** Transmissibility of drug resistance was first demonstrated in 1957 and provided the explanation for the marked increase in the rise of drug resistance in the *Shigella* isolated from bacillary dysentery in Japan. The majority of the strains were resistant not only to a single drug but to other drugs which included streptomycin, sulfonamides, tetracycline, and chloramphenicol. When cells of a multiple resistance strain of *Shigella* or *Salmonella* were mixed with cells of a sensitive strain of *E. coli*, multiple resistance was found to be transferred to the latter organism. Transfer is now known to occur among all genera of the Enterobacteriaceae.

The genetic elements that control multiple drug resistance of this type have the properties of episomes and are designated resistance factors or R factors. Two components make up the R factor: (1) the R determinant for drug resistance and (2) the resistance transfer factor or RTF, which is responsible for the transmissibility of the R determinant. In order for R factors to transfer, cell-to-cell contact, or conjugation, is required. Strains undergo *conjugation*, a process in which genetic material is passed during direct cell contact. If one cell is drug resistant, this trait can be passed along to the partner. The recipient can in turn transfer the resistance characteristic (R) to another microorganism. Recent work gives evidence that the R factor can also be transmitted by bacteriophage. There is also clearcut clinical evidence that transfer of drug resistance of this type occurs within the human intestinal tract.

**Transduction.** Transduction, another mechanism of genetic transfer, is the transmission of a portion of the chromosome of one bacterial cell, for example cell *a*, into another bacterial cell, cell *b*, by a matured temperate bacteriophage that lysogenizes bacterial cell *b*. A graphic example of transduction can be noted in a situation whereby the microorganism *S. aureus*, resistant to penicillin, is usually mediated by a penicillinase plasmid. This plasmid is similar in several ways to a nontransmissible R factor of the enteric bacteria. For example, it is a resistance determinant in the absence of an RTF. Transfer then is made possible by transduction instead of mating or conjugation. During the process of transduction of a staphylococcal cell, a plasmid can either select a specific site that insures its replication and distribution to daughter cells as autonomous units, or it can become integrated into the bacterial chromosome or another penicillinase plasmid already located at a maintenance site. The penicillinase plasmids in staphylococci contain the determinants for the enzyme  $\beta$ -lactaminase.

**Exercises (095):**

1. What are episomes?

2. What are plasmids?

3. In what two genetic units of the cell does the genetic information that controls bacterial cell resistance occur?

4. What are two methods through which resistance may be accomplished by genetic exchange?

5. The genetic elements that control infectious multiple drug resistance have the properties of \_\_\_\_\_ and are designated \_\_\_\_\_ factors or \_\_\_\_\_ factors.

6. What are two components that make up the R factor?

7. What condition is required for R factors to transfer?

8. Describe a penicillinase plasmid.

9. How is the transfer of the plasmids made possible?

10. During the process of transduction of a staphylococcal cell, how does the plasmid function in accomplishing resistance?

11. The penicillinase plasmids in staphylococci contain the determinants for what enzyme?

096. Indicate whether given statements correctly reflect the biochemical process of drug resistance in terms of the chemical changes in the permeability of the organisms to drugs production of metabolites and in the production of enzymes.



**Biochemical Process of Drug Resistance.** We now know that resistance is a result of genetically controlled conditions of the metabolism or structure of the cell. These conditions make it possible for the cell to avoid the action of the drug. However, one or more of the following chemical changes have been found in bacterial mutants selected for resistance. They are (a) decreased permeability of the organism to the drug, (b) increased destruction of the inhibitor, (c) greater production of a metabolite or growth factor with the drug (as a structural) analog, and (d) changes in the properties of enzymes, resulting in a different relative affinity of substrate and antagonist.

Generally, the mechanisms of extrachromosomally controlled drug resistance are different from those dependent on chromosomal genes and usually involve either a decrease in the permeability of the cell or enzymatic inactivation of the inhibitor. Transferable sulfonamide resistance and tetracycline resistance result from reduced cell membrane permeability to drugs. The impermeability mechanism of drug resistance is specific for each drug.

Enzymatic inactivation is the predominant mechanism of transferable resistance to penicillin, chloramphenicol, kanamycin, streptomycin and neomycin. Resistance controlled by chromosomal genes is usually a result of changes in enzymes or active sites involved in essential metabolic reactions in the cell.

#### **Exercises (096):**

Indicate whether each of the following statements is true (T) or false (F), and correct those that are false.

- T F 1. Bacterial mutants selected for resistance will generally show an increased permeability of the organisms to the drug.
- T F 2. Increased destruction of the inhibitor may result as a chemical change in bacterial mutants selected for resistance.
- T F 3. Decreased production of a metabolite results in a chemical change in bacterial mutants selected for resistance.
- T F 4. Bacterial mutants selected for resistance may produce changes in the properties of enzymes, resulting in the same relative affinity of substrate and antagonist.

T F 5. The chromosomal genes usually involve either a decrease in the permeability of the cell or enzymatic inactivation of the inhibitor.

T F 6. The impermeability mechanism of drug resistance is specific for each drug.

T F 7. The impermeability mechanism of drug resistance is the predominant mechanism of transferable resistance to penicillin, chloramphenicol, kanamycin, streptomycin, and neomycin.

T F 8. Resistance controlled by chromosomal genes is usually a result of changes in enzymes or active sites involved in essential metabolic reactions of the cell.

#### **5-4. Determination of Bacterial Sensitivity**

In the laboratory, you will perform sensitivity, or susceptibility, tests in order to predict the probable response of an infectious organism to drug therapy. The physician relies on the test to help him select an antibiotic for initial treatment; and, later, to detect the development of microbial resistance to that antibiotic during the course of the disease. As a further aid, as a laboratory technician, you can use sensitivity tests to measure the potency of a drug and to determine the concentration of an antimicrobial agent in selected tissues or body fluids.

In principle, the sensitivity test is simple. You cultivate an organism in either a liquid or solid medium containing an antimicrobial agent. After incubation, observe the culture for the presence or absence of growth (drug-resistance or drug-sensitivity), or as is usually the case, look for the degree of growth inhibition induced by several specific concentrations of a drug.

**097. Cite two chief methods presently used to determine susceptibility of microorganisms to antibiotics, three general considerations and other significant factors upon which the choice of methods to employ should depend, and considerations for interpretation of *in vitro* sensitivity tests.**

**Laboratory Methods for Sensitivity Testing.** The chief methods presently used by the laboratory to



determine susceptibility of a microorganism to an antibiotic include the serial dilution methods, using the broth tube and agar plate dilution procedures, and the agar disc diffusion method, using antibiotic-impregnated discs. The choice of a method to employ in susceptibility testing will depend upon a few considerations. Three general considerations are that there must be (a) a high level of accuracy in the testing procedure, (b) a high degree of reproducibility of the results, and (c) a good correlation of the results with clinical response. Other significant factors related to the technique are that it should possess such attributes as rapidity and practicability. It should provide a distinct end point. It should be applicable to most antibiotics and to most bacteria, and it should produce results within a relatively brief period. In addition, it should permit identification of the etiologic pathogen as well as recognition of a contaminant, and it should distinguish morphologically similar strains with various susceptibility patterns. Each method has its advantages and its limitations, and the technician must understand and appreciate these conditions in order to obtain the maximum usefulness of the result.

You should bear in mind that in the interpretation of any *in vitro* sensitivity tests, they are essentially artificial measurements; thus, the data produced gives only approximate range of effective inhibitory action against the microorganisms. The only positive criterion of microbial response to antibiotics is the clinical response of the patient when adequate dosage of the correct antibiotic is given.

#### Exercises (097):

1. What are the two given methods used to determine susceptibility of microorganisms to antibiotics?
2. What two procedures does the serial dilution method involve?
3. The choice of the method to be used for sensitivity testing will depend upon what three considerations?
4. Briefly list other significant factors that the techniques should have.

5. What two considerations must be kept in mind in the interpretation of *in vitro* sensitivity tests?

098. Identify the broth tube dilution and agar slant or plate methods for susceptibility testing; cite the two types of information obtained from the tube method and the advantages and disadvantages of both methods.

**Dilution Method.** In the broth tube dilution method specific amounts of the antibiotic are prepared serially in decreasing concentrations in broth, and inoculated with a culture of the bacterium to be tested. After a 12- to 18-hour incubation time, the tubes are examined microscopically for evidence of growth. A control tube containing the bacterial inoculum, but without the drug, is always included in the test system.

The tube having the lowest concentration of the drug that inhibits growth tells you the *minimal inhibitory concentration* (MIC). The MIC is usually expressed either in units or micrograms of antimicrobial agent per milliliter. Figure 5-11 illustrates the tube dilution method and shows a MIC of 6.25 micrograms. With minor alterations, the technique can be adapted to the determination of bactericidal levels of the antibiotics known as the minimal bactericidal concentration (MBC). In other words, at this level the organism is completely destroyed.

As an alternate technique, you can incorporate dilutions of the inhibitory agent into agar slants or plates of a solid test medium. The method requires the incorporation of varying concentrations of antibiotic within the agar. It requires fresh slants or plates preferably to be used within 24 hours and not after 1 week of preparation. This method is used only at large facilities and is not practical for the average laboratory. Some authorities feel that the method is superior to the tube dilution method because contaminants can be easily recognized, whereas in the broth tube dilutions they cannot.

The tube dilution method gives an excellent and precise statement about the level of susceptibility of the organism in question. There are certain disadvantages, however. It is a time-consuming and expensive procedure to have routine application in the clinical laboratory. In addition, you must first isolate the test organism in pure culture because the liquid culture system does not permit visual detection of contaminants. Resistant mutants that might develop in the broth tubes would be equally difficult to detect.

Since the introduction of microtechniques, this procedure has been greatly simplified. These microtechniques require only one-fifth of the time as the reagents of the standard tube dilution

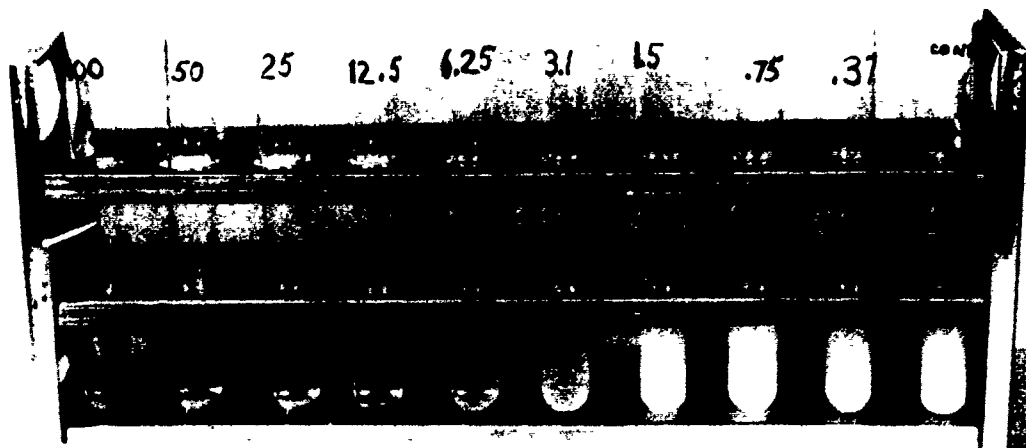

Figure 5-11. Dilution method of sensitivity testing.

methods and can be easily learned and performed. Microtitration equipment is now commercially available. In addition, automated devices are now available which carry out these microtitrations automatically. One example is the Autobac I System which provides an automated instrumental method for the determination of antimicrobial susceptibility of pathogenic organisms.

It is desirous that all clinical laboratories be prepared in terms of equipment and training to offer this service to the clinician, either directly or through a referral laboratory.

**Exercises (098):**

1. In the broth tube dilution method, to what setup is a culture of the bacterium inoculated?
2. How long are the tubes incubated; how are they examined and for what characteristic?
3. What information does the tube having the lowest concentration of the drug that inhibits growth provide?
4. What is the level at which the organism is completely destroyed in the test called?

5. What does the agar slant or plate method involve?

6. Why do some authorities feel that the agar slant or tube method is superior to the tube dilution method?

7. How reliable is the tube dilution method considered to be?

8. What are some disadvantages of the tube dilution method?

9. In what way have the microtechniques greatly simplified the susceptibility testing of pathogenic microorganisms?

**099. Indicate whether given statements correctly reflect the general procedure for the agar disc diffusion method.**

**Agar Disc Diffusion Method.** The agar disc diffusion method has become the most useful and the most used laboratory test for antibiotic susceptibility. The method is simple, provides speed of performance, economy and reproducibility under standard conditions, and is ideally suitable for the

busy diagnostic laboratory. In this method, filter paper discs that have been impregnated with various antimicrobial agents of specific concentration are meticulously placed on an agar culture plate that has been inoculated with a culture of the bacterium to be tested. After an overnight incubation period, the plate is examined for a zone of growth inhibition around the disc containing the agent to which the organism is susceptible, wherein a resistant organism will grow up to and under the periphery of the disc.

#### Exercises (99):

Indicate whether each of the given statements is true (T) or false (F), and correct those that are false.

- T F 1. The agar disc diffusion method is infrequently used because it is time-consuming and expensive.
- T F 2. In the agar disc diffusion method the varying concentrations of antibiotic are incorporated in the media as well as the disc.
- T F 3. After a 3-hour incubation, the plate is examined for a zone of growth inhibition around the disc containing the agent to which the organism is resistant.
- T F 4. A susceptible organism will grow up to and under the periphery of the disc.

100. State reasons for compliance with the standards of the Kirby-Bauer susceptibility method; specify the plating medium recommended in terms of the volume used, reasons for use, and maximum length of storage.

**Kirby-Bauer Susceptibility Method.** The agar disc diffusion method currently recommended by the U.S. FDA and as the revised *Tentative Standards on Antimicrobial Susceptibility Testing* of the National Committee for Clinical Laboratory Standards, is a slight modification of that described by Bauer, Kirby, Sherris, and Truck. The method should be followed exactly as outlined if accurate, reproducible results are to be anticipated. Compliance with the standards of the test

procedures makes it possible for comparison in different locations and situations. There are many variables which enable the procedure to be standardized. The following have been identified:

- a. Selection, volume, and age plating medium.
- b. Storage and handling of discs.
- c. Selection and concentration of antimicrobial discs.
- d. Methodology of testing.
- e. Criteria used for interpreting results.

**Selection Volume and Age of Plating Medium.** Mueller-Hinton agar has been considered the best choice for routine susceptibility testing because it shows good uniformity from batch to batch and is low in tetracycline and sulfonamide inhibitors. The medium will support the growth of the more fastidious pathogens that will not grow on the nonenriched medium if 5 percent defibrinated sheep, horse, or other animal blood is added. When testing *Haemophilus* species, the blood containing medium may be "chocolatized."

The pH of each batch of Mueller-Hinton agar should be checked at the time the medium is poured for use. The pH should be 7.2 to 7.4 at room temperature and may be measured by allowing the agar to solidify around the pH meter electrodes, by macerating the medium in neutral distilled water, or by the use of a surface electrode. The freshly prepared and cooled medium is poured into Petri plates to a uniform depth of 4 mm. This requires approximately 60 ml in 150-mm plates and approximately 25 ml in 100-mm plates. After cooling, plates may be used the same day or stored in the refrigerator at 2° to 8° C. If the plates are to be stored for more than 5 to 7 days, they should be wrapped in plastic to minimize evaporation; otherwise, they may not be stored for more than 7 days. There should be no droplets of moisture on the surface of the plate medium or on the Petri plate cover. Just before use, the plates should be placed in an incubator for about 10 minutes at 35° C with the lids agar until excess surface moisture is lost by evaporation.

#### Exercises (100):

1. If accurate, responsible results of the Kirby-Bauer susceptibility method are to be anticipated, then the method should be \_\_\_\_\_ exactly as outlined.
2. Compliance with the standards of the test procedures makes it possible for \_\_\_\_\_ in different \_\_\_\_\_ and \_\_\_\_\_.



TABLE 5-1  
ZONE SIZE INTERPRETATIVE CHART AND COMMENTS.

Antibiotic or Chemotherapeutic agent	Disc potency	Diameter of zone inhibition (mm)		
		Resistant	Intermediates	Susceptible
Amikacin	10 mcg	11 or less	12 - 13	14 or more
Ampicillin when testing: Gram negative enteric organisms and enterococci	10 mcg	11 or less	12 - 13	14 or more
Staphylococci and penicillin G susceptible organisms	10 mcg	20 or less	21 - 28	29 or more
Haemophilis species <sup>a</sup>	10 mcg	19 or less		20 or more
Bacitracin	10 U	8 or less	9 - 12	13 or more
Carbenicillin when testing: <u>Proteus sp. and E. coli</u>	100 mcg	17 or less	18 - 22	23 or more
<u>Pseudomonas aeruginosa</u>	100 mcg	13 or less	14 - 16	17 or more
Cephalothin <sup>b</sup>	30 mcg	14 or less	15 - 17	18 or more
Chloramphenicol	30 mcg	12 or less	13 - 17	18 or more
Clindamycin <sup>c</sup>	2 mcg	14 or less	15 - 16	17 or more
Colistin <sup>d</sup>	10 mcg	8 or less	9 - 10	11 or more
Erythromycin	15 mcg	13 or less	14 - 17	18 or more
Gentamicin	10 mcg	12 or less	13 - 14	15 or more
Kanamycin	30 mcg	13 or less	14 - 17	18 or more
Methicillin <sup>e</sup>	5 mcg	9 or less	10 - 13	14 or more
Nalidixic acid <sup>f</sup>	30 mcg	13 or less	14 - 18	19 or more
Neomycin	30 mcg	12 or less	13 - 16	17 or more
Nitrofurantoin <sup>g</sup>	300 mcg	14 or less	15 - 16	17 or more
Penicillin G when testing: <sup>g</sup> <u>Staphylococci</u>	10 U	20 or less	21 - 28	29 or more
Other organisms	10 U	11 or less	12 - 21 <sup>h</sup>	22 or more
Polymyxin B <sup>d</sup>	300 U	8 or less	9 - 11	12 or more
Streptomycin	10 mcg	11 or less	12 - 14	15 or more
Sulfonamides <sup>i,1</sup>	300 mcg	12 or less	13 - 16	17 or more
Tetracycline <sup>j</sup>	30 mcg	14 or less	15 - 18	19 or more
Trimethoprim - Sulfamethoxazole	1.25 mcg			
	23.75 mcg	10 or less	11 - 15	16 or more
Tobramycin	10 mcg	11 or less	12 - 13	14 or more
Vancomycin	30 mcg	9 or less	10 - 11	12 or more

COMMENTS

- a. For testing *Haemophilis*, use Mueller-Hinton agar plates supplemented with 1% hemoglobin and 1% isovitalax (BBL).
- b. The cephalothin disc is used for testing susceptibility to all cephalosporin type antibiotics. This includes cephaloridine, cephalixin, cefazolin, and cephapirin. Staphylococci exhibiting resistance to methicillin discs should be reported as resistant to cephalosporin type antibiotics regardless of zone size.
- c. The clindamycin disc is used for testing susceptibility to both clindamycin and lincomycin.
- d. Colistin and polymyxin B diffuse poorly in agar and the accuracy of the diffusion method is thus less than with other antibiotics. Resistance is always significant, but when treatment of systemic infections due to susceptible strains is considered, it is wise to confirm the results of a diffusion test with a dilution method.
- e. Of the penicillinase-resistant penicillins, only methicillin is tested since results also apply to cloxacillin, dicloxacillin, oxacillin, and nafcillin.
- f. Susceptibility data for nalidixic acid, nitrofurantoin, and sulfonamides, other than trimethoprim-sulfamethoxazole, apply only to organisms isolated from urinary tract infections.
- g. Penicillin G is used to test the susceptibility of all penicillinase sensitive penicillins, except ampicillin and carbenicillin. Results may be applied to phenoxymethyl penicillin and phenethicillin's.
- h. This category includes some organisms such as enterococci and gram negative bacilli which may cause systemic infections treatable by high doses of penicillin G. Such organisms should be reported susceptible to penicillin G but not to phenoxymethyl penicillin or phenethicillin.
- i. Any of the commercially available 300 or 250 mcg sulfonamide discs can be used with the same standards of zone interpretation. Blood-containing media, except media containing lysed horse blood, are not satisfactory for testing sulfonamides.
- j. Of the tetracyclines, only tetracycline is tested and the results may be applied to chlortetracycline, demeclocycline, doxycycline, methacycline, oxytetracycline, minocycline, and rolitetracycline.

TABLE 5-2  
PROPOSED DISCS FOR ROUTINE USE

GRAM POSITIVES <sup>b</sup>	GRAM NEGATIVES <sup>c</sup>
1. Amikacin - 10 mcg	1. Amikacin - 10 mcg
2. Cephalothin - 30 mcg	2. Ampicillin - 10 mcg (Results do not apply to other penicillins)
3. Chloramphenicol - 30 mcg	3. Carbenicillin - 100 mcg
4. Clindamycin - 2 mcg	4. Cephalothin - 30 mcg
5. Erythromycin - 15 mcg	5. Chloramphenicol - 30 mcg
6. Gentamicin - 10 mcg	6. Colistin - 10 mcg (Results apply to polymyxin B)
7. Methicillin - 5 mcg (Results apply to other penicillinase resistant semisynthetic penicillins)	7. Gentamicin - 10 mcg
8. Penicillin G - 10 Units (Results apply to ampicillin)	8. Tetracycline - 30 mcg (Results apply to analogues)
9. Tetracycline - 30 mcg (Results apply to analogues)	9. Tobramycin - 10 mcg
10. Vancomycin - 30 mcg	10. Trimethoprim - sulfamethoxazole 1.25 mcg/23.75 mcg
11. Optional (Kanamycin, Ampicillin, Trimethoprim-sulfamethoxazole)	11. Nitrofurantoin <sup>d</sup> - 300 mcg
12. Optional <sup>e</sup> (Neomycin, Bacitracin)	12. Nalidixic acid <sup>d</sup> - 30 mcg
	13. Kanamycin <sup>f</sup> - 30 mcg

COMMENTS

- a. The use of 12 high content discs on one plate requires careful placement of antibiotic discs to avoid overlapping zones.
- b. Staphylococcus, Streptococcus, enterococci, and aerobic gram-positive rods. Enterococci should be tested with the ampicillin disc.
- c. E. coli, Klebsiella, Enterobacter, Proteus, Pseudomonas, etc.
- d. For isolates from urinary tract infections only.
- e. For topical use only.
- f. Kanamycin may be substituted for nitrofurantoin or nalidixic acid on isolates from non-urinary tract infections.



- 5. Apply only to organisms isolated from urinary tract infections.
- 6. Used to test the susceptibility of all penicillinase sensitive penicillins, except ampicillin and carbenicillin.
- 7. Blood containing media, except media containing lysed horse blood, are not satisfactory for testing these.
- 8. The only one of its group tested, and results may be applied to chlorotetracycline, methacycline, oxytetracycline, minocycline, and rolitetracycline.
- 9. Enterococci should be tested with this disc.
- 10. For topical use only.
- 11. May be substituted for nitrofurantoin or nalidixic acid on isolates from non-urinary tract infections.

**103. State the procedures for the standard method of the Kirby-Bauer susceptibility test in terms of the preparation of inoculum, inoculation of the test plated, and the placement of discs.**

**Standard Method.** Repeated studies by authorities have shown that when certified antibiotic discs and a single standard culture medium are used, the greatest factor contributing to reproducibility of the disc test technique is the control of the inoculum size. Let's briefly review the currently recommended method of preparing a standardized inoculum.

**Inoculum preparation.** An inoculating needle or loop is touched to each of four or five well-isolated colonies of a similar morphological type and inoculated into 4 or 5 ml of suitable broth medium such as soybean casein digest broth. The broth is incubated at 35° C for 2 to 5 hours until visible turbidity appears. The turbidity of actively growing broth cultures is then adjusted with saline or broth in order to obtain a turbidity visually comparable to that of a turbidity standard. The turbidity standard is prepared by adding 0.5 ml of 0.048 M BaCl<sub>2</sub> (1.175% wt/vol, BaCl<sub>2</sub> 2H<sub>2</sub>O) to 99.5 ml of 0.36 N H<sub>2</sub>SO<sub>4</sub> (1% vol/vol). This is half the density of a McFarland No. 1 standard. This turbidity standard is agitated on a Vortex mixer immediately prior to use. The standard should be replaced at least once every 6 months unless it is contained in heat-sealed glass tubes. For proper turbidity adjustment, it is helpful to use adequate light and compare the tubes against a white background with a contrasting black line.

**Test plate inoculation.** The inoculum suspension should not be allowed to stand longer than 15 to 20

minutes before the plates are inoculated. To inoculate the agar medium, a sterile cotton swab on a wooden (not plastic) applicator stick is dipped into the standardized suspension, and excess broth is expressed by pressing and rotating the swab firmly against the inside of the tube above the fluid level. The swab is then streaked evenly in three directions over the entire surface of the agar plate to obtain a uniform inoculum. A final sweep is made of the agar rim with the cotton swab. The inoculated plates are allowed to dry for 3 to 5 minutes, but no longer than 15 minutes, before the discs are applied. Figure 5-12 demonstrates what can happen when the inoculum is not evenly streaked. Compare it with figure 5-13.

**Placement of discs.** The antimicrobial-impregnated discs are applied to the surface of the inoculated plates either by a mechanical dispenser or by hand with alcohol-flamed, fine-pointed forceps which must be coded before using. Press all discs gently down onto the agar with the forceps on an inoculating needle to insure complete contact with the agar surface. The discs are distributed evenly in such a manner as to be no closer than 15 mm from the edge of the Petri dish and so that no two discs are closer than 24 mm from center to center, or far enough to prevent overlapping zones of inhibition, as demonstrated in figure 5-14. In general, this limits the number of discs which can be placed on a single plate to 12 or 13 on a 150-mm plate or only 4 or 5 on a 100-mm plate. The plates are inverted and placed in an incubator at 35° C within 15 minutes after the discs are applied. Any longer delay before incubation will allow excess prediffusion of the antimicrobial. Incubation in an environment of increased CO<sub>2</sub> must be avoided because the CO<sub>2</sub> will alter the surface pH enough to affect the antimicrobial activity of some agents.

**Exercises (103):**

1. When certified antibiotic discs and a single standard culture medium are used in the Kirby-Bauer susceptibility method, what is the greatest factor contributing to reproducibility of the disc technique?
2. In preparing the inoculum, about how many colonies are touched with the inoculating needle or loop?
3. For how long is the inoculated broth incubated for the appearance of visible turbidity?

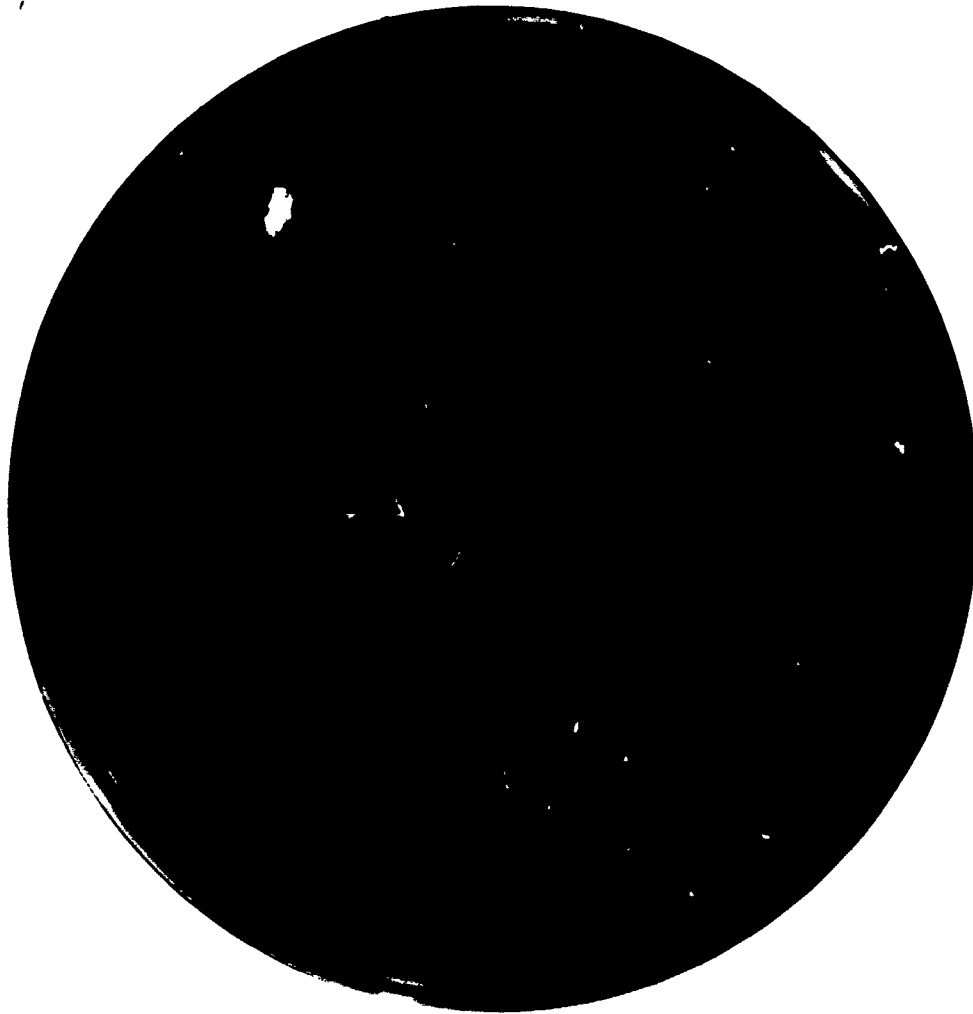

Figure 5-12 Disc diffusion—inoculum not evenly streaked.

4. How often should the turbidity standard be replaced?
5. After adjusting the turbidity of the inoculum suspension, what is the maximum allowable time of standing before the plates are inoculated to the agar medium?
6. How is the swab streaked on the plates?
7. In the placement of discs, why must they be pressed gently down on the agar?
8. How should the discs be evenly distributed on the agar surface?
9. What is the maximum number of discs that may be placed on a 150-mm plate? 100-mm plate?
10. What could result if there is any delay of incubation beyond 15 minutes after the discs are applied?

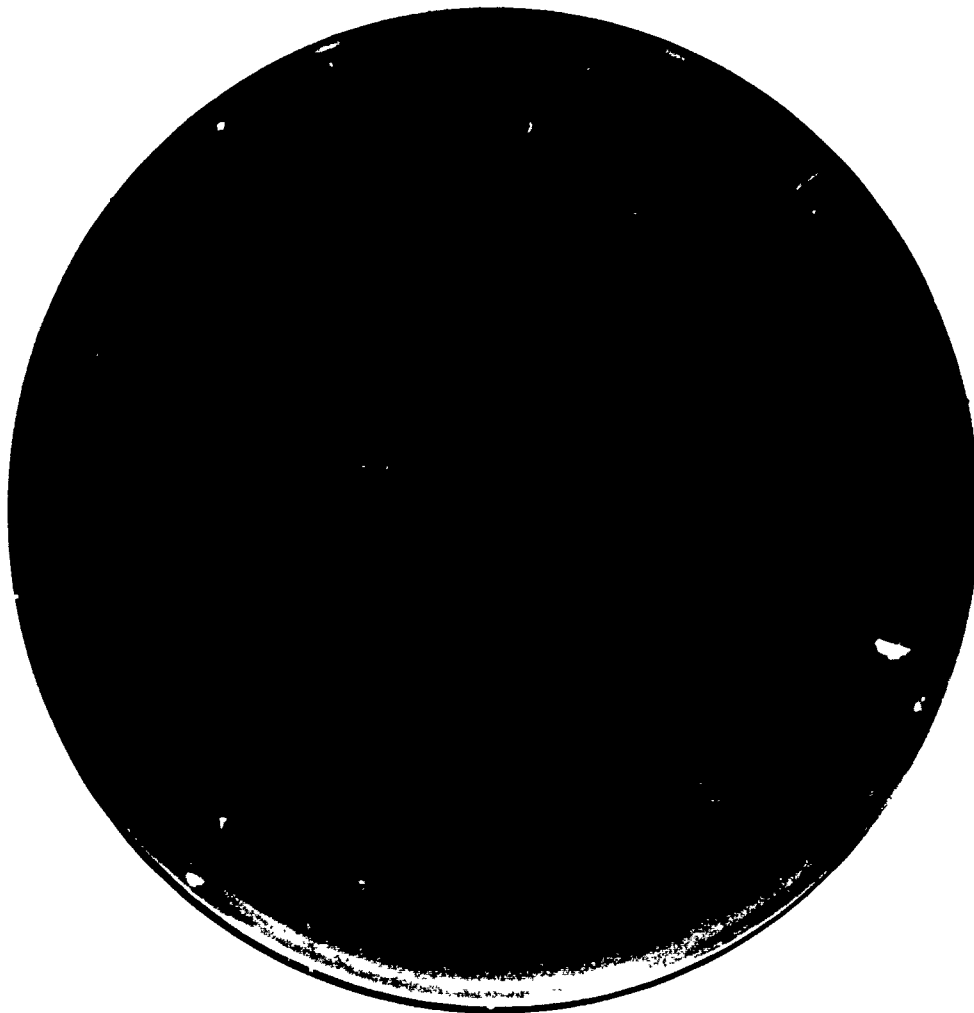

Figure 5-13. Correct technique of diffusion sensitivity testing.

104. Cite guidelines for reading results in susceptibility plates in terms of the principles involved in zone inhibition, devices used for measuring inhibition zones, the significance of organisms growing within the zone, and the implication of the terms used for interpretation of zones.

**Reading of Results.** Two processes result after incubation in which the relative susceptibility of the organism to the antibiotic is demonstrated by a clear zone of growth inhibition around the disc. They are (a) diffusion of the antibiotic and (b) the growth of bacteria.

After 16 to 18 hours of incubation, the plates are examined, and the diameter of the zones of complete inhibition is measured to the nearest whole millimeter, using sliding calipers, a ruler, or a template prepared for this purpose. When an unsupplemented medium is used, the measuring

device is held on the back of the Petri plate. Zones on blood containing media are measured at the agar surface. The end point should be taken as the area showing no visible growth that could be detected with unaided eye. Faint growth or tiny colonies near the edge of the inhibition zones are ignored as is the veil of swarming occurring in the inhibition zones of some strains of *Proteus* species. Large colonies growing within the clear zone of inhibition may represent resistant variants or a mixed inoculum and may require reidentification and retesting. In the case of sulfonamides, slight growth with 80 percent or more inhibition is disregarded and the margin of heavy growth is measured.

**Interpretation of Zone Sizes.** The zone diameters for individual antimicrobics are translated into prefixed susceptible, intermediate, or resistant categories by referring to a zone size interpretative chart such as table 5-1. The interpretations for the antibiotics in table 5-1 are those recommended by

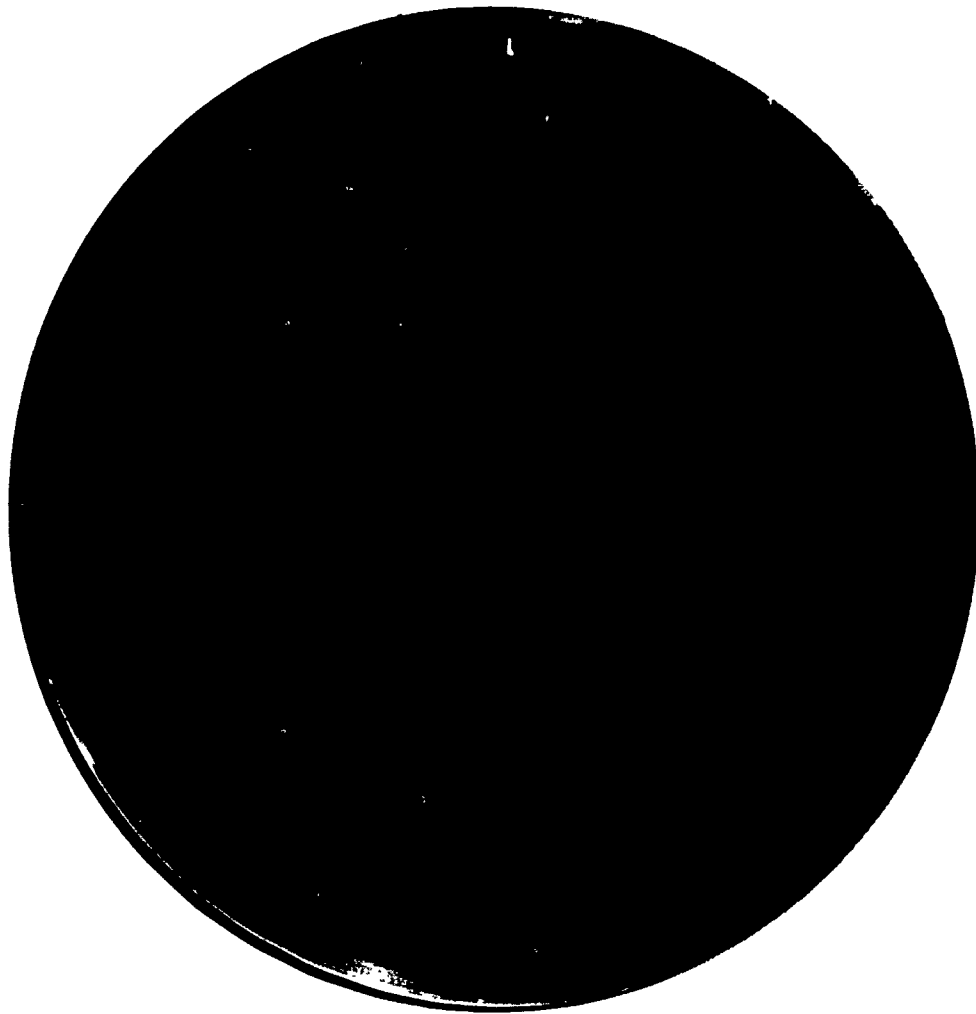

Figure 5-14. Disc diffusion—overcrowding of discs.

the FDA. Zones are interpreted in a similar manner, as presented in figure 5-15, with the ampicillin antimicrobial disc.

The term "susceptible" suggests that an infection caused by the strain tested may be expected to respond favorably to the indicated antimicrobial for that type of infection and pathogen. "Resistant" strains, in contrast, are not inhibited completely by therapeutic concentrations. "Intermediate" suggests that the organisms isolated may respond to unusually high concentrations of the agent due to high dosage levels in areas where the drug is concentrated, or such as the urinary tract. Under other conditions, intermediate results might require further testing due to the unavailability of other agents.

**Exercises (104):**

1. What are the two basic processes that take place after incubation resulting in susceptibility?

2. Approximately how long should the plates be incubated before examining for susceptibility?
3. How are the zones measured and with what devices?
4. How is the faint growth or tiny colonies near the edge of the inhibition zones measured?
5. Large colonies growing within the clean zone of inhibition may represent what condition?

6. What type of followup may be required when large colonies are detected growing within the inhibition zone?
7. What does the term "susceptible" suggest?
8. What characteristics of the isolated organisms does "intermediate" zone suggest?
9. What is the inhibition zone interpreted as when the diameter of zone inhibition is 14 mm or more, with a veil of some strain of *Proteus* species?

105. Indicate whether given statements correctly reflect some limitations of the modified Kirby-Bauer procedure and quality control guidelines for the disc agar diffusion method.

**Limitations of the Modified Kirby-Bauer Procedures.** Basically, the modified Kirby-Bauer procedure has been standardized for testing rapidly growing aerobes or facultative organisms. Members of the family Enterobacteriaceae, *Staph. aureus*, and *Pseudomonas* species are quite common among such types of organisms isolated and tested. Blood ("chocolatized" if required) is added to the Mueller-Hinton agar since the standard holds true for *Haemophilus* and streptococci. *Streptococcus pyogenes* and *S. pneumoniae* are generally

susceptible to penicillin G and are not routinely tested. However, in cases where patients are hypersensitive to penicillin, the isolant may be tested against such antimicrobics as erythromycin and lincomycin.

Organisms that require an increased (CO<sub>2</sub>) tension or an increased anaerobic atmosphere or whose growth rate is unusually slow, do not lend themselves to susceptibility testing by standardized disc-agar diffusion method. Other tests procedures such as agar plate or broth dilution are recommended.

**Quality Control Procedures.** To control the precision and accuracy of disc diffusion tests, it is essential that some form of quality control be carried out in performing the procedure. The "Seattle strains" of *S. aureus* (American Type Culture Collection 25923) and *Escherichia coli* (ATCC 25922) have been designated as standard control organisms and should be included with each day's batch of tests.

A multiple sensitive control strain of *Staphylococcus aureus* (ATCC 25923) should be run with the Gram-positive set of discs and a multiple sensitive control strain of *Escherichia coli* (ATCC 25922) with the Gram-negative set of discs. A control strain of *Pseudomonas aeruginosa* (ATCC 27853) should be tested with amikacin, carbenicillin, chloramphenicol, colistin, gentamicin, kanamycin, tetracycline, and tobramycin. This *Pseudomonas aeruginosa* strain tends to develop carbenicillin resistant mutants during passage on laboratory media. The control strains should be tested daily or at least each time tests are conducted and the zone sizes recorded on a quality control chart for each drug or antibiotic. The zone diameters for the control organisms should fall into the ranges indicated in table 5-3. Variations on either side of the control limits must be investigated and corrected to insure valid susceptibility test results. If these control limits are exceeded, there is significant probability that technical errors are sufficient to result in clinically significant misinterpretations with some of the test organisms.

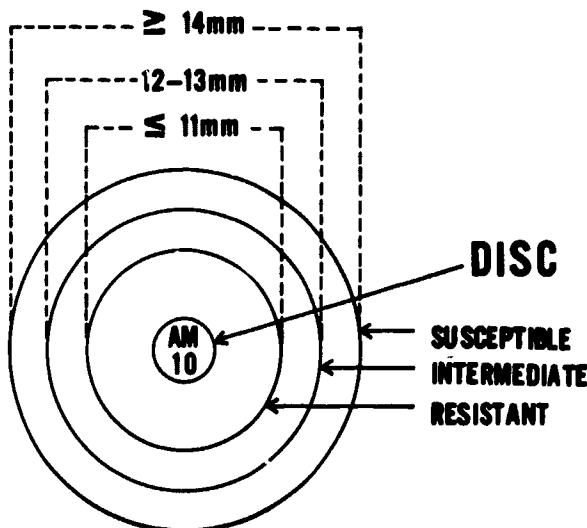

Figure 5-15. Disc with zone interpretation.

**Exercises (105):**

Indicate whether each of the given statements is true (T) or false (F), and correct those that are false.

T F 1. The modified Kirby-Bauer procedure has been standardized for testing rapidly growing aerobes or facultative organisms.

T F 2. Members of the genus *Lactobacillus* and of the species of *Bacteroides* also lend themselves to the standardized method of susceptibility testing.

TABLE 5-3  
SUSCEPTIBILITY OF CONTROL STRAINS

Antibiotic	Disc Potency	Zone diameter of inhibition (mm)		
		<i>S. aureus</i> (ATCC 25923)	<i>E. coli</i> (ATCC 25922)	<i>P. aeruginosa</i> (ATCC 27853)
Amikacin	10 mcg	18-25	18-24	15-22
Ampicillin	10 mcg	24-35	15-20	--
Bacitracin	10 U	17-22	--	---
Carbenicillin	100 mcg	--	24-29	20-24
Cephalothin	30 mcg	25-37	18-23	--
Chloramphenicol	30 mcg	19-26	21-27	6
Clindamycin	2 mcg	23-29	--	--
Colistin	10 mcg	--	11-15	12-16
Erythromycin	15 mcg	23-30	8-14	--
Gantrisin	250 or 300 mcg	23-27	22-26	6
Gentamicin	10 mcg	19-27	19-26	16-21
Kanamycin	30 mcg	19-26	17-25	6
Methicillin	5 mcg	17-22	--	--
Nalidixic acid	30 mcg	--	21-35	--
Neomycin	30 mcg	18-26	17-23	--
Nitrofurantoin	300 mcg	--	20-24	--
Penicillin G	10 U	26-37	--	--
Polymyxin B	300 mcg	7-13	12-16	--
Streptomycin	10 mcg	14-22	12-20	--
Tetracycline	30 mcg	19-28	18-25	9-14
Trimethoprim-sulfamethoxazole	1.25 mcg			
	23.75 mcg	24-32	24-32	--
Tobramycin	10 mcg	19-29	18-26	19-25
Vancomycin	30 mcg	15-19	--	--

T F 3. Even though *Streptococcus pyogenes* and *S. pneumoniae* are generally susceptible to penicillin G, they are still routinely tested.

T F 4. In cases where patients are hypersensitive to penicillin, the isolant may be tested against such antimicrobics as methicillin and clindamycin.

T F 5. Organisms that require an increased CO<sub>2</sub> tension or increased anaerobic atmosphere or whose growth rate is unusually slow readily lend themselves to susceptibility testing by the standardized disc agar diffusion method.

T F 6. The agar plate or broth dilution method is recommended for susceptibility testing of anaerobic organisms.

T F 7. The "Seattle strains" of *S. aureus* (ATCC 25922) and *Pseudomonas aeruginosa* (ATCC 27853) have been designated as standard control organisms.

T F 8. A multiple sensitive strain of *Pseudomonas aeruginosa* (ATCC 27853) should be tested with the Gram-negative set of discs.

T F 9. The control strains should be tested daily or at least each time tests are conducted and the zone sizes recorded on a quality control chart for each drug or antibiotic.

T F 10. Despite the fact that in exceeding the control limits there is significant probability of technical errors, little or no relationship exists between such technical errors and any type of clinically significant misinterpretations with some of the test organisms.



106. State methods used for assaying antimicrobial agents in serum, urine, and other biological fluids, purposes for the test, and method most currently used; specify the given procedure for the method in terms of the antibiotics, quantities of serum, and reagents used.

**Antibiotic Assays.** To assist in judging the level of antimicrobial drug in the patient's tissues, your laboratory may be called upon to assay blood, urine, or other body fluids for their antibiotic content. There are six currently used methods for assaying antimicrobial agents in serum, urine, or other biological fluids. They are:

- a. Agar diffusion.
- b. Turbidimetric.
- c. Inhibition of pH change.
- d. Enzymatic.
- e. Radioimmunoassay.
- f. Chemical.

The test using serum is useful for assessing the adequacy of antibiotic therapy, particularly in problem cases such as enterococcal subacute endocarditis, staphylococcal septicemia, or in patients with renal disease.

In both hospital and industry, the agar diffusion method is currently the most widely used method. In the procedure serum concentration of gentamicin, kanamycin, streptomycin, neomycin, tobramycin, or vancomycin can be measured in 2 hours with an error of less than or equal to 10 percent with a sample of 0.1 ml by a simple agar diffusion assay. The spore of *Bacillus subtilis* ATCC 6633 is used as the assay organism. Assay plates are prepared by adding 0.1 ml of *B. subtilis* spore suspension to each 100 ml of molten assay medium (Difco antibiotic assay medium number 5 at 48 to 65° C), then pouring 5 ml of the uniformly seeded agar into 100-mm diameter plastic Petri dishes. To assay a single serum sample, two plates are required and sixteen 0.25 inch (0.6 cm) paper discs are used. The discs are placed in four rows of four discs in the inverted lid of one of the assay plates, and 0.02 ml of the sample is placed on each of the four discs in the top row. Three standards are used for most clinical assays. For example, human sera containing 12, 6, 1.5 ug/ml of standard are used for the gentamicin serum assay. However, suggested standards for other assays are recommended according to the test procedure. A reference mark is placed on the bottom of each assay plate. After plates are incubated at 37° C for

about 2 hours, zones of inhibition are visible around the discs containing antibiotic. The zones' diameters are measured accurately with a vernier caliper.

The results of the test are calculated by forming a standard curve on semilog paper relating to the concentration of antibiotic in the standard sera, comparing the log scale (ug/ml in serum) to the diameter (mm) of the zone of inhibition produced.

#### Exercises (106):

1. List some methods used for assaying antimicrobial agents in serum urine and biological fluids.
2. For what purposes is antibiotic assay useful?
3. What method for assaying antimicrobial agents in serum, urine, or other biological fluid is the most currently used?
4. In the procedure, a total of how much of the sample is required?
5. What suspension of organism is added to each 100-ml molten assay medium in the preparation of assay plates and what quantity?
6. List some antibiotics of which the serum concentration can be measured.
7. How many standards are used for most clinical assays?
8. In the calculation of the test results, the concentration of antibiotic in the standard sera of the log scale (ug/ml in serum) is compared to what other factor?

## Bibliography

### Books

- Bailey, Robert W., and Elvyn G. Scott. *Diagnostic Microbiology*, 4th Ed. St. Louis: The C.V. Mosby Co., 1974.
- Bauer, John D., Phillip G. Ackerman, and Gelson Toro. *Clinical Laboratory Methods*, 8th Ed. St. Louis: C. V. Mosby Co., 1971.
- Buchanan, R. E., and N. E. Gibbons. *Determinative Bacteriology*, 8th Ed. Baltimore: The Williams & Wilkins Co., 1974.
- Burrows, William. *Textbook of Microbiology*, 20th Ed. Philadelphia: W. B. Saunders Co., 1973.
- Cruickshank, Robert, J. P. Duguid, B. P. Marmion, and R. H. A. Swain. *Medical Microbiology*, 12th Ed. Vol. 1., Edinburgh and London: Churchill Livingstone, 1973.
- Frobisher, Martin, R. D. Hinsdill, K. T. Crabtree, and C. R. Goodheart. *Fundamentals of Microbiology*, 9th Ed. Philadelphia: W. B. Saunders Co., 1974.
- Holt, John G. *The Shorter Bergey's Manual of Determinative Bacteriology*, 8th Ed. Baltimore: The Williams & Wilkins Co., 1977.
- Jawetz, Ernest, J. L. Melnick, and E. A. Adelberg. *Review of Medical Microbiology*, 12th Ed. Los Altos, Calif.: Lang Medical Publications, 1976.
- Joklik, Wolfgang K., and Hilda P. Willett. *Zinsser Microbiology*, 16th Ed. New York: Appleton-Century-Crofts, 1976.
- Lennette, Edwin H., Earle H. Spaulding, and Joseph P. Truant. *Manual of Clinical Microbiology*, 2nd Ed. Washington D.C.: American Society for Microbiology, 1974.
- Prier, James E., J. T. Bartola, and H. Friedman. *Quality Control in Microbiology*, Baltimore: University Park Press, 1975.
- Turk, D.C., and I. A. Porter. *A Short Textbook of Medical Microbiology*, 3rd Ed. Chicago: Year Book Medical Publishers, Inc., 1973.

### Periodicals

- Criteria and Techniques for the Diagnosis of Gonorrhea*. U.S. Department of Health, Education and Welfare, Washington, D.C.: U.S. Government Printing Office, 1972.
- Laboratory Methods in Clinical Bacteriology*. U.S. Department of Health, Education and Welfare. Washington, D.C.: U.S. Government Printing Office, 1977.
- Dowell, V. R., and T. M. Hawkins, *Laboratory Methods in Anaerobic Bacteriology*, U.S. Department of Health, Education, and Welfare, Washington, D.C.: U.S. Government Printing Office, 1974.
- Ewing, W. H., and B. R. Davis, *Media and Tests for Differentiation of Enterobacteriaceae*, U.S. Department of Health, Education, and Welfare, Washington, D.C.: U.S. Government Printing Office, 1973.
- Huffaker, Robert H., *Collection, Handling & Shipment of Microbiological Specimens*, U.S. Department of Health, Education, and Welfare, Washington, D.C.: U.S. Government Printing Office 1974.

Rohde, Paul A., *BBL Manual of Products and Laboratory Procedures*, 5th Ed. Baltimore: Becton, Dickinson and Co., 1973.

**Pamphlets**

*Agarmatic-Agar Sterilizer*, New Brunswick Scientific Co., Inc., Edison, N.J. 1977.

*API 20 Anaerobic System*, Analytab Products Inc., Carle Place, N.Y. 1977.

Ellner, Paul D., Paul A. Granato, and Carolyn B. May. *Improved Anaerobic Methods for the Diagnostic Laboratory*, Diagnostic Microbiology Service, Columbia-Presbyterian Medical Center; and the Department of Microbiology, College of Physicians and Surgeons, Columbia University, New York, N.Y., 1977.

Robertson, E. Arthur, and James D. MacLowry. "Mathematical Analysis of the API Enteric 20 Profile Register Using a Computer Diagnostic Model." *Applied Microbiology*, Vol 28, No. 4, Oct. 1974, pp 691-695.

## Glossary

- Absorption**—Taking up by capillary, osmotic, chemical, or solvent action.  
Examples: (1) absorption of moisture from the air, (2) absorption of gas by water, (3) absorption of nourishment in the small intestine, and (4) absorption by plant roots of nutrients from the soil.
- Adsorption**—A taking up by physical or chemical forces of the molecules of gases, of dissolved substances, or of liquids by the surfaces of solids or liquids with which they are in contact.
- Aerobe**—Organism that requires ready access to air for growth and reproduction.
- Alanine**—An amino acid formed by the hydrolysis of proteins.
- Anaerobe**—Organisms that can grow and reproduce in the complete or virtual absence of molecular oxygen.
- Animalcule**—A minute, usually microscopic organism.
- Anthocyanin**—Any of various soluble glucoside pigments producing blue to red coloring in plants.
- Antigen**—Any substance which, when introduced into the blood or tissues, incites the formation of antibody and which, when mixed with the antibody, reacts with it in some way that can be demonstrated.
- Ascitic Fluid**—Serous fluid in the abdomen.
- Autotrophic**—Needing only carbon dioxide or carbonates as a source of carbon and a simple inorganic nitrogen compound for metabolic synthesis. (Obtains energy from the oxidation of inorganic compounds.)
- Bactericidal**—Destroying bacteria.
- Bacteriophage**—A special group of viruses which are host-specific to certain bacteria. They have been demonstrated in connection with very many bacterial species, but show a high degree of host-specificity, so that any one phage is usually limited not only to a single bacterial species but to certain strains of that species.
- Carotenoids**—Yellow to red pigments found widely in plants and animals.
- Chemotherapeutic**—Chemical agents used in the treatment of disease.
- Coenzyme**—The heat-stable, water-soluble portion of an enzyme which is necessary for the production of fermentation or digestion by means of an enzyme.
- Cytoplasmic Membrane**—A semipermeable membrane located directly beneath the cell wall, governing osmotic activity.
- DNA Polymerase**—Enzymes capable of speeding a chemical action in joining two or more molecules of the deoxyribonucleotides.
- Duplication**—Doubling, the presence of an extra segment of chromosome existing as a separate fragment or attached to a member of normal chromosome complement.
- Enteric Organisms**—Members of the family Enterobacteriaceae, many of which are parasitic and/or pathogenic in plants or in the intestinal tract of vertebrates.
- Epidemiology**—A science that deals with the incidence, distribution, and control of disease in a population.
- Fulminating**—Sudden, severe, coming on suddenly with an intense severity.

**Halogen**—Any element capable of forming a haloid salt. The halogens are chlorine, bromine, iodine, and fluorine.

**Heterotrophic Bacteria**—Bacteria that obtain energy from organic carbon sources.

**Hydrolysate**—A compound produced by a chemical reaction in which a compound reacts with water.

**Inspissator**—An apparatus to make a fluid less thin by evaporation.

**Intercalation**—Inserting between as something in addition.

**Isoniazid**—A compound used in the treatment of tuberculosis.

**Lysochromes**—Any of the naturally occurring pigments soluble in fats or in solvents for fats.

**Lysogeny**—A phage enters a host cell but does not derange its synthetic activity and is integrated into the bacterial chromosome. Such a phage is described as *temperate*, as distinct from *virulent* or *lytic*, and the integrated non-lytic form in which it persists in the cell is called *prophage*.

**Lytic**—Producing the dissolution of cells.

**Melanin**—A dark brown or black animal or plant pigment.

**Mesophilic**—Said of bacteria which develop best at an optimum temperature of 20° to 40° C.

**Metabolism**—The chemical changes in living cells by which energy is provided for vital processes and activities and new material is assimilated.

**Microaerophilic**—Preferring low concentrations of oxygen.

**Oxidation-Reduction**—A chemical reaction in which one or more electrons are transferred from one atom or molecule to another.

**Pathogen**—A microorganism capable of causing disease.

**Pellicle**—A thin skin or film on the surface of a liquid.

**Penicillinase**—An enzymelike substance produced by certain bacteria which has an inactivating effect on penicillin.

**Pleomorphic**—Occuring in various distinct forms within the same species.

**Proteolysis**—The hydrolysis or decomposition of proteins.

**Protista**—A third biological kingdom established by Haeckel in 1866, which is distinguished from animals and plants and is based on the complexity of cellular structure.

**Psychophilic**—Fond of cold; bacteria which develop best between 10° and 20° C.

**Replicate**—To duplicate or reproduce, as to replicate an exact copy of polynucleotide strand of DNA or RNA.

**Saprophyte**—An organism which normally inhabits a certain area of the body without producing disease.

**Spore**—Unicellular resistant or reproductive body produced by plants and some invertebrates.

**Taxonomy**—Branch of biology that deals with the arrangement and classification of animals and plants.

**Thermophilic**—Fond of heat; bacteria which develop best at a temperature of 50° to 60° C.

**Transcription**—The process by which genetic information contained in DNA produces a complementary sequence of bases in an RNA chain.

## Answers for Exercises

### CHAPTER 1

#### Reference:

- 001 - 1. F. The concept of contagious disease preceded the discovery of the infectious agent.
- 001 - 2. F. During the Renaissance, 1453-1600.
- 001 - 3. F. Girolamo Fracastoro.
- 001 - 4. T.
- 001 - 5. T.
- 001 - 6. F. Roger Bacon.
- 001 - 7. T.
- 001 - 8. F. After his death this information was available through the Royal Society of London.

- 002 - 1. c.
- 002 - 2. c.
- 002 - 3. a.
- 002 - 4. a.
- 002 - 5. g.
- 002 - 6. c.
- 002 - 7. g.
- 002 - 8. f.
- 002 - 9. b.
- 002 - 10. f.
- 002 - 11. d.
- 002 - 12. d.

### CHAPTER 2

- 003 - 1. Labeled.
- 003 - 2. 553, Microbiology I; 554, Microbiology II.
- 003 - 3. AF Form 3066, Doctor's Orders; requisition.
- 003 - 4. Possible diagnosis; antibiotic therapy.
- 003 - 5. Name; register; bed; patient.
- 003 - 6. Will not.
- 003 - 7. Check; request form.
- 003 - 8. Check; exactly what is requested.
- 003 - 9. Adequately described.
- 003 - 10. Source; isolate; identify.
  
- 004 - 1. F. Sputum submitted will be representative of the infectious process.
- 004 - 2. F. The stool specimen.
- 004 - 3. F. Material for culture should be obtained before the patient receives therapy.
- 004 - 4. F. Cysteine or thioglycollate.
- 004 - 5. F. Culture specimen first.
- 004 - 6. F. Should not exceed 2 hours
  
- 005 - 1. Samples are not collected at the proper stage of the disease.
- 005 - 2. a. The disease agent.  
b. The primary focal point of infection.  
c. The resistance of the host.

- 005 - 3. *Neisseria*, *Streptococcus*, *Staphylococcus*, *Hemophilus*, and occasionally *Mycobacterium*.
- 005 - 4. *Cryptococcus neoformans*.
- 005 - 5. *Neisseria*.
- 005 - 6. Fibrinogen will cause the specimen to coagulate.
- 005 - 7. These fluids often contain highly infectious organisms.
- 005 - 8. Material that has passed through the walls of vessels into nearby tissues or areas of inflammation.
- 005 - 9. *Clostridium spp.*
- 005 - 10. *Pseudomonas*, *Staphylococcus*, *Streptococcus*.
- 005 - 11. a. Use utmost discretion.  
b. Use tact.  
c. Give the patient privacy.
  
- 006 - 1. F. Only in areas in where *Salmonella*, *Shigella*, or *Staphylococcal* food poisoning is a potential threat.
- 006 - 2. F. *Salmonella* and *Shigella spp.*
- 006 - 3. F. Differential, selective, and inhibitory media.
- 006 - 4. F. Should be clean.
- 006 - 5. F. Particularly *Shigella spp.*
- 006 - 6. F. Different.
- 006 - 7. F. Spittle will not show the bacteria infecting the deeper regions of the respiratory system.
  
- 007 - 1. Diagnosis of streptococcal sore throat, scarlet fever, diphtheria, and whooping cough. To determine the focal point of rheumatic fever and acute glomerulonephritis.
- 007 - 2. Beta hemolytic *streptococcus*, *Staphylococcus spp.* and *Corynebacterium diphtheriae*.
- 007 - 3. 72 hours.
- 007 - 4. From the nasopharynx and/or through the pernasal route (the posterior nasopharynx).
- 007 - 5. Fibers are soaked in sodium salts solutions of numerous organic acids.
- 007 - 6. Pass the swab gently past the crypts and tonsils across to the back surface of the pharynx.
- 007 - 7. This may add many confusing organisms and make isolation of the pathogen difficult.
  
- 008 - 1. F. Cultures first.
- 008 - 2. F. Bacteria may be transferred from the smear slide to the culture media; we then have a contaminated culture.
- 008 - 3. T.
- 008 - 4. F. They must be sterilized in the autoclave.
- 008 - 5. T.
  
- 009 - 1. a. Urethra.  
b. Bladder.  
c. Kidneys.
- 009 - 2. A clean-voided or catheterized specimen of urine is frequently contaminated on collection.



- 009 - 3. Quantitative bacterial cultures.
- 009 - 4. Coliforms, staphylococci, coagulase negative, enterococci, Proteus species, beta hemolytic streptococci.
- 009 - 5. Within 1 hour. Urine supports growth of most urinary pathogens as routine media, and an overgrowth of the organisms in the urine will yield inaccurate results.
- 009 - 6. Refrigerate at 4° C.
- 009 - 7. The patient is instructed to wash the genitalia with a suitable cleansing solution and voids directly into a sterile, screw-capped or appropriate container without contamination of the specimen.
- 009 - 8. A two- or three-glass specimen.
- 009 - 9. The three-glass urine divides the urine as coming from three separate anatomical sections of the urinary system.
- 009 - 10. The bladder.
- 010 - 1. Adequate precaution for proper handling should be noted on the laboratory request for such specimens.
- 010 - 2. The technician must treat each specimen as a potential hazard to his health.
- 010 - 3. The contaminated exterior surface constitutes a source of infection to the handlers.
- 010 - 4. A fresh specimen or a rectal swab.
- 010 - 5. When working with highly contagious material.
- 010 - 6. It helps to minimize contaminations caused by droplets and aerosol, and kills bacteria which falls on the toweling.
- 010 - 7. The entire area should be wiped down with a disinfectant.
- 010 - 8. a. That the tubes are fitted with a tight lid to prevent contamination of the specimen or atmosphere.  
b. That the tubes are not chipped or cracked.  
c. That the centrifuge is balanced.
- 010 - 9. No infectious or toxic materials should be pipetted by mouth.
- 011 - 1. a. Type of specimen.  
b. Source of specimen.  
c. Analysis desired.  
d. Time lapse between collection and inoculation.  
e. Final disposition of container.
- 011 - 2. a. Allow the material to clot and then culture the entire clot.  
b. Use a sterile anticoagulant to prevent the material from clotting.  
c. Perform initial inoculation at the place of collection to avoid clotting.
- 011 - 3. In the study of various body fluids for viral and rickettsial-like organisms.
- 011 - 4. A minimum of three early morning "clean catch" or catheterized urine. The entire volume of each voiding is collected in a sterile container.
- 011 - 5. Give the bacteria a headstart in their growth.
- 011 - 6. The change may cause some bacteria to die while other bacteria grow and multiply faster.
- 011 - 7. They may contain fatty acids which may be detrimental to microbial growth.
- 011 - 8. Autoclave and discard.
- 012 - 1. F. The use of vacuum.
- 012 - 2. T.
- 012 - 3. T.
- 012 - 4. F. They do not.
- 012 - 5. F. Swab sticks from wound cultures.
- 012 - 6. T.
- 012 - 8. F. Buffered glycerine-saline solution of Sachs.
- 012 - 9. T.
- 013 - 1. d.
- 013 - 2. d.
- 013 - 3. b.
- 013 - 4. d.
- 013 - 5. e.
- 013 - 6. a.
- 013 - 7. e.
- 013 - 8. a.
- 013 - 9. c.
- 013 - 10. f.
- 013 - 11. f.
- 013 - 12. g.
- 014 - 1. *Collection, Handling and Shipment of Microbiological Specimens*, DHEW Publication No. (CDC) 75-8263.
- 014 - 2. (a) To protect them in transit and (b) to protect the personnel handling them.
- 014 - 3. Pressures building up as CO<sub>2</sub> is liberated and will explode the thermos or container.
- 014 - 4. Federal Regulation 72.25 of part 72, Title 42, Code of Federal Regulations.
- 014 - 5. ETIOLOGICAL; BIOMEDICAL; DAMAGE; LEAKAGE; NOTIFY.
- 015 - 1. Immediately.
- 015 - 2. 5 percent Lyson or other phenolic compounds.
- 015 - 3. These disinfectants cause corrosiveness and skin irritation.
- 015 - 4. Phenol compounds are absorbed as a thin, fairly durable film on surfaces to which they are applied. This film serves to destroy bacteria that land on the surface for several hours.
- 015 - 5. Halogens, such as iodine and chlorine, heavy metals, synthetic detergents, and alcohols.
- 015 - 6. Air currents caused by movements of equipment and personnel within the laboratory cause the spread of bacteria.
- 016 - 1. F. Take first aid steps immediately.
- 016 - 2. F. Some pathogenic bacteria may enter the bloodstream.
- 016 - 3. F. Running water.
- 016 - 4. T.
- 016 - 5. F. Greater danger.
- 016 - 6. T.
- 016 - 7. T.
- 016 - 8. F. Wash the affected area with a disinfectant type soap; then rinse with large amounts of running water.
- 017 - 1. a. Oral aspiration; pipette.  
b. Syringe needles.  
c. Spray; needles; syringes.  
d. Centrifuge.  
e. Bites.
- 017 - 2. Forbidden; replaced; safe pipetting.
- 017 - 3. Firmly fixed; threads.
- 017 - 4. Hands.
- 017 - 5. Smoke, eat or drink.
- 017 - 6. Minimal safety standards.
- 017 - 7. Easier; interpret; evaluate.
- 017 - 8. Diseases; bacteria.
- 018 - 1. The freeing of an article from all living organisms, including virus, bacteria and their spores, and fungi and their spores, both pathogenic and non-pathogenic.
- 018 - 2. Sterility is an absolute state; thus an article is either sterile or unsterile.

- 018 - 3. Sterilizing culture media, suspending fluids, reagents, containers, and equipment used in microbiology. Also surgical and medical instruments used in procedures that involve penetration into the blood, tissues, and normally sterile parts of the body.
- 019 - 1 The freeing of an article from some or all of its contamination with live pathogenic bacteria which might cause infection during use.
- 019 - 2. The proportion of the pathogenic organisms killed or removed.
- 019 - 3. Heat-resistant spores.
- 019 - 4. Germicide and bactericide.
- 019 - 5. Situations in which sterility is unnecessary or impractical.
- 019 - 6. Sterilization means the complete destruction of the vegetative and spore stages of organisms. Disinfection may not kill the spores, thus not effecting complete sterilization.
- 019 - 7. A substance that can inhibit the growth of microorganisms without actually killing them.
- 019 - 8. An agent that does not cause immediate death of an organism, but rather acts to prevent multiplication of the organisms.
- 019 - 9. Low temperature, desiccation (of some organisms), and antibiotics.
- 019 - 10. Antigrowth; inhibitor.
- 020 - 1. Viability means the ability to live. A viable organism is capable of fulfilling all of life's processes.
- 020 - 2. By altering either the physical or the chemical surroundings of the organism or both, thereby affecting its life processes.
- 020 - 3. Related genus, growth curve (stage of organism), presence of organic matter, temperature, time, and pH.
- 020 - 4. They have the physical protection of their thick coats, their metabolic needs are minimal, and they do not divide, which increases their susceptibility to harmful metabolic agents.
- 020 - 5. Factors which determine the appropriate selection or agent are: (a) The specific situation and (b) whether it is necessary to kill all microorganisms or whether it is necessary to kill certain species.
- 021 - 1. a, b, c, d.
- 021 - 2. c.
- 021 - 3. c.
- 021 - 4. b.
- 021 - 5. b.
- 021 - 6. d.
- 021 - 7. a.
- 021 - 8. a.
- 021 - 9. b, c.
- 021 - 10. b.
- 021 - 11. b.
- 021 - 12. a, c.
- 022 - 1. a. Water reacts with the protein, causing denaturation.  
b. The altered or denatured proteins coagulate with heat and separate out as particles.
- 022 - 2. Time and temperature.
- 022 - 3. Time and temperature, both of which are related to altitude (pressure).
- 022 - 4. A process whereby alternate heating and incubation destroy vegetative forms and allow spores to germinate to vegetative stages and then to be destroyed by successive heating.
- 022 - 5. a. It is time-consuming.  
b. In some fluids, such as water, spores may not grow out promptly.
- c. If the material is freely exposed to air, anaerobic spores may not germinate.  
d. If the material is not freely exposed to air, aerobic spores will not grow out.
- 023 - 1. The autoclave will kill microorganisms, including heat-resistant spores, with moist heat at temperatures above that of boiling water.
- 023 - 2. Temperature and moisture.
- 023 - 3. 15 minutes, 121° C and 15 pounds.
- 023 - 4. They may explode.
- 023 - 5. They will boil over.
- 023 - 6. Never more than two-thirds capacity. One-half capacity is better.
- 023 - 7. As soon as possible.
- 024 - 1. e.
- 024 - 2. e.
- 024 - 3. e.
- 024 - 4. a.
- 024 - 5. d.
- 024 - 6. e.
- 024 - 7. d.
- 024 - 8. d.
- 024 - 9. b.
- 024 - 10. g.
- 024 - 11. c.
- 024 - 12. f.
- 024 - 13. g.
- 024 - 14. c.
- 024 - 15. b.
- 025 - 1. (a) Surface layer, (b) nuclear material, and (c) enzyme systems.
- 025 - 2. Surfactants coat the cell wall of the bacteria and prevent it from absorbing or utilizing nutritional materials.
- 025 - 3. These chemicals will combine indiscriminately with the protein and other compounds within a bacterial cell. They are nonspecific in their action and will combine readily with feces, blood, body tissue, and mucus as well as the protein of the microorganisms.
- 026 - 1. l.
- 026 - 2. l.
- 026 - 3. k.
- 026 - 4. j.
- 026 - 5. j.
- 026 - 6. a.
- 026 - 7. a.
- 206 - 8. a.
- 026 - 9. i.
- 026 - 10. i.
- 026 - 11. i.
- 026 - 12. h.
- 026 - 13. h.
- 026 - 14. a, i.
- 026 - 15. b.
- 026 - 16. c.
- 026 - 17. c.
- 026 - 18. f.
- 026 - 19. e.
- 026 - 20. e.
- 026 - 21. d.
- 026 - 22. d.
- 026 - 23. d.
- 026 - 24. f.
- 027 - 1. These protein substances will readily combine with the disinfectants, thus reducing their effectiveness against the bacterial cell.

- 027 - 2. a. Concentration of organisms.  
b. Concentration of disinfectant.  
c. Temperature of disinfectant.  
d. Presence of cells in the culture having varying susceptibilities.
- 027 - 3. By decreasing the viscosity, increasing the acidity of the bacterial surroundings, and lowering the bacterial surface tension.
- 027 - 4. Diminishing adsorption to the cell wall.
- 027 - 5. This change in pH increases the acidity of the solution surrounding the cells.
- 028 - 1. a. Solubility.  
b. Stability.  
c. Noncorrosive.  
d. Effective power of penetration  
e. High coefficient of disinfection.
- 028 - 2. Phenol (carbolic acid).
- 028 - 3. We must use (1) a single kind of media, (2) a single environment for growing the bacteria, and (3) the temperature must be the same.
- 028 - 4. Only when all conditions and procedures in the test are standardized and controlled.
- 028 - 5. The method compares the ability of phenol against an unknown disinfectant.
- 028 - 6. Phenol coefficient of 4.5.
- 028 - 7. A disinfectant may be found to have a phenol coefficient of 40 when tested in distilled water, whereas this compound may be quite ineffective when applied in the presence of organic matter, such as pus, saliva, feces, or milk.
- 029 - 1. T.
- 029 - 2. F. Heat.
- 029 - 3. F. Those suspended in a nonprotein-type medium are easier to destroy.
- 029 - 4. T.
- 029 - 5. F. Increasing the temperature.
- 029 - 6. T.
- 029 - 7. F. They must be placed in solution to be effective.
- 030 - 1. The absence of septic matter or freedom from infection.
- 030 - 2. We must use aseptic techniques as routinely as possible. Also, the hospital must have a program of aseptic testing.
- 030 - 3. The Hospital Infection Committee.
- 030 - 4. a. Use of heat-sensitive indicators.  
b. Testing the equipment, itself by culturing.  
c. Use of spore strips or ampules.
- 030 - 5. A disadvantage of this method is that one can only assume that if no growth occurs from a particular article, that specific article was sterilized by the autoclave.
- 030 - 6. A spore-impregnated strip of filter paper enclosed in a sterile envelope is placed in the center of the package to be sterilized.
- 030 - 7. *Bacillus stearothermophilus*.
- 030 - 8. *Bacillus subtilis* (globigii).
- 030 - 9. Remove the strip from its envelope, using sterile forceps, place it in a suitable culture medium, and incubate.
- 030 - 10. Sterilization has not been complete.
- 030 - 11. It should grow organisms.
- 031 - 1. Hospital-acquired infections.
- 031 - 2. a. To provide technical experience in hospital surveillance programs before a hospital epidemic occurs.  
b. To educate and motivate personnel to strive to reduce nosocomial infections.
- c. To monitor sterile equipment, disinfection, medication, intravenous fluids, and instruments.  
d. To establish acceptable baselines and limits of bacterial contamination of critical areas.
- 031 - 3. Operating rooms, recovery rooms, burn units, intensive and coronary sections, isolation units, and nurseries.
- 031 - 4. Weekly.
- 031 - 5. Isolettes, soap spouts, formulas, faucets in operating rooms, nebulizers, and vaporizers.
- 032 - 1. T.
- 032 - 2. T.
- 032 - 2. T.
- 032 - 3. F. Nose, throat, and lesions.
- 032 - 4. F. Obtain the specimen from the area of the nostrils which is exposed to the air.
- 032 - 5. F. They are not free of infectious agents.
- 033 - 1. Routinely.
- 033 - 2. Disinfectant.
- 033 - 3. Care; handling.
- 033 - 4. Diligence.
- 033 - 5. Practiced; practiced; everyone.
- 033 - 6. Time-consuming; wash; wear.
- 033 - 7. External; decontaminated.
- 033 - 8. Care.

### CHAPTER 3

- 034 - 1. A taxis is an "arrangement."
- 034 - 2. An orderly arrangement, or sorting of bacteria within an organized classification system.
- 034 - 3. Classification systems are somewhat arbitrary and do not directly reflect evolutionary relationships between different groups of bacteria.
- 034 - 4. They can only theorize as to the evolutionary and the phylogenetic history of these organisms.
- 034 - 5. Conventional practices in taxonomy.
- 034 - 6. F. The prokaryotes and the eukaryotes.
- 034 - 7. T.
- 034 - 8. F. They have naked, nonmembrane-bound nuclear deoxyribonucleic acid without associated basic protein.
- 034 - 9. F. Prokaryotic.
- 034 - 10. F. Eukaryotic protists.
- 034 - 11. T.
- 035 - 1. *Bergey's Manual of Determinative Bacteriology*, or *Bergey's Manual*.
- 035 - 2. The Cyanobacteria or blue-green bacteria (algae) and the Bacteria.
- 035 - 3. The Bacteria.
- 035 - 4. The morphological, cultural, nutritive, biochemical, physiological, serologic, bacteriophage susceptibility, and pathogenic and genetic properties of the organisms.
- 035 - 5. Order.
- 035 - 6. Tribe.
- 035 - 7. Family.
- 036 - 1. Kingdom, phylum, class, order, family, tribe, genus, species.
- 036 - 2. Because of lack of information concerning accurate evolutionary record or bacterial life forms.
- 036 - 3. Kingdom, division, part, order family, genus, species, variety or serogroup.
- 036 - 4. Division II, The Bacteria, and Part 8, Gram-negative Facultatively Anaerobic Rods.
- 036 - 5. Gram-negative anaerobic cocci.

- 037 - 1. Size, shape and arrangement of cells, and internal cellular structures.
- 037 - 2. (a) Spherical—cocci, (b) rod-shaped—bacillus, (c) spiral-shaped—spirillum.
- 037 - 3. Autotrophic bacteria.
- 037 - 4. Heterotrophic.
- 037 - 5. Heterotrophs.
- 037 - 6. Saprophytic bacteria.
- 038 - 1. Micron.
- 038 - 2. Nucleoid or nuclear region.
- 038 - 3. Ribosomes.
- 038 - 4. Capsule.
- 038 - 5. Spore.
- 038 - 6. Coccobacillary.
- 038 - 7. Peritrichous.
- 038 - 8. Subterminal.
- 038 - 9. Palisade.
- 038 - 10. Singly.
- 038 - 11. Pairs.
- 038 - 12. Chains.
- 038 - 13. Side; side.
- 039 - 1. Departures from normal or "typical" growth of a species.
- 039 - 2. Forms and structure of the cell or colony, metabolic processes, immunological character, and ability to produce disease.
- 039 - 3. a. Mutation—a change within the genetic structure of cells in a culture.  
b. Adaptation—a change in appearance or behavior influenced by environmental factors.
- 039 - 4. Spontaneous mutation.
- 039 - 5. First, you would see that a vast number of bacteria that were plated did not grow. In fact, you might observe slow growth on the plate. In time, however, you will see isolated colonies of the resistant bacteria. This exact phenomenon may be seen *in-vivo* also. The patient may be seen to improve after treatment and then relapse to the increased growth of a resistant strain.
- 039 - 6. Adaptation.
- 039 - 7. Adaptation.
- 039 - 8. Involution.
- 039 - 9. A variation in the naturally occurring size and shape of a particular bacterium.
- 040 - 1. (!) Nutrition (proper food), (2) moisture (3) acidity/alkalinity, (4) temperature, and (5) gas exchange.
- 040 - 2. a. A source of carbon (organic or inorganic).  
b. Nitrogen.  
c. Inorganic chemical salts.
- 040 - 3. Peptone, a breakdown from protein; it provides an available source of carbon and nitrogen.
- 040 - 4. For the organism to reproduce on culture media.
- 040 - 5. Buffering substances retard changes in the pH of the growing culture, thus permitting more abundant growth before a limiting acidity or alkalinity is reached.
- 040 - 6. Mesophilic forms.
- 040 - 7. Thermophilic forms.
- 040 - 8. Vital.
- 041 - 1. Hydrogen.
- 041 - 2. It is thereby reduced.
- 041 - 3. Hydrogen peroxide ( $H_2O_2$ ).
- 041 - 4. Catalase.
- 041 - 5. A facultative anaerobe is one which prefers to grow as an anaerobe, but can adapt to aerobic conditions. The vast majority of medically significant bacteria are in this category.
- 041 - 6. It is toxic.
- 041 - 7. They can produce the respiratory enzymes necessary to couple hydrogen atoms with oxygen, the hydrogen acceptor commonly used by both of these types of organisms.
- 041 - 8. Spores.
- 041 - 9. An organism for which oxygen is toxic, except in minute amounts.
- 042 - 1. Colony shape, outline, size, and texture.
- 042 - 2. Circular, undulate, lobate, crenated, concentric.
- 042 - 3. Its elevation.
- 042 - 4. Spread out.
- 042 - 5. Flat, convex, umbilicate, raised, umbonate, papillary, and convex rugose.
- 042 - 6. Degree of virulence and too much moisture on the medium surface.
- 042 - 7. Texture.
- 042 - 8. Heavy capsule formation by individual cells or by secretion produced by bacteria in response to an external stimulus.
- 042 - 9. R colony is produced with dull appearance, less translucent (more opaque) than the S colony, and may have an irregular circumference and a wrinkled or rough surface.
- 043 - 1. a. Types of medium used.  
b. Time and temperature of incubation.  
c. Age of culture.  
d. Other environmental factors.
- 043 - 2. Leukobases and lipochromes.
- 043 - 3. Leukobases.
- 043 - 4. Lipochrome pigments.
- 043 - 5. Leukobases.
- 043 - 6. a. Carotenoids.  
b. anthocyanins.  
c. Melanins.
- 043 - 7. *Sarcina*, *Micrococcus*, *Staphylococcus*.
- 044 - 1. a. Proper collection and transport.  
b. Immediate culture.  
c. Use of freshly prepared and properly reduced media.  
d. Proper anaerobic conditions.
- 044 - 2. The active site of the infection.
- 044 - 3. Precautions should be taken to exclude surface contaminants and aeration of the sample.
- 044 - 4. Tissue samples or fluid aspirates.
- 044 - 5. Cysteine or thioglycollate at room temperature, not exceeding 2 hours.
- 044 - 6. Chilling is detrimental to some anaerobes, and oxygen absorption is greater at lower temperatures.
- 044 - 7. Nasal swabs, throat swabs, sputum, gastric contents, skin, feces, voided or catheterized urine, and vaginal swabs.
- 044 - 8. Contamination with normal flora is likely.
- 044 - 9. 5 to 10 ml to make a 10 Percent V/V.
- 044 - 10. Liquoid may prevent the growth of some anaerobic cocci and slow the growth of some strains of *Bacteroides melaninogenicus*.
- 044 - 11. 2 weeks.
- 044 - 12. Gram stained and cultured by direct plating and enrichment procedures.
- 045 - 1. a. Anaerobic jars.  
b. The Hungate roll-tube or roll-streak tube.  
c. Anaerobic glove box.
- 045 - 2. The addition of hydrogen allows reduction of oxygen to form water. Further, each system uses a catalyst to accelerate the rate of oxygen reduction.
- 045 - 3. To prevent inactivation of the catalyst.
- 045 - 4. Palladium-coated alumina pellets.
- 045 - 5. By heating the pellets in a dry-heat oven at 160° to 170° C for 2 hours.

- 045 - 6. An electrically heated platinized asbestos catalyst.
- 045 - 7. 10 percent hydrogen, 10 percent carbon dioxide, and 80 percent nitrogen.
- 045 - 8. In the generator envelope.
- 045 - 9. Room temperature.
- 045 - 10. Condensed water will appear as a visible mist or fog on the inner wall of the jar, and the lid over the catalyst will become warm.
- 045 - 11. The indicator should appear colorless and the jar will be under a slight positive pressure.
- 045 - 12. Explosive.
- 045 - 13. Extinguished.
- 045 - 14. Wooden; metal safety shield.
- 046 - 1. The system uses enriched media that has been prepared, sterilized, and stored under oxygen-free gas in order to maintain a low oxidation-reduction potential and prevent oxidative changes.
- 046 - 2. Prereduced anaerobically sterilized media (PRAS).
- 046 - 3. a. By needle injection through the oxygen impermeable stopper without introducing air, or b. By passing a gentle stream of oxygen-free gas into the tube by way of a sterile cannula when the stopper is removed.
- 046 - 4. (1) Each tube has its own anaerobic atmosphere and (2) can be incubated in a standard incubator and observed at any time during growth.
- 046 - 5. A self-contained anaerobic system which consists of a closed chamber usually made of flexible clear plastic and fitted with glove for manipulations within the enclosed space.
- 046 - 6. Technical grade nitrogen; a gas mixture of 5 percent CO<sub>2</sub> (bone dry), 10 percent H<sub>2</sub>, and 85 percent N<sub>2</sub>.
- 046 - 7. A drying agent, "Tel-Talc" silica gel, dessicant grade H type IV.
- 046 - 8. Yes, it can be used.
- 046 - 9. These procedures can do done under anaerobic conditions without exposing the bacteria to air.
- 046 - 10. The need for boiling liquid media just before use is eliminated in this technique.
- 046 - 11. For gases that are used when materials are passed into and out of the chamber.
- 047 - 1. T.
- 047 - 2. F. 2 to 3 percent.
- 047 - 3. F. A lighted candle is placed in a container above the cultures.
- 047 - 4. F. 2 to 3 percent.
- 047 - 5. F. Place the candle as high as possible.
- 047 - 6. T.
- 407 - 7. T.
- 047 - 8. F. Acts as an indicator.
- 047 - 9. T.
- 047 - 10. T.
- 047 - 11. F. Discarded.
- 047 - 12. F. 35° C and 37° C
- 047 - 13. F. 35° C.
- 047 - 14. F. Be moist.
- 047 - 15. F. The pH of the surface of the agar will be too low, producing variable results in sensitivity testing.
- 048 - 1. T.
- 048 - 2. F. Blood, serum, amino acids, or vitamins may be required.
- 048 - 3. T.
- 048 - 4. F. They should be excluded; they inhibit production of certain hemolysins.
- 048 - 5. F. It is NOT metabolized by bacteria.
- 048 - 6. T.
- 048 - 7. T.
- 048 - 8. F. False positive with organisms which do not ferment lactose.
- 048 - 9. F. The gelling ability of the medium may be destroyed.
- 049 - 1. To avoid costly duplication of purpose.
- 049 - 2. (a) Cost, (b) judgment or preference of an experienced technician, (c) commercial availability.
- 049 - 3. To support the growth of many organisms (nonfastidious).
- 049 - 4. The glucose content is metabolized to acid end products by certain bacteria.
- 049 - 5. It is used to inhibit or destroy the normal intestinal flora and promote the unrestricted growth of pathogens such as *Salmonella* and *Shigella*.
- 049 - 6. Tetrathionate broth, Selenite broth, and GN broth.
- 049 - 7. An enriched medium contains an added nutritive supplement; and is prepared by adding serum, blood or other nutrients to basic nutrient medium.
- 049 - 8. a. Tetrathionate broth.  
b. Selenite broth.  
c. GN broth.
- 049 - 9. They are designed to separate various organisms depending upon carbohydrate utilization, fermentation or oxidation, or enzyme activity.
- 049 - 10. (a) EMB agar, (b) MacConkey agar, (c) XLD agar.
- 049 - 11. The carbohydrate, lactose and the indicator, phenol red.
- 049 - 12. The selective media inhibit the growth of certain organisms while permitting others to grow.
- 049 - 13. Mannitol salt agar and Phenylethyl alcohol agar respectively.
- 049 - 14. These media may suppress the organisms they are designed to show after some time of growth.
- 050 - 1. Water meeting the USP definition of purified water.
- 050 - 2. By distillation or by ion-exchange treatment.
- 050 - 3. Place in a dry flask of a size suitable to hold twice the final volume of medium desired.
- 050 - 4. Add water to the dehydrated medium slowly at first to make sure that it dissolves completely. Add a little water to make a thick slurry; then add the remaining water.
- 050 - 5. The medium may boil over the top and onto your hands, causing serious burns.
- 050 - 6. Immediately set the flask down on the counter top.
- 050 - 7. They are usually soluble at room temperature.
- 050 - 8. By heating it to a temperature of 50° C in a water bath.
- 050 - 9. Detergents or other contaminating chemicals may act as disinfectants or alter the pH of the medium.
- 051 - 1. 20 to 30 minutes at 121° C.
- 051 - 2. 116° to 118° C.
- 051 - 3. Equipment and tubes.
- 051 - 4. 45° to 50° C.
- 051 - 5. The final pH will be as stated on the label.
- 052 - 1. T.
- 052 - 2. F. Leave the Petri dishes covered until you are ready to pour.
- 052 - 3. F. Pouring should take place in an area free of air currents.
- 052 - 4. T.
- 052 - 5. F. Use sterile gauze over the opening of the pouring flask.
- 052 - 6. F. Gently pass a Bunsen burner flame over the medium before it hardens and allow the medium surface to smooth out.
- 052 - 7. F. Take care not to melt the Petri dishes.
- 053 - 1. From allowing the media to cool too much before pouring.



- 053 - 2. (a) It does not have an even distribution of nutrients, (b) the same organism may give a different colony appearance on various parts of the plate, (c) it is difficult to streak.
- 053 - 3. Do not allow the medium to cool to the point of solidifying before pouring aliquots.
- 053 - 4. (a) The type of medium and (b) the purpose.
- 053 - 5. Dispense; heated; autoclave.
- 053 - 6. Tiit; slant.
- 053 - 7. Slanted; gelled.
- 053 - 8. Butt; slant.
- 053 - 9. Aerobic; anaerobic, butt.
- 053 - 10. One-half.
- 054 - 1. Automatic pipetting machine.
- 054 - 2. Glass or stainless steel.
- 054 - 3. From the delivery tip connected to a rubber tubing.
- 054 - 4. Automatically adjusts to a preset dispensing temperature until you are ready to use it.
- 054 - 5. All types of agar and nutrient broth can be sterilized under perfectly controlled conditions.
- 054 - 6. a. They are closed systems.  
b. Prepares, sterilizes and holds media at desired temperature.  
c. Fills as many as 500 Petri dishes an hour.  
d. Dishes are fed from a carousel module into a UV sterilized filling chamber.  
e. Dishes are automatically stacked and positioned.
- 054 - 7. Workload data, time and cost-saving elements, and quality control.
- 055 - 1. T.
- 055 - 2. F. Stored at room temperature.
- 055 - 3. F. Makes broth unsuitable for bacterial growth.
- 055 - 4. F. Incubated at room temperature.
- 055 - 5. T.
- 055 - 6. F. Dyes in media break down under strong light.
- 055 - 7. T.
- 055 - 8. F. It makes it difficult to obtain isolated colonies and heightens the chances of contaminating an area of the laboratory during streaking.
- 055 - 9. T.
- 056 - 1. l.
- 056 - 2. m.
- 056 - 3. c.
- 056 - 4. c.
- 056 - 5. a.
- 056 - 6. n.
- 056 - 7. d.
- 056 - 8. f.
- 056 - 9. e.
- 056 - 10. e.
- 056 - 11. h.
- 056 - 12. i.
- 056 - 13. g.
- 056 - 14. k.
- 057 - 1. The ability of a specific organism to attach and break down a particular carbohydrate is a useful characteristic, and this is accompanied by identifiable byproducts. Thus, by carefully selecting the test carbohydrates, we can obtain a pattern of fermentation reactions which are characteristic of specific organisms.
- 057 - 2. Sucrose and lactose.
- 057 - 3. They are able to differentiate the organisms on fundamental differences other than outward appearances.
- 057 - 4. Lactose, dextrose, sucrose.
- 057 - 5. Sucrose.
- 057 - 6. Iron sulfide.
- 057 - 7. *Escherichia*, *Enterobacter* and *Klebsiella*.
- 057 - 8. The presence of gas bubbles and H<sub>2</sub>S production.
- 057 - 9. Trypticase agar base and CTA media.
- 057 - 10. Small amounts of acids are not readily dispersed throughout the media.
- 057 - 11. Clostridia, bacilli, common micrococci, enteric bacilli.
- 057 - 12. *Neisseria*, *Pasteurella*, streptococci, *Brucella*, corynebacteria, and vibrios.
- 057 - 13. A change in pH is due to accumulation of metabolic products.
- 058 - 1. e.
- 058 - 2. d.
- 058 - 3. d.
- 058 - 4. d.
- 058 - 5. a.
- 058 - 6. a.
- 058 - 7. g.
- 058 - 8. c.
- 058 - 9. c.
- 058 - 10. b.
- 058 - 11. f.
- 058 - 12. h.
- 058 - 13. i.
- 058 - 14. i.

#### CHAPTER 4

- 059 - 1. Obtaining discrete colonies and pure cultures.
- 059 - 2. As the wire loop is streaked back and forth across the plate, fewer and fewer organisms are deposited on the medium surface. Eventually, only single cells are deposited. The single cells can then multiply into well-separated, pure colonies which can be subcultured for identification.
- 059 - 3. d, a, c, e, b, g, f.
- 059 - 4. To prevent contamination by water condensation.
- 059 - 5. The stabbed sections into the agar; the "O" hemolysins of beta hemolytic streptococci are active only under reduced oxygen tension.
- 059 - 6. By touching the center of a colony with a wire needle.
- 060 - 1. To determine the approximate number of viable organisms in a liquid medium.
- 060 - 2. Water, milk, urine, or broth culture.
- 060 - 3. As the number of colony-forming units per milliliter.
- 060 - 4. To determine the hemolytic activity of deep colonies.
- 060 - 5. Size, shape, and color of colonies.
- 060 - 6. Water or saline.
- 060 - 7. 50; adequately mixed.
- 060 - 8. 1:100 and 1:1000.
- 060 - 9. By multiplying the number of colonies on the plate by the dilution factor which gives the physician the number of bacteria per ml of urine.
- 061 - 1. a. To maintain the viability of an organism by successive transfers to fresh medium.  
b. To grow a large volume of liquid culture for inoculation to differential or fermentation media.
- 061 - 2. Emulsify the material on the moist wall of the tube just above the liquid, and wash down the solid matter by tilting the tube.
- 061 - 3. Droplets will escape from the tube and contaminate the surrounding air. The resulting aerosol can infect you and other technicians.
- 061 - 4. Biochemical tests and to maintain stock cultures.
- 061 - 5. The resulting growth will not give a characteristic appearance.
- 061 - 6. Biochemical tests.



- 061 - 7. You should center the stab line and extend it approximately two-thirds of the depth of the medium.
- 062 - 1. Beta hemolytic streptococci, *Staphylococcus aureus*, *Corynebacterium diphtheriae*, *Borrelia vincentii*, *Hemophilus*, and *Bordetella* species.
- 062 - 2. Blood agar differentiates between the several types of hemolysis and furnishes the nutrients required by many fastidious pathogenic bacteria.
- 062 - 3. Streptolysin S, aerobic or oxygen stable.
- 062 - 4. Chocolate agar or Thayer-Martin medium.
- 062 - 5. This will allow subsurface growth of streptococci which produce the "O" hemolysin under micro-aerophilic conditions.
- 062 - 6. The type of blood used.
- 062 - 7. Sheep blood products an inhibitory action on the growth of *Hemophilus hemolyticus*, a normal throat commensal whose beta hemolytic colonies may be confused with those of beta hemolytic streptococci.
- 062 - 8. It contains inhibitory factors such as antibacterial substances, antibiotics, or excess citrate ions.
- 062 - 9. Anaerobic.
- 062 - 10. Loeffler's serum medium and chocolate tellurite agar.
- 062 - 11. Bordet-Gengou medium.
- 062 - 12. To isolate enteric organisms which might be found on occasion in the throat or nasopharyngeal area, especially in young children.
- 062 - 13. Make a direct smear from the specimen.
- 062 - 14. *Borrelia vincentii* and *Fusobacterium fusiforme*.
- 062 - 15. Mannitol salt agar; colonies produce a yellow discoloration, mannitol fermenter.
- 063 - 1. *S. aureus*, *Streptococcus* spp, *Hemophilus* spp, *Bordetella pertussis*, *Candida* spp *M. tuberculosis* and *Klebsiella pneumoniae*.
- 063 - 2. Blood and chocolate agars, EMB or MacConkey, Mannitol salt agar, and thioglycollate broth.
- 063 - 3. Serve as a guide to subsequent culture procedures.
- 064 - 1. First, set up routine smears and cultures; second, start AFB procedures.
- 064 - 2. The digestion and concentration techniques for the tubercle bacillus destroy other microorganisms.
- 064 - 3. A 5- to 10-ml collection of recently discharged material from the bronchial tree, with minimal amounts of oral or nasal contaminants.
- 064 - 4. Sputum may become toxic to tubercle bacilli and contamination may increase.
- 064 - 5. The early morning cleanly voided midstream portion.
- 064 - 6. The morning after the patient has fasted.
- 064 - 7. The highly acid gastric juices will inactivate the tubercle bacilli.
- 064 - 8. Buffer tablets or sodium carbonate to neutralize the acidity
- 065 - 1. F. Presumptive.
- 065 - 2. F. Mycobacteria stains poorly in the Gram method.
- 065 - 3. F. Carbol-fuchsin stain.
- 065 - 4. T.
- 065 - 5. F. A fluorescence optical system.
- 065 - 6. F. It is neither.
- 065 - 7. T.
- 066 - 1. Concentration procedures free mycobacteria from mucus particles in which they may be lodged. The digestion of tissues which takes place during concentration also destroys organisms other than the tubercle bacillus so that the contaminants won't overgrow the TB organisms during incubation on isolation media.
- 066 - 2. The reagent is mucolytic; thus, mucoproteins in sputum and mucus specimens are readily dissolved by NALC in a weak NaOH solution.
- 066 - 3. Greater survival of the tubercle bacillus during the digestion process because of the lower concentration of alkali present.
- 066 - 4. Sterile phosphate buffer, M/15; centrifugaion.
- 066 - 5. As a digestant to liquefy secretions and control contaminants.
- 066 - 6. Five percent phenol.
- 066 - 7. One hour.
- 066 - 8. Due to low survival rate of mycobacteria after lengthy exposure to the digestant.
- 066 - 9. Benzalkonium chloride shortens the required period, and selectively destroys many contaminants with minimal bactericidal action on tubercle bacilli.
- 066 - 10. Ziehl-Neelson and Modified Kinyoun.
- 066 - 11. Ease, speed, and thoroughness of observation; better contrast, minimal eye strain, and relative unimportance of the color acuity of the technicians.
- 067 - 1. Lowenstein-Jensen, Petragnani, and Middlebrook 7H10.
- 067 - 2. Horizontal position for 1 to 2 days at 35° C to 36° C in the dark.
- 067 - 3. Weekly for 6 to 8 weeks.
- 067 - 4. In the dark in a carbon dioxide incubator at 35° C for 3 weeks.
- 067 - 5. As soon as noted.
- 067 - 6. After 6 to 8 weeks incubation of both 7H10 plates and L-J slants.
- 067 - 7. Because of the higher concentration of bacteriostatic dye.
- 067 - 8. Lowenstein-Jensen medium.
- 067 - 9. Rate of growth, pigmentation, colony morphology, properties of chemical reactions.
- 067 - 10. Some organisms, notably the mycobacteria other than tubercle bacilli and some isoniazid-resistant strains of *Mycobacterium tuberculosis*, do not produce progressive disease in the injected animal.
- 068 - 1. *S. aureus*, *Streptococcus pyogenes*, enteric bacilli, *Bacteroides* species, anaerobic cocci, enterococci, *Hemophilus* species, *Neisseria* species.
- 068 - 2. Heparin.
- 068 - 3. It should be expelled and the material injected directly into an anaerobic transport tube.
- 068 - 4. Centrifuge.
- 069 - 1. a. Pus from deep wound on aspirated abscess.  
b. Necrotic tissue.  
c. Uterine cultures from post abortal sepsis.  
d. Aspirated fluids such as blood, peritoneal, pleural, synovial, or amniotic fluids.
- 069 - 2. One blood agar plate.
- 069 - 3. 35° C to 36° C.
- 069 - 4. 48 hours.
- 069 - 5. Prepare an acid-fast stain and follow the protocol for concentration and inoculation of TB organisms.
- 069 - 6. *Cryptococcus neoformans*.
- 069 - 7. An antibiotic commonly added to media to inhibit bacteria and saprophytic mold growth in fungus cultures.
- 069 - 8. *Cryptococcus neoformans* is one of the few pathogenic fungi sensitive to the additive.
- 070 - 1. Material that has passed through the walls of vessels into nearby tissues or areas of inflammation.

- 070 - 2. Cutaneous ulcers, bone fragments, abscesses, fluid from body cavity (empyema, peritonitis, or pericarditis), tissue fragments (operation or autopsy), cervical or vaginal culture.
- 070 - 3. *S. aureus*, *S. pyogenes*, Enteric bacilli, *Bacteroides* species, *Pseudomonas* species, *Clostridium* species, Peptococcus, Peptostreptococcus, and Enterococci.
- 070 - 4. *Clostridium tetani*, *Francisella tularensis*, *Pasteurella multocida*, *M. tuberculosis*, *M. marinum*, *C. diphtheriae*, *B. anthracis*, systemic fungi, *E. insidiosa*.
- 070 - 5. Swabs from the throat, nose, eye, ear, decubiti, superficial wounds, urethra, vagina, cervix, or rectum.
- 070 - 6. *Clostridium*.
- 070 - 7. Anaerobic.
- 071 - 1. The kidney, the ureters, the bladder, and the urethral passage.
- 071 - 2. Little significance as an indicator of disease.
- 071 - 3. 10,000 to 100,000 per ml.
- 071 - 4. 100,000 per ml or greater.
- 071 - 5. a. The pour plate method.  
b. The calibrated loop plating technique.
- 071 - 6. It is still more accurate.
- 071 - 7. It is more convenient in that it avoids the time-consuming act of preparing dilutions of urine in distilled water.
- 072 - 1. Centrifugation will concentrate contaminants as well as pathogens, and since most routine cultures are not catheterized, the chance of contaminants is more likely.
- 072 - 2. A positive growth will invariably result.
- 072 - 3. Screening.
- 072 - 4. When counts of  $10^2$  (100,000) and greater are observed.
- 072 - 5. No growth after 48 hours.
- 072 - 6. The early morning, clean-voided specimen.
- 073 - 1. Typhoid and paratyphoid fevers, bacillary dysentery.
- 073 - 2. *Escherichia*, *Klebsiella*, *Enterobacter* (*Aerobacter*), *Proteus*, *Clostridium*, *Bacteroides*, *Staphylococcus*, *Pseudomonas aeruginosa*, yeasts, aerobic and anaerobic streptococci.
- 073 - 3. They are used to increase the relative number of pathogens at the expense of the enteric saprophytes so that the pathogens will not be overgrown on a primary plating media.
- 073 - 4. *S. typhi* and *Shigella*.
- 073 - 5. *Salmonella* including *S. typhi*.
- 073 - 6. Through slight modifications by most commercial sources.
- 073 - 7. GN broth.
- 073 - 8. Selenite broth.
- 073 - 9. Noninhibitory and slightly inhibitory plating media.
- 074 - 1. You will have a better idea of what media to use in that you are able to decide what genera of organisms that you are able to decide what genera of organism you are dealing with.
- 074 - 2. EMB, BA, MAC, SS, XLD, and brilliant green agar.
- 074 - 3. It allows you to recognize staph, yeast, and Gram-negative organisms.
- 074 - 4. a. Gram-positive bacteriostatic agents.  
b. A fermentable carbohydrate, usually lactose.  
c. An indicator dye.
- 074 - 5. To differentiate lactose-fermenting from nonlactose fermenting organisms.
- 074 - 6. SS and XLD agars.
- 074 - 7. MacConkey, SS, and deoxycholate-citrate agar.
- 075 - 1. First, stab the butt of the medium to the bottom of the tube, and then streak the entire surface of the slant.
- 075 - 2. Atypical.
- 075 - 3. Lysine-iron agar (LIA) and motility-indole-ornithine (MIO) media.
- 075 - 4. TSI, LIA, Christensen's urea agar, Simmons citrate, motility-indole-ornithine (MIO), and peptone broth media.
- 075 - 5. Positive or negative; 18 to 24 hours.
- 075 - 6. The plastic API Coder.
- 075 - 7. The genus and usually the species corresponding to the observed pattern of test results, along with a percent chart showing the expected frequency of positive results for each biochemical test.
- 076 - 1. F. It causes enterocolitis in newborns and children under 2 years of age. It is found in adult carriers.
- 076 - 2. T.
- 076 - 2. T.
- 076 - 3. F. Broad spectrum antibiotics.
- 076 - 4. T.
- 076 - 5. F. Sodium chloride.
- 076 - 6. T.
- 076 - 7. F. Considerable clinical significance.
- 077 - 1. Bacteria present in the blood stream.
- 077 - 2. A bacteremia or so-called blood poisoning caused by pathogenic microorganisms and their toxic products.
- 077 - 3. Before antimicrobial therapy.
- 077 - 4. Continuous bacteremia.
- 077 - 5. Endocarditis, endarteritis, uncontrolled infections, typhoid fever, brucellosis.
- 077 - 6. Three blood cultures at hourly intervals.
- 077 - 7. 70 to 95 percent alcohol and 2 percent iodine.
- 077 - 8. One minute.
- 077 - 9. One part blood to nine parts broth.
- 077 - 10. It prevents clotting, inactivates leukocytes, complement, and certain aminoglycoside and polypeptide antibiotics.
- 078 - 1. Tryptic soy broth (Difco),  
Trypticase soy broth  
Columbia broth  
Brain Heart Infusion broth.
- 078 - 2. Anaerobic; the bottle should not be vented.
- 078 - 3. In selected cases which are receiving high doses of a penicillin or cephalosporin at the time of collection.
- 078 - 4. Castaneda's double medium and Brucella broth; they are retained for 21 days.
- 078 - 5. On the same day and daily thereafter for at least 7 days.
- 078 - 6. Turbidity, hemolysis, gaseousness, and pellicle or discrete colonies.
- 078 - 7. Prepare Gram-stained smears and subcultures immediately; report the microscopic examination of the smear by phone and in writing to the patient's physician.
- 078 - 8. Inoculate quadrants of prerduced blood agar plate and incubate at 35° C in a GasPak Jar or anaerobic chamber for 48 hours.
- 079 - 1. External genitalia, anterior urethra, and vagina.
- 079 - 2. They are considered to be venereal.
- 079 - 3. *S. epidermidis*, streptococcus mitis, enterococci, peptostreptococci.
- 079 - 4. *Actinobacter ivoffi* and *Haemophilus vaginalis*.
- 079 - 5. When the infection is caused by a variety of bacteria and not by gonococcus.
- 079 - 6. The pH of the secretions and the amount of glycogen present in the epithelium.

- 079 - 7. Lactobacilli designated as Doderlein bacillus and actually *L. acidophilus*.
- 079 - 8. *Haemophilus vaginalis*.
- 080 - 1. The cervix and anal canal.
- 080 - 2. Thayer-Martin and Transgrow media.
- 080 - 3. The combination of a positive oxidase reaction of colonies and Gram-negative diplococci growth on either medium used.
- 080 - 4. Microscopic demonstration of Gram-negative intracellular diplococci on the smear of a urethral discharge.
- 080 - 5. By rolling the swab on the slide, because rubbing the swab on the slide will distort microscopic morphology.
- 080 - 6. A culture specimen should be obtained from the anterior urethra and inoculated to Thayer-Martin on Transgrow medium.
- 080 - 7. The findings of the Gram stain and the tentative clinical diagnosis.
- 080 - 8. Blood, EMB, chocolate, and Mannitol salt agars, thioglycollate, and Thayer-Martin media.
- 081 - 1. a. Use clean slides.  
b. Make more than one slide of a specimen.  
c. Air-dry completely.
- 081 - 2. There exists the risk of "cooking" the smeared cells, thus causing them not to stain well with typical characteristics.
- 081 - 3. Mass of leukocytes and red cells are apt to obscure any bacteria present.
- 081 - 4. Flecks of mucus or blood tinged particles; these elements are more likely to yield organisms on microscopic examination.
- 081 - 5. a. Using a loop or clean wooden applicator stick, spread the sediment to make an even film.  
b. Make a thicker smear, as a rule, than you ordinarily would in staining bacterial cells from broth or solid media.
- 081 - 6. It may be necessary to use 2 or 3 loops of broth to prepare a concentrated film.
- 081 - 7. Pick a minute amount of material from a pure colony and emulsify it in a drop of fresh (bacteria-free) water on a slide.
- 081 - 8. The bacteria will be charred and the morphology altered; the pH modified and the staining properties affected.
- 082 - 1. a. The dye provides a visual contrast between various components of the cell or between the cell and its background.  
b. The dye coating expands the dimensions of the smaller structures and thus improves the resolution of the light microscope.
- 082 - 2. It is an organic compound, usually structured of benzene rings and side groups which are specific for each dye.
- 082 - 3. Chromophore.
- 082 - 4. Methylene blue, crystal violet, basic fuchsin, and safranin.
- 082 - 5. Mordant.
- 082 - 6. Mordant.
- 082 - 7. They are useful in developing a color contrast, and in highlighting special structural features of a cell.
- 083 - 1. Staining in which dye is applied to bacteria to bring into view the general characteristics of cell morphology, such as shape, size, and grouping.
- 083 - 2. The direct stain is applied to stain the microorganisms to give general characteristics of cell morphology, whereas the indirect stain merely colors the background, leaving the organism unstained and contrasted against the background.
- 083 - 3. Indirect.
- 083 - 4. Differential stain.
- 083 - 5. Selective stains.
- 083 - 6. They combine with the basic elements of the cytoplasm.
- 083 - 7. It means that cellular constituents are concentrated at both ends of the cells and stains more intensely or accumulate dye to a greater extent.
- 083 - 8. The nucleic acid components.
- 083 - 9. The nuclear material in bacteria is diffused throughout the cell.
- 083 - 10. a. Concentration of dye.  
b. Concentration of bacteria on the slide.  
c. The length of time that the stain is in contact with the bacteria.
- 083 - 11. The carbohydrate may be fermented with the production of acid or the culture may be old.
- 084 - 1. T.
- 084 - 2. F. A ribonucleic acid component of the cytoplasmic membrane.
- 084 - 3. T.
- 084 - 4. F. Gram-positive.
- 084 - 5. F. Gram-variable.
- 084 - 6. F. Gram-positive organisms may become Gram-negative.
- 084 - 7. T.
- 084 - 8. T
- 084 - 9. F. It is no longer suitable for use.
- 085 - 1. Large amounts of lipids, fatty acids, and waxes.
- 085 - 2. The phenol serves as a carrier of the fuchsin dye in penetrating the lipid layer of the cell.
- 085 - 3. This is caused by the absorption of the carbolfuchsin.
- 085 - 4. The Ziehl-Neelsen stain uses heat to force the stain into the cell, whereas the Modified Kinyoun method uses tergitol to reduce surface tension.
- 086 - 1. Auramine O and Rhodamine B.
- 086 - 2. Glycerol, phenol, and distilled water.
- 086 - 3. On a slide warmer for 2 hours at 65° C or overnight.
- 086 - 4. d, e, a, f, b, c.
- 086 - 5. A Modified Kinyoun or Ziehl-Neelsen stain.
- 086 - 6. a. Allows for rapid scanning of smears magnified 100 times.  
b. Organisms from patients on drug therapy are stained with this method, but do not stain with conventional and fast methods.  
c. Specimens are screened with less eye fatigue.  
d. Provides a substantially greater yield of positives.
- 087 - 1. i.
- 087 - 2. d.
- 087 - 3. d.
- 087 - 4. b.
- 087 - 5. b.
- 087 - 6. j.
- 087 - 7. b.
- 087 - 8. e.
- 087 - 9. h.
- 087 - 10. c.
- 087 - 11. f.
- 087 - 12. a.
- 087 - 13. g.
- 087 - 14. g.

CHAPTER 5

- 088 - 1. A chemical substance, derived from or produced by various species of microorganisms, which is capable in minute concentrations of inhibiting growth.
- 088 - 2. Chemically and in their modes of action.
- 088 - 3. *Bacillus*, *Penicillium*, and *Streptomyces*.
- 088 - 4. The term describes a concept that the pathogen must be destroyed or inhibited without injury to the host.
- 088 - 5. Bacteriostatic.
- 088 - 6. Bactericidal; bacteriostatic.
- 088 - 7. a. Cell wall synthesis.  
b. Cytoplasmic membrane function.  
c. Protein synthesis.  
d. Nucleic acid metabolism.  
e. Intermediary metabolism.
- 089 - 1. Mucopeptides.
- 089 - 2. The peptide linkage between amino acids permits the union of these acids to form larger molecules of nitrogenous substances such as polypeptides and proteins.
- 089 - 3. Higher.
- 089 - 4. It blocks the integration of mucopeptide units into the cell wall structure.
- 089 - 5. Cycloserine molecules resemble molecules of the amino acid alanine. The bacterial cell, not able to tell the difference, picks up the cycloserine molecule. It does not function as well as the alanine molecule. Consequently, the cell peptide formation and possible other reactions involving alanine are blocked.
- 089 - 6. They differ in the chemical composition of their side chains.
- 089 - 7. a. Blocking of amino acid uptake from the external environment.  
b. Inhibition of the synthesis of certain enzymes by the cell.  
c. Interference with cell wall formation.
- 089 - 8. Multiple sites.
- 090 - 1. It provides a barrier that regulates the flow of fluids and metabolites into and out of the cell. It may also aid in the synthesis of other cell structures.
- 090 - 2. The antimicrobial agent combines with a vital part of the membrane, thereby altering the membrane's ability to move material into and out of the cell. There may also be a loss of selective permeability such that some of the internal components can leach out of the cell.
- 090 - 3. The fungi have sterol components in their cytoplasmic membrane with which the antimicrobial agent can act. The bacteria do not.
- 090 - 4. Gram-negative.
- 090 - 5. It causes a breakdown in the membrane's capacity to regulate permeability, and cell constituents diffuse to the exterior.
- 090 - 6. Tyrothricin.
- 091 - 1. c.  
091 - 2. f.  
091 - 3. d.  
091 - 4. d.  
091 - 5. g.  
091 - 6. a.  
091 - 7. e.  
091 - 8. a, i.  
091 - 9. b.  
091 - 10. g.  
091 - 11. h.
- 092 - 1. Duplication and transcription.
- 092 - 2. Cross-linking and intercalation between the stacked bases of the double helix.
- 092 - 3. It inhibits DNA synthesis, which in turn retards the production of RNA and protein.
- 092 - 4. a. Inhibits DNA polymerase activity.  
b. Inhibits cell wall and protein synthesis.  
c. Affects the integrity of the protoplast membrane and causes a leakage of nucleotides into the medium.
- 092 - 5. Chitin.
- 092 - 6. It inhibits mitosis in the metaphase, causing multipolar and abnormal nuclei.
- 093 - 1. F. Breakdown (catabolism) and buildup (anabolism).
- 093 - 2. F. Useful in treating infections caused by the cocci and the Gram-negative rods forms.
- 093 - 3. T.
- 093 - 4. F. Both drugs are involved.
- 093 - 5. T.
- 093 - 6. F. The result is a blocking of metabolic pathways when the faulty molecules enter into cellular reactions.
- 094 - 1. T.
- 094 - 2. F. Drug-resistant mutants arise independently of the antibiotic by mutation.
- 094 - 3. T.
- 094 - 4. F.  $10^5$  to  $10^{10}$  cell divisions.
- 094 - 5. F. The bacterial species and antimicrobial drug.
- 095 - 1. They are extrachromosomal genetic units which are capable of replicating either autonomously or as an integral part of the host chromosome.
- 095 - 2. They are other types of extrachromosomal genetic units which can be transferred by transduction.
- 095 - 3. The bacterial chromosome and the DNA of extrachromosomal plasmids and episomes.
- 095 - 4. Conjugation and transduction.
- 095 - 5. Episomes; resistance; R.
- 095 - 6. The R determinant for drug resistance and the resistance transfer factor or RTF, which is responsible for the transmissibility of the R determinant.
- 095 - 7. Cell-to-cell contact, or conjugation.
- 095 - 8. It is similar in several ways to a nontransmissible R factor; it is a resistance determinant in the absence of an RTF.
- 095 - 9. By transduction instead of mating or conjugation.
- 095 - 10. A plasmid can either select a specific site that insures its replication and distribution to daughter cells as autonomous units, or it can become integrated into the bacterial chromosome or another penicillinase plasmid already located at a maintenance site.
- 095 - 11. B-lactaminase.
- 096 - 1. F. Decreased permeability.
- 096 - 2. T.
- 096 - 3. F. Increased production.
- 096 - 4. F. Results in different relative affinity of substrate and antagonist.
- 096 - 5. F. Extrachromosomally controlled drug resistance.
- 096 - 6. T.
- 096 - 7. F. Enzymatic inactivation.
- 096 - 8. T.
- 097 - 1. a. The serial dilution methods.  
b. The agar disc diffusion method.
- 097 - 2. The broth tube and agar plate dilution procedures.
- 097 - 3. a. High level of accuracy.  
b. High degree of reproducibility.  
c. A good correlation of results with clinical response.

- 097 - 4. a. Rapidity and practicability.  
 b. Provide distinct end point.  
 c. Applicable to most bacteria and antibiotics.  
 d. Produce results within a relatively short period.  
 e. Permit identification of the etiologic agent as well as recognition of contaminant.  
 f. Distinguish morphologically similar strains with various susceptibility patterns.
- 097 - 5. a. They are essentially artificial measurement; data gives only approximate range of effectiveness against bacteria.  
 b. The only positive criterion of microbial response to antibiotics is the clinical response of the patient when adequate dosage is given.
- 098 - 1. To specific amounts of the antibiotic prepared serially in decreasing concentration in broth.  
 098 - 2. 12 to 18 hours. Tubes are examined microscopically for evidence of growth.  
 098 - 3. The minimal inhibitory concentration (MIC).  
 098 - 4. The minimal bactericidal concentration (MBC).  
 098 - 5. It requires the incorporation of varying concentrations of antibiotics within the agar.  
 098 - 6. Contaminants can be easily recognized in the agar or tube method, whereas in the broth tube dilutions they cannot.  
 098 - 7. It gives an excellent and precise statement about the level of susceptibility of the organism in question.  
 098 - 8. It is a time-consuming and expensive procedure to have routine application in the clinical laboratory; it does *not* permit detection of contaminants, and resistant mutants that develop in the broth tubes would be equally difficult to detect.  
 098 - 9. These techniques require only one-fifth of the time as the reagents of the standard tube dilution methods and can easily be learned and performed.
- 099 - 1. F. It is the most useful and used method; it is simple, fast, and economical.  
 099 - 2. F. Filter paper discs are impregnated with various antimicrobial agents of specific concentrations.  
 099 - 3. F. Susceptible.  
 099 - 4. F. Resistant.
- 100 - 1. Followed.  
 100 - 2. Comparison; locations; situations.  
 100 - 3. Mueller-Hinton agar; it shows good uniformity from batch to batch, and it is low in tetracycline and sulfonamide inhibitors.  
 100 - 4. 5 percent defibrinated sheep, horse, or other animal blood.  
 100 - 5. 7.2 to 7.4; at room temperature.  
 100 - 6. 60 ml and 25 ml.  
 100 - 7. 7 days.
- 101 - 1. Kept frozen at less than -14° C.  
 101 - 2. 1 to 2 hours; to minimize condensation resulting from warm air reaching the cold containers.  
 101 - 3. Kept in the refrigerator.  
 101 - 4. They should not be used beyond the expiration date, but most be discarded on their expiration date.
- 102 - 1. a.  
 102 - 2. 1.  
 102 - 3. b, c.  
 102 - 4. d.  
 102 - 5. e, g, k.  
 102 - 6. h.  
 102 - 7. g.  
 102 - 8. f.  
 102 - 9. i.
- 102 - 10. m, n.  
 102 - 11. j.
- 103 - 1. Control of the inoculum size.  
 103 - 2. Four or five colonies.  
 103 - 3. Two to five hours.  
 103 - 4. At least once every 6 months unless it is contained in heat-sealed glass tubes.  
 103 - 5. 15 to 20 minutes.  
 103 - 6. The swab is streaked evenly in three directions over the entire surface of the plates. A final sweep is made of the agar rim with the cotton swab.  
 103 - 7. To insure complete contact with the agar surface.  
 103 - 8. They should be no closer than 15 mm from the edge of the Petri dish; no two discs should be closer than 24 mm; they should be far enough to prevent overlapping zones of inhibition.  
 103 - 9. 12 or 13 discs; 4 or 5 discs.  
 103 - 10. Any longer delay before incubation will allow excess prediffusion of the antimicrobial.
- 104 - 1. a. Diffusion of the antibiotic.  
 b. The growth of bacteria.  
 104 - 2. 16 to 18 hours.  
 104 - 3. The diameter of the zones is measured to the nearest whole millimeter using sliding calipers, a ruler, or a template prepared for this purpose.  
 104 - 4. They are ignored as is the veil of swarming occurring in the inhibition zones of some strains of *Proteus* species.  
 104 - 5. Resistant variants or a mixed inoculum.  
 104 - 6. Reidentification and retesting.  
 104 - 7. That an infection caused by the strain tested may be expected to respond favorably to the indicated antimicrobial for that type of infection and pathogen.  
 104 - 8. The organisms may respond to unusually high concentrations of the agent, due either to high dosage levels or in areas, such as the urinary tract, where the drug is concentrated.  
 104 - 9. Susceptible.
- 105 - 1. T.  
 105 - 2. F. Members of the family Enterobacteriaceae, *Staph. aureus*, and *Pseudomonas*.  
 105 - 3. F. They are not routinely tested.  
 105 - 4. F. Erythromycin and lincomycin.  
 105 - 5. F. They do not lend themselves to such a method of susceptibility testing.  
 105 - 6. T.  
 105 - 7. T.  
 105 - 8. F. A multiple strain of *E. Coli* (ATCC 24922).  
 105 - 9. T.  
 105 - 10. F. Technical errors are sufficient to result in clinically significant misinterpretations.
- 106 - 1. a. Agar diffusion.  
 b. Turbidimetric.  
 c. Inhibition of pH change.  
 d. Enzymatic.  
 e. Radioimmunoassay.  
 f. Chemical.  
 106 - 2. Assessing the adequacy of antibiotic therapy, particularly in problem cases such as enterococcal subacute endocarditis, staphylococcal septicemia, or patients with renal diseases.  
 106 - 3. The agar diffusion method.  
 106 - 4. 0.1 ml.  
 106 - 5. 0.1 ml of *B. subtilis* spore suspension  
 106 - 6. Gentamicin, kanamycin, streptomycin, neomycin, tobramycin, or vancomycin.  
 106 - 7. Three.  
 106 - 8. The diameter (in mm) of the zone of inhibition produced.



S T O P -

1. MATCH ANSWER SHEET TO THIS EXERCISE NUMBER.
2. USE NUMBER 2 PENCIL ONLY.

EXTENSION COURSE INSTITUTE  
VOLUME REVIEW EXERCISE

90412 01 22

LABORATORY PROCEDURES IN CLINICAL BACTERIOLOGY (PART I)

Carefully read the following:

DO's:

1. Check the "course," "volume," and "form" numbers from the answer sheet address tab against the "VRE answer sheet identification number" in the righthand column of the shipping list. If numbers do not match, return the answer sheet and the shipping list to ECI immediately with a note of explanation.
2. Note that item numbers on answer sheet are sequential in each column.
3. Use a medium sharp #2 black lead pencil for marking answer sheet.
4. Write the correct answer in the margin at the left of the item. (When you review for the course examination, you can cover your answers with a strip of paper and then check your review answers against your original choices.) After you are sure of your answers, transfer them to the answer sheet. If you have to change an answer on the answer sheet, be sure that the erasure is complete. Use a clean eraser. But try to avoid any erasure on the answer sheet if at all possible.
5. Take action to return entire answer sheet to ECI.
6. Keep Volume Review Exercise booklet for review and reference.
7. If mandatorily enrolled student, process questions or comments through your unit trainer or OJT supervisor. If voluntarily enrolled student, send questions or comments to ECI on ECI Form 17.

DON'Ts:

1. Don't use answer sheets other than one furnished specifically for each review exercise.
2. Don't mark on the answer sheet except to fill in marking blocks. Double marks or excessive markings which overflow marking blocks will register as errors.
3. Don't fold, spindle, staple, tape, or mutilate the answer sheet.
4. Don't use ink or any marking other than a #2 black lead pencil.

NOTE: NUMBERED LEARNING OBJECTIVE REFERENCES ARE USED ON THE VOLUME REVIEW EXERCISE. In parenthesis after each item number on the VRE is the Learning Objective Number where the answer to that item can be located. When answering the items on the VRE, refer to the Learning Objectives indicated by these Numbers. The VRE results will be sent to you on a postcard which will list the actual VRE items you missed. Go to the VRE booklet and locate the Learning Objective Numbers for the items missed. Go to the text and carefully review the areas covered by these references. Review the entire VRE again before you take the closed-book Course Examination.

90412-01-22



MULTIPLE CHOICE

1. (001) The discovery of infectious agents was long preceded by which of the following concepts?
  - a. Spontaneous generation.
  - b. Contagious disease.
  - c. Self-multiplication.
  - d. Microfermentation.
  
2. (001) Fracastoro, father of the germ theory of disease, recognized the three sources of contagious material were by contact, by fomites and from
  - a. organismic multiplication.
  - b. contamination.
  - c. a distance.
  - d. inanimate objects.
  
3. (002) The theory that "infection was due to passage of minute bodies capable of self-multiplication from infection to infection" was first proposed by which of the following bacteriologists?
  - a. Joseph Lister.
  - b. Robert Koch.
  - c. Edward Jenner.
  - d. Francesco Redi.
  
4. (002) Which of the following bacteriologists is credited with establishing valid criteria for determining the cause of infectious disease?
  - a. John Tyndall.
  - b. Louis Pasteur.
  - c. Franz Schulze.
  - d. Robert Koch.
  
5. (003) When a specimen is received in the laboratory, primarily, you must check the request form(s) to ensure that
  - a. you know exactly what test is requested.
  - b. the specimen belongs to the correct patient.
  - c. the patient's name is exactly written.
  - d. the patient is still in the hospital.
  
6. (003) In order to isolate and identify the disease causing organism, the request form accompanying the specimen must include the
  - a. register number.
  - b. current antibiotic therapy.
  - c. bed number and ward location.
  - d. specimen source.

90412-01-22

7. (004) Instruments, containers, and other equipment coming in direct contact with most specimens must be sterile except which of the following?
- a. Stool specimens.
  - b. Sputum specimens.
  - c. Wound culture specimens.
  - d. Cerebrospinal fluid.
8. (005) Material that has passed through the walls of vessels into nearby tissues or areas of inflammation most adequately describes a/an
- a. transudate.
  - b. exudate.
  - c. drainage.
  - d. leakage.
9. (006) In order to isolate pathogenic agents from a large number of saprophytes of the intestinal tract, we need all of the following media except a
- a. differential.
  - b. selective.
  - c. inhibitory.
  - d. transport.
10. (006) Which of the following organisms is particularly difficult to isolate if there is a delay in culturing rectal swabs?
- a. Shigella spp.
  - b. E. coli.
  - c. Proteus morganii.
  - d. Staphylococcus spp.
11. (007) How many hours will the biological cultures be kept moist by using the rayon-tipped swab with an ampul containing 0.5 ml of Stuarts transport medium?
- a. 12.
  - b. 36.
  - c. 48.
  - d. 72.
12. (008) What effect does the addition of contaminated swabs have upon the disinfectant when the solution is not frequently replaced with a fresh quantity?
- a. The strength of the disinfectant increases.
  - b. The disinfectant becomes diluted and loses its effectiveness.
  - c. The disinfectant becomes diluted and more effective.
  - d. The strength of the disinfectant will remain the same.
13. (009) If you are unable to set up the urine culture within the specified time, where should the urine be stored and at what temperature?
- a. Incubator at 35° C.
  - b. Incubator at 37° C.
  - c. Refrigerator at 4° C.
  - d. Refrigerator at 10° C.

90412-01-22

14. (009) The purpose of the midstream urine analysis is to help identify infection of the
- a. urethra.
  - b. bladder.
  - c. ureters.
  - d. kidney.
15. (010) Because of the danger of personnel getting an infection, laboratory technicians should refuse to accept a specimen for bacteriological examination if
- a. there is no request slip.
  - b. it does not have a tight-fitting lid.
  - c. the specimen is not wrapped.
  - d. there is evidence of a contaminated outer surface.
16. (011) What type of specimen is recommended for collection when tuberculosis of the kidneys is suspected?
- a. One 24-hour urine collection.
  - b. Two 24-hour urine collections.
  - c. Three early morning "three glass" specimens; save the first glass in a sterile container.
  - d. Three early morning "clean catch" or catheterized urine; save entire volume in a sterile container.
17. (012) Desiccation is defined as the
- a. process whereby metabolic activities are slowed down to prevent further multiplication.
  - b. removal of water by drying.
  - c. preservation of bacteria by quick freezing.
  - d. addition of water to rehydrate dried bacteria.
18. (012) Charcoal in the Stuart transport medium is used to
- a. inhibit growth of gram negative organisms.
  - b. inhibit growth of saprophytes.
  - c. neutralize certain bacterial inhibitors.
  - d. neutralize the growth of certain gram negative organisms.
19. (013) Which of the following media was introduced for the collection and shipment of stool specimens?
- a. Serum Tellurite agar.
  - b. Cary and Blair transport medium.
  - c. Stuart transport medium.
  - d. Transport charcoal medium.

20. (014) What could result if dry ice is placed inside the thermos or enclosed in hermetically-sealed containers?
- Pressures building up as  $\text{CO}_2$  is liberated and leaks out.
  - Pressures building up as  $\text{CO}_2$  is liberated and will explode the thermos or container.
  - The dry ice expands and will explode the thermos on containers.
  - The dry ice melts and leaks out of the containers.
21. (015) As a practical chemical disinfectant for table top and instruments, what disinfectant has been recommended as having maximal usefulness and effectiveness?
- 5 percent lysol or phenol.
  - 5 percent aqueous iodine.
  - 5 percent chlorine solution.
  - 5 percent formaldehyde.
22. (016) Initial first aid for a laceration caused by handling broken contaminated glassware is to
- cleanse the wound with running water.
  - determine what organism was on the glassware.
  - proceed to the treatment room to see a physician.
  - cleanse the wound with a mild antiseptic.
23. (017) The most frequent causes of laboratory infections are due to all of the following except
- animal bites.
  - centrifuge accidents.
  - spillage of contaminated material
  - accidental inoculation with syringe needles.
24. (018) The freeing of an article from all living organisms, including pathogenic and nonpathogenic virus, bacteria, fungi and their spores adequately defines
- disinfecting.
  - sterilization.
  - relative sterilization.
  - relative disinfecting.
25. (019) The major difference between a disinfectant and an antiseptic is that
- antiseptics inhibit growth; disinfectants kill the bacterial vegetative cell.
  - disinfectants inhibit growth, antiseptics kill the bacteria.
  - disinfectants have a lesser degree of lethal action against bacteria.
  - antiseptics completely destroy or remove all forms of a microorganisms, including the spore forms.

26. (020) All of the following factors are responsible for variations in the susceptibility of microorganisms to various methods of sterilization except
- pH and temperature.
  - presence of organic matter.
  - related genus and growth curve.
  - presence of inorganic matter.
27. (021) During which of the following phases are bacteria more susceptible to damage by antibiotics?
- Lag.
  - Exponentially.
  - Stationary.
  - Senescent.
28. (022) All of the following are disadvantages of the free flowing steam method of sterilization except
- it is time consuming.
  - spores may not grow out in some fluids.
  - anaerobic spores may not germinate if freely exposed to air.
  - aerobic spores will not germinate if freely exposed to air.
29. (023) The autoclave destroys microorganisms with
- moist heat at temperature above boiling.
  - moist heat at boiling temperature.
  - dry heat at temperature above boiling.
  - dry heat at boiling temperature.
30. (024) The sterilization effect of filters is achieved mostly by
- sieve action.
  - mechanical destruction.
  - absorption.
  - chemical action.
31. (025) The sulfonamide drugs are specific chemical combinations that are effective chemical sterilization agents because they
- enter the cell and inhibit enzyme activity.
  - are lethal to living cells due to protein coagulation.
  - prevent the microorganism from receiving sufficient nutritional substances.
  - combine indiscriminately with compounds within a bacterial cell.
32. (026) Chlorine is a useful disinfectant because it has high bactericidal properties and because it
- is nonpoisonous.
  - effectively disinfects water.
  - spreads uniformly over all surfaces.
  - does not evaporate easily.

90412-01-22

33. (027) The speed with which disinfectants act depends upon all of the following factors except
- concentration of organisms.
  - concentration of disinfectant.
  - temperature of disinfectant.
  - temperature of container.
34. (028) Using the FDA method for phenol coefficient, what would be the phenol coefficient of an unknown disinfectant with a dilution of 1:200 that killed the organism at the same time as the standard?
- 1.0.
  - 2.00.
  - 0.20.
  - 0.50.
35. (029) Spores and acid fast bacilli are best killed by
- heat.
  - gaseous disinfectants.
  - liquid disinfectants.
  - ultraviolet radiation.
36. (030) Which of the following organisms is usually used for determining sterility by the autoclave method?
- Bacillus stearothermophilus.
  - Bacillus subtilis.
  - Bacillus subtilis (globigii).
  - Clostridium tetani.
37. (031) Nosocomial infections are infections acquired at
- dining facilities.
  - hospitals.
  - recreational facilities.
  - conventions.
38. (032) All of the following sites are generally used when testing for staph cultures except
- nose.
  - throat.
  - ear.
  - lesions.
39. (033) Good aseptic practice may include all of the following tasks except
- using the correct strength alcohol to disinfect the venipuncture site.
  - using only sterile needles for venipuncture.
  - wiping the benches in bacteriology with a good disinfectant after each days work.
  - washing your hands only after handling each specimen in bacteriology.

90412-01-22



40. (034) The two divisions of Protists, the procaryotes and the eucaryotes are differentiated on what basis?
- Complex genetic structure.
  - Simplex genetic structure.
  - Nuclear structure and cellular organization.
  - Cytoplasmic structure and cellular density.
41. (035) The system of classification and nomenclature used for classifying bacteria is based upon information obtained from
- Bergey's Manual.
  - Diagnostic Microbiology Baily and Scott.
  - Manual of Clinical Microbiology (ASM).
  - AFM 160-52 Clinical Laboratory Procedures: Bacteriology.
42. (036) The traditional ordered schemes of relationships among bacterial groups have been considered inadequate because
- of an over abundance of evolutionary records of bacterial life forms.
  - lack of information concerning accurate evolutionary record of bacterial life forms.
  - of an over abundance of inaccurate records of bacterial life forms.
  - lack of information concerning accurate current record of bacterial forms.
43. (037) Bacteria that obtain their energy from inorganic material and their carbon dioxide are known as
- autotrophic.
  - saprophytic.
  - nonpathogenic.
  - Heterotrophic.
44. (038) What is the unit of measure for bacteria?
- Micron, (2.54 inches).
  - Micron, 1/1000 mm.
  - Nanometer, m. X10<sup>-9</sup>.
  - Angstrom, m. X10<sup>-10</sup>.
45. (038) Refer to figure 3-3. The structure within the bacterial cells responsible for protein synthesis are called
- ribosomes.
  - mesosomes.
  - chromatophore.
  - fimbriae.
46. (039) A change within the genetic structure of bacterial cells best describes
- adaptation.
  - pleomorphism.
  - involution.
  - mutation.

90412-01-22

47. (039) Abnormal, bizarre shapes assumed by bacteria in aging cultures are referred to as
- a. contaminants.
  - b. involution forms.
  - c. reproduction forms.
  - d. pleomorphic forms.
48. (040) Bacteria that grow best at a temperature of 20° to 40° C. are called
- a. psychophilic
  - b. mesophilic.
  - c. thermophilic.
  - d. pleomorphic.
49. (041) A bacteria which prefers to grow as an anaerobe, but can adapt to aerobic conditions best describes a
- a. facultative anaerobe.
  - b. obligate anaerobe.
  - c. a microaerophile.
  - d. facultative aerobe.
50. (041) Free oxygen is toxic to which of the following?
- a. Obligate anaerobes.
  - b. Faculative anaerobes.
  - c. Microaerophilic bacteria.
  - d. Obligate aerobes.
51. (042) H-type colonies of Proteus spp. are due to
- a. capsular material.
  - b. flagellar motion.
  - c. Ohne-hauch forms.
  - d. urease production.
52. (043) The blue pigment produced by the organism Pseudomonas aeruginosa as a result of reactions of leukobases is
- a. anthocyanin.
  - b. melanin.
  - c. pyocyanin.
  - d. carotenoids.
53. (044) Why should anaerobic culture samples not be refrigerated?
- a. Chilling is detrimental and oxygen absorption is greater at lower temperature.
  - b. Chilling results in overgrowth of saprophytes.
  - c. Lower temperature results in increased carbon dioxide and toxicity.
  - d. Lower temperature retards growth and result in mutation.
54. (045) Three systems currently used for isolation of anaerobic bacteria include all of the given systems except
- a. anaerobic jars.
  - b. candle jars.
  - c. the Hungate roll-tube or roll-streak tubes.
  - d. anaerobic glove box.

55. (046) In the glove box anaerobic system, with what drying agent is the relative humidity of the chamber regulated?
- Technical grade nitrogen.
  - A gas mixture of 5 percent CO<sub>2</sub> (bone dry).
  - "Tel-Tale" silica gel, dessicant grade H, type IV.
  - Activated charcoal pellets.
56. (047) Candles should be placed high in the candle jar because
- CO<sub>2</sub> rises and causes the O<sub>2</sub> to increase.
  - CO<sub>2</sub>, heavier than air, fills the bottom first and extinguishes the flame.
  - the candle can be easily lit before sealing the lid.
  - CO<sub>2</sub>, lighter than air, fills the top first and supports the flame.
57. (048) A basal culture medium has sources of all the following constituents except
- carbon.
  - nitrogen.
  - inorganic salts.
  - organic salts.
58. (048) Excessive heat can chemically break down lactose broth, and with organisms which ferment lactose, show what type of result?
- False negative with organisms which ferment lactose.
  - False positive with organisms which do not ferment lactose.
  - False negative with all organisms which occasionally ferment lactose.
  - False positive with all gram positive organisms.
59. (049) The purpose of the selective media is to
- differentiate between the lactose and nonlactose fermenter.
  - select the lactose fermenters among nonpathogens.
  - inhibit the growth of certain organisms while permitting the growth of others.
  - inhibit the growth of all lactose fermenters while permitting the growth of others.
60. (050) Fresh distilled water should be used in rehydrating powdered culture media because fresh water
- has not had time to absorb gases which could alter the final pH.
  - has not had time to become contaminated.
  - is more alkaline in pH than stale water.
  - does not have to be filter sterilized.

90412-01-22

61. (051) Media containing carbohydrates should be autoclaved between what temperature range?
- a. 116° to 118° C.
  - b. 120° to 125° C.
  - c. 126° to 131° C.
  - d. 132° to 137° C.
62. (052) A good technique for preventing contamination before pouring the media is to
- a. wipe the bench area with a suitable disinfectant and remove the tops of petri dishes.
  - b. wipe the bench area with a suitable disinfectant and leave the petri dishes covered until pouring.
  - c. spray the room with a disinfectant spray and leave petri dishes covered until pouring.
  - d. spray the room with a disinfectant spray and remove the tops of petri dishes.
63. (053) Lumps in the medium are caused by
- a. failure to properly dissolve the media before autoclaving.
  - b. allowing the medium to be autoclaved less than 121° C.
  - c. allowing the medium to cool too much before pouring.
  - d. failure to properly cool the medium before pouring.
64. (054) Which of the following factors is least considered before obtaining tubed media from commercial sources?
- a. Workload data.
  - b. Quality control.
  - c. Having the best and latest equipment.
  - d. Time and cost saving elements.
65. (055) What effects does the inoculation of a cold plate have on the growth phase of bacterial organisms?
- a. Lengthens the lag phase and may kill some organisms.
  - b. Lengthens the logarithmic phase and may kill some organisms.
  - c. Decreases the lag phase and enhances bacterial growth.
  - d. Decreases the logarithmic phase and enhances bacterial growth.
66. (056) Which of the following media additives inhibits growth of Gram-positive bacteria and will also suppress the motility of flagellated bacteria?
- a. Sodium azide.
  - b. Chloral hydrate.
  - c. Potassium tellurite.
  - d. Sodium desoxycholate and bile salts.

67. (057) What two carbohydrates are incorporated in some brands of EMB for differentiation of enteric bacteria?
- a. Dextrose and maltose.
  - b. Dextrose and sucrose.
  - c. Lactose and maltose.
  - d. Lactose and sucrose.
68. (057) Which basal medium is particularly recommended for use with organisms not generally considered to be nutritionally fastidious?
- a. Cystine trypticose agar (CTA).
  - b. Trypticose agar base.
  - c. Loeffler medium.
  - d. Transgrow medium.
69. (058) Which of the following biochemical tests may be used to measure the ability of an organism to produce acids from dextrose?
- a. Methyl red.
  - b. Voges-Proskauer.
  - c. Nitrate reduction.
  - d. Indole production.
70. (058) Liquefaction of egg albumin is an example of
- a. gelatin liquefaction.
  - b. protein denaturation.
  - c. proteolysis.
  - d. protein fermentation.
71. (059) Plates are turned upside down after streaking in order to
- a. decrease the lag phase of the growth curve.
  - b. increase the logarithmic growth phase.
  - c. prevent contamination by water condensation.
  - d. prevent over growth by pathogens.
72. (060) In a pour plate preparation, the melted agar should not exceed what temperature and the dilution should be added in what manner?
- a. 35° C., light mixing.
  - b. 40° C., adequate mixing.
  - c. 45° C., light mixing.
  - d. 50° C., adequate mixing.
73. (061) Condensed water over the slant surface of the medium, if not allowed to drain, would more likely cause a/an
- a. increased growth of saprophytes.
  - b. decrease in the growth of pathogens.
  - c. change in the characteristic appearance of the organism.
  - d. enhanced characteristic appearance of the organism.

74. (062) The most characteristic morphological forms of *Corynebacterium diphtheriae* are found in smears from an 18-24 hour culture on which of the following medium?
- a. Loeffler's serum.
  - b. Blood Agar plate.
  - c. Thayer-Martin.
  - d. Lowenstein-Jensen.
75. (063) Which of the following media would not be used for inoculation of sputum for isolation of organisms other than the tubercle bacilli?
- a. Blood and chocolate agars.
  - b. EMB or MacConkey.
  - c. Thioglycollate broth medium.
  - d. Lowenstein-Jensen medium.
76. (064) Stomach or gastric washings for AFB must be processed without delay because the highly acid gastric juices will
- a. cause and overgrowth of the tubercle bacilli.
  - b. cause and overgrowth of saprophytic bacteria.
  - c. inactivate the tubercle bacilli.
  - d. inactivate the fungi present.
77. (065) The fluorochrome staining technique may be adequately described as a
- a. fluorescent optical system.
  - b. immunofluorescent test.
  - c. type of fluorescent antibody test.
  - d. counterstaining procedures.
78. (066) The best yield of tubercle bacilli may be expected to result from the use of the
- a. strongest digestion which gives greater control of contaminants.
  - b. mildest digestion which gives sufficient control of contaminants.
  - c. weakest digestion which gives greater control of contaminants.
  - d. weakest digestion which gives sufficient control of contaminants.
79. (067) Under what atmospheric conditions would the Middlebrook 7H10 cultures be incubated, at what temperature and for how long?
- a. In the light; aerobic incubators; 37°C. for two weeks.
  - b. In the light; anaerobic incubator; 37°C. for three weeks.
  - c. In the dark; carbon dioxide incubator; 35°C. for three weeks.
  - d. In the dark; carbon dioxide incubator; 35°C. for eight weeks.

90412-01-22



80. (067) Petragnani medium is more inhibitory than Lowenstein-Jensen medium because of
- a higher pH.
  - a lower pH.
  - the higher concentration of cyclohexamide.
  - the higher concentration of the bacteriostatic dye.
81. (068) all of the following organisms are frequently encountered in body fluids except
- Enterococci.
  - Hemophilus species
  - Corynebacterium diphtheriae.
  - Anaerobic cocci.
82. (069) Anaerobic plates should be incubated for at least how long?
- 48 hours.
  - 62 hours.
  - 72 hours.
  - 96 hours.
83. (070) Which of the following swab specimens would not be cultured anaerobically?
- Material from superficial wounds.
  - Pus from deep wounds.
  - Pus from aspirated abscess.
  - Material from perirectal sites.
84. (071) On doing a urine colony count, a diseased state is indicated when the colony count is
- less than 10,000 organisms per ml.
  - from 10,000 to 100,000 organisms per ml.
  - over 100,000 organisms per ml.
  - larger than 100,000 organisms per 24-hour specimen.
85. (072) When compared with actual plate counts, the confidence level of the calibrated loop is highest with counts of
- $10^3$  or greater.
  - $10^4$  or greater.
  - $10^5$  or greater.
  - $10^6$  or greater.
86. (073) The first step in isolating and identifying stool pathogens is
- primary plating.
  - enrichment.
  - serological identification.
  - Gram staining.

87. (074) Which of the following media are not primary plating media?
- BA and FMB.
  - MacConkey and SS.
  - XLD and brilliant green agars.
  - TSI and urea agars.
88. (075) How are the biochemical tests for the API 20 Enteric read and approximately how long after inoculation?
- Reactive or weakly reactive; 18 to 24 hours.
  - Reactive or weakly reactive; 9 to 12 hours.
  - Positive or negative; 18 to 24 hours.
  - Positive or negative; 9 to 12 hours.
89. (076) Enteropathogenic E. coli (EPEC) has been isolated as a common cause of enterocolitis in
- adults and children under five years of age.
  - adults and children under ten year of age.
  - newborns and children under five.
  - newborns, infants, and children under 2 years of age.
90. (077) In a continuous bacteremia, such bacterial endocarditis, how many blood cultures would be sufficient and at what hourly intervals should they be taken within a 24-hour period?
- Three blood cultures at hourly intervals.
  - Four blood cultures at two hour intervals.
  - Six blood cultures at hourly intervals.
  - Four blood cultures at two hour intervals.
91. (077) To obtain the best recovery of organisms from a blood culture, what dilution of blood to broth culture has been recommended?
- One to nine.
  - One to five.
  - Two to nine.
  - Two to five.
92. (078) After blood culture specimens are taken and incubated at 35° C., at what times should they normally be inspected for growth?
- After 24 hours and every other day for seven days.
  - After 24 hours and every day for fourteen days.
  - On the same day and every other day for fourteen days.
  - On the same day and every day for seven days.
93. (079) Which of the following organisms is considered to be a usual microflora of the vagina?
- Haemophilus pertussis.
  - Haemophilus ducreyi.
  - Lactobacilli acidophilus.
  - Neisseria gonorrhoea.

90412-01-22

94. (080) How is the "C smear prepared on the slide and why?
- Rubbing the swab gently on the slide to obtain even bacterial distribution.
  - Rolling the swab on the slide to obtain even bacterial distribution.
  - Rolling the swab on the slide to avoid distortion of bacterial morphology.
  - Rubbing the swab gently on the slide to avoid distortion of bacterial morphology.
95. (081) If you prepare a smear by emulsifying a colony in a drop of water, you should be sure that the water is
- heated to a boil.
  - chemically pure.
  - freshly distilled.
  - bacteria free.
96. (082) All of the following are considered basic dyes except
- eosin.
  - crystal violet.
  - safranin.
  - methylene blue.
97. (083) Which of the following type preparations represents the indirect category of staining?
- India ink.
  - Gram stain.
  - Hiss capsule stain.
  - Flagellar stain.
98. (083) The color pattern of a stain is determined by the concentration of bacteria, the concentration of dye, and the
- size of the bacteria.
  - length of the bacteria.
  - pathogenicity of the bacteria.
  - staining time.
99. (084) Because of autolysis, aging, and improper incubation temperature, which of the following conditions is most likely to occur?
- Gram-negative organisms may become Gram-positive.
  - Gram-negative organisms may become Gram-variable.
  - Gram-positive organisms may become Gram-negative.
  - Gram-positive organisms may become Gram-variable.
100. (085) Penetration of basic dye into organisms containing large amounts of lipids or waxes can be facilitated with
- acid-alcohol.
  - alcohol.
  - iodine.
  - phenol.

101. (086) Which of the following reagents is not used in the fluorochrome staining procedure?
- Auramine O and Rhodamine B.
  - Phenol.
  - Tergitol.
  - Glycerol.
102. (087) In the Hiss staining process, the penetration of the dye is caused by the
- phenol.
  - copper sulfate.
  - serum.
  - tergitol.
103. (088) Most antibiotics currently used are derived from all of the following genera of organisms except
- Streptomyces.
  - Bacillus.
  - Penicillium.
  - Bacteriodes.
104. (088) The term used to describe the concept that the pathogen must be destroyed or inhibited without injury to the host is called selective
- injury.
  - toxicity.
  - destruction.
  - bacteriostasis.
105. (089) The cell wall building block of bacteria is composed primarily of which of the following substances?
- Nucleosides.
  - Polysaccharides.
  - Mucopolysaccharides.
  - Mucopeptides.
106. (089) Penicillins are thought to affect the bacterial cells in all of the following manner except
- Inhibition of the synthesis of certain enzymes by the cell.
  - block amino acid uptake from the external environment.
  - interference with cell wall formation.
  - breakdown in the cell membranes capability to regulate permeability.
107. (090) Gramicidins and tyrocidins interfere with cell
- permeability.
  - reproduction.
  - respiration.
  - sterols.
108. (091) In the process of protein synthesis, which of the following ribonucleic acids transmits from the nuclear DNA to the ribosome, the necessary genetic coding instructions for making protein?
- Ribosomal RNA.
  - Messenger RNA.
  - Soluble RNA.
  - Ribosomal and Messenger RNA.

90412-01-22

109. (092) The mechanisms used by drugs to disturb the function or structure of DNA is
- duplication and transcription.
  - duplication and cross-linking.
  - transcription and intercalation between the stacked bases of the double helix.
  - cross-linking and intercalation between the stacked bases of the double helix.
110. (093) Within the bacterial cell, the breakdown of complex nutrients to simplified usable forms is referred to as
- respiration.
  - anabolism.
  - catabolism.
  - nuclei acid metabolism.
111. (091) The frequency rate of spontaneous mutation to resistance varies with what two significant characteristics?
- Bacterial enzymes and growth environment.
  - Bacterial growth and enzymes secreted within the environment.
  - The bacterial species and antimicrobial drug.
  - The bacterial genera and the growth environment.
112. (095) A type of extrachromosomal genetic unit that controls drug resistance and is capable of replicating either autonomously or as an integral part of the host chromosome is most descriptive of a/an
- ribosome.
  - episome.
  - gene.
  - capsule.
113. (096) Bacterial mutants selected for resistance will generally show which of the following characteristic reactions of the organism to the drug?
- Increased permeability.
  - Decreased fragility.
  - Decreased permeability.
  - Increased fragility.
114. (097) Which of the following considerations must be kept in mind in the interpretation of in vitro sensitivity tests?
- They are essentially accurate measurement.
  - The data provides exact range of effectiveness against bacteria.
  - They are the only positive criterion of microbial response to antibiotics.
  - The clinical response of the patient to adequate antibiotic dosage is the only positive criterion.

115. (098) The agar slant or plate method for susceptibility testing requires
- varying concentrations of antibiotics incorporated within the discs.
  - varying concentration of antibiotics within the agar.
  - one standard concentration of antibiotic incorporated within each disc.
  - one standard concentration of antibiotic incorporated within the agar.
116. (099) In the agar disc diffusion method, organisms that grow up to and under the periphery of the discs are said to be
- susceptible.
  - sensitive.
  - resistant.
  - intermediate.
117. (Approximately, how many mls. of medium should be poured into each 150 mm and 100 mm plates, respectively?)
- 100 ml and 50 ml.
  - 90 ml and 35 ml.
  - 60 ml and 25 ml.
  - 30 ml and 15 ml.
118. (101) In order to maintain their potency, which of the following discs should always be kept frozen at less than  $-14^{\circ}$  C. until preparation for use?
- Nalidixic acid, nitrofurantoin.
  - The tetracyclines.
  - The polymyxins.
  - The penicillins.
119. (102) Which of the following two antibiotics diffuse poorly in agar and the accuracy of the diffusion method is thus less than with other antibiotics?
- Colistin and Polymyxin B.
  - Methicillin and Penicillin G.
  - Ampicillin and Kanamycin.
  - Neomycin and Bacitracin.
120. (103) Concerning even distribution of the discs on the agar surface, which of the following directions is not correct?
- No two discs should be closer than 12 mm.
  - They should be no closer than 15 mm. from the edge of the petri dish.
  - No two discs should be closer than 24 mm.
  - They should be far enough to prevent overlapping zones of inhibition.

90412-01-22



121. (103) The maximum number of discs that may be placed on a 150 mm. plate is
- a. 12 or 13.
  - b. 14 or 16.
  - c. 17 or 18.
  - d. 19 or 21.
122. (104) Large colonies growing within the clear zone of inhibition may represent what condition?
- a. Sensitive variants.
  - b. Intermediate variants.
  - c. Resistant variants.
  - d. Slow growth rate.
123. (105) When using standard control organisms in the Kirby-Bauer susceptibility testing, which of the following organisms have been recommended for testing with the Gram negative set of discs?
- a. Pseudomonas aeruginosa (ATCC 27853).
  - b. S. aureus (ATCC 25922).
  - c. E. coli (ATCC 25922).
  - d. Bacillus subtilis (ATCC 6633).
124. (106) All of the following methods are used for assaying antimicrobial agents in serum, urine and biological fluids except the
- a. inhibition of pH change.
  - b. agar disc diffusion.
  - c. radioimmunoassay.
  - d. agar diffusion.

**STUDENT REQUEST FOR ASSISTANCE**

PRIVACY ACT STATEMENT

AUTHORITY: 44 USC 3101. PRINCIPAL PURPOSE(S): To provide student assistance as requested by individual students. ROUTINE USES: This form is shipped with every ECI course package. It is utilized by the student, as needed, to place an inquiry with ECI. DISCLOSURE: Voluntary. The information requested on this form is needed for expeditious handling of the student's need. Failure to provide all information would result in slower action or inability to provide assistance.

**SECTION I: CORRECTED OR LATEST ENROLLMENT DATA:** MAIL TO ECI, GUNTER AFS, ALA 36118

1. THIS REQUEST CONCERNS COURSE <input style="width:100%; height:20px;" type="text"/>	2. TODAY'S DATE <input style="width:100%; height:20px;" type="text"/>	3. ENROLLMENT DATE <input style="width:100%; height:20px;" type="text"/>	4. PREVIOUS SERIAL NUMBER <input style="width:100%; height:20px;" type="text"/>
5. SOCIAL SECURITY NUMBER <input style="width:100%; height:20px;" type="text"/>	6. GRADE/RANK <input style="width:100%; height:20px;" type="text"/>	7. INITIALS <input style="width:100%; height:20px;" type="text"/>	LAST NAME <input style="width:100%; height:20px;" type="text"/>
8. OTHER ECI COURSES NOW ENROLLED IN <input style="width:100%; height:20px;" type="text"/> <input style="width:100%; height:20px;" type="text"/> <input style="width:100%; height:20px;" type="text"/>	9. ADDRESS: (OJT ENROLLEES - ADDRESS OF UNIT TRAINING OFFICE/ALL OTHERS - CURRENT MAILING ADDRESS) <input style="width:100%; height:20px;" type="text"/> <input style="width:100%; height:20px;" type="text"/> <input style="width:100%; height:20px;" type="text"/>		11. AUTOVON NUMBER <input style="width:100%; height:20px;" type="text"/>
	ZIP CODE <input style="width:100%; height:20px;" type="text"/>	12. TEST CONTROL OFFICE ZIP CODE/SHRED <input style="width:100%; height:20px;" type="text"/>	
10. NAME OF BASE OR INSTALLATION IF NOT SHOWN ABOVE: <input style="width:100%; height:20px;" type="text"/>			

<input type="text"/>	<input type="text"/>	<input type="text"/>
<input type="text"/>	<input type="text"/>	<input type="text"/>
<input type="text"/>	<input type="text"/>	<input type="text"/>

**SECTION II: Old or INCORRECT ENROLLMENT DATA**

1. NAME:	2. GRADE/RANK:	3. SSAN:
4. ADDRESS:	5. TEST OFFICE ZIP/SHRED:	

**SECTION III: REQUEST FOR MATERIALS, RECORDS, OR SERVICE** ADDITIONAL FORMS 17 available from trainers, OJT and Education Offices, and ECI. The latest course workbooks have a Form 17 printed on the last page.

(Place an "X" through number in box to left of service requested)

1	EXTEND COURSE COMPLETION DATE. (Justify in Remarks)
2	SEND VRE ANSWER SHEETS FOR VOL(s): 1 2 3 4 5 6 7 8 9 - ORIGINALS WERE: NOT RECEIVED, LOST, MISUSED
3	SEND COURSE MATERIALS (Specify in remarks) - ORIGINALS WERE: NOT RECEIVED, LOST, DAMAGED.
4	COURSE EXAM NOT YET RECEIVED. FINAL VRE SUBMITTED FOR GRADING ON (Date):
5	RESULTS FOR VRE VOL(s): 1 2 3 4 5 6 7 8 9 NOT YET RECEIVED. ANSWER SHEET(s) SUBMITTED ON (Date):
6	RESULTS FOR CE NOT YET RECEIVED. ANSWER SHEET SUBMITTED TO ECI ON (Date):
7	PREVIOUS INQUIRY (ECI FORM 17, LTR, MSG) SENT TO ECI ON:
8	GIVE INSTRUCTIONAL ASSISTANCE AS REQUESTED ON REVERSE:
9	OTHER (Explain fully in remarks)

REMARKS: (Continue on Reverse)

OJT STUDENTS must have their OJT Administrator certify this request. ALL OTHER STUDENTS may certify their own requests.	I certify that the information on this form is accurate and that this request cannot be answered at this station. (Signature)
--	---



**SECTION IV: REQUEST FOR INSTRUCTOR ASSISTANCE**

**NOTE:** Questions or comments relating to the accuracy or currency of textual material should be forwarded directly to preparing agency. Name of agency can be found at the bottom of the inside cover of each text. All other inquiries concerning the course should be forwarded to ECI.

VRE ITEM QUESTIONED:

MY QUESTION IS:

Course No. \_\_\_\_\_

Volume No. \_\_\_\_\_

VRE Form No. \_\_\_\_\_

VRE Item No. \_\_\_\_\_

Answer You Chose  
(Letter) \_\_\_\_\_

Has VRE Answer Sheet  
been submitted for grading?

YES  NO

**REFERENCE**

(Textual support for the  
answer I chose can be  
found as shown below)

In Volume No: \_\_\_\_\_

On Page No: \_\_\_\_\_

In \_\_\_\_\_ (left) \_\_\_\_\_ (Right)  
Column

Lines \_\_\_\_\_ Through \_\_\_\_\_

Remarks:

90412 02 7910

CDC 90412

# MEDICAL LABORATORY TECHNICIAN - MICROBIOLOGY

(AFSC 90470)

Volume 2

*Laboratory Procedures in Clinical Bacteriology*

(PART II)



Extension Course Institute

Air Training Command

Prepared by  
CMSgt Joselyn H. Thompson  
School of Health Care Sciences, USAF (ATC)  
Sheppard AFB, Texas 76311

Reviewed by  
Elmore C. Hall, Education Specialist  
Extension Course Institute (ATC/AU)  
Gunter AFS, Alabama 36118



PREPARED BY  
SCHOOL OF HEALTH CARE SCIENCES, USAF (ATC)  
SHEPPARD AIR FORCE BASE, TEXAS

---

EXTENSION COURSE INSTITUTE, GUNTER AIR FORCE STATION, ALABAMA

THIS PUBLICATION HAS BEEN REVIEWED AND APPROVED BY COMPETENT PERSONNEL OF THE PREPARING COMMAND  
IN ACCORDANCE WITH CURRENT DIRECTIVES ON DOCTRINE, POLICY, ESSENTIALITY, PROPRIETY, AND QUALITY.

## Preface

THE MOST MEDICALLY important genera, beginning with gram-positive cocci and bacilli, that cause some of the most serious human diseases will be discussed in this volume. Subsequently, a description of gram-negative cocci and coccoid organisms will be followed by that of the enteric groups. Finally, we will examine the acid-fast bacilli and spirochetes. Our study of pathogens will consist of a brief review of their general characteristics, clinical significance, isolation, cultivation, and the current accepted procedures for identifying them. Wherever possible, we have emphasized the need for continued quality control in all techniques.

Foldouts 1, 2, and 3 are printed as a separate inclosure.

Direct your questions or comments relating to the accuracy or currency of this volume to the course author: School of Health Care Sciences, USAF (ATC), ATTN: CMSgt Joselyn H. Thompson, Sheppard AFB, TX, 76311. (If you need an immediate response, call the author, AUTOVON 736-2809, between 0800 and 1900 (CST), Monday through Friday. *(NOTE: Do not use the suggestion program to submit changes or corrections for this course.)*)

If you have questions on course enrollment or administration, or on any of ECI's instructional aids (Your Key to a Successful Course, Behavioral Objective Exercises, Volume Review Exercise, and Course Examination), consult your education officer, training officer, or NCO, as appropriate. If this person can't answer your questions, send them to ECI, Gunter AFS AL 36118, preferably on ECI Form 17, Student Request for Assistance.

This volume is valued at 39 hours (13 points).

Material in this volume is technically accurate, adequate, and current as of March 1979.



# Contents

	<i>Page</i>
<i>Preface</i> .....	<i>iii</i>
<i>Chapter</i>	
1 The Gram-Positive Organisms .....	1
2 The Gram-Negative Cocci and Coccoid Forms .....	40
3 The Small Gram-Negative Bacilli .....	52
4 The Enteric Organisms .....	v
5 Mycobacterium .....	97
6 The Spirochetes .....	108
 <i>Bibliography</i> .....	 120
<i>Answers for Exercises</i> .....	123

**NOTE:** In this volume, the subject matter is developed by a series of Learning Objectives. Each of these carries a 3-digit number and is in boldface type. Each sets a learning goal for you. The text that follows the objective gives you the information you need to reach that goal. The exercises following the information give you a check on your achievement. When you complete them, see if your answers match those in the back of this volume. If your response to an exercise is incorrect, review the objective and its text.

## The Gram-Positive Organisms

THE GRAM-POSITIVE bacteria of interest to us are distributed among a dozen or more genera. Seven of these genera contain the coccal forms, and the others consists of rods, or elongated rod-like forms. Collectively, the gram-positive cocci are responsible for an impressive variety of human infections. These infections range from a relatively simple involvement of the skin and mucous membranes to more serious diseases manifested by pneumonia, septicemia, rheumatic fever, acute glomerulonephritis, or deep tissue abscesses.

Among the rod forms we find pathogens that also cause severe superficial and systemic lesions, as well as toxin-producing organisms which give off some of the most poisonous substances known to man. From time to time we will mention the more common saprophytes of various genera as we proceed with a discussion of the gram-positive organisms, because the saprophytic species complicate the process of isolating and identifying the pathogens.

### 1-1. The Staphylococci

Staphylococci are among the most frequently encountered isolates in the bacteriology laboratory because they are always present in the air, on dust particles, and on the body. Most species are harmless, but almost any one of the saprophytic forms can cause disease if given the right conditions. Ordinarily, however, we think of the pathogenic staphylococci as belonging to one or the other of two species. Their taxonomic relationship is as follows:

#### PART 14 GRAM-POSITIVE COCCI

- a Aerobic and/or facultatively anaerobic
  - Family I *Micrococaceae*
  - Genus I *Micrococcus*
  - Genus II *Staphylococcus*
  - Species *S. aureus*
  - S. epidermidis*
  - Genus III *Planococcus*

**200.** Point out the clinical significance of staphylococcal infections in terms of the diseases caused, means of transmission, the reasons for susceptibility of hospital patients, the carrier rates of hospital patients and personnel, and the cause of staphylococcal food poisoning.

**Clinical Significance.** Staphylococci are frequently recovered from the skin, the nasal and other mucous membranes of man, and in various food products. The human nose and nasopharynx are the natural reservoirs of the organisms. Many pathogenic strains are carried in the nasal passages of asymptomatic individuals who transmit the organisms to susceptible persons. These organisms manifest themselves in localized suppurations such as simple pustules or hair follicle infections. In time, the simple infections can develop into carbuncles and even form metastatic abscesses in other tissues.

Osteomyelitis, an infection of the growing bone, is most frequently caused by *S. aureus*. One of the characteristic features of *S. aureus* bacteremia is the production of metastatic abscesses. The most frequent sites of the metastatic abscesses are the skin, subcutaneous tissues, and lungs. Pneumonia, meningitis, and endocarditis are relatively infrequent diseases associated with particularly virulent strains.

Most of the serious staphylococcal infections currently encountered are seen in patients whose normal host defenses are badly impaired. Hospitalized, debilitated patients who have been subjected to extensive surgery or who have serious underlying diseases are especially susceptible to infection with staphylococci. Hospital personnel and patients have significantly higher carrier rates than the general population. These organisms are generally resistant to penicillin and to other antibiotics. Direct person to person contact is the most important means of transmission.

In general, staphylococcal diseases may be divided into three major groups; (a) infections occurring locally

or involving contagious sites, (b) infections that are spreading primarily via the bloodstream, and (c) food poisoning.

*Staphylococcus aureus* is considered the most highly pathogenic species; *S. epidermidis* is rarely pathogenic. Infections with *Staphylococcus aureus* often present difficult treatment problems because some strains rapidly develop resistance to certain commonly prescribed antimicrobial agents. The most common form of bacterial food poisoning in the United States is staphylococcal food poisoning.

The organisms produce a heat-stable (resistant to boiling) exotoxin while growing in foods such as refrigerated custard or cream-filled bakery products. Ham, processed meats, ice cream, cottage cheese, hollandaise sauce, and chicken salads are foods that are often implicated. Foods containing the enterotoxin are normal in appearance, taste, and odor. Sufficient toxin is produced in 4 to 6 hours at 30° C., but not at refrigerated temperature, to produce symptoms of food poisoning.

The enterotoxin is rapidly absorbed by the intestinal mucosa, resulting in nausea, vomiting, diarrhea, and acute prostration within 2 to 6 hours after the contaminated food is consumed. Staphylococcal food poisoning is not an infection, but an intoxication resulting from the ingestion of the preformed toxin. Hence, the implicated foods, rather than stool specimens, are more likely to yield the pathogen on bacteriological analysis.

#### Exercises (200):

1. Which two areas of the body are considered to be the natural reservoirs of staphylococci?
2. What are the most frequent sites of metastatic abscesses caused by *S. aureus* bacteremia?
3. Why are hospitalized patients more susceptible to staphylococcal infections?
4. In what groups of the population are the carrier rates higher?
5. The most important means of transmission is by \_\_\_\_\_ contact.
6. The most highly pathogenic species is \_\_\_\_\_.

7. What condition causes staphylococcal food poisoning?

8. *Staphylococcus aureus* belongs to what family?

**201. State general characteristics of the genus *Staphylococci*, cite the three species currently recognized, and point out the most useful single criterion for recognition of the most highly pathogenic member of the species.**

**General Characteristics.** *Staphylococcus* is the only genus of medical importance in the family Micrococcaceae. The genus contains gram-positive cocci that are facultatively anaerobic and grow in irregular clusters. The members of the genus *Micrococcus* may be distinguished from staphylococci by certain specific characteristics, such as (a) anaerobic growth and fermentation of glucose; (b) structural contents of the cell wall; (c) and the percentage of guanine plus cytosine content of the DNA. The three species currently recognized are *S. aureus*, *S. epidermidis*, and *S. saprophyticus*. The production of coagulase is the most useful single criterion for the recognition of *S. aureus*. A staphylococcus producing coagulase is considered to be *S. aureus* irrespective of colonial pigmentation. Pigment production is a variable trait of staphylococci, and its correlation with pathogenicity is not reliable.

#### Exercises (201):

1. Members of the genus *Micrococcus* may be distinguished from staphylococci by what characteristics?
2. What are the three recognized species of the genus *Staphylococcus*?
3. What is the most useful single criterion for the recognition of *S. aureus*?
4. Why is pigment production not considered to be a reliable trait of pathogenicity for staphylococci?

**202. State growth requirements and significant cultural characteristics of staphylococci.**

**Growth and Cultural Characteristics.** Staphylococcus is a facultative anaerobe, but more abundant growth is obtained under aerobic conditions. However, some strains require an increased CO<sub>2</sub> tension. Although the optimum growth temperature range is at 30° C. to 37° C., growth occurs over a wide temperature range of 6.5° C. to 46° C. Staphylococci require a number of amino acids, thiamine, and adenine for growth on chemically defined media. For growth under anaerobic conditions uracil and pyruvate (or acetate) are required. The optimum pH is 7.0 to 7.5 with a growth over a range of pH 4.2 to 9.3. Staphylococci grow well on most routine laboratory media, such as nutrient agar or trypticase soy agar.

Pigment production may be best observed by growth on agar plates at 37° C. for 24 hours, followed by incubation at room temperature for an additional 24 to 48 hours. Under anaerobic conditions, no pigment is produced. Abundant growth occurs in 18 to 24 hours on blood agar. Usually, colonies will be 1 to 3 mm in diameter, opaque, circular, smooth and raised with a butyrous consistency. The colonies are more opaque than those of the streptococci and pneumococci. Colonies of most strains of *S. aureus* are golden yellow. The colonial pigmentation is caused by carotenoid pigments and ranges from deep orange to pale yellow.

A zone of complete hemolysis surrounds colonies of organisms that produce soluble hemolysins. Complete hemolysis also may be produced by strains of *S. epidermidis*, although its production is primarily associated with *S. aureus*. The colonies of *S. epidermidis* are circular, smooth, and usually a pale translucent white. *S. aureus* is a nonmotile coccus, 0.8 to 1.0 μm in diameter which divides into three planes to form irregular grape-like clusters of cells. Usually, in smears from pus, the cocci appears singly, in pairs, or in short chains. The irregular clusters are found characteristically in smears from cultures grown on solid medium. In broth cultures, short chains and diplococcal forms, that are common to and resembling pneumococci, are noted. A few strains are noted to produce a capsule or slime layer that enhances virulence of the organism. Through such techniques as negative staining, phase contrast microscopy, or electron microscopy, the capsule can be seen. *S. aureus* is gram positive, but old cells and phagocytosed organisms stain negative.

**Exercises (202):**

1. On the basis of their requirements for atmospheric oxygen, how is staphylococcus classified?
2. More abundant growth of staphylococci is obtained under what atmospheric conditions?

3. What is the optimum growth temperature range for *Staphylococcus* spp?
4. What constituents are required for growth of *Staphylococcus* spp under anaerobic conditions?
5. Pigment production is best observed by growth on what type of plates; at what temperature and times of incubation?
6. What kind of pigment is produced under anaerobic conditions?
7. Compared with streptococci and pneumococci, the staphylococci colonies are (more/less) opaque.
8. Colony pigmentation is caused by what type of pigments?
9. Usually in smears from pus the cocci appear in what characteristic forms?
10. Irregular clusters are found characteristically in what type of medium?
11. What forms may be noted on smears obtained from broth cultures?
12. A few strains of staphylococci are noted to produce a \_\_\_\_\_ or \_\_\_\_\_ that enhances virulence of the organism.

**203. Cite the methods used to identify and separate the genus *Staphylococcus* in terms of the principles, procedures, reagents, interpretation, and sources of error.**

**Laboratory Identification.** The two species of clinical significance in the genus *Staphylococcus* can be identified and separated by such characteristics as colonial appearance and microscopic morphology, catalase production, coagulase production, and mannitol and glucose fermentation. Since the colonial characteristics and morphology have been discussed we will study other characteristics for identification.

**Catalase production.** Staphylococci and micrococci are catalase positive, pneumococci and streptococci do not possess this enzyme. Peptococci may or may not produce catalase. An 18- to 24-hour slant culture, incubated at optimal temperature is used. Pour 1 ml of a 3 percent solution of hydrogen peroxide over the growth. The reaction is positive if there is an appearance of vigorous gas bubbles. The action of catalase liberates oxygen from the peroxide and gives a vigorous bubbling.

The test may also be conducted by emulsifying a colony from a slant culture in one drop of 30 percent hydrogen peroxide (suproxol) on a glass slide. A positive catalase test is indicated by immediate bubbling. If the colony is taken from blood agar, extreme care must be exercised. The enzyme catalase is present in red blood cells, and the carry-over of blood cells with the colony can give a false-positive reaction.

**Coagulase test.** The coagulase tube test is the best single test for identifying pathogenic staphylococci. The test demonstrates free coagulase. Coagulase activity is generally accepted as a marker of pathogenic strains. The enzyme coagulase is produced which clots rabbit and human plasma. Coagulase production is also one of the major criteria used to differentiate *S. aureus* from *S. epidermidis*.

To perform the tube test citrated rabbit plasma, (available commercially) 0.5 ml undiluted or a 1:4 dilution in a small tube is inoculated heavily with a 24-hour culture of the organism and incubated at 36° C. in a water bath. Partial or complete coagulation in 1 to 4 hours is interpreted as positive. Along with each test, set up cultures of a known coagulase-positive organism, a coagulase-negative organism, and if possible, a weak coagulase producer as controls. Examine for clotting at intervals of 30 minutes for 4 hours. The test must be observed for at least 24 hours to rule out the chance of a delayed clot which would indicate a positive reaction. Certain staphylococci that produce coagulase also produce staphylokinase (an enzyme which will dissolve the formed clot); the tube of plasma must be checked at 30-minute intervals for presence of a clot in order to prevent the reporting of a false-negative reaction.

A positive coagulase test is indicated by any degree of clotting in plasma to a solid clot that is immovable when the tube is inverted. False-positive tests may occur with mixed cultures of some gram-negative rods, such as *Pseudomonas*, even though the mechanism of clotting differs. In addition, citrated plasma may also be coagulated by organisms such as some citrated utilizing enterococci.

The coagulase slide test demonstrates the presence or absence of bound coagulase of clumping factors. The test is used by many laboratories as a screening procedure and gives results comparable to the tube test. It is performed by emulsifying growth from a typical colony in a drop of water on a slide and adding a loopful of fresh human plasma, then mixing thoroughly for 5 seconds. A positive reaction is indicated by white clumps which usually appear immediately or within 5 seconds. All negative tests must be confirmed by the tube test, since some strains of *S. aureus* may be negative.

**Carbohydrate fermentations.** Most strains of *S. aureus* ferment mannitol and can tolerate relatively high concentrations of sodium chloride (7.5 percent to 10 percent). Isolation of the organism from material such as feces, in which a large and varied bacterial flora exists, is made possible using Mannitol Salt Agar as a selective medium. A medium such as Mannitol Salt Agar that contains a high concentration of sodium chloride inhibits most other organisms. Colonies of *S. aureus* will be surrounded by a yellow zone indicating fermentation of mannitol and *S. epidermidis* by red to purple zones.

Procedures to determine the ability of the organisms isolated to produce acid from various carbohydrates is not usually necessary. Criteria used for the identification of staphylococci are colonial appearance, microscopic morphology, catalase and coagulase production, and when warranted, mannitol fermentation. Other biochemical tests such as gelatin liquefaction, acetyl methyl carbinol production, carbohydrate fermentations, and reaction in litmus milk are not necessary for identification purposes.

#### Exercises (203):

1. What procedures are used for identification and separation of staphylococci?
2. In the catalase test what action causes the appearance of gas bubbles?
3. Why must extreme care be exercised in performing the catalase test on a glass slide if the colony is taken from blood agar?
4. What is the best single test for identifying pathogenic staphylococci?
5. What enzyme is produced in a positive coagulase test, and how does it react with rabbit and human plasma?

6. To perform the tube test, what type of plasma is used and what quantities?
7. A weak clot in the coagulase tube test indicates what type of result?
8. What is staphylokinase?
9. Why must the coagulase test be checked at 30-minute intervals?
10. What two organisms may produce false-positive tests?
11. What type of coagulase is demonstrated by the coagulase slide test?
12. Why must all negative coagulase slide tests be confirmed by the tube test?
13. Why is sodium chloride incorporated into Mannitol Salt Agar?
14. List three procedures that are not necessary for identification staphylococci

**204. Indicate whether given statements correctly reflect the similarities and distinguishing characteristics of the genera *Micrococcus*, *Staphylococcus*, and *Planococcus*.**

**Related Micrococci.** The family of Micrococcaceae includes genera *Micrococcus*, *Staphylococcus*, and *Planococcus*. Other genera of saprophytes resemble the staphylococci so closely in morphology that the harmless forms are sometimes mistaken for their pathogenic relatives. *Staphylococcus* and *Micrococcus* will show irregular clusters resembling bunches of grapes. One strain of *Micrococcus* will sometime

show tetrads or flat square groups of four. *Staphylococcus* will not demonstrate tetrads. *Planococcus* occurs singly in pairs, threes, or in tetrads. It is motile, each cell having one or two flagella, and will not ferment glucose. The genus *Micrococcus* holds a heterogeneous group of gram-positive aerobic cocci which form irregular clumps of cells easily confused with the grape-like clusters of the staphylococci. *Micrococcus* species are coagulase-negative, however, and ferment glucose aerobically. Staphylococci can ferment glucose anaerobically.

*Micrococcus* is a common inhabitant of soils and fresh water. It is frequently found in the skin of man and other animals. The ability to form tetrads on packets has turned out to be quite a variable property, and many organisms formerly placed in the genera *Gaffkya* or *Sarcina* have been shown to be identical to organisms in the genus *Micrococcus* with regard to their metabolism, cell wall chemistry, and DNA composition. In the 8th Edition of *Bergey's Manual*, *Gaffkya* has been dropped as a genus designation and the anaerobic *Sarcina* has been included in the family Peptococcaceae.

**Exercises (204):**

Indicate whether each of the following statements is true (T) or false (F) and correct those that are false.

- T F 1. *Planococcus* will show irregular clusters resembling bunches of grapes.
- T F 2. One strain of *Staphylococcus* will sometimes show tetrads.
- T F 3. *Micrococcus* is motile and will not ferment glucose.
- T F 4. *Micrococcus* species are coagulase-negative.
- T F 5. Staphylococci can ferment glucose anaerobically.
- T F 6. Many organisms formerly placed in the genera *Gaffkya* or *Sarcina* have been shown to be identical to organisms in the genus *Micrococcus*.



T F 7. The ability of organisms of the family Micrococcaceae to ferment glucose anaerobically and produce coagulase has out to be a variable property.

TABLE 1-1  
LYTIC GROUPS OF *STAPHYLOCOCCUS* TYPING  
PHAGES INCLUDED IN THE BASIC SET OF TYPING PHAGES

Lytic group	Phages in group									
I	29	52	52A	79	80					
II	3A	3C	55	71						
III	6	42I	47	53	54	75	77	83A	84	85
IV	42D									
Unassigned			81	187						

205. Cite the principle, purpose, and general procedure of bacteriophage typing and point out the phage groups associated with given staphylococci infections.

**Bacteriophage Typing.** Staphylococci, especially *S. aureus*, can be identified and classified into groups on the basis of their susceptibility to various bacteriophages. The technique involves bacteriophage typing, in that strains of *Staphylococcus* species are identified, based on their susceptibility to lysis by different bacteriophages. Bacteriophages are bacterial viruses that attack and destroy the cells. By seeding a plate of medium with a pure culture of the organism and applying droplet suspensions of several known phage types we can establish a pattern of susceptibility/resistance to lysis which serves to "fingerprint" the staphylococcus.

We simply record the presence or absence of plaques (cleared areas) on the surface of the plate at the site where each phage suspension was deposited. Plaque formation at that site indicates lysis of the cells by phage particles and, hence, susceptibility of the bacterium to that particular phage. The 22 phages that now constitute the basic set are shown in table 1-1. The phage patterns of different strains fall essentially into four broad groups, phage I to IV. The phages within a group are unrelated and possess different morphologic and serologic properties. For example, group II strains of staphylococci are often associated with skin infections, such as impetigo and pemphigus of the newborn. The production of enterotoxin is confined primarily to phage groups III and IV. Bacteriophages 52, 52A, 80 (group I), and 81 (unassigned) predominated in the hospital environment and had been common among hospital personnel. Hospital epidemics started with strains of a few phage patterns (phages 75, 77) in group III and group I (phage 80), but later shifted to resultant strains of the 52/52A/80/81 complex. This is now followed by strains lysed by phage 83A (group III) and strains of the 83A/84/85 complex. Phage typing is of great value in epidemiological investigations; however, because of the involved and precise procedures required, it is not recommended for use by the diagnostic laboratory as an attempt to establish a routine typing service. Phage typing may be referred to State Public Health Laboratories, the Center for Disease Control in Atlanta, or the Epidemiology Division (USAFSAM), Brooks AFB, Texas.

**Exercises (205):**

1. Bacteriophage typing is based upon the identification of strains of *Staphylococcus* species by what principle?
2. What are bacteriophages?
3. How is the pattern of susceptibility/resistant to lysis performed?
4. In phage typing, what is another name for the clear area formed as a result of the added bacteriophage?
5. What lytic group have been commonly associated with skin infections, such as impetigo and pemphigus of the newborn?
6. The toxic metabolite responsible for staphylococcal food poisoning is restricted mainly to what two lytic groups?
7. Currently, what strains are associated with hospital epidemics?
8. Phage typing is of great value in what type of investigations?
9. To which laboratories should you refer phage typing requests?

## 1-2. The Streptococci

The streptococcal forms, although smaller in size than the staphylococcus, closely resemble the latter in morphology of the individual cells. On the basis of differences in physiology and chemical makeup, however, the chain-forming cocci are placed in a separate family, Streptococcaceae. This family includes a variety of pathogenic and saprophytic microbes which tend to grow sparsely on initial isolation in the laboratory.

In addition to the genus *Streptococcus*, the genera *Peptococcus* and *Peptostreptococcus* are considered of interest to the medical bacteriologist. The genus *Streptococcus* contains the aerobic and facultatively anaerobic species most commonly implicated in human disease. The genera *Peptococcus* and *Peptostreptococcus* are strict anaerobes or microaerophiles which grow poorly on conventional media. The organisms are classified as shown below:

### PART 14 GRAM-POSITIVE COCCI

- a. Aerobic and/or facultatively anaerobic
  - Family II. *Streptococcaceae*
  - Genus I. *Streptococcus*
- b. Anaerobic
  - Family III. *Peptococcaceae*
  - Genus I. *Peptococcus*
  - Genus II. *Peptostreptococcus*

**206. State the clinical significance of streptococcal infections in terms of the diseases caused, and the groups most commonly implicated in given infections; cite diseases caused by the anaerobes of the genera *Peptococci* and *Peptostreptococci*, and the distinguishing characteristics of these organisms.**

**Clinical Significance.** Once again, man has taken first place to be considered the most susceptible of all animals to streptococcal infections. There is no organ or tissue of the body that is completely immune. Among the diseases of great importance caused by these organisms are streptococcal pharyngitis, scarlet fever, impetigo, and endocarditis. In addition, infections caused by group A streptococci may lead to the postinfection syndromes of acute rheumatic fever, rheumatic heart disease, and acute glomerulonephritis. Nephritis may follow streptococcal impetigo, but acute rheumatic fever does not. Neonatal meningitis and sepsis, omphalitis, and vaginitis can be caused by a group A streptococci and group B streptococci (*S. agalactiae*). Bacterial endocarditis, urinary tract infection, and wound infection are common diseases caused by group B streptococci. Group D streptococci are frequently found in the urine of patients with urinary tract infection, and in the blood of patients with bacterial endocarditis. Antibiotic susceptibility of group D streptococci is markedly different from that of the other streptococci; thus, identification of enterococci is important.

A wider variety of clinical manifestations are caused by streptococci than any other genus of bacteria. Group A streptococcus remains the organism most commonly isolated from human infections. Over one hundred thousand Americans develop post-streptococcal heart disease each year, and some 17,000 die from such complications.

Anaerobes of the genus *Peptococcus* are found normally in the respiratory and genital tract of humans. They are often isolated from breast abscesses, prostatitis, and in mixed culture from lung and genital infections.

*Peptostreptococcus* are encountered in pelvic abscesses, the diseased appendix, sinus and ear infections, and in gangrenous wounds. They are capable of giving rise to severe suppurative lesions characterized by an extremely foul odor. The nonhemolytic streptococci are, for the most part, saprophytic forms found naturally in milk and other dairy products. A few strains have been isolated from cases of subacute bacterial endocarditis.

Peptococci are incriminated less frequently than peptostreptococci in anaerobic infections. They may be distinguished from the latter by the fact that peptococci are catalase-positive and do not produce a sharp, pungent odor.

### Exercises (206):

1. What organ or tissue of the body is immune to streptococcal infections?
2. What are some diseases of great importance caused by streptococci?
3. Infections caused by group A streptococci may lead to which postinfection syndromes?
4. What are some diseases commonly caused by group B streptococci?
5. What group of streptococci are frequently found in the urine of patients with urinary tract infection and in the blood of patients with bacterial endocarditis?
6. Why is identification of group D streptococci important?

- 7 What group of streptococci is most isolated from human infections?
- 8 What are some sources from which *Peptococcus* species may be isolated?
- 9 What are some diseases in which *Peptostreptococcus* are encountered?
- 10 What characteristics distinguish peptococci from peptostreptococci?

**207. Point out general characteristics of streptococci, in terms of morphology and capsule formation, and cite conditions required for growth, significance of colony appearance, and the environment recommended for culture of streak plates.**

**General Characteristics.** Streptococci are gram-positive, spherical, oval, or occasionally elongated into rods and occurring in pairs or as short or long chains. Cell size varies from 0.5 to 1  $\mu$ m in diameter, depending on growth conditions and age of culture. Liquid cultures normally yield longer chains than cultures grown on agar. Although a few motile forms have been reported, the cells are normally nonmotile. Characteristically, streptococci are gram-positive but may become gram-negative as the cell ages. Capsules are usually noted in virulent forms and contain an abundance of hyaluronic acid.

Growth on agar surface is scanty; thus, enriched infusion medium such as brain heart infusion, trypticase soy, or heart infusion agars is required.

**Growth Requirements and Cultural Characteristics.** Streptococci are facultative with respect to oxygen. Many strains grow better anaerobically than aerobically. Streptococcal colonies are small, translucent, to slightly opaque, circular, generally less than 1 mm in size, convex, and appear as minute beads of moisture on a moist agar surface. Colonies are less moist and almost opaque on drier surfaces. Pneumococcal colonies are flatter and translucent. Variation in colony occurs frequently showing the mucoid, smooth or glossy, and matt or rough forms. Virulence is indicated by the presence of the mucoid and matt forms which contain relatively large amounts of M protein, whereas the glossy or smooth forms contains very little of this substance and are usually not virulent. After repeated transfer on laboratory media avirulent rough or smooth colonies will eventually

develop. Streptococci are oxidase-negative. *Neisseria* is oxidase-positive. However, this property with the Gram stain characteristics and cellular morphology differentiates streptococci from *Neisseria*. Growth is best at 35° C. to 37° C. unless otherwise stated. Sheep blood that is free from fermentable carbohydrates and has a final pH of 7.3 to 7.4 is preferred. The presence of dextrose in the basal medium for flood plates results in the inhibition of hemolysis by beta-hemolytic streptococci. All streak plates should be incubated anaerobically in the presence of 10 percent CO<sub>2</sub>. The conditions achieved in candle jar incubation permit the detection of hemolytic activity by streptococci on streaked blood plates if the hemolytic activity is read from the growth in the stabbed areas of the plate as described previously in the plating technique. This will permit the detection of both O and S hemolysins. Characteristically, after 18 to 24 hours of growth on blood agar streptococci produce varying degrees of hemolytic activity used as one form of their identification.

**Exercises (207):**

1. What are some morphological forms of streptococci?
2. The cell size varies from 0.5 to 1  $\mu$ m in diameter, depending on what two factors?
3. In what forms are capsules observed, and what substance do they contain?
4. When compared with streptococcal colonies, how do the pneumococcal colonies differ?
5. Virulence of the organisms is indicated by the presence of what forms in colony appearance?
6. Which forms contain very small amounts of M protein?
7. After repeated transfer on laboratory media, what forms will eventually develop?

8. When compared with *Neisseria*, what reaction does streptococci produce to the oxidase test, and what other characteristics will differentiate streptococci from *Neisseria*?
9. What should be the final range of pH of the sheep blood used for growth of streptococci and the quantity of fermentable carbohydrates present?
10. Under what environment should the streak plates be incubated?

**208. Identify given systems for classification of the streptococci in terms of the criteria and principles used, and select the hemolytic reactions on blood agar in terms of their distinctive characteristics produced by the bacterial colony.**

**Classification of the Streptococci.** Several schemes for classifying the streptococci have been proposed. Two of the more widely used schemes are those devised by Lancefield and Sherman. The Lancefield classification is based on the antigenic structure of the organisms. The composition of a carbohydrate antigen—C substance—is different for each immunologic group in this series. The Sherman system has as its basis a compilation of common physiological properties, the most important of which is the temperature limit for growth. The Sherman system divides the streptococci into the pyogenic group, the viridans group, the enterococcus group, and the lactic group. The Brown classification is based on the reaction in blood agar. However, the Lancefield system, based on the antigenic characteristic of the group—specific C substance—is probably the most reliable and is the one used predominantly in *Bergey's Manual of Determinative Bacteriology* and in other current texts.

**Hemolytic Reactions on Blood Agar.** The hemolytic activity on blood agar is the most useful method for preliminary differentiation of human streptococcal strains. The hemolytic action of streptococci on red blood cells was described and defined by Brown in 1919. Many types may be observed, including subsurface colonies, on pour plates as follows:

**Alpha ( $\alpha$ )**—an indistinct zone of partially lysed red blood cells surrounds the colony, often accompanied by a greenish to brownish discoloration.

**Beta ( $\beta$ )**—a clear, colorless zone around the streptococci colonies, in which the red blood cells have undergone complete discoloration. This type is best seen in deep colonies in a pour plate. On the other

hand, surface colonies may appear as alpha or non-hemolytic due to inactivation of one of the hemolysins, streptolysin O, which is oxygen labile and streptolysin S, an oxygen-stable hemolysin which may be present in only small amounts in these strains the hemolyze the surface poorly.

**Gamma ( $\gamma$ )**—no apparent hemolytic activity or discoloration produced by the colony.

**Alpha-prime ( $\alpha'$ ) or Wide Zone Alpha (WZ $\alpha$ )**—a small halo or envelope of intact or partially lysed red blood cells lying adjacent to the bacterial colony, with a zone of complete hemolysis extending further out into the medium. This can be confused with a beta hemolytic colony when only surface growth is observed.

**Sherman System.** In the Sherman system, as previously indicated, the species are divided into four groups:

- Pyogenes.
- Viridans.
- Enterococcus.
- Lactic.

In table 1-2, the distinguishing cultural characteristics are portrayed for streptococci of the Sherman classification. The corresponding Lancefield groups are shown parenthetically. In the *Bergey's Manual*, the Sherman classification has been omitted from the key since newly recognized species may cut across the broad lines of Sherman's major divisions.

**Exercises (208):**

Match each of the given systems for classification of the streptococci, the hemolytic reactions on blood agar, and related characteristics in column B with the statements in column A by placing the letter of the column B item beside the number of the column A item that most nearly describes it. Each element in column B may be used once, more than once, or not at all.

Column A	Column B
_____ 1. Classification based on the antigenic characteristic of the Group C substance.	a. Alpha-prime or Wide Zone Alpha
_____ 2. Is probably the most reliable system of classification and is used predominately in <i>Bergey's Manual</i> and other current texts	b. Beta
_____ 3. Based on the hemolytic action of streptococci on red blood cells	c. Alpha
_____ 4. The colony is surrounded by an indistinct zone of partially lysed red blood cells, often accompanied by a greenish to brown discoloration.	d. Gamma
_____ 5. A clear, colorless zone around the streptococci colonies, in which the red blood cells have undergone complete discoloration	e. The Sherman classification
	f. Str.-ptolysin O
	g. Viridans group
	h. Streptokinase
	i. The Lancefield classification
	j. Pyogenic group
	k. Lactic group.
	l. Enterococci group.
	m. The Brown classification.
	n. Streptolysin S

TABLE 1-2  
GROUP DIFFERENTIATION OF *STREPTOCOCCUS* SPECIES

Group	Hemolysis	Growth at 10°C. 45°C.	Growth in 6.5% NaCl
Pyogenes (Gp A and C)	Beta or alpha	- (1)	-
Viridans (4)	Alpha or none	-(2) +(3)	-
Enterococci (Gp D)	Alpha, beta or none	+ +	+
Lactic (Gp N)	None	+ -	-

- (1) Exceptions with *Streptococcus sanguis*.  
 (2) Exceptions with *Streptococcus uberis*.  
 (3) Exceptions with *Streptococcus mitis*.  
 (4) Members of the Viridans group belong to Lancefield groups A, D, G, and K. Some strains cannot be grouped serologically.

- 6 Reactions may be produced by surface colonies due to inactivation of one of the hemolysins
- 7 Is oxygen labile.
- 8 Is oxygen stabile.
- 9 This type may be present in only small quantities in those strains that hemolyze the surface poorly
- 10 No apparent hemolytic activity or discoloration produced by the colony.
11. This reaction can be confused with a beta hemolytic activity colony with a surface growth is observed.
- 12 A small halo or envelope of intact or partially lysed red blood cells lying adjacent to the bacterial colony with a zone of complete hemolysis extending further out into the medium.
- 13 Designations of four physiological divisions (pyogenic, viridans, lactic, and enterococci)
14. This group, by Sherman classification, produces alpha or no hemolysis, grows at 45° C., but does not grow in 6.5 percent NaCl.
- 15 This group produces alpha, beta, or no hemolysis; grows at 10° C. and 45° C. and in 6.5 percent NaCl.
16. Similar to Groups A and C of the Lancefield classification.

**209. Identify characteristics of the Lancefield serological group, the Sherman group, and similarities and distinctive features of both groups; point out distinctive features of members of the genus *Pepiostreptococcus*.**

**Group Characteristics.** The Lancefield serological groups are designated by the letters A through O. Groups A and C contain most of the human pathogens. These and nine other serological groups produce hemolysis; accordingly, they are referred to as the "hemolytic" streptococci. Organisms in Group D, including the enterococci, may be either hemolytic or nonhemolytic. Group N organisms are nonhemolytic. Currently, 21 species of *Streptococcus* are recognized.

The most important member of the pyogenic group clinically is *Streptococcus pyogenes* (Lancefield Group A). This species produces beta-hemolysis on blood agar. The organism grows at the usual cultural temperatures, but not at 10° C. or 45° C. The viridans group does not give beta-hemolysis on blood agar. As a rule, no growth is obtained at 10° C. Many species produce an alpha-hemolysis, but the effect on red blood cells depends upon the species origin of the red blood cells used, pH, and temperature. Viridans streptococci are found most frequently as normal flora in the human respiratory tract.



The enterococcus group yields variable hemolysis on blood agar. Growth generally takes place at both 10° C. and 45° C. Although these organisms are considered normal flora of man's intestinal tract, they can be pathogenic when introduced into the bloodstream, meninges, urinary tract, and various other tissues. Enterococci differ from the remainder of the streptococci in that they multiply in broth media containing 6.5 percent sodium chloride. This group is also quite resistant to most antimicrobial agents. The lactic group is characterized by variable hemolytic reactions on blood agar and growth at 10° C. but not 45° C. The lactic organisms are nonpathogenic. They are present in milk, and are often responsible for its souring.

Members of the genus *Peptostreptococcus*, which we noted earlier have been recovered from infections in various organs of the body, are generally considered apart from the streptococci of the two classifications discussed above. Of the 13 known species, only three are of medical interest: *P. anaerobius*, *P. foetidus*, and *P. putridus*. These organisms are catalase-negative like members of the genus *Streptococcus*, and they also produce a variety of hemolysins. A fetid odor and gas production on high protein media, along with the requirement for anaerobiosis, are distinguishing characteristics of the group.

#### Exercises (209):

1. Which of the Lancefield serological groups contain most human pathogens?
2. What type of hemolysis is produced by Group N organisms, and to what group of the Sherman classification is it similar?
3. The most important member of the pyogenes group is \_\_\_\_\_.
4. Which of the groups does not give hemolysis on blood agar?
5. What type of hemolysis does the enterococcus group yield on blood agar?
6. What are two distinctive characteristics of enterococci?

7. In what two ways are the genera *Peptostreptococcus* and *Streptococcus* similar?

8. What are some distinguishing characteristics of the members of the genus *Peptostreptococcus*?

**210. Identify two general types of characteristics used for identifying beta hemolytic streptococci, the Lancefield groups and related species, their distinguishing features, and the diseases with which they are commonly associated.**

**Laboratory Identification.** Beta hemolytic streptococci are usually identified on the basis of cultural and physiological characteristics. Table 1-3 lists pertinent information on those groups responsible for the majority of human streptococcal infections.

Even though beta hemolytic streptococci of Groups A, B, C, D, E, F, G, H, K, L, and others are noted in Lancefield's classification, Group A strains (*S. pyogenes*) are most often associated with communicable disease in humans and are the etiological agents in streptococcal pharyngitis, scarlet fever, epidemic wound infections, and the like.

In table 1-3, note that the reactions obtained in *Streptococcus faecalis* (SF) broth and sodium hippurate broth do not separate Group A from Group C (human) streptococci. However, this degree of differentiation is not usually necessary since infections by members of both groups generally respond to identical antimicrobial agents.

We see in table 1-3 that SF broth is selective for *Streptococcus faecalis* and other members of Group D. Sodium azide in the medium prevents the growth of other streptococcal groups. After incubation for 24 hours at 37° C. the presence of growth, coupled with an indicator change from purple to a yellowish-brown, indicates a positive reaction. Similarly, sodium hippurate broth distinguishes Group B streptococci from groups A, C, and D. The inoculated medium is incubated for 48 hours and then tested for the presence of benzoic acid. This compound is formed by the hydrolysis of sodium hippurate. The formation of a stable precipitate after we add 12 percent ferric chloride indicates a positive reaction.

#### Exercises (210):

1. Beta hemolytic streptococci are usually identified on the basis of what two characteristics?



TABLE 1-3  
CHARACTERISTICS OF BETA HEMOLYTIC STREPTOCOCCI  
RESPONSIBLE FOR HUMAN INFECTION

Lance-field	Type Species	Source	Disease	Surface Colonies Blood Agar	Subsurface Colonies Blood Agar	SF Medium	Sodium Hippurate
Group A	<i>S. pyogenes</i>	Human infections and carriers (usually respiratory).	Erysipelas, impetigo, septic sore throat, scarlet fever, rheumatic fever, acute glomerulonephritis, puerperal sepsis, septicemia, etc.	Grayish-white, opaque to translucent; hard with tendency for whole colony to move on probing; hemolytic zones approximately 2 mm.	Lens or disc-shaped with 2 mm. zone of hemolysis.	No growth	Negative
Group B	<i>S. agalactiae</i>	Bovine infections and milk. Human intestinal, genitourinary, and respiratory tracts.	Urinary tract infections, peritonitis, endometritis, wound infections, rarely septicemia.	Gray, translucent, with soft texture; slight hemolytic zone.	0.5 mm. zones of lysis after 24 hours; 0.1 mm. zone after 48 hours. Double ring hemolysis following refrigeration overnight.	No growth	Positive
Group C (human)	<i>S. equisimilis</i>	Upper respiratory and intestinal tracts of humans.	Suppurative lesions of man, usually in mixed infections. Throat infections.	Indistinguishable from Group A.	Indistinguishable from Group A.	No growth	Negative
Group D (enterococci).	<i>S. faecalis</i> var. <i>zymogenes</i>  <i>S. durans</i>	Intestinal and genitourinary tracts of humans. Milk and milk products.	Same as Group B.	Gray, somewhat translucent, soft; hemolytic zones slightly wider than the colonies.	Hemolytic zones approximately 3 to 4 mm.	Growth, with acid reaction.	Negative

NOTE: *Streptococcus faecalis* and *S. liquefaciens* are also members of Serologic Group D; however, these species usually produce alpha hemolysis on blood agar. Also *S. faecalis* is occasionally observed to be nonhemolytic (gamma). These forms represent the only nonbeta species that may be uniformly grouped serologically.

2. What strains of streptococci are the etiological agents in streptococcal pharyngitis, scarlet fever, and epidemic wound infections?
3. What given strain of beta-hemolytic streptococci shows a positive sodium hippurate and is frequently isolated from urinary tract infections, peritonitis, endometritis, wound infections, but rarely in septicemia?
4. The surface colonies of Group C beta hemolytic streptococci when compared with those of Group A are \_\_\_\_\_.
5. What group of beta hemolytic streptococci, when the surface colonies are compared with the other groups, will most frequently show gray, somewhat translucent, soft, hemolytic zones slightly wider than the colonies?
6. How do the reactions obtained on SF broth and sodium hippurate broth separate Group A from Group C streptococci?
7. What is the principle of using sodium hippurate broth to differentiate between Lancefield's Group B from A, C, and D?

**211. State the purpose and principle of the bacitracin disc test and some important factors which influence the accuracy and reliability of the test.**

**The Bacitracin Disc Test.** The Bacitracin disc test is often useful in distinguishing between Lancefield's Group A and other groups of the beta hemolytic streptococci. The test depends on the selective inhibition of Group A streptococci on blood agar plate by a paper disc containing 0.04 units of bacitracin. The users of bacitracin discs should be aware of several important factors.

a. Discs sold and used for bacitracin susceptibility testing have too high a concentration of bacitracin to differentiate between Group A and Non-group A streptococci. Use *differential* (0.04 units of Bacitracin), not *sensitivity* (10 units of bacitracin) discs. There

is a high degree of correlation between bacitracin and serological tests with Group A streptococci

b. A heavy inoculum of a pure culture is advisable. The test has been designed for use with pure cultures, not mixed cultures.

c. The test is designed for differentiating beta-hemolytic streptococci. Determine the hemolysis correctly before doing this differential test. Many alpha-hemolytic streptococci, including pneumococci, are sensitive to bacitracin differential discs.

d. Reports have indicated some variation in lots of commercial discs; thus, each new lot of discs should be tested with known strains of Group A and Non-group A streptococci.

e. Any zone of inhibition, regardless of diameter, is positive. No zone of inhibition means the culture is resistant. Users of the differential discs should realize that growth of some strains of beta-hemolytic streptococci other than Group A is inhibited by the bacitracin disc. Thus, results should be reported as follows: "Presumptive beta-hemolytic Group A by bacitracin," or "Beta-hemolytic streptococci, not Group A by bacitracin". Further identification procedures include the use of immunofluorescence technics and the Lancefield serological procedures

#### Exercises (211):

1. What is the purpose of the bacitracin disc test?
2. How does the bacitracin disc work?
3. Why should disc sold and used for bacitracin susceptibility testing not be used in the bacitracin disc test?
4. Why should you ensure the use of a pure culture in the bacitracin disc test?
5. Why is it important to determine the hemolysis correctly before doing the bacitracin disc test?
6. What size should the inhibition zone be before reporting as positive?
7. What are two other procedures used for Group A streptococci identification?

**212. List the species of streptococci that produce alpha hemolysis; cite the area of the body in which they are most frequently found, and name the insidious and fatal infection that can be caused by these organisms.**

**Alpha and Gamma Streptococci.** As previously indicated, the streptococci that do not possess group antigens and that generally produce alpha hemolysis are known as alpha hemolytic (viridans) streptococci. They include such species as *S. salivarius*, *S. mitis*, and *S. sanguis* and are constantly present in the human oropharynx. These organisms are the most common cause of subacute bacterial endocarditis, an insidious and fatal infection that if untreated, usually follows dental or surgical procedures or instrumentation in patients with a previously damaged heart valve or lesion of the endocardium. *Streptococcus MG*, which may be isolated from the respiratory tract, is a rarely isolated species and has been used in an agglutinate test for the serological diagnosis of *Mycoplasma pneumoniae* infections (primary atypical pneumonia).

Gamma streptococci colonies produce no change in surface or subsurface colonies in blood agar. They have been poorly defined taxonomically and are rarely isolated from clinical material. Table 1-4 presents additional data to help in identifying the various alpha and gamma *Streptococcus* species that cause disease in man.

**Exercises (212):**

1. What group antigens does alpha streptococci possess?
2. List three species of streptococcal organisms that produce alpha hemolysis.
3. These organisms are constantly present in what area of the human body?
4. What fatal (if untreated) and insidious disease is commonly caused by these organisms?
5. From what source of the body is *Streptococcus MG* isolated?

**1-3. Pneumococci**

*Pneumococcus* was classified formerly in the genus *Diplococcus* by American taxonomists. It is now more

properly designated *Streptococcus pneumoniae*, which nomenclature has been adopted in the 8th Edition of *Bergey's Manual of Determinative Bacteriology*. The taxonomy of this organism is as follows:

- PART 14. GRAM-POSITIVE COCCI
  - a. Aerobic and/or facultatively anaerobic
    - Family II *Streptococcaceae*
    - Genus I. *Streptococcus*
    - 7. *Streptococcus pneumoniae*

**213. State the clinical significance of pneumococci and cite some general characteristics of the organisms.**

**Clinical Significance.** Pneumococci are the cause of approximately 80 percent of the cases of lobar pneumonia and roughly 1.5 percent of the bronchial pneumonia in man. The sputum is usually bloody or rusty and has a thick viscous consistency. In the early stages of pneumococcal pneumonia, bacteremia may be present. Pneumococci can invade other tissues, either as complications of pneumonia or as independent and primary infections. From the respiratory tract the organisms frequently spread to the sinuses and middle ear. A meningitis may result from blood stream infection following pneumonia.

Virulent pneumococci are generally spread by asymptomatic carriers. The pneumococci are "opportunistic pathogens" in that they apparently do not invade except when an individual's resistance to infection declines. Pneumococcal pneumonia can hasten the fatal termination of such diseases as influenza, tuberculosis, congestive heart failure, and cancer. The organism has also been implicated in postsurgery complications.

**Exercises (213):**

Complete the following statements:

1. Pneumococci are the cause of a approximately \_\_\_\_\_ percent of the cases of lobar pneumonia and roughly \_\_\_\_\_ percent of bronchial pneumonia in man.
2. The sputum is usually \_\_\_\_\_ or \_\_\_\_\_ and has a \_\_\_\_\_ consistency.
3. In the early stages of pneumococcal pneumonia \_\_\_\_\_ may be present.
4. From the respiratory tract, the organisms frequently spread to the \_\_\_\_\_ and \_\_\_\_\_.
5. A \_\_\_\_\_ may result from bloodstream infection following pneumococcal pneumonia.
6. The pneumococci are \_\_\_\_\_ in that they apparently do not invade except when an individual's \_\_\_\_\_ to infection \_\_\_\_\_.
7. The organism has also been implicated in \_\_\_\_\_ complications.

**TABLE 1-4**  
IDENTIFICATION OF ALPHA AND GAMMA *STREPTOCOCCUS* SPECIES

<i>Species</i>	<i>Source</i>	<i>Pathogenicity</i>	<i>SF Broth</i>	<i>Mannitol</i>	<i>Inulin</i>	<i>Reduction Methylene Blue Milk</i>	<i>Colonies on Blood Agar</i>	<i>Growth in 5% Sucrose Broth</i>	<i>Colonies 5% Sucrose Agar</i>
<i>S. salivarius</i>	Respiratory tract	Mild respiratory tract infections, subacute bacterial endocarditis, etc.	No growth	-	+	-	Alpha 24 to 48 hours	No change	Large, mucoid raised.
<i>S. mitis</i>	Respiratory tract	Mild respiratory tract infections, subacute bacterial endocarditis, etc.	No growth	-	-	-	Alpha 24 to 48 hours	No change	Small convex.
<i>S. sanguis</i>	Blood	Subacute bacterial endocarditis	No growth	-	+	-	Alpha 24 to 48 hours	Jelling of broth	Small convex.
<i>Streptococcus MG</i>	Respiratory tract	Secondary invader primary atypical pneumonia	No growth	-	-	-	No hemolysis 24 hrs. Alpha 24 to 48 hours	No change	Small, convex, fluorescent in ultraviolet light.
<i>S. faecalis</i> (enterococcus Group D)	Intestinal and genitourinary tracts	Urinary tract infections, peritonitis, endometritis, subacute bacterial endocarditis	Growth	+	-	+	No hemolysis 24 hrs. Slight alpha 48 hours	No change	Small convex.

15

215

214

214. Indicate whether given statements correctly reflect the general characteristics of pneumococci.

**General Characteristics.** The pneumococci are small, slightly elongated cocci arranged in pairs—diplococci. In young cultures the cells are frequently lancet-shaped, with the adjoining ends flattened or slightly curved. The organisms may occur singly, in pairs, or in short chains. Pneumococci are typically gram-positive, but older cultures become gram-negative and show a tendency to lyse spontaneously. They are nonmotile and nonsporeforming. Virulent pneumococcal cells are surrounded by a well-defined polysaccharide capsule that is prominent when the organisms are observed in tissue exudates.

The virulence is, in part, dependent upon this capsule which functions as a barrier against phagocytosis. Various strains possess antigenically distinct polysaccharides in the capsule, each inciting the formation of antibodies in the host. The antipolysaccharide antibodies are specific, because once formed they will react typically with only the particular type of capsular polysaccharide that initiated their production. Such reactions result in the destruction and removal of the capsule from the cell wall, thereby rendering the pneumococcus vulnerable to phagocytosis.

Gram-stained smears of sputum or blood specimens reveal the typical gram-positive, lancet-shaped diplococci shown in figure 1-1. The organisms may also be seen in spinal fluid sediment, pleural fluids, or other exudates from infected tissue. The presence of a capsule is revealed in gram-stained smears as a thick halo around the cell when observed under reduced light. The polysaccharide material is more easily seen by performing a capsule stain or an India ink preparation.

Pneumococci strains require an enriched medium for their primary isolation. Trypticase soy or brain-heart infusion agar enriched with 5 percent defibrinated sheep, horse, or rabbit blood is recommended.

**Exercises (214):**

Indicate whether each of the following statements is true (T) or false (F) and correct those that are false.

- T F 1. In young cultures, the gram-stain show the cells occurring most frequently with blunt ends, with adjoining parallel pairs (palisades) of diplococci.
- T F 2. Avirulent pneumococci cells are surrounded by a well-defined polysaccharide capsule.

T F 3. The virulence is somewhat dependent upon the capsule which functions as a barrier against phagocytosis.

T F 4. The antipolysaccharide antibodies lack specificity because they react with several different capsular polysaccharides.

T F 5. Gram-stained smears of sputum or blood specimens reveal the typical gram-positive, lancet-shaped diplococci.

T F 6. The presence of a capsule is revealed in gram-stained smears as a central swelling of the cell when observed under reduced light.

T F 7. Trypticase soy or brain-heart infusion agar enriched with 5 percent defibrinated sheep, horse, or rabbit blood is recommended for culture.

215. Cite some cultural characteristics of pneumococci in terms of the optimum pH, growth environment, and colony appearance, and point out the three major cultural phases and their significance.

**Cultural Characteristics.** The optimum pH for growth is 7.4 to 7.8. Approximately 5 to 10 percent of pneumococcal strains require an increased CO<sub>2</sub> concentration for primary growth on solid media. Thus, a candle jar or CO<sub>2</sub> incubator should be used. On blood agar, after 18 to 24 hours' incubation at 37° C., colonies of pneumococci have a fairly typical appearance. Typical pneumococcal colonies on blood agar are round and glistening with entire edges, transparent, mucoid, and about 1 mm in diameter (Type II colonies). Young colonies are domed or hemispherical in shape, but as the culture ages, autolysis results in sinking of the central portion of the colony to give rise to a flattened surface, similar to a central depression surrounded by an elevated rim.

Young cultures of incapsulated organisms produce circular, glistening, dome-shaped colonies about 1 mm in diameter. Colonies incubated anaerobically are surrounded by a zone of alpha hemolysis similar to the

greenish hemolysis observed with the viridans streptococci. Under anaerobic conditions colonies are surrounded by a zone of beta hemolysis due to oxygen labile pneumolysin O.

Colonies produced by Type III organisms are larger in size, have a watery appearance, and are usually more mucoid and confluent than those produced by the other types, a reflection of the greater size of its capsule.

There are three major cultural phases of the pneumococcus. These are the mucoid (M), the smooth (S), and the rough (R) phases. The mucoid (M) form represents normal colony appearance. It is due to the formation of a type-specific polysaccharide in the capsular material known as the specific soluble substance (SSS). The smooth (S) form has an even, shiny appearance. Its colonies lack the polysaccharide material of the mucoid phase. The rough (R) form has a rough or textured surface, and the colony is usually slightly smaller. Like the smooth form, it does not possess the mucoid type polysaccharide. Most pathogenic pneumococci are encapsulated and form the M colony. Loss of the capsule is accompanied by a loss of virulence and antigenic specificity.



Figure 1-1 *Streptococcus pneumoniae* - Gram stain of blood culture smear

**Exercises (215):**

1. What is the optimum pH required for growth of pneumococci, and approximately what percent of pneumococcal strains require an increased CO<sub>2</sub> concentration?
2. Briefly describe the typical pneumococcal colonies on blood agar.
3. Describe the appearance of the colonies as a result of autolysis.
4. Briefly describe the appearance of young cultures of encapsulated organisms.
5. What type of hemolysis is usually observed with colonies that are incubated aerobically?
6. Under anaerobic conditions, what type of hemolysis is observed and why?
7. Describe the appearance of type III colonies.

8. What are three major cultural phases of pneumococcus?
9. What phase represents the normal colony appearance?
10. The mucoid phase is due to the formation of what material?
11. What are two significant characteristics noted in most pathogenic strains of pneumococci?

**216. Identify the tests used in the laboratory identification of pneumococci in terms of the reagents, procedures, and sources of errors.**

**Laboratory Identification.** Pneumococci may be tentatively identified by the colony characteristics. However, there are certain other tests for the presumptive identification of this organism. These tests provide a reliable means of differentiating pneumococci from the alpha streptococci or other cocci. These tests include (a) bile solubility, (b) inulin fermentation, (c) optochin susceptibility, (d) the mouse virulence, and (e) the Neufeld-Quellung reaction.



**Bile solubility test.** Bile, bile salts such as sodium desoxycholate, sodium taurocholate, or sodium dodecyl sulfate (Dreft), considered surface-active agents, will act upon the cell wall of pneumococci and result in lysis of the cell. For the test, use a 24- to 48-hour culture broth of pure culture. Prepare two tubes each containing a sample of fresh culture of light suspension of the organism in buffered broth, pH 7.4. To one tube, add a few drops of 10 percent solution of sodium desoxycholate and comparable volume of sterile physiological saline solution to the second tube. If the cells are "bile soluble," the tube containing the bile salt should lose its turbidity in 5 to 15 minutes, showing an increase in viscosity along with the clearing.

**Inulin fermentation test.** This test should not be used alone because most strains of pneumococci will ferment this carbohydrate. It should be used in conjunction with other confirmatory tests, such as bile solubility, or optochin sensitivity as an identification since some strains of *Streptococcus sanguis* and *Streptococcus salivarius* also ferment it. Nevertheless, most strains of pneumococci will ferment this carbohydrate.

**Optochin disc sensitivity test.** Most strains of pneumococcus are sensitive to ethylhydrocupreine hydrochloride (optochin), whereas most strains of alpha-hemolytic streptococci are not. This test is currently the most widely used test for differentiating pneumococci from other alpha streptococci. The optochin or Taxo® P discs are placed on the heavily inoculated area of a blood agar plate. After 18 to 24 hours incubation at 36° C., pneumococci will usually exhibit a zone of inhibition greater than 15 mm in diameter as seen in figure 1-2.

Occasional strains of pneumococci are not inhibited. Reports from The Center for Disease Control (CDC) indicates that they have received cultures of "penicillin-resistant pneumococci" proving to be



Figure 1-2 Culture of *Streptococcus pneumoniae* showing zone of inhibition.



Figure 1-3 Capsular precipitin or Neufeld-Quellung reaction.

alpha streptococci, exhibiting a moderate inhibition zone of approximately 10 to 12 mm optochin, especially when a light inocula were used. The test should not be used to identify organisms in mixed cultures such as sputum.

**Animal inoculation.** The white mouse is particularly sensitive to infection with many pneumococcal types when inoculated by the intraperitoneal route. A single colony-forming unit of some types is a lethal dose. The mouse is exquisitely sensitive to most of the capsular types of pneumococci and to fatal infection 16 to 48 hours after infection. The mouse usually effectively eliminates other organisms that may be present in the 1 ml emulsified sputum, since pneumococci may be isolated in pure culture from the heart blood. Several pneumococcus types, of which type 14 is the most common, are less virulent for the mouse and do not produce fatal infections within 4 days.

**Neufeld-Quellung reaction.** The simplest, most rapid, and accurate way to identify pneumococci present in biological specimens, or in cultures, is by means of the seriological test known as the Quellung reaction. The test is not frequently used today because the treatment of pneumococcal infections is no longer dependent upon identification of the specific capsular type. However, the procedure has proved of value in epidemiological studies. If gram-stains of clinical material show the pneumococcus in relatively pure culture, samples of the specimen may be reacted with type-specific antisera on a glass slide and observed for the Neufeld-Quellung reaction. We expose the organism to type-specific antisera for the strains most commonly responsible for human infections. When a pneumococcus type is mixed with its specific antipolysaccharide antibody, the capsule appears to swell and becomes markedly defined under microscopic observation. This is the basis of the Neufeld-Quellung reaction, as shown in figure 1-3. Table 1-5 shows how we

**TABLE 1-5**  
DIFFERENTIATION OF PNEUMOCOCCI FROM ALPHA STREPTOCOCCI

Organism	Hemolysis	Colonial Morphology	Capsules	Quellung Reaction	Optochin (Taxo-P) <sup>®</sup>
Pneumococci	Alpha	Small, flat, shiny or mucoid, depressed center and concentric rings	Usually present	Positive	Sensitive
Alpha Streptococci	Alpha	Small, raised dome-shaped, smooth, translucent, or opaque	Absent	Negative	Resistant

NOTE: Colonies of pneumococcus type III are generally larger, raised, and more mucoid, with a tendency to form confluent growth. These forms resemble droplets of oil.

can distinguish between pneumococci and the morphologically similar alpha streptococci by employing a combination of tests—bile solubility, optochin sensitivity, and serological studies.

**Exercises (216):**

Match each test in column B with the statements in column A by placing the letter of the column B item beside the number of the column A item that most nearly describes it. Each element in column B may be used once, more than once, or not at all.

*Column A*

- \_\_\_\_\_ 1. Sodium desoxycholate, will act upon the cell wall of pneumococci and result in lysis of the cell.
- \_\_\_\_\_ 2. The test is positive for some strains of *Streptococcus sanguis* and *Streptococcus salivarius*.
- \_\_\_\_\_ 3. If this test is positive, the tube containing the bile salt should lose its turbidity in 5 to 15 minutes.
- \_\_\_\_\_ 4. Most strains of pneumococci will ferment this carbohydrate.
- \_\_\_\_\_ 5. Currently the most widely used test to differentiate pneumococci from alpha streptococci.
- \_\_\_\_\_ 6. After 18 to 24 hours incubation at 36° C., pneumococci will usually exhibit a zone of inhibition greater than 15 mm.
- \_\_\_\_\_ 7. A single colony-forming unit of some types is a lethal dose in this test.
- \_\_\_\_\_ 8. The test is not frequently used today because the treatment of pneumococcal infections is no longer dependent upon identification of the specific capsular type.
- \_\_\_\_\_ 9. Occasional strains of pneumococci are not inhibited in this test.

*Column B*

- a. Neufeld-Quellung reaction.
- b. Optochin disc sensitivity test (Taxo® P).
- c. Inulin fermentation.
- d. Animal inoculation.
- e. Bile solubility.
- f. Taxo® A.

*Column A*

- \_\_\_\_\_ 10. This test should not be used to identify organisms in mixed cultures.
- \_\_\_\_\_ 11. In this test, type 14 is the most common among the less virulent strains which do not produce fatal infections within 4 days.
- \_\_\_\_\_ 12. When a pneumococcus type is mixed with its specific antipoly-saccharide antibody, the capsule appears to swell.

**1-4. Corynebacterium**

Currently as constituted, the genus *Corynebacterium* includes three major groups: (a) human and animal parasites and pathogens, (b) plant pathogenic corynebacteria, and (c) nonpathogenic corynebacteria. Anaerobic diphtheroids, such as *C. acnes* and *C. parvum*, and now excluded from the genus *Corynebacterium* and reclassified in the genus *Propionibacterium*.

*Corynebacterium diphtheriae* is the only major human pathogen of the corynebacteria group of organisms, a group that also contains a number of harmless, poorly described saprophytes frequently found on the surface of mucous membranes. Three distinct cultural types recognized are *gravis*, *intermedius*, and *mitis*. Corynebacteria are classified taxonomically as follows:

**PART 17. ACTINOMYCETES AND RELATED ORGANISMS**  
Coryneform Group of Bacteria

Genus I. *Corynebacterium*

- a. Human and Animal Parasites and Pathogens.
- b. Plant Pathogenic Corynebacteria.
- c. Non-pathogenic Corynebacteria.

**217. Cite the clinical significance of *Corynebacterium diphtheriae* in terms of the sources of isolation, disease produced, process, and the type of toxin produced.**

**Clinical Significance.** *Corynebacterium diphtheriae* is found in the upper respiratory tract of infected individuals and asymptomatic carriers. The organism is rarely isolated from the skin or wounds. The bacilli are spread by nasal or oral droplets, or by direct contact. The virulent bacilli invade the mucous membranes, multiply rapidly, and produce a powerful exotoxin. Absorption of the toxin by the mucous membrane yields an acute inflammatory response and destruction of the epithelium. The accumulation of fibrin, red blood cells, and white blood cells results in the formation of a gray, clotted film or "pseudomembrane" that covers the tonsils, pharynx, or larynx.

As the disease progresses, the toxin is absorbed by other tissues. The organisms remain localized in the upper respiratory tract. In clinically typical diphtheria, lesions and pseudomembranes in the throat usually yield large numbers of the characteristic bacilli upon direct microscopic examination of smears. It is the exotoxin, disseminated to the blood and deeper tissues, which accounts for the symptoms of systematic involvement.

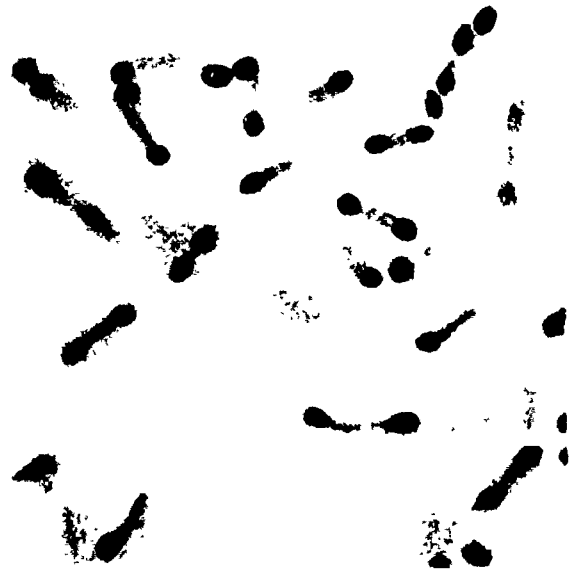

Figure 1-4. *Corynebacterium diphtheriae*.

**Exercises (217):**

1. *Corynebacterium diphtheriae* is most likely to be isolated from what part of the body of infected individuals and asymptomatic carriers?
2. How is the bacilli spread?
3. How does the virulent bacilli cause cell destruction?
4. How is the "pseudomembrane" formed, and what organs are affected?
5. As the disease progresses, what happens to the toxin?
6. In clinically typical diphtheria, what specimens will yield large amounts of the characteristic bacilli upon direct microscopic examination of smears?
7. What type of toxin is produced?

**218.** Point out some general characteristics of corynebacteria in terms of the morphology, the type of stain used, the characteristic appearance after staining process, and general methods used for identification.

**General Characteristics.** The corynebacteria are slender, gram-positive rods measuring from 1 to 6 microns in length and 0.3 to 0.8 microns in width. They usually exhibit considerable pleomorphism. In addition to straight or slightly curved rods, club- or dumbbell-shaped forms are common. The diversity of shapes stems from the irregular distribution of cytoplasmic granules—metachromatic or Babes-Ernst granules—that distort the cell wall.

In smears stained with Loeffler's alkaline methylene blue and similar dyes, the metachromatic granules appear as deeply stained bodies against a lighter cytoplasm. This contrast gives the cell a banded, barred, or beaded appearance. Corynebacteria are characteristically arranged in palisades, but L-, V, or Y-shaped branching forms may also occur. Microscopic groupings have been compared to "Chinese letters" or piles of matches as shown in figure 1-4. Although the appearance of *C. diphtheriae* in stained smears is highly characteristic, it should not be identified by morphology alone because many diphtheroids and actinomycetes stain in the same irregular fashion and are also pleomorphic. It is important to remember, however, that diphtheroids are usually shorter and thicker, with rounded ends, and are found in parallel rows or irregular groups as we can observe in figure 1-5 with *Corynebacterium pseudodiphtheriticum*. Confirmation requires that *C. diphtheriae* be isolated in pure culture and identified by means of cultural, biochemical, and toxigenicity tests.

**Exercises (218):**

1. What causes the pleomorphism observed on examining a gram-stain of corynebacteria?
2. What stain(s) is used to demonstrate the characteristic appearance of corynebacteria?
3. With the type staining indicated in exercise 2, how do the metachromatic granules appear?
4. Characteristically, corynebacteria are arranged in what morphological forms?
5. What other two groups of organisms stain in the same irregular fashion as *C. diphtheriae* and are also pleomorphic?
6. What is the usual morphological appearance of diphtheroids bacilli?
7. Confirmation requires that *C. diphtheriae* be isolated in pure culture and identified by which three methods?

**219. Cite some media required for growth of corynebacteria, colony, and morphological appearance on given media, and point out differences between *C. diphtheriae* and *C. haemolyticum* as well as *C. ulcerans* and the general characteristics by which they can be differentiated.**

**Cultural Characteristics.** Good growth of the corynebacteria is usually obtained on enriched media, such as infusion agar with added blood. The most characteristic morphological forms are found in smears from an 18- to 24-hour culture on Loeffler serum medium which appears to enhance pleomorphism. Potassium tellurite added to blood or chocolate agar provides a differential and selective medium. Contaminants are not inhibited, and after one day *C. diphtheriae* appears as characteristic gray or black colonies. This characteristic is significant in distinguishing the organism in mixed cultures and aids to differentiate the three types: *gravis mitis*, and *intermedius* as shown



Figure 1-5. *Corynebacterium pseudodiphtheriticum*.

in table 1-6. *C. diphtheriae* is aerobic and grows best at 35° C. to 37° C. Many media incorporating the use of salts of tellurite have been formulated for the isolation of *C. diphtheriae*. The Center for Disease Control (CDC) has used Cysteine-Tellurite (CT) medium and a modification of Tinsdale's medium (serum-cysteine-thiosulfate-tellurite agar) for isolating *C. diphtheriae* from mixed cultures. Many authorities prefer using CT medium if one tellurite medium can be used because it has yielded positive culture when Tinsdale's medium failed to support the growth of *C. diphtheriae*.

*Corynebacterium haemolyticum* grows poorly on tellurite medium. The morphology is similar to *C. diphtheriae*. Growth in broth is poor without added serum enrichment. The organisms have been reported in cases of acute pharyngitis and cutaneous infections. Even though the organism morphologically resembles *C. diphtheriae*, it can be readily differentiated by cultural and biochemical characteristics. It does not produce diphtheria toxin.

*Corynebacterium ulcerans* has more marked pleomorphism than that of *C. diphtheriae*. There are fewer metachromatic granules than *C. diphtheriae*. Some strains produce diphtheria toxin in addition to a toxic factor that is not an exotoxin. Growth is similar to *C. diphtheriae* on tellurite medium and is more luxuriant on Loeffler or Pai medium.

**Exercise (219):**

1. Good growth of the corynebacteria can be obtained on enriched media such as \_\_\_\_\_ with added \_\_\_\_\_.
2. The most characteristic morphological forms of corynebacteria are found in smears from an 18- to 24-hour culture on what medium?

TABLE 1-6  
COLONY CHARACTERISTICS OF CORYNEBACTERIA

Species	Blood Agar (18 to 24 hours)	Loeffler's Serum Medium (18 to 24 hours)	Potassium Tellurite Agar (48 hours)
<i>C. diphtheriae</i> , var. <i>gravis</i>	Small, gray, dull opaque colonies which are non-hemolytic.	Circular, convex, cream-colored colonies with raised centers.	Flat; irregular, slate-gray colonies with a dull surface (2 to 3 mm. in diameter).
<i>C. diphtheriae</i> , var. <i>intermedius</i>	Small, gray, dull opaque colonies which are non-hemolytic.	Similar to var. <i>gravis</i> .	Circular, convex colonies with brownish-gray color against a white background (0.2 to 0.3 mm. in diameter).
<i>C. diphtheriae</i> , var. <i>mitis</i>	Small, gray, dull opaque colonies which are usually hemolytic.	Similar to var. <i>gravis</i> .	Black, convex colonies with a glistening surface (1.0 to 1.5 mm. in diameter).
Diphtheroid bacilli	*Colonies considerably variable and nonhemolytic.	Similar to var. <i>gravis</i> .	Flat colonies, light gray or dark in center with white or gray translucent periphery.

\* Certain diphtheroids form colonies that are dull and flat with a slightly rough surface. Others form staphylococcus-like colonies that are large, grayish white and smooth surfaced. Yellowish pigmented forms resembling *Neisseria* spp. are occasionally encountered.

3. What substance added to blood or chocolate agar provides a differential and selective medium?
  4. What type of colony appearance is evident when the differential and selective medium is used as in exercise 3?
  5. The differential and selective medium used is significant in distinguishing the organism in \_\_\_\_\_ cultures and aids in differentiating the three types of *C. diphtheriae*; namely, \_\_\_\_\_ and \_\_\_\_\_.
  6. What medium has been used successfully by the Center for Disease Control (CDC) when Tinsdale's medium failed to support the growth of *C. diphtheriae*?
  7. Even though *C. haemolyticum* is morphologically similar to *C. diphtheriae*, it can be readily differentiated by what two characteristics?
  8. Even though the growth of *C. ulcerans* is similar to *C. diphtheriae*, how does the morphological characteristics of *C. ulcerans* differ?
220. State the laboratory methods used for identification of *C. diphtheriae* in terms of the principle, and types of tests and procedures; cite some diphtheroid bacilli which are morphological similar and sometimes indistinguishable from the diphtheria bacilli.
- Laboratory Identification.** The diphtheria bacilli on tellurite media are shorter, staining more uniform,

and the granules are less readily seen than when grown on Loeffler or Pai medium. As a result of this, most laboratories use both media.

**Toxigenicity tests.** The one reliable criterion for identifying a diphtheria bacillus is its ability to produce diphtheria toxin. There are two methods used to determine the toxigenicity of a suspect strain of *C. diphtheriae*: the in vivo and the in vitro.

**a. In vivo test.** Guinea pigs are usually used. In the test two guinea pigs are used weighing about 300 to 400 g each. The hair of each animal is shaven on the abdomen. One animal is injected intraperitoneally with 250 units of diphtheria antitoxin, thus making it the protected animal. Two hours later 4 ml of broth culture is injected subcutaneously into the animal. The second unprotected animal is the test animal. If the culture contains a toxigenic strain of *C. diphtheriae*, the unprotected guinea pig will die within 24 to 96 hours. The animal protected by antitoxin will exhibit no ill effects from the injection. If both animals show no ill effects, a nontoxigenic strain may be present. If both animals show ill effects, the organism is not *C. diphtheriae*.

**b. In vitro test.** For this method, a tube of melted basal medium is cooled to about 48° C. and poured into a plate that contains about 2 ml of sterile rabbit

serum and 1 ml of 0.3 percent potassium tellurite. The medium is thoroughly mixed and allowed to almost harden. Then, to the serum-medium mixture is added a sterile filter paper (1.5 by 7 cm) that has been immersed in a tube containing diphtheria antitoxin which has been diluted to contain 100 units of antitoxin per ml. The strip is pushed below the surface with sterile forceps. The plate is dried at 36° C. to ensure a moisture-free surface. Streak a loopful of the *C. diphtheriae* across the plate perpendicular to the paper in a single line as shown in figure 1-6. Incubate the plate at 36° C. for 1 to 3 days and examine. The antitoxin from the paper strip, and any toxin produced by the growing diphtheria culture, will diffuse through the medium and react in optimal proportions to produce thin lines of precipitate as shown. These lines at a 45-degree angle are seen between the filter paper and bacterial streak with those strains that are toxigenic. Known positive and negative controls should be included in the test.

**c. Biochemical tests.** Biochemical test results can often be used in addition to the morphological and cultural characteristics. Biochemical tests are helpful in differentiating *C. diphtheriae* from other corynebacteria which are often present in nose and throat cultures. *C. diphtheriae* ferments glucose and maltose,

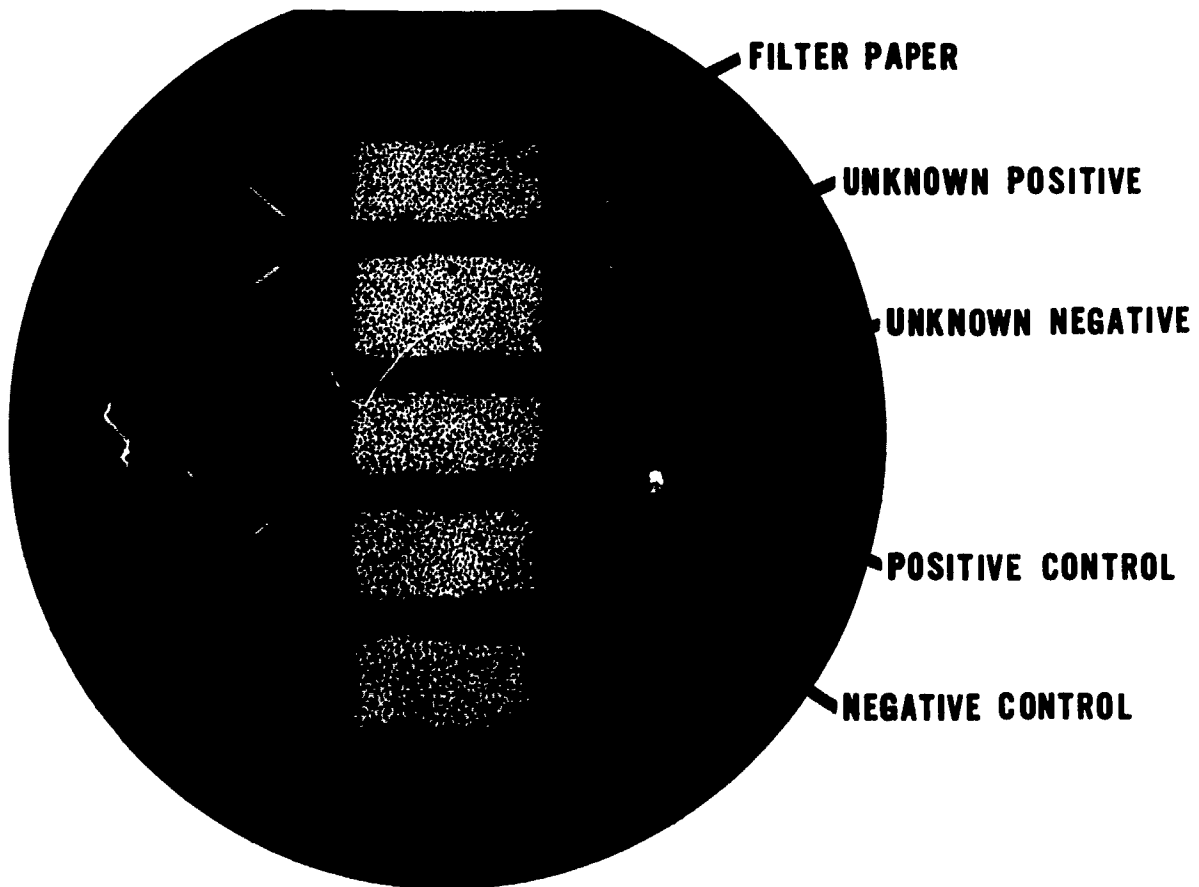

Figure 1-6. Method for in vitro demonstration of Toxigenicity of *Corynebacterium Diphtheriae*.



producing acid only. Lactose, mannitol, trehalose, and xylose are not fermented. The ability to hydrolyze urea of an isolate that morphologically somewhat resembles *C. diphtheriae* should rule it out from further consideration.

**Diphtheroid Bacilli.** It is seldom necessary to distinguish between species of the diphtheroids. The task of differentiating diphtheroids from the diphtheria bacillus is made easier, however, if you are familiar with the colonial and cellular morphology described in table 1-7. The anaerobic diphtheroids are rarely found in disease processes, but they have been implicated in cases of subacute bacterial endocarditis from time to time. *Propionibacterium acnes* (*C. acnes*), found in acne pustules, and occurring also in other types of lesions as a saprophyte, the most common anaerobic diphtheroid, has been confused with *Actinomyces* species. Since the actinomyces are catalase-negative and the corynebacteria are positive, differentiation is not difficult. Further, none of these corynebacteria produce a soluble toxin.

**Exercises (220):**

1. How do the diphtheria bacilli appear morphologically when grown on tellurite media as compared to when grown on loeffler or Pai medium?
2. What two media are used for cultivation of *C. diphtheriae*?
3. The one reliable criterion for identifying a diphtheria bacillus is based on what characteristics of the organism?
4. What type of animals are used for the in vivo toxicogenicity tests, and at what site is antitoxin injected into the protected animal?
5. What quantity of the broth culture is injected and how is it injected?
6. If the culture contains a toxigenic strain of *C. diphtheriae*, what will happen to the unprotected animal?
7. If both animals show no ill effects, what is the most likely result?
8. In the in vitro toxicogenicity test, what is added to the serum-medium mixture before it is completely hardened?

TABLE 1-7  
CHARACTERISTICS OF DIPHTHEROIDS

Name	Blood Agar (18 to 24 hours)	Loeffler's Serum (18 to 24 hours)	Loeffler's Methylene Blue Stain
<i>C. enzymicum</i>	Small, colorless, moist, or yellow-white	Fine, moist, confluent growth	Similar to <i>C. diphtheriae</i>
<i>C. striatum</i>	Circular, white, smooth, entire. Fifth day, slight hemolysis	Slightly raised, convex	Coccioid and long filamentous forms. Large metachromatic granules appear as regular bars
<i>C. xerosis</i>	Minute, circular, almost transparent, raised, smooth, pearly white	Thin, gray, adherent	Exhibits polar staining
<i>C. pseudo-diphtheriticum</i>	Gray to cream, smooth, entire	Gray to cream, smooth entire	Fairly uniform in size. No swollen ends; not barred. Granules usually absent
<i>C. acnes</i>	Very small, circular, transparent, rose colored (late)	Small, gray, (late rose colored)	Quite long, club shaped; sometimes possess rudimentary branches

9. What action is observed if the antitoxin from the paper strip reacts with any toxin produced by the growing diphtheria culture?
10. What two biochemicals are fermented by *C. diphtheriae* and which are *not* fermented?
11. What characteristic should rule out an isolate from further consideration that morphologically resembles *C. diphtheriae*?
12. What anaerobic diphtheroid is often confused with *Actinomyces* species?
13. What staining characteristics exhibited by *C. xerosis* are not typical of these diphtheroids?

#### 1-5. *Listeria* and *Erysipelothrix* Infections

*Listeria* and *Erysipelothrix* organisms resemble corynebacteria morphologically, and until the 8th Edition of *Bergey's Manual*, they were classified with these organisms in the family Corynebacteriaceae.

*L. monocytogenes* is widely distributed in nature and in a variety of animal reservoirs. The organism is morphologically similar to the diphtheroid forms. In man it produces infection with a variety of manifestations. Meningitis is the most frequent disease caused by the organism. The most unusual is an infection of the genital tract of the pregnant female and infection of the offspring either before birth or during delivery.

*E. rhusiopathiae* is the causative agent of the disease erysipeloidosis, and has a predilection for the skin, joints, and endocardium. The disease is primarily an occupational one, affecting individuals who handle fish, shellfish, poultry, and certain meat products, particularly pork.

Other properties of *Listeria* and *Erysipelothrix* are similar to those of the Lactobacillaceae, the group with which they are tentatively associated in Part 16 of *Bergey's* scheme as follows:

#### PART 16 GRAM-POSITIVE, ASPOROGENOUS ROD-SHAPED BACTERIA

Family I Lactobacillaceae

Genus I Lactobacillus

Genera of Uncertain Affiliation

Genus *Listeria*

Genus *Erysipelothrix*

221. Indicate whether given statements correctly reflect the general and cultural characteristics of *Listeria monocytogenes* in terms of the morphological appearance, growth requirements, colony appearance, and optimal temperature requirements.

#### General Characteristics of *Listeria Monocytogenes*.

*Listeria monocytogenes* is a gram-positive, nonspore-forming rod with rounded ends or diphtheroid-like bacilli. They usually occur in pairs and may resemble diplococci as indicated in figure 1-7,A. No capsule or spores are formed. The cell measures 0.4 to 0.5 to 0.5 to 2.0  $\mu$ m. The bacilli often form "palisades" on gram-stained smears, as shown in figure 1-7,A. Metachromatic granules are not observed. The organisms are actively motile by means of peritrichous flagella. Also observe in figure 1-7,B, the morphological appearance of *Listeria monocytogenes* after two days of incubation at 37° C.

**Cultural Characteristics.** *L. monocytogenes* is aerobic to microaerophilic, but growth is improved when cultures are incubated under reduced oxygen and a 5 to 10 percent CO<sub>2</sub> concentration. The organism grows well on sheep blood agar medium and after incubation at 37° C. produces small (1 to 2 mm) translucent colonies, gray to white, completely hemolytic colonies. Optimal temperature ranges from 30° C. to 37° C.; however, growth temperature ranges from 3° C. to 45° C. Colonies are recognized by their blue-green color as seen with oblique light on the clear tryptose agar. There is an umbrella-type growth 3 to 5 mm below the surface after stab of motility medium incubated at 20° C. to 25° C. Motility is more pronounced at room temperature than at higher temperatures.

#### Exercises (221):

Indicate whether each of the given statements is true (T) or false (F) and correct those that are false.

- T F 1. *Listeria monocytogenes* is a gram-positive spore-forming, nonmotil, bacilli with metachromatic granules.
- T F 2. Like Corynebacteria, the bacilli of *Listeria* often form "palisades" on gram stained smears.
- T F 3. *L. monocytogenes* usually occurs singly in chains and may resemble diplococci.



A. Young culture  
B. After 2 days incubation at 37° C

Figure 1-7. *Listeria Monocytogenes*

- T F 4. *Listeria* is aerobic to microaerophilic, but growth is improved when cultures are incubated under reduced oxygen and a 5 to 10 percent CO<sub>2</sub> concentration.
- T F 5. The organisms grow well on sheep blood agar medium and produce small, translucent colonies, gray to white alpha hemolysis.
- T F 6. Colonies are recognized by their blue-green color as seen with oblique light on the clear potassium tellurite agar.
- T F 7. Optimal growth temperature ranges from 3° C. to 45° C.
- T F 8. Motility is more pronounced at room temperature than at higher temperatures.

**Laboratory Identification.** Isolation of the organism from blood, spinal fluid, and meconium can be made by primarily inoculating sheep blood agar, tryptose agar, trypticase soy, tryptic soy, and thiol or brain heart broths. After enrichment in tryptose broth or similar medium, subculture directly to McBride *Listeria* medium. Blood agar plates should be examined for round, translucent, slightly raised, bluish-gray colonies with a fine-textured surface that varies from 0.3 to 1.5 mm in diameter and has a narrow zone of complete hemolysis. If clear media such a tryptose agar or McBride agar is used, after 18 to 24 hours incubation, they should be examined by unfiltered oblique illumination with a scanning microscope. The colonies appear characteristically blue-green color. These colonies are translucent, round, slightly raised, watery in consistency, and are 0.2 to 0.8 mm in diameter. The petri dish cover is removed and the colonies are examined with a hand magnifying lens. The motility is best demonstrated by the stab inoculation of two tubes containing 0.1 percent dextrose semi-solid agar. One should be incubated at 36° C. and the other at 25° C. Motility in the agar is more pronounced at 25° C. A ring forms just beneath the surface of the agar; a cloudlike growth then extends downward from the ring. A stained slide will show the difference in morphology. *L. monocytogenes* produces catalase. In routine fermentation studies, the organism produces acid from glucose, trehalose, and salicin in 24 hours; and is produced irregularly or slowly from lactose, maltose, and sucrose. Acid is not produced from mannitol or dulcitol. Table 1-8 shows distinguishing properties of *L. monocytogenes* in relationship to other nonsporulating gram-positive bacteria.

222. Point out laboratory techniques used for identification of *Listeria monocytogenes* in terms of the media used, distinctive growth, biochemical characteristics, and result obtained on the pathogenicity test.

**TABLE 1-8**  
**DISTINGUISHING PROPERTIES OF CERTAIN NONSPORULATING**  
**GRAM-POSITIVE ORGANISMS**

Organism	Morphology	Beta Hemolysis	Catalase	Motility	Acid from Glucose	Acid from Mannitol	Keratoconjunctivitis
<i>Listeria monocytogenes</i>	Rod	+	+	+	+	-	+
<i>Erysipelothrix rhusiopathiae</i>	Rod	-	-	-	+	-	-
<i>Corynebacterium</i> sp.	Rod	±	+	-	±	±	-
<i>Lactobacillus</i> sp.	Rod	-	-	-	+	±	-
<i>Streptococcus faecalis</i>	Coccus	-	-	-	+	+	-
<i>Streptococcus pyogenes</i>	Coccus	+	-	-	+	-	-

The ocular (Anton) test is reliable for pathogenicity. A drop of 24-hour broth culture is introduced into the conjunctival sac of a young rabbit. Marked purulent conjunctivitis develops within 24 to 36 hours after instilling *L. monocytogenes*, and will eventually heal completely.

**Exercises (222):**

1. List some media used for primary inoculation of *Listeria*.
2. After enrichment, the subculture should be directly inoculated to what medium?
3. In looking for *Listeria*, blood agar plates should be examined for what type of colonies?
4. How should tryptose or McBride agars be examined after 18 to 24 hours' incubation?
5. How will the colonies appear on examination of tryptose or McBride if growth is present?
6. Motility is best demonstrated by the stab inoculation of two tubes containing what medium?
7. Among the organisms *Listeria monocytogenes*, *Erysipelothrix rhusiopathiae*, and *Corynebacterium* sp., which organism(s) produce catalase?
8. Which carbohydrates are NOT fermented by *Listeria monocytogenes*?
9. In the ocular test for pathogenicity, what type of animal is used, and what result constitutes a positive test?

**223. Indicate whether each given statement correctly reflects the general characteristics and methods used for the identification of *Erysipelothrix rhusiopathiae*.**

**General Characteristics of *Erysipelothrix Rhusiopathiae*.** There is a morphological similarity between *Erysipelothrix rhusiopathiae* and *Listeria monocytogenes*. The smooth erysipelotheix colonies reveal slender gram-positive rods, measuring about 0.2 to 0.4 micron by 0.4 to 2.5 microns. The rods are straight or curved, with rounded ends. The cells from rough colonies may also appear as long filamentous structures.

*Erysipelothrix rhusiopathiae* grows poorly on simple media. The addition of serum or glucose enhances growth. The rough colony form of growth is favored at 37° C., while the smooth colony is produced at 33° C. After a 24-hour incubation period, the small, rough colony has a matte surface with an edge similar to anthrax colonies. The smooth colonies are round, water clear, and glistening. Many of these colonies produce partial hemolysis on blood agar after prolonged incubation. This genus is facultatively anaerobic, although it tends to grow microaerophilically. It is catalase-negative.

**Laboratory Identification.** The provisional diagnosis of erysipeloidosis is based primarily on clinical findings, but the final diagnosis rests on the isolation and identification of *Erysipelothrix rhusiopathiae* from suspected lesions. Biopsies of the lesion should be taken for culture, because positive cultures are rarely obtained from swab specimens. Initial cultivation should be started in a glucose broth, with subsequent subculture to blood agar plates. In a gelatin stab, the growth is filiform at first; then lateral radiating growth appears, lending a "test tube brush" appearance. On gelatin slants, the smooth (S) forms remain along the line of inoculation, whereas the rough (R) form spreads out over the surface.

Differentiation of the three genera *Corynebacterium*, *Listeria*, and *Erysipelothrix* is important. Table 1-8 lists some of the characteristics which help in distinguishing them. The most clear-cut difference is the absence of catalase production in *Erysipelothrix*, but motility and microscopic morphology are helpful.

**Exercises (223):**

Indicate whether each of the following statements is true (T) or false (F) and correct those that are false.

- T F 1. There is a morphological similarity between *Erysipelothrix rhusiopathiae* and *Listeria monocytogenes*.
- T F 2. *Erysipelothrix rhusiopathiae* grows well on simple media, and the addition of serum or glucose retards growth.
- T F 3. The rough colony form of growth is favored at 33° C., while the smooth colony is favored at 37° C.

- T F 4. Many of these colonies produce complete hemolysis after prolonged incubation on blood agar.
- T F 5. The final diagnosis of erysipeloidosis is based on the isolation and identification of *Erysipelothrix rhusiopathiae* from suspected lesions.
- T F 6. Swabs specimens are more appropriate because positive cultures are rarely obtained from biopsies of the lesions
- T F 7. On gelatin slants, the smooth (S) forms remain along the line of inoculation.
- T F 8. The most clear-cut difference is the absence of catalase production in *Erysip. lothrix*.

#### 1-6. *Bacillus Anthracis*

Among the members of the genus *Bacillus*, only *Bacillus anthracis* (anthrax bacillus) is clearly established as a pathogen. Certain other species of *Bacillus*, other than *B. anthracis* can be involved, even though infrequently in human disease processes. *B. sereus*, *B. circulans*, *B. pumilus*, *B. sphaericus*, and *B. subtilis* have been occasionally incriminated in cases of meningitis, pneumonia, and septicemia as reported by different bacteriologists. It is important to be aware of these saprophytes because their microscopic and colonial morphology is often indistinguishable from that of the anthrax bacillus. The saprophytic species from soil and air frequently occur as laboratory contaminants. The taxonomic classification of the bacilli is as follows:

#### PART 15. ENDOSPORE-FORMING RODS AND COCCI

Family I. *Bacillaceae*  
Genus I *Bacillus*

**224. Indicate whether given statements correctly reflect the clinical significance of *B. anthracis* in terms of the nature of origin, susceptibility of occupational groups, sources of entry into the body, types of anthrax, and the nature of the spores.**

**Clinical Significance.** *Bacillus anthracis*, the chief human pathogen in the genus *Bacillus*, is rarely encountered in the average hospital or public health laboratory. Anthrax is primarily a disease of herbivorous animals incurred during grazing on pastures contaminated by anthrax spores. Viable spores germinate in the intestinal tract or the buccal mucosa, and the bacilli are disseminated via the lymphatics to the bloodstream and deeper tissues. Infections in man are almost always of animal origin, occurring in butchers, herdsmen, woolhandlers, tanners, and other occupational groups dealing with infected animals or their products

The organisms may enter through the skin, the respiratory tract, or the intestinal mucosa. Cutaneous anthrax, the most common form of human infection, results from direct contact with infected tissue, hides, hairs, or bristles. Skin lesions may liberate bacilli, resulting in septicemia and widespread involvement of internal organs. Primary pulmonary anthrax arises from inhalation of spores disseminated into the air during the processing of infected materials, especially animal hides and fleece. Symptoms of pneumonia often progress to a fatal septicemia in untreated cases. Intestinal anthrax results from consumption of insufficiently cooked meat from infected animals or from ingestion of foods contaminated with spores. Pulmonary anthrax and infections of the intestinal tract are very rare in man, but the latter are the most common form of the disease in animals.

*Bacillus anthracis* produces no soluble exotoxin or endotoxin. Virulence is apparently associated with the ability to form a capsule. The capsule is composed of polypeptide made up of d-glutamic acid units instead of the polysaccharides common to capsules of most other bacteria.

The vegetative cells of *Bacillus* spp. are no more resistant to disinfectants or heat than other bacteria, but the spores are highly resistant. Anthrax spores have been known to survive for decades in soil. The spores ordinarily survive boiling for several minutes, and exposure to most disinfectants must be prolonged to be effective. Standard sterilization temperatures and the usual periods of heating in the autoclave successfully destroy all bacillus spores.

One of the most recent episodes of anthrax in this country resulted from imported bongo drums covered with animal hide containing the spores. Cutaneous anthrax has also resulted from contact with products such as shaving brushes made with animal bristles, ivory keys on a piano, and wool products.

#### Exercises (224):

Indicate whether each of the given statements is true (T) or false (F) and correct those that are false.

- T F 1. *Bacillus anthracis*, the chief human pathogen in the genus *Bacillus*, is most frequently encountered in the average hospital laboratory or public health laboratory.



- T F 2. Anthrax is primarily a disease of carnivorous animals incurred during grazing on pastures contaminated by anthrax spores.
- T F 3. Viable spores germinate in the intestinal tract or the buccal mucosa, and the bacilli are disseminated via the lymphatics to the blood and deeper tissues.
- T F 4. Infections in man are almost always of animal origin.
- T F 5. Infections most frequently occur among butchers, herdsmen, woolhandlers, and tanners.
- T F 6. Primary pulmonary anthrax arises from inhalation of spores disseminated into the air and is the most common form of human infection.
- T F 7. In primary pulmonary anthrax, symptoms of pneumonia often progress to a fatal septicemia in untreated cases.
- T F 8. *B. anthracis* produces a soluble endotoxin.
- T F 9. Spores produced by *B. anthracis* are poorly resistant and survive poorly in soil.
- T F 10. Standard sterilization will successfully destroy all bacillus spores.

**225. Point out some general and cultural characteristics of *B. anthracis* with reference to morphology, gram-staining, temperature of abundant spore formation, and appearance on sheep blood agar.**

**General Characteristics.** Members of the genus *Bacillus* are large, gram-positive, aerobic, sporeforming rods, usually occurring in chains, as shown in figure 1-8,A. Individual cells range between 1 to 3  $\mu\text{m}$  in width and 5 to 10  $\mu\text{m}$  in length. *Bacillus anthracis* is encapsulated and nonmotile, but the many saprophytic forms lack capsules and are usually actively motile. The encapsulated cells of *B. anthracis* found in direct smears of clinical specimens are rarely observed in smears from laboratory cultures. Most bacilli appear as long, straight-sided rods with curved ends, but the cells of *B. anthracis* often possess swollen, square, or concave ends. *B. anthracis* does not sporulate in living tissue, but spores are formed when the organism is exposed to the external environment.

In gram-stained smears of exudates and blood, *B. anthracis* is seen as large gram-positive bacilli, usually in chains of 2 to 6 cells. The bacilli may be numerous in blood smears from generalized anthrax. The capsules cannot be clearly observed in gram-stained preparations; yet, their presence may be noted as imperfectly stained, granular halos with ragged edges. Additional stains such as spore and capsule should be performed with culture isolates.

**Cultural Characteristics.** The organisms grow well on most common laboratory media, but in order to demonstrate characteristic colonial morphology, the specimens should be inoculated on 5 percent blood agar plates. The optimal temperature for maximum growth is 37° C., but growth ceases when temperatures reach as low as 12° C. and as high as 45° C. However, by continued cultivation, the organism may become adapted to either a low or high temperature and eventually attain luxuriant growth. When the organism is cultured at 42° C. to 43° C., it becomes avirulent or attenuated. Spores are formed abundantly at 32° C. to 35° C.

On sheep blood agar after 18- to 24-hours' incubation, typical colonies of the anthrax bacillus are 2 to 3 mm in diameter and appear gray-white, opaque, and dull, with irregular edges and a rough "frosted glass" appearance as shown in figure 1-8,B. On sheep blood agar, the colonies are invariably nonhemolytic. Smooth and rough forms may be observed, and they both may be virulent.

**Exercises (225):**

1. How does *B. anthracis* compare with the many saprophytic forms in terms of the capsule production and motility?
2. Under what conditions are the encapsulated cells of *B. anthracis* found?
3. When does *B. anthracis* sporulate in living tissue?



A



B

A. Morphology  
B. Colony

Figure 1-8. *Bacillus Anthracis*

4. How do the gram-stained smears of exudates and blood of *B. anthracis* appear?
5. How well are capsules observed in gram-stained preparations? If seen, how do they appear?
6. What medium should be inoculated in order to demonstrate characteristic colonial morphology?
7. At what temperatures does growth cease?
8. At what temperature ranges would virulent strains become avirulent?
9. Spores are formed abundantly at what temperature?
10. After 18- to 24-hours' incubation, how do typical colonies of the anthrax bacillus appear on sheep blood agar?

11. What type of hemolysis is produced by the colonies?

**226. Cite an important characteristic for differentiating *B. anthracis* from other saprophytic forms; the organism most easily mistaken for *B. anthracis*; the general procedure for processing smears for microscopic examination; the medium recommended when the fluorescent-antibody technique is to be used; and methods for testing motility and pathogenicity.**

**Laboratory Identification.** Hemolysis is an important basis for differentiation. Anthrax colonies are nonhemolytic or weakly hemolytic on blood agar, noted in figure 1-8,B, while saprophytic forms are usually surrounded by a definite zone of hemolysis, as shown in figure 1-9,B. *Bacillus cereus* is the organism most easily mistaken for *B. anthracis*. Biochemical properties useful in the identification of *B. anthracis* are listed in table 1-9. Neither morphology (figure 1-9A) nor the usual cultural characteristics will differentiate *B. anthracis* from nonmotile strains of *B. cereus*.

For the microscopic examination, one of the air-dried, heat-fixed smears from the patient must be gram stained. The second should be reserved for fluorescent-antibody staining. Additional stains for

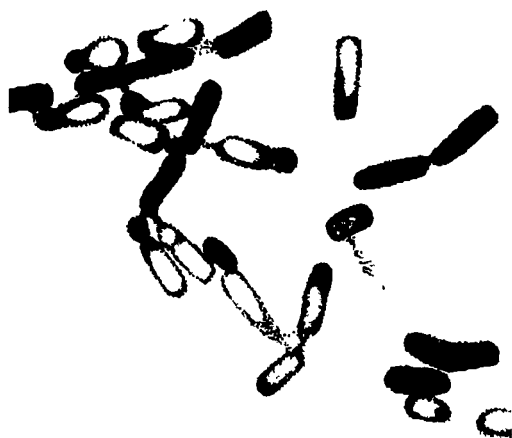

A

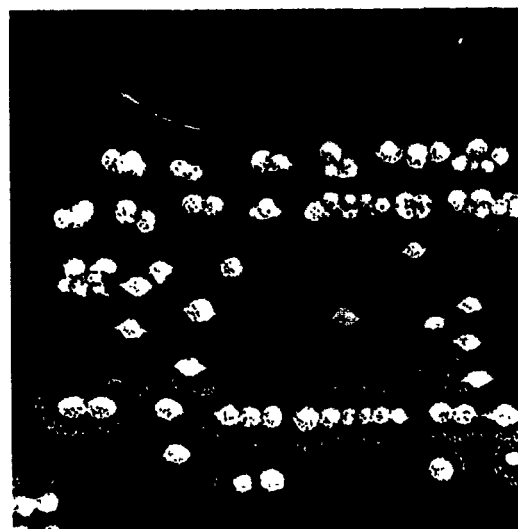

B

A Morphology  
B. Colony

Figure 1-9 *Bacillus Subtilis*

spore and capsule should be performed with organisms isolated from cultures.

When cultures are collected after initiation of antibiotic therapy, the fluorescent antibody technique may prove extremely important. If the organisms are to be examined by this technique, they must be grown on sodium bicarbonate media under a CO<sub>2</sub> atmosphere to allow capsules to develop. The capsule is a key factor only in smears taken directly from tissue or body fluids. Motility testing is useful, although this property is variable to some extent among the saprophytic species. The test may be performed on a hanging drop or by inoculating a motility medium and incubating for 4 days at 37° C. *B. anthracis* is non-motile.

The pathogenicity of the organisms is determined by injecting processed 24-hour broth culture into a guinea pig or into each of several white mice. Death resulting from anthrax infection usually occurs in 2 to 5 days but may be as late as 10 days. The organisms are readily recovered from the heart, blood, spleen, liver, and lungs of the animal.

**Exercises (226):**

1. What important characteristic may serve to differentiate anthrax colonies from saprophytic forms?
2. What organism is most easily mistaken for *B anthracis*?

3. What two staining procedures are initially done on the air-dried, heat-fixed smears from the patient for the microscopic examination?
4. What type of additional stains should be performed with organisms isolated from cultures?
5. If the organisms are to be examined by the florescent antibody-technique, they must be grown on what media? Why?
6. What two methods may be used for motility testing?
7. The pathogenicity test is determined by injecting processed 24-hour broth culture into one of what two animals?
8. The organism is recovered from which organs of the sacrificed animal?

**TABLE 1-9**  
**DIFFERENTIAL CHARACTERISTICS OF *BACILLUS ANTHRACIS***  
**AND *BACILLUS CEREUS***

ORGANISMS		CHARACTERISTICS							
	Blood Agar colony	Motility	Tenacity*	Hemolysis	Bicarbonate medium (CO <sub>2</sub> )	Fluorescent-antibody test	Pathogenicity (animal)	Litmus milk	Methylene blue
<i>B. anthracis</i>	Rough, flat, usually many comma-shaped outgrowths	Negative	Positive	None or very weak	White, round, raised, glistening, mucoid	Positive	Positive	Not reduced or slowly reduced or peptonized	Not reduced or slightly reduced in 24 hours
<i>B. cereus</i>	Rough, flat, none or few comma-shaped outgrowths	Usually Positive	Negative	Usually beta hemolytic	Flat, dull	Negative	Negative	Usually reduced in 2 to 3 days	Usually reduced in 24 hours.

\* Refers to appearance of colony when pushed gently; resembles beaten egg whites.

## 1-7. The Clostridia

*Bergey's Manual of Determinative Bacteriology*, 8th Edition, lists 61 species of clostridia. For convenience in identification, the genus is divided into four groups on the basis of spore position and gelatin liquefaction. Five species, require special media or conditions, which could not be compared directly with others, are described in the fifth group. Fortunately, not all are encountered in routine bacteriological examination, but several species are of great medical importance. Unlike the other members of the genus *Bacillus*, the genus *Clostridium* consists of obligate anaerobes. Taxonomic classification is as follows:

### PART 15. ENDOSPORE-FORMING RODS AND COCCI

#### Family I. *Bacillaceae*

#### Genus III *Clostridium*

**227. Cite the clinical significance of the pathogenic clostridia in terms of the types of diseases they produce; type of toxins; the most important histotoxic clostridia; the method used for classifying the toxins; some characteristics of the histotoxic clostridia; and the manner in which clostridial myonecrosis develops.**

**Clinical Significance.** Clostridia are widely distributed in soil, dust, and water and are common inhabitants of the intestinal tract of animals, including man. The pathogenic species produce soluble toxins, some of which are extremely potent. True exotoxins are produced by the pathogenic clostridia, several species of which are of medical significance.

The pathogenic clostridia can be divided into three major groups according to types of diseases they produce. They are as follows: (a) the histotoxic clostridia, which cause a variety of tissue infections subsequent to wounds or other traumatic injury; (b) *Clostridium tetani*, the causative agent of tetanus or "lockjaw", which produces disease through a potent exotoxin that is produced during limited growth within tissue; (c) *C. botulinum*, which is the cause of botulism, a food poisoning caused by the ingestion of a powerful exotoxin previously formed by the organisms in contaminated food.

**The Histotoxic Clostridia.** The histotoxic clostridia cause a severe infection of muscle, clostridial myonecrosis. The frequently used and older synonyms for this infection are "gas gangrene" and "clostridial myositis." The term "gas gangrene," however, is misleading since the presence of gas in the infected tissues may be a late or variable manifestation of the disease and the "clostridial myositis" suggests muscle inflammation rather than the actual pathological condition, necrosis. The most important histotoxic clostridia are *Clostridium perfringens*, *C. novyi*, and *C. septicum*. Three other organisms of lesser importance and also capable of producing clostridial myonecrosis are *C. histolyticum*, *C. sordellii*, and *C. fallax*. All of these

histotoxic clostridia produce a variety of toxins of different potencies, and for each species toxins are designated by Greek letters in order of importance or discovery. Thus, the alpha toxins of unlike species are not identical. These histotoxic clostridia are not highly invasive pathogens, but they play an opportunistic role that requires a special set of conditions within tissue in order to initiate infection. *C. perfringens* is cultured from 60 to 90 percent of cases of myonecrosis. *C. perfringens* has five toxin types designated as A through E. Type A produces the classic gas gangrene in humans. *C. novyi* is divided into four toxigenic types: A, B, C, and D. Type A, again, is implicated in gas gangrene of humans. *C. perfringens* is the most frequent cause of the disease, either singly or in combination with other anaerobes.

Clostridial myonecrosis develops as a complication of severe traumatic injuries, especially lacerated wounds accompanied by a compound fracture. In these injuries the blood circulation to a local tissue area is often impaired or destroyed. The resulting necrotic tissue, void of oxygen and rich in microbial nutrients, affords an ideal anaerobic environment in which clostridial spores germinate and multiply. The organisms actively metabolize tissue carbohydrates to acid and gas. The gangrenous process extends to other tissues primarily as a result of exotoxins excreted by the pathogenic clostridia. In addition, bacterial enzymes may exhibit hemolytic, necrotizing, and lethal effects on tissue cells. Clostridial myonecrosis consists usually of a mixed infection of toxigenic (toxin-producing) and proteolytic (protein-destroying) clostridia and other gram-positive or gram-negative anaerobic organisms. The accessory organisms may contribute to the severity of infection. The antitoxin employed in treating gangrene usually consists of pooled, concentrated immune globulins against toxins of *C. perfringens*, *C. novyi*, and *C. septicum*.

#### Exercises (227):

1. What are the three major groups of pathogenic clostridia?
2. What type of disease is caused by *C. tetani*?
3. What is botulism?
4. What disease is caused by the histotoxic clostridia?
5. Why is the term "gas gangrene" considered to be misleading?

6. Which three organisms are considered the most important histotoxic clostridia?
7. Since all the other histotoxic clostridia produce a variety of toxins, how are they designated?
8. What type of role does the histotoxic clostridia play within the tissue in order to initiate infection?
9. How many toxin types does *C. perfringens* have? What are they?
10. Which organism is the most frequent cause of clostridial myonecrosis?
11. How does clostridial myonecrosis develop?

**228. Point out the clinical significance of *Clostridium tetani* and *Clostridium botulinum* in terms of the origin of the disease process, the types of toxins produced; and some symptoms associated with diseases caused by these organisms.**

**Clostridium Tetani.** *Clostridium tetani* is the etiologic agent of tetanus (lockjaw). This disease follows the introduction of tetanus spores (from soil or feces) into puncture wounds, burns, surgical sutures, or traumatic injuries. If anaerobic conditions prevail in the wound, the spores germinate to form the vegetative bacilli which produce the toxin whose action precipitates the disease. The rapidly absorbed toxin acts on the tissue of the spinal cord and peripheral motor nerve endings. The toxemia is evidenced by muscle spasms near the site of infection and subsequent spasms of the jaw muscles (lockjaw). The nerves of other voluntary muscles are progressively involved, causing toxic spasms and convulsions.

**Clostridium Botulinum.** *Clostridium botulinum* is responsible for an often fatal type of food poisoning called botulism. Outbreaks occur following the ingestion of food in which the organism has produced a highly potent exotoxin. In the anaerobic environment of a foodstuff, the spores germinate to form vegetative cells which, in turn, produce the toxin. The spores will withstand a temperature of 100° C. for at least 3 to 5 hours.

Toxin-containing foods may appear spoiled and rancid, and cans may be swollen due to gas formation by the organism. In some cases, however, the food appears entirely innocuous. The toxin itself is destroyed by heating the food at 100° C. for 10 minutes. Outbreaks of botulism are rare in the United States because of rigid quality control in commercial canning and food preservation. Nevertheless, cases of botulism still occur from consumption of home-preserved foods containing *C. botulinum* exotoxin.

There are seven serologically distinct types of *C. botulinum* designated A through G, on the basis of the type of toxin produced. Man is susceptible to types A, B, E, and F, birds primarily to A and C, ruminants to C and D, and mink to A, B, C, and E. Type A toxin is the most poisonous substance known. From 18 to 48 hours following the consumption of toxic food, neurotoxic symptoms are evidenced by visual disturbances, inability to swallow, and speech difficulty. Progressive signs of bulbar paralysis are exhibited, and the disease can terminate fatally from respiratory failure and cardiac arrest.

#### Exercises (228):

1. What are some ways in which *C. tetani* enters the body?
2. Rapidly absorbed toxins act upon what tissue?
3. In the anaerobic environment of a foodstuff, the spores of *C. botulinum* germinate to produce what substance?
4. Man is susceptible to which of the serological types of toxins produced by *C. botulinum*?
5. What type toxin is the most poisonous substance known?
6. What are some initial symptoms which follow 18 to 24 hours after the consumption of toxic food?

**229. Indicate whether the given statements correctly reflect general characteristics of members of the genus *Clostridium* in terms of morphology, staining characteristic and growth requirements.**



**General Characteristics.** Members of the genus *Clostridium* are large, gram-positive rods of variable length and breadth, ranging from long filamentous forms to short, plump bacilli. In an appropriate environment, most species produce a single, round or oval spore, which may be located centrally, subterminally, or terminally within the vegetative cell. The spores appear as swollen bodies since they are generally wider than the diameter of the rods in which they develop. The shape and position of the spore, as well as the fact that it does or does not distort the vegetative cell, are characteristics which help in species identification.

Spores of clostridia are not stained by the routine aniline dyes. In methylene blue- and gram-stained smears, spores are seen as unstained areas against the darkly staining cytoplasm, or as free hyaline bodies shown in figure 1-10. The relatively impervious spores may be effectively stained by the Wirtz-Conklin technique discussed in Chapter 4 of Volume 1. Stained smears of culture materials usually reveal spores, except that *C. perfringens* fails to sporulate on most laboratory media.

Gram-stained smears of fresh clinical specimens show large gram-positive rods with or without spores. Unfortunately, however, the bacilli of gas gangrene cannot be distinguished morphologically from the saprophytic putrefactive anaerobes that may be associated with gangrene. Frequently, specimens from gangrenous lesions are contaminated with gram-negative rods and gram-positive cocci. For these reasons, direct smears are only of presumptive value, and gangrenous lesions must be cultured. Direct examination of suspected foods from outbreaks of botulism is of little or no value, since very few organisms are ordinarily present in such specimens.

The majority of clostridia are obligate anaerobes. The majority of them are motile, but *C. perfringens*, the species most frequently isolated from clinical material, is nonmotile. Growth may be obtained over a wide range of temperature, but 37° C. is optimum for pathogenic species. Although the nutritive requirements among the clostridia vary, the organisms can be isolated from specimens using blood agar of thioglycollate medium containing 0.6 percent glucose. Anaerobic conditions may be provided by incubating the inoculated blood agar plates in a suitable anaerobic environment. The clostridia grow well in the depths of thioglycollate medium, which provides the necessary anaerobic conditions without the necessity of providing an airtight seal for the mouth of the culture tube.

**Exercises (229):**

Indicate whether each of the given statements is true (T) or false (F) and correct those that are false.

T F 1. Members of the genus *Clostridium* are small, gram-positive rods, short and plump bacilli.



Figure 1-10. *Clostridium Tetani*.

- T F 2. In the suitable environment, most species produce a single, round, or oval spore which may be located centrally, subterminally, or terminally within the vegetative cell.
- T F 3. Spores of clostridia are best stained with methylene blue-and gram-stains.
- T F 4. *Clostridium septicum* fails to sporulate on most laboratory media.
- T F 5. Direct examination of suspected foods in cases of botulism is of great value in identifying the organism.
- T F 6. The majority of clostridia are microaerophiles.
- T F 7. The majority of clostridia are nonmotile, except *C. perfringens*.
- T F 8. The clostridia grow well in the depths of thioglycollate medium, which provides the necessary anaerobic conditions.

**236 Cite media used for isolation of the pathogenic clostridia, growth characteristics, fermentative reactions, and media recommended for species differentiation.**

**Laboratory Identification.** After overnight incubation on rabbit, sheep, ox, or human blood agar at 37° C., typical colonies of almost all *Clostridium* spp. produce distinct, complete hemolysis. *Clostridium perfringens* produce a distinct characteristic pattern of hemolysis on blood agar plates, precipitation in serum on egg yolk media, and stormy fermentation in milk media. For example, on blood agar the colonies of most strains demonstrated a characteristic target or double zone of hemolysis, as shown in figure 1-11. This results from a narrow zone of complete hemolysis due to the theta toxin and a much wider zone of incomplete hemolysis due to the alpha toxin. This is seen as a definite, narrow 1- to 2-mm zone immediately around the colony, surrounded by a wider 4- to 5-mm zone of partial hemolysis. If growth of large gram-positive bacilli is obtained on blood agar in an anaerobic culture, a member of the genus *Clostridium* should be strongly suspected.

In addition to clostridia, gangrenous infections may contain enteric bacteria or *Pseudomonas* spp. Under such circumstances, the primary anaerobic blood agar plate may be overgrown with these gram-negative organisms, thereby making the isolation of *Clostridium* spp. on blood agar difficult or impossible. If overgrowth occurs, incubate the primary thioglycollate medium (inoculated at the time the plate was streaked) for 48 to 72 hours. During this extended period of incubation the gram-negative bacilli will tend to die out, allowing isolation of clostridia in subculture.

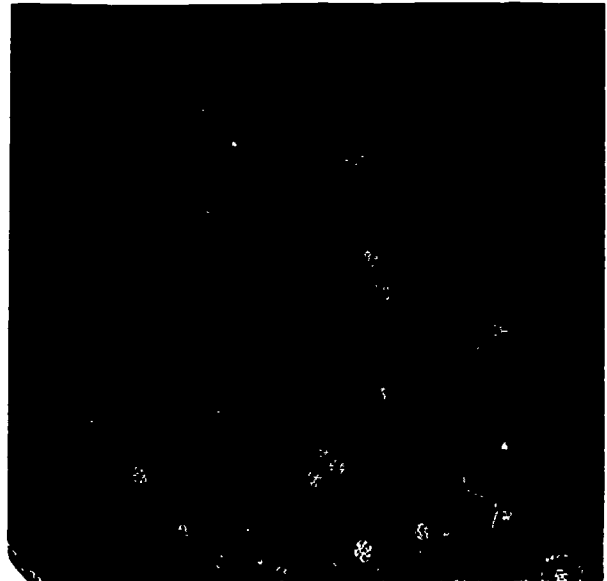

Figure 1-11. *Clostridium perfringens*.

When spores of a possible *Clostridium* spp. are seen in thioglycollate medium containing a mixed culture, heat resistance of the spore form may be used to advantage in obtaining isolation. An inoculum consisting of a sample of the mixed bacterial culture is placed in a fresh tube of thioglycollate medium and heated at 80° C. for 15 to 30 minutes. This heating will destroy all vegetative cells, but not the spores. The heated medium is then incubated for 24 to 48 hours, and the germinating spores give rise to a population of clostridia free of nonsporeforming species. Rarely will *Clostridium perfringens* be isolated by this method, however, because the bacterium generally

Dextrose	Negative		<i>C. tetani</i> <i>C. histolyticum</i>	
	Positive	Lactose Positive	<i>C. perfringens</i> <i>C. septicum</i> Nonpathogens of butylbutyric group	
		Lactose Negative	<i>C. hemolyticum</i> <i>C. sporogenes</i> <i>C. botulinum</i> <i>C. novyi</i>	Others

Figure 1-12. Fermentative groups of *Clostridium* species.

TABLE I-10  
DISTINGUISHING CHARACTERISTICS OF SOME  
FREQUENTLY ENCOUNTERED CLOSTRIDIA

Organisms	Colonies on blood agar	Hemolytic zones	Spores	Sporangia	Motility	Cooked meat medium	Dextrose	Lactose	Sucrose	Salicin	Indole	Nitrate reduction	Gelatin liquefaction
<i>C. perfringens</i>	Round, smooth, opaque	Double	Rare, ovoid, eccentric	Not swollen	-	Gas; no digestion	+	+	+	Usually -	-	+	+
<i>C. septicum</i>	Medium, rhizoid	Single	Ovoid, eccentric	Slightly swollen	+	Gas; no digestion	+	+	-	+	-	+	+
<i>C. novyi</i>	Medium rhizoid	Single	Ovoid eccentric	Slightly swollen	+	Gas; no digestion	+	-	-	-	-	-	+
<i>C. biferm-tans</i>	Crenated to Ameboid	Single	Ovoid, eccentric	Not swollen	+	Gas; blackening	+	-	-	+(-)	+	-	+
<i>C. sporogenes</i>	Large, rhizoid	Single	Ovoid, eccentric	Swollen	+	Gas; blackening, digestion	+	-	-	-	-	-	+
<i>C. botulinum</i> A, B	Granular translucent, fimbriate	Single	Ovoid, eccentric	Swollen	+	Gas, blackening, digestion	+	-	-	-	-	-	+
<i>C. histolyticum</i>	Smooth, transparent	Single	Ovoid subterminal	Swollen	+	Gas, blackening	-	-	-	-	-	-	+
<i>C. tetani</i>	Spreading, translucent filamentous	Single	Round, terminal drumstick	Swollen	+	Slight gas; slow blackening	-	-	-	-	-	-	+

fails to sporulate in culture. Thus, this method is not recommended for *C. perfringens*.

Cooked-meat medium also may be used for cultivation of the spore forming anaerobes. Tubes of this medium require a petrolatum seal if obligate anaerobes are being cultured. Proteolytic activity is recognized by digestion of the solid material of the medium which is quite readily detected. The Negler reaction is recommended for rapid identification of *C. perfringens*. The medium in this reaction, 10 percent egg yolk in blood agar base, is placed in a Petri dish and one half the surface is smeared with a few drops of *C. perfringens* type A antitoxin (antilecithinase). The culture is then streaked in a single line diagonally across the plate. A dense opalescence (precipitate) in human serum is produced by growing organisms or by the supernatant fluid from an overnight culture. This reaction is caused by alpha toxin (a lecithinase C) and is specifically inhibited by *C. perfringens* antitoxin.

Bacteria may be tentatively identified as members of the genus *Clostridium* on the basis of strict anaerobiosis, and characteristic microscopic and colony morphology. Final identification is dependent upon the results of biochemical studies and the demonstration of exotoxin production.

The clostridia may be placed in three fermentative groups on the basis of their reactions in dextrose and lactose, as shown in figure 1-12. The characteristics recommended for species differentiation are listed in table 1-10. Media recommended for species differentiation include the following: (a) Trypticase agar base—for motility, spore formation, and stock culture; (b) Trypticase dextrose, lactose, sucrose, salicin agar—for fermentation; (c) Thioglycollate plus gelatin (Thiogel, BBL); (d) Trypticase blood agar—for hemolysis; (e) Trypticase nitrate broth—for indole production and nitrate production; (f) Cooked-meat medium under petrolatum—for proteolysis. The inoculated media indicated are incubated for 2 to 7 days at 35° C. to 37° C. In most cases 2 days are sufficient if growth is prompt and adequate.

#### Exercises (230):

1. *C. perfringens* produce a characteristic pattern on what three media?
2. On blood agar, what characteristic type of hemolysis is demonstrated by *C. perfringens*?
3. What causes the characteristic type of hemolysis produced on blood agar by *C. perfringens*?
4. If overgrowth occurs in the primary isolation of *Clostridium* spp., what should be done to eliminate this condition?
5. When a sample of the mixed bacterial culture is placed in a fresh tube of thioglycollate medium and heated at 80° C. for 15 to 30 minutes, the heating will destroy all negative cells, but not spores. Why will *Clostridium perfringens* rarely be isolated by this method?
6. In the cooked-meat medium, how is proteolytic activity recognized?
7. The Negler reaction is recommended for rapid identification of what organisms?
8. In the Negler reaction, what inhibits the reaction caused by the alpha toxin (a lecithinase C)?
9. Members of the genus *Clostridium* may be tentatively identified on the basis of what three characteristics?
10. Clostridia may be placed in three fermentative groups on the basis of their reactions on what two carbohydrates?
11. Among the media recommended for species differentiation, which medium is used for motility, spore formation, and stock culture?
12. Which medium is used for proteolysis?

## The Gram-Negative Cocci and Coccoid Forms

THE BACTERIOLOGIST HAS long been acquainted with members of the family *Neisseriaceae*, the true gram-negative cocci, because two species of the aerobic genus *Neisseria* have proved to be persistent challenges to the medical profession. *Neisseria gonorrhoeae*, the causative agent of the venereal disease, gonorrhoea, is still prevalent around the world. The meningococcus, *N. meningitidis*, poses a constant threat in the form of outbreaks of cerebrospinal meningitis, even in the most advanced nations.

Other organisms of the family *Veillonellaceae*, chiefly of the genus *Veillonella*, are not as well known, but these gram-negative cocci are associated with disease as secondary invaders or as "opportunistic pathogens." Other genera in the family *Neisseriaceae* include *Branhamella*, *Moraxella*, and *Acinetobacter*. The morphological similarity of these genera to the *Neisseria* and *Veillonella*, and the occurrence of each of these groups in clinical specimens, complicated the diagnostic problem. The aforementioned coccoid forms are thought to be closely related taxonomically to the *Neisseria*.

*Acinetobacter* species, formerly members of De Bord's tribe *Mimiae*, have undergone a major taxonomic revision, and the organisms known previously as *Herellea vaginicola* and *Mima polymorpha* are considered by medical bacteriologists as members of the genus *Acinetobacter*. The aforementioned organisms are listed in the 8th Edition of *Bergey's Manual of Determinative Bacteriology* as follows:

### PART 10. GRAM-NEGATIVE COCCI AND COCCOBACILLI

Family I.	<i>Neisseriaceae</i>
Genus I.	<i>Neisseria</i>
Genus II.	<i>Branhamella</i>
Genus III.	<i>Moraxella</i>
Genus IV.	<i>Acinetobacter</i>

### PART 11. GRAM-NEGATIVE ANAEROBIC COCCI

Family I.	<i>Veillonellaceae</i>
Genus I.	<i>Veillonella</i>

There is one last genus that we will mention in this chapter, the *Mycoplasma*, or so-called pleuropneumonia-like organisms (PPLO).

Presently, there are seven identified species of *Mycoplasma* indigenous to man. Since the time of

discovery, these organisms have been studied in infections of the urogenital and respiratory tracts, wound infections, as tissue culture contaminants, and in animal hosts other than man. Cells do not gram stain but can be stained (poorly) with Giemsa. They are a heterogeneous group of unicellular, procaryotic organisms that lack a cell wall. The PPLO have been set apart in their own order and family as indicated below:

### PART 19. THE MYCOPLASMAS

Class I.	<i>Mullicutes</i>
Order I.	<i>Mycoplasmatales</i>
Family I.	<i>Mycoplasmataceae</i>
Genus I.	<i>Mycoplasma</i>
Family II.	<i>Acholeplasmataceae</i>
Genus I.	<i>Acholeplasma</i>

#### 2-1. *Neisseria* Infections of Man

Most of the ten *Neisseria* species are saprophytes, but two of them, *N. gonorrhoeae* and *N. meningitidis*, are human pathogens, as we noted previously. During an infection these two organisms are often seen intracellularly in white blood cells. The nonpathogenic *Neisseria* occur extracellularly and are important only in that they may be mistaken morphologically for pathogenic forms. Rarely have any of the saprophytes been implicated in disease. With the exception of *N. gonorrhoeae* and *N. caviae*, all species may be encountered in the respiratory tract of normal individuals.

231. Cite the clinical significance of pathogenic *Neisseria* in terms of the types and severity of infections associated with the disease.

**Clinical Significance.** The gonococcus invades the mucous membranes of the genitourinary tract or the conjunctiva. Typical gonorrhoea of males results in a urethritis characterized by painful urination and the formation of greenish-yellow pus. In gonorrhoea of females, the untreated infection usually spreads from the vagina to the urethra, cervix, and rectum. Such infections give rise to a mucopurulent discharge. The

gonococcus may invade the bloodstream from localized infections in both males and females, and lesions can form in the joints, heart valves, and meninges. *N. gonorrhoeae* commonly infects the eyes of the newborn (ophthalmia neonatorum) during passage through the birth canal. If untreated, the infection usually results in permanent blindness. In the United States the incidence of gonorrheal conjunctivitis has been greatly reduced by the legal requirement that as a preventive measure suitable medications be instilled into the conjunctival sac of all newborn infants. In both males and females, other sites that may become infected primarily or secondarily are the conjunctiva, rectum, and nasopharynx.

The portal of entry for meningococci is the nasopharynx. The organisms may constitute part of the transient flora in immune individuals, producing no symptoms, or they may set up a local nasopharyngeal infection in susceptible persons. The infection can extend to the bloodstream and to the meninges, causing meningitis. Eight groups of *N. meningitidis*, designated A, B, C, D, X, Y, Z, and Z<sup>1</sup> have been identified on the basis of agglutination reactions. Organisms in groups A, B, and C are responsible for the great majority of clinically recognized diseases. Group A strains are generally involved in epidemics of meningitis. Groups B and C have caused sporadic cases of meningitis, but group D strains have rarely been isolated from the disease in the United States. The serological typing of *N. meningitidis* found in nose and throat cultures should be done, because an increase in group A in a given population could have public health significance.

A number of saprophytic *Neisseria* species can be isolated from the upper respiratory tract of man. The most common are *N. catarrhalis*, *N. sicca*, and members of the pigmented flava group—*N. flavescens*, *N. subflava*, *N. flava*, and *N. perflava*. At this point, note that former *N. catarrhalis* has been transformed to a new genus, *Branhamella*, because it differs substantially from *Neisseria* species. The 8th Edition of *Bergey's Manual* combines the former species, *N. subflava*, *N. flava*, and *N. perflava* into one species, *N. subflava*. *N. lactamica* is encountered frequently in throat or nasopharyngeal cultures and rarely in specimens of spinal fluid or secretions from the urogenital tract.

#### Exercises (231):

1. In gonorrhea of females, if untreated, what condition can result?
2. What complications may result from localized infections in males and females?

3. Why is the incidence of gonorrheal conjunctivitis of infants so low in the United States?
4. What is the major portal of entry for meningococci?
5. The great majority of clinically recognized disease is found in which serological groups of organisms?
6. What strains of serological group are involved in epidemics of meningitis?
7. The former *N. catarrhalis*, a saprophyte, has been transferred to what new genus?
8. *N. subflava*, *N. flava*, and *N. perflava* have been combined into one species, namely \_\_\_\_\_.

**232. Point out techniques used in the laboratory identification of pathogenic *Neisseria* in terms of smear preparation, criteria for diagnosis in male and female, media used, inoculation of spinal fluid, blood and other body fluids, tests used for presumptive evidence, and factors affecting the viability of *N. meningitidis*.**

**Laboratory Identification.** *Neisseria* species characteristically appear as diplococci, approximately 0.6 by 0.8 micron in size. The organisms are nonspore-forming and nonmotile. In stained smears of pus or body fluids the paired cells often have the shape of coffee beans or kidney beans, jointed together on their concave or flattened sides. The organisms are seen within the polymorphonuclear leukocytes in detail A of foldout 1. Leukocytes may contain 20 to 50 cocci, or more. In stained smears from cultures, the typically flattened border of adjacent cells is observed. Note, for example, the arrangement and morphology of diplococci in detail B of foldout 1. While both detail A and detail B show *N. gonorrhoeae*, the microscopic morphology of *N. meningitidis* does not differ sufficiently to permit distinction between the two species.

Extra care must be taken in preparing smears from clinical materials containing these cocci. Swab specimens should be lightly rolled, rather than rubbed, on glass slides to accomplish an even distribution, and to



prevent destruction of white cells or tissue cells. This technique will give smears of even thickness that are easily scanned for the presence of intracellular organisms. The preparation of joint fluids for direct examination and culturing of *N. gonorrhoeae* is best accomplished by centrifuging the specimen and using the sediment as an inoculum. In the later, chronic stages of gonorrhea, few cocci are present in clinical materials.

In males a diagnosis of gonorrhea is usually based on history, characteristic clinical signs, and symptoms. In addition, microscopic demonstration of gram-negative, intracellular diplococci on a smear of a urethral discharge exudate constitutes sufficient basis for a diagnosis of gonorrhea.

The urethral discharge is taken directly from the penile orifice. When there is no discharge at the time of examination or the male is asymptomatic, it will be necessary to obtain a specimen from within the urethral canal for culture. Prostatic fluid may be inoculated directly onto TM medium.

To diagnose gonorrhea in women, culture specimens should be obtained from the cervix and the anal canal and inoculated on separate Thayer-Martin (TM) culture plates or in separate Transgrow bottles. The combination of a positive-oxidase reaction of colonies and gram-negative diplococci grown on either medium provides sufficient criteria for diagnosis of gonorrhea. Ideally, specimens from suspected gonococcal lesions or infected sites should be inoculated directly upon selected media when collected and placed under increased CO<sub>2</sub> at 35° C. to 37° C.

In cases of meningococcal meningitis the spinal fluid usually contains polymorphonuclear white blood cells. Therefore, any cloudy or "milky" spinal fluid received by the laboratory is considered potentially infectious. We must take all necessary precautions to insure the safety of laboratory workers, for example, aseptic techniques. It is important to immediately inoculate spinal fluid and blood specimens taken from suspected cases. *N. meningitidis* may be isolated from specimens such as spinal fluid, blood, material from petechial skin lesions, fluid aspirated from joints, pus, and nasopharyngeal or throat swabs. The organism is rarely cultured from the urogenital tract. Thayer-Martin selective medium is used only for culture of material which is expected to contain a mixed flora. Several drops of the specimen can be spread over the surface of blood or chocolate agar media and incubated in a candle jar at 35° C. A positive oxidase test on the colonies would be presumptive evidence of the presence of the organism of gonorrhea.

Confirmation by the gram stain will indicate the typical morphology. Identified colonies of the organisms may then be transferred to blood agar to obtain pure cultures for biochemical tests. Remember that the viability of *N. meningitidis* is readily lost as a result of drying, chilling, exposure to unfavorable pH, lysis by tissue enzymes or autolytic meningococcal enzymes, or the antimeningococcal activity of other

bacteria. Thus, cultures should be without much delay. Media stored in a refrigerator should be allowed to warm to 25° C. before use.

#### Exercises (232):

1. In preparing smears from clinical materials containing possible *Neisseria gonorrhoeae*, for what two reasons should swab specimens be lightly rolled, rather than rubbed on glass slides?
2. In males, what report on the smears constitutes sufficient basis for a diagnosis?
3. In male patients, when there is no discharge at the time of examination or the patient is asymptomatic, from what site should the specimen be obtained?
4. Prostatic fluid may be inoculated directly to what medium?
5. To diagnose gonorrhea in women, culture specimens should be obtained from what two sites and inoculated to what two separate media?
6. What criteria provide sufficient diagnosis of gonorrhea in females?
7. When specimens such as spinal fluid, blood, material from petechial skin lesions, fluid aspirated from joints, pus, and nasopharyngeal or throat swabs for *N. meningitidis* are expected to contain a mixed flora, what medium should be used?
8. Ordinarily, when a pure culture of *N. meningitidis* is suspected, what media should be used?
9. The viability of *N. meningitidis* is readily lost as a result of what factors?

233. State the general growth requirements of *Neisseria* species in terms of the most favored growth conditions; cite the purpose of Thayer-Martin medium, the use of and reactions obtained with the oxidase test, the respiratory enzyme produced by oxidase-positive organisms, the reagent used to inhibit the spreading growth of *Proteus* and *Pseudomonas*, the carbohydrate fermented by *N. gonorrhoeae* on CTA, and an advantage of the direct FA staining procedure.

**Growth Requirements and Identification.** While *Neisseria* species are aerobic, an atmosphere of increased carbon dioxide—a candle jar—greatly favors colony development. The organisms also require a moist atmosphere. The optimum growth temperature for pathogenic species, especially, *N. gonorrhoeae*, is between 35° C. and 36° C.; however, a 37° C. incubator will give satisfactory results. After 48 hours' incubation on chocolate or TM media, pathogenic species appear as small, glistening, soft-textured, translucent or transparent colonies shown in detail C, *N. gonorrhoeae*, and detail D, *N. meningitidis*, in foldout 1.

Thayer-Martin medium for isolating gonococci and meningococci permits growth of those organisms while simultaneously suppressing saprophytic *Neisseria* species. In addition, overgrowth of gonococcal colonies by bacterial contaminants present in cervical, vaginal, and rectal specimens is also reduced. All members of the genus *Neisseria*, as well as members of other genera such as *Pseudomonas*, *Moraxella*, and *Aeromonas*, are oxidase-positive. If primary gonococcus (GC) cultures are overgrown by *Proteus* "spreaders" report the culture as unsatisfactory and request another specimen. The addition of trimethoprim lactate (5 µg/ml) to either the TM or Transgrow media will inhibit the spreading growth of both *Proteus* and *Pseudomonas*. The oxidase test employs the use of the indicator dye tetramethyl-p-phenylene diamine dihydrochloride or the dimethyl derivative to give a color change that begins to appear within a few seconds. Bacteria that produce the respiratory enzyme, cytochrome oxidase, oxidize the dye in the reagent to give a color change. If positive, a color change in the colony will be observed—pink, progressing to maroon, to dark red, and finally to black.

The oxidase reaction is of particular value in examining an agar plate containing colonies of *Neisseria* spp. obscured by heavy growth of other organisms. Foldout 1, detail E, shows the differentiation of colonies by this technique. Colonies treated with oxidase reagent will still give typical results on gram staining. Identification of the genus *Neisseria* is established if the colony is oxidase-positive, and if it is found to be a typical gram-negative diplococcus. Oxidase reactions cannot be used to distinguish species, however, since all *Neisseria* are oxidase-positive. Confirmation of species is required where

possible gonorrhea or meningitis is concerned. This may be accomplished by a careful study of growth characteristics and the reactions obtained in appropriate carbohydrate media as shown in table 2-1.

A presumptive identification of *N. gonorrhoeae* may be confirmed by carbohydrate fermentation reactions preferably or by direct FA staining. *N. gonorrhoeae* ferments glucose only, producing acid but no gas on cysteine-trypticase agar (CTA), pH 7.6, as shown in table 2-1. The medium readily supports the growth of fresh isolates of gonococci and meningococci, although occasional strains of gonococci may grow poorly or not at all.

CTA is especially recommended for fermentation studies because *Neisseria* spp. will grow on it without an increased CO<sub>2</sub> atmosphere. Freedom from the CO<sub>2</sub> requirement is desirable, since absorption of the gas by fermentation media is accompanied by a drop in pH, resulting in false-positive reactions (change in color of indicator). Moreover, CTA is a semisolid agar, which enables us to detect minute amounts of acid formed by weakly fermenting strains of *Neisseria*. Phenol red indicator is incorporated in the medium, so positive reactions are evidenced by a change from red to yellow within 18 to 72 hours.

The direct FA staining procedure is a less time-consuming and laborious procedure for identifying colonies of *N. gonorrhoeae* than are fermentation tests; but owing to some lack of sensitivity due to cross-reaction with group B meningococci, the procedure appears less satisfactory for primary cultures.

#### Exercises (233):

1. What type atmosphere greatly favors colony development of *Neisseria* species?
2. What is the most optimum growth temperature range for pathogenic *Neisseria* species?
3. In the isolation of gonococci and meningococci, what purpose does the Thayer-Martin medium serve?
4. In order to detect oxidase-positive organisms, the reagent dye is oxidized by what respiratory enzyme produced by the *Neisseria* species?
5. What reagent may be added to TM or Transgrow media to inhibit the spreading growth of both *Proteus* or *Pseudomonas*?

TABLE 2-1  
IDENTIFICATION OF *NEISSERIA* SPECIES

	<i>Branhamella</i> ( <i>Neisseria</i> ) <i>catarrhalis</i>	<i>Neisseria</i> <i>flavescens</i>	<i>Neisseria</i> <i>gonorrhoeae</i>	<i>Neisseria</i> <i>meningitidis</i>	<i>Neisseria</i> * <i>subflava</i>	<i>Neisseria</i> <i>lactamica</i>	<i>Neisseria</i> * <i>flava</i>	<i>Neisseria</i> * <i>perflava</i>	<i>Neisseria</i> <i>sicca</i>	<i>Neisseria</i> <i>MUCOSA</i>
Number of strains	49	5	180	2000	23	289	26	58	56	36
Oxidase	+	+	+	+	+	+	+	+	+	+
Carbohydrates in CTA base										
Glucose	-	-	A(-)	A(-)	A(-)	A	A(-)	A(-)	A(-)	A(-)
Lactose	-	-	-	-	-	A	-	-	-	-
Sucrose	-	-	-	-	-	-	-	A	A	A
Maltose	-	-	-	A(-)	A	A	A	A	A	A
Fructose	-	-	-	-	-	-	A	A	A	A
Growth on:										
Nutrient agar 35°C	+(-)	+	-	-(+)	+	+(-)	+(-)	+(-)	+	+
Nutrient agar 25°C	+(-)	+	-	-	+	+(-)	+(-)	+(-)	+	+
Thayer-Martin	-	-	+	+	-	+	-	-	-	-
Nitrate, routine	+(-)	-	-	-	-	-	-	-	-	+gas
Pigmentation on Loefflers	- (slight yellow)	yellow (slight yellow)	-	- (slight yellow)	yellow (slight yellow)	slight yellow -	yellow (slight yellow)	yellow (slight yellow)	- (slight yellow)	- (slight yellow)

\*In the 8th Edition of Bergey's Manual, all three species are called *N. subflava*.

6. What type of color change of the colonies is observed in a positive oxidase test when the colonies are treated with oxidase reagent?
7. What carbohydrate does *N. gonorrhoeae* ferment on CTA, producing acid, but no gas?
8. What indicator dye is incorporated in the CTA medium?
9. What advantage does the FA staining procedure have over the fermentation test for identifying colonies of *N. gonorrhoeae*?
10. Why does the FA staining technique appear to be less satisfactory for primary cultures?

## 2-2. The Genus *Veillonella*

The anerobic cocci occur in the mouth, respiratory tract, intestinal tract, and the urogenital system. The 8th Edition of *Bergey's Manual* list six distinct species, but only two have been characterized. The other four have been listed as *species incertae sedis* (in an uncertain position). The two that are described in detail are *Veillonella parvula* and *V. alcalescens*. The genus is listed in PART 11 of *Bergey's Manual* as presented earlier in this chapter.

**234. Indicate whether given statements correctly reflect the general characteristics of members of the genus *Veillonella*.**

**General Characteristics.** Members of the genus *Veillonella* are small gram-negative cocci measuring 0.3 to 0.4  $\mu\text{m}$  in diameter, occasionally reaching a size of 2.0  $\mu\text{m}$ . They occur in pairs, in short chains, and in masses. Sometimes individual cells cannot be distinguished within the masses of organisms. Colonial morphology is described in table 2-2.

TABLE 2-2  
SPECIES DIFFERENTIATION OF THE GENUS *VEILLONELLA*

Organism	Gas Produced Peptone Agar	Colony Morphology	Growth at		Indole	Gelatin
			22°C.	37°C.		
<i>V. parvula</i>	+	Minute, transparent, bluish, weak hemolysis on blood agar.	Feeble	+	+	-
<i>V. alcalescens</i>	+	Minute, often a green pigment is produced. No hemolysis on blood agar.	±	+	-	-
<i>V. discoides</i>	+	(Deep colonies) Lenticular, up to 1 mm. in diameter. Grows in narrow disc 1 cm. below agar surface.	-	+	-	-
<i>V. reniformis</i>	-	(Deep colonies) punctiform then lenticular. 0.3 to 0.5 mm. in diameter.	-	+	+	-
<i>V. orbiculus</i>	-	(Deep colonies) Lenticular, large regular, whitish, translucent.	-	+	-	-
<i>V. vulvovaginitidis</i>	-	(Deep colonies) small, whitish.	-	+	-	+

The biochemical activity of the organisms is considered to be pronounced. Whereas *Peptococcus* and *Peptostreptococcus* can be thought of as the anaerobic counterparts of *Staphylococcus* and *Streptococcus*, *Veillonella* can be considered the anaerobic counterpart of the genus *Neisseria*.

Members of this genus are obligate anaerobes that grow well on routine bacteriological media. Optimum temperature is 37° C., but some strains grow at 22° C. Of the six *Veillonella* species, three produce gas in peptone agar, and three do not. Sugars are not fermented. The colonies are oxidase-negative. Laboratory diagnosis rests upon the morphology and biochemical activity of the genus and species set forth in table 2-2. The fact that these organisms are anaerobic and oxidase-negative differentiates them from *Neisseria*.

#### Exercises (234):

Indicate whether each of the given statements is true (T) or false (F) and correct those that are false.

- T F 1. Members of the genus *Veillonella* are small coccobacilli measuring 0.3 to 0.4  $\mu\text{m}$  in diameter.
- T F 2. The biochemical activity of *Veillonella* is highly variable.
- T F 3. *Veillonella* can be considered the anaerobic counterpart of *Haemophilus*.
- T F 4. Members of the genus *Veillonella* are obligate anaerobes that grow well on routine bacteriological media.
- T F 5. The fact that *Veillonella* are anaerobic and oxidase-negative differentiates them from *Neisseria*.

### 2-3. The Genera *Acinetobacter* and *Moraxella*

*Herellea vaginicola* and *Mima polymorpha* are now included as members of the genus *Acinetobacter*. They can be classified as *A. anitratum* (*H. vaginicola*) or *A. lwoffii* (*M. polymorpha*). These organisms are oxidase-negative, nonmotile diplococci to coccobacillary forms. Members of the genus *Acinetobacter* are found in the nose, vagina, and conjunctiva as saprophytes or as part of the normal flora. They have

been recovered from many areas of the body as pathogens, however. These coccoid organisms (small, rounded bacilli) can cause conjunctivitis, meningitis, a gonorrhea-like urethritis, and septicemia. They appear as secondary invaders in cases of severe burns.

*Moraxella*, another genus of the family *Neisseriaceae*, is found in the same type of clinical material as *Acinetobacter* species. While *Moraxella* resemble *Neisseria* and may be confused with them, *Moraxella* show bacillary forms in a gram-stained smear. Both *Acinetobacter* and *Moraxella* are classified as members of the family *Neisseriaceae* and appear listed in *Bergey's Manual* under PART 10 as indicated earlier in this chapter.

235. Cite some general characteristics of the genus *Acinetobacter* in terms of the common species, appearance in different media, and differential biochemical reactions.

**General Characteristics of the Genus *Acinetobacter*.** The genus *Acinetobacter* includes *A. anitratum* (*H. vaginicola*) and *A. lwoffii* (*M. polymorpha*). The members of the International Subcommittee on the Taxonomy of *Moraxella* and Allied Bacteria concluded that the genus *Acinetobacter* consist of a single species, *Acinetobacter calcoaceticus*.

Both varieties of *A. calcoaceticus* grow well and may be recovered on simple media without enrichments or supplements. These organisms have often been misinterpreted as gonococci in stained preparations. They are oxidase-negative and nonmotile. Generally, they appear coccoid in shape, but may be seen as rods, diplobacilli, or occasionally in short chains. The pleomorphic rods measure 0.5 to 0.8  $\mu\text{m}$  wide by 1.0 to 3.0  $\mu\text{m}$  in length. Diplococcal forms predominate on solid media—rods and filaments in liquid media.

An occasional strain may fail to produce hemolysis on blood agar but the majority of cultures of both varieties produce indeterminate or partial rather than clear, sharp, well-defined zones of beta hemolysis. These organisms do not reduce nitrate, though some may show weak activity. They grow well on MacConkey agar but poorly, or not at all, on SS agar.

The colony size of *A. calcoaceticus anitratum* after 18 to 24 hours of aerobic growth on blood agar plates averages 2.0 to 3.0 mm in diameter, and *A. lwoffii* usually produce smaller colonies of 1.0 to 1.5 mm. Colonies of both varieties are circular, convex, smooth, glossy, butyrous, uniformly creamy to grayish-white, and opaque with entire edges. Rough or very mucoid strains may be encountered. Mucoid forms are encapsulated. *A. anitratum* is the most frequently isolated member of the genus having been recovered from a wide variety of clinical sources. The role of *A. lwoffii* in human infections is more difficult to assay since most strains are of questionable clinical significance.

Members of the genera *Acinetobacter* and *Moraxella* are considered to be rod-shaped. However, they may often appear coccoid and may resemble species of *Neisseria* and *Branhamella*, which are true cocci. The oxidase test readily differentiates the genus *Acinetobacter* from the other three genera as indicated in table 2-3.

In addition, both varieties of *A. calcoaceticus* produce strong positive tests for catalase but fail to demonstrate decarboxylase, dihydrolase, or deaminase, and neither do they grow on cetrimide agar.

**Exercises (235):**

1. What two species are included in the genus *Acinetobacter*?
2. The members of the International Subcommittee on the Taxonomy of *Moraxella* and Allied Bacteriology concluded that the genus *Acinetobacter* consist of a single species called \_\_\_\_\_.
3. What morphological forms of these organisms predominate on solid media? Liquid media?
4. What type of hemolysis is produced by a majority of the variety of cultures of both varieties of *Acinetobacter Calcoaceticus*?
5. How well do these organisms grow on MacConkey agar and SS agar?

6. Which variety of *A. calcoaceticus* produces smaller colonies on blood agar plates?
7. Which variety is the most frequently isolated of the genus?
8. Members of the genera *Acinetobacter* and *Moraxella* are considered to have what specific type morphology?
9. What specific biochemical test readily differentiates the genus *Acinetobacter* from the genera *Neisseria*, *Branhamella*, and *Moraxella*?
10. Both varieties of *A. calcoaceticus* produce strongly positive results for what biochemical tests?
11. List other biochemicals and one medium upon which the organisms will produce negative tests and will not grow respectively.

**236. Identify general characteristics of the genus *Moraxella* and specific characteristics common to the given species in terms of biochemical reactions, growth characteristics, and sources of isolation.**

**TABLE 2-3**  
DIFFERENTIAL PROPERTIES OF THE GENERA OF THE FAMILY NEISSERIACEAE

Genus	Morphology	Fermentation of Glucose	Oxidase
<i>Neisseria</i> : <i>N. gonorrhoeae</i> , <i>N. meningitidis</i> , <i>N. sicca</i> , <i>N. subflava</i> , <i>N. flavescens</i> , <i>N. mucosa</i> , <i>N. lactamica</i> , (species incertae sedis)	Gram-negative cocci	+	+
<i>Branhamella</i> : <i>B. catarrhalis</i>	Gram-negative cocci	-	+
<i>Moraxella</i> : <i>M. lacunata</i> , <i>M. bovis</i> , <i>M. nonliquefaciens</i> , <i>M. phenylpyruvica</i> , <i>M. osloensis</i>	Short gram-negative rods	-	+
<i>Acinetobacter</i> : <i>Ac. antratum</i>	Short gram-negative rods	+	-
<i>Ac. Lwoffii</i>		-	-



### General Characteristics of the Genus *Moraxella*.

Five species of *Moraxella* are recognized by the International Subcommittee on *Moraxella* and Allied Bacteria. These are *M. lacunata*, *M. bovis*, *M. liquefaciens*, *M. phenylpyruvica*, and *M. osloensis*. *Moraxellae* are nonmotile, gram-negative bacilli or coccobacilli that are oxidase-positive. They occur singly, in pairs, or in short chains. Most strains are biochemically inactive with respect to carbohydrate oxidation, denitrification, and the production of deaminase, decarboxylase, and dihydrolase.

*Moraxella lacunata* and *M. bovis*. Members of the species will produce an alkaline slant on TSI, but cultures of *M. lacunata* fail to grow on this medium. *M. lacunata* and *M. bovis* are more fastidious than other species of *Moraxella*. *M. lacunata* was originally described as the etiological agent in chronic conjunctivitis.

*Moraxella nonliquefaciens* and *M. osloensis*. Cultures of *M. nonliquefaciens* do not grow on MacConkey, whereas 50 percent of strains of *M. osloensis* do so. *M. nonliquefaciens* occur more frequently in the respiratory tract than any of the other species of *Moraxella*. Although *M. osloensis* involvement in human infection is comparatively rare, it is easily confused with *N. gonorrhoeae* from genitourinary sources, because it is oxidase-positive and appears as gram-negative coccobacillary form resembling gonococci. *M. osloensis* does not ferment CTA glucose medium and does not grow on nutrient agar.

*Moraxella phenylpyruvica*. The significant characteristics of members of *M. phenylpyruvica* are hydrolysis of urea and deamination of phenylalanine or tryptophan. As previously indicated, the oxidase test readily differentiates the genus *Acinetobacter* from *Moraxella*.

### Exercises (236):

Match each item in column B with the statements in column A by placing the letter of the column B item beside the number of the column A item that most nearly describes it. Each element in column B may be used once, more than once, or not at all.

Column A	Column B
_____ 1. Gram negative, nonmotile bacilli or coccobacilli and oxidase-positive.	a. <i>M. nonliquefaciens</i>
_____ 2. Gram-negative, nonmotile bacilli or coccobacilli and oxidase-negative.	b. <i>M. phenylpyruvica</i>
_____ 3. Members fail to grow on TSI slant.	c. <i>N. gonorrhoea</i>
_____ 4. Are more fastidious than other species of <i>Moraxella</i> .	d. <i>Acinetobacter</i>
_____ 5. Was originally described as the etiological agent in chronic conjunctivitis.	e. <i>M. osloensis</i>
_____ 6. Cultures do not grow on MacConkey.	f. <i>M. lacunata</i>
_____ 7. Occur more frequently in the respiratory tract than any other species of <i>Moraxella</i> .	g. <i>M. bovis</i>
	h. <i>Branhamella</i>
	i. <i>Moraxellae</i>

### Column A

- \_\_\_\_\_ 8. Does not ferment CTA glucose medium and does not grow on nutrient agar.
- \_\_\_\_\_ 9. Fifty percent of this strain grows on MacConkey.
- \_\_\_\_\_ 10. The significant characteristics of members of this species are hydrolysis of urea and deamination of phenylalanine or tryptophan.

### 2-4. *Mycoplasma*

*Mycoplasma* are wide-spread in nature and are part of the indigenous microbial flora of the oropharynx of the genitourinary tract of birds and mammals, including man. Similar microorganisms subsequently isolated from pathological processes in man were previously termed pleuropneumonia-like organisms (PPLO). Species of *Mycoplasma* have been found in clinical specimens obtained from the mouth and pharynx; the genitalia in cases of nonspecific urethritis; and the lungs in primary atypical pneumonia. They have also been implicated in such diseases as chronic vulvitis, vaginitis, cystitis, and ovarian abscesses. *Mycoplasma* can reach the bloodstream as a result of trauma in childbirth, and it has been suggested that these organisms can be transmitted through sexual contact. Cases of infection traced directly to improper handling of clinical specimens in the laboratory have been reported.

237. State some general characteristics of *Mycoplasma* in terms of the cell structure, morphology, diseases caused by these organisms, stains, and methods used for observation in broth cultures.

**General Characteristics.** The mycoplasmas are a heterogeneous group of unicellular, procaryotic organisms that lack a cell wall. Mycoplasmas are intermediate in size between bacteria and viruses. The major human pathogen among the mycoplasmas is *Mycoplasma pneumoniae*, formerly known as the Eaton agent. This organism is the cause of primary atypical pneumonia. Cold agglutinins, antibodies that agglutinate human red blood cells in the cold, appear in the serum of a portion of patients with atypical pneumonia. Also of medical importance are the T strains of mycoplasma that may cause nongonococcal urethritis.

Currently, there are seven species of *Mycoplasma* indigenous to man. These are noted in table 2-4.

Membrane-bounded cells appear as coccoid bodies, filamentous, and star-shaped forms. Individual mycoplasma cells range in diameter from 125 to 330 nm for the spherical forms, to 150  $\mu$ m in length for filaments. They stain poorly, or not at all, with aniline dyes and best with Giemsa or Dienes stain. Cells are best observed in broth cultures by darkfield or phase-contrast microscopy.

TABLE 2-4  
MYCOPLASMA SPECIES INDIGENOUS TO MAN

Species	Usual Habitat
<i>M. hominis</i>	Oropharynx, genitourinary tract and anal tract (healthy and ill persons), blood and pleural fluid (ill persons only)
<i>M. fermentans</i>	Genitourinary tract (healthy and ill persons)
<i>M. salivarium</i>	Oropharynx (healthy and ill persons)
<i>M. orale</i> types I, II, III	Oropharynx (healthy and ill persons), bone marrow (ill persons only)
<i>M. pneumoniae</i>	Oropharynx (primarily ill persons), lung (ill persons only)
<i>M. arthritidis</i>	Animal origin; questionable human sources
T-strains	Genitourinary tract (healthy and ill persons)

**Exercises (237):**

Complete the following statements.

1. The mycoplasmas are a heterogeneous group of \_\_\_\_\_, \_\_\_\_\_ organisms that lack a \_\_\_\_\_.
2. Mycoplasmas are intermediate in size between bacteria and \_\_\_\_\_.
3. The major human pathogen among the mycoplasmas is \_\_\_\_\_.
4. This organism is the cause of \_\_\_\_\_.
5. \_\_\_\_\_ appear in the serum of a portion of patients with atypical pneumonia.
6. The \_\_\_\_\_ of mycoplasma may cause nongonococcal urethritis.
7. Membrane-bounded cells appear as \_\_\_\_\_ bodies, \_\_\_\_\_ and \_\_\_\_\_ forms.
8. Individual mycoplasma cells range in diameter from \_\_\_\_\_ to \_\_\_\_\_ nm for spherical forms, to \_\_\_\_\_  $\mu\text{m}$  in length for filaments.
9. These organisms stain best with \_\_\_\_\_ or \_\_\_\_\_ stain.
10. Cells are best observed in broth cultures by \_\_\_\_\_ or \_\_\_\_\_ microscopy.

**238. Cite some cultural characteristics of *Mycoplasma* in terms of the requirements for growth enrichment media and colony appearance.**

**Cultural Characteristics.** Most species are facultative anaerobes, although growth is better in an aerobic environment. Growth of the parasitic mycoplasmas is best encouraged on an enriched medium containing heart infusion agar, such as mycoplasma agar base or PPLO agar, horse serum, yeast extract, and penicillin G. Two major groups of mycoplasma are recognized, the mycoplasmataceae that require sterol for growth, and the Acholeplasmataceae that do not require sterol. On solid media, mycoplasma produces very small colonies, 10 to 600  $\mu\text{m}$  in diameter. They have an opaque, granular central area that grows down into the medium and a translucent peripheral zone. The colonies appear with brown or yellow centers and are the so-called "mulberry" colonies. This biphasic growth gives the colony a fried egg appearance. Colonies of *M. pneumoniae* are shown in figure 2-1. These colonies are difficult to remove even with a wire loop. On blood agar most organisms produce an alpha or beta type hemolysis. As previously indicated,

species of *Mycoplasma* also require sterol for growth and incorporate it into the cell membrane. Since sterols are not present in bacteria that possess cell walls or in their L forms variants, the requirement of sterols for growths is of special interest to microbiologists. Further, since the organisms grow into the medium, a soft agar is recommended. An alkaline pH (7.6 to 7.8) favors growth, and the optimum temperature is 37° C.

**Exercises (238):**

1. Most species of *Mycoplasma* are classified in which category on the basis of their requirement for atmospheric oxygen as the hydrogen acceptor?
2. Growth of mycoplasma is better in what type of environment?
3. Growth of parasitic mycoplasmas is best encouraged on an enriched media containing what substances?
4. What group of mycoplasma requires sterol for growth?
5. Briefly describe the appearance of mycoplasma on solid media.
6. What type of hemolysis is produced on blood agar?

**239. Point out methods used in the identification of *Mycoplasma* in terms of selective media, atmospheric requirements for species, procedures for examination of cultures, staining techniques, and biochemical characteristics used for species identification.**

**Laboratory Identification.** Primary cultures of clinical specimens such as swabs from the throat, genital tract, rectum, and wounds are placed in a tube of a selective broth such as PPLO enrichment broth or mycoplasma broth base with crystal violet. Both broths contain crystal violet as the bacterial inhibitor. Cultures are incubated for several days at 37° C., then subcultured to freshly prepared solid media and

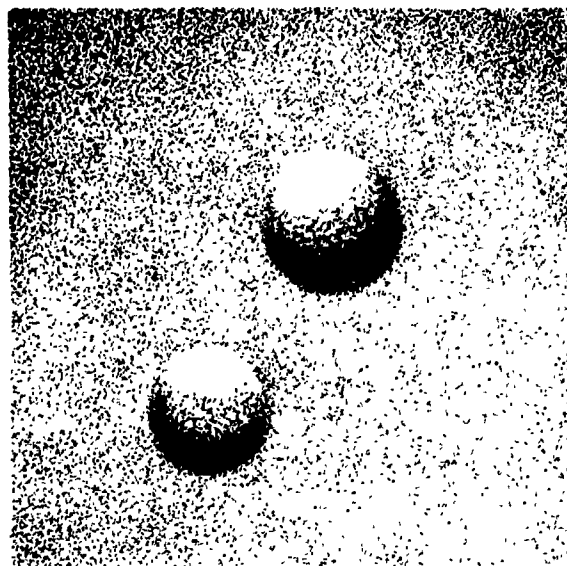

Figure 2-1. Colonies of *Mycoplasma pneumoniae*.

incubated as before. *Mycoplasma pneumoniae* grow in air or 5 percent CO<sub>2</sub>. *M. fermentans*, *M. orale*, and *M. salivarium* require an anaerobic atmosphere of 95 percent N<sub>2</sub> and 5 percent CO<sub>2</sub> in an evacuation replacement jar. Plates should be examined at 7, 14, and 21 days; for those *M. pneumoniae* should be held for 30 days before discarding. The use of a differential agar medium containing urea and manganous sulfate is recommended for primary cultivation of T strain mycoplasma. The T strain mycoplasma possesses the ability to hydrolyze urea and will appear on this medium as dark, golden brown colonies. Individual colonies can be studied in greater detail by the use of Dienes staining techniques. We cut out a small block of the medium in which the suspected colony is growing and place it on a glass microscope slide, colony side up. A cover slip holding a drop of Dienes' stain (previously dried) is laid on the surface of the block, with the stained side in contact with the colony on the agar. The colonies are examined with the low power objective. They will show a dark blue center and light edges. It is important to note that the stain is not decolorized by PPLO colonies, but it is decolorized by bacterial colonies. Decolorization usually takes place in about 30 minutes.

The groups of species can be distinctly separated by biochemical characteristics such as glucose fermentation, arginine hydrolysis, urea hydrolysis, and aerobiasis.

**Exercises (239):**

1. What selective broths may be used for isolation of pathogenic mycoplasma? What bacterial inhibitor do they contain?

2. *Mycoplasma pneumoniae* grows in what two atmospheric environments?
3. What type of environment is required for *M. fermentans*, *M. orale*, and *M. salivarium*?
4. How often should plates be examined?
5. Before discarding, how long should the plates examined for *M. pneumoniae* be held?
6. For the primary cultivation of T strain mycoplasma, a differential medium containing what two constituents is recommended?
7. How will the T stain mycoplasma appear on this medium?
8. Individual colonies can be studied in greater detail by using what staining technique?
9. After a small block of the medium containing the suspected colony is cut out and placed on a glass slide, what is placed over the surface of the block?
10. What biochemical characteristics are used for separation of groups of species?

## The Small Gram-Negative Bacilli

THE SMALL gram-negative bacilli are distinguished morphologically from the gram-negative cocci and coccoid organisms by the tendency of the bacilli to grow in rod form. In many instances, however, the distinction is difficult to make. Under the microscope, a coccus, a coccoid form, and an oval-shaped short rod can look pretty much alike. We are quite often dependent, therefore, on knowledge of the source of the specimen and the clinical findings to supplement information gathered from morphological, cultural, and serological studies of the pathogen.

The small gram-negative bacilli discussed in this section are currently classified as genera of uncertain affiliation. The first of these involve a wide range of pathogens causing epidemic and septicemic diseases of domestic animals and birds whereby man may be infected. The diseases result from a wide variety of pathogens, ranging from those caused by animal bites, tularemia, and undulant fever to *Haemophilus* and *Bordetella* species that cause pharyngeal, respiratory illness, meningitis, acute conjunctivitis, soft chancre on chancroid, and whooping cough. The genera consist of minute, filterable forms as well as long, filamentous branching organisms. For the most part, they are inhabitants of the mucous membranes of warm-blooded animals and man.

This coverage of the small gram-negative bacilli will exclude many of the species that contribute only occasionally to disease. Our main emphasis will be placed on those microorganisms which one can expect to encounter with reasonable frequency in the clinical or epidemiological laboratory. We will touch briefly, however, on a few infectious agents representing genera with which the bacteriologist should be familiar, in general, even though he or she does not often find them among the cultures.

The taxonomic relationship of the small gram-negative rods is shown in the following scheme.

### PART 7. GRAM-NEGATIVE AEROBIC RODS AND COCCI

#### Genera of Uncertain Affiliation

Genus	<i>Brucella</i>
Genus	<i>Bordetella</i>
Genus	<i>Francisella</i>

### PART 8. GRAM-NEGATIVE FACULTATIVELY ANEROBIC RODS

#### Genera of Uncertain Affiliation

Genus	<i>Haemophilus</i>
Genus	<i>Pasteurella</i>
Genus	<i>Actinobacillus</i>
Genus	<i>Streptobacillus</i>
Genus	<i>Calymmatobacterium</i>

### PART 9. GRAM-NEGATIVE ANAEROBIC BACTERIA

Family I.	<i>Bacteroidaceae</i>
Genus I.	<i>Bacteroides</i>

#### 3-1. *Pasteurella* and *Francisella*

Organisms of the genus *Pasteurella* have a wide range and are responsible for epidemic and systemic diseases of domestic animals and birds. Many of these zoonotic species may also be transmissible to man. The genus consists of an extremely heterogeneous group of organisms, but only four species are currently recognized: *P. multocida*, *P. pneumotropica*, *P. haemolytica*, and *P. urea*. The major human pathogen is *P. multocida*.

*Francisella tularensis* causes tularemia, a major zoonotic disease indigenous to many areas of the United States. The organism is transmitted by insect vectors, or by the handling or injection of infected animals. The organism was previously classified as *Bacterium tularense* and *Pasteurella tularensis*, but is currently classified in the genus *Francisella*, which is a genus of uncertain affiliation. It is the causative organism of tularemia or "rabbit fever," which, like plague, is primarily a disease of rodents secondarily acquired by man. The reservoir of infective agent is maintained in rodents by biting flies, ticks, and rabbit louse. All of these vectors are capable of spreading the disease from animal-to-animal. Humans contract tularemia either by handling the flesh of infected animals or through the bite of an arthropod vector. The main source of infection is the wild rabbit. The bacilli enter through cutaneous abrasions, or possibly through the intact skin of the hunter as he processes the animal for food. An aerosol of body fluids from infected animals may cause infection of the conjunctiva or lungs.



240. Point out the site commonly inhabited by *Pasteurella multocida*, the diseases caused, clinical specimens from which the organism is isolated, and the morphological, growth, and cultural characteristics of the organism.

***Pasteurella multocida*.** The *Pasteurella* species are present as normal flora in many domestic animals. *P. multocida* commonly inhabits the nasopharynx of the cat similar to that of alpha hemolytic streptococcus in man. It survives poorly in soil and water, and is transmitted most commonly by direct contact, usually a bite. Approximately one-half of the human cases of *P. multocida* infection result from the bites or scratches of dogs or cats. The tonsils of dogs are a site commonly inhabited by *P. multocida*. The organisms responsible for outbreaks of cholera are domestic or wild fowl, hemorrhagic septicemia of cattle, and primary secondary pneumonias. Clinical specimens include sputum, pus, blood, spinal fluid, and tissues.

*P. multocida* are small, nonmotile, ovoid, or rod-shaped organisms, approximately 1.4 by 0.4  $\mu\text{m}$  in size. They are gram-negative and show bipolar staining especially in preparations from infected tissues. Virulent *P. multocida* organisms are encapsulated. Collectively, the four *Pasteurella* species appear as short, rounded rods, or coccoids exemplified in foldout 1, detail F. *P. multocida* grows well at 35° C. on chocolate or blood agar, where it produces small, nonhemolytic, translucent colonies with a characteristic musty odor. Use of increased CO<sub>2</sub> tension during incubation may be helpful.

*Pasteurella* is facultatively anaerobic. They are catalase-positive and usually oxidase-positive. They have a fermentative metabolism, and acid is produced by most strains from glucose, mannitol, and sucrose. Distinguishing properties of *P. multocida* are shown in table 3-1. Researchers have used the oxidase reaction in their key to separate *Yersinia* (oxidase-negative) from *Pasteurella* (oxidase-positive). This

reaction may be variable for *P. multocida*] The  $\beta$ -D-galactosidase (ONPG) reaction does seem to provide a means of separating *P. multocida* (negative) from *Yersinia* (positive).

There are four principal colonial variations that occur. They are mucoid, smooth (iridescent), smooth (noniridescent), and rough. The mucoid (M) colonies are relatively avirulent and highly pathogenic for animals. However, virulent strains for humans produce smooth (S) iridescent colonies. Noniridescent, smooth, transitional forms are weakly virulent, and the (R) form, which is granular and dry, is avirulent.

Five major antigenic types of *P. multocida* have been identified and designated A, B, C, D, and E on the basis of their capsular or surface polysaccharides. Human strains fall into Groups A and D.

#### Exercises (240):

1. *Pasteurella multocida* is a common inhabitant of what organs of domestic animals?
2. What are some diseases caused by *P. multocida*?
3. The organism may be isolated from what clinical specimens?
4. Approximately one-half of the human cases of *P. multocida* result from what conditions?
5. Briefly describe the morphology of *P. multocida*.

TABLE 3-1  
DIFFERENTIATION OF PASTEURELLA SPECIES

Species	Hemolysis on Blood Agar	Growth on MacConkey's Agar	Indole	Urease	Mannitol
<i>P. multocida</i>	-	-	+	-	+
<i>P. pneumotropica</i>	-	-	+	+	-
<i>P. haemolytica</i>	+	+	-	-	+
<i>P. ureae</i>	-	+	-	+	+



6. On what two given media does *P. multocida* grow well?
7. How do the colonies of *P. multocida* appear on the given media?
8. What biochemical test provides a reliable means of separating *P. multocida* from *Yersinia*, and which organism produces a positive test?
9. What type of colonial variation is produced by virulent strains for humans?
10. Human strains of *P. multocida* fall into what two antigenic groups?

**241. Cite means by which *Francisella tularensis* is transmitted, specimens from which the organisms may be isolated, media used for isolation, morphology and cultural appearance, and the techniques used for rapid and specific identification of *F. tularensis*.**

***Francisella (Pasteurella) Tularensis.*** *Francisella tularensis* causes tularemia. The disease is transmitted to humans by a variety of animals, including wild rabbits, muskrats, beavers, squirrels, woodchucks, sheep, and game birds, or by biting insects, such as ticks or deer flies. Infection follows handling of infected animal carcasses, insect bites, ingestion of improperly cooked meat or contaminated water, or inhalation of airborne organisms. Man-to-man transmission is extremely rare.

Clinical diagnosis can be confirmed by isolation of *F. tularensis* from local lesions, regional lymph nodes, sputum, gastric aspirates, or nasopharyngeal washings. In oculoglandular (eye gland) tularemia, conjunctival scrapings frequently yield the organism. *F. tularensis* is rarely recovered from the blood other than during the first few days after infection and in untreated fulminating disease.

*F. tularensis* will not grow on ordinary media. Cultivation is most successful on cystine-glucose-blood agar containing thiamine, and growth is favored by incubation at 37° C. in a candle jar. Blood cultures utilize thioglycollate-heart-infusion agar or hemoglobin-cystine agar. Primary growth from the specimens requires from 4 to 7 days. In young cultures,

the colonies are very tiny, although later a relatively heavy growth of small, gray, transparent-to-translucent mucoid colonies develop. Subcultures to cystine-glucose-blood agar plates usually yield abundant growth within 2 to 3 days. Lymph fluid, blood, sputum, and material from localized lesions in suspected cases of tularemia should be cultured. Blood samples may be taken repeatedly, particularly during the first week of infection.

The organism is an obligate aerobe. Glucose, maltose and mannose, and fructose are fermented with acid but no gas. H<sub>2</sub>S is produced in media containing cysteine.

The cells of *Francisella tularensis* are gram-negative, small in size, 0.3 to 0.5 by 0.2 μm. In young cultures the coccoid forms predominate, while in older cultures the bacillary form is more prevalent. The bacillary forms are usually quite pleomorphic and may be bipolar stained. Oval, bean shapes, dumbbell shapes, involution forms, and filamentous forms may be observed. Although this organism has no capsule, an envelope can be seen on a gram-stained smear of exudates.

Biochemical characterization and animal inoculation are not required or recommended for routine identification of *F. tularensis*. Direct or indirect fluorescent-antibody techniques are considered to be the best tools for rapid and specific identification of *F. tularensis*. Remember that the danger of handling infected animals and virulent cultures cannot be overstressed. Infection and mortality rates among laboratory workers have been documented.

#### Exercises (241):

1. What are some ways through which *F. tularensis* is transmitted?
2. Clinical diagnosis can be confirmed by isolation of the organisms from what specimens?
3. During what course of the infection is *F. tularensis* likely to be recovered from the blood?
4. Cultivation is most successful on what type of given solid media?
5. How do the colonies of young cultures appear on cystine glucose-blood agar?

6. In young cultures, what type of morphological forms predominate? Older cultures?
7. What techniques are considered to be the best tools for rapid and specific identification of *F. tularensis*?

### 3-2. *Haemophilus* and *Bordetella*

The species of gram-negative bacilli belonging to the genera *Haemophilus* and *Bordetella* are fastidious organisms requiring enriched media. Three species of *Haemophilus* were split off from the genus and placed in a new group, the *Bordetella*. Members of the two genera are morphologically similar, and they are found, with a few important exceptions, in the same habitat—the human nasopharynx and adjacent areas of the respiratory tract.

The taxonomic relocation of the *Bordetella* was justified by two features. First, the three species that were formerly called *Haemophilus* are antigenically related to each other; and, second, these species have basically different nutritional needs from the *Haemophilus* with regard to components of blood. For growth on laboratory media, *Haemophilus* species must have one or the other, or both, or two compounds: hemin (the X factor), a heat stable derivative of hemoglobin; and nicotinamide-adenine-dinucleotide (NAD) (the V factor), a heat-sensitive respiratory coenzyme. *Bordetella* species do not require that these factors be supplied in the medium.

242. State some morphological characteristics of *Haemophilus* species, the two factors necessary for growth in terms of their contents and characteristics, heat-labile inhibitors of *H. influenzae* in fresh human and sheep blood, and the meaning of "satellitism."

***Haemophilus* Species.** Members of the genus *Haemophilus* are strict parasites. *Haemophilus* is aerobic but facultatively aerobic. They are isolated from various types of lesions and secretions of vertebrates and on normal mucous membranes. Some species are pathogenic. These organisms are minute gram-negative rods and often coccobacillary. The formation of threadlike filaments and pleomorphism are common. Bipolar straining is frequent. The cells measure about 0.2 to 0.5 by 0.3 to 0.2  $\mu\text{m}$ . The source of the isolate sometimes influences its morphology; for example, a diplococcal form predominates in smears from spinal, synovial, or pleural fluid. Note in foldout I, detail G where *H. influenzae* tend to produce long, thin filaments and aberrant cells. The seven species of *Haemophilus* which are found in humans are listed in table 3-2.

Whole blood contains the two factors that are necessary for the growth of the genus *H. influenzae*. They are:

- a. X factor—a heat-stable substance, hemin, associated with hemoglobin.
- b. V factor—a heat-labile substance which is coenzyme I, nicotinamide-adenine-dinucleotide (NAD), supplied by yeast, potato extract, and certain bacteria in addition to that found in blood.

Specimens should be inoculated directly onto the surface of rabbit, guinea pig, horse blood, or on supplemented chocolate agar plates. Fresh human and sheep blood contain heat-labile inhibitors of *H. influenzae* and should not be used for blood-agar plates. These inhibitory compounds are destroyed by the temperature of 70° C. to 75° C. required to lyse red blood cells in making chocolate agar. Since heat-labile V factor is also destroyed in the process, the growth substance must be restored by adding commercially available enrichment supplements or yeast extract to blood agar after converting it by heat to chocolate agar.

If enrichment supplements are not available, a plain blood agar plate can be streaked with the specimen presumed to hold *Haemophilus* spp. Immediately thereafter, one or two streaks of a staphylococcus culture are applied at right angles to the primary inoculum. After 24- to 48-hours' incubation, *H. influenzae* and other species requiring V factor will appear as small colonies growing in close proximity to the staphylococci. This phenomenon is referred to as "satellitism" and results from factor V production by the staphylococci. We can see in figure 3-1 how diffusion of V factor into the surrounding medium provides a readily available enrichment source for the *Haemophilus* spp. Normally, however, *H. influenzae* grows very poorly on blood agar, and supplemented chocolate agar is preferred for isolating these organisms. Plain chocolate agar is unsatisfactory unless growth supplements are added.

The addition of 300  $\mu\text{m}$  of bacitracin (disc) to a chocolate agar plate may be used to suppress the growth of the other organisms. This will sharply increase the yield of *Haemophilus* in mixed flora samples.

#### Exercises (242):

1. Briefly describe the morphology of *Haemophilus*.
2. What morphological form sometimes predominates in smears from spinal, synovial, or pleural fluid?
3. For growth on laboratory media, *Haemophilus* species must have one or the other, or both, of what two compounds?

TABLE 3-2  
SOURCES OF *HAEMOPHILUS* SPECIES COMMONLY ISOLATED FROM HUMANS

Species	Source
<i>H. influenzae</i> (encapsulated)	Blood, cerebrospinal fluid, pus or wound.
<i>H. influenzae</i> (nontypable)	Sputum or ear, urine-rare.
<i>H. aegyptius</i>	Eye-contagious conjunctivitis (pink-eye).
<i>H. haemolyticus</i>	Sputum or ear.
<i>H. ducreyi</i>	Genital chancroid.
<i>H. aphrophilus</i>	Blood, cerebrospinal fluid, pus or wound.
<i>H. parainfluenzae</i>	Sputum or ear, blood or CSF-rare.
<i>H. parahaemolyticus</i>	Sputum or ear, blood or CSF-rare.

4. Of the X and V factors, which is heat stable and which is heat labile?
5. When attempting to isolate *H. influenzae*, why is fresh human and sheep blood NOT recommended?
6. Why is the V factor added after blood agar has been converted to chocolate agar?
7. If enrichment supplements are not available, how can blood agar plates be used to cultivate *Haemophilus* species?
8. What is meant by "satellitism"?
9. When a sharp increase in the yield of *Haemophilus* has resulted from the addition of 300 µg of bacitracin (disc) to a chocolate agar plate, what purpose does the bacitracin disc serve?

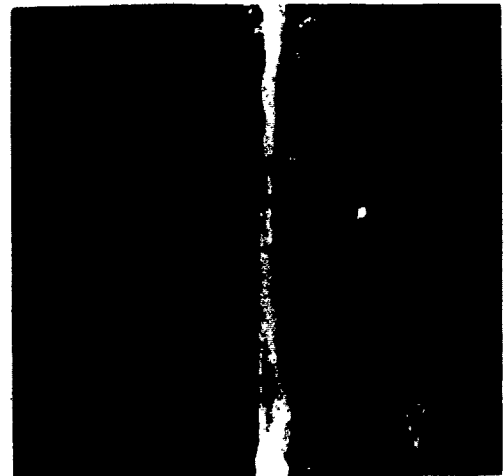

Figure 3-1. *Haemophilus Influenzae* — Satellitism with staphylococci on blood agar.

243. Identify the given *Haemophilus* species in terms of their growth requirements, colonial and morphological characteristics, and diseases with which they are commonly associated.

**Identification of *Haemophilus* Species.** Differentiation of *Haemophilus* species is largely based on ability to hemolyze, accessory growth factor requirements, and enhancement of growth under CO<sub>2</sub>. Note table 3-3. Determination of these growth requirements may be tested by different means. The simplest method is to place paper strips containing X factor, V factor, and both X and V factors on Trypticase soy agar or brain heart infusion agar previously inoculated with the test organism. The inoculum should be diluted (a 1:100 dilution of a 16- to 24-hour culture is satisfactory) to prevent carryover of X factor. Duplicate plates should be incubated under atmospheric O<sub>2</sub> and in the presence of 10 percent CO<sub>2</sub> and read after 24 and 48 hours of incubation. Incubation under 10 percent CO<sub>2</sub> enhances or is necessary to the growth of some strains, particularly on primary isolation.

***Haemophilus influenzae.*** *H. influenzae* is a fastidious organism requiring an infusion medium containing X and V factors. Luxuriant growth occurs on supplemented chocolate agar. Growth on this medium appears in 18- to 24-hours as small, colorless, transparent, moist colonies about 1 to 2 mm, with a distinct "mousy" odor. On blood agar, the organisms grow poorly and if any growth occurs, only tiny colonies are produced. Colonies are large and characteristic on blood agar when they are growing near

staphylococci, neisseria, pneumococci, and other organisms capable of synthesizing an extra amount of V factor. Six serological types are recognized; they are *a, b, c, d, e,* and *f,* identified by the Quellung method or precipitin reaction. Most meningeal infections are caused by Type *b,* but the majority of respiratory strains are not type specific and are less virulent.

***Haemophilus aegyptius.*** *H. aegyptius* is associated with the highly communicable form of conjunctivitis known as pink eye. The organism morphologically resembles *H. influenzae.* It requires both X and V factors, and produces small, transparent, nonhemolytic colonies on blood agar. They exhibit satellitism with *Staphylococcus* colonies. Like *H. influenzae,* the colonies show a bluish sheen in oblique transmitted light.

***Haemophilus haemolyticus.*** *H. haemolyticus* is found normally in the upper respiratory tract of man but rarely causes infection. It requires both X and V growth factors. Colonies resemble *H. influenzae* but are surrounded by a wide zone of clear hemolysis.

On throat cultures, the colonies of *H. haemolyticus* should be differentiated from those of beta hemolytic streptococci, since both are surrounded by a zone of clear hemolysis. *H. haemolyticus* are generally soft, pearly, and translucent compared to the firm, white opaque colonies of Group A streptococci. A colony gram stain will readily differentiate the two groups.

***Haemophilus parainfluenzae* and *Haemophilus parahaemolyticus.*** *H. parainfluenzae* and *H. parahaemolyticus* are found in the normal respiratory tract of man and are rarely associated with subacute bacterial endocarditis. Both require only the V factor for growth. *H. parainfluenzae* resembles *H. influenzae*

TABLE 3-3  
GROWTH REQUIREMENTS AND HEMOLYTIC ACTION OF *HAEMOPHILUS* SPECIES

Species	X Factor	V Factor	Hemolysis	Increased CO <sub>2</sub> Requirement
<i>H. influenzae</i>	+	+	-	-
<i>H. aegyptius</i>	+	+	-	-
<i>H. haemolyticus</i>	+	+	+	-
<i>H. ducreyi</i>	+	-	slight	+
<i>H. aphrophilus</i>	-	-	-	+
<i>H. parainfluenzae</i>	-	+	-	-
<i>H. parahaemolyticus</i>	-	+	+	-

both colonially and morphologically. It does not produce hemolysis and shows satellitism around staphylococcal colonies. *H. parahaemolyticus* resembles *H. haemolyticus* even though it produces larger colonies on blood agar. These colonies produce zones of beta hemolysis.

**Haemophilus ducreyi.** *H. ducreyi* is the cause of a venereal disease known as chancroid. *H. ducreyi* may be responsible for up to 10 percent of venereal disease in civilian population but in troops invading tropical countries the frequency of chancroid has been second only to gonorrhoea. The small gram-negative rods occur as long strands in smears from the genital ulcer. The pleomorphic organisms in fresh smears may appear gram-positive. They may be seen intracellularly or extracellularly. *H. ducreyi* grows on meat infusion on blood-enriched medium with increased CO<sub>2</sub>, but primary isolation may be very difficult. Better results have been obtained by inoculating freshly clotted rabbit blood, incubating at 37° C. and subculturing daily to rabbit blood agar until growth is detected. Patients infected with this organism develop a hypersensitivity to it which may be detected by intradermal injection of heat-killed cells. The test is positive one to two weeks after infection.

**Haemophilus aphrophilus.** Many strains of *H. aphrophilus* will not grow in the presence of moisture. Most strains are cultured from patients with a damaged endocardium congenital heart disease and secondary brain abscess. The organism is a very fastidious and microaerophilic organism and is killed rapidly by drying. It requires increased CO<sub>2</sub> for growth.

#### Exercises (243):

Match each item in column B with the statements in column A by placing the letter of the column B item beside the number of the column A item that most nearly describes it. Each element in column B may be used once, more than once, or not at all.

- | Column A  | Column B  |
|---|---|
| _____ 1 Tests upon which the differentiation of <i>Haemophilus</i> species is largely based.  | a. <i>H. haemolyticus</i>   |
| _____ 2 The purpose for making a 1:100 dilution of a 16- to 24-hour culture for inoculum for growth factor requirement.                               | b. <i>H. ducreyi</i>  |
| _____ 3 Six serological types of this species are recognized.   | c. <i>H. parahaemolyticus</i>   |
| _____ 4 Growth on supplemented chocolate agar appears in 18 to 24 hours as small, colorless, transparent moist colonies with a distinct "mousy" odor. | d. <i>H. aphrophilus</i>  |
| _____ 5 Associated with the highly communicable form of conjunctivitis known as pink-eye.   | e. <i>H. influenzae</i>   |
|   | f. <i>H. aegyptius</i>  |
|   | g. <i>H. parainfluenzae</i>   |
|   | h. Quellung method or precipitin reaction   |
|   | i. To prevent carry over of factor X.   |
|   | j. To prevent carry over of factor Y.   |
|   | k. Ability to hemolyze, accessory growth factor requirements, and enhancement of growth under CO <sub>2</sub> . |
|   | l. Beta hemolytic streptococci  |

#### Column A

- \_\_\_\_\_ 6 Is found in the upper respiratory tract of man but rarely causes infection.
- \_\_\_\_\_ 7. Colonies resemble *H. influenzae*, but are surrounded by a wide zone of clear hemolysis.
- \_\_\_\_\_ 8. A colony gram-stain will readily differentiate the two groups when the smear is taken from the culture.
- \_\_\_\_\_ 9. Both require only the V factor.
- \_\_\_\_\_ 10. Is the cause of a venereal disease known as chancroid.
- \_\_\_\_\_ 11. Grows on meat infusion or blood-enriched medium with increased CO<sub>2</sub>, but primary isolation from genital ulcer may be very difficult and requires X factor only.
- \_\_\_\_\_ 12. Patients infected with this organism develop a hypersensitivity to it which may be detected by intradermal injection of heat-killed cells.
- \_\_\_\_\_ 13. Many strains will not grow in the presence of moisture.
- \_\_\_\_\_ 14. Most strains are cultured from patients with a damaged endocardium, congenital heart disease, and secondary brain abscess.

244. Cite morphological and cultural characteristics of *Bordetella* species, differences in X and V factor requirements when compared with *Haemophilus* species; disease caused by *Bordetella pertussis*; spore-forming characteristics and ability to produce motility; the ingredients in Bordet-Gengou media; the specimen of choice for isolation of *B. pertussis*; and the cultural and biochemical characteristics of the organism.

**Bordetella Species.** We pointed out in the introductory paragraph of this section that three species, *B. pertussis*, *B. parapertussis*, and *B. bronchiseptica* were formerly classified with the genus *Haemophilus*. The *Bordetella* species are named for the French microbiologist, Jules Bordet, who isolated the whooping cough agent in 1906. The *Bordetella* are less demanding in their nutritional requirements with respect to the X and V factors of blood. This characteristic, we noted, was one of the reasons for classifying these organisms separately.



The organisms are small, gram-negative coccobacilli, 0.2 to 0.3  $\mu\text{m}$  by 0.5 to 1.0  $\mu\text{m}$ , appearing singly, in pairs, and in small clusters. Upon primary isolation cells are uniform in size, but in subcultures they become quite pleomorphic and filamentous, and thick bacillary forms are common. Toluidine blue may be used to demonstrate bipolar staining. *B. bronchiseptica*, which possesses lateral flagella, is the only motile member of the genus. Capsules produced are demonstrated by capsular strains but not by capsular swelling.

*Bordetella* organisms are strict aerobes, and their respiratory system is never fermentative.

***Bordetella pertussis.*** *Bordetella pertussis* is responsible for an infection of the tracheal and bronchial epithelium, a disease known as whooping cough. The organism interferes with ciliary action and causes episodes of uncontrollable coughing accompanied by inspiratory whoops. It can also cause cerebral and pulmonary complications.

Morphologically, *B. pertussis* is a small, ovoid, gram-negative rod that measures 0.3 to 0.5 micron in width and 1.0 to 1.5 microns in length. It is nonspore-forming and nonmotile. In bronchial secretions the bacilli usually occur singly and in masses. Occasional diplobacilli may be observed. Chains are not formed in exudates but may be seen in broth culture. Smooth colonies usually yield encapsulated cells. The bacilli of *B. pertussis* closely resemble the coccobacillary forms of *Haemophilus influenzae*; however, *B. pertussis* does not ordinarily produce the threadlike filaments or other pleomorphic forms exhibited by *H. influenzae*.

*Bordetella pertussis* is an aerobe and requires a complex medium. Laboratory identification is based on the isolation of the organism from nasopharyngeal swab cultures or by the cough plate technique. The medium of Bordet and Gengou containing glycerol,

potato, and 15- to 20-percent blood is recommended. Another Bordet-Gengou plate which contains 0.5 units of penicillin/ml of medium may be used. Penicillin is added to retard growth of contaminants. The cough plate technique involves holding the petri dish of Bordet-Gengou medium about six inches from the mouth of the patient and having the patient cough onto the exposed medium. The plate is incubated at 35° C. and examined after three to five days. Growth is slow. Colonies are small, domeshaped, and possess a gray metallic luster resembling mercury drops or a bisected pearl, as shown in figure 3-2. A beta hemolysis is produced; however, the edge of the zone of hemolysis is fuzzy and indefinite because of the large concentration of blood used in the medium.

A nasopharyngeal swab is the specimen of choice. A swab made of Telfon tubing to which a small wad of cotton has been securely attached is most satisfactory. Once the swab is taken it is imperative that it be streaked immediately on Bordet-Gengou agar.

As a rule, carbohydrates are not fermented by *B. pertussis*, although an occasional lactose and glucose fermenter may be encountered. Approximately 70 percent of the strains isolated are catalase-positive. We find in table 3-4 that citrates are not used as the sole source of carbon, and the species is urea-negative. In fact, citrate utilization, urease production, motility, and nitrate reduction are the prime means of distinguishing *B. pertussis* from the other two species. The brownish hemolysis surrounding *B. parapertussis* colonies is caused by a high concentration of copper-containing protein. We noted earlier that the "fuzzy" hemolysis of *B. pertussis* results from the high concentration of red cells in the Bordet-Gengou medium.

*Bordetella pertussis* is further identified by a slide agglutination test with specific antiserum. Fluorescent antibody staining may also be used as a method of identification.



A

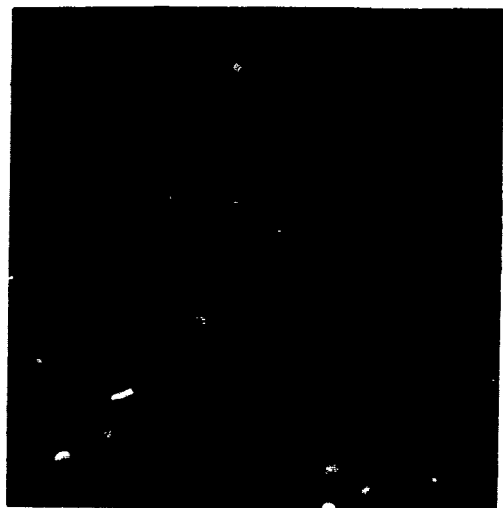

B

Figure 3-2. *Bordetella pertussis*.



TABLE 3-4  
CHARACTERISTIC OF THE *BORDETELLA* SPECIES

Species	Citrate	Urea	Motility	Nitrate Reduced	Hemolysis
<i>B. pertussis</i>	-	-	-	-	+ (fuzzy)
<i>B. parapertussis</i>	+	+	-	-	+ (brown)
<i>B. bronchiseptica</i>	+	+	+	(+)	+

( ) = usually

**Exercises (244):**

- How do members of the genus *Bordetella* differ from those of the genus *Haemophilus* in terms of their X and V factor requirements?
  - Upon primary isolation, how do the cells of *Bordetella* appear as compared with those from subcultures?
  - How are capsules produced by *Bordetella* demonstrated?
  - Describe *Bordetella pertussis* in terms of their sporeforming characteristics and ability to produce motility.
  - What type of infections is caused by *Bordetella pertussis*?
  - When do *B. pertussis* produce threadlike filaments or other pleomorphic forms exhibited by *H. influenzae*?
  - What three major ingredients are found in Bordet-Gengou media?
  - How do the colonies of *B. pertussis* characteristically appear on Bordet-Gengou medium?
  - What is the specimen of choice for isolation of *B. pertussis*?
  - What four biochemical tests are the prime means of distinguishing *B. pertussis* from the other two species?
  - What other two tests may be used to identify *B. pertussis*?
245. Indicate whether given statements correctly reflect the morphological, colonial, and biochemical characteristics of *Bordetella parapertussis* and *Bordetella bronchiseptica*.
- Bordetella Parapertussis.* *Bordetella parapertussis* is occasionally isolated from patients with an acute respiratory infection resembling mild whooping cough. Morphologically and colonially, it is similar to *B. pertussis*, but instead of a "fuzzy" hemolysis on Bordet-Gengou agar, it produces a brown pigment in the underlying medium. It does not require the X or V

factors for growth and is nonmotile. *B. parapertussis* is typically the most rod-shaped, and can, to a limited degree, appear in palisade arrangements. The organism does not produce indole and does not ferment carbohydrates. The organism produces a positive urease and catalase test and utilizes citrate.

***Bordetella bronchiseptica.*** *Bordetella bronchiseptica* has been isolated occasionally from patients with symptoms similar to those caused by *B. pertussis*. It differs from *B. pertussis* in that it is motile and possesses peritrichous flagella. The organism grows well on blood agar and produces smooth, raised, glistening colonies with hemolytic zones. Indole is not produced, and none of the carbohydrates is fermented. Within four hours, urea is split, nitrates are frequently reduced, and citrate is used as a source of carbon.

#### Exercises (245):

Indicate whether each of the given statements is true (T) or false (F) and correct those that are false.

- T F 1. *Bordetella parapertussis* is occasionally isolated from patients with an acute respiratory infection resembling mild whooping cough.
- T F 2. *B. parapertussis* is colonially and morphologically similar to *Haemophilus influenzae*.
- T F 3. Instead of a brown pigment on Bordet-Gengou medium, *B. parapertussis* produces a "fuzzy" hemolysis.
- T F 4. *B. parapertussis* does not require the X or V factors for growth and is nonmotile.
- T F 5. *B. parapertussis* is typically the most rod-shaped and can, to a limited degree, appear in palisade arrangements.
- T F 6. *B. parapertussis* produces a negative urease and catalase and does not utilize citrate.
- T F 7. *B. bronchiseptica* differs from *B. pertussis* in that it is nonmotile and does not possess peritrichous flagella.

T F 8. *B. bronchiseptica* grows well on blood agar and produces smooth, raised, glistening colonies.

T F 9. Indole is not produced and none of the carbohydrates is fermented.

#### 3-3. The Genus *Brucella*

The disease in man known as brucellosis or "undulant fever" can be caused by any one of three *Brucella* species that normally occur as pathogens of domestic animals. *B. melitensis* (Malta fever) is associated with the disease in goats, *B. abortus* with cattle (Bang's disease), and *B. suis* with swine.

246. Indicate whether given statements correctly reflect the clinical significance of the brucellosis.

**Clinical Significance.** The disease of brucellosis in man follows the ingestion of raw milk and improperly cooked meat from infected animals or direct contact with contaminated animal tissue. The incidence of brucellosis is high among slaughter house attendants, veterinarians, sausage makers, butchers, dairymen, and similar occupational groups exposed to infected animals.

After entry into the human host, the organisms spread by way of lymph channels and the bloodstream to various organs including the liver, spleen, bone marrow, and other areas of the reticuloendothelial system. The organisms form multiple abscesses in these tissues, and osteomyelitis or meningitis may occur. At the height of infection, acute febrile episodes (undulant fever) result as organisms are intermittently released into the bloodstream. The bacilli remain dormant in deep tissues (chronic brucellosis), and relapses may occur.

#### Exercises (246):

Indicate whether each of the given statements is true (T) or false (F) and correct those that are false.

- T F 1. Man may become infected with brucellosis from the ingestion of raw milk and improperly cooked meat from infected animals.
- T F 2. The incidence of brucellosis is high among laboratory technicians.

- T F 3. After entry into the human host, the organisms spread by way of lymph channels and the bloodstream.
- T F 4. The organisms encyst in the infected tissues and osteomyelitis or meningitis may occur.
- T F 5. At the height of the infection, acute febrile episodes (undulant fever) result as organisms are intermittently released into the bloodstream.
- T F 6. The bacilli do not remain dormant in deep tissues and relapses do not occur.

flagella, so they are nonmotile. *B. melitensis* usually produces coccil forms in exudates and tissue, where *B. abortus* and *B. suis* produce the bacillary form. The Brucellae are strict aerobes. They grow slowly and require complex media for primary isolation.

Blood taken during the febrile stage is the specimen of choice for isolating Brucella species. Lymph aspirations, biopsy materials, spinal fluid, or swab specimens of deep lesions may also be examined. The isolates require complex media for growth. Although many special media have been devised, such media as serum-dextrose agar or trypticase soy agar are satisfactory for use. Incubate primary cultures at 37° C. under 10 percent CO<sub>2</sub> tension for about 4 to 5 days before making first transfer unless visible growth appears. Reincubate primary culture, renewing CO<sub>2</sub> if it has been dissipated, and make subsequent transfers every four days. The primary culture should be incubated for at least 21 days before the specimen is reported as negative. *B. abortus* can only be cultivated from clinical specimens in an atmosphere of 5 to 10 percent carbon dioxide. *B. melitensis* and *B. suis* will grow with or without increased carbon dioxide. The use of the modified Castaneda bottle is highly recommended for culturing blood from multiple specimens collected.

Colonies of *Brucella* are spheroidal in shape, moist, translucent, and slightly opalescent or iridescent which become brownish with age. They are 2 to 7 mm in diameter.

The most common tests used for the differentiation of the species of *Brucella* are: (a) the need for increased CO<sub>2</sub>, especially on primary isolation; (b) the production of H<sub>2</sub>S for a period of four to five days; (c) the bacteriostatic action of basic fuchsin and thionin in solid media; (d) agglutination in monospecific sera and the urease test, which is useful in differentiation of *B. suis* from other *Brucella* species, as noted in table 3-5.

**247. Point out the morphological, physiological, and cultural characteristics of *Brucella* species; cite the specimen of choice, media used for isolation, and tests used for differentiation of *Brucella* species.**

**General Characteristics.** *Brucella* are small, nonmotile rods, usually coccobacillary forms ranging from 0.5- to 0.7-by 0.6 to 1.5 μm. In freshly isolated cultures they are encapsulated and form smooth or mucoid colonies. Gram-negative cells occur singly, in pairs, or in short chains. *Brucella* spp. do not possess

TABLE 3-5  
IDENTIFICATION OF BRUCELLA SPECIES

Species	Carbon Dioxide Requirements	Growth in presence of		Urease 4 hrs	Hydrogen Sulfide
		Basic Fuchsin	Thionin		
<i>Brucella melitensis</i>	-	+	+	±	+ or - for 1 day
<i>Brucella abortus</i>	+	+	-	±	+ for 2 days
<i>Brucella suis</i>	-	-	+	±	+ for 4 days

The agglutination test, which uses a standardized, heat-killed, smooth *Brucella* antigen, is the most reliable of the serological tests. The indirect FA test has been successfully used for detecting antibody in human sera.

The spleen, liver, and genitalia of healthy male guinea pigs will become infected within 30 days by all pathogenic species of *Brucella*.

#### Exercises (247):

1. Briefly describe the morphological appearance of *Brucella*.
2. In freshly isolated cultures, what colonial forms are noted?
3. Which of the *Brucella* species usually produces coccidial forms in exudates and tissue?
4. What is the specimen of choice for isolating brucella organisms from an infected person?
5. What media may be used for isolation of *Brucella*?
6. For how long should the primary *Brucella* cultures be incubated before the specimen is reported as negative?
7. Which of the *Brucella* spp. can only be cultivated in an atmosphere containing 5 to 10 percent CO<sub>2</sub>?
8. How do the colonies of *Brucella* appear on solid media?
9. What special bottle medium is highly recommended for culturing blood from multiple specimens collected?
10. What are the most common tests used for differentiation *Brucella* species?

11. What test is useful in differentiating *B. suis* from other *Brucella* species?

12. What agglutination test is considered to be the most reliable of the serological tests?

#### 3-4. Other Genera of Clinically Significant Gram-Negative Bacilli

In this section we briefly mention specific pathogens within the genera *Actinobacillus*, *Calymmatobacterium*, *Streptobacillus*, and *Bacteroides*. Some are primarily animal pathogens but are transmissible to man. We will take note of the heterogeneous organisms grouped under the genus *Bacteroides*. These species live in such close association with man, and in such profusion, that they are frequently found in clinical specimens as "secondary-invaders" of the disease process. A brief discussion concerning the agent of Legionnaires' disease, an unusual and fastidious gram-negative bacillus causing a serious type of pneumonia, is also mentioned.

**248. State the disease caused by members of the genus *Actinobacillus*, areas from which *Actinobacillus* is isolated and frequently found, the organism primarily associated with human diseases, source of isolation of *A. lignieresii* and *A. equuli*, media used, growth requirements, and colonial characteristics.**

*Actinobacillus*. Members of the genus *Actinobacillus* cause acute septicemia or purulent granulomatous lesions or abscesses in cattle, horses, swine, and sheep, and occasionally in humans and other animals. The glanders bacillus, formerly named *Actinobacillus mallei*, has been improperly classified in this genus. *A. mallei* will be found as *Pseudomonas mallei* in the 8th Edition of *Bergey's Manual* and will be discussed with the genus *Pseudomonas*. *Actinobacillus* is isolated from lesions and is frequently found in the mouth and gastrointestinal tract of natural hosts.

*A. actinomycetemcomitans*, listed as species incertae sedis, is primarily associated with human diseases. It grows best on serum or blood agar in an atmosphere of 10 percent carbon dioxide. Colonies on agar are about 1 mm in diameter (after 2 to 3 days), are starlike, and adhere to the agar. Most clinical isolates of this species have been from infected blood and bone. The organism is a normal inhabitant of the mouth. A number of cases of subacute bacterial endocarditis due to *A. actinomycetemcomitans* have been cited.

Many *Actinobacillus* infections have been attributed erroneously to *A. lignieresii* and *A. equuli*. The characteristics of the two designated species are indistinguishable. The organisms are present in purulent discharge of lesions. Isolation is best accomplished in slightly alkaline nutrient media enriched with 5 percent blood or 10 percent serum.

They are gram-negative, spores are absent, and they are nonmotile. Organisms are coccobacilli measuring 0.3 to 0.5  $\mu$ m by 0.5 to 1.5  $\mu$ m, and occur singly, in pairs, and in short chains. They may be present in pleomorphic coccil, long bacillary, and filamentous forms.

*A. lignieresii* and *A. equuli* strains are best isolated in blood agar or 10 percent serum media. These organisms are aerobes and facultative anaerobes. Fresh isolates on nutrient media grow well in an atmosphere of 10 percent CO<sub>2</sub>. The optimal growth temperature is 37° C. After 24 hours of incubation, the rough colonies are 0.5 to 1.0 mm in diameter, slightly raised, grayish, opaque, convex, tenacious, and firmly adherent to the medium. Smooth colonies are small, discrete, convex, and semiopaque, with entire edges and glistening surfaces.

Nitrites are produced from nitrates. The urease test is positive. Growth occurs on gelatin, but not liquefaction. Indole is not produced. Hydrogen sulfide is produced feebly or not at all, and hemolysis is variable.

#### Exercises (248):

Complete the following statements.

- Members of the genus *Actinobacillus* cause acute \_\_\_\_\_ or purulent granulomatous \_\_\_\_\_ or \_\_\_\_\_ in cattle, horses, swine and sheep, and occasionally in humans.
- A. mallei* will be found as \_\_\_\_\_.
- Actinobacillus* is frequently found in the \_\_\_\_\_ and \_\_\_\_\_ of natural hosts.
- \_\_\_\_\_, listed as species incertae sedis, is primarily associated with human diseases.
- Most clinical isolates of the above species have been obtained from infected \_\_\_\_\_ and \_\_\_\_\_.
- Both species \_\_\_\_\_ and \_\_\_\_\_ have been found in purulent discharge of lesions and have indistinguishable characteristics.
- Isolation is best accomplished in a slightly \_\_\_\_\_ nutrient media enriched with 5 percent \_\_\_\_\_ or 10 percent \_\_\_\_\_.
- Both of the above species of *Actinobacillus* are gram-\_\_\_\_\_, spores are \_\_\_\_\_, and they are \_\_\_\_\_. They are coccobacilli and occur \_\_\_\_\_, in \_\_\_\_\_ and in short \_\_\_\_\_.
- A. lignieresii* and *A. equuli* strains are best isolated in \_\_\_\_\_ or 10 percent \_\_\_\_\_ media.
- Fresh isolates of these organisms on nutrient media grow well in an atmosphere of \_\_\_\_\_.

11. After 24 hours of incubation, the rough colonies are 0.5 to 1.0 mm in diameter, slightly \_\_\_\_\_, \_\_\_\_\_, \_\_\_\_\_, \_\_\_\_\_, and firmly adherent to the medium.

12. Smooth colonies are \_\_\_\_\_, \_\_\_\_\_, \_\_\_\_\_, and \_\_\_\_\_ with entire edges and \_\_\_\_\_ surfaces.

249. Cite the diseases caused by *Calymmatobacterium granulomatis* and *Legionella pneumophila*, culture methods, media, staining methods, and specimens of choice.

***Calymmatobacterium Granulomatis.*** *Calymmatobacterium granulomatis* is the only species of the genus and is the etiologic agent of granuloma inguinale, a disease characterized by chronic ulcerative lesions of the genital area. Although considered by many to be a venereal infection, transmission of the causative agent by sexual contact has not been fully substantiated.

The organism is a gram-negative, pleomorphic rod exhibiting bipolar staining. The bacilli measure approximately 1.0 to 2.0 microns in length and have rounded ends. They occur singly or in clusters. Capsules may be observed when the organisms are found inside mononucleated white cells. When inside such cells, they are often referred to as "Donovani bodies," shown in figure 3-3. *C. granulomatis* cannot be isolated on ordinary culture media, but growth takes place in chick embryo tissues. Another successful cultural procedure has employed coagulated egg yolk slants known as "Dulancy slants."

Laboratory diagnosis is accomplished by demonstrating "Donovani bodies" in large mononuclear white cells obtained from ulcerated lesions. If Wright's stain is used, blue bacilli surrounded by a well-defined, dense, pink capsule are observed. This organism, besides being morphologically similar to the enteric gram-negative rods, demonstrates a cross-complement fixation with members of the genus *Klebsiella*, suggesting a closer relationship with the enteric forms that the taxonomic classification indicates.

***Legionella pneumophila.*** *Legionella pneumophila* is the causative agent of Legionnaires' disease, a severe type of pneumonia. The mortality is 15 to 20 percent. The organism may be difficult to stain by the gram stain, but the cell wall structure is typical of gram-negative bacilli when observed with the electron microscope. The organism in tissue is best stained by a silver impregnation technique such as the Dieterle stain. The direct fluorescent antibody staining technique was used effectively by CDC. The organisms appear as short pleomorphic rods, 1  $\mu$ m in diameter and 1 to 4  $\mu$ m in length and sometimes show bipolar staining. *L. pneumophila* produces a weakly positive catalase, a positive oxidase, positive gelatin, and



apostive urease. It does not produce acid from carbohydrates, ONPG is negative, and it produces a brown soluble pigment. Two media used by CDC are Feeley-Gorman agar and Charcoal Yeast Extract agar. On Feeley-Gorman, the organism appears as smooth raised colonies, having a cut-glass appearance when viewed under the dissecting microscope. It produces a brown pigment which fluoresces when viewed under UV light. On Charcoal Yeast Extract agar, the organisms appear as white smooth colonies showing a similar cut glass appearance as grown on Feeley-Gorman agar. Pleural fluid or transtracheal aspirates are specimens of choice. Lung biopsy and autopsy specimens may be cultured on Mueller-Hinton agar supplemented with 1 percent hemoglobin and 1 to 2 percent Iso-Vitalex. The CDC should be notified of any suspected organisms.

**Exercises (249):**

1. What disease is caused by the organism *Calymmatobacterium granulomatis*, and what is a characteristic of the disease?
2. How does the organism appear after gram-staining?
3. Capsules which may be observed when the organisms are found in mononucleated white cells are referred to as \_\_\_\_\_.
4. What media are used for growth of the organism?
5. What other given staining method is used to demonstrate the capsules in large mononuclear white cells and how do they appear?
6. What disease is caused by the organism *Legionella pneumophila*?
7. What staining technique is best for observing *L. pneumophila* in tissue specimens?
8. Describe the morphological appearance of *L. pneumophila*.

9. What two media are used by CDC for identification of the organism?
10. On which of the two media do the organisms appear as smooth, raised colonies, having cut-glass appearance when viewed under the dissecting microscope?
11. What are two specimens of choice for isolation of *L. pneumophila*?

**250. State the primary human pathogen of the genus *Streptobacillus*, the common habitat of the organism, diseases produced source of isolation, staining methods, appearance of gram stained organisms, media used, meaning of the L form of the species, cultural requirements, and colonial characteristics.**

***Streptobacillus.*** The primary human pathogen of this genus is *Streptobacillus moniliformis*, the cause of one type of rat-bite fever and of a milk-borne disease known as "Haverhill fever." This normal inhabitant of the mouth of rats, both wild and laboratory types, infects humans as the result of a rat bite. The disease is similar clinically to that produced by *Spirillum minor*—"ratbite fever." *Streptobacillus moniliformis* can be isolated from the blood. A blood specimen is citrated by adding 10 ml of blood to 10 ml of



Figure 3-3. *Calymmatobacterium granulomatis*.



sterile 2.5 percent sodium citrate to a sterile flask. The mixture should be centrifuged and the sedimented red cells used to inoculate culture media. Prepare three separate films, and stain with Gram, Wayson, and Giemsa stains.

This gram-negative organism is quite pleomorphic, varying in form from a short rod to long, interwoven filaments. These filaments break up into chains of bacilli and coccobacillary forms. Examination of the filaments often reveal yeastlike swellings. The filaments, which attain a length of 150 microns, may be curved and even looped. When cultured in a laboratory animal or on suitable media, a more uniform bacillary form measuring 2.0 to 4.0 microns in length emerges. The organism is nonsporeforming and non-encapsulated.

Blood, ascitic fluid, or serum is required for growth. The organisms have been maintained on a number of common basal media enriched with 15 percent sterile defibrinated rabbit blood. Further, the addition of 10 to 30 percent ascitic fluid to thioglycollate makes an excellent recovery medium. It is preferable to use a clear medium which will enhance the isolation and maintenance of the more fragile and nutritionally fastidious L form variants. This L form grows into the medium and cannot usually be transferred with the laboratory loop. Transfer is accomplished by cutting out a small block of medium which contains a colony and then subculturing it to fresh media.

*S. moniliformis* is a facultative anaerobe and requires CO<sub>2</sub> and moisture for primary isolation for fresh isolates and for some laboratory strains. It has an optimum temperature of 37° C.

On solid media growth is slow, taking up to 48 to 72 hours. On serum or ascitic fluid media growth appears as discrete (1.0 to 2.5 mm in diameter) colonies which are circular and colorless or gray-white. They are convex, with a smooth glistening surface that is butter-like in consistency. Coarse, granular colonies may be observed occasionally. L form colonies are found growing in the immediate proximity of the regular colonies. In broth media, growth usually occurs at the bottom of the container. It resembles small white "fluff balls" or "cotton balls." If blood is used, growth on the sedimented red blood cells is quite striking. These "balls" can be removed intact for culturing and staining.

Diagnosis is made by isolation of the organism from blood or from joint fluids and pus. Agglutinins appear in the patient's serum within ten days and reach a maximum in three or four weeks.

#### Exercises (250):

1. What species is the primary pathogen of the genus *streptobaccillus*?
2. What is the normal habitat of this organism?

3. How do humans become infected?
4. What diseases are produced by the organisms?
5. From what specimen can the organism be isolated?
6. After preparing the specimen for culture and making three separate films, what three stains may be used?
7. How does the organism appear on the gram-stain?
8. What three enrichment substances are required for growth?
9. What type medium is preferable and will enhance the isolation and maintenance of the more fragile and nutritionally fastidious L form variants?
10. What is the L form of *Streptobacillus moniliformis*?
11. What type of growth environment is required for primary isolation of fresh isolates of *S. moniliformis*?
12. In broth media, where does growth of *S. moniliformis* usually occur and what does it resemble?

**251. Identify the given *Bacteroides* species in terms of their common sources of isolation, general and cultural characteristics, and media used.**

***Bacteroides* Species.** Organisms of the genus *Bacteroides* have been implicated in bacteremias, abscesses, peritonitis, salpingitis, meningitis, otitis media, and other conditions. But there is no direct

evidence of a primary role for them in human disease. They appear to be associated with diseased or injured tissue as secondary invaders. The bacteroids are normal inhabitants of the mouth, intestinal tract, and vagina. There are 22 different species of the genus *Bacteroides* discussed in the 8th Edition of *Bergey's Manual*. Some bacteroides species most common in clinical specimen are included in this section.

***Bacteroides fragilis*.** *Bacteroides fragilis* is the anaerobe most frequently isolated from clinical infections. It is the predominant organism of the normal human intestinal tract. The species is divided into five subspecies, *fragilis*, *thetaiotaomicron*, *vulgatus*, *distasonis*, and *ovatus*. Subspecies *fragilis* is the most common clinical isolate from infection, although it is the least numerous of the subspecies in the normal fecal flora. On blood agar, *B. fragilis* grows as a small, smooth, white to gray, nonhemolytic, translucent, glistening colony about 1 to 2 mm in diameter. The organism is a slender gram-negative bacillus with rounded ends. Some are pleomorphic with filaments and bipolar staining. Differentiation of subspecies requires a study of final pH in carbohydrates and the metabolic products from growth in peptone-yeast extract glucose broth (PYG) by gas chromatography.

***Bacteroides melaninogenicus*.** *Bacteroides melaninogenicus* is subdivided into three subspecies: *asaccharolyticus*, *intermedius*, and *melaninogenicus*. The organism is normally part of the microflora of the oropharynx and upper respiratory tract, gastrointestinal tract, and genitourinary tract. It is an important pathogen in lung abscess and is less frequently isolated than *B. fragilis*. The colonies produce a clear hemolysis on blood agar, and most strains produce a brown to black colony after five to seven days. It is an important pathogen in oral, pulmonary, obstetric, and gynecologic infections.

***Bacteroides corrodens*.** *B. corrodens* is a somewhat fastidious species that has been more frequently isolated with improvement in anaerobic techniques. The organism is isolated from pleuropulmonary infections, infections of the intestinal tract, and rarely from blood cultures of bacteremic patients. The original description of this organism included both obligate anaerobic and facultative strains; as now defined, it refers only to the anaerobic strains. Facultative strains have been placed in a separate genus and species, *Eikenella corrodens*. The obligately anaerobic strains grow slowly. Colonies are translucent and pinpoint, with edges spreading and eroding or pitting the agar. *B. corrodens* is bacillary with rounded ends, and rarely filamentous.

***Bacteroides oralis*.** *B. oralis* was previously considered an uncommon isolate from infections. Cellular

morphology may be coccobacillary or elongated bacilli. The colonies are yellowish, glistening, and often hemolytic. The organism is present in the normal flora of the mouth, gastrointestinal tract, and urogenital tract. Clinical isolation is from oral, pulmonary, or genital tract infections.

#### Exercises (251):

Match each of the following *Bacteroides* species in column B with the statements in column A by placing the letter of the column B item beside the number of the column A item that most nearly describes it. Each element in column B may be used once, more than once, or not at all.

- | Column A  | Column B                                  |
|---|---|
| _____ 1. The anaerobe most frequently isolated from clinical infections.  | a. <i>B. melaninogenicus</i>              |
| _____ 2. The predominant organism of the normal intestinal tract.   | b. <i>B. oralis</i>                       |
| _____ 3. The subspecies considered to be the most common clinical isolate from infection.   | c. <i>B. corrodens</i>                    |
| _____ 4. The least numerous of the subspecies in the normal fecal flora.  | d. <i>E. corrodens</i>                    |
| _____ 5. Grows as a small, smooth, white to gray, nonhemolytic translucent, glistening colony about 1 to 2 mm in diameter.            | e. <i>B. fragilis</i> ss. <i>fragilis</i> |
| _____ 6. Is subdivided into three subspecies.   | f. <i>B. fragilis</i> ss. <i>ovatus</i>   |
| _____ 7. Normally part of the microflora of the oropharynx and upper respiratory tract and gastrointestinal and genitourinary tracts. | g. <i>B. fragilis</i>                     |
| _____ 8. An important pathogen in lung abscess.   |   |
| _____ 9. Considered to be an important pathogen in oral, pulmonary, obstetric, and gynecologic infections.                            |   |
| _____ 10. Is isolated from pleuropulmonary infections, infections of the intestinal tract, and rarely from blood cultures.            |   |
| _____ 11. The facultative strains of <i>B. corrodens</i> .  |   |
| _____ 12. Colonies are translucent and pinpoint, with edges spreading and eroding or pitting the agar.                                |   |
| _____ 13. Colonies are yellowish, glistening, and often hemolytic.  |   |

## The Enteric Organisms

OF ALL THE clinical specimens submitted to the laboratory for bacteriological examination, the feces contain the greatest number of organisms, both in quantity and in the variety of genera represented. The feces normally contain millions of bacteria per gram. Most of the bacteria are harmless normal flora, but others cause some of the world's most prevalent diseases. The pathogenic and nonpathogenic gram-negative bacilli that you isolate from stool specimens are often referred to as the "enterics" because of their natural habitation in the intestinal tract. Aside from these forms, there are "enteric-like" organisms which closely resemble the enterics, and which occur often enough in feces or other clinical specimens to complicate the process of identification.

The prompt and accurate identification of enteric organisms serves several useful purposes. It can help locate and isolate "carriers" and give advance warning of epidemics. It can confirm the nature of an infection in cases where the clinical picture is not typical; and it can assist the physician in prescribing an effective course of therapy. The enterics are not limited to the feces, however. Almost every organ or body fluid may become diseased as a result of infection with these microbes. Consequently, learning the enteric identification procedures is an important part of the bacteriologist's training, because this knowledge is put to daily use in the hospital laboratory.

### 4-1. Enterobacteriaceae: Classification and General Characteristics

The bacteria that make up the family Enterobacteriaceae are closely related in the physiological sense. Their similarities in fundamental metabolic processes usually make generic distinctions difficult. To complicate the task of laboratory identification, we often find marked variability from culture-to-culture of a given species with respect to fermentation patterns and other traits useful in characterizing an organism. As a consequence, there is still a great deal of uncertainty regarding the exact taxonomic position of many of the gram-negative enteric forms.

**252. Identify some general characteristics of the family Enterobacteriaceae.**

**The Family Enterobacteriaceae.** The family Enterobacteriaceae is composed of a large number of closely related bacterial species that inhabit the large bowel of man and animals, soil, water, and decaying matter. They have often been referred to as the enteric bacilli or enterics because of their normal habitat in man. Organisms such as the agents of typhoid fever and bacillary dysentery are among some of the most important intestinal pathogens of man found in this group. Most enterics do not cause disease when confined to the intestinal tract of a normal host, but given an altered host or an opportunity to invade other body sites, have the capability of producing disease in any tissue.

The organisms of this family are responsible for a significant number of hospital acquired infections and cause urinary tract and wound infections, pneumonia, meningitis, and septicemia.

The enterobacteria have also played a significant role in the field of molecular biology. Valuable information concerning microbial genetics and regulatory mechanisms have been derived from experimentation with these organisms. Owing to the need for accurate information on the epidemiology of enteric infections, and the intense study required, the speciation and the characterization of the family has been carried out to a higher degree than with other bacteria.

### Exercises (252):

1. What are some habitats of the closely related bacterial of the Enterobacteriaceae?
2. What two intestinal diseases are produced by some important intestinal pathogens of man?
3. What are some other general infections caused by species of the enterobacteria?
4. In what general way have the enteric bacteria played a significant role in the field of molecular biology?

5. To what degree are these organisms identified compared with other bacteria? Why?

253. Indicate whether given statements correctly reflect the systems of classification and nomenclature used for Enterobacteriaceae and the basis for the inclusion of the genus *Yersinia* in the family Enterobacteriaceae.

**Taxonomy of the Enterobacteriaceae.** The system of classification and nomenclature of the family Enterobacteriaceae proposed by Ewing is divided into tribes consisting of closely related species. This classification scheme, presented in table 4-1, is not universally accepted, as indicated by the universal scheme from the 8th Edition of *Bergey's Manual of Determinative Bacteriology*, table 4-2. Experts in the field expect that additional changes will take place in the near future. For the sake of consistency, references to nomenclature in this section will use the Ewing scheme, since it is the method used in the United States by most clinical journals and the Center for Disease Control at the time of writing.

There has been general agreement on one major taxonomic change, which is the inclusion of the genus

TABLE 4-2  
CLASSIFICATION OF ENTEROBACTERIACEAE  
ACCORDING TO BERGEY'S MANUAL

Family: Enterobacteriaceae	
Group I	Eschericheae
Genus I	<i>Escherichia</i>
Genus II	<i>Edwardsiella</i>
Genus III	<i>Citrobacter</i>
Genus IV	<i>Salmonella</i>
Genus V	<i>Shigella</i>
Group II	Klebsielleae
Genus VI	<i>Klebsiella</i>
Genus VII	<i>Enterobacter</i>
Genus VIII	<i>Hafnia</i>
Genus IX	<i>Serratia</i>
Group III	Proteeae
Genus X	<i>Proteus</i>
Group IV	Yersinieae
Genus XI	<i>Yersinia</i>
Group V	Erwinieae
Genus XII	<i>Erwinia</i>

*Yersinia* in the family Enterobacteriaceae on the basis of biochemical and serologic reactions.

TABLE 4-1  
CLASSIFICATION OF ENTEROBACTERIACEAE  
ACCORDING TO EWING

Family: Enterobacteriaceae	
Tribe I	Eschericheae
Genus I	<i>Escherichia</i>
Genus II	<i>Shigella</i>
Tribe II	Edwardsielleae
Genus I	<i>Edwardsiella</i>
Tribe III	Salmonelleae
Genus I	<i>Salmonella</i>
Genus II	<i>Arizona</i>
Genus III	<i>Citrobacter</i>
Tribe IV	Klebsielleae
Genus I	<i>Klebsiella</i>
Genus II	<i>Enterobacter</i>
Genus III	<i>Serratia</i>
Tribe V	Proteeae
Genus I	<i>Proteus</i>
Genus II	<i>Providencia</i>
Tribe VI	Erwinieae
Genus I	<i>Erwinia</i>
Genus II	<i>Pectobacterium</i>

**Exercises (253):**

Indicate whether each of the statements is (T) true or (F) false and correct those that are false.

- T F 1. The system of classification and nomenclature of the family Enterobacteriaceae proposed by Ewing is divided into five tribes consisting of species remotely related.
- T F 2. The classification scheme by Ewing is universally accepted.
- T F 3. The Bergey's scheme for classification of Enterobacteriaceae is the method used in the United States by most clinical journals and the Center for Disease Control.
- T F 4. There has been general agreement on one major taxonomic change which is the inclusion of *Yersinia* in the family Enterobacteriaceae.

T F 5. *Yersinia* is included on the basis of morphological and cultural characteristics.

the close resemblance of the two pathogens, *Shigella* and *Salmonella*, on EMB agar.

Comparison of growth on MacConkey's agar in foldout 1, detail K, and foldout 2, detail L, just as effectively shows the dissimilarity on differential media of lactose-positive and lactose-negative enterics.

**254. Cite distinctive morphological properties of members of the family Enterobacteriaceae in terms of their characteristics and purposes and the biochemical properties in terms of their functions; point out their cultural appearance on given media.**

**Morphology.** The Enterobacteriaceae are small (0.5  $\mu\text{m}$  to 3.0  $\mu\text{m}$ ), gram-negative, nonsporeforming rods. They may be motile or nonmotile. When motile, movement is by means of peritrichous flagella, a property that aids in differentiating the enterics from the polar flagellated bacteria of the families Pseudomonadaceae and Vibrionaceae, which can be isolated from the similar sources. Several strains of *Salmonella*, *Shigella*, *Escherichia*, *Klebsiella*, *Enterobacter*, and *Proteus* possess fimbriae or pili. Fimbriae are not organs of locomotion; they are smaller than flagella and bear no antigenic relationship to them. These structures are readily observed under the electron microscope. Two genera, *Shigella* and *Klebsiella*, are characteristically nonmobile. Enteric bacilli may possess a well-defined capsule, as in the genus *Klebsiella*, and may also have a loose, ill-defined coating referred to as a "slime layer," as seen in some *Escherichia*; or they may possess neither type structures.

**Biochemical Properties.** Enterobacteriaceae are facultative organisms that are biochemically diverse and complex. Under anaerobic or low oxygen conditions they attack carbohydrates fermentatively, but given sufficient oxygen they utilize other pathways for energy production. Various species differ in the carbohydrates they ferment. By definition, however, all enterics ferment glucose with the production of acid and reduce nitrates to nitrites but do not produce indol phenol oxidase or liquefy alginate. Gas formation in the form of hydrogen and carbon dioxide during glucose fermentation varies with the species and is a useful tool in preliminary identification of the organism. For example, all *Shigella* and *Salmonella typhi*, important enteropathogens, characteristically do not produce gas.

**Cultural Properties.** Culturally, the enteric gram-negative bacteria produce similar growth on blood agar, usually appearing as relatively large, shiny, gray colonies, which may or may not be hemolytic. Species that produce hydrogen sulfide show a definite greening around subsurface colonies in blood agar. Some colonies are large and mucoid, as in the case of *Klebsiella*, certain types of *Shigella*, and certain variants of *Salmonella*, especially *Salmonella typhimurium*. Foldout 1, details I and J, demonstrate

**Exercises (254):**

1. Under what conditions do the Enterobacteriaceae form spores?
2. When motile, by what type structure is movement of the organism accomplished?
3. What purpose does the above property for movement serve?
4. What type of antigenic relationship does the fimbriae have to the flagella?
5. What two genera of the Enterobacteriaceae are characteristically nonmotile?
6. What genus of the enteric bacilli may possess a well defined capsule?
7. What type of carbohydrate do all enterics ferment with the production of acid?
8. Members of Enterobacteriaceae do not produce \_\_\_\_\_ or liquefy \_\_\_\_\_.
9. Gas formation during glucose fermentation is in the form of what two gases?
10. What two important enteropathogens do not produce gas?



11. What characteristic on blood agar is noted around subsurface colonies of species that produce hydrogen sulfide?

12. What organisms are likely to produce large and mucoid colonies?

255. Cite media used for primary isolation of Enterobacteriaceae from stool, blood, and urine cultures, the purpose of the media, the color appearance of *Salmonella* and *Shigella* on given media, the significance of the color reactions on TSI agar, additional media used in conjunction with TSI agar for primary differentiation, isolation techniques recommended for blood cultures, and some members of Enterobacteriaceae isolated from urine cultures.

**Isolation of Enterobacteriaceae.** Collection and preparation of stool specimens and the physiological basis for employing the various types of culture media were discussed in volume 1. We also gave you detailed instructions on how to inoculate specimens of different categories to specific media in order to successfully isolate the microorganisms ordinarily found in those specimens.

The processing of stool specimens for enteric isolation follows a well-established pattern. Let us review in brief the stepwise procedure for isolation of Enterobacteriaceae.

**Isolation from stools.** First, inoculate an enrichment broth such as GN broth, selenite broth of Liefson, or the tetrathionate broth of Mueller. These media are inhibitory for the normal intestinal inhabitants and must be used. Concurrent with inoculation of the enrichment broth, streak plates of assorted selective and differential media with the stool specimen.

There are many plating media in use. Some are selective while others are inhibitory. Among those widely used are desoxycholate citrate agar, Salmonella-Shigella (SS) agar, Hektoen enteric agar (HEA), bismuth sulfite agar, brilliant green agar (BGA), eosin-methylene blue (EMB) agar, xylose-lysine-desoxycholate (XLD) agar, and MacConkey agar. Note that to inhibit the spreading of *Proteus* strains on MacConkey or EMB media, you may increase the agar concentrations to 5 percent. Remember that selective media suppress growth of contaminating forms, usually nonpathogens, and allow the infectious species to survive and proliferate.

Differential agars such as eosin-methylene blue and MacConkey's employ the principle of color distinction between lactose-positive and lactose-negative

colonies (nonpathogens and pathogens). Colors are based on change in pH of an indicator dye when acids are produced from lactose.

In attempting to isolate enteropathogenic *Escherichia coli*, *Klebsiella*, *Enterobacter*, or *Citrobacter* from stool samples, tetrathionate and selenite enrichment broths are not used because these broths are inhibitory to most strains of these genera. MacConkey or EMB agar are used for primary isolation.

Isolated colonies on these media furnish the inoculum for one of the more complex formulations such as triple sugar iron (TSI) or Kligler's agar slants. Reactions on TSI or Kligler's provide presumptive information on which we can base our choice of fermentation and other metabolic tests to establish genus and species identity. The three color patterns illustrated in foldout 1, detail H, are possible with TSI or Kligler's agar:

- Acid (yellow) reaction throughout—lactose fermentation.
- Acid (yellow) butt and alkaline (red) slant—glucose fermentation.
- Alkaline (red) butt and slant—no sugars fermented.

In addition, gas formation is shown by bubbles in the medium, and H<sub>2</sub>S production is evidenced by a blackening of the agar in the butt of the tube. TSI contains a third sugar, sucrose, which, if fermented, points to one of the slow-lactose fermenters. A positive sucrose gives an all-yellow reaction identical to that of lactose fermentation. Many investigators prefer to use lysine-iron agar (LIA) and motility-indol-ornithine (MIO) media in conjunction with triple-sugar-iron (TSI) or Kligler's iron (KI) agar for primary differentiation.

**Isolation from blood.** General methods for collecting blood cultures have been discussed in Chapter 4, volume 1. Specimen from a bacteremia frequently contain less than one microorganism per ml. It is advisable to inoculate 5 ml into 100 ml of glucose-phosphate broth and 5 ml into 100 ml of fluid thioglycollate medium. Blood contains no normal flora; thus, enrichment media such as selenite broth are unnecessary. Cultures should be examined after 18 to 24 hours of incubation at 35° C. to 37° C. If negative they should be reincubated for 3 weeks and examined at frequent intervals.

Laboratory personnel are reminded that in typhoid fever a blood culture may be positive before stool cultures may be positive. After incubation, blood cultures are streaked on media as is described for stools.

**Isolation from urine.** Members of Enterobacteriaceae isolated from the urinary tract includes species of *Salmonella* and certain members of *Escherichia*, *Klebsiella*, and *Proteus* genera. Specimens of urine should be inoculated directly onto plating media. Blood-agar and a differential plating media are recommended.



**Exercises (255):**

1. Give three examples of enrichment broths which must first be inoculated for isolation of Enterobacteriaceae from stool specimens.
2. List some plating media used.
3. What can be done in the preparation of MacConkey and EMB media to inhibit the spreading of *Proteus* strains?
4. What is the purpose of selective media?
5. How do eosin-methylene blue and MacConkey agars provide for the differentiation of lactose and nonlactose fermenting organisms?
6. In attempting to isolate enteropathogenic *E. coli*, *Klebsiella*, *Enterobact.*, or *Citrobacter* from stool samples, why is use of tetrathionate and selenite enrichment broths not recommended?
7. What carbohydrate is found in TSI and not Kligler's iron agar?
8. On TSI or Kligler's agar when the reaction gives an acid (yellow) butt and alkaline (red) slant, what carbohydrate is most likely fermented?
9. A positive sucrose gives what type of reaction in the tube?
10. What other primary differential media may be used in conjunction with TSI and KIA?
11. Specimen from a bacteremia frequently contain approximately what quantity of microorganisms per ml?
12. What quantity of blood may be used for blood cultures and to inoculate what suggested media?
13. Why is an enrichment unnecessary?
14. What are some members of Enterobacteriaceae isolated from the urinary tract?

**256. Identify the tribes, genera, and species of organisms from given tables and figure based on the biochemical reactions obtained on the given media.**

**Laboratory Identification.** Colonies selected from the primary isolation media are inoculated to TSI. The reactions given by various members of Enterobacteriaceae on TSI agar are recorded in table 4-3. Good results have been obtained with other systems or devices instead of TSI, KIA, LIA, or MIO media. Systems or devices such as Auxotab, the Enterotube, and R-B System have yielded good results. They will be discussed later in this chapter. The colonies from primary media are speciated by various biochemical tests. The reactions used by Ewing to divide the family into the tribes are presented in table 4-4. The use of the TSI or KIA, LIA, and MIO with cultures of Enterobacteriaceae, regardless of their source, permits the laboratory to issue a preliminary or presumptive report regarding most isolates at 18 to 24 hours. In some cases specific identification can be made on the basis of the reactions in these three media. (TSI or KIA, LIA, and MIO). An example is given in the diagram in figure 4-1. Foldout 3 shows the tests on which group differentiation of the Enterobacteriaceae may be made.

**Exercises (256):**

Match each tribe, genus, and species organisms in column B with the reactions in column A by placing the letter of the column B item beside the number of the column A item that most nearly describes it. Each element in column B may be used once or more than once.

Column A					Column B
_____ 1.	Phenylalanine deaminase positive (+)				a. Escherichiaeae
	Slant	Butt	Gas	H <sub>2</sub> S	b. Edwardsiellae
_____ 2.	K	A	+	+++	c. <i>Shigella</i>
_____ 3.	A(K)	A	-	-	d. <i>Klebsiella</i>
_____ 4.	K	A	-	-	e. <i>Enterobacter</i>
_____ 5.	A(K)	A	+	+++	f. <i>Serratia</i>
_____ 6.	A	A	++	-	g. <i>Providencia</i>
_____ 7.	Urea pos. within 2 to 4 hours.				h. <i>Arizona</i>
_____ 8.	Urea pos. at 24 hours or more.				i. <i>Salmonellae</i>
_____ 9.	Voges-Proskauer positive				j. <i>S. typhi</i>
					k. <i>P. mirabilis</i>

TABLE 4-3  
REACTIONS OF ENTEROBACTERIACEAE IN TSI AGAR

GENERA AND SPECIES	SLANT	BUTT	GAS	H <sub>2</sub> S
<i>Escherichia</i>	A(K)	A	+(-)	-
<i>Shigella</i>	K	A	-	-
<i>S. typhi</i>	K	A	-	+(-)
Other <i>Salmonella</i>	K	A	+(-)	+++(-)
<i>Arizona</i>	K	A	+	+++
<i>Citrobacter freundii</i>	K(A)	A	+	+++(-)
<i>C. diversus</i>	K(A)	A	+	-
<i>Edwardsiella</i>	K	A	+	+++
<i>Klebsiella</i>	A	A	++	-
<i>Enterobacter</i>	A	A	++	-
<i>E. hafnia</i>	K	A	+	-
<i>Serratia</i>	A(K)	A	-	-
<i>Proteus vulgaris</i>	A(K)	A	+	+++
<i>P. mirabilis</i>	K(A)	A	+	+++
<i>P. morgani</i>	K	A	-(+)	-
<i>P. rettgeri</i>	K	A	-	-
<i>Providencia</i>	K	A	+(-)	-

K, alkaline.

A, acid.

Symbol enclosed in parentheses indicate occasional reactions.

Column A

10. Delayed lactose fermentation may not show up on TSI agar  
11. Citrate (Simmons) positive or delayed positive

Column B

- l. *P. rettgeri*  
m. *Citrobacter freundii*  
n. *P. vulgaris*

4-2. The Opportunistic Enterobacteriaceae

Some authorities have found it clinically useful to divide the family Enterobacteriaceae into the intestinal pathogens and the opportunistic pathogens. Those

enterics that can be found as part of the normal bowel flora or as free living forms and also serve as potential pathogens for nonintestinal tissue constitute the opportunists. They include organisms of the genera *Escherichia*, *Edwardsiella*, *Arizona*, and *Citrobacter* and the tribes of *Klebsiellae* and *Proteeae*. *Escherichia* and *Arizona* are included in the definition of opportunists despite the association of certain strains with intestinal disease because most isolates of these genera are from sources other than the intestines. The epidemiology, frequency, severity, and treatment of disease caused by the opportunistic enteric bacilli may vary with different species, but they are all capable of producing similar disease.

**TABLE 4-4**  
DIFFERENTIATION OF THE TRIBES OF ENTEROBACTERIACEAE BY BIOCHEMICAL METHODS

TEST OF SUBSTRATE	TRIBES				
	Escherichiaee	Edwardsiellae	Salmonellae	Klebsiellae	Proteae
Hydrogen sulfide (TSI)	-	+	+	-	+ or -
Urease	-	-	-	- or +	+ or -
Indol	+ or -	+	-	-	+ or -
Methyl red	+	+	+	-	+
Voges-Proskauer	-	-	-	+	-
Citrate (Simmons)	-	-	+	+	d
KCN	-	-	- or +	+	+
Phenylalanine deaminase	-	-	-	-	+
Mucate	d	-	d	+ or -	-
Mannitol	+ or -	-	+	+	- or +

NOTE: *S. typhi*, *S. enteritidis* bioserotype paratyphi-A, and some rare bioserotypes fail to utilize citrate. Cultures of *S. enteritidis* bioserotype paratyphi-A and some rare bioserotypes may fail to produce hydrogen sulfide; an occasional strain of almost any serotype of salmonellae may be hydrogen sulfide negative. Some cultures of *P. mirabilis* may yield positive Voges-Proskauer tests. Some strains of *E. agglomerans* deaminate phenylalanine.

+ = 90% or more positive within 1 or 2 days; - = 90% or more no reactions; (+) = delayed positive (3 or more days); d = different biochemical reactions, +, (+), -, + or - = most cultures positive, some negative; - or + = most strains negative, some positive; - or (+) = most cultures negative, some positive delayed.

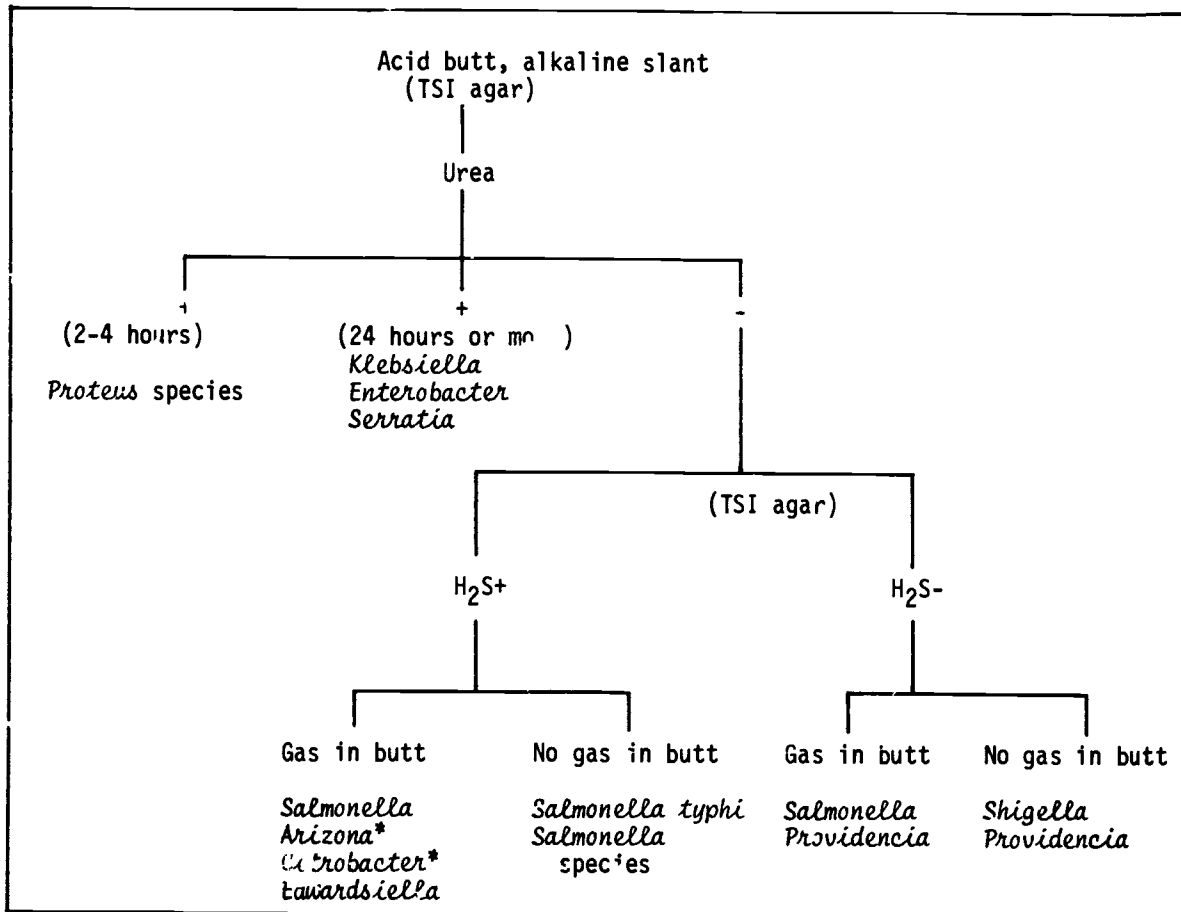

\*Delayed lactose fermentation may not show up on TSI agar.

Figure 4-1. Tentative differentiation of enterobacteriaceae.

257. Cite the three genera of the tribe Klebsiellae, the three species of the genus *Klebsiella*, current nomenclature for the given species of *Klebsiella*, disease caused by the given species, cultural and biochemical characteristics of *K. pneumoniae*, and differences of biochemical reactions between *K. pneumoniae* and *E. aerogenes*.

**Klebsiella-Enterobacter-Serratia Division.** The tribe Klebsiellae consists of three genera, *Klebsiella*, *Enterobacter*, and *Serratia*. *Klebsiella* is the second most populous facultative enteric genus found in the bowel of man. *Enterobacter* and *Serratia* also inhabit the intestinal tract but are in smaller numbers. Some species of *Enterobacter* are more commonly found in soil, water, dairy products, and the intestines of animals, including humans. Table 4-5 correlates the present classification of Ewing with some of the former nomenclature used to describe this tribe.

**Genus *Klebsiella*.** The genus *Klebsiella* has three species: *Klebsiella pneumoniae*, *Klebsiella ozaenae*, and *Klebsiella rhinoscleromatis*. Of these species, *K. pneumoniae* (Friedlander's bacillus) is the most often encountered in the laboratory. It can be isolated from

the upper respiratory and intestinal tract of about 5 percent of normal individuals. It is said to be responsible for approximately 2 percent of the bacterial pneumonias. The organism is found as a secondary invader in such diseases as bronchiectasis, tuberculosis, influenza, pleurisy, and pyelonephritis. *K. ozaenae* can be isolated in nasal conditions such as ozena and atrophic rhinitis. *K. rhinoscleromatis* occurs in nasal secretions from rhinoscleroma.

The members of the genus *Klebsiella* are gram-negative, nonmotile, encapsulated, short rods, which possess the biochemical characteristics shown in table 4-7. Speciation of the *Klebsiella* can be achieved by the use of additional biochemical testing.

On blood agar, EMB agar, MacConkey agar, trypticase soy agar, and other routine media, they normally give rise to large mucoid colonies which have a tendency to coalesce. The colonies usually string out when touched with a needle. The growth in broth also can be very stringy and is sometimes difficult to break when making transfers.

In contrast with *K. pneumoniae*, *E. aerogenes* is usually considered motile, may liquefy gelatin, and is not as distinctly capsulated. *E. aerogenes* does not react with *Klebsiella* antiserum and is ornithine-decarboxylase positive.

TABLE 4-5  
COMPARISON OF NEW DESIGNATION OF KLEBSIELLAE WITH OLDER SYNONYMS

New Designation		Older Synonyms
Genus	<i>Klebsiella</i>	
Species	<i>K. pneumoniae</i> <i>K. ozaenae</i> <i>K. rhinoscleromatis</i> <i>K. oxytoca</i>	same but includes nonmotile <i>Aerobacter aerogenes</i> same same <i>Klebsiella pneumoniae</i> indole positive or indole and gelatin negative
Genus	<i>Enterobacter</i>	<del><i>Aerobacter</i></del>
Species	<i>E. cloacae</i> <i>E. aerogenes</i> <i>E. hafniae</i> <i>E. agglomerans</i> <i>E. sakazakii</i> <i>E. gergoviae</i>	<i>Aerobacter cloacae</i> <i>Aerobacter aerogenes</i> Hafnia group, <i>E. alvei</i> <i>Erwinia herbicola</i> <i>Enterobacter cloacae</i> , yellow pigment
Genus	<i>Serratia</i>	
Species	<i>S. marcescens</i> <i>S. liquefaciens</i> <i>S. rubidaea</i>	Same <i>Enterobacter liquefaciens</i> <i>Bacterium rubidaeum</i>

Seventy-two different K antigens have been described. All species of *Klebsiella* share common antigens and thus are able to be typed with the same set of antisera.

3. What is the new name given to the organism *K. pneumoniae* that produces a biochemical reaction of indole positive or indole and gelatin negative?

**Exercises (257):**

1. The tribe Klebsiellae consists of what three genera?

4. What are the three species of *Klebsiella*?

2. Which one of the genera of the tribe klebsiellae is considered to be the second most populous facultative enteric genus found in the bowel of man?

5. What are some diseases caused by *K. pneumoniae*?

TABLE 4-6  
BIOCHEMICAL REACTIONS OF *KLEBSIELLA*

Test	Reaction	Test	Reaction
Adonitol	+ or -	Voges-Proskauer	+
Dulcitol	- or +	Simmons' citrate	+
Glucose	+ with gas	KCN	+
Inositol	+ with gas	Urease	+ (slow)
Lactose	+	Gelatin liquefaction	-
Mannitol	+	Phenylalanine deaminase	-
Salicin	.	Sodium malonate	+
Sucrose	.	Lysine decarboxylase	+
Indole	- (+)	Arginine dihydrolase	-
Methyl r	-	Ornithine decarboxylase	-

6. How do the colonies of *Klebsiella* generally appear on blood agar, EMB, MacConkey, and other routine media?
7. What characteristic is noted when the colonial growth of *Klebsiella* on routine media is touched with a needle?
8. In contrast to *K. pneumoniae*, by what three characteristics does *E. aerogenes* differ?
9. Why can all aspects of *Klebsiella* be typed with the same set of antisera?
2. What are some sources of *Enterobacter*?
3. *Enterobacter* have been isolated most frequently from what type of infections?
4. What species of *Enterobacter* is most frequently isolated?
5. Beside *E. agglomerans* all other species of *Enterobacter* are different from *Klebsiella* by what given characteristics?
6. Most species of *Enterobacter* will ferment lactose rapidly, with the exception of what species?

**258. State the currently recognized species of the genus *Enterobacter*, sources of isolation, frequent sources of isolation in the body, the species that account for the majority of isolates, and contrasting characteristics between *Enterobacter* and *Klebsiella*.**

**Genus *Enterobacter*.** The genus *Enterobacter* contains four currently recognized species—*E. cloacae*, *E. aerogenes*, *E. hafniae* (*Hafnia alvei*) (the former *Hafnia* group), and *E. agglomerans*, which groups the former *Herbicola-Lathyri* bacteria. The species of *Enterobacter* are found in the soil, in water, in dairy products, and in the intestines of animals, including man. *Enterobacter*, like most *Enterobacteriaceae*, are capable of producing disease in any body tissue but have been most frequently isolated from urinary tract infections. *E. cloacae* accounts for the majority of isolates of this genus. Two species, *E. agglomerans* (formerly classified as *Erwinia*) and *E. cloacae*, were associated with a nationwide epidemic involving contamination of intravenous fluids. These species were isolated from eight hospitals in seven states and were responsible for 150 bacteremias and nine deaths. The genus *Enterobacter* can be divided into four genera as shown by the biochemical tests in foldout 3. They are different from *Klebsiella* by the fact that all are motile, and with the exception of *E. agglomerans*, all are ornithine decarboxylase positive. Most isolates of *Enterobacter*, with the exception of *E. hafniae*, ferment lactose rapidly. With *E. hafniae* biochemical tests will be positive at 25° C. than 37° C.

**Exercises (258):**

1. Name the currently recognized species of *Enterobacter*.

**259. Indicate whether given statements correctly reflect some general characteristics of the genus *Serratia*, growth and cultural characteristics of *Serratia marcescens*, differential characteristics, human infections caused by *Serratia marcescens*, and the species less frequently isolated.**

**Genus *Serratia*.** The genus *Serratia* are gram-negative motile rods. Only a small percentage of strains are chromogenic. The three species which currently exist are *S. marcescens*, *S. liquefaciens*, and *S. rubidaea*. The strains of *S. marcescens* that are chromogenic produce a red, non-water-soluble pigment at room temperature, but rarely at 35° C. or above. Organisms of the genus *Serratia* can be differentiated from other enterobacteria by the production of an extracellular DNase.

*Serratia Marcescens* occurs widely in nature, water, soil, milk, and foods, and until recently had been considered to be nonpathogenic. In recent years, they have been implicated in human infections, including pulmonary infection, urinary tract infection, and septicemia. In addition, *Serratia* has been implicated in epidemics within hospitals in much the same manner as hospital staphylococci. Burn cases are particularly susceptible to the organism. *Serratia* can also be a secondary invader in certain types of lung disease. Unlike the other enteric forms, colonies on agar are generally circular, thin, smooth, or rough, occasionally mucoid, and often pigmented (red, pink, magenta). In broth cultures growth may form a red ring at the surface, or a pigmented pellicle.



Infection with pigmented *Serratia* may cause sputum to be tinged with red, thus giving the false impression of hemoptysis.

*S. liquefaciens* and *S. rubidaea* are associated with similar infections but are less frequently isolated.

**Exercises (259):**

Indicate whether each of the following statements is true (T) or false (F) and correct those that are false.

- T F 1. The genus *Serratia* are gram-negative nonmotile rods.
- T F 2. All strains of *Serratia* are chromogenic.
- T F 3. *S. marcescens* that are chromogenic produce a red, non-water-soluble pigment at room temperature, but rarely at 35° C. or above.
- T F 4. Organisms of the genus *Serratia* can be differentiated from other enterobacteria by the production of a positive-phenylalanine deaminase test.
- T F 5. *Serratia marcescens* occur widely in nature, water, soil, milk, and foods and is considered to be nonpathogenic.
- T F 6. *Serratia marcescens* have been implicated in pulmonary and urinary infections and septicemia.
- T F 7. *S. liquefaciens* and *S. rubidaea* are associated with infections caused by *S. marcescens* and are more frequently isolated.

260. Point out some distinctive characteristics of the tribe Proteaceae in terms of their motility and ability to deaminate phenylalanine, distinctive characteristics between *Proteus* and *Providencia*, characteristics of *Proteus* species, infections caused by *Proteus* species, and the designated antigens and their uses.

**Tribe Proteaceae.** Organisms of the tribe Proteaceae are characterized by their motility and ability to deaminate phenylalanine. With the exception of a rare strain, these organisms do not ferment lactose. The tribe Proteaceae consists of two genera, *Proteus* and *Providencia*. *Proteus* species are actively motile at 25° C., but often weakly motile at 35° C.

**Genus *Proteus*.** Organisms of the genus *Proteus* are found in soil, water, sewage, and decaying animal matter as well as the human intestinal tract. All possess a powerful urease which distinguishes them from the genus *Providencia*.

The *Proteus* spp. are phenylalanine deaminase-positive and urea-positive. The *Providencia* organisms are urea-negative but closely resemble *Proteus* in all other respects. The rapid decomposition of urea to ammonia (1 to 4 hours) yields a highly alkaline environment which can be detected with a pH indicator dye. We see in foldout 2, detail O, the distinctive positive reaction of *Proteus*.

Lactose is not fermented, although sucrose-positive strains give an acid slant and butt in TSI agar. Of the four species listed in table 4-5, two species, *P. vulgaris* and *P. mirabilis*, produce H<sub>2</sub>S rapidly and abundantly, liquefy gelatin, and swarm on moist agar media. The other species, *P. morganii* and *P. rettgeri*, lack these characteristics. *P. mirabilis* is the only species that does not produce indol from tryptophan. *P. mirabilis* and *P. vulgaris* are actively motile at 37° C, producing a thin translucent sheet of growth on nonselective agars.

Foldout 2, detail N, shows the difference in appearance between discrete *Proteus* colonies and swarming colonies. In some instances swarming species spread progressively as a surface film over the entire plate.

Swarming may be inhibited on MacConkey and on EMB plates if the agar concentration is increased to 5 percent. On certain enteric isolation media the production of hydrogen sulfide by *P. mirabilis* and *P. vulgaris* may cause the colonies of these organisms to be confused with colonies of the enteric pathogens of the genus *Salmonella*. *P. morganii* is responsible for cases of "summer diarrhea" in infants and children.

*Proteus* spp. cause human infections when introduced into tissues other than the normal intestinal tract. In this connection, *Proteus* ranks next to *E. coli* as the etiological agent of cystitis. The organisms are encountered frequently in eye and ear infections and occasionally in pleurisy, peritonitis, and suppurative abscesses in many areas of the body. *Proteus* spp. are commonly associated with other bacteria in purulent wounds and may contribute to the severity of such infections.

The *Proteus* forms possess a number of O (somatic) and H (flagellar) antigens. The X-19, X-2, and X-K strains contain a distinctive O antigen that is useful in diagnosing certain unrelated diseases serologically. For example, cells of the X-19 strain react with the serum of patients suffering from typhus fever. This phenomenon is called the Weil-Felix reaction. It stems

from the fact that *Proteus* X-19 and *Rickettsia prowazeki*, the agent of typhus, have an antigen so nearly identical that antibodies formed against the rickettsia also react with *Proteus* cells to give an observable agglutination in the test tube.

Cross-reactions are possible between the O antigens of the morphologically similar *Proteus*, *Salmonella*, and *Escherichia* spp. So, serological grouping cannot be relied upon exclusively to distinguish among these genera.

#### Exercises (260):

1. The tribe Proteace consists of what two genera?
2. Organisms of the tribe Proteace are characterized by what two given features?
3. At what temperature is *Proteus* species considered to be actively motile?
4. Although members of the genus *Proteus* and the *Providencia* group are closely related, they can be easily separated on the basis of what simple test procedure?
5. What type of reaction does sucrose-positive strains of *Proteus* give on TSI?
6. Which two of the four species of *Proteus* produce H<sub>2</sub>S rapidly and abundantly, liquefy gelatin, and swarm on moist media?
7. What species is the only one that does not produce indol from tryptophan?
8. How may swarming be inhibited on MacConkey and EMB plates?
9. On certain isolation media, the production of H<sub>2</sub>S by *P. mirabilis* and *P. vulgaris* may cause the colonies of these organisms to be confused with colonies of the enteric pathogen of what genus?

10. What organism is generally associated with "summer diarrhea" of children?
11. What are some infections caused by *Proteus*?
12. What antigenic strains of *Proteus* possess a distinctive O antigen?
13. The most important use of the *Proteus* antigen is in the diagnosis of what type of diseases?
14. What is the Weil-Felix reaction?
15. Serological grouping cannot be relied upon exclusively to distinguish among the *Proteus*, *Salmonella*, and *Escherichia* for what reason?

**261. Point out some biochemical characteristics of the genus *Providencia*, differential, biochemical characteristics between *Providencia* and *Shigella*, infections associated with *Providencia*, and characteristics which differentiate the two species of *Providencia*.**

**Genus *Providencia*.** The genus *Providencia* currently consists of two species: *P. alcalifaciens* and *P. stuartii*. These organisms grow well on moist enteric isolation media. They are gram-negative motile rods that are lactose negative. Since they are hydrogen sulfide negative and many or may not produce gas in glucose, they often resemble shigellae on TSI (or KIA) agar. When sucrose is fermented, the reaction is usually delayed, and thus fermentation of this carbohydrate will not be detected in 48 hours in the TSI slant. *Providencia* may be distinguished from the shigellae by their motility and utilization of citrate. *Providencia* is differentiated from *Proteus* by negative-urease reactions. *Providencia* may be distinguished also from other genera within Enterobacteriaceae by their biochemical characteristics indicated on foldout 3.

The genus *Providencia* has been associated with a number of nosocomial infections involving urinary tract infections, septicemia wound infections, and pneumonia. *P. stuartii* have been particularly incriminated in urinary infection, especially with

underlying urologic disorders, and in various infections of patients in a burn unit.

*P. stuartii* can be differentiated from *P. alcalifaciens* by the ability to ferment inositol. In addition, *P. alcalifaciens* are more susceptible to antimicrobials than are *P. stuartii* organisms.

**Exercises (261):**

1. What reactions does *Providencia* produce with lactose and hydrogen sulfide respectively?
2. What two biochemical characteristics distinguishes *Providencia* from *Shigella*?
3. *Providencia* is differentiated from *Proteus* by what characteristic reaction?
4. *Providencia* has been associated with what type of infections?
5. What species of *Providencia* have been particularly incriminated in urinary infection and in various infections of patients in a burn unit?
6. By what two characteristics can *P. stuartii* be differentiated from *P. alcalifaciens*?

**262. Cite the species presently classified in the tribe Edwardsiellae, source of *Edwardsiella* infections, and some biochemical reactions of the organism.**

**Genus *Edwardsiella*.** *Edwardsiella tarda* is the only species presently classified in the tribe Edwardsiellae. The genus has been formerly classified as the Asakusa groups and the Bartholomew group. These organisms have been isolated from a variety of human sources, including diarrheal disease, from normal stools, blood, wounds, visceral abscesses, meningitis, and urine. In man *Edwardsiella* infections are rare. A number of isolates from animal sources, primarily cold-blooded types, have been reported.

*E. tarda* produces indol, H<sub>2</sub>S, lysine, and ornithine decarboxylases. Lactose is not fermented, nor can acetate be used as a sole source of carbon. The production of H<sub>2</sub>S may cause colonies of *E. tarda* to be

confused with the enteric pathogens of the genus *Salmonella*.

**Exercises (262):**

1. What is the species presently classified in the tribe Edwardsiellae?
2. To what extent are *Edwardsiella* infections found in man?
3. A number of *Edwardsiella* infections are primarily from what sources?
4. What are some positive biochemical results produced by *E. tarda*?
5. The production of H<sub>2</sub>S may cause colonies of *E. tarda* to be confused with the enteric pathogens of what genus?

**263. Identify the organisms considered as the opportunists of the tribe Salmonellae in terms of the genera and species, sources of isolation and biochemical reactions, and the genera of the tribe Erwiniaceae in terms of their significance.**

**Opportunists of Tribe Salmonellae.** The tribe Salmonellae contains two genera, *Citrobacter* and *Arizona* in addition to the intestinal pathogens. These organisms can be isolated from secondary infections. Table 4-5 shows the biochemical differentiation of this tribe.

**Genus *Citrobacter*.** The genus *Citrobacter* contains two species, *C. freundii* and *C. diversus*, a newly described species. Both organisms have been isolated from urinary tract infections, wounds, blood, sputa, and spinal fluid. *Citrobacter diversus* comprises those strains that are indol-positive and positive for ornithine decarboxylase. Members of this genus are gram-negative motile rods that can ferment lactose. Due to their biochemical reactions, particularly during preliminary screening, they are often confused with *Salmonella* and *Arizona*. They are not truly pathogenic and considered opportunists.

Some strains of *C. freundii* possess the Vi antigen found in *Salmonella typhi*. *Citrobacter freundii* produces a positive test for KCN, whereas *Salmonella* and *Arizona* are inhibited on the medium.

**Genus Arizona.** These organisms can be important in human infections, but most organisms of the genus *Arizona* have been isolated from animals, particularly reptiles and birds. The type species of the genus is *Arizona hinshawii* which was formerly referred to as *Paracolobacterium Arizonae*. Although isolates from this organism from man are rare, diseases such as gastroenteritis, bacteremia, pyelonephritis, osteomyelitis, and otitis media have been attributed to it. It is difficult to assess the importance of this organism in gastroenteritis because the majority of the strains ferment lactose, and laboratory technicians have been trained to regard lactose-fermenting organisms as normal fecal flora.

Genus *Arizona* share some biochemical characteristics and a number of antigens with the genus *Salmonella*. This causes some taxonomists to consider it a species of *Salmonella*. Nevertheless, the delayed fermentation of lactose, failure to ferment dulcitol, growth in sodium malonate, and slow gelatin liquefaction help distinguish *Arizonae* from salmonellae.

**Tribe Erwinieae.** Organisms of the tribe Erwinieae, noted primarily as plant pathogens, are members of the family Enterobacteriaceae. The tribe consists of the genera *Erwinia* and *Pectobacterium*. Biochemical reactions of a representative species of each genus are shown in foldout 3.

#### Exercises (263):

1. In addition to the intestinal pathogens, what other two genera are included in the tribe Salmonellae?
2. The two species of *Citrobacter*, *C. freundii* and *C. diversus*, are isolated from what clinical sources?
3. Which member of the genus *Citrobacter* provides a positive indol and ornithine decarboxylase?
4. Some strains of *C. freundii* possess the Vi antigen found in what other organism?
5. When *C. freundii* is compared with *Salmonella* and *Arizona*, which organism(s) produce a positive test for KCN?
6. Most organisms of the genus *Arizona* have been isolated from what sources?
7. What are some diseases caused by *A. hinshawii*?

8. Why is it difficult to assess the importance of *A. hinshawii* in gastroenteritis?
9. The genus *Arizona* shares some biochemical characteristics and a number of antigens with what genus?
10. What biochemical characteristics help to distinguish *Arizonae* from Salmonellae?
11. What two genera comprise the tribe Erwinieae?
12. The organisms of the tribe Erwinieae are primarily what type of pathogens?

264. Cite the two closely related genera of the tribe Escherichieae, some biochemical and cultural characteristics of *E. coli*, medium recommended for enteropathogenic strains, disease syndromes associated with *E. coli*, and the significance of serological typing of enteropathogenic strains.

**Tribe Escherichieae.** *Shigella* and *Escherichia*, two closely related genera, comprise the divisions of the tribe Escherichieae. All *Shigella* are intestinal pathogens and as such will be discussed in section 4-3. The genus *Escherichia* contains a single species, *Escherichia coli*, which is the predominant facultative organism found in the large bowel. Biochemical and serological tests are required for accurate differentiation between the two genera. In most cases, however, differentiation is easily achieved, since *E. coli* is usually motile, ferments lactose and other carbohydrates, produces lysine decarboxylase, and utilizes acetate as the sole source of carbon.

**Genus Escherichia.** Certain strains of *E. coli* are capable of causing primary intestinal disease as well as extra intestinal infection; thus, the organism occupies a unique position among opportunistic enteric bacilli. In the field of molecular biology, *E. coli* has been the subject of more experimental research than any other microorganism.

The genus *Escherichia* includes the former *Alkalescens-Dispar* group, which are biochemically and antigenically related to the escherichiae. Typical escherichiae are readily recognized and may be differentiated from other members of the Enterobacteriaceae by their rapid fermentation of lactose with

acid and gas and their response to the classical IMViC tests (++--). Some strains, however, either fail to ferment lactose or do so slowly. Both motile and non-motile forms occur. The strains of the *Alkalescens-Dispar* group are anaerogenic (non-gas producing), nonmotile, and thus can be confused with *Shigella*.

Most strains of *E. coli* produce large, characteristic lactose-fermenting colonies on MacConkey agar and EMB agar. These organisms are usually inhibited in enrichment broths and the more highly selective agar plating media. Use less inhibitory (differential) media such as MacConkey agar or EMB agar for direct isolation of *Escherichia*. Blood agar plates should be used because certain enteropathogenic strains may not grow on MacConkey, but will grow well on blood plates. Most strains are non-hemolytic. Cultures of the genus *Escherichia* will give reactions shown in table 4-5.

**Clinical infection.** *E. coli* is the most common cause of urinary tract infections in man, both hospital and community acquired. The organism may be associated with a number of disease syndromes. Among these are (1) pyelitis, pyelonephritis, appendicitis, peritonitis, gallbladder infection, septicemia, meningitis, and endocarditis; (2) epidemic diarrhea of adults and children; and (3) "traveler's" diarrhea.

**Antigenic structure.** Serologic typing of the O, K, and H antigens of *E. coli* provides a useful epidemiological tool especially in infantile diarrhea. Presently 150 O, 90 K and 50 H antigenic types have been described. The serologic type of an *E. coli* isolate is given in the form: O type; K type; H type, as in the example *E. coli* 111:58(B4):2.

#### Exercises (264):

1. What two closely related genera does the tribe Escherichieae include?
2. *Escherichia coli* may be differentiated from *Shigella* by which characteristics?
3. *E. coli* has been the subject of more experimental research than any other microorganism in what particular field of biology?
4. What are some characteristics by which *E. coli* may be differentiated from other members of the Enterobacteriaceae?
5. Why could strains of *Alkalescens-Dispar* group be confused with *Shigella*?

6. How do the colonies of *E. coli* appear on MacConkey and EMB agars?
7. On what media are these organisms inhibited?
8. Why should blood agar plates be used for isolation of enteropathogenic strains of *E. coli*?
9. List some disease syndromes with which *E. coli* may be associated.
10. The serological typing of the O, K, and H antigens of *E. coli* can serve what purpose?

**265. State the clinical significance of Enteropathogenic *E. coli* in terms of the disease caused, the specific cause of diarrhea, and the mechanism through which the organisms cause the disease.**

**Enteropathogenic Escherichia Coli.** Enteropathogenic strains of *E. coli* are responsible for an acute diarrhea in children under two years of age. Fourteen O antigen groups of *E. coli* have been associated with epidemic diarrhea of the newborn. They may also cause diarrhea in adults. Epidemics of these enteropathogens have caused hospital nurseries to close down to stem the number of infections.

Recent studies of the pathogenesis of bacterial diarrhea have identified intestinal secretion of fluid and electrolytes in diseases associated with enterotoxins. The enterotoxins of both cholera and certain of the noninvasive (toxigenic) strains of *E. coli* cause diarrhea through similar mechanism(s)—that is, stimulation of adenylate cyclase in the small intestine (and in nonintestinal tissue), thereby giving rise to excessive secretion of fluid by the intestine.

A significant quantity of evidence has accumulated in recent years to implicate the enterotoxigenic strains of *E. coli* as a cause of severe diarrheal disease in human beings. There is not necessarily any correlation between toxigenicity and the classic enteropathogenic serotypes.

Two distinct enterotoxins, one heat stable and non-antigenic (ST) and the other heat labile, antigenic (LT) and cholera-like, have been characterized from *E. coli*. LT has been definitely shown to cause diarrheal disease in humans, and recent evidence has also shown ST to be involved.



Several assay methods are currently available for detecting these enterotoxins. These methods vary in their ability to detect one or the other enterotoxins. Tests for the detection of enterotoxin production, although presently available only at reference centers, may be an important serologic procedure for clinical relevance in large outbreaks.

#### Exercises (265):

1. In children under two years of age, Enteropathogenic strains of *E. coli* are responsible for what disease?
2. How many groups and what types of *E. coli* have been associated with epidemic diarrhea?
3. Current studies related to bacterial diarrhea have identified intestinal secretion of fluids and electrolytes in the disease associated with what poisonous substance?
4. Enteropathogenic *E. coli* cause a rise of excessive secretion of fluid by the small intestine and non-intestinal tissue due to stimulation of what substance?
5. What two distinct enterotoxins have been characterized from *E. coli*?
6. Which of the toxins has been definitely shown to cause diarrheal disease in humans?

#### 4-3. Enterobacteriaceae: Salmonella and Shigella, Intestinal Pathogens

Diarrhea generally represents, at most, an inconvenience for the adult population of well-developed countries. However, among the very young and old and the malnourished in marginal living conditions, diarrhea poses a crippling and even life-threatening condition. Diarrhea also has altered military history by incapacitating large numbers of men, making them unfit for battle.

The family Enterobacteriaceae contains two of the most common and important causes of diarrhea, the genera *Salmonella* and *Shigella*.

266. Point out the four species of *Shigella* in terms of their distinctive biochemical and cultural characteristics, and cite the antigens and their divisions by which these organisms are identified serologically.

**Genus *Shigella*.** *Shigella* are primarily human pathogens and have been isolated only occasionally from animals, particularly primates. The genus *Shigella* is classified in the tribe *Escherichieae* together with the genus *Escherichia*. *S. dysenteriae*, *S. flexneri*, *S. boydii*, and *S. sonnei* constitute the four species of the genus. Speciation is based upon serologic and biochemical reactions. All four species can cause bacillary dysentery, but the severity of the disease, mortality, and frequency of isolation differ from each species.

**Biochemical and cultural characteristics.** All *Shigella* are nonmotile, do not produce  $H_2S$ , and, with exception of certain types of *S. flexneri*, do not produce gas during carbohydrate fermentation. These factors distinguish these organisms from *Salmonella*. In contrast to *E. coli*, they do not produce lysine decarboxylase, utilize acetate as a carbon source, or ferment lactose rapidly. *S. sonnei* will ferment lactose upon extended incubation. Some of the biochemical tests useful in speciation of the genus are found in table 4-7.

Colonies of shigellae are usually smaller than those of salmonellae, but on occasion mucoid variants may be found in subgroup C. Lactose-negative colonies that resemble shigellae are picked from isolation plates to TSI or KIA agar slants. If these show acid butt, no hydrogen sulfide, and an alkaline slant and prove to be urease-negative, they may be tested with *Shigella* polyvalent typing sera. Of course, this procedure is recommended only for presumptive identification. Cultures should always be checked for purity and motility and then confirmed with additional biochemical tests. The tests listed in foldout 3 are recommended for screening of *Shigella* cultures.

**Serologic identification.** All *Shigella* possess O antigens, and some possess K antigens. Those strains possessing K antigens appear as smooth colonies when grown on blood agar. Using the O antigen the shigella are divided into four groups designated A, B, C and D, which correspond to the species *S. dysenteriae*, *S. flexneri*, *S. boydii*, and *S. sonnei*, respectively. At the present time there are ten serologic types of *S. dysenteriae*, six of *S. flexneri*, 15 of *S. boydii*, and one of *S. sonnei*.

#### Exercises (266):

1. Speciation of *Shigella* is based upon what two reactions?
2. All *Shigella* are nonmotile, do not produce  $H_2S$ , and do not produce gas during carbohydrate fermentation with the exception of what species?



TABLE 4-7  
SOME BIOCHEMICAL TESTS USED IN THE SPECIATION OF *SHIGELLA*

Test	<i>S. dysenteriae</i>	<i>S. flexneri</i>	<i>S. flexneri</i> 6	<i>S. boydii</i>	<i>S. sonnei</i>
Mannitol	-	+	+	+	+
Ornithine decarboxylase	-	-	-	-	+
Arginine dihydrolyase	+	-	+	+	-
Jordan's tartrate	+	-	-	-	+
Indol	+	+	-	+	-

- The factors in question 2 distinguish *Shigella* from what other intestinal pathogen?
- Shigella* do not produce lysine decarboxylase, utilize acetate as a source of carbon, or ferment lactose rapidly in contrast to what given organism?
- Usually when the colonies of *Shigellae* compare with those of salmonellae, they appear (smaller/larger/the same).
- Organisms may be tested for presumptive identification with *Shigella* polyvalent typing sera when they are urease-negative and show what reactions on TSI or KIA?
- What two antigens do *Shigella* possess?
- Using the O antigen the *Shigella* are divided into what four groups?
- The above four groups correspond to what four species of *Shigella*, respectively?

267. Indicate whether given statements correctly reflect the clinical significance of *Shigella* infections in terms of the characteristics of the disease, the common etiologic agent of bacillary dysentery in North America and the United Kingdom, carriers of *Shigella*, and sources of isolation.

**Clinical Significance.** All *Shigella* species cause bacillary dysentery, a diarrhea characterized by watery feces tinged with blood, mucus, and groups of polymorphonuclear leukocytes. The organism enters the small bowel, multiplies, then proceeds to the terminal ileum and colon, where it penetrates the epithelial cells and multiplies. This causes inflammation, sloughing of cells, and superficial ulceration. Rarely does the organism penetrate the intestinal wall and spread to other parts of the body. Death is most likely to occur in the pediatric population and when *S. dysenteriae* is the causative organism.

In North America and the United Kingdom, *S. sonnei* has become the most common etiologic agent in bacillary dysentery or shigellosis. In the United States 85 percent of *Shigella* isolates are *S. sonnei* and 14 percent are *S. flexneri*. Colicin, typing of strains of *S. sonnei*, is being performed in some reference laboratories. Colicins which are produced by different gram-negative enteric bacteria are antibiotic-like substances that may have a lethal effect on other bacteria from the same habitat.

Animal host is lacking, and the spread of *Shigella* is from man-to-man, and the reservoirs are carriers who shed the organisms in their feces. From these carriers the *Shigella* can be spread via flies, fingers, food, or feces. *Shigella* can be isolated from clothing, toilet seats, or water contaminated by infected individuals.

**Exercises (267):**

Indicate whether each is true (T) or false (F) and correct those that are false.

- T F 1. All *Shigella* species cause bacillary dysentery.
- T F 2. The organism enters the large bowel and remains there to penetrate the intestinal walls and multiplies.
- T F 3. Death is most likely to occur in the pediatric population when *S. dysenteriae* is the causative organism.
- T F 4. In North America and the United Kingdom, *S. dysenteriae* is the most common etiologic agent of bacillary dysentery.
- T F 5. In the United States, 85 percent of *Shigella* isolates are *S. flexneri* and 14 percent are *S. sonnei*.
- T F 6. Colicins are produced by different gram-negative enteric bacteria and are antibiotic-like substances that may have a lethal effect on other bacteria from the same habitat.
- T F 7. Dogs and cats spread *Shigella* to man.
- T F 8. *Shigella* can be spread via flies, fingers, food, or feces.
- T F 9. *Shigella* can be isolated from clothing, toilet seats, or water contaminated by infected individuals.

268. State some general characteristics of the genus *Salmonella*, the three species proposed by Ewing, biochemical and cultural characteristics, and the scheme and principle involved in the serologic identification of these organisms.

**Genus *Salmonella*.** The genus *Salmonella* is composed of a more complex and diverse group of organisms than the genus *Shigella*. They infect many animal species besides man and are capable of invading extraintestinal tissues, causing enteric fevers, the most severe of which is typhoid fever. *Salmonella* is more biochemically reactive and contains over 1,500 antigenic types.

Ewing and his coworkers have proposed that there are only three species of *Salmonella*: *S. choleraesuis*, *S. typhi*, and *S. enteritidis*, with other antigenic types being serotypes of *S. enteritidis*. The Ewing scheme is currently being used by the Center for Disease Control.

**Biochemical and cultural characteristics.** The salmonellas, with the exception of a rare isolate, do not ferment lactose. They are usually motile, but non-motile forms do occur. With the exception of *S. typhi* and *S. enteritidis* serotype Galinarum, they all produce gas in glucose. In addition, the H<sub>2</sub>S production by *S. typhi* may be very slight. Suspected colonies of salmonellae on isolation media are inoculated to slants of TSI (or KIA) agar. Isolates that produce acid, gas, and hydrogen sulfide in the butt and an alkaline slant in this medium and are urease-negative should be tested with *Salmonella* polyvalent antisera. Biochemical tests used to differentiate the genus *Salmonella* from the other genera of the tribe Salmonelleae are described in table 4-4. Those characteristics used to speciate the genus *Salmonella* are shown in table 4-8.

**Serologic identification.** The Kauffman-White antigenic scheme for the genus *Salmonella* gives species status to each antigenic type. The O and H antigens are the major antigens used to type *Salmonella*. The O, or somatic, antigens are similar to those of other enterobacteria, but the H, or flagellar, antigens of *Salmonella* are diphasic. That is, the H antigens can exist in either of two major phases, phase one or specific phase, and phase two nonspecific phase.

Since approximately 65 different somatic antigens have been recognized, serologic typing with polyvalent O antisera is essential. These sera are commercially available and will agglutinate the majority of strains found in the United States and Canada. Group identification is determined by O-typing sera, and type identification is determined by H-typing antisera. O-grouping sera for subgroups A, B, C<sub>1</sub>, C<sub>2</sub>, D, and E as well as H-typing sera for flagellar antigens a, b, c, d, i, 1, 2, 3, 5, 6, and 7 are available. Vi antiserum is also available.

**Exercises (268):**

1. *Salmonella* infect many animal \_\_\_\_\_ besides man and are capable of invading \_\_\_\_\_ tissues.
2. Ewing and coworkers have proposed that the only three species of *Salmonella* are *S.* \_\_\_\_\_, *S.* \_\_\_\_\_ and *S.* \_\_\_\_\_.

TABLE 4-8  
BIOCHEMICAL SPECIATION OF *SALMONELLA*

Test	<i>S. typhi</i>	<i>S. cholerae-suis</i>	<i>S. enteritidis</i> *
Citrate	-	-	+
Ornithine decarboxylase	+	-	+
Gas from glucose	-	+	+
Trehalose	-	+	+

\*Commonly isolated bioserotypes

- The salmonellas, with the exception of a rare isolate, do not ferment \_\_\_\_\_.
- All the salmonellas produce gas in glucose with the exception of *S. \_\_\_\_\_* and *S. \_\_\_\_\_* serotype Galinarum.
- The H<sub>2</sub>S production by *S. \_\_\_\_\_* may be very slight.
- Isolates that produce acid gas and \_\_\_\_\_ in the butt and an \_\_\_\_\_ slant on TSI or KIA and are urease-\_\_\_\_\_ are suspected colonies of salmonellae.
- Suspected colonies described in question 6 are tested with *Salmonella \_\_\_\_\_* antisera.
- The \_\_\_\_\_ antigenic scheme for the genus *Salmonella* gives species status to each antigenic type.
- The \_\_\_\_\_ and \_\_\_\_\_ antigens are the major antigens used to type salmonella.
- The \_\_\_\_\_ antigens of *Salmonella* can exist in either two or more phases, phase one \_\_\_\_\_ phase or phase two \_\_\_\_\_ phase.
- Group identification is determined by \_\_\_\_\_ typing sera and type identification as determined by \_\_\_\_\_ typing antisera.
- O-grouping sera are available for subgroups \_\_\_\_\_, \_\_\_\_\_, \_\_\_\_\_, \_\_\_\_\_, \_\_\_\_\_, and \_\_\_\_\_.

269. Indicate whether given statements correctly reflect the clinical significance of *Salmonella* in terms of the invasive characteristics of the organism, the ability of the organism to survive intracellularly, three distinct entities of the disease, and mechanisms of transmission.

**Clinical Significance.** Virulent *Salmonella* penetrate the epithelial lining of the small bowel like the invasive *Shigella*. However, unlike *Shigella*, the *Salmonella* do not merely reside in the epithelial lining but pass directly through the epithelial cells into the subepithelial tissue. The biochemical mechanism of

penetration is not known, but the process appears to be similar to phagocytosis.

The ability of the *Salmonella* to survive intracellularly may be due to the surface O antigens or in the case of *S. typhi*, the presence of the Vi antigen.

The actual disease process may be present as any of three distinct clinical entities. They are gastroenteritis, a septicemia with focal lesions, or an enteric fever such as typhoid fever.

Contaminated food and water are the mechanisms of transmission for all *Salmonella*, including *S. typhi*; the only difference is the source of infection. In *S. typhi* infection (typhoid fever) the human carrier is the source, whereas in the other salmonellosis animals are most important.

**Exercises (269):**

Indicate whether each statement is true (T) or false (F) and correct those that are false.

- T F 1. Virulent *Salmonella* penetrate the epithelial lining of the small bowel like the invasive *Shigella*.
- T F 2. Like *Shigella*, the *Salmonella* sometimes merely reside in the epithelial lining and do not pass directly through the epithelial tissue.
- T F 3. The biochemical mechanism of penetration appears to be similar to phagocytosis.
- T F 4. The ability of the *Salmonella* to survive intracellularly may be due to the surface H antigens, or in the case of *S. typhi* the presence of the O antigen.

TABLE 4-9  
DIFFERENTIAL CHARACTERISTICS OF *YERSINIA* SPECIES

Characteristic	<i>Y. pestis</i>	<i>Y. enterocolitica</i>	<i>Y. pseudotuberculosis</i>
Colony forms	Two	Two	Two
Optimal growth temperature	25 to 30 C	25 to 30 C	25 to 30 C
Motility at 25 C	-	+	+
Serogroups	One	Two	Five
Catalase	+	+	+
Oxidase	-	-	-
Coagulase	++	-	-
Fibrinolysin	+	-	-
Hemolysis on blood agar	-	alpha	-
Medium containing bile salts	+	+	+
H <sub>2</sub> S	-	-	-
Indole	-	-	-
Methyl red	+	+	+
Voges-Proskauer	-	+	-
Urease	-	+	+
Nitrate	Variable	Reduced	Reduced
Cellobiose	-	+	-
Glucose	+	+	+
Glycerol	Variable	+	+
Lactose	-	-	-
Melibiose	-	-	+
Maltose	+	+	+
Mannitol	+	+	+
Rhamnose	-	-**	+
Salicin	+	-	+
Sucrose	-	+	-

\*Using rabbit plasma

\*\*Occasional strains are rhamnose positive

- T F 5. The disease may be present as any of three distinct entities such as gastroenteritis, bacillary dysentery, and an enteric fever.
- T F 6. In a *S. typhi* infection (typhoid fever), the animal is the carrier and source.

#### 4-4. Related Gram-Negative Bacilli

For the first time in any major classification of bacteria, the genus *Yersinia* is placed in the family *Enterobacteriaceae*. The genus was created by the division of *Pasteurella* and includes three species: *Y. pestis*, *Y. pseudotuberculosis*, and *Y. enterocolitica*.

In addition to the organisms that make up the enterics there is a fairly large group of gram-negative aerobic, facultatively anaerobic, usually saprophytic bacilli. They may appear during the routine search for pathogenic forms. Members of the genus *alcaligenes* are common, apparently saprophytic, inhabitants of the intestinal tract of vertebrates. Members of the genus *Pseudomonas*, *Vibrio*, and *Aeromonas* are discussed briefly in this section as related gram-negative bacilli.

The taxonomic relationship of these gram-negative rods we will mention is shown in the following scheme.

#### PART 7. GRAM-NEGATIVE AEROBIC RODS AND COCCI

- Family I. *Pseudomonadaceae*
- Genus I. *Pseudomonas*
- Genera of Uncertain Affiliation
- Genus *Alcaligenes*

#### PART 8. GRAM-NEGATIVE FACULTATIVELY ANAEROBIC RODS

- Family II. *Vibrionaceae*
- Genus I. *Vibrio*
- Genus II. *Aeromonas*

270. Cite the species of the genus *Yersinia*, the causative agent of plague, the three clinical forms of plague, the main vector for transmission, morphological appearance of the cells with given stains, growth requirements, colony appearance on given media, clinical specimen used for isolation, and methods used for culture identification.

**Genus *Yersinia*.** The genus *Yersinia* recently incorporated in the family *Enterobacteriaceae* consists of the species: *Y. pestis*, *Y. enterocolitica*, and *Y. pseudotuberculosis*. The three species are primarily animal pathogens but also produce human disease.

***Yersinia pestis.*** *Yersinia pestis* is the causative agent of plague, a disease with a high mortality in human beings, rats, and is infectious for mice, guinea pigs, and

rabbits. The three clinical forms of plague that are recognized in humans are bubonic, pneumonic, and septicemic. The rat flea is the main vector for transmission. *Yersinia pestis* is a gram-negative non-motile coccobacillus. Cells appear short, plump, sometimes elongated and pleomorphic, usually in singly or in pairs, and occasionally in short chains. Cells show marked bipolar staining, especially in tissue impressions, aspirates of buboes, and pus stained with polychrome stains, such as the Giemsa and Wayson stains, but not by Gram stain. The cells also have a safety pin appearance, with the polar bodies staining blue and the remainder light blue to reddish. The coccoid, round, filamentous, elongated, and other forms commonly occur, especially in old cultures. A capsule can be demonstrated in animal tissue and in young cultures which will yield a positive fluorescent-antibody reaction, but which a presumptive diagnosis may be made.

*Y. pestis* are facultative anaerobes. They are anaerogenic and usually do not ferment lactose. They are oxidase-negative and do not produce catalase. The organism grows slowly on nutrient agar and fairly rapidly on blood agar, producing small nonhemolytic, round, transparent, glistening, colorless colonies with an undulate margin. Opaque colonies with yellowish centers and whitish edges, which develop a soft mucoid consistency due to capsular material, are noted in older enlarged types. Biochemical properties are shown in table 4-9.

Clinical materials containing *Y. pestis* are extremely hazardous. Aspirates from buboes, pus from the area of the flea bite, sputum, throat swabs, or blood should be carefully collected and placed in Cary-Blair transport media for transfer to the laboratory.

Extreme caution must be observed by the laboratory worker when handling suspect cultures or pathological materials. A biological safety hood should be used. Cultures may be identified by specific bacteriophage typing, by the fluorescent-antibody test, or by agglutination with specific antisera.

#### Exercises (270):

1. The three species of the genus *Yersinia* are *Y.* \_\_\_\_\_, *Y.* \_\_\_\_\_, and *Y.* \_\_\_\_\_.
2. Which of the three species of *Yersinia* is the causative agent of plague?
3. What are the three clinical forms of plague?
4. What insect is the main vector for transmission of plague?

5. How do the cells appear in tissue impressions, aspirates of buboes and pus, when stained with polychrome stains such as the Giemsa and Wayson stains?
6. What morphological forms commonly occur in older cultures?
7. A presumptive diagnosis may be made from a positive fluorescent test from animal tissue and young cultures when what morphological form is demonstrated?
8. How well does the organism grow on nutrient agar and blood agar, respectively?
9. How does the organism appear on blood agar?
10. What clinical specimens may be obtained for culture?
11. What transport medium has been recommended?
12. Clinical materials containing *Y. pestis* are extremely \_\_\_\_\_ and extreme \_\_\_\_\_ must be observed by the laboratory worker when handling suspect cultures or pathological material.
13. Cultures may be identified by what three methods?

**271. State some general characteristics of diseases caused by *Yersinia enterocolitica* and *Yersinia pseudotuberculosis*, growth, staining characteristics and media used for *Y. enterocolitica*, and the diseases caused by *Y. pseudotuberculosis*, media used, and colonial forms of the organism.**

***Yersinia enterocolitica.*** *Yersinia enterocolitica* has been implicated in human disease with a variety of clinical syndromes. They include gastroenteritis, bacteremia, peritonitis, cholecystitis, visceral abscesses, and mesenteric lymph adenitis. Infection caused by *Yersinia* species other than *Y. pestis* is termed "Yersiniosis." These may involve *Y. pseudotuberculosis* and *Y. enterocolitica*. These are zoonotic diseases, in which human infection appears to be acquired accidentally from disease cycles of wild and domestic animals.

*Y. enterocolitica* is not easily isolated and identified in the microbiology laboratory. The organism grows slowly at 35° C. These organisms are frequently overlooked because the biochemical reactions for the most part resemble those of many members of the family Enterobacteriaceae. The organism is a gram-negative coccobacillus occasionally showing bipolar staining. Many strains show little, if any, bipolarity with Wayson's stain.

*Y. enterocolitica* grows on blood agar and such selective media as MacConkey agar, EMB agar, deoxycholate agar, and *Salmonella* and *Shigella* agar for most strains. Table 4-9 shows biochemical and other characteristics of this microorganism.

***Yersinia pseudotuberculosis.*** *Y. pseudotuberculosis* causes disease primarily in rodents, particularly in guinea pigs. However, it also causes two recognized forms of disease in human beings. The most serious of these is a fulminating septicemia which is usually fatal, while the more common form is a mesenteric lymphadenitis, which may stimulate appendicitis.

The organism appears as a small gram-negative coccobacillus, showing pleomorphism, found singly, in short chains, and in small clusters.

The organism grows well on blood agar and on media containing bile salts, such as MacConkey agar. Two colonial forms of growth may be noted: a smooth grayish-yellow translucent colony in 24 hours at 25° C. to 30° C., and a raised colony with an opaque center and a lighter margin with serrations that develop simultaneously with incubation. Differential characteristics of the species are shown in table 4-10.

#### **Exercises (271):**

Complete the following statements:

1. Infections caused by *Yersinia* species other than *Y. \_\_\_\_\_* is termed "\_\_\_\_\_."
2. Such infections may involve the organisms *Y. \_\_\_\_\_* and *Y. \_\_\_\_\_*.
3. These infections are a result of \_\_\_\_\_ diseases, in which human infection appears to be acquired accidentally from disease cycles of \_\_\_\_\_ and \_\_\_\_\_ animals.
4. *Y. \_\_\_\_\_* is not easily isolated and identified in the microbiology laboratory; it grows \_\_\_\_\_ at 35° C.
5. The organisms cited in question 4 are frequently overlooked because the biochemical reactions for the most part resemble those of many members of the family \_\_\_\_\_.



6. Many strains of *Y.* \_\_\_\_\_ show little, if any, bipolarity with \_\_\_\_\_ stain.
7. *Y.* \_\_\_\_\_ grows on blood agar and such selective media as \_\_\_\_\_ agar, \_\_\_\_\_ agar, \_\_\_\_\_ agar and \_\_\_\_\_ agar for most strains.
8. *Y.* \_\_\_\_\_ causes disease primarily in rodents, particularly in guinea pigs.
9. Two colonial forms of *Y.* \_\_\_\_\_ noted are a smooth \_\_\_\_\_ colony in 24 hours at 25° C. to 30° C. and a \_\_\_\_\_ colony with an opaque center and a lighter margin with \_\_\_\_\_ that develop simultaneously with incubation.

272. Indicate whether given statements correctly reflect the genera under which the genus *Alcaligenes* is listed in the 8th Edition of *Bergey's Manual*, the definition of *Achromobacter* species, the biochemical and cultural characteristics of these organisms, and sources of isolation.

**Genus *Alcaligenes*.** The genus *Alcaligenes* is listed under genera of uncertain affiliation in the 8th Edition of *Bergey's Manual*. *Alcaligenes* and *Achromobacter* have long been poorly defined and are difficult to identify.

Researchers at the Center for Disease Control recommend that *Alcaligenes* should be defined as follows: gram-negative rods, motile with peritrichous flagella, oxidase-positive, nonsaccharolytic, and urease-negative. Citrate is utilized as a source of energy. They produce an alkaline slant-neutral butt on TSI after 24 hours and the butt becomes alkaline after 5- to 7-days. Hydrogen sulfide is not produced in the butt on TSI medium. Growth occurs on MacConkey agar but is inhibited on SS agar. Only three species of *Alcaligenes* are considered to be of sufficient importance. They are *A. faecalis*, *A. odorans*, and *A. denitrificans*. *A. odorans* produces a pronounced dark green color on blood agar, whereas other species vary from indeterminate lysis to greenish brown. This organism also produces a sweet odor similar to that of peeled apples. These organisms are most frequently isolated from clinical sources such as the ear, urine, spinal fluid, pleural fluid, wounds, abscesses, and feces.

***Achromobacter* Species.** Researchers of the American Society for Microbiology recommend that *Achromobacter* include only gram-negative rod-shaped, peritrichously flagellated bacteria, which are oxidase-positive, are strictly aerobic, attack carbohydrates oxidatively, and fail to produce 3-ketolactonate. They are two biotypes each of *A. xylosoxidans* and of *Achromobacter* species. They all grow on MacConkey and SS agars, and *A. xylosoxidans* usually grows on cetrinide agar. *Achromobacter* species is urease-positive using Christian's agar and *A. xylosoxidans* is not.

*Achromobacter* is most often isolated from blood, spinal fluid, urine, the respiratory tract, wounds, and feces.

#### Exercises (272):

Indicate whether each statement is true (T) or false (F) and correct those that are false.

- T F 1. The genus *Alcaligenes* is listed under the family Enterobacteriaceae in the 8th Edition of *Bergey's Manual*.
- T F 2. *Alcaligenes* has been defined by CDC researchers as gram-negative rods, non-motile with peritrichous flagella, oxidase-negative, nonsaccharolytic, and urease-negative.
- T F 3. On TSI, *Alcaligenes* produce an alkaline slant-neutral butt after 24 hours, and the butt becomes alkaline after 5 to 7 days.
- T F 4. *Alcaligenes* grows on SS agar, but is inhibited on MacConkey agar.
- T F 5. The species of *Alcaligenes* are isolated from clinical sources such as the ear, urine, blood, spinal fluid, pleural fluid, wounds, abscesses, and feces.
- T F 6. *Achromobacter* species has been defined as gram-negative rod-shaped, peritrichously flagellated bacteria, which are oxidase-negative, strictly aerobic, attack carbohydrates oxidatively, and produce 3-ketolactonate.
- T F 7. A *chromobacter* species and the two biotypes of *A. xylosoxidans* grow on MacConkey and SS agars.
- T F 8. *Achromobacter* is most often isolated from soil, market fruits and vegetables, and from surface water.

273. Point out some clinical sources of *Pseudomonas aeruginosa*, cultural and biochemical characteristics, methods used for identification, the disease caused by *Pseudomonas pseudomallei*, cultural and biochemical characteristics, and methods used for identification of this organism.

**Genus *Pseudomonas*.** The genus *Pseudomonas* is composed of a large number of nonfermentative, aerobic, gram-negative rods that inhabit the soil and water. These organisms play an important role in the decomposition of organic matter in their normal habitat. While most *Pseudomonas* species do not infect man, some are important opportunistic pathogens that infect individuals with impaired host defenses.

***Pseudomonas aeruginosa*.** The *Pseudomonas* species most frequently associated with human disease is *P. aeruginosa*. It may infect burn sites, wounds, the urinary tract, and the lower respiratory tract, especially in patients whose defenses have been impaired. In some hospitals this organism causes 10 to 20 percent of the nosocomial infections.

*P. aeruginosa* is a gram-negative rod, 0.5 to 1.0 by 3.0 to 4.0  $\mu\text{m}$ . It usually possesses a single polar flagellum, but occasionally two or three may be produced. Rods may occur singly, in pairs, or in short chains. The organism produces a flat colony with a ground-glass appearance on blood agar and produces a zone of hemolysis. Mucoid strains are frequently isolated from the sputum of patients with cystic fibrosis. Colonies tend to spread and give off a characteristic grapelike odor. Most strains excrete pyocyanin and fluorescein (pyoverdin), giving the colony a characteristic blue-green color. Perhaps the most striking feature of *P. aeruginosa* is its ability to produce a blue or blue-green pigment. This pigment does not color the colony, but readily diffuses throughout the surrounding medium, as seen in foldout 2, detail P. However, approximately 4 percent do not produce pyocyanin.

*P. aeruginosa* is oxidase-positive by Kovacs method and utilizes glucose oxidatively in O-F medium; gluconate is oxidized to ketogluconate. *P. aeruginosa* is lysine and ornithine decarboxylase-negative and arginine dihydrolase-positive. Most strains grow at 42° C. on trypticase agar slants. The organism grows on EMB on MacConkey agar as a nonlactose fermenter. It is suspiciously placed on TSI or KIA agar as a suspected colony from stool and may be incorrectly identified because of the alkaline slant and butt reaction characteristic of this organism.

During an epidemiologic investigation, an identification system that uses a standardized technique of bacteriophage typing has been recommended for tracing *Pseudomonas* strains. A system of typing by pyocin production and a serologic typing system have been used as markers to trace the sources of infections due to this organism.

***Pseudomonas pseudomallei*.** The other *Pseudomonas* species generally considered to be pathogenic for man is *Pseudomonas pseudomallei*. This organism is a common inhabitant of the soil in Southeast Asia. It causes melioidosis, a glanders-like disease in man. Although apparently rare in natives, the disease was an important and sometimes fatal infection in the U.S. Armed Forces in Vietnam. *P. pseudomallei* is multitrichous, with a tuft of three or more flagella per pole, and morphologically similar to *P. aeruginosa*. The colonies frequently are wrinkled and on prolonged incubation become umbonate in character, particularly on blood agar. These organisms may be cultivated on most laboratory media, growing well on trypticase soy agar, on blood agar, and on MacConkey agar; but not on *Salmonella-Shigella* agar on cetrimide agar. The oxidase reaction is positive, an oxidative acidity is produced in glucose O-F medium and growth occurs at 42° C. The agglutination and fluorescent-antibody reactions are useful for identification of *P. pseudomallei*.

#### Exercises (273):

1. What are some clinical sources of *Pseudomonas aeruginosa*?
2. What type of colony appearance is produced on blood agar?
3. Mucoid strains are isolated from the sputum of patients with what disease?
4. What other significant characteristics are noted about the colony appearance?
5. What causes the colony to have a characteristic blue-green color?
6. What percent do not produce this characteristic color?
7. What reactions does *P. aeruginosa* produce on lysine and ornithine decarboxylase? Arginine dehydrolase?

8. The organism is suspiciously placed on TSI or KIA and may be incorrectly identified because of what characteristic reaction?
9. During an epidemiologic investigation what technique is recommended for identification of *Pseudomonas* strains?
10. What other methods of identification have been used as markers to trace the sources of infection due to *Pseudomonas* strains?
11. What disease is caused by *Pseudomonas pseudomallei*?
12. How do the colonies of *P. pseudomallei* appear on blood agar?
13. *P. pseudomallei* does not grow well on what two media?
14. What reaction is obtained on the oxidase test? Glucose O-F medium?
15. What techniques are useful for identification of *Pseudomonas pseudomallei*?

274. Indicate whether given statements correctly reflect some general characteristics of *Aeromonas* species, the species most often misidentified as an enteric bacillus, and differences in morphological and biochemical characteristics between Aeromonads and Enterobacteriaceae.

**Genus *Aeromonas*.** The genus *Aeromonas* contain several species, all of which are found free-living in water. Most are pathogens for cold-blooded animals and have not been implicated in human diseases. However, one species, *Aeromonas hydrophilia* is a well documented pathogen of man, responsible for septicemia, exudates from wounds and ulcers, pus from osteomyelitis, throat swabs, urine, bile, and feces

of persons with diarrheal disease and normal stool. *A. hydrophilia* grows readily on media used for the Enterobacteriaceae and is often misidentified as an enteric bacillus. Aeromonads are differentiated from Enterobacteriaceae in that they possess a single polar flagellum, and produce a positive reaction from indol-phenol-oxidase in addition to other differential biochemical tests.

#### Exercises (274):

Indicate whether the following statements are true (T) or false (F) and correct those that are false.

- T F 1. Most species of *Aeromonas* have been implicated in human diseases and are thus pathogens for warm blooded animals.
- T F 2. *Aeromonas hydrophilia* is a pathogen of man responsible for septicemia and exudates from wounds and ulcers.
- T F 3. *A. formicans* is often misidentified as an entire bacillus.
- T F 4. Aeromonads are differentiated from Enterobacteriaceae in that they possess a single polar flagellum and produce a negative reaction from indol-phenol-oxidase in addition to other differential biochemical tests.

275. Cite the disease caused by *Vibrio cholerae*, characteristics of the disease, the toxin produced, mode of transmission of the disease, morphological appearance, cultural requirements and growth characteristics of the organism, type of specimens collected, media used, and other methods of identification.

**Genus *Vibrio*.** The 8th Edition of *Bergey's Manual* has established a new taxonomic family, the Vibrionaceae. The genus *Vibrio* is included in this family and contains some of the most important intestinal pathogens of man. The species of medical importance are *V. cholerae* and *V. parahaemolyticus*.

***Vibrio Cholerae*.** *V. Cholerae* is the causative agent of Asiatic cholera. In its most severe form, Asiatic cholera is an acute diarrheal disease characterized by massive loss of fluid and electrolyte which, if untreated, may result in cardiovascular collapse and death in a single day. Even though such cases are the

exception, epidemiological studies indicate that for each severe case there are 25 to 100 mild to asymptomatic infections.

It is now firmly established that the disease is produced by a heat-labile enterotoxin produced by *V. cholerae* multiplying in the small bowel. This causes vomiting and profuse diarrhea (rice-water stools), resulting in severe dehydration, anuria, hypochloremia, acidosis, and circulatory failure. The mortality rate ranges between 30 and 50 percent in untreated cases. Cholera is transmitted from infected individuals or convalescing carriers through contaminated food and water.

*Vibrio cholerae* and its biotype El Tor are gram-negative, actively motile rods possessing a single polar flagellum. On carefully prepared stained smears one may observe the slightly curved rods. Most authorities feel that the El Tor biotype is less susceptible to environmental changes than the *V. cholerae* type, and for this reason is more readily recovered from specimens submitted to the laboratory.

*Vibrio cholerae* is a facultative anaerobic organism with an optimum temperature of 18° C. to 37° C. A liquid stool is best collected by rectal catheter, and formed stools should be collected in disinfectant-free containers. Rectal swabs are most effective when inserted beyond the anal sphincter. The Center for Disease Control recommends the use of two plating media and one enrichment broth. Thiosulfate-citrate-bile salt-sucrose (TCBS) agar, a selective medium, at pH 8.6 and taurocholate gelatin agar (TGA), a non-selective media, give good results.

After 18 to 24 hours at 35° C. on TCBS, *V. cholerae* appears as medium-sized, smooth, yellow colonies with opaque centers and transparent periphery. On gelatine medium, the colonies are somewhat flattened and transparent, surrounded by a cloudy halo. This characteristic is accentuated by refrigeration which demonstrates gelatin liquefaction. The enrichment broth medium is alkaline peptone water which, by its contents of high alkalinity, tends to suppress other intestinal bacteria. The culture on this medium should not be allowed to go beyond 18 to 20 hours because suppressed forms may begin to develop. Suspicious colonies from agar media are selected and inoculated to appropriated media or tested with O typing sera by slide test. A variety of tests, such as the string test and darkfield motility test, are useful in the hands of experienced field workers, but may cause confusion and misinterpretation in the hands of less experienced laboratory personnel. Table 4-10 depict some biochemical properties that distinguish *V. cholerae* from the noncholera vibrios and also differentiate between *V. cholerae* and its biotype El Tor.

#### Exercises (275):

1. What two species of the genus *Vibrio* are considered of medical importance?
2. What disease is caused by *Vibrio cholerae*?

TABLE 4-10  
DISTINGUISHING PROPERTIES OF VIBRIO SPECIES

Test	<i>V. cholerae</i>	<i>V. cholerae</i> El Tor biotype	<i>V. para-</i> <i>haemolyticus</i>
String test after 45 to 60 seconds	+	+	-
Hemagglutination test	-	+	-
Polymyxin B susceptibility test	**	-	-
Phage IV susceptibility test	**	-	-
VP	-	+	-
Hemolysis of sheep RBC	-	***	-
Sucrose	+	+	-
Salt-free broth	+	+	-
Broth containing 7% to 10% NaCl	-	-	+
Cholera red test	+	+	-
Agglutination in O group serum	+	+	-

\*\*Indicates susceptibility.

\*\*Considerable variability in hemolytic activity has been reported.

3. In its most severe form what are some characteristic symptoms of the disease?
4. What type of toxin is produced by *V. cholerae*?
5. How is cholera transmitted?
6. What morphological appearance may be noted on carefully prepared stained smears?
7. What is the reason given by most authorities for a more frequent recovery of the El Tor biotype from specimens submitted to the laboratory?
8. Liquid stools are best collected using what technique?
9. What selective and nonselective media may be used?
10. After 18 to 24 hours at 35° C. on TCBS, how do the colonies of *V. cholerae* appear?
11. How do the colonies of *V. cholerae* appear on TGA medium?
12. What is the enrichment broth medium used?
13. Why should the culture in the enrichment broth medium not be allowed to go beyond 18 to 20 hours?
14. What specified typing sera is used for identifying suspected colonies from agar media?
15. What other two tests may be used by experienced workers for identification of suspected organisms?

276. State the common environment of *Vibrio parahaemolyticus*, diseases caused by the organism, transport media used for feces and rectal swabs, and media recommended for isolation.

**Vibrio Parahaemolyticus.** *V. parahaemolyticus* is a marine organism that inhabits estuaries throughout the world and is perhaps more important in the United States, since *V. cholerae* and the El Tor biotype are rarely encountered. *V. parahaemolyticus* can cause gastroenteritis or food poisoning related to the consumption of contaminated seafood, and more serious infection, such as septicemia with shock, hemolytic anemia, and disseminated intravascular coagulation.

The organism is halophilic, or having an affinity for salt environment, and grows well in peptone water medium containing 7 to 8 percent NaCl. However, the organism does not normally utilize citrate. *V. parahaemolyticus* resembles the other vibrio species in its structural and staining characteristics.

Feces and rectal swabs should be cultured quickly or placed into Cary-Blair or Amies' transport medium. Specimens should be inoculated into TCBS and alkaline peptone broth (pH 8.5) supplemented with 3 percent NaCl. After overnight incubation alkaline peptone broth is subcultured to TCBS. Some characteristics of this species are noted in table 4-10. *V. alginolyticus* is closely related to *V. parahaemolyticus* and is considered to be a biotype of it.

#### Exercises (276):

1. *Vibrio parahaemolyticus* is halophilic or having an affinity for \_\_\_\_\_ environment.
2. What are some diseases caused by *V. parahaemolyticus*?
3. What enrichment and selective medium may be used?
4. What transport media may be used for feces and rectal swabs?
5. What other species is closely related to *V. parahaemolyticus* and is considered to be a biotype of it?

277. Identify the rapid methods used for identification of Enterobacteriaceae in terms of the principles, procedures and materials used, and comparative comments of researchers.



**Rapid Methods for Identification of Enterobacteriaceae.** Rapid methods designed to reduce the amount of time of identifying members of Enterobacteriaceae have been developed. These methods have been rated as good, with accuracy correlation from 87 to 96 percent or higher, depending on the number and variety of cultures tested. Much emphasis is placed upon the competence and technical skill of the person or persons performing the tests. One must be aware of the fact that the results will only be as good as the laboratory skill shown. Complete information on the use of any of these systems may be obtained from the manufacturers. There are currently in use at least six different systems. Many of them are in their third or fourth generation, which should significantly increase their accuracy.

**API System (Analytical Products Inc).** The API 20 enteric system uses 22 biochemical tests that can produce results from a single bacterial colony in 18 to 24 hours. In order to supply the inoculum, the colony is emulsified in 5 ml of distilled water and the inoculation is carried out with a Pasteur pipet. Viable cells are introduced into the small plastic cupules and tubes arranged in a plastic tray, to which water has been added to provide humidity, for 18 hours. Guides for the proper reading of the tests are provided and organisms may be identified with the help of a profile register provided by the manufacturer after a numerical value is established with the use of an API coder. Some authorities feel that the API strip is currently the most complete and accurate kit for speciation of Enterobacteriaceae.

**Enterotube System.** The new, improved enterotube permits simultaneous inoculation and performance of 11 biochemical tests from a single colony. A well-isolated colony is usually selected from MacConkey, EMB, or Hektoen agar plates that have been inoculated with a clinical specimen. Each compartment of the tube is self-inoculated by touching the needle to a single colony and drawing it through all media in the tube. Researchers note that this is the simplest and most convenient of all kits to use.

**Inolex (Auxatab) Enteric 1 System (Colab Laboratories, Inc.).** This system consists of a card with ten capillary units containing ten different reagents designed to differentiate between the genera of the Enterobacteriaceae on a reduced time schedule and to differentiate the species of *Enterobacter* and *Proteus*. The battery of tests is set up from an inoculum using a single colony selected from a primary isolation plate.

**Minitek System (BBL).** This system utilized paper disks impregnated with individual substrates. These disks are placed in wells, in a plastic plate, and inoculated with a broth suspension of the isolate. Identification of the organism is based on color reactions occurring in the disks following overnight incubation. The user can select from among 35 different disks currently available for tests necessary for identification of organisms. One chief researcher feels that the accuracy of identification of this system is not

of the same order as that attainable with API and Enteratube systems.

**PathoTec Rapid I-D System.** This system consists of a set of 12 test strips impregnated with various biochemical reagents in carefully measured concentrations. Selected test strips have been reported to identify approximately 95 percent of the Enterobacteriaceae in approximately four hours after initial isolation. The strips are added to prepared (13 X 100 mm) test tubes. The cytochrome oxides and esculin hydrolysis test strips are inoculated by rubbing inoculum from selected colonies on designated areas, while the remaining strips are placed in tubes to which a measured amount of cell suspension has been added. The cytochrome oxidase test is read after 30 seconds, while the remaining tests are recorded after approximately 4 hours at 35° C.

**The R/B System.** The R/B System consists of the two basic tubes, the r/b 1 and the r/b 2, as well as the Expanders Cit/Rham and Soranase™. These constricted tubes contain sterile media and are used to determine 14 biochemical parameters. Special media are contained in the tubes which provide a reliable means observing the reactions for separating aerobic from anaerobic reactions and for the stabilizations of the media. This particular system results in high accuracy and reproducibility and is more rapid than a conventional system with respect of "setting up" interpretation.

#### Exercises (277):

Match each column B item with the statements in column A by placing the letter of the column B item beside the number of the column A item that most nearly describes it. Each element in column B may be used once or more than once.

#### Column A

- \_\_\_\_\_ 1. Viable cells are introduced into the small plastic capsules and tubes arranged in a plastic tray to which water has been added to provide humidity for 18 hours.
- \_\_\_\_\_ 2. Organisms may be identified with the help of a profile register provided by the manufacturer after a numerical value has been established with the use of a coder.
- \_\_\_\_\_ 3. This system permits simultaneous inoculation and performance of 11 biochemical tests from a single colony.
- \_\_\_\_\_ 4. Consists of a card with 10 capillary units containing 10 different reagents designed to differentiate between the genera of the Enterobacteriaceae on a reduced time schedule.
- \_\_\_\_\_ 5. Each compartment of the tube is self-inoculated by touching the needle to a single colony and drawing it through all media in the tube.
- \_\_\_\_\_ 6. This system utilizes paper disks impregnated with individual substrates.
- \_\_\_\_\_ 7. Consists of a set of 12 test strips impregnated with various biochemical reagents in carefully measured concentrations.
- \_\_\_\_\_ 8. Not to be considered to produce the same accuracy of identification as results attainable with API and Enterotube systems.
- \_\_\_\_\_ 9. The cytochrome, oxidase, and esculin hydrolysis test strips are inoculated by rubbing inoculum from selected colonies.



- \_\_\_\_\_ 10. The remaining strips are placed in the tubes to which a measured amount of cell suspension has been added.
- \_\_\_\_\_ 11. This system uses two basic tubes which are constricted and contain sterile media. These tubes are used to determine 14 biochemical parameters.
- \_\_\_\_\_ 12. This system results in high accuracy and reproducibility and is more rapid than a conventional system with respect of "setting up" interpretation

*Column B*

- a Minitek System (BBL)
- b Patho Tec Rapid I-D System
- c Inolex (Auxotab) Enteric System (Colab Laboratories Inc)
- d API System (Analytab Products Inc)
- e The R/B System
- f Enterotube System

## Mycobacterium

THE MOST STRIKING characteristic of the mycobacteria is the enormous amount of lipid present in their cell walls. This comprises 40 percent of the total cell dry weight; thus, these cells grow as extremely rough colonies which do not readily absorb water. The Mycobacteria are difficult to stain, but once stained, they resist decolorization with acid alcohol. Organisms possessing the ability to retain a stain in spite of washing with acid alcohol are referred to as acid-fast. Only the members of the genus *Mycobacterium* and a few species of *Nocardia* possess this property.

The Mycobacteriaceae contain a single genus, *Mycobacterium*, whose properties characterize the family. In the Bergey classification scheme, these organisms are grouped with Actinomycetes and related organisms in PART 17. The nocardias, having a number of features in common with the mycobacteria, also belong to this group.

Most acid-fast species belong to the genus *Mycobacterium*, which claim the renowned pathogens as the tubercle bacilli and the causative agent of leprosy. Members of the genus *Nocardia* are aerobic bacilli, some weakly acid-fast, that grow well on common laboratory media. The pathogenic species are *N. farcinica* and *N. asteroides*. The first is associated with a chronic tuberculosis-like disease of cattle. *N. asteroides* has been isolated from abscesses in man, and it also causes conditions resembling pulmonary tuberculosis.

The pathogenic actinomycetes (*Nocardia* and *Actinomyces*) are recognized morphologically in the laboratory as gram-positive, sometimes partially acid-fast rods with beaded and branching shapes. Rapid growth on ordinary culture media distinguishes them from the tubercle bacilli.

### 5-1. The Agents of Leprosy and Tuberculosis

Leprosy is an ancient disease that was well known as early as 1400 B.C. It still occurs in certain Asiatic countries, in South America, and to a limited extent in the Southern United States. *Mycobacterium leprae*, also referred to as Hansen's bacillus, was discovered in 1878. The organism spreads mainly by personal contact, but exposure over a period of years seems to be necessary for infection to take place. Details of the actual mechanism of transmission are still lacking.

Tuberculosis is also one of the world's oldest diseases. The disease is of a persistent and chronic nature that is usually caused by *Mycobacterium tuberculosis* but occasionally by other species, such as *M. bovis* and *M. kansasii*.

Since the last two decades, it has become generally accepted that mycobacteria other than *M. tuberculosis* can be the cause of human infections. Although *M. tuberculosis* is still the mycobacterium most frequently isolated from clinical specimens, *M. kansasii* and the *M. avium* are well established pathogens and their recognition becomes equally significant. Mycobacteria other than *M. tuberculosis* may account for as much as 10 percent of all human mycobacterial infection.

**278. Cite the causative organisms of leprosy in humans and in rats, morphological and growth characteristics, and the method of laboratory diagnosis.**

**Mycobacterium leprae.** *M. leprae* of man and *M. lepraemurium* of rats are the cause of human and rat leprosy, respectively. Typical cells of *Mycobacterium leprae* are found predominantly in smears and scrapings obtained from the skin and mucous membrane, particularly of the nasal septum of patients with nodular leprosy.

**Morphology and growth.** The organism has not been successfully cultivated on artificial media, but it can be propagated on the footpad of mice. Morphologically, Hansen's bacillus closely resembles the tubercle bacillus. The cells are slender rods measuring from 1.0 to 8.0  $\mu\text{m}$  long and 0.3 to 0.5  $\mu\text{m}$  wide. They are acid-fast and may appear beaded. The bacilli are generally found within tissue cells but may also be seen extracellularly. Characteristically, the bacterial cells are arranged in groups or packets, side-by-side.

Due to the prolonged generation time of *M. leprae*, growth in foot pads of mice is not considered practical as a diagnostic test. The armadillo has been used experimentally because of its susceptibility to *M. leprae*.

**Laboratory diagnosis.** Serological tests for syphilis in lepers frequently yield biological false-positive results. Diagnosis is made by the demonstration of

acid-fast bacilli in smears of skin, in nasal scrapings, and in tissue sections from typical tuberculoid leprosy. In addition, the occurrence of anesthesia and the presence of acid-fast rods that cannot be cultured are actually the only criteria available for diagnosis. Lepromin, a sterile extract of leprosy tissue containing numerous *M. leprae* organisms is used to determine a relative resistance or susceptibility to the disease. It is of no aid in the diagnosis of leprosy for two reasons: (1) lepromatous patients have an impaired cellular immune response and thus will not react; and (2) most persons will give a positive reaction to lepromin.

**Exercises (278):**

1. What is the causative organism of leprosy in humans? In rats?
2. From what type specimens are the organisms more likely to be noted?
3. On what artificial media has the organism been successfully cultivated?
4. As a diagnostic test, what type of in vivo growth is considered practical?
5. Diagnosis of leprosy is dependent upon what laboratory results?
6. What other two criteria for diagnosis are available for consideration?
7. What is lepromin and for what purpose is it used?

**Cite the clinical significance of tuberculosis in terms of the organs involved, manner of spreading, the principal agents of tuberculosis in man, and the forms of tuberculosis responsible for the highest mortality.**

**Tuberculosis—Clinical Significance.** Although capable of involving almost any organ of the body, tuberculosis is most commonly associated with lungs, from which it spreads from person-to-person through coughing or expectoration.

The human and bovine tubercle bacilli (*M. tuberculosis* and *M. bovis*) are the principal agents of tuberculosis in man. Human strains are almost always responsible for the classic pulmonary disease. Infections with the bovine species are occasionally pulmonary, but more often involved other tissues. Bovine tuberculosis is not common in adults, but it does occur with some frequency in children, especially in certain European countries. The avian tubercle bacillus (*M. avium*), found in wild birds and domesticated fowl, is reported from time to time as the cause of human infections.

Tubercle bacilli usually enter the body by way of the respiratory or alimentary tract. In man, the respiratory tract is the most frequent and important portal of entry. Infection arises through aerosol droplets and contaminated dust particles. Infections are also acquired from fomites (towels, drinking cups). The consumption of unpasteurized milk or inadequately cooked meat from infected cattle is an important source of infection where bovine tuberculosis is not well controlled.

Following initial infection, tubercle bacilli form primary and secondary lesions. The organisms may spread to various tissues via the lymphatic system, bloodstream, or by direct extension. Bloodstream dissemination can result in the so-called military, or "mustard seed," tuberculosis. Practically any tissue of the body is susceptible to invasion; however, more than 90 percent of the deaths from tuberculosis are due to the pulmonary form.

**Exercises (279):**

1. Which two organisms are considered to be the principal agents of tuberculosis in man?
2. Human strains are most frequently responsible for what type of tubercular disease?
3. How is bovine tuberculosis transmitted to man?
4. How does the tubercle bacilli usually enter the body?
5. Bloodstream dissemination of the tubercle bacilli can result in what kind of tuberculosis?
6. Most of the deaths resulting from tuberculosis are due to which form of the disease?

280. Indicate whether given statements correctly reflect the morphology, colony characteristics, and growth requirement of *Mycobacterium bovis*.

***Mycobacterium Bovis*.** The rods of the bovine tubercle bacilli are often shorter and plumper than the human tubercle bacillus, and primary isolation is somewhat more difficult. Bovine tubercle bacilli are rarely isolated in the United States, but remain significant pathogens in other parts of the world. Since growth is inhibited by glycerol, the colonies are smaller than the human species on glycerol agar.

These organisms require a larger incubation period of generally 3 to 6 weeks, and appear as tiny, translucent, smooth, pyramidal colonies when grown at 35° C. on egg medium. They adhere to the surface of the medium but are emulsified easily. These organisms will grow only at 35° C. On 7H10 the colonies are rough and resemble those of *M. tuberculosis*.

**Exercises (280):**

Indicate whether each statement is true (T) or false (F) and correct those that are false.

- T F 1. The rods of the bovine tubercle bacilli are often longer and more slender than the human tubercle bacilli, and primary isolation is somewhat more difficult.
- T F 2. The colony growth of the bovine tubercle bacilli is enhanced by glycerol and are larger than the human species on glycerol agar.
- T F 3. *M. bovis* require a longer incubation period than *M. tuberculosis*, of generally 3 to 6 weeks.
- T F 4. *M. bovis* colonies appear tiny, translucent, smooth, and pyramidal when grown at 35° C on 7H10.
- T F 5. *M. bovis* will grow only at 35° C.

281. Identify the atypical mycobacteria and the members of the Runyon subgroups in terms of the given definitions, cultural and morphological properties, species in each group, diseases with which species are associated, and the metabolic characteristics of each subgroup.

**Atypical Mycobacteria.** The term "atypical" is much used for mycobacteria other than *M. tuberculosis* or *M. bovis* which occur in clinical specimens. Thus, atypical mycobacteria refers to a number of anonymous acid-fast bacilli whose composite characteristics prevent their being classified with any of the established species of *Mycobacterium*. Many of these forms produce a disease which is clinically similar to tuberculosis; yet, culturally, they exhibit several features which set them apart from the human, avian, and bovine species. These organisms have no clearly established animal hosts. It is not known precisely how they are transmitted from one individual to another, but some of them can cause a severe and often fatal disease in man. Nevertheless, it is better to avoid the term "atypical mycobacteria" because in reality, these bacteria are *not atypical*, but rather characteristic of their particular species.

**Runyon Group.** In 1959, Runyon proposed a scheme for separation of the medically significant unclassified bacteria. The Runyon classification of the atypical acid-fast bacilli uses cultural and morphological properties, animal studies, and metabolic traits to assign these organisms to four subgroups. These subgroups are also given descriptive names:

- Group I —Photochromogens
- Group II —Scotochromogens
- Group III—Nonphotochromogens
- Group IV—The rapid growers

**Group I. photochromogens.** The photochromogens can produce pulmonary disease in man. The organisms form a yellow pigment in the presence of light; hence, the name photochromogen. *M. kansasii*, commonly called the "yellow bacillus," is the most frequent isolate from this group. On L-J slant medium, a young actively growing culture that has been exposed to light for as little as one hour and reincubated in the dark will produce a bright lemon-yellow pigment in 6 to 24 hours. The three photochromogenic mycobacteria in Group I are: *M. kansasii*, *M. marinum* and *M. simae*.

**Group II. scotochromogens.** The scotochromogens are pigmented in the dark. The culture usually forms a deep yellow to orange color, which darkens to an orange or dark red when exposed to continuous light for two weeks. This pigmentation is observed on all types of media at all stages of growth. These characteristics significantly aid in the identification of these organisms.

The Group II scotochromogens consists of two groups: the potential pathogens, *M. scrofulaceum* and *M. szulgai*; and the so labeled "tap water" scotochromogen, isolated from laboratory water stills, faucets, soil, and natural waters. The latter organism is now classified as *M. gordonae*. *M. scrofulaceum* produces a yellow or orange pigment whether cultivated in the light or in darkness. Considered to be a potential pathogen, this organism has been associated with cases of lymphadenitis in children. *M. szulgai* has been associated with pulmonary disease, cervical adenitis, and alecranon bursitis.

**Group III. nonphotochromogens.** The nonphotochromogens consist of a variety of both pathogenic and nonpathogenic mycobacteria that do not develop pigment on exposure to light. The following species are recognized in this group:

a. *M. avium* complex, which includes Battey bacilli and *M. intracellulare*, cause a form of tuberculosis clinically indistinguishable from the pulmonary infections brought on by *M. tuberculosis* and *M. kansasii*. Unlike the true tubercle bacillus, the Battey strains often show a primary drug resistance that makes treatment difficult. Multiple drug regimens, usually including both isoniazid and rifampin, may be effective.

b. *M. xenopi* has been isolated from the sputum of patients with pulmonary disease.

c. *M. ulcerans* is associated with skin lesions and is considered to be the causative agent of Buruli ulceration, a necrotizing ulcer found in African natives.

d. *M. terrae* complex organisms have been isolated from soil and vegetables, as well as from humans. Their pathogenicity remains questionable.

e. *M. gastri* has not been associated with disease in humans, but has occurred primarily as a single colony isolated from gastric washings.

f. *M. triviale*. These bacilli have been recovered from patients with previous tuberculosis infections, but are considered to be unrelated to human infections.

**Group IV. rapid growers.** Group IV of the Runyon scheme consists of mycobacteria that are characterized by their ability to grow in 3 to 5 days on a variety of culture media incubated at 25° C. or 35° C. instead of 2 to 3 weeks. Two members of this group, *M. fortuitum* and *M. chelonae*, are associated with human pulmonary infection. Although *M. fortuitum* is also common in the soil, it may be frequently isolated from sputum without necessarily being implicated in a diseased process.

*M. smegmatis*, *M. phlei*, and *M. vaccae* are considered saprophytes and are nonpathogenic. *M. smegmatis*, commonly referred to as the "smegmabacillus," is found occasionally in urine specimens. This bacillus is very difficult to distinguish microscopically from the pathogenic acid-fast bacilli. The organism is widely distributed in water, soil, and dust and can be isolated from human smegma. *M. phlei* is also found in the soil, in dust, and on plants. Commonly called the "timothy grass bacillus," the organism forms a dark-yellow, soft, waxy colony.

You should note that the majority of Group IV mycobacteria are not stained by the fluorochrome stain. However, all are stained by the Ziehl-Neelsen technique.

### Exercises (281):

Match each column B item with the statements in column A by placing the letter of the column B item beside the number of the column A item that most nearly describes it. Each element in column B may be used once or more than once.

#### Column A

1. Many of these forms produce a disease which is clinically similar to tuberculosis but, culturally, they show several features which set them apart from the human, avian, and bovine species.
2. These organisms form a yellow pigment in the presence of light.
3. *M. kansasii*, *M. marinum*, and *M. simae* are species in this subgroup.
4. The culture in this subgroup usually forms a deep yellow to orange color which darkens to an orange or dark red when exposed to continuous light for two weeks and are also pigmented in the dark.
5. "Tap water" scotochromogen isolated from laboratory water stills, faucets, soil, and natural waters.
6. Considered to be a potential pathogen associated with cases of lymphadenitis in children.
7. Consists of a variety of both pathogenic and nonpathogenic mycobacteria that do not develop pigment on exposure to light.
8. Cause a form of tuberculosis clinically indistinguishable from the pulmonary infections brought on by *M. tuberculosis* and *M. kansasii*.
9. Characterized by their ability to grow in 3 to 5 days on a variety of culture media incubated at 25° C. or 35° C. instead of 2 to 3 weeks.
10. *M. fortuitum* and *M. chelonae* are associated with human pulmonary infections and are members of this subgroup.
11. Most of the organisms in this subgroup are not stained by the fluorochrome stain, but all are stained by the Ziehl-Neelsen technique.

#### Column B

- a. Group I Photochromogens
- b. Group III Nonphotochromogens
- c. Atypical Mycobacteria
- d. Group II Scotochromogens
- e. Group IV Rapid Growers
- f. *M. szulgai*
- g. *M. scrofulaceum*
- h. Battey bacillia and *M. intracellulare*

### 5-2. Distinguishing Characteristics of Tubercle Bacilli

As with most bacterial species, cellular size and shape of the mycobacteria differ with the environment in which the organisms are found—the culture tube and clinical specimen from various anatomical



sources. Sputum, urine, and gastric washings are most often received in the laboratory; but tissue specimens, lymph aspirations, and pleural, pericardial, spinal, or joint fluids are submitted upon occasion. We learned in Chapter 4 of the first volume how to concentrate and digest urine, sputum, and gastric washings prior to microscopic examination and culturing. The other body fluids are not ordinarily digested, but the bacilli in them should be concentrated by centrifuging the specimen and using the sediment for making smears.

**282. Specify some morphological characteristics of *M. tuberculosis* and other mycobacteria, the recommended format for reporting stained slide preparations, and common colony morphology of mycobacteria.**

**Morphological Characteristics of *M. Tuberculosis* and Other Mycobacteria.** Generally, we expect to see cells ranging in size from 0.3 to 0.6  $\mu\text{m}$  and 0.6 to 4.0  $\mu\text{m}$  in length appearing either as slightly curved or straight rods. They may be found as short cells or as threadlike shapes. They sometimes appear branched or swollen, with a beaded effect. In tissues and exudates tubercle bacilli often take the form of small, thin rods with rounded ends. They may be straight or slightly curved. In smears from cultures, longer filamentous forms are occasionally observed, as well as swollen or club-shaped cells. Tubercle bacilli occur singly, in small groups, or frequently in clumps of indiscernible individual cells. Detail Q of foldout 2 illustrates a typical acid-fast smear. None of the mycobacteria produce spores. Virulent strains often have a capsular substance, especially when grown on a serum-enriched medium. The cell wall is unlike that of gram-positive or gram-negative cells and contains high concentrations of lipids. *M. tuberculosis* also possess a number of protein antigens which by themselves do not appear to be toxic or involved in virulence. However, the host's cellular immune response to certain of these mycobacterial proteins apparently accounts for the acquired immunity and allergic response to the tubercle bacilli.

**Reporting of microscopic examination.** The bacteriology technician is responsible for reading preparations stained with either fluorochrome or carbolfuchsin stains and must take quantitative notations of the numbers of organisms observed per field or per slide. However, the following method of reporting is recommended by the American Thoracic Society of the American Lung Association:

- a. Three to nine bacilli per slide—report as “rare.” (+)
- b. Ten or more cells per slide—report as “few.”
- c. More than 1 per oil immersion field—report as “numerous.”
- d. One to two in entire smear—report number found and request another specimen.

The same reporting format may be used for fluorescence microscopy, with one exception; that is, that the observation of greater than 2 bacilli per high dry field (630 x) is reported as numerous. Some workers differentiate microscopically between typical acid-fast forms—for example, the long, slender, sometimes beaded bacilli—and atypical organisms—the short, broad, pale-staining or branching cells. This distinction is difficult to make, at best, and should not be attempted without extensive laboratory experience in observing the tubercle bacilli.

**Colony morphology.** Colony morphology among the mycobacteria ranges from the dry, nodular, rough, “cauliflower” growth typical of the human tubercle bacillus (seen in detail R of foldout 2) to the smooth, moist glistening slant of a scotochromogenic mycobacterium shown in detail S of foldout 2. Note, however, in detail T of foldout 2 that the photochromogens of Runyon's atypical classification, as well as others, can look deceptively like the human strain seen in detail R of foldout 2.

Most of the mycobacterial colonies are buff, off-white, or cream colored. Some of these nonpigmented strains give a hint of faint yellow or pink. The highly pigmented atypical bacilli of the Photochromogen and Scotochromogen groups appear bright yellow, orange, or brick red under certain cultural conditions. Two examples are given in details S and T of foldout 2. The influence of light on pigment production is an important factor in identification.

#### Exercises (282):

1. What morphological shapes of the tubercle bacilli might be observed in tissues and exudates?
2. What shapes might be observed in smears from cultures?
3. What type of spores does the mycobacteria produce?
4. The cell wall of mycobacteria, unlike that of gram-negative or gram-positive cells, contains high concentrations of what substance?
5. What substance of the mycobacterial cells might be responsible for the host's cellular immune response and apparently accounts for the host's acquired immunity and allergic response to the tubercle bacilli?



6. After reading a stained preparation with the fluorochrome technique, you observed ten or more cells per slide. What quantitative notation would you report?
7. If you observed one or two cells in the entire smear, what should you report?
8. What is the colony morphology growth typical of the human tubercle bacillus on Lowenstein-Jensen medium?
9. What colony consistency might be observed on Lowenstein-Jensen medium of a scotochromogenic mycobacterium?
10. How would most mycobacterial colonies appear on Lowenstein-Jensen medium?

283. Cite three cultural properties by which mycobacterial pathogens may be identified, significant distinguishing characteristics of the given species, the advantage of Middlebrook 7H10 agar, and the effect of CO<sub>2</sub> on the growth of the tubercle bacilli.

**Cultural Properties.** Most mycobacterial pathogens may be identified by rate of growth, pigmentation, colony morphology, and one or two other properties. Nevertheless, the results of a single test must never be depended upon for identification of the organism.

The mycobacteria are aerobic and will not grow under strict anaerobic conditions. An incubation temperature of 37° C. is near the optimum. Growth is slow, usually requiring two weeks or longer, as we can judge from the data in table 5-1. The tendency of the human, avian, and bovine species to form colonies only at elevated temperatures (no growth at 25° C.) is significant in distinguishing them from the atypical groups.

We pointed out in Volume 1 that an enriched medium such as Lowenstein-Jensen's or Petragnani's is required for growth, and even with these enriched media the cultures should be kept for at least eight weeks before discarding as negative. Remember to examine the tubes every three or four days, and periodically loosen the screw caps of the culture tubes to replenish the oxygen supply. Media for the mycobacteria are usually purchased pretubed because of the labor and expense of preparation. The principal growth promoting constituents are homogenized whole egg, glycerol, asparagin, and potato starch. Malachite green is added to inhibit the growth of contaminating organisms.

Middlebrook 7H10 agar with oleic acid, dextrose, and citrate enrichment has been added to the arsenal of diagnostic media. It is excellent for primary isolation and susceptibility testing of *M. tuberculosis*. This medium has several advantages. Early detection of colonies with the aid of the microscope is possible because the medium is clear. It permits easy separation

TABLE 5-1  
GROWTH TEMPERATURE RELATIONSHIP

ORGANISM	COLONY FORMATION (DAYS)	
	25°C	37°C
<i>M. tuberculosis</i>	No growth	12 to 25
<i>M. bovis</i>	No growth	25 to 40
<i>M. avium</i>	Slight or no growth	21 to 28
<i>M. ulcerans</i>	60	60
Photochromogens (Group I)	12 to 25	10 to 21
Scotochromogens (Group II)	12 to 25	10 to 21
Nonphotochromogens (Group III)	12 to 25	10 to 21
Rapid Growers (Group IV)	7	3 to 5

of mixed colony types, and contamination with other bacteria or fungi does not alter or destroy the agar base medium as quickly as the egg base medium of Lowenstein-Jensen or Petragnani's. Whereas up to eight weeks' cultivation is required on egg base media, Middlebrook 7H10 shows growth within 3 weeks. Middlebrook 7H10 must be relatively fresh, however, and cultures must be incubated under increased CO<sub>2</sub> tension. It is important to note that even with egg base media the presence of CO<sub>2</sub> definitely stimulates the rate of growth of the tubercle bacilli.

#### Exercises (283):

1. What are three properties by which most mycobacterial pathogen may be identified?
2. How well are mycobacterial organisms expected to grow under strict anaerobic conditions?
3. What are the principal growth promoting constituents in Lowenstein-Jensen and Petragnani medium?
4. What are several advantages of Middlebrook 7H10 agar?
5. What effect does the presence of CO<sub>2</sub> have on the growth of the tubercle bacilli?

#### 5.3. Special Diagnostic Tests

The identification of *Mycobacterium* isolates rests partly on the comparison of several characteristics which we have already covered: the temperature range for growth, the period required for colony formation, and the effect of bright light on pigment production. In addition, there are certain biochemical procedures that are useful in differentiating the various species and groups. If facilities for carrying out these special tests are not available, the cultures should be referred promptly to a mycobacteriologic reference laboratory. During this time, an interim report based on the result of smear and growth on culture should be sent promptly to the clinician.

**284.** Identify the biochemical procedures used for detecting mycobacteria species in terms of their purpose, technique, and reactions.

**Biochemical Procedures.** As we find in table 5-2, the human strains of mycobacteria, whether virulent or not, are able to form *niacin* (nicotinic acid) when grown on one of the egg media we have discussed. Bovine species are usually negative, and avian species are consistently negative.

**Niacin test.** Niacin in the culture is detected by a color reaction with cyanogen bromide and aniline. To test for niacin production we pipette 1.0 ml. of sterile saline to a three week, or older, culture slant. (Be sure that there is no niacin-containing additive such as penicillin in the medium.) In order to extract the niacin, puncture the slant around the growth with the dropper pipette tip. The colonies should be covered with the saline and allowed to stand for about 30 minutes. Transfer a portion of the saline to a small screw-capped test tube. Add an equal portion of aniline and cyanogen bromide solution to the saline extract. If niacin is present, a yellow color will appear almost instantly. A positive and a negative niacin test are shown in detail U of foldout 2. **CAUTION:** Cyanogen bromide is a tear gas, so perform the test in a well-ventilated area or a fume hood.

**Catalase activity.** All acid-fast bacilli produce catalase, but the production of this enzyme decreases when the bacilli become resistant to the therapeutic agent, isoniazid. The slackening of catalase activity is correlated with a weakening of virulence for the guinea pig. It is also possible to subgroup acid-fast bacilli on the basis of their catalase activity at different temperatures and pH. At 68° C. and pH 7.0 the catalase of human and bovine tubercle bacilli is selectively inactivated. Under the same conditions, all other acid-fast species are catalase-positive.

To check the catalase activity at room temperature prepare a 1:1 mixture of 10 percent Tween 80 and 30 percent hydrogen peroxide. Add .05 ml of the mixture to the Lowenstein-Jensen slant. Bubbling indicates a positive-catalase test. To test catalase activity at 68° C. add several loopfuls of mycobacteria from a slant of 0.5 ml. of a phosphate buffer solution (pH 7.0) in a test tube. Incubate at 68° C. in a water bath for 30 minutes. Add 0.5 ml. of the tween-hydrogen peroxide mixture to the buffer-growth solution and observe for the bubbling indicative of a positive reaction.

**Arylsulfatase test.** The arylsulfatase test recorded in table 5-2 measures the ability of mycobacteria species to form the enzyme arylsulfatase. The test is particularly useful in differentiating the potential pathogens *M. fortuitum* and *M. chelonae* from other Group IV rapid growers.

The test is performed by inoculating 0.1 ml of an actively growing tween-albumin broth culture to a substrate containing 0.001M tripotassium phenolphthalein disulfate, along with known negative, weakly positive. These cultures are incubated at 35° C. for three days, and then six drops of one molar sodium carbonate are added to each tube. When detectable amounts of arylsulfatase have been produced, phenolphthalein will be split from the sulfate and detected by alkalizing with sodium carbonate. A positive

**TABLE 5-2**  
**BIOCHEMICAL PROPERTIES OF THE MYCOBACTERIA**

Species or Subgroup	Niacin Production	Nitrate Reduction		Catalase Produced (mm)			Tween Hydrolysis (Days)		Tellurite Reduction in 3 days	Pigment Formation		Growth on 5 percent NaCl	Growth in less than 7 days at 37°C	Produce Arylsulfatase enzyme +3 days	Growth on MacConkey Agar
		>1+	>3	>40	>50	68+	+5	+10		Dark	Light				
<i>M. tuberculosis</i> <i>M. bovis</i>	A E	A E	A F	A A	E E	E E	C E	C E	E E	E E	E E	E E	E E	E E	E E
				Runyon Group I (Photochromogenic) (lemon-yellow pigment)											
<i>M. kansasii</i> <i>M. marinum</i>	E E	A E	A E	A C	A D	A E	A A	A A	E E	E A	A A	E -	E D (32°)	E E	E E
				Runyon Group II (Scotochromogenic) (yellow-orange to dark red)											
<i>M. scrofulaceum</i> <i>M. aquae</i> <i>M. florescens</i>	E E E	D E A	E E B	A A A	A A A	A A A	E B A	E A A	E E E	A A A	A A A	E E C	E E E	E E E	E E E
				Runyon Group III (no pigments in light)											
<i>M. avium</i> <i>M. intracellulare</i> <i>M. xenopi</i> <i>M. gastri</i>	E E E E	F E E E	E E E E	A A A A	E E E E	A A A A	E E E A	E E E A	C B E E	E E D* E	D E D* E	E E E E	E E E E	E E C E	E E E E
				Runyon Group IV (rapid growers) (some scotochromogens)											
<i>M. fortuitum</i> <i>M. smegmatis</i> <i>M. phlei</i>	E E E	C A A	C D D	A A A	A A A	A A A	E A A	D A A	A A A	E E A	E E A	A A A	A A A	A E E	A E E

A = 85% or more  
B = 75-84%  
C = 50-4%  
D = 15-49%  
E = <15%

34

\*Percent increases with age.

reaction ranges from a faint pink ( $\pm$ ) to a light red (3+) and a negative reaction shows no color.

**Nitrate reduction test.** The nitrate reduction test is helpful in differentiating the slower-growing organisms, *M. tuberculosis* and *M. kansasii*, from members of Group II mycobacteria and the clinically significant *Mycobacterium avium* complex organisms. *M. tuberculosis* and *M. kansasii* are strong nitrate reducers, whereas members of group II mycobacteria are generally negative.

A positive reaction is noted by immediate formation of a bright red color when compared with the reagent control. A small amount of zinc dust should be added to confirm a negative test. Note that a red color, due to the reduction of nitrate by the zinc, confirms the negative test.

**Tween 80 hydrolysis.** Tween 80, a derivative of sorbitan monooleate, is hydrolyzed by certain species of mycobacteria with the production of oleic acid. This acid is indicated by a change in color from amber to pink in the presence of the pH indicator neutral red. A positive test is indicated by a color change from amber-to-pink-to red. Most strains of *M. kansasii* are positive within 5 days, whereas many strains of *M. tuberculosis* are positive in 10 to 20 days. Clinically significant Group II and Group III cultures usually remain negative for three weeks. However, the less clinically significant strains are positive within five days.

**Growth on MacConkey agar.** *M. fortuitum* and *M. chelonae* are differentiated from other Group IV rapid growers by growth on MacConkey agar in five days. On occasion, other Group IV organisms will grow within 11 days.

**Sodium chloride tolerance test.** The sodium chloride tolerance test is useful for the general separation of the rapid-growing mycobacteria (positive) from the slow-growing strains (negative), and also to aid in the identification of *M. trivale* (positive) and *M. flavescens* (sometimes positive).

**Tellurite reduction test.** The tellurite reduction tests appears to be the most valuable in the separation of the potentially pathogenic *M. avium* complex strains from the saprophytic nonphotochromogens. A solution of tellurite is added to Middlebrook 7H9 broth with ACD enrichment and Tween 80, the base medium.

Mycobacterium is inoculated to the medium and incubated at 35° C. for seven days. Two drops of a sterile 0.2 percent solution of potassium tellurite are then added to the medium, which is returned to the incubator and examined daily for reduction of the colorless tellurite salt to a black metallic tellurium or a "dirty brown" in the case of highly pigmented strains.

Tellurite will be reduced by most *M. avium* complex strains, and the majority of Group IV rapid growers in three to four days.

#### Exercises (284):

Match each of the biochemical procedures in column B with the statements in column A by placing the letter

of the column B item beside the number of the column A item that most nearly describes it. Each element in column B may be used once or more than once.

- | Column A   | Column B                           |
|--|------------------------------------|
| _____ 1 The substance in this test will be detected in the culture by a color reaction with cyanogen bromide and aniline   | a. Tween 80 hydrolysis             |
| _____ 2 If this test is positive, a yellow color will appear almost instantly.   | b. Growth on MacConkey agar        |
| _____ 3 It is also possible to subgroup acid-fast bacilli on the basis of the results obtained from this test at different temperatures and pH.  | c. Tellurite reduction test        |
| _____ 4 In this procedure, the test at room temperature requires a preparation of a 1:1 mixture of 10 percent Tween 80 and 30 percent hydrogen peroxide.   | d. Nitrate reduction test.         |
| _____ 5 This test is particularly useful in differentiating the potential pathogens <i>M. fortuitum</i> and <i>M. chelonae</i> from other Group IV rapid growers.  | e. Arylsulfatase test.             |
| _____ 6 This test is helpful in differentiating the slower-growing organisms <i>M. tuberculosis</i> and <i>M. chelonae</i> from other Group IV rapid growers.  | f. Niacin test.                    |
| _____ 7 The test is performed by inoculating 0.1 ml of an actively growing Tween-albumin broth culture to a substrate containing 0.001M tripotassium phenolphthalin disulfate, along with a known negative, weakly positive.                           | g. Sodium chloride tolerance test. |
| _____ 8 A positive reaction is noted by immediate formation of a bright red color when compared with the reagent control.  | h. Catalase activity.              |
| _____ 9 Is a derivative of sorbitan monooleate and is hydrolyzed by certain species of mycobacteria with the production of oleic acid. This acid is indicated by a change in color from amber to pink in the presence of the pH indicator neutral red. |                                    |
| _____ 10. <i>M. fortuitum</i> and <i>M. chelonae</i> are differentiated from other Group IV rapid growers by reaction on this test.  |                                    |
| _____ 11. A test useful for the general separation of the rapid-growing mycobacteria (positive) from the slow-growing strains (negative).  |                                    |

Column A

- 12. Appears to be the most valuable test in separating the potentially pathogenic *M. avium* complex strains from the saprophytic non-photochromogens.
- 13. Will show a positive reaction by most *M. avium* complex strains and the majority of group IV rapid growers in three to four days.

285. Cite the three drugs predominantly used in the chemotherapy of tuberculosis, the principle of the methods used for susceptibility testing of mycobacteria, and type of drug susceptibility testing recommended for all specimens with positive smears, the purpose of the dilution, and the methods for incubating, reading, and reporting susceptibility tests.

**Susceptibility Testing.** In most instances, newly diagnosed cases of tuberculosis will be treated with two or more of the five primary treatment drugs, isoniazid, streptomycin, p-*amino-salicylic acid*, ethambutol, and rifampin. A significant improvement in the chemotherapy of tuberculosis is due largely to the availability of two drugs—ethambutol and rifampin. These have greatly reduced the need for the use of aminosalicylic acid, which now occupies a minor role, and for streptomycin. Isoniazid, however, retains dominant status. The standard method of the Kirby-Bauer susceptibility test, in which bacterial susceptibility to a given drug is measured in terms of inhibition surrounding a disk, is not suitable for mycobacteria. This is so because the slow growth of mycobacteria permits complete dispersal of the drug in the medium.

The generally accepted methods for determining drug susceptibility of mycobacteria are based on growth on solid medium.

*Direct drug susceptibility testing.* The selection of a method, for example, direct or indirect, generally

depends on the number of bacilli seen on stained slides prepared from the digested specimen. However, the direct method is encouraged if acid-fast bacilli are seen on the smear of the digest of the clinical specimen. Dilutions are made according to the number of organisms seen on the smear under oil immersion as given in table 5-3. The dilution is necessary to provide an inoculum size that will yield at least 40 to 50 colonies on the control plate when performing drug susceptibility tests but not large enough to allow overgrowth of drug-resistant mutants. Such overgrowths can occur spontaneously in drug-susceptible populations. After dilution, the direct drug susceptibility testing may be carried out by inoculating the following media in Felsen quadrant 7H10 plates, available from commercial sources. Using sterile disposable capillary pipets, three drops (0.15 ml) of the two dilutions selected in table 5-3 are added to each quadrant. Paper disks containing appropriate concentrations of the primary antituberculous drugs are now commercially available. Disks are dispensed in the individual sectors of quadrant petri dishes as indicated in table 5-3.

*Incubation and reading.* Incubate the plates at 37° C. in an atmosphere of 5 to 10 percent CO<sub>2</sub> and read weekly for three weeks. The amount of growth should be recorded as follows:

- Innumerable to confluent growth—+++ to ++++
- Approximately 100 to 200 colonies—++
- 50 to 100 colonies: +
- Fewer than 50 colonies: actual count. Report at three weeks or earlier if clearly recognizable growth occurs on drug-containing as well as on control media.

*Reporting of drug susceptibility tests results.* Report of drug susceptibility tests should include the following information:

- a. Type of test—direct or indirect.
- b. Number of colonies on control quadrant.
- c. Number of colonies on drug quadrant.
- d. Concentration of the drug in each quadrant.

TABLE 5-3  
DILUTION OF CONCENTRATED SPECIMEN FOR INOCULA

No. of acid-fast bacilli per oil immersion field (avg. 20 fields)	Control quadrant 1	Control quadrant 2	Drug quadrant
Less than 1	Undiluted	1:100	Undiluted
1 to 10	1:10	1:1000	1:10
More than 10	1:100	1:10,000	1:100

A rough approximation of the percentage of organisms resistant to the drug may be calculated from these data as follows:

$$\frac{\text{Number of colonies on drug quadrant} \times 100}{\text{Number of colonies on control quadrant}} =$$

Percent resistance at that drug concentration.

**Exercises (285):**

1. What two drugs are primarily used in the chemotherapy of tuberculosis and which other retains the dominant status of continued usage?
2. Why is the Kirby-Bauer susceptibility test not suitable for mycobacteria?
3. The generally accepted methods for determining drug susceptibility of mycobacteria are based on growth on \_\_\_\_\_ .

4. What method of susceptibility testing is encouraged for all digested specimens with positive smears?

5. The size of the dilutions is dependent upon what factor?

6. What is the purpose of the dilution?

7. What type of plates are inoculated?

8. At what temperature and atmospheric conditions are the plates incubated? How often are they read?

9. What would you record if you observed 50 to 100 colonies?

10. The report of drug susceptibility tests should include what information?



## The Spirochetes

TRADITIONALLY, THE TERM "spirochete" embraces a host of slender, flexible, filamentous, corkscrewlike organisms distributed widely in water, soil, plants, animals, and man. Most of these bacteria are saprophytes, but a few are pathogenic. Those pathogenic for man cause such diseases as yaws, relapsing fever, syphilis, and certain hemorrhagic disorders.

Spirochetes were among the earliest microorganisms to be seen. Van Leeuwenhoek, soon after his invention of the light microscope, saw and described various types of spirochetes from his own mouth and gums. The first spirochete associated with a specific disease was *Borrelia recurrentis*, discovered in the blood of a patient with relapsing fever around 1873. The causative agent of syphilis, *Treponema pallidum*, was not described until about 1905, although the disease had been recognized clinically since the time of Columbus' voyage to America.

The true spirochetes belong to the order Spirochaetales, whose subordinate taxonomic groups are shown in the following classification scheme from the 8th Edition of *Bergey's Manual*.

Three genera included in the order Spirochaetales are pathogenic for man:

### PART 5 SPIROCHETES

Order: Spirochaetales

Family I. Spirochaetaceae

Genus III. *Treponema*

Species. *pallidum*, *pertenue*, *microdentium*

Genus IV. *Borrelia*

Species. *recurrentis*, *vincentii*

Genus V. *Leptospira*

Species. *icterohemorrhagiae*, *canicola*, *pomona*

### 6-1. General Characteristics of the Family Spirochaetaceae

There are five genera of the family Spirochaetaceae of which *Treponema*, *Borrelia*, and *Leptospira* species cause major human illnesses. Differentiation among genera of the family Spirochaetaceae is based primarily on morphology. However, other differentiation properties are staining characteristics, oxygen requirements, and cellular motility. Multiplication for all five genera is by transverse fission.

286. Indicate whether given statements correctly reflect morphological characteristics of members of the family Spirochaetaceae, growth requirements, methods of staining, and a method used for identification.

**Morphology and General Characteristics.** The members of the family Spirochaetaceae take the form of slender spirals. They range from 3 to 500  $\mu\text{m}$  long and 0.2 to 0.75  $\mu\text{m}$  wide. They are helically coiled organisms and consist of a protoplasmic cylinder intertwined with one or more axial fibrils; both of these are enclosed in an outer envelope. Even though they are gram-negative, only *Borrelia* stains well with aniline dyes.

Giemsa or silver impregnation are best for staining. In figure 6-1, note the typical morphological differences of each genus. Cellular motility includes rapid rotation around the long axis, flexation of cells, and locomotion along a helical path. Spirochaetaceae may be aerobic, facultatively anaerobic or anaerobic. Many are recognized by darkfield microscopy, since they may be below the resolution of light microscopy.

### Exercises (286):

Indicate whether each of the given statements is true (T) or false (F) and correct those that are false.

- T F 1. The members of the family Spirochaetaceae take the form of slender spirals.
- T F 2. Members show bizarre pleomorphism, with spheroid swellings along irregularly stained filaments and free round bodies.
- T F 3. Even though members of family Spirochaetaceae are gram-positive, only *Borrelia* stain well with aniline dyes.
- T F 4. Acid fast and flagella stains are best for staining the members of this family.

### BORRELIA

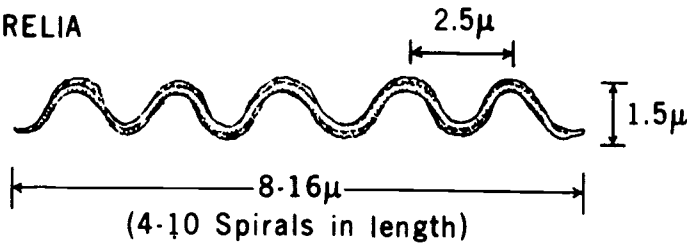

Length 8-16 $\mu$   
Amplitude 1.5 $\mu$   
Spiral length 2.5 $\mu$

### TREPONEMA

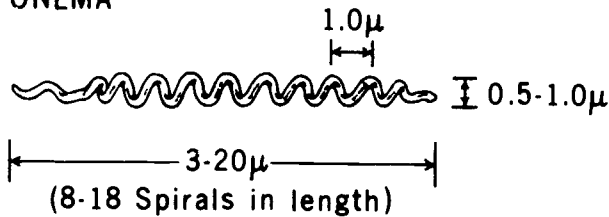

Length 3-18 $\mu$   
Amplitude 0.5-1.0 $\mu$   
Spiral length 1.0 $\mu$

### LEPTOSPIRA

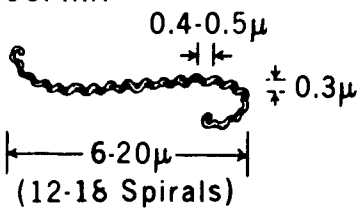

Length 6-20 $\mu$   
Amplitude 0.3 $\mu$   
Spiral length 0.4-0.5 $\mu$

Figure 6-1. Major shapes of spirochetes.

- T F 5. Spirochaetaceae may be considered to be strictly facultatively anaerobic.
- T F 6. Many are recognized by phase microscopy since they are below the resolution of light microscopy.

#### 6-2. The Genus *Borrelia*

Spirochetes of the genus *Borrelia* cause relapsing fever in man. This is an acute infection characterized by febrile episodes that subside spontaneously but tend to recur over a period of weeks. Ticks and lice transmit the organisms. The disease is described by other terms such as "tick fever," "borreliosis," and "famine fever."

*Borrelia* may be separated from other members of the Spirochaetaceae by their characteristic morphology as revealed by the electron microscope. The current classification of *Borrelia* is based on the arthropod vector.

**287. Point out the clinical significance of the Spirochetes of *Borrelia* in terms of the disease caused, the effect of the organisms upon given organs of the body, means of transmission, and the principal species found in the United States.**

**Clinical Significance.** Spirochetes of *Borrelia* are the causative agents of an acute febrile illness in man, relapsing fever, which is transmitted by an infected arthropod. Relapsing fever is a severe febrile systemic illness with a rapid onset after an incubation period of 2 to 15 days. After 3 to 7 days of fever, an afebrile interval of several days to several weeks follows. A relapse then occurs as a result of antigenic variation. After 3 to 7 days when the fever subsides, the number of organisms in the bloodstream decreases. Organisms may cause multiple lesions in the spleen, liver, kidney, and gastrointestinal tract. *Borrelia recurrentis* is the only species transmitted by lice. This is presently confined primarily to Eastern Africa. There are nine species of *Borrelia* transmitted by ticks, each of which is named after the species of *Ornithodoros* tick transmitting the infection.

The principal species found in the United States are *B. hermsii*, *B. parkei*, and *B. turicatae*.

**Exercises (287):**

1. What disease is caused by *Borrelia spp*?
2. The organisms may cause multiple lesions in what organs of the body?
3. Which species of *Borrelia* is the only one transmitted by lice?
4. The principal species of *Borrelia* transmitted by ticks found in the United States are *B.* \_\_\_\_\_, *B.* \_\_\_\_\_, and *B.* \_\_\_\_\_.

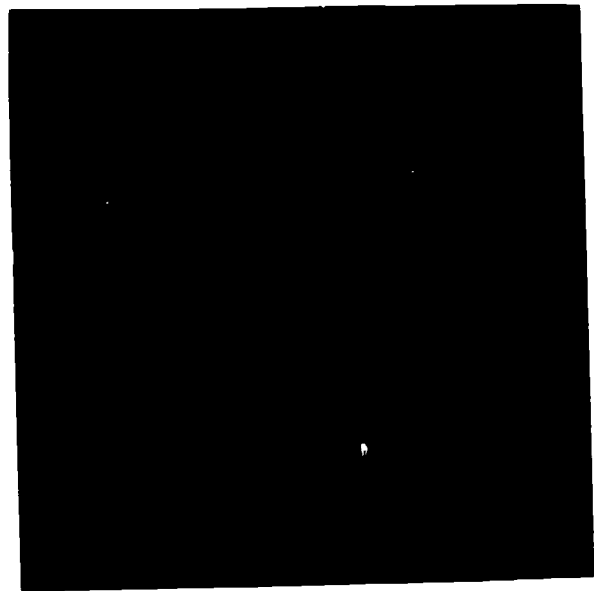

Figure 6-2. Photomicrograph of *Borrelia* under darkfield.

**288. Indicate whether given statements correctly reflect morphological and physiological characteristics of *Borrelia spp*.**

**Morphology and Physiology.** Morphologically, this spirochete is a spiral thread measuring 0.2 to 0.5  $\mu\text{m}$  in width and 8 to 16  $\mu\text{m}$  in length. It may possess from four to ten spirals, with most cells showing around five. Spirals are large and wavy with a distance of approximately 2.5  $\mu\text{m}$  between them. Amplitude is about 1.5  $\mu\text{m}$  as we have shown in figure 6-1. Occasionally, axial terminal filaments are seen, and these may give the appearance of flagella. The spirochetes can be stained with the Gram stain, in which they appear gram-negative. The Romanowsky modification or Giemsa stain which stains the organism purple can also be used. The mechanics of staining cause some distortion and straightening of the spirals, and experience must be gained if this manner of generic identification is to be relied upon.

For best results in viewing morphology, a direct wet preparation is used. Note, for example, the darkfield micrograph in figure 6-2. Under these conditions, the actively motile spirochetes have a corkscrew movement along with lateral oscillation (side-to-side). The motion is not necessarily directional, and the organism may be seen to move back and forth.

**Exercises (288):**

Indicate whether each of the following statements is true (T) or false (F) and correct those that are false.

- T F 1. The spirochete of *Borrelia spp.* may possess from four to ten spirals, with most cells showing around five.

- T F 2. Spirals are small and wavy with a distance of approximately 1.5  $\mu\text{m}$  between them.

- T F 3. The spirochetes can be stained with the Gram stain, in which they appear gram-positive.

- T F 4. Giemsa stain can be used.

- T F 5. Actively motile spirochetes have a corkscrew movement along with lateral oscillation.

- T F 6. The motion is usually directional, and the organism is seen to move steadily along.

**289. Cite the contents of media used for culture of *Borrelia*, cultural characteristics, method of culture, and the methods of laboratory identification.**

**Culture and Laboratory Identification.** The spirochetes of *Borrelia* can be artificially cultured in media containing blood, serum, or tissue, but it rapidly loses

its pathogenicity for animals when transferred repeatedly in vitro. *Borrelia* are strict anaerobes. Tubes of borrelia culture medium are inoculated with 0.1 ml of citrated blood and incubated at 35° C. At two-day intervals, a drop of medium is removed and examined by darkfield microscopy for the presence of organisms. Laboratory diagnosis is based, however, on finding the spirochetes in the blood during a period of fever. In a freshly collected specimen the organisms are actively motile under darkfield illumination. Since identification in the direct preparation is often difficult, a stained blood smear provides the opportunity for further study. Figure 6-3 permits a size comparison between the spirochete and surrounding red cells.

For animal inoculation, young mice are inoculated via the intraperitoneal route with 1 ml of blood. At daily intervals the tail is snipped and the blood is examined by darkfield microscopy or stained smears.

#### Exercises (289):

1. The spirochetes of *Borrelia* can be artificially cultured in media containing which constituents?
2. Under what growth environment is *Borrelia* expected to survive?
3. Tubes of borrelia culture media are inoculated with what quantity of citrated blood and incubated at what temperature?
4. What quantity and how often is the medium examined for the presence of the spirochetes?
5. What method of microscopic examination is primarily used for the identification of *Borrelia spp*?
6. What are three sources of specimen for examination by the microscopic examination?

#### 6-3. The Genus *Treponema*.

The 8th Edition of *Bergey's Manual* lists 11 species of the genus, *Treponema*. The species in this genus comprise two major groups. They are (1) those normally present in the mouth, urogenital tract, and gastrointestinal tract of humans and animals; and (2) the several pathogenic species. In the former group are



Figure 6-3 Photomicrograph of *Borrelia* in rat blood.

found *T. Macrodentium* and *T. orale* from the oral cavity, *T. refringens*, from the genital area. In the latter group are *T. pallidum*, the causative agent of syphilis, *T. pertenuis*, and *T. carateum*, the etiological agents respectively of yaws and pinta. These organisms are morphologically and serologically indistinguishable from *T. pallidum*.

**290. Specify the disease caused by *Treponema vincentii*, morphological and staining characteristics, method of laboratory identification, and organisms mistakenly identified as *Treponema vincentii*.**

*Treponema Vincentii* (Older Name Was *Borrelia Vincentii*). *Treponema vincentii* and *Bacteriodes melaninogenicus* have been thought to be involved in a fusospirochetal disease (caused by both fusiform bacteria and spirochetes). It is commonly referred to as Vincent's angina or trench mouth. The disease was prevalent among the infantry during World War I. *T. vincentii* is an active motile spirochete. Individual cells are approximately 7.0 to 12.0  $\mu\text{m}$  in length with 3 to 8 spirals. The organism stains gram-negative.

To identify *Treponema vincentii* as the causative agent of Vincent's angina, it is necessary to find the spirochete. In positive cases, you will also find fusiform bacilli (*Bacteriodes melaninogenicus*) on the same stained slide. *Bacteriodes melaninogenicus* are gram-negative fusiform bacilli appearing as long or short, slender, curved rods with pointed ends. Occasionally, they appear as long filaments. They occur singly or in pairs attached end-to-end as a result of incomplete fission. Size varies from 0.30 to 0.9  $\mu\text{m}$  in width and 3 to 12  $\mu\text{m}$  in length.

*Treponema vincentii* can be stained by Loeffler's methylene blue, carbol-fuchsin, Giemsa stain, Wright's stain, or the Gram stain. Smears from the deeper parts of the throat lesions or buccal ulcer most often show the spirochetes. The combination of fusiform bacilli and spirochetes seen on a Gram-stained smear made from typical lesions is good evidence that *Treponema vincentii* is the causative agent. There are many spirochetes which exist as part of the normal flora of the mouth, however. Spirochetes such as *Treponema microdentium* and *Treponema mucosum* can be mistakenly identified as *Treponema vincentii*. Therefore, the association of fusiform bacilli with the spirochetes is an important element in correct identification.

**Exercises (290):**

1. What are fusospirochetal diseases?
2. What is the disease caused by *Treponema vincentii*?
3. What fusiform bacilli is observed in positive cases of *Treponema vincentii* infections?
4. How do the spirals of *T. vincentii* appear in terms of size and number of spirals?
5. What stains can be used for staining *T. vincentii*?
6. Using the Gram staining technique, how does *T. vincentii* appear?
7. Smears for examination and staining may be obtained from what body sources?
8. What observation made of the slide is good evidence that *T. vincentii* is the causative agent of the disease?
9. What other two spirochetes can be mistakenly identified as *T. vincentii*?

**291. Cite the clinical significance of *Treponema pallidum* in terms of the disease caused, manner of transmission, and certain characteristics of the disease.**

***Treponema Pallidum*—Clinical Significance.** *Treponema pallidum* (pale thread) is the etiologic agent of syphilis, a highly contagious disease transmitted from person-to-person through intimate contact, usually sexual. Infections may be transmitted occasionally through indirect means such as fomites (drinking cups, towels), but only when the time interval between contamination of the article and its subsequent contact with an individual is very short. For this reason, fomites used by persons with open, infective lesions should be considered highly contagious.

*Treponema pallidum* enters the skin or mucous membranes through minute breaks. The spirochetes remain for a time at the site of infection and multiply. The characteristic inflammatory response known as the chancre follows. This stage is referred to as primary syphilis, and the chancre forms within 10 to 90 days after infection. The chancre lasts from 1 to 3 weeks and may heal spontaneously. Primary syphilis is generally diagnosed by darkfield microscopic detection of *Treponema pallidum*, although a positive serologic test for syphilis will occasionally be obtained in this stage of the disease.

Within 2 to 12 weeks after the primary chancre heals, a generalized skin rash usually appears. This stage of the disease is referred to as secondary syphilis. Symptoms usually disappear within about three weeks and, in untreated cases, may reappear one or more times as relapses. In secondary syphilis, the characteristic skin lesions contain *Treponema pallidum*. An increasingly positive serologic test is the rule. The subsequent latent stage of syphilis is usually shown by a persistently positive reaction in serologic tests. Late symptomatic syphilis, which can be expected to follow the latent period in untreated cases, can also be detected by reactive serologic tests.

**Exercises (291):**

1. What disease is caused by *Treponema pallidum*?
2. How is syphilis transmitted?
3. How does *Treponema pallidum* enter the skin or mucous membranes?
4. During which of the three stages of syphilis does the chancre usually first appear?

5. During the secondary stage of syphilis, where may the spirochetes of *T. pallidum* be isolated?

**292. Specify the morphological appearance of *Treponema pallidum*, the reason for the difficulty encountered using the Gram staining technique, other methods of satisfactory staining, the survival techniques used for these organisms, and its application and conditions for laboratory diagnosis.**

**Morphology.** The spirochetes of *Treponema pallidum* occur as very fine, delicate spiral forms having a flexible cylindrical body measuring approximately 0.25  $\mu\text{m}$  in diameter and 5 to 16  $\mu\text{m}$  in length. The spiral height (amplitude) is approximately 1.0  $\mu\text{m}$ . The organism possesses from 8 to 15 regular spirals. Figure 6-4 is a photomicrograph of two spirochetes of *T. pallidum*. Motility is generally slow, although the cell rotates rapidly on its axis. During the rotational process, the organism bends to form circular as well as S shapes. In the material aspirated from the lesion of early syphilis, the cell tends to be elongated (like an overstretched spring) and movement is more snake-like. This is due to the greater density of the fluid caused by mucus present in the lesion.

**Staining.** Staining of *Treponema pallidum* by the Gram technique is usually unsuccessful. Although the organism may take the dye, the amount of protoplasm available for staining is so small that the necessary visual contrast is lacking. Staining can be accomplished satisfactorily, however, by using special techniques such as the silver impregnation method of Levaditi, or one of its several modifications. This technique is based on the coating of the surface of the treponeme with metallic silver to increase contrast. In the Fontana-Tribondeau method the cell surface is coated with reduced silver nitrate. In figure 6-5, we see stained spirochetes typical of *T. pallidum*. In the absence of silver impregnation materials, the nigrosin or India ink preparations can be used. These dyes do not stain the treponeme, but instead provide a black background in which the organisms stand out in relief. Recently, fluorescent-antibody techniques have been used with some success.

The organism can also be demonstrated in smears or frozen sections by immunofluorescence using specific fluorescein-conjugated antisera.

**Growth.** The pathogenic treponemes have not been cultivated in the laboratory. Only saprophytic, non-pathogenic treponemes are cultivatable. They are anaerobic, ferment glucose or amino acids, and require serum bovine albumin or volatile fatty acids for growth. As indicated, pathogenic treponemes cannot be grown in vitro but will survive for several days under anaerobic conditions in media containing bovine serum ultrafiltrate, pyruvate, albumin, and a

sulphydryl compound. The basis of the *Treponema pallidum* inhibition test for serodiagnosis of syphilis is dependent upon the use of in vitro survival of organisms in suspension prepared from infected rabbits, incubated with serum and complement. Laboratory diagnosis must therefore be based on staining fluorescent antibody techniques, serological reactions, and the darkfield examination.

**Exercises (292):**

1. Briefly describe the morphological appearance of *Treponema pallidum*.
2. In early syphilis, when the spirochete tends to be elongated like an overstretched spring and movement is more snakelike. What factor is probably responsible for this condition?
3. Why is the spirochete of *Treponema pallidum* difficult to stain with Gram stain?
4. Staining may be accomplished satisfactorily by what other technique using what principle?
5. What other technique may be used to increase surface contrast?
6. The organism can also be demonstrated in smears or frozen sections by immunofluorescence using what technique?
7. The pathogenic treponemes have been cultivated by what technique?
8. Pathogenic treponemes will survive for several days under anaerobic conditions in media containing what substances?
9. What test is based upon the use of in vitro survival of organisms in suspension?
10. The suspension is prepared in what manner?





314

Figure 6-4. Photomicrograph of *T. Pallidum* (two organisms).

11. Laboratory diagnosis is based upon which techniques?

293. Specify the purpose of the darkfield condenser, the purpose of proven patient preparation prior to performing a darkfield examination, techniques in collecting specimens, and the value of the darkfield in the diagnosis of syphilis.

**Darkfield Technique for *T. Pallidum*.** Let's take a look at the darkfield technique that is employed during first examination of the syphilitic lesion. Most of the microscopy you have done has been with "brightfield" illumination. This form of microscopy was covered in detail in CDC 90411, Chemistry and Urinalysis. A cutaway of a conventional binocular microscope showing the light path is illustrated in figure 6-6. The inset is a closer view of the condenser area. In the darkfield setup, we replace the standard microscope condenser with a special darkfield condenser to provide oblique rather than direct lighting of the specimen.

In brightfield microscopy, the substage condenser provides a solid cone of light that is concentrated on the specimen, as we see in figure 6-7,A. In "darkfield illumination," (fig. 6-7,B) the cone of light is hollow, leaving a dark central area. It is this darkened center that we see when we look through the microscope. Thus, the darkfield condenser provides scattered light that reflects off any object in the darkened field, giving us bright objects against a black background. In most laboratories that perform the darkfield examination, one microscope adapted for this procedure with special condenser and objective lenses is set aside for the purpose.

Collecting material from a syphilitic lesion for darkfield study must be done carefully. First, you must clean the lesion of surface crust, detritus and pus, with gauze or a cotton applicator. If the patient has treated his lesion with a germicidal agent, examination is deferred until all germicide has been removed by washing and several hours have elapsed. Primary lesions are then mildly traumatized to provoke a serum exudate. We do this by gently rolling the lesion between the gloved finger and thumb or by rubbing its surface with a dry cotton applicator. Hemorrhage should be avoided, although a few erythrocytes or pus cells are desirable to aid in obtaining a proper focus. Secondary lesions are merely cleansed with a saline gauze and abraded.

Fresh preparations for microscopic examination are made from accessible lesions by touching the slide to tissue juice and immediately placing the cover glass over the drop of fluid. Petroleum jelly placed around the edge of the cover slip will prevent drying. If the lesion is less accessible, the fluid may be collected in



Figure 6-5. Stained smear of *T. Pallidum* in tissue exudate.

a capillary pipette and placed on the slide. Examine immediately with the darkfield microscope for the characteristic morphology and motility of *T. pallidum*, seen in figure 6-8.

There are many saprophytic spirochetes that are not easily distinguished from *T. pallidum*. A diagnosis of syphilis based solely on the darkfield examination, especially of material from the oral cavity, is not valid because of the variety of saprophytic spirochetes present. Moreover, "artifact spirochetes" are sometimes mistaken for *T. pallidum* by those unfamiliar with the appearance of blood, pus, tissue cells, and bacteria under darkfield illumination. Wavy, filamentous structures may actually simulate spirochetes. The physician uses the result of this microscopic examination as only one factor in arriving at a correct diagnosis.

#### Exercises (293):

1. How does the darkfield condenser provide the darkfield illumination?
2. Why is proper patient preparation necessary prior to performing a darkfield examination?
3. Why are primary lesions mildly traumatized in the collection of the specimen for darkfield examination?
4. Why is a diagnosis of syphilis based solely on the darkfield examination not valid especially of the oral cavity?

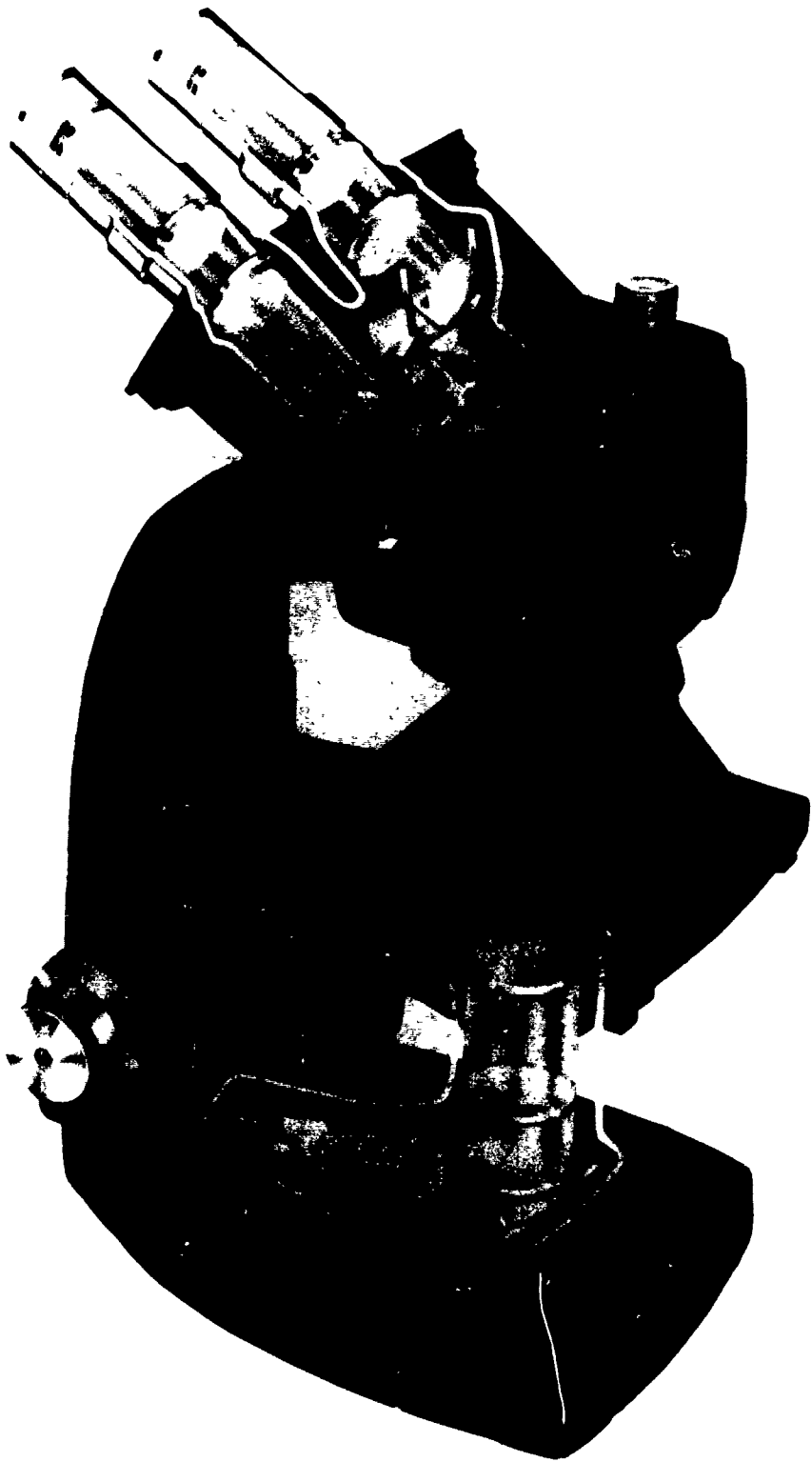
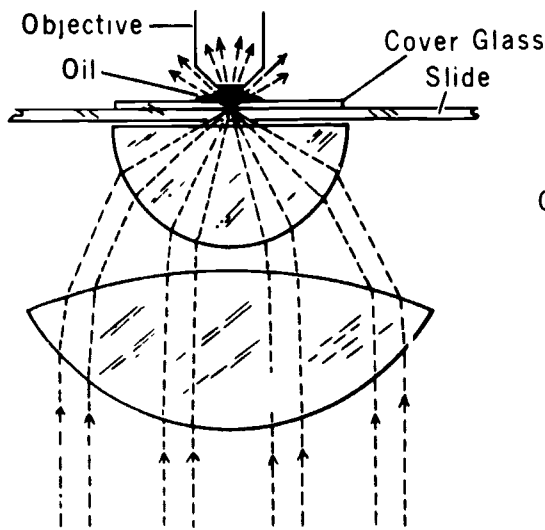
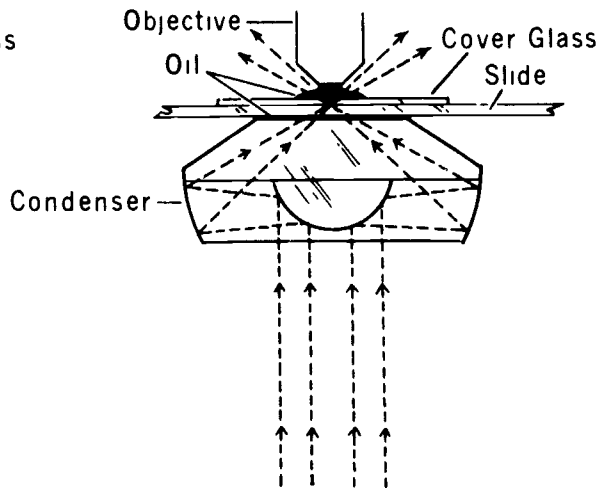

Figure 6-6. Binocular microscope — cutaway view. (Courtesy Bausch & Lomb, Rochester, New York)



BRIGHT FIELD

**A** ABBÉ CONDENSER



DARK FIELD

**B** CARDIOID CONDENSER

Figure 6-7. Brightfield versus darkfield condenser system

**6-4. Genus Leptospira**

Two species, *Leptospira interrogans* and *Leptospira biflexa*, were proposed by the *Leptospira* subcommittee in 1973. *L. interrogans* includes all pathogenic leptospire, whereas *L. biflexa* includes the saprophytic or water leptospira that commonly occur in fresh, surface waters. *Leptospira interrogans*, with many serotypes, include those encountered in the United States such as *icterohemorrhagiae*, *canicola*, *ballum*, *grippityphosa*, *bataviae*, *autumnalis*, and *pomona*.

**294. Point out the clinical significance of Leptospirosis in terms of the disease condition, means of transmission, and organs affected, and cite other leptospiral organisms and their sources.**

**Clinical Significance.** Leptospirosis is an acute illness associated with febrile jaundice and nephritis. It was first recognized by Weil in 1886 as a clinical entity distinct from other icteric fevers. Referred to as "Weil's disease," the infection is caused by a leptospira transmitted to man from infected rodents. The principal sources of leptospiral infecting humans are urine and tissues of infected animals. The usual sequence of events begins when a person becomes infected through skin contact with urine from an infected animal or by exposure to urine-contaminated water or soil. The organisms enter the blood and then invade various tissues and organs, particularly the kidney, liver, meninges, and conjunctiva. One serotype, *icterohemorrhagiae*, causes a more severe illness referred to as Weil's disease or infectious jaundice, and the fatality

rate from Weil's disease may run as high as 25 percent.

Leptospirosis in humans is primarily associated with occupational exposure. Work with animals or in rat-infested surroundings poses infection hazards. These may include such workers as veterinarians, dairymen, swineherds, abattoir workers, miners, and fish and poultry processors. All pathogenic species of leptospira are placed in one species, *Leptospira interrogans*, containing many serotypes. Those serotypes encountered in the United States include *icterohemorrhagiae*, *canicola*, *ballum*, *grippityphosa*, *bataviae*, *autumnalis*, and *pomona*. Certain serotypes are routinely associated with specific hosts. For example, *icterohemorrhagiae* with rodents, *canicola* with dogs, *pomona* with pigs, and *autumnalis* and *grippityphosa* with mice; however, cross infections do occur.



Figure 6-8. Darkfield of *T. Pallidum*.

**Exercises (294):**

1. What condition is associated with Leptospirosis?
2. How is the disease transmitted to man?
3. After the organisms enter the blood, what tissues and organs are affected?
4. What serotype causes a more severe illness referred to as Weil's disease?
5. All pathogenic species of leptospira are classified as what species?

**295. Cite morphological characteristics peculiar to the spirochete of *Leptospira*, cultural and growth requirements, media used, and cultural appearance on given media.**

**Morphology.** The species of *Leptospira* are thin, flexible, tightly coiled organisms. The spirochetes measure approximately  $0.15\ \mu\text{m}$  in diameter, with a length ranging from  $7.0$  to  $20.0\ \mu\text{m}$ . There are generally 12 to 18 spirals in each cell, with each spiral having a height of about  $0.4$  to  $0.5\ \mu\text{m}$ . One characteristic peculiar to most of the leptospira is that the terminal third of the organism is quite flexible and is often seen in the form of a hook (see fig. 6-9). The hook may be on one end or both. If on both ends, the hooks may be bent in the same direction or in opposite directions, as we find in figure 6-10.

In darkfield, the organism is actively motile with a progressive undulating movement, and it displays rapid spinning around its long axis. *L. icterohemorrhagiae* cannot be easily stained by routine procedures. One of the silver impregnation methods works well, however, in trained hands. These methods may be of value when cultural and serological procedures are not possible.

**Growth and Cultural Characteristics.** Culturally, the leptospiral forms are aerobic and grow best at an optimal temperature of  $30^\circ\text{C}$ . Serotype *icterohemorrhagiae* and some of the other species can be easily cultivated in a liquid medium containing 10 percent rabbit serum or serum albumin plus fatty acids at pH 6.8 to 7.8. The incubation time for optimal growth ranges from a few days to four weeks or longer, but

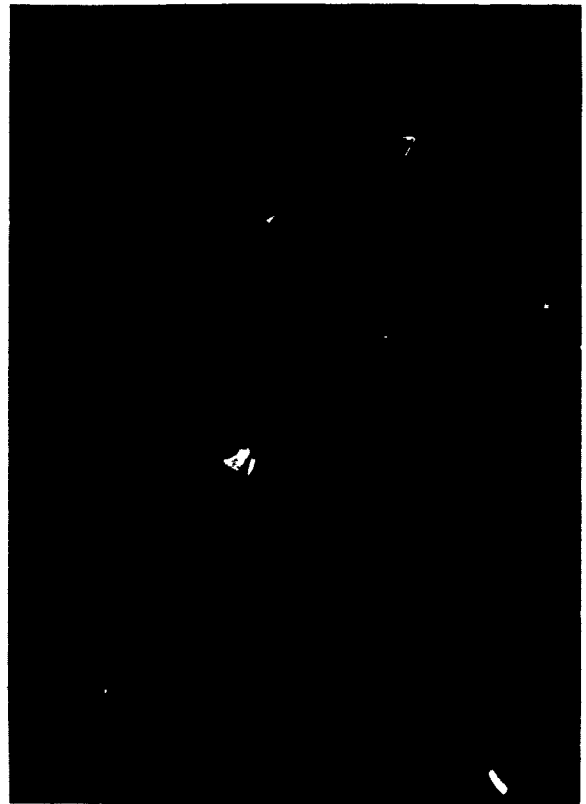

Figure 6-9. Electron photo of *Leptospira*.

usually 6 to 14 days. Fletcher's semisolid and Stuart's liquid media containing rabbit serum will grow most strains of leptospires. Colonies on the surface of agar plates are rarely seen. Fluid media inoculated with leptospires become faintly turbid.

**Exercises (295):**

1. What is the major morphological characteristic peculiar to the spirochete of *Leptospira*?
2. How does the spirochete appear in darkfield?
3. What type of environmental condition is required for growth of *Leptospira* and at what optimal temperature?
4. Serotype *icterohemorrhagiae* and some other species can be easily cultivated in a liquid medium containing what substances?

5. What is the incubation time required for optimal growth.
6. Fluid media inoculated with leptospires show what appearance?

**296. Point out the methods used for laboratory identification of *Leptospira*, specimens required for culture, and serological techniques used for detection of leptospiral antibodies.**

**Laboratory Identification.** The observation of *Leptospira* in a darkfield examination of blood would provide strong support; however, unequivocal diagnosis requires that the organisms be grown and identified as *Leptospira* by serological methods. The bacteria can be isolated early in the disease by culturing the patient's blood or urine and by animal inoculation (guinea pigs or hamsters). Antibodies may be detected in the patient's serum within a week after the onset of disease. Various serological techniques have been used including the microscopic agglutination-lysis test, the genus-specific hemagglutination test, and the fluorescent-antibody test. Specialized sera, not normally available in the diagnostic laboratory, are required for identification of specific serotypes. The most useful strain-specific serologic test is the microscopic agglutination test (agglutination-lysis). This test was the original method for determining antibody response to leptospirosis and remains the reference method.

**Exercises (296):**

1. Unequivocal diagnosis requires that Leptospiral organisms be grown and identified by which methods?



Figure 6-10. *Leptospira* as viewed with darkfield.

2. What specimens are required for culture of *L. icterohemorrhagiae*?
3. How soon after the onset of the disease is the antibody detected in the patients serum?
4. What serological techniques have been used for detection of leptospiral antibodies?
5. Which of the serological techniques is considered to be the most useful strain specific?



## Bibliography

### Books

- Bauer, John D., Phillip G. Ackerman, and Gelson Toro. *Clinical Laboratory Methods*, 8th Ed. St. Louis: C.V. Mosby Co., 1971.
- Buchanan, R.E., and N.E. Gibbons. *Determinative Bacteriology*, 8th Ed. Baltimore: The Williams & Wilkins Co., 1974.
- Burrows, William. *Textbook of Microbiology*, 20th Ed. Philadelphia: W.B. Saunders Co., 1973.
- Cruickshank, Roert, J.P. Duguid, B.P. Marmion and R.H. A. Swain. *Medical Microbiology*, 12th Ed. Vol. 1., Edinburgh and London: Churchill Livingstone, 1973.
- Frobisher, Martin, R.D. Hinsdill, K.T. Crabtree, and C.R. Goodheart. *Fundamentals of Microbiology*, 9th Ed. Philadelphia: W.B. Saunders Co., 1974.
- Finegold, Sydney M., William J. Martin and Elvyn G. Scott. *Bailey and Scott's Diagnostic Microbiology*, 5th Ed. St. Louis: The C.V. Mosby Co., 1978.
- Holt, John G. *The Shorter Bergey's Manual of Determinative Bacteriology*, 8th Ed. Baltimore: The Williams & Wilkins Co., 1977.
- Jawetz, Ernest, J.L. Melnick, and E.A. Adelberg. *Review of Medical Microbiology*, 12 Ed. Los Altos, Calif.: Lang Medical Publications, 1976.
- Joklik, Wolfgang K. and Hilda P. Willett. *Zinsser Microbiology*, 16 Ed. New York: Appleton-Century-Crofts, 1976.
- Lennette, Edwin H., Earle H. Spaulding, and Joseph P. Truant. *Manual of Clinical Microbiology*, 2nd Ed. Washington, D.C.: American Society for Microbiology, 1974.
- Prier, James E., J.T. Bartola, and H. Friedman. *Quality Control in Microbiology*, Baltimore: University Park Press, 1975.
- Prier, James E., Josephine T. Bartola and Herman Friedman. *Modern Methods in Microbiology Systems and Trends*, Baltimore: University Park Press, 1976.
- Ravel, Richard. *Clinical Laboratory Medicine*, 3rd Ed., Chicago: Year Book Medical Publishers, Inc., 1978.
- Turk, D.C. and I.A. Porter. *A Short Textbook of Medical Microbiology*. 3rd Ed. Chicago: Year Book Medical Publishers, Inc., 1973.
- Volk, Wesley A. *Essentials of Medical Microbiology*, Philadelphia: J.B. Lippincott Company, 1978.

### Periodicals

- Criteria and Techniques for the Diagnosis of Gonorrhoea*, U.S. Department of Health, Education and Welfare, Washington, D.C.: Government Printing Office, 1972.
- Laboratory Methods in Clinical Bacteriology*, U.S. Department of Health, Education and Welfare. Washington, D.C.: U.S. Government Printing Office, 1977.
- Dowell, V.R. and T.M. Hawkins, *Laboratory Methods in Anaerobic Bacteriology*, U.S. Department of Health, Education, and Welfare, Washington, D.C.: U.S. Government Printing Office, 1974.

- Ewing, W.H. and B.R. Davis, *Media and Test for Differentiation of Enterobacteriaceae*, U.S. Department of Health, Education, and Welfare, Washington, D.C.: U.S. Government Printing Office, 1973.
- Huffaker, Robert H., *Collection, Handling & Shipment of Microbiological Specimens*, U.S. Department of Health, Education, and Welfare, Washington, D.C.: U.S. Government Printing Office, 1974.
- King, Elizabeth O., *The Identification of Unusual Pathogenic Gram Negative Bacteria*, U.S. Department of Health, Education and Welfare, Public Health Service, Atlanta: Center for Disease Control, 1977.
- Rohde, Paul A., *BBL Manual of Products and Laboratory Procedures*, 5th Ed. Baltimore: Becton, Dickinson and Co., 1973.

#### **Pamphlet**

- Agarmatic-Agar Sterilizer*, New Brunswick Scientific Co., Inc., Edison, N.J. 1977.
- API 20 Anaerobic System*, Analytab Products Inc., Carl Place, N.Y. 1977.
- Eliner, Paul D., Paul A. Granato and Carolyn B. May. *Improved Anaerobic Methods for the Diagnostic Laboratory*, Diagnostic Microbiology Service, Columbia-Presbyterian Medical Center; and the Department of Microbiology, College of Physicians and Surgeons, Columbia University, New York, N.Y., 1977.
- Quadri, Hussain S.M., and R.R. Wende. *A Single-Blood Culture System: Evaluation and Comparison With Two Other Systems*, Canadian Journal of Microbiology, Vol. 23, No. 8, 1977.

## ANSWERS FOR EXERCISES

### CHAPTER I

**Reference:**

- 200 - 1. The nose and nasopharynx.  
 200 - 2. The skin, subcutaneous tissues, and lungs.  
 200 - 3. Their normal host defenses are badly impaired; they are debilitated patients who have been subjected to extensive surgery or who have serious underlying diseases.  
 200 - 4. Hospital personnel and patients.  
 200 - 5. Direct person-to-person.  
 200 - 6. *S. aureus*.  
 200 - 7. Ingesting food that contains significant amounts of the heat stable exotoxin produced by *Staphylococcus aureus*. The toxin is rapidly absorbed by the intestinal mucosa, resulting in acute symptoms.  
 200 - 8. Micrococcaceae.
- 201 - 1. a. Anaerobic growth and fermentation of glucose;  
 b. Structural content of the cell wall;  
 c. The percentage of guanine plus cytosine content of the DNA.  
 201 - 2. *S. aureus*, *S. epidermidis* and *S. saprophyticus*.  
 201 - 3. Coagulase production.  
 201 - 4. It is a variable trait and thus not reliable.
- 202 - 1. Facultative anaerobe.  
 202 - 2. Aerobic.  
 202 - 3. 30° to 37° C.  
 202 - 4. Uracil and pyruvate (or acetate).  
 202 - 5. On agar plates at 37° C. for 24 hours, followed by incubation at room temperature for an additional 24 to 48 hours.  
 202 - 6. None.  
 202 - 7. More.  
 202 - 8. Carotenoid.  
 202 - 9. Singly, in pairs, and short chains.  
 202 - 10. Solid medium.  
 202 - 11. Short chains and diplococcal forms that are common to and resembling pneumococci.  
 202 - 12. Capsule; slime layer.
- 203 - 1. Colonial appearance, microscopic morphology, catalase production, coagulase production, and mannitol and glucose fermentation.  
 203 - 2. The action of catalase liberating oxygen from the peroxide.  
 203 - 3. The enzyme catalase is present in red blood cells and the carry-over of blood cells with the colony can give a false-positive reaction.  
 203 - 4. The coagulase tube test.  
 203 - 5. Coagulase; it clots rabbit and human plasma.  
 203 - 6. 0.5 ml of citrated plasma, undiluted or a 1:4 dilution.  
 203 - 7. A positive test.  
 203 - 8. Staphylokinase is an enzyme produced by some staphylococci and has the ability to dissolve clots.  
 203 - 9. The enzyme staphylokinase, if present, could dissolve the clot, resulting in a false-negative reaction.
- 203 - 10. *Pseudomonas* and citrate utilizing enterococci.  
 203 - 11. Bound coagulase.  
 203 - 12. Some strains of *S. aureus* may be negative by the slide test.  
 203 - 13. A high concentration of sodium chloride in Mannitol Salt Agar is inhibitory to most organisms.  
 203 - 14. Gelatin liquefaction; acetyl methyl carbinol production; carbohydrate fermentation; reaction in litmus milk.
- 204 - 1. F. Occurs singly, in pairs, threes, or in tetrads.  
 204 - 2. F. One strain of *Micrococcus* will sometimes show tetrads.  
 204 - 3. F. *Planococcus*.  
 204 - 4. T.  
 204 - 5. T.  
 204 - 6. T.  
 204 - 7. F. The ability to form tetrads or packets.
- 205 - 1. Based on their susceptibility to lysis by different bacteriophages.  
 205 - 2. Bacterial viruses that attack and destroy the cells.  
 205 - 3. By seeding a plate of medium with a pure culture of the organism and applying droplet suspensions of several known phage types.  
 205 - 4. Plaque.  
 205 - 5. Types in Group II.  
 205 - 6. Group III and IV.  
 205 - 7. Strains of the 83A/84/85 complex.  
 205 - 8. Epidemiological.  
 205 - 9. State Public Health Laboratories, Center for Disease Control in Atlanta, Epidemiological Division (USAFSAM), Brooks AFB, Texas.
- 206 - 1. None.  
 206 - 2. Streptococcal pharyngitis, scarlet fever, impetigo, and endocarditis.  
 206 - 3. Acute rheumatic fever; rheumatic heart disease, and acute glomerulonephritis.  
 206 - 4. Bacterial endocarditis, urinary tract infection, and wound infection.  
 206 - 5. Group D streptococci.  
 206 - 6. Antibiotic susceptibility is markedly different from that of the other streptococci.  
 206 - 7. Group A.  
 206 - 8. Breast abscesses, prostatitis, and mixed cultures from lung and genital infections.  
 206 - 9. Pelvic abscesses, the diseased appendix, sinus and ear infections, and gangrenous wounds.  
 206 - 10. Peptococci are incriminated less frequently than peptostreptococci in anaerobic infections. Peptococci are catalase-positive and do not produce a sharp, pungent odor.
- 207 - 1. Spherical, oval, occasionally elongated into rods and occurring in pairs or a short or long chains.  
 207 - 2. Growth conditions and age of culture.

- 207 - 3. In virulent forms; they contain an abundance of hyaluronic acid.
- 207 - 4. Colonies are flatter and translucent.
- 207 - 5. Mucoid and matt forms.
- 207 - 6. Glassy and smooth forms.
- 207 - 7. Avirulent rough or smooth colonies.
- 207 - 8. Streptococci are oxidase-negative; and gram-stain characteristics and cellular morphology.
- 207 - 9. pH of 7.3 to 7.4; no fermentable carbohydrate should be present.
- 207 - 10. Anaerobically in the presence of 10 percent CO<sub>2</sub>.
- 208 - 1. i.
- 208 - 2. i.
- 208 - 3. m.
- 208 - 4. c.
- 208 - 5. b.
- 208 - 6. c, d.
- 208 - 7. f.
- 208 - 8. n.
- 208 - 9. n.
- 208 - 10. d.
- 208 - 11. a.
- 208 - 12. a.
- 208 - 13. e.
- 208 - 14. g.
- 208 - 15. l.
- 208 - 16. j.
- 209 - 1. Groups A and C.
- 209 - 2. No hemolysis; to the Lactic group.
- 209 - 3. *S. pyogenes* (Lancefield Group A)
- 209 - 4. The viridans group.
- 209 - 5. Variable (alpha, beta, or gamma).
- 209 - 6. They multiply in broth containing 6.5 percent sodium chloride, and they are resistant to most antimicrobial agents.
- 209 - 7. These organisms are catalase-negative, and they produce a variety of hemolysins.
- 209 - 8. Gas production on high protein media along with requirement for anaerobiosis.
- 210 - 1. Cultural and physiological.
- 210 - 2. Group A strains.
- 210 - 3. Group B (*S. agalactiae*) (table 1-3).
- 210 - 4. Similar (table 1-3).
- 210 - 5. Group D. (enterococci). *S. faecalis* (table 1-3).
- 210 - 6. They do not separate the groups; this degree of differentiation is not usually necessary since infections by members of both groups generally respond to identical antimicrobial agents.
- 210 - 7. Sodium hippurate is hydrolyzed to benzoic acid. Benzoic acid is then tested for using 12 percent ferric chloride solution.
- 211 - 1. It is used in distinguishing between Lancefield's Group A and other groups of the beta-hemolytic streptococci.
- 211 - 2. The test depends on the selective inhibition of Group A streptococci on blood agar plate by a paper disc containing 0.04 units of bacitracin.
- 211 - 3. The concentration of the discs used for susceptibility test is too high to differentiate between Group A and Non-group A streptococci.
- 211 - 4. The test has been designed for use with pure cultures; mixed cultures will yield inaccurate results.
- 211 - 5. Many alpha-hemolytic streptococci, including pneumococci, are sensitive to bacitracin differential disc.
- 211 - 6. Any zone of inhibition, regardless of diameter, is positive.
- 211 - 7. Immunofluorescence techniques and the Lancefield serological procedures.
- 212 - 1. None.
- 212 - 2. *S. salivarius*, *S. mitis*, and *S. sanguis*.
- 212 - 3. Oropharynx.
- 212 - 4. Bacterial endocarditis.
- 212 - 5. The respiratory tract.
- 213 - 1. 80; 1.5.
- 213 - 2. Bloody; rusty; thick viscous.
- 213 - 3. Bacteremia.
- 213 - 4. Sinuses; middle ear.
- 213 - 5. Meningitis.
- 213 - 6. Opportunistic pathogens; resistance; declines.
- 213 - 7. Postsurgery.
- 214 - 1. F. Cells are frequently lancet-shaped, with the adjoining ends flattened or slightly curved.
- 214 - 2. F. Virulent pneumonia cells.
- 214 - 3. T.
- 214 - 4. F. They are specific; they will react typically with only the particular type of capsular polysaccharide that initiated their production.
- 214 - 5. T.
- 214 - 6. F. As a thick halo around the cell.
- 214 - 7. T.
- 215 - 1. pH 7.4 to 7.8; 5 to 10 percent.
- 215 - 2. Round and glistening with entire edges, transparent, mucoid, and about 1 mm in diameter.
- 215 - 3. There is sinking in the central portion of the colony to give rise to a flattened surface, similar to a central depression surrounded by an elevated rim.
- 215 - 4. They produce circular, glistening, dome-shaped colonies about 1 mm in diameter.
- 215 - 5. Alpha hemolysis.
- 215 - 6. Beta hemolysis; due to oxygen-labile pneumolysin O.
- 215 - 7. They are larger in size, have a watery appearance, and are more mucoid and confluent.
- 215 - 8. The mucoid (M), the smooth (S), and the rough (R).
- 215 - 9. The mucoid (M).
- 215 - 10. The formation of a type-specific polysaccharide in the capsular material known as specific soluble substance (SSS).
- 215 - 11. They are encapsulated and form the M colony.
- 216 - 1. e.
- 216 - 2. c.
- 216 - 3. e.
- 216 - 4. c.
- 216 - 5. b.
- 216 - 6. b.
- 216 - 7. d.
- 216 - 8. a.
- 216 - 9. b.
- 216 - 10. b.
- 216 - 11. d.
- 216 - 12. a.
- 217 - 1. The upper respiratory tract.
- 217 - 2. By nasal or oral droplets or by direct contact.
- 217 - 3. They invade the mucous membranes, multiply rapidly, and produce a powerful exotoxin. Absorption of the toxin by the mucous membrane yields an acute inflammatory response and destruction of the epithelium.
- 217 - 4. It is formed by the accumulation of fibrin, red blood cells, and white blood cells as a gray, clotted film. It covers the tonsils, pharynx, or larynx.
- 217 - 5. It is absorbed into the tissues.
- 217 - 6. Lesions and pseudomembranes in the throat.
- 217 - 7. An exotoxin.
- 218 - 1. Irregular distribution of cytoplasmic granules.
- 218 - 2. Loeffler's alkaline methylene-blue and similar dyes.
- 218 - 3. As deeply stained bodies against a lighter cytoplasm.
- 218 - 4. Palisades, but L-, V-, or Y-shaped branching forms may occur.
- 218 - 5. Diphtheroids and actinomycetes.

- 218 - 6. Shorter and thicker, with rounded ends, and are found in irregular groups or parallel rows.
- 218 - 7. Cultural, biochemical, and toxigenicity tests.
- 219 - 1. Infusion agar; blood.
- 219 - 2. Loeffler serum medium.
- 219 - 3. Potassium tellurite.
- 219 - 4. Characteristic gray or black colonies.
- 219 - 5. Mixed; *gravis intermedius*; *mitis*.
- 219 - 6. Cysteine tellurite (CT) medium.
- 219 - 7. Cultural and biochemical.
- 219 - 8. *C. ulcerans* have more marked pleomorphism than that of *C. diphtheriae*, and there are fewer metachromatic granules.
- 220 - 1. They appear shorter, staining more uniform, and the granules are less readily seen.
- 220 - 2. Tellurite media and Loeffler or Pai medium.
- 220 - 3. Its ability to produce diphtheria toxin.
- 220 - 4. Guinea pigs; intraperitoneally.
- 220 - 5. 4 ml; subcutaneously.
- 220 - 6. It will die within 24 to 96 hours.
- 220 - 7. A nontoxigenic strain may be present.
- 220 - 8. A sterile filter paper that has been immersed in a tube containing diphtheria antitoxin.
- 220 - 9. A diffusion through the medium and a reaction in optimal proportions to produce thin lines of precipitate.
- 220 - 10. Maltose and glucose; lactose, mannitol, trehalose, and xylose are not fermented.
- 220 - 11. The ability to hydrolyze urea.
- 220 - 12. *Propionibacterium acnes* (*C. acnes*).
- 220 - 13. The organism exhibits bipolar staining.
- 221 - 1. F. It is a nonsporeforming, mobile, rounded ends/diphtheroids with no metachromatic granules
- 221 - 2. T.
- 221 - 3. F. Occurs usually in pairs and may resemble diplococci.
- 221 - 4. T.
- 221 - 5. F. Complete hemolysis.
- 221 - 6. F. Tryptose agar.
- 221 - 7. F. 30° C. to 37° C
- 221 - 8. T.
- 222 - 1. Sheep blood agar, tryptose agar, trypticase soy, tryptic soy, and thiol or brain heart infusion broths.
- 222 - 2. McBride Listeria medium.
- 222 - 3. Round, translucent, slightly raised bluish-gray colonies with fine-textured surface and showing a narrow zone of complete hemolysis.
- 222 - 4. By unfiltered oblique illumination with a scanning microscope.
- 222 - 5. Characteristically blue-green color, translucent, round, slightly raised and watery in consistency.
- 222 - 6. 0.1 percent dextrose semisolid-agar.
- 222 - 7. *L. monocytogenes* and *Corynebacterium* sp.
- 222 - 8. Mannitol and dulcitol.
- 222 - 9. A young rabbit; marked purulent conjunctivitis develops with 24 to 36 hours after instilling *L. monocytogenes*.
- 223 - 1. T.
- 223 - 2. F. Grows poorly on simple media; the addition of serum or glucose enhances growth.
- 223 - 3. F. 37° C. and 33° C., respectively.
- 223 - 4. F. Partial hemolysis.
- 223 - 5. T.
- 223 - 6. F. Biopsies of the lesions should be taken; positive cultures are rarely obtained from swab specimens
- 223 - 7. T.
- 223 - 8. T.
- 224 - 1. F. Rarely encountered.
- 224 - 2. F. Herbivorous.
- 224 - 3. T.
- 224 - 4. T.
- 224 - 5. T.
- 224 - 6. F. Cutaneous anthrax is the most common form
- 224 - 7. T.
- 224 - 8. F. No soluble toxins produced.
- 224 - 9. F. They are highly resistant and have been known to survive for several years in soil.
- 224 - 10. T.
- 225 - 1. *Bacillus anthracis* is encapsulated and non-motile, whereas the saprophytic forms lack capsules and are usually actively motile.
- 225 - 2. Incapsulated cells are found in direct smears of clinical specimens.
- 225 - 3. It does not, but spores are formed when the organism is exposed to the external environment.
- 225 - 4. Large gram-positive bacilli, usually in chains of two to six cells.
- 225 - 5. They cannot be clearly observed; if seen, they may be noted as imperfectly stained, granula halos with ragged edges.
- 225 - 6. 5 percent blood agar plates.
- 225 - 7. As low as 12° C. and as high as 45° C.
- 225 - 8. 42° C. to 43° C.
- 225 - 9. 32° C. to 35° C.
- 225 - 10. They are 2 to 3 mm in diameter and appear gray-white, opaque, and dull, with irregular edges and a rough "frosted glass" appearance.
- 225 - 11. They are invariably non-hemolytic.
- 226 - 1. Anthrax colonies are non-hemolytic or weakly hemolytic on blood agar, while saprophytic forms are usually surrounded by a definite zone of hemolysis.
- 226 - 2. *Bacillus cereus*.
- 226 - 3. Gram-stain and fluorescent antibody staining.
- 226 - 4. Stains for spore and for capsule.
- 226 - 5. Sodium bicarbonate media under a CO<sub>2</sub> atmosphere; this allows the capsules to develop.
- 226 - 6. A hanging drop or by inoculating a suitable motility medium and incubating for 4 days at 37° C.
- 226 - 7. A guinea pig or white mice.
- 226 - 8. The heart, blood, spleen, liver, and lungs.
- 227 - 1. a. The histotoxic clostridia.  
b. *Clostridium tetani*.  
c. *Clostridium botulinum*.
- 227 - 2. Tetanus or lockjaw.
- 227 - 3. Botulism is a food poisoning caused by ingestion of a powerful exotoxin previously formed by the organism *C. botulinum* in contaminated food.
- 227 - 4. Clostridial myonecrosis.
- 227 - 5. The presence of gas in the infected tissues may be a late or variable manifestation of the disease.
- 227 - 6. *Clostridium perfringens*, *C. novyi*, and *C. septicum*.
- 227 - 7. By Greek letters in order of importance or discovery.
- 227 - 8. They play an opportunistic role; they are not highly invasive.
- 227 - 9. Five; A through E.
- 227 - 10. *C. perfringens*.
- 227 - 11. It develops as a complication of severe traumatic injury, especially lacerated wounds, accompanied by a compound fracture. Blood circulation is impaired or destroyed. The necrotic tissues, void of oxygen, provide a rich medium for which clostridial spores germinate and multiply.
- 228 - 1. The disease follows the introduction of tetanus spores into puncture wounds, burns, surgical sutures, or traumatic injuries.
- 228 - 2. The spinal cord and peripheral motor nerve endings.
- 228 - 3. A highly potent exotoxin.
- 228 - 4. A, B, E, and F.
- 228 - 5. Type A.
- 228 - 6. Neurotoxic symptoms are evidenced by visual disturbances, inability to swallow, and speech difficulty.

- 229 - 1. F. Large gram-positive rods of variable length and breadth, ranging from long filamentous forms to short, plump bacilli.  
 229 - 2. T.  
 229 - 3. F. Wirtz-Conklin stain, for spores.  
 229 - 4. F. *C. perfringens*.  
 229 - 5. F. Direct examination is of little value because very few organisms are ordinarily present in such specimens.  
 229 - 6. F. Obligate anaerobes.  
 229 - 7. F. Majority are motile except *C. perfringens*.  
 229 - 8. T.
- 230 - 1. Hemolysis on blood agar plates, precipitation in serum or egg yolk media, and stormy fermentation in milk media.  
 230 - 2. A target or double zone of hemolysis.  
 230 - 3. A narrow zone of complete hemolysis due to the theta toxin and a much wider zone of incomplete hemolysis due to the alpha toxin.  
 230 - 4. Incubate the primary thioglycollate medium for 48 to 72 hours. During the extended period of incubation, the gram-negative bacilli will tend to die out, allowing isolation of clostridia in subculture.  
 230 - 5. The bacterium generally fails to sporulate in culture.  
 230 - 6. By digestion of the solid material of the medium.  
 230 - 7. *C. perfringens*.  
 230 - 8. The presence of *C. perfringens* antitoxin.  
 230 - 9. Strict anaerobiosis, microscopic, and colony morphology.  
 230 - 10. Dextrose and lactose.  
 230 - 11. Trypticase agar base.  
 230 - 12. Cooked meat medium.

## CHAPTER 2

- 231 - 1. The infection usually spreads from the urethra, cervix, and rectum.  
 231 - 2. Lesions can form in the joints, heart valves, and meninges.  
 231 - 3. Because of the legal requirement as a preventive measure suitable medication must be applied to the eyes of all newborn.  
 231 - 4. Nasopharynx.  
 231 - 5. Groups A, B, and C.  
 231 - 6. Group A.  
 231 - 7. *Branhamella*.  
 231 - 8. *N. subflava*.
- 232 - 1. To accomplish an even distribution and to prevent destruction of white cells or tissue cells.  
 232 - 2. Microscopic demonstration of gram-negative intracellular diplococci on smear of a urethral discharge.  
 232 - 3. From within the urethral canal.  
 232 - 4. Thayer-Martin (TM) medium.  
 232 - 5. The cervix and anal canal; to Thayer-Martin (TM) and Transgrow bottles.  
 232 - 6. The combination of a positive-oxidase reaction of colonies and gram-negative diplococci grown on either medium. (TM or Transgrow.)  
 232 - 7. Thayer-Martin (TM).  
 232 - 8. Blood and chocolate agars.  
 232 - 9. Drying, chilling, exposure to unfavorable pH, lysis by tissue enzymes, or autolytic meningococcal enzymes.
- 233 - 1. An atmosphere of increased carbon dioxide (candle jar).  
 233 - 2. Between 35° C. and 36° C.  
 233 - 3. It permits growth of gonococci and meningococci while it simultaneously suppresses saprophytic *Neisseria* species and other bacterial contaminants.  
 233 - 4. Cytochrome oxidase.  
 233 - 5. Trimethoprim lactate (5 µg/ml).  
 233 - 6. Pink, to dark red and finally black colonies.  
 233 - 7. Glucose.
- 233 - 8. Phenol red indicator  
 233 - 9. It is less time-consuming.  
 233 - 10. Lack of sensitivity due to crossreaction with group B meningococci.
- 234 - 1. F. Small cocci.  
 234 - 2. F. It is pronounced.  
 234 - 3. F. *Neisseria*.  
 234 - 4. T.  
 234 - 5. T.
- 235 - 1. *A. antratum* and *A. lwoffii*.  
 235 - 2. *Acinetobacter Calcoaceticus*  
 235 - 3. Diplococcal forms predominate solid media; rods and filaments in liquid media.  
 235 - 4. Indeterminate or partial rather than clear, sharp, well defined zones of beta hemolysis.  
 235 - 5. They grow well on MacConkey agar, but poorly or not at all on SS agar.  
 235 - 6. Var. *A. lwoffii*.  
 235 - 7. *A. Antitratum*.  
 235 - 8. Rod-shape.  
 235 - 9. The oxidase test: it is oxidase-negative.  
 235 - 10. Catalase.  
 235 - 11. Decarboxylase, dihydrolase, or diaminease; cetrimide agar.
- 236 - 1. i.  
 236 - 2. d.  
 236 - 3. f.  
 236 - 4. f, g.  
 236 - 5. f.  
 236 - 6. a.  
 236 - 7. a.  
 236 - 8. e.  
 236 - 9. e.  
 236 - 10. b.
- 237 - 1. Unicellular; procaryotic; cell wall.  
 237 - 2. Viruses.  
 237 - 3. *Mycoplasma pneumoniae*.  
 237 - 4. Primary atypical pneumoniae  
 237 - 5. Cold agglutinins.  
 237 - 6. T strains.  
 237 - 7. Coccoid; filamentous; star-shaped.  
 237 - 8. 125; 330; 150.  
 237 - 9. Giemsa; Dienes.  
 237 - 10. Darkfield; phase-contrast.
- 238 - 1. Facultative anaerobes.  
 238 - 2. Aerobic.  
 238 - 3. Heart infusion agar; horse serum; yeast extract; and penicillin G.  
 238 - 4. The *Mycoplasmataceae*.  
 238 - 5. Very small colonies, 10 to 600 µm in diameter, opaque, granular central area that grows into the medium and translucent peripheral zone. They appear with brown or yellow centers.  
 238 - 6. Alpha or beta hemolysis.
- 239 - 1. PPLO enrichment broth and mycoplasma broth base; crystal violet.  
 239 - 2. Air and 5 percent CO<sub>2</sub>.  
 239 - 3. Anaerobic atmosphere of 95 percent N<sub>2</sub> and 5 percent CO<sub>2</sub> in an evacuation replacement jar.  
 239 - 4. At 7, 14, and 21 days.  
 239 - 5. 30 days.  
 239 - 6. Urea and manganese sulfate.  
 239 - 7. Dark, golden brown colonies.  
 239 - 8. Dienes staining technique.  
 239 - 9. A coverslip holding a drop of Dienes stain (previously dried) is laid on the surface of the block, with the stained side in contact with the colony on the agar.  
 239 - 10. Glucose fermentation, arginine hydrolysis, urea hydrolysis, and aerobiosis.



CHAPTER 3

- 240 - 1. The nasopharynx of the cat and tonsils of dogs.  
 240 - 2. Outbreaks of cholera in domestic or wild fowl, hemorrhagic septicemia of cattle, and primary and secondary pneumonia.  
 240 - 3. Sputum, pus, blood, spinal fluid, and tissues.  
 240 - 4. Bites or scratches of dogs or cats.  
 240 - 5. Gram-negative, small nonmotile, ovoid, or rod-shaped organisms, approximately 1.4 by 0.4  $\mu\text{m}$  in size.  
 240 - 6. Chocolate or blood agar.  
 240 - 7. Small, nonhemolytic, translucent colonies with a characteristic musty odor.  
 240 - 8.  $\beta$ -D-galactosidase test (ONPG); *Yersinia* is positive.  
 240 - 9. Smooth (S) iridescent colonies.  
 240 - 10. Groups A and D.
- 241 - 1. Handling of infected animal carcasses, insect bites, ingestions of improperly cooked meat or contaminated water, and inhalation of airborne organisms.  
 241 - 2. Local lesions, regional lymph nodes, sputum, gastric aspirates, or nasopharyngeal washings.  
 241 - 3. During the first few days after infection and in untreated fulminating disease.  
 241 - 4. Cystine-glucose-blood agar, containing thiamine. Blood cultures: thioglycollate, heart-infusion agar, or hemoglobin-cystine agar.  
 241 - 5. Young colonies appear very tiny; later, relatively heavy growth of small, gray, transparent to translucent, mucoid colonies develop.  
 241 - 6. The coccoid forms; bacillary forms respectively.  
 241 - 7. Direct or indirect fluorescent-antibody techniques.
- 242 - 1. Minute gram-negative rods, often cocobacillary, threadlike filaments, bipolar staining, and pleomorphism are common.  
 242 - 2. A diplococcal form.  
 242 - 3. X factor-hemin, associated with hemoglobin and V factor, a coenzyme I, nicotinamide-adenine-dinucleotide (NAD).  
 242 - 4. X factor is heat stable and V factor is heat labile.  
 242 - 5. They both contain heat-labile factors which are inhibitory to *H. influenzae*.  
 242 - 6. The V factor, being heat labile, is destroyed at the temperature required to convert blood agar into chocolate agar. It must, therefore, be added as supplement.  
 242 - 7. By first streaking the blood agar plate surface with the suspected *Haemophilus* spp. and then making a single streak with *Staphylococcus* spp.  
 242 - 8. The phenomenon of small colonies growing only in close proximity to another colony which provides the smaller colonies with the required growth factors is referred to as "satellitism."  
 242 - 9. It suppresses the growth of the other organisms.
- 243 - 1. k.  
 243 - 2. i.  
 243 - 3. e.  
 243 - 4. e.  
 243 - 5. f.  
 243 - 6. a.  
 243 - 7. a.  
 243 - 8. a, e.  
 243 - 9. c, g.  
 243 - 10. b.  
 243 - 11. b.  
 243 - 12. b.  
 243 - 13. d.  
 243 - 14. d.
- 244 - 1. *Bordetella* spp. do not require X or V factor, whereas *Haemophilus* spp. require X or V or both.  
 244 - 2. Cells are uniform in size, but in subcultures they become quite pleomorphic and filamentous, and thick bacillary forms are common.
- 244 - 3. By capsular stains.  
 244 - 4. Nonsporeforming and nonmotile.  
 244 - 5. An infection of the tracheal and bronchial epithelium known as whooping cough; also, cerebral and pulmonary complications.  
 244 - 6. *B. pertussis* does NOT ordinarily produce such structures.  
 244 - 7. Glycerol, potato, and 15- to 20-percent blood.  
 244 - 8. Small, dome-shaped, and possess a gray metallic luster resembling mercury drops or a bisected pearl.  
 244 - 9. A nasopharyngeal swab.  
 244 - 10. Citrate utilization, urease production, motility, and nitrate reduction.  
 244 - 11. A slide agglutination test and fluorescent antibody staining.
- 245 - 1. T.  
 245 - 2. F. *Bordetella pertussis*.  
 245 - 3. F. It produces a brown pigment.  
 245 - 4. T.  
 245 - 5. T.  
 245 - 6. F. Positive urease and catalase tests, and utilizes citrate.  
 245 - 7. F. It is motile and possesses peritrichous flagella.  
 245 - 8. T.  
 245 - 9. T.
- 246 - 1. T.  
 246 - 2. F. Slaughter house attendants, veterinarians, sausage makers, butchers, dairymen, and occupational groups exposed to infected animals.  
 246 - 3. T.  
 246 - 4. F. The organisms form multiple abscesses.  
 246 - 5. T.  
 246 - 6. F. Bacilli remain dormant; relapses may occur.
- 247 - 1. Small, nonmotile rods; usually cocobacillary forms; gram-negative cells occurring singly, in pairs, or in short chains.  
 247 - 2. Encapsulated, and they form smooth and mucoid colonies.  
 247 - 3. *Brucella melitensis*.  
 247 - 4. Blood taken during the febrile stages.  
 247 - 5. Serum-dextrose agar and trypticose soy agar.  
 247 - 6. 21 days.  
 247 - 7. *Brucella abortus*.  
 247 - 8. Spheroidal in shape, moist, translucent, and slightly opalescent or iridescent.  
 247 - 9. Modified Castaneda bottle.  
 247 - 10. a. The need for increased  $\text{CO}_2$ .  
 b. The production of  $\text{H}_2\text{S}$  for a period of 4 to 5 days.  
 c. The bacteriostatic action of basic fuchsin or thionin in solid media.  
 d. Agglutination in monospecific sera.  
 e. Urease test.  
 247 - 11. Urease test.  
 247 - 12. The test which uses a standardized, heat-killed smooth *Brucella* antigen.
- 248 - 1. Septicemia; lesions; abscesses.  
 248 - 2. *Pseudomonas mallei*.  
 248 - 3. Mouth; gastrointestinal tract.  
 248 - 4. *A. actinomycetemcomitans*.  
 248 - 5. Blood; bone.  
 248 - 6. *A. lignieresii*; *A. equuli*.  
 248 - 7. Alkaline; blood; serum.  
 248 - 8. Negative; absent; nonmotile; singly; pairs, chains.  
 248 - 9. Blood agar; serum.  
 248 - 10. 10 percent  $\text{CO}_2$ .  
 248 - 11. Raised, grayish, opaque, convex, tenacious.  
 248 - 12. Small, discrete, convex, semiopaque; glistening.
- 249 - 1. *Granuloma inguinale*, a disease characterized by chronic ulcerative lesions of the genital area.  
 249 - 2. Pleomorphic rod exhibiting bipolar staining.  
 249 - 3. Donovan bodies.

- 249 - 4. Chick embryo tissues and coagulated egg yolk slants known as "Dulaney slants."  
 249 - 5. Wrights-stain; blue bacilli surrounded by a well-defined, dense, pink capsule.  
 249 - 6. Legionnaire's disease, a severe type of pneumonia.  
 249 - 7. A silver impregnation technique, such as the Dieterle stain.  
 249 - 8. Short pleomorphic rods, 1  $\mu$  m in diameter and 1 to 4  $\mu$  m in length, sometimes showing bipolar staining.  
 249 - 9. Feeley-Gorman agar and Charcoal Yeast Extract agar.  
 249 - 10. Feeley-Gorman agar.  
 249 - 11. Pleural fluid and/or transtracheal aspirates.
- 250 - 1. *Streptobacillus moniliformis*.  
 250 - 2. The mouth of rats, both wild and laboratory types.  
 250 - 3. As the result of a rat bite.  
 250 - 4. One type of "ratbite" fever and of a milk-borne disease known as "Haverhill fever."  
 250 - 5. The blood.  
 250 - 6. Gram, Wayson, and Giemsa stains.  
 250 - 7. Gram-negative, quite pleomorphic, varying in form from a short rod to long, interwoven filaments.  
 250 - 8. Blood, ascitic fluid, or serum.  
 250 - 9. A clear medium (ascitic fluid or serum).  
 250 - 10. The L form is a colonial variant, where the colony grows into the medium and cannot usually be transferred with the laboratory loop.  
 250 - 11. Requires CO<sub>2</sub> and moisture for some laboratory strains.  
 250 - 12. Growth usually occurs at the bottom of the container; it resembles small white "fluff balls" or "cotton balls."
- 251 - 1. g.  
 251 - 2. g.  
 251 - 3. e.  
 251 - 4. e.  
 251 - 5. g.  
 251 - 6. a.  
 251 - 7. a.  
 251 - 8. a.  
 251 - 9. a.  
 251 - 10. a, c.  
 251 - 11. d  
 251 - 12. c  
 251 - 13. b.

#### CHAPTER 4

- 252 - 1. The large bowel of man and animals, soil, water, and decaying matter.  
 252 - 2. Bacillary dysentery and typhoid fever.  
 252 - 3. Hospital acquired infections, urinary tract, wound infections, pneumonia, meningitis, and septicemia.  
 252 - 4. Valuable information concerning microbial genetics and regulatory mechanisms have been derived from experimentation with these organisms.  
 252 - 5. Speciation and characterization of the family has been carried out to a higher degree than other bacteria because of the need for accurate information on the epidemiology of enteric infections and intense study required.
- 253 - 1. F. Six tribes, closely related.  
 253 - 2. F. It is not.  
 253 - 3. F. Ewing scheme.  
 253 - 4. T.  
 253 - 5. F. Biochemical and serologic reactions.
- 254 - 1. They are nonsporeforming rods.  
 254 - 2. Peritrichous flagella.  
 254 - 3. It aids in differentiating the enterics from the polar flagellated bacteria of the families Pseudomonadaceae.  
 254 - 4. None.  
 254 - 5. *Shigella* and *Klebsiella*.  
 254 - 6. *Klebsiella*.
- 254 - 7. Glucose.  
 254 - 8. Indol phenol oxidase; alginate.  
 254 - 9. Hydrogen and carbon dioxide.  
 254 - 10. *Shigella* and *Salmonella*.  
 254 - 11. A definite greening.  
 254 - 12. *Klebsiella*, certain types of *Shigella*, and certain variants of *Salmonella*, especially, *S. typhimurium*.
- 255 - 1. GN broth, selenite broth, or tetrathionate broth.  
 255 - 2. Desoxycholate citrate agar, *Salmonella-Shigella* (SS) agar, Hektoen enteric agar (HEA), bismuth sulfite agar, brilliant green agar (BGA), eosin-methylene blue (EMB) agar, xylose lysine desoxycholate (XLD) agar, MacConkey agar.  
 255 - 3. You may increase the agar concentration to 5 percent.  
 255 - 4. They suppress growth of contaminating forms, usually nonpathogens, and allow the infectious species to survive and proliferate.  
 255 - 5. Colors are based on a change of pH when acids are produced as a result of lactose fermentation. This change in pH affects the color of the indicator dye present in the agar.  
 255 - 6. These broths are inhibitory to most strains of these genera.  
 255 - 7. Sucrose.  
 255 - 8. Glucose.  
 255 - 9. An all-yellow reaction.  
 255 - 10. Lysine-iron agar (LIA) and motility-indol-ornithine (MIO).  
 255 - 11. 1 microorganism per ml.  
 255 - 12. 5 ml of blood into 100 ml of glucose phosphate broth, and 5 ml of blood into 100 ml of fluid Thioglycollate medium.  
 255 - 13. Blood contains no normal flora.  
 255 - 14. *Salmonella*, certain members of *Escherichia*, *Klebsiella*, and *Proteus*.
- 256 - 1. g, l, m.  
 256 - 2. b, h.  
 256 - 3. f.  
 256 - 4. c.  
 256 - 5. n.  
 256 - 6. d.  
 256 - 7. k, l, n.  
 256 - 8. d, e, f.  
 256 - 9. d, f, k.  
 256 - 10. h, m.  
 256 - 11. i, d, k.
- 257 - 1. *Klebsiella*, *Enterobacter*, and *Serratia*.  
 257 - 2. *Klebsiella*.  
 257 - 3. *K. oxytoca*.  
 257 - 4. *K. pneumoniae*, *K. ozaenae*, and *K. rhinoscleromatis*. It is said to be responsible for approximately 2 percent of the bacterial pneumonias. It is a secondary invader in diseases such as bronchiectasis, tuberculosis, influenza and pleurisy.  
 257 - 5. Large mucoid colonies which have a tendency to coalesce.  
 257 - 6. Colonies usually string out.  
 257 - 7. *E. aerogenes* is usually motile, may liquefy gelatin, and is not as distinctly capsulated.  
 257 - 8. All species of *Klebsiella* share common antigens.
- 258 - 1. *E. cloacae*, *E. aerogenes*, *E. hafniae*, and *E. agglomerans*.  
 258 - 2. The soil, water, dairy products, intestine of man and animal.  
 258 - 3. Urinary tract.  
 258 - 4. *E. cloacae*.  
 258 - 5. They are motile and *K. agglomerans* is sometimes motile.  
 258 - 6. *E. hafniae*.
- 259 - 1. F. Motile rods.  
 259 - 2. F. Only a small percentage are chromogenic.  
 259 - 3. T.  
 259 - 4. F. By the production of an extracellular DNase.

- 259 - 5. F. In recent years, they have been implicated in human infections.
- 259 - 6. T.
- 259 - 7. F. They are less frequently isolated.
- 260 - 1. *Proteus* and *Providencia*
- 260 - 2. Positive Motility and ability to deaminate phenylalanine.
- 260 - 3. 25° C.
- 260 - 4. Urease test.
- 260 - 5. Acid slant and acid butt.
- 260 - 6. *P. vulgaris* and *P. mirabilis*.
- 260 - 7. *P. mirabilis*.
- 260 - 8. Increase the agar concentration to 5 percent.
- 260 - 9. *Salmonella*.
- 260 - 10. *Proteus morganii*.
- 260 - 11. Cystitis, eye and ear infections, pleurisy, peritonitis, and suppurative abscesses.
- 260 - 12. The X-19, X-2, and X-K strains.
- 260 - 13. Rickettsial.
- 260 - 14. The Weil-Felix reaction is a name applied to the phenomenon of having certain strains of *Proteus* spp. react with the antibodies formed against rickettsia.
- 260 - 15. Cross-reactions are possible between the O antigens of these morphologically similar genera.
- 261 - 1. Lactose negative and hydrogen sulfide negative.
- 261 - 2. *Providencia* is motility positive and utilizes citrate. *Shigella* is not motile and does not utilize citrate.
- 261 - 3. Negative urease reaction.
- 261 - 4. Urinary tract infections, septicemia, wound infections, and pneumonia.
- 261 - 5. *P. stuartii*.
- 261 - 6. *Providencia stuartii* ferments inositol, *P. alcalifaciens* does not, and *P. stuartii* is also more resistant to antimicrobials than *P. alcalifaciens*.
- 262 - 1. *Edwardsiella tarda*.
- 262 - 2. They are rare.
- 262 - 3. Cold-blooded animals.
- 262 - 4. Positive in: inol, H<sub>2</sub>S, lysine, and ornithine decarboxylases.
- 262 - 5. *Salmonella*.
- 263 - 1. *Citrobacter* and *Arizona*.
- 263 - 2. Urinary tract infections, wounds, blood, sputa, and spinal fluid.
- 263 - 3. *C. diversus*.
- 263 - 4. *Salmonella typhi*.
- 263 - 5. *C. freundii*.
- 263 - 6. Animal, particularly reptiles and birds.
- 263 - 7. Gastroenteritis, bacteremia, pyelonephritis, osteomyelitis, and otitis media.
- 263 - 8. Majority of the strains ferment lactose, and laboratory technicians have been trained to regard lactose-fermenting organisms as normal fecal flora.
- 263 - 9. *Salmonella*.
- 263 - 10. *Arizona* produces the delayed fermentation of lactose, fails to ferment dulcitol, growth in sodium malonate, and slow gelatin liquefaction.
- 263 - 11. *Erwinia* and *Pectobacterium*.
- 263 - 12. Plant pathogens.
- 264 - 1. *Shigella* and *Escherichia*.
- 264 - 2. *E. coli* is usually motile, ferments lactose and other carbohydrates, produces lysine decarboxylase, and utilizes acetate as a sole source of carbon.
- 264 - 3. The field of molecular biology.
- 264 - 4. Rapid fermentation of lactose with acid and gas and their response to the classical IMViC tests (++)
- 264 - 5. They are anaerogenic and nonmotile.
- 264 - 6. They are large and lactose-fermenting colonies.
- 264 - 7. Enrichment broths and the more highly selective agar plating media.
- 264 - 8. Certain strains may not grow on MacConkey, but will grow well on blood plates.
- 264 - 9. (1) Pyelitis, pyelonephritis, appendicitis, peritonitis, gallbladder infection, septicemia, meningitis, endocarditis.  
(2) Epidemic diarrhea of adults and children; and "traveler's" diarrhea.
- 264 - 10. A useful epidemiological tool especially in infant diarrhea.
- 265 - 1. An acute diarrhea.
- 265 - 2. Fourteen O antigen groups.
- 265 - 3. Enterotoxins
- 265 - 4. Adenylate cyclase.
- 265 - 5. One heat stable and non-antigenic (ST) and the other heat labile and antigenic (LT).
- 265 - 6. LT.
- 266 - 1. Serologic and biochemical reactions.
- 266 - 2. *S. flexneri*
- 266 - 3. *Salmonella*.
- 266 - 4. *E. coli*.
- 266 - 5. Smaller.
- 266 - 6. Acid butt, no hydrogen sulfide, and an alkaline slant.
- 266 - 7. O antigens, and some possess K antigens.
- 266 - 8. A, B, C and D.
- 266 - 9. A—*S. dysenteriae*; B—*S. flexneri*; C—*S. boydii*; and D—*S. sonnei*.
- 267 - 1. T.
- 267 - 2. F. The organism enters the small bowel, multiplies, then proceeds to the terminal ileum and colon where it penetrates the epithelial cells and multiplies.
- 267 - 3. T.
- 267 - 4. F. *S. sonnei*.
- 267 - 5. F. 85 percent: *S. sonnei* and 14 percent: *S. flexneri*.
- 267 - 6. T.
- 267 - 7. F. Animal host is lacking
- 267 - 8. T.
- 267 - 9. T.
- 268 - 1. *Species; extraintestinal.*
- 268 - 2. *Choleraesuis; typhi; enteritidis.*
- 268 - 3. *Lactose.*
- 268 - 4. *Typhi; enteritidis.*
- 268 - 5. *Typhi.*
- 268 - 6. *Hydrogen sulfide; alkaline; negative.*
- 268 - 7. *Polyvalent.*
- 268 - 8. *Kauffman-White.*
- 268 - 9. O; H.
- 268 - 10. H; specific; nonspecific.
- 268 - 11. O; H-.
- 268 - 12. A; B; C; C<sub>2</sub>; D, E.
- 269 - 1. T.
- 269 - 2. F. Unlike shigella, the salmonella pass directly through the epithelial cells into the subepithelial tissue.
- 269 - 3. T.
- 269 - 4. F. O antigens; Vi antigen respectively.
- 269 - 5. F. Gastroenteritis, a septicemia, and an enteric fever.
- 269 - 6. F. The human carrier is the source; animals are most important in the other salmonellosis.
- 270 - 1. *Pestis; enterocolitica; pseudotuberculosis.*
- 270 - 2. *Yersinia pestis.*
- 270 - 3. Bubonic, pneumonic, and septicemic.
- 270 - 4. The rat flea.
- 270 - 5. Cells show marked bipolar staining. They also have a safety pin appearance, with polar bodies staining blue and the remainder light blue to reddish.
- 270 - 6. The coccoid, round, filamentous, elongated, forms.
- 270 - 7. A capsule.
- 270 - 8. Nutrient agar, slowly; on blood agar, fairly rapidly.
- 270 - 9. Small, nonhemolytic, round, transparent, glistening colorless colonies with an undulate margin.
- 270 - 10. Aspirates from buboes, pus from the area of the flea bite, sputum, throat swabs, or blood.

- 270 - 11. Cary-Blair transport media.  
 270 - 12. Hazardous; caution.  
 270 - 13. Specific bacteriophage typing, by the fluorescent-antibody test, and by agglutination with specific antisera.
- 271 - 1. *Pestis; Yersiniosis.*  
 271 - 2. *Enterocolitica; pseudotuberculosis.*  
 271 - 3. Zoonotic; wild; domestic.  
 271 - 4. *Enterocolitica; slowly.*  
 271 - 5. Enterobacteriaceae.  
 271 - 6. *Enterocolitica; Wayson's.*  
 271 - 7. Enterocolitica; MacConkey; EMB; deoxycholate; *Salmonella* and *Shigella.*  
 271 - 8. *Pseudotuberculosis.*  
 271 - 9. Pseudotuberculosis; grayish-yellow translucent; raised; serrations.
- 272 - 1. F. Listed under genera of uncertain affiliation in the 8th Edition of *Bergey's Manual.*  
 272 - 2. F. Motile, oxidase-positive.  
 272 - 3. T.  
 272 - 4. F. Growth occurs on MacConkey agar and is inhibited on SS agar.  
 272 - 5. T.  
 272 - 6. F. Oxidase-positive, fail to produce 3-ketolactonate.  
 272 - 7. T.  
 272 - 8. F. Blood, spinal fluid, urine, the respiratory tract, wounds, and feces.
- 273 - 1. Burn sites, wounds, the urinary tract, and the lower respiratory tract.  
 273 - 2. A flat colony with a ground-glass appearance which produces a zone of hemolysis.  
 273 - 3. Cystic fibrosis.  
 273 - 4. They tend to spread and give off a characteristic grape-like odor.  
 273 - 5. The secretion of pyocyanin and fluorescein (pyoverdin).  
 273 - 6. Approximately 4 percent.  
 273 - 7. Negative; positive.  
 273 - 8. Alkaline slant and butt.  
 273 - 9. A standardized technique of bacteriophage typing.  
 273 - 10. A system of typing by pyocin production and a serologic typing system.  
 273 - 11. Melioidosis, a glanders-like disease in man.  
 273 - 12. They are wrinkled and on prolonged incubation become umbonate.  
 273 - 13. *Salmonella-Shigella* agar and cetrinide agar.  
 273 - 14. Positive; oxidative acidity.  
 273 - 15. The agglutination and fluorescent-antibody reactions.
- 274 - 1. F. Most are pathogens for cold blooded animals and have not been implicated in human diseases.  
 274 - 2. T.  
 274 - 3. F. *A. hydrophilia.*  
 274 - 4. F. Positive reaction from indol phenol oxidase.
- 275 - 1. *V. cholerae* and *V. parahemolyticus.*  
 275 - 2. Asiatic cholera.  
 275 - 3. An acute diarrheal disease characterized by massive loss of fluid and electrolyte. Vomiting and profuse diarrhea results in severe dehydration, anuria, hypochloremia, acidosis, and circulatory failure.  
 275 - 4. A heat-labile enterotoxin.  
 275 - 5. Infected individuals or convalescing carriers through contaminated food.  
 275 - 6. Slightly curved rods.  
 275 - 7. El Tor biotype is less susceptible to environmental changes than *V. cholerae* type.  
 275 - 8. A rectal catheter.  
 275 - 9. Thiosulfate-citrate-bile salt-sucrose (TCBS) agar (selective) and taurocholate gelatin agar (TGA) (nonselective).  
 275 - 10. Medium-sized, smooth, yellow colonies with opaque centers and transparent periphery.  
 275 - 11. Somewhat flattened and transparent surrounded by a cloudy halo.
- 275 - 12. Alkaline peptone water.  
 275 - 13. Suppressed forms may begin to grow.  
 275 - 14. O typing sera by slide test.  
 275 - 15. The string test and darkfield motility test.
- 276 - 1. Salt.  
 276 - 2. Gastroenteritis or food poisoning; more serious infections such as septicemia with shock, hemolytic anemia, and disseminated intravascular coagulation (DIC).  
 276 - 3. TCBS and alkaline peptone broth.  
 276 - 4. Cary-Blair or Amies' transport medium.  
 276 - 5. *V. alginolyticus.*
- 277 - 1. d.  
 277 - 2. d.  
 277 - 3. f.  
 277 - 4. c.  
 277 - 5. f.  
 277 - 6. a.  
 277 - 7. b.  
 277 - 8. a.  
 277 - 9. b.  
 277 - 10. b.  
 277 - 11. e.  
 277 - 12. e.

## CHAPTER 5

- 278 - 1. *Mycobacterium leprae; Mycobacterium lepraemurium.*  
 278 - 2. Smears and scrapings obtained from the skin and mucous membrane, particularly in the nasal septum of patients with nodular leprosy.  
 278 - 3. None.  
 278 - 4. Growth in foot pads of mice.  
 278 - 5. Demonstration of acid-fast bacilli in smears of skin, in nasal scrapings, and in tissue sections from typical tuberculoid leprosy.  
 278 - 6. The occurrence of anesthesia and the presence of acid-fast rods that cannot be cultured.  
 278 - 7. A sterile extract of leprosy tissue containing numerous *M. leprae* organisms used to determine a relative resistance or susceptibility to the disease.
- 279 - 1. *M. tuberculosis;* and *M. bovis.*  
 279 - 2. Classic pulmonary.  
 279 - 3. Through the consumption of raw milk or inadequately cooked meat from infected cattle.  
 279 - 4. By way of the respiratory or alimentary tract.  
 279 - 5. It can cause miliary, or "mustard seed," tuberculosis.  
 279 - 6. The pulmonary form.
- 280 - 1. F. They are often shorter and plumper than the human tubercle bacillus.  
 280 - 2. F. The colony growth of the bovine species is inhibited by glycerol and are smaller than the human species on glycerol agar.  
 280 - 3. T.  
 280 - 4. F. Appear rough and resemble those of *M. tuberculosis.*  
 280 - 5. T.
- 281 - 1. c.  
 281 - 2. a.  
 281 - 3. a.  
 281 - 4. d.  
 281 - 5. f.  
 281 - 6. g.  
 281 - 7. b.  
 281 - 8. h.  
 281 - 9. e.  
 281 - 10. e.  
 281 - 11. e.
- 282 - 1. They often take the form of small, thin rods with rounded ends, straight or slightly curved.

- 282 - 2. Longer filamentous forms are occasionally observed, as well as swollen or club-shaped cells.
- 282 - 3. None.
- 282 - 4. Lipids.
- 282 - 5. Mycobacterial proteins (a number of protein antigens).
- 282 - 6. "Few."
- 282 - 7. Report the number found and request another specimen.
- 282 - 8. Dry, nodular, rough, "cauliflower" growth.
- 282 - 9. Smooth, moist, glistening slant.
- 282 - 10. Buff, off-white, or cream colored.
- 283 - 1. Rate of growth, pigmentation, and colony morphology.
- 283 - 2. They will not grow.
- 283 - 3. Homogenized whole egg, glycerol, asparagin, and potato starch.
- 283 - 4. Early detection of colonies with the aid of the microscope is possible because the medium is clear. It permits easy separation of mixed colony types, and contamination with other bacteria or fungi does not alter or destroy the egg base medium as quickly as the egg base media. Middlebrook shows growth within three weeks instead of up to eight weeks on egg base media.
- 283 - 5. It stimulates the rate of growth.
- 284 - 1. f.
- 284 - 2. f.
- 284 - 3. h.
- 284 - 4. h.
- 284 - 5. e.
- 284 - 6. d.
- 284 - 7. e.
- 284 - 8. d.
- 284 - 9. a.
- 284 - 10. b.
- 284 - 11. g.
- 284 - 12. c.
- 284 - 13. c.
- 285 - 1. Rifampin and ethambutol; isoniazid.
- 285 - 2. The slow growth of mycobacteria permits complete dispersal of the drug in the medium.
- 285 - 3. Solid medium.
- 285 - 4. The direct method.
- 285 - 5. The number of organisms seen on the smear under oil immersion.
- 285 - 6. The dilution is necessary to provide an inoculum size that will yield at least 40 to 50 colonies on the control plate when performing drug susceptibility tests but not large enough to allow overgrowth of resistant mutants.
- 285 - 7. Felsen quadrant 7H10 plates.
- 285 - 8. 37° C.; 5 to 10 percent CO<sub>2</sub>. They are read weekly for three weeks.
- 285 - 9. One plus (+)
- 285 - 10. Type of test—direct or indirect; number of colonies on control quadrant; number of colonies on drug quadrant; concentration of drug on each quadrant.
- 286 - 1. T.
- 286 - 2. F. They are helically coiled organisms and consist of a protoplasmic cylinder intertwined with one or more axial fibrils.
- 286 - 3. F. Members are gram-negative.
- 286 - 4. F. Giemsa and silver impregnation.
- 286 - 5. F. Aerobic, facultatively anaerobic or anaerobic.
- 286 - 6. F. Darkfield microscopy.
- 287 - 1. Relapsing fever, an acute febrile illness in man.
- 287 - 2. The spleen, liver, kidneys, and gastrointestinal tract.
- 287 - 3. *Borrelia recurrentis*.
- 287 - 4. *Hermsii; parker; turicatae*.
- 288 - 1. T.
- 288 - 2. F. Large and wavy with a distance of approximately 2.5 μm between them.
- 288 - 3. F. Gram-negative.
- 288 - 4. T.
- 288 - 5. T.
- 288 - 6. F. Motion is not necessarily directional; the organism may be seen to move back and forth.
- 289 - 1. Blood, serum, or tissue.
- 289 - 2. Strictly anaerobic.
- 289 - 3. 0.1 ml of citrated blood; incubated at 35° C.
- 289 - 4. A drop of medium is removed at 2-day intervals.
- 289 - 5. Darkfield microscopy.
- 289 - 6. a. Culture media containing growth of organisms.  
b. Blood from febrile patients.  
c. Blood from inoculated animals (n.c.c.)
- 290 - 1. Diseases caused by both fusiform bacteria and spirochete.
- 290 - 2. Vincent's angina or trench mouth.
- 290 - 3. *Bacteriodes melanogenicus*.
- 290 - 4. Approximately 7 to 12.0 μm in length with three to eight spirals.
- 290 - 5. Loeffler's methylene blue; carbol-fuchsin; Giemsa, Wright, or Gram stain.
- 290 - 6. Gram-negative.
- 290 - 7. Deeper part of the throat lesions or buccal ulcer.
- 290 - 8. The combination of fusiform bacilli and spirochetes.
- 290 - 9. *T. microdentium* and *T. mucosum*.
- 291 - 1. Syphilis.
- 291 - 2. Through intimate contact, usually sexual. Infections may be transmitted occasionally through indirect means such as fomites (drinking cups, towels) when the time interval between contact with an individual is very short.
- 291 - 3. Through minute breaks.
- 291 - 4. The primary stage.
- 291 - 5. Skin lesions.
- 292 - 1. A spirochete having a flexible cylindrical body measuring 5 to 16 μm in length and possessing eight to fifteen spirals.
- 292 - 2. This is due to the greater density of the fluid caused by mucus present in the lesion.
- 292 - 3. The amount of protoplasm available for staining is so small that the necessary usual contrast is lacking.
- 292 - 4. Silver impregnation method; this technique is based on the coating of the surface of the treponeme with metallic silver to increase contrast.
- 292 - 5. Nigrosin or India ink.
- 292 - 6. Specific fluorescein-conjugated antisera.
- 292 - 7. The pathogenic treponemes have not been cultivated in the laboratory.
- 292 - 8. Bovine serum ultrafiltrate, pyruvate, albumin, and a sulfhydryl compound.
- 292 - 9. The *Treponema pallidum* inhibition test.
- 292 - 10. From infected rabbits, incubated with serum and complement.
- 292 - 11. Staining fluorescent antibody, serological reactions, and darkfield examinations.
- 293 - 1. The darkfield condenser provides scattered light that reflects off any object in the darkened field, producing bright objects against a black background.
- 293 - 2. If the patient has treated his lesion with a germicidal agent, examination must be deferred until all germicide has been removed by washing and several hours have elapsed.
- 293 - 3. To provoke a serum exudate.
- 293 - 4. A variety of saprophytic spirochetes are present.
- 294 - 1. An acute illness with febrile jaundice and nephritis.

## CHAPTER 6

- 294 - 2 From infected rodents by way of urine and tissues of the infected animals, or by exposure to urine contaminated water or soil.
- 294 - 3. The kidney, liver, meninges, and conjunctiva
- 294 - 4. *Icterohemorrhagiae*
- 294 - 5. *Leptospira interrogans*
- 295 - 1. The terminal third of the organism is quite flexible and often forms a hook
- 295 - 2 The organism is actively motile with a progressive undulating movement, and displays rapid spinning around its long axis.
- 295 - 3. Aerobic condition, 30° C.
- 295 - 4 Ten percent rabbit serum or serum albumin plus fatty acids.
- 295 - 5. Ranges from a few days to four weeks or longer, but usually 6 to 14 days.
- 295 - 6. Become faintly turbid.
- 296 - 1 Serological methods
- 296 - 2. Blood or urine.
- 296 - 3. Within a week.
- 296 - 4 Microscopic agglutination-lysis test, the genus-specific hemagglutination test, and the fluorescent antibody test.
- 296 - 5. The microscopic agglutination (agglutination-lysis).



	ESCHERICHIAE		EDWARD-SIELLAE	SALMONELLEAE				KLEBSIELLEA				KLEBSIELLEA			PROTEAE				YERSINIAE			ERWINIAE					
	ESCHERICHIA	SHIGELLA	EDWARD-SIELLA	SALMONELLA	ARIZONA	CITROBACTER		KLEBSIELLA FREUNDII	ENTEROBACTER				SERRATIA			PROTEUS				PROVIDENCIA			YERSINIA			ERWINIA (3)	PECTONIBACTERIUM (4)
			FREUNDII			DIVERSUS	CLOACAE		AEROGENES	HAFNIAE	AGGLOMERANS	MARCESCENS	LIQUEFACIENS	RUBIDAEA	VULGARIS	MIRABILIS	MORGANII	RETTGERI	ALCALIFACIENS	STUARTII	PESTIS (1)	PSEUDOTUBERCULOSIS (2)	ENTEROCOLITICA (2)				
Indole	+	-or+	+	-	-	-	+	-	-	-	-or+	-	-	-	+	-	+	+	+	-	-	(4)	-	-or+			
Methyl red	+	+	+	+	+	+	+	-or+	-	-	-or+	-or+	-or+	+	+	+	+	+	+	+	+	+	+	+	+		
Voges-Proskauer	-	-	-	-	-	-	-	+	+	+	+	+	+	+	-or+	-	-	-	-	-	-	-	-	-	-or+		
Simmons' citrate	-	-	-	d	+	+	+	+	+	d	d	+	+	+	+	+	+	+	+	+	+	+	+	+	d 35C +or(+) 25C		
Hydrogen sulfide (TSI)	-	-	+	+	+	+	+	-	-	-	-	-	-	-	+	+	-	-	-	-	-	-	-	-	-		
Urease	-	-	-	-(5)	-	d <sup>w</sup>	d <sup>w</sup>	d <sup>w</sup>	+	-	-	d	d <sup>w</sup>	d <sup>w</sup>	d <sup>w</sup>	+	+	+	+	+	+	+	+	+	d		
KCN	-	-	-	-	-	+	-	+	+	+	+	-or+	+	+	-or+	+	+	+	+	+	+	+	+	+	+		
Motility	+	-	+	+	+	+	+	-	+	+	+	+	+	+	+	+	+	+	+	+	+	+	+	+	+		
Gelatin (22°C)	-	-	-	-	(+)	-	-	-	(+)or-	-or+	-	d	+	+	+	-	-	-	-	-	-	-	-	-	-		
Lysine decarboxylase	d	-	+	+	+	-	-	+	-	+	+	-	+	+	+	+	+	+	+	+	+	+	+	+	-		
Arginine dihydrolase	d	d	-	+	+	d	+	+	+	+	+	-	-	-	-	-	-	-	-	-	-	-	-	-	-		
Ornithine decarboxylase	d	d(4)	+	+	+	d	+	-	+	+	+	-	+	-	-	-	-	-	-	-	-	-	-	-	-		
Phenylalanine deaminase	-	-	-	-	-	-	-	-	-	-	-	-or+	-	-	+	+	+	+	+	+	+	+	+	+	-		
Maltose	-	-	-	-	+	-or+	-or+	+	+	+	+	+	+	+	+	+	+	+	+	+	+	+	+	+	-		
Gas from glucose	+	-(6)	+	+	+	+	+	+	+	+	+	+	+	+	+	+	+	+	+	+	+	+	+	+	-or+ 35C d 25C		
Lactose	+	-(6)	-	-	d	(+)or+	d	+	+	+	+	+	+	+	+	+	+	+	+	+	+	+	+	+	d 35C +or(+) 25C		
Sucrose	d	-(6)	-	-	-	d	-or+	+	+	+	+	+	+	+	+	+	+	+	+	+	+	+	+	+	+		
Mannitol	+	+	-	+	+	+	+	+	+	+	+	+	+	+	+	+	+	+	+	+	+	+	+	+	+		
Dulcitol	d	d	-	d(8)	-	d	+	+	+	+	+	+	+	+	+	+	+	+	+	+	+	+	+	+	-		
Salicin	d	-	-	-	-	d	(+)or+	+	+	+	+	+	+	+	+	+	+	+	+	+	+	+	+	+	d 35C +25C		
Adonitol	-	-	-	-	-	-	+	+	+	+	+	+	+	+	+	+	+	+	+	+	+	+	+	+	-		
Inositol	-	-	-	d	-	-	+	+	+	+	+	+	+	+	+	+	+	+	+	+	+	+	+	+	-		
Sorbitol	d	d	-	+	+	+	+	+	+	+	+	+	+	+	+	+	+	+	+	+	+	+	+	+	-		
Arabinose	+	d	-or+	+(8)	+	+	+	+	+	+	+	+	+	+	+	+	+	+	+	+	+	+	+	+	+		
Raffinose	d	d	-	-	-	d	-	+	+	+	+	+	+	+	+	+	+	+	+	+	+	+	+	+	d 35C +or(+) 25C		
Rhamnose	d	d	-	+	+	+	+	+	+	+	+	+	+	+	+	+	+	+	+	+	+	+	+	+	d		

(1) Adapted from Sonnenwirth, A.C.: *Yersinia*. In Lemmetz, E.N., Spaulding, E.H., Truant, J.P., editors: Manual of clinical microbiology, ed. 2, Washington, D.C., 1974, American Society for Microbiology.

(2) Adapted from Darland, G., Brigg, V.N., and Davis, B.R.: The biochemical characteristics of *Yersinia enterocolitica* and *Yersinia tuberculosis*. DHEW publ. No. (CDC) 75-8294, Washington, D.C., 1974, Department of Health, Education, and Welfare.

(3) Adapted from Buchanan, R.A., and Gibbons, N.E., editors: Bergey's manual of determinative bacteriology, ed. 8, Baltimore, 1974, The Williams & Wilkins Co.

(4) Majority of strains isolated in the United States are indole positive, whereas most of the strains isolated in Europe have been indole negative.

(5) Rare exceptions.

(6) Certain biotypes of *S. flexneri* produce gas; cultures of *S. sonnei* ferment lactose and sucrose slowly and decarboxylate ornithine.

(7) Gas volumes produced by cultures of *Serratia*, *Proteus*, and *Providencia* are small.

(8) *S. typhi*, *S. enteritidis*, *blumer*, *Paratyphi-A* and *Fullerum* and a few others ordinarily do not ferment dulcitol promptly. *S. cholerae-suis* does not ferment arabinose. +, 90% or more positive in 1 or 2 days; -, 90% or more negative; d, different biochemical types [+ (+), - (-); (+), delayed positive (decarboxylase reactions, 3 or 4 days); + or -, majority of cultures positive; - or +, majority negative; w, weakly positive reaction. NB. This chart is simply a guide. Users are urged to consult other publications, such as CDC publications entitled "Biochemical Reactions Given by Enterobacteriaceae in Commonly used Tests" and "Differentiation of Enterobacteriaceae by Biochemical Reactions" (V.N. Brigg, 1973), for percentage data, additional tests, and references.

S T O P -

1. MATCH ANSWER SHEET TO THIS EXERCISE NUMBER.
2. USE NUMBER 2 PENCIL ONLY.

EXTENSION COURSE INSTITUTE  
VOLUME REVIEW EXERCISE

90412 02 22

LABORATORY PROCEDURES IN CLINICAL BACTERIOLOGY

Carefully read the following:

DO's:

1. Check the "course," "volume," and "form" numbers from the answer sheet address tab against the "VRE answer sheet identification number" in the righthand column of the shipping list. If numbers do not match, return the answer sheet and the shipping list to ECI immediately with a note of explanation.
2. Note that item numbers on answer sheet are sequential in each column.
3. Use a medium sharp #2 black lead pencil for marking answer sheet.
4. Write the correct answer in the margin at the left of the item. (When you review for the course examination, you can cover your answers with a strip of paper and then check your review answers against your original choices.) After you are sure of your answers, transfer them to the answer sheet. If you have to change an answer on the answer sheet, be sure that the erasure is complete. Use a clean eraser. But try to avoid any erasure on the answer sheet if at all possible.
5. Take action to return entire answer sheet to ECI.
6. Keep Volume Review Exercise booklet for review and reference.
7. If mandatorily enrolled student, process questions or comments through your unit trainer or OJT supervisor. If voluntarily enrolled student, send questions or comments to ECI on ECI Form 17.

DON'Ts:

1. Don't use answer sheets other than one furnished specifically for each review exercise.
2. Don't mark on the answer sheet except to fill in marking blocks. Double marks or excessive markings which overflow marking blocks will register as errors.
3. Don't fold, spindle, staple, tape, or mutilate the answer sheet.
4. Don't use ink or any marking other than a #2 black lead pencil.

NOTE: NUMBERED LEARNING OBJECTIVE REFERENCES ARE USED ON THE VOLUME REVIEW EXERCISE. In parenthesis after each item number on the VRE is the Learning Objective Number where the answer to that item can be located. When answering the items on the VRE, refer to the Learning Objectives indicated by these Numbers. The VRE results will be sent to you on a postcard which will list the actual VRE items you missed. Go to the VRE booklet and locate the Learning Objective Numbers for the items missed. Go to the text and carefully review the areas covered by these references. Review the entire VRE again before you take the closed-book Course Examination.

90412 02 22

## MULTIPLE CHOICE

Note to Student: Consider all choices carefully and select the best answer to each question.

1. (200) Staphylococcal food poisoning is caused by an exotoxin that is
  - a. heat labile.
  - b. an endotoxin.
  - c. heat stable.
  - d. destroyed by refrigeration.
2. (200) Acute symptoms of staphylococcal food poisoning that results from ingesting food containing significant amounts of staphylococcal exotoxin is caused by the toxin's
  - a. rapid deterioration in the intestinal mucosa.
  - b. rapid absorption in the intestinal mucosa.
  - c. rapid absorption in the stomach.
  - d. rapid deterioration in the stomach.
3. (201) Members of the genus Micrococcus may be distinguished from staphylococci by all of the following characteristics EXCEPT
  - a. anaerobic growth.
  - b. fermentation of lactose.
  - c. structural content of the cell wall.
  - d. the percentage of guanine plus cytosine content of the DNA.
4. (202) Concerning staphylococcus, smears from broth cultures are most likely to show
  - a. irregular clusters and diplobacilli.
  - b. long chains and diplobacilli.
  - c. short chains and diplococcal forms.
  - d. irregular clusters and diplococcal forms.
5. (202) Which two constituents are required for growth of Staphylococci spp. Under anaerobic conditions?
  - a. Uracil and cytosine.
  - b. Uracil and pyruvate.
  - c. Guanine and pyruvate.
  - d. Guanine and cytosine.
6. (203) Which two organisms may produce false-positive coagulase tests?
  - a. Pseudomonas and citrate utilizing enterococci.
  - b. Proteus and citrate utilizing enterococci.
  - c. Enterococci and citrate utilizing streptococci.
  - d. Enterococci and proteus.

90<sup>u</sup>12 02 22

7. (204) Which genera of the family Micrococcaceae is motile and will not ferment glucose?
- a. Micrococcus.
  - b. Staphylococcus.
  - c. Planococcus.
  - d. Aerococcus.
8. (205) Bacteriophage typing is based upon the identification of strains of Staphylococcus species by their
- a. susceptibility to lysis by different bacteriophages.
  - b. susceptibility to lysis by different antibodies.
  - c. agglutination by different bacteriophages.
  - d. agglutination by different antibodies.
9. (206) Which streptococci are frequently found in the urine of patients with urinary tract infection and in the blood of patients with bacterial endocarditis?
- a. Group A.
  - b. Group B.
  - c. Group C.
  - d. Group D.
10. (207) Virulence of the streptococcal organisms is indicated by the presence of
- a. glistening and moth forms.
  - b. mucoid and matt forms.
  - c. crenated and glistening forms.
  - d. circular and glistening forms.
11. (208) Which type of hemolysin is oxygen stable and is present in only small quantities in those strains that hemolyze the media surface poorly?
- a. Streptolysin O.
  - b. Streptolysin S.
  - c. Alpha toxin.
  - d. Beta toxin.
12. (209) Which type of hemolysis does the enterococcus group yield on blood agar?
- a. Beta.
  - b. Alpha.
  - c. Gamma.
  - d. Variable.
13. (209) The fact that the streptococci multiply in broth containing 6.5 percent sodium chloride and are resistant to most antimicrobial agents indicates the presence of
- a. Group A.
  - b. Group B.
  - c. Group C.
  - d. Group D.

90412 02 22

14. (210) Hydrolysis of sodium hippurate by some streptococci yields an end product of
- a. oxidase.
  - b. benzoic acid.
  - c. ferric chloride.
  - d. streptokinase.
15. (211) The purpose of the bacitracin disc test is to distinguish between Lancefield's Group A and
- a. Streptococcus pneumoniae.
  - b. Streptococcus agalactiae.
  - c. other groups of the beta hemolytic streptococci.
  - d. other groups of pneumococcus type III colonies.
16. (212) Which of the following species of streptococcal organisms does NOT normally produce alpha hemolysis?
- a. Streptococcus pyogenes.
  - b. Streptococcus sanguis.
  - c. Streptococcus salivarius.
  - d. Streptococcus mitis.
17. (213) Pneumococci are the cause of approximately what percent of lobar pneumonia and roughly what percent of bronchial pneumonia in man?
- a. 50 percent; 1.5 percent respectively.
  - b. 80 percent; 1.5 percent respectively.
  - c. 80 percent; 20 percent respectively.
  - d. 20 percent; 80 percent respectively.
18. (214) The presence of a capsule is revealed in the gram-stained smears for pneumococcus as
- a. a central swelling of the cell when observed under reduced light.
  - b. a thick halo around the cell.
  - c. capsular swelling around the cell.
  - d. cellular agglutination.
19. (215) Two significant characteristics noted in most pathogenic strains of pneumococci are that they form the
- a. M colony and are encapsulated.
  - b. S colony and are encapsulated.
  - c. S colony and show no capsules.
  - d. M colony and show no capsules.
20. (215) Which type of hemolysis is usually observed with pneumococcus-suspected colonies that are incubated aerobically?
- a. Alpha hemolysis.
  - b. Alpha hemolysis due to oxygen labile pneumolysin O.
  - c. Beta hemolysis due to oxygen labile pneumolysin O.
  - d. Beta hemolysis.

90412 02 22

21. (216) Which test is currently the most widely used to differentiate pneumococci from alpha streptococci?
- a. Bile solubility.
  - b. Taxo A.
  - c. Optochin disc sensitivity.
  - d. Neufeld-Quellung reaction.
22. (216) In which of the following tests for pneumococcal identification will sodium deoxycholate act upon the cell wall of pneumococci and result in lysis of the cell?
- a. Animal inoculation.
  - b. Neufeld-Quellung.
  - c. Bile solubility.
  - d. Optochin disc sensitivity.
23. (217) In clinically typical diphtheria, which specimen(s) will yield large amounts of the characteristic bacilli upon direct microscopic examination of smears?
- a. Skin lesions.
  - b. Skin lesions and wounds.
  - c. Nasal lesions and wounds.
  - d. Lesions and pseudomembranes in the throat.
24. (218) Which stain is used to demonstrate the characteristic appearance of corynebacteria?
- a. Giemsa
  - b. Wright.
  - c. Kinyoun carbolfuchsin.
  - d. Leoffler's alkaline methylene blue.
25. (218) Compared with *Corynebacterium diphtheriae*, *Corynebacterium pseudodiphtheriticum* shows which combination of morphological characteristics?
- a. Longer and slender, with tapered ends, in irregular groups or parallel rows.
  - b. Longer and slender, with rounded ends, in irregular groups or parallel rows.
  - c. Shorter and thicker, with rounded ends, in irregular groups or parallel rows.
  - d. Shorter and thicker, with tapered ends, in palisades, and occasional L-V- or Y-branching forms.
26. (219) Even though *C. haemolyticum* is morphologically similar to *C. diphtheriae*, it can be readily differentiated by which two characteristics?
- a. Cultural and serological.
  - b. Cultural and toxigenicity tests.
  - c. Biochemical and serological.
  - d. Biochemical and cultural.

90412 02 22



27. (220) The one reliable criterion for identifying a diphtheria bacillus is based on which characteristic?
- The presence of capsular swelling.
  - The presence of Babes-Ernst granules.
  - The ability to produce diphtheria toxins.
  - The ability to produce diphtheria antitoxins.
28. (220) In the in vitro toxigenicity test, a sterile filter paper added to serum medium mixture has been immersed in a tube containing
- diphtheria toxin.
  - diphtheria antitoxin.
  - a suspension of viable organisms.
  - a suspension of killed organisms.
29. (221) Listeria monocytogenes grow well on sheep blood agar medium and produce
- alpha hemolysis.
  - gamma hemolysis.
  - alpha-prime hemolysis.
  - beta hemolysis.
30. (221) Colonies of Listeria monocytogenes are recognized by their blue-green color as seen with oblique light on
- potassium tellurite agar.
  - tryptose agar.
  - blood agar.
  - motility test medium.
31. (222) Which two organisms produce catalase?
- Listeria monocytogenes and Corynebacterium ssp.
  - Erysipelothrix rhusiopathiae and Streptococcus foecalis.
  - Listeria monocytogenes and Erysipelothrix insidiosa.
  - Corynebacterium acnes and Erysipelothrix insidiosa.
32. (223) After prolonged incubation, many colonies of Erysipelothrix insidiosa will produce
- Alpha hemolysis on blood agar.
  - Beta hemolysis on blood agar.
  - Gamma hemolysis on artificial media.
  - Alpha-prime hemolysis on artificial media.
33. (223) The most clear-cut differential criterion for identification of Erysipelothrix is a negative reaction on
- Glucose.
  - Lactose.
  - H<sub>2</sub> in TSI.
  - Catalase.

90412 02 22

34. (224) The capsule of Bacillus anthracis differs from the polysaccharide capsule of most other bacteria in that the capsule of Bacillus anthracis is
- more resistant to autoclaving.
  - not visible when stained with a capsule stain.
  - composed of a polypeptide.
  - not apparently associated with virulence.
35. (225) Bacillus anthracis differ from saprophytic forms in that Bacillus anthracis possess which of the following characteristics?
- Capsulated and nonmotile.
  - Capsulated and motile.
  - FA antibody test negative and motile.
  - FA antibody test negative and no capsule.
36. (225) After 18 to 24 hours incubation, typical colonies of the anthrax bacillus will show which of the following characteristics on sheep blood agar?
- 2mm to 3mm in diameter, gray-white, opaque, and dull, with irregular edges and "frosted glass" appearance.
  - 4mm to 6mm in diameter, gray-white, glistening and smooth edges.
  - 2mm to 3mm in diameter, gray-white, glistening and smooth edges.
  - 4mm to 6mm in diameter, gray-white, opaque, and dull, with complete margins and "frosted glass" appearance.
37. (226) If Bacillus anthrax organisms are to be examined by the fluorescent antibody technique, on what media must the organisms be grown and for what purpose?
- Sheep blood agar plates under a CO<sub>2</sub> atmosphere to allow capsules to diminish.
  - Sodium bicarbonate media under a CO<sub>2</sub> atmosphere to allow the capsules to develop.
  - Sodium bicarbonate media under a CO<sub>2</sub> atmosphere to allow the capsules to diminish.
  - Sheep blood agar plates under a CO<sub>2</sub> atmosphere to allow capsules to develop.
38. (227) Which of the following organisms of Clostridium spp. is the most frequent cause of clostridial myonecrosis?
- Clostridium perfringens.
  - Clostridium tetani.
  - Clostridium septicum.
  - Clostridium novyi.

90412 02 22

39. (228) The rapidly absorbed toxins of Clostridium tetani act on
- epithelial and connective tissue.
  - the spinal cord and peripheral motor nerve endings.
  - adipose and periodontal tissue.
  - lymph nodes and soft bone.
40. (229) The majority of Clostridia are motile. Which of the following species is nonmotile?
- Clostridium tetani.
  - Clostridium botulinum.
  - Clostridium septicum.
  - Clostridium perfringens.
41. (230) The characteristic type of hemolysis produced by Clostridium perfringens is due to
- a narrow zone of complete hemolysis due to the theta toxin and a wider zone due to the alpha toxin.
  - a narrow zone of complete hemolysis due to the alpha endotoxin and a wider zone due to the theta exotoxin.
  - a wider zone of complete hemolysis due to the theta toxin and a narrow zone due to the alpha toxin.
  - a wider zone of complete hemolysis due to alpha endotoxin and a narrow zone due to the theta exotoxin.
42. (230) Members of the genus Clostridium may be tentatively identified on the basis of all of the following except
- colony morphology.
  - microscopic morphology.
  - strict anaerobiosis.
  - capsule formation.
43. (231) Ophthalmia neonatorum, an eye infection of the newborn, is usually caused by
- Neisseria flava.
  - Neisseria cabiae.
  - Neisseria gonorrhoeae.
  - Neisseria meningitidis.
44. In male patients, when there is no urethral discharge at the time of examination or the patient is asymptomatic, the specimen is obtained from
- the foreskin.
  - the scrotum.
  - the urethral canal.
  - penile lesions.
45. (232) When specimens such as a spinal fluid, blood, material from petechial skin lesions, fluid aspirated from joints, pus, and nasopharyngeal or throat swabs are cultured for Neisseria meningitidis and are expected to contain a mixed flora, which of the following media would most likely be used?
- Blood agar.
  - Enriched chocolate agar.
  - Thayer-Martin.
  - Mueller-Hinton.

90412 02 22

46. (233) The oxidate test to detect oxidase positive organisms utilizes a bacteria which oxidizes the reagent dye. Which respiratory enzyme does this bacteria produce?
- Peroxidaze.
  - Hydrogenase.
  - Cytochrome oxidase.
  - Indol phenol oxidase.
47. (233) Which characteristic reaction is produced by Neisseria gonorrhoeae on CTA?
- Glucose fermented, producing acid with no gas.
  - Glucose not fermented, acid and gas produced.
  - Sucrose fermented, producing acid with no gas.
  - Sucrose not fermented, acid and gas produced.
48. (234) Which organisms is small, gram-negative, 0.3 to 0.4  $\mu\text{m}$ , and anaerobic?
- Neisseria meningitidis.
  - Acinetobacter calcoaceticus.
  - Veillonella alcalescens.
  - Haemophilus ducreyi.
49. (235) Which reaction best describes the type of hemolysis produced by most varieties of Acinetobacter calcoaceticus?
- Intermediate, or partial.
  - Definite zones of beta hemolysis.
  - Clear, sharp, well defined zones of alpha-prime hemolysis.
  - Definite zones of alpha-prime hemolysis.
50. (236) Which organism will not grow on Mac Conkey agar?
- M. nonliquefaciens.
  - M. phenylpyruvia.
  - M. osloensis.
  - M. bovis.
51. (237) Membrane-bounded cells of Mycoplasma spp. appear as
- bacillary bodies, filamentous and star-shaped forms.
  - coccoid bodies, filamentous and star-shaped forms.
  - bacillary bodies, spirochetal and star-shaped forms.
  - coccoid bodies, spirochetal and flagellated forms.
52. (238) Most species of Mycoplasma are classified as facultative anaerobes. Mycoplasma growth occurs best in
- an anaerobic environment.
  - an aerobic environment.
  - a 20 percent reduced oxygen intension environment.
  - a 30 percent reduced oxygen intension environment.

90412 02 22

53. (239) Plates examined for M. pneumoniae should be held for
- a. 5 days.
  - b. 10 days.
  - c. 20 days.
  - d. 30 days.
54. (240) Which biochemical test provides a reliable means of separating P. multocida from Yersinia, and which group of organisms produces a positive test?
- a. Oxidase, P. multocida.
  - b. Catalase, Yersinia.
  - c. B-D-galactosidase test (ONPG), Yersinia.
  - d. Methyl red and Voges-Proskauer, P. multocida.
55. (241) Which technique is considered to be the best tool for rapid and specific identification of F. tularensis?
- a. Serological.
  - b. Biochemical.
  - c. Cultural and isolation.
  - d. Fluorescent-antibody.
56. (242) When a sharp increase in the yield of Haemophilus results from the addition of 300 µg of bacitracin disc to a chocolate agar plate, the bacitracin disc
- a. provides X factor necessary for Haemophilus.
  - b. suppresses the growth of other organisms.
  - c. provides V factor necessary for Haemophilus.
  - d. suppresses the growth of Haemophilus spp.
57. (243) Which organism is associated with the highly communicable form of conjunctivitis known as pink eye?
- a. H. aphrophilus.
  - b. H. ducreyi.
  - c. H. haemolyticus.
  - d. H. aegyptius.
58. (243) Which organism grows on meat infusion or blood-enriched medium with increased CO<sub>2</sub>, and for which primary isolation may be very difficult?
- a. H. aegyptius.
  - b. H. ducreyi.
  - c. H. influenzae.
  - d. H. haemolyticus.
59. (244) Bordetella pertussis will possess which two characteristics?
- a. Sporeforming and motile.
  - b. Sporeforming and nonmotile.
  - c. Nonsporeforming and nonmotile.
  - d. Nonsporeforming and motile.

90412 02 22

60. (244) The specimen of choice for isolation of Bordetella pertussis is
- a. urine.
  - b. blood.
  - c. a swab from skin lesions.
  - d. a nasopharyngeal swab.
61. (245) Bordetella bronchiseptica differs from Bordetella pertussis in that B. bronchiseptica is
- a. nonmotile and possesses peritrichous flagella.
  - b. motile and possesses peritrichous flagella.
  - c. motile and does not possess peritrichous flagella.
  - d. nonmotile and does not possess peritrichous flagella.
62. (246) The incidence of brucellosis is high among all of the following occupational groups except
- a. slaughter house attendants.
  - b. veterinarians.
  - c. laboratory technicians.
  - d. dairymen.
63. (247) The specimen of choice for isolating Brucellae organisms from an infected person is
- a. a nasopharyngeal swab.
  - b. urine.
  - c. infected tissue and exudate.
  - d. blood taken during the febrile stages.
64. (247) For how many days should the primary Brucellae cultures be incubated before the specimen is reported as negative?
- a. 7.
  - b. 14.
  - c. 21.
  - d. 28.
65. (248) Which Actinobacillus spp. is considered to be primarily associated with human diseases?
- a. equuli.
  - b. lignieresii.
  - c. suis.
  - d. actinomycetemcomitans.

90412 02 22



66. (249) Which staining technique may be used to demonstrate the capsules of Calymmatobacterium granulomatis in large mononuclear white cells, and how do they appear?
- Gram stain; gram positive bacilli surrounded by a well-defined, pink capule.
  - Wright's stain; blue bacilli surrounded by a well-defined, dense, pink capule.
  - Gram stain; blue bacilli surrounded by a well-defined dense, pink capule.
  - Wright's stain; pink cocobacilli surrounded by a well-defined, dense, pink capule.
67. (249) Two specimens of choice for the isolation of Legionella pneumophila are
- sputum and cerebrospinal fluid.
  - urine and cerebrospinal fluid.
  - transtracheal aspirates and urine.
  - pleural fluid and transtracheal aspirates.
68. (250) In broth media, growth of Streptobacillus moniliformis occurs at which part of the media, and with which characteristic appearance?
- Top; filamentous and stringy.
  - Bottom; filamentous and stringy.
  - Bottom; small white "fluff balls".
  - Top; small white "fluff balls".
69. (251) Which Bacteriodes spp. is most frequently isolated from clinical infections?
- |                       |                             |
|-----------------------|-----------------------------|
| a. <u>corrodens</u> . | c. <u>fragilis</u> .        |
| b. <u>oralis</u> .    | d. <u>melaninogenicus</u> . |
70. (252) Which condition is least caused by organisms of the family Enterobacteriaceae?
- |                      |                              |
|----------------------|------------------------------|
| a. Wound infections. | c. Urinary tract infections. |
| b. Meningitis.       | d. Undulant fever.           |
71. (253) The genus Yersinia is included in the family Enterobacteriaceae on the basis of which two characteristics and reactions?
- Morphological and cultural.
  - Morphological and biochemical.
  - Biochemical and cultural.
  - Biochemical and serological.

90412 02 22

72. (254) Members of Enterobacteriaceae do not
- produce positive indol or liquefy gelatin.
  - produce indol phenol oxidase or liquefy alginate.
  - form gas during glucose fermentation.
  - produce acid with glucose fermentation.
73. (255) Which broth would not be considered when primary inoculation to an enrichment media is required for Enterobacteriaceae?
- GN.
  - Selenite.
  - Tetrathionate.
  - Brain heart infusion.
74. (255) In attempting to isolate enteropathogenic E. coli, Klebsiella, Enterobacter or Citrobacter from stool samples, the use of tetrathionate and selenite broths is NOT recommended because these broths
- provide too much enrichments to these stains.
  - suppress growths of contaminating forms of these stains.
  - are inhibitory to most strains of these genera.
  - are inhibitory to most contaminating forms.
75. (256) Which organism produces a positive Voges-Proskauer reaction?
- Salmonella typhi.
  - Proteaa.
  - Klebsiella.
  - Escherichiae.
76. (257) In contrast to K. pneumoniae, E. aerogenes have which three characteristics and reactions?
- Usually motile, liquefy gelatin, and not as distinctly capsulated.
  - Usually nonmotile, sucrose positive, and not as distinctly capsulated.
  - Liquefy gelatin, gas from glucose, and more distinctly capsulated.
  - Liquefy gelatin, mannitol positive, and more distinctly capsulated.
77. (258) Most species of Enterobacter will ferment lactose rapidly. Which species is an exception?
- Aerogenes.
  - Hafniae.
  - Agglomerans.
  - Cloacae.
78. (259) The chromogenic strains of Serratia marcescens show which of the following characteristics?
- Brown, water-soluble pigment at room temperature.
  - Red, water-soluble pigment at 35°C or above.
  - Red, non-water-soluble pigment at room temperature.
  - Brown, non-water-soluble pigment at 35°C or above.

90412 02 22

79. (260) Although members of the genera Proteus and Providencia are closely related, they can be easily separated on the basis of which biochemical test?
- Urease.
  - Motility.
  - Malonate.
  - Phenylalanine deaminase.
80. (260) One important use of the Proteus antigens is in the diagnosis of
- rickettsial diseases.
  - viral diseases.
  - bacterial diseases.
  - protozoal diseases.
81. (261) Providencia may be differentiated from Shigellae by which two characteristics?
- Positive motility and ability to utilize citrate.
  - Positive motility and ability to hydrolyze urea.
  - Positive Voges-Proskauer and ability to hydrolyze urea.
  - Positive Voges-Proskauer and ability to liquefy gelatin.
82. (262) The production of H<sub>2</sub>S may cause colonies of Edwardsiella tarda to be confused with enteric pathogens of the genus
- Salmonella.
  - Shigella.
  - Escherichia.
  - Citrobacter.
83. (263) The genus Arizona shares some biochemical characteristics and a number of antigens with
- Shigella.
  - Enterobacter.
  - Salmonella.
  - Edwardsiella.
84. (264) Escherichiae may be differentiated from other members of Enterobacteriaceae by which of the following characteristics?
- Slow fermentation of lactose with acid and gas, and response to IMViC tests (++).
  - Rapid fermentation of lactose with acid and gas, and response to IMViC tests (++).
  - No fermentation of lactose without acid or gas, and response to IMViC tests (++).
  - No fermentation of lactose without acid or gas, and response to IMViC tests (++).
85. (265) Which of the toxins produced by Escherichia coli have been definitely shown to cause disease in humans?
- Heat stable and nonantigenic (ST).
  - Heat stable exotoxins.
  - Heat labile exotoxins.
  - Heat labile and antigenic (LT).

90412 02 22

86. (266) Most Shigella are nonmotile, do not produce H<sub>2</sub>S, and do not produce gas during carbohydrate fermentation. An exception is
- Shigella dysenteriae.
  - Shigella boydii.
  - Shigella sonnei.
  - Shigella flexneri.
87. (267) In the U.S. the percentages of Shigella isolates that are *S. sonnei* and *S. flexneri*, respectively, are
- 85 percent and 14 percent.
  - 85 percent and 24 percent.
  - 65 percent and 14 percent.
  - 65 percent and 24 percent.
88. (268) The salmonellas, with the exception of a rare isolate, DO NOT ferment
- Trehalose.
  - Arabinose.
  - Glucose.
  - Lactose.
89. (269) Salmonella may be present as any of the listed distinct entities except
- gastroenteritis.
  - septicemia.
  - enteric fever.
  - bacillary dysentery.
90. (270) A presumptive diagnosis of plague may be made from a positive fluorescent test of animal tissue and young cultures when morphological forms of which structures are demonstrated?
- Spores.
  - Coccioid.
  - Filamentous.
  - Capsules.
91. (271) Which causative agent of yersiniosis is frequently overlooked because the biochemical reactions resemble those members of the family Enterobacteriaceae?
- Yersinia pestis.
  - Yersinia enterocolitica.
  - Yersinia pseudotuberculosis.
  - Pasteurella tularensis.
92. (272) One would least expect to isolate Achromobacter species from
- urine.
  - the respiratory tract.
  - market fruits and vegetables.
  - cerebrospinal fluid.

90412 02 22

93. (273) The characteristic blue-green color produced by colonies of Pseudomonas aeruginosa is a result of
- melanins.
  - lipochrome pigments.
  - carotenoid pigments.
  - pyocyanin and fluorescein.
94. (273) The disease meliodosis, an endemic glanders-like disease in man, is caused by
- Pseudomonas aeruginosa.
  - Pseudomonas fluorescens.
  - Pseudomonas pseudomallei.
  - Pseudomonas mallei.
95. (273) Pseudomonas pseudomallei may be cultivated on all of the following except
- trypticase soy agar.
  - blood agar.
  - MacConkey agar.
  - SS agar.
96. (274) Aeromonads are differentiated from Enterobacteriaceae in that they possess
- a single polar flagellum and produce a positive indol-phenol-oxidase reaction.
  - a single polar flagellum and produce a negative indol-phenol-oxidase reaction.
  - peritrichous flagella and produce a positive indol-phenol-oxidase reaction.
  - peritrichous flagella and produce a negative indol-phenol-oxidase reaction.
97. (275) Carefully prepared stained smears of Vibrio cholerae will reveal
- coccobacillary rods.
  - filamentous rods.
  - slightly curved rods.
  - encapsulated rods.
98. (275) Which selective medium is used for isolation of Vibrio cholerae?
- Taurocholate gelatin agar (TGA).
  - Alkaline peptone water.
  - Thioglycollate broth.
  - Thiosulfate-citrate-bile salt-sucrose agar (TCBS).
99. (276) Which transport medium has been recommended for feces and rectal swabs in the isolation of Vibrio parahaemolyticus?
- Cary-Blair or Amies'.
  - Stuart.
  - Charcoal.
  - Selinite.

90412 02 22

100. (277) In which method for identification of Enterobacteriaceae are viable cells introduced into small plastic capsules to which water has been added to provide humidity for a specified number of hours?
- Minitek System (BBL).
  - The R/B System.
  - API System (Analytab Products Inc).
  - Enterotube System.
101. (278) The causative organism of leprosy in humans is
- Mycobacterium lepraemurium.
  - Mycobacterium leprae.
  - Mycobacterium tuberculosis.
  - Actinomyces bovis.
102. (279) Which two organisms are considered to be the principal agents of tuberculosis in man?
- Mycobacterium tuberculosis and Mycobacterium bovis.
  - Mycobacterium tuberculosis and Mycobacterium gordonal.
  - Mycobacterium bovis and Mycobacterium avium.
  - Mycobacterium bovis and Kansasii.
103. (280) How is the bovine tubercle bacilli affected by glycerol, and how do the species appear of glycerol agar?
- Colony growth is enhanced by glycerol, and the colonies are smaller than the human species.
  - Colony growth is limited by glycerol, and the colonies are smaller than the human species.
  - Colony growth is not affected by glycerol, and the colonies are larger than the human species.
  - Colony growth is not affected by glycerol, and the colonies are larger than the human species.
104. (281) "Tap water" scotochromogen, which is isolated from laboratory water stills, faucets, soil, and natural waters, is classified as
- Mycobacterium scrofulaceum.
  - Mycobacterium intracellulare.
  - Mycobacterium gordonae.
  - Atypical mycobacteria.
105. (282) In reporting acid-fast bacilli as recommended by the American Thoracic Society of the American Lung Association, you would report ten or more cells per slide as
- "Few bacilli seen."
  - "Rare bacilli seen."
  - "Numerous bacilli seen."
  - "Resubmit another specimen."

90412 02 22



106. (282) Which colony characteristics would be expected of the human tubercle bacillus on Lowenstein-Jensen medium?
- Smooth, moist glistening slant.
  - Smooth, domed to spreading yellow colonies.
  - Dry, to smooth, opaque variation on slant.
  - Dry, nodular, rough, "cauliflower" growth.
107. (283) Most mycobacterial pathogens may be identified by all of the following properties EXCEPT
- rate of growth.
  - pigmentation.
  - colony morphology.
  - strict anaerobiosis.
108. (284) A medium containing 0.001M tripotassium phenolphthalein disulfate would most likely be used to test for
- arylsulfatase.
  - tween 80 hydrolysis.
  - tellurite reduction.
  - nitrate reduction.
109. (285) In direct tubercle bacilli susceptibility testing, the dilution is dependent upon the
- number of organisms seen on the smear under oil immersion.
  - number of organisms seen on the smear under high power.
  - quantity and thickness of the spectrum submitted.
  - sources of the specimen.
110. (285) In direct tubercle bacilli susceptibility testing, plates are incubated at which temperature, which environment, and how often are they read?
- 37°C; 5 to 10 percent CO<sub>2</sub>; weekly for 8 weeks.
  - 37°C; 5 to 10 percent CO<sub>2</sub>; weekly for 3 weeks.
  - 25°C; 5 to 5 percent CO<sub>2</sub>; weekly for 8 weeks.
  - 25°C; 5 to 5 percent CO<sub>2</sub>; weekly for 3 weeks.
111. (286) Members of the family Spirochaetaceae are best stained with
- Ziehl-Neelson stain.
  - Gram stain.
  - Fluorochrome or modified Kinyoun stain.
  - Giemsa or silver impregnation stain.
112. (287) Borrelia recurrentis causes relapsing fever that is transmitted
- by ticks.
  - by arthropods.
  - by rodent bites.
  - through polluted drinking water.

90412 02 22

113. (288) The spirochetes of Borrelia species, when Gram stained, will appear
- a. gram-negative.
  - b. gram-positive.
  - c. gram-variable.
  - d. unrelated.
114. (289) Under what growth environment is Borrelia expected to survive?
- a. Aerobic.
  - b. Microaerophilic.
  - c. Facultatively anaerobic.
  - d. Strictly anaerobic.
115. (290) The disease Vincent's angina or "trench mouth" is caused by Bacteriodes melaninogenicus and
- a. Borrelia recurrentis.
  - b. Treponema vincentii.
  - c. Treponema mucosum.
  - d. Treponema vaccinae.
116. (291) During secondary syphilis, the most logical place to isolate Treponema pallidum would be the
- a. skin lesions that make up the rash.
  - b. urethra.
  - c. chancre.
  - d. bloodstream.
117. (292) Which test for pathogenic treponemes is based upon the use of in vitro survival of organisms in suspension?
- a. Treponema pallidum inhibition test.
  - b. VDRL.
  - c. Direct Fluorescent Antibody test for T. pallidum (DTATP).
  - d. Fluorescent Treponemal Antibody-Absorption (FTA-ABS).
118. (293) In the collecting of a specimen for a darkfield examination, primary lesions are mildly traumatized in order to
- a. obtain a small hemorrhage.
  - b. provoke the surface tension.
  - c. obtain more pus cells.
  - d. provoke a serum exudate.
119. (294) Which serotype of Leptospira causes a severe illness referred to as Weil's disease or infectious jaundice?
- a. Leptospira icterohemorrhagiae.
  - b. Leptospira autumnalis.
  - c. Leptospira canicola.
  - d. Leptospira ballum.

90412 02 22

120. (295) Leptospiral forms will grow best at which specified cultural environment and temperature?
- a. Anaerobic; 37°C.
  - b. Aerobic; 37°C.
  - c. Aerobic; 30°C.
  - d. Anaerobic; 30°C.
121. (296) Which specimen(s) is/are required for culture of Leptospira interrogans?
- a. Sputum.
  - b. Gastric washing.
  - c. Blood or urine.
  - d. Bronchial exudates or secretion.
122. (296) Which serological technique, used for the detection of leptospiral antibodies, is considered to be the most useful strain-specific test?
- a. Microscopic agglutination-lysis.
  - b. The genus-specific hemagglutination.
  - c. The fluorescent antibody test.
  - d. The Direct Fluorescent Antibody test.

90412 02 22

**STUDENT REQUEST FOR ASSISTANCE**

PRIVACY ACT STATEMENT

AUTHORITY: 44 USC 3101. PRINCIPAL PURPOSE(S): To provide student assistance as requested by individual students. ROUTINE USES: This form is shipped with every ECI course package. It is utilized by the student, as needed, to place an inquiry with ECI. DISCLOSURE: Voluntary. The information requested on this form is needed for expeditious handling of the student's need. Failure to provide all information would result in slower action or inability to provide assistance.

**SECTION I: CORRECTED OR LATEST ENROLLMENT DATA:** MAIL TO: ECI, GUNTER AFB, ALA 36118

1. THIS REQUEST CONCERNS COURSE <input style="width:100%; height:20px;" type="text"/>	2. TODAY'S DATE <input style="width:100%; height:20px;" type="text"/>	3. ENROLLMENT DATE <input style="width:100%; height:20px;" type="text"/>	4. PREVIOUS SERIAL NUMBER <input style="width:100%; height:20px;" type="text"/>
5. SOCIAL SECURITY NUMBER <input style="width:100%; height:20px;" type="text"/>	6. GRADE/RANK <input style="width:100%; height:20px;" type="text"/>	7. INITIALS <input style="width:100%; height:20px;" type="text"/>	LAST NAME <input style="width:100%; height:20px;" type="text"/>
8. OTHER ECI COURSES NOW ENROLLED IN <input style="width:100%; height:40px;" type="text"/>	9. ADDRESS: (OJT ENROLLEES - ADDRESS OF UNIT TRAINING OFFICE/ALL OTHERS - CURRENT MAILING ADDRESS) <input style="width:100%; height:30px;" type="text"/> <input style="width:100%; height:30px;" type="text"/> <input style="width:100%; height:30px;" type="text"/>		11. AUTOVON NUMBER <input style="width:100%; height:20px;" type="text"/>
	10. NAME OF BASE OR INSTALLATION IF NOT SHOWN ABOVE: <input style="width:100%; height:20px;" type="text"/>	12. TEST CONTROL OFFICE ZIP CODE/SHRED <input style="width:100%; height:20px;" type="text"/>	

**SECTION II: Old or INCORRECT ENROLLMENT DATA**

1. NAME:	2. GRADE/RANK:	3. SSAN:
4. ADDRESS:	5. TEST OFFICE ZIP/SHRED:	

**SECTION III: REQUEST FOR MATERIALS, RECORDS, OR SERVICE**

ADDITIONAL FORMS 17 available from trainers, OJT and Education Offices, and ECI. The latest course workbooks have a Form 17 printed on the last page.

(Place an "X" through number in box to left of service requested)

1	EXTEND COURSE COMPLETION DATE. (Justify in Remarks)
2	SEND VRE ANSWER SHEETS FOR VOL(s): 1 2 3 4 5 6 7 8 9 - ORIGINALS WERE: NOT RECEIVED, LOST, MISUSED
3	SEND COURSE MATERIALS (Specify in remarks) - ORIGINALS WERE: NOT RECEIVED, LOST, DAMAGED.
4	COURSE EXAM NOT YET RECEIVED. FINAL VRE SUBMITTED FOR GRADING ON (Date):
5	RESULTS FOR VRE VOL(s): 1 2 3 4 5 6 7 8 9 NOT YET RECEIVED. ANSWER SHEET(S) SUBMITTED ON (Date):
6	RESULTS FOR CE NOT YET RECEIVED. ANSWER SHEET SUBMITTED TO ECI ON (Date):
7	PREVIOUS INQUIRY (ECI FORM 17, LTR, MSG) SENT TO ECI ON:
8	GIVE INSTRUCTIONAL ASSISTANCE AS REQUESTED ON REVERSE:
9	OTHER (Explain fully in remarks)
REMARKS: (Continue on Reverse)	

OJT STUDENTS must have their OJT Administrator certify this request.  
ALL OTHER STUDENTS may certify their own requests.

I certify that the information on this form is accurate and that this request cannot be answered at this station. (Signature)



**SECTION IV: REQUEST FOR INSTRUCTOR ASSISTANCE**

**NOTE:** Questions or comments relating to the accuracy or currency of textual material should be forwarded directly to preparing agency. Name of agency can be found at the bottom of the inside cover of each text. All other inquiries concerning the course should be forwarded to ECI.

VRE ITEM QUESTIONED:

MY QUESTION IS:

Course No. \_\_\_\_\_

Volume No. \_\_\_\_\_

VRE Form No. \_\_\_\_\_

VRE Item No. \_\_\_\_\_

Answer You Chose  
(Letter) \_\_\_\_\_

Has VRE Answer Sheet  
been submitted for grading?

YES  NO

**REFERENCE**

(Textual support for the  
answer I chose can be  
found as shown below)

In Volume No: \_\_\_\_\_

On Page No: \_\_\_\_\_

In \_\_\_\_\_ (Left) \_\_\_\_\_ (Right)  
Column

Lines \_\_\_\_\_ Through \_\_\_\_\_

Remarks:

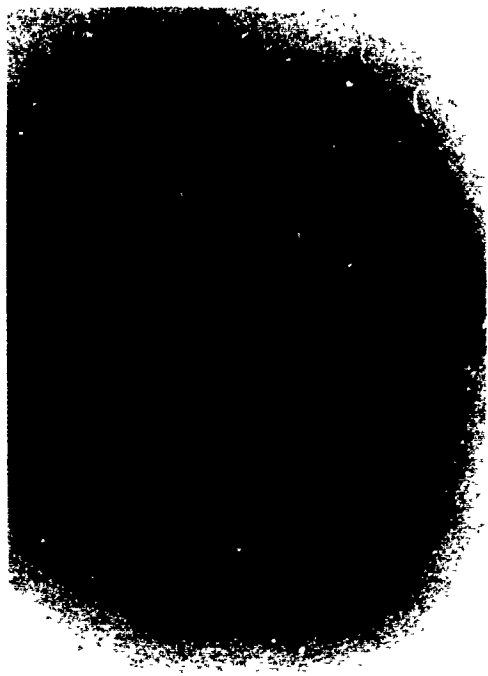

(L) *ESCHERICHIA COLI*  
Culture on MacConkey's agar.



(M) *ESCHERICHIA COLI*  
Culture on EMB agar.



Discrete Colonies



Swarming Colonies

(N) *PROTEUS SPECIES* - On blood agar

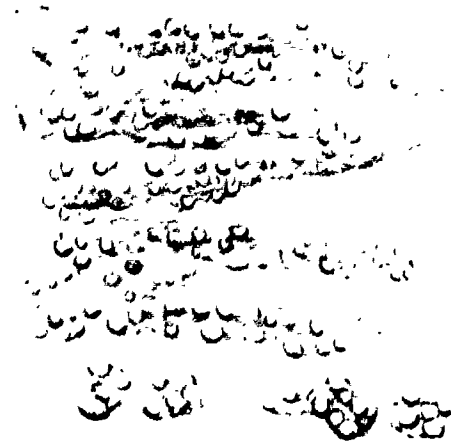

(P) *PSEUDOMONAS AERUGINOSA*  
Culture on Mueller-Hinton agar.

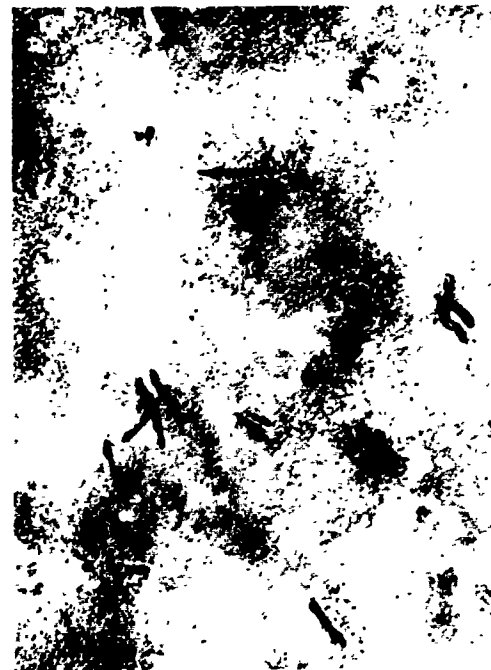

(Q) *MYCOBACTERIUM TUBERCULOSIS*  
Smear of concentrated sputum specimen stained with Ziehl-Neelsen acid-fast stain.

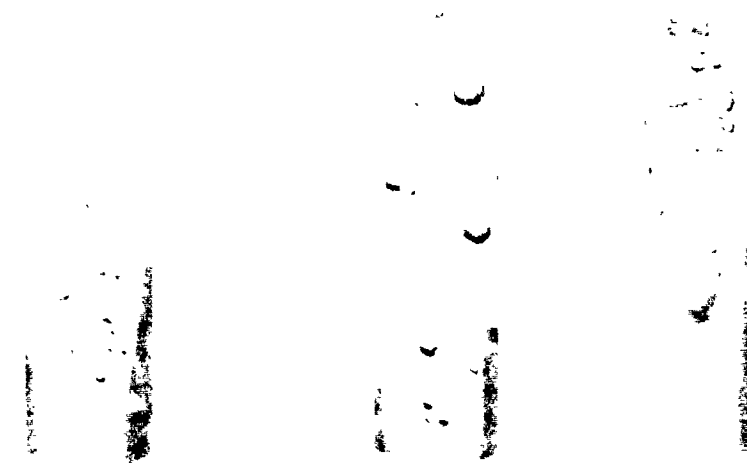

(R) *MYCOBACTERIUM TUBERCULOSIS*  
Human type Cultures of concentrated sputum specimen on Lowenstein Jensen medium

(S) *MYCOBACTERIUM*  
Atypical or anonymous type.  
Scotochromogen on Lowenstein-Jensen medium  
Yellow-orange pigment is formed even in darkness



- (O) **PROTEUS SPECIES**  
 Urease production  
 Left Negative reaction  
 of *E. coli*  
 Right Positive reaction.



- (T) **MYCOBACTERIUM**

Photochromogen on Lowenstein-Jensen medium. Left: growth for five days in the dark at room temperature Right: yellow pigment by incubation in sunlight

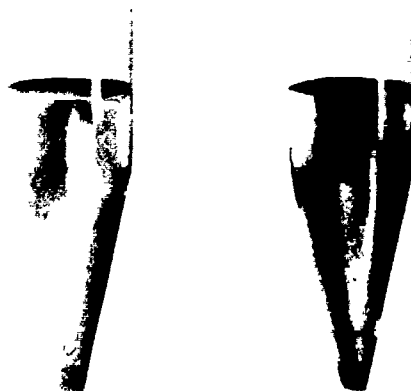

- (U) **MYCOBACTERIUM TUBERCULOSIS**  
 Niacin production. Left: Negative (colorless) Right: Positive test (lemon yellow color).

Foldout 2. Details L through U.

90412 03 8007

CDC 90412

**MEDICAL LABORATORY  
TECHNICIAN—MICROBIOLOGY**

(AFSC 90470)

Volume 3

*Clinical Parasitology*



**Extension Course Institute**

**Air Training Command**

359

**Prepared by**  
**CMSgt Joselyn H. Thompson**  
**School of Health Care Sciences, USAF (ATC)**  
**Sheppard AFB, Texas 76311**

**Reviewed by**  
**Elmore C. Hall, Education Specialist**  
**Extension Course Institute (ATC/AU)**  
**Gunter AFS, Alabama 36118**



**SCHOOL OF HEALTH CARE SCIENCES, USAF (ATC)**  
**SHEPPARD AIR FORCE BASE, TEXAS**

**EXTENSION COURSE INSTITUTE, GUNTER AIR FORCE STATION, ALABAMA**

**THIS PUBLICATION HAS BEEN REVIEWED AND APPROVED BY COMPETENT PERSONNEL OF THE PREPARING COMMAND  
IN ACCORDANCE WITH CURRENT DIRECTIVES ON DOCTRINE, POLICY, ESSENTIALITY, PROPRIETY, AND QUALITY.**

## P r e f a c e

CLINICAL PARASITOLOGY has steadily kept abreast with the enormous changes in medical and public health science. This volume, the third of four volumes of CDC 90412, presents information on parasites of medical importance, including protozoa and helminths. Color illustrations on foldouts 1, 2, and 3 are presented at the back of this volume to assist you in learning to identify malarial parasites.

Direct your questions or comments relating to the accuracy or currency of this volume to the course author: SHCS—USAF (ATC), ATTN: CMSgt J. H. Thompson, Sheppard AFB TX 76311. If you need an immediate response, call the author, AUTOVON 736-2809 between 0800 and 1600 hours (CST), Monday through Friday. (NOTE: Do not use the suggestion program to submit changes or corrections for this course.)

If you have questions on course enrollment or administration, or on any of ECI's instructional aids (Your Key to a Successful Course, Behavioral Objective Exercises, Volume Review Exercise, and Course Examination), consult your education officer, training officer, or NCO, as appropriate. If this person can't answer your questions, send them to ECI, Gunter AFS AL 36118, preferably on ECI Form 17, Student Request for Assistance.

This volume is valued at 21 hours (7 points). Material in this volume is technically accurate, adequate, and current as of January 1980.

# Contents

	<i>Page</i>
<i>Preface</i> .....	iii
<i>Chapter</i>	
1 Introduction to Medical Parasitology .....	1
2 Protozoa Infecting Man .....	8
3 Platyhelminthes Infecting Man .....	40
4 Nematodes Infecting Man .....	62
<i>Bibliography</i> .....	83
<i>Answers for Exercises</i> .....	84

**NOTE:** In this volume, the subject matter is developed by a series of student-centered objectives. Each of these carries a three-digit number and is in boldface type. Each sets a learning goal for you. The text that follows the objective gives you the information you need to reach that goal. The exercises following the information give you a check on your achievement. When you complete them, see whether your answers match those in the back of this volume. If your response to an exercise is incorrect, review the objective and its text.

## Introduction to Medical Parasitology

**THIS VOLUME PRESENTS** you, the medical laboratory technician, with background and technical knowledge associated with the parasites of major medical importance. Its purpose is to establish a foundation on which you can increase your ability and skill in finding, identifying, and discussing human parasites in future laboratory performance. This ability and skill requires individual initiative, technical knowledge, and experience.

It is apparent that a wide-ranging diversity exists among the organisms included in the study of medical parasitology. For example, what common characteristics identify these organisms? Very little, if one compares a round or flatworm with the protozoan that causes malaria. In fact, protozoa are no longer considered to be animals and are often placed in a separate kingdom, the Protista, as discussed in Volume 1, Chapter 3.

This chapter begins with a discussion of the development of medical parasitology, followed by classification (nomenclature and identification). General relationships of the host and parasite, with descriptions of how parasites affect the host, are explained next. The chapter ends by presenting information of the four important sources or modes by which parasites are transmitted.

### 1-1. Medical Parasitology

A parasite is any plant or animal that lives on or within another organism, deriving its sustenance or protection without making compensation. The uncompensated organism is referred to as the host. Parasitology is the science of parasitism and deals with the relationship between a parasite and its host. Medical parasitology refers to parasites which infect man. Thus, in the fields of medicine and public health, the subject matter of parasitology is limited to parasitism in man. An attempt will be made to correlate the medical and biologic approaches to the subject; for example, to devote appropriate attention to both the host and the parasite.

Medical laboratory parasitology is an essential clinical aid which enables a physician to diagnose and treat patients suffering from parasitic infections.

**400. State the four groups to which the most important species of animal parasites belong, and the kingdom to which the protozoa have been assigned.**

**Classification of Parasites.** The most important species of animal parasites of man belong to four groups of animals: the Protozoa, or single-celled animals; the Nematoda, or true roundworms; the Platyhelminthes, or flatworms; and the Arthropoda, which includes not only the true insects but ticks, mites, and others. It is now generally agreed that protozoa are neither plants nor animals, but instead belong in a separate kingdom. Thus, the designation of a phylum for all protozoa is being abandoned in favor of a kingdom, Protista, composed of a number of phyla. Those organisms encountered in the vast field of medical parasitology can be separated into a number of phyla and classes. However, in this volume, for the sake of simplicity, we will consider them into two major groups: the single cell protozoa and the helminths, in which the adult stage is a worm. Table 1-1 shows the principal subdivisions and classes or subphyla and classes of the parasites of medical importance.

#### Exercises (400):

1. The most important species of animal parasites belong to which four groups?
2. What group is designated as flatworms?



TABLE 1-1  
 PRINCIPAL CLASSES AND PHYLA OF  
 PARASITES OF MEDICAL IMPORTANCE

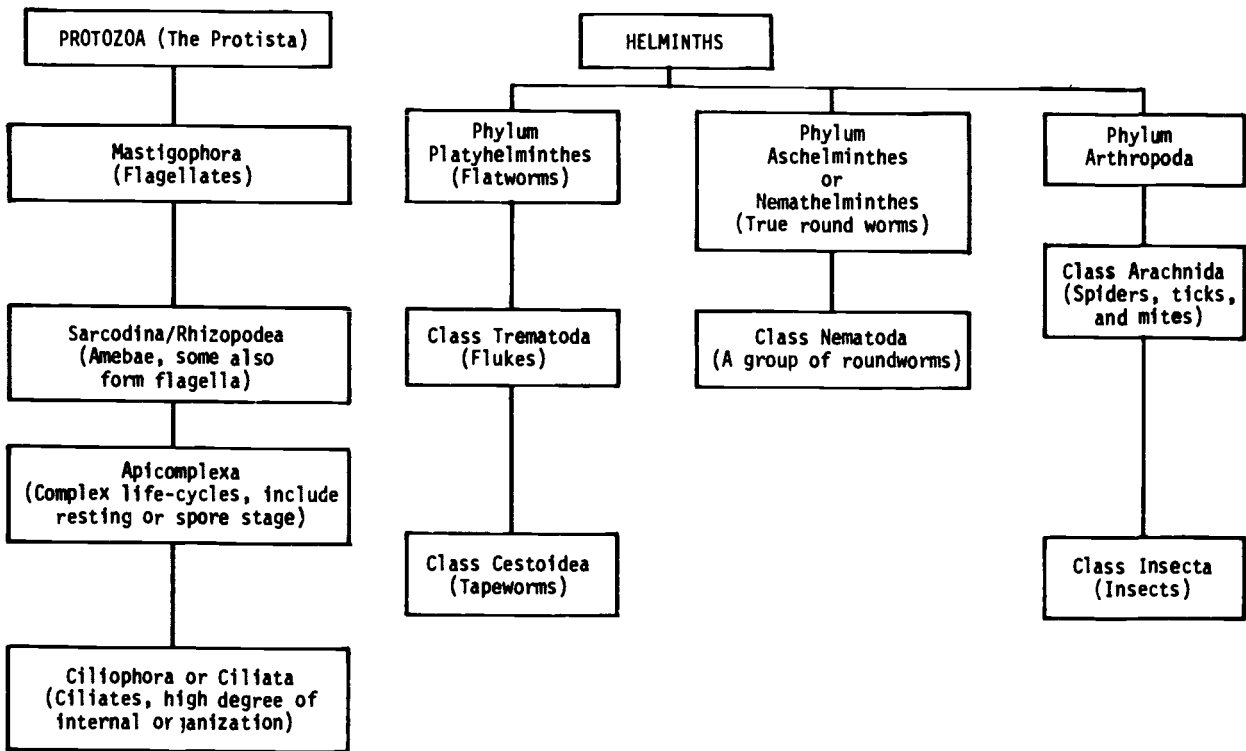

3. What group has been designated as true roundworms?

4. The designation of a phylum for all protozoa is being abandoned in favor of a kingdom called \_\_\_\_\_.

401. Identify the four groups of protozoa in terms of their characteristic features and some of the species which these groups include.

**Protozoa.** The parasites of the group Protozoa may be classified in four groups designated by various authors as subdivisions and classes.

**Mastigophora.** Mastigophora are flagellates with one or more whiplike flagella; and in some cases, an undulating membrane, such as trypanosomes. These include intestinal and genitourinary flagellates such as *Giardia*, *Trichomonas*, *Retortamonas* (*Embaamonas*), *Enteromonas*, *Chilomastix*, and the blood and tissue flagellate such as *Leishmania* and *Trypanosoma*.

**Rhizopoda or Sarcodina.** Sarcodina is typically ameboid, and is represented in man as species of *Entamoeba*, *Endolimax*, *Iodamoeba*, and *Dientamoeba*.

**Apicomplexa.** Members of the class Apicomplexa are obligate parasites of animal hosts. Human diseases include the systemic infections malaria and toxoplasmosis and an intestinal disease caused by members of the genus *Sarcocystis*, previously designated *Isospora*. The life cycles of the Apicomplexa are considerably more varied than those described for other pathogenic protozoa. Thus, a new vocabulary is required to describe the stages in the incredibly complex life cycle of these parasites.

**Ciliophora or Ciliata.** This complex protozoa bears cilia characteristically distributed in highly organized rows or patches with two kinds of nuclei in each individual. This class is composed largely of free-living organisms, and *Balantidium coli* is the only species that causes diseases in humans.

**Exercise (401):**

1. Match each column B item with the statements in column A by placing the letter of the column B item beside the number of the column A item that most

nearly describes it. Each element in column B may be used once or more than once.

Column A

- (1) Flagellates with one or more whiplike flagella.
- (2) *Leishmania* and *Trypanosoma* belong to this group.
- (3) Typically ameboid.
- (4) Represented in man as *Entamoeba*, *Endolimax*, *Iodamoeba*, and *Dientamoeba*.
- (5) Human diseases include the systemic infections of malaria and toxoplasmosis.
- (6) Members of this class are obligate parasites of animal hosts.
- (7) Members include the genus *Sarcocystis* which causes an intestinal disease.
- (8) *Balanidium coli* is the only species of this group that causes diseases in humans.

Column B

- a. Rhizopoda or Sarcodina.
- b. Mastigophora.
- c. Ciliophora or Ciliata.
- d. Apicomplexa.

2. What characteristic appearance do the Platyhelminthes have?

3. All medically important species belong to what two classes of the Platyhelminthes?

4. Which of the two groups in question 3 include flukes?

5. What are the distinguishing characteristics of the phylum Nematelminthes?

6. What is the class designated for the parasitic species of roundworms?

402. Cite the two phyla in which helminths are classified, the classes assigned to these phyla, and their distinguishing characteristics.

**Helminths.** Helminths are classified in the phyla Platyhelminthes (flatworms) and Aschelminthes (roundworms). Many live in the intestinal tract of the parasitized host, while others invade internal organs such as the liver, lungs, blood, subcutaneous tissue, and brain; and yet others are free-living and nonparasitic. The majority are macroscopic, but identification often requires a microscopic examination of their eggs.

Three parasitic classes in man to be discussed are the Cestoda and the Trematoda—both flatworms—and the Nematoda, a group of roundworms.

**Platyhelminthes.** The Platyhelminthes, or flatworms, lack a true body cavity (celom) and are characteristically flat in dorsoventral section. All medically important species belong to the classes Cestoda (tapeworms) and Trematoda (flukes). The flukes or trematodes are typically leaf-shaped and hermaphroditic, but the schistosomes (*Schistosoma* species) are more elongated and have separate sexes.

**Nematelminthes.** The Nematelminthes, or roundworms, are represented by many parasitic species in the class Nematoda. All are worm-like, unsegmented, round in body section, with a well-developed digestive system, and separate sexes.

**Exercises (402):**

1. Helminths consists of what two phyla?

**1-2. Host-Parasite Relationships**

Parasites have specific relationships with the animals they infest or infect. These relationships are determined by specific requirements, such as a need for food or protection, or as an essential step in the life cycle of the parasite. Some parasites infect a wide variety of hosts to which they have become adapted. A few, such as *Enterobius vermicularis*, the human pinworm, only infect one host. As you can see, parasitism is not a haphazard phenomenon. Perhaps a closer look at host-parasite relationships will have this subject clearer.

403 Point out the two types of parasites and cite examples of each.

**Types of Parasites.** Some parasites adapt themselves to the outer coverings of other animals. Thus, we find parasites that live on the skin and in the hair, or they may burrow just beneath the skin. Other parasites enter the body of the organism that they infect. Malaria is a good example here. The malaria parasite enters the body and infects red blood cells. The location within or upon the body where parasites may be found provides a basis for classifying them into two broad categories. These categories are ectoparasites and endoparasites.

**Ectoparasites.** Those parasites which are found on or within the skin or outside the body are called ectoparasites. These afflictions are called infestations rather than infections. Arthropods such as mites, body lice, and ticks are the most frequently encountered ectoparasites. Since the identification of ectoparasites is more properly the domain of the entomologists, our

discussion of the arthropods will relate mainly to their role as vectors of parasitic diseases.

**Endoparasites.** Those parasites which are located within the host's body are called endoparasites. These may be found in such areas as the intestines, liver, lungs, blood vessels, and muscles. The majority of medically important parasites are endoparasites. Medical problems related to them are termed infections.

**Exercises (403):**

1. What are the two general types of parasites?
2. Those parasites which are found on or within the skin or outside the body are called \_\_\_\_\_.
3. Those parasites which are located within the host's body are called \_\_\_\_\_.
4. What are some examples of ectoparasites?
5. In what areas of the body are endoparasites likely to be found?

**404. Identify the types of hosts and related association in terms of their given characteristics, and examples of organisms in such relationships.**

**The Host.** Let us now consider the host itself. A host, you should recall, is that organism which furnishes food or protection for a parasite. During its life cycle, a parasite may require one or more hosts, or at some stages it may not require a host. In some cases, man as a host appears to be a dead end. An example is *Trichinella spiralis* infection, in which the parasite is walled off in human tissue and is not usually transmitted to another host.

**Definitive hosts.** A definitive host is one in which a parasite reaches sexual maturity and is able to complete its reproductive functions. In most cases of parasitic infections of man, man is the definitive host. At sexual maturity the parasite is capable of reproducing its own kind. Evidence of this will be observed by the presence of reproductive products and structures such as ova, cysts, proglottids, and the like. Tissue invasion is probably accomplished both by lytic and physical means during the reproductive processes. Infections are confirmed with the presence of reproductive structures and products.

**Intermediate hosts.** An intermediate host is one in which a parasite undergoes essential immature development stages. Some parasites, such as the schistosomes, are capable of completing their preliminary development in one intermediate host. Other parasites, such as *Clonorchis sinensis*, require two intermediate hosts in order to complete their preliminary development.

Man is usually the definitive host. However, man can also be an intermediate host. For example, sexual maturity of the malarial parasite takes place in the mosquito; thus, the mosquito is the definitive host. It is the asexual stage of the malarial parasite which is found in man; thus, man is the intermediate host in this life cycle. Man serves as both the definitive and intermediate host in the case of *Trichinella spiralis*. The female trichinae gives birth to larvae which encyst as the infective stage in the same host.

The terms "definitive" and "intermediate" host should be used with some reservations. The genus *Leishmania*, for example, has no known means of sexual reproductive. The terms "definitive" and "intermediate" are not applicable in this life cycle.

**Reservoir hosts.** In addition to the designation "definitive" and "intermediate," a host may also be called a *reservoir* host. A reservoir host is an animal species on which the parasite depends for its survival in nature and thus serves as a source of infection for other susceptible hosts, including man. For example, the hog harbors the organism *Trichinella spiralis*, which causes trichinosis in man and also armadillos with the agent of Chagas' disease, *Trypanosoma cruzi*.

**Vectors.** In addition to their role as reservoirs, some hosts serve as vectors. A *vector* is a parasite carrier, usually an arthropod, which transfers parasites from one host to another. This is true of organisms such as mosquitoes, flies, ticks, and mites. Because of the many different kinds of organisms in the world, there are many different types of vectors.

**Symbiosis.** A close association of two species of organisms in nature is called *symbiosis*. The partners in this association are termed symbionts. This relationship may have several aspects. One aspect is the association in which both organisms benefit, or *mutualism*. A second aspect is an association in which one organism benefits and the other is unaffected. This is known as *commensalism*. The third aspect of symbiosis is *parasitism*. In parasitism, one organism (parasite) is benefited at the expense of the other organism (host). A parasite is successful only when it is in a delicate balance with its host. If that balance is upset, the host may expel or even destroy the parasite, or the host may be damaged to such an extent that it dies and, as a result, the parasite dies. Parasitology is important to us because this balance is not always maintained.

**Exercise (404):**

1. Match each column B item with the statements in column A by placing the letter of the column B item

beside the number of the column A item that most nearly describes it. Each element in column B may be used once or more than once.

Column A	Column B
— (1) A parasite reaches sexual maturity and is able to complete its reproductive functions.	a. Intermediate host.
— (2) A parasite undergoes essential immature development stages.	b. Reservoir host.
— (3) Schistosomes are capable of completing their preliminary development in this type host.	c. Symbiosis.
— (4) Two such type hosts are required by <i>Clonorchis sinensis</i> .	d. Parasitism.
— (5) An animal species on which the parasite depends for its survival in nature and thus serves as a source of infection for other susceptible hosts, including man	e. Commensalism.
— (6) A parasite carrier, usually an arthropod.	f. Definitive host.
— (7) A close association of two species of organism in nature.	g. Vector.
— (8) The association in which both organisms benefit	h. Mutualism.
— (9) An association in which one organism benefits and the other unaffected.	
— (10) One organism is benefited at the expense of the other organism.	

**405. Identify the ways in which damage to the host is manifested in terms of examples and resulting conditions.**

**Parasitic Effects.** Throughout this volume we will use the terms "definitive," "intermediate," and "reservoir" when referring to a host. Now that we know a little about parasites and hosts, let's discuss the effects of parasites on the host. By definition, each parasite must have at least one host and, as mentioned previously, may have several. For a given parasite to live successfully within a host, several conditions are necessary:

- There must be a dependable means of transmission to the host.
- Environmental conditions must provide suitable access to the host.
- The parasite must be able to thrive and reproduce in the host once access is made.

If any one of these three circumstances is altered or eliminated, a parasite cannot exist. However, if these prerequisites are met, a parasite will be successful.

Damage to the host can manifest itself in several ways. These are:

- Trauma.
- Lytic action.
- Tissue response.
- Blood loss.
- Secondary infection.

**Trauma.** Traumatic damage to tissue can occur as a result of normal larval migration. For example, in hookworm infections, as the individual larvae penetrate into the air sacs, minute focal hemorrhages are produced. On the other hand, in cases of simultaneous massive migration of larvae, a bronchial pneumonitis of clinical grade is usually produced. Intestinal parasites such as *Ascaris lumbricoides* and *Taenia saginata* may cause intestinal obstruction if the worm population is high. Other parasites may cause trauma to the intestines in their attempt to maintain attachment on the intestinal mucosa. A few parasites are capable of producing damage to the retinal, renal, or cerebral capillaries.

**Lytic action.** Lytic destruction or damage is caused by the invasion of certain parasites because of their enzyme activity. The protozoan *Entamoeba histolytica* can colonize in the large intestine, thus causing considerable damage as the organisms invade the tissues by lytic digestion.

**Tissue response.** Some parasites, notably helminths (worms), by their invasion of tissue, cause the human host to respond by producing eosinophilia. This production of eosinophiles in the bloodstream is most notable in infections with *Strongyloides stercoralis*, *Ascaris lumbricoides*, and *Trichinella spiralis*.

**Blood loss.** Parasites such as *Ancylostoma duodenale* and *Necator americanus*, when present in large numbers, can cause considerable blood loss. With this loss of red blood cells, the body responds with increased erythropoietic activity. If the body response is not sufficient, an anemia results.

**Secondary infection.** Once the body becomes weakened by anemia or tissue damage—or both anemia and tissue damage—secondary invaders, usually bacteria, may add to the disease process. Secondary infection may occur in the liver, lungs, or intestinal mucosa.

Parasitic infections, unlike bacterial infections, usually produce only short-lived immunity, if any. As a result, repeated infections are quite possible. It is known that long-lasting immunity is derived from infection and spontaneous cure in cutaneous leishmaniasis. However, immunological defenses against parasitic infections are limited.

**Exercise (405):**

1. Match each column B item with the statements in column A by placing the letter of the column B item beside the number of the column A item that most nearly describes it. Each element in column B may be used once or more than once.

Column A

- (1) Can occur as a result of normal larval migration.
- (2) Results from the attempt of parasites to maintain attachment on the intestinal mucosa.
- (3) Is caused by the invasion of certain parasites because of their enzyme activity.
- (4) This action can be caused by *Entamoeba histolytica* as the organisms invade the tissues
- (5) This reaction is most notable in infections with *Strongyloides stercoralis*, *Ascaris lumbricoides*, and *Trichinella spiralis*.
- (6) Parasites such as *Ancylostoma duodenale* and *Necator americanus*, when present in large numbers, can cause this condition.
- (7) Once the body becomes weakened by anemia or tissue damage—or both anemia and tissue damage, this condition can result.
- (8) The condition resulting from symptoms in question 7 may occur in the liver, lung, or intestinal mucosa.

Column B

- a. Blood loss.
- b. Lytic action.
- c. Secondary infection.
- d. Trauma.
- e. Tissue response.

406. Identify the given modes of infection in terms of examples, vectors, and parasitic organisms encountered.

**Modes of Infection.** Man becomes infected with parasites by various means. Parasitic diseases may be grouped according to mode of transmission as follows:

- Filth-borne or contaminative.
- Soil- or water-borne.
- Food-borne.
- Arthropod-borne.

**Filth-borne or contaminative.** Transmission by filth or contamination is a serious problem where personal hygiene is lacking. Some of the intestinal protozoa are dependent upon this condition for direct transmission. Parasites such as *Dientamoeba fragilis* and *Trichomonas hominis* have no known cystic stage, so they must be transmitted directly. Other intestinal protozoa and some intestinal helminths such as *Hymenolepis nana* and *Enterobius vermicularis* are not dependent upon direct transmission, but they are readily transmitted by that route. These organisms produce cysts or eggs that are fully developed when passed and can survive and remain infective for long periods outside the host. As you can see, these parasites can be spread easily by careless food handlers and nursery attendants. Even flies and cockroaches can carry the cysts and eggs from one place to another. Personal hygiene and community sanitation are a must to prevent the spread of these parasites.

**Soil- or water-borne.** Soil- or water-borne parasitic infections are among the most difficult to control. The eggs of parasites such as *Ascaris*, *Trichuris*, and hookworms require a period of

development in the soil before they become infective. People acquire *Ascaris* and *Trichuris* infections by eating dirt. Of course, this is one of the favorite pastimes of children. Infective hookworm larvae normally infect man by penetrating the skin and, as you would expect, the parasite is most common in areas where people do not wear shoes. The intermediate hosts and the infective stage of blood flukes require water. The cercariae of blood flukes infect people by penetrating the skin when they are exposed to contaminated water (swimming and bathing). Education of the population and strict sanitary control of excreta disposal are the only effective means of preventing infection with these parasites.

**Food-borne.** Man acquires parasitic infections by eating many things other than soil. Inadequately cooked beef, pork, fish, and shellfishes, as well as some vegetables, are important sources of infection. The infective stages of some tapeworms are found in beef, pork, and fish. Eating improperly prepared pork is the most common source of *Trichinella spiralis* in man. Raw crabs and crayfish are considered a delicacy in some parts of the world. They are intermediate hosts that harbor the infective stage of the lung fluke. Some flukes, such as sheep liver fluke, infect people when they consume raw aquatic plants. The infective larvae of these flukes encyst on such vegetation. You can see from these examples that food is an important source of infection. To prevent food contamination, excreta must be disposed of according to strict public health rules; and all foods must be properly prepared if these parasites are to be controlled.

**Arthropod-borne.** Parasites that are transmitted by arthropod vectors produce diseases that are frequently fatal. Members of this group and their vectors are found in most temperate and tropical regions of the world. Some of these parasites have been significant deterrents to the economic development of some countries. These arthropod-borne parasites include both protozoa and helminths. In each case, the arthropod is an essential intermediate host and vector. Malaria is the most widespread of these parasites, and species of the *Anopheles* mosquito which serve as the vector are found in almost every country of the world. This is the reason that such a great effort is made to prevent infected individuals from entering this country. Some parts of Africa are literally ravaged by sleeping sickness. This often fatal disease is caused by African trypanosomes which are transmitted by tsetse flies. The group of helminths that are arthropod-borne are known as filariids. There are several of these parasites, and each causes a characteristic disease such as elephantiasis, ophthalmitis and "Calabar swelling." The vectors for these parasites include mosquitoes, mango flies *Simulium* flies, and some biting gnats. Tremendous amounts of money and time have been spent in an effort to eradicate these diseases, but they are still the most important public health problems in the tropics today.



**Exercise (406):**

1. Match each column B item with the statements in column A by placing the letter of the column B item beside the number of the column A item that most nearly describes it. Each element in column B may be used once or more than once.

*Column A*

- (1) Parasites such as *Eientamoeba fragilis* and *Trichomonas hominis* . . . no cystic stage, so they must be transmitted by this mode
- (2) Flies and cockroaches can carry cysts and eggs from one place to another, resulting in such a manner of transmitting disease

*Column B*

- a Food-borne
- b Soil- or water-borne
- c Filth-borne or contaminative
- d Arthropod-borne

*Column A*

- (3) Personal hygiene and community sanitation are a must to prevent the spread of parasites through this mode
- (4) *Ascaris*, *Trichuris*, and hookworms require a period of development by this mode before they become infective
- (5) The intermediate hosts and the infective stage of blood flukes require such a mode
- (6) Inadequately cooked beef, pork, fish/shellfish, as well as some vegetables, are consistent with this mode of acquiring parasitic infections.
- (7) Malaria is the most widespread of parasites by this mode and species of the *Anopheles* mosquito serve as the vector
- (8) The mode in which sleeping sickness is caused by African trypanosomes



## Protozoa Infecting Man

THE SUBPHYLA YOU will study in this chapter are listed in table 2-1. The listed subphyla contain the protozoa of major medical importance. These parasites live in the digestive tract, genitalia, tissues, and bloodstream. Most of the parasites that infect the tissues and bloodstream require a vector. Most of these protozoa are pathogenic, but a few are nonpathogenic or only cause mild tissue irritation. The nonpathogenic protozoa are important to the laboratory technician only from the standpoint of clearly distinguishing them from the harmful forms.

The study of Chapter 2 will begin with the flagellates, to be followed by the amebae, then the sporozoans. The chapter will end with the intestinal ciliate, *Balantidium coli*. In this chapter and those to follow, the study will be limited chiefly to morphology, pathogenesis, and diagnosis.

### 2-1. Flagellates

As you study the flagellates, you will cover each genus of medical importance. They will be discussed in the order in which they appear in table 2-1.

**407.** Point out the two stages in the life cycle of *Leishmania*, factors dependent upon their classification, possible pathological effects of *Leishmania donovani*, specimens, stain, media, and a serological method of laboratory identification.

**The Leishmania.** You can divide the life history of *Leishmania* species into two stages. In man and other mammals a nonflagellated stage exists which is called a leishmanial form organism (shown in fig. 2-1). The amastigotes noted in figure 2-1 are forms that lack a long flagellum. In the sandfly vector genus *Phlebotomus*, and when grown in culture media, the parasite lives as a flagellated leptomonial form of organism. Figure 2-2 illustrates the flagellated leptomonial form of this group of organisms. The morphology of the three presently recognized species of *Leishmania* organisms (*L. donovani*, *L. tropica*, *L. braziliensis*) is identical. They are classified on the basis of clinical manifestations and geographical distribution.

***Leishmania donovani.*** *L. donovani* is found in many regions of Asia, Africa, Europe, South America, and Central America. Rounded, leishmania forms

contain a nucleus and kinetoplast (parabasal body plus blepharoplast), but they lack a flagellum. Leishman-Donovan bodies, as the leishmania forms are called, are widely distributed within the body of a patient with kala-azar (visceral leishmaniasis). The parasites seem to be more abundant, however, in the reticuloendothelial cells of the liver, spleen, bone marrow, and visceral lymph nodes.

The pathogenesis and symptomatology of the disease develop as follows: once the leptomonial stage is transmitted by the vector to man, the leishmaniae develop in the cells of the skin of the host. After a variable period of time, some of the organisms gain access to the blood stream or lymphatics and are transported to the viscera, where they enter fixed tissue macrophages. The parasites multiply rapidly and are found to be abundant in the spleen, liver, and bone marrow. The rapid intracellular multiplication of parasites causes an excess production of macrophages. In time this causes a decrease in neutrophils. Finally, the red bone marrow slows down the production of red cells and anemia develops. The decrease in neutrophils favors secondary bacterial infections in the unprotected host.

Laboratory diagnosis is limited to the actual demonstration of the organism. The specimen of choice is a Giemsa stained bone marrow specimen. Of course, the organisms can be demonstrated in spleen, liver, or lymph node biopsy impression smears or tissue sections of those organs. The organisms are rarely observed in peripheral blood smears. They can be cultured on NNN medium (Novy, MacNeal, Nicolle); however, this technique is of limited diagnostic value because of the time required for the organisms to grow. *Leishmania* species can also be cultured on diphasic blood-agar medium. Impression slide smears can be stained with Giemsa or Wright stain. The culture medium and stains are also applicable to the other leishmanias to be studied. A complement fixation test of great diagnostic value is available.

#### Exercises (407):

1. The life cycle of *Leishmania* is divided into what two stages?

TABLE 2-1  
OUTLINE OF PROTOZOA PARASITES

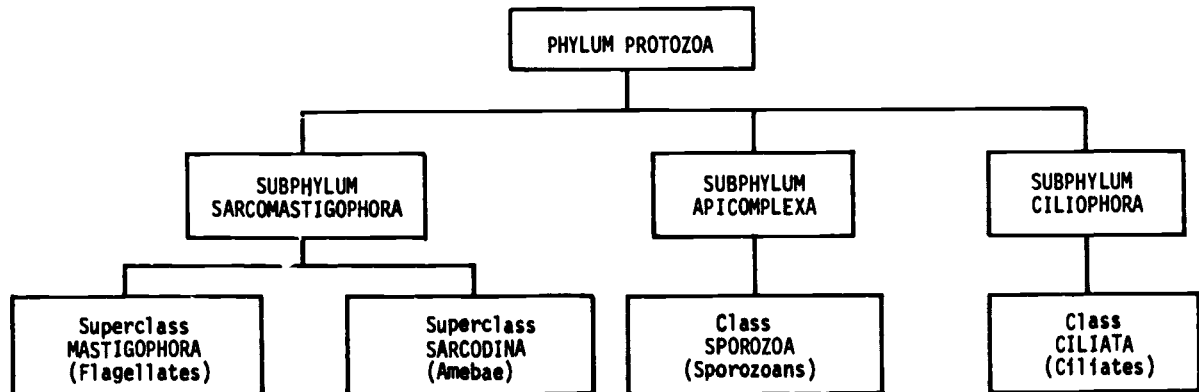

*Leishmania donovani*  
*Leishmania tropica*  
*Leishmania braziliensis*  
*Trypanosoma rhodesiense*  
*Trypanosoma gambiense*  
*Trypanosoma cruzi*  
*Chilomastix mesnili*  
*Giardia lamblia*  
*Trichomonas vaginalis*  
*Trichomonas tenax*  
*Trichomonas hominis*

*Entamoeba histolytica*  
*Entamoeba hartmanni*  
*Entamoeba coli*  
*Entamoeba gingivalis*  
*Endolimax nana*  
*Dientamoeba fragilis*  
*Iodamoeba butschlii*

*Isospora belli*  
*Isospora hominis*  
*Toxoplasma gondii*  
*Plasmodium vivax*  
*Plasmodium falciparum*  
*Plasmodium malariae*  
*Plasmodium ovale*

*Balantidium coli*

2. In which of the leishmanial stages are both man and mammals the hosts?
  3. In what insect vector does the other stage of the parasite develop?
  4. What morphological differences are there among the three recognized species of *Leishmania*?
  5. *Leishmania* organisms may be classified according to what two factors?
  6. What cells and organs of the body are susceptible to the Leishman-Donovan bodies of *Leishmania donovani*?
  7. What is the specimen of choice?
  8. What two given media may be used for culture of the organisms?
  9. What given serological procedure for leishmaniasis is of great diagnostic value?
408. State the disease caused by *Leishmania tropica*, manner of transmission, and the source of specimen for laboratory examination.
- Leishmania tropica*.** The disorder caused by *Leishmania tropica* is often called oriental sore or cutaneous leishmaniasis. It is common in the Middle East, and it is endemic in Mexico, Africa, India, and other parts of Asia. Sores begin as small red papules which enlarge to an inch or more in diameter. These may develop into unsightly ulcerating lesions if they become secondarily infected. The sores persist for a few months to a year or more.
- L. tropica* is not able to penetrate the normal unbroken skin. Infection is normally caused by the bite of the sandfly vector. This parasite can be transmitted by intimate contact or autoinoculation. Secondary bacterial infections are not uncommon. Persons who

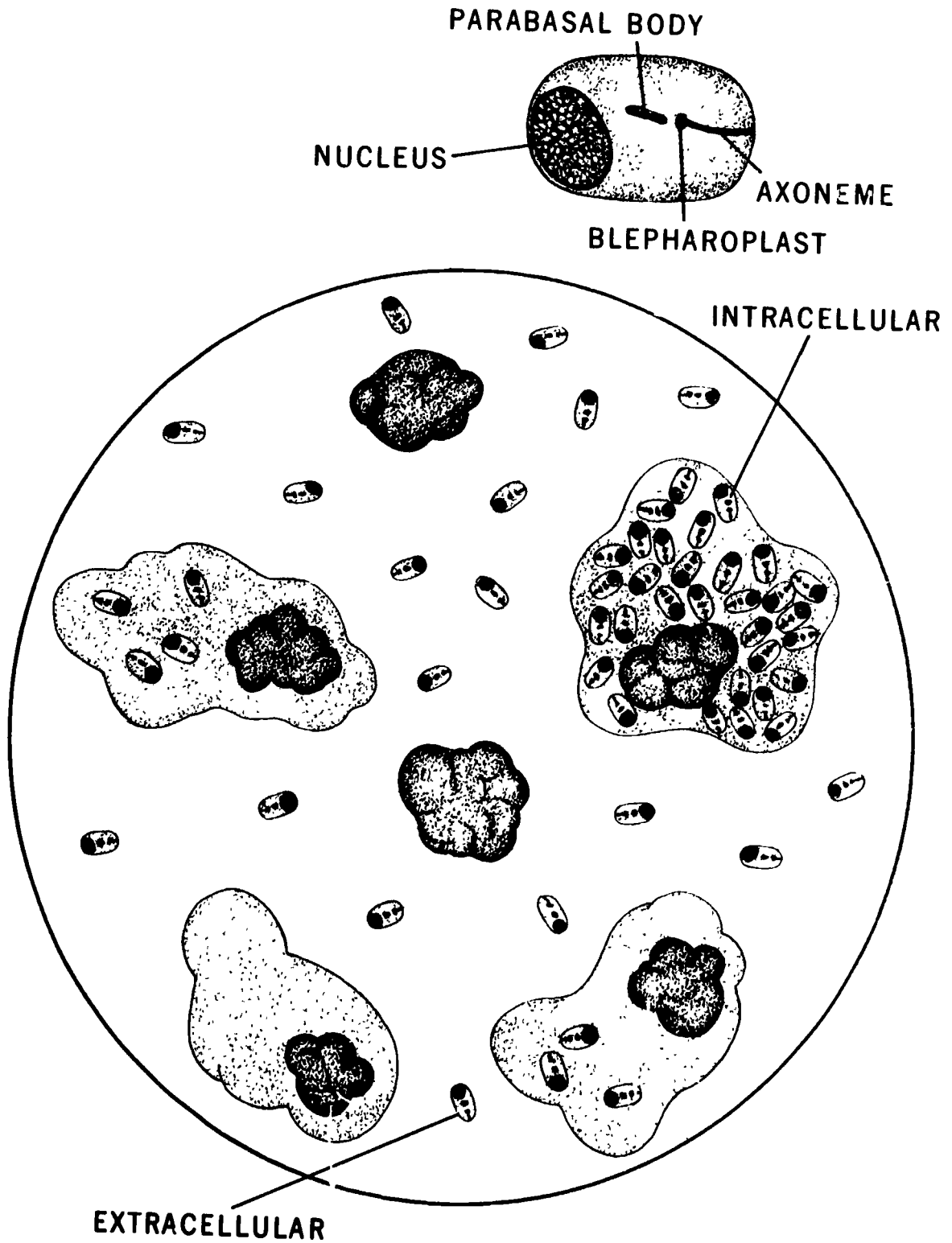

Figure 2-1. A spleen smear showing numerous intra- and extracellular amastigotes of *Leishmania donovani*

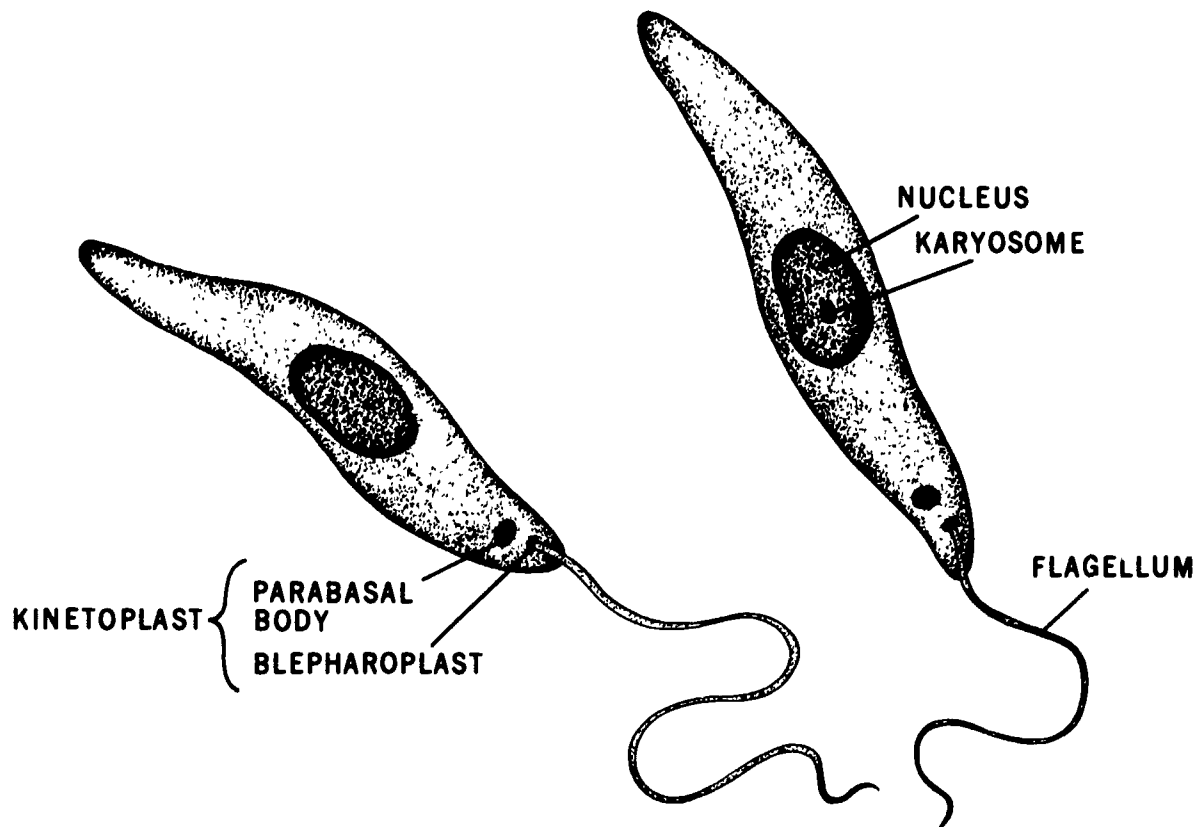

Figure 2-2. *Leishmania*: leptomonads.

become infected with this species usually develop a lifelong immunity.

In morphology, *L. tropica* is identical to both *L. donovani* and *L. braziliensis*. Parasites of *L. tropica* are found in macrophages around the margins of the necrotic lesions. It is useless to make smears from peripheral blood in attempting to find *L. tropica*. They can be found in material from the edge of a sore. Smears prepared with this material and stained with Giemsa or Wright stain will usually show microscopic evidence of infection. If smears prove negative, then cultures on NNN or other suitable media should be completed.

**Exercises (408):**

1. The disorder caused by *Leishmania tropica* is called \_\_\_\_\_.
2. After infected with the parasite, how can it be transmitted?

3. If a technician prepares slide smears from a patient's peripheral blood to search for *Leishmania tropica* parasites, what would be the value of the laboratory examination?

409. State the areas of the body affected by *Leishmania braziliensis*, the geographical areas in which the disease is commonly caused, areas of the body destroyed by the disease, and three laboratory procedures which may be used in identification of *Leishmania* parasites.

***Leishmania braziliensis.*** *Leishmania braziliensis* causes a disease known as South American mucocutaneous leishmaniasis, or espundia. Initially the parasites are localized in cutaneous sores, as in the case of *L. tropica*. As the disease advances, the organisms localize in mucous membranes of the nose and pharynx. There is a tendency for sores to spread over extensive areas and for numerous sores to appear. In later stages of the disease secondary foci occur in the nasal cavities, mouth, and pharynx; however, these generally develop several months to several years after cutaneous lesions appear. The

disease occurs in large areas of tropical America from Yucatan in Mexico through Central America into northern Argentina.

Studies of this parasite suggest the possibility that there are several strains scattered through parts of South America and southern Mexico. Secondary lesions usually appear before the primary sore has healed, but they may occur months or years afterwards. Mucocutaneous involvement results in clogging of nostrils, fetid breath, and damage to the organs of smell, hearing, and sometimes sight. In advanced stages the nasal septum and surfaces of the palate are destroyed. Death frequently occurs in advanced untreated cases. This is usually due to secondary bacterial infections; however, patients may live for several years.

Laboratory procedures used for diagnosis of *L. braziliensis* include direct examination of exudates or biopsies from involved areas as mentioned for *L. donovani* and *L. tropica*. Also, cultures and serological methods may be useful. One will not find this species in peripheral blood unless the parasites are found in the local circulation close to a lesion.

#### Exercises (409):

1. As the disease known as espundia (caused by the *Leishmania braziliensis* parasites) advances, in what mucous membranes of man do the parasites localize?
2. In what geographical areas is the disease caused by the parasite *Leishmania braziliensis* found?
3. The disease mucocutaneous leishmaniasis (or espundia), in its advanced stages, may destroy certain areas adjacent to the face. Name two areas which may be destroyed.
4. List three laboratory procedures which may be used to assist in the identification of *Leishmania* parasites.

410. Cite the *Trypanosoma* parasites that cause African sleeping sickness; the vector, the vectors for *Trypanosoma cruzi*, and the centrifuged specimen used in the laboratory diagnosis of *Trypanosoma rhodesiense*.

The *Trypanosomes*. You will study the three trypanosomes of medical importance in the next few paragraphs. The three are *Trypanosoma rhodesiense*, *Trypanosoma gambiense*, and *Trypanosoma*

*cruzi*. *T. rhodesiense* and *T. gambiense* produce the disease known as African sleeping sickness. As the name implies, it is restricted to the African continent. *Trypanosoma rhodesiense* and *T. gambiense* are considered to be mutants of *T. brucei*, which is a parasite of African game animals. The African trypanosomes use *Glossina* (the tsetse fly) as a vector. The organisms are morphologically indistinguishable. This supports the hypothesis that they are from the same stock. *T. cruzi* uses triatomid (conenose) bugs as vectors. *T. cruzi* is restricted to the Americas. Figure 2-3 illustrates a typical trypanosome.

When you study the morphology of the unstained trypanosome in a wet preparation of blood or spinal fluid, the parasite appears as a colorless, slender body which measures approximately 15 to 30  $\mu\text{m}$  in length. It travels with a spinning type of motion. Both the anterior flagellum and the undulating membrane can usually be observed.

The three trypanosomes are morphologically similar. A blepharoplast is located at the posterior end, from which a flagellum arises. A nucleus containing a karyosome is present, and an undulating membrane extends almost the length of the body.

*Trypanosoma rhodesiense*. *Trypanosoma rhodesiense* is present in the circulating blood during febrile episodes. During nonfebrile states, the organisms are more abundant in the lymph glands. In the cases that reach the late stages of the disease, the trypanosomes may be found in the cerebrospinal fluid and within the tissues of the central nervous system. This organism is apparently more virulent than *T. gambiense*. Death may occur within 3 or 4 months following infection. The initial symptoms of infection are recurring fever and headache followed by weakness, enlarged glands, edema, and muscular tenderness. In the late stages there is physical depression, stupor, unconsciousness, coma, and death.

Laboratory diagnosis includes the following procedures:

- Stained blood smears.
- Wet slide preparations of blood.
- Centrifuged spinal fluid.
- Animal inoculation.
- Demonstration of trypanosomes in bone marrow and lymph node aspirates.

Cultivation can be attempted on Weinman's medium; however, it is difficult to get a viable culture of either *T. rhodesiense* or *T. gambiense*.

#### Exercises (410):

1. Which two *Trypanosoma* parasites produce the disease known as African sleeping sickness?

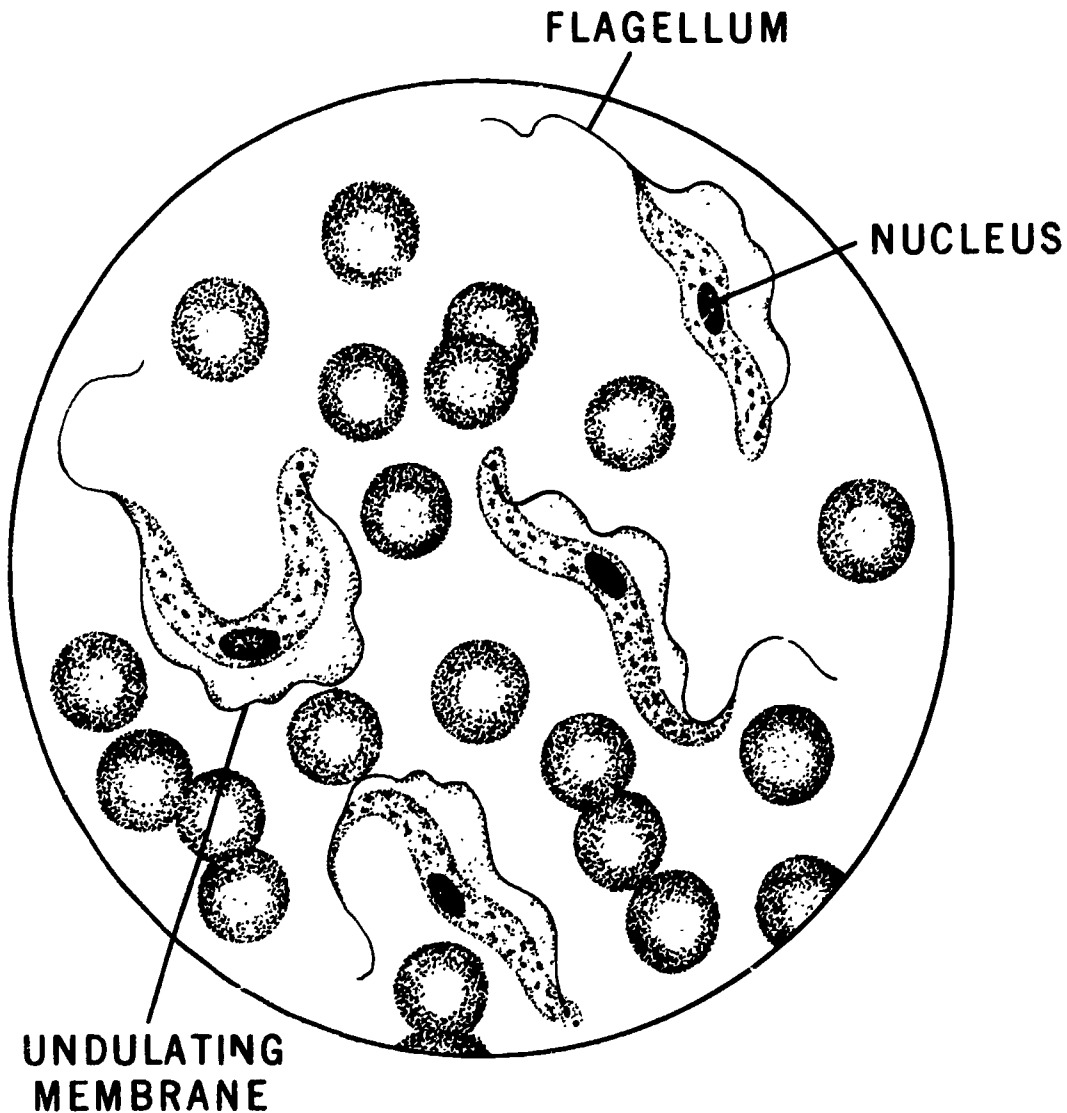

Figure 2-3. Typical trypanosomes.

2. What is the vector of the African trypanosomes?
  3. What are the vectors of *Trypanosoma cruzi*?
  4. When you study the morphology of the unstained trypanosome in a wet preparation of blood or spinal fluid, how does the parasite appear?
  5. During the nonfebrile states, where are most *Trypanosoma rhodesiense* parasites more abundantly found in the body?
  6. What particular body fluid is centrifuged when performing laboratory diagnosis of *Trypanosoma rhodesiense*?
411. Indicate whether given statements correctly reflect the vector of *Trypanosoma gambiense*, morphological comparison with *Trypanosoma rhodesiense*, location of the parasites in the vertebrate hosts at given times, and the character of the Gambian disease.
- Trypanosoma gambiense*. *Trypanosoma gambiense* produces the disease often called Gambian sleeping sickness. It is geographically distributed in tropical West and Mid-Africa. As previously mentioned, it is transmitted through the bite of an infected tsetse fly (the biological vector). Mechanical



transmission of the disease is possible if a fly bites an individual who has the disease and within a very short period of time bites a noninfected person. The transmitted parasite, in this case, does not undergo the usual multiplication in the salivary gland of the fly but is transferred directly from contaminated mouth parts. This method of transmission occurs frequently in severe epidemics.

The morphology of *T. gambiense* is indistinguishable from that of *T. rhodesiense*. Within vertebrate hosts these parasites localize first in the blood, but later they are found in greater numbers in enlarged lymph glands. In the late stages of the disease, the parasite may be found in the cerebrospinal fluid. Invasion of the central nervous system takes place later in the course of the disease than it does in infections with *T. rhodesiense*.

The Gambian disease appears milder than infections with the Rhodesian type. Initial symptoms include fever and headache recurring irregularly, followed by weakness, enlarged glands, edema, and muscular tenderness. The disease does not usually result in death. However, fatal cases do occur, particularly among patients who develop nervous system involvement and complications from other tropical diseases. The disease is diagnosed by demonstrating the parasite in blood and other body fluids using the same techniques used to diagnose *T. rhodesiense*.

#### Exercises (411):

Indicate whether each of the following statements is true (T) or false (F), and correct those that are false.

- T F 1. *Trypanosoma gambiense* is transmitted through the bite of an infected triatomid bug.
- T F 2. Mechanical transmission of the disease is possible if the vector bites an individual who has the disease and within a very short period of time bites a noninfected person.
- T F 3. The morphology of *T. gambiense* is clearly distinguishable from *T. rhodesiense*.
- T F 4. Within the vertebrate hosts, *T. gambiense* parasites are localized first in enlarged lymph glands.
- T F 5. Infection with Gambian disease appears milder than with the Rhodesian type, and symptoms include fever and headache recurring irregularly; thus, one would

consider Gambian disease to be an acute infection.

412. State the disease caused by *Trypanosoma cruzi*, means of transmission of the disease, and the manner in which the infective trypanosome-form enters the hosts; cite a distinctive characteristic between *Trypanosoma cruzi* and a leishmanial-form organism in tissue infections.

*Trypanosoma cruzi*. *Trypanosoma cruzi* causes an illness known as Chagas' disease. It is most prevalent in parts of Mexico and Central and South America. A few cases have been reported from Texas. Man is only one of many mammals that are susceptible to the parasite. Many domestic and wild animals are reservoirs for this organism.

*Trypanosoma cruzi* ordinarily requires a vector for transmission. Infants can acquire the parasite by prenatal infection, and the organism is occasionally transmitted by blood transfusion. The primary means of transmission is by an insect vector.

The vectors in Chagas' disease are several species of triatomid bugs commonly known as assassin or kissing bugs. As the infected bug takes a blood meal, it discharges liquid feces containing the infective trypanosome form of the parasite, which is rubbed into the bite site, or at times actively invades mucous membranes when the feces are wiped into the eye or mouth. The infective trypanosome is engulfed by macrophages. Within macrophage cells the parasite develops into the leishmanial form of the organism (similar to that in fig. 2-1). The parasite multiplies in the leishmanial form and produces a local swelling (chagoma). A few days later it is found in the circulating blood as a trypanosome-form organism again. The organism never multiplies in the trypanosome form. These trypanosome forms of the organisms enter visceral reticuloendothelial cells, myocardial tissue, endocrine gland tissue, or almost any type of cell. Within the cell, the organism reverts to the leishmanial form. It is in this form that reproduction occurs. Eventually the cell ruptures, releasing numerous leishmanial forms of the organism which very rapidly develop into trypanosome forms. The change is so rapid that leishmanial forms are not seen in peripheral blood. Some of the trypanosome forms enter peripheral circulation, but most infect other tissue cells and revert to the leishmanial forms and continue reproducing.

Symptomatology during the primary parasitemia (acute phase) consists of fever and a marked toxic condition. The acute phase usually persists for about 12 to 30 days. In some cases, children die during this phase. Patients who survive the acute phase develop the chronic state of the disease. Symptoms of this phase depend upon where the parasites localize. This stage may last for years. In this stage, there are usually very few trypanosomes in the circulating blood.

*T. cruzi* in the trypanosome form is morphologically similar to the other trypanosomes, but it is different enough for you to identify the organism. You will sometimes see the trypanosome form as a delicately spindle-shaped organism, about 20  $\mu\text{m}$  long with only two or three curves in the narrow, undulating membrane. There is also a short, free flagellum. Other times, the organism may appear as a considerably shorter, broader, more or less C-shaped organism, with or without a free flagellum. In its intracellular phase, *T. cruzi* is a typical leishmania-form organism, oval in shape, 1.5 to 5  $\mu\text{m}$  in length, with a large nucleus and a deeply staining kinetoplast (fig. 2-1). In reticuloendothelial cells, you cannot distinguish *T. cruzi* from the *Leishmanias*. A distinguishing feature to remember is that *T. cruzi* invades heart muscle cells and nerve tissue cells as a leishmanial-form organism. The *Leishmanias* do not invade these tissues.

Laboratory diagnosis is made by finding the typical trypanosomes of *T. cruzi* in blood films during febrile periods. Aspirates of spleen, lymph node, liver, or bone marrow are the materials of choice for finding the leishmania-form organisms. NNN media should be inoculated at the same time the smears are made. Quite often you can culture the organisms in this manner even if there are too few to find on a stained smear. Complement fixation is sometimes a satisfactory method of diagnosis when dealing with chronic cases. In endemic areas, xenodiagnosis is frequently employed. In this procedure a clean (uninfected) triatomid bug is allowed to bite the patient. If the patient is infected, the fecal material of the bug will contain the organisms after about 10 days.

In this study of the trypanosomes, note that the African trypanosomes and *T. cruzi* are found on separate continents; yet they are very closely related organisms. The next organisms that we will discuss are the intestinal parasites *Chilomastix mesnili* and *Giardia lamblia*. They are not systematically closely related; but because they form resistant cysts, it will be convenient for you to study them together.

#### Exercises (412):

1. *Trypanosoma cruzi* causes an illness known as \_\_\_\_\_.
2. Even though the disease is prevalent in parts of Mexico, and Central and South America, a few cases have been reported in the state of \_\_\_\_\_.
3. The primary means of transmission is by several species of \_\_\_\_\_.

4. How does the infective trypanosome form enter the hosts?
5. Reproduction of *Trypanosoma cruzi* takes place in visceral reticuloendothelial cells, myocardial tissue, endocrine gland tissue in which of the two forms of the organisms?
6. *Trypanosoma cruzi* can be distinguished from the *Leishmanias* by what feature?
7. For laboratory diagnosis during febrile periods, the typical trypanosomes of *T. cruzi* may be found in what type of body fluid preparations?

413. Indicate whether given statements correctly reflect the common habitats of *Chilomastix mesnili* and *Giardia lamblia*, the predominant form of *Giardia lamblia* found in severe diarrhea, the most characteristic morphological structure of *Chilomastix mesnili*, and symptoms or illness caused by *Chilomastix mesnili*.

**Chilomastix and Giardia.** *Chilomastix mesnili* and *Giardia lamblia* are flagellated, protozoan parasites of the human intestinal tract. *Chilomastix mesnili* normally inhabits the large intestine, while *Giardia lamblia* inhabits the upper small intestine. Each of these organisms exhibits actively motile trophozoites and also resistant encysted forms. They are passed from the body in fecal material in either form, except in severe diarrhea. In severe diarrhea the predominant form found is the trophozoite *C. mesnili* and *G. lamblia* do not produce serious intestinal disease. In fact, some authorities consider them nonpathogens. Since *G. lamblia* is one of the most frequently found human intestinal parasites, it is appropriate that you become familiar with this group.

***Chilomastix mesnili.*** *Chilomastix mesnili* is found in the lumen of the large intestine and obtains food from enteric bacteria in the large intestine. It is widely distributed, but is more prevalent in warm climates.

The parasite occurs in the trophozoite and cystic stages. Freshly passed liquid stools show trophozoites that are very actively motile; they move about in a jerky, spiral fashion with directional movement. Movement is accomplished by means of flagella which can be observed in stained preparations. Figure 2-4, A, shows a drawing of the trophozoite.

The distinctive features of the trophozoite are clearly visible in hematoxylin stained preparations. Prominent internal structures include an anteriorly located nucleus and a primitive mouth (cytostome).

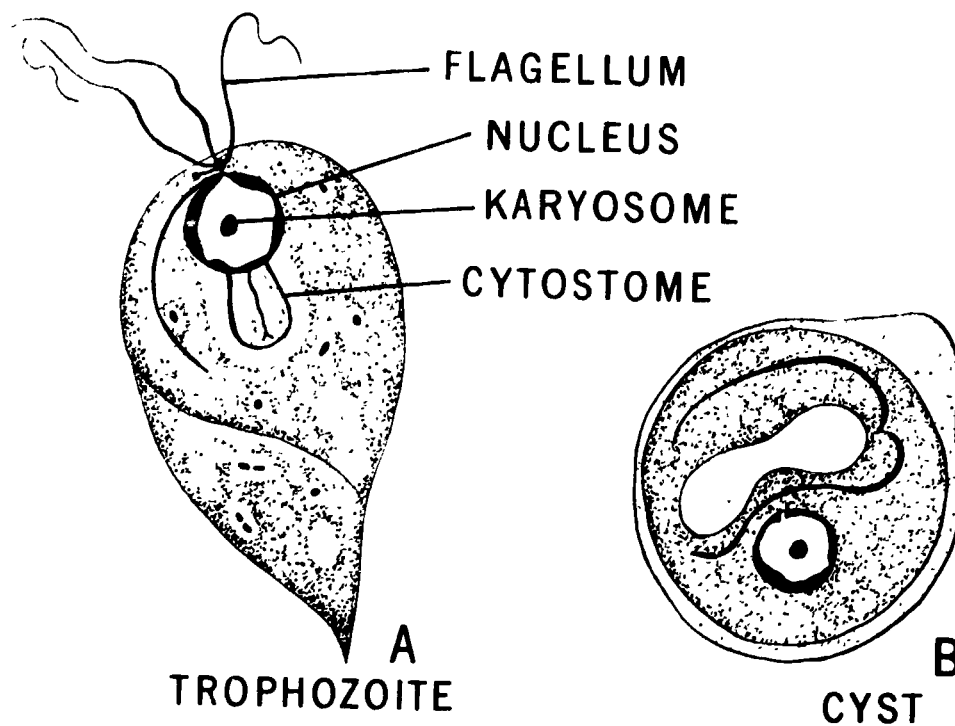

Figure 2-4 *Chilomastix mesnili*

The nucleus has a well-defined nuclear membrane. The karyosome is small, dot-like, and centrally located. Immediately above the nucleus in the anterior end of the organism there is a small group of blepharoplasts, from which three flagella extend anteriorly. A fourth extends posteriorly about one-half the length of the body. There are two curved fibrils, one on each side of the cytostome.

Stained cysts of this species are lemon shaped, as shown in figure 2-4,B. In length they are about equal to the diameter of a red blood cell and about two-thirds as wide. The most characteristic morphological structure is a protuberance on one margin, giving the cysts the shape of a lemon. Cysts usually contain a single nucleus situated near the protuberance. Remnants of the trophozoite remaining in the cysts are the cytostome and the two fibrils.

*C. mesnili* is not pathogenic. One must be careful in laboratory examinations not to confuse the organism with *Trichomonas hominis*, which is also found in fecal specimens. Confirmation is made by examining fixed stained preparations.

#### Exercises (413):

Indicate whether each of the following statements is true (T) or false (F) and correct those that are false.

T F 1. *Chilomastix mesnili* normally inhabits the upper small intestine.

T F 2. *Giardia lamblia* inhabits the upper small intestine.

T F 3. In severe diarrhea the predominant form of *Giardia lamblia* found is the trophozoite.

T F 4. *Chilomastix mesnili* obtains food from enteric bacteria in the upper small intestine.

T F 5. Prominent internal structures of *C. mesnili* include an anteriorly located nucleus and a primitive mouth (cytostome).

T F 6. The most characteristic morphological structure of *C. mesnili* trophozoite is the small dot-like and centrally located karyosome.

T F 7. Remnants of the trophozoite remaining in the cysts are the cytostome and the two fibrils.

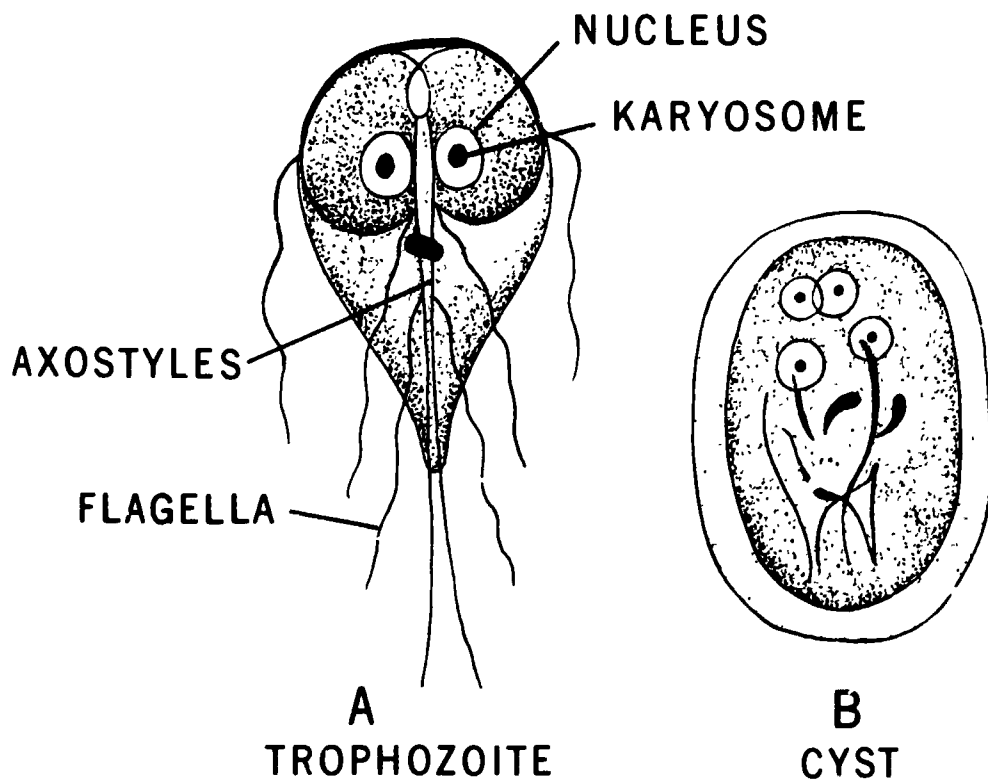

Figure 2-5 *Giardia lamblia*

T F 8. *Chilomastix mesnili* causes severe diarrhea.

T F 9. *Chilomastix mesnili* can be confused with *Trichomonas vaginalis*, which is usually found in fecal specimens.

414. Specify the approximate length and shape of *Giardia lamblia* in relation to a red blood cell, distinctive morphological features, and the appearance of the nuclei in the cystic state.

*Giardia lamblia*. In fresh preparations, the trophozoite of *Giardia lamblia* is actively motile and demonstrates nondirectional movement. It resembles a longitudinally cut pear. It is about twice the diameter of a red blood cell in length, and only slightly wider than a red blood cell. It is shaped much like a saucer. The concave side forms a sucking disc by which the parasite adheres to mucous membrane surfaces.

The best way for you to study the detailed morphology of this species is to use an iron hematoxylin stained preparation. *G. lamblia* is the only bilaterally symmetrical protozoan infecting man.

Figure 2-5,A, shows some of the important structures. Distinctive features that you usually find are:

- Four pairs of flagella.
- Two nuclei in the anterior third of the body, one on either side of the axostyles.
- A rod-like structure lying diagonally across the center of the body that is believed to be the parabasal body.

This organism is commonly found in the cystic stage but is frequently found in the trophozoite stage in loose stools. In hematoxylin stained preparations of the cystic stage, the nuclei stand out as four "eye-like" ovoid objects similar to the nuclei seen in the trophozoite. These nuclei are generally grouped near the anterior end of the organism. The remains of the axostyles also appear as curved rods running down the center of the cyst. Figure 2-5,B, shows these features in a drawing of the cyst.

*Giardia lamblia* is the most frequently diagnosed parasite in the intestine of man. It does not usually produce any illness of significance. The organism has been implicated as the cause of:

- Intestinal irritation.
- Chronic diarrhea.
- Slight epigastric pain.
- Decrease in fat absorption.
- Weight loss.

**Exercises (414):**

1. What is the approximate length and shape of *Giardia lamblia* as compared with that of a red blood cell and what does it resemble?
  2. What staining preparation is recommended for study of detailed morphology of *Giardia lamblia*?
  3. What are three distinctive features of *Giardia lamblia*?
  4. In hemotoxylin stained preparations of the cystic stage, how do the nuclei stand out?
415. Point out the species among the Trichomonads that is considered to be a mild pathogen, the stage in

which the organism exists, the specimen from which the organism is obtained, the disease condition caused, and the methods of laboratory diagnosis.

**The Trichomonads.** The trichomonads are small flagellated, pear-shaped protozoans with prominent undulating membranes. They do not form cysts and, as a result, are usually seen as actively motile trophozoites. On occasions they assume a rounded-up form that resembles a cyst. They are not genuine cysts. These organisms, as a rule, thrive where there is a lack of personal hygiene. The most common human trichomonads are: *Trichomonas vaginalis*, *T. tenax*, and *T. hominis*. *T. vaginalis* is considered a mild pathogen. The other trichomonads are considered nonpathogens.

*Trichomonas vaginalis.* This species has a worldwide distribution. The organism exists only in the trophozoite stage. When found in fresh urethral or vaginal discharges, the trophozoites are readily visible under high, dry magnification. The presence of flagellates in the genitourinary tract strongly suggests a diagnosis of *T. vaginalis*. No other flagellates are ordinarily found at that site in man. Figure 2-6 is a drawing of the organism

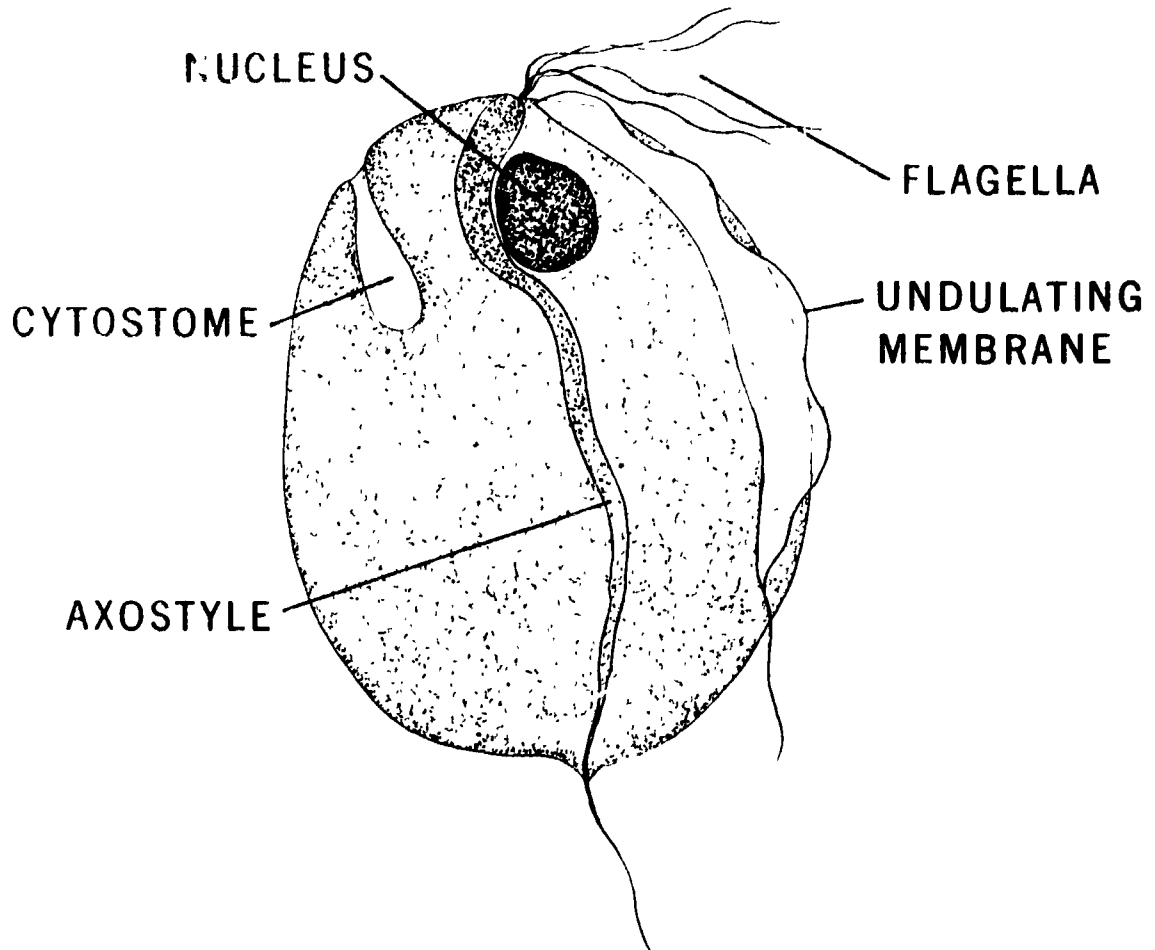

Figure 2 6. *Trichomonas vaginalis*



The internal and external structures of *T. vaginalis* are best observed if the preparation has been stained. There are four anteriorly directed flagella arising from the blepharoplast. A fifth flagellum is directed posteriorly along the margin of the relatively short undulating membrane. It does not extend beyond the posterior limit of the membrane. The nucleus is usually elongated, with the nuclear chromatin uniformly distributed. There are numerous rod-like granules evenly distributed throughout the cytoplasm. The supporting axostyle originates in the blepharoplast and terminates posteriorly in a long, free portion protruding from the body wall.

In females *T. vaginalis* causes severe irritation of the vaginal and urethral mucosa. The inflammatory condition that results can be very intense. The inflammation develops from the degeneration of the epithelium caused by large numbers of flagellates. This condition causes the increased production of vaginal secretions. In the male the flagellates may cause an irritating urethritis or prostatitis.

Laboratory diagnosis is made by the recovery and identification of the organisms from vaginal or urethral secretions. Frequently the organism is found in centrifuged urine specimens. Motile forms can be observed for about 1 hour in urine after the specimen is voided. More than 1 hour after the specimen is voided you will normally find only nonmotile organisms. To recover the parasite from genitourinary secretions, collect the specimens on cotton-tipped applicator sticks. Place the applicator sticks in a small amount of normal saline. Reliable culture techniques are available and should be employed when direct smears are negative. Avoid contamination of urine by feces, because *T. hominis* can be easily mistaken for *T. vaginalis*.

#### Exercises (415):

1. Which of the species among the human trichomonads is considered to be a mild pathogen?
2. In what biological stage does *Trichomonas vaginalis* exist?
3. The flagellate is found in what specimens?
4. How is the urethral or vaginal mucosa affected by *T. vaginalis*?

5. How is the organism obtained for laboratory diagnosis?

416. Indicate whether given statements correctly reflect the source of *Trichomonas tenax*, pathogenicity, source of isolation, and method used for laboratory identification.

*Trichomonas tenax*. *Trichomonas tenax* is a common parasite of the mouth. It lives in the tartar around the teeth and gingival margins. *T. tenax* is encountered in all areas of the world.

*T. tenax* has been recovered only in the trophozoite stage. It has a length of 6 to 12 $\mu$ m and a granular cytoplasm. The undulating membrane is relatively short. In stained preparations, the axostyle protrudes a considerable distance beyond the posterior margin of the body. Figure 2-7 shows a drawing of the *T. tenax*.

*T. tenax* is of little pathological significance and is considered to be harmless. It has been incriminated, however, in a few respiratory infections and lung abscesses, probably as a secondary invader. The presence of the organism indicates very poor dental and oral hygiene.

You can recover *T. tenax* by obtaining smears from areas between the teeth, margins of the gums, and tonsils. Make plain wet mounts or stain slides of material from the mouth to isolate the parasite.

#### Exercises (416):

Indicate whether each of the following statements is true (T) or false (F) and correct those that are false.

- T F 1. *Trichomonas tenax* is a common parasite of the intestinal tract.



Figure 2-7. *Trichomonas tenax*.



T F 2. *Trichomonas tenax* lives in the lumen of the large intestine.

T F 3. The undulating membrane is relatively short.

T F 4. *Trichomonas tenax* is of little pathological significance and is considered to be harmless.

T F 5. The presence of the organism indicates very poor dental and oral hygiene.

T F 6. Plain wet mounts on stained slides are made by obtaining smears from areas between the teeth, margins of the gums, and tonsils.

**419. Indicate whether given statements correctly reflect the appearance of *Trichomonas hominis* in fresh preparations, distinctive features, pathological significance, and features of differentiation between *Trichomonas hominis* and *Trichomonas vaginalis*.**

*Trichomonas hominis*. As with the other trichomonads, there is no known cystic stage. In fresh preparations (wet mounts) the organism exhibits a wobbly yet progressive motion which is brought about by the active vibration of the flagella and the undulating membrane. To observe the organism as shown in figure 2-8, the microscope light must be decreased considerably, since the parasite is very



Figure 2-8. *Trichomonas hominis*.

hyaline, clear, and finely granular. Specimens stained with hematoxylin show the internal and external structures very clearly.

The distinctive features of *T. hominis* are:

- Pear-shaped body.
- Three to five anteriorly directed flagella originating from the blepharoplast.
- A single, posteriorly directed flagellum which also originates from the blepharoplast and borders an undulating membrane.
- The flagellum bordering the undulating membrane extends beyond the posterior margin of the membrane.
- A prominent nucleus.

You will find motile *T. hominis* only in fresh stool preparations. This species has no known pathological significance. You must be able to identify the organism in case of contamination of urine specimens with feces. There are two features for differentiation between *T. hominis* and *T. vaginalis* when stained with hematoxylin, namely:

a. The undulating membrane of *T. hominis* is longer and the flagellum bordering that membrane extends beyond the posterior border.

b. *T. hominis* averages 7 to 8  $\mu\text{m}$  in length, while *T. vaginalis* averages 13  $\mu\text{m}$  in length.

#### Exercises (417):

Indicate whether each of the following statements is true (T) or false (F) and correct those that are false.

T F 1. In fresh preparations, *Trichomonas hominis* shows a sluggish, non-directional motion which is brought about by the lack of a flagella and short undulating membrane.

T F 2. Specimens stained with hematoxylin show the internal structures very clearly.

T F 3. *Trichomonas hominis* shows a prominent nucleus.

T F 4. The flagellum bordering the undulating membrane extends beyond the posterior margin of the membrane.

T F 5. You will find motile *Trichomonas hominis* only in fresh stool preparation.

T F 6. *Trichomonas hominis* found in the stool is of great pathological significance.

T F 7. *Trichomonas vaginalis* has a longer undulating membrane, and the flagellum bordering the membrane extends beyond the posterior border when compared to *Trichomonas hominis*.

## 2-2. Amebae

Finding and accurately identifying cysts and trophozoites of amebae in the routine examination of specimens are the most difficult tasks confronting the laboratory technician. One must be able to differentiate those of medical importance from those which are harmless. Our study of the amebae will be confined to the seven listed in table 2-1. The organisms will be discussed in the order given in table 2-1.

Six of these amebae inhabit the human intestinal tract, and one is found in the spaces around the teeth. Various stages that you can find in fresh specimens and in fixed preparations will be described in the section which follows.

418. State the reason why *Entamoeba histolytica* is considered to be the most pathogenic amoeba, morphological features of the trophozoite, and cystic stages, diagnostic characteristics, and reaction of the trophozoites when present in fresh, warm, stool specimens.

**Entamoeba Histolytica.** *Entamoeba histolytica* is the most pathogenic of the amebae because of its ability to invade and destroy tissue. It has been found in populations worldwide. The organism is more prevalent in warmer climates than in cooler areas.

Figure 2-9,A, represents a drawing of the trophozoite of *E. histolytica*. Trophozoites are three or four times the size of a red blood cell. An actively motile trophozoite has a clear zone of ectoplasm occupying about a third of the entire cell. The remainder is composed of fine granular endoplasm in which food vacuoles and the nucleus float about. When warm, these amebae are very active. They move rapidly and extend a single, clear pseudopod in any direction. However, they do tend to travel in a straight line. Food inclusions consist of red blood cells, white blood cells, and other cellular debris. The nucleus in fresh preparations may be barely visible as a faint ring or not visible at all. In stained preparations the ectoplasm and endoplasm are not differentiated into clearly defined zones. In all stages of development, the nucleus is almost perfectly circular. The limiting membrane of the nucleus, known as the nuclear membrane, has on its inner surface a thin layer of evenly distributed chromatin granules that are

bead-like in arrangement. At the center of the nucleus is a small dot-like body known as the endosome or karyosome. In the course of transition from the active trophozoite to the dormant, cyst stage several well-defined intermediate stages can be identified.

Progressing from the trophozoite stage, the precyst shown in figure 2-9,B, is seen next. The uninucleate, binucleate, and quadrinucleate cyst (mature form) follow in succession. As the encystment process begins, pseudopods are lost and the organism rounds up. A well-defined cyst wall or protective covering is secreted as encystment advances. As the cyst develops, food inclusions are extruded and chromatin bodies of varying shapes and sizes appear. The uninucleate cyst occasionally displays a broad, oval clear area which is a glycogen vacuole. Figure 2-9,C, shows the organism as it progresses to the binucleate stage. The glycogen vacuole, when present, becomes smaller and chromatoidal material begins to congregate into fewer and more uniform masses as the cyst matures.

The mature cyst has four nuclei and is shown in figure 2-9,D. Throughout this gradual transition the intranuclear characteristics remain unchanged. The dot-like karyosome and the peripherally arranged, bead-like chromatin granules are identical in all stages of development. Glycogen vacuoles are not usually observed in the mature cyst. The principle morphological features of the mature cyst are the presence of four nuclei and rod-like chromatoidal bodies with smoothly rounded ends. In old cysts the chromatoidal bodies may be completely lacking.

If the parasite invades the intestinal tissue, the chances are very great that the organisms will go on to invade the liver, especially if the patient is not treated. Furthermore, invasion of the skin, lungs, and brain has been known to occur. Fatalities, although rare, do occur.

Identification of *E. histolytica* is not too difficult if you have the proper type of specimen. In fresh, warm stool specimens, trophozoites of *E. histolytica* will be actively motile and move in a definite direction, while the trophozoites of *Entamoeba coli* will move in a sluggish manner without direction. You should not expect to find trophozoites in formed stool specimens. However, you can easily identify cysts in stained smears. You should examine liquid stools as soon as possible after elimination and make smears of any mucus that you find. Trophozoites are most often found in the mucus. Early examination is necessary because trophozoites degenerate in a very short time. The sample should be immediately preserved if it cannot be examined at once.

### Exercises (418):

1. *Entamoeba histolytica* is the most pathogenic of the amoeba because of its ability to \_\_\_\_\_ and \_\_\_\_\_ tissue.

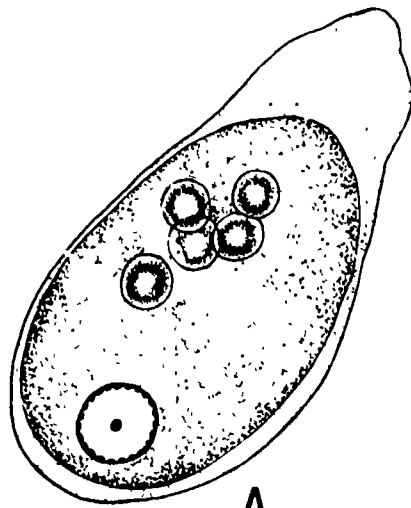

A  
TROPHOZOITE

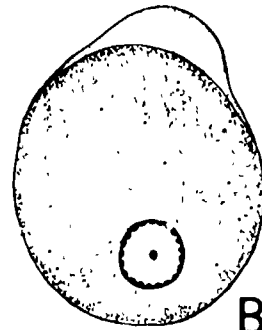

B  
PRECYST

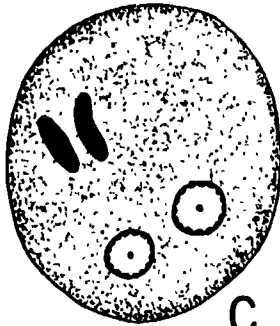

C  
BINUCLEATE CYST

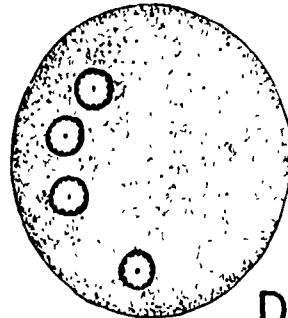

D  
MATURE CYST

Figure 2 9 *Entamoeba histolytica*

384

2. How much larger are the trophozoites when compared with the size of a red cell?
3. When warm, the amoeba are very (sluggish/active)
4. Food inclusions in the trophozoite consist of what substances?
5. How does the nucleus appear in fresh preparations?
6. In all stages of development, the nucleus is almost perfectly \_\_\_\_\_.
7. What distinctive characteristics are observed on the inner surface of the nuclear membrane and in the nucleus of the cell?
8. The uninucleate cyst occasionally displays a broad, oval, clear area which is a \_\_\_\_\_.
9. What are the principal morphological features of the mature cyst?
10. In fresh, warm stool specimens, trophozoites of *E. histolytica* will be (active/sluggish) and move in a (non-directional/directional) manner.
11. One would not expect to find trophozoites in what types of stool specimens?
12. Why is early examination of the specimen necessary?

419. Identify given characteristics of *Entamoeba hartmanni*, *Entamoeba coli*, and *Entamoeba gingivalis* in terms of morphological differences and similarities, and pathological significance.

**Entamoeba Hartmanni.** *Entamoeba hartmanni* is the organism that has been previously known as small race *E. histolytica*. Morphologically *E. hartmanni* is exactly like *E. histolytica*, except that the cysts are less than 10  $\mu\text{m}$  in size, whereas, those of *E. histolytica* are greater than 10  $\mu\text{m}$ . It is important that you be able to make this differentiation, because *E. hartmanni* is not known to be pathogenic, whereas *E. histolytica* may produce very serious disease.

**Entamoeba Coli.** *Entamoeba coli* is found in all countries of the world. There are several characteristics which differentiate this species from *E. histolytica*. *E. coli* is the largest of the intestinal amebae and displays numerous types of food inclusions, including bacteria, starch, fragments of the host's body cells, and yeast. Movement is sluggish and nondirectional. Pseudopods are usually very narrow and composed mostly of endoplasm. They are less hyaline, much shorter, and more blunt than those of *E. histolytica*. Figure 2-10,A, depicts the trophozoite stage.

In unstained preparations the nucleus of *E. coli* is usually visible, appearing as a large refractile ring within which may be seen a small eccentric hyaline mass, the karyosome. Among the distinctive characteristics found in stained preparations is a prominent nucleus. On the inner periphery of the nuclear membrane the chromatin material is arranged in irregular masses. The karyosome is comparatively large and usually off-center within the nucleus. As the organism progresses through the various stages in the process of encystment, several clearly recognizable transitional forms can be observed. These include precysts, binucleate cysts, quadrinucleate cysts, and mature cysts with eight nuclei.

During transition from the trophozoite to the precystic stage shown in figure 2-10,B, food inclusions are expelled; and many small masses of chromatin material appear. A glycogen vacuole is frequently present, and it may push the nucleus off to one side of the precyst.

The next stage observed is the binucleate cyst shown in figure 2-10,C. A rather dense mass of glycogen is often found in unripe cysts. It is easily demonstrated with iodine stain. As the cyst ripens, the glycogen material appears less dense or entirely disappears.

Two further nuclear divisions occur, resulting in the eight-nucleated (mature) form. This is shown in figure 2-10,D. At this stage most of the chromatoid material has disappeared, and that remaining consists of irregular shaped, splinter-like particles.

*E. coli* produces neither symptoms nor pathology in man. It definitely presents a problem in differentiating it from the pathogenic *E. histolytica*, especially for technicians who have not had practice in comparing the two parasites in the trophozoite stage.

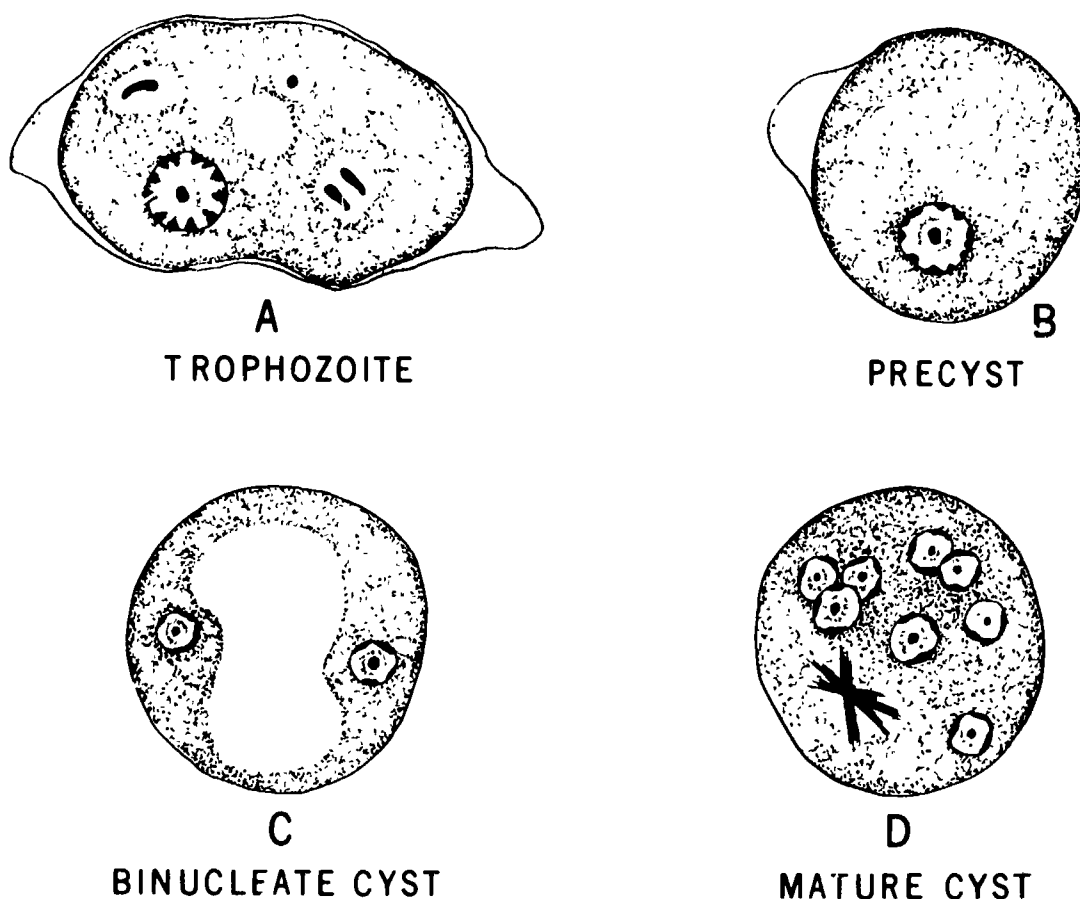

Figure 2-10 *Entamoeba coli*

**Entamoeba Gingivalis.** No cyst of *E. gingivalis* has been observed. As the parasite undergoes active movement, you can see a distinction between the ectoplasm and endoplasm. The pseudopods form various shapes while the parasite is in motion. Figure 2-11 is a drawing of this species in motion.

*E. gingivalis*, like *Trichomonas tenax*, is found in the dental plaque. The specific identifying features are a round nucleus, a nuclear membrane lined with chromatin granules, and a small, centrally located karyosome. These features can be observed only in stained preparations.

*E. gingivalis* is not a pathogenic amoebae; but its presence indicates poor oral hygiene, since the organism thrives on diseased gums and unhealthy oral conditions. You must be able to differentiate *E. gingivalis* from *T. tenax* and other organisms found in the mouth.

**Exercise (419):**

- Match each column B item with the statements in column A by placing the letter of the column B item beside the number of the column A item that most nearly describes it. Each element in column B may be used once or more than once.

**Column A**

- (1) The organism known as the small race of *E. histolytica*
- (2) Is the largest of the intestinal amoebae
- (3) Pseudopods are usually very narrow, composed mostly of endoplasm and are less hyaline, much shorter and more blunt than those of *E. histolytica*
- (4) The cysts are less than 10  $\mu$ m
- (5) The mature cysts have eight nuclei.
- (6) Produce neither symptoms nor pathology in man
- (7) In the mature cysts, most of the chromatoid material has disappeared and that remaining consists of irregularly shaped, splinter-like particles
- (8) No cyst of this amoeba has been observed
- (9) Like *Trichomonas tenax*, is found in the tartar between teeth

**Column B**

- a *Entamoeba gingivalis*
- b *Entamoeba coli*
- c *Entamoeba hartmanni*
- d *E. histolytica*

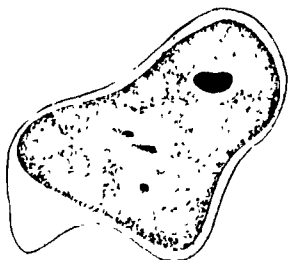

Figure 2-11 *Entamoeba gingivalis*

420. State important points for identifying the trophozoites of *Endolimax nana* in stained preparations and the appearance of the organism in the cystic stages.

**Endolimax Nana.** *Endolimax nana* is small, as its name implies. It has a diameter of 6 to 15  $\mu\text{m}$ . Like *E. histolytica* and *E. coli*, it is found worldwide. *E. nana* has all the stages of development that are found in *E. histolytica* and *E. coli*. Generally, movement of the trophozoite is non-directional, and pseudopods are extruded in various directions. Figure 2-12.A, provides a drawing of the trophozoite stage.

The cytoplasm of the *E. nana* trophozoites is finely granulated and has vacuoles. In stained preparations, nuclear characteristics, size, and appearance are the important points by which you can identify the species. The nuclear membrane is often invisible, and the nucleus is made conspicuous by a large eccentric karyosome. The area between the ill-defined nuclear membrane and the karyosome forms a "halo-like," narrow, clear zone free of granulation.



A  
TROPHOZOITE

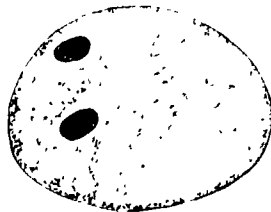

B  
BINUCLEATE CYST



C  
MATURE CYST

Figure 2-12 *Endolimax nana*

As the organism develops into the cyst stage, the food inclusions are lost, and the cytoplasm becomes more granular. Gradually a thin elastic cyst wall is secreted. Figure 2-12.B, demonstrates the binucleate cyst. In this stage, the nuclear characteristics are similar to those of the uninucleate form.

Figure 2-12.C, shows the appearance of the mature cyst. The mature stage is the form most frequently seen in routine fecal examinations. In stained preparations, you will find the four nuclei clustered, usually, at one pole of the mature cyst. The karyosomes and the surrounding nuclear membranes are oval in shape. The karyosome fills about one-half the total area of the nucleus. Cysts are sometimes round, but most often they are ovoid in shape. Chromatoidal bodies are occasionally seen in this species as small, slightly curved rods in the cytoplasm. The endoplasm often contains a number of small refractile granules.

*E. nana* is nonpathogenic, and you will find the parasite quite often during routine fecal examinations. You can see the organism in wet preparations, but it is difficult to differentiate from other species. However, the organism is easy to identify in stained preparations.

#### Exercises (420):

1. *Endolimax nana* has all stages of development that are found in \_\_\_\_\_ and \_\_\_\_\_.
2. Generally, movement of the trophozoite is \_\_\_\_\_.
3. In stained preparation \_\_\_\_\_ and \_\_\_\_\_ are the important points by which you can identify these species.



- 4 The nuclear membrane is often \_\_\_\_\_, and the nucleus is made conspicuous by a large eccentric \_\_\_\_\_
- 5 The area between the ill-defined membrane and the karyosome forms a " \_\_\_\_\_," narrow, \_\_\_\_\_ zone free of granulation
- 6 In stained preparations, you will find the \_\_\_\_\_ nuclei clustered, usually at one pole of the \_\_\_\_\_ cyst.
- 7 The karyosomes and the surrounding nuclear membranes are \_\_\_\_\_ in shape

421. Indicate whether given statements correctly reflect morphological features and pathogenicity of *Dientamoeba fragilis*.

*Dientamoeba Fragilis*. Living trophozoites of *Dientamoeba fragilis* project clear pseudopods. The movement of the organism is active and progressive. With a drop in temperature, the organism soon

becomes inactive, rounds up, and quickly disintegrates. The organism ruptures in tapwater and disintegrates. This is the only intestinal amoeba of man in which no cystic stage is known. Figure 2-13 (A and B) shows drawings of both the uninucleate and binucleate trophozoites.

An examination of the distinctive features of *D. fragilis* in stained preparations shows that the cytoplasm is finely granular in appearance. Food inclusions generally consist of bacteria. About 80 percent of the organisms of this species contain two nuclei. Each karyosome consists of an aggregation of four to eight separate granules. The nuclear membrane is indistinct, or invisible, and there is no chromatin lining on the inner periphery of the nuclear membrane.

In a few cases, *D. fragilis* has been suspected of producing a slight irritation of the intestinal mucosa. There is no invasion of the intestinal tissue. The incidence of this parasite in the United States is very low.

#### Exercises (421):

Indicate whether each of the following statements is true (T) or false (F) and correct those that are false.

T F 1. The movement of *Dientamoeba fragilis* is sluggish and non-directional.

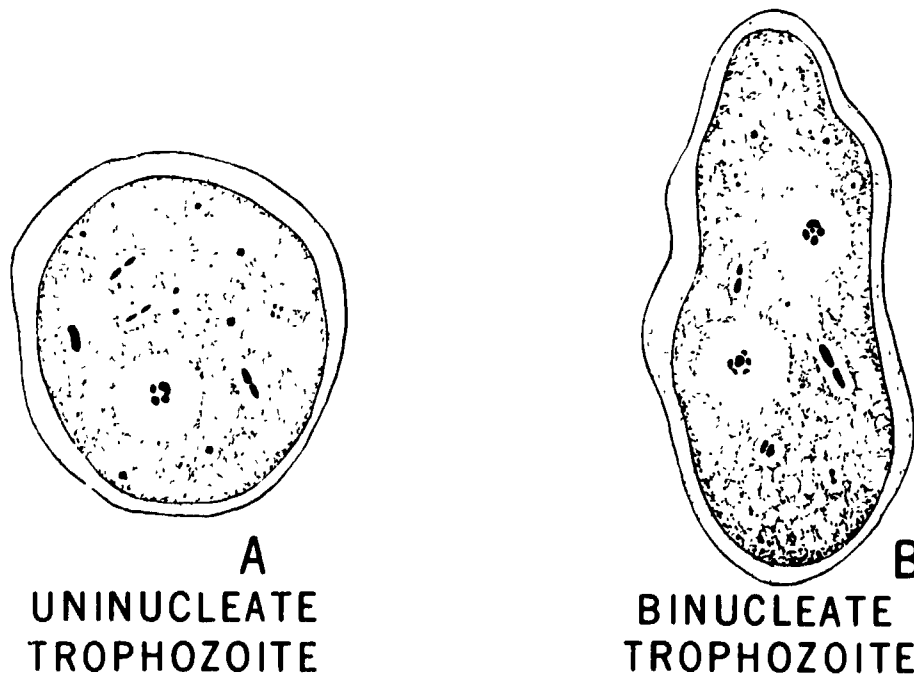

Figure 2-13 *Dientamoeba fragilis*

T F 2. With a drop in temperature, the organism soon becomes inactive, rounds up, and quickly disintegrates.

T F 3. The distinctive features of *D. fragilis* in stained preparations shows that the cytoplasm is smooth in appearance.

T F 4. About 80 percent of the organisms contain two nuclei.

T F 5. *D. fragilis* has been suspected of producing a slight irritation of the intestinal mucosa in a few cases.

T F 6. There is some minute invasion of the intestinal tissue.

T F 7. The incidence of this parasite in the United States is very low.

**422. State distinctive morphological characteristics of *Iodamoeba butschlii* and requirement for laboratory identification.**

***Iodamoeba Butschlii.*** *I. butschlii* is found in all countries of the world but is less common than some of the other amoebae. It is the only species of intestinal amoeba of man in which a single nucleus persists throughout both the trophozoite and cystic stages.

The living trophozoite, shown in figure 2-14,A, is about one and one-half times the diameter of a red cell. Movement is sluggish; pseudopods are leaf-like and greenish yellow in appearance. They have broad clear margins. You will have difficulty in differentiating the trophozoites of *I. butschlii* from those of *E. hartmanni* if you do not pay close attention to the nuclear detail.

The cyst stage of *I. butschlii* has a single nucleus, as shown in figure 2-14,B. The nucleus is spherical, has a rather thick membrane, and has a large karyosome which is central or somewhat eccentric. The nuclear membrane in well-stained preparations displays irregularly spaced chromatin granules which appear as a "scallop-like" fringe lining the membrane. A unique feature of this organism is the large glycogen vacuole which stains brown with iodine. The cyst is usually neither round nor oval, but rather irregular with no specific form.

Laboratory identification of this species requires stained specimens. It is best for you to use both hematoxylin and iodine stained preparations. One must be careful to distinguish the parasite from *E. histolytica* and *E. hartmanni*. *I. butschlii* is usually considered to be harmless.

**Exercises (422):**

1. A single (nucleus/cell wall) persists throughout both the trophozoite and cystic stages

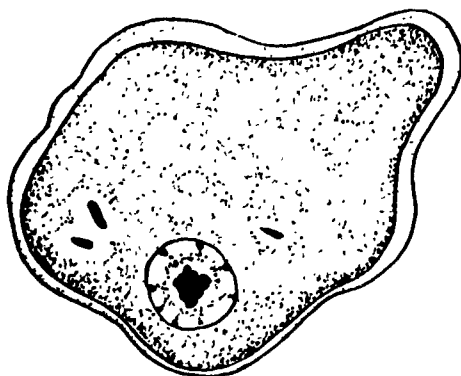

**A**  
**TROPHOZOITE**

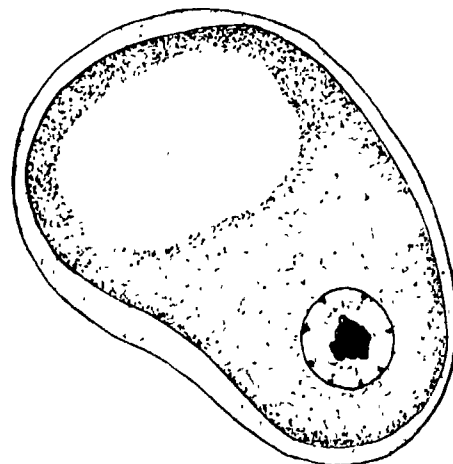

**B**  
**CYST**

Figure 2 14 *Iodamoeba butschlii*

2. Movement is (rapid/sluggish); pseudopods are (oval-shaped/ leaf-like) and (greenish/brownish) in appearance.
3. If you do not pay close attention to the nuclear detail, you will have difficulty in differentiating *I. butschlii* from those of \_\_\_\_\_.
4. The cyst stage of *I. butschlii* has (a single/two) nuclei.
5. The nuclear membrane in well-stained preparations displays irregularly \_\_\_\_\_ granules.
6. A unique feature of this organism is the large \_\_\_\_\_ which stains \_\_\_\_\_ with \_\_\_\_\_.
7. Laboratory identification of this species requires \_\_\_\_\_ specimens.
8. *Iodamoeba butschlii* is usually considered to be (invasive/ harmless).

### 2-3. Apicomplexa

Lack of agreement and dissatisfaction have increasingly resulted among protozoologists regarding the grouping of parasitic protozoa traditionally assigned to the class or subphylum Sporozoa. One researcher proposed a new subphylum, the Apicomplexa, to be comprised of organisms that possess a certain combination of structures, the *apical complex*, distinguishable with the electron microscope.

The class Sporozoa includes several species that parasitize man. These are the *Toxoplasma* organisms, the coccidia and the extremely important malarial parasites.

Sporozoan organisms have an interesting and complex life cycle. They reproduce through alternating sexual and asexual cycles. The coccidia go through both the sexual and asexual cycle in one host. The malarial parasites require two hosts.

In the sexual cycle, male and female gametes join to form a zygote which develops into an *oocyst*. When the

*oocyst* reaches maturity, it ruptures and releases sporozoites. This is the sexual cycle, referred to as *sporogony*.

The asexual cycle is initiated by the sporozoites which, in developing, are transformed into trophozoites. Each trophozoite produces a *schizont*. The schizont produces a number of *merozoites*. This is the asexual cycle and is referred to as *schizogony*. Some of the merozoites will develop into male gametocytes; others will develop into female gametocytes. These unite to start the sexual cycle again. For many years very little was known about the reproductive cycle of *Toxoplasma*. The importance of the organism has stimulated a tremendous amount of research in recent years. Thus, the onetime obscure protozoan parasite of an obscure African rodent has become one of the most exciting subjects in parasitology.

We shall limit our discussion of the organisms in the class Sporozoa to two species of *Isospora*, the *Plasmodia* (malarial parasites), and one *Toxoplasma* species (*Toxoplasma gondii*). These three groups are representative of the Sporozoa and include almost all of the organisms of the class Sporozoa that parasitize man.

423. Cite the two members of the subclass Coccidia that parasitize man, the disease condition caused, the appearance of the immature oocyst of *Isospora belli*, and the forms of cyst found in fresh fecal material infections caused by *Isospora hominis*; point out the reason why careful examination, using screening and concentration techniques for either organisms, is important.

The Coccidia, *Isospora hominis* and *Isospora belli* are the only members of the subclass Coccidia that parasitize man. The organisms invade and destroy the mucosal tissue of the small intestine and cecum, causing a mucous diarrhea, low-grade fever, loss of appetite, and nausea.

Fresh fecal specimens from infected persons yield either oocysts or sporocysts, depending on which species causes the infection. If the infection is caused by *Isospora belli*, immature oocysts are passed. The immature oocyst illustrated in figure 2-15,A, looks like a thick-walled, transparent, lemon-shaped structure containing a single spherical mass of protoplasm. If you keep the stool at 25° to 30° C. for several hours, the protoplasmic mass will divide into two equal masses which are the immature sporocysts. After 18-36 hours, you will find four sporozoites within each sporocyst. The sporocyst membrane is thin and very difficult to see.

In infections caused by *Isospora hominis*, you will find mature sporocysts in fresh fecal material. They are illustrated in figure 2-15,B. You may find them singly or in pairs. The single ones that you see have been released from ripe oocysts. Some workers feel that *I. hominis* infections occur higher in the gut than *I. belli*

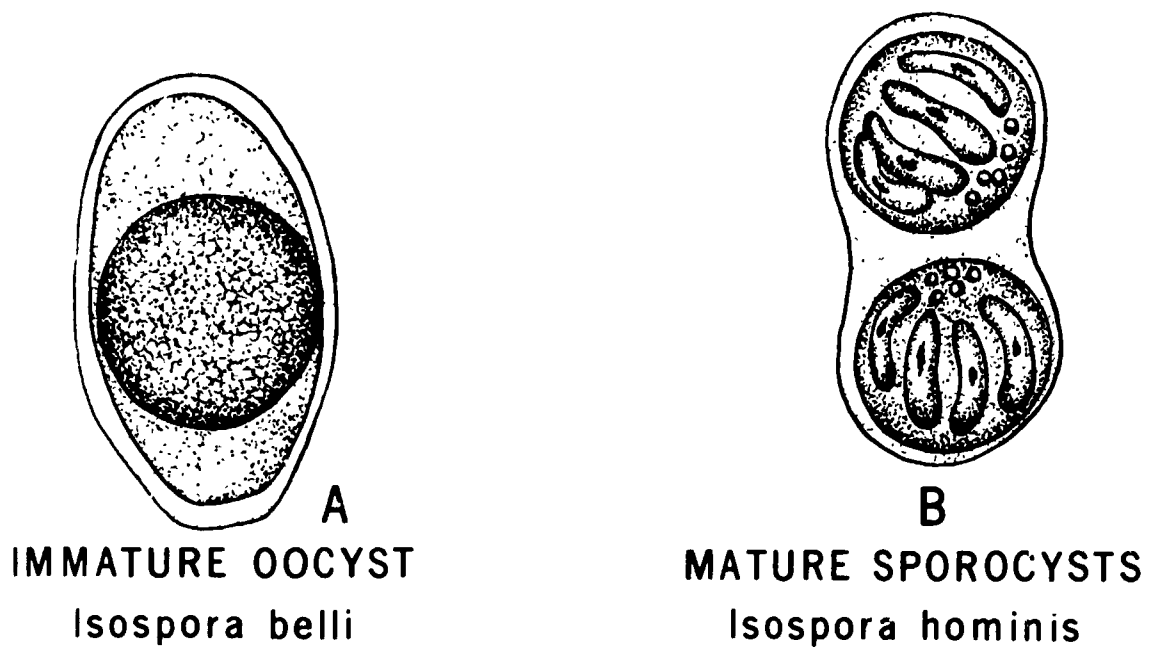

Figure 2-15 Coccidia

infections and that this results in mature sporocysts being passed.

If you examine fecal material using the usual screening or concentration techniques, it is unlikely that you will find either of the organisms. This is due to the fact that in active infections, oocysts are not passed in large numbers. Also, the oocysts and sporocysts are so transparent they are usually overlooked. If a coccidia infection is suspected, then you must thoroughly examine the specimen using good concentration techniques. The concentrated sample should be stained with iodine. Oocysts and sporozoites do not take up the stain and will appear as shiny, transparent, unstained bodies surrounded by stained sediment.

**Exercises (423):**

1. What two members of the subclass Coccidia parasitize men?
2. What disease condition is caused by both organisms?
3. How would the immature oocyst of *Isospora belli* be recognized in a fresh fecal specimen?
4. What forms of cysts would you find in fresh fecal material in infections caused by *Isospora hominis*?
5. For what two reasons is it unlikely that you will find either of the organisms upon examining fecal material using the usual screening or concentration techniques?

**424. Describe the appearance of *Toxoplasma gondii* when stained with Giemsa stain; state the disease caused, modes of transmission, and the definitive host of the organism.**

**Toxoplasma Gondii.** *Toxoplasma gondii* is a sporozoan parasite that commonly infects many different birds and mammals, including man. It is most prevalent in moist, warm climates, but it has been reported from all continents of the world. The organism (fig. 2-16) is a small comma-shaped, slightly oval body 4 to 7  $\mu\text{m}$  long by 2 to 4  $\mu\text{m}$  wide. When stained with Giemsa, the organism shows a delicate light blue cytoplasm with a reddish, oval nucleus towards the broad end.

**Clinical significance.** *Toxoplasma gondii* is the causative agent of toxoplasmosis in man and animals and is widespread in the population. The disease is transmitted via raw or poorly cooked meat, and possibly in some cases by oocysts in feces of infected

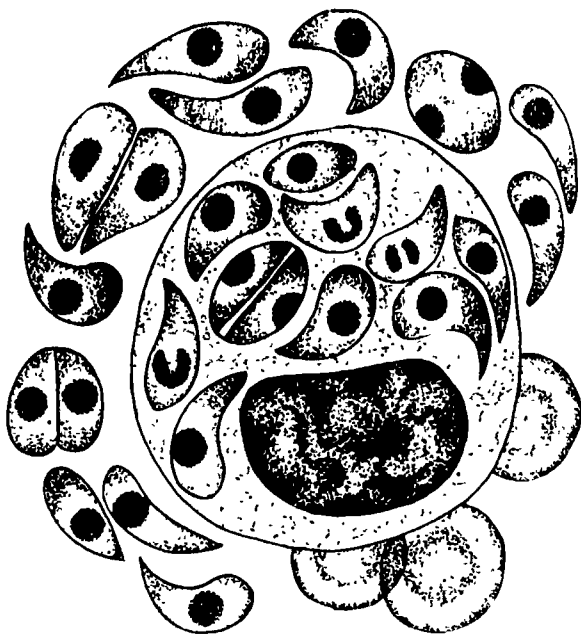

Figure 2-16 *Toxoplasma gondii*

cats. There may be a congenital form transmitted to the fetus during the early stages of pregnancy or an acquired form. The congenital form is manifest in the infant or young child as an encephalitis and convulsions may occur. In such cases parenchymal and reticuloendothelial cells are generally affected and lesions occur in the brain, spleen, kidneys, adrenal, and lymph nodes. The clinical picture of acquired toxoplasmosis may resemble infectious mononucleosis with a low grade fever. In summary, it must be stated that during toxoplasmosis infections, the sites most commonly attacked are the lymph nodes, brain, eyes, and lungs.

**Life cycle.** Recent evidence shows that *T. gondii* is a coccidial parasite, thus it belongs along with the malarial parasites in the subphylum or class Sporozoa. In the definitive or final host, which is the domestic cat or other members of the family Felidae, an asexual cycle as well as a sexual cycle occurs in the epithelial cells of the small intestine. Only the cats are known to excrete oocysts in feces. Within a few days, these sporulate so that each oocyst contains two sporocysts, each with four sporozoites. Ingestion by another animal, including humans, of the oocysts releases the enclosed sporozoites which then multiply in epithelial cells, leukocytes, the reticuloendothelial system, and the central nervous system. Thus, human infection can occur not only by ingestion of cysts in undercooked meat, but by ingestion of mature oocysts as well. Once the organism infects an animal, it reproduces itself by *endodyogeny*. The process (fig. 2-17) begins with a longitudinal division of the nucleus. The two daughter nuclei each take on part of the cytoplasm of the parent



Figure 2-17 Reproductive process of *T. gondii*

cell. Two immature organisms develop within the parent cell; and, at a certain stage of development, the parent cell ruptures, freeing the two daughter cells.

#### Exercises (424):

1. How would you recognize *Toxoplasma gondii* when it is stained with Giemsa?
2. What disease is caused by *Toxoplasma gondii*?
3. How is the disease transmitted?
4. The clinical picture of acquired toxoplasmosis may resemble what other type of given disease with a low grade fever?
5. What animal is considered to be the definitive host?
6. In what part of the animal does an asexual as well as sexual cycle occur?
7. What condition can result from ingestion of mature oocyst by another animal, including human?

**425. Cite morphological features of *Toxoplasma gondii* in terms of the usual shape, cell structures and components, differences in the leishmanial stage compared with *Leishmania* species and *Trypanosoma cruzi*, the cell structures compared with *H. capsulatum*, and specify some sources of pseudocysts.**

**Morphology of *Toxoplasma gondii*.** The individual cells or trophozoites measure 4 to 7 by 2 to 4  $\mu\text{m}$ , and are usually crescent shape with one end pointed and the



other rounded. The cell of the organism is made up of distinct cytoplasm and nuclear chromatin, but there are no flagella or other visible structures. This organism is differentiated from the leishmanial stage of *Leishmania* species and *Trypanosoma cruzi* by the absence of inclusions other than the nucleus.

The fungus *Histoplasma capsulatum* is another primarily intracellular organism that is easily confused with *Toxoplasma*. *H. capsulatum* appears in the tissues as small, oval, encapsulated yeast-like cells 3 to 5  $\mu\text{m}$  in diameter. The organisms have a central stained mass that is surrounded by a clear zone, but there is no true nucleus and there is no parabasal body present.

*T. gondii* may appear singly or during acute infections in clusters (pseudocysts within fixed host cells). They may be found at times within wandering Macrophages in exudates (peritoneal, pleural, or cerebral), and in circulating blood. In technical preparation, some may be extra cellular as indicated in figure 2-16. At the proper time the process of endodyogeny leads to the production of true cysts containing many naked merozoites, mainly in brain and muscle tissue. Cells which become cysts are destroyed beyond recognition, and the parasites develop a highly elastic, tough membrane that distinctly separates the cysts from any host cells. Cysts contain few to many merozoites, but they usually have many.

#### Exercises (425):

1. What shape is usually assumed by the organism *Toxoplasma gondii*?
2. What are distinctive components of the cell?
3. *Toxoplasma gondii* is differentiated from the leishmanial stage of *Leishmania* species and *Trypanosoma cruzi* by the absence of what structures?
4. How does the cell structure compare with *H. capsulatum*?
5. Pseudocysts may be noted in what specimen sources?

426. Point out the three approaches available for laboratory diagnosis of toxoplasmosis in terms of the specimens used, general procedures, and cite some serologic tests available.

**Laboratory Diagnosis.** Serologic tests for Toxoplasmosis are of greatest significance. However, there are three approaches available:

1. Direct examination.
2. Isolation of organisms.
3. Examination for a presumptive diagnosis.

**Direct examination.** Direct examination impression films of suspected tissues or fluids should be air-dried and stained with Giemsa's stain for direct examination. The preparations usually examined are tissues taken by biopsy, sputum, vaginal exudates, and the sediment of spinal, pleural, or peritoneal fluids.

**Isolation of organisms.** A variety of specimens are inoculated intraperitoneally into groups of white mice that have been dye-tested to make certain that they are free from infection. The diagnosis is confirmed by demonstration of cysts in the brains of the inoculated mice. Culture has proved to be very difficult.

**Presumptive diagnosis.** A presumptive diagnosis can be made by a positive delayed skin reaction or by serologic means. The Sabin-Feldman dye test was the original standard procedure. The dye test involves working with live *Toxoplasma* organisms, but is very sensitive and it demonstrates specific antibody to *Toxoplasma*. The Sabin-Feldman dye test is being replaced by the Indirect Fluorescent Antibody (IFA) procedure, which detects the same antibody as the dye test and has the same sensitivity. Other methods available are the indirect hemagglutination and complement-fixation procedures.

#### Exercises (426):

1. What are three given available approaches for laboratory diagnosis of toxoplasmosis?
2. Impression films (smears) suspected of Toxoplasmosis are obtained from what sources?
3. Diagnosis is confirmed by demonstration of cysts in what organs of the inoculated white mice?
4. What serologic test is considered to be the original dye test and involves working with live *Toxoplasma* organisms?
5. The original dye test is being replaced by what test?



6. What other serologic methods are available for diagnosis of Toxoplasmosis?

427. Cite the two reproductive cycles of plasmodia species in terms of the stages of development and the vector of the disease; point out the four species of malarial parasites.

The **Plasmodia**. Malaria, a very debilitating disease, has plagued man throughout recorded history. It was prevalent during the Greek and Roman empires. The disease was responsible for over 25 percent of all hospital admissions during the Civil War and the Spanish-American War. Epidemics of malaria severely hampered Allied operations in the Pacific and Asian theaters of World War II. American troops stationed in Korea during the police action of the early 1950's were exposed to its ravages. Recently, it has created significant problems among U.S. Forces stationed in Southeast Asia.

Many different kinds of birds and mammals can contract malaria. However, specific species of plasmodia infect specific animals. The species are similar in many respects, but each possesses qualities or characteristics that differentiate it from the others. Before you study the individual characteristics of each of these species, you should familiarize yourself with the way these organisms reproduce and how they are transferred to man.

The reproductive cycle of the malarial parasite is similar to that of other members of the subphylum Sporozoa. It consists of alternating sexual and asexual cycles. In contrast to the sexual and asexual cycles of *Isospora* that take place in a *single* host, the sexual and asexual cycles of the plasmodia take place in two separate hosts: man and mosquitoes. The asexual portion of the cycle that takes place in man is schematically illustrated in figure 2-18.

**Intrahuman Asexual Cycle of Reproduction.** The disease is started in humans as a result of being bitten by an infected female *Anopheles* mosquito. The mosquito needs a blood meal to nourish herself prior to laying eggs. After the mosquito inserts its proboscis into a capillary, it pumps saliva into the capillary to prevent coagulation of the blood. Sporozoites from the salivary glands are deposited into the person's circulation.

Once sporozoites get into the circulation, they make their way to the liver, where they invade parenchyma cells. It has been estimated that within 30 minutes after a bite the sporozoites have completely disappeared from the blood.

In the liver the parasite begins the *exoerythrocytic stage*. Here the sporozoites mature into *schizonts*. The schizonts develop daughter merozoites. Some of the merozoites re-enter other parenchymal cells in the liver and continue the *exoerythrocytic* phase. Others enter the circulation and invade red blood cells.

The series of events that go on within red blood cells is referred to as the *erythrocytic stage*. The merozoite, after entering the red blood cell, develops into an ameba-like trophozoite. The trophozoite ingests the hemoglobin of the cell. The protein portion of hemoglobin is used by the parasite as nourishment; the iron portion is not used. This iron collects in the parasite, and you see it as dark granules which are referred to as *malarial pigment*.

The trophozoite continues to develop until a schizont is produced. This schizont develops numerous merozoites which are released into the circulation when the red blood cell ruptures. Some of these merozoites enter other red blood cells and start the erythrocytic stage again. The other merozoites enter red blood cells and develop into male or female gametocytes. The parasites are sucked up in the blood meal of a mosquito. Within the mosquito, the parasite reproduces through the sexual cycle as described below and illustrated in figure 2-19.

**Intramosquito Sexual Cycle of Reproduction.** Gametocytes sucked up in the blood meal are either male microgametocytes or female macrogametocytes. They are transported to the mosquito's mid-gut. Each microgametocyte eventually produces several flagellated microgametes (male sex cells). Each macrogametocyte is transformed into a single macrogamete (oocyte), which is an unfertilized female sex cell. The union of microgamete and oocyte results in a free-swimming *ookinete*, which migrates into the stomach wall and becomes an encysted oocyst. The oocyst produces within itself numerous sporozoites. When ripe, the oocyst ruptures and releases the sporozoites into the body cavity of the mosquito. The sporozoites migrate to the salivary glands, from which they escape when the mosquito feeds.

Study of the reproductive cycle of malarial parasites in man and the mosquito has contributed greatly to efforts to control the disease. The peculiar rhythmic fevers seen in malaria coincide with the rupture of red blood cells and the release of merozoites from mature schizonts. The period between fever peaks varies according to which species causes the infection. Table 2-2 gives the time intervals of the fever spikes for each of the species, along with a comparison of several other features that will aid you in differentiating them.

In table 2-1 you will notice that the four species of human malaria parasites are:

- *Plasmodium vivax*
- *Plasmodium falciparum*
- *Plasmodium malariae*
- *Plasmodium ovale*

**Exercises (427):**

1. What disease-bearing parasites, which can infect man, are of the genus *Plasmodium*?

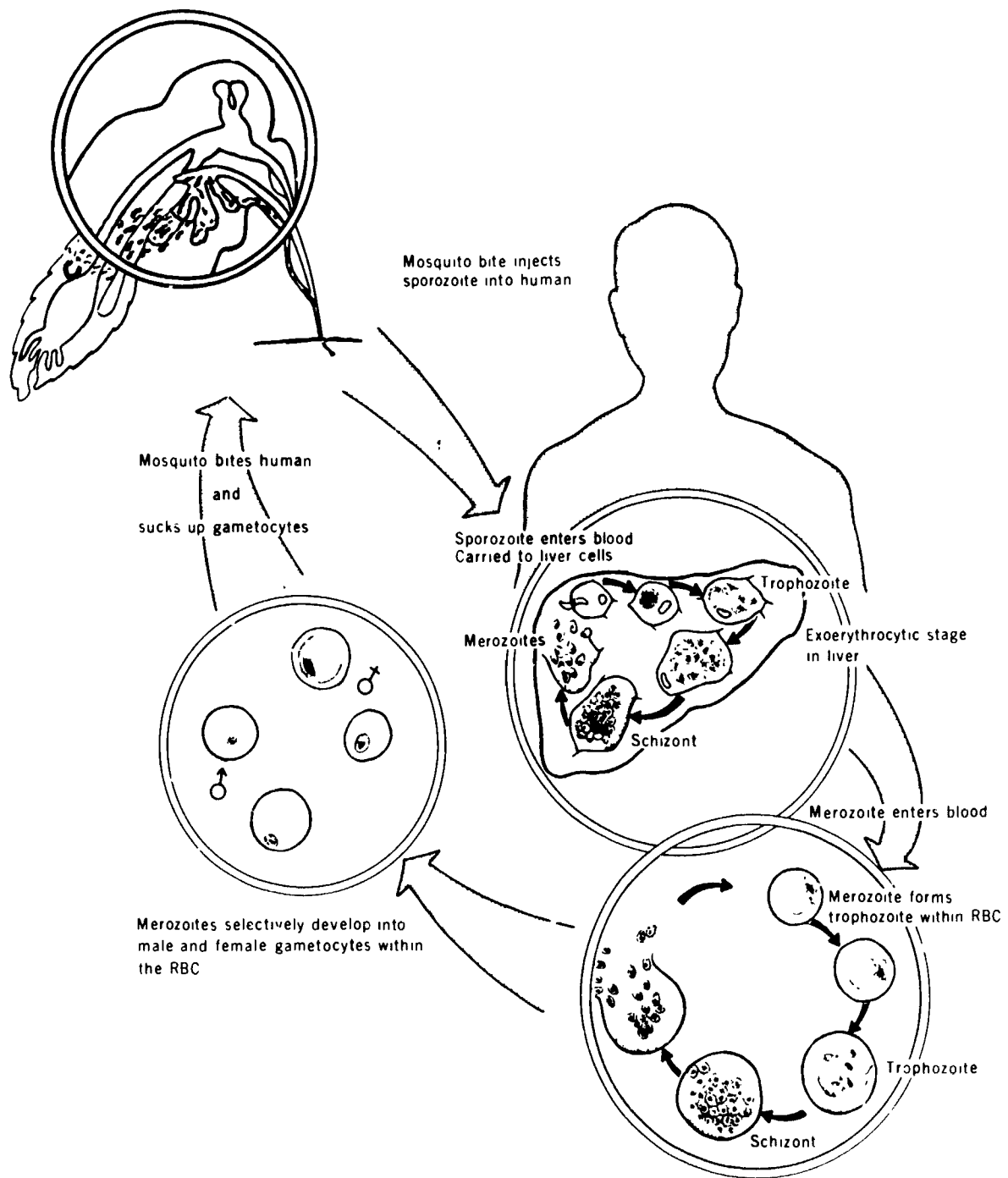

Figure 2 18 Asexual cycle of plasmodia

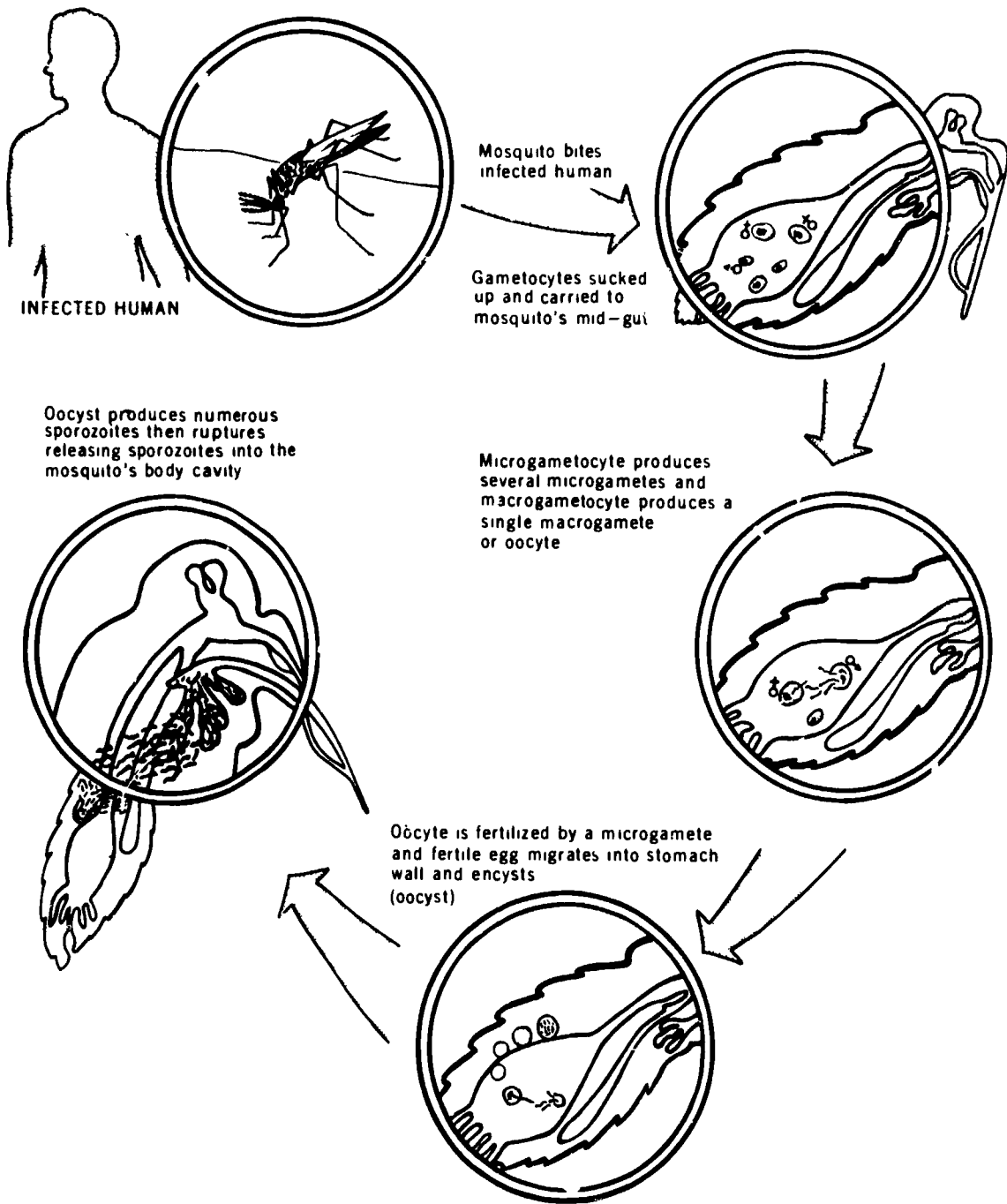

Figure 2-19 Sexual cycle of plasmodia

**TABLE 2-2**  
**CHARACTERISTICS OF PLASMODIA SPECIES**

	Duration of Asexual Cycle	Stages Seen in Peripheral Blood	Shuffner Granules	Appearance of Trophozoite	Malarial Pigment	Number of Merozoites in Schizont
<i>P. vivax</i>	48 hours	All	Yes	Very Ameboid	Light and Diffuse	Usually 12-18 (Could be 12-24)
<i>P. malariae</i>	72 hours	All	No	Compact, Slightly Ameboid	Very Dense	Usually 8 (Could be 6-12)
<i>P. falciparum</i>	48 hours	All	Yes	Slightly Ameboid	Light and Diffuse	Usually 8 (Could be 6-12)
<i>P. falciparum</i>	48 hours	Rings, Large Gametocytes	No	Rare in Peripheral Blood	Dense in Gametocyte	Rare in Peripheral Blood

2. The reproductive cycle of the malarial parasite is similar to that of other members of what subphylum?
3. The disease malaria is started in humans as a result of being bitten by what type of insect?
4. The asexual cycle of the malarial parasite takes place in (man/the mosquito).
5. The malarial parasite begins the exoerythrocytic stage in what organ?
6. During the asexual reproductive cycle of the malarial parasite, what develops as a result of the schizonts?
7. The series of events that go on within red blood cells is referred to as the \_\_\_\_\_ stage.
8. The \_\_\_\_\_ portion of hemoglobin ingested by the trophozoite is used for nourishment and the \_\_\_\_\_ portion is not used.
9. Each microgametocyte eventually produces several \_\_\_\_\_ microgametocytes or \_\_\_\_\_ sex cells.
10. Each macrogametocyte is transformed into a single macrogamete (oocyst), which is an \_\_\_\_\_ sex cell.
11. Four species of malarial parasites which can affect man are *P.* \_\_\_\_\_, *P.* \_\_\_\_\_, *P.* \_\_\_\_\_, and *P.* \_\_\_\_\_.

**428. State the term used to describe the type of malaria caused by the *Plasmodium vivax* and morphological features in the stages of its development.**

***Plasmodium Vivax.*** *Plasmodium vivax* is the most widely distributed of the *Plasmodium* parasites and is found in all tropical zones of the world. The disease caused by an infection of *P. vivax* is called "tertian" malaria, a term that refers to the 48-hour period required for schizonic development in the blood to take place. Fever spikes occur at 48-hour intervals (or every third day).

Morphologically, the stages of its development may be summarized as follows:

a. The young trophozoite (ring form) usually has a large chromatin dot. The cytoplasmic circle is large and pale blue in color.

b. A growing trophozoite has an irregular outline with several finger-like pseudopodia. Fine, yellow-brown granules (malaria pigment) may be present in the cytoplasm, and the chromatin dots are single and compact.

c. In the large trophozoite, the parasite practically fills the enlarged red blood cell. Chromatin is seen as an abundant loose or compact mass.

d. Chromatin in an immature schizont is divided into two or more irregular masses. Pigment is generally clumped into several large particles.

e. A mature schizont (segmenter) is divided into 12 to 24 merozoites with oval nuclei surrounded by a similarly shaped mass of cytoplasm.

f. The macrogametocyte is circular or ovoid mass with homogenous cytoplasm that has no vacuoles. The chromatin mass is single, small, compact, dark red in color, and eccentric in position.

g. Usually the microgametocyte is circular when fully mature. Cytoplasm stains light blue and the chromatin mass is large, diffuse, light red in color, and located at or near the center of the organism.

Specific features of *P. vivax* can be observed in the drawings in foldout 1. The drawings show the appearance of the various stages as seen in the red blood cells on stained preparations.

#### Exercises (428):

1. What is the term used to describe the disease caused by *P. vivax*?
2. In the type of malaria caused by *P. vivax*, at what intervals do fever spikes occur?
3. The young trophozoite (ring form) usually has a \_\_\_\_\_ chromatin dot.
4. A growing trophozoite has an \_\_\_\_\_ outline with several finger-like pseudopodia.
5. A mature schizont is divided into \_\_\_\_\_ to \_\_\_\_\_ merozoites.
6. Usually the microgametocyte is \_\_\_\_\_ when fully mature.

429. State the term used to describe the disease produced by *Plasmodium falciparum*, and point out significant morphological appearances.

**Plasmodium Falciparum.** *Plasmodium falciparum* produces a disease called malignant tertian or

estivo-autumnal (Summer-Autumn) malaria. The ring forms are smaller than those of the other species described in this chapter. Foldout 2 illustrates the appearance of *P. falciparum*. *P. falciparum* is found in many tropical countries.

The following are some features of *P. falciparum*:

a. Ring forms with single or double chromatin dots are often seen in peripheral smears. Multiple rings may be seen. This form and the gametocyte are the only stages normally found in the peripheral blood.

b. Trophozoites larger than ring forms are rarely observed in peripheral blood. The cytoplasm appears compact and light blue in color. Very dark pigment is scattered throughout the cytoplasm.

c. Presegmenting schizonts are rarely observed in peripheral blood. If found, the parasite is small; and its pigment is usually clumped in one small, dark mass.

d. A mature schizont, or segmenter, is rarely seen in peripheral blood. It is divided into 8 to 32 merozoites and fills about two-thirds of a normal-sized blood cell.

e. Macrogametocytes are long, slender, sausage-shape, with a concentrated mass of dark pigment near the center surrounding a dark red chromatin mass. They are commonly observed in peripheral blood smears.

f. The cytoplasm of the microgametocyte is generally paler in color than in the macrogametocyte. The parasite is broader, shorter, and has more rounded ends than the macrogametocyte. Heavy granules of pigment are present. These forms are commonly observed in peripheral smears.

#### Exercises (429):

1. *Plasmodium falciparum* produces a disease called \_\_\_\_\_ or \_\_\_\_\_ malaria.
2. The \_\_\_\_\_ are smaller than those of other species described in this chapter.
3. Ring forms with \_\_\_\_\_ or \_\_\_\_\_ chromatin dots are often seen in peripheral smears.
4. \_\_\_\_\_ larger than ring forms are rarely observed in peripheral blood.
5. \_\_\_\_\_ schizonts are rarely observed in peripheral blood.
6. \_\_\_\_\_ are long, slender, sausage-shape, with a concentrated mass of dark pigment near the center \_\_\_\_\_ a dark red chromatin mass.
7. The \_\_\_\_\_ of the microgametocyte is generally paler in color than the macrogametocyte.

430. State the term often used to denote an infection with *Plasmodium malariae*, and specify significant morphological features observed on stained smears.

**Plasmodium Malariae.** *Plasmodium malariae* require about 72 hours to complete the cycle in man. The term "quartan malaria" is often used to denote an infection with this species of organism. It is not as prevalent, nor is it as widely distributed as *P.*

*vivax* and *P. falciparum*. The parasite is illustrated in foldout 3.

*P. malariae* presents the following appearance in stained smears:

a. The ring form contains a single, heavy chromatin dot. The cytoplasmic circle is small and compact.

b. Cytoplasm in the growing trophozoite is compact and frequently in the form of a trapezoidal-shaped band across the center of the red cell. Coarse, dark brown, or black pigment granules are often present.

c. The large trophozoite fills, or almost fills, a normal-sized red blood cell. Pigment granules are large, dark, and generally peripherally arranged. The cytoplasm is dense, dark blue, and often in the form of a broad band.

d. In the presegmenting schizont the chromatin is divided into a number of masses. The cytoplasm is dense, dark blue in color, and the pigment is dark and evenly distributed throughout the parasite.

e. A mature schizont, or segmenter, has 6 to 12 merozoites, usually in a single circle surrounding a large clump of hemozoin (decomposed hemoglobin) granules. This is called the rosette or daisy form.

f. The macrogametocyte is circular or ovoid and regular. The cytoplasm is dense, dark blue, and contains abundant, coarse, dark pigment. It has chromatin which is similar to that in *P. vivax*.

#### Exercises (430):

1. The term "\_\_\_\_\_ " is often used to denote an infection with *Plasmodium malariae*.
2. The ring form contains a \_\_\_\_\_, \_\_\_\_\_ chromatin dot.
3. The cytoplasm is \_\_\_\_\_ and \_\_\_\_\_.
4. Cytoplasm in the growing trophozoite is \_\_\_\_\_ and frequently in the form of a \_\_\_\_\_ band across the center of the red cell.
5. The large \_\_\_\_\_ fills or almost fills a normal-sized blood cell.
6. Pigment \_\_\_\_\_ are large, dark, and generally peripherally arranged.
7. A \_\_\_\_\_ schizont has \_\_\_\_\_ to \_\_\_\_\_ merozoites, usually in a single circle surrounding a large clump of hemozoin.
8. The merozoites usually in a single circle surrounding a large clump of hemozoin is called the \_\_\_\_\_ or \_\_\_\_\_ form.

431. Cite the geographical region where *Plasmodium ovale* is most commonly found; the erythrocytic cycle and distinctive morphological features. State techniques for preparation and staining of smears for identification of malarial parasites.

**Plasmodium Ovale.** Incidence of *Plasmodium ovale* is very low. The parasite is almost completely limited to parts of West Africa. All of the stages found in *P. vivax* and *P. malariae* are also found in *P. ovale*.

In certain respects, an infection of *P. ovale* resembles *P. vivax*; in other respects it is more like *P. malariae*. The erythrocytic cycle requires 48 hours. Schuffner's stippling is more markedly observed in cells infected with *P. ovale* than in those infected with *P. vivax*.

As the trophozoite matures, the cytoplasm is to be relatively condensed as it is in *P. malariae*. The red blood cells that are infected become oval shaped. They may be of normal size or slightly enlarged, but not usually paler than normal. There is not much pigment, and when present it is light brown. The mature schizont contains 6 to 12 merozoites which surround a central mass of pigment. The gametocytes are very much like those of *P. malariae*; but they can be differentiated in thin blood films by the presence of Schuffner's granules (dots) in the cells. Differentiation from the same stage of *P. vivax* is made on the basis of the denser and more compact makeup of *P. ovale*.

In studying the history and pathology of malaria, you will find that the disease has been a problem to mankind throughout the centuries. The disease can produce allergic manifestations; anemia; congestion of capillaries; enlargement of the spleen; and congestion of the kidneys, stomach, and intestines. It also produces enlargement, congestion, and pigmentation of the liver; a decrease in the functioning of the bone marrow; and fatty degeneration of the heart. It has been estimated that almost 100 million persons are afflicted with malaria. Of the species of malaria that infect man, *P. falciparum* causes the most severe disease.

**Laboratory Identification.** Accurate diagnosis of malaria and identification of the species can be made only by laboratory studies. There are certain steps the technician might follow to improve his success in finding the organisms. These are:

- a. Prepare both thick and thin blood smear preparations.
- b. Use slides that are chemically clean.
- c. Include Giemsa stain in addition to Wright or other stains.
- d. Keep prepared slides protected from damage by insects.
- e. Collect blood smears from the patient during and immediately following episodes of fever.
- f. If malaria organisms are not found initially, continue the collection of smears for several days.

#### Exercises (431):

1. *Plasmodium ovale* is almost completely limited to what geographical region?
2. The erythrocytic cycle requires how many hours?



3. Red blood cells infected with *Plasmodium ovale* will show more of what type of dots over those infected with *P. vivax*?
4. The gametocytes are very much like those of *P. malariae*; but they can be differentiated in thin-blood films by the presence of \_\_\_\_\_ granules in the cells.
5. What species of malaria causes the most severe disease?
6. What other stain should be included in addition to Wright's stain for malarial smears?
7. At what recommended times should smears be collected from patients suspected of malaria?

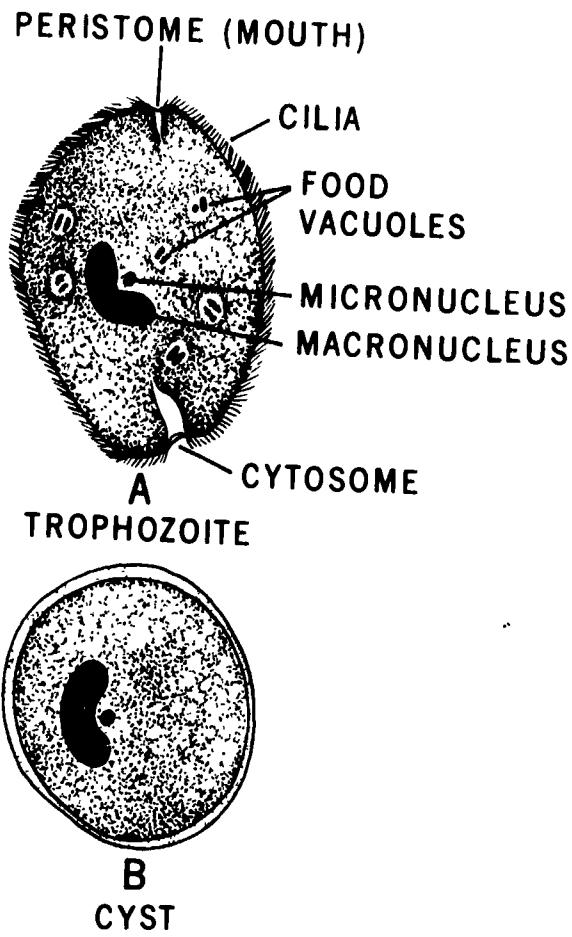

Figure 2-20 *Balantidium coli*.

**2-4. Ciliates**

Species of the ciliated protozoa are conspicuous because of the hair-like cilia which covers their bodies. They are found in both vertebrate and invertebrate animals. Wave-like movements of the cilia provide the organisms a means of locomotion. Only one species, *Balantidium coli*, is of medical significance.

**432. Point out the relative size of *Balantidium coli*, morphological characteristics, and symptoms of illness caused by the organism.**

**Balantidium Coll.** *Balantidium coli* is the largest protozoan of man, and it exists in both the trophozoite and cyst stage. The species inhabits the large intestine of man and other animals. The motile trophozoite, found in fresh preparation, is large, oval, and slightly greenish in color. They display directional, rapid, and smooth gliding movements. On one side of the anterior end is a deep cleft which is the cytostome or primitive mouth.

Figure 2-20, A, is a drawing of the trophozoite stage. The outer surface of the body is covered with a delicate pellicle, on the surface of which are implanted numerous short cilia in regular rows. Food vacuoles are very numerous and consist almost entirely of starch. In living trophozoites one and sometimes two excretory vacuoles can be seen.

In stained specimens of trophozoites, the longitudinal rows of cilia stand out prominently. The most prominent internal structures are the two nuclei. The large kidney-shaped nucleus is called the

macronucleus. There is a small, dot-like micronucleus which lies nestled within the concave portion of the macronucleus. This species is a heavy feeder, and the cytoplasm is usually filled with food inclusions.

The cyst stage of *B. coli* is not often found. When you see cysts on a stained smear, they will be large, double-walled spherical bodies about 55 microns in diameter. The cytoplasm of the cyst is dense but uniformly granulated and lacks food inclusions. The macronucleus and micronucleus stain deeply, and they are identical to those seen in the trophozoite. An example of the cyst stage is shown in figure 2-20, B.

Medical experts disagree on the extent of pathology caused by *B. coli*. All agree that it is a pathogen. In a majority of cases, it causes diarrhea. In a few cases, it has been known to invade extra-intestinal sites, producing severe disease and death. Laboratory identification should cause you no special problem, because of the large size and shape of the organism.

**Exercises (432):**

1. In comparison with other protozoans which infect man, what is the relative size of *Balantidium coli*?

2. What type of size, shape, and appearance does *B. coli* have?

3. How does the outer surface of the body of the troph appear?

4. What are the most prominent internal structures?

5. What is the large kidney-shaped nucleus called?

6. What symptom and condition are caused by *Balantidium coli*?

## Platyhelminthes Infecting Man

THIS CHAPTER will be concerned with selected members of the Phylum Platyhelminthes (flatworms). The flatworms are among the oldest parasites known to man. The Class Trematoda (flukes) and the Class Cestodea (tapeworms) contain the flatworms of medical importance. The parasites of these two classes are listed in table 3-1. The worms do not have a circulatory system or a body cavity, but they do have a nervous system and a highly refined method of reproduction. The flatworms vary greatly in shape; most flukes resemble a broad leaf, while the tapeworms resemble a ribbon. A fluke develops as a single unsegmented unit, whereas a tapeworm develops as chain-like segments called proglottids.

First to be considered are the trematodes (flukes). Various species of flukes establish themselves in specific organs, including the lungs, liver, intestine, and certain blood vessels in the mesenteries and bladder. Adult flukes, other than those which inhabit the intestine, are rarely eliminated from the body because of their location. Depending on the species of fluke, eggs may be recovered from sputum, feces, or urine.

The cestodes (tapeworms) will be discussed in the second half of this chapter. These worms belong to the Class Cestodea. All members of the Class Cestodea are parasitic. The adults are intestinal parasites of vertebrates, and their eggs are passed from the host in feces.

While studying this chapter, keep in mind that flotation techniques are not recommended for the detection of the eggs of these parasites. The specific gravity of flatworm eggs is too high for them to be floated consistently with flotation techniques that you use for other types of eggs. The eggs can be easily recovered if you employ direct fecal films, sedimentation techniques, or formalin-ether concentration techniques. Unless it is stated otherwise in the discussion of the individual parasite, you should use the techniques mentioned above.

### 3-1. Trematodes (Flukes)

In order for you to understand flukes, you must acquaint yourself with their anatomy and morphology. Figures 3-1 and 3-2 illustrate the important anatomical features of both immature and mature flukes. To follow the life cycle of these parasites, you will have to

be familiar with the terminology used. Cercariae, hermaphroditic metacercariae, miracidium, operculum, rediae, schistosome, and sporocyst are some of the descriptive terms you should know.

**433. Cite the name given to trematodes that live in the blood stream, disease caused by *Schistosoma mansoni*, significant features of the life cycle, the most prominent feature which helps to identify *Schistosoma mansoni* infection, specimen for recovery of *Schistosoma mansoni* egg, and recommended laboratory techniques for identification of the organism.**

**Schistosomes (Blood Flukes).** Trematodes that live in the blood stream of man are called schistosomes, or blood flukes. These worms live in pairs in the venules of specific areas. Schistosomes are unique among the flukes because the males and females are separate worms. The other flukes of man are hermaphroditic, and each individual worm has both male and female sex organs. The schistosomes are the cause of a chronic and progressive disease. They may live for 30 years or longer in a human host.

*Schistosoma mansoni.* *Schistosoma mansoni*, also known as Manson's blood fluke, causes the disease variously known as Manson's schistosomiasis, intestinal schistosomiasis, or schistosomiasis mansoni. It is found chiefly in eastern and central Africa, the Middle East, the Caribbean area, and South America as far south as Brazil. Man is the definitive host, and snails of several genera are intermediate hosts.

The life cycle begins with the interlocked male and female *S. mansoni* (fig. 3-3) in a small venule of the mesentery of the large intestine. The male worm has a ventrally located sex canal called the gynecophoral canal. The lateral margins of the male fold around the female and hold her in the canal. After insemination, the female migrates to the end of the venule to lay eggs. Through lytic action, and by means of a sharp point on the shell, eggs are able to penetrate the small blood vessels and tissues of the mesentery, eventually reaching the lumen of the intestine, where they are expelled with feces.

The eggs contain a ciliated miracidium which escapes from the shell when the eggs come in contact with water. The miracidium seeks out and penetrates an appropriate snail. In the snail, two asexual

TABLE 3 1  
 PHYLUM PLATYHELMINTHES

CLASS TRIMATODA  
 (Flukes)

- Clonorchis sinensis*
- Metacercaria japonicum*
- Schistosoma haematobium*
- Fasciola hepatica*
- Dicrocoelium dehariticum*
- Clonorchis sinensis*
- Opiathorchis felinus*
- Opiathorchis viverrini*
- Fasciolopsis buski*
- Heterophyes heterophyes*
- Metagonimus yokogawai*
- Caryocotyle canaliculata*

CLASS CLSTODIA  
 (Tapeworms)

- Monostephanus*
- Sparganum*
- Theriac*
- Hymenobothrium*
- Hymenobothrium*
- Sparganum*

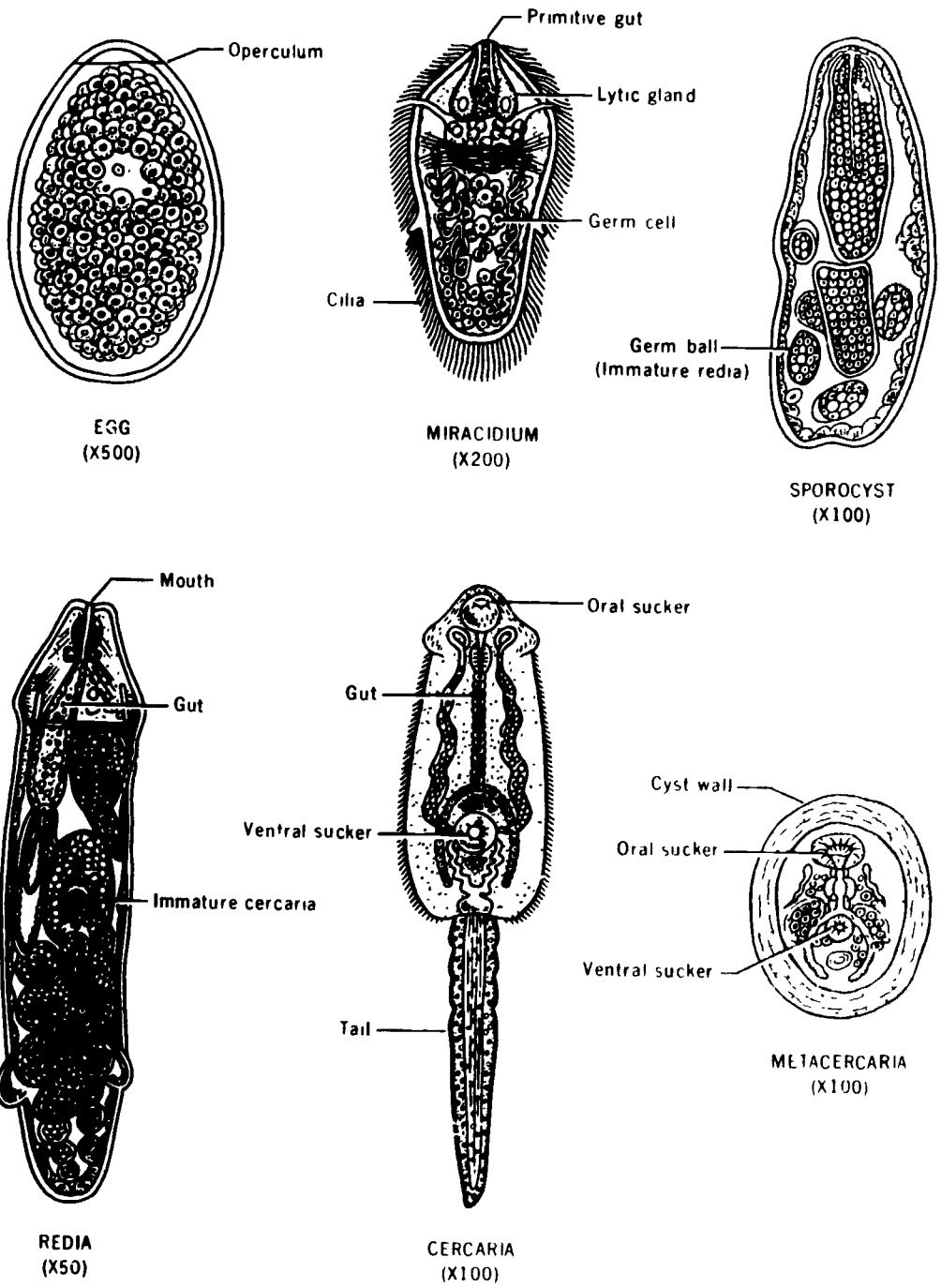

Figure 3-1. Immature stages of flukes

41.4

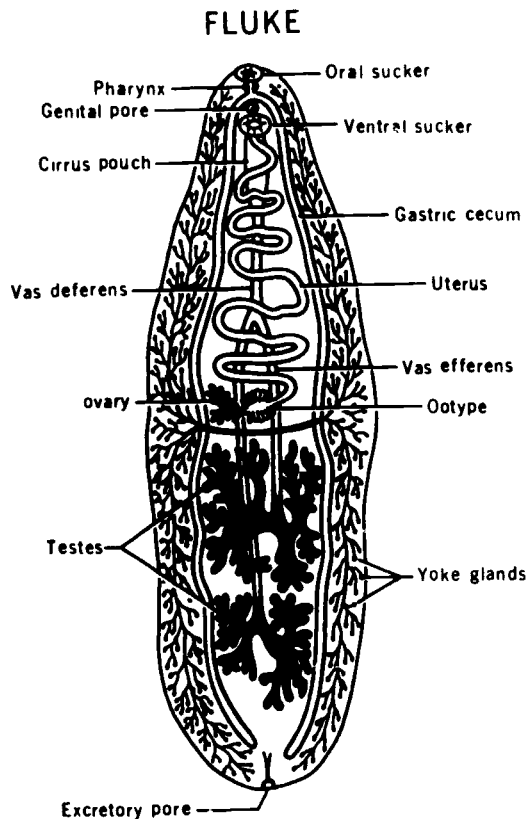

Figure 3-2 Mature fluke

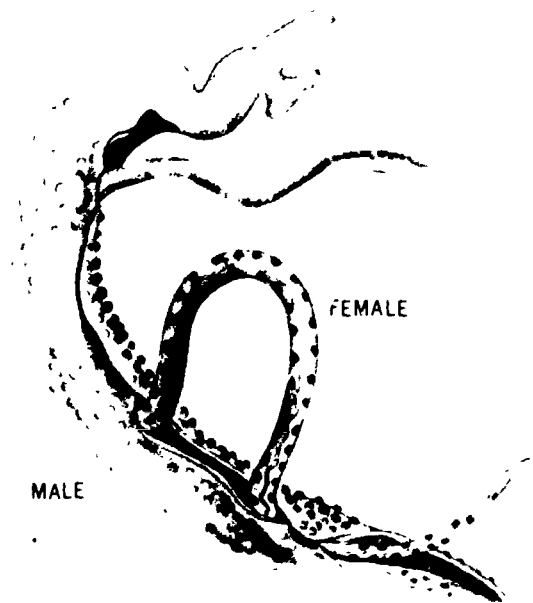

Figure 3-3 Male and female *Schistosoma mansoni*

generations of sporocysts are produced; the second generation sporocyst produces cercariae. The cercariae escape from the snail and swim about in the water. On contact with man, they penetrate the skin and migrate through the bloodstream to the mesenteric venules. Cercariae require an incubation period of 7 to 8 weeks to develop into adult male and female worms. After the females mature and are inseminated, they pass eggs, thus completing the cycle.

Adult *S. mansoni* and *Schistosoma haematobium* are morphologically similar. The male fluke is about 12 mm long and possesses six to nine testes. The body of the male is flattened and folded ventrally to form the sex canal in which the female is held. The female is longer than the male (16 mm as compared with 12 mm), thread-like, and has an anteriorly located ovary. The outer surface of the adult *S. mansoni* is covered with minute sensory papillae, known as tuberosities. Figure 3-4 illustrates a mature egg. The egg ranges in size from 114 to 175  $\mu\text{m}$  long by 45 to 68  $\mu\text{m}$  wide. It is narrow and rounded at the anterior end with a more broadly rounded posterior end. The most noticeable morphological feature is the long, sharp, lateral spine on the posterior third of the egg. The eggs have a non-operculate shell. When mature, they are yellow brown in color,



Figure 3-4. Egg of *Schistosoma mansoni*



transparent, and contain a ciliated miracidium that is fully developed.

*S. mansoni* causes dysenteric symptoms with bloody mucus, and in old chronic infections, polypoid growths develop within the bowel. The latter condition is due to the proliferation of tissue about masses of disintegrated eggs which failed to break through into the intestinal lumen. The rectum and large intestine are the organs and tissues most seriously affected by the infection. Eggs are frequently carried through the portal blood vessels to the liver, where they filter out into the periportal tissue and cause cirrhosis of the liver.

Laboratory diagnosis of *S. mansoni* depends upon finding the characteristic eggs in fecal specimens. The number of eggs you find in a direct fecal smear parallels, to some degree, the severity of the infection. Appropriate concentration methods such as sedimentation, or acid-ether-formalin concentration are recommended. Complement-fixation, slide flocculation, and fluorescent antibody tests are the methods you should use when you do not find eggs in fecal specimens from suspected cases.

#### Exercises (433):

1. What are trematodes that live in the blood called?
2. The Mansoni blood fluke causes \_\_\_\_\_ schistosomiasis or \_\_\_\_\_ schistosomiasis.
3. What organisms are the definitive and intermediate host respectively?
4. The life cycle begins with the interlocked \_\_\_\_\_ and \_\_\_\_\_ *S. mansoni*.
5. How do the eggs of *S. mansoni* get into the feces?
6. When the eggs come in contact with water, what escapes from the shell?
7. What other organism is produced from two asexual generations of sporocysts in the snail?

8. What forms, on contact with man, penetrate the skin and migrate through the bloodstream to the mesenteric venules?

9. What is the most prominent feature which helps to identify *Schistosoma mansoni* egg, and where on the egg is this feature located?

10. In what type of specimen would you expect to find the characteristic eggs of *Schistosoma mansoni*?

11. What methods are recommended for laboratory diagnosis?

**434. State the geographical region to which *Schistosoma japonicum* is restricted, the comparative size of the adult male and female organism, and stages of the development of pathological effects and their significance.**

*Schistosoma japonicum*. *Schistosoma japonicum* is frequently referred to as the Oriental blood fluke. *S. japonicum* is restricted to the Far East: Japan, China, Formosa, and the Philippines. Many mammals—including dogs, cats, horses, cattle, rats, and mice—act as reservoir hosts. Snails of the Genus *Oncomelania* are the intermediate hosts.

The life cycle of *S. japonicum* is essentially the same as that of *S. mansoni*. The adult worms of *S. japonicum* inhabit the smaller venules of the mesentery of the small intestine, whereas those of *S. mansoni* inhabit the venules of the mesentery of the large intestine. Therefore, the small intestine is more seriously affected in cases of *S. japonicum*, whereas the large intestine is more seriously affected in cases of *S. mansoni*.

The adult male of *S. japonicum* is 12 to 20 mm long. The integument is not tuberculated, but it is covered with minute spines, especially in the locality of the suckers and the gynecophoral canal. There are seven testes in the male *S. japonicum*. The female is about 26 mm long, and the integument is also covered with minute spines. The ovary is just below the center of the body, and the vitelline (yolk-producing) glands are limited to the lateral margins of the distal quarter of the body. The uterus consists of a long, straight tube containing up to 50 eggs.

The eggs (fig. 3-5) are smaller than the eggs of the other species of schistosomes. They measure about 70 to 100 microns by 50 to 65 microns. You can see a wart-like thickening near the posterior end when the egg is positioned properly.

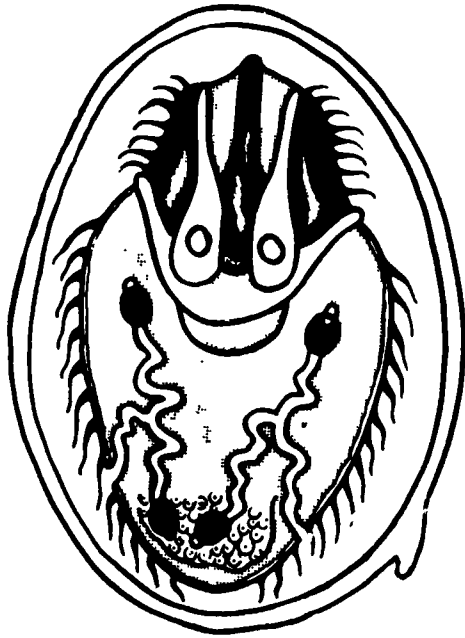

Figure 3-5. Egg of *Schistosoma japonicum*.

The development of the pathological effects caused by *S. japonicum* may be divided into three distinct stages:

- (1) Period of incubation.
- (2) Period of egg laying and extrusion.
- (3) Period of proliferation and tissue repair.

The first two stages comprise the acute stage of the disease. The period of proliferation and tissue repair is known as the chronic stage. During the chronic stage, the liver and spleen enlarge greatly. Intestinal disturbances during the chronic stage are caused by thickening of the intestinal wall, the formation of ulcers, and the development of polypoid growths.

You can assist in making a specific diagnosis of this disease by finding the characteristic eggs of *S. japonicum* in fecal specimens. You will find the methods recommended for detecting the eggs of *S. mansoni* satisfactory for detecting those of *S. japonicum*.

#### Exercises (434):

1. To what geographical region is *Schistosoma japonicum* restricted?
2. What other mammals act as reservoir hosts?

3. What part of the digestive system do the adult worms *Schistosoma japonicum* inhabit?
4. What is the comparative size of adult male and female *Schistosoma japonicum* parasites?
5. The eggs of *Schistosoma japonicum* are (larger/smaller) than the eggs of other species of schistosomes.
6. What are the three stages of the development of pathological effects of *S. japonicum*?
7. What two stages comprise the acute stage of the disease?
8. The spleen and liver are enlarged greatly in what stage?

435. Point out the other name for *Schistosoma haematobium*, the common habitat in the body, the definitive host and the intermediate host, the location of the spine on the egg, and the most frequent symptom noted with recent infections.

*Schistosoma haematobium*. This parasite is also known as the vesical blood fluke. The disease caused by *S. haematobium* is sometimes called vesical schistosomiasis, schistosomiasis haematobia, urinary bitharziasis, or schistosomal hematuria, depending upon the geographical location where the cases are found. The disease is widespread in Africa and surrounding islands. Occasional cases have been found in the southern tips of Europe and India.

The life cycle of *S. haematobium* is very similar to that of *S. mansoni* and *S. japonicum*. However, the coupled worms usually inhabit the finer veins of the bladder and uterus rather than the mesentery of the intestine as with the other two species. On rare occasions, however, they do lodge in the venules of the intestinal mesentery.

Man is the only definitive host for *S. haematobium*, and snails of the Genus *Bulinus* are the most common intermediate hosts. Morphologically, *S. haematobium* closely resembles *S. mansoni*; however, adult *S. haematobium* are slightly larger than *S. mansoni*. The male *S. haematobium* has only four or five testes. The male is

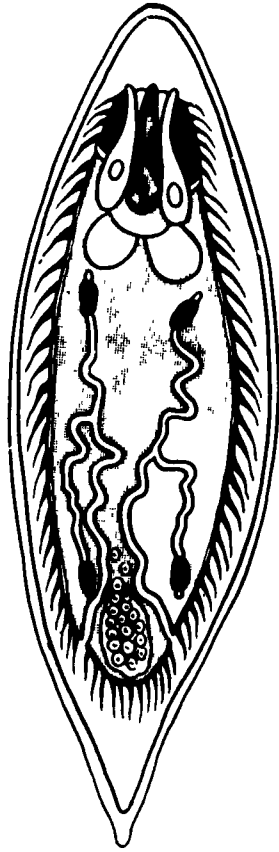

Figure 3-6 Egg of *Schistosoma haematobium*.

covered with minute integumentary tuberosities; but in the female, the tuberosities are usually confined to the extremities.

The eggs (fig. 3-6) are 112 to 170 microns long by 40 to 70 microns wide. They are spindle shaped, rounded anteriorly, and conical at the posterior extremity. The posterior end terminates in a blunt-pointed spine. The egg is non-operculate, has a thin transparent shell, and is yellow brown in color. When passed in feces, the egg normally contains a fully developed miracidium.

The pathological effects of *S. haematobium* can be serious. Penetration of the skin by the cercariae of *S. haematobium* produces almost no local cellular reaction. The pathogenic effects of *S. haematobium* consist of:

- a. Local as well as systemic reactions to metabolic products of growing and mature worms.
- b. Trauma with hemorrhage as eggs escape from the venules.
- c. Pseudo-abscess and pseudo-tubercle formation around eggs lodged in the tissues.

Frequently, the only symptom noted in recent infections is bloody urine. Chronic cystitis is often encountered in older infections. Advanced cases of visceral schistosomiasis often result in abscesses,

scarring of the bladder wall, and invasion of other body organs.

Examine both feces and urine for eggs when *S. haematobium* is suspected. The techniques used to examine feces in cases of *S. mansoni* and *S. japonicum* are also satisfactory for *S. haematobium*. Examine urine for eggs by pouring the specimen into a conical flask and allowing it to settle. Make a smear of the sediment and examine it with the microscope. If a centrifuge is handy, use it to speed sedimentation of the specimen.

#### Exercises (435):

1. *Schistosoma haematobium* is also known as the \_\_\_\_\_ fluke.
2. What parts of the body do the worms usually inhabit?
3. \_\_\_\_\_ is the only definitive host for *S. haematobium*, and \_\_\_\_\_ of the Genus *Bulinus* are the most common intermediate hosts.
4. What is the only symptom frequently noted in recent infections?
5. What specimens are examined for eggs when *S. haematobium* is suspected?

436. Cite the two species of liver flukes of greatest interest, the common name given to *Fasciola hepatica*, the definitive hosts and intermediate host, the size of the egg, and the method for positive identification of *Fasciola hepatica*.

**Liver Flukes.** Liver flukes live in the bile ducts and frequently cause considerable liver damage. None of the liver flukes are found exclusively in man. The two species of greatest general interest are *Fasciola hepatica*, the sheep liver fluke, and *Clonorchis sinensis*, the oriental liver fluke. However, interest in other species discussed in this section is increasing rapidly as more is learned about them.

*Fasciola hepatica*. The sheep liver fluke is found in all sheep-raising countries, including the United States. It is known as the sheep liver fluke because it commonly infects sheep. Although the parasite is generally associated with sheep and cattle, man becomes infected by ingesting the infective larvae

which have encysted on plants such as lettuce and watercress.

Humans, sheep, and cattle are the definitive host, while snails belonging to the Family Lymnaeidae are the intermediate hosts. Undeveloped eggs are passed in the feces of the definitive host. The eggs mature in 9 to 15 days after reaching water, and then free-swimming miracidia escape from the egg shells and penetrate the proper snails. Within the snails the miracidia transform into sporocysts, and the sporocysts produce first-generation and second-generation rediae in about 4 weeks. The rediae produce cercariae, which escape from the snails and encyst on aquatic vegetation as infective metacercariae. After ingestion of contaminated plants by one of the definitive hosts, the metacercariae excyst in the intestine and migrate through the intestinal wall into the body cavity of the infected host. From there they penetrate through the liver parenchyma into the biliary passages, where they develop into mature worms. This migration and development require 3 to 4 months.

As the metacercariae invade the liver tissues, they produce traumatic and necrotic lesions. Moderate to heavy infections in man give rise to severe symptoms. Patients have hepatic colic, eosinophilia, diarrhea, and eventually anemia. In some human infections, immature as well as mature worms have been found in abscesses in blood vessels, lungs, and even the brain.

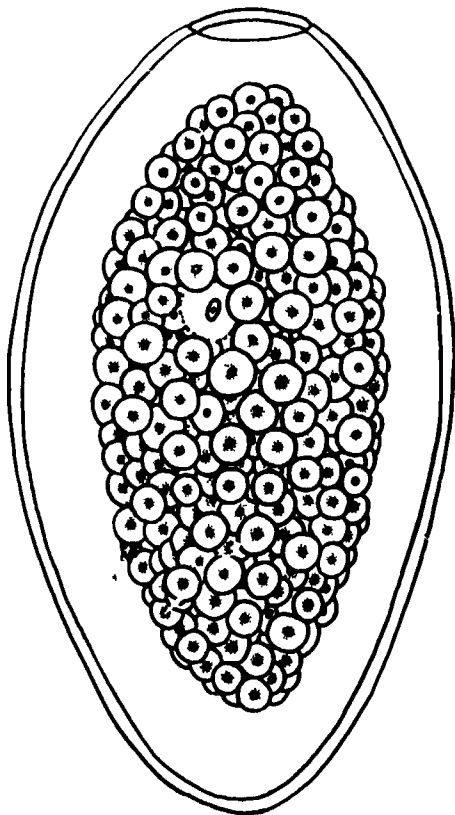

Figure 3-7 Egg of *Fasciola hepatica*.

The egg (fig. 3-7) is one of the largest produced by a helminth that infects man. It is oval in shape and measures about 80 to 150  $\mu\text{m}$ . The egg is yellow brown and has an operculum.

The usual laboratory examination requires that you identify eggs which you find in feces. Eggs of *F. hepatica* are impossible to differentiate from those of *Fasciolopsis buski*; therefore, you should report them as "eggs morphologically resembling the Genus *Fasciola* and *Fasciolopsis*." The only way for you to positively identify the parasite as *F. hepatica* is to recover the typical *F. hepatica* eggs from uncontaminated bile collected by the attending physician. This will give you a positive identification, because *F. buski* inhabits the intestine and not the bile ducts.

False fascioliasis occurs when someone ingests liver infected with *F. hepatica*. The eggs are then passed in the feces of the person eating the liver. You can see how this could easily be mistaken for actual infection. This may be ruled out if the patient is kept on a liver-free diet for 3 days or more. If the patient continues to pass eggs, he probably has a true infection.

#### Exercises (436):

1. What are the two species of liver flukes of greatest interest?
2. What is the common name given to *Fasciola hepatica*?
3. Although *Fasciola hepatica* is generally associated with cattle and sheep, how does man become infected?
4. What group comprises the definitive hosts of *Fasciola hepatica*?
5. \_\_\_\_\_ belonging to the Family *Lymnaeidae* are the intermediate hosts.
6. Give the size and a brief description of the egg.

7. Since the eggs of *F. hepatica* are impossible to differentiate from those of *F. buski*, how can one positively identify the parasite of *Fasciola hepatica*?

8. How can false fascioliasis occur?

437. Indicate whether given statements correctly reflect the habitat of *Dicrocoelium dendriticum*, the intermediate host, description of the eggs, and size of the eggs.

*Dicrocoelium dendriticum*. *D. dendriticum* is a parasite commonly found in the bile duct of sheep and other herbivorous animals. The parasite is widely distributed in Europe, North Africa, Northern Asia, and some other areas in the Orient. *D. dendriticum* has frequently been reported when actually the patient was not infected at all. This happens quite often when people eat sheep liver that has been infected and the eggs are then passed in the feces just as in false fascioliasis. However, the parasite does infect man and is frequently reported from Europe, Asia, and Africa.

Snails are the first intermediate host, and ants are the second intermediate host. Man is infected by accidentally ingesting ants that contain infective metacercariae. The eggs (fig. 3-8) are asymmetrically ovoidal, thick shelled, dark brown in color, have a broad convex operculum, and measure 38 to 45  $\mu\text{m}$  by 22 to 30  $\mu\text{m}$ . They contain a mature miracidium when passed in the feces of the definitive host.

#### Exercises (437):

Indicate whether each of the following statements is true (T) or false (F) and correct those that are false

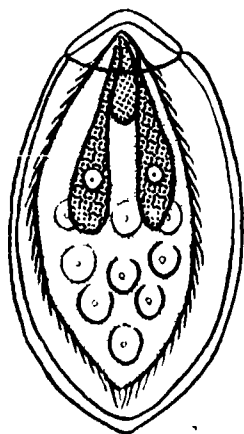

Figure 3-8 Egg of *Dicrocoelium dendriticum*

T F 1. *D. dendriticum* is a parasite commonly found in the intestine of sheep and herbivorous animals.

T F 2. *D. dendriticum* has frequently been reported when actually the patient was not infected at all.

T F 3. Man is the second intermediate host.

T F 4. Man is infected by accidentally ingesting snails that contain infective metacercariae.

T F 5. The eggs are asymmetrically ovoidal, thick shelled, dark brown, and have no operculum.

T F 6. Eggs measure 38 to 45 mm by 22 to 33 mm.

438. State the common name for *Clonorchis sinensis*, the regions to which the organism is most common, the usual habitat of the adult worm, the shape and size of the adult worm, disease caused, and the size and shape of the eggs.

*Clonorchis sinensis*. *Clonorchis sinensis* is known as the Chinese liver fluke. There are several authors who feel that the genus *Clonorchis* has characteristics sufficiently like *Opisthorchis* to classify the species *sinensis* under the latter genus. Therefore, you may see the term "*Opisthorchis sinensis*" in parts of China, Japan, Formosa, and Indochina. There is no evidence that the infection has become established in any region outside the China Sea area. Frozen fish and dried or pickled fish shipped from endemic areas probably account for infection in persons who have never visited areas where the parasite is found. There are many reservoir hosts for this parasite, including the dog and cat.

The adult worm lives in the bile passages and occasionally in the pancreatic duct. It is a flat, transparent, flabby worm that is somewhat spade shaped. It is relatively small (10 to 25 mm in length by 3 to 5 mm in width). One of the most characteristic features of the worm is the large branched testes which are situated one behind the other in the posterior third of the body.

The eggs are fully embryonated when discharged into the bile ducts. They are passed in the feces, and a miracidium hatches only after the egg is ingested by a



snail of the Family Amnicolidae. The miracidium develops a first generation sporocyst in which second generation rediae are produced. Cercariae are produced in the rediae, and they escape from the snail and encyst as metacercariae in the skin of fresh water fish. Man becomes infected by ingesting infected fish. The metacercariae excyst in the intestine and make their way into the common bile duct and finally to the distal bile capillaries, where they develop into mature worms in about 1 month. Approximately 3 months are required for the whole cycle.

The parasites cause inflammation of the bile ducts, and the body attempts to encapsulate them. This results in the production of considerable fibrous tissue in the bile ducts. In very heavy infections, severe damage may result in cirrhosis of the liver or even death.

Laboratory diagnosis is based on the recovery of typical eggs from feces. The egg (fig. 3-9) is small and ovoid with a distinct operculum that fits into a rimmed extension of the shell. They have moderately thick, light yellow-brown shells; and they measure about  $29\mu\text{m}$  by  $15\mu\text{m}$ .

#### Exercises (438):

1. What is the common name for *Clonorchis sinensis*?
2. *Clonorchis sinensis* is the most important liver parasite of man in which regions of the world?
3. What are two reservoir hosts?
4. Where does the adult worm live in the body?

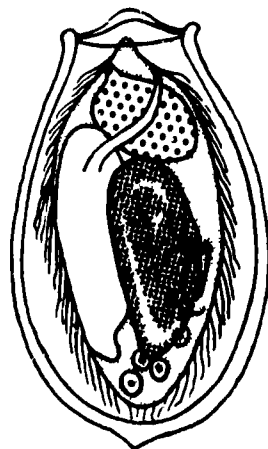

Figure 3-9. Egg of *Clonorchis sinensis*

5. What disease condition does *Clonorchis sinensis* cause?
6. From what specimen are the eggs recovered for laboratory diagnosis?
7. Briefly describe the egg of *Clonorchis sinensis*.
8. What is the average size of the egg?

**439. Indicate whether given statements correctly reflect the region where *Opisthorchis felineus* is commonly found, differences and similarities in the size of the adult worm and the eggs of *Opisthorchis felineus* and *Clonorchis*, the intermediate hosts of *Opisthorchis felineus*, and the region where *Opisthorchis viverrini* is commonly found.**

*Opisthorchis felineus*. *Opisthorchis felineus* is widely distributed in eastern and southeastern Europe and Asiatic U.S.S.R., and it is reported to be common in Vietnam. The worm is smaller than *Clonorchis* (10 mm by 2.5 mm as compared with 20 mm by 4 mm); otherwise, they are very similar. The eggs of the two worms are also very similar. They are slightly narrower than those of *Clonorchis*. The egg (fig. 3-10) of *O. felineus* is  $30\mu\text{m}$  by  $11\mu\text{m}$ , whereas that of *C. sinensis* is about  $29\mu\text{m}$  by  $16\mu\text{m}$ . A snail is the first intermediate host, and cyprinid fresh water fish are the second intermediate host. In addition to man, many fish-eating mammals are infected. Clinical aspects and diagnostic procedures are essentially the same as those of clonorchiasis.

*Opisthorchis viverrini*. *Opisthorchis viverrini* is closely related to *O. felineus*. As many as 75 percent of the people from some areas of northeastern Thailand have been found to be infected with the parasite. The eggs are slightly smaller than those of *Clonorchis* and *O. felineus*. They measure  $26\mu\text{m}$  by  $13\mu\text{m}$ .



Figure 3-10. Egg of *Opisthorchis felineus*



### Exercises (439):

Indicate whether each of the following statements is true (T) or false (F) and correct those that are false.

- T F 1. *Opisthorchis felineus* is widely distributed in eastern and southeastern Europe and Asiatic U.S.S.R.
- T F 2. The worm is larger than *Clonorchis*.
- T F 3. The eggs of *Opisthorchis felineus* and *Clonorchis* are not alike.
- T F 4. *O. felineus* is 29 by 16  $\mu\text{m}$ , whereas *C. sinensis* is 30 by 11  $\mu\text{m}$  in size.
- T F 5. A snail is the first intermediate host and the cyprinid fresh water fish are the second intermediate host.
- T F 6. Approximately 75 percent of the people from some areas of northeastern Thailand have been found to be infected with *Opisthorchis viverrini*.
- T F 7. Eggs of *Opisthorchis viverrini* are slightly larger than those of *Clonorchis* and *T. felineus*.

**440.** State the countries and region where *Fasciolopsis buski* is most commonly found, the length and width of the organism, the intermediate host, the manner in which a person becomes infected with the worm, the size of the egg and the method of diagnosis.

**Intestinal Flukes.** In this country, intestinal flukes are of little medical importance. There are no known intestinal flukes that are strictly human parasites. A number of species parasitize humans as well as other animals. In certain localities, this condition constitutes a serious medical problem because the other animals form a large reservoir of infection. The best example of this is *Fasciolopsis buski* in southeastern Asia, where it is a common parasite of pigs and humans.

*Fasciolopsis buski*. This fluke is called the giant intestinal fluke. It is most common in India, China, and the southwest Pacific. It is found in man, swine, and occasionally in dogs.

*Fasciolopsis buski* is the largest and best known of the intestinal flukes of man. It measures over an inch in length and about a half inch in width. The worm is leaf like in appearance and has a spinose integument. The ventral sucker (acetabulum), located near the anterior end, is three to four times as large as the oral sucker. *F. buski* has highly branched testes, which occupy the posterior three-fifths of the body.

The eggs must get into fresh water after being passed in feces. There, they hatch in 3 to 7 weeks. A miracidium escapes from the egg and penetrates an appropriate snail intermediate host of the Genus *Hippeutis* or *Segmentina*. After the miracidium undergoes the necessary development, cercariae escape from the snail and encyst on water chestnut or water caltrop as metacercariae. Human infection occurs when a person ingests the metacercariae while cracking nuts of the above plants with his teeth.

The egg is practically identical to that of *F. hepatica*, shown in figure 3-7. It is operculate and measures 130  $\mu\text{m}$  to 140  $\mu\text{m}$  by 80  $\mu\text{m}$ . Diagnosis is based on the recovery of typical eggs from feces and on the physician's clinical findings.

Pathological effects of *F. buski* include anemia, emaciation, and inflammation and ulceration of the intestinal mucosa. Intestinal obstruction and toxic reactions frequently occur in cases of heavy infection.

### Exercises (440):

1. *Fasciolopsis buski* is called the giant \_\_\_\_\_.
2. It measures over \_\_\_\_\_ in length and about a \_\_\_\_\_ inch in width.
3. *F. buski* is most common in \_\_\_\_\_, \_\_\_\_\_, and in the \_\_\_\_\_ Pacific.
4. A \_\_\_\_\_ of the Genus *Hippeutis* or *Segmentina* is the intermediate host.
5. Human infection occurs when a person ingests the \_\_\_\_\_ while \_\_\_\_\_ of the water chestnut.

6. The egg is practically identical to that of \_\_\_\_\_.
7. *F. buski* is operculate and measures \_\_\_\_\_ to 140  $\mu\text{m}$  by \_\_\_\_\_ to 85  $\mu\text{m}$ .
8. Diagnosis is based on the recovery of typical eggs from \_\_\_\_\_ and on the physician's \_\_\_\_\_.

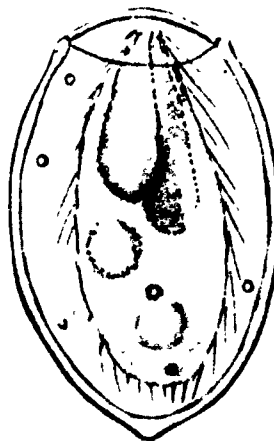

Figure 3-11. Egg of *Heterophyes heterophyes*

**441. State the countries and region where *Heterophyes heterophyes* is found, suitable hosts, the first and second intermediate host, location of the adult parasite in the definitive hosts, mode of transmission, size of adult worm, size of the egg, and the symptom of the infection.**

*Heterophyes heterophyes*. *Heterophyes heterophyes* is found in Egypt, Palestine, and the Orient. Suitable hosts include dogs, cats, rabbits, and a few other mammals, as well as man. Snails of the Genus *Pironella* are first intermediate hosts, and fresh water fish are second intermediate hosts.

Adult parasites live in the small intestine of the definitive host. Frequently they are present in large numbers. The eggs are completely embryonated when they pass from the host. Miracidia hatch from the eggs after the eggs are ingested by the proper snail. After the necessary development is completed in the snail, cercariae escape from the snail and penetrate beneath scales of certain fish, where they encyst as the infective metacercariae. The final host becomes infected by eating uncooked fish that contain metacercariae.

The adult worm is very small. It measures approximately 0.4 mm by 1.5 mm. The oral sucker is ventrally located, but it is only about one-third as large as the acetabulum. The adult worm is covered with minute spines which are set closely together.

The egg (fig. 3-11) is small (30 by 17  $\mu\text{m}$ ) operculate, brownish in color, and contains a well-developed ciliated miracidium. It will be very difficult for you to differentiate the eggs of this parasite from *Opisthorchis*, *C. sinensis*, *M. yokogawai*. You can easily recover the eggs from feces by the standard procedures.

*H. heterophyes* attaches itself to the intestinal mucosa, provoking symptoms of mild diarrhea, usually with no serious pathology. Occasionally, the worms bore their way through the mucous lining of the intestine. When that happens, the minute eggs penetrate into the mesenteric lymphatics. They have been known to reach the heart and promote cardiac failure

**Exercises (441):**

- Heterophyes heterophyes* is found in \_\_\_\_\_, \_\_\_\_\_, and the \_\_\_\_\_.
- Suitable hosts include \_\_\_\_\_, \_\_\_\_\_, \_\_\_\_\_ and other mammals, as well as man.
- Snails of the Genus *Pironella* are \_\_\_\_\_ intermediate hosts, and fresh water fish are \_\_\_\_\_ intermediate hosts.
- Adult parasites live in the \_\_\_\_\_ intestine of the definitive hosts.
- The final host becomes infected by eating uncooked \_\_\_\_\_ that contain \_\_\_\_\_.
- The adult worm measures approximately \_\_\_\_\_ mm by \_\_\_\_\_ mm.
- H. heterophyes* eggs can be recovered from \_\_\_\_\_ by the standard procedures.

8. *H. heterophyes* attaches itself to the \_\_\_\_\_  
\_\_\_\_\_ provoking symptoms of \_\_\_\_\_  
\_\_\_\_\_.

9. They have been known to reach the \_\_\_\_\_ and  
promote \_\_\_\_\_ failure.

**442. Indicate whether given statements correctly reflect the regions where *Metagonimus yokogawai* is most common, suitable definitive hosts, mode of infection, the size of the egg and symptoms of the disease.**

*Metagonimus yokogawai*. *Metagonimus yokogawai* is a common parasite of the Far East and the Balkan States. Man and several other mammals are suitable definitive hosts. Snails of several genera serve as the first intermediate host. Man becomes infected by eating uncooked freshwater fish on which the infective metacercariae have encysted.

The ineffective metacercariae of *M. yokogawai* excyst in the small intestine of the definitive host and attach themselves to cells in the mucosal crypts and grow to maturity. Normally, the eggs are passed into the intestinal lumen and pass out with feces. However, some of the worms may penetrate so deeply into the intestinal wall that some eggs can get into the general blood circulation, as in *H. heterophyes* infections.

The egg (fig. 3-12) is operculate, brownish in color, measures 28  $\mu\text{m}$  by 17  $\mu\text{m}$ , and contains a well developed ciliated miracidium. Diagnosis is based on the recovery of characteristic heterophyid eggs in feces. More than likely you will not be able to differentiate the eggs of *M. yokogawai* from those of *H. heterophyes*, and you can expect to have difficulty in

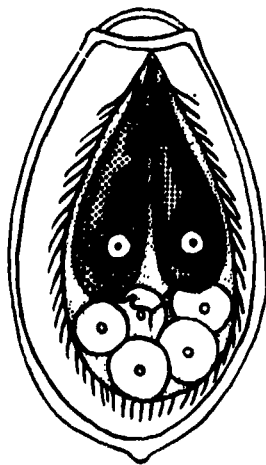

Figure 3-12 Egg of *Metagonimus yokogawai*

differentiating them from those of *Clonorchis* and *Opisthorchis*. Experts differentiate them by extensive study of morphological differences and also study of life-cycle forms.

Patients with *M. yokogawai* usually have persistent intestinal disturbances and diarrhea. Eggs that get into the circulating blood may reach the heart and central nervous system, where they can cause serious cardiac and nervous disturbances.

#### Exercises (442):

Indicate whether each of the following statements is true (T) or false (F) and correct those that are false.

T F 1. *Metagonimus yokogawai* is a common parasite of Egypt and Palestine.

T F 2. Man and several other mammals are suitable definitive hosts.

T F 3. Man becomes infected by eating uncooked freshwater snails on which the infective metacercariae have encysted.

T F 4. Some worms may penetrate so deeply into the intestinal wall that some eggs can get into the general blood circulation.

T F 5. The egg is operculate, brownish in color, measures 28 by 17  $\mu\text{m}$ , and contains a well developed miracidium.

T F 6. More than likely you will be able to easily differentiate the eggs of *M. yokogawai* from those of *H. heterophyes*.

T F 7. Patients with *M. yokogawai* usually show no type of intestinal disturbances.

**443. State the name of the only lung fluke that infects man, the morphological features of the adult worm, the appearance of the adult worm and eggs in the lungs, the size and appearance of the eggs, symptoms of infections, and method of diagnosis.**

**Lung Fluke (*Paragonimus Westermani*).** The only lung fluke of man is *Paragonimus westermani*. It is a

common infection of man in Asia. A very similar or identical fluke is found in cats, dogs, pigs, and wild carnivores in Africa and North and South America.

Humans are commonly infected with this species in Japan, Korea, Formosa, the Philippines, and Thailand. It is endemic in small foci of Africa and northern South America. *P. westermani* has been recovered from wild felines in India, Malaysia, Indonesia, and Thailand.

Morphologically the adult is plump and ovoidal in cross section, about 12 mm long and one-third as wide. The worm is reddish brown when alive. Its surface is covered with large spines.

The adult worms usually live in pairs in the parenchyma of the lungs. Eggs are deposited around the worms, and many of them are able to get into the respiratory passages. They are coughed up, swallowed, and pass from the host in feces. The eggs are unembryonated and require approximately 16 days in clear running water to complete their development. Then the eggs hatch, releasing a miracidium which penetrates a snail intermediate host. The miracidium transforms into a sporocyst, and within the sporocyst many rediae develop. Each rediae produces many cercariae which escape from the snail and penetrate suitable freshwater crabs and crayfish. The cercariae then encyst as infective metacercariae. When the infected crabs or crayfish are eaten raw, the metacercariae are freed in the small intestine. They burrow through the intestine into the peritoneal cavity, then through the diaphragm and on into the lungs.

The eggs of *P. westermani* (fig. 3-13) are relatively large, measuring approximately 80 to 120  $\mu\text{m}$  in length

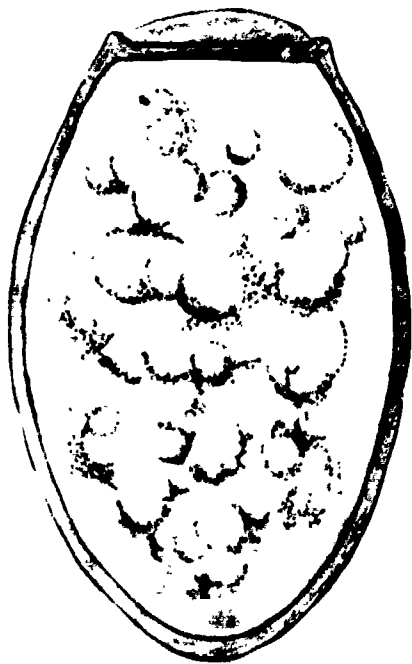

Figure 3-13 Egg of *Paragonimus westermani*

by 45 to 60  $\mu\text{m}$  in width. The egg shell is relatively thick and golden brown in color. The eggs have a flat-shaped operculum, and they are unembryonated when passed.

A *Paragonimus* infection causes a chronic bronchial cough with bloody sputum. The bloody sputum is the result of small blood vessels in the capsule around the worms leaking into a bronchiole, thus allowing blood and eggs to get into the sputum. The worms do not always find their way to the lungs. They have been found in many other organs. Frequently in these cases, abscesses are formed and death may result.

Specific diagnosis is easily made when the eggs of *P. westermani* are recovered from rusty or blood-tinged sputum, feces, pleural aspirates, or from peritoneal abscesses. In suspected cases where eggs cannot be recovered, intradermal tests and complement fixation tests may prove to be very helpful.

#### Exercises (443):

1. The only lung fluke of man is \_\_\_\_\_.
2. Morphologically the adult worm is \_\_\_\_\_ and \_\_\_\_\_ in cross section, about \_\_\_\_\_ mm long and \_\_\_\_\_ as wide.
3. The worm is \_\_\_\_\_ when alive, and its surface is covered with large \_\_\_\_\_.
4. The adult worms usually live in \_\_\_\_\_ in the \_\_\_\_\_ of the lungs.
5. Eggs are deposited \_\_\_\_\_ the worms and many of them are able to get into the \_\_\_\_\_ passages.
6. The eggs of *P. westermani* measure approximately \_\_\_\_\_ to \_\_\_\_\_  $\mu\text{m}$  in length by \_\_\_\_\_ to \_\_\_\_\_  $\mu\text{m}$  in width.
7. The eggs have a \_\_\_\_\_-shaped operculum and they are \_\_\_\_\_ when passed.
8. A *Paragonimus* infection causes a chronic \_\_\_\_\_ with bloody sputum.
9. The bloody sputum is the result of small \_\_\_\_\_ vessels in the \_\_\_\_\_ around the worms leaking into a \_\_\_\_\_, thus allowing blood and \_\_\_\_\_ to get into the sputum.
10. Specific diagnosis is easily made when the eggs or *P. westermani* are recovered from rusty or \_\_\_\_\_ sputum, \_\_\_\_\_, \_\_\_\_\_ aspirates or from \_\_\_\_\_ abscesses.

#### 3-2. Cestodes (Tapeworms)

Adult tapeworms are flat, ribbon-like, segmented worms. The individual segments are called proglottids. The worm does not have a mouth, gut, or body cavity. They attach themselves to the intestinal mucosa by a scolex (head) that has suckers. The adult worm (fig. 3-14) is separated into the following recognizable regions: (a) scolex; (b) neck, a region of growth that immediately follows the scolex; (c) immature proglottids; (d) mature proglottids; and (e) gravid

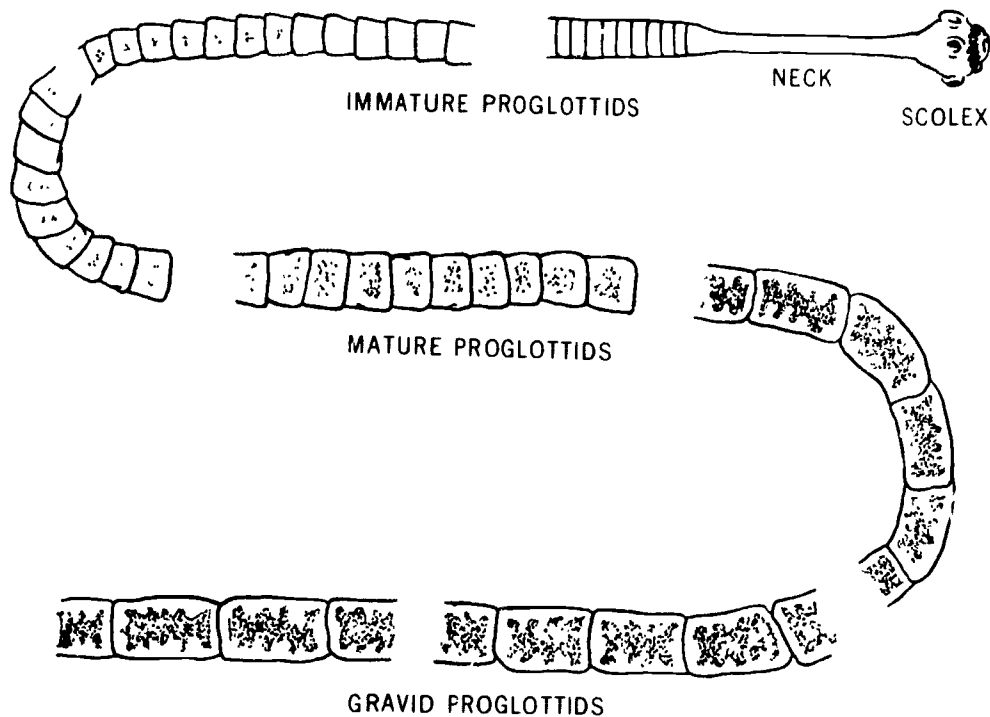

Figure 3-14 Adult tapeworm

proglottids. The entire length of the worm that is made up of proglottids is called the strobila.

The scolex of *Diphyllobothrium latum* is long and spatulate with a long, sucking groove on each side. The other tapeworms that infect man have knob-like scolices which possess cup-like suckers at each of the four angles. Some of them also have interior muscular projection (rostellum) armed with numerous hooks.

There is a complete set of male and female organs for each mature proglottid. *Diphyllobothrium* discharges unembryonated eggs that must reach cool, clear water before further development occurs. The eggs of the other cestodes contain fully developed hexacanth embryos which have three pairs of hooklets.

The larval stages of some cestodes can parasitize man. In such infections, the larvae may be found in almost any tissue of the body. In cases of larval infection by cestodes such as *Echinococcus*, the infection can be fatal. In some geographical locations human infections with the larval cestodes are quite common. The diagnosis of these larval infections is usually made by a pathologist from examination of histological sections of biopsy material.

As a means of getting eggs out of the host, some cestodes discharge eggs singly, some shed one entire gravid proglottid at a time, and some shed groups of gravid proglottids. Recovery and identification of the scolex is necessary for treatment to be considered satisfactory. The six species listed in table 3-1 are the cestodes that commonly parasitize man. These

parasites live as adults in the intestine of man. Each of the species that frequently infect man will be discussed in this section.

444. Point out the common name of *Diphyllobothrium latum*, the length of the worm and number of proglottids, the manner through which man becomes infected, the shape of the scolex, the principal diagnostic features of the proglottids, and the morphology and size of the eggs.

**Diphyllobothrium Latum.** *Diphyllobothrium latum* is commonly known as the fish tapeworm or broad tapeworm. The worm may be up to 35 feet long and may have as many as 4,000 proglottids. *D. latum* is a common parasite in parts of Europe, Russia, Japan, Philippines, Australia, South America, and North America. Dogs, wolves, bears, and a few other carnivores, in addition to man, are hosts for this worm.

The eggs are passed in feces and require about 2 weeks in cool, clear water to complete embryonation. When the egg hatches, a coracidium (ciliated embryo) escapes through the operculum and swims about. The coracidium must be eaten by a small crustacean within 12 hours. In the crustacean the coracidium develops into a proceroid larva. The crustacean infected with the proceroid larva must be eaten by a freshwater fish before larval development can be completed. In the fish, the proceroid larva migrates to muscle tissue and develops into a plerocercoid larva (sparganum). When

an uncooked fish containing a plerocercoid larva is ingested by man or some other suitable carnivore, the larva attaches to the intestine, where it matures and passes eggs, thus completing the cycle.

The scolex (fig. 3-15) of an adult *D. latum* is small and spoon-shaped. It has two longitudinal slits (bothria), which serve as sucking organs for attachment. Neither hooks nor true suckers are present. The mature proglottids of *D. latum* (fig. 3-15) are broader than they are long, whereas the gravid proglottids are about as long as they are wide. The principal diagnostic features of mature and gravid proglottids are the centrally situated rosette-shaped uterus and a genital pore which lies in the center of each segment. *D. latum* eggs (fig. 3-15) are broadly ovoid and shaped very much like a hen egg. The shell is moderately thick and golden brown when passed in feces. The eggs vary greatly in size ( $59\ \mu\text{m}$  to  $71\ \mu\text{m}$  by  $42\ \mu\text{m}$  to  $49\ \mu\text{m}$ ), and they contain a partially developed embryo when passed. At the anterior pole there is a prominent operculum, and at the posterior pole there is a small knob-like protuberance.

The symptoms produced in man by *D. latum* are nausea, loss of appetite, abdominal discomfort, weakness, hunger, weight loss, and anemia. Occasionally, infected individuals may vomit portions of a worm. You should not have any difficulty in properly identifying the worm, because the characteristics of the scolex, proglottids, and the eggs are all very specific for the species.

#### Exercises (444):

1. What is the common name given to *Diphyllobothrium latum*?

2. What is the approximate length of the adult worm and approximate number of proglottids?
3. How does man become infected with *Diphyllobothrium latum*?
4. What is the general size and shape of the scolex?
5. What are two principal diagnostic features in both mature and gravid proglottids that are centrally situated?
6. Briefly describe the morphology and appearance of the egg.
7. What is the approximate size of the eggs?
8. What features are noted at the anterior and posterior poles of the egg?



SCOLEX

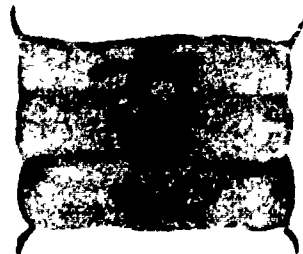

PROGLOTTID



EGG

Figure 3-15. *Diphyllobothrium latum*.



445. Cite the common name of *Taenia saginata*, the approximate length of the worm and number of proglottids, the geographical locations where the organism is most prevalent, and the definitive and intermediate hosts, the appearance and shape of the scolex, the morphology of the mature and gravid proglottids, the appearance of the embryo, and the symptoms caused by the organism.

**Taenia Saginata.** *Taenia saginata* is the largest tapeworm that infects man. The worm is usually about 15 feet long, but it may reach a total of 75 feet. There are usually 1,000 to 2,000 proglottids. *T. saginata* is widely known as the beef tapeworm. It is distributed worldwide, but is most prevalent in countries of southwestern Europe, Africa, and South America.

Man is the definitive host for the adult worm, and cattle are the intermediate hosts. The proglottids and eggs are scattered on soil and grass through human feces. When the embryonated egg is ingested by a cow, the hexacanth embryo hatches from the egg in the cow's intestine. The embryo bores through the intestinal wall and gets into the blood or lymph circulation. The embryo is carried to the cow's skeletal muscles, where it encysts and develops into a typical cysticercus larva in 60 to 75 days.

The scolex (fig. 3-16) of *T. saginata* has no rostellum nor attachment hooks. The attachment organs consist of four cup-shaped hemispherical suckers, one at each of the four corners of the scolex. Mature proglottids are slightly broader than long, whereas the gravid proglottids are considerably more narrow and about three times as long as the broadest portion of the segment. The central tube of the uterus of a gravid proglottid (fig. 3-16) has 15 to 20 lateral branches on each side. The entire uterus is filled with thick shelled eggs. The eggs (fig. 3-16) are longitudinal by striated. The striations are very fine and close together, and they are readily observed with a microscope using reduced light. There is a clear line of demarcation around the

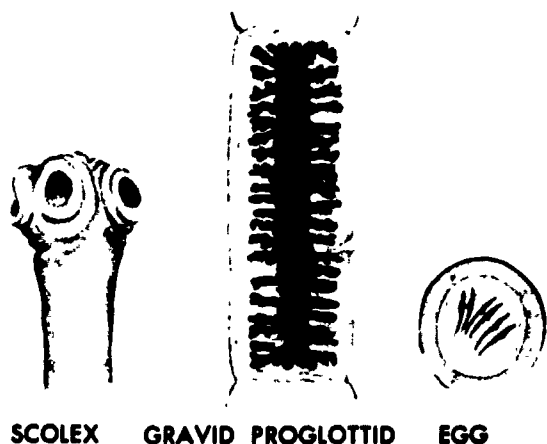

Figure 3-16. *Taenia saginata*.

hexacanth embryo, since the embryo does not completely fill the egg.

*T. saginata* is often the cause of intestinal problems because of its large size. It causes appendicitis, systemic intoxication, hunger pains, diarrhea, vomiting, and weight loss. It can also cause intestinal obstruction. The infection can mimic the symptoms of peptic ulcer and gallbladder disease.

You cannot differentiate *T. saginata* from the pork tapeworm (*T. solium*) solely on the basis of egg morphology. You should report that eggs of the Genus *Taenia* are present. You can make positive identification of *T. saginata* from a gravid proglottid. A gravid proglottid of *T. saginata* has 15 to 20 main lateral branches on each side of the uterine stem, whereas *T. solium* has only 7 to 13 uterine branches. Press a gravid proglottid between two glass slides and then count the lateral branches with the use of a hand lens.

**Exercises (445):**

1. Which is the largest of the tapeworms that infect man?
2. What is the common name of *Taenia saginata*?
3. What is the usual approximate length of *Taenia saginata*?
4. What is the approximate number of proglottids?
5. Despite worldwide distribution, the beef tapeworm is most prevalent in countries of South Western \_\_\_\_\_, \_\_\_\_\_, and \_\_\_\_\_.
6. What mammal is the intermediate hosts? Definitive hosts?
7. Briefly describe the appearance and shape of the scolex?
8. How do the mature and gravid proglottids compare in size?

9. How many lateral branches of the uterus may be found in a gravid proglottid of *T. saginata*?
10. What is the importance of the size of *T. saginata* in relation to the pathology it can cause?
11. How can the laboratory technician distinguish between *T. saginata* and *T. solium* parasites if he has one or more mature gravid proglottids from each of the two species?
12. How can the proglottids of the *Taenia* tapeworms be easily observed?

**446. Point out the type of meat from which *Taenia solium* has been acquired, the appearance of the scolex, the average number of hooks on the rostellum, and the disease condition resulting from a parasitic infection of *Taenia solium*.**

**Taenia Solium.** *Taenia solium* is found in areas where people eat improperly cooked pork. Man is the only definitive host for the adult worm, and hogs are the usual intermediate hosts. Naturally, the best way to control the parasite is to cook all pork and to treat all human cases.

Gravid proglottids are passed in human feces, and the eggs are discharged from the proglottids when they reach the soil. The eggs must be ingested by a pig or a man for development to progress. After a man or a pig ingests an egg, a hexacanth (six-hooked) embryo hatches from the egg and bores through the intestinal wall and is carried by the blood or lymph circulation to various tissues of the body. The embryo develops into a cysticercus larva within 2 to 3 months. A larval infection is known as cysticercosis. The cysticercus is the infective stage that leads to development of the adult *Taenia solium*. The adult tapeworm develops only after man ingests raw or improperly cooked pork which contains an infective cysticercus larvae.

The scolex (fig. 3-17) of the adult *T. solium* has four suckers and a prominent rounded rostellum that is armed with a double circle of hooks. There are 22 to 32 hooks, alternately large and small in a regular pattern on the margin of the rostellum. Mature proglottids are slightly wider than long. The elongated, egg-filled, gravid proglottid (fig. 3-17) has a characteristic uterine branching pattern which is diagnostic for this species of *Taenia*. The uterus of *T. solium* consists of a single longitudinal, centrally situated tube which has 7 to 13 (usually 9) branches on each side. The eggs cannot be distinguished from those of *Taenia saginata*. You can easily identify *T. solium* by examining the scolex or a

pressed gravid proglottid, using the method discussed in the section on *T. saginata*.

*T. solium* infection causes irritation of the mucosa of the intestine and on rare occasions causes obstruction of the intestine. The infection may result in nervous disorders due to the production of toxic substances by the adult worm. In cases of cysticercosis, the larvae are most frequently located in subcutaneous tissues; but they have been found in practically every organ and tissue of the body. When they lodge in the brain, the outcome is often fatal.

(446):

1. If the parasite *Taenia solium* has been acquired, what type meat must have been consumed by the patient?
2. Briefly describe the appearance of the scolex of *Taenia solium*.
3. Approximately how many hooks are there on the rostellum?
4. Approximately how many uterine branches does *T. solium* have?
5. What disease conditions are caused by *T. solium*?

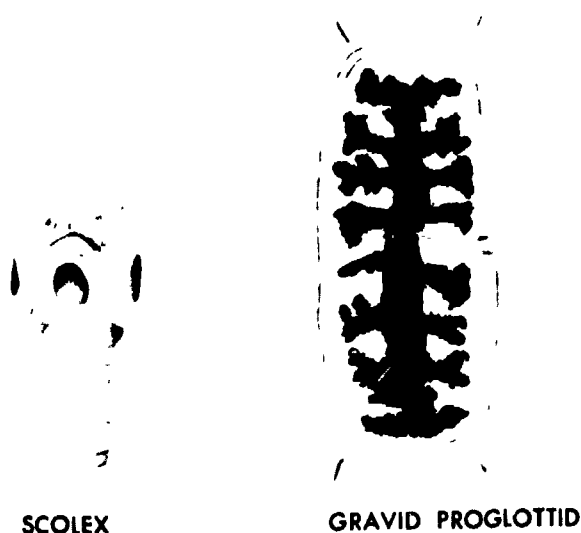

Figure 3-17 *Taenia solium*

447. State the climate where *Hymenolepis nana* is most prevalent, the common name, the approximate length of the adult worm and number of proglottids, the appearance of the scolex and appropriate number of hooklets, the appearance and size of the eggs, the symptoms produced by the organism, characteristic features of the eggs, and differences between the scolex of *H. nana* and *H. diminuta*.

**Hymenolepis Nana.** *Hymenolepis nana* is found all over the world, but it is most prevalent in warm climates. This worm is known as the dwarf tapeworm of man; however, rats and mice are also definitive hosts. It is common in Europe, Russia, Latin America, India, and the southern United States. Of all the tapeworms found in America, *H. nana* is the most common. The worm is only about 2 inches long but can have as many as 200 proglottids.

The eggs are embryonated when passed. *H. nana* does not require an intermediate host. When eggs are ingested by a definitive host, a hexacanth embryo is liberated in the small intestine. The embryos bore into the intestinal mucosa, where they transform into cysticercoid larvae in about 1 week. The cysticercoid larvae migrate back into the intestine. When they attach to the mucosa and develop into mature worms in about 2 weeks. In some cases, the eggs of *H. nana* may hatch as they travel down the intestine. This phenomenon is known as internal autoinfection and is thought to be responsible for some of the very heavy infections that are frequently encountered.

Recognition of the tapeworm is based on the following characteristics:

a. The scolex (fig. 3-18) has four suckers, and a rostellum that is armed with a single row of 20 to 30 hooklets.

b. The mature proglottids (fig. 3-18) are much broader than long, and there are three testes present that are arranged in a row across the proglottid.

c. The eggs (fig. 3-18) are nearly spherical and measure 30 to 47  $\mu\text{m}$  in diameter. The eggshell is made up of two thin membranes; the inner membrane has polar knobs to which threadlike filaments are attached. The eggs contain hexacanth embryos when passed.

Light infections may or may not produce symptoms. There may be diarrhea, vomiting, insomnia, weight loss, and even allergic reactions. Heavy infections almost always produce moderate to profuse diarrhea, nervous disorders, abdominal pain, and in some cases, extreme apathy.

You will be expected to identify the characteristic eggs of *H. nana*. When the eggs are present, you should look for the characteristic polar knobs and filaments. When only worms are available, stain the mature proglottids. The presence of three ovoid testes along the lower margin is characteristic for the genus *Hymenolepis*. When eggs are not available, you should examine the scolex of an adult worm to differentiate *H. nana* from the rat tapeworm, *H. diminuta*. The scolex of *H. nana* has a rostellar crown of 20 to 30 hooklets which may be inverted, whereas the scolex of *H. diminuta* has a deep sucker-like pocket into which the small rostellum is usually retracted. The rostellum of *H. diminuta* does not have hooklets.

**Exercises (447):**

1. *Hymenolepis nana* is most prevalent in \_\_\_\_\_ climates.
2. What is the common name of *H. nana*?

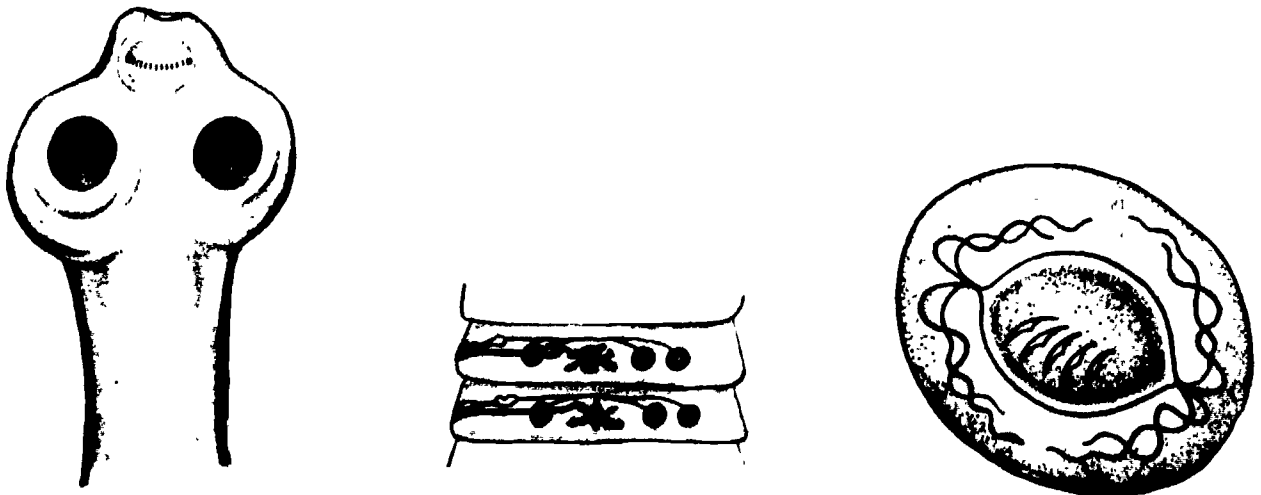

Figure 3-18. *Hymenolepis nana*

3. What is the approximate length of the worm and number of proglottids?
4. How many suckers does the scolex have?
5. What is the approximate number of hooklets on the rostellum?
6. What are two characteristic features of the mature proglottid?
7. What is the approximate size of the eggs?
8. Briefly describe the appearance of the egg.
9. What are some symptoms of a light infection of *H. nana*?
10. When the eggs of *H. nana* are present, you should look for the characteristic \_\_\_\_\_ and \_\_\_\_\_.

11 How can you differentiate the scolex of *H. nana* from that of *H. diminuta*?

448. Indicate whether given statements correctly reflect the most common host of *Hymenolepis diminuta*, a description of the scolex, differences and similarities between *H. diminuta* and *H. nana* eggs, length development in the definitive host, and the technique recommended for recovery of eggs.

**Hymenolepis Diminuta.** *Hymenolepis Diminuta* is a common parasite of rats, mice, and other rodents; therefore, it has been given the name rat tapeworm. However, it is occasionally found in humans, usually children. *H. diminuta* has been reported from human hosts from most areas of the world.

*H. diminuta* is small in comparison with some of the other tapeworms. Nevertheless, it is considerably larger than *H. nana*. It may be 20 inches long and have up to 2,000 proglottids. As you can see in figure 3-19, the scolex of *H. diminuta* is knob-like and has four relatively small suckers. At the tip of the scolex you can see a deep sucker-like pocket into which a small, unarmed rostellum is retracted. The mature proglottids are about three times as wide as they are long. Each mature proglottid contains three ovoid testes in a line across the proglottid. The gravid proglottids disintegrate, releasing fully embryonated eggs. The eggs, as illustrated in figure 3-19, are similar to those of *H. nana*, but with a little study, you will have no difficulty telling them apart. The eggs of *H. diminuta* are larger, 72 to 86  $\mu\text{m}$  by 60 to 79  $\mu\text{m}$ ; and the polar filaments which are characteristic of *H. nana* are not present.



SCOLEX

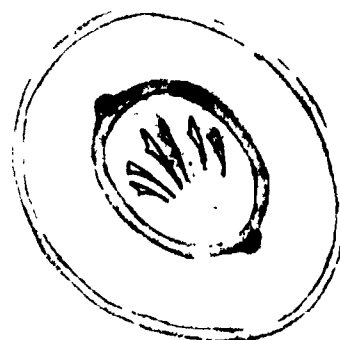

EGG

Figure 3-19. *Hymenolepis diminuta*.

After the eggs are voided in feces, they must be ingested by a suitable arthropod before further development is possible. The arthropods in this case are larval rodent fleas, meal moths, and many species of beetles. Cysticercoid larvae develop in the required intermediate hosts. When the arthropod intermediate host is ingested, the cysticercoid larvae is freed and attaches itself to the intestinal mucosa. Complete development in the definitive host requires about 3 weeks.

*H. diminuta* is similar to *H. nana* in many ways. The worms are morphologically similar, and the symptoms they produce are much the same. You can differentiate the eggs of *H. diminuta* from those of *H. nana* because the eggs of the former have no polar filaments. Remember that you will have to use sedimentation or centrifugation techniques and not flotation methods to concentrate the eggs. The methods for identifying the whole worm when eggs are not available are the same as those discussed in the section on *H. nana*.

**Exercises (448):**

Indicate whether each of the following statements is true (T) or false (F) and correct those that are false.

- T F 1. *H. diminuta* is one of the most common parasite of man and occasionally found in rodents.
- T F 2. *H. diminuta* is large in comparison with some of the other tapeworms.
- T F 3. *H. diminuta* is considerably larger than *H. nana*.
- T F 4. The scolex of *H. diminuta* is knob-like and has four relatively small suckers.

T F 5. At the tip of the scolex you can see a deep sucker-like pocket into which a small rostellum, armed with hooklets, is retracted.

T F 6. Eggs of *H. diminuta* are larger than those of *H. nana* and has polar filaments.

T F 7. The life cycle requires a stage of development in one of the various arthropods.

T F 8. Complete development in the definitive host requires about three weeks.

T F 9. Sedimentation or centrifugation techniques are used for recovery of eggs rather than flotation methods.

449. Cite the two animals to which the species *Dipylidium caninum* is common, the common name of *D. caninum*, the comparison between the proglottids of *D. caninum* and *H. diminuta*, the distinctive feature of the gravid proglottids, and the extent of development after *D. caninum* eggs have been expelled.

**Dipylidium Caninum.** *Dipylidium caninum* is a common parasite of both the dog and cat, and it is an occasional parasite of humans. Children are most often infected because children are frequently in close contact with infected pets. This parasite has a worldwide distribution and is known as the dog tapeworm.



Figure 3-20. *Dipylidium caninum*.

The scolex (fig. 3-20) of *D. caninum* has four rounded suckers and a retractile rosetellum with six rows of minute hooklets. *D. caninum* is about the size as *H. diminuta* but has fewer proglottids. Both worms are about 20 inches long, but *D. caninum* usually has fewer than 1,000 proglottids, whereas *H. diminuta* has between 1,000 and 2,000. The proglottids of *H. diminuta* are very wide from side to side and narrow from top to bottom, but those of *D. caninum* are long and slender. The gravid proglottids of *D. caninum* (fig. 3-20) are shaped much like cucumber or pumpkin seeds. This is the only tapeworm infecting man that has proglottids with genital pores on each side. The intact gravid proglottids contain many polytomial-shaped egg capsules (fig. 3-20) which contain numerous embryonated eggs. The ripe proglottids separate from the strobila and pass from the host. Upon reaching the soil, they fragment, setting free the egg capsules. The individual eggs are almost spherical,  $45 \mu\text{m} \times 50 \mu\text{m}$ , with a shell of two thin layers.

The expelled eggs must be ingested by the dog louse or larvae of certain fleas before further development can occur. The eggs hatch in the arthropods, and the embryos transform into cysticercoid larva. The definitive host becomes infected when an infected arthropod intermediate host is ingested. After the infected arthropod is ingested, the cysticercoid larva attaches to the intestinal mucosa of the definitive host and develops to a mature worm.

*D. caninum* may cause profuse diarrhea and unrest in children. In some cases the worm may cause sensitization reactions such as urticaria, fever, and

eosinophilia. You will have no difficulty in making the proper identification if you find any of the characteristic parts of the tapeworm.

#### Exercises (449):

1. The species *Dipylidium caninum* is a common parasite of what two animals?
2. What is the common name for *D. caninum*?
3. Why are children most often infected with *D. caninum* parasite?
4. With respect to length and number of proglottids, how do *D. caninum* and *H. Diminuta* compare?
5. What is the distinctive feature of the gravid proglottids of *D. caninum*?
6. How much further development occurs when *D. caninum* eggs have been expelled by a cat or dog host?



## Nematodes Infecting Man

THE UNSEGMENTED roundworms make up the phylum Nematoda. Members of this group have a complete digestive tract. They have a body cavity, but it is not lined with mesothelium like a true body cavity. It is usually packed with reproductive organs. The sexes are usually separate.

While many species of nematodes are free living, many parasitize plants, and many others are obligate parasites of animals. Nematodes are the most common parasites of man. Among native populations in tropical countries where sanitation is poor, nematode infections are universal. Even though these parasites are not a serious problem in the United States today, they are problems for our troops in areas where large reservoirs of infection exist.

Nematode life cycles include the following fundamental stages: the egg, four larval stages, and the adult. The number of eggs produced per day varies greatly from one species to another. The eggs of different nematodes are in specific stages of development when passed. This phenomenon ranges from one extreme to the other. Some nematodes pass unembryonated eggs, whereas others pass eggs that are fully embryonated. Some even retain the eggs in-utero until they hatch. The larvae are then passed.

On the basis of their habitat, nematodes of humans are divided into the intestinal roundworms and the somatic or tissue roundworms. With the exception of *Trichinella*, the intestinal roundworms do not require an intermediate host; they have a more or less direct life cycle. The somatic or tissue roundworms and *Trichinella* require intermediate hosts; they have indirect life cycles.

This chapter is divided into three sections. The first section covers the intestinal nematodes of humans. The second section includes the nematodes of human that live as adults in the tissues. The third section deals with nematodes that normally parasitize other animals but which are capable of entering the human body. Table 4-1 illustrates the taxonomic relationship of the various parasites discussed in this chapter.

### 4-1. Intestinal Nematodes

The intestinal nematodes, with the exception of *Trichinella*, do not have an intermediate host in their life cycle. The eggs or larvae are passed in feces and require a period of development outside the host to

reach the infective stage. The life cycles of the intestinal nematodes vary in complexity from the very simple pattern of *Enterobius* to the involved pattern of *Strongyloides*.

**450** Cite the regions where *Enterobius vermicularis* is more commonly found, characteristic shape and size of the eggs, the manner in which the eggs are ingested, and method of collection for laboratory diagnosis.

**Enterobius Vermicularis.** *Enterobius vermicularis*, the pinworm, or seatworm, is cosmopolitan in distribution, but is more common in cooler temperate regions than in strictly tropical areas. It is the most common nematode infecting humans in the United States. It is most frequently found in small children who live in crowded conditions.

Adult pinworms (fig. 4-1) are cylindrical in shape and whitish in color. As with most nematodes the male is smaller than the female. The male is about 2 mm to 5 mm long, and the female is approximately 10 mm long. The posterior end of the male is sharply curved so that its body resembles an upside down question mark.

The eggs of *E. vermicularis* (fig. 4-1) are more or less flat on one side and broadly rounded on the other. They have a colorless double shell that is very sticky. This sticky outer shell makes the egg stick to clothing and to the perianal skin. The eggs are almost fully embryonated when passed. In a matter of a few hours after passage the eggs are infective.

Infective eggs are accidentally ingested from contaminated fingers or along with dust. They hatch in the small intestine; and larvae make their way to the large intestine, where they mature in from 15 to 28 days. After mating, the gravid female migrates to the anus and crawls out, whereupon she usually ruptures, spilling eggs all over the perianal folds.

The presence of worms and eggs on the skin causes anal itching, which is quite severe at times. Occasionally, in female patients, a worm will crawl into the vagina, on into the fallopian tubes, and eventually into the peritoneal cavity, causing severe complications. Pinworms are normally inhabitants of the cecum. Because they are frequently found in the appendix, they are often suspected of causing appendicitis; but their presence is probably incidental.

Laboratory diagnosis is made by finding typical adults or eggs. Because of the migratory behavior of

TABLE 4-1  
CLASSIFICATION OF PHYLUM NEMATODA

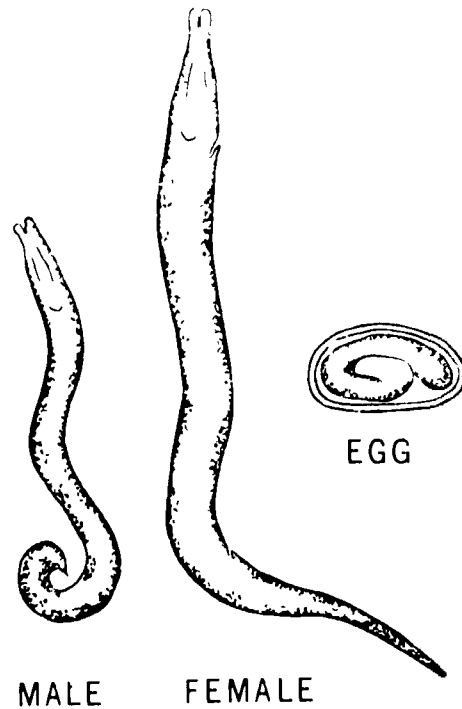
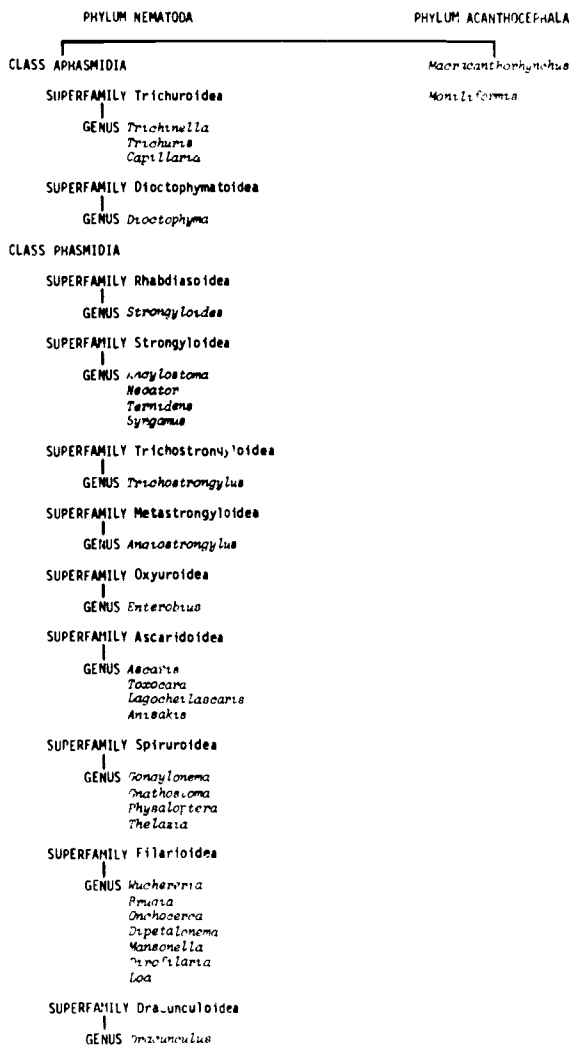

Figure 4-1 *Enterobius vermicularis*

gravid females, eggs are only rarely found in routine fecal examinations. You should instruct parents to collect the specimen by pressing the sticky side of the pinworm paddle to the perianal folds. The pinworm paddle is available through medical supply channel and is stocklisted as Tube, Specimen, FSN 6640-00-926-8959. It is best to get the specimen 2 to 4 hours after the patient has gone to bed or early in the morning before bathing and before a bowel movement.

**Exercises (450):**

1. *E. vermicularis* is more common to what regions?

2. The eggs of *E. vermicularis* may be identified by what characteristic shape?
3. How are infective eggs ingested?
4. What *Enterobius vermicularis* egg characteristic allows them to attach readily to a person's clothing and perianal skin?
5. How should you collect a specimen of *Enterobius Vermicularis* eggs for making laboratory diagnosis?
6. When is it best to get the specimen?

451. Cite the climatic conditions in which Trichuris Trichiura infections are most prevalent, the manner in which man becomes infected, the size of the male and female adult worms, the color and shape of the eggs, symptoms caused, and recommended laboratory techniques.

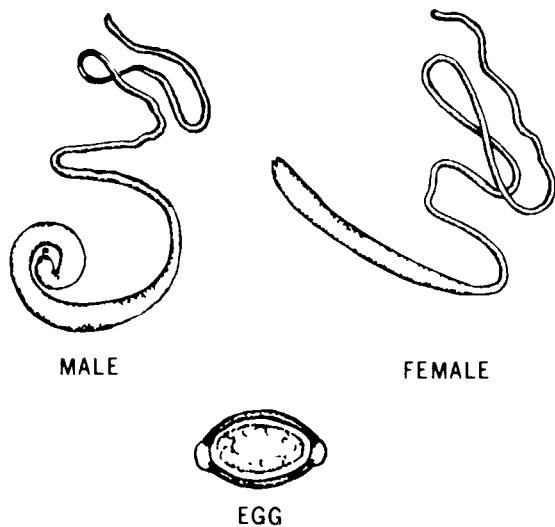

Figure 4-2 *Trichuris trichiura*

**Trichuriasis Trichiura.** *Trichuris* (whipworm) infections are widely distributed, but they are prevalent only in warm or moist temperate climates. The worm is frequently present in individuals who also harbor *Ascaris* and hookworm.

*Trichuris* eggs, in the unsegmented stage, are passed from the host in feces. They are not infective until 10 to 14 days of development in moist, shady soil. Man becomes infected by ingesting infective eggs. The eggs hatch in the small intestine, and the emerging larvae enter the intestinal crypts and penetrate into the glands and stroma, where they obtain nourishment. They gradually migrate down the intestine; and in about 10 days they begin to appear in the cecum, which is the habitat of the adult worms. The worms reach maturity in about 90 days after the eggs are ingested. These worms usually live for several years.

The anterior two-thirds of the worm is slender and threadlike, whereas the posterior one-third is thick and fleshy. The anterior of the worm is delicately but firmly threaded into the mucosa of the cecum. The male (fig. 4-2) measures 30 mm to 45 mm in length. Its posterior end is heavyset and curled into a full circle. The female (fig. 4-2) measures 35 mm to 50 mm in length. Its body is bluntly rounded at the posterior end. The female *T. trichiura* has only one ovary and produces relatively few eggs (3,000 to 6,000 per day). The eggs (fig. 4-2) measure 50  $\mu$ m to 54  $\mu$ m by 22.5  $\mu$ m. They are barrelshaped and have a double shell. The outer shell is stained with bile, which gives it a golden brown color. They have what appear to be unstained mucoid plugs at each end of the shell.

Light infections do not usually cause symptoms. The presence of moderate to large numbers of worms causes bloody diarrhea. In direct saline smears from such cases, you will find eggs, many eosinophils, and Charcot-Leyden crystals. The eosinophils and Charcot-Leyden crystals may even be present several

weeks before the worms start to produce eggs. You will have to use a concentration technique to find eggs in light infections. The zinc sulfate centrifugal flotation method is generally excellent, but it will not float infertile nematode eggs. The acid-formalin-ether concentration is satisfactory, and the Kato thick smear has recently been shown to be excellent for detecting nematode eggs.

#### Exercises (451):

1. *Trichuris trichiura* infections are most prevalent in what climatic conditions?
2. How does man become infected with *T. trichiura*?
3. What are the comparative sizes of the male and female adult worm, respectively?
4. What color and shape are *Trichuris trichiura* (whipworm) eggs?
5. What symptoms might be noted with a moderate to large number of worms?

452. State the areas where *Ascaris lumbricoides* is most prevalent and common, the time required for development of the infective stage of the egg, the approximate quantity of eggs produced daily by the female, the appearance of eggs, common symptoms of lung migration of the larvae, and techniques for detection of eggs.

**Ascaris Lumbricoides.** *Ascaris lumbricoides* is found all over the world except in areas that are very cold and dry. It is most prevalent in tropical areas, but it is a common parasite in cooler climates as well.

The eggs of *Ascaris* are unsegmented when passed and must undergo a period of development in the soil before they are infective. Under favorable conditions, the eggs develop to the infective stage in about 3 weeks. The eggs may remain viable in soil for months or even years. They are very resistant to drying and low temperatures.

Digestive juices act on the egg shell, and the larva escapes in the small intestine. The larva migrates through the intestinal mucosa and makes its way to the liver, then to the heart, and finally to the capillaries of the lungs. There it enters an alveolus, where it undergoes one molt and grows to about 2 mm in length. After about 9 days in the alveolus, the third

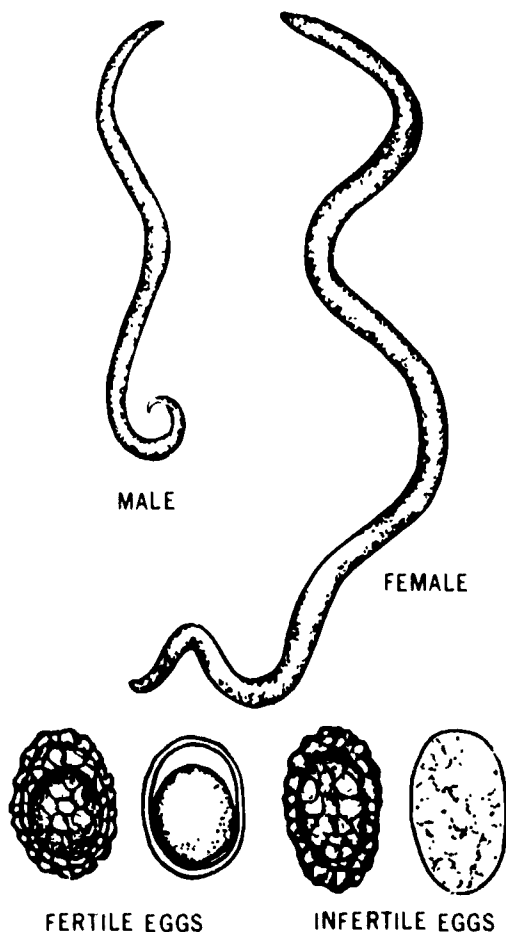

Figure 4-3 *Ascaris lumbricoides*.

stage larva migrates up the trachea and is swallowed. In the intestine two more molts occur, and the worms become sexually mature in 8-12 weeks from the time the eggs were ingested. They usually live for about one year.

Adult *A. lumbricoides* (fig. 4-3) are large worms. The female measures from 20 cm to 45 cm in length and are about 5 mm in diameter; the males are roughly two-thirds as long and somewhat smaller in diameter. The female produces an average of about 200,000 eggs per day. The characteristic fertile egg (fig. 4-3) has a thick, transparent inner shell that is covered by an irregular wrinkled albuminous coat. The fertile egg contains a coarsely granular embryonic cell which usually does not completely fill the shell. Bile pigments in the intestinal tract of the host stain the eggs so that they are golden brown when passed in the feces. Typical fertile eggs are ovoidal and measure 65  $\mu\text{m}$  to 75  $\mu\text{m}$  by 35  $\mu\text{m}$  to 50  $\mu\text{m}$ . Unfertilized female worms produce infertile eggs (fig. 4-3) that are more elongate than fertile eggs. They measure about 90  $\mu\text{m}$  by 40  $\mu\text{m}$  and contain an amorphous mass of granules and globules which completely fills the shell. Both fertile

and infertile eggs may be found without the outer albuminous coat (fig. 4-3). These decorticated eggs closely resemble hookworm eggs, but they have a much thicker shell; they contain an undivided cell mass, whereas hookworm eggs usually contain a zygote that is in the four or eight cell stage.

As the larvae of *A. lumbricoides* migrate through the lungs, pulmonary signs and symptoms appear. These symptoms are most noticeable during the second week after infective eggs are ingested. The most common symptoms of lung migration of the larvae are cough, fever, and occasionally blood-tinged sputum. In light infections, the adult worms usually cause little or no problem. In moderate infections there is frequently abdominal pain or discomfort. Large numbers of worms become a burden, and their large size makes them a potential problem. *A. lumbricoides* become very active during febrile diseases and some abdominal conditions. They may attempt to migrate out of the body in both directions, or they may congregate in a tight mass which may block the intestine. The adult worms frequently migrate up the trachea and out of the patient's nose; or they may stimulate the patient to vomit, with the worm being passed in the vomitus.

When the larvae are migrating through the lungs, you will find many eosinophils and Charcot-Leyden crystals in sputum specimens. You may also find some larvae in the sputum, but you can recover them more readily from gastric washings. After the worms become sexually mature, you can generally find eggs in simple saline smears of the feces. You do not have to use concentration techniques because of the large number of eggs produced by each female worm. Detection of single-worm infections presents difficulties because no eggs, or the peculiar infertile eggs, are found in the stool specimen. You should not rely solely on flotation techniques because infertile eggs are too dense to float with the ordinary techniques. You should always use a direct saline smear in conjunction with any concentration technique.

#### Exercises (452):

1. *Ascaris lumbricoides* is most prevalent in \_\_\_\_\_ areas but is a common parasite in \_\_\_\_\_ climates as well.
2. Under favorable conditions, the eggs develop to the infective stage in about \_\_\_\_\_ weeks.
3. Why does *Ascaris lumbricoides* remain viable in the soil for months or even years?

4. How do *Ascaris lumbricoides* eggs differ from hookworm eggs?
5. Approximately how many eggs does the female produce on a daily average?
6. What causes the eggs to appear golden brown when passed in the feces?
7. What are the most common symptoms of lung migration of the larvae?
8. When the larvae are migrating through the lungs, one will find many \_\_\_\_\_ and \_\_\_\_\_ crystals in sputum specimens.
9. Why are concentration techniques not necessary?
10. One should not rely solely on flotation techniques for what reason?
11. One should always use a \_\_\_\_\_ smear in conjunction with any concentration techniques.

**453. Point out the two species of hookworms of major importance to man, the principal factors controlling the distribution of hookworms, the manner in which the infective stage filariform larvae of *Necator americanus* infect the human host, the method of differentiating the two species, and the significance of the egg count.**

**Hookworms.** There are two species of hookworms of major importance to man. *Ancylostoma duodenale* (Old World) and *Necator americanus* (New World). *A. duodenale* is found principally in Southern Europe, Northern Africa, China, and Japan. *Necator americanus* is found in the Southern United States, Central America, the West Indies, and South America east of the Andes, as well as in Central and South Africa, Southern Asia, and Polynesia. The principal factor controlling the distribution of these parasites is temperature. *N. americanus* eggs are quickly killed at

temperatures below 45° F., whereas those of *A. duodenale* survive at considerably lower temperatures.

The life cycles of the hookworms are very similar. The adults attach themselves by their buccal capsules to the mucosa of the small intestine of the host. The females lay a fairly large number of eggs per day; *Necator* produces more than 5,000 and *Ancylostoma* more than 10,000 daily. Passed hookworm eggs are usually in early cleavage and rapidly develop to the first larval stage. When feces containing hookworm eggs are deposited on warm, moist, sandy soil, rhabditiform larvae hatch within 24 to 48 hours. Under favorable conditions, the larvae undergo two molts in about 5 to 8 days. The resulting larvae are third stage filariform larvae which are infective.

The infective stage filariform larvae of *Necator* infect the human host only by penetrating the skin. The infective larvae of *Ancylostoma* can establish infection after being swallowed or by penetrating the skin. After the larvae penetrate the skin, they enter the blood vessels and are carried to the lungs, where they develop to fourth stage larvae. After about 1 week, they make their way up the pulmonary tree and are swallowed. They attach themselves to the mucosa of the small intestine, where they continue to develop to the adult stage. Then they mate and begin to lay eggs. From the time of skin penetration to egg laying is about 6 weeks. *Ancylostoma* larvae do not undergo any essential development in the lungs, and the filariform infective larvae that are swallowed simply penetrate into the intestinal wall and develop to the fourth stage before they emerge and attach themselves to the intestinal mucosa. Adult worms of both species live and produce eggs for about 5 to 10 years.

Allergic lesions may develop locally at the site of larval penetration. As with *Ascaris* infections, a single heavy exposure to infective larvae can cause pulmonary symptoms of hacking cough and fever consequent to larval migration through the lungs. This might occur, for example, in troops confined to foxholes or in other situations permitting intimate exposure to large numbers of infective larvae. Iron deficiency anemia is the classical symptom of hookworm disease. It develops only in persons with large worm burdens or in the presence of other conditions that contribute to the depletion of body stores of iron. During World War II, it was found that our troops had relatively light infections and hookworm anemia did not develop. *A. duodenale* generally produces a more severe disease than *N. americanus* when similar numbers of worms are present.

Diagnosis is made by demonstrating hookworm eggs in stool specimens. You cannot differentiate the species of hookworms on the basis of egg morphology alone. Only on rare occasions will you be required to identify hookworms to species. In the event such identification is required before treatment, set up a "Harada-Mori" culture. After about 1 week check the culture for filariform larvae. Examine the buccal



structures of the larvae under high power. The buccal canal in each is lined with cuticle, but in *Necator* it is thickened at one level to give the appearance of a minute, spear-like structure. The buccal canal of *Ancylostoma* is smooth. With the aid of table 4-2 and figure 4-4, you can easily identify the adults as to species. Concentration techniques are not needed to detect the eggs (fig. 4-4) if infection is heavy enough to produce hookworm disease. On routine fecal examinations, you will recover eggs from patients with only one or two egg-producing worms with either the zinc-sulfate centrifugal flotation concentration method, the formalin-acid-ether concentration method, or the Kato thick smear method.

To give the physician some idea of the significance of the infection, you should perform a simple egg count.

Make a saline direct smear using sufficient feces (2 mg) to cover the tip of an applicator stick. Systematically cover the entire smear and count all the eggs. Fewer than five eggs per smear indicates light infection that ordinarily does not produce anemia. Counts of 20 or more eggs per smear indicate clinical significance. Very heavy infections will produce over 100 eggs per smear. Such heavy infections usually cause an observable anemia.

**Exercises (453):**

1. What are the two species of hookworms that are of major importance to man?

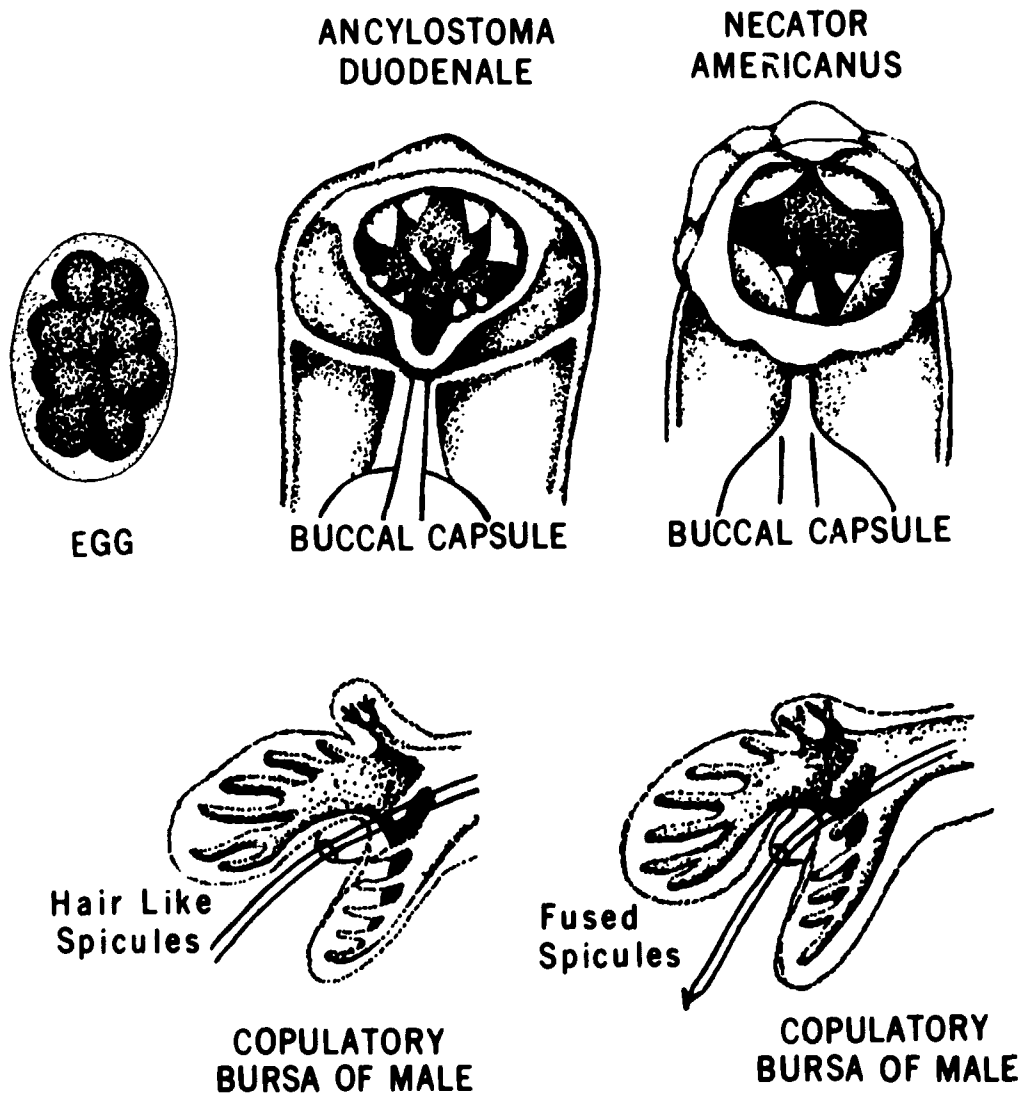

Figure 4.4. Hookworms



TABLE 4-2  
CHARACTERISTICS OF HOOKWORMS

	<i>A. Duodenale</i>	<i>N. Americanus</i>
Approximate size, mm.	Male, 10; Female, 12	Male, 8; Female, 10
Position of head	Anterior end continues in same curve as body	Anterior end strongly reflexed dorsally
Buccal capsule	Four conspicuous curved ventral teeth, one pair small teeth deep in capsule	Two ventral semilunar plates, two poorly developed dorsal plates, one median dorsal tooth, and a pair of short triangular lancets deep in capsule
Copulatory bursa	Dorsal ray divided in distal third, each division ends in three digitations (tripartite)	Dorsal ray divided at base, each division ends in two digitations (bipartite)
Copulatory spicules	Two hair-like spicules	Spicules fused at tip into a barb
Vulva	In posterior half	In anterior half

2. What is the principal factor controlling the distribution of hookworms?
3. Temperatures of 45° F. will quickly kill the eggs of which species?
4. Of the two species of hookworms of major importance to man, which is more likely to be found in the United States?
5. How does the infective stage filariform larvae of *Necator americanus* infect the human host?
6. What type of anemia is considered to be a classical symptom of hookworm disease?
7. Which of the two hookworms produces the more severe disease?
8. How does the buccal canal of *Ancylostoma* compare with *Necator*?
9. If hookworm eggs are detected when you are performing a routine fecal examination using the zinc-sulfate centrifugal flotation method, what would a count of five or less indicate?

**454. Cite the states where *Strongyloides stercoralis* is endemic, the sex of *S. stercoralis* in the parasitic stage, the two routes of development of the larvae, the manner of entry and development of the infective filariform larvae in the body, symptoms related to the disease process, method for laboratory diagnosis, and points to differentiate the rhabditoid larvae of *Strongyloides* from hookworm.**

**Strongyloides Stercoralis.** *Strongyloides*, like the hookworm, requires warm, moist soil for completion of its life cycle. In general, the distribution of *Strongyloides* parallels that of human hookworms. Its distribution pattern is much more spotty than that of the hookworms, and fewer people are infected. It is found mainly in tropical and subtropical areas. Cases are rarely reported from Europe. In the United States, *S. stercoralis* is endemic along the Gulf coast of Florida, Louisiana, Mississippi, and Alabama.

*Strongyloides stercoralis* has a rather complicated life cycle. The parasitic adults live in the mucosa of the small intestine. Eggs are passed directly into the mucosa, where they embryonate and hatch. Rhabditiform larvae reach the lumen of the intestine and are passed in the feces. Once they are passed, they may follow either a direct or indirect route of development. The indirect route of development occurs when larvae develop into free-living adult male and female worms. This usually happens when the rhabditoid larvae are deposited on warm, moist, shaded soil. The free-living adult females produce eggs, and 2 to 3 days later free-living rhabditoid larvae hatch. Within 24 hours after the eggs hatch, the rhabditoid larvae develop into infective filariform larvae. Species of *Strongyloides* which parasitize man have only one completely free-living generation, but some species that parasitize other mammals may have more than one free-living generation. The direct mode of development usually occurs when drier and cooler conditions are prevalent. Under such conditions, the free-living rhabditoid larvae that are deposited on the soil develop directly into infective filariform larvae, thus bypassing the free-living adult stage. The filariform larvae, regardless of mode of development, may live for as much as 2 weeks on the soil.

On contact, the infective filariform larvae penetrate the skin and enter the small blood vessels, through which they are carried to the lungs. In the lungs they break out of the capillaries into the air spaces and then make their way to the intestine. They enter the mucosa of the small intestine, molt twice, and mature in about 2 weeks. There are no males in the parasitic stage; there are only females. The adult female worm is parthenogenetic (produces viable eggs without fertilization by a male worm). In some cases the rhabditoid larvae transform into infective filariform larvae before they are passed from the intestine of the host. When that happens, the infective larvae penetrate the intestinal wall (autoinfection); and hyperinfection of the host occurs.

The tunneling process in the small intestine and the tissue reaction to eggs, worms, and larvae cause epigastric pain, abdominal cramps, and diarrhea. Symptoms may resemble those of peptic ulcer. Significant eosinophilia is present in about half of the cases. Patients with hyperinfection may have fever and other generalized symptoms. Severe infections, especially if associated with other debilitating conditions, can lead to death.

Diagnosis is usually made by finding the motile rhabditoid larvae (fig. 4-5) in feces or duodenal contents. The larvae are large (0.25 mm to 0.40 mm) and actively motile. You can see them easily on direct saline smears with the aid of a microscope. In suspected cases where you do not find the larvae on the direct smear, set up a Baermann apparatus (fig. 4-6). Cover a piece of filter paper with feces. Place the filter paper, feces side down, on the gauze. Fill the funnel to the level of the filter paper with water. Incubate at 37° C. to 40° C. for 1 hour. The larvae will migrate from the

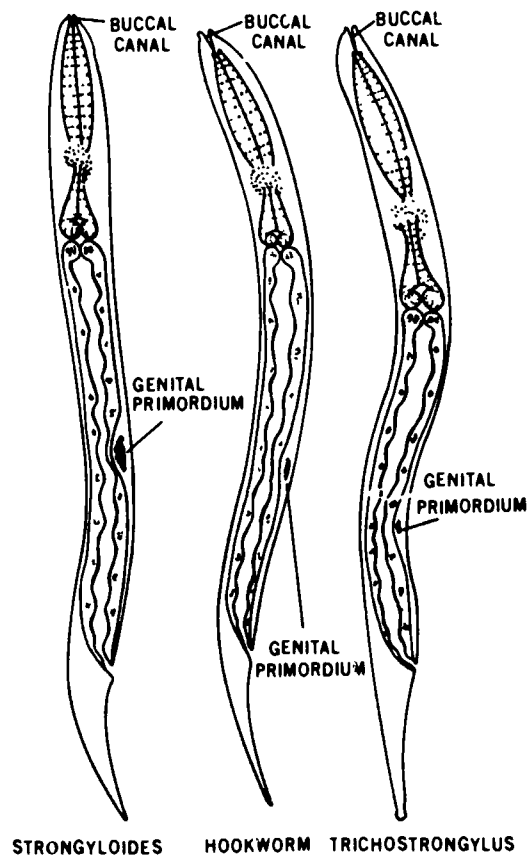

Figure 4-5 Rhabditoid larvae

feces into the water and settle to the bottom. Draw off 10 cc of water from the bottom of the funnel and centrifuge. Examine the sediment for typical larvae. Examine fecal specimens as soon after passage as possible because if hookworm eggs are present they will hatch within 24 hours and further confuse you. The rhabditoid larvae of *Strongyloides* will develop into filariform larvae in 24 hours at room temperature. On rare occasions, larvae may be found in sputum, urine, or aspirates from body cavities.

The points to be especially noted to differentiate the rhabditoid larvae of *Strongyloides* from those of the hookworms (fig. 4-5) are:

- The buccal canal of *Strongyloides* is very short, whereas that of the hookworms is longer and narrow.
- The genital primordium of *Strongyloides* is much larger than that found in the hookworms.

When examining filariform larvae (fig. 4-7), note the long, slender body shape and the relatively long esophagus, which approximately half the body length. The filariform larva of *Strongyloides* can be distinguished from a filariform larva of hookworm because *Strongyloides* has a notched tail, whereas a filariform larva of hookworm has a pointed tail.

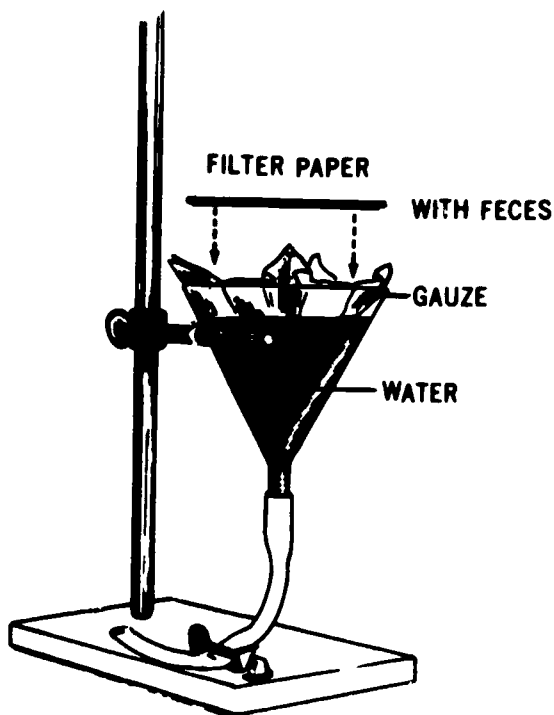

Figure 4-6 Baermann apparatus

**Exercises (454):**

1. In the United States, *Strongyloides stercoralis* is endemic in which states?
2. What is the sex of *S. stercoralis* in the parasitic stage?
3. What route of development occurs when the larvae develop into free-living adult male and female worms, which usually happens when the rhabditoid larvae are deposited on warm, moist, shaded soil?
4. The direct mode of development usually occurs under what climatic conditions?
5. How does the infective filariform larvae enter the small blood vessels?

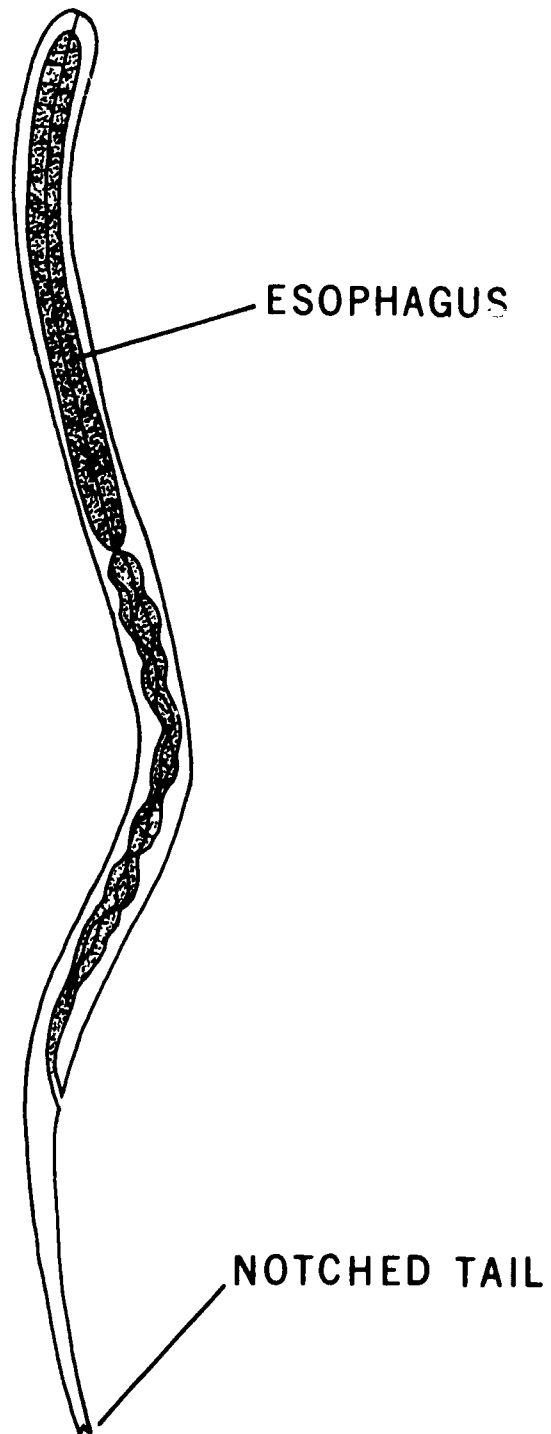

Figure 4-7. Filariform larva of *Strongyloides*.

6. What conditions cause symptoms such as epigastric pain, abdominal cramps, and diarrhea?
7. Diagnosis is usually made by finding the motile rhabditoid larvae in what two body substances?
8. List two ways that you can differentiate the rhabditoid larvae of *Strongyloides stercoralis* from those of hookworms.

455. State the principal reservoir for human infection of *Trichinella*, the type of muscle that is invaded by *Trichinella*, the infective stage of the larvae, the technique for viewing encapsulated larvae, and agglutination procedures available for the diagnosis of Trichinosis.

**Trichinella Spiralis.** *Trichinella* has a world wide distribution. The principal reservoir for human infection is the pig. As expected, the parasite is most commonly found in pork-eating populations. *Trichinella* has traditionally been a serious problem in parts of Europe and the United States until recent decades. It is still widely distributed in Germany, Poland, Spain, Hungary, and the lower Danube countries. There are still reports of small epidemic outbreaks occurring in the United States and Latin America. In the last few years there have been several outbreaks reported from Thailand.

*Trichinella* is unique among the intestinal nematodes that parasitize man. Its life cycle does not include any developmental states outside the body of a host, and it does not involve a true intermediate host. It develops about equally well in man, pigs, rats, and many other mammals. Man usually gets his *Trichinella* infections by eating uncooked portions of an infected pig, and the pig could just as readily acquire infection by eating raw garbage or feeding on carcasses and viscera of infected hogs.

The cycle in man begins when he ingests meat, usually pork, that contains infective larvae. In the small intestine, the cyst that surrounds the larvae is digested, and the larvae enter the intestinal crypts. The larvae mature very rapidly. The adults (fig. 4-8) are small white worms, just visible to the unaided eye, the male being 1.5 mm long and the female about 3.9 mm long. The male dies after mating and is passed from the intestine in a very short time. Upon fertilization, the female burrows more deeply into the intestinal mucosa, and by the 5th to 7th day begins to deposit larvae directly into the mucosa. A single female gives birth to several hundred larvae over a period of 4 to 16 weeks or more. The little larvae measure 100  $\mu\text{m}$  long and 6  $\mu\text{m}$  in diameter. They reach the mesenteric

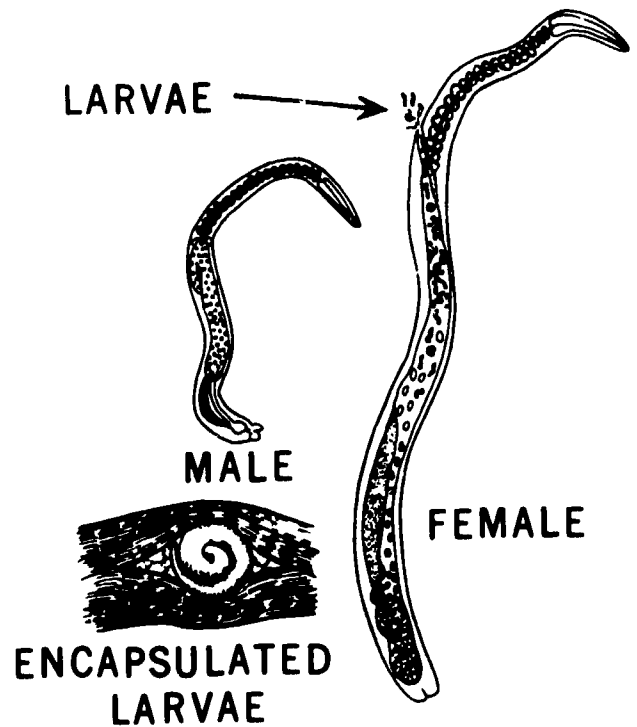

Figure 4-8. *Trichinella spiralis*

venules and lymphatics and become distributed to all parts of the body. The young larvae leave the capillaries and invade voluntary (striated) muscle. This is the only tissue in which the larvae are able to develop and grow. The muscles most frequently affected are in the diaphragm, larynx, and tongue, and the biceps, gastrocnemius, and deltoid muscles. One to two weeks after exposure, most of the larvae have reached striated muscle. About 3 weeks after exposure, the larvae in the muscles (fig. 4-8) have grown to about 1 mm in length. At this stage they have become coiled and encapsulation has begun. The larvae are infective for another host when they reach the coiled stage. Calcification of the capsule begins after about 8 weeks. In 9 to 12 months most of the encapsulated larvae are completely calcified and dead, but some may live for several years.

The severity of the disease caused by *Trichinella spiralis* is related to the number of larvae ingested. Ingestion of a small dose of larvae probably goes unrecognized. In heavier infections, as the young worms excyst and migrate into the intestinal mucosa, the patient exhibits symptoms of gastroenteritis. As the worms mature and release young larvae, acute inflammatory reactions occur around the larvae as they become temporarily trapped in capillaries of various organs during their migration through the tissues. An eosinophilia of 15 to 50 percent develops during this period. Patients with severe infections may experience symptoms affecting special muscle groups, such as painful swallowing, breathing, or chewing. In

very heavy infections, as the larvae continue to be produced and continue to invade the muscles, the outcome may be fatal; or permanent crippling of the patient may result.

A definitive diagnosis of *Trichinella* is very difficult to make in the early stages of the disease. During the very early stages, the physician has nothing to go on but the patient history. At that point the patient will have an eosinophilic leukocytosis. You can sometimes find *T. spiralis* larvae in the centrifuged sediment of hemolyzed blood during the early phases of heavy infections or in the cerebrospinal fluid when CNS involvement is present. Larvae can usually be found in suspected meat if it is still available. Compress a portion of the tissue between two glass slides before examining it with the microscope and you will be able to easily see the encapsulated larvae. If large amounts of tissue are available, digest it with gastric juices and then examine the sediment for freed *Trichinella* larvae. As the infection advances and larvae reach the muscles (7 to 14 days), it is possible to recover them from muscle biopsies. Use the compression slide technique for muscle biopsies as well as examining suspected meat. Skin test antigens are available for *Trichinella*, and the physician will occasionally use them as an aid in diagnosing the disease. Reliable agglutination procedures are available for this infection. A bentonite flocculation test and an indirect hemagglutination test have been found to be sensitive and satisfactorily specific. The tests, when performed on acute and convalescent serum, will show significant increase in titer.

#### Exercises (455):

1. What animal is the principal reservoir for human infection of *Trichinella*?
2. After the young larvae leave the capillaries, what type of muscle do they invade?
3. At what stage of development does the larvae become infective?
4. When does calcification of the encapsulated larvae begin?
5. What technique can be used for viewing the encapsulated larvae in tissue?

6. The physician has a patient who ate some raw sausage yesterday. Today the patient is experiencing bloody diarrhea and other abdominal symptoms. You are able to find many *Trichinella spiralis* larvae in some of the leftover sausage, but you cannot find any larvae in a muscle biopsy specimen from the patient. Why?
7. What two agglutination procedures are available and considered to be sensitive and adequately specific for *Trichinella spiralis* when the tests are performed on acute and convalescent serum?

#### 4-2. Filariae and Dracunculus

Filarial worms live as adults in the blood and lymphatic circulatory systems, muscles, connective tissues, and body cavities of vertebrates. *Dracunculus medinensis* is similar to the filarial worms, but they are not taxonomically related. However, it is convenient to consider them both in this section.

456. Identify the given filarial worms in terms of their appearance, behavioral characteristics and development of the microfilariae, the regions to which they are endemic, and sources of isolation.

**Filariae.** The true filarial worms are unique because they have an embryonic stage known as a microfilaria (fig. 4-9) which is deposited directly into the tissues by the females. The young embryos migrate through the tissues to the blood or lymphatic vessels, and they periodically appear in the vessels of the skin. In some species, the microfilariae retain the shell of the egg as a sheath, and in other species they actually hatch from the egg. Bloodsucking insects, while taking a blood

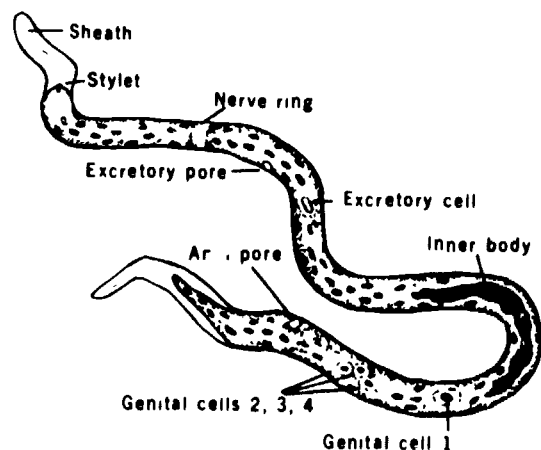

454

Figure 4-9. Microfilaria.



meal, take in some microfilariae. In appropriate bloodfeeding insects, microfilariae undergo a period of development and become infective third stage filariform larvae. When the infected insect takes another blood meal, the larvae escape from the proboscis and enter the skin through the bite wound. The larvae then require several months of development to become mature worms.

**Wuchereria Bancrofti.** *W. bancrofti* is widely distributed in most tropical areas of the world. In some of the South Pacific islands and parts of India the parasite is endemic; however, in most of the areas where the worm is widespread, relatively few individuals are infected. Man is the only known host.

*W. bancrofti* is a small, thread-like worm (fig. 4-10). The males measure about 4 centimeters long and the females about 8 centimeters long. The adults usually live in lymph nodes and lymphatic vessels in the groin and external genitalia. The microfilariae commonly circulate in peripheral blood only at night (nocturnal periodicity). Strains of the parasite from the South Pacific islands demonstrate practically no periodicity. The parasite is transmitted by many species of culicine and anopheline mosquitoes.

In the early stages of infection there are periods of fever, pain, and some swelling of the lymph nodes and lymph channels. In chronic cases, the lymph vessels become obstructed; and extensive growth of connective tissue develops in the groin, external genitalia, and legs, producing disfigurement (elephantiasis). Only a small percentage of acute cases continue to the chronic stage of elephantiasis.

The demonstration of microfilariae or adult worms is the only proof of filariasis. Techniques for demonstrating microfilariae of *W. bancrofti* in blood specimens also apply to other filariae whose microfilariae circulate in the blood. A careful search for microfilariae should always be made when filariasis is suspected, and examinations should be repeated at intervals. Microfilariae of *W. bancrofti* may be found in preparations of blood as aspirated contents of lymph nodes or hydroceles or in chylous urine. In areas

where *W. bancrofti* demonstrates nocturnal periodicity, microfilariae are most readily detected in blood taken at night. In the South Pacific Islands, the nonperiodic microfilariae may be slightly more numerous in the daytime than at night.

In well-established infections, microfilariae may be seen microscopically, thrashing about in a drop of fresh blood. You should mix one drop of blood with one or two drops of physiological saline on a glass slide; spread the preparation and cover it with a 22 x 50 mm coverslip. Use the low power objective for scanning the slide. Wet preparations are good to use for screening purposes. When you find microfilariae, prepare thick or thin stained blood smears to identify the species. It may be necessary, particularly in new infections, to use one of the concentration methods to detect microfilariae. The Knott technique is most commonly employed. The procedure is very simple and effective. Withdraw 2 cc of blood from a vein and dilute it in 10 cc of 2 percent formalin. Mix in a 15 cc centrifuge tube, centrifuge for 5 minutes at 2,000 rpm, decant the supernatant, and examine the sediment for microfilariae. You can spread, dry, fix, and stain the sediment with Giemsa as you did the thick or thin blood smears. Table 4-3 and figure 4-11 give the information necessary to identify the species in stained films. The demonstration of adult worms in lymph node biopsies gives verification of the clinical diagnosis even in the absence of microfilariae. Biopsies are not recommended as a routine diagnostic procedure. In the event that biopsies are taken, they should be studied by a trained pathologist and parasitologist.

Other laboratory studies are sometimes helpful in filariasis. Leukocytosis and eosinophilia may be present, but they are not specific. Immunological tests of all kinds have been employed, but skin tests and complement-fixation tests have received the most attention. The antigens usually employed are derived from *Dirofilaria immitis*, a filariid which occurs in dogs. The tests are not species specific, and the techniques have not been standardized; however, results of these tests may be helpful in conjunction with other findings. They are especially useful when testing large groups of patients as in surveys. They require very critical evaluation in individual cases.

**Brugia Malayi.** *B. malayi* is found in Southeast Asia. Its range extends from Ceylon northward into India and from Indonesia and Borneo through Malaya and Thailand to South Korea. *Brugia malayi* occurs naturally in cats and monkeys, as well as man. The adult parasites live in lymph nodes and vessels and produce the same type of symptoms and disease as *Wuchereria bancrofti*. *B. malayi* adults and microfilariae are very similar to *Wuchereria bancrofti*, but they differ sufficiently to be assigned to two different genera. Adult *B. malayi* are about half as large as *W. bancrofti*. The microfilariae of both species (table 4-3 and fig. 4-11) are sheathed. *B. malayi* microfilariae have two cells in the tip of the tail which are not present in *W. bancrofti*. The microfilariae of *B.*

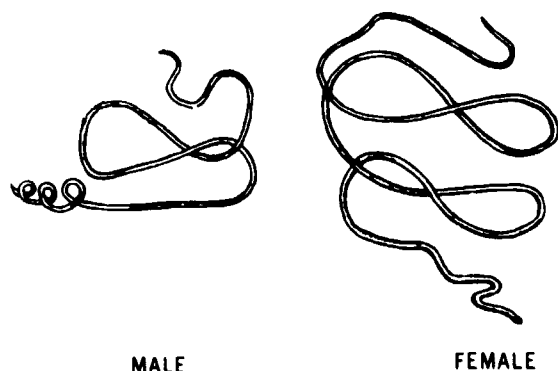

Figure 4-10. *Wuchereria bancrofti*.



# MICROFILARIAE

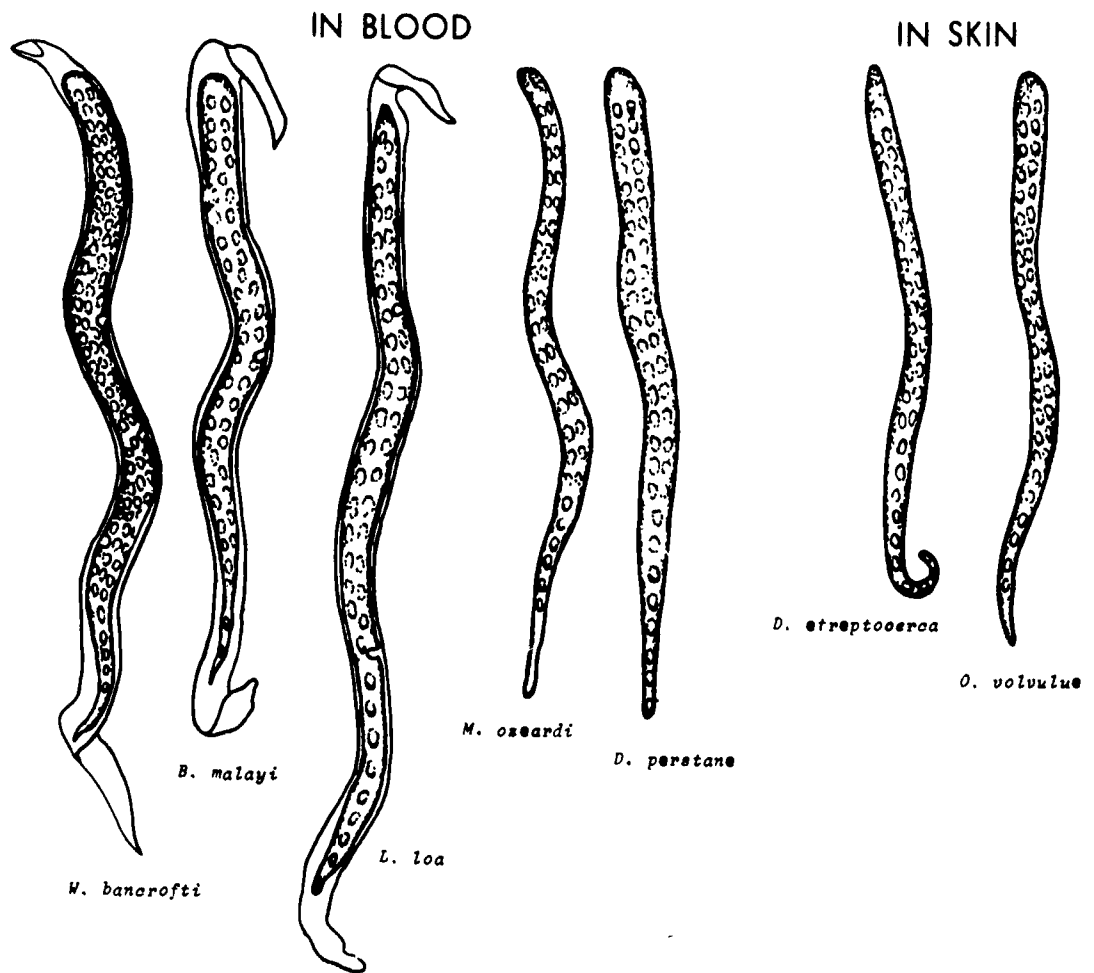

Figure 4-11. Microfilariae.

**TABLE 4-3**  
CHARACTERISTICS OF MICROFILARIAE

SPECIES	FOUND IN	LENGTH (IN MICRONS)	PERIODICITY	SHEATH	TAIL MORPHOLOGY
<i>W. bancrofti</i>	Blood	245-295	Usually Nocturnal	Present	Tapers to delicate point; Nuclei do not extend to tip of tail.
<i>B. malayi</i>	Blood	177-230	Nocturnal	Present	Tapers to delicate point; Two terminal nuclei.
<i>L. loa</i>	Blood	250-300	Diurnal	Present	Tapers gradually; Nuclei continuous into tail.
<i>M. oesardi</i>	Blood	185-200	None	Absent	Tapers gradually; Nuclei do not extend to tip of tail.
<i>D. perstans</i>	Blood	190-200	None	Absent	Tapers gradually; Bluntly rounded; nuclei to tip of tail.
<i>D. streptocera</i>	Skin	180-240	None	Absent	Slender hooked tail; Bluntly rounded; nuclei to tip of tail.
<i>O. volvulus</i>	Skin	150-287 or 285-368	None	Absent	Tapers gradually; Nuclei do not extend to tip of tail.

*malayi* usually exhibit nocturnal periodicity just as those of *W. bancrofti* do, but the periodicity does not appear to be as strong in some areas.

**Loa Loa.** *Loa loa* is commonly known as the eye worm or missionary worm. It is found in central and western Africa. The principal endemic areas lie on the coastal plains from Sierra Leone to Angola and along the watersheds of main rivers. They are medium sized worms (males 30 to 35 mm long and females 50 to 70 mm long) that inhabit subcutaneous tissues of humans. As the worms migrate around in the subcutaneous tissues, calabar swellings appear and remain for 2 to 3 days. The painful swellings are believed to be allergic responses to the worms. On occasions, adult worms migrate beneath the conjunctiva of the eye. The parasite causes no serious damage to the host, but it is rather disturbing for a worm to migrate across the eye.

Flies of the genus *Chrysops* are the intermediate hosts of *Loa loa*. You probably know them as tabanid or deer flies. They usually bite man between dawn and dusk—the same time that the microfilariae of *Loa loa* are found in the peripheral circulation. The appearance of microfilariae in the peripheral circulation only during the daytime is called *diurnal* periodicity. The microfilariae (table 4-3 and fig. 4-11) are sheathed and have a core of nucleated cells that extends without interruption into the tip of the tail. When you are unable to find microfilariae in suspected cases, the patient should be skin tested with a filarial antigen. An immediate positive reaction will almost always occur in people who have the parasite.

**Onchocerca Volvulus.** *Onchocerca volvulus* has a very irregular distribution in the African and American tropics. It is not endemic in coastal areas. The principal endemic foci in Africa are inland, along river courses, whereas in Central and South America the disease is confined to coffee plantations at elevations of 1,000 to 3,500 feet. The adult worms are quite long and slender (males 19 to 42 mm long by 130 to 210 mm, females 335 to 500 mm long by 270 to 400 mm). They usually live in pairs in subcutaneous nodules. The nodules may occur on any part of the body. In Africa the nodules frequently occur over any bony prominences of the body, whereas in Central and South America they are found more frequently on the head or scalp. The microfilariae are not sheathed. The microfilariae of *Onchocerca* remain in the superficial lymphatic spaces and connective tissues of the skin after they escape from the nodules. They rarely, if ever, get into the bloodstream.

The insect intermediate hosts belong to the genus *Simulium*, commonly known as black flies. Members of the genus *Simulium* are blood suckers, but they have chewing mouthparts. To take a blood meal, they chew a hole in the skin to the capillary bed. They lap up the blood, and at the same time, the tissue juices which contain the microfilariae of *O. volvulus*.

The nodules of *Onchocerca volvulus* cause little or no inconvenience. As the microfilariae migrate about through the skin, sensitization reactions occur. In addition to itching, the skin becomes dry, wrinkled, rough, and shining. Eventually the skin thickens and loses its elasticity. In some areas there is a very high incidence of blindness among people who have *Onchocerca volvulus* infections. Blindness is a result of the damage caused by microfilariae migrating through the eye.

The microfilariae (table 4-3 and fig. 4-11) do not enter the bloodstream; therefore, you cannot find them by examining blood smears, not even with concentration methods. Since the microfilariae are in the skin, the examination of skin snips is the most practical diagnostic measure. Remove a thin skin shaving about 0.5 cm in diameter with a razor blade, tease the specimen apart in a drop of saline, and examine it microscopically for microfilariae. Excised nodules should be examined for microfilariae and adult worms.

**Dipetalonema (Acanthocheilonema) Perstans.** *Dipetalonema perstans* is quite common in the tropical regions of western and central tropical Africa and northern South America. It apparently is a harmless parasite that lives in body cavities. Biting gnats belonging to the genus *Culicoides* serve as intermediate hosts. The microfilariae (table 4-3 and fig. 4-11) circulate in the peripheral blood. You will have to differentiate them from the microfilariae of the more harmful species.

**Dipetalonema (Acanthocheilonema) Streptocerca.** *Dipetalonema streptocerca* is common in the same areas as *Onchocerca volvulus*. Species of *Culicoides* serve as intermediate hosts for this parasite. Adult worms live in cutaneous connective tissue, and the microfilariae found in the skin are similar to the microfilariae of *O. volvulus*. The microfilariae (table 4-3 and fig. 4-11) of *D. streptocerca* are most frequently found in skin snips, but you must make the snip deep enough to include dermal tissue. Most infected persons are symptomless, but they may have some cutaneous edema and disfigurement.

**Mansonella Ozzardi.** *M. ozzardi* occurs only in Central America, South America, and the West Indies. Species of the genus *Culicoides* and possibly species of the genus *Simulium* serve as intermediate hosts. The adult worms live in body cavities and apparently cause no harm. The microfilariae (table 3-4 and fig. 4-11) are recovered from peripheral blood.

#### Exercise (456):

1. Match each column B item with the statements in column A by placing the letter of the column B item beside the number of the column A item that most nearly describes it. Each element in column B may be used once, more than once, or not at all.

Column A

- (1) Is endemic in some South Pacific Islands and parts of India.
- (2) The adult worms usually live in lymph nodes and lymphatic vessels.
- (3) Transmitted by many species of culicine and anopheline mosquitoes.
- (4) Is found in Southeast Asia; this range extends from Ceylon northward into India and from Indonesia and Borneo through Malaya and Thailand to South Korea.
- (5) Microfilariae may be found in preparations of blood or aspirated contents of lymph nodes or hydroceles or chylous urine.
- (6) In this technique 2 cc of blood is withdrawn from the vein and diluted in 10 cc of 2 percent formalin.
- (7) The antigens are derived from this filarid which occurs in dogs and is used in the complement-fixation test.
- (8) The microfilariae have two cells at the tip of the tail which are not present in *Wuchereria bancrofti*.
- (9) Is commonly known as the eye worm or missionary worm.
- (10) The microfilariae appear in the peripheral circulation mainly during the daytime.
- (11) They usually live in pairs in subcutaneous nodules.
- (12) They remain in the superficial lymphatic spaces and connective tissue of the skin after they escape from the nodules.
- (13) The examination of skin snips is the most practical diagnostic measure for this microfilariae.
- (14) Is apparently a harmless parasite that lives in the body cavities and biting gnats belonging to the genus *Culicoides* serve as intermediate hosts.
- (15) Adult worms live in cutaneous connective tissue and the

Column B

- a. *Wuchereria bancrofti*
- b. *Dirofilaria immitis*
- c. *Mansonella ozzardi*
- d. *Dipetalonema persians*
- e. *Loa loa*
- f. *Onchocerca volvulus*
- g. *Brugia malayi*
- h. *Dipetalonema streptocerca*
- i. Knott's technique
- j. Baermann's technique

Column B

- microfilariae found in the skin are similar to the microfilariae of *O. volvulus*.
- (16) Occurs only in Central America, South America, and the West Indies.
- (17) In the microfilariae commonly circulate the peripheral blood only at night (*nocturnal periodicity*).

457. State the comparative size of the adult female *Dracunculus medinensis* and the filarial worms, the body sites of the adult female, the effect of the larvae on the skin, the intermediate host, manner in which people become infected, and the method of positive diagnosis.

**Dracunculus Medinensis.** *Dracunculus medinensis*, known as the guinea worm or fiery serpent, is found in man throughout tropical Africa and especially in much of the Middle East. It has been reported from horses, cattle, leopards, polecats, and monkeys from the endemic areas. It is found in furbearing animals in North America and dogs in China.

*Dracunculus* is similar to the filarial worms but there are fundamental differences. The adult female *Dracunculus* is much larger than the filarial worms. *Dracunculus* females pass first stage rhabdoid larvae rather than pre-larval embryos (microfilariae). The larvae are passed from the host and do not get into the skin or into the circulatory system of the host.

The adult female *Dracunculus* lives in the subcutaneous tissues, usually on the arms or legs of man. When ready to release larvae, the female causes a blister to form in the skin of the host. A loop of the uterus of the worm lies very near the blister, and when the blister comes in contact with water in a stream, lake or pond, the blister bursts. The uterus then prolapses and ruptures, releasing large numbers of larvae into the water. The larvae must be ingested by copepods belonging to the genus *Cyclops*, which serve as intermediate host. In the copod the larvae develop to infective third stage larvae in about 3 weeks.

People become infected with *Dracunculus* by drinking water that contains the minute infected *Cyclops*. When the infected *Cyclops* reaches the intestine, the larvae are freed as the copepod is digested. The larvae make their way through the intestinal wall and into the body cavity. There they develop to maturity in 8 to 12 months. The cycle is completed when the female becomes gravid and migrates to the subcutaneous tissues.

As the adult female migrates to the subcutaneous tissues, there may be pronounced allergic reactions such as skin rashes, nausea, vomiting, and diarrhea. After the female worm reaches the skin and the blister ruptures, there is a good chance for a secondary bacterial infection in the worm channel.

A positive diagnosis cannot be made until the worm forms a blister on the skin. At times, you may demonstrate the larvae by placing the blister in contact with water and allowing it to rupture. Of course, you can make a specific diagnosis as soon as you find the worm protruding from the subcutaneous channel.

#### Exercises (457):

1. What is the comparative size of the adult female *Dracunculus medinensis* and the filarial worms?
2. In what type tissues and body sites is the adult female *Dracunculus* usually found?
3. When the larvae is ready to be released from the tissues, what skin condition is caused by the female?
4. If a patient has blisters on the skin that are suspected to be caused by *Dracunculus medinensis*, how can the larvae be demonstrated?
5. How do people become infected with *Dracunculus*?
6. When can you make a specific diagnosis of infection with *Dracunculus*?

#### 4-3. Zoonotic Nematodes

Parasite infections that are maintained at more or less stable rates in wild and domestic animal populations are said to be enzootic. When a human is infected with an animal parasite, it is known as a zoonotic infection. They are only incidental parasites of humans. Some have limited geographical distributions, whereas others are quite widespread. The possibility that military operations may extend into areas where personnel incur a greater risk of exposure to zoonotic infections is ever present. Furthermore, the military medical service is often called upon to provide medical care for native populations. Your knowledge of these parasites and the various tools of diagnosis will be a great help to physicians who must diagnose and treat patients with zoonotic infections.

Four categories were established to show the relationships that exist among various zoonotic helminth infections:

a. Category I: Humans are normal and adequate, though unnatural *final* hosts.

b. Category II: Humans are more or less normal, but inadequate, *final* hosts.

c. Category III: Humans are more or less normal, but unnatural, *paratenic* hosts.

d. Category IV: Humans are more or less normal, but unnatural, *intermediate* hosts.

The first three of these categories are used here to organize the zoonotic nematode infections which make up this section. None of the nematodes discussed in this section fits Category IV, which applies mainly to larval tapeworms.

458. Identify given nematodes in terms of the type pathogen, animal sources, mode of transmission, diseases caused, comparison of the eggs and physical characteristics of the organisms with other known organisms, and the method of diagnosis.

**Category I.** The first category includes parasites for which humans are normal and adequate, though unnatural, final hosts. The nematodes of this group develop and behave in man essentially as they do in their natural hosts. Some of the nematodes in this group are very common and are of considerable importance in certain localities. *Capillaria philippinensis* was identified in 1963 as a parasite of humans in the Philippines. The organism's appearance as a human pathogen was sudden and unexpected. Appearing as a zoonotic disease, it was readily transmitted between humans by fecal contamination.

*Capillaria philippinensis.* *C. philippinensis* is the only intestinal capillariid known to parasitize man. As the name indicates, this parasite is found in the Philippines. Several thousand cases have been reported since the parasite was first discovered in 1963. All cases reported to date have been from the Philippines.

The small adult worm (less than 5 mm long) is found imbedded in the mucosa near the junction of the large and small intestines. The eggs are very similar to those of *Trichuris trichiura*; therefore, it will be necessary to measure the eggs to differentiate the two parasites. The eggs of *T. trichiura* measure 50 to 54 by 22.5  $\mu\text{m}$  whereas those of *C. philippinensis* measure about 36 to 45 by 21  $\mu\text{m}$ .

Thus far, none of the details of the life cycle of *C. philippinensis* have been reported. A large percentage of the people infected with this parasite have very severe symptoms, and many deaths have been attributed to infection with *C. philippinensis*. Many of the patients have been weak and very emaciated when first seen for treatment. Intractable diarrhea has been a common symptom.

*Capillaria hepatica.* *C. hepatica* is a delicate, threadlike parasite that lives in the parenchyma of the liver of mammals, especially rodents. The female worms pass eggs directly into the liver tissues, causing fibrosis. As the worms and eggs accumulate in the liver,

considerable damage results. To make a positive diagnosis, a liver biopsy must be performed to recover the worm or the typical eggs. Morphologically the eggs (fig. 4-12) are similar to those of *T. trichiura*. They measure 51 to 61 by 30 to 35  $\mu\text{m}$  which is slightly larger than those of *T. trichiura*. The eggs of *C. hepatica* are more barrel-shaped, and the shells appear velvety, because they are finely pitted with minute pores. You may occasionally find these eggs in the feces of human patients. Do not confuse them with *T. trichiura*. The presence of the eggs in feces does not mean that the patient has *C. hepatica*; it only means that the patient has recently eaten infected liver. The eggs of *C. hepatica* are not infective until they have undergone a period of embryonation in damp, shaded soil. Mammals become infected when they ingest infective eggs.

*Ancylostoma ceylanicum*. *A. ceylanicum* is a hookworm that normally parasitizes dogs and cats in Southeast Asia and Brazil. In some areas, it is a more common parasite of humans than the other hookworms. The adult parasites are about 30 percent smaller than *A. duodenale*, and the buccal cavity and bursa are characteristic for the species. The larval stages are very similar to those of *A. duodenale*, and the eggs are indistinguishable from the other hookworm eggs.

*Ternidens deminutus*. The natives of Southern Rhodesia, Malawi, and Mozambique are commonly infected with *T. deminutus*. The parasite resembles a hookworm, but the buccal capsule is terminally located, and the buccal cavity is guarded on the inside of a double row of stiff bristles. The worms attach themselves by inserting their heads into the intestinal wall. Eggs are passed in feces and hatch in the soil. After a period of development, the larvae become infective. Infection occurs when infective, third stage larvae are ingested. The eggs of *Ternidens* can be distinguished from hookworm eggs only because they are larger. *Ternidens* eggs average 84 to 51  $\mu\text{m}$ , whereas hookworm eggs may be as large as 70 by 40  $\mu\text{m}$ . You should not confuse *Ternidens* with hookworms, because the usual forms of hookworm treatment are only moderately effective against *Ternidens*.

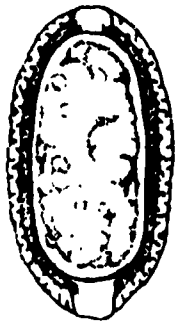

Figure 4-12. Egg of *Capillaria hepatica*.

*Syngamus*. Members of the genus *Syngamus* are small nematodes that live in the respiratory tract of birds and mammals. The males and females are permanently joined together for mating. Man is an incidental host for *S. laryngeus* and possibly *S. nasicola*. Human infections have been reported from Puerto Rico, Brazil, the West Indies, and the Philippines. The adult worms irritate the upper respiratory tract, causing coughing, sneezing, and an asthma-like condition. Diagnosis is made by finding the adult worms or eggs in sputum or feces. The eggs are ovoidal, and the shell appears to be made up of a large number of prisms cemented together. Be aware of these parasites, and do not confuse the eggs with pollen grains that are commonly observed in sputum and feces.

*Trichostrongylus*. Members of the genus *Trichostrongylus* are typically found in ruminants, attached to the small intestine. They are considered incidental parasites of man; however, *T. orientalis* is more commonly found in man than in other animals in Japan and Korea. *Trichostrongyles* are found in man in many areas of the world, including Africa, Iran, Iraq, India, Armenia, Siberia, Indonesia, Japan, Korea, China, Formosa, Australia, and (rarely) the United States.

Eggs are passed in feces. They require moisture, warm temperature, shade, and grass or carpet vegetation for proper development. Rhabditoid larvae hatch in the grass, and after a period of development they become infective. The larvae cannot infect a host by penetrating the skin; they must be ingested. Contaminated green vegetables are the main source of infection. The larvae burrow into the intestinal wall, and a few days later they re-emerge without making a lung migration. They attach themselves by inserting the anterior part of their body into the intestinal wall, where they remain to develop to maturity. Infections usually consist of only a few worms, but heavy infections can occur. The usual infections cause no symptoms, but heavy infections cause symptoms similar to hookworm disease.

Diagnosis is based on finding characteristic eggs in stool specimens. The eggs are also very similar to those of hookworms. They are larger than hookworm eggs, and they are more pointed at one end. To confirm the diagnosis, it is necessary to measure the eggs.

*Trichostrongylus* eggs measure 70 to 90 by 40 to 50  $\mu\text{m}$ , whereas hookworm eggs measure up to 70 by 40  $\mu\text{m}$ . You can cultivate eggs and identify the larvae. The first and second stage larvae are rhabditoid. They are similar to the rhabditoid larvae of hookworms, but they can be readily distinguished because they have a minute beadlike knob at the tip of the tail (fig. 4-5). You should make every effort to properly identify the parasite because *Trichostrongylus* does not respond to the usual hookworm treatments.

*Thelazia*. Two species of the genus *Thelazia* have been reported from the conjunctival sac of man. *Thelazia callipaeda* has been reported from several oriental countries. *Thelazia californiensis* has been



reported from the western states of the United States. These parasites normally inhabit the conjunctival sac of dogs and other mammals. They are only incidental parasites of man. The worms measure about 4.5 mm by 0.25 to 0.85 mm. Females produce clear, thin shelled embryonated eggs which measure 57 by 35  $\mu\text{m}$ . Certain species of flies serve as intermediate hosts. The worms have a rough cuticle which causes considerable damage to the tissues of the eye as they crawl back and forth across the front of the eye. Diagnosis depends upon the identification of the worm after it is removed from the eye.

*Physaloptera*. *Physaloptera caucasica* is the only species of the genus *Physaloptera* that is known to parasitize man. It is a natural parasite of the intestinal tract of some monkeys. It has been reported to be found in man in the Caucasus, tropical Africa, Southern Rhodesia, India, Panama, and Columbia. The adults are found attached to the walls of the esophagus, stomach, and small intestine. If you do not examine them carefully, you may confuse them with *Ascaris*. The eggs have thick, smooth shells; and they are fully embryonated when passed in the feces. They measure 44 to 65  $\mu\text{m}$ , by 32 to 45  $\mu\text{m}$ . Infertile *Physaloptera* eggs resemble fetid decorticated *Ascaris* eggs; however, fertile *Physaloptera* eggs contain a fully developed larva, whereas the eggs of *Ascaris* never contain a larva when passed in feces. Examine several eggs to properly differentiate the two.

*Diocotophyma renale*. *Diocotophyma*, commonly known as the giant kidney worm, is widely distributed throughout the world. It is primarily a parasite of fish-eating carnivores, but is occasionally found in horses, cattle, and humans. *Diocotophyma* adults are very large, reddish nematodes which inhabit and destroy the parenchyma of the kidney. Males measure from 150 to 400 mm long, and females measure up to 1,000 mm long. Females pass eggs that are unembryonated, dirty brown in color, have deep pittings in the shell except at the poles, and measure 64 to 68  $\mu\text{m}$  by 40 to 44  $\mu\text{m}$ . Diagnosis is made by finding typical eggs in urine.

*Gongylonema pulchrum*. *G. pulchrum* inhabits the mucosa of the esophagus of ruminants. It has also been found in pigs, bears, hedgehogs, monkeys, and occasionally in man. The parasite has been reported from most areas of the world. In man the worm has been found in the mucosa and subdermal connective tissues in the vicinity of the mouth, not the esophagus. It produces local irritation and inflammation. The adult worms are threadlike, and the females are larger than the males. They may measure up to 145 mm long. The females lay fully embryonated eggs which are transparent, thickshelled, broadly ovoidal, and measure 50 to 70  $\mu\text{m}$  by 25 to 37  $\mu\text{m}$ . Various species of dung beetles and cockroaches serve as intermediate hosts. The definitive host is infected by swallowing an infected insect.

*Acanthocephala*. *Acanthocephala* is the phylum commonly known as thorny-headed worms. They are not nematodes, but they are included here for the sake

of convenience. They are parasites of the intestinal wall tract of vertebrates. They firmly attach themselves to the intestinal wall by a retractable proboscis that is covered with hooks. The worms are not segmented; they have no digestive tract, and the sexes are separate. Species of this phylum require an intermediate host to complete their life cycles. *Macracanthorhynchus hirudinaceus*, normally a parasite of pigs, and *Moniliformis moniliformis*, normally a parasite of rodents, are the only two species of the phylum that have been reported in man. Reports of these parasites in man have been rare.

#### Exercise (458):

- Match each column B item with the statements in column A by placing the letter of the column B item beside the number of the column A item that most nearly describes it. Each element in column B may be used once, more than once, or not at all.

Column A	Column B
— (1) The only intestinal capillariid known to parasitize man.	a. <i>Capillaria philippinensis</i>
— (2) The eggs are very similar to those of <i>Trichuris trichiura</i> .	b. <i>Diocotophyma renale</i>
— (3) Is a delicate threadlike parasite that lives in the parenchyma of the liver of mammals, especially of rodents.	c. <i>Acanthocephala</i>
— (4) The female worms pass eggs directly into the liver tissues, causing fibrosis.	d. <i>Gongylonema pulchrum</i>
— (5) When compared to the eggs of <i>Trichuris trichiura</i> , they are more barrel-shaped, and the shells appear velvety, because they are finely pitted with minute pores.	e. <i>Thelazia callipaeda</i>
— (6) When the eggs are present in the feces, the patient is more likely to be infected with this capillariid.	f. <i>Capillaria hepatica</i>
— (7) A hookworm that normally parasitizes dogs and cats in Southeast Asia and Brazil.	g. <i>Anclostoma ceylanicum</i>
— (8) Can be differentiated from <i>Ancylostoma duodenale</i> in the adult stage.	h. <i>Syngamus laryngeus</i>
— (9) The males and females of this nematode are permanently joined together for mating.	i. <i>Trichostrongylus orientalis</i>
— (10) The eggs of this nematode can be confused with pollen grains that are observed in sputum and feces.	j. <i>Strongyloides</i>
	k. <i>Ternidens deminutus</i>
	l. <i>Physaloptera caucasica</i>
	m. <i>Macracanthorhynchus hirudinaceus</i>



Column B

- (11) These eggs are very similar to those of hookworms; they are larger than hookworm eggs, and more pointed at one end.
- (12) The rhabditoid larvae can be distinguished from hookworm because they have a minute, beadlike knob at the tip of the tail.
- (13) This parasite normally inhabits the conjunctival sac of dogs and other mammals and are incidental parasites of man.
- (14) A natural parasite of the intestinal tract of some monkeys.
- (15) The infertile eggs of this parasite resembles fertile *Ascaris* eggs.
- (16) The fertile egg of this parasite contains a fully developed larva, whereas the eggs of *Ascaris* never contain a larva when passed in the feces.
- (17) The buccal capsule is terminally located, and the buccal cavity is guarded on the inside by a double row of stiff bristles.
- (18) Commonly known as the giant kidney worm, and is primarily a parasite of fish-eating carnivores.
- (19) Diagnosis is made by finding typical eggs in urine.
- (20) The mucosa and subdermal connective tissues in the vicinity of the mouth may be infected with this parasite.
- (21) The phylum commonly known as the thorny-headed worms
- (22) Is normally a parasite of pigs.

459. Identify the nematodes in the given category in terms of their definitive hosts, intermediate hosts, sources in identification, disease caused, and the manner in which man becomes infected.

Category II. In the second category, humans are more or less normal, but inadequate, final hosts. Some nematodes that usually infect other animals can infect humans, but they do not complete their normal development. The parasites behave and develop in

humans just as they do in natural final hosts until certain stages are reached. Most of these parasites are stymied in their development before they begin to deposit reproductive products. They usually lose their way and end up in abnormal sites in humans. These factors make it very difficult to arrive at a proper diagnosis.

*Dirofilaria D. immitis* is the heartworm of dogs. It is a common parasite of dogs throughout most of the tropical and subtropical areas of the world. *D. immitis* utilizes mosquitoes as intermediate hosts. The parasite has occasionally been found encapsulated in the lung of humans. They have been found on radiographic examinations as coin lesions which required surgery to rule out a malignancy. Many of the worms have been found to be sexually mature, but no microfilariae of *D. immitis* have been found in the blood of humans. Skin tests and complement-fixation tests employing *Dirofilaria* antigens may be useful in cases where typical coin lesions are discovered.

There is another group of *Dirofilaria* that are found in tumors and abscesses in the subcutaneous tissues and tissues of the eyes of humans. They have been reported from most areas of the world. The worms collectively referred to as *Dirofilaria "conjunctivae."* As with *D. immitis* in humans, *D. conjunctivae* often reaches sexual maturity; however, they rarely produce microfilariae, and the microfilariae are not found in the blood of humans. The various species of *Dirofilaria* that cause these infections in man are normally common parasites of the native animals of the particular area.

*Angiostrongylus cantonensis. A. cantonensis* is normally a parasite that is found in the lungs of rats. It is enzootic in most areas of the Pacific. Snails, planarians, shrimp, and many other invertebrates serve as intermediate hosts. The intermediate hosts ingest the eggs of the parasite that are passed in the feces of the rat. Larvae hatch from the eggs and develop to the infective stage in the intermediate host. Rats eat the snails, releasing the larvae. The larvae make a peculiar migration during which they go to the brain for a period of development before they go to the lungs. Humans become infected in the same manner as rats, but the worms do not complete their migration to the lungs. They remain in the brain and spinal column, causing a disease known as *eosinophilic meningitis*. The worms develop to the adult stage in man, but they do not reach full maturity. Man is frequently infected in many of the Pacific islands, Vietnam, and Thailand. People who are infected have very severe headaches and other neurological symptoms. The spinal fluid is usually loaded with eosinophils. Occasionally, immature worms are also recovered from the spinal fluid. There are other helminths that sometimes cause a similar syndrome; but in the areas where *A. cantonensis* is common among rats, it is the most frequent cause of eosinophilic meningitis in man. A skin test utilizing antigen made from the worm may be helpful in making a diagnosis.

**Anisakis.** *Anisakis* is a member of the *Ascaris* group. It is normally a parasite of fish-eating marine mammals. Little is known of the life history of the parasite, but it is thought that marine cephalopods serve as intermediate hosts and that marine fishes serve as paratenic hosts. Man becomes infected by eating insufficiently cooked marine fish. In man the larvae develop very little, but they burrow into the mucosa of the stomach or intestine. *Anisakis* infections are usually mistaken for peptic ulcers or malignant tumors. The parasite is most commonly reported in man from Japan. It is occasionally reported from Europe. You can expect to encounter *Anisakis* in any area where uncooked marine fishes are eaten.

**Logocheilascaris.** *Logocheilascaris minor* is normally parasite of the intestinal tract of the cloudy leopard (feline). It has been reported to inhabit the tissues of the neck near the jaw, the nasal passages, and the maxillary sinuses of man. *L. minor* develops to maturity in man and even passes eggs which closely resemble *Toxocara* eggs. The worms are usually associated with a large abscess. You can recover both worms and eggs from the abscess exudates. The life cycle of the small worms (male 9 mm long; female 15 mm long) has not been worked out. Human infections have been reported from Tobago, Trinidad, and Surinam.

**Exercise (459):**

- Match each column B item to the statements in column A by placing the letter of the column B item beside the number of the column A item that most nearly describes it. Each element in column B may be used once, more than once, or not at all.

**Column A**

- (1) Is the heartworm of dogs
- (2) This parasite has occasionally been found encapsulated in the lungs of human.
- (3) They rarely produce microfilariae, and the microfilariae are not found in the blood of humans.
- (4) Normally a parasite that is found in the lungs of rats.
- (5) Snails, planarians, shrimp, and many other invertebrates serve as intermediate hosts.
- (6) Human becomes infected with this parasite in the same manner as the rat
- (7) Is a member of the *Ascaris* group and is normally a parasite of fish-eating marine mammals
- (8) These worms do not complete their migra-

**Column B**

- a *Anisakis*
- b *Toxocara*
- c *Dirofilaria immitis*
- d *Logocheilascaris minor*
- e *Angiostrongylus cantonensis*

**Column A**

tion to the lungs, they remain in the brain and spinal column, causing a disease known as *eosinophilic meningitis*.

- (9) In man the larvae develop very little, but they burrow into the mucosa of the stomach or intestine.
- (10) Normally a parasite of the intestinal tract of the cloudy leopard (feline).
- (11) Has been reported to inhabit the tissues of the neck near the jaw, the nasal passages, and the maxillary sinuses of man.
- (12) Develops to maturity in man and even passes eggs which closely resemble *Toxocara*

**460. Identify the organisms in the given category in terms of the type of host, normal habitat, method of identification, distinctive features, and diagnostic symptoms.**

**Category III.** In this type of infection, humans are more or less normal, but unnatural paratenic hosts. A paratenic host is a special type of transport host in which infective stage larvae persist without essential development and usually without growth. One parasitologist has proposed the term "paratenesis" to describe the various forms of transport involving paratenic hosts. These include transport through a series of paratenic hosts; transport through one or a series of paratenic hosts towards the final host; and transport from host to host, which preserves the infective larva from season-to-season (transport across time as well as across space).

***Gnathostoma spinigerum.*** *G. spinigerum* is a parasite that lives in tumors within the walls of the stomachs of dogs, cats, and certain wild carnivores. The parasite is found in animals in Southeast Asia, Japan, China, India, Indonesia, parts of Europe, and Australia. Most human cases have been reported from Thailand.

Copepods serve as intermediate hosts. Coldblooded vertebrates, fish-eating birds, and mammals other than final hosts serve as paratenic hosts. Final hosts become infected when they ingest infected copepods or infected paratenic hosts. Paratenic hosts, including man, become infected when they ingest infected copepods or other infected paratenic hosts. The larva can pass through several paratenic hosts before it reaches a final host. In paratenic hosts, the parasite remains in a larval stage and becomes encapsulated in muscle tissue rather than maturing and migrating to the stomach wall.

The migrating larvae produce a kind of creeping eruption and occasionally cause serious problems by invading the eye. There is an eosinophilia associated

with the infection, but that is a common finding with tissue-invading nematodes. The larvae must be removed from the skin for you to positively identify them. They measure 10 to 50 mm by 1 to 2.5 mm, which is considerably larger than most nematode larvae that cause creeping eruption. The most distinctive feature is a large head bulb (fig. 4-13) that has eight rings of hooklets.

*Toxocara*. The genus *Toxocara* includes ascarids that infect dogs and cats. They are widely distributed over most of the world. Most birds and mammals, including man, can serve as paratenic hosts. In humans such infections are known as *Visceral larva migrans*. Young children about 1 to 4 years of age are most frequently infected. This is to be expected, since they put everything, including dirt, in their mouths.

As with *Ascaris lumbricoides*, the larvae migrate through the intestine and into the other body tissues; but instead of making the normal lung passage and returning to the intestine, *Toxocara* larvae continue to migrate through the body and concentrate particularly in the liver in humans. The resulting disease may be very mild, with an eosinophilia of 20 to 80 percent the only symptom noted. Frequently, the disease is severe with intermittent fever, cough, hepatomegaly, and hyperglobulinemia. It is sometimes fatal. Specific diagnosis requires identification of the larvae, which are usually found in liver biopsies. Skin tests and serological procedures have shown some promise, but as yet they are not reliable.

*Ancylostoma*. Some species of the genus *Ancylostoma* cause the disease *cutaneous larva migrans*. The infective larvae penetrate the skin and migrate around, causing an intensely itching, creeping eruption. After a period of migrating through the skin, large numbers of the larvae are sometimes found in sputum specimens. Since some species of *Ancylostoma* infect a host more readily when the larvae are ingested than by skin penetration, it is possible that the larvae which are swallowed in the sputum migrate through the intestine and invade the viscera, as do the larvae of *Toxocara*. Larvae of *Ancylostoma* are known to invade the viscera of some small mammals and remain there in an infective state for long periods of time. It is



Figure 4-13. Larvae of *Gnathostoma spinigerum*.

possible that the same thing happens in humans, although the larvae of *Ancylostoma* have not been identified from human viscera. *Ancylostoma* has not as yet been proven to be a cause of visceral larva migrans. A diagnosis of cutaneous larva migrans is usually made by the physician on the appearance of the lesions.

#### Exercise (460):

- Match each column B item with the statements in column A by placing the letter of the column B item beside the number of the column A item that most nearly describes it. Each element in column B may be used once, more than once, or not at all.

Column A	Column B
— (1) A parasite that lives in tumors within the walls of the stomachs of dogs, cats, and certain wild carnivores.	a. <i>Toxocara</i>
— (2) Cold blooded vertebrates, fish-eating birds, and mammals other than final hosts serve as paratenic hosts.	b. <i>Ascaris lumbricoides</i>
— (3) A special type of transport host in which infective stage larvae persist without essential development and usually without growth.	c. <i>Ancylostoma</i>
— (4) The migrating larvae of this parasite produce a kind of creeping eruption and occasionally cause serious problems by invading the eye.	d. <i>Gnathostoma spinigerum</i>
— (5) The most distinctive feature of this parasite is a large head bulb that has eight rings of hooks.	e. <i>Cutaneous larva migrans</i>
— (6) Infections caused by <i>Toxocara</i> .	f. Paratenic host
— (7) Specific diagnosis requires identification of the larvae, which are usually found in liver biopsies	g. Intermediate host
— (8) A disease caused by some species of <i>Ancylostoma</i> .	h. <i>Visceral larva migrans</i>
— (9) Larvae are known to invade the viscera of some small mammals and remain there in an infective state for long periods of time.	
— (10) The infective larvae penetrate the skin and migrate around, causing an intensely itching, creeping eruption.	

## Bibliography

### Books

- Davidsohn, Israel and John B. Henry. *Clinical Diagnosis By Laboratory Methods*, 15th Ed. Philadelphia: W. B. Saunders Company, 1974.
- Faust, Ernest C., Paul Russell and Rodney Jung. *Clinical Parasitology*, 8th Ed. Philadelphia: Lea & Febiger, 1977.
- Finegold, Sydney M., William J. Martin and Elvyn G. Scott. *Bailey and Scott's Diagnostic Microbiology*, 5th Ed. St. Louis: The C. V. Mosby Company, 1978.
- Freeman, Bob A. *Textbook of Microbiology*. 21st Ed. Philadelphia: W. B. Saunders Company, 1979.
- Javetz, Ernest, J. L. Melnick and E. A. Adelberg, *Review of Medical Microbiology*, 13th Ed. Los Altos, Calif.: Lang Medical Publications, 1979.
- Joklik, Wolfgang K. and Hilda P. Willett. *Zinsser Microbiology*, 16th Ed. New York: Appleton-Century-Crofts, 1976.
- Linnette, Edwin, Earl Spaulding and Joseph Truant. *Manual of Clinical Microbiology*, 2nd Ed. Washington, D. C.: American Society for Microbiology, 1974.
- Ravel, Richard. *Clinical Laboratory Medicine*, 3rd Ed. Chicago: Year Book Medical Publishers, Inc., 1978.
- Schmidt, Gerald D. and Larry S. Roberts, *Foundations of Parasitology*, St. Louis: The C. V. Mosby Company, 1977.
- Smith, Alice L. *Principles of Microbiology*, 8th Ed. St. Louis: The C. V. Mosby Company, 1977.
- Volk, Wesley A. *Essentials of Medical Microbiology*. Philadelphia: J. B. Lippincott Company, 1978.

### Periodicals

*Laboratory Procedures for the Diagnosis of Intestinal Parasites*, U. S. Department of Health, Education and Welfare, Washington, D. C.: Government Printing Office, 1974.

### Department of the Air Force Publications

AFM 160-48, *Clinical Laboratory Procedures—Parasitology*.

NOTE. None of the items listed in the bibliography are available through ECI. If you cannot borrow them from local sources, such as your base library or local library, you may request one item at a time on a loan basis from the AU Library, Maxwell AFB AL 36112, ATTN: ECI Bibliographic Assistant. However, the AU Library generally lends only books and a limited number of AFMs. TOs, classified publications, and other types of publications are not available. Refer to current indexes for the latest revisions and changes to the official publications listed in the bibliography.

# ANSWERS FOR EXERCISES

## CHAPTER 1

### Reference:

- 400 - 1. Protozoa, Nematoda, the Platyhelminthes, and Arthropoda.  
400 - 2. The Platyhelminthes.  
400 - 3. The Nematoda.  
400 - 4. Protista.
- 401 - 1. (1) b.  
(2) b.  
(3) a.  
(4) a.  
(5) d.  
(6) d.  
(7) d.  
(8) c.
- 402 - 1. Platyhelminthes and Aschelminthes.  
402 - 2. They lack a true body cavity (celom) and are characteristically flat in dorsoventral section.  
402 - 3. Cestoda and Trematoda.  
402 - 4. Trematoda.  
402 - 5. Worm-like, unsegmented, round in body section, with a well-developed digestive system, and separate sexes.  
402 - 6. Nematoda.
- 403 - 1. Ectoparasites and endoparasites.  
403 - 2. Ectoparasites.  
403 - 3. Endoparasites.  
403 - 4. Mites, body lice, and ticks.  
403 - 5. Intestines, liver, lungs, blood vessels, and muscles.
- 404 - 1. (1) f.  
(2) a.  
(3) a.  
(4) a.  
(5) b.  
(6) g.  
(7) c.  
(8) h.  
(9) e.  
(10) d.
- 405 - 1. (1) d.  
(2) d.  
(3) b.  
(4) b.  
(5) e.  
(6) a.  
(7) c.  
(8) c.
- 406 - 1. (1) c.  
(2) c.  
(3) c.  
(4) b.  
(5) b.

- (6) a.  
(7) d.  
(8) d.

## CHAPTER 2

- 407 - 1. A leishmanial form and a flagellated leptomonad form.  
407 - 2. The leishmanial form.  
407 - 3. The sandfly, genus *Phlebotomus*.  
407 - 4. None.  
407 - 5. Clinical manifestations and geographical distribution.  
407 - 6. The reticuloendothelial cells of liver, spleen, bone marrow and visceral lymph nodes.  
407 - 7. A Giemsa-stained bone marrow specimen.  
407 - 8. NNN medium and diphasic blood agar medium.  
407 - 9. A complement fixation test.
- 408 - 1. Oriental sore or cutaneous leishmaniasis.  
408 - 2. By intimate contact or autoinoculation.  
408 - 3. Such an examination is useless, because the parasites are found in the tissues adjacent to the sores which they produce, rather than in the peripheral blood.
- 409 - 1. In those of the nose and pharynx.  
409 - 2. In large areas of tropical America, from Yucatan in Mexico through Central America, and into northern Argentina.  
409 - 3. The nasal septum, or the surfaces of the palate.  
409 - 4. a. Examination of exudates collected from involved areas.  
b. Cultures.  
c. Serological procedures.
- 410 - 1. *Trypanosoma rhodesiense* and *Trypanosoma gambiense*.  
410 - 2. The tsetse fly.  
410 - 3. Triatomid (conenose) bugs.  
410 - 4. The parasite appears as a colorless, slender body which measures approximately 15 to 30  $\mu\text{m}$  in length.  
410 - 5. In the lymph glands.  
410 - 6. Spinal fluid.
- 411 - 1. F. An infected tsetse fly.  
411 - 2. T.  
411 - 3. F. The morphology of *T. gambiense* is indistinguishable from that of *T. rhodesiense*.  
411 - 4. F. In the blood.  
411 - 5. F. Chronic.
- 412 - 1. Chagas' disease.  
412 - 2. Texas.  
412 - 3. Triatomid bugs.  
412 - 4. As the infected bug takes a blood meal it discharges liquid feces containing the infective trypanosome form of the parasite, which is rubbed into the bite site, or at times actively invades the mucous membranes when the feces are wiped into the eye or mouth.  
412 - 5. The leishmanial forms.



- 412 - 6. *Trypanosoma cruzi* invades heart muscle cells and nerve cells as a leishmanial form organism, but *Leishmanias* do not invade these tissues.
- 412 - 7. Blood films.
- 413 - 1. F. The large intestine
- 413 - 2. T.
- 413 - 3. T.
- 413 - 4. F. The large intestine.
- 413 - 5. T.
- 413 - 6. F. Is a protuberance on one margin, giving the cysts the shape of a lemon.
- 413 - 7. T.
- 413 - 8. F. *Chilomastix mesnili* is not pathogenic
- 413 - 9. F. *Trichomonas hominis* is also found in fecal specimens
- 414 - 1. It is twice the diameter of a red blood cell in length, and its shape resembles a longitudinally cut pear.
- 414 - 2. Iron hematoxylin stain.
- 414 - 3. a. Four pairs of flagella.  
b. Two nuclei in the anterior third of the body, one on either side of the axostyles.  
c. A rod-like structure lying diagonally across the center of the body.
- 414 - 4. The nuclei stand out as four "eye-like" ovoid objects similar to the nuclei seen in the trophozoite.
- 415 - 1. *Trichomonas vaginalis*.
- 415 - 2. The trophozoite stage.
- 415 - 3. Urethral or vaginal discharge.
- 415 - 4. It causes severe irritation and an inflammation which develops from the degeneration of the epithelium caused by large numbers of flagellates.
- 415 - 5. From centrifuged urine specimens, genitourinary secretions collected on cotton-tipped applicator sticks placed in a small amount on saline, and culture techniques when direct smears are negative.
- 416 - 1. F. Mouth.
- 416 - 2. F. In the tartar around the teeth and gingival margins.
- 416 - 3. T.
- 416 - 4. T.
- 416 - 5. T.
- 416 - 6. T.
- 417 - 1. F. A wobbly yet progressive motion which is brought about by the active vibration of the flagella and the undulating membrane.
- 417 - 2. T.
- 417 - 3. T.
- 417 - 4. T.
- 417 - 5. T.
- 417 - 6. F. Of no pathological significance.
- 417 - 7. F. *T. hominis* has a longer undulating membrane and the flagellum bordering the membrane extends beyond the posterior border.
- 418 - 1. Invade; destroy.
- 418 - 2. Three or four times.
- 418 - 3. Active.
- 418 - 4. Red blood cells, white blood cells, and other cellular debris.
- 418 - 5. It may be barely visible as a faint ring or not visible at all.
- 418 - 6. Circular.
- 418 - 7. On the inner surface of the nuclear membrane is a thin layer of evenly distributed chromatin granules that are bead-like in arrangement and a small dot-like, centrally located karyosome.
- 418 - 8. Glycogen vacuole.
- 418 - 9. The presence of four nuclei and rod-like chromatoidal bodies with smoothly rounded ends.
- 418 - 10. Active, directional.
- 418 - 11. Formed stool specimens.
- 418 - 12. Trophozoites degenerate in a very short time.
- 419 - 1. (1) c.  
(2) b.  
(3) b  
(4) c.  
(5) b.  
(6) a, b, c.  
(7) b.  
(8) a.  
(9) a.
- 420 - 1. *E. histolytica*; *E. coli*.
- 420 - 2. Non-directional.
- 420 - 3. Nuclear characteristics; size; appearance.
- 420 - 4. Invisible; karyosome.
- 420 - 5. Halo-like; clear.
- 420 - 6. Four; mature.
- 420 - 7. Oval.
- 421 - 1. F. Active and progressive.
- 421 - 2. T.
- 421 - 3. F. Finely granular.
- 421 - 4. T.
- 421 - 5. T.
- 421 - 6. F. No invasion.
- 421 - 7. T.
- 422 - 1. Nucleus.
- 422 - 2. Sluggish; leaf-like; greenish.
- 422 - 3. *E. hartmanni*.
- 422 - 4. A single.
- 422 - 5. Spaced chromatin.
- 422 - 6. Glycogen vacuole; brown; iodine.
- 422 - 7. Stained.
- 422 - 8. Harmless.
- 423 - 1. *Isospora hominis* and *Isospora belli*.
- 423 - 2. The organisms invade and destroy the mucosal tissue of the small intestine and cecum, causing a mucous diarrhea, low-grade fever, loss of appetite, and nausea.
- 423 - 3. The immature oocyst would appear as a thick-walled, lemon-shaped, transparent structure containing a single spherical mass of protoplasm.
- 423 - 4. Mature sporocysts.
- 423 - 5. In active infections, oocysts are not passed in large numbers. Also, the oocysts and sporocysts are so transparent that they are usually overlooked.
- 424 - 1. The organism shows a delicate, light blue cytoplasm with a reddish, oval nucleus towards the broad end.
- 424 - 2. Toxoplasmosis.
- 424 - 3. By way of raw or poorly cooked meat, and possibly in some cases by oocysts in feces of infected cats. Also, congenital transmission plays a small but medically important role.
- 424 - 4. Infectious mononucleosis.
- 424 - 5. The cat or other members of the family Felidae.
- 424 - 6. In the epithelial cells of the small intestine.
- 424 - 7. Enclosed sporozoites are released which then multiply in the epithelial cells, leukocytes of the reticuloendothelial system, and the central nervous system.
- 425 - 1. Crescent shape with one end pointed and the other rounded.
- 425 - 2. Distinct cytoplasm and nuclear chromatin, with no flagella or other visible structures.
- 425 - 3. Inclusions other than the nucleus.
- 425 - 4. *H. capsulatum* appears in the tissue as small, oval, encapsulated yeast-like cells, and *T. gondii* have a central stained mass that is surrounded by a clear zone, but there is no true nucleus and there is no parabasal body present.
- 425 - 5. Within wandering macrophages in exudates (peritoneal, pleural, or cerebral), and in circulating blood.
- 426 - 1. Direct examination, isolation of organisms, and examination for a presumptive diagnosis.



- 426 - 2. Tissues taken by biopsy, sputum, vaginal exudates, and the sediment of spinal, pleural, or peritoneal fluids.
- 426 - 3. The brain.
- 426 - 4. The Sabin-Feldman dye test.
- 426 - 5. The Indirect Fluorescent Antibody (IFA) procedure.
- 426 - 6. The indirect hemagglutination and complement-fixation procedures.
- 427 - 1. Malarial parasites.
- 427 - 2. Sporozoa.
- 427 - 3. An infected female *Anopheles* mosquito.
- 427 - 4. Man.
- 427 - 5. In the liver.
- 427 - 6. Daughter merozoites.
- 427 - 7. Erythrocytic.
- 427 - 8. Protein; iron.
- 427 - 9. Flagellated; male.
- 427 - 10. Unfertilized female.
- 427 - 11. *Vivax*, *malariae*, *falciparum*, *ovale*.
- 428 - 1. "Tertian" malaria.
- 428 - 2. 48-hour intervals (or every third day).
- 428 - 3. Large.
- 428 - 4. Irregular.
- 428 - 5. 12; 24
- 428 - 6. Circular.
- 429 - 1. "malignant tertian"; *estivo-autumnal*.
- 429 - 2. Ring forms.
- 429 - 3. Single; double.
- 429 - 4. Trophozoites.
- 429 - 5. Presegmenting.
- 429 - 6. Macrogametocytes; surrounding.
- 429 - 7. Cytoplasm.
- 430 - 1. Quartan malaria.
- 430 - 2. Single, heavy.
- 430 - 3. Small; compact.
- 430 - 4. Compact; trapezoidal-shaped.
- 430 - 5. Trophozoite.
- 430 - 6. Granules.
- 430 - 7. Mature; 6; 12.
- 430 - 8. Rosette' daisy.
- 431 - 1. Parts of West Africa.
- 431 - 2. 48 hours.
- 431 - 3. Schuffner's.
- 431 - 4. Schuffner's.
- 431 - 5. *Plasmodium falciparum*.
- 431 - 6. Giemsa-stain.
- 431 - 7. During and immediately following episodes of fever.
- 432 - 1. *Balantidium coli* is the largest protozoan which may infect man.
- 432 - 2. Large, oval, and greenish in color.
- 432 - 3. The outer surface is covered with a delicate pellicle, on the surface of which are implanted numerous short cilia in regular rows.
- 432 - 4. The two nuclei.
- 432 - 5. Macronucleus.
- 432 - 6. It causes diarrhea; in a few cases, it has been known to invade extra-intestinal sites, producing severe disease and death.
- 433 - 1. Schistosomes or blood flukes.
- 433 - 2. Manson's; intestinal.
- 433 - 3. Man and snails of several genera.
- 433 - 4. Male; female.
- 433 - 5. Through lytic action, and by means of a sharp point on the shell, eggs are able to penetrate the small blood vessels and tissues of the mesentery, eventually reaching the lumen of the intestine where they are expelled in the feces.
- 433 - 6. A ciliated *miracidium*.
- 433 - 7. The cercariae.
- 433 - 8. The cercariae.
- 433 - 9. A long and sharp lateral spine that is located along one side on about the posterior third of the egg.
- 433 - 10. Fecal material.
- 433 - 11. Appropriate concentration methods such as sedimentation and acid-ether-formalin concentration
- 434 - 1. The Far East.
- 434 - 2. Dogs, cats, horses, cattle, rats, and mice.
- 434 - 3. The smaller venules of the mesentery of the small intestine.
- 434 - 4. The female is slightly longer, about 26 mm. as compared with 12 to 20 mm. length of the male.
- 434 - 5. Smaller.
- 434 - 6. a. Incubation.  
b. Egg laying and extrusion.  
c. Proliferation and tissue repair.
- 434 - 7. Incubation and egg laying and extrusion.
- 434 - 8. Proliferation and tissue repair.
- 435 - 1. Vesical blood.
- 435 - 2. The finer veins of the bladder and uterus
- 435 - 3. Man; snails.
- 435 - 4. Bloody urine.
- 435 - 5. Feces and urine.
- 436 - 1. *Faciola hepatica* and *Clonorchis senensis*.
- 436 - 2. The sheep liver fluke.
- 436 - 3. By ingesting the infective larvae which have encysted on plants such as lettuce and watercress.
- 436 - 4. Humans, sheep, and cattle.
- 436 - 5. Snails.
- 436 - 6. 80 x 150 $\mu$ m; the egg is yellow brown and has an operculum.
- 436 - 7. Recover the typical *F. hepatica* eggs from uncontaminated bile collected by the attending physician.
- 436 - 8. If someone ingests liver infected with *F. hepatica*.
- 437 - 1. F. The bile duct.
- 437 - 2. T.
- 437 - 3. F. Ants are the second intermediate host.
- 437 - 4. F. Ingesting ants.
- 437 - 5. F. They have a broad convex operculum
- 437 - 6. T.
- 438 - 1. Chinese liver fluke.
- 438 - 2. China, Japan, Formosa, and Indochina.
- 438 - 3. The dog and cat.
- 438 - 4. In the bile passages and occasionally in the pancreatic duct.
- 438 - 5. Inflammation of the bile ducts. In very heavy infections, severe damage may result in cirrhosis of the liver or even death.
- 438 - 6. T.
- 438 - 7. The egg is small and ovoid with a distinct operculum that fits into a rimmed extension.
- 438 - 8. They measure about 29 by 16 $\mu$ m.
- 439 - 1. T.
- 439 - 2. F. Smaller.
- 439 - 3. F. They are similar.
- 439 - 4. F. *O. filineus* is 30 by 11 mm and *C. senensis* is 29 by 16 mm.
- 439 - 5. T.
- 439 - 6. T.
- 439 - 7. F. Slightly smaller.
- 440 - 1. Intestinal fluke.
- 440 - 2. An inch; half.
- 440 - 3. India, China; Southwest.
- 440 - 4. Snail.
- 440 - 5. Metacercariae; cracking nuts.

### CHAPTER 3

- 440 - 6. *Fasciola hepatica*  
 440 - 7. 130, 80.  
 440 - 8. Feces; clinical findings
- 441 - 1. Egypt, Palestine; Orient  
 441 - 2. Dogs, cats, rabbits  
 441 - 3. First; second  
 441 - 4. Small.  
 441 - 5. Fish; metacercariae.  
 441 - 6. 0.4; 1.5  
 441 - 7. Feces.  
 441 - 8. Intestinal mucosa, mild diarrhea.  
 441 - 9. Heart, cardiac
- 442 - 1. F The Far East and the Balkans States  
 442 - 2. T.  
 442 - 3. F. Uncooked freshwater fish.  
 442 - 4. T  
 442 - 5. T  
 442 - 6. F One will not be able to.  
 442 - 7. F Persistent intestinal disturbances and diarrhea
- 443 - 1. *Paragonimus westermani*.  
 443 - 2. Plump; ovoidal; 12, one-third  
 443 - 3. Reddish brown; spines  
 443 - 4. Pairs; parenchyma.  
 443 - 5. Around; respiratory.  
 443 - 6. 80; 120; 45; 60.  
 443 - 7. Flat; unembryonated.  
 443 - 8. Bronchial cough  
 443 - 9. Blood; capsule; bronchiale; eggs.  
 443 - 10. Blood-tinged; feces; pleural; peritoneal.
- 444 - 1. Fish tapeworm or broad tapeworm.  
 444 - 2. Up to 35 feet long and having as many as 4,000 proglottids.  
 444 - 3. When an uncooked fish containing a *plerocercoid* larva is ingested.  
 444 - 4. Small and spoon-shaped.  
 444 - 5. The rosette-shaped uterus and the genital pore.  
 444 - 6. Broadly ovoid and shaped very much like a hen egg. The shell is moderately thick and golden brown when passed in feces.  
 444 - 7. They vary in size ranging from 59 to 71  $\mu$ m by 42 to 49  $\mu$ m.  
 444 - 8. At the anterior pole there is a prominent operculum, and at the posterior pole there is a small knob-like protuberance.
- 445 - 1. *Taenia saginata*.  
 445 - 2. The beef tapeworm.  
 445 - 3. 15 feet long, but it may reach a total of 75 feet.  
 445 - 4. 1,000 to 2,000 proglottids.  
 445 - 5. Africa, Europe; South America.  
 445 - 6. Cattle; man.  
 445 - 7. The scolex has no rostellum nor attachment hooks. The attachment organs consist of four cup-shaped hemispherical suckers, one at each of the four corners of the scolex.  
 445 - 8. Mature proglottids are slightly broader than long, whereas the gravid proglottids are considerably more narrow and about three times as long as the broadest portion of the segment.  
 445 - 9. From 15 to 20.  
 445 - 10. Because of its large size, the *T. Saginata* species is often the cause of excessive digestive pathology.  
 445 - 11. By counting the number of lateral uterine branches or arms.  
 445 - 12. Press them between two microscopic slides and use a hard lens.
- 446 - 1. Improperly cooked pork.  
 446 - 2. The scolex has four suckers and a prominent rounded rostellum that is armed with a double circle of hooks.  
 446 - 3. There are 22 to 32 hooks.
- 446 - 4. 7 to 13.  
 446 - 5. Irritation of the mucosa of the intestine and on rare occasions obstruction of the intestine, and nervous disorders due to the production of toxic substances by the adult worm.
- 447 - 1. Warm.  
 447 - 2. The dwarf tapeworm  
 447 - 3. 2 inches, and as many as 200 proglottids.  
 447 - 4. Four.  
 447 - 5. 20 to 30 hooklets.  
 447 - 6. They are broader than long and there are three testes present that are arranged in a row across the proglottid  
 447 - 7. 30 to 47  $\mu$ m.  
 447 - 8. The shell is made up of two thin membranes; the inner membrane has polar knobs to which threadlike filaments are attached.  
 447 - 9. Diarrhea, vomiting, insomnia, weight loss, and allergic reactions.  
 447 - 10. Polar knobs; filaments.  
 447 - 11. The scolex of *H. nana* has a rostellar crown of 20 to 30 hooklets which may be inverted, whereas the scolex of *H. diminuta* has a deep, sucker-like pocket into which the small rostellum is usually retracted and *H. diminuta* has no hooklets.
- 448 - 1. F. A common parasite of rats, mice, and other rodents.  
 448 - 2. F. Small.  
 448 - 3. T.  
 448 - 4. T.  
 448 - 5. F. No hooklets.  
 448 - 6. F. No polar filaments present  
 448 - 7. T.  
 448 - 8. T  
 448 - 9. T
- 449 - 1. The dog and the cat.  
 449 - 2. The dog tapeworm.  
 449 - 3. Because of their frequent close contact with infected pets.  
 449 - 4. They are the same approximate length, but *D. caninum* usually has fewer proglottids.  
 449 - 5. They resemble the shape of a cucumber or pumpkin seed  
 449 - 6. The eggs must be ingested by one of various insects, such as the dog louse or certain larvae fleas, which serve as intermediate hosts.

#### CHAPTER 4

- 450 - 1. Cool or temperate regions than in strictly tropical areas  
 450 - 2. Flat on one side and broadly rounded on the other.  
 450 - 3. From contaminated fingers or along with dust.  
 450 - 4. The outer shell of the egg is sticky.  
 450 - 5. Press the sticky side of the pinworm paddle to the perianal folds.  
 450 - 6. It's best to get the specimen 2 to 4 hours after the patient has gone to bed or early in the morning before bathing and a bowel movement.
- 451 - 1. Warm or moist.  
 451 - 2. By ingesting infective eggs.  
 451 - 3. The male measures 30 to 45 mm in length and the female measures 35 to 50 mm in length.  
 451 - 4. *Trichuris trichiura* eggs are golden brown and barrel shaped.  
 451 - 5. Bloody diarrhea.
- 452 - 1. Tropical; cooler.  
 452 - 2. Three.  
 452 - 3. Because they are very resistant to drying and low temperatures.  
 452 - 4. *Ascaris lumbricoides* eggs have a much thicker shell; and they contain an undivided cell mass, whereas hookworm eggs contain a zygote that is in the four or eight cell stage.  
 452 - 5. 200,000 eggs per day.

- 452 - 6. Eggs are stained by bile pigments in the intestinal tract of the host.
- 452 - 7. Cough, fever, and occasionally blood-tinged sputum
- 452 - 8. Eosinophils; Charcot-Leyden.
- 452 - 9. Because of the large number of eggs produced.
- 452 - 10. Infertile eggs are too dense to float with the ordinary techniques.
- 452 - 11. Direct saline.
- 453 - 1. *Ancylostoma duodenale* and *Necator americanus*
- 453 - 2. Temperature.
- 453 - 3. *N. americanus*.
- 453 - 4. *N. americanus*.
- 453 - 5. By penetrating the skin.
- 453 - 6. Iron deficiency anemia.
- 453 - 7. *A. duodenale*.
- 453 - 8. The buccal canal of *Ancylostoma* is smooth, but in *Necator* it is thickened at one level to give the appearance of a minute, spear-like structure.
- 453 - 9. Light infection that ordinarily does not produce anemia.
- 454 - 1. Along the Gulf coast of Florida, Louisiana, Mississippi and Alabama.
- 454 - 2. Female.
- 454 - 3. Indirect route.
- 454 - 4. Drier and cooler conditions.
- 454 - 5. The infective larvae penetrate the skin.
- 454 - 6. The tunneling process in the small intestine and the tissue reaction to eggs, worms, and larvae.
- 454 - 7. Feces or duodenal contents.
- 454 - 8. a. The buccal canal of *Strongyloides* is very short, while that of the hookworm is longer and narrow.  
b. The genital primordium of *Strongyloides* is much larger than in the hookworm.
- 455 - 1. The pig.
- 455 - 2. Voluntary (striated).
- 455 - 3. After they have become coiled and encapsulation has begun.
- 455 - 4. After about 8 weeks.
- 455 - 5. Compress a portion of the tissue between two glass slides before examining it with the microscope.
- 455 - 6. It takes 7 to 14 days after exposure for most of the larvae to be filtered out in the muscle.
- 455 - 7. Bentonite flocculation test and indirect hemmagglutination test.
- 456 - 1. (1) a.  
(2) a  
(3) a.  
(4) h  
(5) a.  
(6) j.  
(7) b  
(8) g  
(9) e.  
(10) e.  
(11) f.  
(12) f.  
(13) f.  
(14) d
- (15) h.  
(16) c  
(17) a.
- 457 - 1. The adult female *Dracunculus medinensis* is much larger.
- 457 - 2. In the subcutaneous tissues, usually on the arms or legs of man.
- 457 - 3. The female causes a blister to form in the skin of the host.
- 457 - 4. By placing the blister in contact with water, allowing the blister to rupture.
- 457 - 5. By drinking water that contains the minute infected *Cyclops*, which serves as the intermediate hosts for the organism.
- 457 - 6. As soon as you find the worm protruding from the subcutaneous channel.
- 458 - 1. (1) a.  
(2) a. f.  
(3) f.  
(4) f.  
(5) f.  
(6) a.  
(7) g.  
(8) g  
(9) h.  
(10) h.  
(11) i.  
(12) i.  
(13) e.  
(14) l.  
(15) l.  
(16) l.  
(17) k.  
(18) b.  
(19) b  
(20) d.  
(21) c.  
(22) m
- 459 - 1. (1) c.  
(2) c.  
(3) ..  
(4) e.  
(5) e.  
(6) e.  
(7) a  
(8) e.  
(9) a.  
(10) d  
(11) d.  
(12) d.
- 460 - 1. (1) d.  
(2) d.  
(3) f  
(4) d.  
(5) d.  
(6) h.  
(7) a.  
(8) e.  
(9) c.  
(10) c.

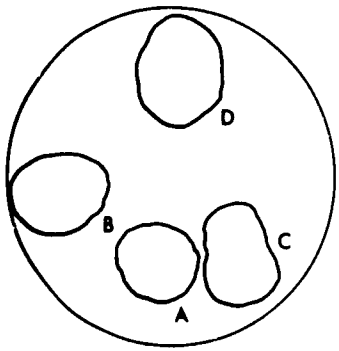

**I. Young Trophozoites**

A and B—Young ring forms.  
C and D—Half-grown trophozoites.

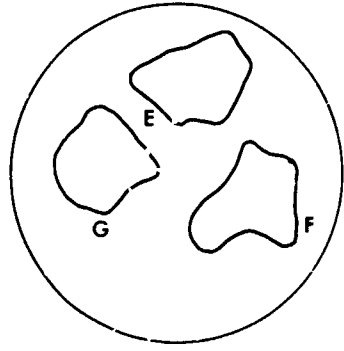

**II. Old Trophozoites**

E, F, and G—Trophozoites with nuclear chromatin ready to subdivide.

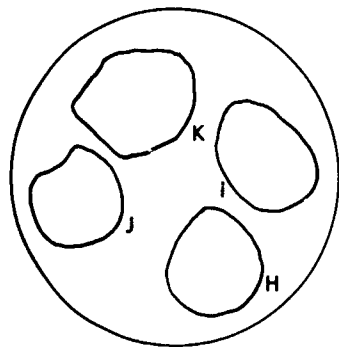

**III. Young Schizonts**

H and I—Young Schizonts showing first division of nuclear chromatin.  
J and K—Older schizonts showing from four to many subdivisions of nuclear chromatin.

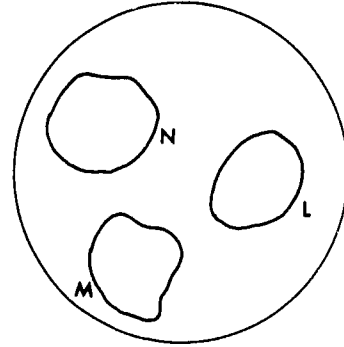

**IV. Half-grown Schizonts**

L, M, and N—Schizonts showing seven, eight, and ten nuclear subdivisions.

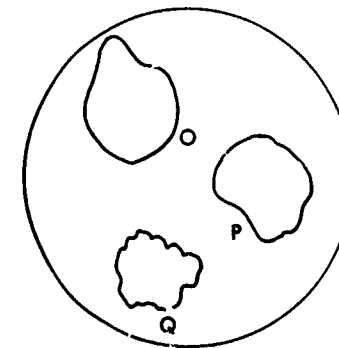

**V. Mature Schizonts**

O, P, and Q—Mature schizonts showing complete subdivision of nuclear chromatin and clumping of malarial pigment.

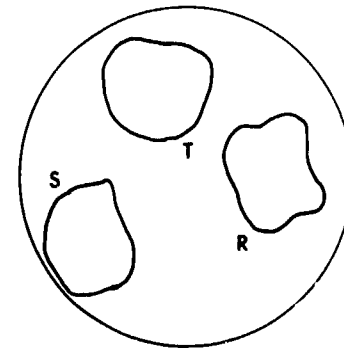

**VI. Gametocytes or Sexual Forms**

R—Male gametocyte or microgametocyte. Note diffuse nuclear chromatin.  
S and T—Female gametocyte or macrogametocyte. Note compact chromatin.

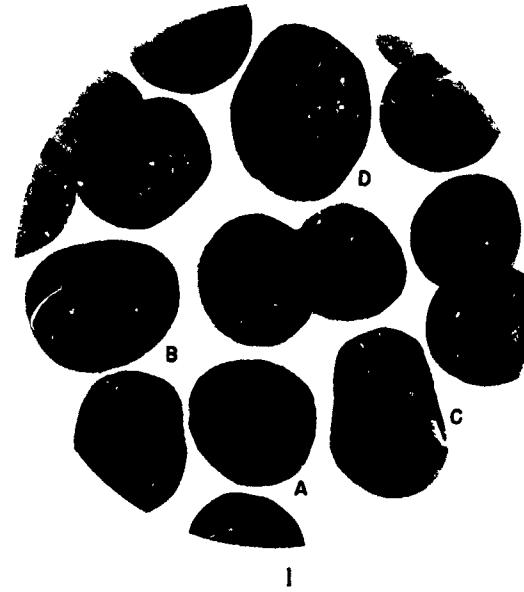

I

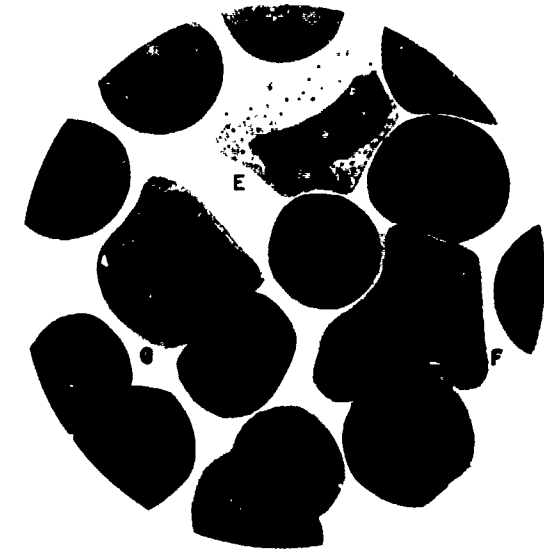

II

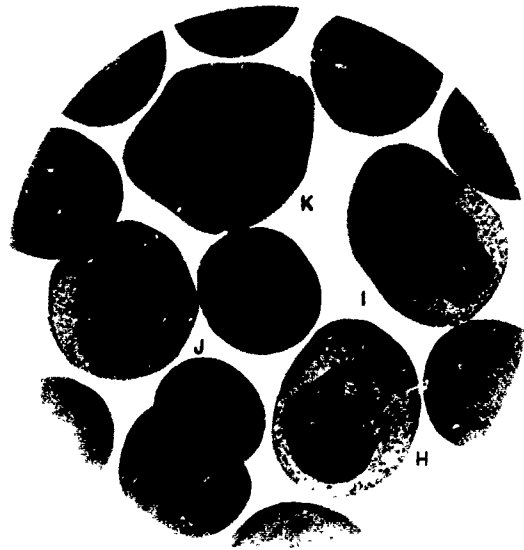

III

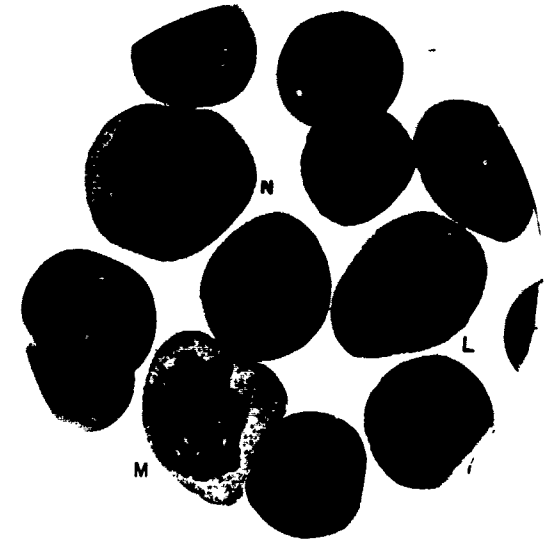

IV



V



VI

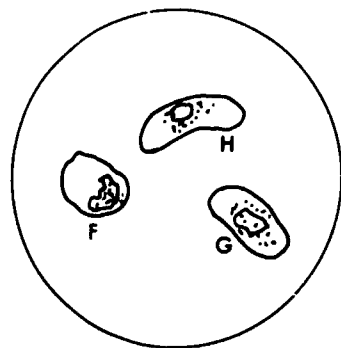
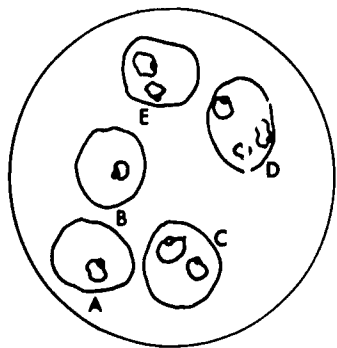

**I. Trophozoites in Peripheral Blood**

A—Young ring forms.  
B, C, and D—Young trophozoites.  
Note multiple infections of cells and appliqué forms.  
E—These are oldest forms normally found in peripheral blood.

**II. Gametocytes or Sexual Forms in Peripheral Blood**

F—Gametocyte folded over.  
G—Microgametocyte or male gametocyte. Note diffuse chromatin.  
H—Female or macrogametocyte. Note compact chromatin.

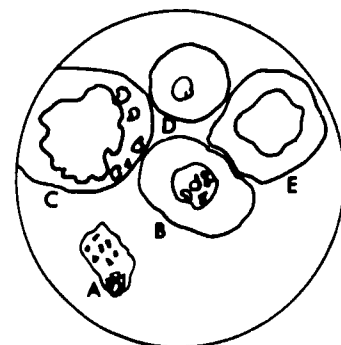
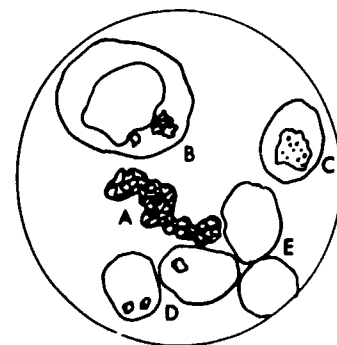

**III. Impression Smear of Spleen**

A—Free pigment of splenic pulp  
B—Pigment in macrophage.  
C—Half-grown schizont in cell.  
D—Parasitized red cells.  
E—Lymphocytes.

**IV. Impression Smear of Bone Marrow**

A—Free pigment granules.  
B—Nucleated red cell.  
C—Pigment in macrophage.  
D—Parasitized red cell.  
E—Eosinophile.

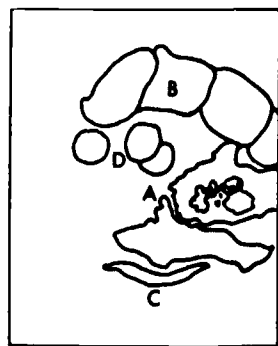
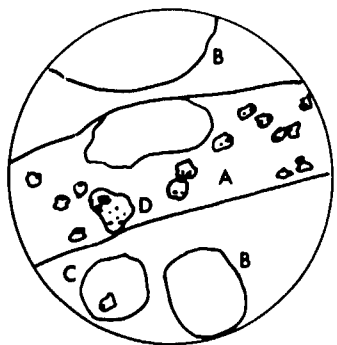

**V. Impression Smear of Brain**

A—Capillary blocked with parasitized erythrocytes  
B—Gliol cells.  
C—Trophozoite in red cell  
D—Maturing schizont.

**VI. Section of Liver**

A—Kupffer cells with pigment.  
B—Hepatic cells.  
C—Endothelial cell.  
D—Free red blood cells.

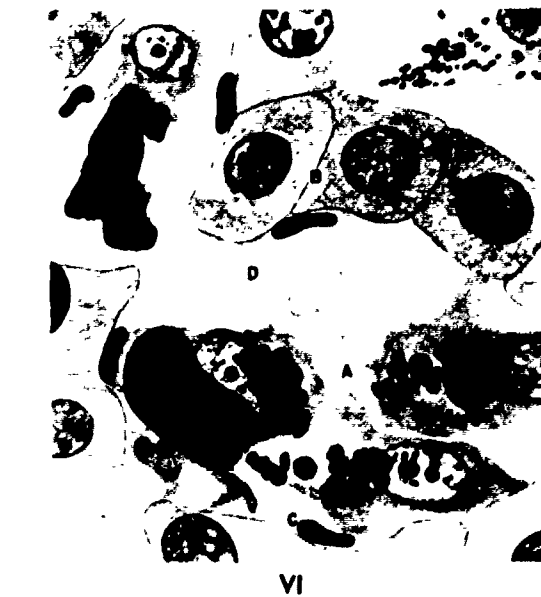
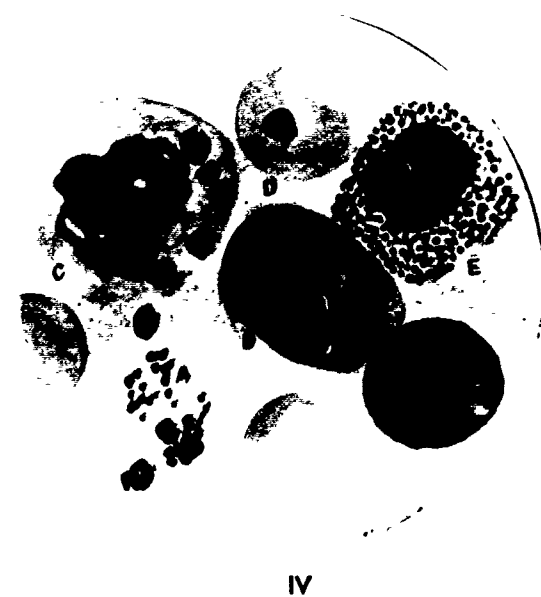
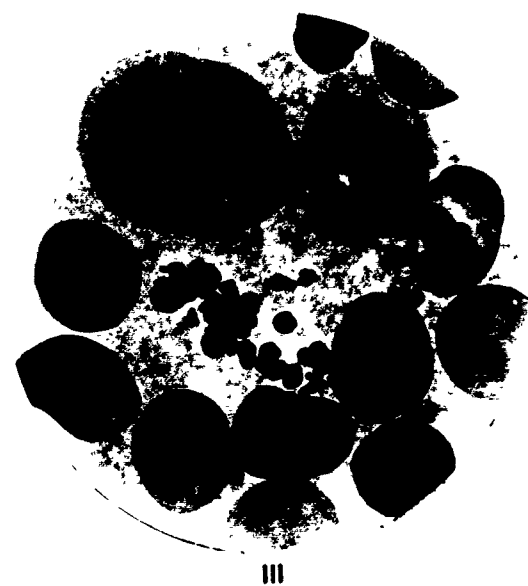

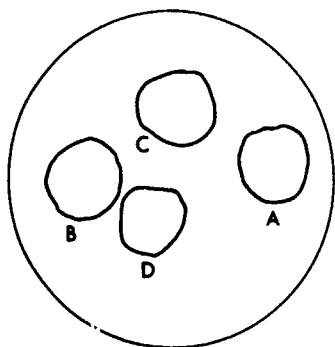

**I. Young Trophozoite**

A, B, and C—Progressively older ring forms.  
D—Band trophozoite.

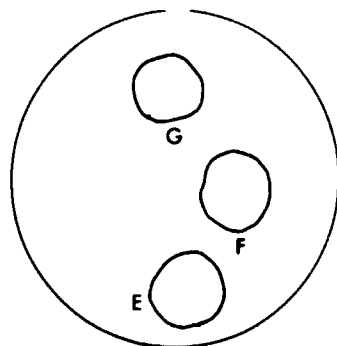

**II. Half-grown Trophozoite**

E—Ring form.  
F and G—Mature trophozoites.  
Note amount of pigment; compactness of cytoplasm.

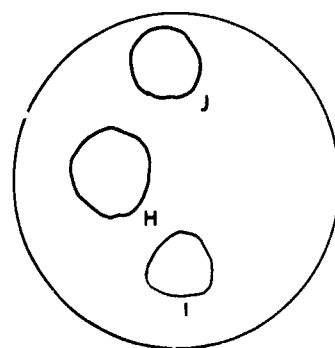

**III. Young Schizonts**

H—Band schizont.  
I and J—Three- and five-nucleated schizonts.  
Note large amount of pigment.

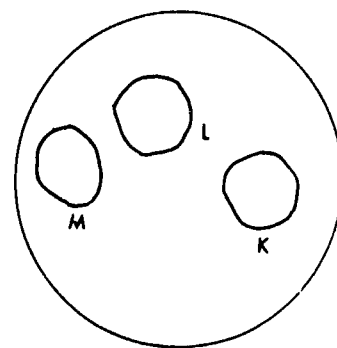

**IV. Half-grown Schizonts**

K, L, and M—Four- to six-nucleated schizonts.  
Note amount of pigment.

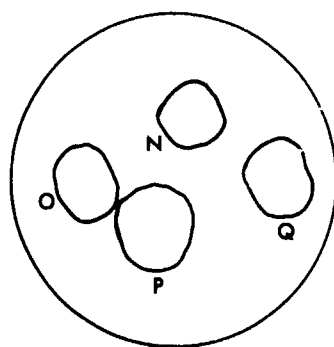

**V. Mature Schizonts**

N, O, P, and Q—Eight- or ten-nucleated schizonts ready to segment and release merozoites. Note "daisy" forms.

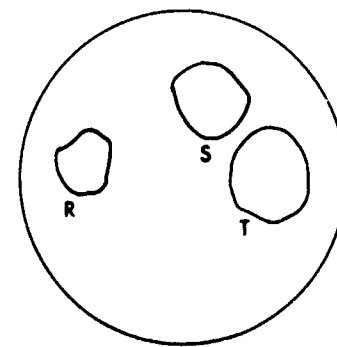

**VI. Gametocytes or Sexual Forms**

R and S—Male gametocytes or microgametocytes.  
T—Female gametocyte or macrogametocyte.

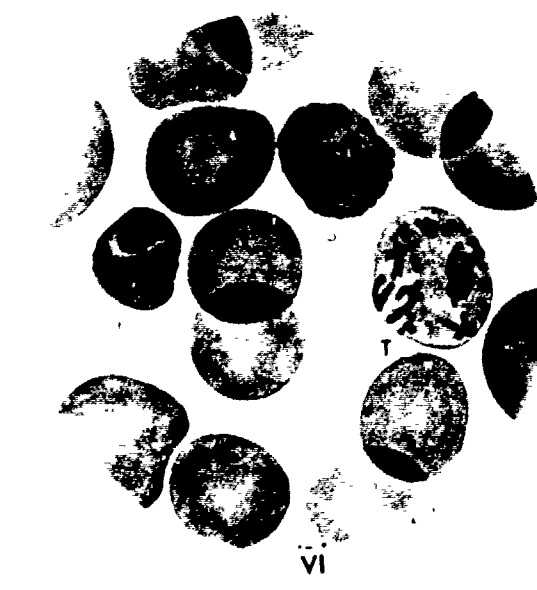
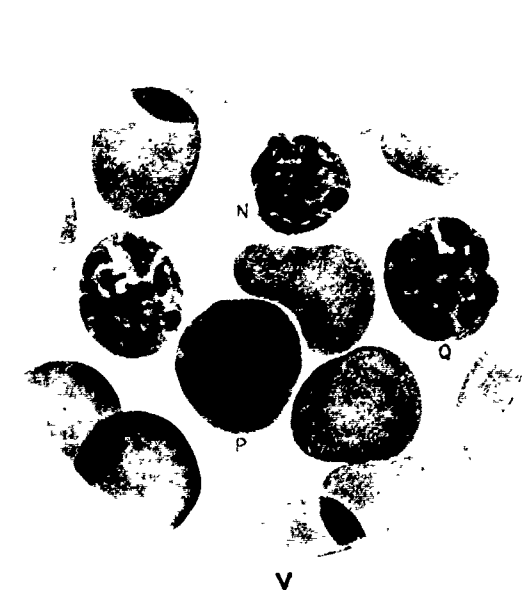



S T O P -

1. MATCH ANSWER SHEET TO THIS EXERCISE NUMBER.
2. USE NUMBER 2 PENCIL ONLY.

EXTENSION COURSE INSTITUTE  
VOLUME REVIEW EXERCISE  
90412 03 22  
CLINICAL PARASITOLOGY

Carefully read the following:

DO's:

1. Check the "course," "volume," and "form" numbers from the answer sheet address tab against the "VRE answer sheet identification number" in the righthand column of the shipping list. If numbers do not match, return the answer sheet and the shipping list to ECI immediately with a note of explanation.
2. Note that item numbers on answer sheet are sequential in each column.
3. Use a medium sharp #2 black lead pencil for marking answer sheet.
4. Write the correct answer in the margin at the left of the item. (When you review for the course examination, you can cover your answers with a strip of paper and then check your review answers against your original choices.) After you are sure of your answers, transfer them to the answer sheet. If you have to change an answer on the answer sheet, be sure that the erasure is complete. Use a clean eraser. But try to avoid any erasure on the answer sheet if at all possible.
5. Take action to return entire answer sheet to ECI.
6. Keep Volume Review Exercise booklet for review and reference.
7. If mandatorily enrolled student, process questions or comments through your unit trainer or OJT supervisor. If voluntarily enrolled student, send questions or comments to ECI on ECI Form 17.

DON'Ts:

1. Don't use answer sheets other than one furnished specifically for each review exercise.
2. Don't mark on the answer sheet except to fill in marking blocks. Double marks or excessive markings which overflow marking blocks will register as errors.
3. Don't fold, spindle, staple, tape, or mutilate the answer sheet.
4. Don't use ink or any marking other than a #2 black lead pencil.

NOTE: NUMBERED LEARNING OBJECTIVE REFERENCES ARE USED ON THE VOLUME REVIEW EXERCISE. In parenthesis after each item number on the VRE is the Learning Objective Number where the answer to that item can be located. When answering the items on the VRE, refer to the Learning Objectives indicated by these Numbers. The VRE results will be sent to you on a postcard which will list the actual VRE items you missed. Go to the VRE booklet and locate the Learning Objective Numbers for the items missed. Go to the text and carefully review the areas covered by these references. Review the entire VRE again before you take the closed-book Course Examination.

90412 03 22

## MULTIPLE CHOICE

Note to Student: Consider all choices carefully and select the best answer to each question.

1. (400) Which of the following is considered a kingdom for which the phylum protozoa is being abandoned?
  - a. Protista.
  - b. Nematoda.
  - c. Arthropoda.
  - d. Platyhelminthes.
2. (400) Which group of parasites is designated as flatworms?
  - a. Platyhelminthes.
  - b. Sarcodina.
  - c. Arthropoda.
  - d. Protozoa.
3. (401) Flagellates with one or more whiplike flagella may be classified in which group of protozoa?
  - a. Apicomplexa.
  - b. Ciliata.
  - c. Mastigophora.
  - d. Rhizopoda.
4. (401) Which group contains Balantidium coli?
  - a. Apicomplexa.
  - b. Ciliophora.
  - c. Mastigophora.
  - d. Sarcodina.
5. (402) The distinguishing characteristics of the phylum Platyhelminthes include
  - a. a wormlike, unsegmented, flat body section and a well-developed digestive system.
  - b. a wormlike, unsegmented, round body section and a well-developed digestive system.
  - c. the lack of a true body cavity, a well-developed digestive system, and separated sexes.
  - d. the lack of a true body cavity and a characteristically flat dorsoventral section.
6. (402) Which of the following is hermaphroditic and includes flukes such as the Schistosoma species?
  - a. Arthropoda.
  - b. Cestoda.
  - c. Ciliophora.
  - d. Trematoda.
7. (403) All of the following parasites are examples of ectoparasites except
  - a. body lice.
  - b. blood flukes.
  - c. mites.
  - d. ticks.

90412 03 22

8. (403) Endoparasites are likely to be found in all areas of the body except the
- a. liver.
  - b. intestines.
  - c. nasopharynx.
  - d. muscles.
9. (404) "An animal species on which the parasite depends for its survival in nature and thus serves as a source of infection for susceptible hosts" best describes which type of host?
- a. Definitive.
  - b. Intermediate.
  - c. Reservoir.
  - d. Terminal.
10. (404) Which condition best describes an association of two organisms in which one is benefited at the expense of the other?
- a. Vectors.
  - b. Mutualism.
  - c. Commensalism.
  - d. Parasitism.
11. (405) For a parasite to exist, all of the following conditions are necessary except
- a. access to a suitable host.
  - b. benefit to both host and parasite.
  - c. a dependable means of transmission to the host.
  - d. environmental conditions providing suitable access to the host.
12. (405) Which reaction is most notable in infections with Strongyloides stercoralis, Ascaris lumbricoides, and Trichinella spiralis?
- a. Tissue response.
  - b. Lytic action.
  - c. Trauma.
  - d. Secondary infection.
13. (406) Parasites such as Dientamoeba fragilis and Trichomonas hominis have no cystic stage, so they must be transmitted by which mode?
- a. Food-borne.
  - b. Soil- or water-borne.
  - c. Arthropod-borne.
  - d. Filth-borne or contaminative.
14. (406) Infective Ascaris, Trichuris, and hookworms are usually transmitted by which mode of infection?
- a. Filth-borne or contaminative.
  - b. Soil- or water-borne.
  - c. Arthropod-borne.
  - d. Food-borne.

90412 03 22

15. (407) *Leishmania* organisms may be classified according to what two factors?
- Clinical manifestation and morphology.
  - Clinical manifestation and geographical distribution.
  - Geographical distribution and morphology.
  - Geographical distribution and life cycle.
16. (407) During the life cycle of *Leishmania donovani*, the parasite lives as a flagellated leptomonad form in which vector?
- Sandfly.
  - Bee.
  - Mosquitoe.
  - Tick.
17. (408) A technician would most likely find *Leishmania tropica* upon examination of smears from which source?
- Mucous secretions of the infected area.
  - Peripheral blood.
  - Material from the edge of a sore.
  - Pus from an infected area.
18. (408) If smears for *Leishmania tropica* are negative, cultures should be made on which medium?
- NNN.
  - Motility.
  - Brain-heart infusion.
  - Trypticase soy broth.
19. (409) As the disease caused by *Leishmania braziliensis* advances in man, in what mucous membranes do the parasites localize?
- The genitalia.
  - The labial mucosa.
  - The nose and pharynx.
  - The ear and pharynx.
20. (410) Which arthropod is the vector of the African trypanosomes?
- The tsetse fly.
  - The triatomid bug.
  - The sandfly genus, *Phlebotomus*.
  - The mosquito, *Anopheles* spp.
21. (410) During nonfebrile states, where are *Trypanosoma rhodesiense* organisms more abundant?
- Spinal fluid.
  - Lymph glands.
  - Blood.
  - Urine.
22. (411) Within the vertebrate hosts, where do *Trypanosoma gambiense* parasites localize first?
- The lymph glands.
  - The spinal fluid.
  - The bladder.
  - The blood stream.

90412 03 22

23. (411) Which statement is correct about Gambian sleeping sickness?
- It requires a vector.
  - It is fatal.
  - It is diagnosed by complement fixation.
  - It is more serious than the Rhodesian type.
24. (412) Trypanosoma cruzi may be transmitted by all of the following means except
- insects.
  - prenatal infection.
  - blood transfusion.
  - filth or contamination.
25. (412) During febrile periods, the typical trypanosomes of T. cruzi may be found in which of the following body fluid preparations?
- Urinary sediment.
  - Centrifuge spinal fluid.
  - Blood films.
  - Concentrated stool specimens.
26. (413) Chilomastix mesnili normally inhabits what section of the intestine?
- The upper small intestine.
  - The lower small intestine.
  - The large intestine.
  - The appendix.
27. (413) Giardia lamblia inhabits what section of the intestine?
- The upper small intestine.
  - The lower small intestine.
  - The lower large intestine.
  - The upper large intestine.
28. (413) The most characteristic morphological structure of a C. mesnili cyst is
- the small dot-like and centrally located karyosome.
  - the large dot-like and centrally located karyosome.
  - a protuberance on one margin, giving the cysts the shape of a bean.
  - a protuberance on one margin, giving the cysts the shape of a lemon.
29. (414) Which of the following is not a distinctive feature of Giardia lamblia?
- Four pairs of flagella.
  - Two nuclei in the anterior third of the body.
  - A rod-like structure lying diagonally across the center of the body.
  - Four nuclei in the posterior third of the body.

30. (414) In hematoxylin stained preparations, the cystic stage of Giardia lamblia shows
- four "eye-like" ovoid objects similar to the nuclei seen in the trophozoite.
  - two "eye-like" ovoid objects similar to the nuclei seen in the trophozoite.
  - a primitive mouth and an anteriorly located nucleus.
  - a primitive mouth and a posteriorly located nucleus.
31. (415) The presence of flagellates in the genitourinary tract strongly suggests a diagnosis of
- Trichomonas tenax.
  - Trichomonas hominis.
  - Trichomonas vaginalis.
  - Trichomonas gallinae.
32. (415) For laboratory diagnosis of Trichomonas vaginalis which specimen is not suitable?
- Urethral secretion.
  - Centrifuged urine.
  - Prostatic secretion.
  - Concentrated stool specimen.
33. (416) Trichomonas tenax is a common parasite of the
- intestinal tract.
  - mouth.
  - urethral tract.
  - prostate gland.
34. (416) Trichomonas tenax is of little pathological significance and is considered harmless, even though as a secondary invader it has been incriminated in which of the following?
- Infections of the lumen of the large intestine.
  - Respiratory infections and lung abscesses.
  - Gingivitis.
  - Tonsillitis.
35. (417) In fresh preparations, which characteristic behavior is shown by Trichomonas hominis?
- A sluggish, non-directional motion due to the lack of a flagellum and short undulating membrane.
  - A sluggish, non-directional motion due to the presence of a long flagellum and short undulating membrane.
  - A wobbly yet progressive motion due to the active vibration of the flagella and the undulating membrane.
  - A wobbly yet progressive motion due to the lack of a flagellum and an undulating membrane.

90412 03 22



36. (417) Trichomonas hominis, as compared to Trichomonas vaginalis, shows which distinctive characteristic?
- A shorter undulating membrane and the flagellum extends beyond the posterior border.
  - A longer undulating membrane and the flagellum is shorter than the posterior border
  - A longer undulating membrane and the flagellum bordering the membrane extends beyond the posterior border.
  - A shorter undulating membrane and the flagellum is shorter than the posterior border.
37. (418) Entamoeba histolytica is the most pathogenic of the amoeba because it
- invades and destroys tissue.
  - causes lytic action and blood loss.
  - causes lytic action and invades tissue.
  - causes trauma and immune responses.
38. (418) All of the following are usually observed in the mature Entamoeba histolytica cyst except
- four nuclei.
  - glycogen vacuoles.
  - rod-like chromaloidal bodies.
  - bead-like chromatin granules.
39. (419) Which of the following is considered the largest intestinal amoeba?
- Entamoeba gingivalis.
  - Entamoeba coli.
  - Entamoeba hartmanni.
  - Entamoeba histolytica.
40. (419) Which of the following statements is not true of Entamoeba gingivalis?
- It thrives on diseased gums.
  - It is a pathogenic type of amoeba.
  - It is associated with the tartar between the teeth.
  - It may indicate poor oral hygiene.
41. (420) In stained preparations, Endolimax nana can be identified by all of the following except
- size.
  - appearance.
  - nuclear characteristics.
  - specimen source.
42. (420) Which choice presents characteristics noted in stained preparations of the mature Endolimax nana cyst?
- Four nuclei clustered, usually at one pole of the cyst.
  - Two nuclei clustered, usually at one pole of the cyst.
  - Four nuclei clustered, usually at the center of the cyst.
  - Two nuclei clustered, usually at the center of the cyst.

43. (421) Which choice best describes the characteristic movements of Dientamoeba fragilis?
- Active, but non-directional.
  - Sluggish and non-directional.
  - Active and progressive.
  - Sluggish, but directional.
44. (421) With a drop in temperature, Dientamoeba fragilis will
- become active and encyst.
  - become inactive and encyst.
  - round up and degenerate.
  - round up and flatten out.
45. (422) In man, which of the following intestinal amoeba is the only species in which a single nucleus persists throughout both trophozoite and cystic stages?
- E. coli.
  - D. fragilis
  - I. butschlii.
  - E. histolytica.
46. (422) In the cyst stage, a unique feature of Iodamoeba butchlii is the presence of
- injected food particles which stain brown with iodine.
  - a glycogen vacuole which stains brown with iodine.
  - a large glycogen vacuole which will not stain with iodine.
  - ingested food particles which will not stain with iodine.
47. (423) In infections caused by Isospora hominis, which cysts are found in fresh fecal specimens?
- Mature sporocysts.
  - Immature sporocysts.
  - Mature oocyst.
  - Immature oocyst.
48. (423) If you examine a direct fecal smear for oocysts and sporocysts of Isospora belli or Isospora hominis, they may be overlooked for what two reasons?
- They are quite transparent and are not passed in large numbers during active infections.
  - They are not stained by iodine and are passed in large numbers during active infections.
  - They are quite transparent and are not developed during active infections.
  - They are not stained by iodine and are not fully developed during active infections.

49. (424) When stained with Giemsa, the cytoplasm of the Toxoplasma gondii organism appears
- a. grey.
  - b. brown.
  - c. yellow.
  - d. light blue.
50. (424) Toxoplasma gondii may be transmitted by all of the following means except
- a. raw or poorly cooked meat.
  - b. oocysts in feces of infected cats.
  - c. congenitally.
  - d. the bite of the sandfly vector.
51. (425) Which animal is considered the definitive host of Toxoplasma gondii?
- a. Cat.
  - b. Dog.
  - c. Rabbit.
  - d. Squirrel.
52. (425) Toxoplasma gondii is usually
- a. crescent shape with one end pointed and the other rounded.
  - b. crescent shape with both ends rounded.
  - c. cylindrical with one end pointed and the other rounded.
  - d. cylindrical with both ends rounded.
53. (426) In the diagnosis of toxoplasmosis, smears may be made from suspected specimens of all the following except
- a. vaginal exudates.
  - b. tissue taken by biopsy.
  - c. sediment of spinal, pleural or peritoneal.
  - d. urinary sediment.
54. (426) Which serological test for toxoplasmosis has replaced the original standard procedure that involved the use of live Toxoplasma organisms?
- a. The Indirect Fluorescent Antibody procedure.
  - b. The Sabin-Feldman dye test.
  - c. The indirect haemagglutination procedure.
  - d. The complement-fixation test.
55. (427) The erythrocytic stage of the malarial parasite takes place within the
- a. liver.
  - b. spleen.
  - c. white blood cells.
  - d. red blood cells.

90412 03 22

56. (427) During the asexual reproductive cycle of the malarial parasite which of the following develop from shizonts?
- a. Macrogametocytes.                      c. Microgametocytes.  
b. Daughter merozoites.                d. Oocysts.
57. (428) Which species of malarial parasite is most widely distributed throughout the world?
- a. Plasmodium malariae.                c. Plasmodium vivax.  
b. Plasmodium ovale.                    d. Plasmodium gallinaceum.
58. (428) In the type of malaria caused by P. vivax, the fever is considered to spike at intervals of
- a. 24-hours.                                c. 48-hours.  
b. 36-hours.                                d. 72-hours.
59. (429) Smaller ring forms and double chromatin dots are characteristic of
- a. Plasmodium vivax.                    c. Plasmodium ovale.  
b. Plasmodium falciparum.            d. Plasmodium malariae.
60. (429) Which of the following best describes the morphology of the macrogametocytes of Plasmodium falciparum?
- a. Diffused nuclear chromatin surrounding a dark blue chromatin mass.  
b. Slender sausage-shape with a concentrated mass of dark pigment near the center.  
c. Cytoplasm generally darker pink.  
d. Cytoplasm generally darker blue.
61. (430) Which term describes the appearance of merozoites of Plasmodium malariae in a single circle surrounding a large clump of hemozoin?
- a. Rosette.                                c. Rosewood.  
b. Cauliflower.                        d. Cartwheel.
62. (430) Of the various species of malaria, which causes the most severe disease in man?
- a. Plasmodium ovale.                    c. Plasmodium malariae.  
b. Plasmodium vivax.                    d. Plasmodium falciparum.
63. (431) Which granules will be present in greater numbers on red blood cells infected with Plasmodium ovale than on those infected with Plasmodium vivax?
- a. Maurer's.                                c. Schuffner's.  
b. Chromatin.                            d. Cytoplasmic.

90412 03 22

64. (431) The gametocytes of Plasmodium ovale are very much like those of P. malariae. They can be differentiated in thin blood films by the presence of which of the following?
- Ameboid shape
  - Light pigment.
  - Schuffner's granules.
  - Maurer's granules.
65. (432) As compared to other protozoa, Balantidium coli is
- the smallest found in man.
  - the largest found in man.
  - found in vertebrate animals only.
  - found in invertebrate animals only.
66. (432) The most prominent internal structures of Balantidium coli are the
- internal cilia.
  - quadranucleated cysts.
  - binucleated cysts.
  - two nuclei.
67. (433) Intestinal schistosomiasis is caused by which species of fluke?
- Schistosoma hepatica.
  - Schistosoma japonicum.
  - Schistosoma haematobium.
  - Schistosoma mansoni.
68. (433) Which choice presents the intermediate and definitive hosts, respectively, for the organism causing intestinal schistosomiasis?
- Snails and dogs.
  - Snails and man.
  - Fish and man.
  - Fish and dogs.
69. (433) To develop into adult male and female worms, cercariae of Schistosoma mansoni require an incubation period of
- 1 to 2 weeks.
  - 3 to 4 weeks.
  - 5 to 6 weeks.
  - 7 to 8 weeks.
70. (434) The adult worms of Schistosoma japonicum inhabit the
- smaller venules of the mesentery of the small intestine.
  - smaller venules of the mesentery of the large intestine.
  - duodenum.
  - large intestine and appendix.
71. (434) As compared to the eggs of the other species of schistosomes, Schistosoma japonicum eggs are
- smaller.
  - larger.
  - the same size.
  - longer and narrower.

90412 03 22

72. (435) Adult Schistosoma haematobium worms normally inhabit which parts of the body?
- The smaller venules of the mesentery of the large intestine.
  - The smaller venules of the mesentery of the small intestine.
  - The finer veins of the bladder and uterus.
  - The finer veins of the spleen and liver.
73. (435) Which choice best presents the shape and location of the spine on a Schistosoma haematobium egg?
- Blunt-pointed; at the anterior end.
  - Blunt-pointed; at the posterior end.
  - Sharp-pointed; at the anterior end.
  - Sharp-pointed; at the posterior end.
74. (436) All of the following are considered definitive hosts of Fasciola hepatica except
- humans.
  - sheep.
  - cattle.
  - snails.
75. (436) False fascioliasis can occur when
- someone ingests liver infected with Fasciola hepatica.
  - someone ingests liver infected with Fasciolopsis buski.
  - the eggs of Fasciola hepatica are discharged in the urine.
  - the eggs of Fasciolopsis buski are discharged in the urine.
76. (437) Man can be infected with Dicrocoelium dentriticum by accidentally ingesting
- snails that contain infective metacercariae.
  - ants that contain infective metacercariae.
  - fish that contain infective cercariae.
  - snails that contain infective cercariae.
77. (437) Eggs of Dicrocoelium dentriticum can be described as
- small and nonasymmetrical, thin-shelled with an operculum.
  - small and nonasymmetrical, thin-shelled with no operculum.
  - asymmetrically ovoidal, thick-shelled, dark brown in color, and having a broad convex operculum.
  - asymmetrically ovoidal thick-shelled, dark brown in color, and having no operculum.
78. (438) Identification of C. senensis is based on the recovery of typical eggs from
- uncontaminated bile.
  - catherized urine.
  - feces.
  - liver biopsy.

90412 03 22



79. (438) The egg of Clonorchis sinensis is
- small and ovoid with a distinct operculum that fits into a rimmed extension.
  - small and ovoid with no operculum.
  - large and round with a distinct operculum that fits into a rimmed extension.
  - large and round with no operculum.
80. (439) In comparison to O. Filineus, Clonorchis worms and eggs are, respectively,
- larger and slightly wider.
  - larger and slightly narrower.
  - smaller and slightly wider.
  - smaller and slightly narrower.
81. (440) The egg of Faciolopsis buski is practically identical to those of which fluke?
- Heterophyes heterophyes.
  - Opisthorchis felineus.
  - Clonorchis sinensis.
  - Fasciola hepatica.
82. (440) Diagnosis of Faciolopsis buski is based on which findings?
- The recovery of typical eggs in the sputum and on the physician's clinical findings.
  - The recovery of typical eggs in the feces and on the physician's clinical findings.
  - Intestinal obstruction, toxic reaction, and the recovery of eggs in the urine.
  - Intestinal obstruction, toxic reaction, and the recovery of eggs in the sputum.
83. (441) Since the egg of Heterophyes heterophyes is small, operculate, brownish in color, and contains a well-developed ciliated miracidium, it will be difficult to differentiate it from all of the following parasites except
- Opistorchis.
  - Clonorchis sinensis.
  - Metagonimus yokogawai.
  - Faciola hepatica.
84. (441) Heterophyes Heterophyes can be easily recovered by standard procedures from which specimen?
- Urine.
  - Feces.
  - Sputum.
  - Spinal fluid.

90412 03 22

85. (442) Man becomes infected with Metagonimus yokogawai by eating uncooked freshwater fish on which the infective metacercariae have encysted. The first intermediate hosts for M. yokogawai are
- clams.
  - fish.
  - snails.
  - shrimp.
86. (442) Diagnosis of Metagonimus yokogawai is based on the recovery of characteristic heterophyid eggs in which of the following?
- Blood.
  - Urine.
  - Feces.
  - Sputum.
87. (443) The adult worms of Paragonimus westermani usually live in pairs in which part of the body?
- The parenchyma of the lungs.
  - The intestinal mucosa.
  - Mesenteric lymphatics.
  - The bile passages and occasionally in the pancreatic duct.
88. (443) Specific diagnosis of Paragonimus westermani infection is easily made when the eggs are recovered from all of the following specimens except
- Peritoneal abscesses.
  - Blood-tinged sputum.
  - Pleural aspirates.
  - Blood-tinged urine.
89. (444) The Diphyllobothrium latum (commonly known as the fish or broad tapeworm) may be as long as
- 5 inches.
  - 35 inches.
  - 5 feet.
  - 35 feet.
90. (444) What are the principal diagnostic features of mature and gravid proglottids of Diphyllobothrium latum?
- Both have a centrally situated rosette-shaped uterus and a genital pore.
  - Mature proglottids are considerably longer, while gravid proglottids are broader.
  - Both have an eccentrically situated rosette-shaped uterus and a genital pore.
  - Mature proglottids are considerably longer and do not have a genital pore, while gravid proglottids are shorter and have a genital pore.

90412 03 22

91. (444) What features are noted at the anterior posterior poles, respectively, of the Diphyllobothrium latum egg?
- Thread-like filaments and a large polar knob.
  - A prominent operculum and a small knob-like protuberance.
  - No operculum and a large polar knob.
  - A prominent operculum and thread-like filaments.
92. (445) The gravid proglottid of the Taenia saginata has approximately how many main kateral branches on each side of the uterine stem?
- 2 to 4.
  - 5 to 10.
  - 10 to 15.
  - 15 to 20.
93. (445) The proglottids of the Taenia tapeworms can be easily observed by pressing the proglottids between two glass
- slides and using a hand lens.
  - cover slips and using a hand lens.
  - slides and using a dissecting microscope.
  - cover slips and use a dissecting microscope.
94. (446) Taenia solium is usually acquired by eating improperly cooked
- beef.
  - fish.
  - pork.
  - lamb.
95. (446) The gravid proglottid of the Taenia solium has how many lateral branches on each side of the uterine tube?
- 3 to 5.
  - 5 to 7.
  - 7 to 13.
  - 13 to 17.
96. (447) Which tapeworm is known as the dwarf tapeworm of man and is the mcst common tapeworm found in American ?
- Hymenolepis diminuta.
  - Hymenolepis nana.
  - Taenia saginata.
  - Taenia solium.

90412 03 22

97. (447) What distinguishes the scolex of H. nana from that of H. diminuta?
- The scolex of H. nana has rostellar crown of 20 to 30 hooklets whereas the scolex of H. diminuta has a deep sucker-like pocket into which a small rostellum with no hooklets is retracted.
  - The scolex of H. nana has a deep sucker-like pocket into which a small rostellum with no hooklets is retracted whereas the scolex of H. diminuta has a rostellar crown of 20 to 30 hooklets.
  - The scolex of H. nana has four suckers and a prominent rounded rostellum whereas the scolex of H. diminuta has a rostellar crown of 20 to 30 hooklets.
  - The scolex of H. nana has neighte rostellum nor attachment hooklets whereas the scolex of H. diminuta ha: a deep sucker-like pocket into which a small rostellum is retracted.
98. (448) In comparison to Hymenolepis nana, the worm of Hymenolepis diminuta is
- extremely variable in size.
  - the same size.
  - smaller.
  - larger.
99. (448) In comparison to Hymenolepis nana, the ova of Hymenolepis diminuta are
- smaller.
  - larger.
  - the same size.
  - extremely variable in size.
100. (449) The Dipylidium caninum species is the most common tapeworm found in the
- |                 |                   |
|-----------------|-------------------|
| a. dog and pig. | c. cat and pig.   |
| b. dog and cat. | d. pig and horse. |
101. (449) In terms of the lengths and thenubmer of proglottids, Dipylidium caninum and Hymenolepis diminuta
- have different lengths, and D. caninum has more proglottids.
  - have different lengths, and D. caninum usually has fewer proglottids.
  - are approximately the same length, but D. caninum usually has more proglottids.
  - are approximately the same length, but D. caninum usually has fewer proglottids.

90412 03 22

102. (449) One distinctive feature of the gravid proglottids of D. caninum is that they resemble
- a deep sucker-like pocket.
  - a rosette-shaped uterus.
  - the shape of a cucumber or pumpkin seed.
  - the shape of a pear of light bulb.
103. (450) The most common nematode infecting humans in the United States is
- Trichuris trichiura.
  - Enterobius vermicularis.
  - Ancylostoma duodenale.
  - Trichinella spiralis.
104. (450) What allows eggs of E. vermicularis to attach readily to a person's clothing and perianal skin?
- A sticky outer shell.
  - A sticky inner shell.
  - A slime secreted by the outer shell.
  - A slime secreted by the inner shell.
105. (451) Which adult worm has a whip-like anterior portion?
- Trichuris trichiura.
  - Enterobius vermicularis.
  - Strongyloides stercoralis.
  - Ancylostoma duodenale.
106. (451) Which color and shape best describes the usual appearance of Trichuris trichiura eggs?
- Clear and barrelshaped.
  - Clear and elliptical shape.
  - Golden brown and barrelshaped.
  - Golden brown and elliptical shape.
107. (452) The eggs of Ascaris lumbricoides appear golden brown when passed in the feces because they are
- aged when passed.
  - coated with feces.
  - stained by pigments from ruptured rbc's.
  - stained by bile pigments in the intestinal tract of the host.
108. (452) Ascaris lumbricoides eggs differ from hookworm eggs in the A. lumbricoides eggs have a much thicker shell and contain an individual cell mass whereas hookworm eggs
- are fully embryonated when passed.
  - contain a zygote that is usually in the two cell state.
  - contain a zygote that is in the four or eight cell stage.
  - are fertilized and broadly ovoidal with a thick, transparent shell.

90412 03 22

109. (453) How do the infective stage filariform larvae of Necator americanus infect the human host?
- By penetrating the skin.
  - By infecting waterchestnuts which are then eaten by man.
  - By infecting fruits and meats which are then eaten by man.
  - By penetrating snails and fish eaten by the host.
110. (453) Which statement is correct regarding Necator americanus and Ancylostoma duodenale parasites?
- The eggs cannot be differentiated.
  - Ancylostoma duodenale are more slender.
  - Necator americanus are more slender.
  - Only Necator americanus eggs are referred to as "hookworm ova."
111. (454) When rhabditiform larvae of the Strongyloides stercoralis follow the indirect route of development, they
- are deposited on dry, cool soil.
  - live as long as two months in the soil.
  - develop into free-living adult male and female worms.
  - develop into infective filariform larvae within 24 hours after leaving the intestine.
112. (454) Which point should be noted to differentiate the rhabditoid larvae of Strongyloides from those of hookworms?
- The larva of hookworm has a notched tail.
  - The larva of Strongyloides has a pointed tail.
  - The buccal canal of Strongyloides is very short.
  - The genital primordium of Strongyloides is much smaller.
113. (455) Trichinella is unique among intestinal nematodes of man in that
- its principal reservoir is the rat.
  - it has an embryonic stage known as microfilaria.
  - the young larvae live and grow in involuntary muscle.
  - its life cycle does not include any development stages outside the body of a host.
114. (455) After exposure, approximately how many days does it take for larvae of Trichinella spiralis to reach the striated muscles?
- |                 |                   |
|-----------------|-------------------|
| a. 1 to 2 days. | c. 7 to 14 days.  |
| b. 3 to 5 days. | d. 15 to 30 days. |

90412 03 22



115. (456) In areas where Wuchereria bancrofti demonstrates nocturnal periodicity, microfilariae are most readily detected in blood specimens taken
- a. at night.
  - b. during the day.
  - c. in the early morning.
  - d. in the early afternoon.
116. (456) The microfilariae of Onchocerca volvulus are usually found in which specimen?
- a. Fecal specimen collected at night.
  - b. Gastric contents collected at any time.
  - c. Peripheral blood specimen collected at the peak of the fever.
  - d. Skin-snip specimen collected at any time.
117. (457) As compared to filarial worms, the size of the adult female Dracunculus medinensis is
- a. the same.
  - b. larger.
  - c. somewhat smaller.
  - d. very much smaller.
118. (458) If a patient is suspected of being infected with Dracunculus medinensis, how can the larvae be demonstrated?
- a. Examine fecal material microscopically.
  - b. Rupture any blisters by applying water.
  - c. Centrifuge arterial blood.
  - d. Prepare egg cultures.
119. (458) Which of the following zoonotic nematodes are found embedded in the mucosa near the junction of the large intestines and have eggs very similar to but smaller than those of Trichuris trichiura?
- a. Syngamus.
  - b. Ancylostoma ceylanicum.
  - c. Capillaria philippinensis.
  - d. Ternidens deminutus.
120. (458) Which listed information is useful in confirming a diagnosis of Trichostrongylus orientalis infection?
- a. Eggs are smaller than hookworm eggs.
  - b. Eggs are more blunt on both ends than hookworm eggs.
  - c. Eggs measure 25 to 65 by 15 to 35  $\mu\text{m}$ .
  - d. Eggs measure 70 to 90 by 40 to 50  $\mu\text{m}$ .

90412 03 22

121. (459) All of the following are true of Dirofilaria immitis except that it
- a. is the heartworm of dogs.
  - b. utilizes mosquitoes as intermediate hosts.
  - c. has been found in the lungs of humans.
  - d. has been frequently found in human feces.
122. (459) The course of their migrations leads the larvae of Angiostrongylus cantonensis to which of the following in both rats and man?
- a. Lungs.
  - b. Brain.
  - c. Kidneys.
  - d. Liver.
123. (460) What infection of young children may be caused by parasites of the genus Toxocara?
- a. Cutaneous larva migrans.
  - b. Visceral larva migrans.
  - c. Infantile paralysis.
  - d. Ringworm.
124. (460) Ancylostoma has been proven to be a cause of
- a. massive abscesses.
  - b. cutaneous larva migrans.
  - c. elephantiasis.
  - d. visceral larva migrans.

## ATC/ECI SURVEY

The remaining questions (125-135) are not part of the Volume Review Exercise (VRE). These questions are a voluntary ATC/ECI survey. Using a number 2 pencil, indicate what you consider to be the appropriate response to each survey question on your answer sheet (ECI Form 35), beginning with answer number 125. Do not respond to questions that do not apply to you. Your cooperation in completing this survey is greatly appreciated by ATC and ECI. (AUSCN 100)

### PRIVACY ACT STATEMENT

- A. Authority: 5 U.S.C. 301, Departmental Regulations
- B. Principal Purpose: To gather preliminary data evaluating the ATC/ECI Career Development Course (CDC) Program.
- C. Routine Uses: Determine the requirement for comprehensive evaluations in support of CDC program improvement.
- D. Whether Disclosure is Mandatory or Voluntary: Participation in this survey is entirely voluntary.
- E. Effect on the Individual of not Providing Information: No adverse action will be taken against any individual who elects not to participate in any or all parts of this survey.

### QUESTIONS:

125. If you have contacted ECI for any reason during your enrollment, how would you describe the service provided to you?

- a. Excellent.
- b. Satisfactory.
- c. Unsatisfactory.
- d. Did not contact ECI.

126. My ECI course materials were received within a reasonable period of time.

- a. Strongly agree.
- b. Agree.
- c. Disagree.
- d. Strongly disagree.

127. The condition of the course materials I received from ECI was:

- a. A complete set of well-packaged materials.
- b. An incomplete set of well-packaged materials.
- c. A complete set of poorly packaged materials.
- d. An incomplete set of poorly packaged materials.

90412 03 22

128. The reading level of the material in the course was too difficult for me.

- a. Strongly agree.
- b. Agree.
- c. Disagree.
- d. Strongly disagree.

129. The technical material in the course was too difficult for me at my present level of training.

- a. Strongly agree.
- b. Agree.
- c. Disagree.
- d. Strongly disagree.

130. The illustrations in the course helped clarify the information for me.

- a. Strongly agree.
- b. Agree.
- c. Disagree.
- d. Strongly disagree.

131. Approximately how much information in the course provides general information about your AFSC?

- a. Between 80 and 99%.
- b. Between 60 and 79%.
- c. Between 40 and 59%.
- d. Between 20 and 39%.

132. Approximately how much information in this course was current?

- a. Between 80 and 99%.
- b. Between 60 and 79%.
- c. Between 40 and 59%.
- d. Between 20 and 39%.

133. The format of the text (objective followed by narrative and exercises) helped me study.

- a. Strongly agree.
- b. Agree.
- c. Disagree.
- d. Strongly disagree.

134. The volume review exercise(s) helped me review information in the course.

- a. Strongly agree.
- b. Agree.
- c. Disagree.
- d. Strongly disagree.

135. Check the rating which most nearly describes the usefulness of the information in this CDC in your upgrade training program.

- a. Excellent.
- b. Satisfactory.
- c. Marginal.
- d. Unsatisfactory.

**NOTE:** If you know this CDC contains outdated information or does not provide the knowledge that the current specialty training standard requires you to have for upgrade training, contact your OJT advisor and fill out an AF Form 1284, Training Quality Report.

90412 05 22

**STUDENT REQUEST FOR ASSISTANCE**

PRIVACY ACT STATEMENT

AUTHORITY: 44 USC 3101. PRINCIPAL PURPOSE(S): To provide student assistance as requested by individual students. ROUTINE USES: This form is shipped with every ECI course package. It is utilized by the student, as needed, to place an inquiry with ECI. DISCLOSURE: Voluntary. The information requested on this form is needed for expeditious handling of the student's need. Failure to provide all information would result in slower action or inability to provide assistance.

**SECTION I: CORRECTED OR LATEST ENROLLMENT DATA:** MAIL TO ECI, GUNTER AFS ALA 36118

1. THIS REQUEST CONCERNS COURSE <input style="width:100%; height:20px;" type="text"/>	2. TODAY'S DATE <input style="width:100%; height:20px;" type="text"/>	3. ENROLLMENT DATE <input style="width:100%; height:20px;" type="text"/>	4. PREVIOUS SERIAL NUMBER <input style="width:100%; height:20px;" type="text"/>
5. SOCIAL SECURITY NUMBER <input style="width:100%; height:20px;" type="text"/>	6. GRADE/RANK <input style="width:100%; height:20px;" type="text"/>	7. INITIALS <input style="width:100%; height:20px;" type="text"/>	LAST NAME <input style="width:100%; height:20px;" type="text"/>
8. OTHER ECI COURSES NOW ENROLLED IN <input style="width:100%; height:20px;" type="text"/> <input style="width:100%; height:20px;" type="text"/> <input style="width:100%; height:20px;" type="text"/>	9. ADDRESS. (OJT ENROLLEES - ADDRESS OF UNIT TRAINING OFFICE/ALL OTHERS - CURRENT MAILING ADDRESS) <input style="width:100%; height:20px;" type="text"/> <input style="width:100%; height:20px;" type="text"/> <input style="width:100%; height:20px;" type="text"/>		11. AUTOVON NUMBER <input style="width:100%; height:20px;" type="text"/>
	ZIP CODE <input style="width:100%; height:20px;" type="text"/>	12. TEST CONTROL OFFICE ZIP CODE/SHRED <input style="width:100%; height:20px;" type="text"/>	
	10. NAME OF BASE OR INSTALLATION IF NOT SHOWN ABOVE: <input style="width:100%; height:20px;" type="text"/>		

**SECTION II: Old or INCORRECT ENROLLMENT DATA**

1. NAME:	2. GRADE/RANK:	3. SSAN:
4. ADDRESS:	5. TEST OFFICE ZIP/SHRED:	

**SECTION III: REQUEST FOR MATERIALS, RECORDS, OR SERVICE**

ADDITIONAL FORMS 17 available from trainers, OJT and Education Offices, and ECI. The latest course workbooks have a Form 17 printed on the last page.

(Place an "X" through number in box to left of service requested)

1	EXTEND COURSE COMPLETION DATE. (Justify in Remarks)
2	SEND VRE ANSWER SHEETS FOR VOL(s): 1 2 3 4 5 6 7 8 9 - ORIGINALS WERE: NOT RECEIVED, LOST, MISUSED
3	SEND COURSE MATERIALS (Specify in remarks) - ORIGINALS WERE: NOT RECEIVED, LOST, DAMAGED.
4	COURSE EXAM NOT YET RECEIVED. FINAL VRE SUBMITTED FOR GRADING ON (Date):
5	RESULTS FOR VRE VOL(s): 1 2 3 4 5 6 7 8 9 NOT YET RECEIVED. ANSWER SHEET(s) SUBMITTED ON (Date):
6	RESULTS FOR CE NOT YET RECEIVED. ANSWER SHEET SUBMITTED TO ECI ON (Date):
7	PREVIOUS INQUIRY (ECI FORM 17, LTR, MSG) SENT TO ECI ON:
8	GIVE INSTRUCTIONAL ASSISTANCE AS REQUESTED ON REVERSE:
9	OTHER (Explain fully in remarks)

REMARKS. (Continue on Reverse)

OJT STUDENTS must have their OJT Administrator certify this request.	I certify that the information on this form is accurate and that this request cannot be answered at this station. (Signature)
ALL OTHER STUDENTS may certify their own requests.	

ECI FORM 17 JUN 77 PREVIOUS EDITIONS MAY BE USED

**SECTION IV: REQUEST FOR INSTRUCTOR ASSISTANCE**

**NOTE:** Questions or comments relating to the accuracy or currency of textual material should be forwarded directly to preparing agency. Name of agency can be found at the bottom of the inside cover of each text. All other inquiries concerning the course should be forwarded to ECI.

VRE ITEM QUESTIONED. MY QUESTION IS:

Course No. \_\_\_\_\_

Volume No. \_\_\_\_\_

VRE Form No. \_\_\_\_\_

VRE Item No. \_\_\_\_\_

Answer You Chose  
(Letter) \_\_\_\_\_

Has VRE Answer Sheet  
been submitted for grading?

YES  NO

**REFERENCE**

(Textual support for the  
answer I chose can be  
found as shown below)

In Volume No: \_\_\_\_\_

On Page No: \_\_\_\_\_

In \_\_\_\_\_ (Left) \_\_\_\_\_ (Right)  
Column

Lines \_\_\_\_\_ Through \_\_\_\_\_

Remarks:



90412 04 8201

CDC 90412

# MEDICAL LABORATORY TECHNICIAN — MICROBIOLOGY

(AFSC 90470)



Volume 4

*Laboratory Procedures in Clinical  
Mycology*



Extension Course Institute

Air Training Command

481

Prepared by  
CMSgt Joselyn H. Thompson  
School of Health Care Sciences, USAF (ATC)  
Sheppard Air Force Base, Texas 76311

Reviewed by: Elmore C. Hall, Education Specialist  
Edited by: Tommie F. Davis  
Extension Course Institute (ATC/AU)

Gunter AFS, Alabama 36118



SCHOOL OF HEALTH CARE SCIENCES, USAF (ATC)  
SHEPPARD AIR FORCE BASE, TEXAS

---

EXTENSION COURSE INSTITUTE, GUNTER AIR FORCE STATION, ALABAMA

THIS PUBLICATION HAS BEEN REVIEWED AND APPROVED BY COMPETENT PERSONNEL OF THE PREPARING COMMAND  
IN ACCORDANCE WITH CURRENT DIRECTIVES ON DOCTRINE, POLICY, ESSENTIALITY, PROPRIETY, AND QUALITY.

## P r e f a c e

THE TECHNICIAN with limited experience in mycology is frequently required to culture and identify fungi isolated from clinical specimens. Even though the technician often requires guidance in identifying the great variety of organisms encountered, this volume is intended to provide a brief but excellent source of information concerning the characteristics of fungi of medical importance. This will include discussions of the taxonomic relationships, cellular morphology, cultural properties of fungi, and the fungi as disease agents. You will also learn collection and processing techniques, as well as guidelines for shipping specimens. There are discussions of yeastlike fungi, monomorphic molds, dimorphic fungi, and saprophytic fungi. Finally, the last chapter of the volume presents the most recent guidelines for the collection, preservation, packaging, and shipment of clinical specimens for viral and rickettsial studies.

Three color illustrations, foldouts 1, 2, and 3, are included as a supplement.

The inclusion of names of any specific commercial product, commodity, or service in this publication is for information purposes only and does not imply indorsement by the Air Force.

A glossary of terms used in this course is included in this volume.

Direct your questions or comments relating to the accuracy or currency of this volume to the course author: SHCS/MJTW, USAF, ATTN: CMSgt J. H. Thompson, Sheppard AFB TX 76311. If you need immediate response, call the author, AUTOVON 736-2809, between 0800 and 1600 hours (CST), Monday through Friday. *(NOTE: DO NOT use the suggestion program to submit changes or corrections for this course.)*

If you have questions on course enrollment or administration, or on any of ECI's instructional aids (Your Key to a Successful Course, Behavioral Objective Exercises, Volume Review Exercise, and Course Examination), consult your education officer, training officer, or NCO, as appropriate. If this person can't answer your questions, send them to ECI, Gunter AFB AL 36118, preferably on ECI Form 17, Student Request for Assistance.

This volume is valued at 30 hours (10 points).

Material in this volume is technically accurate, adequate, and current as of July 1981.

# Contents

	<i>Page</i>
<i>Preface</i> . . . . .	<i>iii</i>
<i>Chapter</i>	
1 Introduction to Medical Mycology . . . . .	1
2 The Yeastlike Fungi and the Monomorphic Molds . . . . .	24
3 The Pathogenic Dimorphic Fungi . . . . .	59
4 The Saprophytic Fungi . . . . .	73
5 Laboratory Diagnosis of Viral Rickettsial and Chlamydial Diseases . . . . .	91
<i>Bibliography</i> . . . . .	111
<i>Glossary</i> . . . . .	113
<i>Answers for Exercises</i> . . . . .	116

**NOTE:** In this volume, the subject matter is developed by a series of student-centered objectives. Each of these carries a three-digit number and is in boldface type. Each sets a learning goal for you. The text that follows the objective gives you the information you need to reach that goal. The exercises following the information give you a check on your achievement. When you complete them, see whether your answers match those in the back of this volume. If your response to an exercise is incorrect, review the objective and its text.

## Introduction to Medical Mycology

**MEDICAL MYCOLOGY** is the study of fungi which can invade the human body and produce disease. Fungi are small members of the plant kingdom without chlorophyll, roots, stems, or leaves. They have extremely simple fundamental structures known as hyphae (vegetative structures) and spores (reproductive structures). With these two basic structures they live, multiply, and carry out the other functions characteristic of micro-organisms in general.

This chapter shows the basis for classifying fungi, describes their morphological and cultural properties, and gives methods for the collection and processing of specimens. The techniques commonly used in identification of the medically important fungi are discussed. We discuss in some detail in subsequent chapters the yeastlike fungi, the monomorphic molds, the dimorphic or diphasic fungi, and finally the saprophytic forms. Chapter 5 of this volume introduces you to the nature of the viruses and sets forth the guidelines for collection, preservation, and shipment of clinical specimens for diagnostic testing.

### 1-1. Characteristics of the Fungi

Fungi lack chlorophyll and are probably degenerate offsprings of chlorophyll-bearing ancestors, most likely the algae. They are nonmotile (with the exception of certain spore forms) and may grow as single cells (yeasts) or as long branched filamentous structures (mycelia). Most fungi produce asexual and sexual spores, and their identification into classes is, to a great extent, based on the type of spore and the method by which these spores are produced.

**600.** Identify the two subdivisions of fungi in terms of the types of fungi produced, the four given classes of the subdivision Eumycotina in terms of the types which are

**common to them, hyphae produced, spore produced, types of reproduction, and their pathogenic significance.**

**Classification.** Many classification systems are available for the fungal groups, but most of them are complicated and difficult for practical purposes. Figure 1-1 is a relatively simple scheme that can be used to classify these micro-organisms. In this system, the fungi are grouped into two subdivisions of the division Mycota: the Eumycotina (true fungi) and Myxomycotina (true slime molds). For all practical purposes, the Eumycotina are divided into four classes. The four classes and their subgroups are outlined in figure 1-1. The distinguishing characteristics of each class are summarized in table 1-1. The terms used to describe the various structural parts are defined in the glossary at the end of the volume.

**Class *Phycomycetes*.** The class *Phycomycetes* contains the most primitive of the fungi. Most members produce broad, aseptate hyphae. They reproduce asexually by forming sporangia that contain sporangiospores (endospores). Sexual reproduction when present is by means of gametes, gametangia, oospores, or zygospores. The asexual structures are depicted in figure 1-2. This group contains only a few pathogens.

**Class *Ascomycetes*.** The class *Ascomycetes* is represented by two morphologically distinct types. The first type has unicellular, round, or oval forms reproducing asexually by the simple budding of blastospores, as shown in figure 1-3,A. This type is represented by the perfect yeast, genus *Saccharomyces*. Under favorable conditions, sexual ascospores are formed. Four or eight ascospores develop within each saclike inclosure called an ascus. The asci break open to release ascospores. This is illustrated in figure 1-3,B. Note in figure 1-3,C, that a second type of *Ascomycetes* has separate hyphae producing filamentous forms

KINGDOM - Protista  
 DIVISION - Mycota (fungi)  
 SUBDIVISION 1. Eumycotina (true fungi, eumycetes)  
   Class 1. Phycomycetes (primitive fungi)  
     Subclass 1. Chytridiomycetidae (water molds)  
       Order Chytridiales  
         Blastocladales  
         Monoblepharidiales  
     Subclass 2. Hyphochytridiomycetidae (water molds)  
       Order Hydrochytriales  
     Subclass 3. Oomycetidae (water molds, blights, downy mildews)  
       Order Saprolegniales  
         Leptomitales  
         Leginidales  
         Peronosporales  
     Subclass 4. Plasmodiophoromycetidae (club-root organisms)  
       Order Plasmodiophorales  
     Subclass 5. Zygomycetidae (bread molds, pin molds)  
       Order Mucorales  
         Entomophthorales  
         Zoopagales  
     Subclass 6. Trichomycetidae (commensals with arthropods)  
   Class 2. Ascomycetes (sac fungi)  
     Subclass 1. Hemiascomycetidae  
     Subclass 2. Euascomycetidae  
     Subclass 3. Loculoascomycetidae  
   Class 3. Basidiomycetes (club fungi)  
     Subclass 1. Heterobasidiomycetidae  
     Subclass 2. Homobasidiomycetidae  
   Class 4. Deuteromycetes (Fungi Imperfecti)  
     Order Sphaeropsidales  
       Melanconiales  
       Moniliales  
       Mycelia Sterilia  
 SUBDIVISION 2. Myxomycotina (slime fungi)  
   Class 1. Myxomycetes  
   Class 2. Acrasiomycetes

Figure 1-1 Classification of fungi

which reproduce asexually by spores called conidia. Some pathogens are found in this group.

*Class Basidiomycetes.* In the class *Basidiomycetes* the mycelium is septate. Sexual reproduction is by means of basidiospores developed on club-shaped structures called basidia. Each basidium usually bears four exogeneous basidiospores resembling toes on a foot. Figure 1-4 shows these characteristics. This group includes the rusts, smuts, fleshy mushrooms, and puffballs. They play no role in disease production in humans, except in mushroom poisoning.

*Class Deuteromycetes* The class *Deuteromycetes* (fungi imperfecti) contains, with few exceptions, the fungi pathogenic to man. These fungi lack a demonstrable means of sexual reproduction and, therefore, are considered imperfect. They are represented by two morphologically distinct types: a septate, filamentous (mold) form, shown in figure 1-5, and an imperfect yeast form resembling the perfect yeast form, shown in figure 1-3,A. The Deuteromycetes are important because they include many known disease-producing fungi.



Taxonomic Class of Fungi	Septate	Type of reproduction	Characteristics of spore	Formation of spore	Similar organisms	Pathogenicity
Phycomycetes	Aseptate	Asexual	Sporangiospore	Sporangiospore	Nuisance fungi including genera <i>Asclia</i> , <i>Mucor</i> , and <i>Phytophthora</i>	Very rare - Mucormycosis
		Sexual	Zygospore or oospore	Fusion of nuclei		
Ascomycetes	Septate	Asexual	Blastospore	Budding	<i>Allocheria</i> <i>Aspergillus</i> <i>Piedra</i>	----Rare---- Maduromycosis Aspergillosis Black Piedra
			Conidium	Conidiophore		
		Sexual	Ascospore	Ascus	<i>Saccharomyces</i> (perfect yeast)	
Basidiomycetes	Septate	Sexual	Basidiospore	Basidium	Mushrooms, smuts and rusts	----Rare---- Mushroom poisoning
Deuteromycetes (fungi imperfecti)	Septate	Asexual	Thallospore	Thallus (hypha)	Most saprophytes and pathogens encountered in medical mycology (Imperfect mold and yeast)	Most mycoses encountered in medical mycology
			Conidium	Conidiophore		

TABLE 1-1  
CHARACTERISTICS OF THE CLASSES OF FUNGI

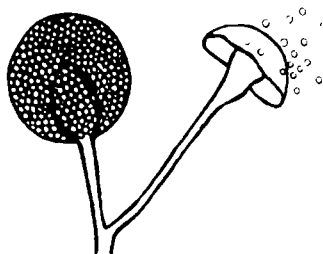

Figure 1-2 Asexual structures of Phycomycetes

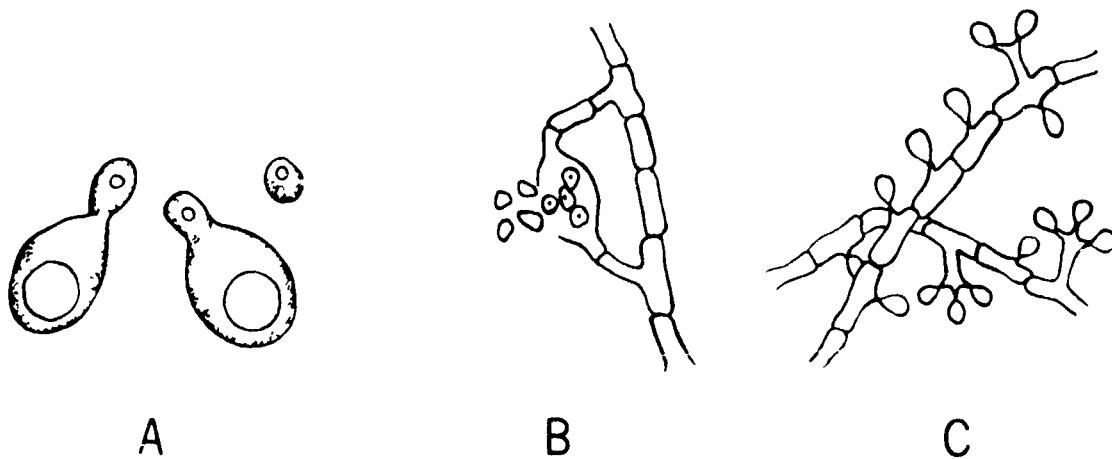

Figure 1-3 Reproductive forms of Ascomycetes

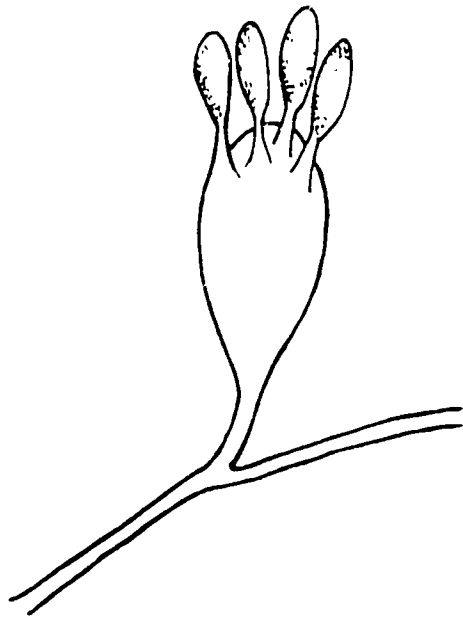

Figure 1-4 Characteristics of basidiospores

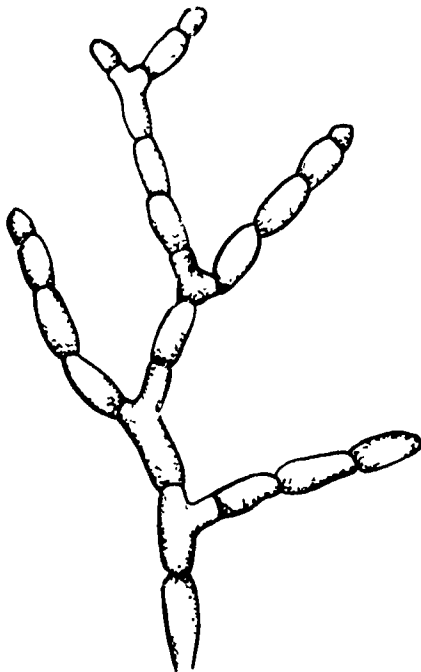

Figure 1-5 Mold form of Deuteromycetes

Exercises (600):

1. Match each column B item with the statements in column A by placing the letter of the column B item beside the number of the column A item that most nearly describes it. Each element in column B may be used once, more than once, or not at all.

Column A	Column B
___ (1) The division classified as true slime molds	a <i>Deuteromycetes</i>
___ (2) The division classified as true fungi	b <i>Ascomycetes</i>
___ (3) Divided into four classes	c <i>Basidiomycetes</i>
___ (4) Contains the most primitive of the fungi	d <i>Phycomycetes</i>
___ (5) Most members produce broad, aseptate hyphae	e Eumycotina
___ (6) This class produces a perfect yeast, genus <i>Saccharomyces</i>	f Myxomycotina
___ (7) Sexual reproduction is represented by means of gametes, gametangia, oospores, or zygospores	g <i>Myxomycetes</i>
___ (8) The second part of this class has septate hyphae producing filamentous forms which reproduce asexually by spores called conidia.	h Blastocladales
___ (9) Examples of this type are nuisance fungi including genera <i>Absidia</i> , <i>Mucor</i> , and <i>Rhizopus</i> .	
___ (10) Sexual reproduction is by means of basidio-spores developed on club-shaped structures called basidia	
___ (11) This group includes the rusts, smuts, fleshy mushrooms, and puffballs	
___ This class contains, with few exceptions, the fungi pathogenic to man	
___ (13) Examples of this group include most saprophytes and pathogens encountered in medical importance	
___ (14) These fungi lack a demonstrable means of sexual reproduction and, therefore, are considered imperfect	

601. Cite the characteristics of the vegetative phase of the fungi life cycle in terms of the cellular morphology, the manner in which they relate to each other, and their functions.

**Cellular Morphology.** The microscopic morphology of the fungi shown in the foregoing figures is an important aid to identification. The type of hypha, spore and spore-bearing structure, and the manner in which these organs relate to each other in many instances will give a direct, accurate diagnosis of the mycotic agent

under investigation. When direct morphological studies in themselves are not sufficient, special techniques must be utilized. These techniques will be discussed in detail in Section 1-3 of this chapter.

The life cycle of the fungi can be separated into two phases: the vegetative and the reproductive.

**Vegetative Phase.** The vegetative phase is characterized by elongated, branching filaments which may be septate or aseptate (refer to the glossary for the distinction between them). These tubular filaments are known individually as hypha, or a hyphae, when more than one is being considered. A mass of hyphae is referred to as a mycelium. The hyphae have cell walls of varying thicknesses lined with layers of cytoplasm. The thickness of the walls may increase greatly as the fungus matures. Chitin is the primary constituent of the cell walls of most of the higher fungi; while in some forms, cellulose is probably the chief ingredient. If cross-walls (septa) are formed, the hypha is divided into cells, and each cell may contain one, two, or several nuclei. When cross-walls are not formed (aseptate or coenocytic hypha), the entire hyphal filament is made up of a single cell with many nuclei embedded in the peripheral cytoplasm; and scattered fairly uniformly throughout its mass.

Vegetative hyphae have a twofold function. They first serve to anchor the fungus to the substratum—either by penetration of simple hyphal filaments or, as in the case of the Genus *Rhizopus*, by means of rootlike rhizoids which permit better adherence to the substratum and provide a greater surface area for direct diffusion. The diffusion of enzymes from the fungus into the substratum converts nutrient material into simpler compounds which can be absorbed by the fungus and used for its growth and reproduction. The second important function of vegetative hyphae, then, is the procurement of food.

#### Exercises (601):

1. What type of filaments may be noted in the vegetative phase of the fungi life cycle?
2. What are the individual tubular filaments called?
3. What is a mass of these individual filaments called?
4. What substance is the primary constituent of the cell walls of most higher fungi?
5. What are the two functions of the vegetative hyphae?

602. State conditions for the development of the reproductive phase of the fungi life cycle, the morphological structures present, the types of structures, and their functions.

**Reproductive Phase.** The reproductive phase usually commences when the fungus has reached maturity or when it faces unfavorable environmental conditions, such as temperature variations or lack of nourishment. The reproductive organ is called a spore. The spore may either be unicellular or multicellular; and when released from the mother plant, it is capable of duplicating the species. Although primarily reproductive in function, spores additionally serve to disperse the fungus and protect it from extinction during adverse environmental conditions. Spores may be sexual (formed by the fusion of two nuclei) or asexual. Asexual sporulation takes place by simple fission of a single nucleus. Some fungi are capable of only asexual sporulation, whereas others have the capacity for both asexual and sexual spore formation. Along with characteristic morphology, the way in which they reproduce is an important means of classifying and identifying fungi. of asexual spores: the thallospore (body spore), endospore, and the ectospore. The thallospores are further delineated into three varieties: the arthrospore, blastospore, and chlamyospore. These various forms are shown in figure 1-6. Arthrospores develop within a septate hyphal filament, shown in figure 1-6,A. They are disseminated by a breaking up of the spore chain thus formed. Blastospores, shown in figure 1-6,B, arise from simple budding of the yeast or yeastlike fungi. They may also develop directly from true or pseudomycelia. The chlamyospore, shown in figure 1-6,C, is a rounded, thick-walled body which is formed by a vegetative hyphal segment. It is a highly resistant, resting spore capable of survival long after the vegetative mycelium has lost its viability.

A second asexual type of spore, called an endospore (see fig. 1-2), is borne within a saclike membrane. The last variety of asexual spore, the entospore, is formed either directly on the mycelium or on a modified supportive structure (for example, conidiophore, sporangiophore). Ectospores are always borne free (no inclosure), vary greatly in size and shape, and are technically referred to as conidia. The small, unicellular type is called a microconidium, while the larger, multicellular type is termed a macroconidium. Examples of both types are shown in figure 1-7,A and B. Almost all the medically important fungi belong to the class *Deuteromycetes*, in which no sexual means of reproduction has been found. Therefore, our discussion of sexual sporulation will be limited to those few cases where specific identification demands it.

#### Exercises (602):

1. Under what conditions would the reproductive phase commence?

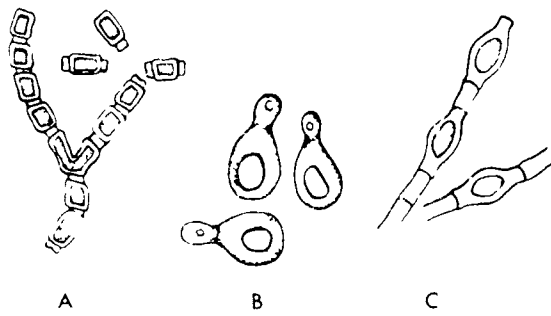

Figure 1-6 Varieties of thallospores

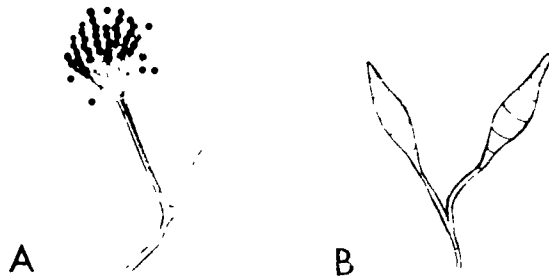

Figure 1-7 Ectospores (*microconidium*, *macroconidium*)

2. What are two environmental conditions that could activate the reproductive phase?
3. The reproductive organ is called a \_\_\_\_\_.
4. What three important functions does the spore serve?
5. What are the three varieties of the asexual spore?
6. List the three types of thallospores?
7. How does the endospore differ from the ectospore?
8. Ectospores vary greatly in size and shape and are technically referred to as \_\_\_\_\_.
9. The small unicellular type of ectospore is called a \_\_\_\_\_ while the larger, multicellular type is termed a \_\_\_\_\_.
10. Almost all the medically important fungi belong to the class \_\_\_\_\_.

**603. Cite the pH at which fungi grow best, oxygen requirement for growth, some antibiotics used in culture media and their purpose and disadvantage, difference in growth rate between bacteria and pathogenic fungi, and the size of fungi when compared with bacteria.**

**Cultural Properties.** Like bacteria, the fungi are lacking in chlorophyll and must rely on some source of available organic material for food. There are fungi which can produce enzymes capable of breaking down nearly all the organic substances known to man. In some cases, their food requirements include complex sugars, proteins, and fats. Other fungi have little need for preformed nutrients and can grow in pickle brine or organic acids when the necessary minerals are present. It is not unusual to find fungi growing on fingerprints left on camera lenses. Unlike the bacteria, which prefer a slightly alkaline pH, fungi grow best at an acid pH, normally around pH 5.6. Commercially prepared Sabouraud dextrose agar, the primary isolation medium for most pathogenic fungi, will closely approximate this figure when rehydrated for use. A modified Sabouraud dextrose agar with pH 6.5 to 6.8 and containing antibiotics has been found more effective in recovering medically important fungi on initial isolation. With the exception of members of the genus *Actinomyces*, the pathogenic fungi are aerobic and require oxygen for growth.

Since the fungi and many bacteria can use identical substances for growth, antibiotics (chloramphenicol, cycloheximide) are often incorporated into Sabouraud dextrose agar and other fungi media to inhibit contaminating bacteria and saprophytic fungi. There is one disadvantage, however; numerous fungi of medical importance are also inhibited and may not be recorded from initial plating if antibiotics are present.

There is a considerable difference in the growth rate between the fungi and the bacteria. When culturing bacteria, colony examination and biochemical testing can usually be accomplished 24 to 48 hours after the specimen is inoculated to media. The fungi, particularly the pathogenic forms, may require 3 to 5 weeks, or longer, to reach a growth state which permits definitive diagnosis.

From the standpoint of size, the fungi are relatively large in comparison to the bacteria. The yeasts (nonfilamentous fungi) generally reach a diameter of about 5 or 6 microns, almost as large as an average red blood cell. Filamentous mold hyphae normally range in width from 5 to 50  $\mu\text{m}$  and may attain a length of several millimeters.

#### Exercises (603):

1. There are fungi which can produce \_\_\_\_\_ capable of breaking down nearly all \_\_\_\_\_ known to man.

2. Fungi grow best at an \_\_\_\_\_ pH, normally around pH \_\_\_\_\_.

3. What are two antibiotics often incorporated into fungus media?

4. Pathogenic fungi are \_\_\_\_\_ and require \_\_\_\_\_ for growth.

5. Antibiotics are incorporated in fungus media for what purpose?

6. What disadvantages must be considered when using media in which antibiotics are incorporated?

7. When culturing bacteria, colony examination and biochemical testing can usually be accomplished \_\_\_\_\_ to \_\_\_\_\_ hours after specimen inoculation. The pathogenic fungi may require \_\_\_\_\_ to \_\_\_\_\_ (days/weeks) or longer to reach a growth state which permits definitive diagnosis.

8. From the standpoint of size, the fungi are relatively (large/small) in comparison to the bacteria.

**604. Point out the two basic fungal forms and their characteristics and the three varieties of fungi based on colony appearance and the characteristics of each.**

**Colony Morphology.** One of the most important criteria for identifying the fungi is colonial appearance. As previously noted, there are two basic fungal forms: the yeasts (characterized by simple budding) and the filamentous molds (recognized by production of innumerable filamentous hyphae). Certain fungus species of medical importance are known to multiply only by budding, regardless of whether they are incubated at 25° or 35° C. This budding type of multiplication produces a pasty or mucoid, rounded colony on the substratum that could easily be mistaken for bacterial growth. Fungi which propagate only by budding are designated monomorphic (one-form) yeasts.

Other genera of medical importance are known to multiply solely by the protrusion of a germ tube through the spore wall (spore germination), whether cultured at

TABLE 1-2  
CLASSIFICATION OF PATHOGENIC FUNGI ACCORDING TO MACROSCOPIC MORPHOLOGY

THE YEAST-LIKE FUNGI

Superficial Fungus

*Trichosporon cutaneum*

Cutaneous Fungi

*Candida albicans*<sup>1</sup> and *Candida* spp.

Systemic Fungi

*Cryptococcus neoformans*  
*Geotrichum candidum*

MONOMORPHIC MOLD FUNGI

Superficial Fungi

*Piedraia hortai*  
*Pullularia werneckii*

Cutaneous (Dermatophytic) Fungi

*Microsporum* spp.  
*Trichophyton* spp.  
*Epidermophyton floccosum*  
*Keratinomyces ajelloi*

Subcutaneous (Chromoblastomycotic) Fungi

*Cladosporium carrionii*  
*Fonsecaea compacta*  
*Fonsecaea pedrosoi*  
*Phialophora verrucosa*

Subcutaneous (Maduromycotic) Fungi

*Allegheria boydii*  
*Madurella grisea*  
*Madurella mycetomii*  
*Phialophora jeanselmei*

Systemic Fungi

*Actinomyces israelii*  
*Actinomyces bovis*  
*Nocardia asteroides*  
*Coccidioides immitis*

DIMORPHIC FUNGI

Subcutaneous Fungi

*Sporotrichum schenckii*

SYSTEMIC FUNGI

*Blastomyces dermatitidis*  
*Paracoccidioides brasiliensis*  
*Histoplasma capsulatum*

<sup>1</sup>*Candida albicans* has been implicated in systemic infections.



TABLE 1-3  
CLASSIFICATION OF PATHOGENIC FUNGI ACCORDING TO MYCOSIS

<i>Mycosis</i>	<i>Important Etiological Agents</i>	<i>Macroscopic Morphology</i>
SUPERFICIAL		
Black Piedra-----	<i>Piedraia hortai</i> -----	Monomorphic Mold.
Tinea Nigra-----	<i>Trichophyton</i> spp-----	Monomorphic Mold.
Tinea Versicolor-----	<i>Malassezia furfur</i> -----	Unknown to date.
White Piedra-----	<i>Trichosporon outanum</i> -----	Monomorphic Yeast.
CUTANEOUS		
Candidiasis-----	<i>Candida albicans</i> and other <i>Candida</i> spp---	Monomorphic Yeast.
Tinea Barbae-----	<i>Trichophyton</i> spp-----	Monomorphic Mold.
Tinea Capitis-----	<i>Microsporum</i> spp-----	Monomorphic Mold.
	<i>Trichophyton</i> spp-----	Monomorphic Mold.
Tinea Corporis-----	Same as Tinea Capitis-----	
Tinea Cruris-----	<i>Candida albicans</i> -----	Monomorphic Yeast.
	<i>Epidermophyton floccosum</i> -----	Monomorphic Mold.
	<i>Trichophyton</i> spp-----	Monomorphic Mold.
Tinea Pedis-----	Same as Tinea Cruris-----	
SUBCUTANEOUS		
Chromoblastomycosis-----	<i>Cladosporium carrionii</i> -----	Monomorphic Mold.
	<i>Fonsecaea compacta</i> -----	Monomorphic Mold.
	<i>Fonsecaea pedrosoi</i> -----	Monomorphic Mold.
	<i>Phialophora verrucosa</i> -----	Monomorphic Mold.
Mycetoma, Actinomycotic-----	<i>Actinomyces israelii</i> -----	Monomorphic Mold.
	<i>Nocardia asteroides</i> -----	Monomorphic Mold.
	<i>Nocardia brasiliensis</i> -----	Monomorphic Mold.
Mycetoma, Maduromycotic-----	<i>Allescheria boydii</i> -----	Monomorphic Mold.
	<i>Phialophora jeanselmei</i> -----	Monomorphic Mold.
	<i>Madurella grisea</i> -----	Monomorphic Mold.
	<i>Madurella mycetozii</i> -----	Monomorphic Mold.
	<i>Cephalosporium falcatiforme</i> -----	Monomorphic Mold.
Rhinosporeidiosis-----	<i>Rhinosporidium seeberii</i> -----	Unknown to date.
Sporotrichosis-----	<i>Sporotrichum schenckii</i> -----	Dimorphic.
SYSTEMIC		
Actinomycosis-----	<i>Actinomyces israelii</i> -----	Monomorphic Mold.
Blastomycosis-----	<i>Blastomyces dermatitidis</i> -----	Dimorphic.
Candidiasis-----	<i>Candida albicans</i> and other <i>Candida</i> spp---	Monomorphic Yeast
Coccidioidomycosis-----	<i>Coccidioides immitis</i> -----	Monomorphic Mold.
Cladosporiosis-----	<i>Cladosporium bantianum</i> -----	Monomorphic Mold.
Cryptococcosis-----	<i>Cryptococcus neoformans</i> -----	Monomorphic Yeast.
Geotrichosis-----	<i>Geotrichum candidum</i> -----	Monomorphic Yeast.
Histoplasmosis-----	<i>Histoplasma capsulatum</i> -----	Dimorphic.
Nocardiosis-----	<i>Nocardia asteroides</i> -----	Monomorphic Mold.
	<i>Nocardia brasiliensis</i> -----	Monomorphic Mold.
Paracoccidioidomycosis-----	<i>Paracoccidioides brasiliensis</i> -----	Dimorphic

25° or 35° C. These germ tubes become the long filaments, or hyphae, and they ultimately form the mycelial mass characteristics of molds. Mycelial growth is usually quite rapid, and macroscopic differentiation from the yeast form presents no great problem. The aerial hyphae of the mycelium usually give rise to spores which are disseminated by air currents to propagate the species. These filamentous forms that reproduce only by spore germination are defined as the monomorphic (one-form) molds.

Another group of fungi, including those which cause some of the most serious mycotic infections in man, possess the unique capability of multiplying at 35° C in the form of the monomorphic yeasts and at 25° C in the form of the monomorphic molds. By exhibiting this temperature-dependent diphasic phenomenon, a given species of the group can exist either as a saprophytic mold in nature or as a parasitic yeast form in human tissues. These morphological variations are reversible when incubation temperatures are adjusted, and many times this reversibility assists in accurate diagnosis. Those fungi capable of existing in two forms are known as the dimorphic (two-form) fungi. Foldout 1, detail A, (separate inclosure) shows typical colonies of dimorphic fungi, and table 1-2 lists representative species of each group.

#### Exercises (604):

1. What are two basic fungal forms?
2. Which of the forms is characterized by simple budding?
3. Which form is recognized by production of innumerable filamentous hyphae?
4. What are the fungi which propagate only by budding called?
5. Why could the budding form in question No. 4 be easily mistaken for bacterial growth?
6. The filamentous forms that reproduce only by spore germination are defined as the \_\_\_\_\_

7. The group of fungi that are capable of multiplying at 35° C in the form of the monomorphic yeasts and at 25° C in the form of the monomorphic molds are known as the \_\_\_\_\_

8. What example of the type of fungi described in question No. 7 is shown in foldout 1, detail A?

#### 605. Identify the categories of mycosis with their related characteristics.

**Fungi as Agents of Disease.** When a person is afflicted with a mycotic infection, the condition is normally referred to as a mycosis. Fungi can be categorized as to the type of tissue for which they have a natural affinity. The four categories are as follows:

- (1) Superficial mycosis.
- (2) Cutaneous mycosis.
- (3) Subcutaneous mycosis.
- (4) Systemic mycosis.

The etiological agents of the superficial mycoses are confined to the outermost layers of the skin and the hair. The superficial mycoses are generally the least serious of the fungous diseases. The agents of the cutaneous mycoses, sometimes called the dermatophytes, possess a particular affinity for the keratin of the skin, hair, and nails. They cause infections of a more serious nature than the superficial fungi, including ringworm infections of the feet, groin, or nails.

The responsible agents of the subcutaneous mycoses invade muscle tissue. These mycotic infections are considerably more serious than the cutaneous type. The agents of the systemic mycoses attack the deep tissues and organs of the body, often creating symptoms that resemble other diseases of the particular organ or tissue invaded. It is not unusual for a person so afflicted to demonstrate cutaneous manifestations, as well. The deep-seated fungal infections are the most serious encountered in medical mycology. An outline of the pathogenic fungi according to type of mycosis is given in table 1-3. The type of morphism characteristic of the etiological agents is also included.

#### Exercises (605):

Indicate whether each of the given statements is true (T) or false (F) and correct those that are false.

- \_\_\_\_\_ 1. When a person is afflicted with a mycotic infection, the condition is normally referred to as a mycosis.

- 2. The etiological agents of the superficial mycoses attack the deep tissues and organs of the body.
- 3. The superficial mycoses are generally the least serious of the fungus diseases.
- 4. The agents of the cutaneous mycoses, sometimes called dermatophytes, possess a particular affinity for the keratin of the skin, hair, and nails.
- 5. Ringworm infections of the feet, groin, or nails are caused by the agents of superficial mycoses.
- 6. The agents of the subcutaneous mycoses invade muscle tissues.
- 7. The agents of the systemic mycoses attack deep tissues and organs of the body.
- 8. Candidiasis is an example of a superficial mycosis.
- 9. Histoplasmosis is an example of a systemic mycosis.
- 10. Tinea Barbae is an example of a superficial mycosis.

## 1-2. Collection and Processing of Specimens

In medical mycology, clinical laboratory procedures are directed toward the demonstration, isolation, and identification of pathogenic fungi found in body tissue and fluids. The site of infection will dictate the type of specimen that can be obtained. For the most part, specimens received or collected by the mycology laboratory will be skin, nail scrapings, or suspect hairs. However, it is well to remember that the systemic fungi

may have cutaneous manifestations, and so aseptic technique should be used to protect the laboratory workers.

**606. Point out some techniques used in processing specimens for diagnosis of superficial and cutaneous mycotic infections, recommended media and incubation temperatures, the purpose for the use of ultra violet light, and recommended staining techniques.**

**Specimen Processing.** Skin and nail scrapings are used primarily to diagnose superficial and cutaneous mycotic infections. The potassium hydroxide wet mount (described in detail in the next section of this chapter) is used in the examination of these specimen. In essence, we transfer a small fragment of the material into a drop or two of 10 percent potassium hydroxide (KOH) or sodium hydroxide (NaOH) on a clean glass slide and coverslip it for microscopic viewing. Other fragments may be mounted in lactophenol-cotton blue and similarly examined. Whether or not fungal elements are observed, fragments of material should be inoculated routinely on Sabourauds and Mycosel or mycobiotic agar and incubated only at 25° to 30° C.

It is now recommended that the mold form of these fungi be first recovered at 25° or 30° C and any isolates suspicious of being dimorphic be secondarily cultured to the yeast form by incubating subcultures at 35° C on special enriched media. This technique differs from past practice of setting up fungal cultures at 37° C to recover the yeast form of the dimorphic fungi. The setting up of separate cultures at 37° and 25° C has been an expensive and time-consuming practice as reflected by the relatively low rate of recovery of these species in most laboratories.

Two superficial mycotic agents and certain of the cutaneous agents may be isolated from hair. It is best to examine the suspect area of the patient's scalp under a Wood's lamp (ultraviolet light) in a dark room to detect hairs that fluoresce with a bright, yellow-green color. Hairs infected by certain fungi may fluoresce when placed under a filtered ultraviolet light. Pluck some of the fluorescing hairs and place them in a sterile petri dish until time for examination. Remember, however, that tinea capitis, caused by most species of *Trichophyton*, and many infections with *M. gypseum*, do not show fluorescence. If no fluorescent hair is seen, re-examine the patient under ordinary light and pluck hair stubs from the edge of the patches of infection. Hairs are cultured in the same manner as skin and nail scrapings. If infections with *Piedraia hortai* or *Trichosporon cutaneum* are suspected, Sabouraud dextrose agar without chloramphenicol and cycloheximide should also be inoculated. Both fungi are sensitive to these antibiotics. (See table 1-4.)

Although pathogenic fungi isolated from sputum are generally systemic, we should recall that repeated isolation of saprophytes, such as *aspergillus* or *mucor* species, may be of clinical significance. A first-morning, 24-hour, or 3-day collection of sputum in a clean,

TABLE 1-4  
MICROSCOPIC APPEARANCE OF PATHOGENIC FUNGI IN HAIR INFECTIONS

Microscopic Morph	Fungi	Mycosis
Black hard, nodules or granules (mycelium) firmly attached to hair shaft, asci with ascospores present within nodules.	<i>Piedraia hortai</i>	Black Piedra, a superficial mycosis
White, tan to light brown, soft nodules (mycelium), loosely attached to hair shaft, arthrospores and blastospores may be seen.	<i>Trichosporon cutaneum</i>	White Piedra, a superficial mycosis
Mycelium and arthrospores within (endothrix) hair shaft.	<i>Trichophyton soudanense</i> <i>Trichophyton tonsurans</i> <i>Trichophyton violaceum</i> <i>Trichophyton yaoundei</i>	Tinea, a cutaneous mycosis (endothrix hair invasion)
Mycelium within hair shaft, mycelium secondarily breaks out to surface of hair shaft, arthrospores formed only on outside (ectothrix) of hair shaft.	<i>Microsporum audouinii</i> <i>Microsporum canis</i> <i>Microsporum distortum</i> <i>Microsporum ferrugineum</i> <i>Microsporum gypseum</i> <i>Trichophyton equinum</i> <i>Trichophyton megninii</i> <i>Trichophyton mentagrophytes</i> <i>Trichophyton rubrum</i> <i>Trichophyton verrucosum</i>	Tinea, a cutaneous mycosis (ectothrix hair invasion)
Mycelium within hair shaft, no arthrospores formed, hair shaft usually contains fat droplets and empty channels resulting from disintegrating hyphae.	<i>Trichophyton schoenleinii</i>	Tinea, a cutaneous mycosis (favic-endothrix hair invasion)

sterile, wide-mouth, screw-capped bottle can be used. Centrifuge the sputum and examine the sediment directly on a clean glass slide under coverslip. First scan under low power and then high power, using reduced illumination. Because more than one mycotic agent may give the same clinical signs, several routine identifying steps should be followed. After direct examination, use a Gram stain to demonstrate hyphae or blastospores. Fungal structures stain Gram-positive. An acid-fast stain will demonstrate the mycelium of *Nocardia* species. The Giemsa or Wright stain is useful for *Histoplasma capsulatum*. An India ink mount will reveal the encapsulated budding or nonbudding blastospores of *Cryptococcus neoformans*. Regardless of the presence or absence of fungal structures microscopically, skin scrapings, hair, and nails should be cultured on media for primary isolation of dermatophytes, saprobic (opportunistic) and pathogenic fungi. Table 1-5 lists several of the more commonly used fungal culture media and suggested indications for their use.

#### Exercises (606):

1. What types of specimens are primarily used to diagnose superficial and cutaneous mycotic infections?
2. What type of microscopic wet mount technique is used in the examination of the above specimens?
3. Fragments may be viewed by what other technique?
4. What media are routinely used for the fragments material obtained?

TABLE 1-5  
FUNGAL CULTURE AND INDICATIONS FOR USE

Primary Isolation Media	
Media	Indications for Use
Brain-heart infusion agar Brain-heart infusion agar with antibiotics Brain-heart infusion diphasic blood culture bottles Dermatophyte test medium Inhibitory mold agar Mycosel or mycobiotic agar Sabouraud's 2 percent dextrose agar SABHI agar	Primary isolation of saprobic (opportunistic) and pathogenic fungi. Primary isolation of pathogenic fungi exclusive of dermatophytes. Recovery of fungi from blood.  Primary isolation of dermatophytes, recommended as screening medium only. Primary isolation of pathogenic fungi exclusive of dermatophytes. Primary isolation of dermatophytes. Primary isolation of saprobic and pathogenic fungi. Primary isolation of saprobic and pathogenic fungi.
Differential Test Media	
Media	Indications for Use
Ascospore agar Casein agar Cornmeal agar with Tween 80 and trypan blue Cottonseed conversion agar Czapek's agar Niger seed agar Nitrate reduction medium Potato dextrose agar  Rice medium Trichophyton agars 1-7 Tyrosine agar  Urea agar  Xanthine agar Yeast fermentation broth Yeast nitrogen base agar	Detection of ascospores in ascosporogenous yeasts such as <i>Saccharomyces</i> species. Identification of <i>Nocardia</i> species and <i>Streptomyces</i> species. Identification of <i>Candida albicans</i> by chlamydospore production. Speciation of <i>Candida</i> by microscopic morphology. Conversion of dimorphic fungus <i>Blastomyces dermatitis</i> from mold to yeast form. Isolation and differential identification of aspergilli. Identification of <i>Cryptococcus neoformans</i> . Detection of nitrate reduction in confirmation of <i>Cryptococcus</i> species. Demonstration of pigment production by <i>Trichophyton rubrum</i> . Preparation of microslide cultures. Identification of <i>Microsporium audouinii</i> . Speciation of members of <i>Trichophyton</i> genus. Identification of <i>Nocardia</i> species and <i>Streptomyces</i> species. Detection of <i>Cryptococcus</i> species. Differentiate <i>Trichophyton</i> , mentagrophytes from <i>Trichophyton rubrum</i> . Detection of <i>Trichosporon</i> species. Identification of <i>Nocardia</i> species and <i>Streptomyces</i> species. Speciation of yeasts by determining fermentations. Speciation of yeasts by determining carbohydrate assimilations.

5. At what temperatures should these cultures be incubated?
6. Isolates suspected of being dimorphic should be secondarily incubated at what temperature?
7. Why is the Wood's lamp (ultraviolet light) used to examine suspected area of the patients scalp?
8. What given species do not show fluorescence?
9. From what site of the scalp are the hair stubs plucked?
10. If infections with *Piedraia hortai* or *Trichosporon cutaneum* are suspected, the culture media used should not contain what two antibiotics?
11. What type staining may be used to demonstrate hyphae or blastospores?
12. An acid-fast stain will demonstrate the mycelium of what species?
13. What two stains are useful for *Histoplasma capsulatum*?
14. An India ink mount will reveal the encapsulated budding or nonbudding blastospores of what species?
15. Regardless of the presence or absence of fungal structures microscopically, skin scrapings, hair, and nails should be cultured on primarily what type of media?

**607. Briefly cite methods for collecting exudates, body fluids, and body tissues for fungus cultures, and also specify and recommended culture techniques.**

**Exudates, Body Fluids, and Body Tissues.** Exudates, body fluids, and body tissues require special mention. Collect exudates and pus from the active margin of open abscesses or ulcers. Material from closed lesions aspirated with a syringe by a physician should be inoculated directly to appropriate media or placed in sterile, screw-capped vials or tubes for later inoculation. Spinal fluid should be placed in sterile, screw-capped tubes. Other body fluids and tissue, such as peripheral blood, urine, synovial fluid, bone marrow, or biopsy material collected under aseptic conditions, may be inoculated directly to culture media. Large volumes that require centrifugation to concentrate them or specimens that cannot be immediately processed can be temporarily stored in sterile, screw-capped tubes or bottles.

The culture techniques used for exudates, body fluids, and tissues are essentially the same as those for sputum. Note in table 1-6; however, that the etiological agent of rhinosporidiosis, *Rhinosporidium seeberri*, cannot be cultured. The clinical material in suspected cases must be examined directly or fixed for histological examination.

The cultures should be examined at least three times a week for visible evidence of fungal growth. All cultures should be incubated at 30° C (optimal) for a minimum of 30 days before being discarded. Six weeks of incubation is considered to be optimal, but space limitations do not always make this possible. Note that the SABHI agar referred to in this volume represents a combination of Sabouraud dextrose agar (SAB agar) at pH 5.6, and brain-heart-infusion (BHI agar), with or without added blood. This is one of the most useful media for isolation of pathogens.

#### Exercises (607):

1. From what specified site of open abscesses or ulcers should exudates and pus be collected for fungus culture?
2. What preparation is necessary before inoculating body fluids and tissue, such as peripheral blood, urine, synovial fluid, bone marrow, and biopsy material, to culture media.
3. What preparation is necessary for sputum?



TABLE 1-6  
SPECIMENS AND MEDIA REQUIREMENTS FOR THE RECOVERY OF FUNGI FROM SPECIFIC MYCOTIC DISEASES

DISEASE	TYPE OF SPECIMEN	COMMON CULTURE MEDIA
Aspergillosis	<ol style="list-style-type: none"> <li>1. Respiratory secretions</li> <li>2. External auditory canal</li> <li>3. Corneal scrapings</li> <li>4. Sputum</li> </ol>	Sabouraud's dextrose agar and chloroamphenicol Brain-heart infusion agar Inhibitory mold agar SABHI agar Brain-heart infusion agar containing antibiotics (Media containing cyclohexamide are unsatisfactory and inhibit the growth of aspergilli.)
Plasmodium	<ol style="list-style-type: none"> <li>1. Respiratory secretions</li> <li>2. Skin</li> <li>3. Bone (osteomyelitis)</li> <li>4. Urine (rarely positive)</li> <li>5. Mucous membranes</li> </ol>	Sabouraud's dextrose agar Brain-heart infusion agar Inhibitory mold agar SABHI agar Brain-heart infusion agar with <sup>2</sup> antibiotics and cyclohexamide.
Candidiasis	<ol style="list-style-type: none"> <li>1. Respiratory secretions</li> <li>2. Blood</li> <li>3. Urine</li> <li>4. Skin</li> <li>5. Nails</li> <li>6. Oral and vaginal cavities</li> <li>7. Autopsy tissue</li> </ol>	Most common fungal and bacterial culture media are satisfactory; however, those containing cyclohexamide inhibit some species. Biphasic brain-heart infusion agar/broth is recommended for blood cultures.
Coccidioidomycosis	<ol style="list-style-type: none"> <li>1. Respiratory secretion</li> <li>2. Lung tissue (biopsy)</li> <li>3. Skin</li> <li>4. Cerebrospinal fluid</li> <li>5. Joints (synovitis)</li> <li>6. Mucous membranes</li> </ol>	Sabouraud's dextrose agar Brain-heart infusion agar Inhibitory mold agar SABHI agar Brain-heart infusion blood agar with antibiotics and cyclohexamide. Brain-heart infusion blood agar with antibiotics
Cryptococcosis	<ol style="list-style-type: none"> <li>1. Pulmonary secretions</li> <li>2. Cerebrospinal fluid</li> <li>3. Urine</li> <li>4. Blood</li> <li>5. Bone marrow</li> </ol>	Sabouraud's dextrose agar Inhibitory mold agar Brain-heart infusion agar SABHI agar Brain-heart infusion blood agar with antibiotics. Media containing cyclohexamide inhibit growth of
Geotrichosis	<ol style="list-style-type: none"> <li>1. Respiratory secretions</li> <li>2. Oropharynx</li> <li>3. Stool</li> </ol>	Sabouraud's dextrose agar Brain-heart infusion agar Inhibitory mold agar SABHI agar Brain-heart infusion blood agar with antibiotics.
Histoplasmosis	<ol style="list-style-type: none"> <li>1. Respiratory secretions</li> <li>2. Lung tissue (biopsy)</li> <li>3. Bone marrow</li> <li>4. Blood</li> <li>5. Urine</li> <li>6. Scrapings from skin lesion</li> <li>7. Spinal fluid</li> </ol>	Sabouraud's dextrose agar Brain-heart infusion broth/agar Inhibitory mold agar SABHI agar Brain-heart infusion blood agar with antibiotics and cyclohexamide Brain-heart infusion broth for blood cultures

TABLE 1-6 (Cont'd)

DISEASE	TYPE OF SPECIMEN	COMMON CULTURE MEDIA
Nocardosis <sup>4</sup>	<ol style="list-style-type: none"> <li>1. Pulmonary secretions</li> <li>2. Material from sinus tract</li> <li>3. Blood (rarely positive)</li> <li>4. Brain abscess</li> </ol>	Sabouraud's dextrose agar Brain-heart infusion agar SABHI agar Biphasic brain-heart infusion agar/broth recommended for blood cultures. Antibiotics in media inhibit the growth of nocardiae.
Sporotrichosis	<ol style="list-style-type: none"> <li>1. Respiratory secretions</li> <li>2. Lymphocutaneous abscesses</li> <li>3. Synovial fluid</li> <li>4. Nasal sinuses</li> </ol>	Sabouraud's dextrose agar Brain-heart infusion agar Inhibitory mold agar SABHI agar Brain-heart infusion blood agar with antibiotics. <sup>1</sup> Brain-heart infusion blood agar with antibiotics and cyclohexamide. <sup>2</sup>
Piedra	Clipped hair	Sabouraud's dextrose agar
Tinea Nigra	Skin scrapings	Mycosel or mycobiotic agar <sup>3</sup>
Tinea Versicolor	Skin scrapings	Not available at present
Onychomycosis	Nails scrapings	Mycosel agar or mycobiotic agar
Tinea Capitis	Plucked hair	
Tinea Corporis	Skin scrapings	
Tinea Pedis	Skin scrapings	
Mycetoma	<ol style="list-style-type: none"> <li>1. Draining cutaneous sinuses</li> <li>2. Bone</li> </ol>	Sabouraud's dextrose agar Brain-heart infusing agar Inhibitory mold agar SABHI agar All media should contain antibiotics and cyclohexamide. <sup>2</sup>
Chromomycosis	Skin, brain	Sabouraud's dextrose agar Brain-heart infusion agar Inhibitory mold agar SABHI agar All media should contain antibiotics and cyclohexamide. <sup>2</sup>
Rhinosporidiosis	<ol style="list-style-type: none"> <li>1. Biopsied nasal and ocular polyps</li> <li>2. Skin scrapings</li> </ol>	Not available at present.

1. Contains gentamicin, 5 g/ml and chloramphenicol, 16 g/ml or penicillin, 20 units/ml and streptomycin, 40 units/ml.
2. Contains gentamicin, 5 g/ml and chloramphenicol, 16 g/ml or penicillin, 20 units/ml and streptomycin, 40 units/ml and cyclohexamide, 0.5mg/ml.
3. Contains chloramphenicol, 50 g/ml, and cyclohexamide, 0.5 mg/ml.
4. Not a mycotic infection, but organisms are frequently received on fungal culture media.

4. Beside skin scrapings, what other type of specimens may be obtained when rhinosporidiosis is suspected?
5. How many times a week should cultures be examined?
6. For how long must cultures be incubated before discarding as negative and at what optimal temperature?

**608. Specify basic techniques and guidelines for shipment of fungus specimens.**

**Preparation of Specimens for Shipment.** For a number of reasons, it is sometimes necessary to send a clinical specimen or an unidentified fungus isolate to a reference laboratory for further study. Breakage and possible contamination of the container can be avoided by proper attention to packaging. Cultures should be submitted in screw-cap glass tubes which permit tight closure and sealed with adhesive tape. Wrap specimen container in cotton or other absorbent material and insert into a metal container. Follow basic guidelines for shipment of bacteriological specimens as given in Volume 1 of this CDC. Test tubes must always be wrapped individually in cotton or paper before placing them in a metal container. Any free space in the specimen container is then stuffed with cotton or other packing material to prevent breakage. The specimen container is capped and placed in a cardboard, corrugated fiberboard, wood, or container of equivalent strength. Fluid specimens obtained under aseptic conditions; for example, blood, spinal fluid, or aspirated pus, may be shipped if they are tightly sealed in sterile vials or tubes carefully packed. Hair, skin, and nail scrapings or pure cultures of suspected pathogens may also be shipped; but urine, bronchial washings, or biopsied tissue usually become quickly overgrown with contaminants in transit, making the isolation of pathogenic fungi improbable. If sputum samples must be shipped via mail, overgrowth with contaminating microorganisms may be controlled by adding 50,000 units of penicillin, 100,000 µg of streptomycin, or 0.2 µg of chloramphenicol for each milliliter of material.

Cotton swabs should never be mailed because they will dry out. Of course, petri dishes are subject to breakage and leakage and, thus, should not be used for mailing purposes.

Labeling information needed by the reference laboratory includes:

- a. The patient's name, age, and sex.
- b. Identification number or registration number.

- c. Name of the requesting physician and the submitting facility.
- d. Specimen origin and date of collection.
- e. Provisional diagnosis or suspected organism.

When cultures are submitted, such information as type of medium, date of inoculation, and incubation temperature are extremely helpful. Additional data which can be of value, when relevant, are the patient's record of residency and travel in the United States and foreign countries, and the results of any skin or serological tests.

**Exercises (608):**

1. How should fungus specimens be shipped for culture to a reference laboratory?
2. How should test tubes be wrapped and in what kind of container are they placed?
3. If sputum samples must be shipped via mail, overgrowth with contaminating organisms may be controlled by adding what substances?
4. How should cotton swabs be sent?

**1-3. Mycology Techniques**

The techniques used in medical mycology are similar, in many respects, to those used in medical bacteriology. That is to say, we attempt to plant an organism on artificial culture media and grow it out in isolated colony form. The culture can then be studied from the standpoint of its morphology, physiological properties, and immunologic characteristics. With the mycotic agents, however, much greater emphasis is placed on differences in colony appearance and details of cell structure and arrangement. Correspondingly, less reliance is placed on fermentation reactions and serological tests. In this section, therefore, we will mention some of the techniques designed to make morphological studies of the fungi easier.

**609. State the type of instrument used in transferring mycelial growth, advantages and disadvantages for the use of culture tubes or petri dishes, and a technique for transfer of cultures.**

**Techniques for Specimen Culture.** The mycologist uses a stiff, nichrome wire (22 gauge) with the last 4 or 5 mm bent at right angles to the main shaft. The wire is fixed firmly in a metal handle for ease in transferring mycelial growth. A pair of short, stiff teasing needles are useful in pulling apart dense mycelium for microscopic examination. Test tubes (18 x 150 mm) afford a larger butt, more resistant to drying; hence, these tubes are preferable because of the longer period often necessary for adequate fungal growth. The slants should be thick, and after inoculation the caps should be screwed on but left slightly loose. Culture tubes are more easily stored, require less space, are obviously safer for small laboratories, and have a lower dehydration rate than culture plates. Leave screw caps of the tubes slightly loose to permit oxygen to enter and also allow the slant surface to remain dry through air exchange with the outside. A dry surface gives better sporulation and better pigment production. Laboratories staffed with experienced personnel in handling fungal cultures may use petri dishes. Although somewhat more hazardous, the advantages of petri dishes include better aeration of cultures, a large surface area which provides better isolation of colonies, and greater ease of examination and subculture of fungal colonies.

Transfer of cultures should be done over absorbent paper (paper toweling) moistened with a fungicidal agent. It is also wise to use a small vial of sand moistened with a fungicidal agent to remove excessive fungal material from the wire before you flame it. This move prevents dangerous spattering of infectious material as the wire is sterilized in the flame.

#### Exercises (609):

1. What type of instrument may be useful in pulling apart dense mycelium for microscopic examination?
2. What are some advantages to the use of culture tubes over culture plates for fungus cultures.
3. What are two advantages for maintaining a dry surface on the fungus cultures?
4. Although somewhat more hazardous, what are some advantages for the use of petri dishes?
5. Transfer of cultures should be done over absorbent paper moistened with a \_\_\_\_\_.

610. Specify the wet mount procedures in terms of their purposes, the techniques used, reagents, and given advantages.

**Wet Mounts.** The technique of wet mounting is used for preparing specimens either from patients or cultures for microscopic viewing. Once a yeast or mold has been recovered on primary isolation medium, it is necessary to prepare mounts for microscopic study of the colonies.

Superficial dermatophyte infections can often be diagnosed by demonstrating the characteristic delicate hyphal forms in KOH mounts of skin scales, nail scrapings, or infected hair.

**Potassium hydroxide (KOH) mounts.** The potassium hydroxide (KOH) wet mount is perhaps the most widely used of these. Let's assume that a patient with a lesion on his arm has been sent to the mycology laboratory. We wash the lesion area thoroughly with 70 percent alcohol to remove any dirt particles, bacteria, and medication which might interfere with microscopic examination. Then scrape the outer, active margin of the lesion with a sterile scalpel blade. Deposit the scrapings directly into a sterile petri dish. We transfer a small fragment of the material into a drop or two of 10 percent KOH on a clean glass slide and coverslip it. Let the preparation sit at room temperature for 15 to 30 minutes so that tissue and debris will dissolve in the KOH. Then examine the slide under low, then high magnification. To save time, you may heat the slide gently for a few seconds over a flame. Do not boil the KOH. The strong alkali serves as a clearing agent, making the fungal elements (spores and/or mycelium) more easily discernible. The KOH mount informs us only of the presence or absence of fungal elements in the tissue scrapings. A positive identification requires culturing and additional observation of the ensuing growth.

**Lactophenol-cotton blue (LPCB).** Lactophenol-cotton blue wet mounting fluid is the basic stain used in mycology. It serves a threefold purpose. The lactic acid in it acts as a preservative; phenol serves as a fungicidal or killing agent; and cotton blue (Poirrier's blue) lends color to the structures and makes them more readily observable.

**Tease mount technique.** Ordinarily, the specimen used for making teased, wet mount preparations is obtained from a fungus growing on the surface of a culture medium. Remove a small quantity of the mycelium with a stiff needle and scrap off into 1 or 2 drops of lactophenol-cotton blue mounting fluid placed on a clean glass slide. Next, gently pull the mycelium apart so that individual structures will be clearly visible. Rough handling will destroy the all-important spore-hyphal relationship, or natural arrangement, and make identification difficult. The slide may now be coverslipped and examined under the microscope. The slide can be preserved for later use by sealing the edges with fingernail polish or varnish.

The most significant drawback of the tease mount method is the difficulty in preserving continuity between

the spore, fruiting structures, and hyphae after such rough handling. This fault can be critical when exact microscopic definition is required for differential identification.

**Scotch tape technique.** Some workers prefer the Scotch tape wet mount to the teased preparation because the Scotch tape technique is relatively simple, it subjects the fungus to considerably less trauma, and it preserves the structural relationship that is essential for accurate identification. There are two disadvantages to this technique: Visual acuity is partially lost due to the tape itself, regardless of its clarity; and tape does not lend itself to the preservation of slides for future study because there is a tendency for the tape to loosen. A piece of clear Scotch tape approximately 1 sq cm in size is used. We unplug the tube containing the fungal growth and touch the sticky surface of the scotch tape to the mycelium with forceps. The tape is then placed (sticky surface down) on top of 1 or 2 drops of lactophenol-cotton blue on a clean glass slide. Press the tape gently but firmly against the glass slide. The mount may then be examined microscopically.

**India ink preparation.** The India ink wet mount technique is used primarily to detect *Cryptococcus neoformans* in the spinal fluid, but other body fluids may be similarly examined. After we centrifuge the specimen, we transfer a loopful of the sediment to a clean glass slide and mix the material with a small drop of undiluted India ink. After coverslipping, we examine the slide microscopically. Since the ink is unable to penetrate the large capsule surrounding *Cryptococcus neoformans*, the capsule appears as a clear disc against a black background. We also see a centrally-located dense, single or budding cell within the disk. Figure 1-8 provides an example. The sole purpose of the India ink is to reveal the capsule of *C. neoformans* as an aid to accurate diagnosis. If the wire loop is used for mixing spinal fluid and ink, allow the wire to cool sufficiently to prevent precipitation of the ink by heat.

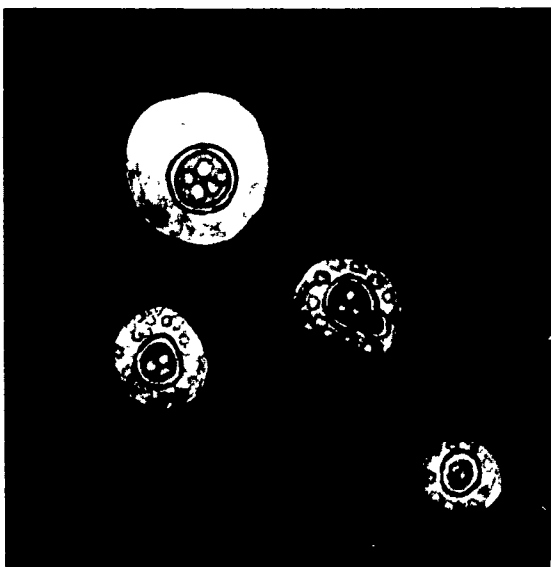

Figure 1-8. *Cryptococcus neoformans* in India ink preparation wet mount.

#### Exercises (610):

1. What general information does the KOH mount provide?
2. Before collecting skin scrapings for KOH mount, why is the lesion area thoroughly washed with 70 percent alcohol?
3. What size of the lesion is scraped with the scalpel blade in collecting scrapings for the KOH mount?
4. How may the clearing effect of 10 percent KOH be hastened?
5. What purpose does the lactic acid serve in the Lactophenol-cotton blue (LPCB)?
6. The specimen used for making teased, wet mount preparations is obtained from what source?
7. What is the most significant drawback of the tease mount method?
8. Why is the Scotch tape wet mount technique preferred by some workers?
9. What is the sole purpose of India ink when used to detect *Cryptococcus neoformans*?
10. If the wire loop is used for mixing spinal fluid and ink, the wire loop should be allowed to cool sufficiently for what reason?

**611. Identify the stain preparations used in the microscopic identification of fungi in terms of their primary purposes such as the microscopic features and organisms for which they are specifically used to observe.**

**Stained Preparations.** Stained preparations are useful for demonstrating a range of microscopic features and may be used, when indicated, as an aid in identification of certain fungi. Thus, dried and fixed films may be stained by Gram method, periodic acid-Schiff (PAS) Wright stain, or Giemsa stain.

**Gram stain.** Gram's stain is useful in demonstrating mycelial elements and yeast cells in a variety of specimens. The mycologist uses this method when examining granules, or other specimens for presence of an actinomycete. The stain is not primarily used to demonstrate the presence of fungi in specimens. All fungi are gram-positive, often staining so heavily that it is not possible to observe morphological features.

**Acid-fast stain.** An acid-fast stain is used to detect the partially acid-fast hyphal segments of *Nocardia*. Acid-fast organisms stain red.

**Wright stain or Giemsa stain.** Wright stain or Giemsa stain is used for detecting intracellular yeast forms of *Histoplasma capsulatum* in blood and bone marrow, since the organism is too small to notice readily without staining.

**The periodic acid-Schiff (PAS) stain and Gomori's Methanamine silver (GMS) stain.** The PAS and GMS stains are often used for demonstrating fungi in tissue. Yeasts forms or hyphae segments are best demonstrated in tissues by the use of either of these stains. The dyes included in these stains specifically stain the carbohydrate-rich constituents of fungal cell wall.

#### Exercises (611):

1. Gram stain is useful in demonstrating \_\_\_\_\_ and \_\_\_\_\_ in a variety of specimens.
2. The Gram stain is used when examining \_\_\_\_\_ or other specimen for the presence of an \_\_\_\_\_.
3. The Gram stain (is/is not) primarily used to demonstrate the presence of fungi in specimen.
4. All fungi are gram (positive/negative).
5. An acid-fast stain is used to detect the partially acid-fast hyphal segments of \_\_\_\_\_.
6. Wright or Giemsa stain is used for detecting \_\_\_\_\_ forms of \_\_\_\_\_ in blood and bone marrow.

7. Yeasts forms or hyphal segments are best demonstrated in tissues by the use of either the \_\_\_\_\_ stain or \_\_\_\_\_ constituents of fungal cell walls.

**612. State methods used for culture of fungi from clinical specimens in terms of recommended techniques, inhibitory substances, recommended incubation temperature, and frequency of gross examination, and cite growth characteristics which aid in final identification.**

Two principal techniques used in cultivating fungi are the routine tube or culture bottle method and the slide culture method.

**Routine Tube Culture Method.** Normally, the routine or bottle culture is used to isolate fungi from clinical specimens. The culture tubes should be fitted with cotton plugs or screw caps. From a review of table 1-5, it is readily seen that mycologists have a number of options in the selection of media for primary recovery and differential testing of fungi. These decisions must be based on individual needs. Mycosel or mycobiotic agar and Sabouraud 2 percent dextrose agar are widely accepted media for primary isolation of dermatophytes, saprobic (opportunities) and pathogenic fungi, respectively.

Chloramphenicol or cyclohexamide, or both of these inhibitory substances, may be added to the medium as recommended in table 1-6 to retard growth of contaminants which include saprophytic fungi and contaminating bacteria.

The clinical material is inoculated with the 22-gauge nichrome needle by making two or three deep cuts into the medium at about the midpoint of the slant surface. As previously mentioned, it is now recommended that the mod form of these fungi cultures be first recovered at 25° or 30° C and any suspected dimorphic growth be converted to the yeast form by incubating subcultures at 35° C on special enriched media. Be sure that all tubes are properly labeled prior to incubation.

Gross examination of inoculated tubes should be carried out on a routine daily basis. If this is not possible, they should be examined at least three times a week for visible evidence of fungus growth. The following growth characteristics aid appreciably in the final identification of the fungus: rate of growth, colony size, and surface topography (flat, heaped, folded, or smooth); texture (yeastlike, glabrous, powdery, granular, velvety, or cottony); and surface pigmentation on both front and reverse sides of the slant.

Using either the teased or Scotch tape wet mount, we can now examine the colony microscopically. It may be possible to identify the fungus by this direct examination if spores or other diagnostic structures are present. Otherwise, additional procedures may be necessary; for example, slide cultures for maintaining



structural relationships, and special media conducive to sporulation or production of other diagnostic structures.

7. Gross examination of fungus cultures should be made at least how many times per week?

**Exercises (612):**

1. What two media are widely used for primary isolation of dermatophytes, saprobic, and pathogenic fungi?
2. What two principal techniques are used in cultivating fungi?
3. What two inhibitory substances may be added to the medium to retard growth of contaminants?
4. It has been recommended that the mold form of the fungus cultures be first recovered at what incubated temperatures?
5. Suspected dimorphic growth may be converted to the yeast form by incubating subcultures at what temperature?
6. List the growth characteristics which should be noted when macroscopically examining a fungus culture.

613. State the primary purpose for the use of the slide culture technique, media required, procedure, and the type of staining recommended.

**Slide Culture Method.** Slide cultures for monomorphic mold permit the microscopic observation of the undisturbed relationship of spores to hyphae—one of the main criteria for identification of pathogenic or saprophytic monomorphic mold. A medium that is conducive to sporulation or mold should be used in this culture. Thus, if a teased or Scotch tape mount fails to yield sufficient information for identification, or in the event that permanent study slides are desired, the slide culture for monomorphic molds can be set up. This procedure, shown in figure 1-9, uses a petri dish containing a bent glass rod, a coverslip, and an ordinary microscopic slide, all of which have been wrapped in metal foil and sterilized. With a sterile scalpel blade, cut approximately 1 square centimeter of medium from a plate of Sabouraud dextrose agar or potato dextrose agar. Place it aseptically on the center of the microscopic slide atop the bent glass rod within the petri dish. Inoculate each of the four sides of the square of medium by making a cut of about 1 millimeter into the medium. Cover the square of inoculated medium with the coverslip and add 8 to 10 drops of sterile water to the bottom of the petri dish. Replace the top of the petri dish and incubate the culture at 25° C until growth appears.

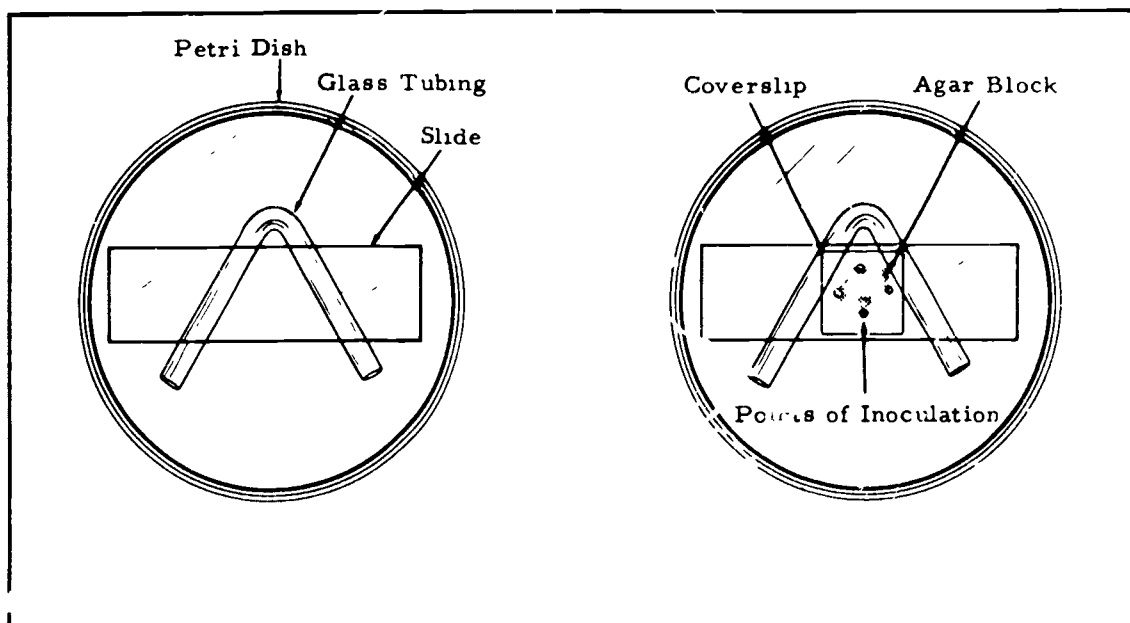

Figure 1-9 Procedure for slide culture

The slide culture may be examined microscopically without disturbing the coverslip. When the desired stage of growth has been reached, a lactophenol-cotton blue preparation may be made by gently lifting the coverslip (with its adhering fungus) and laying it on a microscopic slide holding 1 or 2 drops of the dye. Permanent mounts can be made by blotting the excess dye around the edges of the coverslip and sealing the coverslip with fingernail polish or varnish. Highly virulent molds should not be grown in slide culture because of the danger of infection to persons handling them.

#### Exercises (613):

Indicate whether each of the given statements is (T) true or false (F) and correct those that are false.

- \_\_\_ 1. Slide cultures for monomorphic mold permit the microscopic observation of the undisturbed relationship of spores to hyphae.
- \_\_\_ 2. A medium that is not conducive to sporulation of mold should be used in the slide culture.
- \_\_\_ 3. An India ink preparation may be made by gently lifting the coverslip with its adhering fungus and laying it on a microscope slide holding 1 or 2 drops of the dye.
- \_\_\_ 4. Highly virulent molds may be grown in slide culture because of the ease in handling.

**614. Cite safety precautions for the mycology laboratory in terms of equipment, purpose, and techniques.**

**Safety Precautions.** Every laboratory performing diagnostic work in mycology should be equipped with a bacteriological safety hood operating under negative air pressure to draw fungus spores away from the technician. Many fungi produce spores which are very light and easily become airborne. Thus, precautions are necessary to prevent contamination of the laboratory and infection of the personnel. The principles of major precautions for the mycology laboratory are essentially the same as those for any other clinical laboratory:

- a. Do not eat, drink, or smoke in the laboratory.
- b. Wear a laboratory coat or smock when working in the laboratory.

- c. Work in a biologic hood when processing specimens other than hair, skin, and nail scrapings.
- d. Do not mouth pipet
- e. Wipe up all spills and splatters with disinfectant (5 percent Staphene or Amphyl is good).
- f. Wipe bench tops with disinfectant when work is completed.
- g. Wash hands with soap and water before leaving laboratory.

There are several precautions that apply specifically to the mycology laboratory:

- a. Do not set up a slide culture of a mold until it has been examined in a teased preparation.
- b. Do not set up slide cultures of *Histoplasma capsulatum*, *Coccidioides immitis*, or *Blastomyces dermatitidis* for identification purposes.
- c. Do not make Scotch tape preparations of pathogenic mold (excluding dermatophytes). All such preparations may easily contaminate the working environment.
- d. Discard supernatants and all other unneeded specimens into containers with disinfectant.
- e. Do not work with *H. capsulatum* and *C. immitis* without a hood. These are Class III organisms (Fungi) and should be handled in the same manner as *M. tuberculosis*. *B. dermatitidis* is a Class II organism (Fungi), but it should be handled in a hood.
- f. All fungus cultures to be discarded must first be killed by autoclaving.
- g. Tubed slants of media should be used for primary isolation. Petri plates should never be used if *Coccidioides* is suspected or if a culture is to be mailed.
- h. Avoid splattering when you flame the wire needles or loops. In order to avoid this hazard, many workers prefer to use Bacteriators available from Scientific Products.

Probably a good rule-of-thumb is to handle each specimen as if it contained a highly virulent mycotic agent. In the event of an accident, such as splashing of infectious material into the eye or on open skin, report this immediately to a physician. If you drop a culture, cover the debris with disinfectant. As with any other type of accident in microbiology, use good judgment and be prepared to institute decontamination measures immediately.

#### Exercises (614):

Indicate whether each of the given statements is true (T) or false (F) and correct those that are false.

- \_\_\_ 1. Slide cultures of *Histoplasma capsulatum*, *Coccidioides immitis*, or *Blastomyces dermatitidis* may be safely set up for identification purposes.

- \_\_\_ 2. Scotch tape preparation of pathogenic molds should be made as desired.
- \_\_\_ 3. Do not work with *H. capsulatum* and *C. immitis* without a hood.
- \_\_\_ 4. All fungus cultures to be discarded must first be killed by chemical sterilization.
- \_\_\_ 5. Petri plates may be used when *Coccidioides* is suspected.
- \_\_\_ 6. Each specimen should be handled as if it contained a highly virulent mycotic agent.
- \_\_\_ 7. If you drop a culture, cover the debris with disinfectant.

## The Yeastlike Fungi and the Monomorphic Molds

ALTHOUGH THE yeastlike fungi have many morphological and physiological characteristics identical to the true yeasts, they differ in that the former lack the ability to reproduce sexually. All the fungi in this group produce moist colonies with a creamy consistency, at least in their early growth phase. These organisms are fundamentally unicellular in nature; however, some members produce both a pseudomycelium and a true mycelium. The medically important yeastlike fungi are discussed in the opening section. The remainder of the chapter considers the monomorphic molds.

The monomorphic molds multiply only in filamentous form, regardless of whether their environmental temperature is 25° or 35° C. Growth is characterized by tubular branching septate hyphae which intermingle to form a mass of mycelium on artificial media as well as natural substrate. The aerial hyphae develop modified branches, called phores, upon which a diversity of conidia is proliferated. Generally, mold growth is dry and dusty, particularly after sporulation. The majority of fungi pathogenic for man are monomorphic molds.

We cover the clinical aspects and laboratory diagnosis of the monomorphic molds, commencing with the least severe superficial forms. The dermatophytes (cutaneous monomorphic molds) and the subcutaneous agents are discussed from the same standpoint. A section regarding the deep-seated diseases caused by the systemic monomorphic molds completes this chapter.

### 2-1. The Pathogenic Yeastlike Fungi

Pathogenic species of the yeastlike fungi are frequently recovered from clinical specimens, such as skin scrapings, sputum, mucocutaneous swabs, and feces obtained from individuals who demonstrate no adverse symptomatology. This means that the organisms are present in or on the host but do not become invasive or toxic unless certain physiological changes occur either locally or systemically to alter susceptibility to infection. Some of the conditions permitting these opportunistic organisms to cause disease include traumatic injury, chronic debilitating, and metabolic diseases, and the increased use of steroids and antibiotics. In order to firmly establish the taxonomic relationship of the yeastlike fungi, refer to table 2-1.

Form-Class	Deuteromycetes (Fungi Imperfecti)
Form-Order	Pseudosporangiumales
Form-Family	Cryptococcaceae
Genus 1	Cryptococcus
Genus 2	Torulopsis (same as genus 1, but no capsule or starch-like polysaccharide produced)
Genus 3	Pityrosporum
Genus 4	Rhodotorula
Genus 5	Candida
Genus 6	Trichosporon
Genus 7	Geotrichum

TABLE 2-1  
CLASSIFICATION OF THE PATHOGENIC YEASTS

**615. Cite some microscopic structures to be noted in clinical material when looking for yeastlike fungi, characteristics of the given genera, and culture techniques and cultural characteristics used for the identification of yeastlike fungi.**

**Isolation and Identification.** As in all phases of medical mycology, the clinical material is examined directly in wet preparation for the presence of large, unicellular budding cells and pseudo or true mycelium. *Candida* species reproduce primarily by means of simple budding, but they have the ability to form pseudo and true mycelium. "Pseudomycelium" is the term applied when the daughter cell fails to detach from the mother cell. If this process is repeated, a chain of daughter cells may result, forming a fragile filament closely resembling true mycelium. True mycelium is formed by septation of a germ tube developed from a mother cell. Quite similar to the true yeasts are the member of the Genus *Cryptococcus*. All species have the ability to encapsulate, and reproduction is solely by simple budding. *Geotrichum spp.* never reproduce by simple budding and therefore are the most atypical of the yeastlike group. Instead, true mycelium which readily breaks up into rectangular arthrospores is formed. The Genus *Trichosporon* reproduces by means of blastospores, and the formation of a true mycelium which fragments into arthrospores. Members of the Genus *Pityrosporum* are unicellular, reproducing only

by means of simple budding. The buds are separated from the mother cell by a cross-wall, which makes identification relatively simple. If any of these yeastlike structures are seen in direct preparation of the specimen, cultural studies must be instituted.

**Cultivation.** It is essential that organisms be isolated in pure form in order for you to perform accurate morphological procedures and other tests that may be necessary. Probably the best method of separating mixed yeast populations is to inoculate the specimen into a tube of Sabouraud dextrose broth. This broth is identical to Sabouraud dextrose agar, except it contains no agar and will not solidify. It is available in dehydrated form. After overnight incubation at 35° C, the tube is gently shaken and a loopful streaked to a blood agar plate. Following 24 or more hours of incubation, colonies of different types are picked and inoculated on slants of Sabouraud dextrose agar for incubation at 35° C. The growth from individual colonies should now be in pure form on the slants. In order to prevent bacterial growth, a 0.05-mg/ml concentration of chloramphenicol should be incorporated into the medium, while the addition of cycloheximide in a concentration of 0.5 mg/ml will prevent the growth of saprophytic fungi. Dehydrated media containing the above constituents in proper concentration are available. If bacterial overgrowth still results, four tubes of Sabouraud dextrose broth to which 1 drop, 2 drops, 3 drops, and 4 drops of N HCL have been added, respectively, are inoculated with the original isolate. After overnight incubation at 35° C, a loopful of broth is transferred from the acid tube showing no bacterial growth to a blood agar plate. Following overnight incubation at 35° C, colonies are picked for inoculation to Sabouraud dextrose agar.

**Examination of pure cultures.** Pure cultures of the yeastlike fungi must be studied microscopically to determine what structures are present. The absence of mycelium is indicative of a species of *Candida*, *Cryptococcus*, or a true yeast. The presence of mycelium with both arthrospores and blastospores is strongly suggestive of the genus *Trichosporon*. When only arthrospores are formed, the unknown is most likely *Geotrichum candidum*. When the growth is very slimy and mucoid, and only encapsulated blastospores are seen microscopically, it is likely to be a *Cryptococcus spp.* A definitive identification, however, is based on a combination of physiological and biological tests which will be discussed later in this section. If *Candida albicans* is suspected as a result of finding blastospores and pseudo and true mycelium in wet preparation, the growth should be inoculated to chlamydospore agar or Cornmeal Tween 80 agar.

**Exercises (615):**

1. What is meant by the term "Pseudomycelium"?

2. Why is *Geotrichum spp.* considered to be the most atypical of the yeastlike group?
  3. How does the Genus *Trichosporon* reproduce?
  4. How do members of the Genus *Pityrosporum* reproduce, and how do they appear?
  5. Why is it essential to isolate an unknown yeastlike fungi in its pure form?
  6. In order to prevent the growth of bacteria and saprophytic fungi respectively, what substances are incorporated into the medium?
  7. When using N HCL to obtain bacteria free cultures, which tube of Sabouraud dextrose broth is used for inoculation of a blood plate?
  8. When examining pure cultures of the yeastlike fungi, the absence of mycelium may suggest which species?
  9. The presence of mycelium with both arthrospores and blastospores strongly suggests what Genus?
  10. When the growth is very slimy and mucoid, and only encapsulated blastospores are seen microscopically, what species is suggested?
  11. If *Candida albicans* is suspected as a result of finding blastospores, pseudo- and true mycelium in wet preparation, the growth should be inoculated to what media?
- 616. State conditions which result in the prevalence of candidiasis in certain regions of the world and diseases associated with candidiasis.**

**Candida Albicans.** Candidiasis, formerly known as Moniliasis, is the disease caused by *Candida albicans*.

This organism has no geographic limitation. However, in regions of the world where carbohydrates make up a large portion of the diet and profuse sweating is commonplace, the incidence of infection is greater than elsewhere. The fungus is a normal inhabitant of the intestinal tract, and its incidence of that region of the body has been shown to increase with age. Since *Candida albicans* can be found at some point in or upon almost all humans, candidiasis infections are considered endogenous in origin. The organism is usually classified as a cutaneous fungus, and its occurrence in systemic diseases was for many years a rarity. The therapeutic use of steroids and antibiotics over extended periods has resulted in a significant increase in systemic infections.

*Candida albicans* has a particular affinity for the mucous membranes of the oral cavity where it produces confluent or discrete patches that bleed quite readily. This form of the disease is called thrush. It is found in newborn infants who probably were infected during passage through the vagina where *Candida albicans* exists, generally asymptotically, in a large number of women. Thrush is also common in diabetics, people on prolonged corticosteroid or antibiotic therapy, and the aged.

Another form of the disease, vulvovaginal candidiasis, occurs sometimes in diabetic and pregnant women, probably due to the higher sugar content of the urine or vaginal secretions. The disease may develop wherever two skin surfaces are in contact over such long periods that perspiration cannot evaporate. The breakdown of urea in the perspiration to ammonia results in chemical irritation and allows the organism to become invasive. *Candida albicans* is a common invader of the nails and toes. It causes a wet, weeping variety of tinea pedis (athlete's foot).

Pulmonary candidiasis is sometimes diagnosed in conjunction with some other respiratory disease. This is considered a secondary invasion by the fungus. Endocardial candidiasis, encountered in drug addicts who fail to sterilize their needles and syringes, is a disease similar to subacute bacterial endocarditis. One last form of infection, disseminated candidiasis, involves the vital body organs. It is generally associated with the terminal stages of some other fatal disease.

#### Exercises (616):

1. List two reasons for a high incidence rate of candidiasis in certain regions of the world.
2. What reason is given for the significant increase of *Candida* in systematic infections?
3. What is the name commonly applied to a *Candida albicans* infection of the oral mucous membranes?

4. How can obesity result in candidiasis?

5. Why do drug addicts often contract endocardial candidiasis?

617. Cite the given method for reporting *Candida*, the appearance of the organism on Sabouraud dextrose agar, and tests used for the identification of the yeast.

**Laboratory Identification.** Laboratory identification of *Candida albicans* first involves the direct microscopic examination of clinical material, such as skin and nail scrapings in a potassium hydroxide wet mount. Mucosal scrapings are examined either on a gram-stained smear or in wet mount using lactophenol cotton blue. The sediment of specimens such as spinal fluid, bronchial washings, and sputum are examined similarly. If the typical picture of budding yeast cells and mycelium pinched in at the septations is seen, a preliminary report of "Forms suggestive of *Candida*" is indicated. In such cases it is helpful to the physician to indicate the number of organisms per microscopic field. See figure 2-1.

The young colonies on Sabouraud dextrose agar at 35° C. are white, soft, and generally have smooth surfaces and borders. Older colonies frequently show a fringe of submerged mycelium appearing as feathery outgrowths deep in the agar. See detail B of foldout 1 for the macroscopic morphology of *C. albicans* on Sabouraud dextrose agars. If microscopic examination of wet mounts reveals structures suggestive of *Candida*, it is then essential to establish whether or not the culture is *C. albicans* or a saprophyte.



Figure 2-1 *Candida albicans*



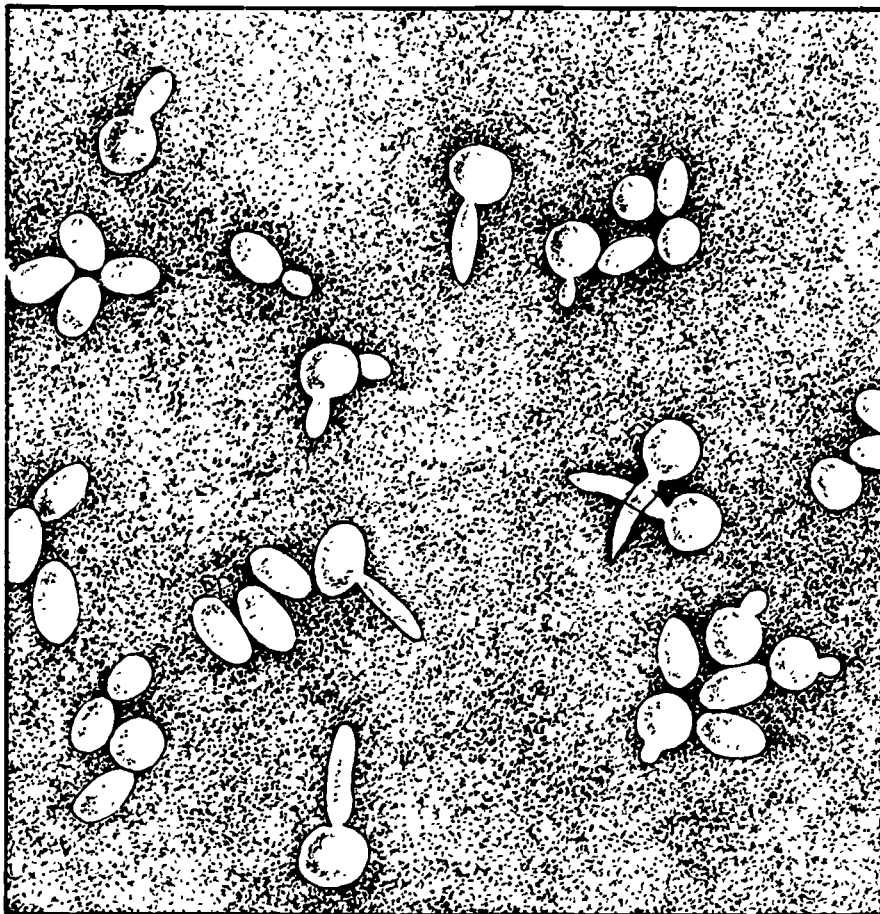

Figure 2-2 Germ tubes of *C. albicans*

Previously, either the spider-like colonial morphology of the organism on eosin methylene blue agar or the presence of chlamydospores on Cornmeal Tween 80 agar was used to obtain a definitive identification of *Candida albicans*. Either of these criteria is still acceptable; however, the germ tube test is more rapid and currently preferred by most laboratories.

**Germ tube test.** A very light suspension of a yeast-like colony is made in a tube containing 0.5 to 1.0 ml of sterile serum. Bovine or sheep serum is often recommended, but pooled human serum may also be used provided controls are included. The tubes are incubated at 35° C for 3 hours. A drop of the serum-yeast mixture is placed on a microscope slide and examined under low power magnification for germ-tube production as noted in figure 2-2.

**Carbohydrate assimilation.** Carbohydrate assimilation tests are perhaps the most widely used of all methods for identification of yeasts. All methods use a basal medium which will support the growth of yeasts only if appropriate carbohydrate sources are added. Individual carbohydrates may be either added directly to the medium or incorporated into filter paper discs which are placed in contact with the medium. The presence of growth either in the medium or adjacent to the discs indicates that the carbohydrate included within

the medium has been utilized by the organism being tested.

**Carbohydrate fermentation.** Carbohydrate fermentation tests have been utilized longer than any other tests for the identification of yeasts. They are now categorized as secondary tests used to supplement assimilation studies where there is difficulty in making a definitive identification. Assimilation and fermentation tests are shown in table 2-2.

**Commercial kits.** Commercially available kits useful for the identification of yeasts are now being promoted. When properly used by experienced personnel, these tests are quite satisfactory. However, there are inconsistencies in results, and such factors as cost, stability, and adaptability in any given laboratory setting should be considered before using them. The kits and sources of information are listed:

API Clinical Yeast System (API 20C)  
Analytab Products Inc.  
Plainview, New York 11803

Uniyest Tek,  
Corning Medical Diagnostics  
Roslyn, New York 11576

Microb-drop Yeast Identification System  
Clinical Sciences Inc.  
Whippany, New Jersey 07981

TABLE 2-2  
DIFFERENTIATION OF SPECIES

Species	Morphology on Corn Meal Agar + 1% tween 80 or Chlamydospore Agar  Cut-streak plate	Sabouraud dextrose broth  Growth characteristics	Sugar* fermentation reactions				Sugar Assimilation					
			D	M	S	L	Dextrose	Galactose	Lactose	Maltose	Raffinose	Sucrose
<i>C. albicans</i>	Irregular or spherical clusters of blastospores of septa. Chlamydo-spores single or in clusters. May be very numerous (chlamydo-spores do not develop at 37° C.)	No surface growth	Ag	Ag	A or O	O	+	+	O	+	O	+
<i>C. guilliermondii</i>	Very fine mycelium. Small clusters of blastospores at the septa.	No surface growth	O or Ag	O	O or Ag	O	+	+	O	+	+	+
<i>C. krusei</i>	Elongate cells forming a branched mycelium easily disintegrated. "Crossed sticks" at septa.	Wide surface film	Ag	O	O	O	+	O	O	O	O	O
<i>C. parapsilosis</i>	Fine and coarse mycelium (giant forms). Blastospores single or in short chains at septa or distal ends of cells.	No surface growth	Ag or A	O or A	O or A	O	+	+	O	+	O	+
<i>C. pseudotropicalis</i>	Very elongate cells which readily fall apart and lie parallel. "Logs in stream".	No surface growth	Ag	O	Ag	Ag	+	+	+	O	+	+
<i>C. stellatoidea</i> (probably a variant of <i>C. albicans</i> )	More extensive mycelium with irregular or spherical clusters of blastospores at septa. Chlamydo-spores rare (may show a supporting cell).	No surface growth	Ag	Ag	A or O	O	+	+	O	+	O	O
<i>C. tropicalis</i>	Blastospores anywhere along mycelium or in irregular clusters. Chlamydo-spores very rare.	Narrow surface film with bubbles	Ag	Ag	Ag	O	+	+	O	+	O	+

\* D = dextrose M = maltose S = sucrose L = lactose

Serological and animal pathogenicity tests are of no value in the laboratory diagnosis of *Candida albicans*. *Candida* spp. other than *albicans* are rarely agents of disease, and their identification is usually not necessary in diagnostic work. One exception occurs in cases where the organism is repeatedly isolated from clinical material that is normally sterile, or when no other recognized pathogenic organism has been recovered from the lesion or diseased clinical material.

#### Exercises (617):

1. How would the technician report a microscopic picture of budding yeast cells and mycelium pinched in the septations?
2. How do young colonies of *Candida* appear on Sabouraud dextrose agar?
3. How do the older colonies of *Candida* appear on Sabouraud dextrose?
4. What test is considered to be the most rapid and currently preferred test for identification of *Candida albicans*?
5. What type of serum may be used in the Germ Tube test?
6. In the Carbohydrate Assimilation test for the identification of yeast, what condition indicates that the carbohydrate included within the medium has been utilized by the organism being tested?
7. How are Carbohydrate Fermentation tests categorized?
8. What are factors to be considered prior to the use of commercial kits for yeast identification?
9. Of what clinical significance is the use of serological and animal pathogenicity tests in the laboratory diagnosis of *Candida albicans*?

**618.** Point out the most common portal of entry for spores of *Cryptococcus neoformans* and the techniques used to detect this organism in clinical material.

**Cryptococcus Neoformans.** Cryptococcosis, formerly known as torulosis, European blastomycosis, or Busse-Buschkes diseases, is worldwide in distribution in both animals and man. The causative agent, *Cryptococcus neoformans*, has a particular affinity for the central nervous system; however, skin, bones, and other organs may also be infected. Its prevalence is probably underestimated as a result of failure to suspect its presence. *C. neoformans* has been recovered from areas in or upon the bodies of many individuals who indicate no adverse symptomology. It was discovered that *C. neoformans* is saprophytically associated with pigeon droppings found under roosting sites.

Inhalation of spores borne on dust particles (causing pulmonary cryptococcosis) is by far the most common portal of entry. *C. neoformans* has also been cultured from the blood of infected patients. Some workers are of the opinion that meningitis may result directly from a nasopharyngeal involvement. At the present time, proof is lacking that a primary cutaneous form of the disease occurs. Primary pulmonary cryptococcosis gives rise to chronic lung infections. Although the pulmonary disease may prove fatal, dissemination to the central nervous system usually occurs first. It is likely that many pulmonary cryptococcosis infections go undetected and heal spontaneously, as in the case with some of the other deep mycoses. Disseminated cryptococcosis generally involves the central nervous system. The spinal fluid is discolored a dirty yellow; the protein and cell count elevated (predominately lymphocytes), and the sugar is reduced.

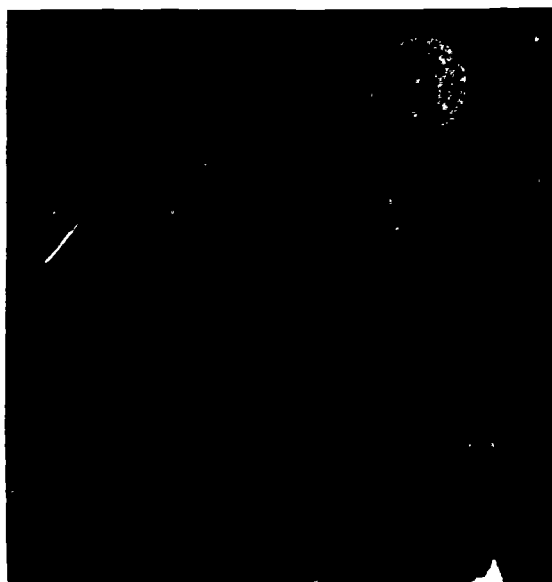

Figure 2-3. *Cryptococcus neoformans*

TABLE 2-3  
DIFFERENTIATION OF *CRYPTOCOCCUS NEOFORMANS* FROM *CRYPTOCOCCUS* SPP

Test	<i>Cryptococcus neoformans</i> (pathogen)	<i>Cryptococcus</i> sp (saprophyte)
Incubation at 25° C	Slow to moderate rate of growth; smooth, moist, mucoid, cream colored to tan.	Slow to moderate rate of growth; smooth, pasty, and cream colored (A very few species might look like <i>C. neoformans</i> at 25° C)
Incubation at 37° C	Better growth than at 25° C, characteristic shiny, mucoid, and glistening growth.	No growth or very little growth (some exception)
India Ink Wet Mount	Thick capsules present	Capsules present or absent, usually thin if present.
Urea Test (agar medium)	Positive The urea test rules out other yeasts (especially the <i>Saccharomyces</i> ), which are urea negative.	Positive
Nitrate Assimilation Test	Nitrate, KNO <sub>3</sub> , not assimilated	Nitrate, KNO <sub>3</sub> , assimilated
Animal Pathogenicity Test	Positive	Negative

Direct examination of clinical materials such as sputum, urine, or spinal fluid is accomplished with the India wet mount (see fig 2-3) If the volume of fluid permits, these specimens should be centrifuged and the sediment used in making the preparation.

Regardless of the microscopic findings, the clinical material should be cultured on Sabouraud dextrose agar without cycloheximide, since *C. neoformans* is sensitive to this antibiotic. Inoculation of an enriched medium such as blood or brain heart infusion agar is also recommended. Usually, the saprophytic cryptococci are unable to grow at 35° C. It should not be assumed, on the other hand, that any *Cryptococcus* which grows at 35° C is *C. neoformans* because certain saprophytic strains do not conform to this pattern. The colonial morphology may take 10 to 14 days to develop to a stage where macroscopic evaluation is possible. The colonies are white or cream to tan, and soft and creamy in texture. Incubation in a candle jar may stimulate capsule production. See figure 1, detail c. If capsular material is produced, the colonies are slimy or mucilaginous.

When growth is adequate there are other tests useful in identifying *C. neoformans*. Only members of the Genus *Cryptococcus* have the ability to produce urease, and on this basis the cryptococci may be separated from the true yeasts and other yeastlike fungi. In order to determine whether the *Cryptococcus* spp. is *C. neoformans* or a saprophytic form requires further testing. *C. neoformans* differs from the saprophytic cryptococci in its pattern of nitrate and sugar assimilation seen in table 2-3. A pathogenicity test using mice inoculated intracerebrally may be used instead of the nitrate and sugar assimilation tests. The mice are sacrificed at the end of 2 weeks and the gelatinous brain

material examined for encapsulated, budding yeast cells. Serological testing has proved of little or no value.

#### Exercises (618):

1. What is the probable reason for the low prevalence of infections with *Cryptococcus neoformans*?
2. *Cryptococcus neoformans* has a particular affinity for what systems and organs of the body?
3. What is the most common portal of entry of infective spores of *C. neoformans*?
4. What technique is routinely used to detect *C. neoformans* in chemical material?
5. Why should the clinical material suspected of *C. neoformans* infection be cultured on Sabouraud dextrose agar without cycloheximide?

6. How is incubation temperature useful in differentiating *C. neoformans* from saprophytic cryptococci?
7. What does a positive urease test indicate if the technician is attempting to identify a member of the yeast?

**619. Cite the causative agent of geotrichosis, the difficulty of assessing the role of this organism in disease, and the unusual characteristics of the organism regarding its colonial and microscopic appearance.**

**Geotrichum Candidum.** *Geotrichum candidum* is the causative agent of disease—geotrichosis. Since *G. candidum* is commonly present in the gastrointestinal tract, usually as a saprophyte, a diagnosis is dependent on repeated demonstration of this fungus in direct examination of clinical material and the absence of any other pathogenic agent.

*G. candidum* has been implicated in mild respiratory infections. Coughing and the production of blood-streaked sputum may result. On rare occasion the fungus has been recovered in cases of colitis. *Geotrichum candidum* is also a frequent secondary invader, and therefore, its role in disease is difficult to assess.

Identification of *Geotrichum candidum* is based on its colonial and microscopic morphology. Direct mounts of

clinical material demonstrate large (4 to 10  $\mu$ m), round, oval, or rectangular cells which may or may not be joined together to form wide mycelial filaments. See figure 2-4 for the microscopic appearance of *Geotrichum candidum*.

*Geotrichum candidum* in its early growth phase appears similar to the other yeastlike organisms, both colonially and microscopically. (See FO 1, detail D.) As the colony matures, it takes on a fluffy mycelial character which is readily observable. Microscopically, this fluffy mycelial phase appears in the form of chains of rectangular arthrospores; there may also be many individual disarticulated, cylindrical, barrel-shaped, or sometimes elliptical arthrospores.

Blastospores are not produced. *G. candidum* does not ferment carbohydrates, but assimilates glucose and xylose. Animal inoculation or serologic testing procedures are of no diagnostic value.

#### Exercises (619):

1. \_\_\_\_\_ is the causative agent of the disease geotrichosis.
2. Why is the role of *Geotrichum candidum* in disease difficult to assess?
3. What is an unusual characteristic of *G. candidum* regarding its colonial and microscopic morphology?
4. What two sugars does *G. candidum* assimilate?

**620. State the part of the body that is affected by *Trichosporon cutaneum*, its microscopic appearance at the infected site, and cultural and biochemical characteristics.**

**Trichosporon Cutaneum.** White piedra is a relatively rare superficial mycosis of man which affects the hair of the scalp or body. The agent responsible for the disease, *Trichosporon cutaneum* (formerly known as *Trichosporon bergelii*) not only grows on the hair, but also invades the hair shaft, causing it to disintegrate and break off.

Hairs suspected of being infected with *T. cutaneum* are plucked and examined in 10 percent KOH wet mount. If the organism is present, you will see soft nodules, ranging from white to light brown in color, loosely attached to the hair shaft. Arthrospores and blastospores may also be observed. An additional step

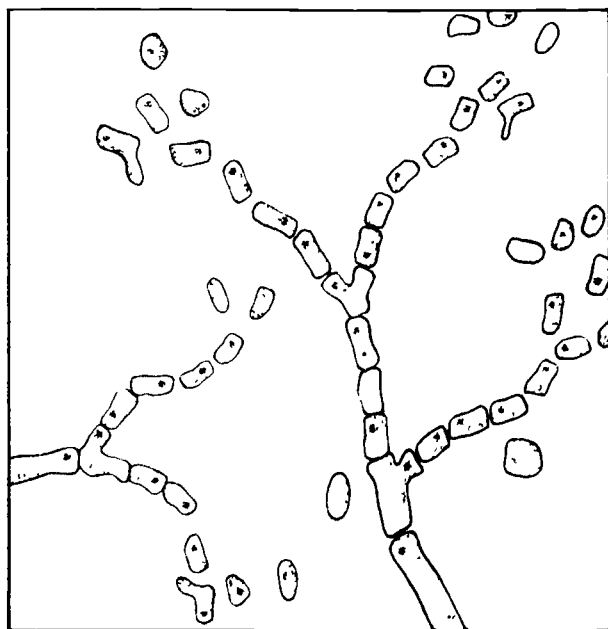

Figure 2-4. *Geotrichum candidum*.



to identify the organism will require culturing on Sabouraud dextrose agar with cycloheximide. The typical colony is soft in consistency and cream to white in color, later becoming greyish, wrinkled, and heaped. (See FO 1, detail E.) Microscopic morphology is characterized by a true mycelium which produces both blastospores and arthrospores. Biochemically, the fungus shows an inability to ferment sugars or to assimilate glucose, galactose, sucrose, maltose, and lactose. Typical microscopic morphology may require use of the slide culture described in Chapter 1.

6. Biochemically, the fungus shows an inability to ferment \_\_\_\_\_ or to assimilate glucose, galactose, sucrose, \_\_\_\_\_, and \_\_\_\_\_.
7. Microscopic morphology is characterized by a true mycelium which produces both \_\_\_\_\_ and \_\_\_\_\_.

**Exercises (620):**

1. The agent responsible for white piedra is \_\_\_\_\_
2. White piedra affects the \_\_\_\_\_ of the scalp or body.
3. If the organism is present you will see soft \_\_\_\_\_ ranging from \_\_\_\_\_ to light \_\_\_\_\_ in color.
4. An additional step to identify the organism will require culturing on Sabouraud dextrose agar with \_\_\_\_\_.
5. The typical colony is \_\_\_\_\_ in consistency and \_\_\_\_\_ to \_\_\_\_\_ in color, later becoming \_\_\_\_\_, wrinkled and \_\_\_\_\_.

621. Cite the microscopic feature of *Pityrosporum ovale* that readily distinguishes it from the other yeastlike fungi, the specimen sources from which *Torulopsis glabrata* is commonly isolated, the appearance of *T. glabrata* on sheep blood agar, and the cultural and biochemical reactions.

**Pityrosporum Ovale.** The members of the Genus *Pityrosporum* are common saprophytes on the skin of man. *Pityrosporum ovale* was once erroneously considered to be a causative agent of dandruff. The organism requires oleic acid, which is found in the sebaceous material abundantly produced by the scalp. Identification is necessary to insure differentiation from the pathogenic yeastlike fungi.

Table 2-4 may be used as a practical approach to identification of yeasts. However, as previously

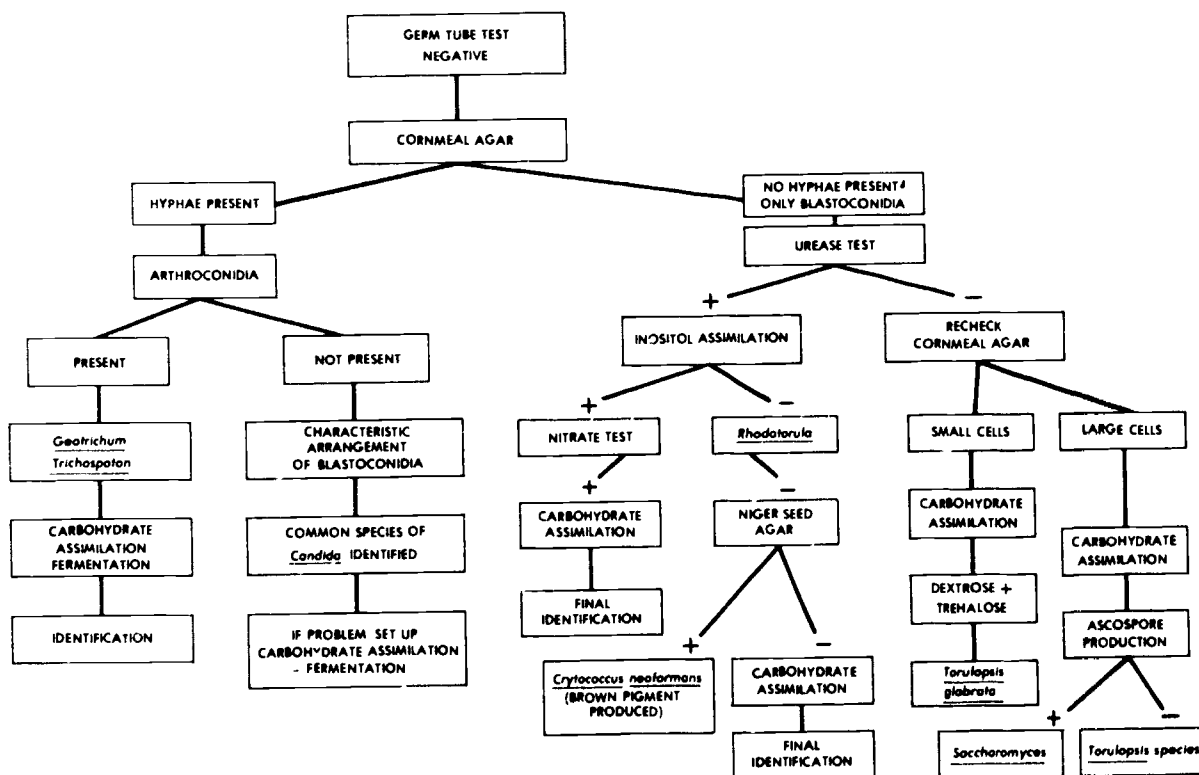

TABLE 2-4  
A PRACTICAL SCHEME FOR THE LABORATORY IDENTIFICATION OF YEASTS



mentioned, commercially available kits, useful for the identification of yeasts are now being promoted.

*Pityrosporum ovale* can be cultured on ordinary media if fatty substances containing oleic acid are added. The yeastlike colony ranges in color from cream to tan. Identification is based on the microscopic observation of very small, yeastlike cells. The bud is separated from the mother cell by a cross-wall. There is no mycelial formation.

**Torulopsis Glabrata.** *Torulopsis glabrata* is closely related to *Cryptococcus* and *Candida* species. It was once considered to be a nonpathogenic saprophyte from the soil, being widely distributed in nature. It is a small intracellular parasite, and infection in tissues somewhat resembles histoplasmosis. The organism is commonly isolated from urine and sputum and may be involved in infections as an important opportunistic pathogen.

After 1 to 3 days' incubation at 35° C, *T. glabrata* appears as tiny, white, raised, nonhemolytic colonies on sheep blood agar. The Gram stain reveals round to oval budding yeasts, 2 to 4 µm in diameter; no hyphae or capsules are seen. Cultures on Cornmeal Tween agar are negative for mycelia or pseudophyphae; the Germ Tube test is also negative. The organism ferments glucose and trehalose and does not assimilate carbohydrates.

#### Exercises (621):

1. What microscopic feature of *Pityrosporum ovale* readily distinguishes it from the other yeastlike fungi?
2. *Torulopsis glabrata* is commonly isolated from which specimen sources?
3. How does *T. glabrata* appear on sheep blood agar?
4. What does the gram stain show?
5. What result is obtained on the Germ Tube test?
6. What two sugars does the organism ferment and what reaction is obtained on the carbohydrate assimilation test?

## 2-2. The Superficial Monomorphic Molds

There are three medically important mycotic agents in this category: *Piedraia hortai*, *Cladosporium werneckii*, and *Malassezia furfur*, as shown in table 2-5.

**622. Cite the structures formed along the shafts of the hair of the scalp with *Piedraia hortai*, and the cultural and microscopic characteristics of the organism.**

**Piedraia Hortai.** *Piedraia hortai* is the causative mycotic agent of the hair infection, black piedra. Hard, brown, or black nodules are formed along the shafts of the hair of the scalp. Other than a clicking sound when the hair is combed, the disease is asymptomatic. These nodules are hard enough to cause a gritty sound when pressed between glass slides. Black piedra occurs primarily in Asia and Latin America.

Identification of *P. hortai* is based on microscopic examination of KOH mounts of suspect hairs as well as colonial morphology. The fungus grows well on cycloheximide agar, producing black to greenish-black colonies which are smooth and raised. Microscopically, the colony from culture is found to consist of dark, closely septate filaments of hyphae, chlamydospores, and on rare occasion asci. Microscopic examination of the hair nodule will reveal many oval asci containing 2 to 8 ascospores encased in a darkly pigmented mycelium.

#### Exercises (622):

1. What are the structures formed along the shafts of the hair of the scalp infected with black piedra?
2. What effect is produced when an individual with *Piedraia hortai* combs his or her hair?
3. How does the organism appear on cycloheximide agar?
4. How does the colony from a culture appear microscopically?
5. Microscopic examination of the hair nodule infected with *Piedraia hortai* will reveal what structures?

TABLE 2-5  
MORPHOLOGICAL CHARACTERISTICS OF SUPERFICIAL MONOMORPHIC MOLDS

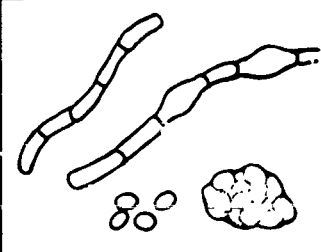
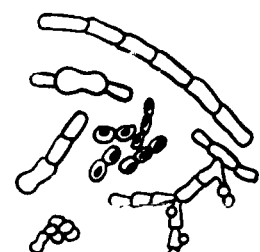
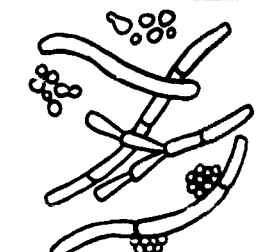
Morphological Characteristics	<i>Piedra hortae</i>	<i>Cladosporium</i>	<i>Malassezia furfur</i>
Growth rate	slow	slow	not cultured on artificial media
Colony texture	velvety	moist, smooth to velvety	not applicable
Topography	raised or flat with cerebriform undulations	flat	not applicable
Surface color	dark, greenish-black to black	shiny, dark greenish-black to black	not applicable
Back (reverse) color	same as surface	same as surface	not applicable
Microscopic	dark, thick-walled closely septate hyphae; chlamydospores, asci and ascospores may be present	dark, branched, septate hyphae (1.5-3M in D.); blastospores, chlamydospores, and 1-3 celled conidia may be present	branching, septate hyphae; grape-like clusters of thick-walled spores (3-8 M in D.) along the hyphae.
Sketch of microscopic appearance in wet mount			

623. Point out the asymptomatic disease caused by *Cladosporium werneckii*, the appearance when observed in 10 percent KOH mounts, and cultural characteristics of the organism.

**Cladosporium Werneckii.** *Cladosporium werneckii* is the etiological agent of the asymptomatic disease called tinea nigra. The disease is characterized by the development of dark brown to black blotches on the palms of the hand, or on rare occasion, other parts of the body. Generally, only one lesion is present; however, there may be multiple areas of infection on one hand. Although considered a tropical disease, a few scattered cases have been reported in the United States.

*Cladosporium werneckii* appears as dematiaceous (pigmented black or dark brown) branched hyphae when observed in 10 percent KOH mounts of suspect lesions. The organism grows readily but slowly on cycloheximide agar. It produces a moist, yeastlike, greenish-black raised colony. Older colonies develop a gray-black serial mycelium. Microscopic examination of early colonial growth reveals spherical or oval budding cells, many of which are divided centrally by a cross-wall. Short chains of these cells are common. Mounts from the periphery of older colonies reveal

dematiaceous, septate hyphae along which clusters of blastospores develop.

**Exercises (623):**

1. What is the asymptomatic disease caused by the fungi, *Cladosporium werneckii*?
2. How does *C. werneckii* appear microscopically in 10 percent KOH mounts of suspected lesions?
3. How does the colony appear on cycloheximide agar?
4. What does the microscopic examination of early colonial growth show?

624. Sta : characteristics of the disease caused by *Malessezia furfur* and the manner in which *Malessezia furfur* differs culturally from the other superficial monomorphic molds.

**Malassezia Furfur.** The mycotic agent responsible for the disease, tinea versicolor, in *Malessezia furfur*. This superficial infection of the skin characteristically produces scaly brown patches in such areas as the chest, back, neck, axillae, face, arms, thighs, or groin. These patches cause occasional itching; if exposed to the sun, they tan unevenly. This chronic disease is found worldwide; however, it is most prevalent in the tropics.

Although areas infected with *M. furfur* will fluoresce under ultraviolet light, identification rests on microscopic examination of skin scrapings in 10 percent potassium hydroxide or methylene blue. The use of transparent Scotch tape has also been suggested. When the sticky surface of the tape is pulled from the lesion, it carries the scales loaded with the fungus, which may then be placed on a microscopic slide, with or without stain, and examined. Microscopically, unattached hyphal segments are found. These are curved and short, each segment about 3 to 4 microns in diameter by 8 to 12 microns in length. Clusters of blastospores are also present. These are sufficiently larger, 4 to 6 microns in diameter, than *C. albicans* to permit easy differentiation. *M. furfur* cannot be cultured on artificial media.

#### Exercises (624):

1. *Malessezia furfur* causes the disease \_\_\_\_\_
2. Identification of *M. furfur* rests on microscopic examination of skin scrapings in \_\_\_\_\_  
or \_\_\_\_\_ blue.
3. How does *Malessezia furfur* differ culturally from the other superficial monomorphic molds?

#### 2-3. The Cutaneous Monomorphic Molds

These fungi are the dermatophytes that generally infect only the hair, skin, and nails of man and animals. They have a particular affinity for keratinized tissue of the skin and its appendages but will also grow on media which is lacking in Keratin. Present indications are that other body tissues may possess substances which are inhibitory to growth of these fungi.

All the dermatophytes were considered until recently to belong exclusively in the class *Deuteromycetes*, or fungi imperfecti. Demonstration of ascospores in *Keratinomyces ajelloi* and *Microsporium gypseum* indicates that some of the dermatophytes are actually in the class *Ascomycetes*. Until further discoveries are made, we will consider that the majority of dermatophytes belong in the class *Deuteromycetes*.

Identification of the dermatophytes cannot be based solely on macroconidial morphology, since some strains produce these structures only rarely, while others never produce macroconidia. Also, mutant strains vary greatly in colony characteristics and pigmentation. For these reasons, physiological criteria may be more important than morphology in the identification of some members of this group. The more common physiological tests usually consist of nutritional tests to determine the need for special growth factors, optimal temperature requirements, and determination of the type of hair digestion "in vitro." The dermatophytes grow very well on a standard medium, such as Sabouraud dextrose agar. The culture growth patterns on this medium for the common dermatophytes are shown in detail F of foldout 1. As we discuss each organism, refer to this foldout and study the applicable characteristics. The addition of chloramphenicol and cycloheximide have not demonstrated any inhibitory effect on their growth and so may be incorporated in the medium in the prescribed strength. With the addition of these antibiotics to retard growth of contaminants, the pH of Sabouraud dextrose agar may be elevated to a range of 6.8 to 7.0, which is optimal for growth of the dermatophytes. The ideal temperature range for their multiplication is between 25° and 30° C.

While some dermatophytic species are found worldwide, others may be limited to a very small geographical area. Three broad categories, shown in table 2-6, are used to classify these fungi: *Anthropophilic* dermatophytes usually only infect man, *zoophilic* dermatophytes infect lower animals as well as man; and *geophilic* dermatophytes are saprophytes whose natural habitat is the soil. The last group does, however, infect man from time to time. Global distribution of these fungi is probably influenced a great deal by host preference and natural habitat.

The diseases caused by the dermatophytes are called tinea, or ringworm, because the lesion normally spreads out in a circular manner from the initial point of infection. The word tinea means worm in Latin, and early workers felt these round lesions were caused by worms. A ringworm infection of the body is called tinea corporis; the feet, tinea pedis; the scalp, tinea capitis; the groin, tinea cruris, and the nails, tinea unguium. These are shown in table 2-7. Fungal infection resembling tinea unguium of the nails may also be caused by *C. albicans*. We will discuss members of the Genera *Microsporum*, *Trichophyton*, *Epidermophyton*, and *Keratinomyces* from the standpoint of clinical aspects and laboratory diagnosis. The major characteristics of the most common dermatophytes are shown in table 2-8.

TABLE 2-6  
ECOLOGY OF DERMATOPHYTES

ANTHROPOPHILIC AGENTS	GEOPHILIC AGENTS
<i>Microsporium audouinii</i> <i>Microsporium distortum</i> <i>Microsporium ferrugineum</i> <i>Trichophyton concentricum</i> <i>Trichophyton megninii</i> <i>Trichophyton mentagrophytes</i> (downy) <i>Trichophyton rubrum</i> <i>Trichophyton schoenleinii</i> <i>Trichophyton soudanense</i> <i>Trichophyton tonsurans</i> <i>Trichophyton violaceum</i> <i>Trichophyton soudouei</i>	<i>Keratinomyces ajelloi</i> <i>Microsporium cookei</i> <sup>1</sup> <i>Microsporium gypseum</i> <i>Trichophyton terrestre</i> <sup>1</sup>  <b>ZOOPHILIC AGENTS</b>  <i>Microsporium canis</i> <i>Microsporium sambreuseghemii</i> <i>Trichophyton equinum</i> <i>Trichophyton gallinae</i> <i>Trichophyton mentagrophytes</i> (granular) <i>Trichophyton verrucosum</i>

<sup>1</sup> Saprophytic for humans

TABLE 2-7  
HUMANS CUTANEOUS MYCOSES AND ETIOLOGICAL AGENTS

<i>Tinea Capitis</i> (scalp)	<i>Tinea Barbae</i> (beard)	<i>Tinea Corporis</i> (body)	<i>Tinea Cruris</i> (groin)	<i>Tinea Pedis</i> (foot)	<i>Tinea Unguium</i> (nail)
<p style="text-align: center;">Agents</p> <i>M. audouinii</i> <sup>1</sup> <i>M. canis</i> <i>M. distortum</i> <i>M. ferrugineum</i> <i>M. gypseum</i> <i>T. megninii</i> <i>T. mentagrophytes</i> <i>T. schoenleinii</i> <sup>2</sup> <i>T. tonsurans</i> <sup>1, 4</sup> <i>T. violaceum</i> <sup>4</sup>	<p style="text-align: center;">Agents</p> <i>T. megninii</i> <i>T. mentagrophytes</i> <i>T. rubrum</i> <i>T. verrucosum</i>	<p style="text-align: center;">Agents</p> <i>M. audouinii</i> <i>M. canis</i> <i>M. distortum</i> <i>M. ferrugineum</i> <i>M. gypseum</i> <i>T. concentricum</i> <i>T. mentagrophytes</i> <i>T. rubrum</i> <i>T. schoenleinii</i> <i>T. tonsurans</i> <i>T. verrucosum</i> <i>T. violaceum</i>	<p style="text-align: center;">Agents</p> <i>C. albicans</i> <i>E. floccosum</i> <i>T. mentagrophytes</i> <i>T. rubrum</i>	<p style="text-align: center;">Agents</p> <i>C. albicans</i> <i>E. floccosum</i> <i>T. mentagrophytes</i> <sup>3</sup> <i>T. rubrum</i> <sup>3</sup>	<p style="text-align: center;">Agents</p> <i>C. albicans</i> <i>E. floccosum</i> <i>T. megninii</i> <i>T. mentagrophytes</i> <i>T. rubrum</i> <i>T. schoenleinii</i> <i>T. violaceum</i>

<sup>1</sup> Agent of epidemic ringworm

<sup>2</sup> Most common cause of athlete's foot

<sup>3</sup> Agent of favic ringworm (*tinea favosa*)

<sup>4</sup> Agent of black-dot ringworm

TABLE 2-8  
MAJOR CHARACTERISTICS OF THE DERMATOPHYTES

Genus	Infected Areas	Host Preference	Host Invasion	Wood's U.V. Light Fluorescence	Usual Conidia Characteristics
<i>Microsporium</i>	Skin, hair, and rarely the nails	Primarily children below age of puberty, also adults	Ectothrix mosaic pattern of spores on hair shaft	Usually positive—exception sometimes negative for <i>M. gypseum</i>	Many macroconidia (echinulated, thick walls), few microconidia
<i>Trichophyton</i>	Skin, hair, and nails	Children and adults	Ectothrix, endothrix, and favic-endothrix	Usually negative—exception sometimes positive for <i>T. tonsurans</i> or <i>T. schoenleinii</i>	Few macroconidia (smooth, thin walls), many microconidia
<i>Epidermophyton</i> ( <i>E. floccosum</i> )	Skin and nails	Children and adults	None	Not applicable	Many macroconidia in clusters (smooth, thin walls), no microconidia

520

625. Cite one of the most important modes of transmission of tinea capitis and the appearance of *Microsporum audouinii* under ultraviolet light and the microscopic appearance of this organism obtained from skin scrapings.

**Microsporum Audouinii.** *Microsporum audouinii* is the most important causative agent of tinea capitis among grade school children in the United States. The disease affects boys more readily than girls in a ratio of about 3:1 or 4:1. It is an anthropophilic, or man-loving fungus, and in those rare cases involving animals the disease is mild and short lived. The infection is spread readily from child to child, either by direct contact or through the communal use of hats, combs, or brushes. One of the most important modes of transmission has been found in barber shops, where unsanitary equipment results in rapid dissemination of the disease.





The primary lesion occurs on the scalp, frequently at the hairline or in the area of the part. Usually, very little inflammation, erythema, or kerion formation accompanies the disease; the usual symptoms are hair loss and scaling. A kerion is a raised mass of tissue, suppurating at numerous points. Generally, the disease demonstrates well-defined patches of scaliness and hair loss, but it is not uncommon for scattered single hairs to be infected. *M. audouinii* invades the hair in a characteristic manner causing what is referred to as small-spored ectothrix invasion. The spores are formed

from mycelia which have developed within the hair, broken through to the outer surface, and then fragmented into a sheath of tightly packed arthrospores. When the symptoms include much tissue inflammation and kerion formation, the disease course is generally short, or about 2 to 4 weeks in duration. More commonly, when the infection causes only hair loss and scaling it may heal spontaneously in 3 or 4 months. Some cases linger on for 2 to 3 years, however.

In laboratory identification we examine the scalp of the patient for hair loss, scaling, erythema, and/or kerionic lesions. The scalp should be scanned under the ultraviolet light of a Wood's lamp in a dark room, paying particular attention to any suspicious areas previously observed in daylight. If *M. audouinii* is present, even only on a few hairs, it will fluoresce a bright yellowish green. But it is well to note that some strains of *M. audouinii* will not fluoresce when exposed to ultraviolet light. In early infections, where only the base of the hair is involved, it may be necessary to pluck the hair and examine it under the Wood's lamp to detect fluorescence.

Skin scrapings or hair should be collected from the margin of the lesion. When ultraviolet light is used, hair which fluoresces should be plucked and mounted in 10 percent potassium hydroxide. Microscopically, a sheath of small spores in mosaic completely surrounds the hair at its base; mycelium is found running lengthwise within the hair. Mycelium and chains of arthrospores are found in skin scrapings. On Sabouraud dextrose agar

TABLE 2-9  
THE GROWTH OF *MICROSPORUM AUDOUNII* AS COMPARED TO OTHER SPECIES OF MICROSPORUM

Organism	Growth Pattern on Rice Grains	Characteristic Macroconidium, Sketch
<i>M. audouinii</i>	negligible growth, producing brown coffee-stain discoloration on rice grains.	
<i>M. canis</i>	good growth, white cottony mycelium producing many characteristic macroconidia.	
<i>M. cookei</i> (saprophytic)	good growth, white cottony mycelium, usually not necessary for identification.	
<i>M. distortum</i>	good growth, white cottony mycelium producing many characteristic macroconidia.	
<i>M. gypsum</i>	good growth, white granular appearance resembling finely ground gypsum.	

containing chloramphenicol and cycloheximide, the following colonial characteristics will be observed: The colony is slow-growing, flat, velvety with whitish-tan to brownish surface. The reverse pigment, if present, may be light salmon, or orange tan. The growth of *M. audouinii* on rice grain medium is very poor, as compared to the other species of *Microsporium*. This relationship is shown in table 2-9. Microscopically, in wet mounts from culture, the mycelium is usually sterile (Pectinate) with many chlamydospores present. The rare microconidia are clavate in shape and borne sessile on the hyphae. Some strains of *M. audouinii* may form small numbers of macroconidia, but these are bizarre-shaped and of little diagnostic value.

**Exercises (625):**

1. What fungi is the most important causative agent of tinea capitis among grade school children in the United States?
2. What part do barber shops play in the transmission of *M. audouinii*?
3. What is a kerion?
4. If *M. audouinii* is present, how does it appear under the ultraviolet light?
5. When examining an early suspect case of tinea capitis for fluorescence under UV light, what added step should be taken to avoid a false negative result?
6. The scrapings should be collected from what site of the lesion?
7. How does the organism appear in a 10 percent potassium hydroxide mount?
8. What colonial characteristics will be observed on Sabouraud dextrose agar containing chloramphenicol and cycloheximide?

**626. Cite the type of parasite that *Microsporium canis* may be classified as and the type of procedure used to identify this fungi; specify the colony appearance on Sabouraud dextrose agar with antibiotics and the macroconidia as observed in wet mounts from culture.**

**Microsporium Canis.** *Microsporium canis* is primarily an animal parasite. Because it is the most common cause of ringworm in cats and dogs throughout the world, it is classified as a zoophilic fungus. Human infections, especially in children, are not unusual. They generally result from contact with infected puppies or kittens. It is commonplace for several or all the members of a family to become infected; however, it is difficult to determine whether the organism was contracted from a common source or resulted from human to human transfer. About 10 percent of tinea capitis infections in the United States are due to *M. canis*. This percentage may run as high as 65 percent in specific areas, probably reflecting the disease incidence in the local dog and cat population. The infection may appear on any skin surface of the body; it is usually inflammatory, with development of kerions and much suppuration. When this is the case, spontaneous healing usually takes place after 3 to 4 weeks. In the chronic form with little or no inflammation healing may require many months.

The patient is examined first for hair loss and skin lesions, which may be dry and scaly or suppurative and kerionic in nature. *M. canis* causes a small-spored ectothrix invasion of hair, and as in the case of *M. audouinii*, it fluoresces a bright yellow green under UV light. *M. audouinii* and *M. canis* cannot be differentiated on the basis of clinical symptoms or hair examination. Cultural studies are required. A potassium hydroxide mount of an infected hair or skin scrapings will result in findings identical to those elaborated for *M. audouinii*.

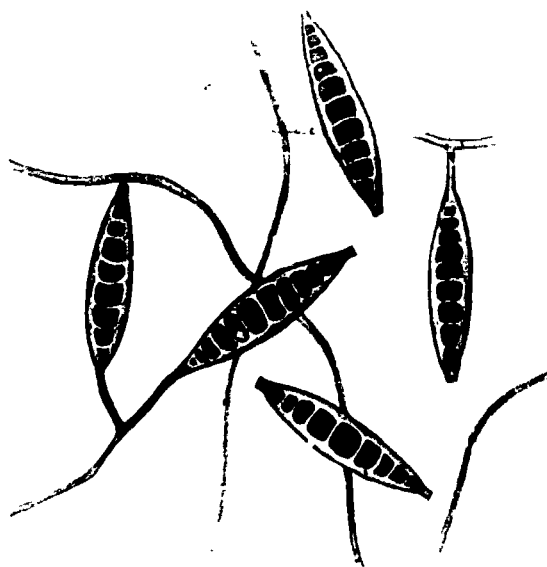

Figure 2-5 *Microsporium canis* (microconidia)



Growth on Sabouraud dextrose agar with antibiotics is rapid; and the colony will at first be white and silky with a bright yellow marginal pigment. As the colony ages its surface becomes dense, tan, and cottony, sometimes in irregular tufts or concentric rings. On rare occasion there will be no reverse (underside) pigmentation; but usually a bright yellow pigment is present, and it gradually turns dull orange brown. *M. canis* grows well on rice grains. Microscopically, macroconidia are numerous in wet mounts, 8 to 15 celled, and spindle shaped. They often terminate in a distinct knob and have thick echinulated walls, as shown in figure 2-5. The microconidia are few in number, clavate, and usually borne sessile on the hyphae.

#### Exercises (626):

1. *Microsporum canis* is primarily classified as what type of parasite?
2. With regard to the spontaneous healing of tinea infections due to *M. canis*, which form of the disease is of shorter duration?
3. Why is it impossible to differentiate *M. audouinii* from *M. canis* on the basis of clinical material or symptoms?
4. What procedures must be followed to identify these fungi?
5. How does the colony of *M. canis* first appear on Sabouraud dextrose agar with antibiotics?
6. As the colony ages, how does its surface become?
7. Describe the macroconidia of *M. canis* as observed in wet mount from culture.

627. Point out the frequent source of *Microsporum gypseum* as a saprophyte, the appearance when viewed under a Wood's lamp, the cultural appearance on Sabouraud dextrose agar, and the typical microscopic picture when viewed in a wet mount from culture.

**Microsporum Gypseum.** *M. gypseum* is a geophilic fungus, and therefore most infections of both man and animals may be traced to the soil. Human infections are rare in spite of the fact that recovery of this fungus from soil samples is very common. Generally, people with ringworm infections develop a single lesion on an exposed area of skin or the scalp. Considerable tissue reaction is present, and the development of kerions is not uncommon. When these areas heal, scarring and permanent hair loss are a frequent result.

A preliminary examination of the patient for skin lesions and hair loss is made. Lusterless, brittle hairs are plucked for examination, and skin scrapings are taken from the margin of the infected area. Examination of the hairs in direct potassium hydroxide mount reveals a large spored (5 to 8  $\mu$ m) ectothrix type invasion, with arthrospores in chains or irregular masses on the air surface. Mycelium runs lengthwise within the hair. Similarly mounted skin scrapings show masses of arthrospores, occasionally in chains, and mycelium. Hairs infected with *M. gypseum* either fluoresce very poorly or not at all, so a Wood's lamp is of little value. This organism grows well on rice grain medium.

Cultural studies are essential for identification. Growth of Sabouraud dextrose agar with antibiotics is rapid. The colony is flat, with irregular fringed borders and a coarsely powdery surface ranging from light ochre to deep cinnamon brown. Tufts of white, fluffy, sterile growth develop rapidly on the colony surface, and the reverse pigment is usually a dull yellow to tan or, rarely, pinkish to red. Microscopic examination of a wet mount illustrated in figure 2-6 shows numerous macroconidia, 3 to 9 celled, ellipsoid, shorter and broader than those of *M. canis*, with thinner, echinulated walls. The microconidia are rare, clavate, and usually borne sessile on the hyphae.

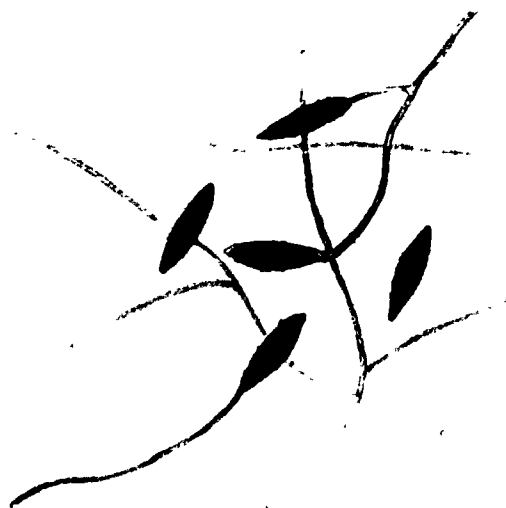

Figure 2-6. *Microsporum gypseum* (macroconidia)

TABLE 2-10A  
CULTURAL CHARACTERISTICS AND MACROSCOPIC MORPHOLOGY OF DERMATOPHYTES

Organism	Key to Plate II	Growth Rate	Texture	Topography	Surface Pigment	Back (reverse) Pigment
<i>T. floccosum</i>	A	Slow	Powdery	Flat or heaped, folded in center	Olive green to tan	Yellow to tan
<i>K. ajellii</i>	B	Rapid	Powdery	Flat	White cream to pink	Purple, black or absent.
<i>M. audouinii</i>	C	Slow	Velvety	Flat	Cream to tan	Pink to brown
<i>M. canis</i>	D	Rapid	Cottony	Flat	White to yellow	Translucent yellow or absent.
<i>M. cookei</i>	E	Rapid	Flat, central growth	Powdery to granular	White to pink	Red to deep purple
<i>M. distortum</i>	F	Rapid	Velvety	Flat	Cream to tan	Tan
<i>M. gypseum</i>	G	Rapid	Powdery to granular	Flat	Tan to cinnamon brown	Yellow to tan
<i>T. mentagrophytes</i>	H	Rapid	Velvety, powdery, or granular	Flat	Usually white, cream, or tan; rarely pink, red, yellow, or orange	Usually rose to brown or colorless, rarely yellow to orange
<i>T. rubrum</i>	I	Slow	Usually cottony, rarely powdery	Flat, rarely folded	Usually white; rarely rose	Usually deep red; rarely colorless
<i>T. schoenleini</i>	J	Slow	Moist and glabrous, or powdery to velvety	Usually heaped and folded; rarely submerged	Usually white, cream, or tan; rarely brown	Tan or absent
<i>T. tonsurans</i>		Rapid	Usually velvety to powdery, rarely granular	Usually heavily folded with depressed centers; rarely flat	Tan, white, yellow, rose, lavender, or brown	Yellow, red, brown, purple, or absent
<i>T. verrucosum</i> ( <i>T. faviforme</i> )	L	Very slow, stimulated by thiamine 37° C.	Moist and glabrous, powdery or velvety	Usually heaped and folded, rarely flat	White, tan or yellow	Yellow or absent
<i>T. violaceum</i>	M	Slow	Moist, glabrous to leathery, or velvety; rarely cotton	Finely wrinkled	Cream, then violet to purple, or colorless	Purple or absent
<i>T. concentricum</i> <sup>1</sup>		Slow	Glabrous, downy areas	Heaped and folded, often cracked	White, tan or brown	Yellow
<i>M. ferrugineum</i> ( <i>M. ferrugineum</i> )		Slow	Moist and glabrous, or velvety	Finely wrinkled, or flat with radial grooves	Rust or white	Rust or colorless
<i>T. mentagrophytes</i> <sup>1</sup>		Rapid	Velvety	Flat, may have radial grooves	White to rose	Deep rose

<sup>1</sup> Rare ecological agents in North America  
<sup>2</sup> Rare Trichophyton spp. not included in this manual include *T. equinum*, *T. gallinae*, *T. terrestre*, and *T. yaoundei*

TABLE 2-10B  
MICROSCOPIC MORPHOLOGY OF DERMATOPHYTES

Organism	Key Figure	Production of Macroconidia	Shape of Macroconidia	Thickness of Macroconidial Wall	Surface of Macroconidial Wall	Microconidia
<i>E. floccosum</i>		Abundant in clusters	Clavate	Thin	Smooth	Unknown
<i>K. ajelloi</i>		Abundant	Elliptical	Thick	Smooth	Pyriform, numerous or rare
<i>M. audouinii</i>		Rare or absent	Irregular to spindle-shaped	Thick	Echinulated	Usually few; rarely numerous
<i>M. canis</i>		Abundant	Spindle-shaped	Thick	Echinulated	Present
<i>M. cookei</i>		Abundant	Elliptical	Thickest of <i>Microsporum</i>	Echinulated	Present
<i>M. distortum</i>		Abundant	Bizarre, almost any shape	Thick	Echinulated	Present
<i>M. gypseum</i>		Abundant	Elliptical	Thin	Echinulated	Present
<i>T. mentagrophytes</i>		Few to many	Clavate or variable	Thin	Smooth	Few to many, spherical
<i>T. rubrum</i>		Usually, few; rarely numerous	Pencil-shaped long	Thin	Smooth	Few to many, oval to elongate
<i>T. schoenleinii</i>		Unknown				Rare, induced on enriched medium
<i>T. tonsurans</i>		Rare	Clavate to irregular	Thin	Smooth	Many; pyriform to elongate; large and irregular with age
<i>T. verrucosum</i> ( <i>T. faviforme</i> )		Rare; induced on thiamine medium	Irregular	Thin	Smooth	Rare; induced on thiamine medium
<i>T. violaceum</i>		Rare, induced on thiamine medium	Clavate to irregular	Thin	Smooth	Rare, induced on thiamine medium
<i>T. concentricum</i> <sup>1</sup>		Unknown				Rare, pyriform
<i>M. ferrugineum</i> <sup>1</sup> ( <i>T. ferrugineum</i> )		Unknown				Rare, induced on enriched medium
<i>T. megninii</i> <sup>1</sup>		Rare	Clavate to narrow	Thin	Smooth	Pyriform, numerous or rare

<sup>1</sup> Rare etiological agents in North America

NOTE: Rare *Trichophyton* spp. not included in this manual include *T. equinum*, *T. gallinae*, *T. soudanense*, *T. terrestre*, and *T. vaouleri*

### Exercises (627):

1. Where is *M. gypseum* found very frequently as a saprophyte?
2. How do tinea infections of *M. gypseum* respond when viewed under a Wood's lamp?
3. Describe the colonial appearance of *M. gypseum* on Sabouraud dextrose agar with antibiotics?
4. How would you describe the typical microscopic picture of *M. gypseum* when viewed in wet mount from culture?

628. State the significance of members of the Genus *Trichophyton* in ringworm of the feet and nails, the appearance of the species in the given types of hair infections, the meaning of black dot ringworm, the growth patterns and the difference in invasiveness of *T. rubrum* from that of *T. mentagrophytes* with regard to the invitro hair culture.

**Genus *Trichophyton*.** The members of the Genus *Trichophyton* are the most important causative agents of ringworm of the feet and nails throughout the world. They sometimes cause tinea infections on other body areas, such as the trunk, scalp, or beard area of males. Spontaneous healing at puberty (as with microsporium infections) does not occur and as a result, adult infections are not uncommon. Infections with members of the Genus *Trichophyton* result in a great variation in tissue response, ranging from superficial scaling and hair loss to highly inflammatory lesions. For this reason, diagnosis on the basis of the clinical symptoms is highly unreliable.

Various members of the Genus *Trichophyton* attack the hair in differing manner, thereby aiding somewhat in their differentiation. Diagnosis is nonetheless dependent on isolation and identification. Many species of *Trichophyton* have been described, but it is likely that a substantial number of these were variants of a single species. On the basis of current studies, twelve distinct species have been described. The methods used for identifying the more common trichophyton disease agents from the standpoint of preliminary diagnosis and cultural and microscopic characteristics are elaborated in tables 2-10A and 2-10B, respectively.

As stated above, the manner in "in vivo" hair invasion can be helpful in differentiating the

*Trichophyton* spp. *T. mentagrophytes*, *T. equinum*, *T. verrucosum*, and *T. rubrum* all cause an ectothrix-type invasion with arthrospores grouped on the outside of the hair shaft. *T. tonsurans* and *T. violaceum* cause endothrix-type hair infections in which the arthrospores are found only within the hair shaft. The hair in this type invasion becomes very fragile due to swelling. It breaks off close to or below the scalp surface. The resulting black, speckled appearance has given rise to the term "black-dot" ringworm. Light-haired individuals fail to demonstrate this characteristic. One final type of hair invasion called "favic" is characteristic of *T. schoenleinii*. In contrast to the previous types, the hair is filled with mycelium on only rarely is an arthrospore seen. The hair does not become fragile and often does not break off. It is not unusual to see empty spaces where mycelium has degenerated. The spaces may become filled with air bubbles and fluid when wet mounts are prepared. Mutant strains of dermatophytes other than *T. schoenleinii* may also produce a favic type of hair invasion.

Some species of *Trichophyton* have demonstrated an ability to grow in two distinct forms: "downy" variety and "granular variety." The downy variety of *T. mentagrophytes*, or *T. mentagrophytes* var. *interdigitale*, has a relatively low virulence in man and is normally associated with chronic tinea pedis. The granular variety of animal origin is highly virulent, causing inflammatory suppurative ringworm. *T. rubrum*, as well as other *Trichophyton* species, also have this ability to increase their virulence by animal transfer. Nutritional tests using growth requirements for vitamins and amino acids are helpful in differentiating *Trichophyton* species. Special media are available through commercial sources in dehydrated form, and the techniques used may be found in most mycology textbooks. The growth patterns on these media are described in table 2-11. If atypical isolates of *T. rubrum* or *T. mentagrophytes* are encountered, an "in vitro" hair culture may be used for separation of the two species. The test is based on ability to invade the hair. Varieties of *T. mentagrophytes* are capable of causing wedge-shaped perforations of the hair, while varieties of *T. rubrum* will not perforate the hair. The hair will usually not show perforations until the 10th to 14th day, and the test should not be considered negative until 28 days have elapsed. The steps in this technique may also be found in most up-to-date clinical mycology textbooks. Characteristics microscopic morphology of the more common genera and species of *Trichophyton* are illustrated in figures 2-7A through 2-7F.

### Exercises (628):

1. The members of the Genus \_\_\_\_\_ are the most important causative agents of ringworm of the feet and nails.

2. What is meant by black-dot ringworm?
3. What two species of *Trichophyton* cause endothrix-type hair infections?
4. How does the pigment usually produce on the reverse side of the medium by *T. rubrum* compare with that of *T. schoenleinii*?
5. How does the shape of the macroconidia of *T. tonsurans* compare with that of *T. rubrum*?
6. How does the invasiveness of *T. rubrum* differ from *T. mentagrophytes* with regard to the "in vitro" hair culture test?

TABLE 2-11  
GROWTH PATTERNS FOR TRICHOPHYTON

ORGANISM	MEDIUM NO.			
	#1	#2	#3	#4
	Basal Medium Only	Inositol	Thiamin + Inositol	Thiamin
<i>T. verrucosum</i>				
84%	0	± to 1+	4+	0
16%	0	0	4+	4+
<i>T. schoenleinii</i>	4+	4+	4+	4+
<i>T. tonsurans</i>	± to 1+	0 to ±	3+	4+
<i>T. mentagrophytes</i>	4+	4+	4+	4+
<i>T. rubrum</i>	4+	4+	4+	4+
<i>T. violaceum</i>	± to 1+	ND	ND	4+
<i>T. concentricum</i>				
50%	4+	4+	4+	4+
50%	2+	2+	4+	4+
<i>T. terrestre</i>	4+	4+	4+	4+

0 = no growth  
 ND = not done  
 4+ = rich abundant growth  
 1+ = submerged growth of approximate 10 mm.  
 ± = growth about 2 mm or less.

NOTE: Pure cultures from no-vitamin-enriched medium, such as Sabouraud's dextrose agar or Mycosel should be used. Bacterial contaminated cultures should not be used in that many bacteria synthesize vitamins that can invalidate the test. It is also important when inoculating the different agars that the substances contained in one not be carried over to the next tube. Inocula to the nutrition tubes must be very small. Nutritional tests are incubated at 30 C for 1 to 2 weeks before interpreting.

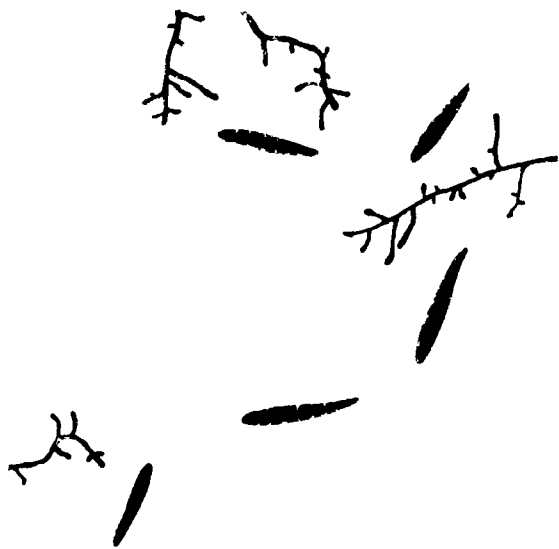

Figure 2-7A *Trichophyton mentagraphytes*  
(clavate macroconidia)



Figure 2-7D *Trichophyton tonsurans*

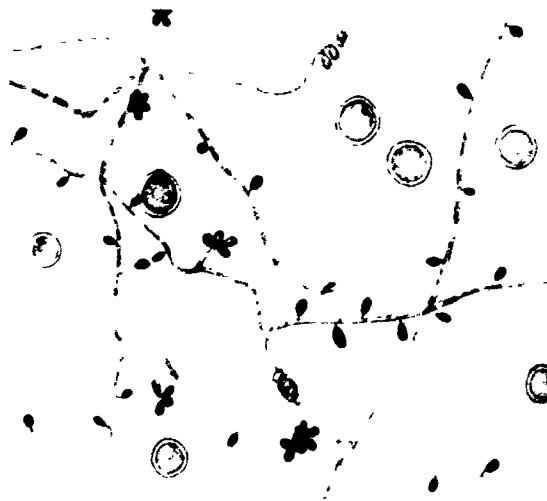

Figure 2-7B *Trichophyton* (microconidia on short pedicles  
in grapelike bunches).



Figure 2-7E. *Trichophyton violaceum*

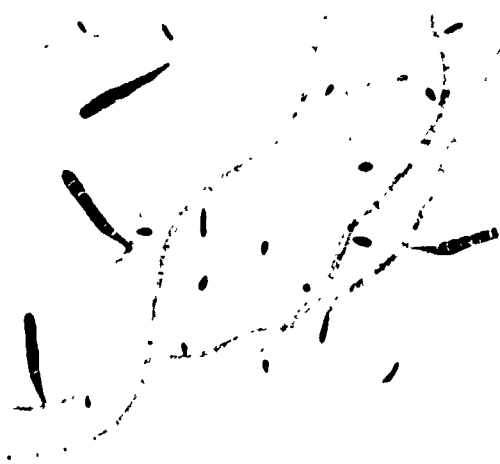

Figure 2-7C *Trichophyton rubrum*



Figure 2-7F *Trichophyton schoenleinii*



629. Specify the type of tissue invaded by *Epidermophyton floccosum*, the appearance under UV light, the growth appearance on Sabouraud dextrose agar, and the diagnostic value of the morphological characteristics of the microconidia.

**Epidermophyton Floccosum.** *Epidermophyton floccosum* is one of the more common etiological agents of tinea cruris (ringworm of the groin), and tinea pedis (ringworm of the feet). It is, however, well below *T. rubrum* and *T. mentagrophytes* in incidence as the agent of these dermatophytic diseases. It has also been isolated on occasion as the etiological agent of tinea unguium. *E. floccosum* does not invade the hair and will not fluoresce under UV light.

Laboratory identification of *E. floccosum* is based on colonial and microscopic characteristics. Scrapings are collected from the periphery of skin lesions and examined in 10 percent potassium hydroxide for the presence of mycelium and chains of arthrospores. Regardless of the findings, the scrapings should be cultured on Sabouraud dextrose agar with or without antibiotics. Growth of *E. floccosum* is slow. At first it is fluffy white, gradually becoming velvety or powdery. The surface is flat and radially folded, and a tan to olive-green color develops. Reverse pigment is a yellowish tan. When growth is mature, teased mounts of *E. floccosum* will reveal numerous macroconidia; 2 to 4 celled, large, broad, blunt to clavate in shape, with smooth, thin walls. They may be borne singly or in groups of two or three. These groupings are shown in figure 2-8. Many chlamydospores may be present and microconidia are absent.



Figure 2-8 *Epidermophyton floccosum* (macroconidia)

**Exercises (629):**

Indicate whether each of the given statements is true (T) or false (F) and correct those that are false.

- \_\_\_ 1. *Epidermophyton Floccosum* does not invade the skin.
- \_\_\_ 2. *Epidermophyton Floccosum* will fluoresce under UV light.
- \_\_\_ 3. Skin scrapings of *E. floccosum* should be cultured on Sabouraud dextrose agar without antibiotics only.
- \_\_\_ 4. Growth of *E. floccosum* is slow.
- \_\_\_ 5. The morphological characteristics of the microconidia of *E. floccosum* are of great diagnostic value.
- \_\_\_ 6. Growth on Sabouraud dextrose agar reveals a flat or radially folded surface, and tan to olive-green color develops.

630 State reasons why the ability to identify *Keratinomyces ajelloi* is important; specify the growth appearance on Sabouraud dextrose agar and the macroconidia in wet mount from culture.

**Keratinomyces Ajelloi.** This dermatophyte and *M. gypseum* are the only geophilic fungi with global distribution. *K. ajelloi* has been isolated only on rare occasions from animals, and it is generally felt to be of little clinical importance. Since data regarding the prevalence of dermatophytes in many regions of the world is scanty, and the etiological agents of many ringworm infections go unreported and possibly undiagnosed, it is important that the technician be able to isolate and identify this potential agent of cutaneous mycotic disease.

As with the previously discussed dermatophytes, suspect hair and skin scrapings are collected for KOH wet mount examination and for culturing. *K. ajelloi* does not fluoresce under ultraviolet light. The wet mount of the hair may demonstrate mycelium within the shaft without a distinct sheath of spores around the

hair. Skin scrapings in wet mount may reveal mycelium and chains of arthrospores. When cultured on Sabouraud dextrose agar with or without antibiotics, colony growth is rapid and either flat or somewhat heaped or folded. The surface is finely powdery, or downy, and cream to tan or orange tan in color. Characteristically, areas of white fluffy growth develop rapidly, and the reverse pigmentation may be either a deep bluish black or absent.

Microscopic examination of a teased mount from culture will demonstrate many macroconidia. They are long and slender with parallel walls tapering at each end (cylindro-fusiform); 8 to 12 cells are present. The macroconidial walls are wide (thicker than those of *M. canis*) and have a smooth surface, as shown in figure 2-9. Microconidia are abundant in some strains, while rare in others. When present, they are ovate to pyriform in shape and borne sessile on the hyphae.

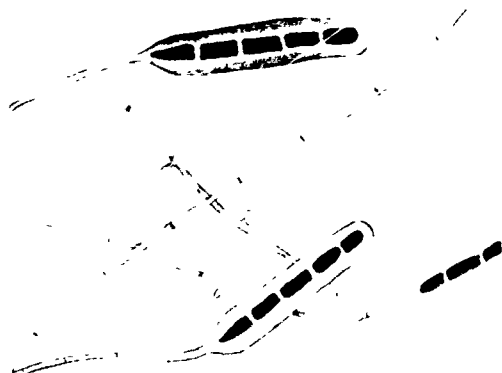

Figure 2-9 *Keratinomyces ajelloi* (macroconidia)

#### Exercises (630):

1. It is important that the technician be able to isolate and identify *K. ajelloi* for which two reasons?
2. Describe the growth appearance of *K. ajelloi* on Sabouraud dextrose agar with or without antibiotics.
3. What specimens are collected for KOH wet mount examination and culturing?
4. Describe the macroconidia of *K. ajelloi* in wet mount from culture.

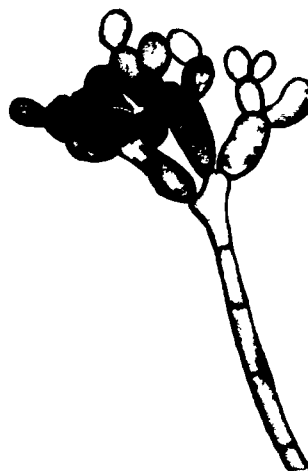

Figure 2-10A. Chromoblastomycotic—  
Cladosporium type.

#### 2-4. The Subcutaneous Monomorphic Molds

This group of fungi, as the heading implies, produces disease in both the cutaneous and subcutaneous tissues. Members, have on rare occasion penetrated to the deep organs of the body.

631. Cite the manner in which most cases of chromoblastomycosis are contracted, the fungi responsible for this disease, and the diagnostic structures observed in clinical material.

Figure 2-10B Chromoblastomycotic—  
Phialophora type.



Figure 2-10C. Chromoblastomycotic—Acrotheca type.

**Chromoblastomycotic Fungi.** Chromoblastomycotic fungi are the etiological agents of chromoblastomycosis. Like the other agents of subcutaneous mycotic diseases, in all probability they lead a saprophytic existence in nature. Most human or animal infections are traceable to wounds contaminated with soil or vegetative matter. Embedding of the chromoblastomycotic fungal agent in the cutaneous or subcutaneous tissues results. The disease seems to be more common in tropical and subtropical areas of the world, but at least 24 cases have been reported in the United States. The disease itself produces no specific pigment, and the organisms do not multiply in the tissues by a true budding process. Hence, the name chromoblastomycosis is a misnomer. At present, however, this term continues to be used for this particular type of mycosis.

There are three types of conidiophore formation demonstrated by the various species causing chromoblastomycosis. The ability to differentiate them will aid appreciably in definitive identification. In the cladosporium type, formally called hormodendrum type, the conidiophore is a simple stalk slightly enlarged at its distal tip. Conidia are produced at this distal tip, forming chains which branch if a single conidium forms two or more buds. This type of sporulation is shown in figure 2-10A. These chains are often broken up in tease-mount preparations, and under high magnification scars may be seen at their former points of attachment. These darkened scars are referred to as disjunctors. A second type of sporulation, shown in figure 2-10B and referred to as the phialophora type, is characterized by the development of highly distinctive conidiophores called phialides which may develop terminally or along the mycelium. These phialides are flasklike structures having a large round or oval base, constricted neck, and a cup-shaped outlet which may flare out to form a distinct lip. Conidia are developed endogenously within the base and extruded through the outlet. They accumulate in a spherical mass of loosely adherent

spores. A final type of sporulation (see fig. 2-10C) called acrotheca type is characterized by the formation of conidia along the sides of irregularly club-shaped conidiophores. The conidia are usually single but, on occasion, may show a tendency to form chains. When the conidia become detached, as occurs in the preparation of a teased mount, the conidiophores present a roughened, irregular surface due to scarring. These scars represent the former points of attachment of the conidia on the conidiophore.

The fungi responsible for chromoblastomycosis are *Philophora verrucosa*, *Cladosporium carrionii*, *Fonsecaea pedrosoi*, and *Fonsecaea compacta*. The characteristics of the disease are the same regardless of which of these fungi is the etiological agent, and therefore they will be discussed collectively. The infection usually begins as a papule or pustule at the site of initial penetration. This persists for a long time, and gradually enlarges and becomes ulcerated. Other lesions may develop by direct extension of the primary lesion, additional implantations, or via the lymphatic system. For some little understood reason, the disease tends to remain localized in the limb or area initially infected. Eventually, large masses protruding several centimeters above the skin level will develop. It is not uncommon for these masses to be attached by a narrow pedicle. Bacterial invasion is quite common, causing purulent, foul smelling crusting of the lesions. In advanced cases lymphatic stasis and elephantiasis are quite common. These masses, especially on the feet, may become so enlarged they resemble small cauliflowers.

A few cases of chromoblastomycosis with central nervous system involvement have typical skin lesions. These presumably are the result of blood stream dissemination. Other cases, however, show no skin lesions, indicating that some internal organ, possibly the lung, was the initial unrecognized focus of infection.

In the laboratory diagnosis of chromoblastomycosis scrapings, scales, or exudate are examined in potassium hydroxide mount for the presence of small clusters of spherical dark brown thick-walled cells that reproduce by equatorial splitting (not budding). The abundance of organisms in the clinical material makes direct examination a rapid means of diagnosis. The material should be cultured on Sabouraud dextrose agar with antibiotics and incubated at room temperature. The fungi causing chromoblastomycosis all produce dark colonies which are heaped or sometimes slightly folded, and typically slow growing. The colonies are covered with a short aerial mycelium which forms a greyish velvet nap, while the reverse pigmentation is a jet black.

A teased mount should be examined microscopically for the type, or types, of sporulation. In species demonstrating multiple types of sporulation, determination of the predominating form can be useful in accurate identification. Table 2-12 contains data regarding the colonial morphology, microscopic morphology, and physiological characteristics of the agents of chromoblastomycosis and the closely related saprophytic *cladosporium* species. Histopathologically, chromoblastomycosis may be readily diagnosed in tissue sections stained with hematoxylin and eosin, or by use

TABLE 2-12  
LABORATORY IDENTIFICATION OF CHROMOBLASTOMYCOTIC SPECIES

Organism	Macroscopic Morphology	Microscopic Morphology	Types of Sporulation	Liquefaction of Gelatin	Hydrolysis of Loeffler's Serum Slant
<i>Cladosporium carrionis</i>	Slow growing; dark, greenish-black.	Chains of spores are long and branching; appear similar to those of the saprophytic <i>Cladosporium</i> sp.	Cladosporium	0	0
<i>Fonsecaea compacta</i>	Slow growing; dark, greenish-black.	Spores are not elongate as in other species but are nearly round and occur in closely packed short chains; cladosporium type sporulation predominates.	Acrotheca, cladosporium, and phialophora	0	0
<i>Fonsecaea pedrosoi</i>	Slow growing; dark, greenish-black	Chains of spores are usually short. Cladosporium type sporulation usually predominates. Acrotheca and phialophora types of sporulation are rare in most strains. Occasional strains show largely acrotheca type sporulation.	Acrotheca, cladosporium, and phialophora	0	0
<i>Phialophora verrucosa</i>	Slow growing; dark, greenish-black; occasional strain produces a soluble brown pigment.	Sporulation may occur on aerial mycelium or in the depths of the medium	Phialophora	0	0
<i>Cladosporium</i> species (saprophyte)	Rapid growing; dark, greenish-black.	Chains of spores are long and branching	Cladosporium	+	+

of the periodic-acid-Schiff (PAS) staining procedure. The fungi causing the disease all appear identical in tissue, and in potassium hydroxide wet mounts of scrapings or exudate. The sclerotic bodies stain dark red in a PAS preparation. Animal inoculation and serological tests are not used in diagnosing this disease.

**Exercises (631):**

1. How are the most cases of chromoblastomycosis contracted?
2. List the three types of conidiophore formation which are demonstrated by the chromoblastomycotic fungi.
3. Which of the three types of conidiospore formation is a simple stalk slightly enlarged at its distal tip?
4. What type is characterized by the formation of conidia along sides of irregularly club-shaped conidiophores?

5. How much of the body is equally involved in most cases of chromoblastomycosis?
6. The fungi responsible for chromoblastomycosis are *Phialophora* \_\_\_\_\_, *Cladosporium* \_\_\_\_\_, *Fonsecaea* \_\_\_\_\_, and *Fonsecaea* \_\_\_\_\_.

7. Describe the structures which make a rapid diagnosis of chromoblastomycosis possible in direct examination of clinical material.
8. Suspected material should be placed on what medium and incubated at what temperature?
9. How does examination of wet mounts made from culture aid in specie identification of chromoblastomycotic agents?

TABLE 2-13  
AGENTS OF MADUROMYCOSIS

Appearance in Tissues							
Species	Morphology of Granules						
	Color	Size	Shape	Texture	Contents	"Cement"	Clubs
<i>Allescheria boydii</i>	White or yellowish	500 $\mu$	Round or lobulated	Soft	Hyaline hyphae up to 5 $\mu$ D. Chlamydospores 3-20 $\mu$ D., especially at the periphery.	0	0
<i>Cephalosporium falciforme</i>	white or yellowish	1-1.5 mm	Irregular	Soft	Hyaline hyphae up to 3-4 $\mu$ D. Chlamydospores up to 12 $\mu$ D.	0	0
<i>Madurella grisea</i>	black	1mm or larger	Round or lobed	Soft at first, become hard & brittle	Unpigmented central zone contains hyaline hyphae. Periphery of large brown cells in band of dark brown "cement"	Dark brown "cement" in periphery only	0
<i>Madurella mycetomii</i>	black	1 mm	Round or lobed	Firm at first, Later hard and brittle	Light brown or hyaline hyphae 1-5 $\mu$ D. Chlamydospores up to 25 $\mu$ . Abundant at periphery. Brown particles in hyphae and chlamydospores.	Hyphae embedded in brown granular "cement"	0
<i>Phialophora jeanselmei</i>	black	Variable	Irregularly round to vermicular with hollow center or crescent to helicoid	Soft	Largely dark brown chlamydospores 5-10 $\mu$ . Occasionally brown hyphae.	0	0

632. Define the term mycetoma; cite reasons for the greater incidence of Maduromycosis in areas with hot, dry climates; name other fungi producing mycetomas and their differences, fungi responsible for maduromycosis, the gross characteristics which should be carefully noted concerning the granules obtained from clinical material; and give the reason for not using cycloheximide in Sabouraud dextrose agar.

**Maduromycotic Fungi.** Although infections of maduromycotic fungi show global distribution, they are considerably more prevalent in tropical and subtropical areas. The fungal agents responsible for this disease are saprophytic in soil and vegetation and gain entry either by a scratch or penetrating wound. The greater incidence in hot, humid climates can be related to the fact that the causative fungi flourish under these environmental conditions and the inhabitants are more likely to go barefoot.

The disease (maduromycosis) is chronic, sometimes lasting a lifetime. It may affect any part of the body although foot infections are most common. Since parts of the body other than the foot may be infected, the term "mycetomic," meaning fungus tumor, was introduced. After gaining entrance, the responsible mycotic agent invades the subcutaneous tissue; and

eventually muscle, bone, and other surrounding tissue become involved. The region affected becomes one in which acute purulent abscesses are continuously developing, burrowing in several directions, and eventually discharging to the surface. Localized areas of inflammation and swelling appear as new abscesses form, while older areas demonstrate healing by dense fibrosis. When the foot is involved, it becomes tender and painful and loses most of its original contour because of swelling. Draining sinuses cover the surface, exuding pus-containing granules, which are readily seen. These granules may be white, yellow, red, or black in color, depending on the fungal agent. They may attain a size of 2 to 3 mm. An experienced mycologist can often identify a specific maduromycotic fungal agent on the basis of the structural elements of the granules produced.

Other fungi, such as *Actinomyces spp.* and *Nocardia spp.*, cause mycetomas; however, the mycelia are considerably smaller in diameter (less than 1  $\mu$ m), and they do not produce the large numbers of chlamydospores normally found in maduromycotic infections.

The fungi responsible for this disease are *Allescheria boydii*, *Cephalosporium falciforme*, *Madurella grisea*, *Madurella mycetomii*, and *Phialophora jeanselmei*. With the exception of *Cephalosporium falciforme*,

TABLE 2-1  
AGENTS OF MADUROMYCOSIS—MORPHOLOGICAL AND PHYSIOLOGICAL CHARACTERISTICS

Organism	Macroscopic Morphology	Microscopic Morphology	Physiological Characteristics			
			Optimum Temperature	Proteolytic Activity	Amylolytic Activity	Carbon Assimilation
<i>Allocheria boydii</i>	Colony rapid-growing. Fluffy aerial mycelium, at first white, later dark brownish-gray. Reverse of colony gray to black. Rarely membranous ivory-colored colonies.	Hyphae hyaline 1-8 $\mu$ D. Unicellular grayish-brown borne singly, pyriform 4-8/8-10 $\mu$ in clusters or corms. Cleistothecia with 8 spored asci may be present.	30°-37° C...	+	+	Maltose 0
<i>Cephalosporium falcatiforme</i>	Colony slow-growing, fluffy or tufted, lavender, buff, or pinkish. Reverse currant red. May produce a soluble pigment.	Hyphae hyaline 3-4 $\mu$ D. Conidia stalk-shaped borne successively in terminal clusters from simple conidiophores.	30° C.....	Weak	0	Maltose +
<i>Madurella grisea</i>	Colony slow-growing with tan or gray velvety aerial mycelium over a brown mat.	Hyphae of two types: pale thin cylindrical 1-2 $\mu$ or dark thick "toruloid" made up of chains of budding cells 3-4 $\mu$ . Chlamydospores rare. Conidia, sclerotia, or hyphal inclusions absent.	30° C.....	Weak	+	Sucrose +
<i>Madurella mycetozooi</i>	Colony slow-growing flat or folded membranous or fluffy white, yellow, or yellow-brown.	Hyphae 1-4 $\mu$ with numerous chlamydospores up to 8 $\mu$ D. Some strains produce conidia from tiny flask-shaped phialides. Black sclerotia, up to 150 $\mu$ sometimes produced.	37° C.....	Weak	+	Sucrose 0
<i>Phialophora jeanneaneni</i>	Colonies slow-growing, black, at first moist with skin-like surface, becomes covered with grayish velvety aerial mycelium. Black on reverse.	Hyphae at first "toruloid" made up of chains of budding cells, later becomes straight and regular. Conidia produced in tube-like phialides. Pulcherric-like sporulation also described.	30° C.....	0	0	Sucrose +

NOTE: *A. boydii*, *C. falcatiforme*, and *P. jeanneaneni* can usually be identified on the basis of their gross and microscopic morphology. The lack of proteolytic activity of *P. jeanneaneni* serves to separate this fungus from the asphytic *Cladosporium* species which have similar colonies. *M. mycetozooi* and *M. grisea* are identified on the basis of both their morphological and physiological characteristics.

cultures of these fungi are shown in detail A of foldout 2 (separate inclosure). Diagnosis of one of these agents of maduromycosis normally begins with examination of pus, curettings, or tissue biopsy material for the presence of granules. These granules, which may vary in size between 0.5 and 2 mm, are first examined grossly in potassium hydroxide or water, and such characteristics as color, texture, shape, and size carefully noted. A granule should be crushed between two slides and studied microscopically. It is essential at this point to distinguish maduromycotic granules, which contain a mycelium between 2 to 4  $\mu$ m in diameter and numerous clamydospores, from actinomycotic granules which contain a mycelium of less than 1  $\mu$ m in diameter and no clamydospores. Refer to table 2-13 for a comprehensive description of the granules produced by the agents of maduromycosis.

The contents of the granules or material aspirated from unopened lesions should be cultured on Sabouraud dextrose agar containing antibacterial agents. Cycloheximide should not be used since some of the fungi which cause maduromycosis are sensitive to this antibiotic. Prior to culturing, wash the granules in physiological saline containing a combination of either penicillin and streptomycin (5,000 units/ml) or chloramphenicol (0.05 mg/ml). The granules may be left over night in this solution prior to culturing. Several tubes of media should be inoculated in order to permit incubation at both 35° C and room temperature. Identification of these fungi is based on their morphological and physiological characteristics which are shown in table 2-14.

#### Exercises (632):

1. What does the term "mycetoma" mean?
2. Give two reasons for the greater incidence of maduromycosis in areas with hot, humid climates.
3. Maduromycosis may affect any part of the body although \_\_\_\_\_ infections are the most common.
4. An experienced mycologist can often identify a specific maduromycotic fungal agent on the basis of \_\_\_\_\_ elements of the \_\_\_\_\_ produced.
5. How may the mycetomas caused by the maduromycotic fungi be microscopically differentiated from those caused by other fungi as the *Actinomyces spp.* or *Nocardia spp.*?



6. The fungi responsible for maduromycosis are *Allescheria* \_\_\_\_\_, *Cephalosporium* \_\_\_\_\_, *Madurella grisea*, *Madurella* \_\_\_\_\_ and \_\_\_\_\_ *jeanselmei*.

7. List the gross characteristics which should be noted concerning "grains" obtained from clinical material.

8. Why is it inadvisable to use cycloheximide in the media when culturing for suspect maduromycotic agents?

9. Which of the agents of maduromycosis depicts a macroscopic morphology of slow-growing colonies, black, at first moist with skin-like surface, becomes covered with grayish velvety aerial mycelium, and is black on reverse?

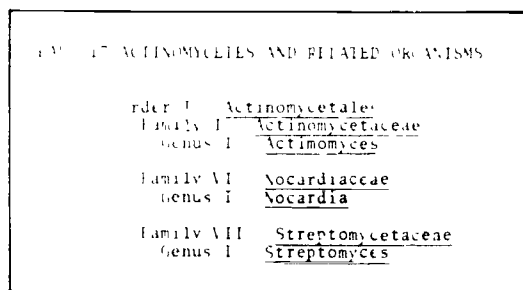

Figure 2-11. Classification of Systemic Monomorphic molds.

and fungi have developed, and still others prefer to call them "higher bacteria." There is, however, a general agreement that the actinomycetes belong in an intermediate location between bacteria and fungi. Although they were discussed briefly in Volume 2, Chapter 5, The Acid-Fast Bacilli, we will consider them as fungi for purpose of this work, since the diagnostic techniques used closely resemble those used for other mycotic agents.

633. Cite the areas of the body where the organisms causing Actinomycosis are common inhabitants, describe the typical sulfur granules, define the term "lumpy jaw", and cite the threat which abdominal actinomycosis presents to wounds of the intestinal walls.

## 2-5. The Systemic Monomorphic Molds

These organisms which produce deep-seated human infections have a taxonomic position which differs appreciably from that of fungi previously considered. These organisms exist midway between the complex molds. They are pathogenic and are placed in the order Actinomycetales according to Bergey's manual, as shown in figure 2-11.

These organisms have an irregular morphology, and they occasionally produce branching forms which are generally considered as rudimentary and in some cases true mycelium. This mycelium is quite thin, 1  $\mu$ m or less in diameter, and in one family, the *Actinomycetaceae*. There is a tendency to fragment quite readily into bacillary and coccoid forms which are extremely difficult to distinguish from bacterial cells. Their close relationship to the bacteria is pointed up by the fact that, like the bacteria, they cause suppurative tissue reactions and are sensitive to many of the same antibiotics. Another feature of the family *Actinomycetaceae* is a lack of chitin and cellulose in the cell walls. Bacteria lack these substances, while they are normal constituents of the walls of the *Eumycetes*, the true fungi.

Many schemes for the classification of this group, Order *Actinomycetales* have been proposed. However, differences of opinion still exist among investigators with respect to the phylogentic relations among these organisms. Some regard them as degraded fungi, others see them as a primary stock from which both bacteria

**Clinical Aspects of Actinomycosis.** Actinomycosis is a worldwide chronic, suppurative, granulomatous infection which may exist in several well-defined clinical forms. The causative agents of the disease have never been isolated from any natural habitat outside the human body; however, their existence in saprophytic and parasitic form in man and animals is common. In tonsils removed by tonsillectomy, a significant number contain an anaerobic actinomycete. Anaerobic actinomycetes are common inhabitants of the tonsillar crypts, gingiva, and teeth of apparently normal individuals. Therefore, the disease must be considered endogenous in origin.

Cervico-facial actinomycosis due to *Actinomyces israelii* frequently follows tooth extraction or fractures of the teeth-bearing areas. Usually, the primary site of infection is at the angle of the jaw, although the maxillary sinus is also particularly susceptible. After gaining entry the organisms spread to soft tissue and bone of the face and neck, causing much swelling and the development of abscesses which drain a purulent fluid. The fluid contains tiny yellowish-white friable masses of the causative fungi, commonly referred to as "sulfur granules."

*Actinomyces bovis* causes a similar disease in cattle that is commonly referred to as "lumpy jaw." Cervico-facial actinomycosis is the most commonly occurring form of the disease in humans. Another type of

infection, thoracic actinomycosis, is caused by aspiration of the organism from the mouth. Eventually, draining sinuses may penetrate to the body surface and the purulent exudate contains the typical "sulfur granules."

Abdominal actinomycosis may develop from traumatic injuries to the intestinal wall, since *Actinomyces israelii* is often present asymptotically in the human intestine. Occasionally, it develops in the appendiceal area with no evidence of external trauma. This disease may occur anywhere in the body through blood stream dissemination; however, this is the exception rather than the rule.

#### Exercises (633):

1. Anaerobic actinomycetes are common inhabitants of what parts of the body?
2. Cervico-facial actinomycosis due to *Actinomyces* \_\_\_\_\_ frequently follows \_\_\_\_\_ or fractures of the teeth-bearing areas.
3. What name is commonly applied to the tiny yellowish-white friable masses which are found in the purulent fluid in cases of actinomycosis.
4. What is meant by the term "lumpy jaw."
5. Why is abdominal actinomycosis a definite threat in wounds of the intestinal wall?

634. Specify some general physiological characteristics of *Actinomyces israelii* and *Actinomyces bovis*, the type of specimen submitted, characteristic appearance of *A. israelii* in thioglycollate broth, and the significance of the "sulfur granules."

**Laboratory Diagnosis of Actinomycosis.** *A. israelii* and *A. bovis* have the following general physiological characteristics: They both require anaerobic or microaerophilic conditions and an enriched medium such as brain-heart-infusion agar, brain-heart-infusion blood agar, or thioglycollate broth for primary isolation. The optimum pH range of the media is between 6.8 and 7.4 with incubation at 35° C. Frequent

transfers are necessary to maintain these organisms, since they tend to die off quite rapidly due to the depletion of essential growth factors and the accumulation of acids.

See table 2-15, The Physiological Characteristics of *Actinomyces israelii*, *A. Bovis*, *A. naeslundii*, and Anaerobic Diptheroids. From a morphological standpoint most strains of *A. israelii* produce rough (R) colonies, while the majority of *A. bovis* isolates are smooth (S). The (R) colonies of *A. israelii* are dull white, heaped up, and irregular and show spiderlike filaments on the agar surface. Mature colonies give the appearance of a molar tooth. In thioglycollate broth *A. israelii* produces discrete, lobated, breadcrumb-type colonies about 1 centimeter below the surface. Gram stain of this growth reveals branching filaments which readily fragment to coccoid, bacillary, or diptheroids forms. The (S) colonies of *A. bovis* are lacking in spidery filaments and appear moist, compact, rounded, and glistening. When cultured in thioglycollate broth, a turbid appearance is common with many of the organisms settling to the bottom of the tube. Several types of growth patterns are produced by *A. bovis* in thioglycollate broth, depending on the strain. A Gram stain of this (S)-type growth will usually reveal only bacillary forms due to the fragility of the filaments.

The clinical specimen usually received in the mycology laboratory is pus, either aspirated from a closed lesion or collected in a sterile tube from a draining sinus. Sputum may be submitted in those cases where pulmonary actinomycosis is suspected. The pus or sputum should be spread out and searched carefully for "sulfur granules." The tiny granules, 2 to 5 mm. in diameter, are round and firm in consistency. They should be removed and placed in a small amount of sterile saline prior to preparation of fresh mounts, stained smears, and cultures. If the granules are gently pressed between slide and coverslip for direct examination, we see a lobated, opaque body under low magnification. There may be gelatinous projections, or clubs, over the surface of the granule; however, these sometimes do not occur. High magnification shows the granule to be composed of intertwined, delicate, and branched filaments of 1  $\mu$ m or less in diameter.

The granule should be crushed and smeared out on the slide for Gram and acid-fast staining. The Gram-stained slide will reveal thin gram-positive, branched mycelium and many short lengths of Gram-negative mycelium which closely resemble bacilli. The Gram-negative, rod-shaped forms are the result of physiological changes in older colonies. If no granules are found in the pus or sputum, smears of the clinical material should be stained and examined for Gram-positive branched forms. If non-acid-fast, branching, Gram-positive, thin forms resembling *Actinomycetes* spp. are observed, or if the physician suspects Actinomycosis on the basis of the clinical picture, cultures should be made.

Suspicious colonies can be picked from streaked plates and inoculated in thioglycollate broth which will more readily reveal the typical branching forms. Pure cultures are essential for use in physiological testing. *Actinomyces naeslundii*, a common inhabitant of the

TABLE 2-15  
 PHYSIOLOGICAL CHARACTERISTICS OF *ACTINOMYCES ISRAELII*, *A. BOVIS*,  
*A. NAESLUNDII* AND AEROBIC DIPHTHEROIDS

	<i>Actinomyces israelii</i>	<i>Actinomyces bovis</i>	<i>Actinomyces naeslundii</i>	Anaerobic diphtheroids
Maximum Growth Reached	3-7 Days	2-3 Days	1-2 Days	3-4 Days
O <sub>2</sub> Requirements	Anaerobic (or microaerophilic after first isolation)	Anaerobic (or microaerophilic after first isolation)	Facultative, especially in presence of increased CO <sub>2</sub>	Anaerobic or microaerophilic
Aerobic conditions	0 or 1+	0 or 1+	1+ to 2+	0 or 1+
Air + 10% CO <sub>2</sub> (Candle jar)	0 or 1+	0 or 1+	4+	0 or 1+
Anaerobic conditions (N <sub>2</sub> + CO <sub>2</sub> )	4+	4+	4+	4+
Cetolase production	0	0	0	+
Starch hydrolysis	± or 0	4+	± or ~	0
Nitrate reduction	80% +	0	90% +	Usually ++
Indol formation	0	0	0	Usually ++
Gelatin liquefaction	0	0	0	+ (May take 1-3 weeks)**
Litmus milk reactions	0 to 1+ acid No coagulation Slight reduction No peptonization	0 to 1+ acid No coagulation. Slight reduction. No peptonization	0 to 1+ acid with slight reduction Or acid and acid clot. No peptonization	Acid followed by peptonization (May take 1 to 3 weeks.)**
Sugar Fermentation (Production of acid only)				
Glucose	+	+	+	+
Xylose	80% +	0	0	0
Mannitol	80% +	0	0	+
Raffinose	Variable	0	80% +	Variable
Starch	20% +	+	20% +	0
Glycerol	0	Occasionally +	0	+

\* With *Corynebacterium acnes*, usually either nitrite or indole, or both are produced

\*\* Several non-proteolytic species of anaerobic *Corynebacterium* have been reported but these appear to be rare

mouth, has to date demonstrated no pathogenic properties and may be readily differentiated from *A. israelii* or *A. bovis* by its ability to grow aerobically. Anaerobic diphtheroids which closely resemble the (C) forms of *A. bovis* and *A. israelii* fortunately can be readily differentiated on the basis of biochemical tests. Refer to tables 2-15 and 2-16 for the morphological and physiological characteristics of the actinomyces and the anaerobic diphtheroids.

#### Exercises (634):

1. What type(s) of growth environment and media are required for the primary isolation of *Actinomyces israelii* and *Actinomyces bovis*?
2. Describe the appearance of *A. israelii* in thioglycollate broth.
3. From a morphological standpoint most strains of *A. israelii* produce \_\_\_\_\_ colonies while the majority of *A. bovis* isolates are \_\_\_\_\_.

4. Which of the organisms reaches its maximum growth in 2 to 3 days?
5. What type of clinical specimen should be used for culture of *Actinomyces spp.*?
6. When may sputum be submitted?
7. What is the microscopic appearance of a "sulphur granule" under high magnification?
8. What should you expect to see on the gram stained smear of a crushed granule?
9. How may *Actinomyces naeslundii* be readily differentiated from *A. israelii* and *A. bovis*?

TABLE 2-16  
MORPHOLOGICAL CHARACTERISTICS OF *ACTINOMYCES ISRAELII*, *A. BOVIS*, *A. NAESLUNDII*  
AND AEROBIC DIPHTHEROIDS

Morphology	<i>Actinomyces israelii</i>	<i>Actinomyces bovis</i>	<i>Actinomyces naeslundii</i>	<i>Anaerobic Diptheroids</i>
<p>A. Gross Morphology on BHI Agar with Anaerobic incubation at 37° C.</p> <p>1. Colonies examined after 48 hours under the microscope 100X.</p>	<p>Colonies usually only seen microscopically. They appear as a loose mass of long branching filaments on agar surface ("spider" colonies). Or, appear as small whitish granules with a rough surface and a fringed "lace-like" border. Smooth surfaced pin-head sized colonies with slightly fuzzy edges may occur in some strains—"S" forms.</p>	<p>Colonies are usually pinhead in size, transparent, and look like dew drops. They appear smooth, slightly convex with entire edge. Microscopically they show a smooth but granular surface with a granular or denticulate edge. Some strains are more opaque, rough surfaced and have an irregular or fuzzy border. Rare strains are microscopic in size, and appear as mycelial "spider" colonies as seen in "R" <i>A. israelii</i> strains.</p>	<p>Colonies similar to those of <i>A. bovis</i> or <i>A. israelii</i>.</p> <p>"S" forms most common.</p>	<p>Pin-head sized smooth, transparent glistening colonies with smooth edge.</p>
<p>2. Colonies examined after 7 to 10 days.</p>	<p>Raised irregular to lobulated colonies with white glistening surfaces ("molar tooth" colonies). They tend to indent the agar and are easily moved as a whole. Smooth surfaced colonies which are slightly convex with smooth edges may occur in some strains—"S" forms.</p>	<p>Colonies smooth convex, cream to white and shining with entire border. Some strains show conical or irregular lumpy surface and scalloped borders (may look like an inverted raspberry). Rare strains produce typical "molar tooth" colony seen in "R" <i>A. israelii</i> strains.</p>	<p>Colonies similar to those of <i>A. bovis</i> or <i>A. israelii</i>.</p> <p>"S" forms most common.</p>	<p>Smooth colonies which may show granular surface, and entire, slightly granular, edge.</p>
<p>B. Growth in Thioglycollate Broth at 37° C.</p>	<p>Distinct colonies which are rough and lobulated or show fuzzy edges. Colonies do not break up when tube is shaken. Broth is clear. Smooth strains may appear more diffuse.</p>	<p>Most strains produce a soft, diffuse growth. Other strains produce large lobulated bread-crumbs colonies which are easily broken up. Flaky or mucoid growth is seen in some strains. Rare strains produce granular discrete colonies as seen in "R" <i>A. israelii</i> strains.</p>	<p>Rapid growth—usually more diffuse than <i>A. bovis</i>, granular or floccose colonies may be present. Broth somewhat cloudy.</p>	<p>Rapid growth—diffuse, and often pink colored. Tends to concentrate along side of tube. Colonies easily broken up. Broth cloudy.</p>
<p>C. Microscopic Morphology.</p>	<p>Gram positive rods and branched forms, 1 micron or less in diameter. Variations in diameter and clubbed ends are common. Long mycelial filaments occasionally seen. Nonbranching diptheroid-like rods only may be formed by "S" forms.</p>	<p>Gram positive diptheroid forms most common. Difficult to find branching. Some strains somewhat more filamentous. Rare "R" strains show long branching filaments.</p>	<p>Similar to <i>A. bovis</i> or <i>A. israelii</i> but more irregular forms. Gram positive short mycelial forms with many branches. Some thick, very irregular forms, and few long mycelial elements which vary in thickness throughout. Some diptheroid-like forms.</p>	<p>Gram positive bacillar or slightly branched organisms. "X" or "Y" shaped forms commonly occur.</p>

635. State the disease caused by *Nocardia* spp. and techniques for culture and identification of the given species.

**Nocardiosis.** *Nocardia* spp. caused a chronic or acute granulomatous or suppurative disease in man and animals which may be systemic, resembling tuberculosis, or subcutaneous in the form of a mycetoma. Several filamentous members of the order *Actinomycetales* produce human disease in addition to *Actinomyces israelii*. At one time, they were all classed in the Genus *Nocardia*. Some of them are now considered to fall in the Genus *Streptomyces*, and they also will be discovered in this section. The causative fungi of Nocardiosis are saprophytic in the soil, and therefore, the disease is exogenous in origin. The disease is cosmopolitan in distribution, with greater prevalence in the tropic and subtropical areas of the world. Pulmonary infections result from the inhalation of the causative fungal agent, while the mycetomal form normally results from the penetration of the fungus due to injury. No transmission between individuals or animals and humans takes place. Refer to table 2-17 for species differentiation.

**Clinical aspects of nocardiosis.** The pulmonary disease is caused primarily by *Nocardia asteroides*. *Nocardia brasiliensis* may also cause this form of the disease, but the organism is more often associated with the mycetomal type of infection. As previously stated, pulmonary nocardiosis occurs as a result of inhalation of the fungal spores, and the infection often remains

confined to the lungs. Blood stream dissemination is not unusual, and the organism attacks the central nervous system in about a third of the cases of disseminated nocardiosis. After entry to the lungs, single lesions may develop, but the more common picture is one of scattered infiltration of a miliary type resembling tuberculosis. There is a tendency for the lesions to penetrate the pleural wall, causing abscesses on the chest wall and rib involvement. As a result of these extensions, thoracic skin lesions of a draining sinus type may develop.

Actinomycotic mycetoma may result from injuries contaminated with *Nocardia brasiliensis*, *Streptomyces madurae*, *Streptomyces pelletieri*, or *Streptomyces somaliensis*. The gross morphology of two of these fungi is shown in detail B of foldout 2. Frequently the foot is involved, since many people go barefoot in the warm, humid areas of the world. The fungal tumor resembles that described for mycetomas due to *Actinomyces israelii*. The variations result because the different etiological agents of mycetoma may have an affinity for different tissues. Also, "sulfur granules," when they are produced, will vary considerably in morphology and color, dependent on the causative fungal agent. Refer to table 2-18 for geographic distribution and appearance in tissue.

**Laboratory diagnosis of nocardiosis.** Clinical materials such as pus, sputum, tissue, or spinal fluid are collected in sterile containers. Pus and sputum should be carefully examined for grains, although they are generally absent from the sputum in cases of pulmonary nocardiosis. Acid fast and Gram stains should be

TABLE 2-17  
LABORATORY IDENTIFICATION AND DIFFERENTIATION OF PATHOGENIC  
*NOCARDIA* AND *STREPTOMYCES*

	<i>Nocardia asteroides</i>	<i>Nocardia brasiliensis</i>	<i>Streptomyces</i> sp
Demonstration of Branched Mycelium, characteristic of <i>Actinomycetales</i> (slide culture)	Branched mycelium form	Branched mycelium form	Branched mycelium form
Demonstration of acid-fast staining	Partially acid-fast	Partially acid-fast	Not acid-fast with exception of occasional spores
Other species of <i>Nocardia</i> are not acid-fast			
Hydrolysis of Casein	Does not hydrolyze casein	Readily hydrolyzes casein	Readily hydrolyzes casein
Growth in Gelatin	Does not grow; or grows poorly producing thin, flaky, white growth	Readily grows, producing compact, round colonies	May or may not produce good growth; growth will be stringy or flaky
Pathogenicity to guinea pig	Usually pathogenic to guinea pig	Usually not pathogenic to guinea pig	Not pathogenic to guinea pig



performed on fresh materials, such as centrifuged sediment in the case of spinal fluid or concentrates of sputum and gastric washings. When grains are found, they should be grossly examined and then crushed and stained and microscopically examined. The presence of partially acid-fast, Gram-positive, thin-branched mycelium is indicative of a nocardial infection. Refer to table 2-18 for a resume of the gross and microscopic appearance of grains from tissue.

The specimen should be cultured on Sabouraud dextrose agar without antibiotics, since *N. asteroides* and *N. brasiliensis* are sensitive to these substances. It has been demonstrated that some strains of these organisms lose their viability when subjected to the digestion and concentration techniques normally employed for the recovery of tubercle bacilli; therefore, the specimen should be inoculated on culture media both prior to and following concentration. Multiple cultures should be inoculated to permit incubation at both room temperature and at 35° C. This is necessary because some strains of *N. asteroides* will

grow well at one temperature and not at the other. The technician should be aware of the fact that these organisms grow quite readily on media used for *M. tuberculosis*, particularly if incubated at 35° C. The colonies of *Nocardia spp.* will develop earlier than the tubercle organism (within 1 to 2 weeks) and appear similar to the "atypical" or saprophytic forms of mycobacteria. In order to detect the partially acid-fast branched mycelium of *Nocardia spp.*, a careful examination of the early growth is necessary and may be quite rewarding.

Animal inoculation has been shown to be impractical for routine diagnosis. Identification should be established on the basis of morphological and physiological characteristics. The biochemical tests routinely used for identification and differentiation of the *Nocardia spp.* and the *Streptomyces spp.* include the casein hydrolysis test and the gelatin test. Study table 2-19 for the laboratory identification and differentiation of pathogenic *Nocardia* and *Streptomyces spp.*

TABLE 2-18  
AEROBIC AGENTS OF ACTINOMYCOTIC MYCETOMA—GEOGRAPHIC DISTRIBUTION  
AND APPEARANCE IN TISSUES

Species	Geographic Distribution	Appearance in Tissues
<i>Streptomyces somaliensis</i>	Common cause of mycetomas in Africa  Also present in Saudi Arabia, Brazil, and Mexico	Grains usually present. They are large (up to 1.25 mm D.), yellowish to slightly pink, round or oval, compact and very hard.  Microscopically, grains consist of a matrix of amorphous material with mycelial filaments abundant near the periphery, but not at edge of granule. No clubs have been observed.
<i>Streptomyces pelletierii</i>	Cause of mycetomas in Africa and Latin America	Grains usually present. They are small (less than 1 mm D.), deep garnet red with irregular shape and smooth or denticulate edges - often lobulated.  Microscopically, the grains show a homogenous matrix, and mycelial filaments are difficult to see. No clubs have been observed.
<i>Streptomyces madurae</i>	Cause of mycetomas all over the world. Reported from North, Central, and South America, Africa, India, Europe, and Australia	Grains usually present. They are very large (more than 1 mm D.), yellowish to white or slightly pink, usually irregular to serpiginous in shape.  Microscopically, center of grain appears empty or only loosely filled with mycelial filaments. A dense network or mantle of filaments surrounds central area. These filaments radiate outward and are surrounded by amorphous material forming clubs. Clubs are usually numerous and very long (up to 25 microns) may taper to pointed ends or may branch.
<i>Nocardia brasiliensis</i>	Common cause of both mycetomas and pulmonary disease in Mexico. Also present in Central America, South America, Africa and the United States, and India	Grains usually present. They are small yellowish, lobulated and soft.  Microscopically, the grains appear homogeneous. Mycelial filaments are difficult to observe. Clubs may or may not be present. If grains do not occur, organism is seen as freely branching filaments (acid-fast) in the tissues.
<i>Nocardia asteroides</i>	Cause of both systemic disease and mycetomas all over the world	Grains may or may not occur. They are very small, cream to white.  Microscopically, the grains are homogeneous or composed of a loose clump of mycelial filaments. Clubs may or may not be present.  If grains do not occur, organism is seen as freely branching filaments (acid-fast) in the tissues.



TABLE 2-19  
AEROBIC AGENTS OF ACTINOMYCOTIC MYCETOMA—CULTURAL  
AND PHYSIOLOGICAL CHARACTERISTICS

SPECIES	MORPHOLOGY IN CULTURE (Sabouraud Dextrose Agar)	PHYSIOLOGICAL CHARACTERISTICS			
		Optimum Temperature	Proteolytic Activity	Amylolytic Activity	Pathogenicity for guinea pig or mouse
<i>Streptomyces mitis</i>	Colony (Gross): Creamy colored wrinkled flaky growth loosely adherent to agar. May develop a tan aerial mycelium. Old colony may be brown or blackish. No diffusible pigment.  Microscopic exam: Delicate branched mycelium less than 1 micron in diameter. Aerial mycelium may show chains of spores. Mycelium not acid-fast.	30°	+	+	Pathogenicity tests in mice and guinea pigs not successful
<i>Streptomyces pelletierii</i>	Colony (Gross): Very small glabrous, dry granular adherent colonies. Fungus grows very slowly. Colonies first pale pink, then deep garnet red. No aerial mycelium. No diffusible pigment.  Microscopic exam: Delicate branched mycelium, less than 1 micron in diameter. Conidia rarely seen. Not acid-fast.	35°	+	0	Pathogenicity tests in mice and guinea pigs not successful
<i>Streptomyces madurae</i>	Colony (Gross): Moderately fast growing adherent cream colored glabrous colony with a firm hard surface usually shiny and wrinkled. Colonies may develop a whitish powdery aerial mycelium.  Microscopic exam: Delicate branched mycelium, less than 1 micron in diameter. Chains of conidia may be seen. Not acid fast.	35°	+	+	Pathogenicity tests in mice and guinea pigs not successful
<i>Nocardia brasiliensis</i>	Colony (Gross): Rapid growing, heaped wrinkled or folded colony. Pale tan to yellowish, orange or red-orange. May be glabrous or covered with white powdery aerial mycelium. Some strains produce brownng of the medium.  Microscopic exam: Short irregular rods and coccus forms predominate. Long branched mycelial forms best seen in liquid or slide culture preparations. Forms less than 1 micron in diameter, partially acid-fast, often beaded. Terminal conidia seen in some strains.	30° (Some strains grow well at 37° also.)	+	0	Abscesses and grains may be produced in mice and guinea pigs with some strains
<i>Nocardia asteroides</i>	Same as above.	35° (Some strains grow better at 30°.)	0	0	Usually more virulent for the guinea pig than <i>N. brasiliensis</i> . Abscesses without grains. Frequently causes death

**Exercises (635):**

1. What disease is caused by *Nocardia spp.*?
2. Why is nocardiosis considered to be exogenous in origin?
3. Which species of *Nocardia* is the primary cause of the pulmonary disease?
4. Which species of *Nocardia* is primarily associated with the mycetomal type of infection?
5. Actinomycotic mycetoma may result from injuries contaminated with *Nocardia* \_\_\_\_\_, *Streptomyces* \_\_\_\_\_, *Streptomyces* \_\_\_\_\_, or \_\_\_\_\_ *somaliensis*.
6. In what respect do the mycetomas caused by the aerobic actinomycotic agents vary from those caused by *Actinomyces israelii*?
7. What findings may be expected when grains from a case of nocardiosis are crushed, stained, and microscopically examined?
8. In which of the species of *Nocardia* grains may or may not appear in tissue specimens and they are very small, cream to white?
9. When culturing for *N. asteroides* or *N. brasiliensis*, why is it necessary to inoculate the media prior to and following concentration?
10. What difference is there in the growth rate between a *Nocardia spp.* and *M. tuberculosis* when incubated at 35° C on media normally used to isolate *M. tuberculosis*?
11. What two biochemical tests are routinely used for differentiation and identification of the *Nocardia spp.* and the *Streptomyces spp.*?

## The Pathogenic Dimorphic Fungi

THE TERM "dimorphic," which implies two shapes, refers to that group of fungi that have the unique capability of existing in two morphologically distinct forms. When incubated on an artificial substrate at 25° C, these organisms will grow in a moldlike filamentous form; incubation of the same organism on the substrate at 37° C will result in the development of mucoid bacteriallike colonies of budding yeast cells.

The filamentous moldlike growth occurs in nature and is referred to as the *saprophytic* form. Human and animal infections result when spores produced by the saprophytic form are introduced into the body either from tissue damage or by inhalation. Following entry, the yeast or parasitic form of the fungi develops in the host, whose temperature approximates 37° C.

The dimorphic, or as they are sometimes called, the diphasic fungi, cause the most serious fungal diseases in man. This chapter will discuss *Sporotrix schenckii*, *Coccidioides immitis*, *Blastomyces dermatitidis*, *Paracoccidioides brasiliensis* and *Histoplasma capsulatum* from the standpoint of their clinical effects in man and the methods used in laboratory identification.

### 3-1. Subcutaneous Group

With the exception of *sporotrix schenckii*, which generally infects subcutaneous tissues, the dimorphic fungi cause diseases that are incurable unless diagnosed early so that proper therapeutic treatment can begin. They also confuse diagnosis. It has been estimated that about 8 percent of these people confined to tubercular sanitariums actually are infected with chronic pulmonary histoplasmosis, a disease caused by *Histoplasma capsulatum*. Patients ill with histoplasmosis are also likely to contract tuberculosis. On the other hand, people with tuberculosis are not subject to histoplasmosis from other patients because the disease is not transmissible in the parasitic or yeast form. This principle holds for all the pathogenic diphasic fungi.

When working with the dimorphic fungi in pure culture, a bacterial safety hood is essential. Extreme caution and the best possible aseptic technique must be used continually to prevent laboratory infections. The highly infectious spores produced by the mold form of these fungi easily become airborne if the culture tube is shaken or handled roughly.

**636. Cite the causative organism of sporotrichosis, the general occupational group in which the disease is predominant, the manner in which one becomes infected, characteristics of the course of the disease, and the manifestations of disseminated sporotrichosis.**

**Sporotrichosis.** Sporotrichosis, caused by *Sporotrix schenckii*, is usually a chronic, subcutaneous, lymphatic mycosis and is found worldwide. On rare occasions this fungal agent may disseminate to cause generalized infection of the bones, joints, and body organs. *Sporotrix schenckii* has a wide distribution in nature. Investigators have found it as a saprophyte on living and dead vegetative matter as well as in animal excreta. One particular investigation demonstrated that its growth on mine timbers was markedly enhanced if the temperature was maintained between 79 F and 84 F and the relative humidity never fell below 92 percent. The disease is found predominantly in people who work and play outdoors. Florists are frequently exposed to infection by virtue of handling thorny plants which may be harboring the organism.

Localized lymphatic sporotrichosis, the most common form of the disease, normally results from implantation of the spores in the subcutaneous tissue during a penetrating injury from a thorn or splinter. In spite of topical treatment, the small ulcerated lesion which develops will not heal; it develops into a firm subcutaneous nodule, eventually adhering to the skin. The color of the lesion changes from pink to black as the infection ruptures through the skin to form the typical necrotic chancre. The course of the disease is characterized by a chainlike lymphatic involvement, with swelling of nodes and induration of the connecting lymphatics. The primary lesion as well as the necrotic nodes in close proximity to it have a tendency to ulcerate and excrete a purulent drainage.

Disseminated sporotrichosis is uncommon, probably due to an immune response in those individuals suffering from the chronic lymphatic form of the disease. In a few cases, sporotrichosis may be spread throughout the body, either via the bloodstream or as a result of suppurating lymph nodes. Manifestations of disseminated sporotrichosis include the development of numerous and widespread cutaneous lesions. Oral and nasal mucosa involvement is quite common. Lesions may be found in the kidneys, lungs, bones, joints, muscles, genitourinary system, and other body organs.

**Exercises (636):**

1. What is the causative organism of sporotrichosis?
2. The disease is found predominantly in people who \_\_\_\_\_ and \_\_\_\_\_ outdoors.
3. How does one normally become infected with the most common form of sporotrichosis?
4. What characterizes the course of the disease sporotrichosis?
5. What are some manifestations of disseminated sporotrichosis?

**637. State the type of specimen and media used for culture of *Sporotrix schenckii* and the cultural characteristics of the tissue and mycelial phases of growth.**

**Specimen, Media, and Cultural Characteristics of *S. schenckii*.** A direct examination of clinical material, scrapings from skin lesions, or swabs from draining ulcers is generally of little or no value in identifying *S. schenckii*. In Gram-stained smears, it is very difficult to distinguish the few organisms which may be present from other tissue elements. Pus from unopened subcutaneous nodules or from open draining lesions is inoculated to brain-heart-infusion agar incubated at 35° C and on Sabouraud dextrose agar at room temperature. *Sporotrix schenckii* is not inhibited by chloramphenicol and cycloheximide. Thus, these agents should be added to the medium if contamination is anticipated. Some texts have recommended the use of enriched medium, such as brain-heart infusion agar supplemented with 5 or 10 percent blood.

**Tissue phase.** The tissue (yeast or parasitic) phase develops at 35° C, appearing in 3 to 5 days as smooth, tan, yeastlike colonies. The microscopic appearance of such colonies shows cigar-shaped (fusiform) cells, measuring 1 to 4 µm or less, and round or oval budding cells 2 to 3 µm in diameter. On occasions, a few large pyriform (pear-shaped) cells, 3 to 5 µm in size, may be produced. The microscopic and macroscopic appearance of the yeast phase are shown in figure 3-1 and detail A-2 of foldout 1, respectively.

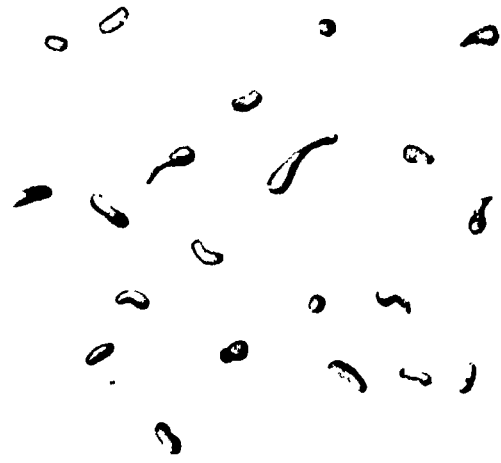

Figure 3-1. Tissue phase of *Sporotrix schenckii*.

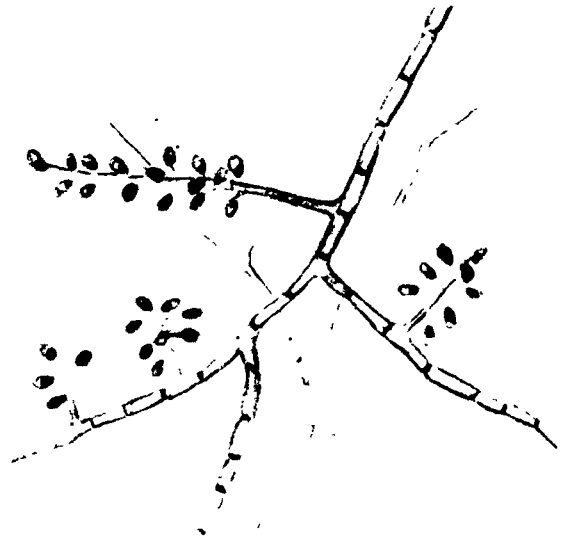

Figure 3-2. *Sporotrix schenckii* (mycelial phase).

**The mycelial phase.** The mycelial phase of *S. schenckii* grows rapidly at room temperature. On Sabouraud dextrose agar at 25° C (room temperature), growth appears in 3 to 5 days as small moist white to cream-colored colonies. With further incubation, these colonies become membranous, wrinkled, coarsely tufted, and the color becoming irregularly dark brown to black. There is considerable variation in colony pigmentation in different stains of *S. schenckii* or even in the same strain. This is due to variations in oxygen supply and the amount of thiamine in the medium.

Microscopically, in teased wet mount a fine (1 to 2 µm in diameter), branching, septate mycelium with pyriform, oval, or spherical conidia on delicate sterigmata is seen. The conidia occur in two distinct patterns shown in figure 3-2. One possible pattern is the

so-called "slevelike" arrangement where the spores are borne individually on delicate sterigmata along the length of a hyphal filament. A second frequently occurring pattern, termed a "flowerette" arrangement, forms if each spore is attached by its own delicate sterigma to a common conidiophore. For best observation of these patterns, the slide culture technique is recommended. The microscopic and macroscopic appearance of this phase is shown in figure 3-2 and detail A-1 of foldout 1, respectively.

#### Exercises (637):

1. What type of specimen is used for culture of *S. schenckii*?
2. What media are used for culture of *S. schenckii*?
3. What other enriched medium has been recommended for use by some authorities?
4. How do the colonies of the tissue phase appear in 3 to 5 days?
5. What characteristic appearance is noted on the microscopic of such colonies in the tissue phase preparation?
6. How do the colonies of the mycelial phase of *S. schenckii* appear on Sabouraud dextrose agar, with 3 to 5 days growth at room temperature?
7. What two conditions are responsible for considerable variation in colony pigmentation in different strains of *S. schenckii*, or even in the same strain?
8. What two patterns describe the arrangement of conidia in cultures of *Sporotrix schenckii*?

**638. State the stains used in the identification of *Sporotrix schenckii*, diagnostic characteristics of the microscopic structures, and the technique used to demonstrate the fungus in smears of lesion exudate and tissue.**

**Differential Considerations.** Unless tissue specimens or other body fluids are stained with Gomori methenamine-silver stain or periodic acid-Schiff stain PAS, microscopic preparations are of little value in the diagnosis of the disease. The diagnosis usually can be made by recovering the causative organism in culture. The flowerette arrangement of the conidia and the hair-like attachments to delicate conidial phores are the features usually sufficient to make diagnosis. Delayed hypersensitivity to *S. schenckii* can be demonstrated in persons with active or past infection by use of 1:2,500 (vol/vol) suspension of heat—or merthiolate—killed yeast or conidia.

Serum of individuals suspected of having sporotrichosis should be tested for agglutinins in which a titer of 1:40 or greater is considered suggestive of the mycosis. In addition in the above techniques, immunofluorescence has been successfully used in demonstrating the fungus in smears of lesions, exudate, and tissue.

#### Exercise (638):

1. Which stains are used in the identification of *S. schenckii* in body fluids or tissue specimens?
2. What are two significant features to be noted in the microscopic preparation that are sufficient to make diagnosis of *S. schenckii*?
3. What technique has been successfully used in demonstrating the fungus in smears of lesions, exudate, and tissue?

### 3-2. Systemic Group

These pathogenic diphasic fungi cause deep-seated diseases which involve one or more of the internal organs of the body. In many instances the bones and subcutaneous tissues are also infected; frequently as a result of bloodstream dissemination, skin lesions may be manifested. Immunologic tests and skin tests demonstrating past or present infection with some members of this group indicate that many individuals

have had subclinical or asymptomatic exposure which otherwise might have gone undetected. In some asymptomatic individuals an indication of systemic mycotic lesions may be seen in X-ray examination, but confirmation of diagnosis may not be reached unless an autopsy is performed and the organism identified. Most often the portal of entry for the infective spores of these organisms is the respiratory system, and early symptoms may be nondiscrete. If the disease goes undiagnosed and improperly treated, the likelihood of its becoming progressive is enhanced, and such cases frequently prove fatal.

**639. Cite the systemic disease produced by *Coccidioides immitis*, regions of the U.S. where the climate is most favorable for the fungus, where it exists, and the two forms of the disease and their characteristics.**

**Coccidioides immitis.** *Coccidioides immitis* is responsible for the systemic disease—coccidioidomycosis. The disease is geographically limited to specific areas of the New World, and since one of these areas happens to be the San Joaquin Valley in south central California, the infection has become known as “valley fever.” *C. immitis* exists as a saprophyte in the soil, producing innumerable infective spores which are readily born by air currents over appreciable distances. Areas other than California which provide suitable climatic conditions for its propagation include Arizona, New Mexico, Texas, and the northern portion of Mexico. Males between 30 and 50 years of age and the darker skinned races are particularly susceptible to infection. Experience has shown that preventive measures to control exposure to dust, such as wetting down dusty areas, planting lawns, and even the wearing of protective masks, markedly reduces the incidence rate in endemic regions.

Primary pulmonary coccidioidomycosis is contracted by inhalation of spores; more than half of those so infected remain asymptomatic and develop an immunity to the disease. Others develop mild symptoms resembling those of the common cold. Some individuals develop severe pulmonary symptoms. As many as 30 percent of the severely infected patients develop allergic skin eruptions in response to toxins produced by this organism. Approximately 999 of 1000 cases gain complete recovery. These people continue to demonstrate a positive skin test with coccidioidin for many years and are seemingly protected with a lifetime immunity to the disease.

Another form of this disease, disseminated coccidioidomycosis, fortunately occurs only in rare instances and probably is directly related to some defect in the patient's immune response. This form of the disease may progress in several patterns with regard to time and extent of involvement. The organism may be spread throughout the body by the bloodstream early in the respiratory phase, resulting in massive involvement. In other cases individuals who are unaware that the disease

is present suddenly manifest a single cutaneous lesion that may worsen or, on occasion, heal spontaneously. The body sites most commonly infected following dissemination from the primary lung lesion include other areas of the lungs, subcutaneous and cutaneous tissues, bones, joints, meninges, the brain, and the viscera. Cutaneous dissemination typically results in the formation of subcutaneous abscesses.

#### Exercises (639):

1. What is the systemic disease produced by *Coccidioides immitis*?
2. How does *C. immitis* exist in its natural original environment?
3. What are some areas other than California which provide suitable climatic conditions for the *C. immitis* to propagate?
4. What are the given forms of *coccidioidomycosis*?
5. Which form of *coccidioidomycosis* is contracted by inhalation of spores?
6. What are the body sites most commonly affected in disseminated *coccidioidomycosis*?

**640. Point out the specimen and media used for culture of *Coccidioides immitis*, the structure that contains endospores, colony appearance, and the appearance of the mature arthrospores of *C. immitis*.**

**Specimen, Media, and Cultural Characteristics.** Clinical materials such as pus, sputum, pleural fluid, or bronchial washings should first be examined in direct wet, unstained mount for the presence of spherules demonstrated in figure 3-3. *C. immitis* appears as a non-budding, thick-walled (up to 2  $\mu\text{m}$ ) spherule or sporangium 20 to 200  $\mu\text{m}$  in diameter containing either granular material or numerous small (2 to 5  $\mu\text{m}$  in diameter) endospores. If distinction between fungus and granulocytic cells is difficult, the preparation may be sealed and allowed to stand for several hours or as long as overnight. If the observed structures are actually



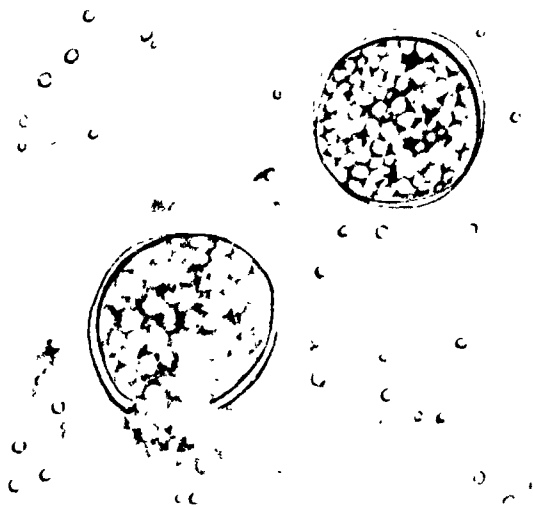

Figure 3-3. Spherules of *Coccidioides immitis*.



Figure 3-4. Arthrospores of *Coccidioides immitis*

spherules, the undischarged endospores will have developed mycelial filaments.

Whether or not spherules are identified in direct wet preparation, the clinical material should be cultured on media such as Sabouraud dextrose agar and brain-heart infusion agar with and without chloramphenicol and cycloheximide. In duplicate sets, one should be incubated at 35° C and the other at room temperature. Growth occurs in 3 to 5 days at room temperature. There is more positive isolation at room temperature. The colonies that appear will be moist, flat and grey. Gradually, an abundant white, fluffy, aerial mycelium develops over the mature colony, as we find in foldout 2, detail C. The pigment on the underside of the colony in most strains is a brownish black. This imparts a greyish appearance to the growth. Typically, some areas of aerial mycelium become flattened, causing a glabrous effect.

The mature colony is now examined microscopically in a lactophenol cotton preparation for the presence of barrel-shaped, tagged arthrospores, 2 by 3  $\mu\text{m}$  to 3 by 5  $\mu\text{m}$ , seen in figure 3-4. Characteristically, these arthrospores develop in alternating segments of the hypha so that a single small undifferentiated cell separates the arthrospores from each other. When mature, these chains separate very readily, and arthrospores carry with them fragments of the small dividing cells, thus initiating the descriptive term "tagged" arthrospore. Investigations have demonstrated the presence of spherules in mycelial cultures. By using special cultural methods not readily adaptable to diagnostic work, they have partially converted the mycelial phase to the spherule or tissue phase. In such experimental cultures, you can see arthrospores gradually developing into spherules, which on reaching maturity send out germinating tubes through the spherule wall to form a new mycelium. Extreme care must be exercised in handling tubes of mycelial growth. Prior to removal of the cap from the tube, the growth

should be flooded with sterile normal saline by inserting a large-gauge syringe needle into the tube alongside the plug. This retards aerosol formation by arthrospores. The inability of saprophytes resembling *C. immitis* to grow on media containing cycloheximide is a characteristic very useful in screening suspicious growth.

#### Exercises (640):

1. What clinical specimens are examined for *C. immitis*?
2. How should the clinical specimens be first examined, and what structure should one look for?
3. How would you describe a spherule?
4. Whether or not spherules are identified in direct wet preparation, the clinical material should be cultured on what media?
5. How will the colony of *C. immitis* appear after incubation on Sabouraud dextrose agar at room temperature for 3 to 5 days?

6. What color is the pigment on the underside of the colony in most strains?
7. The mature colony of mycelial growth of *C. immitis* is examined for what structures and in what type preparation?
8. Why should mycelial cultures of *C. immitis* be flooded with sterile normal saline prior to removing the cap from the tube?

641. Cite a procedure used to establish confirmatory diagnosis of coccidioidomycosis and immunological procedures used to diagnose the disease.

**Confirmatory Diagnosis.** In order to establish a confirmatory diagnosis of coccidioidomycosis, 0.1 ml of suspension of mycelial growth is inoculated intratesticularly in a guinea pig. Orchitis will normally develop within a week, in which case fluid is aseptically withdrawn and examined microscopically in wet preparations for the presence of spherules. When guinea pigs are not available, mice may be substituted; however, the injection should be made intraperitoneally using 1.0 ml of inoculum. The lesion or lymphatic exudate is examined as above, following the death of the mice. The finding of spherules containing endospores is confirmatory.

Several immunological procedures such as the precipitin test and the complement-fixation test have proven very useful in diagnosis of coccidioidomycosis. The coccidioidin skin test is an extremely useful tool for epidemiological studies. However, it is of limited diagnostic value since a positive reaction may indicate either a fully recovered or a presently active case. The precipitin test usually becomes a positive before there is a demonstrable rise in the complement-fixation titer. The precipitins (antibodies) appear within the third to fifth day after onset and reach a maximum level in 1 or 2 weeks. The complement-fixation test is useful only in moderate to severe cases of the disease. Those patients with primary coccidioidomycosis maintain a moderately low titer for several months, which gradually falls as the patient recovers. When the disease is progressive, the titer rises sharply and remains there until the patient's condition improves. Improvement causes the titer to gradually diminish.

#### Exercises (641):

1. In order to establish a confirmatory diagnosis of coccidioidomycosis, what animal inoculation procedure is used?
2. What immunological procedures have proven useful in diagnosis of coccidioidomycosis?
3. What other test has proven useful for epidemiological studies?

642. State the areas in which the disease blastomycosis is limited in distribution, the portal of entry of *Blastomyces dermatitidis* into the body, the clinical forms of blastomycosis, and the form which most frequently occurs.

**Blastomyces Dermatitidis.** North American blastomycosis, Gilchrist's disease, or simply blastomycosis, is synonymous with a disease caused by the diphasic fungus, *Blastomyces dermatitidis*. The disease is chronic, characteristically causing both suppurative and granulomatous lesions that normally originate in the respiratory system. The infection is particularly well named, since only a few confirmed cases have been diagnosed outside North America. The organism seems to be even further limited in distribution to the northern part of the Mississippi Valley, the Ohio River Valley, and the Middle Atlantic states. For many years there was considerable doubt as to the portal of entry of *B. dermatitidis* into the body; however, in recent years investigators have demonstrated this fungus in the soil and now believe that the majority of infections are acquired by inhalation of infective spores.

The clinical forms of the disease are sometimes separated into four categories: primary cutaneous, primary pulmonary, chronic cutaneous, and disseminated. The latter three will be discussed as a single entity since they are so closely related. The primary cutaneous infection is extremely rare and results from accidental inoculation of the organism through the skin. A papule appears at the site of entry. Gradually, a chain of swollen lymph nodes and vessels develops. The organism remains localized in the infected part, much the same as with sporotrichosis.

Primary pulmonary blastomycosis, based on present evidence, is most probably the precursor of both the disseminated and chronic cutaneous forms of the disease. In its early phases, symptoms usually are

indistinguishable from those of the common cold. When dissemination occurs, the tissues most commonly involved are the skin, the bones, especially the vertebrae and ribs, and the viscera. About one-third of the cases manifest lesions of the central nervous system. What is now believed to be a special type of dissemination from pulmonary origin to the skin results in the chronic cutaneous form of this disease. Other tissues of the body remain uninvolved. This most commonly occurring form of the disease may last for years. It characteristically starts as an isolated papular lesion or subcutaneous nodule which becomes an abscess and then ruptures to form an ulcer. New lesions may result from the pulmonary focus or by implantation of the organism to new skin areas from older draining ulcers. It has been estimated that as much as one-sixth of the body surface may become ulcerated with this form of disseminated blastomycosis.

**Exercises (642):**

1. Give two additional names for Gilchrist's disease.
2. *Blastomyces dermatitidis* is limited in distribution to the northern part of the \_\_\_\_\_ valley, the \_\_\_\_\_ River Valley and the \_\_\_\_\_ Atlantic states.
3. How is the majority of infections with *B. dermatitidis* acquired?
4. List the clinical forms of blastomycosis.
5. Which form of blastomycosis occurs most frequently?

**643. State the specimens required for primary pulmonary and disseminated blastomycosis, media used, and the microscopic and macroscopic appearances of the organism at given growth phases.**

**Specimen, Media, and Cultural Characteristics.** Direct examination of clinical materials often proves quite fruitful in cases of North American blastomycosis. In many instances the technician is able to demonstrate the etiological agent in large numbers and thereby lay the groundwork for a provisional diagnosis. Pus or

scrapings should be obtained from the active areas of cutaneous lesions. When primary pulmonary blastomycosis is suspected, sputum or bronchial washings may be examined. When specimens such as urine, gastric washings, spinal fluid, or pleural exudates are collected for laboratory examination the physician undoubtedly suspects the dissemination of the organism. These clinical materials should be examined microscopically in unstained preparations. Staining, for example, the Gram stain, makes it most difficult to distinguish these organisms from lymphocytes. Whenever the volume of specimen permits, the sediment obtained from centrifugation should be studied. If the specimen is dry or dense, as may result with skin scrapings, a drop of water may be added prior to coverslipping the material. Regardless of what form of clinical material is examined, the technician must look for the characteristic budding cells produced by the tissue phase of this fungus. These cells are shown in figure 3-5. In the event of negative findings, the coverslip may be sealed and the specimen incubated for several hours at room temperature. If cells of *B. dermatitidis* are present, they will typically put out single germ tubes as opposed to the multiple germ tubes put out by the spherules of *C. immitis*.

Cultural studies should be used regardless of the findings on direct examination. The clinical material is inoculated to BHI (brain-heart-infusion) blood agar incubated at 35° C and SAB, Sabouraud dextrose agar incubated at room temperature. Some strains have been shown to possess fastidious nutritional requirements. If cycloheximide is added to the medium, incubation should be made at room temperature since the yeast phase of *B. dermatitidis* is sensitive to this antibiotic at 35° C. The mycelial phase is slow-growing and may require up to 2 weeks to become visible. On Sabouraud dextrose agar at room temperature growth may at first appear moist or membranous; however, an aerial mycelium forms rapidly, creating a downy to fluffy colony which at first is white, later becoming deep



Figure 3-5 *Blastomyces dermatitidis*

cream to tan. See detail D-1, foldout 2, for the appearance of the colonies. Microscopic study of this mycelial growth in teased wet mount reveals a septate mycelium and nondiscrete conidia, round to pyriform in shape, ranging from 3 to 5  $\mu\text{m}$  size. These conidia are born either sessile (affixed directly to the hypha), or on the tips of short lateral hyphal branches. The parasite of tissue phase of *B. dermatitidis* can be readily obtained in "in vitro" by inoculating clinical material to both Sabouraud dextrose agar and BHI brain-heart-infusion blood agar and incubating at 35° C. Growth is slow and the colonies are typically cream to tan in color and moist to waxlike in appearance. They are pictured in detail D-2 of foldout 2. The topography is normally rough; however, some strains have been reported to produce smooth, convex colonies. The microscopic picture is quite similar to that seen in direct examination of clinical material from a patient, or from inoculated animals. Large oval to round cells usually about 8 to 10  $\mu\text{m}$  in diameter, sometimes reaching as much as 20  $\mu\text{m}$ , will be seen. These cells are typically single budding and have a thick, refractile wall which is easily distinguishable from the granular cytoplasm that it incloses. The attachment of mother to daughter cell is characteristically by means of a wide base. It creates a configuration which is frequently spoken of as a "figure eight." A few strains of *B. dermatitidis* have demonstrated the capability for multiple budding, but even in such instances the single budding form predominates.

#### Exercises (643):

1. What specimens are required for examination when primary pulmonary blastomycosis is suspected?
2. What specimens are required for examination when disseminated blastomycosis is suspected?
3. Regardless of what form of clinical material examined, what characteristic forms must the technician look for?
4. Clinical materials for blastomycosis should be inoculated to which media?
5. If cycloheximide is added to the medium, incubation should be made at what temperature and for what reason?

6. What growth appearance of the organism is noted on Sabouraud dextrose agar?
7. What does the microscopic study of the mycelial growth in teased wet mount of the above growth reveal?
8. What growth appearance is noted on either brain-heart-infusion blood agar or on Sabouraud dextrose agar when incubated at 35° C?

**644. Cite procedures necessary to establish confirmatory diagnosis of *B. dermatitidis*, the usefulness of the skin test, and the serological test used.**

**Confirmatory Diagnosis.** In order to establish a confirmatory diagnosis of *B. dermatitidis*, it is essential to obtain the yeast or tissue phase of this organism. This can be readily done by cultural methods, and thus the use of animals is unnecessary. Fresh tubes of brain-heart-infusion blood agar should be inoculated with mycelial growth suggestive of this fungus and incubated at 35° C. After a few days, conversion usually begins at the margins of the inoculum. When this colony material is microscopically examined, the typical, wide-based, thick-walled, single-budding cells of the yeast phase can be seen. Additional confirmation is relatively simple since this yeastlike colony readily converts to the mycelial phase when the culture tubes are incubated at room temperature. Skin testing with a mycelial filtrate called blastomycin has been reliable for indication of past and present infections. The reagent is not as consistent in results as that used for histoplasmosis or coccidioidomycosis. This disparity may be due to a lower level of superficial sensitivity in the tested individuals or to variation in the components of the blastomycin. As in the case of the advanced disseminated stage of coccidioidomycosis and histoplasmosis, all skin sensitivity may disappear. The complement-fixation test for *B. dermatitidis* is useful despite difficulty in standardizing reagents. The titer generally rises as the disease progresses and disappears with recovery. A high complement-fixation titer and a negative skin test usually indicates the terminal phase of the disease.

#### Exercises (644):

1. In order to establish a confirmatory diagnosis of *B. dermatitidis*, it is essential to obtain the \_\_\_\_\_ or \_\_\_\_\_ of this organism.

2. After a few days of incubation, conversion usually begins at the \_\_\_\_\_ of the inoculum.
3. When the colony is examined microscopically what typical characteristics are observed of the yeast budding phase?
4. What skin test has been reliable for indication of past and present infections?
5. What serological test has been useful?

**645. Specify the tissue of the body for which *Paracoccidioides brasiliensis* has a special preference, the part of the body that serves as the primary focus of infection with *P. brasiliensis*, and the two categories in terms of their related clinical characteristics.**

**Paracoccidioides Brasiliensis.** Paracoccidiomycosis, often referred to as South American blastomycosis, is a chronic granulomatous mycotic disease of the skin, lungs, and other internal organs with a special preference for the mucous membranes. Although geographically limited to northern South American countries, especially Brazil, Mexico, and Central America, the disease should not be ignored by workers in other global areas. The infection may remain subclinical for many months in travellers from endemic countries. *P. brasiliensis* has been isolated from the soil, and it is believed to exist in nature as either a saprophyte in the soil or as a plant parasite. The disease, therefore, is sometimes acquired by farm workers who use vegetation to pick their teeth or for chewing purposes. There is also recent evidence that the lungs serve as the primary area of infection as a result of inhaling airborne spores. The clinical characteristics of paracoccidiomycosis will be discussed in two categories: the skin and mucocutaneous form, and the disseminated form.

Typically, the primary cutaneous lesion produced by this diphasic fungus appears within the mouth or nose, or at a point within close proximity to these structures. The erythematous mucocutaneous ulcerations which develop spread slowly to many regions of the mouth and have an apparent affinity for the torus palmaris region. Frequently, there is an extension of mucous lesions to the skin, or alternative skin lesions may result from auto-inoculation. Other cutaneous lesions may result from subcutaneous deposit of the fungus as a result of lymphatic or bloodstream spread. Involvement of any body surface is possible, and early diagnosis is

important because the lesions simulate those caused by cutaneous leishmaniasis, yaws, and tuberculosis.

Recent evidence indicates that a high percentage of disseminated cases of *P. brasiliensis* occur, with the lungs providing the primary loci of infection. The symptoms closely resemble those of tuberculosis, and in numerous cases both diseases have been diagnosed in the same patient. On some occasions the lower gastrointestinal tract appears to be the primary site of inoculation. In such cases there is frequently dissemination to the spleen, liver, appendix, and rectal region. Regardless of the primary site of infection, the lymphatics which drain the site and eventually the entire lymphatic system becomes involved. In the early phases of the common oral form of the disease the cervical nodes of the neck usually become painfully swollen and penetrate the skin surface with sinus tracts which drain a purulent fluid, rich in fungal structures. Central nervous system lesions and bone involvement may occur, particularly in those patients where the organism is disseminated via the bloodstream.

#### Exercises (645):

1. *Paracoccidioides brasiliensis* has a special preference for what body tissue?
2. What part of the body serves as the primary focus of infection with *P. brasiliensis*?
3. In which of the two categories of paracoccidiomycosis does this diphasic fungus appear within the mouth or nose, or at a point within close proximity of these structures?
4. Which of the two categories of paracoccidiomycosis manifests symptoms closely resembling tuberculosis?

**646. Point out the specimen and media used for examination and culture of *P. brasiliensis*, the colony appearance and microscopic findings of the mycelial phase, and the macroscopic and microscopic appearance of the yeast phase.**

**Specimen, Media, and Cultural Characteristics.** Direct microscopic examination for the tissue or yeast phase of *P. brasiliensis* should be accomplished. Clinical materials such as pus or scrapings from lesions,



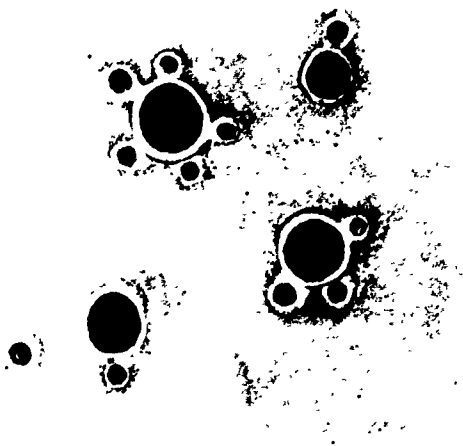

Figure 3-6. *Paracoccidioides brasiliensis*.

sputum, and other body fluids, or aspirated material from infected lymph nodes may be used for this examination. Whether or not the characteristic budding cells are observed in unstained wet preparations, the material must be cultured by methods and materials recommended for the isolation of *B. dermatitidis*. Inoculate clinical materials to BHI blood agar, incubate at 35° C and inoculate to SAB; incubate at room temperature.

On Sabouraud dextrose agar at room temperature the mycelial phase of *P. brasiliensis* develops very slowly. The small, heaped colony which forms after 2 or 3 weeks seldom exceeds a diameter of 20 millimeters, even after several months of incubation. The majority of strains form a short, white, velvety aerial mycelium covering the colony surface. This morphology is shown in foldout 2, detail E-1. Others develop white to cream-colored glabrous colonies which typically are folded irregularly. The usual microscopic findings in teased wet mount consist of only the septate mycelium and chlamydospores. Some investigators describe the presence of microconidia borne laterally, either directly on the hyphae, or on short sterigmata. These conidia are typically pyriform in shape, ranging from 2 to 3  $\mu\text{m}$  in length. When clinical materials are cultured on brain-heart-infusion blood agar at 35° C, the growth which slowly develops is yeastlike in appearance, varying from cream to tan in color. The yeastlike colony is illustrated in E-2 of foldout 2. Macroscopically, some strains present a verrucose and waxy surface while others may be smooth and shiny. In contrast to the mycelial phase, microscopic examination of a teased wet mount reveals structures which are quite distinctive. Whether the fungus is studied directly in clinical material or from culture at 35° C, the microscopic morphological picture shown in figure 3-6 is that of relatively large round cells, ranging between 10 and 60  $\mu\text{m}$  in diameter, and possessing well-defined, refractile cell walls. These yeast or tissue-phase cells of *P. brasiliensis* reproduce typically by multiple budding; however, the single

budding displayed by other pathogenic organisms is not infrequent. The daughter cells appear to be "pinched-off" as they mature; they may develop in two distinct morphological patterns. In the first pattern the buds are quite small and vary only slightly in size; this creates an effect spoken of as the "steering wheel" form. A second pattern results when the buds vary appreciably in size, for example, as much as 10  $\mu\text{m}$  in length. Since budding occurs on all surfaces of the mother cell, and since the connecting points of only a few buds can be seen in any one plane microscopically, a rather bizarre effect is created. The mother cell seems to be surrounded by unconnected cells; in actuality this is not the case. A chaining effect results frequently when daughter cells continue to bud without becoming detached.

#### Exercises (646):

1. What clinical materials are used for examination for *P. brasiliensis*?
2. What media are recommended for growth of *P. brasiliensis*?
3. Describe the colony appearance of *P. brasiliensis* after approximately 2 or 3 weeks.
4. What do the usual microscopic findings in teased wet mount consist of?
5. What growth appearance will be observed on brain-heart-infusion blood agar after incubation at 35° C?
6. Briefly describe the two patterns of daughter cell budding in the yeast (tissue) phase of *P. brasiliensis*.

**647. Cite the culture procedure for confirming the cultural identification of *P. brasiliensis*, and state other diagnostic techniques used in suspected cases of paracoccidioidomycosis and their importance.**

**Conformatory Diagnosis.** In order to confirm cultural identification it is essential to convert the yeastlike growth to the mycelial form, or the mycelial



type growth to the tissue form, depending on which is recovered from initial inoculation. If transformation from tissue to mycelial form is to be attempted, the yeastlike growth should be subcultured on fresh tubes of Sabouraud dextrose agar and incubated at room temperature. Should the reverse situation exist, mycelial growth is subcultured on fresh BHI blood agar and incubated at 35° C. A moist agar surface is highly desirable. Further confirmation is gained by reversing incubation temperatures following the development of adequate growth, and thereby inducing conversion.

Other diagnostic techniques used in suspected cases of paracoccidioidomycosis include animal inoculation, skin testing and the complement-fixation test. Ordinarily, animal inoculation is necessary for either isolation or identification of the fungus; however, the intratesticular injection of guinea pigs can be useful in establishing the pathogenicity of a particular strain. Intradermal skin testing, using a filtrate from broth cultures, called *paracoccidioidin*, has met with some success. Although considerable cross-reactivity with histoplasmin and blastomycin occurs, those individuals with paracoccidioidomycosis show a greater response to paracoccidioidin. The complement-fixation test has proven itself useful for diagnosis and prognosis. Typically, the rise in titer parallels the progress of the disease, and the titer diminishes with remission or recovery.

#### Exercises (647):

1. What culture procedure is necessary for confirming the identification of *P. brasiliensis*?
2. What other diagnostic techniques are used in suspected cases of paracoccidioidomycosis?
3. Intradermal skin testing, using filtrate from broth cultures of *P. brasiliensis*, is called \_\_\_\_\_.
4. The complement fixation test has proven itself for \_\_\_\_\_ and \_\_\_\_\_ of paracoccidioidomycosis.

648. Specify the system of the body preferred by the fungus *Histoplasma capsulatum*, the regions where the disease primarily occurs, some common sources of the organism, the cells which phagocytize fungal elements in the blood stream, and the frequency of occurrence of disseminated histoplasmosis.

**Histoplasma Capsulatum.** *Histoplasma capsulatum* systemic diphasic fungus is responsible for the disease histoplasmosis, an intracellular mycosis which is normally respiratory in origin. The organism demonstrates a distinct preference for the reticuloendothelial system. The disease at one time was considered rare and invariably fatal; it is now known to be quite common in its benign form, especially in those regions where it is endemic. Although the infection occurs primarily in North America—more specifically in the north central part of the United States and along the eastern seaboard—significant outbreaks have been reported in Central and South America, Australia, South Africa and Europe. *H. capsulatum* exists as a saprophyte in the soil, often in association with the excreta of poultry, bats, and birds, such as pigeons, grackles, and starlings. Discovery of the avian source has shed much light on situations involving sudden localized outbreaks of histoplasmosis. Infection typically results following the inhalation of minute airborne spores. Millions of people in the United States presently have or at one time were infected with either benign or acute respiratory histoplasmosis. The pulmonary disease closely mimics numerous other respiratory infections by eliciting an extremely wide range of signs and symptoms.

An unfortunate rare case progresses to severe disseminated or secondary histoplasmosis. As previously stated, *H. capsulatum* displays a marked affinity for the cells of the reticuloendothelial system. Fungal elements, upon reaching the bloodstream or lymphatics, are rapidly phagocytized occasionally by polymorphonuclear leukocytes or by macrophage cells. The organisms propagate and subsequently reach organs rich in reticuloendothelial tissue such as the liver, spleen, lymph nodes, and bone marrow.

#### Exercises (648):

Indicate whether each statement is true (T) or false (F) and correct those that are false.

- \_\_\_\_ 1. *Histoplasma capsulatum* demonstrates a distinct preference for the autonomic nervous system.
- \_\_\_\_ 2. The infection occurs primarily in South America and South Africa and Europe.
- \_\_\_\_ 3. *H. capsulatum* exists as a saprophyte in the soil, often in association with the excreta of poultry, bats, and birds.

- 4. However, discovery of a rodent source has shed much light on situations involving sudden localized outbreaks of histoplasmosis.
- 5. Disseminated or secondary histoplasmosis occurs frequently in adults.

**649. State the technique used in direct examination of clinical materials suspected of *H. capsulatum*, techniques in processing specimens for shipment or culture, the types of cells in which the yeastlike bodies of *H. capsulatum* are found, media used and cite the macroscopic, and microscopic appearances on given media.**

**Specimen, Staining, Media, and Cultural Characteristics.** In contrast to the direct examination of clinical materials in unstained wet mount used when North American blastomycosis or paracoccidioidomycosis is suspected, *H. capsulatum* is best detected using Wright or Giemsa-stained smears of fresh material. Specimens such as smears from lymph node biopsy, cutaneous or mucocutaneous lesions, and bone marrow aspiration are best suited to this technique. Sputum, gastric washings, and other body fluids should be centrifuged and the sediment smeared and stained. These specimens should be collected in sterile containers; if they cannot be processed immediately (or require shipment), the addition of an antibiotic such as chloramphenicol not in excess of 0.2 mg/ml is recommended. Any clinical material received by the laboratory for *H. capsulatum* culturing must be refrigerated if processing is delayed in order to retain the viability of the organism.

The stained organism in tissue form is small, round, yeastlike cell, indistinguishable from many other similar structures which may be found in direct examination of clinical material. These yeastlike cells are readily phagocytized by macrophages and occasionally polymorphonuclear cells, and thus when the typical intracellular form is seen, it is of considerable diagnostic help. The organism within the phagocytic cell ranges from 1 to 4  $\mu\text{m}$  in diameter. It is surrounded by a light blue ring representing its cell wall. The underlying cytoplasm stains a darker blue and contains chromatin material which stains a more intense violet color. Generally, this chromatin substance appears half-moon to crescent in shape.

Whether or not a morphological picture indicative of *H. capsulatum* is observed on the Wright or Giemsa-stained slide preparations, it is essential to attempt cultural recovery of the organism. The clinical material should be inoculated to several tubes of each of the various media used, to increase the likelihood of recovery. It is recommended, however, to inoculate the

specimen directly to duplicate sets of SAB agar and BHI blood agar, with and without antibiotics. Pretreatment of the specimen with antibiotic is not necessary if antibiotic is to be added to the medium. Incubate the BHI blood agar without antibiotic at 35° C and incubate the other media at room temperature.

When attempting cultural recovery of *H. capsulatum* using screw-capped tubes, remember to loosen the cap occasionally since the fungus is a strict aerobe. Another point worthy of re-emphasis is the fact that the yeast or tissue phase will not grow in the presence of antibiotics at 35° C.

A distinct colony on SAB agar or BHI agar may not become discernable for at least 10 to 14 days at room temperature. *H. capsulatum* forms a white, fluffy colony with the typically fine and silky aerial mycelium seen in foldout 2, detail F-1. Gradually, after several weeks the entire slant surface becomes overgrown. It usually develops a buff to dark-tan color which usually coincides with sporulation. Microscopic examination of teased wet mount reveals a septate mycelium with both microconidial and macroconidial sporulation. The microconidia, or small spores, usually develop first and are borne sessile or on short stalks on the hypha. They are round to pyriform in shape, varying between 2 and 6  $\mu\text{m}$  in diameter. Although usually smooth, a few echinulated spores may be seen. Some microconidia may be bicellular, thus being able to produce secondary spores by budding. The characteristic macroconidia which develop are large (7 to 25  $\mu\text{m}$  in diameter), round to pyriform in shape, have a thick wall, and usually have a tuberculated surface. These tubercles are finger-like or spiny projections, which vary considerably in length on the same spore, ranging between 1 and 8  $\mu\text{m}$  length. Representative morphological features are shown in figure 3-7. Some strains of *H. capsulatum* do not produce tuberculate macroconidia, while the saprophytic species of the Genus *Sepedonium* produce macroconidia which are identical to those produced by

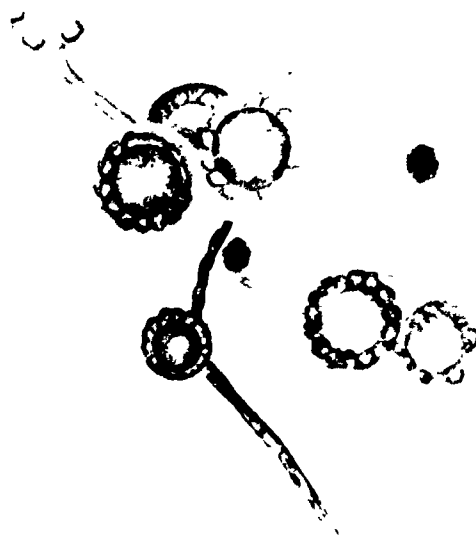

Figure 3-7 Macroconidia of *Histoplasma capsulatum*

some strains of *H. capsulatum*. Differentiation can be based on *H. capsulatum*'s ability to convert to the yeast form at 35° C.

#### Exercises (649):

1. Instead of the using unstained wet mounts in the direct examination of clinical materials as in *Blastomycosis dermatitidis*, *H. capsulatum* is best detected by using what technique?
2. When sputum, gastric washings, or other body fluids require shipment, what should be added to the container?
3. Within what types of cells are the yeastlike bodies of *Histoplasma capsulatum* found?
4. What two given media are recommended for inoculation of clinical material for *H. capsulatum*?
5. Why is the BHI blood agar without antibiotic incubated at 35° C instead of the BHI agar with antibiotic?
6. What appearance may be noted on SAB agar or BHI agar after 10 to 14 days at room temperature?
7. How are the characteristic macroconidia of *H. capsulatum* described?
8. Under what circumstances might the species of *Sepedonium* appear identical to those of *H. capsulatum*?
9. How can nontuberculate *H. capsulatum* be differentiated with certainty from *Sepedonium* species?

650. Cite the techniques used for confirming cultural identification of *H. capsulatum*, procedures in the animal inoculation technique, and the significance and application of immunological tests.

**Confirmatory Diagnosis.** In order to confirm the cultural diagnosis, it is necessary to convert the mycelial growth phase of the fungus to the tissue form. This can normally be satisfactorily accomplished by inoculating some of the mycelial growth to tubes of BHI blood agar with a moist surface and incubating them at 35° C. If the agar surface appears dry, it may be moistened with sterile nutrient broth before use. Several subcultures may be necessary to effect a complete conversion. Most strains of *H. capsulatum* are convertible using this method. After 2 or 3 days' incubation, small, white to cream colored, round, convex colonies normally appear along the margin of the mycelial inoculum. These enlarge and eventually coalesce to form a moist, raised, soft growth (shown in FO 2, detail F-2), the surface of which varies from rough to granular. On occasion it may be highly mucoid. Microscopically, the yeast-phase cells are oval bodies (1.5 by 3.5  $\mu$ m) which frequently display single and multiple budding and are indistinguishable from the fungus cells found in clinical material containing the tissue form of this pathogen.

**Animal inoculation.** Animal inoculation may be required to accomplish conversion of those strains of *H. capsulatum* which will not convert using the cultural technique. In such cases a 0.5-ml suspension of spores or ground mycelium is inoculated intraperitoneally into white mice. Preparation of inoculum involves grinding a 4- to 6-week-old mycelial culture in sterile saline in a tissue grinder and adjusting the suspension to a density of a No. IV MCFarland nephelometer. The mice are autopsied at intervals of 16 to 42 days after injection, and impression smears of both liver and spleen are examined for yeastlike cells. Regardless of the findings at autopsy, these tissues should then be cultured on an appropriate media at 35° C in a further attempt to obtain yeast-phase growth. Some mice which survive for several months may demonstrate a greatly enlarged spleen. The liver and spleen may be heavily infected with yeast cells.

**Immunological tests.** Immunological tests have proven to be valuable tools in the diagnosis and prognosis of individuals with histoplasmosis. The histoplasmin skin test, as with other skin tests used for the diagnosis of systemic fungal diseases, is very useful in epidemiological studies. Its value in diagnosis is limited, however, because a positive response usually can indicate either a past or present infection. Skin sensitivity usually develops 4 to 8 weeks following infection but may decrease during the acute phase and disappear in terminal stages of the illness.

The complement-fixation and precipitin test are two serological techniques normally used for diagnosis and for following the course of histoplasmosis. The use of both histoplasmin and yeast-phase antigen is recommended when complement-fixation testing is

performed. Titers should be determined as soon as the disease is suspected and again after at least a 6-week period. If a high titer results on the first sample and the followup titer is approximately as high or higher, the test is usually considered diagnostic. The precipitin test usually uses the antigen, histoplasmin, and is especially useful in early diagnosis of the acute pulmonary form of the disease. There is a need for careful standardization of test reagents, and best results usually require testing by experienced workers. Because of the variables encountered in serological tests, cultural diagnosis remains the best means of identifying disease due to *H. capsulatum*.

2. After 2 or 3 days' incubation, what type growth appearance is noted along the margins of the mycelial inoculum?
3. Under what conditions may animal inoculation be a required procedure when diagnosing *H. capsulatum*?
4. What must be done after the animal is sacrificed?
5. The histoplasmin skin test has been useful in what type of studies?

**Exercises (650):**

1. What technique is used to confirm cultural identification of *H. caps. tin.*?
6. When is the precipitin test especially useful in testing for histoplasmosis?

## The Saprophytic Fungi

LOGICALLY, THE READER might ask "Since this volume is concerned with medical mycology, why must I be able to identify the saprophytic fungi which are present in cultures normally as a result of airborne contamination or as contaminants of clinical material?" The answer is quite simple and just as logical. It is most important that the medical mycologist be able to distinguish saprophytic fungi from the pathogenic forms to prevent their being erroneously considered as the etiological agents of mycotic infection. It is not unusual for a particular saprophytic species to be isolated repeatedly from the same patient, and thus the inexperienced worker might presume it to be the causative disease agent.

The first section of this chapter considers the most common laboratory contaminants with regard to their colonial morphology and microscopic structure. Most saprophytes that are discussed are referred to solely by genus name since their various species are structurally so similar that speciation is possible only by experts in this particular area of mycology. The second section takes up certain of the saprophytes that are encountered less commonly, although they can be important from the clinical standpoint.

### 4-1. Saprophytes Commonly Encountered in Medical Mycology

The saprophytes are discussed in groups, each group having a particular microscopic structure useful in identification. Also, in each case the gross (macroscopic) morphology on Sabouraud dextrose agar is described. The various microscopic structures used to categorize these organisms include characteristic conidia, conidiophore, sporangiophores, and finally the thallus (body).

**651. Identify given saprophytes with characteristic conidia in terms of their surface pigment, surface texture, significant back or reverse pigment, and microscopic morphology.**

**Saprophytes with Characteristic Conidia.** The common contaminants in order of presentation include species belonging to the Genera *Alternaria*, *Cephalosporium*, *Curvularia*, *Fusarium*, *Helminthosporium*, *Nigrospora*, *Scopulariopsis*, and *Sepedonium*. The macroscopic morphological characteristics of these fungi are elaborated in table 4-1 and illustrated in foldout 2, detail G. Their microscopic morphological features are presented in table 4-2 and depicted in figures 4-1 through 4-8 by drawings made from slide cultures on potato dextrose agar.

*Alternaria* spp. is a rapid growing saprophyte which develops its mycelium close to the agar surface (see fig. 4-1). It is grayish at first, later becoming black with a gray periphery; the underside or reverse pigment is black. The early aerial mycelium is sparse, but gradually areas of white, loose, cottony aerial mycelium develop. They become dull white to grayish in color and eventually may cover the black sporulating mycelium.

The macroconidia are typically uniform, having both transverse and longitudinal septations. The cells occur in chains from the ends of conidiophores and are dark brown in color. Each conidium is formed by the one immediately preceding it in the chain and demonstrates a dark spot at its point of attachment. Any cell comprising the conidium has the capability of showing a germ tube and, thus, perpetuating the species. Frequently, branching chains occur since spore production is accomplished by successive budding of the most distal conidium in the chain.

*Cephalosporium* spp. is rapid-growing (see fig. 4-2). At first, it is deep rose in color, later becoming overgrown with a loose, white aerial mycelium. The flat colony which develops is glabrous to downy and wrinkled, and it displays a surface pigment which may vary from white to gray or pink. A reverse pigment is absent.

Microscopic examination reveals slender, unbranched conidiophores which bear a spherical cluster of conidia at their tips. These conidia are usually single-celled, but occasionally septations will result in conidia which display two or more cells. Production of conidia takes place at the apex of the conidiophore; clustering results as the conidia adhere to each other.

TABLE 4-1  
 MACROSCOPIC MORPHOLOGY OF COMMON SAPROPHYTIC FUNGI  
 HAVING CHARACTERISTIC CONIDIA

<i>Organism</i>		<i>Growth Rate</i>	<i>Surface Topography</i>	<i>Surface Texture</i>	<i>Surface Pigment</i>	<i>Significant Back or Reverse Pigment</i>
<i>Alternaria</i> sp.		Rapid	Flat	Velvety to downy	Green to brown to iridescent black	Black
<i>Cephalosporium</i> sp.		Rapid	Flat	Glabrous to downy, wrinkled	White, gray, or pink	Absent
<i>Curvularia</i> sp.		Rapid	Flat	Cottony	Dark brown to black	Absent
<i>Fusarium</i> sp.		Rapid	Flat	Velvety to tight cotton	White, pink, or pale blue	Absent
<i>Helminthosporium</i> sp.		Rapid	Flat	Cottony	Young: Gray; Mature: Tan, gray-brown or gray-black	Absent
<i>Nigrospora</i> sp.		Rapid	Flat	Cottony to woolly	White to gray	Black
<i>Scopulariopsis</i> sp.		Rapid	Flat	Powdery to granular	White, tan, or brown	Absent
<i>Sepedonium</i> sp.		Rapid	Flat	Cottony	White	Absent

74



TABLE 4-2  
MICROSCOPIC MORPHOLOGY OF COMMON SAPROPHYTIC FUNGI  
HAVING CHARACTERISTIC CONIDIA

<i>Organism</i>	<i>Hypha</i>	<i>Conidiophore</i>	<i>Spore</i>
<i>Alternaria</i> sp.	Septate, dematiaceous	Simple, unbranched	Conidium: septate in two directions (muriform), dematiaceous, occur in chains with broad base of first conidium attached directly to conidiophore.
<i>Cephalosporium</i> sp.	Septate	Simple, branched or unbranched	Conidium: usually single celled (some show 2 - 3 cells) arranged in a clump or head of spores at end of each conidiophore.
<i>Curvularia</i> sp.	Septate, dematiaceous	Simple, unbranched	Conidium: large, thick-walled, multi-septate dematiaceous, curved more on one side than the other side.
<i>Fusarium</i> sp.	Septate	Simple, branched or unbranched, short or long	Conidium: multi-septate, banana or sickle shaped, in banana-like clusters on end of conidiophore; microconidium; oval or spherical, unicellular, or short, simple conidiophore.
<i>Helminthosporium</i> sp.	Septate, dematiaceous	Simple, branched or unbranched, short or long, usually knotted	Conidium: multi-septate, thick-walled elliptical, and dematiaceous.
<i>Nigrospora</i> sp.	Septate	Simple, unbranched, short with inflated end or vesicle	Conidium: black spherical, borne on end of vesicle.
<i>Scopulariopsis</i> sp.	Septate	Simple branched or unbranched	Conidium: lemon-shaped, echinulated, truncate base, occur in chains with truncate base of first conidium attached directly to conidiophore
<i>Sepedonium</i> sp.	Septate	Simple, unbranched, short or long	Conidium: spherical, thick-walled, with projecting spines or tubercles.



Figure 4-1. *Alternaria*



Figure 4-2. *Cephalosporium*.

macroconidia with pointed ends. Oval to spheroid unicellular microconidia are also produced on short, simple conidiophores.

*Helminthosporium* spp. rapidly develops a grayish colony which is flat and cottony (see fig. 4-5). As it matures, the colony forms a matted, black, depressed central mycelium with a raised grayish periphery. Microscopically, the hyphae are septate and dematiaceous. The conidiophore may be simple, branched or unbranched, long or short, and is usually knotted. Numerous elliptical, multiseptate, thick-walled macroconidia develop from the conidiophore. These macroconidia, like the hyphae, are dematiaceous (dark brown). When the macroconidia detach from the phore, a dark scar is left at the former point of attachment. The wormlike shape of the conidiophore is no doubt responsible for the genus name *Helminthosporium*.

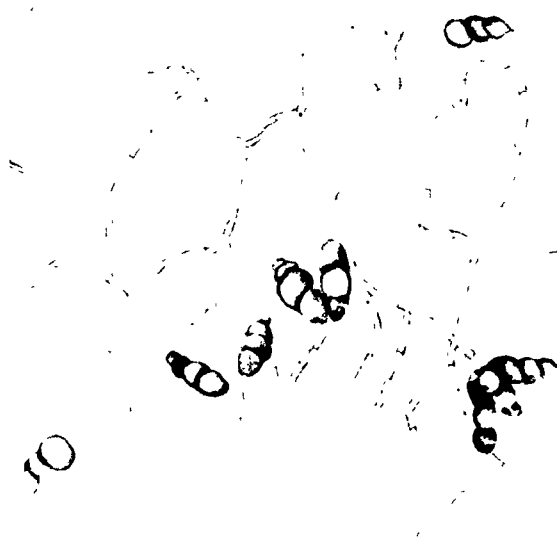

Figure 4-3. *Curvularia*.

*Curvularia* spp. produces a rapid-growing, flat, cottony-type colony which is dark brown to black in color (see fig. 4-3). Reverse pigment is absent. Microscopically, this fungus displays septate, dematiaceous (darkly pigmented) hyphae and simple, unbranched conidiophores. The conidia are large, thick-walled, multicellular, and also dematiaceous. Typically, one side of the conidium shows greater curvature than the other; thus, the genus name *Curvularia* seems most appropriate.

*Fusarium* spp. is a rapid-growing saprophyte which, at first, is white and cottony but soon develops a deep rose color in the center (see fig. 4-4). The pigment shades to a light pink at the periphery. When examined microscopically, this organism displays short, septate hyphal branches giving rise to verticillate conidiophores. These abort (form by laying down a septum) long, fusoid or sickle-shaped, multiseptate

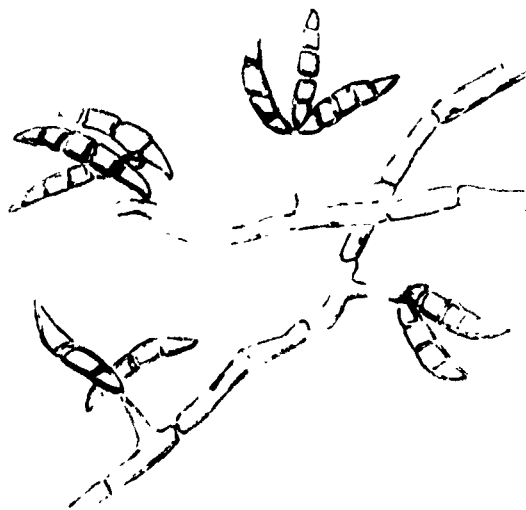

Figure 4-4. *Fusarium*



Figure 4-5. *Helminthosporium*.

*Nigrospora* spp. is a rapid-growing fungus that first develops a colony with compact, wooly, white aerial growth which gradually becomes gray due to the black, sporulating mycelium on the surface of the agar (see fig. 4-6). The reverse pigment is black. Microscopic examination reveals septate hyphae from which develop simple, unbranched, short conidiophores with swollen, vesicle-like ends. The macroconidium which forms on the vesicle is black and spherical. When present in large numbers, it is responsible for the dark grayish colony color as well as the black reverse pigmentation.

*Scopulariopsis* spp. is a slow-growing saprophyte at first membranous, wrinkled, and glabrous with regard to surface texture (see fig. 4-7). As the colony matures, aerial hyphae and conidia develop, giving the culture a powdery, light brown appearance. Microscopically, the hyphae are septate, and the conidiophores are simple—either branched or unbranched. The lemon-shaped, echinulated conidia which develop in



Figure 4-6. *Nigrospora*.



Figure 4-7. *Scopulariopsis*.

unbranching chains on the conidiophores have a characteristic pointed apex and truncate (cut off) base.

*Sepedonium* spp. grows rapidly, forming a flat, cottony colony which displays a white surface pigment (see fig. 4-8). There is no reverse pigment. Microscopic study reveals septate hyphae which show simple long or short, unbranched conidiophores. The macroconidia are spherical and thick-walled with projecting spines or tubercles. This saprophyte, as noted in an earlier chapter, closely simulates some strains of *Histoplasma capsulatum*.

#### Exercise (651):

- Match each of the Genera in column B with the statements in column A by placing the letter of the column B item beside the number of the column A item that most nearly describes it. Each element in column B may be used once or more than once.



Figure 4-8. *Sepedonium*.

- |   |   |
|---|---|
| <ul style="list-style-type: none"> <li>— (1) Is a rapid-growing saprophyte which develops its mycelium close the agar surface pigment; shows green to brown to iridescent black.</li> <li>— (2) The surface texture is velvety to downy.</li> <li>— (3) The macroconidia are typically uniform, having both transverse and longitudinal septations</li> <li>— (4) The surface texture is glabrous to downy and wrinkled, a reverse pigment is absent.</li> <li>— (5) Microscopic examination reveals slender, unbranched conidiophores which bear a spherical cluster of conidia at their tips</li> <li>— (6) The surface pigment produced is dark brown to black and typically one side of the conidium shows greater curvature than the other</li> <li>— (7) The conidia are large, thick-walled, multicellular, and also dematiaceous.</li> <li>— (8) The surface texture is velvety to tight cotton</li> <li>— (9) The conidium is multiseptate, banana, or sickle-shaped and in bananalike clusters on one end of the conidiophore.</li> <li>— (10) The conidiophore may be simple, branched or unbranched, long or short, and is usually knotted.</li> <li>— (11) The wormlike shape of the conidiophore is no doubt responsible for the name of the genus.</li> <li>— (12) The reverse pigment is black. Microscopic examination reveals septate hyphae from which develop simple, unbranched, short conidiophores with swollen, vesicle-like ends.</li> <li>— (13) The macroconidium which forms on the vesicle is black and spherical.</li> <li>— (14) The lemon-shaped, echinulated conidia which develop in unbranching chains on the conidiophores have a characteristic pointed apex and truncate base.</li> <li>— (15) Is a slow-growing saprophyte at first membranous, wrinkled, and glabrous with regard to surface texture.</li> <li>— (16) Grows rapidly, forming a flat, cottony colony which displays a white surface pigment.</li> <li>— (17) The macroconidia are spherical and thick-walled with projecting spines or tubercles.</li> </ul> | <ul style="list-style-type: none"> <li>a <i>Alternaria</i></li> <li>b <i>Nigrospora</i></li> <li>c <i>Scopulariopsis</i></li> <li>d <i>Curvularia</i></li> <li>e <i>Cephalosporium</i></li> <li>f. <i>Fusarium</i></li> <li>g. <i>Sepedonium</i></li> <li>h. <i>Helminthosporium</i></li> </ul> |
|---|---|

**Saprophytes with Characteristic Conidiophores.** The saprophytic fungi which comprise the common laboratory contaminants of this group include members of the Genera *Aspergillus*, *Cladosporium*, *Paecilomyces*, *Penicillium*, and *Trichoderma*. The macroscopic morphological characteristics of these fungi are given in table 4-3 and illustrated in foldout 3, detail A. Their microscopic morphological features are presented in table 4-4 and shown in figures 4-9 through 4-13 in drawings from slide cultures.

*Aspergillus clavatus*, a rapid-growing saprophyte, develops a flat colony with a woolly surface texture (see fig. 4-9). It has a blue-green surface pigment and lacks any reverse pigmentation. The hyphae are branched and septate. The conidiophore is composed of a stalk, vesicle, and sterigmata. The stalk arises from a foot cell and expands at its apex to form a clavate vesicle covered with single rows of sterigmata. Echinulations may be observed on the stalk under oil immersion. The microconidia are smooth, gray-green in color, and occur in unbranched chains from the sterigmata,

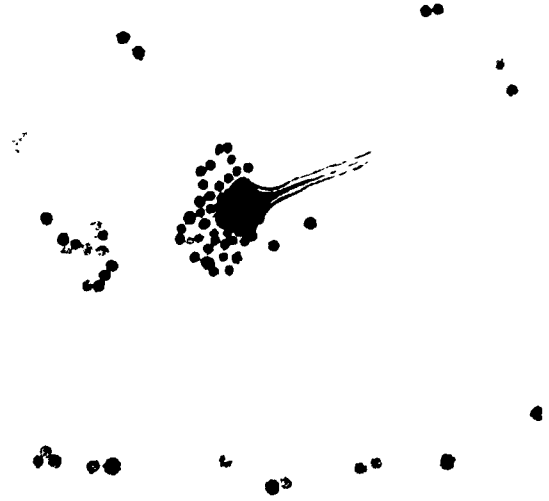

Figure 4-9 *Aspergillus*.

*Aspergillus fumigatus*, a rapid-growing contaminant, forms a flat colony with a velvety or powdery texture. The surface pigment is a dark gray-blue to green, and reverse pigmentation is absent. Microscopically, *A. fumigatus* has a flask-shaped vesicle which sets it apart from *A. clavatus*. Single rows of sterigmata occur only on the upper half of the vesicle, and the stalk is smooth. Microconidia are thick, echinulated, and dark green in color. They occur in unbranched chains from the sterigmata.

The *Aspergillus glaucus* species of *Aspergillus* is rapid-growing and, at first, forms a flat colony which later becomes slightly heaped. The immature colony is woolly in texture, later becoming granular. The young colony is white, while the mature growth shows a green center with a yellow-gold periphery. There is no reverse pigment. *A. glaucus*, microscopically, reveals a glabrous vesicle covered with single rows of sterigmata

**652. Identify given saprophytes with characteristic conidiophores in terms of their growth rate, surface topography, surface texture, surface pigment, significant back or reverse pigment, and microscopic morphology.**

**TABLE 4-3**  
**MACROSCOPIC MORPHOLOGY OF COMMON SAPROPHYTIC FUNGI HAVING**  
**CHARACTERISTIC CONIDIOPHORES**

<i>Organism</i>	<i>Growth Rate</i>	<i>Surface Topography</i>	<i>Surface Texture</i>	<i>Surface Pigment</i>	<i>Significant Back or Reverse Pigment</i>
<i>Aspergillus clavatus</i>	Rapid	Flat	Woolly	Blue to green	Absent
<i>Aspergillus fumigatus</i>	Rapid	Flat	Velvety or powdery	Gray-blue to green, dark	Absent
<i>Aspergillus glaucus</i>	Rapid	Young: flat mature: slightly heaped	Young: floccose mature: granular	Young: white mature: green center with yellow-gold periphery	Absent
<i>Aspergillus niger</i>	Rapid	Flat	Woolly	Young: white to yellow mature: dark brown to black	Absent
<i>Cladosporium</i> sp.	Rapid	Flat to slightly heaped	Glabrous, downy, or velvety	Green to black, dark	Green to black, dark
<i>Paecilomyces</i> sp.	Rapid	Flat	Powdery to velvety	Yellow-brown, gray-green, violet, or white	Absent
<i>Penicillium</i> sp.	Rapid	Flat	Powdery	White-green to blue and other colors	Absent
<i>Trichoderma</i> sp.	Rapid	Flat	Woolly	White to green	Port wine to dark brown soluble pigment

TABLE 4-4  
MICROSCOPIC MORPHOLOGY OF COMMON SAPROPHYTIC FUNGI  
HAVING CHARACTERISTIC CONIDIOPHORES

Organism	Hypha	Conidiophore	Spore
<i>Aspergillus clavatus</i>	Septate, branched.	Consists of stalk, vesicle and sterigmata; stalk expands into <i>clavate</i> vesicle; single rows of sterigmata over <i>entire</i> surface of vesicle, echinulated stalk (oil).	Conidium: smooth, gray-green occur in unbranched chains from sterigmata
<i>Aspergillus fumigatus</i>	Septate, branched.	Consists of stalk, vesicle and sterigmata; stalk expands into <i>flask-shaped</i> vesicle; single rows of sterigmata occur on <i>upper half</i> of vesicle; smooth stalk.	Conidium: thick echinulated, dark green; occur in unbranched chains from sterigmata.
<i>Aspergillus glaucus</i>	Septate, branched.	Consists of stalk, vesicle and sterigmata; stalk expands into <i>globous</i> vesicle; single rows of sterigmata occur over <i>entire</i> surface of vesicle; smooth stalk.	Conidium: (asexual): echinulated, green; occur in unbranched chain from sterigmata; ascospore (sexual), average of 8 within asci, asci within perithecium.
<i>Aspergillus niger</i>	Septate, branched.	Consists of stalk, vesicle and sterigmata; stalk expands into vesicle having usually <i>two</i> (1-2) rows of sterigmata over <i>entire</i> surface of vesicle; smooth stalk.	Conidium: echinulated, dematiaceous; occur in unbranched chains from sterigmata.
<i>Cladosporium</i> sp	Septate, branched.	Simple, branched, produces long branched chains of microconidium (cladosporium-type sporulation).	Conidium: occur in branched chains
<i>Paecilomyces</i> sp.	Septate, branched.	Consists of single or multiple (often in whorles) sterigmata from which chains of microconidia originate.	Conidium: elliptical, occur in unbranched chains which appear to slightly bend in one direction along with conidiopore.
<i>Penicillium</i> spp	Septate, branched.	Simple includes stalk and sterigmata, complex: includes stalk, metulae, and sterigmata; sterigmata are brush like; variations between simple and complex conidiophores are species specific.	Conidium: smooth or echinulated, elliptical; occur in unbranched chains from sterigmata.
<i>Trichoderma</i> sp	Septate, branched.	Simple, branched; sterigmata are alternating or directly opposed on short hyphal stalk of conidiophore.	Conidium: spherical, formed in clusters at tip of sterigmata



The stalk is smooth. The green and echinulated microconidia occur in unbranched chains from the tips of the sterigmata.

*Aspergillus niger* is a rapid-growing species that forms a flat, woolly colony which is, at first, white to yellow. As the colony matures, it becomes dark brown to black. The vesicle of *A. niger* usually has two rows of sterigmata over the entire surface, and the stalk is smooth. The microconidia are echinulated and dematiaceous, occurring in unbranched chains from the tips of the sterigmata.

*Cladosporium* spp. is another rapid-growing saprophyte that develops a flat to slightly heaped colony which may be glabrous, downy, or velvety (see fig. 4-10). Both the front and reverse pigmentation range from dark green to black. The hyphae are septate and branched under the microscope. The conidiophore is simple and branched, forming long, branching chains of continuously budding microconidia. The microconidia may septate and become bicellular when mature. The hyphae, conidiophores, and conidia are dark brown in color.

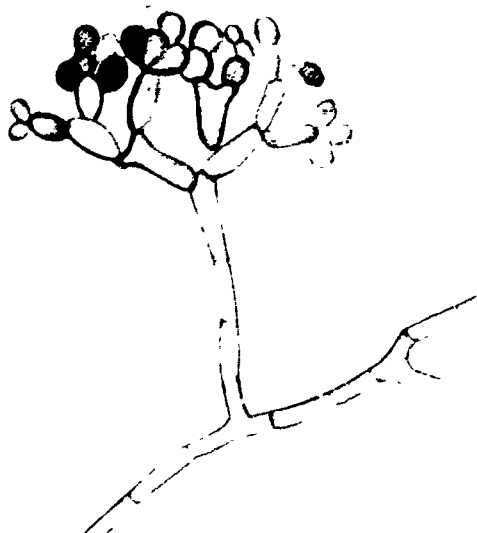

Figure 4-10. *Cladosporium*.

*Paecilomyces* spp. is a rapid-growing contaminant producing a flat colony with a powdery or velvety surface texture (see fig. 4-11). The surface pigmentation may be yellow-brown, gray-green, violet, or white, and reverse pigment is absent. The microscopic picture is one of the septate branched hyphae with conidiophores existing either singly or in groups (often in whorls). Flask-shaped sterigmata with elongate, conidia-bearing tubes may be seen on the conidiophores. The elliptical microconidia occur in unbranched chains and, along with the conidiophores and sterigmata, bend away from the main axis of the hypha.

*Penicillium* spp. is a rapid-growing familiar saprophyte that develops a flat, powdery colony which is generally white-green-blue in color (see fig. 4-12). There is no reverse pigmentation. Microscopically, the genus *Penicillium* typically reveals hyphae which are septate and branched. Conidiophores may be either



Figure 4-11. *Paecilomyces*

simple or complex and are indicative of particular species. The simple conidiophore consists of only a single stalk and sterigma from which microconidia are shown in an unbranched chain. The complex conidiophore includes a stalk which branches out apically in the form of a brush. Each branch develops a metula within which conidia are generated and a flask-shaped sterigmata through which the spores are passed in unbranching chain arrangement. The elliptical microconidia may be either smooth or echinulated.

*Trichoderma* spp., the last member of this group of saprophytes with characteristic conidiophores, also grows rapidly to form a flat, woolly colony which varies from white to green in color (see fig. 4-13). Reverse pigmentation ranges from port wine to dark brown. As with all the previous members of this group the hyphae are septate and branched. The simple branched conidiophores may alternate or directly oppose each other. The spherical microconidia are extended through



Figure 4-12. *Penicillium*.

a sterigmata, forming a loosely adherent globular cluster at its tip.

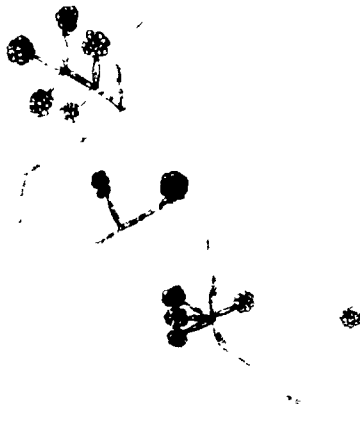

Figure 4-13. *Trichoderma*

**Exercises (652):**

1. Match each member of the Genus of this group in column B with the statements in column A by placing the letter of the column B item beside the number of the column A item that most nearly describes it. Each element in column B may be used once, more than once, or not at all.

*Column A*

*Column B*

- |  |  |
|--|--|
| <ul style="list-style-type: none"> <li>— (1) It has a blue-green surface pigment and lacks any reverse pigmentation.</li> <li>— (2) Consists of stalk, vesicle, and sterigmata; stalk expands into clavate vesicle.</li> <li>— (3) The surface pigment is a dark gray blue to green, and reverse pigment is absent.</li> <li>— (4) Has a flask-shaped vesicle.</li> <li>— (5) Three structures which make up the characteristic conidiophore in the genus <i>Aspergillus</i>.</li> <li>— (6) In young cultures, the surface texture is floccose, and mature cultures show a granular appearance.</li> <li>— (7) Growth rate is rapid; the hypha is septate, branched; the stalk expands into globous vesicle; and single rows of sterigmata occur over entire surface of vesicle.</li> <li>— (8) Is a rapid-growing species that forms a flat, woolly colony which is, at first, white to yellow, and as the colony matures, it becomes dark brown to black</li> </ul> | <ul style="list-style-type: none"> <li>a. <i>Aspergillus clavatus</i></li> <li>b. <i>Trichoderma</i> spp.</li> <li>c. <i>Aspergillus fumigatus</i>.</li> <li>d. <i>Penicillium</i> spp.</li> <li>e. <i>Aspergillus glaucus</i>.</li> <li>f. <i>Paecilomyces</i> spp.</li> <li>g. <i>Aspergillus niger</i></li> <li>h. <i>Cladosporium</i> spp.</li> <li>i. The stalk, vesicle, and sterigmata.</li> <li>j. The stalk, vesicle, and sterigmata</li> </ul> |
|--|--|

- (9) The conidiophores consists of stalk, vesicle, and sterigmata; the stalk expands into the vesicle which usually has two rows of sterigmata over the entire surface
- (10) The surface topography is flat to slightly heaped; the colony may be glabrous, downy, or velvety, and both front and reverse pigmentation range from dark green to black
- (11) The conidiophore is simple and branched, forming long, branching chains of continuously budding microconidia.
- (12) Produces a flat colony with a powdery or velvety surface texture
- (13) The surface pigmentation may be yellow brown, gray green, violet, or white; and reverse pigment is absent.
- (14) A rapid-growing saprophyte that develops a flat, powdery colony which is generally white-green-blue in color.
- (15) The complex conidiophore includes a stalk which branches out apically in the form of a brush.
- (16) Reverse pigmentation ranges from port wine to a dark brown
- (17) The spherical microconidia are extended through a sterigmata, forming a loosely adherent, globular cluster at its tip.

653. Identify given saprophytes with characteristic sporangiophores in terms of their growth rate, surface topography, surface texture, surface pigment, significant back or reverse pigment, and microscopic morphology.

**Saprophytes with Characteristic Sporangiohores.**

Those common contaminants which belong to the Class *Phycomycetes* are described in both a macroscopic and microscopic standpoint in this section. They include species of the Genera *Absidia*, *Mucor*, *Rhizopus*, and *Syncephalastrum*. The macroscopic features of these fungi are listed in table 4-5. Refer to figures 4-14 through 4-17 and table 4-6 for data regarding the microscopic morphology of each member of this group.

*Absidia* spp. is a rapid-growing saprophyte that forms a flat colony which is woolly and coarse in texture and displays a surface pigment varying from white to gray, brown, or yellow (see figure 4-14). Reverse pigmentation is absent. Under the microscope, the hyphae are broad and aseptate. Rhizoids develop at the nodes. The conidiophore is comprised of a stalk which swells apically to form the spore-generating organ called the columella and pear-shaped, saclike sporangium which incloses the columella. The sporangiospores (endospores), when released from the columella, are entrapped in the sporangium.

*Mucor* spp. is a rapid-growing contaminant that forms a flat colony which is also woolly and coarse (see figure 4-15). The surface pigmentation ranges from

**TABLE 4-5**  
**MACROSCOPIC MORPHOLOGY OF COMMON SAPROPHYTIC FUNGI**  
**(PHYCOMYCETES) HAVING CHARACTERISTIC SPORANGIOPHORES**

Organism	Growth Rate	Surface Topography	Surface Texture	Surface Pigment	Significant Back or Reverse Floccet
<i>Abidia</i> sp.	Rapid	Flat	woolly, Coarse.	white to gray, brown, or yellow.	Absent
<i>Mucor</i> sp.	Rapid	Flat	woolly, Coarse.	White to gray, brown, or yellow	Absent
<i>Rhizopus nigricans</i>	Rapid	Flat	Woolly	Gray to brown, dotted with black sporangia.	Absent
<i>Rhizopus oryzae</i>	Rapid	Flat	Woolly	White to gray or brown.	Absent
<i>Syncephalastrum</i> sp.	Rapid	Flat	woolly	White to dark gray.	Absent

Note: The macroscopic morphology of these Phycomycetes resembles the macroscopic morphology of *Higrospora* sp., seen in Foldout 2, G-6.

**TABLE 4-6**  
**MICROSCOPIC MORPHOLOGY OF COMMON SAPROPHYTIC FUNGI**  
**(PHYCOMYCETES) HAVING CHARACTERISTIC SPORANGIOPHORES**

Organism	Hypha	Sporangiophore	Spore
<i>Abidia</i> sp.	Aseptate, rhizoids at nodes.	Consists of stalk, columella and pear-shaped sporangium, arise in groups, internodally.	Sporangiospore, borne in groups upon columella and surrounded by sporangium.
<i>Mucor</i> sp.	Aseptate, branched.	Consists of stalk, columella and spherical sporangium; usually branched.	Same as above.
<i>Rhizopus nigricans</i>	Aseptate, rhizoids at nodes.	Consists of stalk, columella and spherical sporangium, arise in groups from nodes.	Sporangiospores, are black; otherwise, same as above.
<i>Rhizopus oryzae</i>	Aseptate, rhizoids at nodes.	Stalk is striated; otherwise, same as <i>rhizopus nigricans</i> .	Sporangiospores are dark brown; otherwise, same as above
<i>Syncephalastrum</i> sp.	Aseptate, branched.	Complex, producing many clavate sporangia from vesicle, often short and curved.	Sporangiospores formed in clavate sporangium.



Figure 4-14 *Absidia*.

white to gray, brown, or yellow, and no reverse pigmentation is present. The hyphae are broad and aseptate. The conidiophore is essentially the same as with *Absidia* spp., except that the sporangium is spherical in shape. Frequently, there is branching of one conidiophore from another. The sporangiospores are identical to those produced by *Absidia* spp.

*Rhizopus nigricans*, another rapid-growing fungus, forms a flat colony which is woolly in texture (see fig. 4-16). Surface pigmentation is gray to brown and dotted with black sporangia. There is no reverse pigmentation. The microscopic picture reveals broad aseptate hyphae. The conidiophores develop in nodal groups at opposite ends of hyphal runners called stolons. These conidiophores form a spherical sporangium and are essentially the same as those previously described. A tuft of root like hyphae (rhizoid) develops at the ends of the stolon opposite the conidiophore and aids the fungus in adhering to the substratum as well as facilitating assimilation of nutrient material. Except for

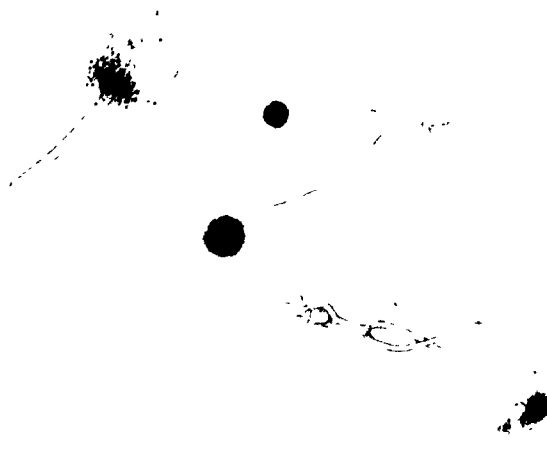

Figure 4-16. *Rhizopus*.

their black color, the sporangiospores appear the same as those of *Absidia* and *Mucor* spp.

The growth rate and macroscopic morphology of *Rhizopus oryzae* cannot be distinguished from that of *R. nigricans*. Microscopically, the only variations from *R. nigricans* involves the stalk of the conidiophore (which is striated) and the sporangiospores which are dark brown rather than black.

*Syncephalastrum* spp. is a rapid-growing contaminant that is essentially the same macroscopically as *R. oryzae* (see fig. 4-17). Microscopic examination reveals the characteristic broad, aseptate hyphae of the Class *Phycomycetes*. The complex conidiophores consist of short branches of aerial hyphae which are greatly swollen at their tip-forming vesicles. These vesicles bear many elongate fingerlike projections, the sporangia, which produce sporangiospores in long chains. When observed under low magnification, this fungus may be readily mistaken for a species of *Aspergillus*.

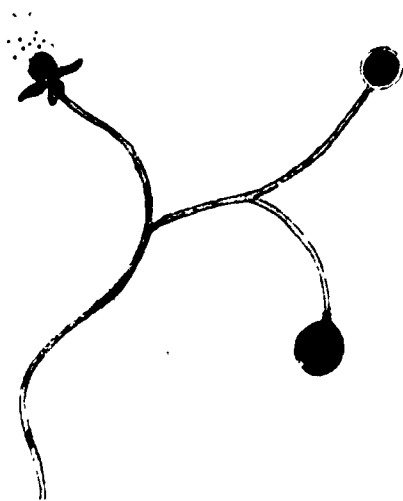

Figure 4-15. *Mucor*.



Figure 4-17. *Syncephalastrum*.

**Exercises (653):**

1. Match each member of the Class *Phycomycetes* in column B with the statements in column A by placing the letter of the column B item beside the number of the column A item that most nearly describes it. Each element in column B may be used once or more than once.

Column A	Column B
— (1) Displays a surface pigment varying from white to gray, brown, or yellow, and reverse pigment is absent.	a. <i>Syncephalostrom</i> spp.
— (2) Consists of stalk, columella, and pear-shaped sporangium, arises in groups, internodally.	b. <i>Rhizopus nigricans</i> .
— (3) Consists of stalk, columella, and spherical sporangium; usually branched.	c. <i>Absidia</i> spp.
— (4) Forms a flat colony which is woolly in texture, surface pigmentation is gray to brown and dotted with black sporangia.	d. <i>Mucor</i> spp.
— (5) Sporangiospores are black.	e. <i>Rhizopus oryzae</i>
— (6) Sporangiospores are dark brown.	
— (7) The stalk of the conidiophore is striated.	
— (8) When observed under low magnification, may readily be mistaken for a species of <i>Aspergillus</i>	
— (9) The conidiophore is complex, consisting of short branches of aerial hyphae which are greatly swollen at their tip-forming vesicles	

654. Identify given saprophytes with characteristics thallus in terms of their growth rates, surface topography, surface textures, surface pigment, back or reverse pigment, and microscopic morphology.

**Saprophytes with Characteristic Thallus.** This final group of common contaminants reproduce by forming spores within or directly from the plant body. The members which are discussed in this section include species belonging to the Genera *Aureobasidium*, *Geotrichum*, *Rhodotorula*, and *Streptomyces*. Refer to table 4-7 for information regarding their macroscopic morphological characteristics and to foldout 3, detail B, for illustration of their colonial morphology on Sabouraud dextrose agar. Table 4-8 is provided as a ready reference to their microscopic morphology.

*Aureobasidium pullulans* is a rapid-growing fungus that forms a heaped, wrinkled colony which varies in texture from pasty to glabrous or leathery. The surface pigment is typically black, with a grayish-pink fringe of submerged mycelial growth. The reverse pigment, when present, is black. In its early stages of development, the hyphae appear thin, hyaline, and septate. As the hyphae mature, large, black (highly dematiaceous), thick-walled cells are formed. The microconidium may bud directly from the walls of young hyphae or develop on short germ tubes elaborated by the older hyphal cells.

*Geotrichum* spp. is a rapid-growing saprophyte that forms a flat colony whose surface texture is at first pasty, later becoming velvety and cottony. The surface color varies from gray to tan, and no reverse pigment is developed. The microscopic picture is one of long,

**TABLE 4-7**  
MACROSCOPIC MORPHOLOGY OF COMMON SAPROPHYTIC FUNGI

Organism	Growth Rate	Surface Topography	Surface Texture	Surface Pigment	Significant Back or Reverse Pigment
<i>Aureobasidium pullulans</i> ( <i>Pullularia pullulans</i> )	Rapid	Flat	Pasty to glabrous to leathery	White or pink, to black	Absent or black
<i>Geotrichum</i> sp.	Rapid	Flat	Pasty to velvety to cottony	Gray to tan	Absent
<i>Rhodotorula</i> sp.	Rapid	Flat	Pasty to mucoid	Orange to red	Absent to orange-red
<i>Streptomyces</i> sp.	Rapid	Heaped	Dry, chalky, leathery	Cream, tan or brown	Absent

**TABLE 4-8**  
**MICROSCOPIC MORPHOLOGY OF COMMON SAPROPHYTIC FUNGI**  
**HAVING CHARACTERISTIC THALLI**

Organism	Hypha	Sporophore	Spore
<i>Aureobasidium pullulans</i> ( <i>Pullularia pullulans</i> )	Septate, thin, hyaline (young) developing into wide, thick-walled dematiaceous (old) hypha.	Conidiophore: not prominent.	Microconidium: may bud from young hypha or from germ tube or old hypha.
<i>Geotrichum</i> sp.	Multiseptate, fragmented into arthrospores.	None	Arthrospore: square to oval segments from fragmented, multiseptate hypha.
<i>Rhodotorula</i> sp.	None	None	Blastospore: budding yeast-type cell.
<i>Streptomyces</i> sp.	Slender, fine (1 micron or less, dia.), branching.	Straight or coiled, breaks up into chains of microconidia.	Microconidium: occurs in chains.

slender, multiseptate hyphae which readily fragment into thin-walled, rectangular arthrospores. These arthrospores are reproductive bodies which proliferate germ tubes to form new hyphal filaments.

*Rhodotorula* spp. produces a colony which develops rapidly. The colony is flat and displays a pasty to mucoid surface texture. The surface pigment is orange to red, and when produced, the reverse pigmentation is an orange red. There are no hyphae or conidiophores developed by this fungus. Reproduction is by means of simple budding of yeast-type cells called blastospores.

In contrast to the great majority of saprophytic fungi, *Streptomyces* spp. is slow in developing. The colony is heaped and somewhat wrinkled—presenting a dry, chalky, leathery appearance on the medium. Surface pigmentation varies considerably, depending on the species. It ranges from cream to tan or brown. There is no reverse pigmentation. The long, slender, branching hyphae (less than one micron in diameter) fragment into chains of microconidia. These chains are very delicate, and morphological studies usually are best accomplished by means of slide cultures.

**Exercises (654):**

1. Match each number of the given saprophytes in column B with the statements in column A by placing the letter of the column B item beside the

number of the column A item that most nearly describes it. Each element in column B may be used once or more than once.

Column A

Column B

- |   |   |
|---|---|
| <ul style="list-style-type: none"> <li>— (1) Forms heaped, wrinkled colony which varies in texture from pasty to glabrous or leathery; surface pigment is typically blank.</li> <li>— (2) The reverse pigment, when present, is black; and the conidiophore is not prominent.</li> <li>— (3) The microconidium may bud directly from the walls of young hyphae or develop on short germ tubes shown by older hyphal cells.</li> <li>— (4) The surface color varies from gray to tan, and no reverse pigment is developed.</li> <li>— (5) The hyphae are long, slender, multiseptate which readily fragment into thin-walled, rectangular arthrospores.</li> <li>— (6) Colony is flat and displays a pasty to mucoid surface texture.</li> <li>— (7) The surface pigment is an orange-red, and there are no hyphae or conidiophores.</li> <li>— (8) Is slow developing, in contrast to the majority of saprophytic fungi.</li> <li>— (9) The colony is heaped and somewhat wrinkled, presenting a dry, chalky, leathery appearance on the medium.</li> <li>— (10) The hyphae are long, slender, and branching, fragmenting into chains of microconidia.</li> </ul> | <ul style="list-style-type: none"> <li>a. <i>Geotrichum</i> spp.</li> <li>b. <i>Rhodotorula</i> spp.</li> <li>c. <i>Streptomyces</i> spp.</li> <li>d. <i>Aureobasidium pullulans</i></li> </ul> |
|---|---|



## 4-2. Saprophytes as the Etiological Agents of Rare Mycoses

Some of the previously discussed saprophytic fungi have been implicated in serious mycotic infections in the tissues of man and animals. Whether these organisms are the actual causative agents of disease or are present simply as contaminants is often difficult to assess. It is well to remember that these saprophytes may be present in the role of secondary invaders, particularly in cases of tuberculosis. Typically, these organisms are opportunistic, becoming pathogenic only under favorable conditions which may occur in people with chronic, debilitating diseases or whose normal immune response has been impaired.

In theory, any of the saprophytes is capable of causing disease in man. The Genus *Aspergillus*, *Penicillium*, and several members of the class *Phycomycetes* have been implicated in the majority of the cases. The laboratory diagnosis of mycoses resulting from these normally innocuous fungi, and those agents causing cladosporiosis and rhinosporidiasis, are discussed in this section.

**655. Cite significant criteria implicating *Aspergillus* species in a disease process, types of aspergillosis and their characteristics, types of specimens required for examination, the microscopic appearance of the mycelium, and the significance of other tests used for identification of the organisms.**

**Aspergillosis.** Aspergillosis is an infrequently occurring mycosis caused by various species of *Aspergillus*. It is typically a granulomatous, necrotizing, cavitory disease of the lungs. On occasion, inflammatory lesions occur in the skin, external ear, nasal sinuses, and the eye. In disseminated form, the bones, meninges, and other body organs may become involved. Species of *Aspergillus* are ubiquitous in nature, and infections have been reported from all areas of the world. Plants, insects, domestic animals, and especially birds are susceptible to aspergillosis. Agricultural workers who are exposed to massive doses of spores frequently contract the primary pulmonary form of the disease often referred to as "farmer's lung." A particular species of *Aspergillus* generally is associated with a specific infection site. Usually, strains of *A. fumigatus* are isolated from cases of pulmonary aspergillosis, while *A. niger* is the most common species causing external ear infections. The various clinical forms include pulmonary, cutaneous, disseminated, and on rare occasion, rhino-ocular infections.

Primary pulmonary aspergillosis, the most common type of human infection, elicits symptoms which closely simulate those of pulmonary tuberculosis. Individuals who live or work in environments where *A. fumigatus* spores are prevalent may become sensitized; thus, when a large number of spores are inhaled, they develop an allergic asthma. Species other than *A. fumigatus* may

also produce sensitization. The most common form of cutaneous aspergillosis is otomycosis, an external ear infection, with *A. niger* as the usual etiological agent. Skin lesions may also result from bloodstream dissemination in cases of fulminating systemic aspergillosis. A few cases of mycetoma (fungal tumor) due to *A. amstelodami* and *A. nidulans* and other species have been reported.

Disseminated aspergillosis normally results from the extension of a primary pulmonary infection which fails to be contained by calcification in the lungs. The fungus is spread to the vital organs of the body via the bloodstream, resulting in widespread tissue necrosis and severe toxemia. *A. fumigatus*, *A. flavus*, and other species have, on rare occasion, invaded the nasal sinuses, the orbit of the eye, and the eye itself, resulting in the rhino-ocular form of aspergillosis. This form of the disease often spreads to the central nervous system.

Since species of *Aspergillus* are so frequently observed in and cultured from clinical materials, their implication in disease processes normally requires repeated recovery from clinical materials in the absence of other pathogenic agents and positive histologic findings. Recovery of the organisms from unexposed specimens, such as pleural or spinal fluid is strong supportive evidence.

Direct wet preparations should be accomplished on sputum, bronchial washings, and other body fluids. When volume is sufficient, it is best to use the centrifuged sediment. The mycelium appears wide, four to six  $\mu\text{m}$  in diameter, of a fairly uniform width, and septate. In the absence of a conidial head, it is not possible to distinguish *Aspergillus* from morphologically similar fungi; however, if large quantities of this type of hyphae are present, it is quite suggestive.

The material must be cultured on media such as Sabouraud dextrose agar containing antibacterial agents other than cycloheximide. Most *Aspergillus* isolates are sensitive to this antibiotic. In addition, an *Aspergillus* Differentiated Medium, developed for detection of *A. flavus* and closely related species, may be used. As soon as growth is adequate, wet mounts are prepared. *A. fumigatus* has been identified as the etiological agent of aspergillosis in 90 to 95 percent of such cases. Animals have been used by several researchers to demonstrate the thermolabile and endotoxin produced by *A. fumigatus*. Animal inoculation techniques are considered unnecessary, however, in identifying the *Aspergilli*. Present immunologic tests are of no value because of the frequency of cross reactions and the lack of standardized reagents.

### Exercises (655):

1. Aspergillosis is typically a \_\_\_\_\_, \_\_\_\_\_ disease of the lungs.

2. Usually, strains of *Aspergillus* \_\_\_\_\_ are isolated from cases of pulmonary aspergillosis.
3. *Aspergillus* \_\_\_\_\_ is the most common species causing external ear infections.
4. What form of aspergillosis is the most common?
5. The form of aspergillosis in question 4 elicits symptoms which closely simulate those of what disease?
6. What type of aspergillosis may result when the extension of a primary pulmonary infection fails to be contained by calcification in the lungs?
7. Since *Aspergillus* species are such common laboratory contaminants, what criteria are necessary to implicate them in a disease process?
8. What type of specimens may be used in direct preparations for *Aspergillus*?
9. How does the mycelium of *Aspergillus* appear?
10. What given media may be used to culture *Aspergillus* isolates?

**656. Identify the four basic types of infections caused by the *Phycomycetes* in terms of their related characteristics and clinical materials required, specify the fungal structures which may be observed in direct microscopic examination of clinical material from cases of phycomycosis.**

**Phycomycosis (Mucormycosis).** Several genera of the class *Phycomycetes* are capable of causing this rapidly fatal disease characterized by acute inflammation and vascular thrombosis. Since the name mucormycosis refers only to species and strains belonging to this genus, the use of the term "phycomycosis" seems much

more appropriate. Genera other than *Mucor* which may be implicated in phycomycosis include *Absidia*, *Rhizopus*, *Mortierella*, and *Basidiobolus*. These ubiquitous fungi, as in the case of *Aspergillus*, are common laboratory contaminants. Unless they are repeatedly isolated from clean clinical material and the findings corroborated culturally and by histologic examination, a definitive diagnosis is difficult. Phycomycosis has been reported from many areas of the world, and it is likely that the disease, although rare, is cosmopolitan in distribution. Systemic infections occur either by inhalation or ingestion of spores or in localized cutaneous form as a result of skin penetration. There are several conditions predisposing to a phycomycosis, and probably the most important of these is diabetes mellitus. Such conditions as malnutrition, uremia, and amebiasis preceding visceral phycomycotic infections have been reported. Another increasingly significant predisposing factor is the prolonged use of antibiotics and steroids. The phycomycoses have been classified into four basic types: cranial-facial, thoracic, abdominal-pelvic, and dermal.

The cranial-facial form of infection, usually effecting patients with severe acidotic diabetes, often originates in the paranasal sinuses. Thoracic phycomycosis results from inhalation of spores or aspiration of fungal material draining from lesions either in the nose or mouth. It is characterized by progressive nonspecific bronchitis and pneumonia. Since the fungi demonstrate a particular affinity for the blood vessels, they are often found in large numbers in their lumens so that thrombi and resultant infarctions are commonplace.

The abdominal-pelvic form of infection presumably originates from the ingestion of infective fungal elements or possibly due to bloodstream dissemination. No particular region of the alimentary tract appears to be more susceptible than another. A few well-documented cases of subcutaneous phycomycosis have been reported from Indonesia. The histories in these cases did not indicate injury to the skin; however, they did indicate that the infection began at one spot as a subcutaneous nodule which gradually increased in size. Healing takes place without specific treatment after periods of several months to a few years. The organisms proved to be *Basidiobolus ranorum*.

For diagnosis of phycomycosis, clinical materials aspirated from nasal sinuses or obtained by a scraping of nasal or oral lesions should be examined directly in potassium hydroxide for the presence of broad (6 to 15  $\mu$ m in diameter), aseptate, branching hyphae. A rare septation may be observed. When body fluids are submitted, such as spinal fluid or bronchial washings, they should be concentrated by centrifugation before examination. The clinical material should be cultured on Sabouraud dextrose agar without cycloheximide and incubated at 25° C. If blood or pus is present in the specimen, give this part of the specimen priority for use in inoculation of the medium. The *phycomycetes* are fast-growing; they rapidly fill the tube with a white, cottony growth which turns gray with sporangial formation. Teased amounts in lactophenol-cotton blue are examined microscopically for broad aseptate

hyphae, sporangia, and spores. Genus identification should be based on structural features such as rhizoids, stolons, or conidial variations. The characteristics of the common agents of phycomycosis are shown in tables 4-5 and 4-6.

The most rapid method of diagnosing a phycomycotic infection is to prepare a frozen section of biopsied tissue stained with hematoxylin and eosin. The fungus appears in the tissue as broad branched, aseptate hyphae which may reach 200  $\mu\text{m}$  in length. Culturing is necessary for genus and species identification. Animal inoculation and immunologic procedures are of no value.

#### Exercises (656):

1. What are some conditions that are predisposing to a phycomycosis?
2. What are the four basic types of infections caused by *Phycomycetes*?
3. Which form of the four basic types of infections usually affecting patients with severe acidotic diabetes often originate in the paranasal sinuses?
4. Which form of infection presumably originates from the ingestion of infective fungal elements?
5. For diagnosis of phycomycoses, what clinical materials are required and examined directly in KOH?
6. What particular characteristics should be observed when looking at a suspected specimen in a KOH preparation?
7. To what given culture medium should the specimen be inoculated and at what temperature?
8. The most rapid method of diagnosing a phycomycotic infection is to prepare a \_\_\_\_\_ of biopsied tissue stained with \_\_\_\_\_ and \_\_\_\_\_.

657. Specify the characteristics of rhinosporidiosis, the characteristics which relate *Rhinosporidium seeberi* to the class *Phycomycetes*, techniques for laboratory identification, and characteristics of *Rhinosporidium seeberi* which distinguish this organism from *Coccidioides immitis*.

**Rhinosporidiosis.** *Rhinosporidium seeberi* is the fungus responsible for rhinosporidiosis, a worldwide human disease. It is a chronic, granulomatous mycosis characterized by the development of polyplike masses, primarily of the mucous membranes. In more than 90 percent of reported cases, the polyps first appeared on the mucous membranes of the nose, either sessile or pedunculated, and often of sufficient size to obstruct breathing. The eyes are frequently involved. Many such cases probably go undiagnosed because of early surgical removal without histological study. Occasional infections of the ears, larynx, and genitalia have also been reported. The natural habitat of the organism is unknown; therefore, the source of infection is obscure. Cases of the disease in India and Ceylon have been associated with swimming and working in stagnant water, and the theory has been advanced that aquatic animals, such as fish or frogs, may host the fungus.

The polyps which develop are soft, red, and lobed. They often resemble the surface of a cauliflower. Small, white spots seen on the surface of the polyp are actually mature sporangia produced by the organism. Microscopic examination of these polyps reveals spherical bodies varying in size between 6 and 300  $\mu\text{m}$ . These bodies represent the progressive stages in the organism's development. As these sporangia enlarge, they develop thick, refractile outer walls, and the cytoplasm undergoes progressive cleavage to form thousands of lobated endospores. When mature, the sporangial wall ruptures and releases the endospores into the surrounding tissue where they enlarge to form new sporangia.

*Rhinosporidium seeberi* has not been cultured; thus, its exact taxonomic position has never been established. Its close resemblance to the sporangial development seen in the *Phycomycetes* suggests that it probably is a member of the class *Phycomycetes*. Other factors supporting this classification are the chitinous and cellulose components of the sporangial walls these constituents are also found in the cell walls of some of the lower *Phycomycetes*.

Laboratory identification of rhinosporidiosis is dependent on clinical observation and histologic examination of biopsied tissue. The sporangia can be seen in unstained preparations with the naked eye; they appear as large cavities in the surrounding tissue. Special staining techniques are not required; however, the periodic-acid-Schiff and Grobule stains are very effective.

There is a possibility that these sporangia may be mistaken for the spherules of *Coccidioides immitis* when examined microscopically. Differentiation of the two may be made on the basis of size, since the mature sporangia of *R. seeberi* attain considerably greater size

than the mature spherules of *C. immitis*. Also, the endospores of *R. seeberi* are lobulated and stain darkly while those of *C. immitis* are nonlobulated with only the endospore wall staining well.

#### Exercises (657):

1. *Rhinosporidium* \_\_\_\_\_ is the fungus responsible for rhinosporidiosis.
2. Briefly describe the disease rhinosporidiosis.
3. Small, white spots seen on the surface of the polyp are actually \_\_\_\_\_ produced by the organism.
4. Why has the exact taxonomic position of *Rhinosporidium seeberi* never been established?
5. Laboratory identification of rhinosporidiosis is dependent on what two factors?
6. How may the sporangia of *R. seeberi* be differentiated from those of *C. immitis*?

**658. Cite the specie of the three *Cladosporium* which is referred to as the one causing *Cladosporiosis*, the microscopic appearance in lesions and from teased mount growths, macroscopic appearance on Sabouraud dextrose agar, and characteristics which distinguish *Cladosporium bantianum* from *Cladosporium carrionii*.**

**Cladosporiosis.** Of the three *Cladosporium* species which cause human disease, only *Cladosporium bantianum* should be referred to as causing Cladosporiosis. *C. carrionii* is an agent of chromoblastomycosis while *C. werneckii* was covered in the chapter concerned with the monomorphic molds. The organism, *C. bantianum*, has been referred to in the past as *Cladosporium trichoides* and *Torula bantiana*.

The fungus causes a brain abscess in man, but its portal of entry remains a mystery. Purulent material from the lesion reveals brown, aseptate, branched hyphae one to two  $\mu\text{m}$  in diameter with many vesicular chlamydo spores that reach a diameter of eight  $\mu\text{m}$ . Macroscopically, on Sabouraud dextrose agar, growth is slow. Flat to some dome-shaped colonies reach a diameter of about three cm developed after 2 weeks.

The surface is velvety and may form radial folds. Front pigmentation is dark olive gray to black while the growth is jet black when viewed from the back.

Teased mounts of the growth microscopically show a brown, septate mycelium from which develop simple or septate conidiophores bearing long, sparsely branched chains of conidia. The conidia are elongate and brown, having dark disjunctors between them or on each end of the free spores. The conidia are budded from the most distal cells, causing these to be the smallest in the chain.

Laboratory identification of *C. bantianum* is based on morphologic and physiologic criteria. The morphologic features of this fungus are elaborated in the preceding paragraphs. *C. bantianum* is morphologically similar to *C. carrionii* but can be distinguished by its more rapid growth rate, the extreme length of its spore chains, the development of longer conidia, and its ability to grow at temperatures as high as 42 to 43° C. *C. bantianum* and *C. carrionii* can be distinguished from the saprophytic *Cladosporium* species on the basis of their slower growth rate and their inability to liquefy gela ..

#### Exercises (658):

1. Of the three *Cladosporium* species, which specie might be referred to as causing Cladosporiosis?
2. The fungus causes a \_\_\_\_\_ in man, but its portal of entry remains a mystery.
3. Purulent material from the lesion reveals \_\_\_\_\_, \_\_\_\_\_, \_\_\_\_\_ hyphae one to two  $\mu\text{m}$  in diameter with many \_\_\_\_\_ that reach a diameter of eight  $\mu\text{m}$ .
4. How does the organism appear on the surface of Sabouraud dextrose agar?
5. Teased mounts of the growth microscopically show a \_\_\_\_\_, mycelium from which develop simple or septate conidiophores bearing sparsely branched \_\_\_\_\_ of \_\_\_\_\_.
6. Laboratory identification of *Cladosporium bantianum* is based on what two criteria?
7. How may *Cladosporium bantianum* be differentiated from *Cladosporium carrionii*?



## Laboratory Diagnosis of Viral Rickettsial and Chlamydial Diseases

IT WOULD BE virtually impossible to adequately provide extensive detail on the diagnosis of viral, rickettsial, and chlamydial disease. Thus, we have included background information on the structure and life cycle of these agents and cited comparison with other infectious microbes.

Most Air Force clinical laboratories do not have the facilities and specially trained personnel required to perform lengthy virological procedures, especially virus isolation. Hence, we must continue to rely upon consultant centers or epidemiological laboratories that are appropriately equipped and staffed to handle viruses. The noticeable change in the clinical laboratory work pattern stems from the greater diversity and volume of specimens submitted for examination. Thus, we would like to stress the care that must be taken to preserve the viability of viruses in clinical materials so that isolation attempts will be successful. Accordingly, the main purpose of this chapter is to set forth general guidelines for the collection, preservation, packaging, and shipment of clinical specimens. The other material included in the chapter is designed to build an understanding of why these guidelines are important.

We present recent findings on the classification, nature, and mode of reproduction of viruses and related pathogens. You take a look at characteristics of the major groups and the diseases they cause. Then, we discuss collection, packaging, and transportation of specimens to virus reference laboratories. Ultimately, there is a short resume of the conventional procedures used by virus diagnostic centers to examine specimens submitted by clinical laboratories.

### 5-1. Introduction to Virology

The viruses make up a unique group of infectious agents that are distinguished from other microorganisms by certain inherent characteristics. Viruses were initially set apart by the fact that they could pass through bacteriological filters; thus the term "filterable virus." Although most viruses are smaller than other microorganisms, small size is only one distinguishing feature. It seems in order, therefore, to begin by reviewing the current criteria used for classification of viruses.

**659. State biological characteristics formerly used in the classification of viruses, the two genetic material of viruses, the classification of virus groups in terms of the type of nucleic acid present, the capsid symmetry, members of the group and principle diseases caused, and the shape of the cubic virus particles.**

**Classification.** Many systems have been employed for classification of viruses, but none of the systems has been accepted by all virologists. The early classification of viruses was based on biological characteristics, including host-range, type of tissue affected, host-response, and type of lesion produced. For example, one frequently finds viruses classified as animal viruses, insect viruses, plant viruses, bacteriophages, respiratory viruses, enteroviruses, viral exanthems, and neurotropic viruses. These biological classifications were dependent on mutational criteria which often proved unstable.

Viral classification has presented some unique problems to the taxonomist, since it has been difficult to establish the evolutionary and phylogenetic relationship among viruses.

The code of bacterial nomenclature is not applicable to viral nomenclature. The problem of classification has been referred to the Internal Committee of Nomenclature of Viruses of the International Association of Microbiological Societies. This committee has recommended family and genera names for most of the virus groups. Current classification of viruses is based on physiochemical criteria. Since viruses have either DNA or RNA as their genetic material, they can be divided into two main classes, designated deoxyriboviruses and riboviruses. Most animal viruses are basically symmetrical structures in which repeating units of protein known as capsomeres are packed around the viral nucleic acid molecule to form either an icosahedral (cubic) or a helical nucleocapsid. Helical nucleocapsids are inclosed within an envelope; however, icosahedral nucleocapsids are sometimes inclosed by an envelope. These envelopes contain cellular lipids and virus-specified proteins. Based on these criteria, many viruses have been classified into the groups shown in Table 5-1.

Cubic virus particles have a multifaceted diamond shaped capsid (protein coat) surrounding a nucleic acid core. Certain cubic viruses, such as the herpesviruses,

**TABLE 5-1**  
**CLASSIFICATION OF THE MORE IMPORTANT VIRUSES AFFECTING MAN**

Nucleic Acid	Group	Capsid Symmetry	Envelope	Approx. Size (nm)	Site of Replication	Ether Sensitive	Members of the group	Principal diseases caused	
RNA	PICORNAVIRUSES	CUBIC	-	20 - 30	Cytoplasm	-	Enteroviruses Polioviruses Coxsackieviruses Echoviruses Rhinoviruses	Poliomyelitis Aseptic meningitis Aseptic meningitis Common cold	
	REOVIRUSES		-	60 - 80	Cytoplasm	-	Reoviruses Rota viruses	Gastro-enteritis	
	TOGAVIRUSES		+	35 - 60	Cytoplasm	-	Alphaviruses Flaviviruses	Encephalitis Yellow fever, dengue Rubella (German measles)	
	ORTHOMYXOVIRUSES	HELICAL	+	80 - 120	Nucleus and Cytoplasm	+	Parainfluenza viruses  Respiratory syncytial virus	Influenza	
	PARAMYXOVIRUSES			100 - 300	Cytoplasm				Group, other respiratory infections Mumps Measles Bronchitis
	RIABDOVIRUSES			80 x 180 50 x 660	Cytoplasm				Rabies Marburg disease
	ARENNAVIRUSES	UNKNOWN	?	50 - 300	Cytoplasm	+		Lymphocytic Choromeningitis Lassa fever	
CORONAVIRUSES	+		80 - 300	Cytoplasm	+	Common cold			
DNA	PAPPOVIRUSES	CUBIC	-	40 - 55	Nucleus	-	Epstein-Barr virus	Warts	
	ADENOVIRUSES		-	70 - 90	Nucleus	-		Respiratory infections	
	HERPESVIRUSES		+	100 - 250	Nucleus	+		Herpes simplex Chicken pox, Shingles Cytomegalic inclusion disease Infectious mononucleosis	
	POX VIRUSES	COMPLEX	+	230 - 300	Nucleus	-		Smallpox	
	HEPATITIS VIRUSES	UNCLASSIFIED		25 - 48 42			A virus B virus	Hepatitis A Hepatitis B	

possess an envelope surrounding the nucleocapsid, thus forming the complete virus. Helical virus particles consist of a nucleocapsid wound in a helical or spiral which is surrounded by a lipoprotein envelope. We will later discuss some of the characteristic differences among the groups in relating to the nature and structure of viruses.

4. In most animal viruses, the symmetrical structures which form repeating units of protein packed around the viral nucleic acid molecule are called

5. What is the nucleic acid and capsid present in Picornaviruses?

**Exercises (659):**

1. What were some of the biological characteristics formerly used to classify viruses?

6. What two general groups of viruses are principal causes of common colds?

2. Current classification of viruses is based on what criteria?

7. The Epstein-Barr virus believed to be the cause of infectious mononucleosis is most likely included under what major group of viruses?

3. What are the two genetic material present in viruses?

8. Briefly describe the capsid shape of cubic virus particles.



9. Helical virus particles consist of a \_\_\_\_\_ wound in a \_\_\_\_\_ which is surrounded by a lipoprotein.

660. State why viruses and rickettsiae are called obligate parasites, cite the type of invertebrate animals in which rickettsial forms are primarily found, hosts of viruses, primary characteristics of chlamydiae, characteristics by which viruses are different from other related microbes, and differences between viruses and related organisms.

**The Nature of Viruses and Related Organisms.** The virus, rickettsial and chlamydiae are obligate parasites which invade the nucleus or cytoplasm of living cells. The parasite reproduces by redirecting the synthetic mechanisms of the host's cell. Diseases in the host is a consequence of this rearrangement or modification of cellular functions. Viruses and rickettsiae survive in nature outside of living cells, but they are inert in the external environment. From this circumstance we derive the term "obligate" parasite. That is to say, a living, susceptible host cell is an absolute requirement for multiplication of the parasite. We will distinguish between viruses, rickettsia, and related microbes in greater detail later in the chapter. At this point it is sufficient to recall that rickettsial forms are primarily parasites of the arthropods (ticks, mites, lice) whereas the viruses use plants, lower animals, humans, and arthropods as hosts. Even bacteria have their virus parasites--the bacteriophages. Chlamydiae are a large group of obligate intracellular parasites closely related to gram negative bacteria. In analyzing gross differences between viruses and other related microbes, several distinctive virus characteristics emerge which include the following:

- a. Nucleic acid type: RNA or DNA; single-stranded or double stranded; mode of reproduction
- b. Size and morphology
- c. Susceptibility to physical and chemical agents.
- d. Absence of enzymes
- e. Immunologic properties
- f. Natural methods of transmission
- g. Host, tissue, and cell tropisms

Viruses consist of an inner core of nucleic acid (either ribonucleic or deoxyribonucleic acid, but never both) and an outer coat of protein. Certain viruses, in addition, display a membrane, or envelope, surrounding the protein coat. But compared to the structurally and physiologically complex bacteria and other single-celled organisms, the viruses have a relatively simple chemical composition.

Most viruses are so small that they cannot be seen with an ordinary light microscope, and some are so small that they approximate the size of the large protein molecules. Viruses seem to occupy a partially explored

twilight zone between the bacterial cells on the one hand and the molecules with which the chemist deals on the other. This could be considered to be smaller than the smallest known bacterial cells and just larger than the macromolecules. For example, it would take 2,500 poliovirus particles to span the point of a pin. Viruses are distinctive and vary considerably in size as noted in table 5-2. Table 5-3 highlights some of the differences between viruses and other microbes.

Unlike the chemically more complex rickettsiae and Chlamydial (psittacosis-lymphogranuloma venereum group), the viruses have no enzymes. They depend upon the host cell to manufacture all of the ingredients needed for energy metabolism, replication of nuclear elements, and production of the protein coat. We have already noted that viruses are inert outside the boundaries of a living cell and that they must infect a susceptible host cell in order for the aforementioned process to take place.

In contrast to the viruses, the rickettsiae and Chlamydiae organisms represented in table 5-3 are large enough to be faintly visible in the ordinary light microscope as pleomorphic, coccobacillary forms. Considered to lie phylogenetically at some intermediate level between viruses and bacteria, they nevertheless require an intracellular environment for growth. Both RNA and DNA components are present, as are enzyme systems essential in energy-yielding reactions. As in the case of the true bacteria, these species reproduce by binary fission.

The intracellular phase of the rickettsial and chlamydial organisms is quite complex. Therefore, our description in the following pages of replication within the host cell will be limited only to typical viruses whose life cycle has been more clearly defined. First, however, we must study the structure of viruses as a basis for understanding how they produce.

#### Exercises (660):

- 1 Explain why viruses and rickettsiae are called "obligate parasites."
2. Rickettsial forms are primarily parasites of the \_\_\_\_\_, such as \_\_\_\_\_, \_\_\_\_\_ and \_\_\_\_\_.
3. What are some hosts used by viruses?
4. What type of parasites are the chlamydiae?

TABLE 5-2  
COMPARATIVE SIZE OF REPRESENTATIVE MICROORGANISMS

Microorganism/Biologic Unit	Approximate diameter (or diameter X length) in nm (m $\mu$ ) 1 nm (m $\mu$ ) = 1/1000 $\mu$ m ( $\mu$ ) = 1/1,000,000 mm.
Red blood cell	7500
Bacterium ( <i>E. coli</i> )	500 x 2000
Poxvirus	230 x 300
Rhabdovirus	60 x 225
Coronavirus	80 - 160
Paramyxovirus	100 - 300
Myxovirus	80 - 120
Herpesvirus	110 - 200
Bacterial virus	25 - 100
Adenovirus	70 - 80
Leukovirus	100
Reovirus	70 - 75
Rubellavirus	50 - 60
Papovavirus	40 - 55
Arbovirus (togavirus)	40
Picornavirus	18 - 30
Certain plant viruses	17 - 30
Serum albumin molecule	5

TABLE 5-3  
COMPARISON OF VIRUSES WITH OTHER INFECTIOUS MICROORGANISMS

Agent	Presence of nucleic acids	Obligate intracellular parasite	Reproduction	Possession of metabolic enzymes	Rigid cell wall	Sensitivity to Antibiotics	Growth on Non-living Media
Viruses	Either DNA or RNA (not both)	+	Replication (synthesis, then assembly of sub-units)	-	-	-	-
Chlamydiae (bedsoniae)	DNA and RNA	+	Binary fission	+ Parts of enzyme systems present	May be present	+	-
Rickettsias	DNA and RNA	+	Binary fission	+	+	+	-
Mycoplasmas	DNA and RNA	-	Binary fission	+	-	+	+
Other bacteria*	DNA and RNA	-	Binary fission	+	+	+	+

\* Note that chlamydiae, rickettsias, and mycoplasmas are now classed as bacteria.

5. What are some characteristics by which viruses differ from other related microbes?

**661. Cite the basic design found in all viruses; the two stages in their life cycle, the three basic forms in virus structure in terms of their symmetry and examples, and probable functions of the viral capsid.**

6. Viruses seem to occupy a partially explored twilight zone between the \_\_\_\_\_ cell on the one hand and the \_\_\_\_\_ with which the chemist deals.

**Virus Structure.** Viruses can be said to have two stages in their life cycle: the intracellular phase of reproduction and the extracellular stage in which the virus exists inertly in the external environment. It is difficult to follow the morphological changes in a virus after the host cell has been penetrated, even with the most powerful electron microscope. Hence, most of our knowledge of structure is based on studies of the extracellular *virion*, the mature, infectious unit often referred to as the "elementary body," or simply as the "virus particle."

7. When comparing the Poxvirus with the Herpesvirus, which is larger in terms of diameter and length?

Like the bacteria we have studied, viruses differ somewhat in form, depending upon conditions of growth. But there is one basic design for all viruses—a protein shell or coat and its inclosed core of nucleic acid. The simplest forms of the virion structure are shown in figure 5 1.

8. When compared with more complex rickettsial and chlamydiae, what enzymes does the virus have?

There are three basic forms in viral structure: the *icosahedral* (cubic), *helical*, and *complex-enveloped*. Whether the form is icosahedral or helical is dictated by the arrangement of the protein molecules that make up the capsid. So all viruses are said to have only one kind of symmetry, either icosahedral, helical, or the complexed enveloped form.

9. When considering sensitivity to antibiotics, which group of infectious organisms is not sensitive?

The icosahedral capsid is usually shown under electron microscopy to be a spherical single layer of protein composed of smaller morphological units, the *capsomeres*. The capsomeres, in turn, consist of groups or "bundles" of structural units. There is evidence that these structural units, which are chemical molecules too

10. Which group of infectious agents reproduce by replication rather than binary fission?

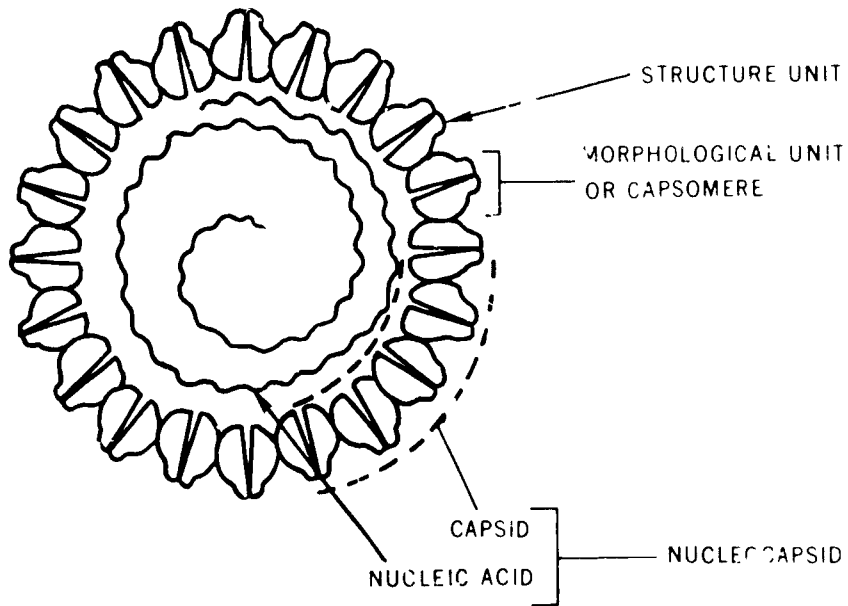

**A. NAKED ICOSAHEDRAL**

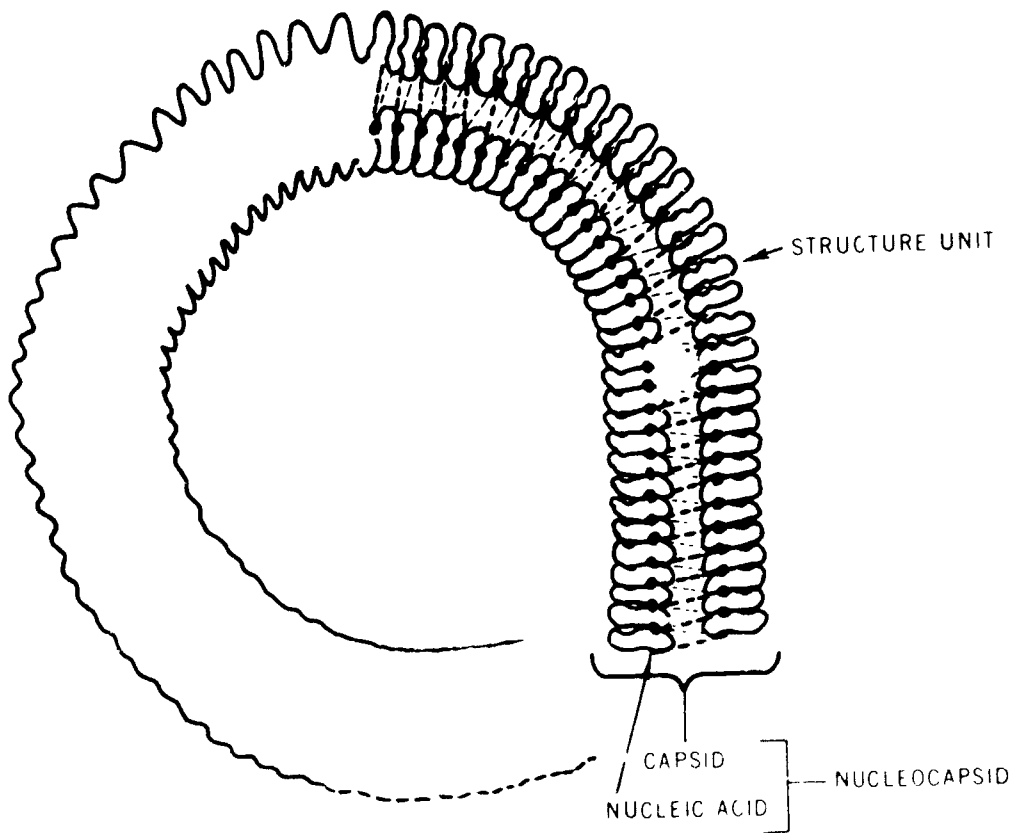

**B. NAKED HELICAL**

Figure 5-1 Icosahedral (cubic) and helical  
 verion structure

small to be seen, may comprise a single polypeptide chain or an aggregate of them. Helical capsids generally do not show capsomeres, as we note in figure 5-1. Their invisible structural units are not arranged into groups corresponding to the capsomeres of the cubic capsids.

The icosahedron, a crystal, is a solid, many-sided geometric form with 20 triangular faces and 12 apexes. In many viruses showing cubic symmetry, the capsid is an icosahedron (20-sided figure) inside which the nucleic acid is coiled, as we have demonstrated. The term "helical" indicates that protein molecules of the capsid are arranged in spiral form, with the inclosed nucleic acid core also stabilized in a spiral configuration. Viruses with helical symmetry are usually rod-shaped.

The virions we have just described represent the simplest forms of virus structure. Certain groups of viruses regularly display an "envelope" of lipoprotein surrounding the capsid. This group consists of the complex-envelope form. The complex-enveloped form is inclosed by a loose covering envelope, and because the envelope is nonrigid, the virus is highly variable in size and shape. Examples are the poxviruses and some of the bacteriophages. The poxviruses, the most complex of the animal viruses, do not have a discernible nucleocapsid structure.

The envelope of lipoprotein is believed to be built around the capsid as a mature virus particle passes through the host's cell membrane on its way to the outside environment. There are indications that some of the larger human viruses possess other well-differentiated anatomical structures, but these structures have not been fully characterized as to composition of function.

We can ascribe certain functions to the viral capsid and its inner core, but the role of the lipoprotein envelope, in those viruses that possess it, is still not clear. The capsid stabilizes the nucleic acid, presumably keeping this nuclear substance inert in the virion until a host cell is invaded. The capsid protects the core from destruction outside the host cell and probably also assists in the attachment of the virion to the host's cell at the time of invasion. The viral protein is antigenic. For example, it stimulates the formation of immune substances (antibodies) in the host, and accounts for the immunological specificity of the virus types within the major taxonomic groups. The nucleic acid core carries the genetic coding information for virus replication; thus, the core corresponds to the genes in higher forms of life. We can look upon the mature virus particle (virion) as a vehicle for transporting infective nucleic acid, the virus core, between cells. Nucleic acids are long-chain polymers (multiples) of nucleotides. A nucleotide consists of either a purine or pyrimidine base linked to a 5-carbon sugar (a pentose) which, in turn, is linked to a molecule of phosphoric acid.

#### Exercises (661):

1. What is the basic design in all viruses?

2. What are the two stages in the life cycle of viruses?

3. What is the extracellular virion?

4. What are the three basic forms in viral structure?

5. What condition dictates whether the virus form is icosahedral or helical?

6. Briefly describe the complex-enveloped form.

7. What are some examples of the complex-enveloped form?

8. Briefly describe the icosahedral virion structures.

9. Viruses with helical symmetry are usually \_\_\_\_\_ shaped.

10. What is the function of the viral capsid?

11. What is the function of the viral protein?

**662. Cite the part of the virion that serves as a template in directing the host cell to manufacture virus protein, and the three forms shown by a host cell in response to a virus infection.**

**Life Cycle.** The life cycle of a typical virus can be broadly separated into the following phases:

- (1) Virus enters a cell.
- (2) Host cell synthesizes new virus components.
- (3) Components are assembled into virus particles.
- (4) Mature virus is released by the cell.

The virion attaches to and penetrates the cell (or is phagocytosed in some cases). At this point, the nucleic acid core separates from the protective capsid. The viral

nucleic acid, acting as a template, or model, for its own multiplication, controls the synthesis by the host cell of new virus protein—both for necessary enzymes and for structural elements. Protein components and newly manufactured nucleic acid are then assembled into complete, infectious virus particles by the host cell according to the genetic code contained in the invading nucleic acid core. Mature virions are usually released by the host cell to complete the life cycle, but there are exceptions which will become apparent shortly.

The response of a host cell to virus infection can take three forms:

- (1) Degeneration of the cell.
- (2) Tumor formation.
- (3) Steady state infection.

Degeneration can occur in either structure or function, ranging from complete lysis of the cell to less pronounced cytopathic effects apparent only by measuring changes in physiological reactions. For example, in some cells, small, round, or oval bodies known as inclusion bodies will be formed as a manifestation of the cytopathic effect. In either event, the effect is "cytotoxic," i.e., it causes death of the cell. Transformation of a normal cell to the neoplastic state occurs in certain virus infections of the Papovavirus group. Papillomas of cattle and other animals, as well as human warts, illustrate this tumor-forming effect. In steady state infections, the host's cellular processes continue without serious disruption. The cells multiply and produce additional viruses through successive generations. It has been surmised that the viral nucleic acid may be able to synchronize its replication with the host cell's cycle of division and continue the steady state existence indefinitely. Evidence from research on bacteriophages suggests that the viral element may shift at any time from cytopathic to steady state and vice versa. The terms "latent infection" and "carrier state" have sometimes been applied to persistent steady state infections.

#### Exercises (662):

1. Briefly state four phases of the life cycle of a typical virus.
2. When the virion attaches to and penetrates the cell, what subsequent action takes place?
3. What part of the virion serves as a template in directing the host cell to manufacture virus protein?
4. What are the three forms that can be taken by the host cell in response to a virus infection?

5. What is an example of a cytopathic effect when cell degeneration occurs?
6. What are some examples of conditions which indicate the transformation of a normal cell to the neo-plastic state?

## 5.2. The Major Groups of Pathogens

Let us briefly discuss some of the prominent features of each of the given major virus groups and note certain of the pathological states that these viruses bring about. The rickettsiae and related forms will be treated similarly.

### 663. Identify the ten groups of RNA viruses in terms of their characteristics, examples of the type of viruses in the groups, and diseases caused.

**The RNA Viruses.** There are ten groups of viruses that contain ribonucleic acid (RNA), but not deoxyribonucleic acid in their nucleic acid core. Eight of these groups of RNA viruses are listed in table 5-1. They are Picornaviruses, Reoviruses, Togaviruses (arboviruses), Myxoviruses (Ortho- and Para-), Rhabdoviruses, Arenaviruses, and the Coronaviruses. Note that group distinctions can be made in most instances on the basis of inactivation by ether, site of replication, approximate size, symmetry of the capsid, and presence or absence of an envelope.

**Picornaviruses.** The name "Picornaviruses" implies extremely small size (pica-very small) and the presence of RNA. For the most part, these viruses range in size from 20 to 30 nm in diameter, their resistance to inactivation by ether indicates the absence of a lipoprotein envelope; and they are protected from heat deactivation by positively charged ions (cations). They include two groups that are of considerable importance in medicine—the enteroviruses and the rhinoviruses.

The Enteroviruses inhabit the human alimentary tract and give rise to infections ranging from nonspecific febrile illnesses to meningitis and paralytic disease, as indicated in table 5-1. They can be recovered from throat washings and stool specimens, occasionally from blood, and rarely from urine and spinal fluid. The Rhinoviruses are found in nose and throat secretions, where they are reportedly associated with one fourth to one-third of all acute upper respiratory infections in adults. These are the viruses most often responsible for the common cold.

**Reoviruses.** The term "reo" relates the association of these viruses with illnesses of both the respiratory and enteric tracts. They are often in association with mild



inflammatory diseases, but have never been shown to be responsible for these conditions. Similar viruses which have been called orbiviruses or duoviruses, but are now generally known as *rotaviruses*, have been found by electron microscopy in the feces of many infants suffering from gastro-enteritis, in many different countries. These viruses are believed to be responsible for the gastro-enteritis.

*Togaviruses (arboviruses)*. The togaviruses differ from the previous two major groups in having lipid-containing envelopes. There are more than 300 of them, mostly transmitted by arthropods such as mosquitoes, ticks, and sandflies (arthropod-borne viruses). Togaviruses diseases are most common where animal hosts and insect vectors are plentiful, for example in tropical forests. A few of the more common togavirus diseases are eastern equine encephalitis (EEE), western equine encephalitis (WEE), Venezuelan equine encephalitis (VEE), St. Louis encephalitis (SLE), and Japanese B encephalitis (JE). Yellow fever and dengue are also included in this group of viruses. On the basis of physicochemical similarities, rubella virus, the causative agent of German measles, is also classified with the togaviruses, even though it is not carried by an arthropod. *Myxoviruses*. The fourth major category of RNA viruses is the Myxoviruses, whose name denotes affinity for mucous membrane cells. These organisms fall into two subgroups as seen in table 5-1. These two groups of enveloped RNA viruses with helical symmetry derive the shared part of their names from their affinity for mucus. By means of spikes projecting from their envelopes they are able to attach themselves to mucoprotein receptors on the surfaces of host cells. *Orthomyxoviruses* are the influenza viruses. This genus has now been renamed *Influenzavirus*. These viruses include the influenza viruses A, B, and C, the virus of swine influenza, and that of fowl plague.

*Paramyxoviruses* appear to be antigenically stable, and certain ones hemagglutinate red blood cells as to myxoviruses with or without hemolysis. Paramyxoviruses of humans include parainfluenza, measles, and mumps viruses. Paramyxoviruses of animals include those of monkeys and the viruses of Newcastle disease, distemper, and rinder-pest (cattle plague).

*Rhabdoviruses*. The rhabdovirus is the causative agent of rabies. It is a helical enveloped RNA which differs from myxoviruses in that its virions are typically bullet-shaped or rod-shaped; or filamentous. Intracytoplasmic inclusions (the Negri bodies) are seen with rabies viruses. The two best studied members of this group are rabies virus and vesicular stomatitis virus (a pathogen of cattle).

*Arenaviruses*. The arenaviruses are medium-sized enveloped RNA viruses characterized by granularity of appearance in electron micrographs. The best studied arenavirus is lymphocytic choriomengitis virus which characteristically produces an asymptomatic infection in mice and occasionally causes meningitis in humans. This group of viruses produce much more serious diseases such as the hemorrhagic fevers seen in South America.

*Coronaviruses* Coronaviruses are so named because of the petallike projections surrounding the envelope. Many distinct types within this group attack the human respiratory tract, usually producing illness indistinguishable from common colds produced by rhinoviruses.

#### Exercises (663)

- Match each column B item with the statements in Column A by placing the letter of the Column B item beside the number of the Column A item that most nearly describes it. Each element in Column B may be used once or more than once.

Column A	Column B
— (1) For the most part these viruses range in size from 20 to 30 nm, and their resistance to inactivation by ether indicates the absence of a lipoprotein envelope.	a. Reoviruses. b. Paramyxoviruses. c. Togaviruses d. Rhabdoviruses. e. Picornaviruses
— (2) These viruses inhabit the human alimentary tract and give rise to infections ranging from nonspecific febrile illness to meningitis and paralytic diseases	f. Enteroviruses. g. Coronaviruses. h. Arenaviruses i. Orthomyxoviruses.
— (3) The viruses are found in nose and throat secretions. These are the viruses most often responsible for the common cold.	j. Rhinoviruses k. Rotaviruses
— (4) These viruses are often in association with mild inflammatory diseases, but have never been shown to be responsible for these conditions.	
— (5) Have been found by electron microscopy in the feces of many infants suffering from gastro-enteritis in many different countries	
— (6) There are more than 300 of these viruses, mostly transmitted by arthropods such as mosquitoes, ticks, and sand flies	
— (7) Principal diseases caused are encephalitis, yellow fever, dengue, and rubella.	
— (8) Are the influenza viruses	
— (9) Those types of this virus in humans include parainfluenza, measles, and mumps	
— (10) Those types of this virus of animals include those of monkeys and the viruses of New Castle disease, distemper, and cattle plague	
— (11) This type is the causative agent of rabies.	
— (12) The best studied of these viruses is lymphocytic choriomengitis virus, which characteristically produces an asymptomatic infection in mice and occasionally in humans.	
— (13) This group of viruses produces serious diseases, such as the hemorrhagic fevers seen in South America	
— (14) Many distinct types within this group attack the human respiratory tract, usually producing illness indistinguishable from common colds produced by rhinoviruses.	

654. Identify the four groups of DNA viruses in terms of their characteristics, examples of the type of viruses

**The DNA Viruses.** The DNA viruses whose nucleic acids are made up of DNA can be subdivided into the four major groups shown in the lower half of table 5-1. The first of these is the Papovaviruses, then the Adenoviruses, the Herpesviruses, and the Poxviruses.

**Papovaviruses.** The first of these DNA viruses, the Papovavirus group, gains its name from a coupling of the first two letters of three viral entities: Papilloma virus of man and rabbits, Polyoma virus of mice, and vacuolating agent of monkeys. Viruses of this group are of great research interest because of their tendency to cause tumors in a wide variety of animals. Fortunately, only the papilloma virus that induces warts is known in humans.

**Adenoviruses.** Adenoviruses are also icosahedral DNA viruses without envelopes. There are at least 33 human adenoviruses; some cause acute respiratory diseases and other cause pharyngitis. However, three disease conditions are caused by the Adenoviruses: an acute respiratory infection, associated mainly with military recruits (virus types 4 and 7); a pharyngitis, caused by type 3; and conjunctival infections, caused by types 3 and 8. These viruses can be isolated from pharyngeal or ocular secretions and from stool specimens.

**Herpesviruses.** The Herpesviruses are the third major group of DNA viruses, described in table 5-1. Ether sensitivity in this case is unique among the DNA viruses. Most of us are familiar with herpes simplex, the lesions commonly referred to as fever blister or cold sores. Some others of the group are much more dangerous to human health. For instance, *Herpesvirus simiae* (B virus of monkeys) is said to be fatal in a high proportion of the cases in which the infection is transmitted to man by monkey bite. *Herpes simplex (herpes hominis)* Virus types 1 and 2 varicella-zoster virus, EB virus, and cytomegalovirus infect humans.

**Herpesvirus hominis** infection can be manifested not only in the frequently encountered fever blister vesicle, but in disseminated disease of major body organs, including the eye, liver, brain, and lungs in certain susceptible persons. Varicella (chicken pox) is a mild, highly infectious disease, chiefly of children. Zoster (shingles) is a sporadic, incapacitating disease of adults (rare in children). Both diseases are caused by the same virus. EB (Epstein-Barr) virus is the causative agent of infectious mononucleosis and has been associated with Burkitt's lymphoma and nasopharyngeal carcinoma. Cytomegalic inclusion disease is a generalized infection of infants caused by intrauterine or early postnatal infection with the cytomegaloviruses.

**Poxvirus.** The Poxvirus group of DNA viruses contains the largest and structurally most complex of all the virions. Members of this group DNA viruses cause skin lesions in various bird and animal species. The viruses of greatest interest to us are those of smallpox, cowpox, and vaccinia. *Contagious pustular dermatitis* ("orf"); is a poxvirus infection occasionally transmitted to man from sheep or goats. The smallpox virus

(variola) is perhaps the one most familiar to use from the standpoint of its historical role as a killer of millions of people before the principle of vaccination was discovered.

The Poxviruses infect a number of lower animals as well as man. The word "pox" is derived from the typical lesions which these agents produce on the skin and mucous membranes. In this regard, the viruses can be isolated from vesicles and pustules, or from mucous secretion and saliva. In the last decade, however, an intensive World Health Organization eradication program has almost eliminated the disease except in Ethiopia and Somalia.

Most of our knowledge about the Poxviruses comes from studies on the vaccinia virus. This is a laboratory strain obtained originally from a cowpox infection and cultured for many years in laboratory animals to provide vaccine for smallpox immunization. Because of immunologic similarities among the Poxviruses, inoculation with the "vaccinia" strain confers protection against the smallpox virus.

The vaccinia virus is morphologically more elaborate than the simple viruses that have only an undifferentiated nucleic acid core protected by a protein capsid. Electron micrographs of thin sections of the virion suggest the presence within the core of a rectangular, biconcave disc containing triple strands of DNA. Two electron-dense masses lie adjacent to the disc. The concave disc as well as the double-layered virus membrane has well-defined ridges and spiculate projections whose function is still unknown.

#### Exercises (664):

- Match each column B item with the statements in column A by placing the letter of the column B item beside the number of the column A item that most nearly describes it. Each element in column B may be used once or more than once.

#### Column A

#### Column B

- |   |                         |
|---|-------------------------|
| (1) Viruses of this group are of great research interest because of their tendency to cause tumors in a wide variety of animals                                     | a Adenoviruses.         |
| (2) Is mainly the cause of three disease conditions: an acute respiratory infection, associated with military recruits, a pharyngitis; and conjunctival infections. | b Herpesviruses.        |
| (3) The lesions commonly referred to as fever blisters or cold sores  | c Poxvirus.             |
| (4) Is the causative agent of infectious mononucleosis and has been associated with Burkitt's lymphoma and nasopharyngeal carcinoma.                                | d Papovaviruses         |
| (5) The third major group of DNA viruses among which ether sensitivity is unique  | e <i>Herpes simplex</i> |
| (6) Contains the largest and structurally most complex of all the virions   | f E. B. (Epstein-Barr)  |
| (7) Intensive World Health Organization eradication program has almost eliminated this virus except in Ethiopia and Somalia   | g Smallpox.             |
| (8) Most of our knowledge about the Poxviruses comes from studies on this virus.  | h Vaccinia virus        |

665. Cite one initial contrasting feature between the rickettsiae and viruses, the nature of the rickettsiae and their characteristics, rickettsial diseases, as to the causative agents and common vectors and the specimens from which the agents can be isolated.

**The Rickettsiae.** The *Rickettsia* are a unique group of bacteria in that they are, with one exception, obligated intracellular parasites. In contrast to the viruses, they are metabolically active, yet they cannot reproduce independently of the host cell. Five distinct disease groups are recognized, as shown in table 5-4. Except for Q-fever organisms, the rickettsiae are transmitted by arthropods and produce infections in humans characterized by fever and rash.

The basis for the distinction lies in (1) the clinical features of the infections produced, (2) epidemiological considerations (the rickettsiae are transmitted by arthropods) and (3) immunological properties such as the possession of a common group antigen.

Formerly, the rickettsiae were considered closely related to the viruses because they are smaller than bacteria and because their growth, like that of viruses, occurs within the cells. It is now clear that the rickettsiae

are small, obligately parasitic, true bacteria showing in thin sections all of the structural features of bacteria as well as possessing most of the enzymes of bacteria and a typical bacterial cell wall. Rickettsiae range from 0.3 to 1.5  $\mu\text{m}$  in length and from 0.25 to 0.5  $\mu\text{m}$  in breadth. They are pleomorphic, forming cocci, bacilli, and filaments.

Table 5-5 lists some of the better-known rickettsial diseases, the causative agents, and their natural vectors.

The epidemic form of typhus is carried from man to man by the body louse, as is trench fever, a disease prominent in the World War of 1914-1918. The recurring form of typhus, Brill's disease, sometimes occurs several years after infection with *R. prowazekii* and does not involve a second contact with the vector. Flea-borne typhus is a natural disease of rats and mice. *R. typhi* infects man by way of the rat flea. The agents of the typhus fevers are recoverable from the blood of a patient and sometimes from bone marrow specimens.

The tick-borne rickettsioses include Rocky Mountain spotted fever, first recognized in the U.S., and several diseases more or less restricted to the Eastern Hemisphere. For example, boutonneuse fever is found in Africa and parts of India and Europe. Russia and Mongolia play host to North Asian tick-borne typhus,

TABLE 5-4  
CLASSIFICATION OF RICKETTSIAE ACCORDING TO DISEASE

I.	Typhus Group
A.	Epidemic typhus, louse-borne — <i>R. prowazekii</i> .
B.	Endemic typhus, murine flea-borne — <i>R. typhi</i> (formerly <i>R. mooseri</i> ).
II.	Spotted Fever Group:
A.	Rocky Mountain Spotted fever (RMSF) — <i>R. rickettsii</i> .
B.	Mediterranean fever (boutonneuse fever), South African tick bite fever, Kenya tick typhus, Indian tick typhus — <i>R. conorii</i> .
C.	North Asian tickborne rickettsiosis — <i>R. sibirica</i> .
D.	Queensland tick typhus — <i>R. Australis</i> .
E.	Rickettsialpox, Russian vesicular rickettsiosis — <i>R. akari</i> .
F.	<i>R. canada</i> — Transmitted by ticks in North America; causes a disease resembling Rocky Mount Spotted fever.
III.	Scrub Typhus (Tsutsugamushi Fever): <i>R. tsutsugamushi</i> . (formerly <i>R. orientalis</i> .)
IV.	Q Fever: <i>Coxiella burnettii</i> .
V.	Trench Fever: <i>R. (Rochalimaea) quintana</i> .

TABLE 5-5  
 REPRESENTATIVE RICKETTSIAE INFECTIONS AND Q FEVER

Diseases	Causative Ager.	Reservoir	Vectors	Weil-Felix Reaction		
				OX 19	OX <sub>2</sub>	OXK
Epidemic typhus	<i>R. prowazekii</i>	Men	Lice	+ + +	(+)	-
Brill's disease	<i>R. prowazekii</i>	—	—	Usually - - -		
Endemic typhus	<i>R. typhi</i>	Rats	Fleas, lice	+ + +	+	-
Spotted fever	<i>R. rickettsii</i> <i>? . conorii</i>	Men, horses, dogs, rodents	Ticks	+ +	+ +	-
Scrub typhus	<i>R. tutsugamushi</i>	Rodents	Mites	-	-	+ + +
Rickettsialpox	<i>R. akari</i>	Mice	Mites	-	-	-
Trench fever	<i>R. quintana</i>	Men	Lice	-	-	-
Q fever	<i>Cl. burnettii</i>	Various animals and birds	Ticks, droplets, dust, milk	-	-	-

while Queensland tick typhus occurs in Australia. Rickettsial pox of the U.S. and Russia and Scrub typhus of the Asian countries are transmitted to man by mites parasitic on certain lower animals. Q-fever, originally isolated in Australia, is unique among the rickettsial diseases in that it is transmitted in nature by ticks, lice, mites, and parasitic flies. The infection occurs in a wide variety of domestic animals and birds. Man ordinarily contracts the illness through contact with meat and dairy animals or their excreta. The agent can be isolated from blood, sputum, urine, and in some cases, spinal fluid.

#### Exercises (665):

1. Even though the rickettsiae and viruses both cannot reproduce independently of the host cell, what contrasting feature readily distinguishes the rickettsiae from the viruses?
2. The rickettsiae are transmitted by arthropods except for what other type of rickettsial organisms?
3. Formerly, the rickettsiae were closely related to the \_\_\_\_\_ because they are \_\_\_\_\_ than \_\_\_\_\_ and because their growth, like that of viruses, occurs within the \_\_\_\_\_.
4. What type of micro-organism is the rickettsiae considered to be? Why?
5. What morphological forms are shown by the rickettsiae?
6. What is the causative agent of epidemic typhus, and what arthropod is the vector?
7. What two given organisms are the causative agents of spotted fever?
8. What organisms are considered to be reservoirs of spotted fever?

9. What organisms have been considered to be reservoirs of Q-fever?

10. The Q-fever agent can be isolated from which specimens?

**666. State the general biological characteristics of the order *Chlamydiales*, distinct biological characteristics when compared with rickettsiae, characteristics of the Psittacosis Group, the Lymphogranuloma Venereum groups, and the TRIC Group; and causative organisms of the disease.**

**Chlamydiae (Bedsoniae).** The chlamydiae, like the rickettsiae, comprise a group of obligately intracellular procaryotic parasites which were formerly referred to as large viruses or as the Psittacosis-Lymphogranuloma venereum-Trachoma group of agents. We now know that the chlamydiae are not viruses but are, with similar characteristics, distantly related to the gram-negative bacteria.

In Bergey's Order II of Part 18, *Chlamydiales* are placed with the gram-negative, intracellular pathogens of vertebrates with an intracellular pattern for reproduction where the host cell furnishes energy-rich substances. Chlamydiae share a common antigenic component not found in rickettsiae.

They are not arthropod-borne; they also differ from rickettsiae in being spherical with no bacillary or filamentous forms, and in having an unusual type of intracellular developmental cycle. The infective forms are about 0.25  $\mu\text{m}$  in diameter, but on entering the host cell they develop into larger bodies up to 2  $\mu\text{m}$  in diameter. They multiply by binary fission and are susceptible to certain antimicrobial drugs. Clusters of chlamydiae form basophilic intracellular inclusions bodies, whereas those formed by viruses are acidophilic. Both RNA and DNA are present in the nuclear element.

**The Psittacosis Group.** Psittacosis is a disease of birds that may be transmitted to humans. In humans the agent is *Chlamydia psittaci* and can infect man and other animals, but outbreaks of the disease are usually associated with birds. The psittacine birds (parrots, parakeets) provide a reservoir in nature. Pigeons, ducks, chickens, and turkeys fall victim to the infection and man contracts the disease via the respiratory route in dressing poultry, or by inhaling the agent in dust contaminated with droppings. The systemic illness is usually expressed as a pneumonialike syndrome. A pneumonitis also occurs in cattle and sheep after exposure to the psittacosis agent.

**Lymphogranuloma Venereum (LGV).** Lymphogranuloma venereum (also known as lymphogranuloma inguinale and venereal bubo) is a disease manifested by lesions of the genital organs. The agent is transmitted through sexual contact and can be



isolated from pus or fluids taken from the surface lesion or bubo (swollen, infected lymph gland).

*Trachoma and Inclusion Conjunctivitis (The TRIC Group).* *Chlamydia trachomatis* is the specific name for the causative organisms of trachoma, inclusion conjunctivitis, and lymphogranuloma venereum. There are different strains of *C. trachomatis*. Trachoma, as a clinical disease, has been known for 3,000 years. It is a form of conjunctivitis in which formation of fibrous tissue in the conjunctiva and cornea commonly leads both to lid deformities and to blindness. It is considered to be the world's most common cause of blindness. It is mainly transmitted by direct and close contact, for example, mother to baby, or by flies.

Inclusion conjunctivitis is a similar but milder condition of worldwide distribution. The causative agent has its primary habitat in the human genital tract. It is frequently associated with the common venereally transmitted condition known as non-gonococcal urethritis, (N.G.U.) or non-specific urethritis (N.S.U.)

#### Exercises (666):

1. The chlamydiae comprise a group of \_\_\_\_\_, intracellular procaryotic parasites which were formerly referred to as large \_\_\_\_\_.
2. In Bergey's Order II of Part 18, *Chlamydiales* are placed as gram-\_\_\_\_\_, \_\_\_\_\_ pathogens of vertebrates with an intracellular pattern for reproduction where the \_\_\_\_\_ cell furnishes energy-rich substances.
3. Chlamydiae share a common antigenic component not found in \_\_\_\_\_.
4. Chlamydiae are not arthropod-borne, and they differ from rickettsiae in being \_\_\_\_\_, with no bacillary or filamentous forms.
5. Clusters of chlamydiae form \_\_\_\_\_ intracellular inclusion bodies, whereas those formed by viruses are \_\_\_\_\_.
6. Psittacosis is a disease of \_\_\_\_\_ that may be transmitted to humans.
7. How does man contract the disease?

8. The systemic illness of psittacosis is usually expressed as a \_\_\_\_\_ syndrome.
9. Lymphogranuloma venereum is a disease manifested by lesions of which body organs?
10. How is the agent of LGV transmitted?
11. From what source(s) is the agent of LGV isolated?
12. What is the specific name given to the causative organisms of trachoma, inclusion conjunctivitis, and lymphogranuloma venereum.

13. Inclusion conjunctivitis has its primary habitat in what part of the human body?
14. Inclusion conjunctivitis is frequently associated with what other common venereally transmitted condition?

#### 5-3. Methods in Collection, Preservation, and Shipment of Viral Specimens

We have learned what viruses are and how their parasitic existence affects the hosts which they depend upon for all their life processes. We will now consider basic procedures necessary to ultimately pinpoint the virus so that infection within the host can be controlled and the spread of the virus to other susceptible hosts curtailed.

667. Cite some general considerations observed in the collection of specimens for viral isolation, minimum data to be supplied with specimen submitted, and the reason for submitting paired serum samples.

**Considerations in Collection of Specimen.** Proper collection of specimens is highly important to the success of any subsequent laboratory examination. The



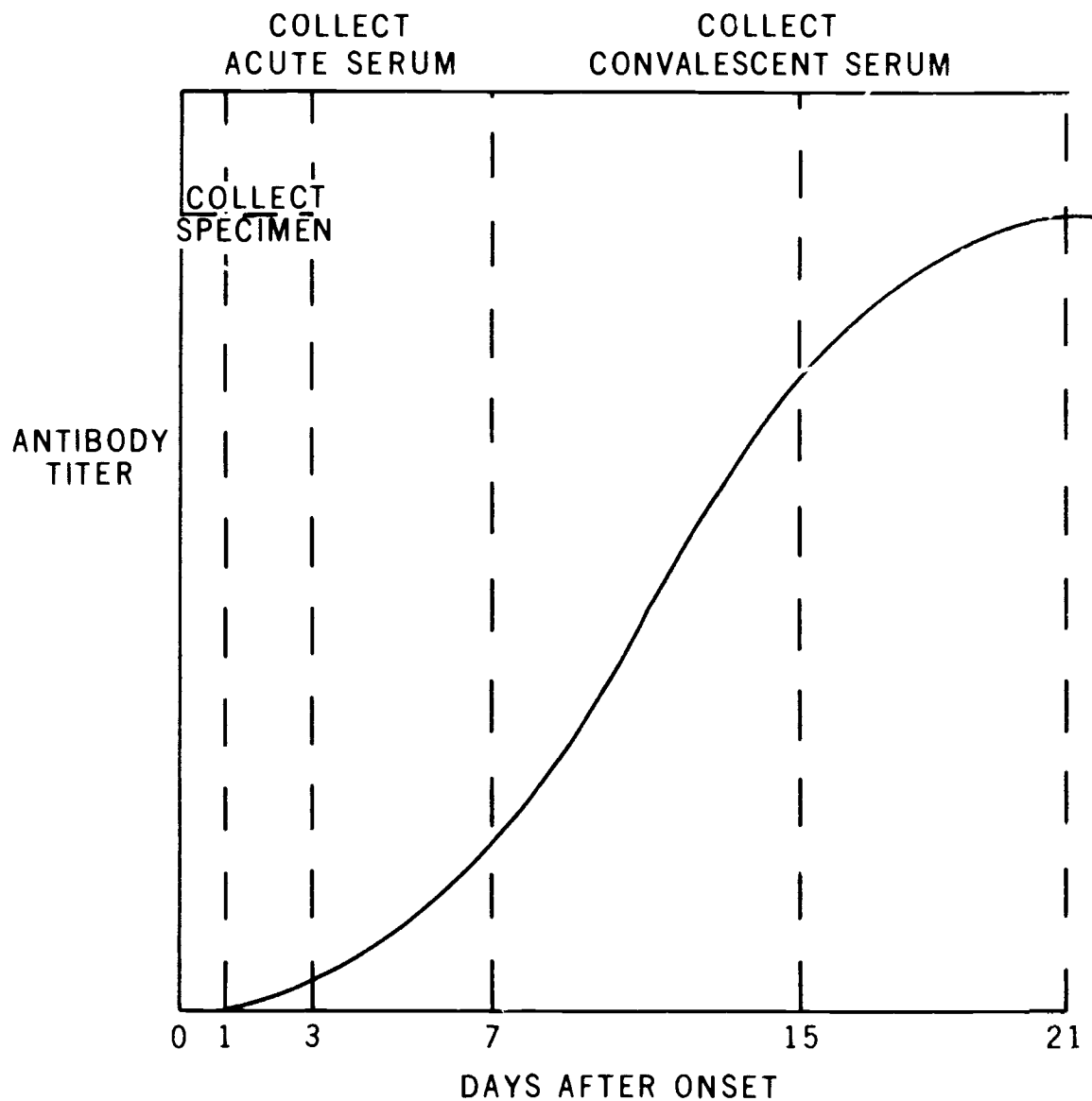

Figure 5-2 Time factor of specimen collection.

type of specimen collected will depend on the nature of the illness. Because of the wide range of agents responsible for similar syndromes, more than one specimen is often required. Specimens should be taken as soon as possible after the onset of symptoms. In order that the correct choice of test systems be performed, the laboratory should be given information in the form of a brief clinical history. The minimum data to be supplied with a specimen is as follows:

- (1) Name of patient—age and sex.
- (2) Summary of pertinent history including date of onset, physical findings, and clinical laboratory tests.
- (3) Virus disease suspected.
- (4) Type of material submitted and date collected.
- (5) Indication of other similar cases in family and vicinity.
- (6) Viral vaccines given to patient with dates.
- (7) Exposure to animals or insect vectors.
- (8) Antibiotic treatment.

With respect to serum specimens for immunological assays, circulating antibodies are usually not formed in the early phase of an infection, as we see in figure 5-2. For that reason we collect paired serum samples—the first as soon as symptoms appear, the second 2 or 3 weeks later. If virus isolation techniques fail, then an elevated antibody titer in the second serum may indicate the identity of the causative virus. It follows, therefore, that time as a factor in specimen collection is equally applicable to virus isolation and serological procedures.

#### Exercises (667):

1. The type of specimen to be collected for viral isolation is dependent upon what initially given factor?

2. Why is more than one specimen often required for viral isolation?
  3. What single factor must be included to insure that the correct choice of systems be performed for the isolation and identification of the virus?
  4. How soon after onset of symptoms in a suspected virus infection should the convalescent-phase serum be drawn?
  5. What is the significance of obtaining the second serum specimen or convalescent serum at the time lapse after infection?
668. Cite the significance for obtaining the correct choice of specimens for viral isolation and point out the specimens for isolation in terms of the quantities, types, methods of collection, and holding media used.

TABLE 5-6  
SPECIMENS FOR VIRAL ISOLATION AND RICKETTSIAE DISEASES

DISEASE SYNDROME	CAUSATIVE AGENT	SPECIMEN FOR ISOLATION	AUTOPSY MATERIAL	SERUM SPECIMENS REQUIRED	
				ACUTE	CONVALESCENT
Central Nervous System	Arthropod-Borne Encephalitis: Eastern Equine Western Equine Venezuelan Equine St. Louis California Japanese B. encephalitis	Blood and CSF  Usually not possible to isolate virus from clinical specimen	Brain Brain Brain Brain Brain Brain	Immediately after onset	2 - 4 weeks later
	Poliovirus Enterovirus Herpes simplex Rabies Lymphocytic choriomeningitis	Stool, throat washing, stool/rectal, CSF Stool, throat washing, stool/rectal, CSF Throat swab/wash/nasopharynx, CSF Saliva Blood and CSF	Brain, Tissue Brain Tissue Brain Brain Brain	Immediately after onset	2 - 4 weeks later
Respiratory System	Influenza Group Adenovirus Group  Parainfluenza Respiratory syncytial Psittacosis	Throat swab/wash/nasopharynx Throat swab/wash/nasopharynx, stool/rectal, urine Throat swab/wash/nasopharynx Throat swab/wash/nasopharynx Throat swab/wash/nasopharynx, sputum	Lung, bronchical tissue Lung  Lung Lung —	Immediately after onset	2 - 4 weeks later
Vesicular Eruptions	Smallpox Vaccinia  Herpes simplex Varicella/Zoster	Throat swab/wash/nasopharynx, blood, scabs, vesicle fluid Throat swab/wash/nasopharynx, vesicle fluid, scrapings, swab	Lung, spleen, liver, brain  Lung, spleen, liver, brain	Immediately after onset	2 - 4 weeks later
Rocky Mountain Spotted Fever Typhus murine, and epidemic Rickettsialpox Q Fever	<i>R. rickettsii</i> <i>P. typhi</i> <i>R. akari</i> <i>Coxiella burnetii</i>	Blood  Blood and sputum		Immediately	2 - 4 weeks later
Miscellaneous Mumps  Measles  Rubella (German measles)  Lymphogranuloma Venereum Cytomegalic inclusion Disease Gastroenteritis	     Cytomegalovirus	Throat swab/wash/nasopharynx, urine, blood, CSF Throat swab/wash/nasopharynx, blood, CSF Throat swab/wash/nasopharynx, urine, blood, CSF  Throat swab/wash/nasopharynx, urine, blood Throat swab/wash/nasopharynx, stool/rectal	   Lymph nodes lung, spleen	Immediately	2 - 4 weeks later     30 days later

**Specimen Collection.** The choice of a specimen is important, especially in trying to isolate a virus, because these infectious organisms are often localized in certain limited areas of the body or only in certain organs. In table 5-6 we have listed representative viruses and the specific or, in some cases, multiple specimens which can be expected to yield the agent. Timing is important, too, because during the course of the disease the infection may progress from a localized to a generalized state, or vice versa, so that a particular tissue or organ system may contain viruses at one point in time and not at another. In day-to-day practice, however, you should follow the guidelines for specimen collection, preservation, and shipment published by the laboratory which provides virus diagnostic services to your hospital.

The types of specimens and a brief description on the collection of each are listed below.

**Blood.** The acute-phase blood should be collected aseptically as soon as possible after the onset of the illness, no later than 5 to 7 days. At least 20 ml of blood (10 ml of serum) should be collected for serological tests. Whole blood is often used for viral isolation; therefore, no anticoagulants or preservatives should be added.

Early separation of the serum from the clot prevents hemolysis which interferes with some tests. Paired sera are necessary for serodiagnosis. One serum should be collected as soon as possible after onset of the disease, and a second serum specimen approximately 14 to 21 days later. Note in figure 5-2 that the acute-phase serum may not show antibodies, whereas the "convalescent" phase specimen can be expected to have a detectable antibody titer. Don't forget, though, that a previous exposure to the virus, or past immunization with a vaccine, may have produced circulating antibodies which will be apparent serologically in the acute phase serum.

There is generally no set "diagnostic titer" of any antibody to viruses. The increasing antibody level revealed by the convalescent serum (usually a fourfold increase or more in titer is meaningful) is the diagnostically significant information derived from serological testing. If no evaluation is found when the two serum specimens are reacted with a known virus antigen, then infection with that given virus is ruled out. In practice, the sera are screened against a battery of several of the more common viruses, the composition of the antigen battery being determined by the patient's clinical record.

If blood is required for virus isolation, a heparinized blood specimen is obtained because such blood samples require co-culture of blood leukocytes in tissue culture. Such types of specimen must be shipped immediately to the virology laboratory for culture. Under normal circumstances the acute-phase serum should be stored frozen at  $-20^{\circ}$  or  $-70^{\circ}$  until the convalescent serum is obtained. Maintain a control roster in order to obtain the convalescent blood sample 14 to 21 days later and process as the acute serum. Then the paired serum samples are forwarded together to the virus laboratory for serological analysis.

**Stool specimens or rectal swabs.** Stool specimens are collected in a clean carton or jar. A one ounce (28-ml) screw-capped glass jar may be used. A 2- or 4-gram specimen is adequate. Holding media are not used for feces other than swab. Thus, specimens should be refrigerated or frozen without preservative. Rectal swabs may be collected by passing a sterile swab moistened with transport medium into the anus so that the cotton tip is no longer visible. The swab is then placed in a suitable transport medium as recommended by the virology laboratory. A holding medium such as Hanks balanced salt solution (BSS) with gelatin is recommended for such type of swabs.

**Throat washing or swab.** Throat washings are preferred to swabs of the nasopharyngeal region for isolating respiratory viruses for adults. The patient is asked to gargle with 10 to 15 ml of tryptose-phosphate broth or other general purpose broth. Instruct the patient to gargle all the medium as far back in the throat as possible for at least 10 seconds and then expel the medium back into a plastic cup. For children, swab the throat thoroughly, using two swabs. Break off the upper portion of the swab into 5 ml of bacteriological broth in a stoppered vial.

**Nasal secretion.** Nasal secretion should be collected with a cotton swab and placed in approximately 3 to 4 ml of tryptose-phosphate broth medium with 0.5 percent to 1 percent gelatin.

**Throat and nasopharyngeal swabs.** Throat swabs are best obtained by rubbing a dry cotton swab on the posterior pharynx. The swab tip should be broken and placed into a tube containing 5 ml of a sterile broth medium. A dry cotton swab may be used to swab each nostril. The swab should be left in the nose a few seconds so that it absorbs as much secretion as possible. The tip is broken off and processed as indicated for the throat swabs.

**Vesicular fluid or skin scrapings.** The vesicular lesions should be opened and the exudate from the lesions absorbed on dry sterile cotton swabs. The swab should be placed in sterile broth. For histological studies, cells should be scraped from the base of lesions with as little blood as possible. The specimen is placed on a clean microscope slide and immersed in ether-alcohol for a minimum of 5 minutes.

**Miscellaneous body fluids** Body fluids such as urine, cerebrospinal fluid, and pleural and pericardial infusions obtained aseptically by the physician are submitted in sterile tubes or jars. Tissue specimens collected aseptically at autopsy are handled similarly. These may include portions of lung, brain, heart muscle, liver, spleen, or kidney, among other possibilities.

#### Exercises (668):

1. Why is the correct selection of clinical specimens important in diagnosing virus diseases?

2. How soon after the onset of the illness should the acute-phase blood be collected?
3. Why is early separation of the serum from the clot important?
4. Approximately how soon after the onset of illness should the second serum specimen be collected?
5. What is the significance of the increasing antibody level revealed by the convalescent serum?
6. If blood is required for virus isolation, what type of sample is obtained? Why?
7. Under normal circumstances, at what temperature should the acute-phase serum be stored until the convalescent serum is obtained?
8. Since holding media are not recommended for stool specimens, how should the specimen be handled?
9. What type of given holding medium is recommended for rectal swabs?
10. What type of specimen is preferred for isolating respiratory viruses of the nasopharyngeal region?
11. What solution may be used for gargle in collecting throat washings?
12. How are throat swabs best obtained for viral studies?
13. When collecting nasopharyngeal specimens, why should the swab be left in the nose a few seconds?
14. For histologic studies, cells should be scraped from the \_\_\_\_\_ of the lesions with as little blood as possible. The specimen is placed on a clean microscope slide and immersed in \_\_\_\_\_ for a minimum of \_\_\_\_\_ minutes.

**669. Point out the significance and techniques for preservation of virus during shipment, the significance of tightly sealed tubes or bottles, and the Federal regulation for shipment of etiological agents.**

**Techniques of Preservation and Shipment.** It is imperative to understand that low temperature is an effective means of maintaining the viability of most viruses. Conversely, exposure of specimens to room temperature for only a few hours may prevent recovery of a virus. If it is ever impossible to deliver a specimen immediately to the virology laboratory, it should be refrigerated and packed in shaved ice for delivery to the laboratory within 12 hours of collection. If the intervals between collection and delivery will exceed 12 hours or longer, freeze the specimen below  $-40^{\circ}\text{C}$  or preferably  $-70^{\circ}\text{C}$ . However, remember to freeze specimens immediately. The temperature of an ordinary household refrigerator is  $-20^{\circ}\text{C}$ , and if *absolutely* necessary can be used up to 4 days.

Specimen tubes or bottles must be tightly sealed. This is especially important with materials for virus isolation, which must be shipped frozen if it will take longer than a few hours to get them to the laboratory. Frozen shipment generally requires dry ice. Dry ice releases  $\text{CO}_2$  gas which can lower pH and inactivate some viruses if the seal is not gas-tight.

The problem we most often encounter are leakage of fluids and breakage of the specimen container. Leaking occurs either because a tube or bottle was insecurely stoppered to begin with or because a pressure change during transit by air breaks the seal. Tubes, jars, and bottles often break if they are dropped, rough handling of the carton can cause the glass containers inside to crack or shatter if they come into violent contact through lack of sufficient packing material.

Ideally, clinical specimens should be protected by sealing them in thick glass ampules, as demonstrated in figure 5-3. Unaffected by pressure changes, these ampules also shield the specimen from released  $\text{CO}_2$  gas that can inactivate a virus. Many laboratories have found screw-capped glass or durable plastic tubes and jars, as well as rubber-stoppered containers, to be satisfactory for shipping specimens if special precautions are taken with the closure. We show in figure 5-3 how a screw-capped tube can be fitted with a rubber gasket and then sealed with adhesive tape. As depicted in the figure, rubber stoppers can also be reinforced with a strong adhesive tape.

# SHIPPING SPECIMENS

(ALLOW FOR CHANGES IN ATMOSPHERIC PRESSURE)

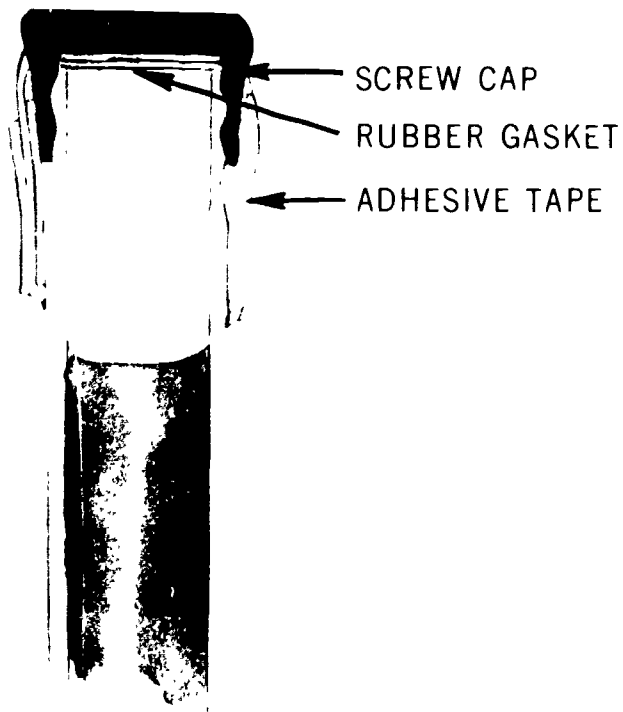

SCREW CAPPED  
TUBES

596



GLASS-SEALED  
AMPULES

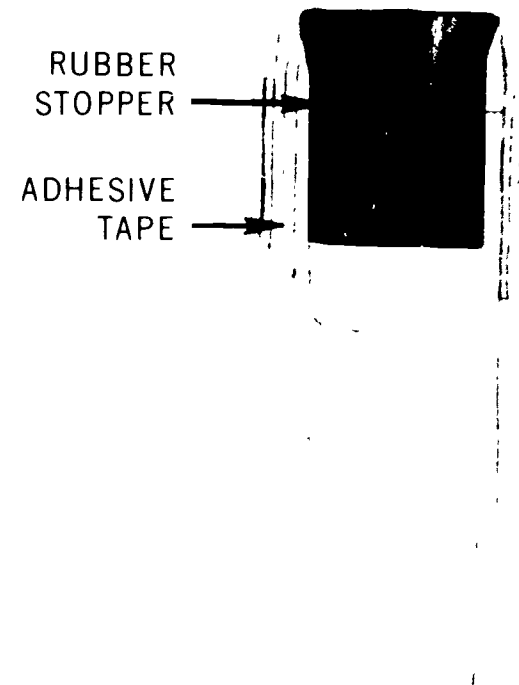

RUBBER-STOPPERED  
TUBES

597

By wrapping individual containers with paper or cotton, we can decrease the opportunity for breakage from movement during shipment. Even greater protection is afforded if we wrap small groups of the tubes or jars and seal them inside tin cans. A number of outer containers are commercially available for protecting the ampules, tubes, and jars which hold the clinical specimens. Fiberboard or a styrofoam shipping container can be loaded with wet ice in plastic bags or solid CO<sub>2</sub>, depending on whether the specimen is to be kept chilled or frozen. The various outer containers are designed to insulate the contents from environmental heat during transit periods of 24 hours to several days. The extent of protection depends upon such individual characteristics as size (ice capacity) and efficiency of the insulating material. The styrofoam container is placed inside a protective outer cardboard container and sealed for shipment.

Specimens for isolation of cytomegalovirus and varicella virus should not be frozen. Respiratory syncytial virus is extremely labile and, if not processed right away, will be lost unless the specimen shell is frozen. Freeze arbovirus specimens immediately or keep at -40° C if they must be held for delivery to the virology laboratory.

Shipment of diagnostic specimens must conform with Federal Regulations 72.25 of part 72, Title 42, Code of Federal Regulations. The regulations basically define etiological agents and provides guidelines for transportation of diagnostic specimens. Labels should conform to guidelines as indicated in Volume 1, Chapter 2. The label for Etiologic Agents/Biomedical Material must appear on the outside of the shipping container unless otherwise directed.

Specimens may be shipped to the virology laboratory as required for the clinical laboratory in that particular region. However, all specimens may be shipped to:

USAFSAM/EPB  
ATTN: Virology Function  
Building 930  
Brooks AFB, Texas 78235

#### Exercises (669):

1. What general temperature range (high or low) is considered to be an effective means of maintaining the viability of most viruses?
2. If it is ever impossible to deliver a specimen immediately to the virology laboratory, under what conditions should the specimen be maintained?
3. If the intervals between collection and delivery will exceed 12 hours or longer, under what conditions should the specimen be maintained?
4. How can the viral specimens shipped in tubes or bottles with dry ice be affected if not tightly sealed when in transit?
5. Specimens for isolation of cytomegalovirus and varicella should/should not be frozen.
6. How should arbovirus specimens be handled if they must be held for delivery to the virology laboratory?

598



## Bibliography

### Books

- Christensen, Mary. *Basic Laboratory Procedures in Diagnostic Virology*, Springfield, Ill.: Charles C. Thomas Publisher, 1977.
- Finegold, Sydney M., William J. Martin and Elvyn G. Scott. *Bailey and Scott's Diagnostic Microbiology*, 5th Ed. St. Louis: The C.V. Mosby Company, 1978.
- Freeman, Bob A. *Textbook of Microbiology*, 21st Ed. Philadelphia: W. B. Saunders Company, 1979.
- Henry, John Bernard, *Clinical Diagnosis and Management by Laboratory Methods*, 16th Ed. Philadelphia: W. B. Saunders Company, 1979.
- Holt, John G. *The Shorter Bergey's Manual of Determinative Bacteriology*, 8th Ed. Baltimore: The Williams & Wilkins Company, 1977.
- Hunter, Peter. *General Microbiology*, St. Louis: The C. V. Mosby Company, 1977.
- Jawetz, Ernest, J. L. Melnick and E. A. Adelberg, *Review of Medical Microbiology*, 13th Ed. Los Altos, Calif: Lang Medical Publications, 1979.
- Joklik, Wolfgang K. and Hilda P. Willett. *Zinsser Microbiology*, 16th Ed. New York: Appleton—Century—Crafts, 1976.
- Koneman, Elmer W., Glenn D. Roberts and Sara E. Wright. *Practical Laboratory Mycology*, Baltimore: The Williams & Wilkins Company, 1979.
- Larone, Davise Honig. *Medically Important Fungi—A Guide to Identification*. Hagerstown, Md.: Harper and Rowe Publishers, 1976.
- Linnette, Edwin, Earl Spaulding and Joseph Truant. *Manual of Clinical Microbiology*, 2nd Ed. Washington D.C.: American Society for Microbiology, 1974.
- Ravel, Richard, *Clinical Laboratory Medicine*, 3rd Ed. Chicago: Year Book Medical Publishers, Inc., 1978.
- Smith, Alice L. *Principles of Microbiology*, 8th Ed. St. Louis: The C. B. Mosby Company, 1977.
- Slack, J. M. and I. S. Snyder *Bacteria and Human Disease*. Chicago: Year Book Medical Publishers Inc., 1978.
- Turk, D. C. and I. A. Porter. *A Short Textbook of Medical Microbiology*, 4th Ed. Chicago: Year Book Medical Publishers Inc., 1978.
- Volk, Wesley A. *Essentials of Medical Microbiology*, Philadelphia: J. B. Lippincott Company, 1978.

Other Government Publications

Balle , Harold C., Francis T. Forrester and H. Craig Lyerla, *Laboratory Diagnosis of Viral Diseases*, Course No. 8241-C. U.S. Department of Health, Education and Welfare, Washington, D.C : U.S. Government Printing Office, 1976.

Haley, Leonor D. and Carey S. Calloway, *Laboratory Methods in Medical Mycology*, U.S. Department of Health, Education and Welfare, Washington, D.C.: U.S. Government Printing Office, 1978.

Huffaker, Robert H., *Collection, Handling and Shipment of Microbiological Specimens*, U.S. Department of Health, Education and Welfare, Washington, D.C.: U.S. Government Printing Office, 1974.

*Specimen Management Handbook - A Users Guid To Services of the Epimemiology Division*, USAF School of Aerospace Medicine, Brooks Air Force Base, Texas, 1980.

NOTES: None of the items listed in the bibliography are available through ECI. If you cannot borrow them from local sources, such as your base library or local library, you may request one item at a time on a loan basis from the AU Library, Maxwell AFB AL 36112, ATTN: ECI Bibliographic Assistant. However, the AU Library generally lends only *books* and a limited number of *AFMs*, *TOs*, classified publications, and other types of publications are *not* available. Refer to current indexes for the latest revisions of and changes to the official publications listed in the bibliography.

## Glossary

- Abstriction**—Formation of asexual spores by the cutting off of portions of the sporophore through the growth of dividing partitions.
- Acrotheca**—A type of spore formation, characteristic of genus *Fonsecaea*, in which conidia are formed along the sides of irregular club-shaped conidiophores.
- Aerobe**—An organism whose growth and reproduction are favored by the presence of air or free atmospheric oxygen.
- Anaerobe**—An organism whose growth and reproduction are favored by the absence of air or free atmospheric oxygen.
- Anthropophilic**—Term applied to fungi that are considered to infect only man.
- Arthrospore**—Asexual spore formed by the disarticulation of the mycelium.
- Ascospore**—Sexual spore, characteristic of the class *Ascomycetes*, produced (union of two nuclei) in a sac structure known as an ascus.
- Ascus**—A specialized sac structure, characteristic of the class *Ascomycetes*, in which ascospores are produced.
- Aseptate**—Term describing absence of cross-walls in a hyphal filament or a spore.
- Basidiospore**—Sexual spore, characteristic of the class *Basidiomycetes*, produced (union of two nuclei) on a specialized club-shaped structure called a basidium.
- Basidium**—A specialized, club-shaped cell, characteristic of the class *Basidiomycetes*, on which exogenous basiospores are borne.
- Blastospore**—An asexual spore produced by a budding process, along the mycelium or from another blastospore.
- Budding**—An asexual reproductive process characteristic of unicellular fungi or spores involving the formation of lateral outgrowth from the parent cell that are pinched off to form new cells.
- Cerebriform**—Resembling the external convolutions and fissures of the brain.
- Chlamydospore**—Thick-walled resistant spore formed by the direct differentiation of the mycelium (concentration of protoplasm and nutrients).
- Cladosporium**—A type of spore formation characteristic of genera *Cladosporium* and *Fonsecaea*, in which conidia are formed in branched chains by conidiospores of various lengths.
- Clavate**—Club-shaped.
- Cleistothecium**—A structure, usually spherical, in which asci are formed.
- Coenocytic**—Term applied to a cell or an aseptate hypha containing numerous nuclei.
- Columella**—The prominent dome-shaped apex of a sporangiophore, characteristic of the class *Phycomycetes*.
- Conidiophore**—A specialized branch of hypha on which conidia are developed either singly or in groups.
- Conidium**—An asexual spore (one- to many-celled, and of many sizes and shapes) produced on a specialized structure known as a conidiophore.
- Coremium**—A sheaflike tuft of conidiophores.
- Dematiaceous**—Pigmented, dark in color.
- Dimorphic**—Term referring to those fungi which can grow and reproduce in either the mold form or the yeast form.
- Echinulated**—Spiny.
- Ectothrix**—Arthrospores formed outside the infected hair shaft.
- En Grappe**—In clumps on the ends of hyphae.
- En Thyse**—Individually along the sides of hyphae.
- Endogenous**—Derived from internal source.
- Endospore**—Spore formed within a special spore case.
- Endothrix**—Arthrospores formed *within* the infected hair shaft.
- Exogenous**—Derived from external source.
- Facultative**—Term referring to ability of an organism to grow and reproduce as an aerobe or an anaerobe.

- Favic Chandeliers**—Specialized hyphae that are curved, branched, and antlerlike in appearance; formed by certain dermatophytes, especially *Trichophyton schoenleinii*.
- Favic-Endothrix**—Hair infection resembling endothrix type; no arthrospores formed.
- Fungus**—A chlorophyll-less saprophyte or parasitic member of the plant kingdom, whose plant body is not differentiated into roots, stems and leaves. In most species the fundamental structural unit is mycelium.
- Fusiform**—Spindle-shaped.
- Gametangium**—A structure in which gametes are produced.
- Gamete**—A sexual cell; especially a cell formed in a gametangium.
- Geophilic**—Term applied to fungi whose natural habitat is in soil.
- Germ Tube**—The tubelike process put out by a germinating spore that develops into the mycelium.
- Glabrous**—Smooth, skinlike in texture.
- Granulomatous**—Composed of tumor or neoplasm made up of granulation tissue.
- Habitat**—Natural place of growth of an organism.
- Helicoid**—Resembling a coil of helix.
- Hyaline**—Glassy and transparent.
- Hypha**—One of the vegetative filaments composing the mycelium of mold fungi.
- Imperfect Fungi**—Fungi that apparently lack the sexual means of reproduction and reproduce only asexually.
- Intercalary**—Said of spores produced between two hyphal segments.
- Kerion**—A pustular infection of the hair follicles of the scalp characterized by a raised, boggy lesion.
- Macroconidium**—Large, often multicellular conidium.
- Macroscopic**—Term referring to gross, cultural morphology that can be observed and studied with the naked eye.
- Microconidium**—Small, single-celled conidium.
- Microscopic**—Term referring to minute morphology that can only be observed and studied under the lens of the microscope.
- Mold**—Macroscopic: filamentous or mycelial form of fungus growth; microscopic: predominance of thread-like hyphae.
- Monomorphic**—Term referring to those fungi which grow and reproduce in only the mold form or the yeast form.
- Muriform**—Term describing a conidium which possesses both transverse and longitudinal septations.
- Mycelium**—A mat of intertwined and branching threadlike hyphae.
- Mycetoma**—Fungus tumor.
- Mycosis**—Fungus disease.
- Nodular Organ**—A knot of close-knit hyphae considered to represent abortive attempts toward sexual reproduction.
- Onychomycosis**—A general term for a fungal infection of the nails.
- Oospore**—A sexual spore produced through the fusion of two unlike gametangia, found in the class *Phycomycetes*.
- Pectinate Hyphae**—Vegetative hyphal branches with unilateral digitate projections resembling teeth of a comb.
- Perfect Fungi**—Fungi that possess both the sexual and the asexual means of reproduction.
- Perithecium**—A special closed structure in which asci are formed.
- Phialophora**—A type of spore formation, characteristic of genus *Phialophora*, in which conidia are formed endogenously in flasklike conidiophores called phialids.
- Pleomorphic**—Term describing the degenerative change of a fungus a reproductive to a completely sterile colony. This process is irreversible and characteristic morphology is lost.
- Pseudohypha**—A chain of elongated budding cells that have failed to detach.
- Pyriform**—Pear-shaped.
- Racquet Hyphae**—Vegetative hyphae showing terminal swelling of segments suggesting a tennis racquet in shape.
- Rhizoid**—Term applied to radiating, rootlike hyphae, extending into the substrate.
- Sclerotic**—Hardened, thick-walled.
- Septate**—Term describing presence of cross-walls in hyphal filament or a spore.
- Sessile**—Said of spores born directly on the hypha as indicated by the absence of a phore.

- Sporangiophore**—A specialized branch of hypha on which sporangia are developed.
- Sporangium**—A closed structure within which asexual sporangiospores are produced by cleavage.
- Spore**—Generally, the reproductive body of a fungus; occasionally, a resistant body for adverse environment.
- Sporephore**—A general term for a spore-bearing structure.
- Sterigma**—The singular of sterigmata.
- Sterigmata**—Short or long projections (from the vesicle portion of a complex conidiophore) on which conidia are developed.
- Stolon**—A runner. A horizontal hypha which sprouts where it touches the substrate and forms rhizoids in the substrate.
- Suppurative**—Producing pus.
- Thallospore**—Spores formed by a change in portion of the thallus.
- Thallus**—A simple plant body; the vegetative part of the fungus plant as distinguished from the productive part.
- Tinea**—“Ringworm”; a prefix used with the infected area of the body (tinea capitis, tinea pedis) to indicate a cutaneous mucosis.
- Truncate**—Having a side or an end cut squarely off.
- Tuberculate**—Having knobby projections.
- Vermicular**—Wormlike in shape or appearance.
- Verrucose**—Warty in appearance.
- Yeast**—Macroscopic: pasty or mucoid form of fungus growth; microscopic: predominance of budding cells.
- Zoophilic**—Term applied to fungi that infect lower animals as well as humans.
- Zygospor**—A thick-walled sexual spore produced through fusion of two similar gametangia; found in the class *Phycomycetes*.

# ANSWERS FOR EXERCISES

## CHAPTER 1

### References:

- 600 - 1 f.  
 600 - 2 e  
 600 - 3 c  
 600 - 4 d  
 600 - 5 d  
 600 - 6 b  
 600 - 7 d  
 600 - 8 b  
 600 - 9 d.  
 600 - 10 c  
 600 - 11 c  
 600 - 12 a.  
 600 - 13 a.  
 600 - 14 a
- 601 - 1. Elongated, branching filaments  
 601 - 2 Hypha or hyphae (plural).  
 601 - 3. Mycelium or mycelia (plural)  
 601 - 4. Chitin.  
 601 - 5. They serve to anchor the fungus to the substratum and procure food for fungus.
- 602 - 1 When fungus has reached maturity or when it faces unfavorable environmental conditions  
 602 - 2 Temperature variations and lack of nourishment.  
 602 - 3. Spore.  
 602 - 4. (1) Duplication of species.  
 (2) Dispersal to new substrate  
 (3) Protection from adverse environmental conditions  
 602 - 5 (1) Thallospore (body spore).  
 (2) Endospore  
 (3) Ectospore.  
 602 - 6. (1) Arthrospores.  
 (2) Blastospores  
 (3) Chlamydo-spores.  
 602 - 7. The endospore is borne within a saclike membrane while the ectospore is borne free  
 602 - 8. Conidia  
 602 - 9. Microconidium; macroconidium.  
 602 - 10 *D. uteromyces*
- 603 - 1 Enzymes; organic substances  
 603 - 2. Acid; 5 6.  
 603 - 3 Cyclohexamide and chloramphenicol  
 603 - 4. Aerobic; oxygen  
 603 - 5 To inhibit contaminating bacteria and saprophytic fungi  
 603 - 6 Numerous fungi of medical importance are also inhibited and may not be recovered from initial plating if antibiotics are present.  
 603 - 7 24 to 48; 3 to 5 weeks  
 603 - 8. Large.
- 604 - 1 The yeasts and the filamentous molds  
 604 - 2 Yeasts.  
 604 - 3 Mold.  
 604 - 4 Monomorphic yeasts.  
 604 - 5. This budding type of multiplication produces a pasty or mucoid, rounded colony on the substratum similar to that of bacterial growth.  
 604 - 6 Monomorphic molds  
 604 - 7 Dimorphic fungi  
 604 - 8 *Sporotrichum schenckii*
- 605 - 1 F (Mycosis)  
 605 - 2 F (They are confined to the outermost layers of the skin and the hair )  
 605 - 3 T  
 605 - 4 T  
 605 - 5 F. (Cutaneous mycoses )  
 605 - 6 T  
 605 - 7 T  
 605 - 8 F (Cutaneous or systemic )  
 605 - 9 T  
 605 - 10 F. (Cutaneous mycosis )
- 606 - 1 Skin and nail scrapings  
 606 - 2 The potassium hydroxide wet mount (KOH preparation)  
 606 - 3 Lactophenol-cotton blue mount  
 606 - 4. Sabouraud's and mycosel or mycobrotic agar  
 606 - 5 25° to 30° C.  
 606 - 6 37° C.  
 606 - 7 Hair infected by certain fungi may fluoresce when placed under filtered ultraviolet light  
 606 - 8 Most species of *Trichophyton* and *M. gypseum*  
 606 - 9 From the edge of the patches of infection  
 606 - 10 Chloramphenicol and cycloheximide  
 606 - 11. Gram stain  
 606 - 12. *Nocardia*.  
 606 - 13 *Giemsa* or *Wright*  
 606 - 14. *Cryptococcus* Neoformans  
 606 - 15. Those used for primary isolation of germaphytes, saprobic, and pathogenic fungi.
- 607 - 1 From the active margin.  
 607 - 2 None, they may be inoculated directly  
 607 - 3 None; same as exudates, body fluids, and tissues  
 607 - 4 Biopsied nasal and ocular polyps  
 607 - 5 At least three times.  
 607 - 6 30 days at 30° C
- 608 - 1 In a screw-cap glass tube which permits tight closure and sealed with adhesive tape.  
 608 - 2. They should be wrapped individually with cotton or other absorbent material and inserted into a metal container.  
 608 - 3 50,000 units of penicillin, 100,000 µg of streptomycin, or 0.2 µg of chloramphenicol for each milliliter of material.  
 608 - 4 They should never be mailed because they will dry out.
- 609 - 1 A pair of short, stiff teasing needles.  
 609 - 2 Culture tubes; are more easily stored, required less space, are safer for small laboratories, and have a lower dehydration rate  
 609 - 3 A dry surface gives better sporulation and better pigment production  
 609 - 4 Better aeration of cultures, a large surface area which provides better isolation of colonies, and greater ease of examination and subculture of fungal colonies  
 609 - 5 Fungicidal agent.
- 610 - 1 The KOH mount informs us only of the presence or absence of fungal elements in tissue scrapings  
 610 - 2 To remove any dirt particles, bacteria, and medication which interferes with microscopic examination.  
 610 - 3 The outer, active margin of the lesion  
 610 - 4 By gentle heating for a few seconds  
 610 - 5 The lactic acid acts as a preservative.  
 610 - 6 A fungus growing on the surface of a culture medium.  
 610 - 7 The difficulty in preserving continuity between the spore, fruiting structures, and hyphae after such rough handling.



- 610 - 8. It subjects the fungus to much less trauma, thereby maintaining the structural relationships essential for accurate identification, and it is relatively simple
- 610 - 9 Its only purpose is to make the encapsulated organisms more easily observable.
- 610 - 10 To prevent precipitation of the ink by the heat
- 611 - 1 Mycelial elements; yeast cells
- 611 - 2 Granules; actinomycete
- 611 - 3 Is not
- 611 - 4 Positive.
- 611 - 5. Norcardia
- 611 - 6 Intracellular yeast; *Histoplasma capsulatum*.
- 611 - 7 Periodic acid-Schiff; Gomori Methanamine
- 611 - 8 Carbohydrate—rich.
- 612 - 1 Mycosel or mycobiotic agar and Sabouraud's 2 percent dextrose agar.
- 612 - 2. The routine tube or culture bottle method and slide culture method.
- 612 - 3 Chloramphenicol or cycloheximide
- 612 - 4 25° or 30° C
- 612 - 5 35° C.
- 612 - 6 a. Growth rate  
b. Colony size.  
c. Surface topography  
d Texture  
e. Front and reverse pigmentation
- 612 - 7 Three.
- 613 - 1. T
- 613 - 2. F (A medium that is conducive should be used.)
- 613 - 3. F (A lactopheno<sup>1</sup>-cotton blue preparation.)
- 613 - 4 F (Highly virulent molds should not be grown in slide culture because of the danger of infection to persons handling them.)
- 614 - 1 F (Do not set up slide cultures on these organisms—they are highly infectious )
- 614 - 2. F (All such preparations easily contaminate the working environment )
- 614 - 3 T
- 614 - 4 F (Autoclaving )
- 614 - 5 (Petri plates should never be used )
- 614 - 6 T
- 614 - 7 T
- 616 - 3 Thrush
- 616 - 4 When two skin surfaces are held together over long time periods perspiration cannot evaporate, and the urea breaks down into ammonia, resulting in a localized chemical irritation
- 616 - 5 Because they fail to adequately sterilize their needles and syringes
- 617 - 1 "Forms suggestive of *Candida* seen "
- 617 - 2 They are white, soft, and generally have smooth surfaces and borders
- 617 - 3 Older colonies frequently show a fringe of submerged mycelium appearing as feathery outgrowths deep in the agar
- 617 - 4 The Germ Tube test
- 617 - 5. Sterile, bovine, sheep, or human serum
- 617 - 6 The presence of growth either in the medium or adjacent to the discs
- 617 - 7 As secondary tests used to supplement assimilation studies where there is difficulty in making a definitive identification
- 617 - 8 Costs, stability, adaptability, in any given laboratory setting (absolute need). Tests are quite satisfactory when used by experienced personnel
- 617 - 9 None.
- 618 - 1 The failure to suspect its presence
- 618 - 2 The central nervous system, however, the bones, skin, and other organs may be infected
- 618 - 3 Inhalation into the respiratory system
- 618 - 4 India ink wet mount
- 618 - 5. *Cryptococcus neoformans* is sensitive to this antibiotic
- 618 - 6. Usually most saprophytic cryptococci are unable to grow at 35° C; however, certain strains do not conform to this pattern
- 618 - 7 This indicates that the yeastlike fungi is a member of the genus *Cryptococcus*
- 619 - 1 *Geotrichum candidum*
- 619 - 2 Because *G. candidum* usually occurs as a secondary invader.
- 619 - 3 In its early growth phase *G. candidum* appears in the form of the other yeastlike fungi, however, as it matures, it assumes a fluffy mycelial character producing chains of arthrospores
- 619 - 4 Glucose and xylose
- 620 - 1 *Trichosporon cutaneum*
- 620 - 2 Hair
- 620 - 3 Nodules; white; brown
- 620 - 4 Cycloheximide
- 620 - 5 Soft; cream; white, greyish, heaped
- 620 - 6 Sugars, maltose; lactose
- 620 - 7 Blastospores, arthrospores.
- 621 - 1 The bud is separated from the mother cell by a cross-wall
- 621 - 2 Urine and sputum
- 621 - 3 As tiny, white, raised, nonhemolytic colonies
- 621 - 4 Round to oval budding yeasts 2 to 4 μm in diameter, no hyphae or capsules are seen
- 621 - 5 Negative
- 621 - 6 Glucose and trehalose, and does not assimilate carbohydrates
- 622 - 1 Hard, brown, or black nodule
- 622 - 2 A clicking sound is produced
- 622 - 3 Black to greenish-black colonies which are smooth and raised
- 622 - 4 The colony consists of dark, closely separate filaments of hyphae, chlamyospores, and on rare occasions asci
- 622 - 5 Many oval asci containing 2 to 8 ascospores encased in a darkly pigmented mycelium
- 623 - 1 Tinea nigra
- 623 - 2 Pigmented black or dark brown branched hyphae
- 623 - 3 A moist, yeastlike, greenish-black raised colony

## CHAPTER 2

- 615 - 1 The term is applied when the daughter cell fails to detach from the mother cell.
- 615 - 2 They never reproduce by simple budding
- 615 - 3 They reproduce by means of blastospores, and the formation of a true mycelium which fragments into arthrospores.
- 615 - 4 They reproduce only by means of simple budding, are unicellular, and the buds are separated from the mother cell by a cross-wall.
- 615 - 5. In order to perform accurate morphological studies and other tests that may be necessary.
- 615 - 6. A 0.05 mg/ml concentration of chloramphenicol and cycloheximide in a concentration of 0.5 mg/ml
- 615 - 7 The acid tube which shows no bacterial growth after overnight incubation at 35° C.
- 615 - 8. Those of *Candida*, *Cryptococcus* or a true yeast
- 615 - 9 *Trichosporon*.
- 615 - 10. *Cryptococcus*
- 615 - 11. Chlamyospore agar or Cornmeal Tween 80 agar
- 616 - 1 a A high-carbohydrate diet  
b Hot climates which result in profuse sweating
- 616 - 2 The therapeutic use of steroids and antibiotics over extended periods

- 623 - 4 Spherical or oval budding cells, many of which are divided centrally by a cross wall. Short chains of these cells are common
- 624 - 1. Tinea versicolor  
624 - 2 10 percent potassium hydroxide; methylene  
624 - 3. *Malessezia furfur* cannot be cultured on artificial media
- 625 - 1. *Microsporum audouinii*.  
625 - 2. Use of unsanitary equipment has been found to be one of the most important modes of transmission of this fungus.  
625 - 3. A raised mass of tissue, suppurating at numerous points  
625 - 4. It will fluoresce a bright yellowish-green.  
625 - 5. The suspect hair should be plucked and then examined under ultraviolet light, since only the base of the hair is involved in early cases.  
625 - 6. The margin.  
625 - 7 A sheath of small spores in mosaic completely surrounds the hair at its base; mycelium is found running lengthwise within the hair. Mycelium and chains of arthrospores are found in skin scrapings  
625 - 8. The colony is slow-growing, flat, and velvety with whitish-tan to brownish surface.
- 626 - 1 An animal parasite or zoophilic fungus.  
626 - 2. The acute inflammatory type.  
626 - 3 They both cause similar symptoms and present a similar microscopic picture from clinical material.  
626 - 4 Cultural studies must be done.  
626 - 5. Growth is rapid; the colony will at first be white and silky with bright yellow marginal pigment.  
626 - 6 Dense, tan, and cottony, sometimes in irregular tufts or concentric rings.  
626 - 7. The macroconidia are numerous, 8 to 15 celled, and spindle shaped. They often terminate in a distinct knob and have thick echinulated walls.
- 627 - 1 In the soil  
627 - 2. They fluoresce poorly or not at all  
627 - 3 The colony is flat, with irregular fringed borders and a coarsely powdery surface ranging from light ochre to deep cinnamon brown  
627 - 4 Numerous macroconidia, 3 to 9 celled, ellipsoid, shorter and broader than those of *M. canis*, with thinner echinulated walls. The microconidia are rare, clavate, and usually borne sessile on the hyphae.
- 628 - 1 *Trichophyton*.  
628 - 2 An endothrix-type infection caused by some members of the genus *Trichophyton* which causes the hair to break off close to or below the scalp surface, creating a black, speckled appearance.  
628 - 3 *T. tonsurans* and *T. violaceum*  
628 - 4 *T. rubrum* usually produces a deep red, rarely colorless appearance, and *T. schoenleui* produces a tan color or no color change on the medium (Table 2-10A)  
628 - 5 *T. tonsurans* shows a clavate to irregular shape and *T. rubrum* is pencil shaped and long (table 2-10B)  
628 - 6 *T. rubrum* will not perforate the hair, while *T. mentagrophytes* is capable of causing wedge-shaped perforations
- 629 - 1 F The hair  
629 - 2 F It does not fluoresce under UV light  
629 - 3 F Either with or without antibiotics  
629 - 4 T  
629 - 5 F *E. floccosum* produces no *microconidia*  
629 - 6 T
- 630 - 1 (1) Data regarding the prevalence of dermatophytes in many regions of the world are scanty  
(2) The etiological agents of many ringworm infections go unreported and possibly undiagnosed  
630 - 2 Flat or somewhat heaped or folded. The surface is finely powdery, or downy, and cream to tan or orange in color
- 630 - 3 Suspected hair and skin scrapings  
630 - 4 The macroconidia are long and slender with parallel walls tapering at each end and are composed of 8 to 12 cells. The walls are wide and have a smooth surface
- 631 - 1 The causative agents are probably saprophytic in nature and most cases result from embedding of the organism in wounds contaminated with soil or vegetative matter  
631 - 2 Cladoporium, Philophora, and Acrotheca  
631 - 3. Cladoporium.  
631 - 4 Acrotheca type.  
631 - 5. The disease tends to remain localized in the limb or area initially infected.  
631 - 6. *Verrucosa*; *carrionii*; *pedrosi*; *compacta*  
631 - 7 The diagnostic picture seen in clinical material is one of small clusters of spherical dark brown, thick-walled cells that reproduce by equatorial splitting (not budding).  
631 - 8 Sabouraud dextrose agar with antibiotics and incubated at room temperature.  
631 - 9. The type or predominating type of sporulation in species exhibiting multiple-type sporulation is useful in accurate identification.
- 632 - 1 Fungus tumor.  
632 - 2. (1) The causative fungi flourishes under these conditions.  
(2) The inhabitants are more likely to go barefoot.  
632 - 3. Foot.  
632 - 4 Structural; granules  
632 - 5 The mycetomas by the *Actinomyces* spp and *Nocardia* spp demonstrate mycelia of considerably less diameter (less than 1  $\mu$ m) and show no chlamydo spores  
632 - 6 *Boydii*; *falsiforme*; *mycetomi*; *Phialophora*  
632 - 7. a. Color  
b Texture.  
c Shape.  
d. Size.  
632 - 8. Some of the fungi which cause maduromycosis are sensitive to this antibiotic.  
632 - 9. *Phialophora jeanselmei* (foldout 2 A-2, table 2-14).
- 633 - 1. The tonsillar crypts, gingiva, and teeth of apparently normal individuals.  
633 - 2 *Israelii*, extraction.  
633 - 3. Sulfur granules.  
633 - 4 "Lumpy jaw" is the term applied to cervico-facial actinomycosis in cattle and is caused by *Actinomyces bovis*.  
633 - 5 Because *A. israelii* is often present asymptotically in the human intestine.
- 634 - 1 They both require anaerobic or microaerophilic conditions and an enriched medium such a brain-heart-infusion agar, brain-heart-infusion blood agar, or thioglycollate broth.  
634 - 2 *A. israelii* produces discrete, lobated, breadcrumb type colonies about 1 cm below the surface  
634 - 3 Rough (R); smooth (S).  
634 - 4. *A. bovis* (table 2-15)  
634 - 5 Pus, either aspirated from a closed lesion or collected in a sterile tube from a draining sinus  
634 - 6 In those cases where pulmonary actinomycosis is suspected  
634 - 7. High magnification shows the granule to be composed of intertwined delicate branched filaments of 1  $\mu$ m or less in diameter  
634 - 8 The Gram-stained slide will reveal thin Gram-positive branched mycelium and many short lengths Gram-negative mycelium which closely resemble bacilli  
634 - 9 By its ability to grow aerobically
- 635 - 1 A chronic or acute granulomatous or suppurative disease in man and animals which may be systemic, resembling tuberculosis or subcutaneous in the form of a mycetoma.  
635 - 2 The causative fungi of nocardiosis are saprophytic in the soil  
635 - 3 *Nocardia asteroides*.  
635 - 4. *Nocardia brasiliensis*  
635 - 5 *Brasiliensis*, *madurae*; *pelletieri*, *Streptomyces*

- 635 - 6 Different tissues of the body are affected, and the grains which are formed will vary considerably in morphology and color, dependent on the species involved
- 635 - 7 Typical findings would be partially acid-fast, Gram-positive, thin-branching mycelium
- 635 - 8 *Nocardia asteroides* (table 2-19)
- 635 - 9 It has been demonstrated that some strains of these organisms lose their viability when subjected to digestive agents
- 635 - 10 The *Nocardia spp* will develop earlier than the tubercle organism
- 635 - 11 The casein hydrolysis and the gelatin test

### CHAPTER 3

- 636 - 1 *Sporotrix schenckii*
- 636 - 2 Work; play
- 636 - 3 The most common form of the disease normally results from implantation of the spores in the subcutaneous tissue during a penetrating injury from a thorn or splinter
- 636 - 4 The course of the disease is characterized by a chainlike lymphatic involvement with swelling of nodes and induration (hardening) of the connecting lymphatics.
- 636 - 5 Some manifestations of disseminated sporotrichosis include the development of numerous and widespread cutaneous lesions. Oral and nasal mucosa involvement is quite common. Lesions may be found in the kidneys, lungs, bones, joints, muscles, genitourinary systems, and other body organs
- 637 - 1 Pus from unopened subcutaneous nodules or from open draining lesions
- 637 - 2 Brain-heart-infusion agar and Sabouraud dextrose agar
- 637 - 3 Brain-heart infusion agar supplemented with 5 or 10 percent blood
- 637 - 4 Smooth, tan, yeastlike.
- 637 - 5 Cigar-shaped (fusiform) cells and round or oval budding cells; occasionally, a few large pyriform cells.
- 637 - 6 Small, moist, white to cream-colored colonies
- 637 - 7 Variations in the oxygen supply and the amount of thiamine in the medium
- 637 - 8 "Sleevelike" and "flowerette "
- 638 - 1 Gomori methenamine-silver stain or periodic acid-Schiff stain (PAS)
- 638 - 2 The flowerette arrangement of the conidia and the hairlike attachments to delicate conidiophores
- 638 - 3 Immunofluorescence
- 639 - 1 Coccidioidomycosis
- 639 - 2 As a saprophyte in the soil, producing innumerable infective spores which are readily born by air currents
- 639 - 3 Arizona, New Mexico, Texas, and the northern portion of Mexico
- 639 - 4 Primary pulmonary coccidioidomycosis and disseminated coccidioidomycosis
- 639 - 5 Primary pulmonary coccidioidomycosis
- 639 - 6 Other areas of the lungs, subcutaneous and cutaneous tissue, bones, joints, meninges, the brain, and the viscera
- 640 - 1 Pus, sputum, pleural fluid, or bronchial washings
- 640 - 2 Examine in direct wet unstained mount for the presence of spherules
- 640 - 3 A non-budding, thick-walled sporangium containing either granular material or numerous small endospores
- 640 - 4 Sabouraud dextrose agar and brain-heart-infusion agar with and without cycloheximide.
- 640 - 5 Moist, flat, and grey. Gradually, an abundant white, fluffy, aerial mycelium develops over the mature colony.
- 640 - 6 Brownish black.
- 640 - 7 Barrel-shaped tagged arthrospores; in a lactophenol-cotton blue preparation.
- 640 - 8 To retard aerosol formation by arthrospores.

- 641 - 1 The use of 0.1 ml of suspension of mycelial growth that is inoculated intratesticularly in a guinea pig or mice if guinea pigs are not available
- 641 - 2 The precipitation test and the complement fixation test
- 641 - 3 The coccidioidin skin test
- 642 - 1 North American blastomycosis and blastomycosis
- 642 - 2 Mississippi; Ohio, Middle
- 642 - 3 By inhalation of infective spores
- 642 - 4 Primary cutaneous, primary pulmonary, chronic cutaneous, and disseminated.
- 642 - 5 The chronic cutaneous form.
- 643 - 1 Sputum or bronchial washings.
- 643 - 2 Urine, gastric washings, spinal fluid, or pleural exudates.
- 643 - 3 For the characteristic budding cells produced by the tissue phase
- 643 - 4 Brain-heart-infusion blood agar and Sabouraud dextrose agar
- 643 - 5 Incubation should be made at room temperature since the yeast phase of *B. dermatitidis* is sensitive to cycloheximide at 35° C.
- 643 - 6 At first moist or membranous, however, an aerial mycelial form rapidly, creating a downy to fluffy deep cream to tan
- 643 - 7 A septate mycelium and nondiscrete conidia round to pyriform in shape ranging from 3 to 5 µm in size.
- 643 - 8 The colonies are typically cream to tan in color and moist to waxlike in appearance.
- 644 - 1 Yeast, tissue phase
- 644 - 2 Margins
- 644 - 3 The typical wide-based, thick-walled, single-budding cells
- 644 - 4 The blastomycin
- 644 - 5 The complement-fixation test
- 645 - 1 Mucous membranes
- 645 - 2 The lungs.
- 645 - 3 The skin and mucocutaneous form
- 645 - 4 The disseminated form
- 646 - 1 Pus or scrapings from lesions, sputum, and other body fluids or aspirated material from infected lymph nodes.
- 646 - 2 Sabouraud dextrose agar and BHI blood agar.
- 646 - 3 Small, heaped, about 20 millimeters in diameter. Most strains form a short, white, velvety aerial mycelium covering the colony surface. Others develop white to cream-colored glabrous colonies which typically are folded irregularly.
- 646 - 4 Only the septate mycelium and chlamydo spores.
- 646 - 5 Yeastlike, cream to tan in color. Some strains present a verrucose and waxy surface while others are smooth and shiny.
- 646 - 6 a Buds are quite small and vary only slightly in size ("steering-wheel" form)  
b Buds vary appreciably in size (as much as 10 µm in length).
- 647 - 1 It is essential to convert the yeast-like growth to the mycelial form or the mycelial type growth to the tissue form
- 647 - 2 Animal inoculation, skin testing, and the complement fixation test
- 647 - 3 Paracoccidioidin.
- 647 - 4 Prognosis, diagnosis
- 648 - 1 F (reticulo endothelial system)
- 648 - 2 F (North America and along the eastern seaboard)
- 648 - 3 T.
- 648 - 4 F (a avian source).
- 648 - 5 F (A rare case progresses to disseminated histoplasmosis)
- 649 - 1 Wright or Giemsa-stained smears
- 649 - 2 Chloramphenicol, not in excess of 0.2 mg/ml.
- 649 - 3 Macrophages and occasionally polymorphonuclear cells
- 649 - 4 SAB agar and BHI blood agar.

- 649 - 5 The yeast or tissue phase will not grow in the presence of antibiotics at 35° C
- 649 - 6 *H. capsulatum* forms a white fluffy colony with the typically fine and silky aerial mycelial
- 649 - 7 Large (7-25 µm in diameter) round to pyriform in shape, thick-walled, and usually having a tuberculated surface
- 649 - 8 Some strains of *H. capsulatum* do not produce tuberculate macroconidia
- 649 - 9 *H. capsulatum* can be converted to its yeast form at 35° C
- 650 - 1 By inoculating some mycelial growth to tubes of BHI blood agar with moist surface and incubating them at 35° C.
- 650 - 2 Small, white to cream colored, round, convex colonies
- 650 - 3 To accomplish conversion of those strains of *H. capsulatum* which will not convert to the yeast phase using the culture technique
- 650 - 4 Infected tissues must be cultured on appropriate media at 35° C in a further attempt to obtain yeast phase growth
- 650 - 5 Epidemiological studies
- 650 - 6 In early diagnosis of the acute pulmonary form of the disease

- (5) a  
(6) b  
(7) b  
(8) c  
(9) c  
(10) c

- 655 - 1 Granulomatous, necrotizing, cavity  
655 - 2 *Fumigatus*  
655 - 3 *Niger*  
655 - 4. Primary pulmonary.  
655 - 5. Pulmonary tuberculosis  
655 - 6 Disseminated aspergillosis.  
655 - 7. a Repeated recovery from clinical materials  
b Absence of pathogenic agents  
c. Positive histologic findings.  
655 - 8 Sputum, bronchial washings, and other body fluids  
655 - 9. Wide, four to six µm in diameter, of a fairly uniform width and septate.  
655 - 10. Sabouraud dextrose agar containing anti-bacterial agents other than cycloheximide and *Aspergillus* Differential Medium.

#### CHAPTER 4

- 651 - 1 (1) a  
(2) a  
(3) a  
(4) e  
(5) e  
(6) d  
(7) d  
(8) f.  
(9) f  
(10) h  
(11) h  
(12) b  
(13) b  
(14) c  
(15) c  
(16) g  
(17) g

- 652 - 1 (1) a  
(2) a  
(3) c  
(4) c  
(5) :  
(6) e  
(7) e  
(8) g  
(9) g  
(10) h  
(11) h  
(12) f  
(13) f  
(14) d  
(15) d  
(16) b  
(17) b

- 653 - 1 (1) c, d  
(2) c  
(3) d  
(4) b  
(5) b  
(6) e  
(7) e  
(8) a  
(9) a

- 654 - 1 (1) d  
(2) d  
(3) d  
(4) a

- 656 - 1 Diabetes mellitus, malnutrition, uremia, amebiasis, prolonged use of antibiotics and steroids  
656 - 2 (a) Cranial-facial, (b) thoracic, (c) abdominal-pelvic, and (d) dermal.  
656 - 3. The cranial-facial.  
656 - 4 The abdominal-pelvic  
656 - 5. Clinical materials aspirated from nasal sinuses or obtained by scrapings of nasal or oral lesions; also, spinal fluids or bronchial washings.  
656 - 6. Broad (6 to 15 µm in diameter), aseptate, branching h y p h a e .  
656 - 7 Sabouraud dextrose agar; 25° C.  
656 - 8. Frozen section, hematoxylin, eosin

- 657 - 1 *Seeberi*.  
657 - 2 It is a chronic, granulomatous mycosis characterized by the development of polyp-like masses primarily of the mucous membranes.  
657 - 3 Mature sporangia.  
657 - 4. The organism has never been cultured.  
657 - 5 Clinical observation and histological examination of biopsied tissue.  
657 - 6 The mature sporangia of *R. seeberi* are considerably greater in size than those of *C. immitis*. Also, the endospore of *R. seeberi* are lobulated and stain darkly while those of *C. immitis* are nonlobulated, and only the endospore wall stains well.

- 658 - 1 *Cladosporium bantianum*  
658 - 2 Brain abscess.  
658 - 3. Brown, aseptate, branched, vesicular Chlamydo-spores  
658 - 4 The surface is velvety and may form radial folds  
658 - 5. Brown septate, chains, conidia.  
658 - 6 Morphologic and physiologic  
658 - 7 *C. bantianum* has a more rapid growth rate; also, by the extreme length of its spore chains, the development of longer conidia, and its ability to grow at temperatures as high as 42° to 43° C

#### CHAPTER 5

- 659 - 1 Host-range, type of tissue affected, host-response and type lesion produced, animal viruses, insect viruses, plant viruses, bacteriophages, respiratory viruses  
659 - 2 Physicochemical.  
659 - 3 Deoxyribonucleic acid (DNA) and ribonucleic acid (RNA).  
659 - 4 Capsomeres.  
659 - 5 Table 5-1: RNA; cubic  
659 - 6 Table 5-1: Picornaviruses and Coronaviruses  
659 - 7 Table 5-1: Herpesviruses

- 659 - 8 They have a multifaceted, diamond-shaped capsid surrounding a nucleic acid core (8) i
- 659 - 9 Nucleocapsid; spiral or helical (9) b
- 660 - 1 Viruses and rickettsiae are inert outside of a susceptible host. Viruses can only reproduce if they are able to penetrate a cell and then redirect host cell functions so that new virus particles are formed. Because the intracellular environment of a host is necessary, we speak of the virus as an obligate parasite. (10) b
- 660 - 2 Arthropod, ticks, lice; mites (11) d
- 660 - 3 Plants, lower animals, humans, arthropods, and bacteria (12) h
- 660 - 4 A large group of obligate intracellular parasites closely related to gram-negative bacteria. (13) h
- 660 - 5 a Nucleic acid type; (b) size and morphology, (c) susceptibility to physical and chemical agents, (d) absence of enzymes; (e) immunologic properties; (f) natural methods of transmission; and (g) host, tissue, and cell tropisms. (14) g
- 660 - 6 Bacterial, molecules
- 660 - 7 Table 5-2. Poxvirus 230 x 300  $\mu\text{m}$  (diameter x length) is larger. Herpesvirus 110—200 nm (approximate diameter)
- 660 - 8 None.
- 660 - 9 Table 5-3 viruses
- 660 - 10 Viruses
- 661 - 1 Although viruses may differ in morphology, depending upon the conditions under which they are grown in the laboratory, the basic design common to all is a core of nucleic acid surrounded by a protein shell.
- 661 - 2 The intracellular phase of reproduction and the extracellular stage in which the virus exists inertly in the external environment.
- 661 - 3 The mature, infectious unit often referred to as the "elementary body" or simply as the "virus particle"
- 661 - 4 (a) The icosahedron (cubic), (b) the helical, (c) the complex-enveloped.
- 661 - 5 The arrangement of the protein molecules that make up the capsid or protein coat
- 661 - 6 It is enclosed by a loose covering envelope, and because the envelope is nonrigid, the virus is highly variable in size and shape
- 661 - 7 The poxviruses and some of the bacteriophages
- 661 - 8 The capsid appears to be a spherical, single layer of protein composed of smaller morphological units or capsomeres. The capsid is an icosahedron (20-sided figure) inside which the nucleic acid is coiled
- 661 - 9 Rod
- 661 - 10. Stabilizes the nucleic acid, presumably keeping this nuclear substance inert in the virus until a host cell is invaded
- 661 - 11 It is antigenic, thus serving to stimulate the formation of immune substances (antibodies) in the host, and accounting for the immunological specificity.
- 662 - 1 (a) Virus enters cell, (b) host cell synthesizes new virus components, (c) components are assembled into particles, (d) mature virus is released
- 662 - 2 The nucleic acid core separates from the protective capsid
- 662 - 3 The nucleic acid core of the virion contains the genetic code to be used by the host cell in manufacturing virus proteins, nucleic acid, and all other components built into new virus particles
- 662 - 4 (a) Cell degeneration, (b) tumor formation or (c) steady state infection
- 662 - 5 The formation of small, round, or oval bodies known as inclusion bodies
- 662 - 6 Papillomas of cattle and other animals, as well as human warts
- 663 - 1 (1) e  
(2) f  
(3) j  
(4) a  
(5) k  
(6) c  
(7) c
- 664 - 1 (1) d  
(2) a  
(3) b, e  
(4) b, f  
(5) b  
(6) c  
(7) g  
(8) h
- 665 - 1 The rickettsiae are metabolically active
- 665 - 2 Q-fever organisms
- 665 - 3 Viruses; smaller, bacteria, cells
- 665 - 4 A. true bacteria. Thin sections show all of the structural features of bacteria and possess most of the enzymes of bacteria and a typical bacterial cell wall
- 665 - 5 Pleomorphic, forming cocci, bacilli, and filaments
- 665 - 6 *R. prowazekii*, the body louse.
- 665 - 7 *R. rickettsii* and *R. conorii*
- 665 - 8 Table 5-5 men, horses, dogs, and rodents
- 665 - 9 Table 5-5 a wide variety of domestic animals and birds
- 665 - 10 Blood, sputum, urine, and in some cases spinal fluid
- 666 - 1 Obligately; viruses
- 666 - 2 Negative, intracellular, host
- 666 - 3. Rickettsiae.
- 666 - 4 Spherical.
- 666 - 5 Acidophilic, acidophilic
- 666 - 6 Birds
- 666 - 7 Via the respiratory route in dressing poultry or by inhaling the agent in dust contaminated with droppings
- 666 - 8 Pneumonia-like.
- 666 - 9 Genital organs
- 666 - 10. Through sexual contact
- 666 - 11 From pus or fluids taken from the surface lesion or bubo (swollen, infected lymph gland)
- 666 - 12 *Chlamydia trachomatis*
- 666 - 13 The genital tract
- 666 - 14 "Non-gonococcal urethritis" (NGU) or "as non-specific urethritis" (NSU)
- 667 - 1 The nature of the illness
- 667 - 2 A wide range of agents may be responsible for similar syndromes
- 667 - 3 Information should be given in the form of a brief clinical history
- 667 - 4 Convalescent serum is collected 2 to 3 weeks after onset of symptoms
- 667 - 5 The time lapse after infection permits antibodies to the virus to be formed. These antibodies can be detected and measured as an aid in diagnosis
- 668 - 1 Many viruses tend to be localized in certain tissues at one point in the disease process, although they may be disseminated throughout the body at other specific times
- 668 - 2 As soon as possible, no later than 5 to 7 days
- 668 - 3 This prevents hemolysis which may interfere with some tests
- 668 - 4 14 to 21 days
- 668 - 5 It is diagnostically significant with a fourfold increase or more
- 668 - 6 A heparinized blood specimen is obtained. Such blood samples require co-culture of blood leukocytes in tissue culture
- 668 - 7 Frozen at  $20^{\circ}$  or  $-70^{\circ}$  C
- 668 - 8 Stool specimen should be refrigerated or frozen without preservative

668 - 9 Hanks balanced salt solution (BSS) with gelatin  
668 - 10 Throat washings.  
668 - 11 Tryptose-phosphate broth  
668 - 12 By rubbing a dry cotton swab on the posterior pharynx  
The swab tip should be broken and placed into a sterile  
broth medium  
668 - 13 So that it absorbs as much secretion as possible  
668 - 14 Base, ether-alcohol, 5

669 - 1 Low  
669 - 2 Refrigerated and packed in shaved ice for delivery to the  
laboratory within 12 hours of collection  
669 - 3 Freeze the specimen below -40° C or preferably -70° C  
669 - 4 Dry ice releases CO<sub>2</sub> gas which can lower pH and inactivate  
some viruses  
669 - 5 Should not  
669 - 6 Freeze immediately or keep at -40° C

610



90412 04 S01 8201

SUPPLEMENTARY MATERIAL

CDC 90412

**MEDICAL LABORATORY  
TECHNICIAN - MICROBIOLOGY**

(AFSC 90470)

Volume 4

Foldouts 1-3



Extension Course Institute

Air Training Command

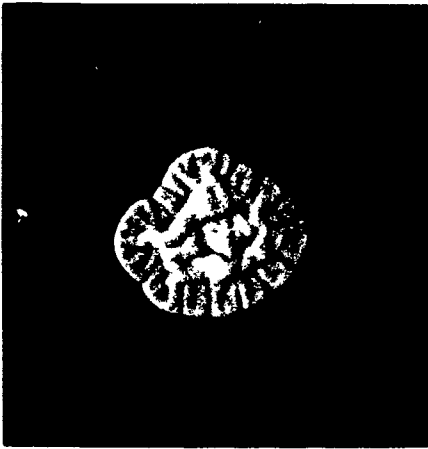

A-1 *Sporotrichum schenckii*  
(mold)



A-2 *Sporotrichum schenckii*  
(yeast)



B *Candida albicans*



F-4 *Microsporum canis*  
(rear)

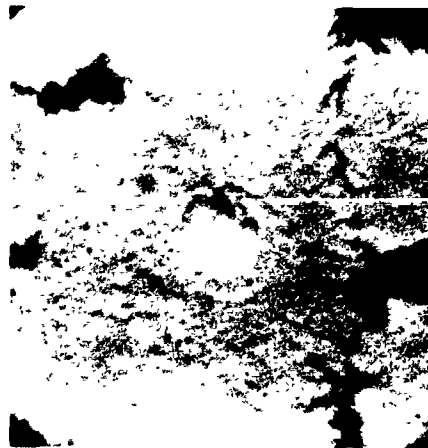

F-5 *Microsporum gypseum* (front)



F-6 *Microsporum gypseum* (rear)

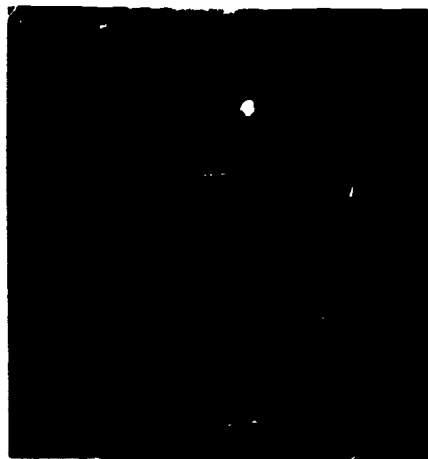

F-13 *Trichophyton tonsurans* (rear)



F-14 *Trichophyton violaceum* (front)

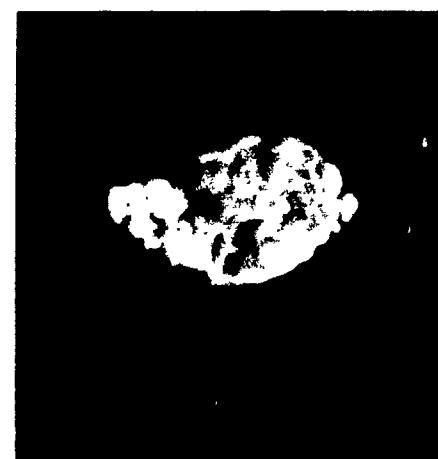

F-15 *Trichophyton schoenleinii* (front)

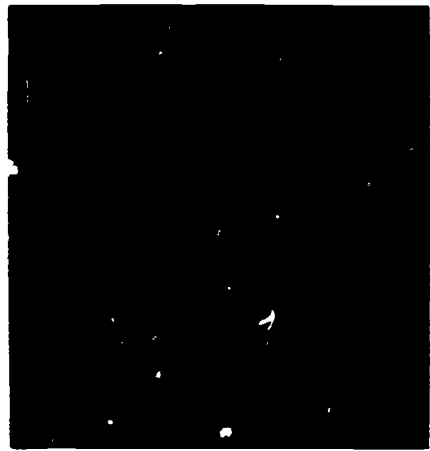

C *Cryptococcus neoformans*

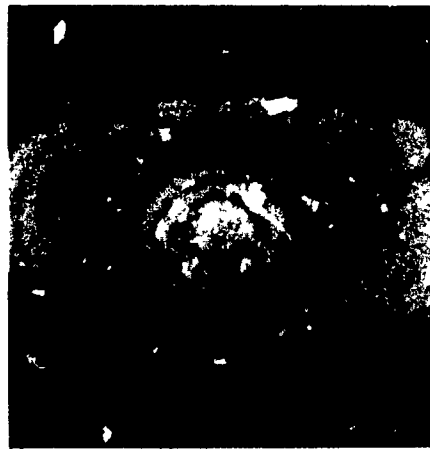

D *Geotrichum candidum*



E *Trichosporon cutaneum*

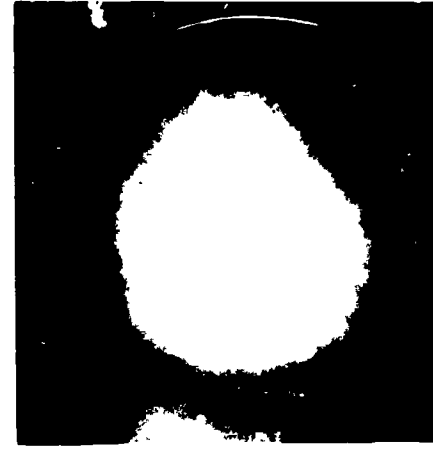

F-1 *Microsporium audouinii* (front)

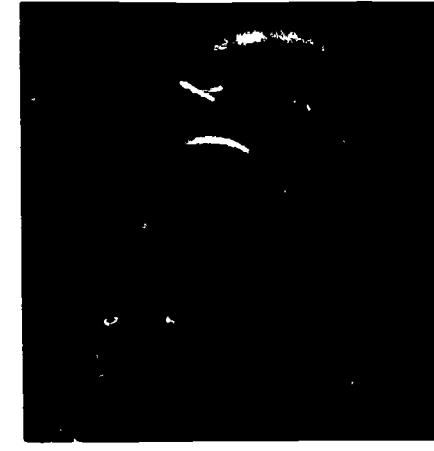

F-2 *Microsporium audouinii* (rear)



F-3 *Microsporium canis* (front)



F-7 *Trichophyton mentagrophytes* (fluffy) (front)



F-8 *Trichophyton mentagrophytes* (fluffy) (rear)



F-9 *Trichophyton verrucosum* (front)



F-10 *Trichophyton rubrum* (front)



F-11 *Trichophyton rubrum* (rear)

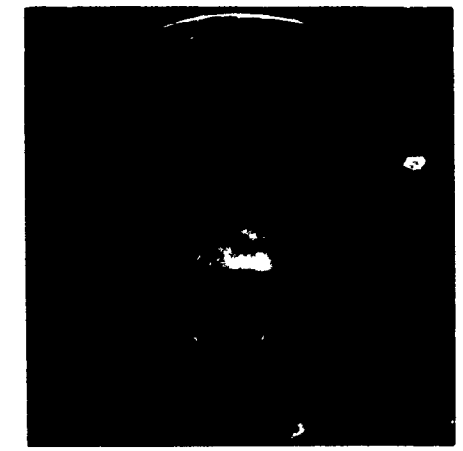

F-12 *Trichophyton tonsurans* (front)



F-16 *Trichophyton schoenleinii* (rear)

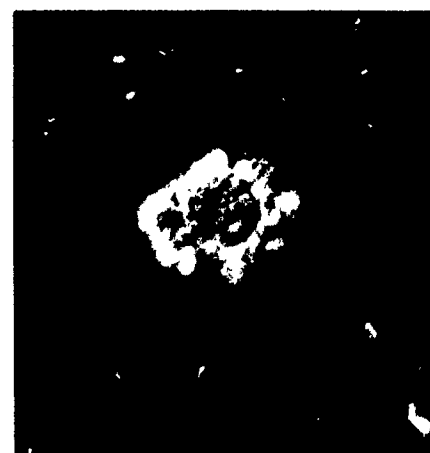

F-17 *Epidermophyton floccosum*



F-18 *Keratinomyces ajelloi*



A-1 *Allescheria boydii*



A-2 *Phialophora jeanselmei*

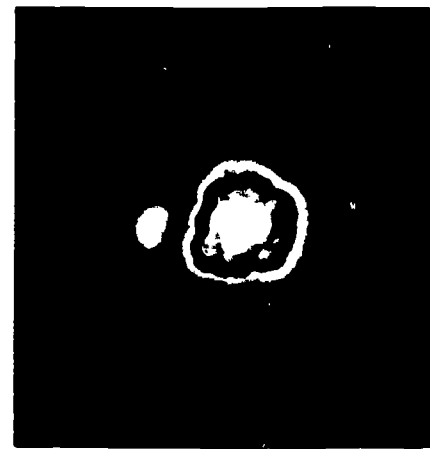

A-3 *Madurella grisea*



E-1 *Paracoccidioides brasiliensis* (mold)

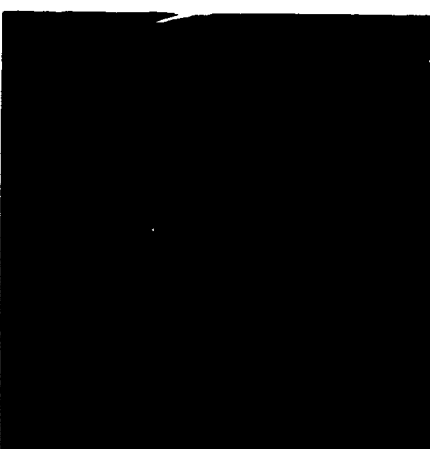

E-2 *Paracoccidioides brasiliensis* (yeast)

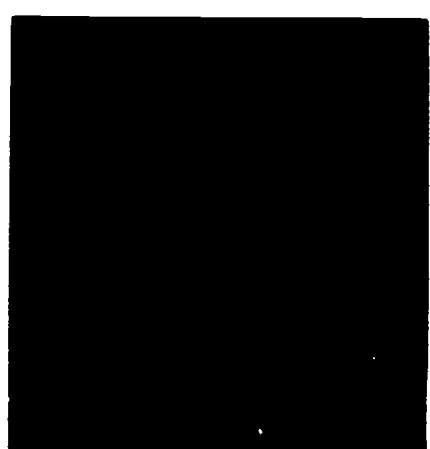

F-1 *Histoplasma capsulatum* (mold)

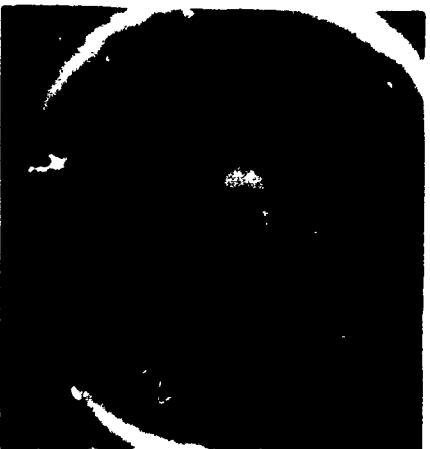

G-3 *Curvularia* sp.

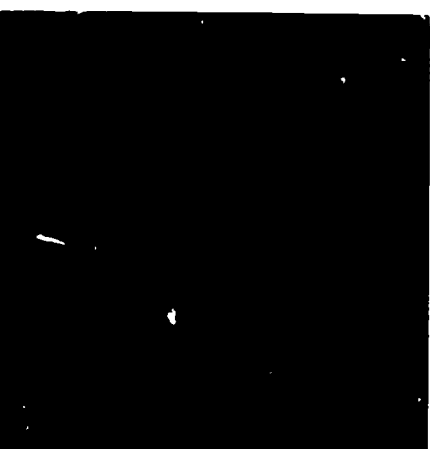

G-4 *Fusarium* sp.



G-5 *Helmenthosporium* sp.

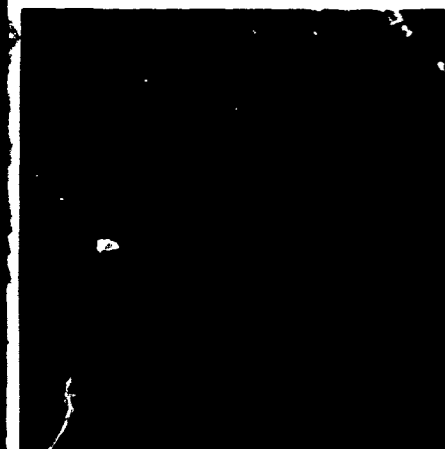

A-4 *Madurella mycetomii*

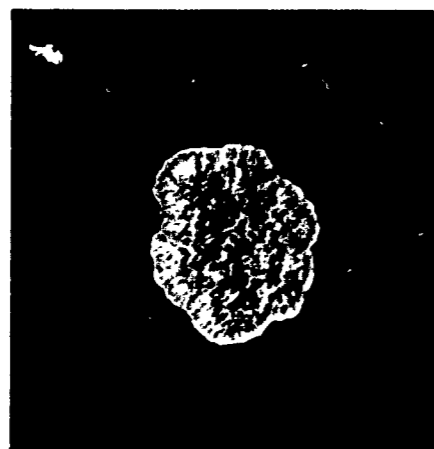

B-1 *Nocardia brasiliensis*

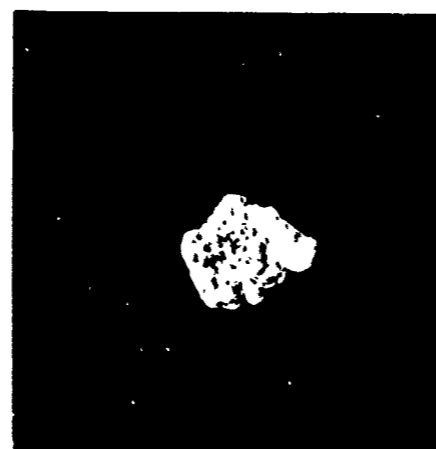

B-2 *Streptomyces* sp.



C *Coccidioides immitis*



D-1 *Blastomyces dermatitidis* (mold)

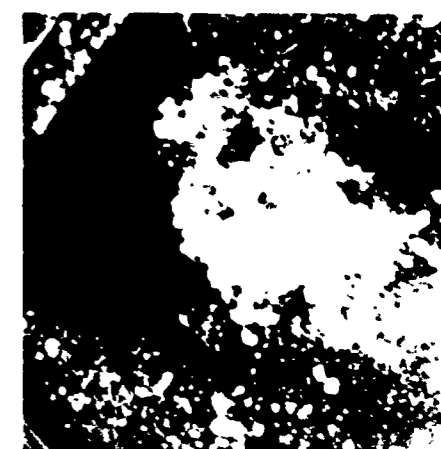

D-2 *Blastomyces dermatitidis* (yeast)

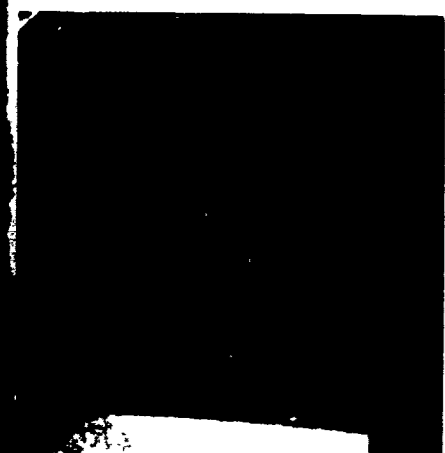

F-2 *Histoplasma capsulatum* (yeast)

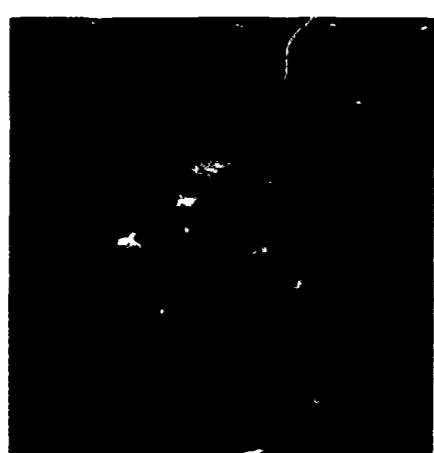

G-1 *Alternaria* sp.

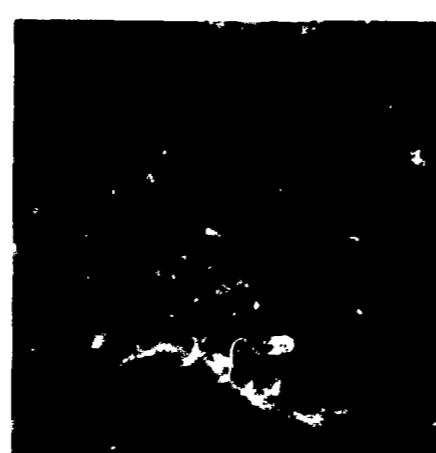

G-2 *Cephalosporium* sp.

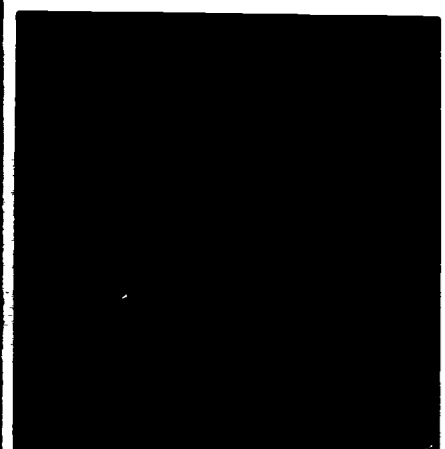

G-6 *Nigrospora* sp.

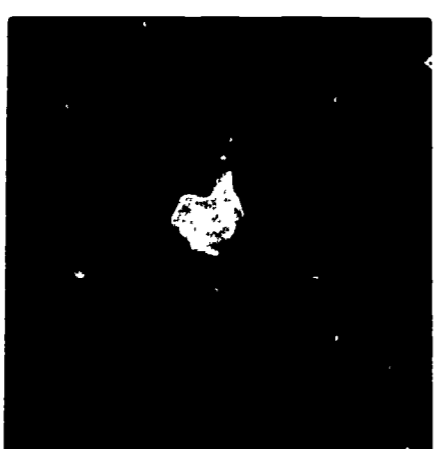

G-7 *Scopulariopsis* sp.

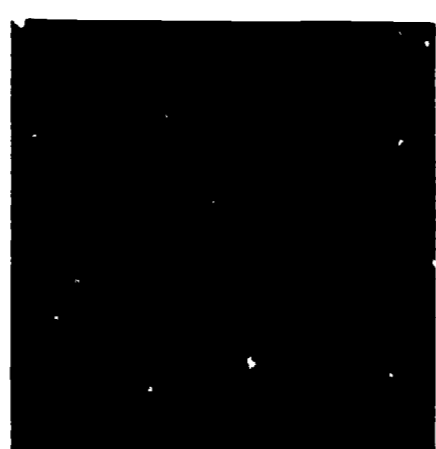

G-8 *Sepedonium* sp.

FOLDOUT 2

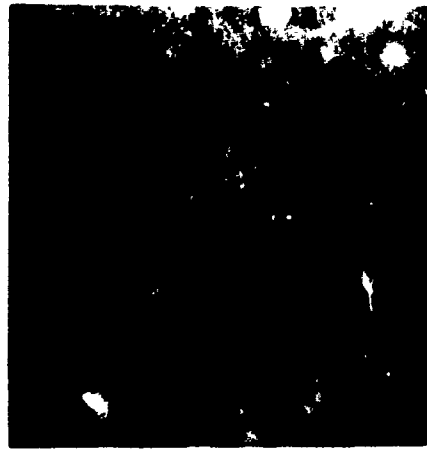

A-1 *Aspergillus clavatus*



A-2 *Aspergillus fumigatus*



A-3 *Aspergillus glaucus*

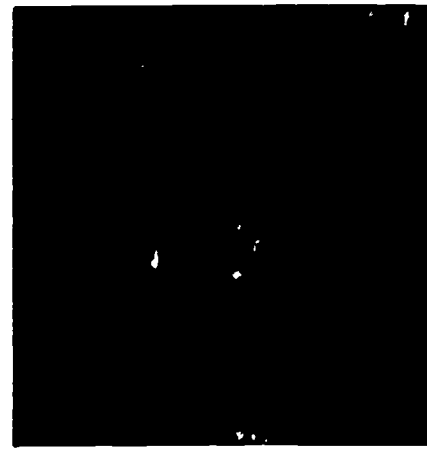

A-4 *Aspergillus niger*

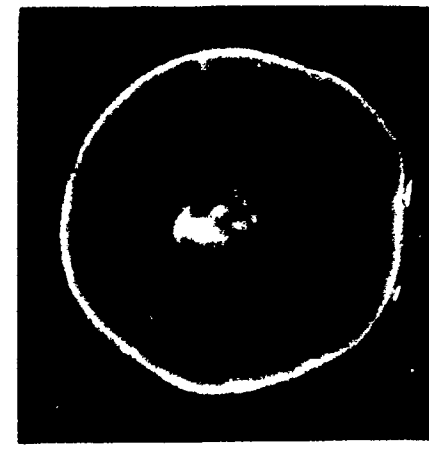

A-5 *Cladosporium* sp.



A-6 *Paecilomyces* sp.

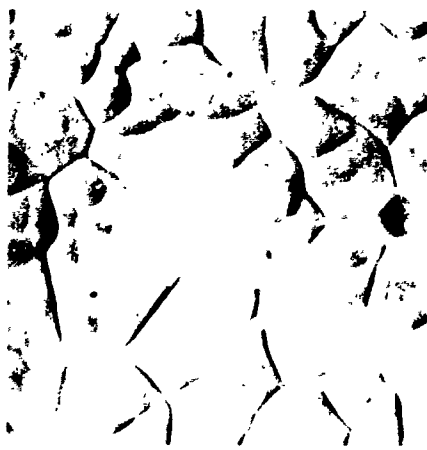

A-7 *Penicillium frequentans*

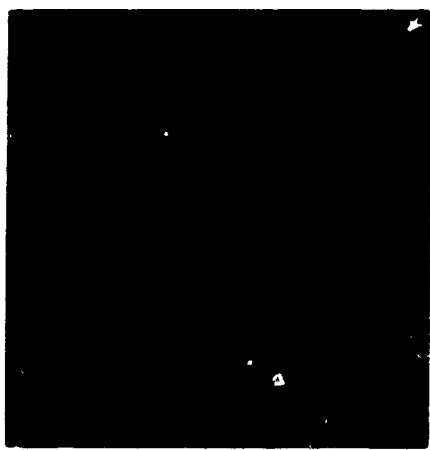

A-8 *Trichoderma* sp.



B-1 *Aureobasidium pullulans*

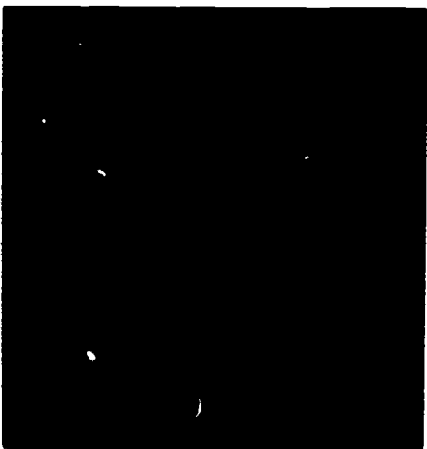

B-2 *Geotrichum* sp.

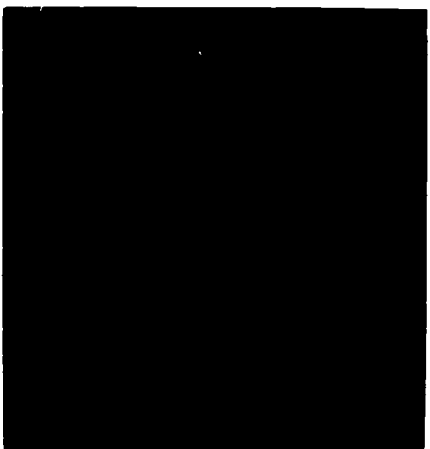

B-3 *Rhodotoruia* sp.



B-4 *Streptomyces* sp.

FOLDOUT 3

619



S T O P -

1. MATCH ANSWER SHEET TO THIS EXERCISE NUMBER.
2. USE NUMBER 2 PENCIL ONLY.

EXTENSION COURSE INSTITUTE  
VOLUME REVIEW EXERCISE

90412 04 22  
LABORATORY PROCEDURES IN CLINICAL MYCOLOGY

Carefully read the following:

DO's:

1. Check the "course," "volume," and "form" numbers from the answer sheet address tab against the "VRE answer sheet identification number" in the righthand column of the shipping list. If numbers do not match, return the answer sheet and the shipping list to ECI immediately with a note of explanation.
2. Note that item numbers on answer sheet are sequential in each column.
3. Use a medium sharp #2 black lead pencil for marking answer sheet .
4. Write the correct answer in the margin at the left of the item. (When you review for the course examination, you can cover your answers with a strip of paper and then check your review answers against your original choices.) After you are sure of your answers, transfer them to the answer sheet. If you have to change an answer on the answer sheet, be sure that the erasure is complete. Use a clear eraser. But try to avoid any erasure on the answer sheet if at all possible.
5. Take action to return entire answer sheet to ECI.
6. Keep Volume Review Exercise booklet for review and reference.
7. If mandatorily enrolled student, process questions or comments through your unit trainer or OJT supervisor. If voluntarily enrolled student, send questions or comments to ECI on EC Form 17.

DON'Ts:

1. Don't use answer sheets other than one furnished specifically for each review exercise.
2. Don't mark on the answer sheet except to fill in marking blocks. Double marks or excessive markings which overflow marking blocks will register as errors.
3. Don't fold, spindle, staple, tape, or mutilate the answer sheet.
4. Don't use ink or any marking other than a #2 black lead pencil.

NOTE: NUMBERED LEARNING OBJECTIVE REFERENCES ARE USED ON THE VOLUME REVIEW EXERCISE. In parenthesis after each item number on the VRE is the Learning Objective Number where the answer to that item can be located. When answering the items on the VRE, refer to the Learning Objectives indicated by these Numbers. The VRE results will be sent to you on a postcard which will list the actual VRE items you missed. Go to the VRE booklet and locate the Learning Objective Numbers for the items missed. Go to the text and carefully review the areas covered by these references. Review the entire VRE again before you take the closed-book Course Examination.

90412 04 22

## MULTIPLE CHOICE

Note to Student: Consider all choices carefully and select the best answer to each question.

1. (600) Which of the following classes of true fungi include the rusts, smuts, fleshy mushrooms, and is contained in poisonous mushrooms?
  - a. Ascomycetes.
  - b. Basidiomycetes.
  - c. Deuteromycetes.
  - d. Phycomycetes.
2. (601) The vegetative phase of the fungi is characterized by which of the following microscopic morphologies?
  - a. Round, segmented spores.
  - b. Round, branching filaments.
  - c. Elongated, segmented spores.
  - d. Elongated, branching filaments.
3. (602) The two specified environmental conditions which could activate the reproductive phase of the fungi life cycle are
  - a. constant temperature and lack of nourishment.
  - b. temperature variations and lack of nourishment.
  - c. constant temperature and abundance of nourishment.
  - d. temperature variations and abundance of nourishment.
4. (602) The spore serves all of the following important functions except
  - a. mutation of the species.
  - b. dispersal to new substrata.
  - c. duplication of the species.
  - d. protection from adverse environmental conditions.
5. (602) Almost all the medically important fungi belong to which of the following classes?
  - a. Ascomycetes.
  - b. Basidiomycetes.
  - c. Deuteromycetes.
  - d. Phycomycetes.
6. (603) Fungi grow best at which of the following pH ranges?
  - a. Acid pH, normally around 3.5.
  - b. Acid pH, normally around 5.6.
  - c. Alkaline pH, normally around 6.5.
  - d. Alkaline pH, normally around 6.8.

90412 04 22

7. (604) A group of fungi capable of multiplying at 35° C in the form of the monomorphic yeasts and at 25° C in the form of the monomorphic molds are known as the
- a. dimorphic fungi.
  - b. dimorphic yeasts.
  - c. monomorphic fungi.
  - d. monomorphic yeasts.
8. (605) Candidiasis is an example of which of the following types of mycosis?
- a. Systemic.
  - b. Subcutaneous.
  - c. Cutaneous or systemic.
  - d. Subcutaneous or systemic.
9. (606) If fungal elements are not observed in a 10 percent KOH mount of clinical material, the specimen should be routinely
- a. cultured in thio at 37° C.
  - b. inoculated to blood and EMB agars.
  - c. reported as negative and discarded.
  - d. inoculated to mycobiologic or Mycosel and Sabouraud's agars.
10. (606) The suspected area of the patient's scalp is examined under a Wood's lamp to detect
- a. hairs that fluoresce with a bright, yellow-green color.
  - b. rings in the scalp that fluoresce with a bright, yellow-green color.
  - c. hairs that fluoresce with a bright, orange-purple color.
  - d. rings in the scalp that fluoresce with a bright, yellow-green color.
11. (606) The India ink wet mount will reveal the encapsulated budding or nonbudding blastospores of which of the following species?
- a. Cryptococcus neoformans.
  - b. Histoplasma capsulatum.
  - c. Nocardia species.
  - d. Trichophyton species.
12. (607) How many times a week should fungus cultures be examined?
- a. Once or twice.
  - b. At least two.
  - c. At least three.
  - d. Four or more.
13. (607) Fungus cultures should be incubated at what optimal temperature and for what minimum number of days before discarding as negative, respectively?
- a. 25° C.; 25 days.
  - b. 30° C.; 30 days.
  - c. 35° C.; 25 days.
  - d. 35° C.; 30 days.

14. (608) Labeling information needed by the reference laboratory obtaining fungus cultures would least include which of the following?
- Organism suspected.
  - Name of the submitting facility.
  - The patient's name, age, and sex.
  - Antibiotics given to the patients.
15. (609) All of the following are advantages in using culture tubes over petri dishes for fungus cultures except
- easy storage.
  - safer for small labs.
  - lower dehydration rate.
  - better aeration of cultures.
16. (610) Before collecting skin scrapings from KOH mount, the lesion area is thoroughly washed with 70 percent alcohol for which of the following reasons?
- To destroy fungus contaminants.
  - To ensure a pure culture of pathogens.
  - To destroy all saprophytic bacteria and fungi.
  - To remove dirt particles, bacteria, and medication.
17. (610) If the wire loop is used for mixing spinal fluid and ink in the India ink mount, the wire loop should be allowed to cool sufficiently for which of the following reasons?
- To enhance precipitation of capsule.
  - To enhance the chances of spore viability.
  - To prevent precipitation of the ink by the heat.
  - To prevent destruction of the capsule by the heat.
18. (611) An acid-fast stain is used to detect the partially acid-fast hyphal segments of which of the following genera?
- Nocardia.
  - Actinomyces.
  - Streptomyces.
  - Mycobacteria.
19. (612) What two media are widely used for primary isolation of dermatophytes, saprobic, and pathogenic fungi?
- Mycosel agar and mycobiotic agar.
  - Mycosel or mycobiotic and blood agar.
  - Sabouraud's 2 percent dextrose and blood agar.
  - Mycosel agar and Sabouraud's 2 percent dextrose agar.
20. (612) It has been recommended that the mold form of the fungus cultures be initially recovered at what two incubated temperatures?
- 20° or 25° C.
  - 25° or 30° C.
  - 30° or 37° C.
  - 35° or 37° C.

90412 04 22

21. (612) When microscopically examining a fungus culture, all of the following characteristics should be observed except
- a. growth rate.
  - b. surface topography.
  - c. Mycelial structure.
  - d. front and reverse pigmentation.
22. (613) Slide cultures for monomorphic mold permit the microscopic observation of what specific characteristic?
- a. Formation of spores at 30° C.
  - b. Formation of spores at 37° C.
  - c. Undisturbed relationship of spores to hyphae.
  - d. Undisturbed relationship of spaces to mycelia.
23. (614) For identification purposes, it would be safe to set up slide cultures on which of the following organisms?
- a. Candida albicans.
  - b. Coccidioides immitis.
  - c. Histoplasma capsulatum.
  - d. Blastomyces dermatitidis.
24. (615) When using normal HCL to obtain bacteria-free cultures, which of the following tubes of Sabouraud dextrose broth is used for inoculation to a blood plate?
- a. The tube incubated at 30° C. and showing bacterial growth.
  - b. The tube incubated at 30° C. and showing no bacterial growth.
  - c. The tube showing bacterial growth after overnight incubation at 35° C.
  - d. The tube showing no bacterial growth after overnight incubation at 35° C.
25. (616) Which of the following reasons is given for the significant increase of Candida in systemic infections?
- a. A high carbohydrate diet.
  - b. Long hot summers causing profuse sweating.
  - c. The decrease in the use of steroids and antibiotics over the years.
  - d. The therapeutic use of steroids and antibiotics over extended periods.
26. (616) Which of the following conditions would most likely be responsible when drug addicts often contract endocardial candidiasis?
- a. High body temperatures.
  - b. Constant low body temperatures.
  - c. Failure to use sterilized needles and syringes.
  - d. Failure to adequately sterilize the drugs they use.

27. (617) Which of the following growth appearances best describes young colonies of Candida on Sabouraud dextrose agar?
- Pink, soft, and generally have smooth surface and borders.
  - White, soft, and generally have smooth surface and borders.
  - Pink, soft, and generally have rough, wrinkled surface and borders.
  - White, soft, and generally have rough, wrinkled surface and borders.
28. (617) According to the text, which of the following tests is considered to be the most rapid and currently preferred test for identification of Candida albicans?
- Germ tube test.
  - India ink test.
  - Carbohydrate Assimilation test.
  - Carbohydrate Fermentation test.
29. (617) In the Carbohydrate Assimilation, what condition indicates that the carbohydrate included within the medium has been utilized by the organism being tested?
- Growth either in the carbohydrate or on the discs.
  - Growth either in the medium or adjacent to the discs.
  - A pH change either in the carbohydrate or in the discs.
  - A pH change either in the medium or adjacent to the discs.
30. (618) What technique is routinely used to detect C. neoformans in clinical material?
- Scotch tape mount.
  - Slide culture mount.
  - India ink wet mount.
  - Lactophenol-cotton blue mount.
31. (618) When a technician obtains a positive urease test in attempting to identify a member of the yeast, a member of which of the following genus is present?
- Nocardia.
  - Coccidoides.
  - Histoplasma.
  - Cryptococcus.
32. (619) What two sugars does G. candidum assimilate?
- Glucose and xylose.
  - Glucose and trehalose.
  - Dextrose and xylose.
  - Dextrose and trehalose.
33. (620) Which of the following organisms is responsible for white piedra?
- Piedra hortai.
  - Malessizia furfur.
  - Pityrosporum ovale.
  - Trichosporon cutaneum.

90412 04 22



34. (621) Pityrosporum ovale is readily distinguished from the other yeastlike fungi by which of the following microscopic features?
- Conidia are absent.
  - Conidia are present.
  - Bud is attached to the mother cell by a cross-wall.
  - Bud is separated from the mother cell by a cross-wall.
35. (622) Which of the following surface color closely resembles that of Piedra hortai?
- Dark orange to brown.
  - Shiny, dark-brownish.
  - Dark, greenish-black to black.
  - Shiny, dark greenish-brown to black.
36. (622) Microscopic examination of the hair infected with Piedra hortai will reveal what structures?
- Dark, branched, septate hyphae.
  - Branching, septate hyphae and thick-walled spores.
  - Many blastospores with one to three celled conidia.
  - Many oval asci containing 2-8 ascospores incased in a darkly pigmented mycelium.
37. (623) Which of the following appearances best describes Cladosporium wernickii in 10 percent KOH mounts from suspected lesions?
- Gray to black arthrospores.
  - Gray to brown blastospores.
  - Pigmented black or dark brown branched hyphae.
  - Pigmented green or dark green branched hyphae.
38. (624) A more accurate diagnosis of tinea versicolor is dependent on
- fluorescence under ultraviolet light.
  - growth characteristics on a slide culture
  - colony characteristics on artificial media.
  - direct microscopic examination in KOH wet mount.
39. (625) How does M. audouinii appear under the ultraviolet light?
- It will fluoresce a bright reddish-orange.
  - It will fluoresce a bright yellowish-green.
  - It will not fluoresce, but show a reddish-orange.
  - It will not fluoresce, but show a bright yellowish-green.

40. (625) If M. audouinii is present, what colony characteristics would be observed on Sabouraud dextrose agar containing chloramphenicol and cycloheximide?
- Fast growing, cottony with whitish to red surface.
  - Fast growing, velvety with whitish-tan to brownish surface.
  - Slow growing, velvety with whitish-tan to brownish surface.
  - Slow growing, cottony with whitish-tan to brownish surface.
41. (626) Which of the following observations from a wet mount best describes the macroconidia of M. canis?
- Ellipsoid, long and slender and 3- to 9-celled.
  - Clavate in shape and borne sessile on the hyphae.
  - Ellipsoid, short, and broad and 3- to 9-celled; have thin echinulated walls.
  - Spindled shaped, 8- to 15-celled; often terminate in a distinct knob.
42. (626) How does M. canis first appear on Sabouraud dextrose agar with antibiotics?
- Growth is rapid; colony will first be white to yellow.
  - Growth is rapid; colony will first be yellow to tan.
  - Growth is slow; colony will first be white to yellow.
  - Growth is slow; colony will first be yellow to tan.
43. (627) Which of the following cultural characteristics best describes M. gypseum?
- Colony is flat, with regular borders, surface pigments red to deep purple.
  - Colony is heaped, with irregular fringed borders, surface pigment red to deep purple.
  - Colony is heaped, with irregular fringed borders, surface pigment tan to cinnamon brown.
  - Colony is flat, with irregular fringed borders, surface pigment, tan to cinnamon brown.
44. (628) From the standpoint of disease severity, granular T. mentagrophytes differ from downy T. mentagrophytes
- in the granular variety being avirulent.
  - in the downy variety being more virulent.
  - only in the downy variety's rate of growth.
  - in the granular variety being more virulent.

45. (629) Skin scrapings of E. floccosum could be cultured on Sabouraud dextrose agar
- with or without antibiotics.
  - with 10 percent potassium hydroxide.
  - with antibiotics on highly virulent strains.
  - without antibiotics on weaker strains only.
46. (630) Which of the following growth characteristics best describes the appearance of Keratinomyces ajelloi on Sabouraud dextrose agar?
- Growth: rapid; texture: powdery; topography: flat; and surface pigment: cream to tan.
  - Growth: slow; texture: cottony; topography: flat; and surface pigment: orange tan.
  - Growth: rapid; texture: cottony; topography: flat; and surface pigment: cream to pink.
  - Growth: slow; texture: powdery; topography: flat; and surface pigment: white cream to pink.
47. (631) Material suspected of chromoblastomycosis should be placed on what medium and incubated at what temperature?
- Cornmeal agar with antibiotics and incubated at 35° C.
  - Sabouraud dextrose agar with antibiotics and incubated at 35° C.
  - Cornmeal agar with antibiotics and incubated at room temperature.
  - Sabouraud dextrose agar with antibiotics and incubated at room temperature.
48. (631) Microscopic examination of teased mounts, made from culture, aids in specie identification of chromoblastomycotic agents by exhibiting the type or predominating type of
- hyphae present.
  - mycelia present.
  - sporulation present.
  - reproductive hyphae.
49. (631) Which of the following is not a type of sporulation demonstrated by the species causing chromoblastomycosis?
- Fonsecaea.
  - Acrotheca.
  - Phialophora.
  - Cladosporium.
50. (632) Mycetomas caused by the maduromycotic fungi may be distinguished from those caused by the Actinomyces and Nocardia spp. on the basis of hyphal diameter and
- Clinical symptoms.
  - "grain" production.
  - "grain" characteristics.
  - Chlamyospore production.

90412 04 22

51. (632) Cycloheximide should not be incorporated in the media when culturing for suspected maduromycotic agents for which of the following reasons?
- Cycloheximide will cause an overgrowth of the fungi.
  - Mutation may result from addition of this antibiotic.
  - Some of these fungi are sensitive to this antibiotic.
  - Cycloheximide will cause an overgrowth of contaminants.
52. (632) Which of the agents of maduromycosis depicts a macroscopic morphology of slow-growing colonies, black, at first moist with skinlike surface; becomes covered with grayish velvety aerial mycelium; and is black on reverse?
- Phialophora jeanselmei.
  - Madurella mycetomii.
  - Allescheria boydii.
  - Cephalosporium.
53. (633) Abdominal actinomycosis is a definite threat in wounds of the intestinal wall because A. israelii is often present asymptotically
- on the skin.
  - in the human intestines.
  - on the tonsillar crypts.
  - on the gingiva and teeth of normal individuals.
54. (634) What type of growth environment and medium are required for the primary isolation of Actinomyces israelii and Actinomyces bovis?
- Aerobic and brain-heart-infusion broth agar.
  - Anaerobic or microaerophilic and Sabouraud dextrose agar.
  - Aerobic and Sabouraud dextrose agar or thioglycollate broth.
  - Anaerobic or microaerophilic and brain-heart-infusion blood agar.
55. (635) Actinomycotic mycetoma may result from injuries contaminated with all of the following organisms except
- Nocardia brasiliensis.
  - Nocardia asteroides.
  - Streptomyces somaliensis.
  - Streptomyces madurae.
56. (636) Typical findings on the microscopic examination of stained, crushed grains from a case of nocardiosis will most likely show
- acid-fast, gram-positive, club-shaped hyphae.
  - acid-fast, gram-negative, club-shaped hyphae.
  - partially acid-fast, gram-positive, thin-branching mycelium.
  - partially acid-fast, gram-negative, thin-branching mucelium.

90412 04 22

57. (635) When culturing for N. asteroides or N. brasiliensis, why is it necessary to inoculate the media prior to and following concentration and digestion techniques?
- Some strains lose their viability when subjected to digestive agents.
  - Some strains become extremely viable when subjected to digestive agents.
  - Most contaminants become extremely viable when subjected to digestive agents.
  - Most contaminants lose their viability when subjected to digestive agents.
58. (635).What difference is there in the growth rate between a Nocardia spp. and M. tuberculosis when incubated at 37° C. on media normally used to isolate M. tuberculosis?
- M. tuberculosis will not grow at 37° C.
  - M. tuberculosis will develop earlier than the Nocardia spp.
  - Nocardia spp. will develop earlier than the tubercle organism.
  - Nocardia spp. will not grow on media normally used to isolate M. tuberculosis.
59. (636) In a few cases, sporotrichosis may spread throughout the body by what means?
- Innumerable skin lesions.
  - Through the digestive system.
  - Transmission through parasitic or yeast forms.
  - Via the bloodstream or as a result of suppurating lymph nodes.
60. (637) What two given media are used for culture of S. schenckii?
- Sabouraud dextrose agar and Ceserin agar.
  - Sabouraud dextrose agar and Cornmeal agar.
  - Brain-heart-infusion agar and Cornmeal agar.
  - Brain-heart-infusion agar and Sabouraud dextrose agar.
61. (637) What two conditions are responsible for considerable variation in colony pigmentation in different strains of S. schenckii or even in the same strains?
- Variations in the oxygen supply and the amount of thiamine in the medium.
  - Variations in the oxygen supply and the amount of peptone in the medium.
  - Variations in the nitrogen supply and the amount of thiamine in the medium.
  - Variations in the nitrogen supply and the amount of peptone in the medium.

62. (638) What stains are used in the identification of S. schenckii in bloody fluids or tissue specimens?
- Comori Methenamine-silver or Giemsa stain.
  - The periodic acid-Schiff (PAS) stain or Giemsa stain.
  - The periodic acid-Schiff (PAS) stain or India-ink preparation.
  - Gomori methenamine-silver or the periodic acid-Schiff (PAS) stain.
63. (639) Primary pulmonary coccidioidomycosis is contracted by inhalation of
- spores.
  - capsules.
  - toxic dust.
  - infected grain.
64. (640) How should the clinical specimens for C. immitis be examined first and what structures should you look for?
- In direct wet, unstained mount for the presence of capsules.
  - In direct wet, unstained mount for the presence of spherules.
  - In lactophenol cotton blue mount for the presence of capsules.
  - In lactophenol cotton blue mount for the presence of spherules.
65. (640) Why should mycelial cultures of C. immitis be flooded with sterile normal saline prior to removing the cap from the tube?
- To retard aerosol formation by arthrospores.
  - To retard aerosol formation by blastospores.
  - To enhance aerosol formation by arthrospores.
  - To enhance aerosol formation by blastospores.
66. (641) In the diagnosis of coccidioidomycosis, which of the following tests becomes positive before there is a demonstrable rise in the complement-fixation titer?
- Precipitin test.
  - Histoplasmin skin test.
  - Tube agglutination test.
  - Latex agglutination test.
67. (642) Majority of infections with B. dermatitidis is acquired in what manner?
- Handling of infected animals.
  - Handling of infected produce.
  - Inhalation of infective spores.
  - Inhalation of infective capsules.
68. (642) Which form of blastomycosis occurs most frequently?
- Disseminated.
  - Chronic cutaneous.
  - Primary cutaneous.
  - Primary pulmonary.

90412 04 22



69. (643) What two types of specimens are among those required when disseminated blastomycosis is suspected?
- a. Sputum and urine.
  - b. Spinal fluid and sputum.
  - c. Pleural exudates and urine.
  - d. Gastric washing and sputum.
70. (643) If cycloheximide is added to the medium for growth of Blastomyces dermatitidis, incubation should be made at what temperature and for what purpose?
- a. At 35° C; the yeast phase will overgrow at 30° C.
  - b. Room temperature; the yeast phase will overgrow at 35° C.
  - c. At 35° C; the yeast phase is sensitive to cycloheximide at 30° C.
  - d. Room temperature; the yeast phase is sensitive to cycloheximide at 35° C.
71. (643) Clinical materials for blastomycosis should be inoculated to which two given media?
- a. Sabouraud dextrose agar and Casein agar.
  - b. Sabouraud dextrose agar and Cornmeal agar.
  - c. Brain-heart-infusion blood agar and Casein agar.
  - d. Brain-heart-infusion blood agar and Sabouraud dextrose agar.
72. (544) When the colony of B. dermatitidis is examined microscopically, what typical characteristics are observed of the yeast budding phase?
- a. Wide-based, thin-walled, double-budding cells.
  - b. Wide-based, thick-walled, single-budding cells.
  - c. Narrow-based, thick-walled, single-budding cells.
  - d. Narrow-based, thin-walled, single-budding cells.
73. (645) Which of the categories of paracoccidiomycosis manifests symptoms closely resembling tuberculosis?
- a. The skin form.
  - b. The mucocutaneous.
  - c. Disseminated form.
  - d. Primary pulmonary.
74. (646) The usual microscopic findings of P. brasiliensis in teased wet mount consist of
- a. septate mycelium and chlamyospores.
  - b. septate mycelium and blastospores.
  - c. aseptate mycelium and chlamyospores.
  - d. aseptate mycelium and blastospores.

90412 04 22

75. (647) In order to confirm a cultural diagnosis of P. brasiliensis, it is essential to
- perform intradermal skin tests.
  - perform animal inoculation tests.
  - demonstrate conversion capability.
  - demonstrate a positive complement fixation test.
76. (647) All of the diagnostic techniques for the identification of P. brasiliensis can be useful in establishing the pathogenicity of a particular strain except
- intradermal skin testing.
  - complement-fixation tests.
  - animal inoculation.
  - strain conversion.
77. (648) Histoplasma capsulatum demonstrates a distinct preference for what system of the body?
- Reticuloendothelial.
  - Autonomic nervous.
  - Central nervous.
  - Integumentary
78. (649) Yeastlike bodies of Histoplasma capsulatum are found within what two types of cells?
- Macrophages and lymphocytes.
  - Microphages and occasionally lymphocytes.
  - Macrophages and occasionally polymorphonuclear cells.
  - Microphages and occasionally polymorphonuclear cells.
79. (649) Why is the BHI blood agar without antibiotic incubated at 35° C instead of the BHI blood agar with antibiotic when culturing for H. capsulatum?
- The yeast phase will not grow in the presence of antibiotic at 30° C.
  - The yeast phase will not grow in the presence of antibiotic at 35° C.
  - The mycelial phase will not grow in the presence of antibiotic at 30° C.
  - The mycelial phase will not grow in the presence of antibiotic at 35° C.
80. (649) How can nontuberculate H. capsulatum be differentiated with certainty from Sepedonium species?
- Sepedonium can be converted to its yeast form at 35° C.
  - Sepedonium can be converted to its mycelial form at 30° C.
  - H. capsulatum can be converted to its yeast form at 35° C.
  - H. capsulatum can be converted to its mycelial form at 30° C.

81. (650) To convert the dimorphic H. capsulatum to the yeast phase, you must:
- Inoculate moist BHI blood agar with mycelial growth and incubate at 35° C for 2 to 3 days.
  - Inoculate moist Saboraud Dextrose agar with mycelial growth and incubate at 35° C for 2 to 3 days.
  - Inoculate moist Saboraud Dextrose agar with mycelial growth and incubate at 30° C for 24 hours.
  - Inoculate moist BHI blood agar with mycelial growth and incubate at room temperature for 2 to 3 days.
82. (651) Which of the following saprophytes has a surface texture that is glabrous to downy and wrinkled and a reverse pigment absent?
- Cephalosporium.
  - Fusarium.
  - Nigrospora.
  - Sepedonium.
83. (651) Which of the following saprophytes produces a surface texture that is velvety to tight cotton?
- Alternaria.
  - Curvularia.
  - Fusarium.
  - Nigrospora.
84. (651) Which of the following saprophytes contain macroconidia that are spherical and thick-walled with projecting spines or tubercles?
- Fusarium.
  - Helminthosporium.
  - Sepedonium.
  - Scopulariopsis.
85. (652) Which of the following forms of Aspergillus spp. has a blue-green surface pigment and lacks any reverse pigmentation?
- Aspergillus fumigatus.
  - Aspergillus clavatus.
  - Aspergillus glaucus.
  - Aspergillus niger.
86. (652) A. fumigatus is set apart from A. clavatus by its
- smooth stalk.
  - growth ability.
  - unbranched hyphae.
  - flask-shaped vesicle.
87. (652) Which of the following saprophytes is a rapid-growing saprophyte that develops a flat, powdery colony which is generally white-green-blue in color?
- Penicillium spp.
  - Paecilomyces spp.
  - Trichoderma spp.
  - Cladosporium spp.

90412 04 22

88. (652) Which of the following saprophytes shows a reverse pigment that ranges from port wine to dark brown?
- a. Aspergillus fumigatus.                      c. Paecilomyces spp.  
 b. Aspergillus glaucus.                      d. Trichoderma spp.
89. (653) Which of the following two characteristics best describes the sporangiphore of Mucor spp?
- a. Spherical sporangium which is usually branched.  
 b. Spherical sporangium which incloses the columella.  
 c. Pear-shaped, saclike sporangium which is usually branched.  
 d. Pear-shaped, saclike sporangium which incloses the columella.
90. (653) When observed under low magnification, which of the following saprophytes with characteristic sporangiophores may readily be mistaken for a species of Aspergillus?
- a. Absidia spp.                                      c. Rizopus nigricans.  
 b. Mucor spp.                                      d. Syncephalostrum spp.
91. (654) Which of the following saprophytes with characteristic thallus shows a microscopic picture of long, slender, multiseptate hyphae which readily fragment into thin-walled, rectangular arthrospores?
- a. Geotrichum spp.                                      c. Streptomyces spp.  
 b. Rhodotorula spp.                                      d. Aureobasidium pullulans.
92. (654) Which of the following macroscopic morphological characteristics best describes those of Streptomyces spp?
- a. Surface topography is flat, surface texture is pasty to mucoid.  
 b. Surface topography is flat, surface texture is pasty to veivety cottony.  
 c. Surface topography is heaped, surface texture is dry, chalky and leathery.  
 d. Surface topography is heaped,, surface texture is pasty to glabrous to leathery.
93. (655) The usual causative agent of pulmonary aspergillosis is
- a. Aspergillus niger.                                      c. Aspergillus flavus.  
 b. Aspergillus amstelodami.                                      d. Aspergillus fumigatus.
94. (656) For diagnosis of phycomycosis, you should inoculate the clinical material using what culture medium and incubate it at what temperature?
- a. Mycobiotic agar; 25° C.  
 b. Mycobiotic agar; 35° C.  
 c. Sabouraud dextrose agar with cycloheximide; 35° C.  
 d. Sabouraud dextrose agar without cycloheximide; 25° C.

90412 04 22

95. (657) Laboratory identification of rhinosporidiosis is dependent on
- cultural studies.
  - direct examination of clinical material.
  - immunologic and animal inoculation tests.
  - clinical observation and histologic examination.
96. (658) How does Cladosporium species appear on the surface of Sabouraud dextrose agar?
- Velvety and may form radial folds.
  - Pasty and may form radial folds.
  - Muroid and slightly heaped.
  - Chalky and slightly heaped.
97. (658) Cladosporium bantianum may be differentiated from Cladosporium carrionii on the basis of all of the following except the
- growth rate.
  - length of spore chains.
  - inability to liquify gelatin.
  - development of longer conidia.
98. (659) What two general groups of viruses include those responsible for the common cold?
- Papovaviruses and Reoviruses.
  - Papovaviruses and Herpesviruses.
  - Herpesviruses and Arenaviruses.
  - Picornaviruses and Coronaviruses.
99. (659) The Epstein-Barr virus, believed to be the cause of infectious mononucleosis, is included under what group of viruses?
- herpesviruses.
  - Papovaviruses.
  - Adenoviruses.
  - Poxviruses.
100. (659) The protein coat of a cubic virus particle is known as the
- capsomere.
  - capsid.
  - virion.
  - envelope.
101. (660) Chlamydiae may be described as a large group of obligate
- intracellular parasites closely related to gram negative bacteria.
  - intracellular parasites closely related to gram positive bacteria.
  - extracellular parasites closely related to gram negative bacteria.
  - extracellular parasites closely related to gram positive bacteria.

90412 04 22

102. (660) Viruses differ from other related microbes by all of the given characteristics except the
- a. nucleic acid type.
  - b. absence of enzymes.
  - c. presence of enzymes.
  - d. size and morphology.
103. (661) The characteristic of the virus which determines whether it is icosahedral or helical is the
- a. size of the lipid molecules that make up the capsid.
  - b. size of the protein molecules that make up the capsid.
  - c. arrangement of the lipid molecules that make up the capsid.
  - d. arrangement of the protein molecules that make up the capsid.
104. (661) The viral capsid serves what functions?
- a. It is antigenic.
  - b. Stabilizes the nucleic acid.
  - c. Stimulates immune substances.
  - d. Accounts for protein specificity.
105. (662) When the virion attaches to and penetrates the host cell, what subsequent action takes place?
- a. The capsid separates from the nucleocapsid.
  - b. The capsid remains intact and the nucleocapsid separates.
  - c. The nucleic acid core separates from the protective capsid.
  - d. The nucleic acid core remains intact and the protective capsid separates.
106. (662) What part of the virion serves as a template in directing the host cell to manufacture virus protein?
- a. The capsomere.
  - b. The nucleocapsid.
  - c. The entire virion.
  - d. The nucleic acid core.
107. (662) Which of the following conditions represents a cytopathic effect when cell degeneration occurs in a viral infection?
- a. The formation of small, round, or oval bodies in the cell.
  - b. The formation of a tumor.
  - c. Steady state infection.
  - d. Cell degeneration.
108. (663) Which of the following viruses are found in nose and throat secretions and are those most often responsible for the common cold?
- a. Coronaviruses.
  - b. Reoviruses.
  - c. Rhinoviruses.
  - d. Togaviruses.

90412 04 22



109. (663) Which of the following types of viruses are the influenza viruses?
- a. Orthomyxoviruses.                      c. Rotaviruses.  
b. Picornaviruses.                         d. Togaviruses.
110. (663) Which of the following types of viruses is the causative agent of rabies?
- a. Enteroviruses.                         c. Rhabdoviruses.  
b. Picornaviruses.                         d. Rhinoviruses.
111. (664) Which of the following groups of viruses is the causative agent of infectious mononucleosis, and has been associated with Burkitt's lymphoma and nasopharyngeal carcinoma?
- a. Adenoviruses.                         c. Papovaviruses.  
b. EB (Epstein-Barr) virus.             d. Poxviruses.
112. (664) Most of our knowledge about the poxviruses comes from studies on which of the following virus?
- a. The vaccinia virus.  
b. The smallpox virus.  
c. Herpes simplex virus.  
d. EB (Epstein-Barr) virus.
113. (665) Even though both the Rickettsiae and viruses cannot reproduce independently of the host cell, what contrasting feature readily distinguishes the Rickettsiae from viruses?
- a. Viruses reproduce by binary fission.  
b. Rickettsiae are metabolically active.  
c. Viruses grow well on nonliving media.  
d. Rickettsiae are obligate intracellular parasites.
114. (665) What type of microorganism is the rickettsiae considered to be and why?
- a. A virus; they possess most enzymes found in viruses.  
b. A virus; they possess a rigid cell wall and lack enzymes.  
c. A true bacteria; they possess most bacterial enzymes and typical cell wall.  
d. A true bacteria; they possess a rigid cell wall and lack bacterial enzymes.
115. (665) Which of the organisms is a causative agent of spotted fever and what is the vector?
- a. R. typhi; fleas.                         c. R. rickettsii; ticks.  
b. R. quinana; lice.                        d. R. tsutsugamushi; mites.

90412 04 22

116. (666) In Bergey's Order II of Part 18, 8th Edition, Chlamydiales are placed as what type organisms?
- Gram-negative, intracellular pathogens of vertebrates.
  - Gram-negative, extracellular pathogens of vertebrates.
  - Gram-positive, intracellular pathogens of vertebrates.
  - Gram-positive, extracellular pathogens of vertebrates.
117. (666) Which of the following characteristics concerning Chlamydiae is correct?
- They are arthropod borne.
  - They have bacillary and Filamentous Forms.
  - They differ from rickettsiae in being spherical.
  - They have the usual type of intracellular developmental cycle.
118. (667) Why is it necessary to obtain paired serum specimens 2 or 3 weeks apart in diagnosing a virus disease?
- Virus isolations are made more easily as the disease progresses.
  - The second specimen serves as a reserve supply of serum if the first becomes contaminated or is lost in transit.
  - Antibody titer drops rapidly after the first week of infection, and this decrease gives an indication of the patient's rate of recovery.
  - Antibodies are usually not formed during the early phase of the disease, and the first specimen provides a base line for the second in testing antibody levels.
119. (668) How soon after the illness should the acute-phase blood for viral serological tests be collected?
- As soon as possible; no later than 5 to 7 days.
  - As soon as possible; no later than 14 to 21 days.
  - Delay for titer rise; no later than 5 to 7 days.
  - Delay for titer rise; no later than 14 to 21 days.
120. (668) If blood is required for virus isolation, what type of sample is obtained and why?
- Heparinized; required for co-culture of blood leukocytes in tissue culture.
  - Heparinized; provides best nutrient medium for growth of virus in leukocytes.
  - Clotted; required for co-culture of blood leukocytes in tissue culture.
  - Clotted; provides best nutrient medium for growth of virus in leukocytes.

121. (668) What type of given holding medium is recommended for rectal swabs to be used for isolation of virus?
- GN broth with gelatin.
  - Thioglycollate medium with gelatin.
  - Cary-Blair transport medium with gelatin.
  - Hanks balanced salt solution (BSS) with gelatin.
122. (663) What given solution may be used for gargle in collecting throat washings for viral isolation?
- Thioglycollate broth.
  - Trypticase soy broth.
  - Tryptose-phosphate broth.
  - Trypticase peptone glucose broth.
123. (669) If the intervals between collection and delivery to the virology laboratory will exceed 12 hours or greater, how should the specimen for viral studies be maintained?
- Store specimen at 4° C.
  - Preferably store at 30° C.
  - Freeze specimen below -40° C or preferably -70° C.
  - Preferably at 30° C and add an equal volume of 50 percent glycerin.
124. (669) What condition can result when viral specimens shipped in tubes or bottles with dry ice are not tightly sealed in transit?
- Dry ice releases CO<sub>2</sub> gas which can lower pH and inactivate some viruses.
  - Dry ice releases CO<sub>2</sub> gas, which increases pH and causes overgrowth of viruses.
  - Dry ice releases O<sub>2</sub> gas which can lower pH and inactivate some viruses.
  - Dry ice releases O<sub>2</sub> gas which lowers pH and causes overgrowth of viruses.

END OF EXERCISE

#### ATC/ECI SURVEY

The remaining questions (125-135) are not part of the Volume Review Exercise (VRE). These questions are a voluntary ATC/ECI survey. Using a number 2 pencil, indicate what you consider to be the appropriate response to each survey question on your answer sheet (ECI Form 35), beginning with answer number 125. Do not respond to questions that do not apply to you. Your cooperation in completing this survey is greatly appreciated by ATC and ECI. (AUSCN 100)

90412 04 22



b. Agree.

d. Strongly disagree.

130. The illustrations in the course helped clarify the information for me.

a. Strongly agree.

c. Disagree.

b. Agree.

d. Strongly disagree.

131. Approximately how much information in the course provides general information about your AFSC?

a. Between 80 and 99%.

c. Between 40 and 59%.

b. Between 60 and 79%.

d. Between 20 and 39%.

132. Approximately how much information in this course was current?

a. Between 80 and 99%.

c. Between 40 and 59%.

b. Between 60 and 79%.

d. Between 20 and 39%.

133. The format of the text (objective followed by narrative and exercises) helped me study.

a. Strongly agree.

c. Disagree.

b. Agree.

d. Strongly disagree.

134. The volume review exercise(s) helped me review information in the course.

a. Strongly agree.

c. Disagree.

b. Agree.

d. Strongly disagree.

135. Check the rating which most nearly describes the usefulness of the information in this CDC in your upgrade training program.

a. Excellent.

c. Marginal.

b. Satisfactory.

d. Unsatisfactory.

NOTE: If you know this CDC contains outdated information or does not provide the knowledge that the current specialty training standard requires you to have for upgrade training, contact your OJT advisor and fill out an AF Form 1284, Training Quality Report.

90412 04 22

23

642

**STUDENT REQUEST FOR ASSISTANCE**

**PRIVACY ACT STATEMENT**

AUTHORITY: 44 USC 3101. PRINCIPAL PURPOSE(S): To provide student assistance as requested by individual students. ROUTINE USES: This form is shipped with every ECI course package. It is utilized by the student, as needed, to place an inquiry with ECI. DISCLOSURE: Voluntary. The information requested on this form is needed for expeditious handling of the student's need. Failure to provide all information would result in slower action or inability to provide assistance.

**SECTION I: CORRECTED OR LATEST ENROLLMENT DATA:** MAIL TO ECI, GUNTER AFS, ALA 36118

1. THIS REQUEST CONCERNS COURSE <input style="width:100%; height:20px;" type="text"/>	2. TODAY'S DATE <input style="width:100%; height:20px;" type="text"/>	3. ENROLLMENT DATE <input style="width:100%; height:20px;" type="text"/>	4. PREVIOUS SERIAL NUMBER <input style="width:100%; height:20px;" type="text"/>
5. SOCIAL SECURITY NUMBER <input style="width:100%; height:20px;" type="text"/>	6. GRADE/RANK <input style="width:100%; height:20px;" type="text"/>	7. INITIALS <input style="width:100%; height:20px;" type="text"/>	LAST NAME <input style="width:100%; height:20px;" type="text"/>
8. OTHER ECI COURSES NOW ENROLLED IN <input style="width:100%; height:20px;" type="text"/> <input style="width:100%; height:20px;" type="text"/> <input style="width:100%; height:20px;" type="text"/>	9. ADDRESS: (OJT ENROLLEES - ADDRESS OF UNIT TRAINING OFFICE/ALL OTHERS - CURRENT MAILING ADDRESS) <input style="width:100%; height:20px;" type="text"/> <input style="width:100%; height:20px;" type="text"/> <div style="text-align: center; margin-top: 5px;">ZIP CODE <input style="width:40px; height:15px;" type="text"/></div>		11. AUTOVON NUMBER <input style="width:100%; height:20px;" type="text"/>
10. NAME OF BASE OR INSTALLATION IF NOT SHOWN ABOVE: <input style="width:100%; height:20px;" type="text"/>			12. TEST CONTROL OFFICE ZIP CCDE/SHRED <input style="width:100%; height:20px;" type="text"/>

**SECTION II: Old or INCORRECT ENROLLMENT DATA**

1. NAME:	2. GRADE/RANK:	3. SSAN:
4. ADDRESS:	5. TEST OFFICE ZIP/SHRED:	

**SECTION III: REQUEST FOR MATERIALS, RECORDS, OR SERVICE**

ADDITIONAL FORMS 17 available from trainers, OJT and Education Offices, and ECI. The latest course workbooks have a Form 17 printed on the last page.

(Place an "X" through number in box to left of service requested)

1	EXTEND COURSE COMPLETION DATE. (Justify in Remarks)
2	SEND VRE ANSWER SHEETS FOR VOL(s): 1 2 3 4 5 6 7 8 9 - ORIGINALS WERE: NOT RECEIVED, LOST, MISUSED
3	SEND COURSE MATERIALS (Specify in remarks) - ORIGINALS WERE: NOT RECEIVED, LOST, DAMAGED.
4	COURSE EXAM NOT YET RECEIVED. FINAL VRE SUBMITTED FOR GRADING ON (Date):
5	RESULTS FOR VRE VOL(s): 1 2 3 4 5 6 7 8 9 NOT YET RECEIVED. ANSWER SHEET(s) SUBMITTED ON (Date):
6	RESULTS FOR CE NOT YET RECEIVED. ANSWER SHEET SUBMITTED TO ECI ON (Date):
7	PREVIOUS INQUIRY (ECI FORM 17, LTR, MSG) SENT TO ECI ON:
8	GIVE INSTRUCTIONAL ASSISTANCE AS REQUESTED ON REVERSE:
9	OTHER (Explain fully in remarks)

REMARKS: (Continue on Reverse)

OJT STUDENTS must have their OJT Administrator certify this request.  
ALL OTHER STUDENTS may certify their own requests.

I certify that the information on this form is accurate and that this request cannot be answered at this station. (Signature)

ECI FORM 17 JUN 77 PREVIOUS EDITIONS MAY BE USED



**SECTION IV: REQUEST FOR INSTRUCTOR ASSISTANCE**

**NOTE:** Questions or comments relating to the accuracy or currency of textual material should be forwarded directly to preparing agency. Name of agency can be found at the bottom of the inside cover of each text. All other inquiries concerning the course should be forwarded to ECI.

VRE ITEM QUESTIONED: MY QUESTION IS:

Course No. \_\_\_\_\_

Volume No. \_\_\_\_\_

VRE Form No. \_\_\_\_\_

VRE Item No. \_\_\_\_\_

Answer You Chose  
(Letter) \_\_\_\_\_

Has VRE Answer Sheet  
been submitted for grading?

YES  NO

**REFERENCE**

(Textual support for the  
answer I chose can be  
found as shown below)

In Volume No: \_\_\_\_\_

On Page No: \_\_\_\_\_

In \_\_\_\_\_ (Left) \_\_\_\_\_ (Right)  
Column

Lines \_\_\_\_\_ Through \_\_\_\_\_

Remarks: