

DOCUMENT RESUME

ED 265 054

SE 046 355

TITLE U.S.-Soviet Cooperation in Space. A Technical Memorandum.

INSTITUTION Congress of the U.S., Washington, D.C. Office of Technology Assessment.

REPORT NO OTA-TM-STI-27

PUB DATE Jul 85

NOTE 117p.

AVAILABLE FROM Superintendent of Documents, U.S. Government Printing Office, Washington, DC 20402.

PUB TYPE Reports - Research/Technical (143)

EDRS PRICE MF01/PC05 Plus Postage.

DESCRIPTORS *Cooperative Programs; *Foreign Policy; *Internat'nal Cooperation; National Security; Policy; *Space Exploration; *Space Sciences

IDENTIFIERS *France; *USSR

ABSTRACT

This report consists of an executive summary and five chapters. Chapter 1, an introduction, discusses the potential advantages and disadvantages of cooperation in space. Chapter 2 outlines the history of United States-Soviet cooperation in space, and the policy debates which have taken place in the U.S. since the beginning of the space age. It focuses on lateral intergovernmental U.S.-Soviet space cooperation, as a background to analyzing policy issues facing Congress today and the kinds of questions these may suggest for the future. Chapter 3 (based on a 1984 workshop of space scientists) identifies some potential areas for expanded U.S.-Soviet cooperation in the space sciences. Chapters 4 and 5 combine this historical and scientific background with the complex array of foreign policy and national security issues which lie at the heart of any U.S.-Soviet cooperative activity in space. Chapter 4 focuses on French policies, since, of all the Western countries, France has had the most extensive and long-term space cooperations with the USSR, and has tended to approach space cooperation with the Soviets in ways quite different from those of the United States. Chapter 5 examines all of these issues as they face U.S. policymakers today. (Supporting documentation, including the text of Public Law 98-562, is included in three appendices.) (JN)

 * Reproductions supplied by EDRS are the best that can be made *
 * from the original document. *

U.S. DEPARTMENT OF EDUCATION
NATIONAL INSTITUTE OF EDUCATION
EDUCATIONAL RESOURCES INFORMATION
CENTER (ERIC)

- This document has been reproduced as received from the person or organization originating it.
- Minor changes have been made to improve reproduction quality.
- Points of view or opinions stated in this document do not necessarily represent official NIE or ERIC positions or policies.

**THIS DOCUMENT IS NOT
REPRODUCIBLE ON MICROFILM**

**THIS DOCUMENT IS NOT
REPRODUCIBLE ON MICROFILM**

U.S.-SOVIET COOPERATION IN SPACE

A TECHNICAL MEMORANDUM

JULY 1985

Technical Memoranda are issued by OTA on specific subjects analyzed in recent OTA reports or on projects in process at OTA. They are issued at the request of Members of Congress who are engaged in committee legislative actions which are expected to be resolved before OTA completes its assessment.



CONGRESS OF THE UNITED STATES
Office of Technology Assessment
Washington, D. C. 20510

Recommended Citation:

U.S.-Soviet Cooperation in Space (Washington, DC: U.S. Congress, Office of Technology Assessment, OTA-TM-STI-27, July 1985).

Library of Congress Catalog Card Number 85-600561

For sale by the Superintendent of Documents
U.S. Government Printing Office, Washington, DC 20402

Foreword

Space holds a fascination for all of us. For many, it represents a final physical frontier—a place to explore the very essence of knowledge, to experiment with new technology, and to seek new levels of human adaptation and change. As the major spacefaring nation on our planet, the United States has taken special pride in our achievements in space.

Discoveries in space science have already added immensely to our fund of knowledge. U.S. scientists have moved quickly to take advantage of new opportunities for learning, and the future of scientific work in space is virtually unlimited.

Given the promise of space, an additional issue comes to the fore. How can the United States proceed in space in relation to the other principal spacefaring nation and superpower—the Soviet Union? What is to be gained or lost by working together in space? With regard to science in particular, can the two countries benefit from joint efforts? Can the two countries cooperate as well as compete?

Since the beginning of the space age, the two countries have been examining these questions. This study was requested by Senators Matsunaga, Mathias, and Pell as a means to shed light on the subject at the time of the 10th anniversary of the major U.S.-Soviet cooperative endeavor, the Apollo-Soyuz Test Project.

OTA is pleased to be able to provide this technical memorandum, outlining the principal issues of the debate, the history of cooperation, and the experience of France, another country involved in space cooperation with the U.S.S.R. Additional OTA documents that may be of interest include *Civilian Space Stations and the U.S. Future in Space*, *Salyut: Soviet Steps Toward Human Presence in Space*, and *International Cooperation and Competition in Civilian Space Activities*. OTA studies in the areas of technology transfer are cited in the text.

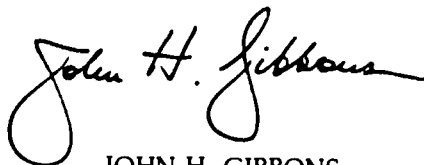

JOHN H. GIBBONS
Director

Related OTA Reports

Civilian Space

- *International Cooperation and Competition in Civilian Space Activities.*
OTA-ISC-239, July 1985. GPO stock #052-003-00958-7.
- *Civilian Space Stations and the U.S. Future in Space.*
OTA-STI-241, November 1984. GPO stock #052-003-00969-2.
- *Civilian Space Policy and Applications.*
OTA-STI-177, June 1982. GPO stock #052-003-00878-5.
- *Radiofrequency Use and Management: Impacts From the World Administrative Radio Conference of 1979.* OTA-CIT-163, January 1982. GPO stock #052-003-00863-7.
- *Solar Power Satellite Systems and Issues.*
OTA-E-144, August 1981. NTIS order #PB 82-108 846.

Technical Memoranda

- *Remote Sensing and the Private Sector: Issues for Discussion.*
OTA-TM-ISC-20, March 1984. GPO stock #052-003-00945-5.
- *Salyut: Soviet Steps Toward Permanent Human Presence in Space.*
OTA-TM-STI-14, December 1983. GPO stock #052-003-00937-4.
- *UNISPACE '82: A Context for International Cooperation and Competition.*
OTA-TM-ISC-26, March 1983. GPO stock #052-003-00962-5.
- *Space Science Research in the United States.*
OTA-TM-STI-19, September 1982. NTIS order #PB 83-166 512.

Military Space

- "Anti-Satellite Weapons, Countermeasures, and Arms Control" (scheduled for publication summer 1985)
- "Ballistic Missile Defense Technologies" (scheduled for publication summer 1985).
- *Arms Control in Space—Workshop Proceedings.*
OTA-BP-ISC-28, May 1984. GPO stock #052-003-00952-8.
- *Directed Energy Missile Defense in Space—Background Paper.*
OTA-BP-ISC-26, April 1984. GPO stock #052-003-00948-0.

Technology Transfer

- *Technology and East-West Trade: An Update.*
OTA-ISC-209, May 1983. GPO stock #052-003-00908-1.
- *Technology and Soviet Energy Availability.*
OTA-ISC-153, November 1981. NTIS order #PB 82-133 455.
- *Technology and East-West Trade.*
OTA-ISC-101, November 1979. NTIS order #PB 80-119 381.

NOTE Reports are available through the U.S. Government Printing Office, Superintendent of Documents, Washington, DC 20402, (202) 783-3238, and the National Technical Information Service, 5285 Port Royal Road, Springfield, VA 22161, (703) 487-4650.

OTA Project Staff for U.S.-Soviet Cooperation in Space

John Andelin, *Assistant Director, OTA
Science, Information, and Natural Resources Division*

Nancy C. Naismith, *Science, Transportation, and Innovation Program Manager*

Nancy Lubin, *Project Director*

Betty Jo Tatum, *Research Assistant*

Philip P. Chandler, II* Courtland Lewis** Michael McFaul
Micheal Strong Kate Tomlinson**

Administrative Staff

Marsha Fenn, *Administrative Assistant*

Gala Adams, *Clerical Assistant*

*Workshop Director
**Contractor

Contributors and Reviewers

During the course of this study, a large number of individuals assisted the OTA staff by providing information from their own research and experience, reviewing draft documents, arranging interviews, providing photographs, and giving their time and energy in many ways. The project staff deeply appreciates this willing and thoughtful help from our colleagues. All responsibility for the document itself rests with OTA.

Reviewers

Richard Barnes, National Aeronautics and Space Administration
Francis Cevasco, Department of Defense
Jennifer Clapp, National Oceanic and Atmospheric Administration
Hubert Curien, Centre National d'Etudes Spatiales, France
Richard DalBello, Office of Technology Assessment
Merton Davies, Rand Corp.
Daniel Deudney, Consultant
Sidney Drell, Stanford University
Eileen Galloway, International Institute of Space Law of the International Astronautical Federation
Ronnie Goldberg, New York Chamber of Commerce and Industry
Loren Graham, Massachusetts Institute of Technology
Alan Greenberg, Department of State
Jerry Grey, Consultant
John Hardt, Congressional Research Service
James Head, Brown University
Benjamin Huberman, Consultant
Douglas Jenkins, American Embassy, France
Francis Kapper, Department of Defense
Saunders Kramer, Consultant
Louis Laidet, French Embassy, Washington, DC
Louis Lanzerotti, AT&T Bell Laboratories
Gordon Law, Office of Technology Assessment
John Logsdon, George Washington University
Edward McGaffigan, Office of Senator Bingaman
George Ojalehto, Department of State
Kenneth Pederson, National Aeronautics and Space Administration
Theodore Postol, Stanford University
Diane Rausch, National Aeronautics and Space Administration
Victor Reis, Science Applications International Corp.
Harold Relyea, Congressional Research Service
Peter Sharfman, Office of Technology Assessment
Eugene Skolnikoff, Massachusetts Institute of Technology
Marcia Smith, Congressional Research Service
Pete Smith, National Aeronautics and Space Administration
Paul Uhlir, National Oceanic and Atmospheric Administration
Charles Vick, Consultant
Mitchell Wallerstein, National Academy of Sciences
Ray Williamson, Office of Technology Assessment
John Zimmerman, Department of State

Contributors

M. Amigues, Ministry of Foreign Affairs, France
Jean Arets, European Space Agency
Harry Atkinson, Science and Engineering Research Council, Great Britain

David Blatherwick, Energy, Space, and Science Division, Foreign and Commonwealth Office,
 Great Britain
 H. Bourlakoff, Centre National d'Etudes Spatiales, France
 Dina Braverman, French Embassy, Washington, DC
 Sir Arnold Burgen, The Royal Society, Great Britain
 James Burke, Jet Propulsion Laboratory
 Odile Burton, French Embassy, Washington, DC
 Anthony Cox, British Embassy, Washington, DC
 Rosemarie Crisostomo, Rand Corp.
 Robert Cronin, Science Applications International Corp.
 Harriet Crosby, Institute for Soviet-American Relations
 Genevieve Debouzy, Centre National d'Etudes Spatiales, France
 Chris Dodge, Congressional Research Service
 Murray Feshbach, Georgetown University
 Louis Friedman, The Planetary Society
 Sue Fruchter, National Aeronautics and Space Administration
 Donna Gold, Congressional Research Service
 Ambassador A. Hartman, U.S. Embassy, Moscow
 Arnold Horelick, Rand Corp.
 Robert Kelley, Federal Bureau of Investigation
 Lee Love, Consultant
 Jack Matlock, National Security Council
 Barbara McKenney, Science Applications International Corp.
 Cheryl Mendonsa, Office of Congressman Brown
 A.C. Nicholas, Space Branch, Department of Trade and Industry, Great Britain
 David Peary, Foreign and Commonwealth Office, Great Britain
 Paul Poujade, Secrétariat Général de la Défense Nationale, France
 Ian Pryke, European Space Agency
 David Roberts, Foreign and Commonwealth Office, Great Britain
 R. Roberts, Department of Trade and Industry, Great Britain
 Peter Roland, and associates, Soviet Department, Foreign and Commonwealth Office, Great Britain
 Joseph Rowe, Library of Congress
 Tamara Sherman, Linguatronics
 John Sopko, Permanent Subcommittee on Investigations, U.S. Senate
 M. Stuyck-Taillandier, Ministry of Foreign Affairs, France
 Sir Iain Sutherland, British Embassy, Moscow
 Lady Jeanne Sutherland, British Embassy, Moscow
 Marvin Tatum, NASA Goddard Space Flight Center Library
 John Thomas, Department of State
 Kip Thorn, California Institute of Technology
 Didier Ullman, Centre National d'Etudes Spatiales, France
 Asa Wember, Consultant
 Peter Warren, The Royal Society, Great Britain
 Sir Frederick Warren, The Royal Society, Great Britain
 Claude Wachtel, Secrétariat Général de la Défense Nationale, France

Interviews were also conducted with Soviet scientists and foreign policy experts at the following institutions: Interkosmos; Institute of Medical and Biological Problems, Ministry of Health; Institute of Space Research, Soviet Academy of Sciences; State Committee for Science and Technology; and Institute for the Study of the U.S. and Canada.

Contents

<i>Chapter</i>	<i>Page</i>
EXECUTIVE SUMMARY	3
1. INTRODUCTION	9
2. HISTORY OF U.S.-SOVIET COOPERATION IN SPACE	15
Background: From the Cold War "Missile Gap" to a Cooperative Space Agreement	15
Early U.S. Interest in Cooperation	15
The Early 1960s: Unfulfilled Promise	17
The Late 1960s: The United States Lands a Man on the Moon	19
The 1970s: Moves Toward Broader Cooperation	23
Rendezvous and Docking for Space Rescue	23
Initiation of Cooperative Space Science and Applications	24
The 1972 Agreement	25
The Apollo-Soyuz Test Project	25
Post ASTP: Changing U.S. Position	32
The 1980s: Promise for the Future?	33
3. COOPERATION IN THE SPACE SCIENCES: THE SCIENTIFIC VIEW	39
Introduction	39
Past U.S.-Soviet Cooperation in the Space Sciences	40
Scientific Basis for Future Cooperation	45
Soviet Cooperative Priorities	48
Summary and Conclusion	48
4. THE VIEW FROM FRANCE: AN ALTERNATIVE PERSPECTIVE	53
Background	53
Astronomy	54
Solar Terrestrial Physics	57
Life Sciences and Materials Processing	57
Planetary Exploration	59
Space Applications	59
Evaluation of French-Soviet Projects	59
Key Issues and Policy Approaches	61
Scientific and Economic Issues	62
Foreign Policy Issues	63
Military Technology Issues	65
Implications for U.S. Policy	66
5. U.S. POLICY ISSUES	71
Background	72
Scientific and Practical Issues	74
Foreign Policy Issues	77
Reduce Tensions	77
Symbolism	80
"Linkage"	81
Maintaining Channels of Communication	83
Military Technology Issues	84
Defining Military Sensitivity	86

Contents—continued

Delineating Responsibilities	90
Utilization of Sensitive Technology	91
The Soviet Approach	92
Summary and Conclusions	95

<i>Appendixes</i>	<i>Page</i>
A. U.S. Cooperative Projects in Space Science and Applications	101
B. Text of Public Law 98-562, Originally Senate Joint Resolution 236, and Presidential Statement	106
C. COSPAS/SARSAT: A Brief Case Study	109

Tables

<i>Table No.</i>	<i>Page</i>
3-1. Potential U.S./U.S.S.R. Collaborative Activities: From OTA Workshop, May 1984	49
3-2. Participants in May 8 Workshop on Possible Future U.S.-Soviet Space Cooperation	49
4-1. Budget of the French Space Agency: Breakdown of Funding	55
4-2. Breakdown of Funding for Bilateral Cooperative Projects	56
4-3. French Space Program: Main Scientific Programs	56

Figures

<i>Figure No.</i>	<i>Page</i>
2-1. Soviet Type G Booster, and U.S. Saturn V	20
2-2. Conceptual Illustration, Soviet Manned Lunar Landing Program, 1967-73	21
2-3. Apollo Command Module and Soviet Soyuz Counterpart	29
2-4. Docking Mechanism Developed for Use in ASTP	30
2-5. ASTP Mission Profile and Timeline	31
2-6. Trajectories of the Various Halley Spacecraft Relative to a Fixed Sun-Earth Line	35
2-7. Primary Operational Soviet Launch Vehicle Family, and Canceled Type-A, A-1, B-1, and Type G-1-e Boosters	38
2-8. Artist's Depiction of Direction of the Soviet Space Program	39
3-1. Photographic Coverage of the U.S. Apollo and Soviet Zond Spacecraft	46
4-1. Soviet Proton Launch Vehicle	60
C-1. Soviet COSPAS Satellite	109
C-2. Basic Operational Configuration of the COSPAS/SARSAT System Components	110
C-3. Through a Network of Satellite-to-Ground and Ground-to-Ground Communications Linkages, COSPAS/SARSAT Affords Coverage of the Entire Globe	111

Executive Summary

Executive Summary

On October 30, 1984, President Reagan signed a Joint Resolution of Congress, now Public Law 98-562, in support of renewing cooperation in space with the U.S.S.R. Since then, a number of specific proposals have been put forward for prospective U.S.-Soviet joint projects—including a congressional resolution introduced by Senator Matsunaga in February 1985 in support of U.S.-Soviet cooperation on Mars exploration missions.

Public Law 98-562 marks the outcome of several years of debate on the merits of cooperation with the U.S.S.R. in space and other activities. This technical memorandum, written at the request of Senators Matsunaga, Mathias, and Pell, is intended to sort out the issues of implementing Public Law 98-562 as they apply to debates in Congress today. It is not intended to determine whether cooperation should be pursued, nor to prescribe optimal methods for doing so. Instead, it is intended to sketch out the broad issues surrounding the implementation of U.S.-Soviet cooperation in space, and to provide a basis for discussing guidelines and specific policy approaches in the future.

U.S.-Soviet cooperation in space comprises a combination of scientific, foreign policy, and national security issues. It is influenced by a background of strained, unpredictable, and ambiguous relations between the two countries overall, and by the fact that international scientific and technological cooperation and the civilian and military uses of space have become more complex and contentious issues in their own right.

In light of conflicting currents in U.S.-Soviet relations, therefore, balancing competing objectives and different perceptions of the U.S.S.R. will be a major challenge in determining the shape and magnitude of future U.S.-Soviet cooperation in space. Four issues are central:

- the scientific and practical benefits that can be gained from space cooperation,
- the potential transfer of militarily sensitive technology or know-how between the two countries,
- the effect of space cooperation on foreign policy, and

- perceptions about Soviet motivations and behavior and the course of U.S.-Soviet relations overall.

From a scientific and practical point of view, past experience has shown that cooperation in space can lead to substantive gains in some areas of space research and applications, and can provide the United States with improved insight into the Soviet space program and Soviet society as a whole. As discussed in chapter 3, scientists in OTA's workshop concluded that the scientific return from U.S. space exploration activities could be expanded significantly by cooperation with the Soviet Union. The scientists also suggested that cooperation be initiated with modest exchanges of solid scientific substance in relatively well-bounded areas, and that the possibility of a large-scale mission might be held out as a long-term goal, provided that it, too, offered rewards of solid scientific substance.

Past experience also suggests that technology transfer from the United States to the U.S.S.R. will remain a major countervailing concern in any future space cooperation. Should cooperation be renewed or expanded, the challenge facing U.S. planners will be to minimize these concerns; but concerns will continue to arise regardless of the scale or level of cooperation. Most people agree that precautions must be taken to prevent transferring militarily sensitive technology and know-how to the U.S.S.R. The difficulties will lie in determining what should be considered militarily sensitive, who should be authorized to make such decisions, and the extent to which potentially sensitive technology or know-how can be protected in any particular exercise.

Past experience, both in low-level cooperation with the U.S.S.R. and in more extensive cooperation with our allies, suggests that this will be a difficult and controversial challenge. The Soviets have no doubt been pursuing an aggressive campaign to acquire Western technology and know-how, particularly in the area of space systems and technology; severely limiting cooperation in space is one way of protecting Western security against such efforts. But Soviet scientists are also conduct-

ing innovative and high caliber work in certain areas of space research and applications. Overly stringent controls could threaten the free interchange of scientific and technical ideas and information in areas complementary to, but not always addressed in, the U.S. space program. In addition, since the Soviets are already cooperating with other Western countries in space research and applications, the United States could find it increasingly difficult to control the flow of information to the U.S.S.R. without isolating itself from the rest of the world space community. A key challenge, then, will be to craft cooperative arrangements that diminish the possibility of aiding Soviet military capabilities but that keep space cooperation substantive and viable.

Perhaps the most difficult challenge will be to assess how space cooperation can be effectively used to support U.S. foreign policy objectives. Space cooperation, on both low and high levels, is inherently symbolic. The main areas of controversy concern whether space cooperation can alter Soviet behavior, and so ease U.S.-Soviet conflicts; and whether starting and/or stopping space cooperation is an appropriate political symbol to underscore other U.S. foreign policy objectives.

The extent to which space cooperation can alter Soviet behavior, and in that way reduce tension in U.S.-Soviet relations overall, is hard to predict. One viewpoint suggests that this is entirely plausible, and cooperation should be pursued toward this end. An opposing viewpoint suggests that there is no reason to believe the Soviets would alter their behavior as a result of U.S.-Soviet cooperation in space and that cooperation might even be dangerous: from this perspective, any reduction in tension would be superficial, and would only lead the United States to lower its guard against an adversary that uses cooperation solely for its own purposes. In between are a range of views, including the belief that a low level of interchange among scientists at a working level, removed from the realm of superpower politics, can be the most effective way for keeping channels of communication open and reducing tensions between the two countries in the long run. Another belief is that space cooperation has no fundamental positive or negative effect on U.S.-Soviet relations, and must be weighed simply on its

own merit. Although there is no evidence from past experience that space cooperation can affect foreign policy in any far-reaching way, many believe the future can be different.

Regardless of whether space cooperation can alter Soviet behavior, another question is whether it is smart to exploit its symbolic value to achieve other U.S. interests. Symbolic value has always been a key component in both the U.S. and Soviet space programs, on low as well as high levels of cooperation. The question of whether cooperation should be initiated or terminated primarily to pursue symbolic goals has generated a controversy of its own. *Creating* a large-scale cooperative effort in space, for example, could bring positive benefit to the United States, by illustrating to other countries the U.S. desire to work with our adversaries to promote peace. But it could also bring risks: 1) it may provide the U.S.S.R. with a great deal of symbolic benefit by casting them as technological equals; and 2) should a large-scale joint project fail, the symbolic cost could be damaging to U.S. interests. The symbolic benefits and risks from U.S.-Soviet cooperation in space would increase with the size, scale, and visibility of any cooperative effort.

Similarly, severely *curbing* or *terminating* cooperation may be an appropriate symbolic measure to show displeasure with egregious Soviet behavior, but it also carries risks. U.S.-Soviet cooperation in space inevitably occurs in the context of U.S.-Soviet relations overall, and the tendency of U.S. policy in the past has been to utilize space cooperation for foreign policy ends. The assumption has been that an abrupt reduction in space cooperation can be an effective means of *protesting* Soviet behavior: when the Soviets do something morally reprehensible at home or abroad, some believe the United States has a moral responsibility to respond, and space cooperation is an effective way of doing so. But as this will generally result in scientific and practical losses, many question this approach, preferring other methods of protest that show displeasure at less cost. They believe that curtailing or terminating space cooperation with the U.S.S.R. brings little benefit, and in fact may harm scientific inquiry and/or U.S.-Soviet relations overall. There is a notable lack of agreement on how past experience might clar-

ify these debates, and the degree to which past experience may be useful in assessing potential future cooperation.

Underlying all of these viewpoints are different assumptions about Soviet objectives and behavior. The Soviet approach to cooperation has tended to mirror its overall approach to U.S.-Soviet relations, reflecting both an official commitment to cooperation in space, and a basic competition between the two superpowers. Soviet leaders have consistently used their space program not only to enhance cooperation, but also to pursue other foreign policy objectives more competitive and confrontational in nature (such as weakening the prestige and influence of the United States while enhancing that of the U.S.S.R., and developing a strong militarily related space capability of their own). This has led to vastly different interpretations of Soviet motivations and actions among U.S. observers, and different interpretations of the lessons of past U.S.-Soviet cooperation. A central U.S. foreign policy challenge, therefore, will be to assess how U.S. objectives may be attained independent of Soviet intentions.

Other countries with space programs of their own are grappling with these same issues. Many of these countries have developed different approaches to cooperating with the U.S.S.R. that may be instructive for U.S. planners, and that will certainly have an impact on the effectiveness of U.S. policy choices in the future. OTA reviewed the issues in French-Soviet space cooperation—the most continuous and extensive East-West cooperation in space science research—to examine whether they might offer insights for U.S. policy.

French-Soviet space cooperation was begun with political aims paramount. As the political climate has become less opportune for promoting such cooperative efforts, however, and as the scientific base of the French space program has grown, scientific and economic aspects have been increasingly emphasized.

In the 1980s, therefore, French policy reflects the view that the scientific and economic benefits, and the political advantages gained from keeping lines of communication open with the

U.S.S.R. through space cooperative efforts, offset any benefits that may be attained by terminating cooperation in symbolic protest. Accordingly, space cooperation has not been dramatically interrupted in response to broader political events. While believing that no area of cooperation with the U.S.S.R. can be totally depoliticized, French planners argue that it is important to seek an area for cooperation where political considerations are reduced as much as possible, but where scientific benefit can be substantial and continuous. In terms of technology transfer, the French believe they have effective mechanisms in place to control the transfer of militarily sensitive technology to the U.S.S.R., and they provide briefings to French scientists who work with Soviet scientists to better control the flow of sensitive information. But the French differ markedly from the United States in defining "militarily sensitive" technologies as only those with direct military application—as opposed to more extensive U.S. definitions—and by tending to be more confident about special "packaging" and other ways in which sensitive technology can be protected.

Because of several factors, then—the conflicts between the gains of cooperation and the risks of technology transfer; disagreement over the relative importance of scientific and practical benefits and foreign policy goals; and possible inconsistencies among foreign policy objectives—there will always be a multiplicity of views about East-West cooperation in space. The ways in which these viewpoints are reflected in policy will determine the size, shape, scope, and effectiveness of any potential space cooperation with the U.S.S.R.

It would clearly be useful to further examine the costs and benefits of past cooperation, as a basis for considering the establishment, cancellation or continuation of cooperative arrangements in the future. At the same time, however, it is important to remember that views on how much cooperation to pursue will necessarily reflect judgments about broader issues of world tensions, Soviet objectives, and the overall course of U.S.-Soviet relations at least as much as they will reflect judgments about the costs and benefits of U.S.-Soviet space cooperation itself.

Chapter 1

Introduction

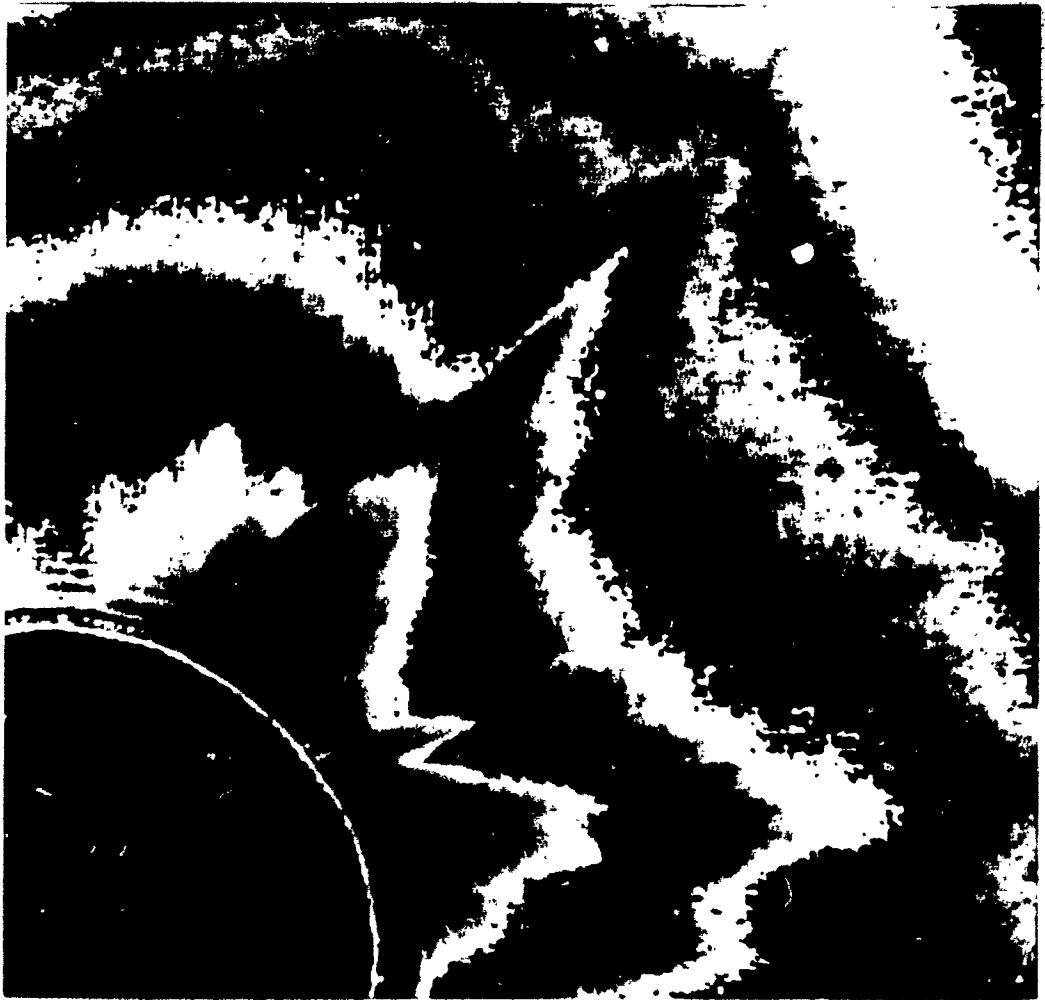

Photo credit: National Aeronautics and Space Administration

Solar corona photo from satellite data

Chapter 1

Introduction

The issue of U.S.-Soviet cooperation in space has been the subject of congressional and other debate since the beginning of the space age in the 1950s. For the most part the two countries have developed extensive space programs in almost complete isolation from each other, with space programs heavily military and strategic in nature. But in light of overall world tensions, U.S.-Soviet cooperation in space has been viewed by both countries as a mechanism for enhancing national prestige, sending peaceful symbolic messages to the rest of the world, pooling important scientific and technical information and insights, and perhaps leading to a genuine reduction of tensions on Earth. In U.S. congressional debates U.S.-Soviet space cooperation has characteristically been promoted as a means of reducing tensions and promoting world peace.

The development of U.S.-Soviet cooperation in space has occurred as part of a growth in U.S.-Soviet scientific and technical (S&T) cooperation overall. Formal cooperation in S&T began between the two countries on a bilateral basis in 1959, with the signing of agreements for scientific exchange programs between the National Academy of Sciences of the United States and the Academy of Sciences of the U.S.S.R. It continued with a variety of interinstitutional agreements between the Soviet Academy of Sciences and such U.S. Government agencies as the National Aeronautics and Space Administration (NASA), the National Oceanic and Atmospheric Administration (NOAA), the Federal Aviation Administration (FAA), the Department of Energy (DOE), and the Department of Agriculture (USDA). In the early 1970s this cooperation culminated in the signing of a broad U.S.-Soviet intergovernmental agreement to cooperate bilaterally in 11 areas of science and technology.

U.S.-Soviet cooperation *in space* has occurred on a number of levels: on a bilateral intergovernmental basis, in multilateral forums, and through more informal scientist-to-scientist exchange. For example, the United States and the Soviet Union have signed broad agreements to cooperate in space on four occasions, the first two at the interagency level

(1962 and 1971, between NASA and the Soviet Academy of Sciences), and the latter two at the intergovernmental level, when an intergovernmental "Agreement Concerning Cooperation in the Exploration and Use of Outer Space for Peaceful Purposes" was signed in 1972 and renewed in 1977. In the multilateral context U.S.-Soviet space cooperation has expanded through international projects and organizations such as the World Weather Watch conducted by the World Meteorological Organization (WMO), and the International Maritime Satellite (INMARSAT) system; the United States and the U.S.S.R. have also signed and ratified four U.N. treaties and agreements concerning the peaceful use of outer space.¹ And U.S.-Soviet interaction and discussions without governmental-level recognition have also taken place in such forums as the International Astronautical Federation (IAF) and the Committee on Space Research (COSPAR), organized in 1958 as a coordinating body of the International Council of Scientific Unions (ICSU).

Despite these various types of cooperative efforts, the history of U.S.-Soviet space cooperation has been an uneven one, marked by intermittent hopes, occasional accomplishments, and many disappointments. The high level of secrecy surrounding Soviet space activities (due to the absence of a separation between Soviet military and civilian space programs) has impeded the interchange of information and ideas. And it has proved to be exceedingly difficult, in the U.S.S.R. as well as in the United States, to separate the issues of U.S.-Soviet military and political competition on Earth from the pursuit of cooperation in space.

¹These are 1) the "Treaty on Principles Governing the Activities of States in the Exploration and Use of Outer Space, Including the Moon and Other Celestial Bodies" (1967) (TIAS 6347; 18 UST 2410; 610 UNTS 205); 2) an "Agreement on the Rescue of Astronauts, the Return of Astronauts, and the Return of Objects Launched in Outer Space" (1968) (TIAS 6599; 19 UST 7570; 672 UNTS 205); 3) the "Convention on International Liability for Damage Caused by Space Objects" (1972) (TIAS 7762; 24 UST 2389; 961 UNTS 187); and 4) the "Convention on Registration of Objects Launched Into Outer Space" (1974) (TIAS 8480; 28 UST 695; 1023 UNTS 15). A fifth treaty, an "Agreement Governing the Activities of States on the Moon and Other Celestial Bodies" (1979), has entered into force, but neither the United States nor the U.S.S.R. has signed it.



Photo credit: National Air and Space Museum
Vanguard I

Thus, notwithstanding a stated desire on the part of both countries to pursue such cooperation, U.S.-Soviet space cooperation in practice has tended to follow the course of U.S.-Soviet relations overall. After more than a decade of frustrated attempts to establish space cooperation during the late 1950s and the 1960s, cooperation reached its high point in the mid-1970s, at the height of detente, with the Apollo-Soyuz Test Project (ASTP), before declining to a very low level in the late 1970s and to the lapsing of the 1972 Agreement in 1982. Now, 10 years after ASTP, the renewal of U.S.-Soviet space cooperation on an intergovernmental basis is once again being actively proposed, but many of the same concerns and issues which characterized

early efforts at cooperation are also being voiced today.

* * * * *

The signing of Public Law 98-562 in October 1984 in support of renewing space cooperation with the U.S.S.R., and subsequent proposals for prospective U.S.-Soviet joint projects, have again brought fundamental questions to the fore. What should specific U.S. objectives be, and how should these objectives be reconciled with each other? Is U.S.-Soviet space cooperation primarily a political or scientific endeavor? Does it in fact promote peace or reduce tensions? What should take precedence when scientific and foreign policy objectives conflict? How much "technology transfer" to the U.S.S.R. should the United States permit so as not to jeopardize real scientific and foreign policy benefits? And to what degree should space cooperation fluctuate depending on broader political events?

These and other questions have triggered a great deal of public debate in the United States. One viewpoint, for example, argues that renewed U.S.-Soviet cooperation in space should be vigorously pursued for political, economic, and scientific reasons. At a time when the "weaponization" of space has become a major concern in the United States and abroad, some observers argue that cooperation in space represents a feasible means for altering this trend. At a time when U.S.-Soviet relations are at one of their lowest points of the last few decades, space cooperation is viewed as a means of reducing tensions. And in more quantifiable terms, the potential scientific and economic benefits of renewed cooperation are considered substantive enough in their own right to merit renewed cooperation. Proponents of these views tend to support a relatively large-scale joint U.S.-Soviet cooperative endeavor in space, insulated from the ups and downs of U.S.-Soviet relations and world politics.

Others, however, are more wary of renewed U.S.-Soviet space cooperation, placing more emphasis on the possible negative foreign policy and national security implications. In terms of potential political benefits, for example, these observers argue that U.S.-Soviet cooperation in space should

not be viewed as the antithesis of militarization of space: one can compete militarily and cooperate at the same time. They argue that space cooperation cannot be insulated from, nor greatly change, broader political events, and may result in Soviet rather than U.S. political advantage. And the scientific and economic benefits, some argue—although real, and at times substantial—are not great enough to offset the technology transfer and national security concerns which would accompany any cooperative venture in space. Proponents of these views tend to oppose renewing cooperation in space, or support pursuing space cooperation on a very low level, perhaps using it as a foreign policy tool when appropriate.

This technical memorandum is designed to sort out these issues as a basis for discussing guidelines and more specific policy approaches in the future. It is not intended to determine whether cooperation should be pursued, nor to prescribe optimal methods for doing so. Instead, it is designed only to clarify the pros and cons of each set of policy issues and highlight the potential conflicts among them.

Following this brief introduction, chapter 2 outlines the history of U.S.-Soviet cooperation in space, and the policy debates which have taken place in the United States since the beginning of the space age. It focuses on bilateral intergovernmental U.S.-Soviet space cooperation, as a background to analyzing policy issues facing Congress today and the kinds of questions these may suggest for the future.

Chapter 3 identifies some potential areas for expanded U.S.-Soviet cooperation in the space sci-



Photo credit: National Air and Space Museum

The world's first cosmonaut—Laika

ences. Based on a workshop of space scientists held at OTA in May 1984, the chapter presents a scientific evaluation of past U.S.-Soviet cooperative efforts in the planetary and space life sciences, and enumerates potential projects for the future which could have substantial scientific merit.

Chapters 4 and 5 combine this historical and scientific background with the complex array of foreign policy and national security issues which lie at the heart of any U.S.-Soviet cooperative activity in space. Chapter 4 focuses on French policies since, of all the Western countries, France has had the most extensive and long-term space cooperation with the U.S.S.R., and has tended to approach space cooperation with the U.S.S.R. in terms quite different from those in the United States. Chapter 5 examines all of these issues as they face U.S. policymakers today.

Chapter 2
**History of U.S.-Soviet
Cooperation in Space**



Photo credit: National Air and Space Museum

Eleventh century tapestry showing the Comet Halley

History of U.S.-Soviet Cooperation in Space

BACKGROUND: FROM THE COLD WAR "MISSILE GAP" TO A COOPERATIVE SPACE AGREEMENT

The history of U.S.-Soviet cooperation in space has been marked by a number of overarching themes. In both countries, space cooperation has ostensibly been viewed as one means to achieve a greater degree of understanding and diminish conflict on Earth; a stated objective of both countries has been to encourage space cooperation for the benefit of mankind. But efforts to establish bilateral U.S.-Soviet cooperation have been marked by certain inherent tensions difficult to resolve: tensions in cooperating in space while competing on Earth; in simultaneously competing and cooperating in space, where, in both countries, military activities have been a prominent, if not driving force; in reconciling U.S.-Soviet space cooperation with the broader U.S.-Soviet political relationship; and tensions *within* both countries among various interests and bureaucratic perspectives in formulating national policy. United States and U.S.S.R. policies traditionally have reflected different viewpoints regarding what cooperation means and how it fits into the broader U.S.-Soviet relationship. All of these issues have colored the history of U.S.-Soviet space cooperation, and continue to shape the direction in which such cooperation may move in the future.

Early U.S. Interest in Cooperation

Since the beginning of the "space age," in the early 1950s, both the United States and the U.S.S.R. have been committed in principle to the idea of international cooperation in space. But against a background of the Cold War and substantial military competition, initial efforts to establish U.S.-Soviet space cooperation met with little success. The Soviet approach to space was characterized by efforts to "score propaganda points against the capitalist West" rather than

work cooperatively,¹ and by a strong concern for secrecy in virtually all of its space activities. The United States, on the other hand, was more favorably disposed towards cooperation with the U.S.S.R., viewing it not only as a means to promote peace, but as a means of pooling technical knowledge, placing the use of space under some degree of control, and of increasing U.S. prestige internationally.² Although Soviet planners gradually warmed toward space cooperation in the 1970s, the 1950s and 1960s were characterized by U.S. overtures for space cooperation which were, for the most part, rejected or ignored. They were marked by only sporadic and low-level cooperation, against a background of strident competition.

One of the earliest forums for encouraging space cooperation in the 1950s was the International Geophysical Year (IGY). The IGY—actually a period of 18 months from July 1957 to December 1958—was established by the International Council of Scientific Unions (ICSU) to pool international efforts in studying our physical environment: the Earth, the oceans, the atmosphere, and outer space. Although the IGY's program initially did not include the launching of artificial satellites, American scientists proposed such an

¹Joseph G. Whelan, "Soviet Attitude Toward Cooperation in Space," in Congressional Research Service, *Soviet Space Programs: 1976-80*, prepared for the Senate Committee on Commerce, Science and Transportation (Washington, DC: U.S. Government Printing Office, 1982), p. 207.

²See Marcia Smith, "International Cooperation in Space," *United States Civilian Space Programs 1958-1978*, a report prepared for the House Subcommittee on Space Science and Applications, Committee on Science and Technology, 97th Cong. (Washington, DC: U.S. Government Printing Office, 1981), pp. 834-837; and Dodd L. Harvey and Linda C. Ciccoritti, *U.S.-Soviet Cooperation in Space* (Miami: Center for Advanced International Studies, University of Miami, 1974), pp. 1-22.

effort: at the planning conference in Rome in 1954 of the committee established to coordinate the IGY effort, the Comité Spécial de L'Année Géophysique Internationale (CSAGI).³ With tens of thousands of scientists from 69 countries participating, the IGY involved investigations in many areas, both in space and on Earth, including those directed at the physics of the upper atmosphere, the Earth's heat and water regimen, and the Earth's structure and shape. Both the United States and the Soviet Union participated in the IGY, and both planned to launch a satellite in conjunction with it.

Largely because of Soviet reluctance to engage in extensive information exchange, however, cooperation in space activities both in planning for the IGY and during the IGY itself remained on a token level. Although the Soviet Union did participate in the IGY, it applied restrictions to IGY agreements for exchange of information in space, and Soviet compliance with IGY requirements in space science was poor.⁴ This was due at least in part to the high level of secrecy and the lack of a clear distinction—unchanged to this day—between the Soviet military and civilian space efforts, which inhibited the Soviets in sharing in-

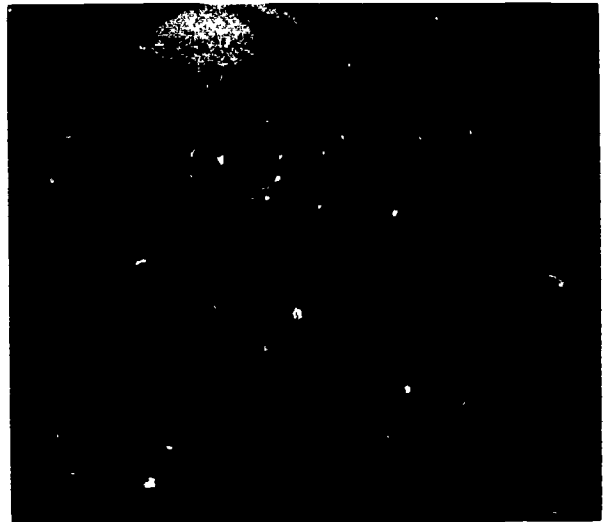

Photo credit: National Air and Space Museum

Sputnik 1

formation and data. The Soviet approach was different from that in the United States, which stressed a separation between civilian and military space efforts.

Both the promise and problems of this space cooperation were highlighted with the Soviets' launching of Sputnik 1 in October 1957. The U.S. public and the Congress were caught by surprise, and the launch was viewed both as a humiliating defeat for U.S. prestige and as a deep national security concern. In the words of one specialist:

The Soviet Union had demonstrated by its satellite program its capacity for launching intercontinental ballistic missiles, and its intention of exploring the space environment whose control could affect methods of maintaining peace and waging war.⁵

The immediate effect of Sputnik, therefore, was to inspire competition. The United States increased funding for its space program, viewing expanded capabilities in space as critical to U.S. prestige and strategic defense.⁶ At the same time, however, it also underlined the importance of en-

³For a more in-depth look at this early part of space history see Walter Sullivan, *Assault on the Unknown. The International Geophysical Year* (New York: McGraw-Hill, 1961)

• Arnold W. Frutkin, *International Cooperation in Space* (Englewood Cliffs, NJ: Prentice-Hall, 1965)

• Constance McLaughlin Green and Milton Lomask, *Vanguard A History* (Washington, DC: National Aeronautics and Space Administration, 1970)

• Michael Collins, *Carrying the Fire, An Astronaut's Journeys* (New York: Farrar, Straus & Giroux, 1974)

• Harvey and Ciccoritti, *U.S.-Soviet Cooperation in Space*, op cit

• Congressional Research Service, Science Policy Research Division, *World-Wide Space Activities*, a report prepared for the Subcommittee on Space Science and Applications of the Committee on Science and Technology, U.S. House of Representatives (Washington, DC: U.S. Government Printing Office, 1977)

• Homer E. Newell, *Beyond the Atmosphere Early Years in Space Science* (Washington, DC: National Aeronautics and Space Administration, 1980).

• Walter A. McDougall, *The Heavens and the Earth: A Political History of the Space Age* (New York: Basic Books, 1985)

⁴See Frutkin, *International Cooperation in Space*, op cit., pp 19-20

The Soviet Union provided virtually no advance information of a substantive character regarding either its satellite or sounding rocket programs, restricted agreements prescribing types of information to be exchanged, and released only limited quantities of digested scientific findings such as normally appear in conventional publications (p 20)

⁵Eilene Galloway, "Congress and International Space Cooperation," *International Cooperation in Outer Space: A Symposium*, prepared for the U.S. Congress, Senate Committee on Aeronautical and Space Sciences (Washington, DC: U.S. Government Printing Office, 1971), p. 4.

⁶John Logsdon, *The Decision to go to the Moon: Project Apollo and the National Interest* (Cambridge, MA: MIT Press, 1970).

couraging international cooperation as a means of promoting peaceful rather than military uses of outer space. As stated by the Preparedness Investigating Subcommittee of the Senate Armed Services Committee in 1958:

... the same forces, the same knowledge, and the same technology which are producing ballistic missiles can also produce instruments of peace and universal cooperation ... the truly worthwhile goal is a world of peace—the only world in which there will also be security.⁷

A total of eight successful satellite launches were accomplished during the IGY: The U.S.S.R. launched Sputnik I, II and III; the United States launched Explorer I, II, and IV, Vanguard I, and Pioneer III. But despite some exchange of information, space cooperation was the most disappointing part of the IGY, and efforts outside of the IGY to engage Moscow in space cooperation remained unanswered or were refused.

Thus, the late 1950s highlighted the twin themes of competition and cooperation which would characterize all subsequent U.S.-Soviet efforts towards cooperation in space. The IGY marked the beginning of efforts of space scientists throughout the world to work together despite political differences. But especially with the launching of Sputnik I, it also showed the difficulties of cooperating, and revealed the Soviets as strong competitors with the United States in space technology and possessors of a military capability with startling implications.

⁷*Inquiry Into Satellite and Missile Programs*, hearings before the Preparedness Investigating Subcommittee of the Senate Committee on Armed Services, 85th Cong., 1st and 2d sess., Part 3 (Washington, DC: U.S. Government Printing Office, 1958), pp. 2429-2430.

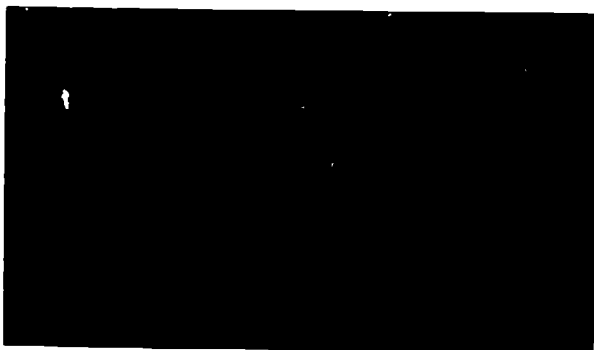

Photo credit: National Air and Space Museum

Explorer 1

One result for the United States was the establishment of the National Aeronautics and Space Administration (NASA) to address both the competitive and cooperative sides of space. NASA was created by the National Aeronautics and Space Act of 1958, whose declaration of policy—that space activities be conducted for peaceful purposes and for the benefit of mankind—included specific goals for encouraging both peaceful competition and cooperation with foreign countries, East and West. For example, the Act calls for “the preservation of the role of the United States as a leader in aeronautical and space science and technology”⁸ and for “cooperation by the United States with other nations and groups of nations. . .”⁹ in the conduct and peaceful application of space-related activities.

The Early 1960s: Unfulfilled Promise

Although the goal of international cooperation had been included in NASA’s charter—and although the 1960s saw expanded U.S. cooperation with countries other than the U.S.S.R., and Soviet cooperation with countries other than the United States—U.S.-Soviet relations regarding space during the decade of the 1960s were characterized primarily by competition. The Kennedy Administration accelerated the pace of U.S. space efforts soon after entering office, and on May 25, 1961, during an address to a joint session of the 88th Congress, President Kennedy called on the country to commit itself to landing a man on the Moon by the end of the decade.¹⁰ Although the idea had been discussed among scientists and in Congress in the late 1950s, this official statement of policy became part of another round of the “space race,” not “won” until 1969. The first half of the 1960s was marked by major achievements in the Soviet Vostok and Voskhod programs, in the U.S. Mercury and Gemini programs, and the first “space walk,” conducted by the Soviet cosmonaut Alexei Leonov in 1965.

⁸National Aeronautics and Space Act of 1958, Public Law 85-568, Section 102(c)(5).

⁹*Ibid.*, Section 102(c)(7) Section 205 of the act provides forral authorization for international cooperation in space.

¹⁰John F. Kennedy, “Special Message to the Congress on Urgent National Needs,” May 25, 1961, *Public Papers of the Presidents of the United States: John F. Kennedy, 1961* (Washington, DC: U.S. Government Printing Office, 1962), pp. 397-407.

But despite the commitment to devote more resources towards the "space race," the idea of cooperation with the U.S.S.R. was not abandoned. President Kennedy explicitly underlined this in his State of the Union message in 1961:

Finally, this Administration intends to explore promptly all possible areas of cooperation with the Soviet Union and other nations "to invoke the wonders of science instead of its terrors." Specifically, I now invite all nations—including the Soviet Union—to join with us in developing a weather prediction program, in a new communications satellite program, and in preparation for probing the distant planets of Mars and Venus, probes which may someday unlock the deepest secrets of the universe.

Today, this country is ahead in the science and technology of space, while the Soviet Union is ahead in the capacity to lift large vehicles into orbit. Both nations would help themselves as well as other nations by removing these endeavors from the bitter and wasteful competition of the Cold War. The United States would be willing to join with the Soviet Union and the scientists of all nations in a greater effort to make the fruits of this new knowledge available to all . . .¹¹

Soon after taking office President Kennedy formed a special panel—a Joint NASA-President's Science Advisory Committee-Department of State Panel, directed by Jerome Wiesner—to study the possibilities for international cooperation in space activities and related fields. Focusing its attention primarily on collaboration between the United States and the U.S.S.R., the Panel made a series of concrete proposals for cooperative activities. Again Soviet interest, however, was not forthcoming on any of these proposals.

Part of the reason for the lack of agreement was the relation of cooperation in space to broader issues of U.S.-Soviet relations. While the United States hoped to isolate cooperation in space as a separate area of negotiation, the U.S.S.R. tended to view it as inextricably intertwined with broader foreign policy issues. Whereas U.S. statements reflected the hope that cooperation in space might lead to more understanding and cooperation in other areas, Soviet statements declared that issues

in those other areas—especially disarmament—had to be settled first.

Soviet planners, therefore, declined to discuss issues of U.S.-Soviet cooperation in space until the political situation changed in 1961, when issues such as the Berlin crisis and the break with the Chinese Communist Party led to a fundamental shift in the Soviet stance toward the United States overall. This shift in attitude was reflected in October 1961 at the 22nd Congress of the Communist Party of the Soviet Union (CPSU), when Soviet party and government officials began discussing a policy of cooperation with other nations in the fields of trade, cultural relations, science, and technology. In December 1961, after years of relative intransigence over other U.N. resolutions, the Soviet Union for the first time gave its support to the passage of a U.N. Resolution stressing "the urgent need to strengthen international cooperation . . . for the betterment of mankind . . ."¹² And Soviet leaders gradually moderated their position toward cooperation in space with the United States. The following February, Khrushchev sent a letter to President Kennedy congratulating the American people on John Glenn's three-orbit flight and suggesting that there be closer cooperation in space activities between the two powers.¹³

¹¹U.N. General Assembly Resolution 1721 (XVI) of Dec. 20, 1961.

¹²Edward Ezell and Linda Ezell, *The Partnership: A History of the Apollo-Soyuz Test Project*, NASA SP-4209 (Washington, DC: National Aeronautics and Space Administration, 1978), pp. 37-38.
(continued on p. 19)

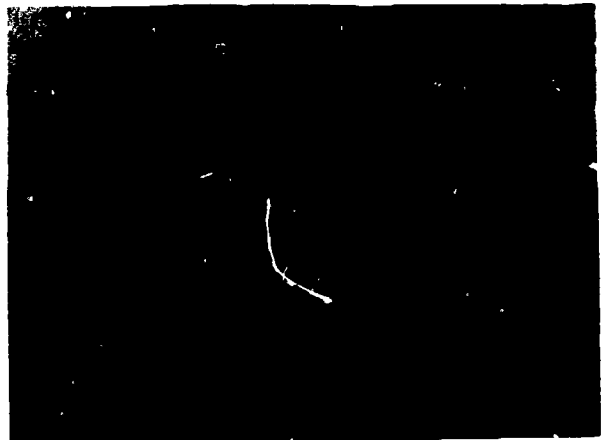

Photo credit: National Air and Space Museum

Yuri Gagarin with Sergei Korolov, U.S.S.R.'s Chief Space Designer, 1950s-1960s

This response led to a series of talks between Hugh Dryden of NASA and Anatoliy Blagonravov of the Soviet Academy of Sciences. These talks, which were suspended temporarily during the Cuban missile crisis, led in turn to the signing of an interagency agreement in December 1962. Generally referred to as the Dryden-Blagonravov agreement of 1962, the agreement stipulated coordinated national efforts in the fields of meteorology, geomagnetism, and satellite communications experimentation. In addition, a 24-hour communications link—the so-called "cold line"—was established for the real time exchange of satellite meteorological data between Washington and Moscow. An additional formal agreement concerned the joint publication of a study on space biology and medicine. Dryden believed that the Soviet concern for secrecy prevented further cooperation.¹⁴

While some useful data were exchanged, however, the results of the agreements were disappointing. Part of this was undoubtedly due to inadequate Soviet technical capabilities for processing data as well as to Soviet intransigence. The meteorological data received by U.S. scientists were late and of poorer quality than had been anticipated; no satellite data were exchanged concerning the magnetosphere; the Soviets received experimental satellite communications but declined to transmit; and the space biology and medicine study was not published until 1975, largely because of delays of up to 2 years in Soviet responses.¹⁵ Despite "frequent and repeated efforts to persuade the Soviets to enter new space projects,"¹⁶ U.S.-Soviet relations generally remained

cold, and the level of cooperation in space seemed to follow suit.

The Late 1960s: The United States Lands a Man on the Moon

During the mid to late 1960s, efforts to expand U.S.-Soviet space cooperation became more modest. Despite previous disappointments, the Johnson Administration continued to pursue such cooperation. But now studies on potential areas for U.S. cooperation in space—such as the Webb Report¹⁷—stressed caution, urging that sights for cooperation be lowered, the serious limitations of cooperating with the U.S.S.R. be recognized, and a "measured approach" with respect to high-level initiatives vis-a-vis the U.S.S.R. be adopted. While the Kennedy Administration had hoped for big projects—extending even to a proposed joint lunar landing—the Johnson Administration shifted back to an emphasis on small "first steps" which might be a basis for broadening cooperation in the future.¹⁸ Cooperation was left primarily for the established NASA-Soviet Academy channels, with few overtures for cooperation coming directly from the President himself. Soviet planners, for their part, seemed less inclined to cooperate, given the greater belligerence in foreign and domestic affairs of the new Brezhnev/Kosygin leadership, the escalation of the war in South Vietnam and, as before, the fact that relationships with respect to space activities were very much determined by the nature of the broader political relationship.

Thus, cooperation in space continued on a very low level. The Soviets began furnishing meteorological data via the long inactive "cold line"; perhaps most importantly, final agreement was reached on a U.N. Outer Space Treaty in 1967, which was implemented by four subsequent international treaties on space law.¹⁹ But proposals for more substantive bilateral cooperation in space were consistently rejected, ignored, or sidestepped

(continued)

For a description of the Soviet change in attitude at this time see Joseph G. Whelan, "Soviet Attitude Toward International Cooperation in Space," *Soviet Space Programs, 1962-65* (Washington, DC: U.S. Government Printing Office, 1966), pp. 427-430.

For a discussion of the events in the U.N. concerning East-West cooperation in space at this time see Eilene Galloway, "Part III: The United Nations," *International Cooperation and Organization for Outer Space* (Washington, DC: U.S. Government Printing Office, 1965), pp. 163-227.

¹⁴Terminated in 1984.

¹⁵Ezell and Ezell, *The Partnership*, op. cit., pp. 58-59.

¹⁶U.S. Congress, Senate, Committee on Aeronautical and Space Sciences, *NASA Authorization for Fiscal Year 1970* (Washington, DC: U.S. Government Printing Office, 1969), especially pp. 635-636.

¹⁷Ibid., p. 636

¹⁸James E. Webb, "Report on Possible Projects for Substantive Cooperation With the Soviet Union in the Field of Outer Space," known as the Webb Report (letter of transmittal dated Jan. 31, 1964) cited in Harvey and Ciccoritti, *U.S.-Soviet Cooperation in Space*, op. cit., pp. 138-139

¹⁹Harvey and Ciccoritti, *U.S.-Soviet Cooperation in Space*, op. cit., pp. 135-139.

²⁰See ch. 1.

Figure 2-1.—Soviet Type G Booster, and U.S. Saturn V

FIGURE - N

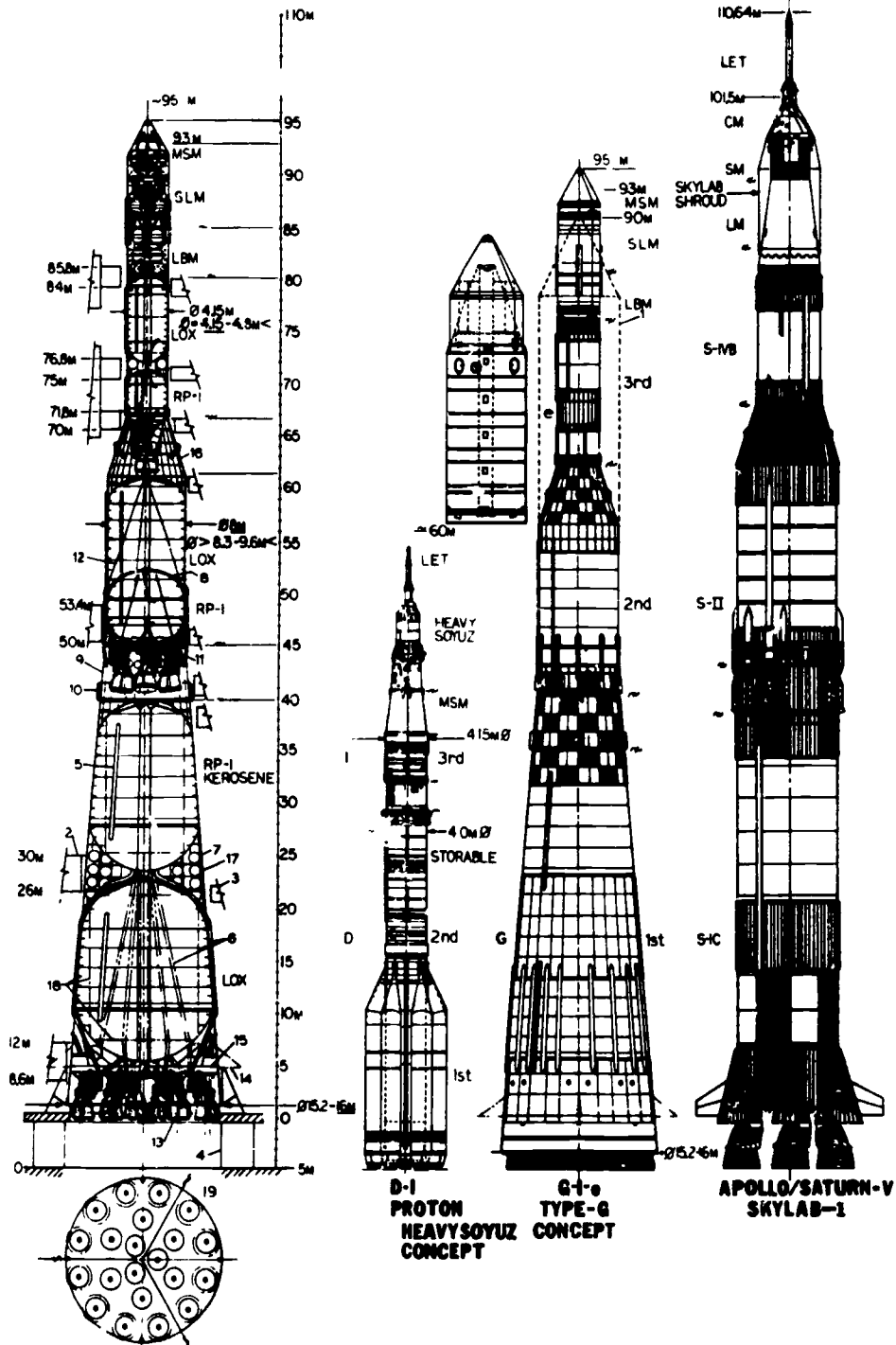

The Type-G booster has never been placed on display, and the U.S.S.R. has never released any data on its characteristics. The design shown here was developed from deductions about the probable Soviet manned lunar mission profile and from a line drawing of its possible service gantry.

SOURCE Charles P. Vick, 1982-84

Figure 2-2.—Conceptual Illustration, Soviet Manned Lunar Landing Program, 1967-73

● LUNAR ORBIT INSERTION (1000 MPS)

● TRANS EARTH INJECTION (950 MPS)

● LUNAR BRAKING MODULE

● SOVIET LUNAR LANDER

● MISSION SUPPORT MODULE

● HEAVY SOYUZ

● EARTH ORBIT RENDEZVOUS

● TRANS LUNAR INJECTION (3100 MPS)

● HEAVY SOYUZ

● SKIP REENTRY INTO EARTH'S ATMOSPHERE OVER THE SOVIET UNION

● CAST OFF ORBITAL MODULE & INSTRUMENT MODULE

● LANDING IN INDIAN OCEAN

D-1 BOOSTER
HEAVY SOYUZ

G-1E BOOSTER
MISSION SUPPORT MODULE
SOVIET LUNAR LANDER
LOI PROPULSION

CONCEPTUAL SOVIET MANNED LUNAR MISSION PROFILE

Soviet manned Lunar landing program from 1967 to 1973 when the program was abandoned. Commentary from Soviet sources, plus the requirements for a manned lunar mission, indicate that the U.S.S.R. had planned to conduct an Earth Orbit Rendezvous (EOR)/Lunar Orbit Rendezvous (LOR) flight profile. A manned craft would meet the huge unmanned payload in Earth orbit before being propelled off to the Moon. At the completion of the lunar phase of the mission, the crew would return to Earth in a variant of their Soyuz spacecraft. All necessary hardware had been developed. The repeated failure of the G-1e booster blocked the mission.

SOURCE: Charles P. Vick, 1983

by Soviet officials. Simultaneously, efforts were intensified to gain the advantage in the new leg of the space race: placing a man on the Moon.

One of the key elements of the Moon race was the ability to launch heavy payloads. The Soviets were testing their Type-G series launchers, but encountered a series of failures. The development of the Saturn V was largely responsible for the United States' success in landing a man on the Moon.²⁰

²⁰For a discussion of the development of U.S. launch vehicles at this time see Charles S. Sheldon II, "Launch Vehicles and Propulsion," *United States Civilian Space Programs 1958-1978*, prepared for the House Subcommittee on Space Science and Applications of the Committee on Science and Technology (Washington, DC: U.S. Government Printing Office, January 1981), pp. 210-217.

For a discussion of the development of U.S.S.R. launch vehicles at this time see Charles P. Vick, "The Soviet G-1-e Manned Lunar Landing Programme Booster," *JBLIS: Journal of the British Interplanetary Society*, XXXVIII, No. 1 (January 1985), pp. 11-18.

With the end of the 1960s, many congressional and other U.S. observers believed that the beginning of the Nixon Administration and the landing of an American on the Moon in 1969 would trigger more U.S.-Soviet cooperation in space. With the United States having "won the space race," many believed that American "superiority" would provide incentive for the U.S.S.R. to cooperate rather than fall farther behind in a costly competition. The new Administration had stated a desire to move from an "era of confrontation to an era of negotiation" in relations with the Soviet Union; the new NASA administrator, Thomas Paine, had renewed efforts to interest the Soviet Academy of Sciences in cooperative projects. The successful landing of the U.S. Apollo 11 manned spacecraft on the Moon encouraged many observers to believe that the Soviets would now accept these offers. A number of congressional addresses and resolutions introduced in the



Photo credit: National Air and Space Museum

U.S. Apollo Astronauts: The First Moon Walk

House and Senate urged that the lunar landing be viewed as a catalyst for changing the direction of the U.S. program to place more emphasis on U.S.-Soviet cooperation rather than competition.²¹

²¹See, for example:

- U.S. Congress, House, Representative Hechler Speaking on Apollo and World Peace, 91st Cong., 1st sess., July 21, 1969, *Congressional Record*, H6116
- U.S. Congress, House, Representative Keith Commenting on Introducing H. Con. Res. 305 Regarding Future Space Exploration Jointly by U.S. and Other Nations, 91st Cong., 1st sess., July 24, 1969, *Congressional Record*, H6294
- U.S. Congress, Senate, Senator Gravel Commenting on and Introducing Senate Resolution 221 to Internationalize the U.S. Space Program, 91st Cong., 1st sess., July 22, 1969, *Congressional Record*, S8385
- U.S. Congress, Senate, Senator Proxmire Introducing Senate Resolution 285—Resolution Authorizing the Senate Foreign Relations Committee to Undertake a Comprehensive Study of All Possibilities for International Cooperation in Space, 91st Cong., 1st sess., Nov. 18, 1969, *Congressional Record*, S14593.
- U.S. Congress, House, Representative Miller Commenting on the Possibility of U.S.-U.S.S.R. Future Exploration of Space, 91st Cong., 1st sess., Aug. 11, 1969, *Congressional Record*, S47251
- U.S. Congress, Senate, Senator Fulbright Commenting on U.S.-Soviet Competition in Space and Possibility of Future Cooperation, 91st Cong., 1st sess., Aug. 11, 1969, *Congressional Record*, S9631
- U.S. Congress, Senate, Senator Percy Commenting on U.S.-Soviet Cooperation in Space, 91st Cong., 1st sess., Aug. 12, 1969, *Congressional Record*, S9828.

But instead of acknowledging 'defeat,' American technological superiority, and a new willingness to cooperate, Soviet officials asserted that there never had been a "space race" to the Moon, and simply congratulated the United States on matching the significant technological achievements already attained by the U.S.S.R.:

Man's walk on the Moon will go down in the chronicles of the twentieth century as an important event, along with such related significant achievements as the launching of the first artificial satellite, the first space flight by Yuri Gagarin, Aleksey Leonov's first walk in space, and the first launchings of automatic spacecraft towards the Moon, Venus, and Mars.²²

After Apollo 11 the Soviets continued until 1976 to launch unmanned probes for exploration of the Moon. Their manned space program was directed more towards Earth-orbit operations, leading to the successful Salyut program of the 1970s. But at the time of the Moon landing extensive U.S.-Soviet cooperation in space appeared to remain elusive.

²²L. Sedov, "Chelovek na lune" [A Man on the Moon], *Pravda*, July 23, 1969

THE 1970s: MOVES TOWARD BROADER COOPERATION

Rendezvous and Docking for Space Rescue

A major shift towards broader cooperation came with the 1970s. The end of the 1960s saw a relaxation of tensions on a number of fronts, including the signing of the Non-Proliferation Treaty in 1968 and the beginning of the Strategic Arms Limitation Talks (SALT I) in 1969. In the period following the lunar landing, one relatively large-scale U.S. proposal for a U.S.-Soviet cooperative space project received a positive response: the idea of astronaut safety and reciprocal rescue capability as a basis for cooperation. In May 1970, a U.S. proposal to develop a common docking mechanism for manned spacecraft and space stations was accepted by the U.S.S.R.

It is unclear why the Soviets became interested in space cooperation with the United States at this time. Some observers argue that Soviet acceptance was based primarily on Soviet technological requirements. Despite some docking successes, the repetition of docking difficulties in the Soviet space program was considered by some to provide a technical incentive for their acceptance of cooperation with the United States. For example, in 1968 the manned Soyuz 3 approached the unmanned Soyuz 2 in orbit with the apparent intention of docking, but no docking occurred. In October of 1969 a tandem flight of three manned spacecraft took place; two of these were expected to dock, but did not do so—presumably a failed mission.

Other observers, however, argue that the Soviet shift was motivated more by political considerations. Following the beginning of a general relaxation of tensions, these observers suggest, the U.S.S.R. viewed a joint U.S.-Soviet venture in space as a means to enhance its image around the world and at home.

The Soviets, for their part, have described the shift almost entirely as an outgrowth of changes in their broader political relation with the United States:

The atmosphere of the "Cold War" of the 1950s to 1960s precluded giving U.S.-Soviet cooperation in space the character of a constantly expanding process. It is not accidental that cooperative activity in the 1960s was limited to an exchange of information, contact between scientists, and individual experiments. Efforts on the part of the U.S. military industrial complex to direct American aeronautics towards military channels, and considerations of prestige and competition . . . created the impression for a wide American public that any Soviet success in space was to the detriment of the "national interests" of the United States.

Changes in the character of Soviet-American relations, and positive results of discussions on the highest level in Moscow and Washington, allowed for a significant expansion of U.S.-Soviet cooperation in the research on and use of space.²³

Discussions were begun in 1970 for joint development of a common docking mechanism. The United States, however, had not intended to establish cooperation on one isolated topic; since before the days of the Dryden-Blagonravov talks, the U.S. thrust had always been toward a broad range of cooperative space activities.²⁴ After the meeting on docking was successful, therefore, discussions of other forms of cooperation were held in Moscow in January 1971, and an agreement was signed between NASA and the Soviet Academy of Sciences involving coordination of space activities, data exchanges, and a lunar sample exchange. This agency-to-agency agreement established the framework for what would evolve into the 1972 intergovernmental agreement.

²³G. S. Khozin, S.S.S.R.-S.Sh.A.: *Orbity kosmicheskogo sotrudnichestva* [U.S.S.R.-U.S.A.: *Orbits of Space Cooperation*] (Moscow: Mezhdunarodnye Otnosheniya, 1976), p. 6

²⁴Harvey and Ciccoritti, *U.S.-Soviet Cooperation in Space*, op. cit., pp. 220-221, 229.

Initiation of Cooperative Space Science and Applications

The text of the agreement of 1971 between NASA and the Soviet Academy of Sciences sets forth a fairly specific plan for cooperation in a number of applications and science areas:

1. In the field of meteorological satellites, to work jointly to make improvements in the current exchange of data and to consider alternative possibilities for coordinating satellite systems of both countries so as to achieve the economic and other advantages of complementary systems.
2. In the field of meteorological rocket soundings, to formulate provisions for a program of soundings along selected meridional lines in cooperation with other countries.
3. In the field of the natural environment, to study the possibility of conducting coordinated surface, air, and space research over specified international waters and to exchange results of measurements made by each country over similar land sites in their respective territories so as to achieve the potential applications of space and conventional survey techniques for investigating the natural environment in the common interests.
4. In the field of exploration of near-Earth space, the Moon, and the planets, to work jointly to define the most important scientific objectives in each area, to exchange information on the scientific objectives and results of their national programs in these fields, to consider the possibilities for coordination of certain lunar explorations, and, in particular, to initiate an exchange of lunar surface samples by performing an agreed exchange of samples already obtained in the Apollo and Luna programs.
5. In the field of space biology and medicine, to develop appropriate procedures and recommendations to assure a more detailed and regular exchange of information including biomedical data obtained in manned space flights.²⁵

²⁵NASA News Release, HQ, 71-57, "U.S.-Soviet Agreement," Mar. 31, 1971; NASA News Release, HQ, 71-9, "U.S./U.S.S.R. Space Meeting," Jan. 21, 1971.

Soviet officials favored signing a more general set of agreements, but NASA negotiators, recalling the disappointing experience of the Dryden-Blaugonravov agreements, argued for a set of goals as specific as possible. Under the framework of this agreement, five Joint Working Groups were established to determine means by which these projects would be implemented: the Joint Working Group on Meteorological Satellites; Joint Working Group on Meteorological Rocket Soundings; Joint Working Group on the Natural Environment; Joint Working Group on the Exploration of near-Earth, the Moon, and the Planets; and the Joint Working Group on Space Biology and Medicine.

Informal discussions of a joint docking proposal took place at the time the 1971 agreement was signed; it remained for a 1972 intergovernmental agreement to incorporate the joint docking project into a formal cooperative project between the two countries.

The 1972 Agreement

The intergovernmental *Agreement Concerning Cooperation in the Exploration and Use of Outer Space for Peaceful Purposes* (see below) was drafted and signed with the dawning of "detente" in U.S.-Soviet relations overall. The Summit meeting between President Nixon and Soviet Premier Brezhnev in Moscow in May 1972—the first time a U.S. President had officially visited the So-

viet capital—triggered hopes that better relations and increased interaction in scientific, economic, and cultural affairs would usher in a new era of peace and cooperation. This summit meeting set the stage for the signing of a total of 11 bilateral agreements for scientific and technical cooperation between 1972-74. In addition to the agreement for cooperation in space, three other bilateral agreements were signed in 1972, for cooperation in science and technology, environmental protection, and medical science and public health. In 1973 four additional agreements were signed, in agriculture, studies of the world's oceans, transportation, and the peaceful uses of atomic energy. Three final agreements were signed in 1974 on housing and other construction, energy, and artificial heart research. The Apollo-Soyuz Test Project (ASTP) was to be among the most ambitious and most spectacular joint efforts between the two countries.

ASTP was specifically described in the points of agreement shown in box 2A, relating to Article 3 of the 1972 Agreement.

The Apollo-Soyuz Test Project (ASTP)

Details of the Apollo-Soyuz Test Project (ASTP) are already well known. As a contribution not only towards detente, but towards the development of a universal, androgynous docking system, the United States and the Soviet Union jointly developed and conducted a flight where the U.S. Apollo spacecraft, carrying a special docking module, rendezvoused and docked with a modified Soviet Soyuz. Soyuz 19 was sent up from Tiuratam (Tyuratam), in the Kazakh Republic of the U.S.S.R., with two cosmonauts on board: Colonel Alexei Arkhipovich Leonov and Valerii Nikolaievich Kubasov. The Apollo was launched from the Kennedy Space Center, with three astronauts: Brigadier-General Thomas P. Stafford, Major Donald K. Slayton, and Major Vance D. Brand.

On July 17, 1975, Apollo and Soyuz docked in orbit 225 kilometers above the Earth, and for 2 days the two crews paid exchange visits and conducted five joint experiments. Figure 2-5 depicts the ASTP mission profile and timeline. Live television coverage of the event was broadcast to mil-

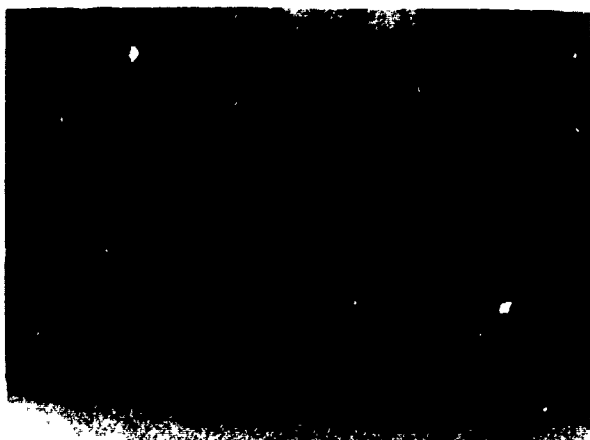
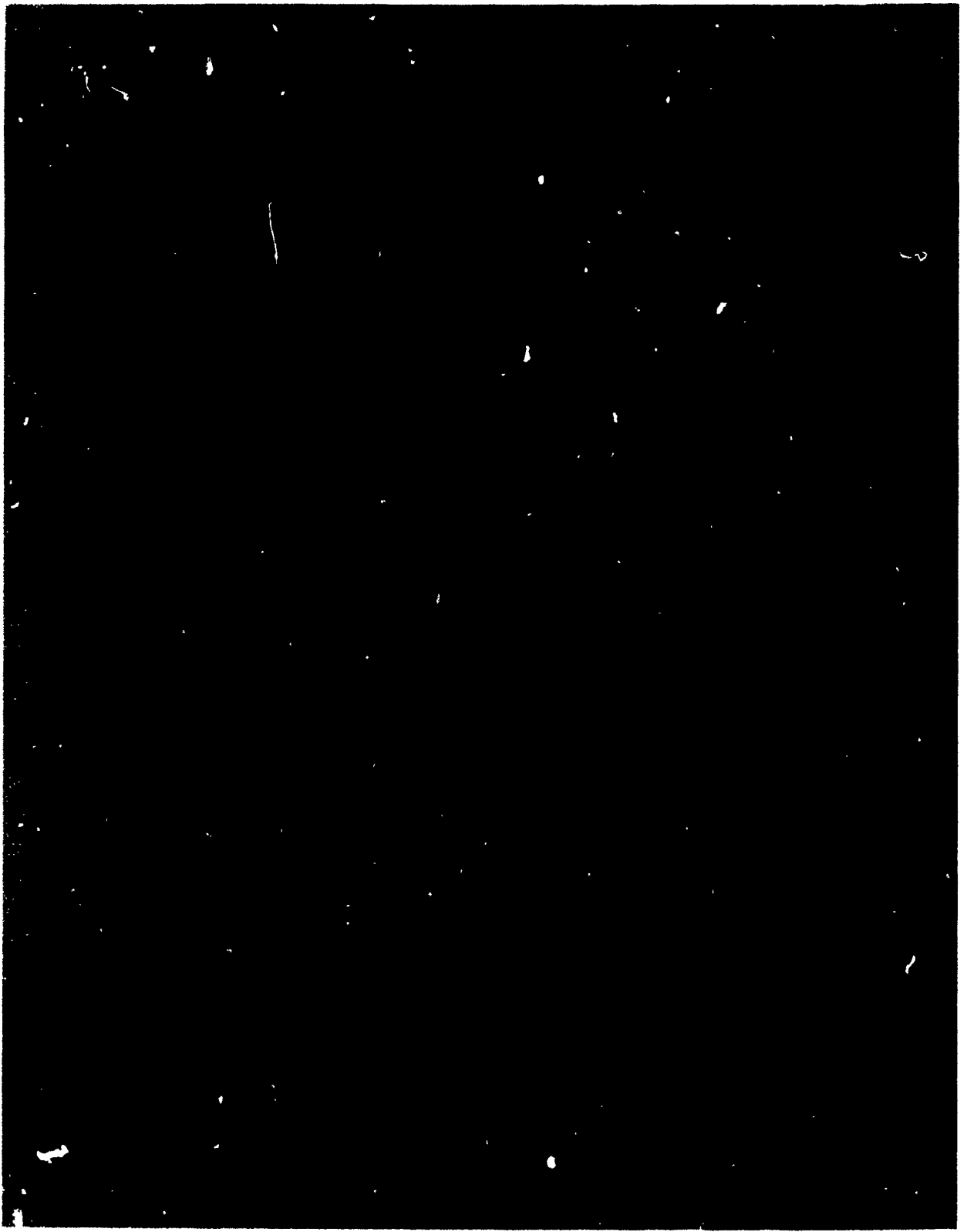

Photo credit. National Aeronautics and Space Administration

President Richard Nixon and Premier Alexei N. Kosygin signing the 1972 Agreement in Moscow





lions around the world with enthusiastic commentary and dramatic pictures. The astronauts and cosmonauts on board emphasized ASTP's importance as a symbol of the peaceful intentions of both countries. And on an official level, the hope was expressed that ASTP would lead to wider and more extensive U.S.-Soviet cooperative efforts in the future. Upon the landing of Apollo and Soyuz spacecraft, L. I. Brezhnev stated:

A relaxation of tensions and improvements in Soviet-American relations have created the conditions for carrying out the first international space flight. They are opening new possibilities for wide, fruitful development of scientific links between countries and peoples in the interests of peace and progress of all mankind.³⁰

Amid the generally enthusiastic response over the success of ASTP, however, many observers began to express criticism of the project as a primarily symbolic, empty, and wasteful use of U.S. space dollars.³¹

³⁰G. S. Khozin, *S.S.S.R.-S.S.A. Orbity kosmicheskogo sotrudnichestva*, op. cit., p. 7

³¹It is difficult to determine the precise cost of ASTP for the United States and U.S.S.R. According to *NASA Pocket Statistics—January 1985* (Washington, DC: Office of Management, NASA, 1985), p. C-5, ASTP cost a total of \$214.2 million. The existing Apollo Command Space Module and Saturn 1B launch vehicle, valued at \$100 million, were transferred to the project at no cost from the completed Apollo program (Similar leftover Apollo hardware was donated to the National Air and Space Museum.) Substantial additional support costs may have been incurred by NASA for ASTP which did not show up as a direct charge to the project. Soviet planners did not publicize their ASTP budget, which precludes a dollar-

Despite the dramatic hopes it represented, the ASTP gradually became the most visible and controversial product of U.S.-Soviet cooperation in space. It became symbolic of cooperation in the minds of most, and for many it was the only memorable product of U.S.-Soviet space cooperation. It has also received the sharpest criticism. Critics argued that it was a "costly space circus," a "250 million dollar handshake,"³² and that funds allocated to ASTP should have been used for more fruitful projects. They also argued that the United States financed a chance for the Soviet Union to present itself as technologically equal to the United States, and asserted that such a joint technological undertaking inevitably involved a transfer of American space technology to the Soviet space program. Finally, they argued that the development of an androgynous docking system itself was unjustified, since the ASTP was to be the last time that the U.S. Apollo spacecraft would be used. Supporters of ASTP countered that no significant technology transfer occurred, and that the joint mission was valuable as a symbol of world peace—"a dramatic demonstration to both nations" and to the world of the potential "prac-

to-ruble comparison. Soviet costs included flying a practice mission, Soyuz 16, which went through all the maneuvers required for docking, and committing a backup Soyuz. See also U.S. General Accounting Office, *A Progress Report on United States-Soviet Union Cooperative Programs* (Washington, DC: U.S. Government Printing Office, Jan. 8, 1975), pp. 34-37.

³²See, for example, James Oberg, *Red Star in Orbit* (New York: Random House, 1981), p. 139.

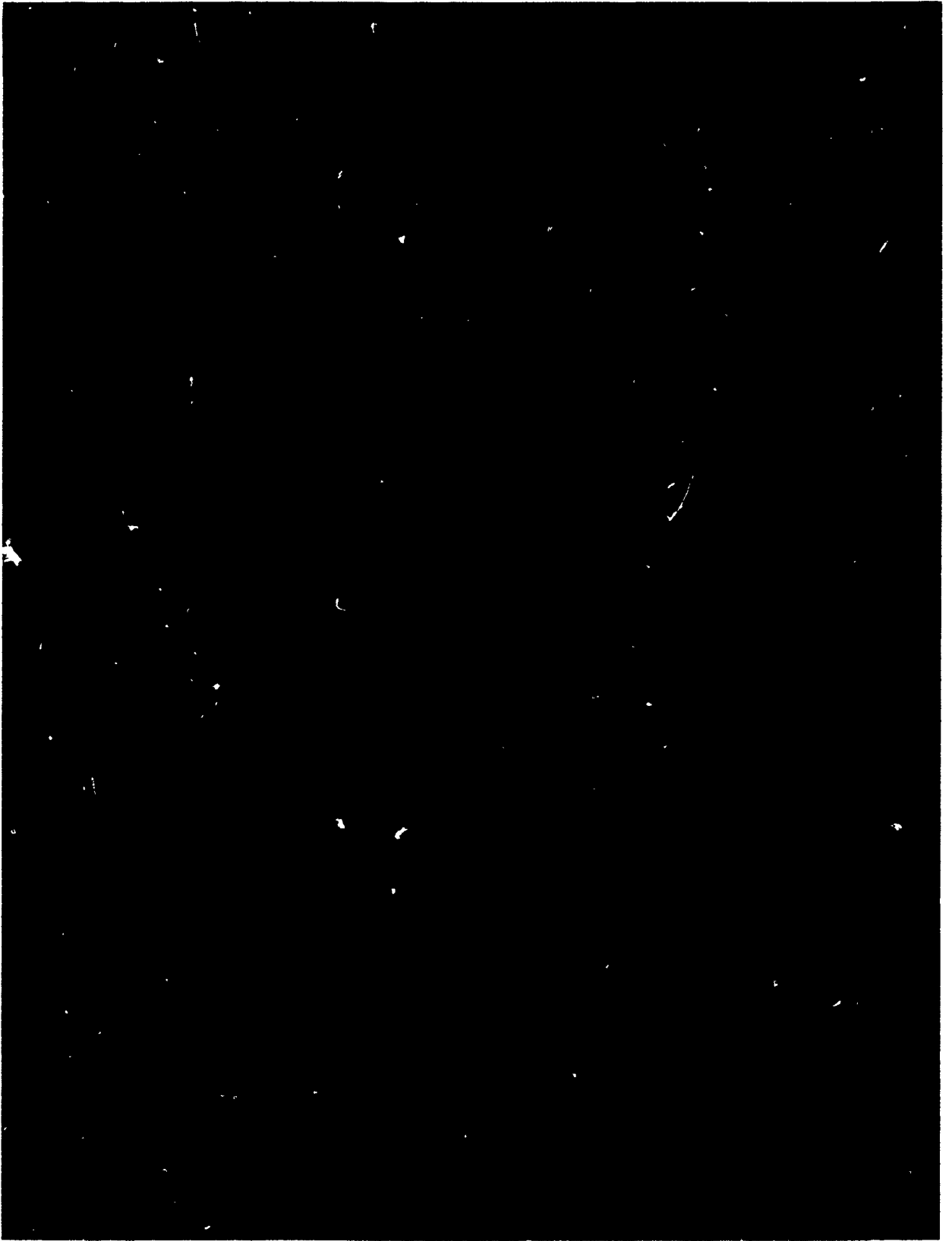
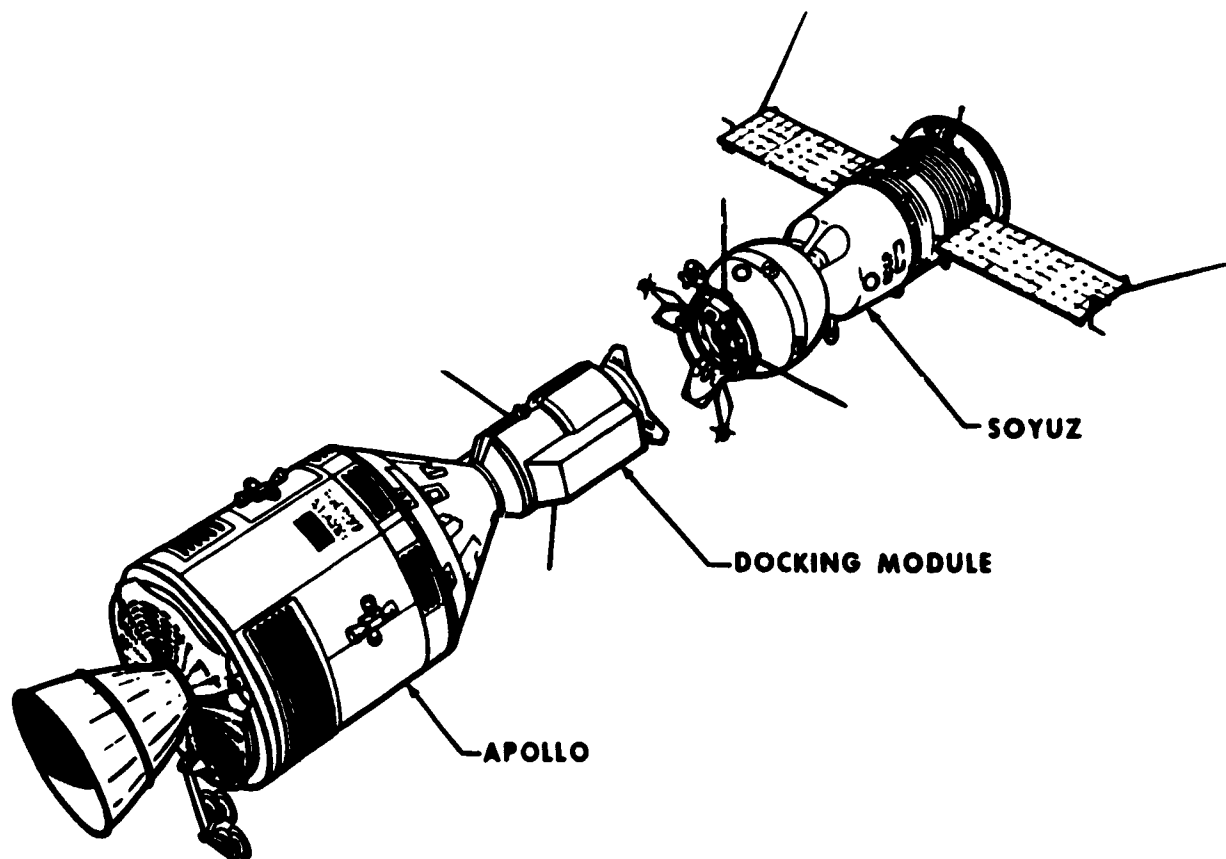

Figure 2-3.—Apollo Command Module and Soviet Soyuz Counterpart



SOURCE: NASA ASTP press release



Photo credit: National Aeronautics and Space Administration

Astronaut Donald K. Slayton and Cosmonaut Aleksei A. Leonov in the Orbital Module during the ASTP

ticality and benefits of detente." In more practical terms, they believed that the result was "a more open [Soviet] space program,"³³ and that the establishment of U.S.-Soviet working procedures for joint manned missions was potentially useful for the future. Disagreements over the benefits and liabilities of ASTP continue today (see chapter 5).

³³Preceding quotes from a letter to Senator Matsunaga from Dr. Thomas O. Paine, dated Sept. 6, 1984, in *East-West Cooperation in Outer Space*, hearings before the Senate Committee on Foreign Relations, Sept. 13, 1984 (Washington, DC: U.S. Government Printing Office, 1984), p. 65.

Figure 2-4.—Docking Mechanism Developed for Use in ASTP

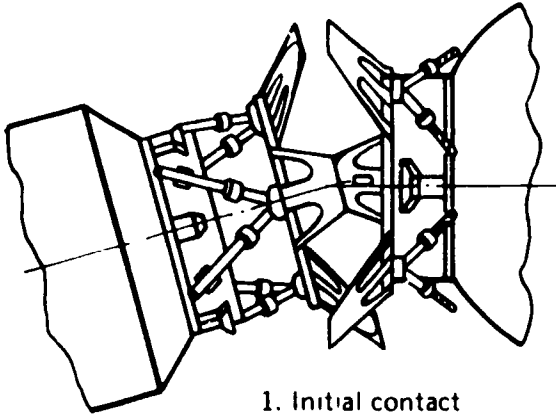

1. Initial contact

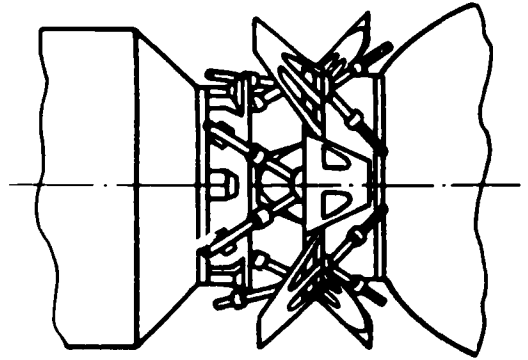

2. Guide ring mate and capture

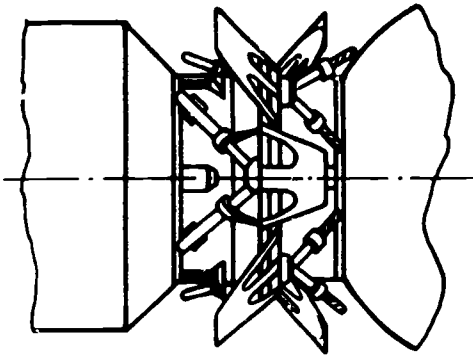

3. Mutual alignment and retraction

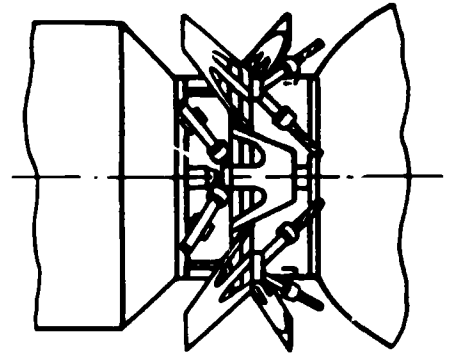

4. Hard and pressure-tight coupling

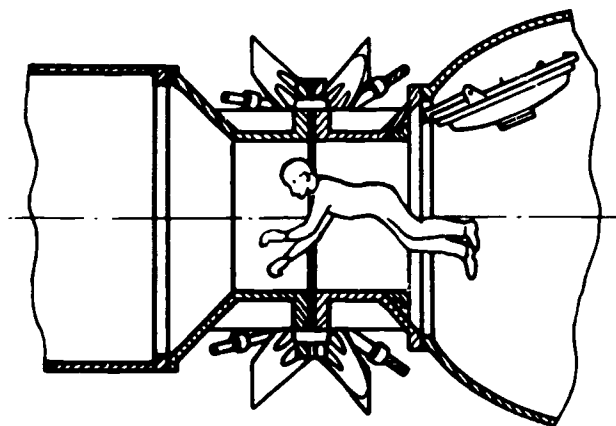

5. Cosmonauts' transfer

SOURCE Soviet ASTP press kit

Figure 2-5.—ASTP Mission Profile and Timeline

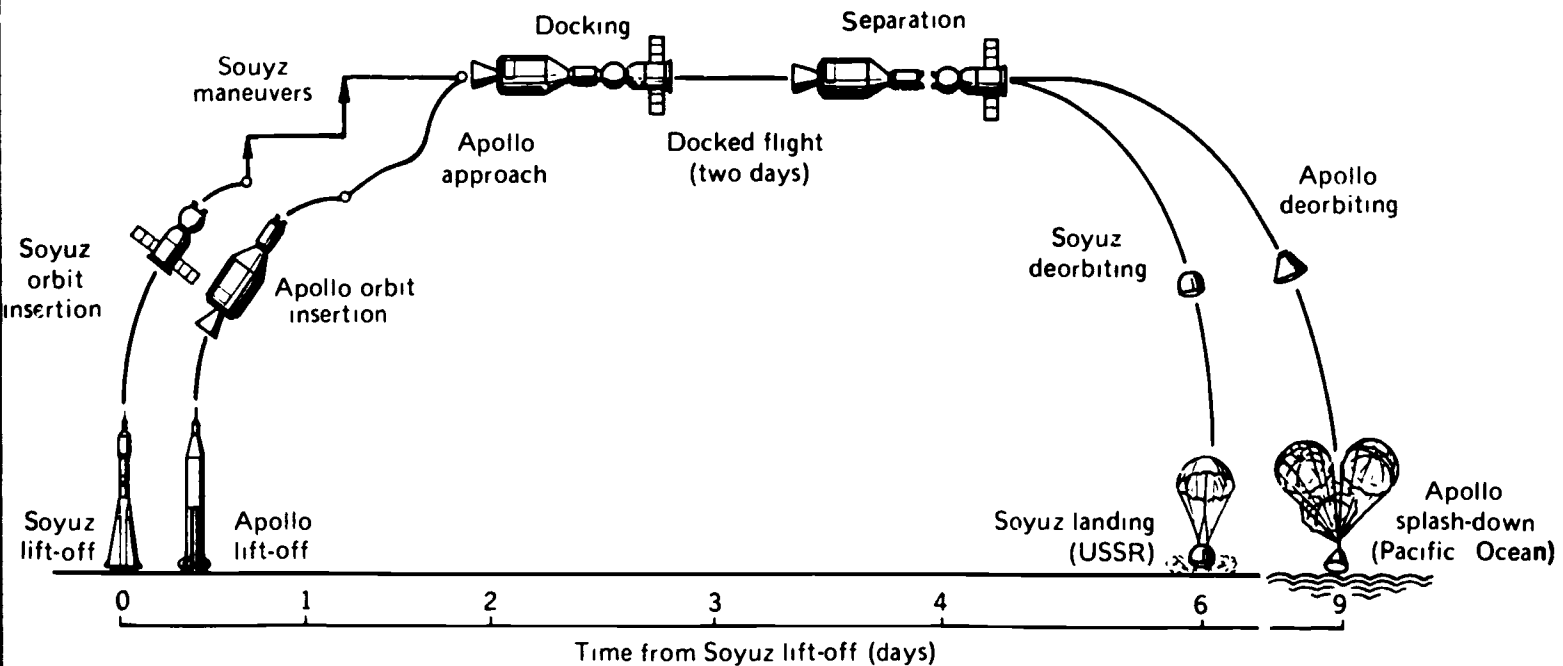

The Joint Apollo-Soyuz Test Project (ASTP) of July 1975 was the high point of U.S.-Soviet cooperation in space. The nine-day mission is the only joint crewed project ever undertaken by the two countries.

SOURCE Soviet ASTP press kit

POST ASTP: CHANGING U.S. POSITION

Whatever the ultimate assessment of the project, the aftermath of ASTP was marked by high hopes for future cooperation which gradually eroded towards the end of the 1970s. Discussions on forms of future cooperation were begun almost immediately after the ASTP was completed. In May 1977, the 1972 agreement was renewed for 5 more years, largely emphasizing the same directions as established in the 1972 agreement: delivery of Soviet lunar samples; mutual briefings on Venera 9 and 10 and Viking landers on Mars; U.S. participation in Soviet experiments aboard their biological satellites; continuation of the joint project for remote sensing of crops and vegetation; and tests to cross-calibrate NASA and Soviet meteorological rockets.³⁴

In addition, the agreement called for looking into another large-scale joint project, a joint Shuttle/Salyut mission, and the possibility of developing an international space platform—activities designed to use complementary areas of the United States and Soviet space programs to provide solid scientific and technical benefits. The long orbital staytime of the Salyut, for example, coupled with the greater flexibility of the Shuttle—its ability to ferry people and large quantities of supplies in a reusable craft—were regarded as especially complementary for joint scientific and applied experiments and for further developing the two countries' rendezvous and docking capabilities.³⁵ An agreement was signed between NASA and the Soviet Academy of Sciences establishing two joint working groups to study "the objectives, feasibility and means of carrying out a joint experimental program using the Soyuz/Salyut and Shuttle spacecraft"³⁶—one working group for basic and applied scientific experiments, and one for operations. A third working group was established "for preliminary consideration of the feasibility of developing an International Space

Platform on a bilateral or multilateral basis in the future."³⁷

The working groups began to meet soon after the agreement was signed to discuss planning for the mission—its feasibility, potential, and possible operating modes for conducting experiments. The working groups were to proceed on the assumption that the first Shuttle/Salyut flight would take place in 1981, but no further commitments were made.

Cooperation in space, however, again became prey to a broader U.S.-Soviet political relationship. By 1978 the human rights issue had already created severe strains in U.S.-Soviet relations. These strains were further aggravated by the establishment of formal diplomatic relations between the United States and China on January 1, 1979, and the granting of most favored nation status to China, but not the U.S.S.R., in the same year; by delays in concluding the SALT II agreement, and then its failure to gain ratification in Washington; by the publication of official evidence alleging the presence of a Soviet brigade in Cuba; by the NATO decision in December 1979 to deploy Pershing II and ground-launched cruise missiles in Europe; and, ultimately, by the Soviet invasion of Afghanistan in the same month. These strains were severely exacerbated by the exile of Andrei Sakharov to Gorkii in January 1979; by U.S. charges in April 1980 of a Soviet violation of the Biological Weapons Convention in an incident in Sverdlovsk 1 year before; and by the cutback in Jewish emigration starting in January 1979 and continuing at least through the first half of the 1980s.

Along with other measures intended to show displeasure with Soviet actions, the United States severely curtailed cooperation in space with the U.S.S.R. By 1978, the White House was questioning whether it was in the interest of the United States to be seen as a cooperative partner in another spectacular and costly manned mission with the U.S.S.R., and the Shuttle/Salyut project was gradually set aside. By the end of the decade, the United States had greatly curtailed cooperation in other areas of space cooperation as well.

³⁷Ibid., p. 4.

³⁴NASA Authorization for Fiscal Year 1978, hearings before the Subcommittee on Science, Technology, and Space for the Committee on Commerce, Science, and Transportation, U.S. Senate, 95th Cong., 1st sess., on S365, Feb. 25, Mar. 1 and 3, 1977, Part 2 (Washington, DC: U.S. Government Printing Office, 1977), p. 815.

³⁵Whelan, "Soviet Attitude Toward International Cooperation in Space," *op. cit.*, pp. 214-221.

³⁶Agreement Between the U.S.S.R. Academy of Sciences and the National Aeronautics and Space Administration of the USA on Cooperation in the Area of Manned Space Flight, May 11, 1977, p. 2.

The 1980s: Promise for the Future?

The early years of the 1980s were not promising for further U.S.-Soviet space cooperation. With U.S.-Soviet cooperation already at an exceedingly low level, declaration of martial law in Poland exacerbated the rift in U.S.-Soviet relations and further reduced initiative for cooperation in space. As part of U.S. sanctions against the U.S.S.R., the 1972/77 Agreement for cooperation in space was allowed to expire when it came up for renewal in 1982.

The level of U.S.-Soviet cooperative space activity since the agreement lapsed has decreased substantially. The joint working groups are no longer constituted, and no new projects have been started.

Despite the lapse of formal cooperation, however, several projects begun under the 1972/77 agreement have continued, and there has been a degree of continuing low-level scientist-to-scientist cooperative activity in certain areas. These ongoing projects include the following areas:

- **Space biology and medicine:** In 1983, for example, Cosmos 1514, a primate mission, carried four U.S. medical research devices; other Cosmos biosatellite flights carrying American experiments included Cosmos 782 (1975), Cosmos 936 (1977), and Cosmos 1129 (1979). This collaboration had been planned before the expiration of the 1977 Agreement, and was allowed to be carried out under agreements between NASA and the Soviet Academy of Sciences. CAT-scan bone data from Salyut missions are still being supplied to NASA, also under continuation from the previous agreement. Some exchanges continue between individual working group members on an informal basis, especially through attendance at professional conferences and meetings.³⁸
- **Near-Earth Space, Moon, and Planets:** Leading Soviet scientists recently presented radar data from Venera 15 and 16, both currently in orbit about Venus, at a number of U.S.

conferences and academic institutions. U.S. and Soviet scientists also continue to exchange Pioneer-Venus radar altimetry data and Venera gas chromatographic and mass spectrometric data. Recent collaborations in studies of solar wind interactions with Venus, landing sites for a forthcoming Venera mission, and Venus lightning have involved exchange and subsequent interpretation of data. Such exchanges are of considerable interest to U.S. scientists in the absence of published data on these topics.

- **Venus Halley (VEGA) Mission:** The present missions to the planet Venus and to Halley's Comet do not involve official U.S.-Soviet cooperation, but coordination among the various countries calls for U.S.-Soviet interaction on different levels. The Soviet Union, the European Space Agency (ESA), and Japan are sending spacecraft to the vicinity of the comet, with the United States playing a supporting role both in preparing for the mission and in subsequent data analysis. To facilitate this cooperation and coordination, an informal multilateral body known as the Interagency Consultative Group (IACG)—an international working group comprised of representatives from NASA, the European Space Agency (ESA), Japan's National Space Development Agency, and the Soviet Interkosmos—was created in 1981. In addition, three experiments designed and built in the United States are flying aboard the two Russian space probes: a comet dust counter, developed by John Simpson, University of Chicago; a Venus nephelometer, by Boris Ragent of NASA Ames Research Center; and a Comet Neutral Mass Spectrometer, by John Hsieh, University of Arizona.³⁹ Other U.S. scientists will be involved in analysis and processing as data are received on Earth.

³⁸See Norman V. Martello, *Biomedical Research Division Significant Accomplishments for FY 1984, NASA Technical Memorandum 86692* (Moffett Field, CA: Biomedical Research Division, Ames Research Center, NASA, February 1985), p. 119.

³⁹See Colin Norman, "U.S. Instruments Fly on Soviet Spacecraft," *Science*, CXXVII, No. 4684 (Jan 18, 1985), pp. 274-275; and Louis D. Friedman and Carl Sagan, *U.S./U.S.S.R. Cooperation in Exploring the Solar System*, an internal report of The Planetary Society (Pasadena, CA: The Planetary Society, 1985). At least four other scientists from the United States are participating as theoretician co-investigators: Bradford Smith, Andrew Nagy, Thomas Cravens, and Asoka Mendis.



Photo credit: National Air and Space Museum

View of Comet Halley, taken 10 May 1910

The present VEGA mission, however, cannot be viewed as an example of official U.S.-Soviet cooperation in space. The interagency agreements governing Halley are bilateral, so that, for example, the United States and ESA have an agreement, but there is no NASA-Interkosmos agreement. Indeed, at present the Soviet Union does not officially recognize the U.S. role in the IACG, and has not recognized U.S. participation in the Venus/Halley's Comet mission; the U.S. experiments are being carried on Soviet spacecraft via third-party agreements.⁴⁰ But in light of the American experiment on board the Soviet spacecraft, and the role of the United States in data analysis and tracking, some observers believe that U.S.-Soviet cooperation will expand as data from the mission are received.

- **Pathfinder and International Halley Watch:** The IACG has identified a number of cooperative activities that will enhance the overall science return from these missions. The most significant of these is "Pathfinder," an

effort which utilizes the U.S.S.R.'s VEGA spacecraft to improve the targetting accuracy of ESA's Giotto spacecraft during the latter's encounter with Halley's Comet. One week later NASA will assist in the Pathfinder activity by providing tracking support from its Deep Space Network antennas in California, Spain, and Australia. Also, several years ago U.S. scientists established the International Halley Watch (IHW), an activity to coordinate ground-based astronomical observations of Halley's Comet. The IHW has become truly international in character, with participation by astronomers all over the world, including the Soviet Union. And some cooperation continues in related areas as well. For example, United States, ESA, Japanese, and Soviet scientists are scheduled to be at NASA's Goddard Space Flight Center when the U.S. International Cometary Explorer (ICE) spacecraft flies by the comet Giacobini-Zinner in September 1985.⁴¹

- **Space Applications:** In the area of space applications, there are at present no ongoing projects begun under the 1972 agreement, al-

⁴⁰The Comet Duster designed by John Simpson, to measure the density and mass distribution of dust particles in the comet's tail, was incorporated in a German package, through the Max Planck Institute in West Germany. The other two experiments were included via Hungarian participation.

⁴¹"First Space Probe to Comet Now Halfway to Target," *Goddard News*, XXXI, No 3 (March 1985), pp. 1-2.

Figure 2-6.—Trajectories of the Various Halley Spacecraft Relative to a Fixed Sun-Earth Line

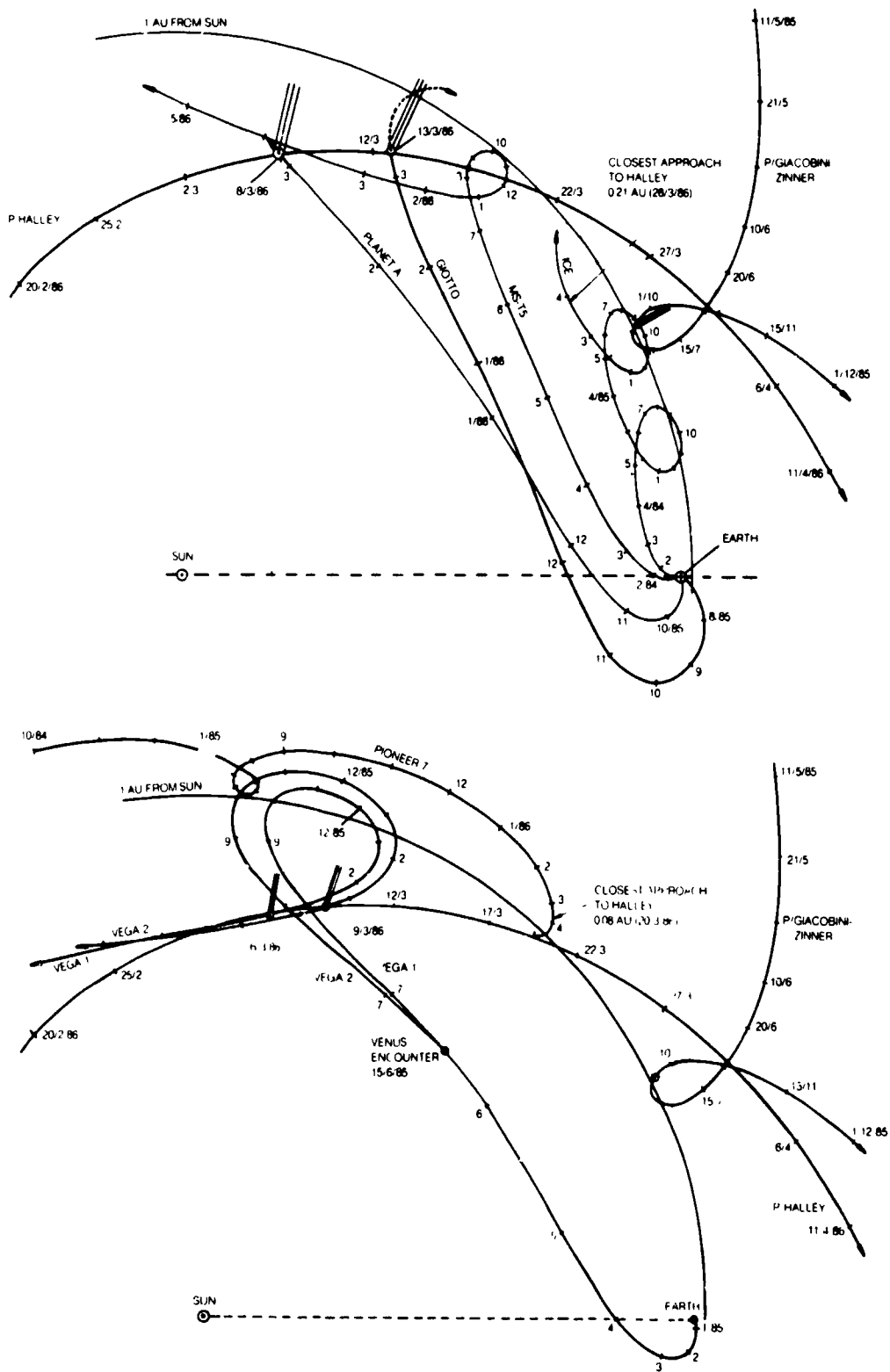

SOUP © European Space Agency

though some level of discussion has continued in forums outside of the now lapsed space agreement. In one of the working groups under the 1972 *Agreement for Cooperation in the Field of Environmental Protection*, for example, which is still in force today—in Working Group VIII, on the Influence of the Environment on Climate and Environmental Protection—some U.S.-Soviet discussion has taken place since 1982 on possibilities for expanding cooperative work in climatic applications of space. The tenth meeting of the working group, for example, in January and February 1985, discussed the possibility of using satellite data for joint cloud, hurricane, and/or surface radiation research, in either this or some other forum.⁴²

The key joint applications projects currently in operation, however, are multilateral in nature, such as the COSPAS/SARSAT search and rescue agreement. As discussed in appendix C, the COSPAS/SARSAT system is the result of two multilateral agreements signed separately: the SARSAT agreement among Canada, France, and the United States; and the COSPAS/SARSAT agreement among the United States, Canada, France, and the U.S.S.R. But the project continues, and in October 1984 the parties signed a new agreement covering extension of the program from its experimental phase to initial operations over the next 5 to 7 years.

- **Non-governmental U.S.-Soviet Telecommunications:** As a sidelight to U.S.-Soviet intergovernmental or interagency cooperation in space, recent years have also seen instances of more indirect "space cooperation" outside of the auspices of official agreement. These have taken the form of satellite telecommunications link-ups, both video and audio, between U.S. and Soviet scientists (and in one case a U.S. Congressman) for discussion of a variety of current scientific and other topics.

The first of these recent "space applications" projects, organized by the Esalen So-

viet-American Exchange Program, took place in September 1982 and May 1983. In the second session, U.S. Congressman George Brown and Soviet Academician E. P. Velikhov discussed the value of satellite telecommunications as a vehicle for scientific and cultural exchange, and proposed that a permanent satellite communication project be established between the United States and the U.S.S.R. Two more exchanges occurred later in 1983, with the second one involving a colloquy between Soviet and American scientists. And in September 1984 a similar satellite teleconference hosted four American and three Soviet scientists (including Dr. Roald Sagdeyev, Director of the Institute of Space Research) in discussions of cooperation in various fields of science: 1) fusion research, 2) astrophysics, 3) seismology, and 4) biophysics.

Whether politically or scientifically motivated, however, cooperation in all of these areas has remained on a very low level. By 1984, Soviet officials were stating that space cooperation, even on the level of scientist-to-scientist exchange, could not be sustained without the framework of a bilateral agreement between the U.S. and Soviet governments.

The mid-1980s, therefore, have brought increased debate concerning the merits and demerits of official, bilateral U.S.-Soviet cooperation in space. These debates have yet to be resolved, and are discussed in chapter 5. In contrast to 1982, however, the mid-1980s have seen a sharp rise in congressional and Administration interest in expanding U.S.-Soviet cooperation in space, on a scale perhaps larger than ever before. In a speech at the White House in June 1984, President Reagan explicitly called for renewing U.S.-Soviet cooperation in space as well as other areas. Hearings on this topic were held by the Senate Committee on Foreign Relations in September 1984. This was followed by the enactment of Public Law 98-562, which calls for "energetically" pursuing a renewal of the 1972/77 agreement on space cooperation and "exploring further opportunities for cooperative East-West ventures in space."

Specific projects have also been proposed. The most prominent of these is the revival of the no-

⁴²See U.S.-U.S.S.R. Agreement on Cooperation in the Field of Environmental Protection: Protocol, Tenth Joint Meeting of Working Group VIII, on the Influence of Environmental Changes on Climate, Jan. 24-Feb. 7, 1985 (unpublished typescript).

tion of a Shuttle/Salyut mission, or a joint simulated space rescue mission as specified in the Public Law. In this project, "marooned" astronauts and cosmonauts would simulate a rescue between the U.S. Shuttle and the Soviet Salyut space station. As currently envisioned, the shuttle would pull up near the Soviet Salyut, and an astronaut wearing a jetpack would fly from the shuttle to the Soviet station, perhaps ferrying a cosmonaut back and forth between the two craft.

On February 6, 1985, Senator Matsunaga introduced S. J. Res. 46 in support of U.S.-Soviet cooperation on Mars exploration missions.⁴³ Initially cosponsored by Senators Proxmire and Simon, the resolution calls for exploring opportunities for cooperation with the Soviet Union on specified Mars exploration missions and examining opportunities for joint East-West Mars-related activities. According to Matsunaga, these missions could be pursued on a manned or unmanned basis. Since both countries are presently planning unmanned missions to Mars, for example—the United States with its scheduled launch of a Mars orbiting mapper in 1990, and the Soviets with a planned launch of a mission to the Mars moon known as Phobos in 1988—he suggests that ways be sought to coordinate missions to best share data and information. A manned mission to Mars, he suggests, could well become "history's most stirring undertaking."⁴⁴ Other proposals include a joint unmanned mission to Venus; joint unmanned exploration of the moon; a joint manned lunar base; and joint study of asteroids and defense against a possible asteroid collision with Earth.⁴⁵

⁴³S. J. Res. 46; A joint resolution relating to NASA and cooperative Mars exploration, referred to the Senate Foreign Relations Committee, introduced by Senator Matsunaga with cosponsors Senators Gorton, Proxmire, Kassebaum, Pell, Stafford, Simon, Major, Kerry, and Cranston. Initially introduced in Jan. 21, 1985, as S. J. Res. 18 by Senator Matsunaga, with cosponsors Senators Proxmire and Simon. As of June 6, 1985, there were 11 cosponsors.

⁴⁴See Spark M. Matsunaga, "Needed: Cooperation, Not War, in Space," *Newsday*, Apr. 9, 1984.

⁴⁵For a discussion of these and other suggestions see:

- Craig Covault, "U.S. Plans Soviet Talks on Joint Manned Mis-

These proposals, however, remain controversial, and as of this writing, Soviet officials have not responded to any of these overtures for renewing cooperation on a bilateral basis. Several prominent Soviet scientists have emphasized their own desire to expand cooperative projects in space, and have underlined the difficulties in doing so without an overarching bilateral intergovernmental agreement. News stories from a meeting in Houston refer to possible "hints" that the Soviets may be interested in expanding space cooperation overall.⁴⁶ But Soviet officials have also stated that the U.S. Strategic Defense Initiative would be a serious obstacle to any major cooperation in space, and that more important military and strategic issues will have to be resolved before serious discussions on renewing any large-scale bilateral cooperation in space can be initiated. Soviet officials so far have not responded to any U.S. overtures on an official basis.

Thus, the same twin issues which surrounded U.S.-Soviet space cooperation more than 30 years ago—competition and cooperation in space, and the relation of space cooperation to broader political relations—are facing proponents and opponents of space cooperation today. Cooperation, however limited, has illustrated the scientific benefits which can be gained from pooling efforts of the two superpowers, particularly in certain areas of space research and applications. But the past 30 years have also highlighted the difficulties in reconciling space cooperation with broader political realities, and shaping and implementing mutually beneficial projects fairly and effectively.

tion," *Aviation Week and Space Technology*, CXXII, No. 1 (Jan. 7, 1985), pp. 16-19.

- John Holmes, "Geneva Talks May Reshape U.S., Soviet Space Roles," *The Washington Times* (Mar. 11, 1985).

- "U.S.-Soviet Space Cooperation Possible, Beggs Says," *Aerospace Daily* (Jan. 10, 1985), p. 52.

⁴⁶See William Harwood, "Soviets Hint Space Cooperation," UPI news story, Apr. 2, 1985; and William Harwood, "Soviets Outline Ambitious Space Program," UPI news story, Apr. 2, 1985.

Figure 2-7.—Primary Operational Soviet Launch Vehicle Family, and Canceled Type-A, A-1, B-1, and Type G-1-e Boosters

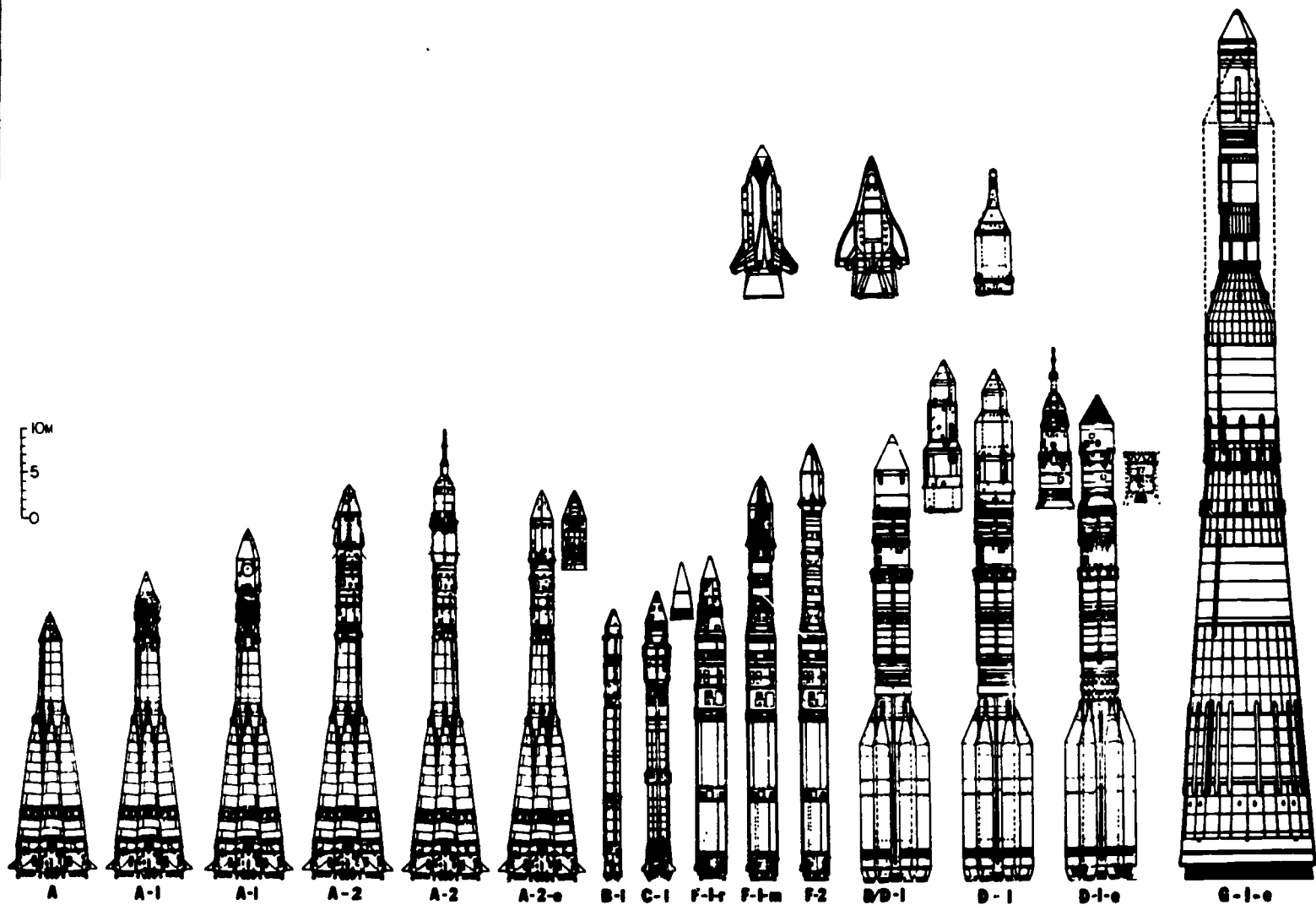

SOURCE: Charles P. Vick, 1993

Figure 2-8.—Artist's Depiction of Direction of the Soviet Space Program

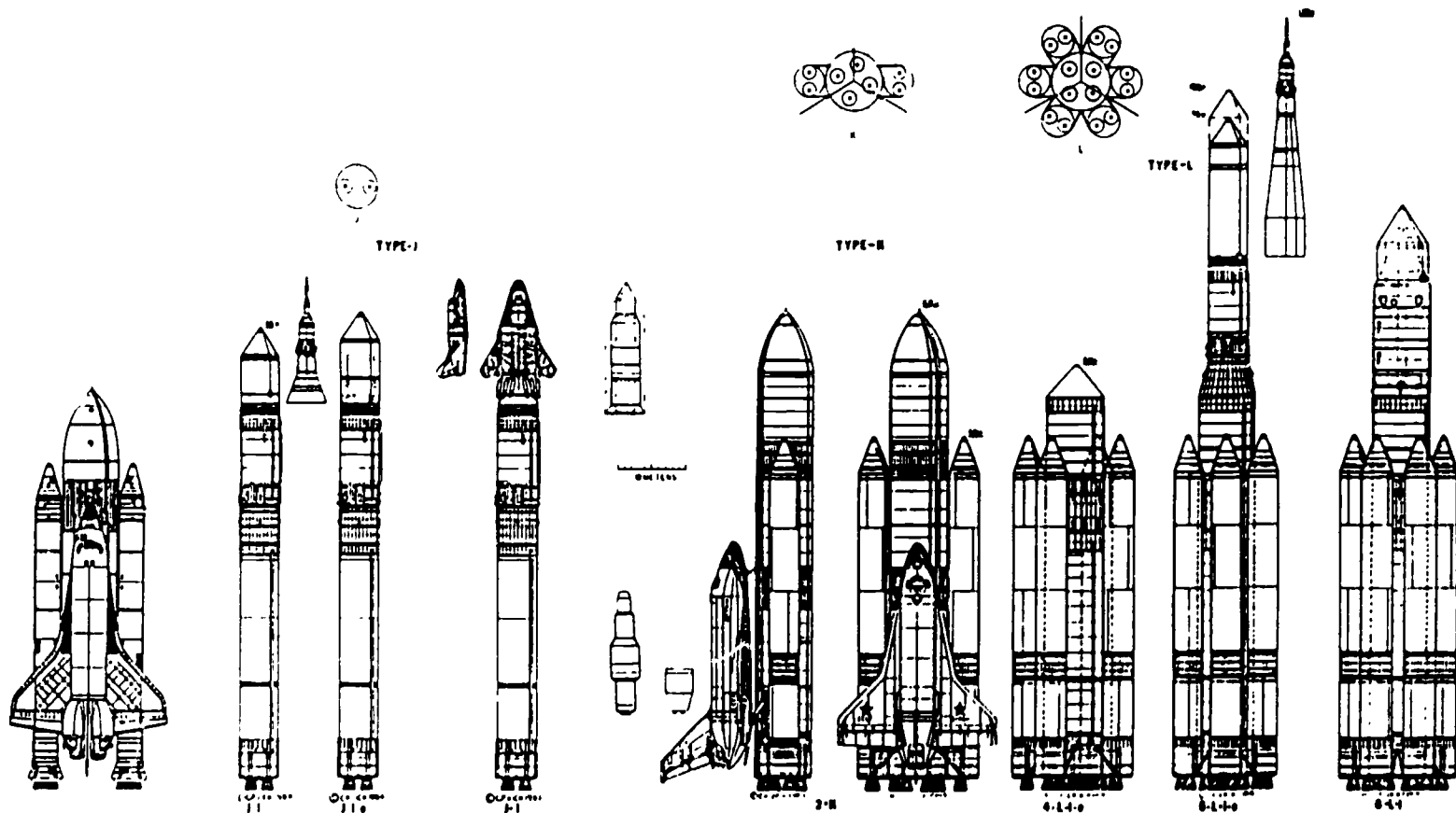

High degree of technical capability being developed by the Soviets today, which may offer new possibilities for cooperation as well as competition.

SOURCE Charles P. Vick, 1964

BEST COPY AVAILABLE

Cooperation in the Sciences: The Science

Chapter 1



Cooperation in the Space Sciences: The Scientific View

INTRODUCTION

As the preceding chapter illustrates, U.S.-Soviet cooperation in space involves a complex, often conflicting mixture of political, scientific, and military issues. These all have a bearing on whether one believes that U.S.-Soviet space cooperation should be pursued and, if so, on the types of projects most appropriate for such activity. These issues and the trade-offs among them are discussed in chapter 5.

In order to clarify some of the specifically scientific and technical issues surrounding cooperation, OTA held a workshop in May 1984 on potential areas for U.S.-Soviet cooperation in the space sciences. Since planetary research and the life sciences are considered the most successful areas of past space cooperation, 13 scientists previously and/or presently involved in cooperative programs with the U.S.S.R. discussed the costs and benefits of past U.S.-Soviet cooperation in the planetary and life sciences and potential areas of such cooperation for the future:

This chapter presents the findings of this workshop in evaluating past and potential U.S.-Soviet space cooperation from a scientific point of view. As illustrated in chapter 2, congressional testimony and other forums have provided evaluations of individual U.S.-Soviet cooperative projects in the past,¹ and several areas outside of the

space sciences have been suggested as potentially promising for U.S.-Soviet cooperation for the future. These range from the joint simulated space rescue mission called for in Public Law 98-562 to joint efforts in near-Earth scientific stations, lunar bases, and trips to asteroids, Mars, or the moons of Jupiter. In the area of space applications, COSPAS/SARSAT has been viewed as a successful paradigm which could be used for other types of activities, such as improvements in meteorological coverage, disaster warning systems, and educational satellite telecommunications. OTA discussions with representatives from Third World countries to the United Nations in May 1984 suggested that U.S.-Soviet cooperative efforts, especially in such areas as developing a worldwide disaster warning system, would have some modicum of international support.

The purpose of this chapter is not to evaluate these or other potential cooperative projects, nor is it to make specific recommendations. Instead, the workshop was intended to focus on one area—space science—which has been regarded as a viable area for cooperation in the past, and may well be among the most valuable for the future. By focusing on one broad area, the workshop was designed to highlight the scientific advantages and disadvantages of cooperation with the U.S.S.R. which may be applicable to other areas as well.

¹See, for example, Joseph G. Whelan, "Soviet Attitude Toward International Cooperation in Space," in Congressional Research Service, *Soviet Space Programs: 1976-1980*, prepared for the Senate Committee on Commerce, Science, and Transportation (Wash-

ington, DC: U.S. Government Printing Office, 1982), pp. 221-260; *East-West Cooperation in Outer Space*, hearings before the Senate Committee on Foreign Relations, Sept. 13, 1984 (Washington, DC: U.S. Government Printing Office, 1984).

PAST U.S.-SOVIET COOPERATION IN THE SPACE SCIENCES

Two primary areas of scientific cooperation under the 1972/77 agreement² examined in OTA's workshop were in: 1) space biology and medicine, and 2) near-Earth space, the Moon, and the planets. Both of these areas of cooperation were regarded as having contributed to scientific knowledge in a way U.S. scientists could not have done alone, although the interchange was not without problems.

Participants viewed the life sciences area as the more substantive and successful, especially in three areas. First was the exchange of flight experimental data regarding human response to spaceflight conditions. Because of the emphasis on extended manned spaceflight in the Soviet space program, of greatest value here were Soviet data on the effects of long-duration flight on bone loss and cardiovascular deconditioning—problems that continue to be of significant concern for manned spaceflight. Data exchanges in this area were particularly valued by U.S. scientists because the Soviets had, in Salyut, the opportunity to conduct an extensive program of repeatable experiments on the response of human beings to long-term stays in space. The U.S. space

program had no manned spaceflight from the Apollo-Soyuz Test Project (ASTP) in 1975 to the first Shuttle launch in 1981.

The second area of especially fruitful cooperation was considered to be joint ground-based simulations of spaceflight conditions. For example, participants cited the long-term bed rest studies as a useful example of such joint simulations, and noted that useful joint symposia were held on vestibular problems (1980) and on cardiovascular changes resulting from spaceflight (1981).

Finally, U.S.-Soviet space cooperation has also involved a good deal of animal (biological) research. The joint U.S.-Soviet three-volume work on space biology and medicine,³ in progress for more than a decade, was published in 1975, and scientific experiments conducted aboard ASTP provided interesting biological data. Perhaps most importantly, the Soviet Cosmos series biosatellites have provided U.S. investigators with a number of opportunities to fly experiments designed to investigate basic biological processes in space, and to exchange information on a range of problems in space biology. The first of several such flight opportunities came in 1975 when the Soviet Union launched Cosmos 782, a "biosatellite" mission carrying 11 U.S. space biology experiments. Subsequently, in 1977, Cosmos 936 was launched carrying 7 U.S. biological experiments; in 1978, Cosmos 1129 carried 14 U.S. biological experiments; and in 1983, Cosmos 1514 was launched carrying 4 additional U.S. biological experiments. According to workshop participants, American experiments have generally been self-contained and delivered to Moscow by U.S. specialists who provide information on how to care for the package until the time of launch. U.S. experimenters have not been allowed at launch or recovery sites, but according to workshop participants, the Soviets have sometimes been quite helpful in other ways, such as in one case allowing an American experiment to fly overweight.

²The Agreement Between the United States of America and the Union of Soviet Socialist Republics Concerning Cooperation in the Exploration and Use of Outer Space for Peaceful Purposes, signed in May 1972 and renewed in May 1977.



Photo credit: Charles P. Vick, Paris Air Show, 1985

Cosmos 1514, launched in 1983, carried four U.S. biological experiments

³*Foundations of Space Biology and Medicine*, edited by Melvin Calvin (U.S.A.) and Oleg G. Gazenko (U.S.S.R.), a joint U.S.-U.S.S.R. publication in three volumes (Washington, DC: Scientific and Technical Information Office, National Aeronautics and Space Administration, 1975).



The workshop scientists involved in these and other exchanges believe that the overall success of the collaboration in life sciences can be attributed to several factors:

- a focus on well-defined and specific scientific objectives;
- the selection of areas of complementary capability, providing strong motivation to cooperate;
- the fact that required instrumentation was not generally of a type raising concerns of technology transfer;

- an institutional organization that granted officials on both sides the autonomy to decide on the implementation of plans; and
- the development of mutual confidence, knowledge, and goals among working groups over a long period of cooperation.

In the planetary category, workshop participants identified the strongest areas of cooperation as lunar studies, the exploration of Venus, and solar-terrestrial physics. The exchange of lunar samples and cartographic data provided both sides with a range of information unobtainable



by either program on its own. Although the Soviets shared few significant data from their Mars missions in the early 1970s (possibly due to failures of spacecraft, resulting in little data to be exchanged), the cooperation in the late 1970s and early 1980s between Soviet scientists in the Venera program and U.S. investigators in the Pioneer Venus program was substantial; it extended to the use of Pioneer Venus data to select Venera landing sites and to attempts to intercalibrate instruments. Soviet data from the 1975 Venera landings on Venus were transmitted promptly, providing several surprises regarding the nature of the Venusian surface. The U.S. Pioneer mission to Venus in 1978 profited from details about the Soviet program that would not have been available without the agreement.⁴

⁴*Technology Transfer and Scientific Cooperation Between the United States and the Soviet Union: A Review*, prepared for U.S. Congress, House Committee on International Relations, Subcommittee on International Security and Scientific Affairs (Washington, DC: U.S. Government Printing Office, 1977), pp. 117-118.

In other areas, data were exchanged on solar-wind phenomena and magnetospheric plasma physics. In the solar-terrestrial area, for example, exchanges of solar wind data obtained by Soviet Prognoz and the International Sun-Earth Explorer (ISEE) spacecraft, developed jointly by the United States and ESA, have been valuable because of differing spacecraft design characteristics. U.S. magnetospheric plasma physics research in space has benefited from cooperation between the two countries in controlled thermonuclear research. Overall, workshop participants noted an evolution toward greater openness in the Soviet planetary program over the past decade.

Finally, workshop participants noted a significant amount of cooperation in astrophysics experiments utilizing detectors mounted on a variety of spacecraft, including Venera and Pioneer Venus, Prognoz, and ISEE. The objective of these experiments was the precise location of gamma-ray bursts by means of simultaneous observations from widely separated spacecraft, with cooperative analysis of resulting data.

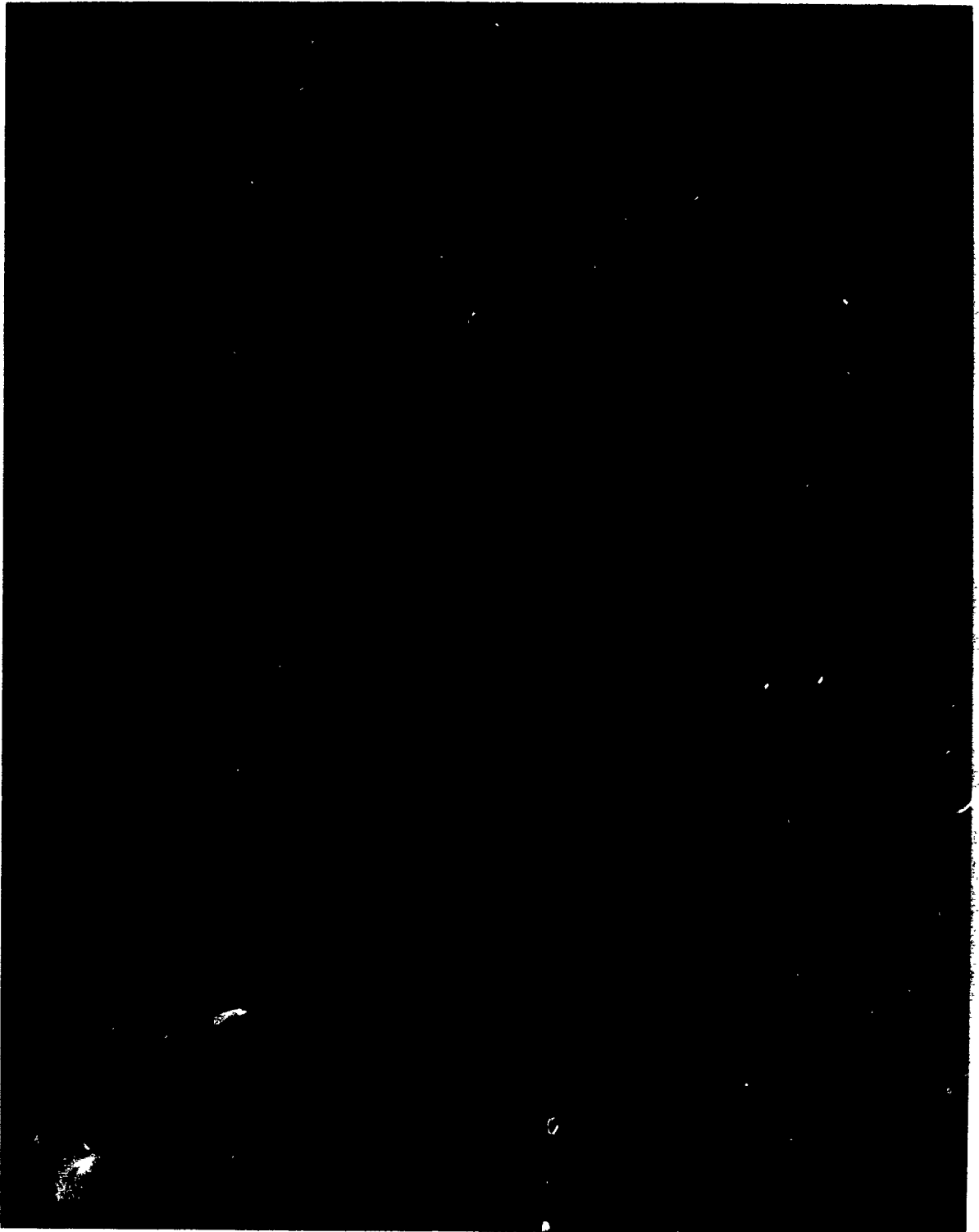

Photo credit: National Aeronautics and Space Administration

Panoramic views of surface of Mars, from the American Viking spacecraft, and of surface of Venus, from the Soviet Venera spacecraft

The workshop scientists involved in these exchanges believe that cooperation started out slowly but eventually became quite fruitful. Particularly with regard to Venus, the United States gained at least as much information as it provided. However, the interaction in the planetary and solar-terrestrial areas was not as consistently smooth as in the life sciences. There were significant difficulties in acquiring information on mission plans, and in obtaining accurate and complete scientific data. These problems varied in severity through time and across different fields. But workshop scientists believed that the situation was improving noticeably, with regard to both openness and data quality, when the intergovernmental agreement expired in 1982. At that time, U.S. scientists were for the first time being taken into Soviet laboratories and shown instruments, performance data, etc.



Photo credit: National Aeronautics and Space Administration

Hurricane over the Atlantic Ocean, as photographed from Skylab 3, Sept. 20, 1973

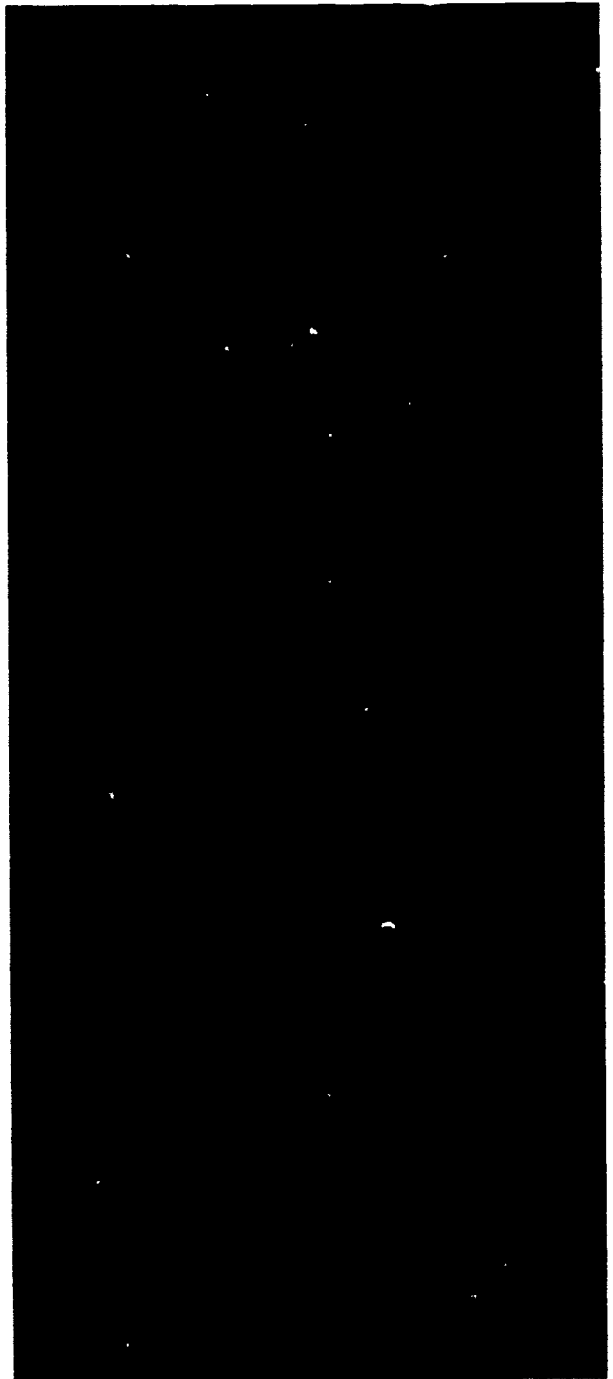

SCIENTIFIC BASIS FOR FUTURE COOPERATION

Workshop discussions resulted in a number of general observations and specific recommendations regarding the content and possible mechanisms for future U.S.-Soviet cooperation in space.

One point of consensus was that such cooperation must be scientifically substantive, with clear scientific objectives, in order to be successful. The Soviet Union has enough to offer scientifically, participants argued, that cooperation for purely political reasons is not, in their view, an adequate rationale for U.S. participation. Areas of complementarity, they stressed—such as that represented by American orbital capability and Soviet lander capability—must be found so that cooperation will be mutually beneficial on a scientific and technical level.

Participants agreed that the simplest levels of exchange—joint discussions, cooperative data analyses, and joint planning of separate missions—would be the most workable. Hosted U.S. experiments on Soviet spacecraft (as well as the reverse) were also viewed as practicable, although it was emphasized that official U.S. concerns about technology transfer have introduced considerable complexity into some of these interactions. Participants agreed that the introduction of hardware into the exchange would invariably be a complicating factor. The difficulty of working together would reach its highest point, they said, in the case of full-scale joint missions, where both hardware and many layers of official participation would be involved.

Based on past successes in planetary, solar-terrestrial, and astrophysics areas of cooperation, it was suggested that should future cooperation be pursued, the concept of coordination and tracking of separate spacecraft be added to joint mission planning. The advantage of this would be to maximize scientific return while minimizing problems of hardware exchange and technology transfer. A second recommendation was to include U.S.-Soviet co-investigators within the framework of cooperation.

Finally, participants also addressed the question of which new areas of scientific exchange currently hold promise for U.S.-Soviet cooperation.

The workshop itself represented a somewhat different breakdown of disciplines than the categories included under the previous agreement. Most notably, astrophysics and heliospheric studies were broken out as separate disciplinary groups. One promising new area was regarded as the field of "global habitability," which includes a wide range of integrated Earth environmental observations. The vast size of the Soviet Union makes that country's participation in this field especially important.

In the life sciences area, the field of exobiology (i.e., nonterrestrial biology and biochemistry) was viewed as one promising area for future cooperation. Workshop participants believed that studies in this area might include search for extraterrestrial intelligence (SETI), or joint collection and analysis of Antarctic meteorites. Global biology would be an important aspect of the global habitability studies just described. Another suggestion was the joint demonstration and testing of advanced life support systems, including those of the "closed," or bioregenerative, type.

In solar-terrestrial physics, workshop participants noted a complementarity in American and Soviet research plans, suggesting that mission coordination and data exchange would yield substantial scientific benefits for both countries. Integration of Soviet data into the online data processing and exchange program now being developed for the International Solar-Terrestrial Physics Program, they believed, would be especially valuable.

Astrophysics, the participants also noted, offers several promising opportunities for complementary and mutually advantageous cooperation. In the radio area, they believed that joint missions in very long baseline interferometry (VLBI) could be undertaken using independent U.S. and Soviet spacecraft, with collaborative planning for the orbits and frequencies to be used. They suggested that U.S. Spacelab experiments involving large-scale equipment such as X-ray detectors of large collecting area could be reflown on the Salyut for long-term exposure. In the first example, two essentially free-standing missions enhance one an-

Figure 3-1.—Photographic Coverage of the U.S. Apollo and Soviet Zond Spacecraft
(example of informal information exchange between U.S. and Soviet scientists)

Coverage of Apollo and Zond Mapping Pictures

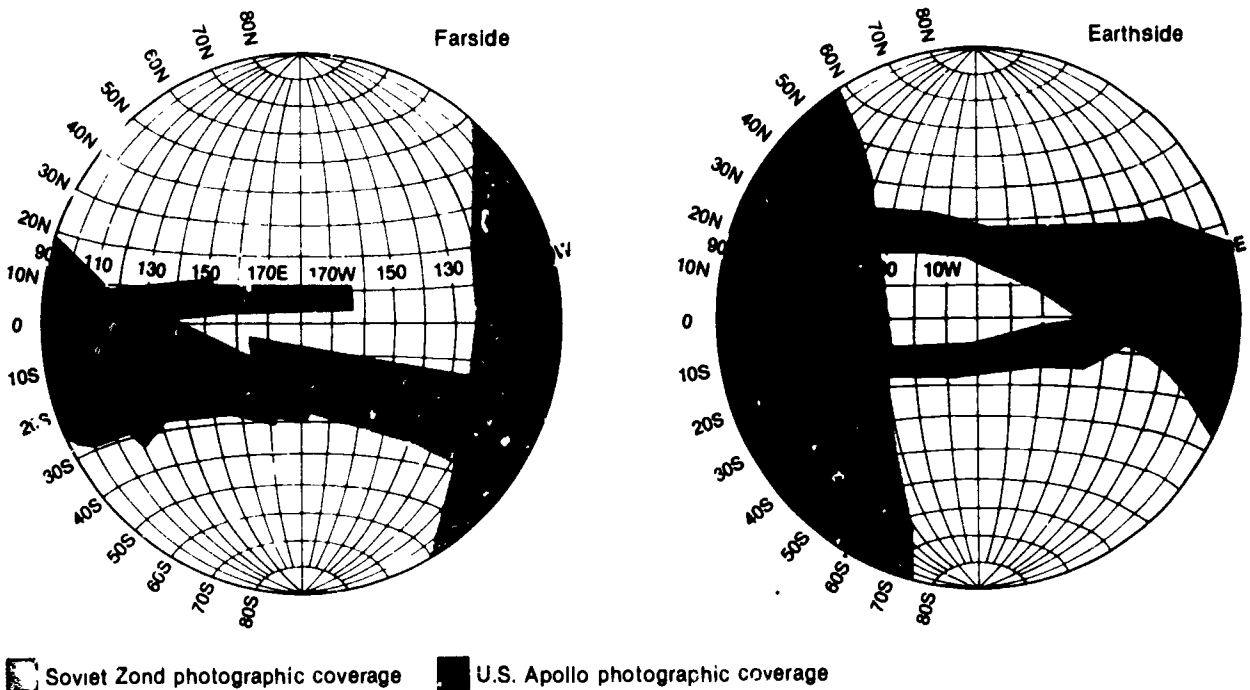

Note: Base map courtesy of National Geographic Society

SOURCE: Merton Davies

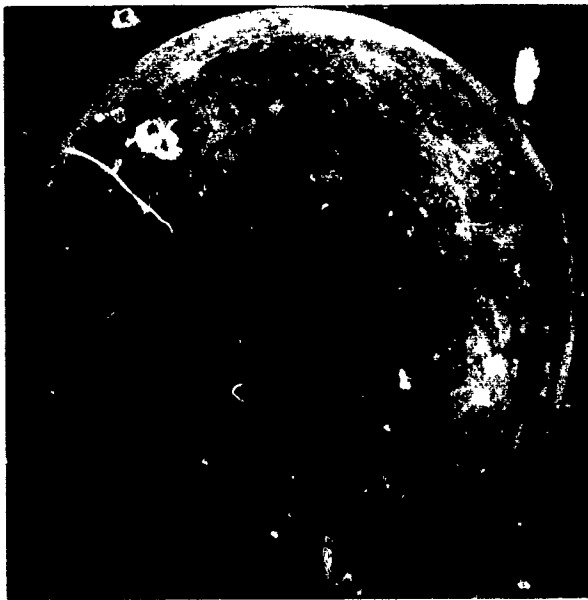

Photo credit: National Aeronautics and Space Administration

The Moon

other by proper coordination and planning; in the second, the scientific potential of expensive experiments is realized more fully by a longer time for making observations in orbit.

Possibilities for cooperative ventures in the planetary field, participants underlined, are numerous, including: lunar geochemical orbiters, continued lunar sample exchange, joint Venus missions (studies of the atmosphere as well as long-lived surface missions); coordination of separate Mars missions or even a joint Mars sample return mission; comet rendezvous and sample return; and outer planet exploration.

A final concern was the relative merit of continuing low-level exchange, as against initiating a high-visibility "spectacular," such as a joint Mars sample return or a joint "Starprobe" mission to the Sun. Workshop participants stressed that large-scale missions would have little lasting sig-

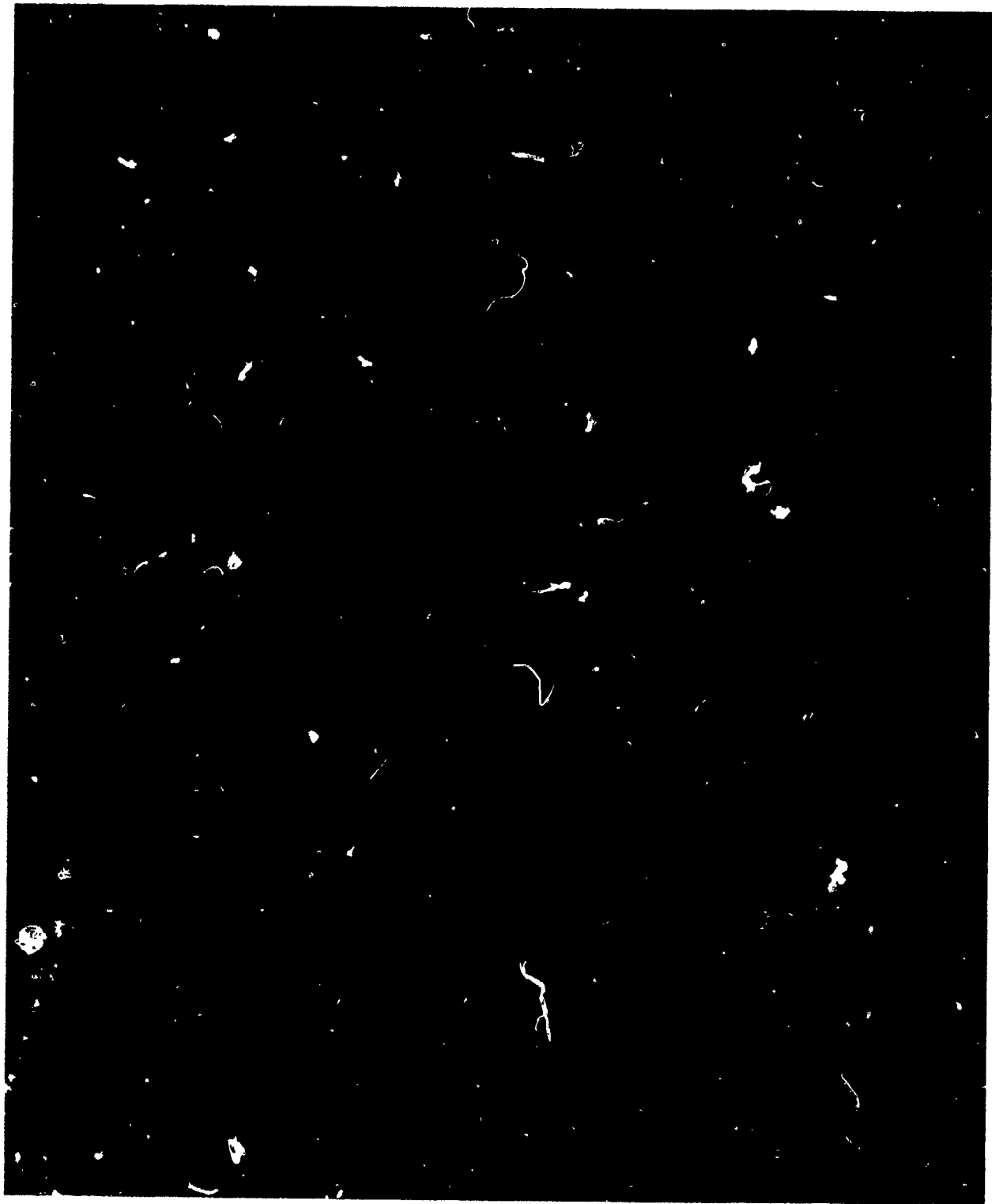

nificance if they did not include substantial scientific content. The consensus was that, given the difficulties inherent in large-scale joint missions, it would be wise to begin with simpler exchanges

of the type now underway, perhaps holding the possibility of such a large-scale mission as a long-term goal.

SOVIET COOPERATIVE PRIORITIES

Shortly after the space science workshop, OTA discussed the workshop results with leading scientists in the U.S.S.R. These interviews, conducted in the Soviet Union, indicated a high degree of commonality with U.S. scientists concerning the most promising areas for future cooperation in space science. The Soviet scientists interviewed by OTA not only listed areas of study, but enumerated projects within fields in order of cooperative appeal. Levels of cooperation, however, were not specified.⁵

Briefly, their suggestions were as follows. (Asterisks indicate projects not mentioned by U.S. scientists at the OTA workshop.)

⁵N Lubin, OTA, interviews in Moscow, June 1984.

- Planetary:
 - Study of asteroids,* comets, and interplanetary dust
 - Study of Mars, including sample return
 - Continuation of Venus study
 - Study of planetary moons and Saturn's rings.
- Life sciences:
 - Human and animal responses to space-flight factors
 - Standardization of research methods and data collection techniques*
 - Further ground-based simulation studies.
- Solar-terrestrial physics/astrophysics:
 - General interest in cooperating in these fields.

SUMMARY AND CONCLUSION

Participants in OTA's workshop underlined that past interactions with the Soviet Union in space science have benefited U.S. scientific programs, and believed that such interactions would again be fruitful, given an appropriate official framework.

According to workshop participants, Soviet capabilities now present an opportunity for a substantive, broad-based exchange that is equally balanced on both sides. In addition to renewing previous areas of scientific exchange, future cooperation could include new areas of joint work (e.g., astrophysics and global studies) that take advantage of our respective strengths and meet mutual needs. A dramatic joint mission to Mars or the Sun could be considered as a long-term goal, to be reached through successive cooperative steps. Types of cooperation, they noted, should be flexible. For example, joint coordination of separate missions could be an effective way to maximize scientific return while minimizing

problems of technology transfer and mission management.

This is not to suggest, participants stressed, that cooperation should offset the development of our independent space capabilities. A key point of the workshop was that the United States must continue to have a strong, active space program of its own in order to be viable as a cooperative partner—whether with the Soviet Union or others. But such cooperation, they argued, can in turn greatly enhance U.S. knowledge and capabilities, and should therefore be carefully designed to assure maximum scientific benefit.

* * * * *

The early *scientific* rationale for cooperation in space activities, following the spirit of the 1957-58 International Geophysical Year (IGY), was that space exploration was too vast and expensive an area of exploration for any one country to under-

Table 3-1.—Potential U.S./U.S.S.R. Collaborative Activities: From OTA Workshop, May 1984

Sun-Earth (Heliophysics):

- Joint meetings to develop space plasma theory
- Joint coordination and data exchange in solar terrestrial physics—specifically for International Solar-Terrestrial Program (U.S./ESA/Japan)
- Exchange of co-investigators
- Hosted instruments (detectors)
- Joint Starprobe mission to the Sun (very long range)

Astrophysics:

- Joint planning for:
 - Gamma-ray burst studies using Gamma Ray Observatory and other spacecraft
 - Very long baseline interferometry (complementary orbits of spacecraft)
- Data exchange regarding contamination of cooled surfaces (infrared telescopes) and plasma glow problems (ultraviolet telescopes)
- Co-investigators on Space Telescope, Gamma Ray Observatory, and Advanced Astronomical X-ray Facility
- Mounting of Spacelab experiments on Salyut for long-term exposure

Planetary:

Venus:

- Joint planning or joint missions as part of a sequence to investigate the properties of the atmosphere of Venus
- Joint planning/missions for "long-lived" Venus surface studies

Mars:

- Coordinated planning for Mars missions ca. 1990 (Phobos lander and Mars Geochemical Climatological Orbiter (MGCO))
- Joint planning/missions for Mars sample analysis or return

Moon:

- Lunar geochemical orbiters
- Continued lunar sample exchange

Comets:

- Soviet contribution to instrument design for U.S. mission to Comet Kopf (1990) [possibly a hosted experiment]
- Coordinated or joint cometary sample return missions

Outer Planets:

- Joint orbiter/probe missions to Saturn, Uranus, or Neptune [after the NASA/ESA Cassini mission to Saturn and Titan, Uranus is the next cooperative opportunity here]

Life Sciences:

Effects of long-duration spaceflight:

- Data exchange and joint or hosted flight experiments, especially on problems of (human) bone loss, radiation effects, life support, and countermeasures
- Joint ground-based simulations (e.g., long-duration bed rest)
- Joint (or hosted) biological experiments aboard Cosmos biosatellites and/or Spacelab, using various animal and plant species

Exobiology:

- Joint unmanned missions or data exchange to further investigate the question of life on Mars
- Joint meetings and/or data exchange regarding search for extraterrestrial intelligence (SETI)
- Joint collection and analysis of Antarctic meteorites

Global biology:

- Earth observations data exchange

Life support systems:

- Joint ground-based demonstration and flight testing of life support systems (including bioregenerative type)

SOURCE Office of Technology Assessment

Table 3-2.—Participants in May 8 Workshop on Possible Future U.S.-Soviet Space Cooperation

Bernard Burke, <i>Workshop Chairman</i> Department of Physics Massachusetts Institute of Technology	Charles Kenel Department of Physics University of California at Los Angeles
Donald De Vincenzi NASA Headquarters	Eugene Levy Lunar Planetary Lab University of Arizona
Thomas M. Donahue Department of Atmospheric and Oceanic Sciences University of Michigan	Harold Masursky U.S. Geological Survey
Paul Gorenstein Center for Astrophysics Harvard University	David Morrison University of Hawaii
James W. Head Department of Geological Sciences Brown University	Tobias Owen Earth and Space Sciences Department State University of New York at Stony Brook
Martin Israel Department of Physics and McDonnell Center for the Space Sciences Washington University at St. Louis	Fred Scarf Space and Technology Group TRW
	Gerald Wasserburg California Institute of Technology

take alone. According to the scientists at OTA's workshop, 25 years of independent space efforts have not discredited that rationale.

OTA's workshop highlighted the belief that cooperation with the U.S.S.R. has been, and can continue to be, mutually beneficial in many areas of scientific research. The following two chapters discuss how the scientific and technical concerns must be integrated with other issues in making decisions today—first, as illustrated in another Western country, and then in the context of issues facing policymakers in the United States.

Chapter 4

The View From France: An Alternative Perspective



Photo credit: Charles P. Vick, Paris Air Show, 1985

Display module of Venera type landing craft of VEGA I and II, carrying experiments from France, the United States, and other countries.

The View From France: An Alternative Perspective

U.S.-Soviet cooperation in space does not occur in a vacuum. Other Western countries have entered into cooperative arrangements with the U.S.S.R. and have faced serious issues and debates of their own. Although these countries are grappling with the same basic issues as U.S. planners, their approaches to cooperation with the U.S.S.R. have been quite different.

Before discussing issues facing U.S. planners, therefore, this chapter examines the approach of another country towards cooperation in space with the U.S.S.R., with an eye towards assessing:

- possible alternative approaches to the policy issues associated with U.S.-Soviet cooperation in space; and
- the potential impact of renewed U.S.-Soviet cooperation on our allies.

France was selected as a focus of study, since of all Western countries, it has had the most continuous and most extensive cooperation with the U.S.S.R. in space science research. Although our

focus is on France, it should be kept in mind that cooperation with the U.S.S.R. is a relatively controversial issue in other Western countries involved in space programs of their own.

The following discussion is based largely on interviews conducted by OTA in France in July 1984, and subsequently in the United States, with representatives from a number of scientific, foreign policy, and defense agencies, including the Centre National d'Etudes Spatiales (CNES), the French Ministry of External Relations, the Secrétariat Général de la Défense Nationale (SGDN), and the European Space Agency (ESA).^{*} After a brief discussion of the background of French-Soviet cooperation in space, this chapter examines the policy issues associated with potential future cooperative projects, how the French approach these issues, and the implications this may hold for U.S. policy.

^{*}Unfootnoted quotations have been taken from these interviews.

BACKGROUND

French-Soviet cooperation in space dates back to 1966, with the visit of Charles de Gaulle to Moscow and the signing on June 30 of an open-ended *Intergovernmental Accord on Scientific/Technical and Economic Cooperation*. The inclusion in this agreement of a large segment on French-Soviet cooperation in "the exploration and peaceful uses of outer space" provided the framework for formal cooperation in space activities generally. An umbrella agreement with no specific time frame of its own, the accord provided an institutional framework within which further agreements could be negotiated. The agreement created a *Grande Commission*, comprised of the

President of CNES,¹ the President of the Advisory Board to the U.S.S.R.'s Interkosmos, and working groups in four key areas of space re-

¹Created in 1962, CNES is charged with five primary missions. As described by CNES officials, these are: 1) to assist French governmental services in the establishment of French space policy; 2) to take the requisite actions to implement this policy and manage the associated programs; 3) to create the appropriate facilities and develop the necessary know-how; 4) to orient the French space industry in order to make use, especially on foreign markets, of the experience and competence acquired and the resources set up over a period of 20 years; and 5) to develop international cooperation on both bilateral and multilateral bases, and to promote scientific and commercial utilization of space technology. CNES is comprised of four main centers: the Paris head office; the Evry Center concerned with launch vehicles; the Toulouse Space Center; and the Guiana Space Center in Kourou, French Guiana. Today, CNES boasts a staff of over 2,000 people, located in four centers, more than half of whom are engineers.

search: scientific studies of space; spatial and aeronomic meteorology; space medicine and biology; and space telecommunications. Annual meetings of the commission were to provide a forum for assessing ongoing programs and initiating new ones.² By the early 1980s, one-third of the more than 2,000 space researchers and technicians in France was working in some way with French-Soviet cooperation in space.

Today space research has grown to a considerable level in France, and cooperation with the U.S.S.R. has grown commensurately. As the main agency in France responsible for national space policy and programs, CNES is in charge of developing international cooperation on both bilateral and multilateral bases. As table 4-1 illustrates, in 1984 CNES's budget was almost \$600 million (4,763 million francs), of which almost half was designated for bilateral and multilateral cooperation. While most of the funds budgeted for such cooperation are directed towards ESA, approximately 51 million francs each year, or about 10 percent of the bilateral budget, is budgeted for cooperation with the U.S.S.R. By comparison, about 83 million francs per year are budgeted for cooperation with the United States.

If cooperation with the U.S.S.R. is significant, however, it is concentrated in a relatively small number of areas. Table 4-2 shows the breakdown of funding for French bilateral cooperative projects by country and category in 1984. The level of French-Soviet cooperation in space is not far below that of French-U.S. cooperation. But while French cooperation with the United States is more diffuse—spread out in Earth observation data collection, scientific experiments, and manned flights—French-Soviet cooperation is largely concentrated in the area of scientific experiments. Indeed, cooperative efforts with the U.S.S.R. account for over 60 percent of the total budget allocated for French cooperative space science experiments generally.

²The presidents of CNES and Interkosmos meet annually, alternately in France and the U.S.S.R., to examine the progress of French-Soviet cooperation in space and to decide on new projects for the following year. The results of such work are presented by the two presidents to the *Grande Commission* which oversees French-Soviet scientific/technical and economic cooperation.

Forms of cooperation between France and the U.S.S.R. have ranged from exchange of data and information to a joint manned flight in 1982. The lion's share of cooperation has fallen in data exchange and Soviet hosting of French experiments. But the first manned space flight is also viewed as a valuable landmark in French-Soviet cooperation. While the next flight of a French spationaute on a foreign spacecraft was on the U.S. Shuttle, when Patrick Baudry joined U.S. astronauts in June 1985, French planners envision another French-Soviet manned space flight if feasible.

Table 4-3 outlines the main scientific programs being undertaken by CNES as of late 1984. According to CNES, projects with the U.S.S.R. are now emphasizing four areas:

- astronomy;
- solar system exploration, including:
 - plasma physics, mainly in the ionosphere and the magnetosphere; and
 - planetary exploration, primarily of Venus and the Comets;
- materials processing in space; and
- life sciences.

While most of these projects are listed in appendix A, some of the major research areas and projects are as follows.

Astronomy

Space observatories provide French scientists with the means to pursue research in modern astronomy and astrophysics from a point beyond the interference of the Earth's atmosphere. Along with ESA, the U.S.S.R. is one of France's chief partners in these endeavors.

One of the key projects in cooperation with the U.S.S.R. is the gamma-ray astronomy project *Sigma*. The *Sigma* program (Système d'imagerie gamma a masque aleatoire), representing a new French-Soviet Gamma Ray and X-ray Space Observatory, calls for the joint French-Soviet manufacturing and placing into orbit of an astronomy satellite which will study the universe with X-ray and gamma-ray telescopes. The French *Sigma* telescope will utilize a Soviet platform, *Astron II*, which will be a modified version of the *Venera*

**Table 4-1.—Budget of the French Space Agency: Breakdown of Funding
(State subsidies and Centre's own resources)^a (In million francs)**

	By program category			By type of system			By category of objectives				
	Amount 1984	Percent 1984	Percent 1983	Amount 1984	Percent 1984	Percent 1983	Amount 1984	Percent 1984	Percent 1983		
European program	1 901 200	39 91	36 12	Launch vehicles	847 900	17 80	14 84	Sciences	425 100	8 92	9 38
Bilateral programs	540 450	11 35	12 26	Satellites	1.654 930	34 74	37 92	Applications	2.384 830	50 07	49 93
National programs	984 130	20 66	24 32	SPACELAB	90 300	1 90	1 46	Telecommunications	612 330	12 86	12 66
Program support	641 050	13 46	11 12	Balloons	18 200	0 38	0 50	Earth observation and data collection	924 600	19 41	22 43
General operating costs	696 475	14 62	16 18	Scientific experiments and experiments	132 500	2 78	2 91	Launch facilities	847 900	17 80	14 84
				R&D	132 500	2 78	3 60	R&D	132 500	2 78	3 60
				Program support	1.820 875	38 23	37 00	Program support	1.820 875	38 23	37 09
Total	4 763 305	100 00	100 00		4.763 305	100 00	100 00		4 763 305	100 00	100 00

^aSums taxes excluded

SOURCE CNES Budget and Programmes of the Centre National d Etudes Spatiales for 1984 p 6

Table 4-2.—Breakdown of Funding for Bilateral Cooperative Projects (in million francs)

Country or organization concerned	Scientific experiments	Telecommunications	Earth observation data collection	Major scientific programs	Export actions	Manned flights	Total
U S A	22 000	—	51 200	—	—	10 000	83.200
U S S R	47 850	—	—	—	—	2.700	50 550
ESA	7 800	—	1 100	—	—	6 400	15.300
FRG	—	358 400	—	—	—	3 100	381.500
Sweden	0 650	0 450	—	—	—	—	1 100
Other countries	—	—	—	—	3 200	—	3.200
To be distributed	—	—	—	25 600	—	—	25.600
Total	78 300	358 850	52 300	25 600	3 200	22.200	540.450

SOURCE CNES, Budget and Programmes of the Centre National d'Etudes Spatiales for 1984, p. 24

Table 4-3.—French Space Program: Main Scientific Programs

Astronomy:

Hipparcos (Astrometrical Satellite)—ESA

ISO (IR Astronomical Observatory)—ESA

Space Telescope—U.S.A./ESA

French Astronomy Program on SPACELAB 1 with:

- Telescope UV Faise—Program in cooperation with U.S.
- Very Wide Field Camera—ESA

Sigma (Gamma Ray Astronomy Project) in cooperation with Soviet Union

A program of balloon-borne equipment in IR and UV astronomy

Planetary exploration:

VEGA—Mission to Venus which will also fly by Halley's Comet in cooperation with the Soviet Union

Giotto—European mission to Halley's Comet—ESA

Plasma physics:

Arcad launched in September 1981 in cooperation with the Soviet Union

Interball—a new project in cooperation with the Soviet Union

Oceanography—meteorology:

Poseidon (Oceanographic satellite using an altimeter for the study of the general circulation of the ocean) either on SPOT 3 or in cooperation on TOPEX (U.S.A.)

Design and development of a passive microwave radiometer to be placed on board the European ERS-1 Earth Resources Satellite.

SOURCE OTA briefing at CNES, July 1984

type adapted for astronomy.³ Scheduled to be launched at the end of 1987, the satellite will be equipped with a French-made gamma telescope, a Soviet-developed X-ray telescope package to be mounted on the side of the gamma-ray telescope

³The satellite will be placed in a very elliptical orbit of 2,000 km perigee and 200,000 km apogee, inclined between 51° and 60°, depending on whether the satellite is launched from Baikonur or Kapustin-Yar. See Pierre Langereux, "Projet franco-sovietique de satellite d'astronomie SIGMA," *Espace*, Oct. 12, 1983; and "French Soviets Define Observation Platform," *Aviation Week and Space Technology*, Feb. 20, 1984, p. 55

tube, and X-ray and gamma-ray burst detectors. The *Sigma* mission will permit gamma-ray emitting objects to be located with a far greater degree of precision (in the range of about a 2 minute arc) than is presently attainable. *Sigma* was originally conceived as a French project; the French then proposed joint conduct with the U.S.S.R.

The *Sigma* program is an outgrowth of several cooperative efforts in astronomy in the past. For example *Signe 3*, a French Earth satellite launched by a Soviet rocket on June 17, 1977, was accorded a great deal of acclaim for its mission to detect and locate the sources of "gamma flashes," a type of cosmic radiation seldom studied.⁴ A joint French-Soviet launch of the astronomy satellite *Gamma I* is scheduled for 1986 to carry three scientific experiments: a large Gamma telescope, *Gamma I*; an X-ray telescope, *Spectre II*; and a smaller Gamma telescope. *Gamma I* is a high-energy gamma radiation study designed to determine the structure of the galaxy and the origin and distribution of gamma sources. Mounted on the same satellite as *Gamma I*, *Spectre II* will examine galactic and extra galactic X-ray and gamma sources, as well as "burster" sources in these wavelengths. The study of gamma ray bursts is a key area of cooperation between France and the U.S.S.R., and the collaborative program in this area is recognized worldwide as one of the leading ongoing initiatives in high-energy astrophysics.

⁴Joseph G. Whelan, "Soviet Attitude Toward International Cooperation in Space," in Congressional Research Service, *Soviet Space Programs: 1976-80*, prepared for the Senate Committee on Commerce, Science and Transportation, CXX, No. 8 (Washington, DC: U.S. Government Printing Office, 1982), p. 286.

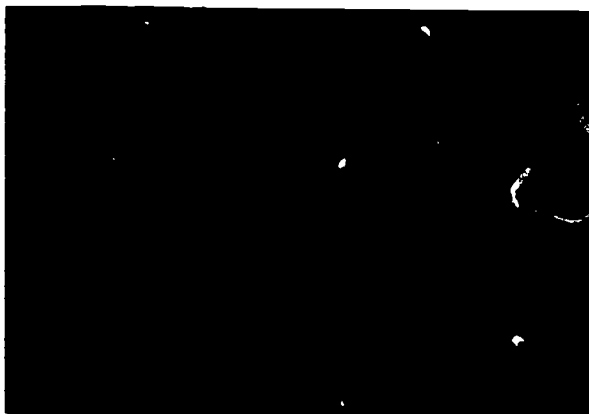
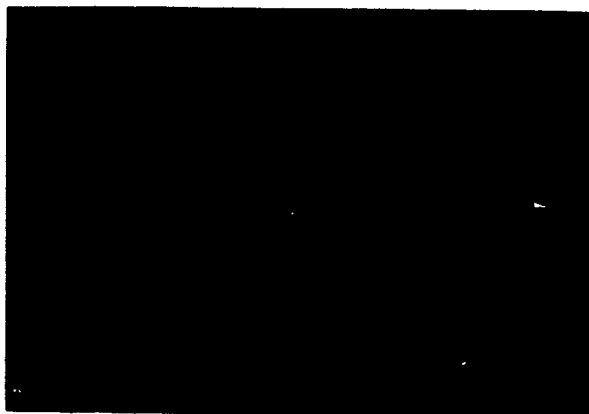

Photo credit: Charles P. Vick

Oreol 3 as displayed at French Pavillon, Paris Air Show, 1985, with Salyut Solar Panel and gravity gradient boom

In the area of optical astronomy, the U.F.T. project in ultraviolet astronomy is another key French-Soviet joint effort. The project consists of a French ultraviolet spectrometer placed in the focal plane of a Soviet telescope to study the ultraviolet spectrum of the stars. The U.F.T. was launched on a Soviet craft on March 24, 1983, to examine the stellar atmospheres in ultraviolet (wavelengths ranging from 1200 to 2500-Å). It was designed for coordinated ground-based measurements of the interstellar medium to be made through an 80 cm. telescope located at an observatory in the Soviet Crimea, and from a high-resolution spectrometer in the Laboratoire d'Astronomie Spatiale (L.A.S., or space astronomy laboratory) in Marseille, France.

Solar Terrestrial Physics

Solar terrestrial physics is an important area of cooperation between France and the U.S.S.R. Particular areas of emphasis are the terrestrial magnetosphere and ionosphere and the interplanetary environment. A key joint effort in this area was the launching on September 21, 1981, of the French *Arcad 3* satellite by a Soviet launch vehicle. The purpose of this project was to study the physical parameters (especially wave characteristics) of the lower magnetosphere at high latitudes. The project was an outgrowth of the launchings of *Oreol 1* and *Oreol 2* in 1971 and 1973, which carried scientific equipment to explore physical phenomena in the Earth's upper atmosphere. At present, the operational phase of *Arcad 3* is continuing, using the French Tromsø ground station for receipt of data. Results of *Arcad 3* are scheduled to be discussed at an international symposium to be held in Toulouse, France, in May 1986.

Araks and *Interball* are two other significant joint French-Soviet efforts in the area of solar terrestrial physics. In the *Araks* project a French rocket placed a Soviet electron accelerator into orbit to study the nature of the aurora borealis, or Polar lights, by injecting electrons into the Polar region of the ionosphere. *Interball* is a new project in French-Soviet cooperation to study the solar wind, and the terrestrial magnetosphere-ionosphere relationship.

Life Sciences and Materials Processing

The first French-Soviet *manned flight* of a French spationaute, Jean-Loup Chretien, on a Soviet spacecraft from June 24-July 2, 1982, was hailed as a great step forward in French research in the fields of the life sciences, and especially in the area of human physiology. Four key experiments were conducted: *Echographie*, *Posture*, *Cytos 2*, and *Biobloc 3*. Echographic experiments provided information on blood circulation and blood volume distribution, as well as a visual representation of heart pumping characteristics. Information of this type is necessary for understand-

ing the way liquid is pumped through the body in a weightless environment. The *Posture* experiment involved the use of French-designed neurophysiological measurement equipment to collect data relating to the influence of gravity on movements and equilibrium. Spationaute Jean-Loup Chretien participated actively in all of these experiments.

In addition to furthering research in the life sciences, the joint flight also provided valuable information for materials processing in space. Materials processing is viewed as an important area for future development in France, a key part of what the French see as the future economic value of space applications for a broad-based, high-technology economy. One of the key tasks of the Chretien mission was to produce certain metal alloys unobtainable on Earth. This was a follow-up to other experiments, such as the *Kristall* experiment, which had been conducted with French hardware by Soviet cosmonauts aboard the *Salyut 6* space station.

Analysis of the results of experiments conducted in both areas during the joint manned flight have continued well into 1985. In addition, cooperative experiments in the material and life sciences continue within the framework of later flights aboard Soviet spacecraft. In addition to the experiments conducted during Chretien's flight, for example, CNES has also been cooperating in biological research with the U.S.S.R. both on Cos-

mos satellites and *Salyut 7*, examining such questions as the influence of cosmic rays on biological organisms, and the effect of microgravity on cell growth. One program, *Biocosmos*, has been studying the behavior of a primate under weightless conditions aboard a Soviet biosatellite. Using French-supplied equipment, Soviet cosmonauts on *Salyut 7* have continued to conduct experiments begun by French principal investigators in conjunction with Chretien's flight.

Overtures have been made to conduct another joint manned flight in the near future. One year after Chretien's flight, French officials are quoted as having stated: "We still are in favour of this idea, especially for long duration flight which will permit us to carry out further biomedical research."⁵ Following the meeting of the *Grande Commission* in Samarkand, U.S.S.R., in October 1984, Frédéric d'Allest, Director Général of CNES, was quoted as stating "the French delegation reaffirmed its great interest in conducting a long duration flight of a French spationaute . . . on board a Soviet orbital station."⁶ He stated that the flight was envisioned to last about 4 weeks, to take place around 1987-88. And OTA interviews with French

⁵Jean-Paul Croize, "Un satellite d'astronomie et des projets ambitieux vers Venus et la Lune. L'espace franco-sovietique," *Le Figaro*, Oct 5, 1983

⁶See Pierre Langereux, "La France interesée par un vol de longue durée avec l'U.R.S.S.," *Air et Cosmos*, No. 1018 (Oct. 13, 1984), p. 55

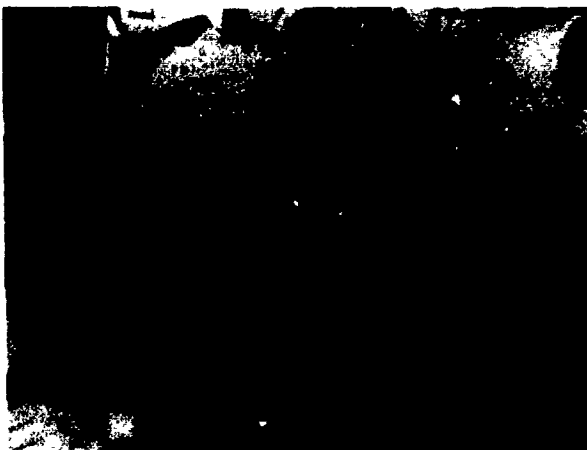

Photo credit: Centre Nationale d'Etudes Spatiales
Salyut 7: Echography experiment



Photo credit: Centre Nationale d'Etudes Spatiales
French "spationaute," Jean Loup Chretien onboard Salyut 7

officials in July and December 1984 suggest that this desire has not changed.

As of late 1984, however, while a number of projects have been adopted for joint French-Soviet cooperation in the near future, there has not been a commitment from the U.S.S.R. to the prospect of hosting another spationaute on a Soviet flight. This suggests that an agreement for another joint manned flight may be less a French decision than one determined in Moscow.

Planetary Exploration

Undoubtedly one of the largest cooperative ventures in planetary exploration between France and the U.S.S.R. is the VEGA, or Venus-Halley Mission. This project represents a multilateral venture with extensive French-Soviet cooperation. The mission involves two Venus landers and atmospheric balloons, as well as a probe toward Halley's Comet. Launched from the U.S.S.R. in December 1984, the mission rendezvoused with Venus in June 1985, and is scheduled to fly by Halley's comet in 1986. The study of Venus involves bilateral cooperation between the U.S.S.R. and France, while the mission to Halley's Comet is an international program in which Hungary, Austria, Bulgaria, Poland, Czechoslovakia, East Germany, and West Germany are also officially participating. Experiments being flown on the balloons, landers, and the Halley probe fall mainly in the following areas:

- study of the Venus atmosphere (pressure, speed, temperature, chemical and isotopic composition, study of the constituents);
- study of the chemical and isotopic composition of Venus soil;
- study of the nucleus and environment of Halley's Comet (physical characteristics, temperature of the molecules, and gas composition);
- observation of solar wind plasma waves;
- study of the interplanetary environment and the intensity of the Lyman emission of hydrogen and deuterium from comets, with the help of an absorption cell multiphotometer; and
- examination/determination of the composition of the gas which comprises the coma and the tail of the comet.

Several French experiments will also be carried out by the Giotto probe, to be launched by the European Space Agency to rendezvous with Halley's Comet in 1986.

In addition to VEGA, the meeting of the *Grande Commission* in October 1984 highlighted some potential future areas of French-Soviet cooperation in planetary research. According to one report, the Commission discussed a potential new mission of an interplanetary probe, *Venera 91*, envisioned to be launched in 1991 to study the planet Venus and asteroids.⁷ According to another, the Soviet Union has proposed to France to participate in its "Planet F" project to launch a Soviet probe to Mars and the Mars moon Phobos in 1988.⁸

Space Applications

In the area of space applications, a key cooperative effort is illustrated by *Sargos*, the French contribution to the Franco-American-Canadian SARSAT system which works in conjunction with the Soviet COSPAS system for the search and rescue of ships and aircraft in distress. France is presently supplying three *Sargos* detector units to SARSAT for the reception of 406 MHz signals, to be placed onboard NOAA satellites. As one of the SARSAT member parties, France participated in the joint demonstration phase, just concluded, which involved an extended checkout of the interoperability of SARSAT with the Soviet COSPAS system. France is also party to the new agreements which continue the system through 1990.

Evaluation of French-Soviet Projects

The French tend to stress the relative strong points of previous space cooperation with the U.S.S.R. and generally support continued cooperative efforts. French scientists appear to have run up against less in the way of harassment, visa problems, time delays, or other logistical problems which have frequently confronted their Amer-

⁷Ibid.

⁸See Pierre Langereux and Serge Berg, "Planet F, projet franco-sovietique de survol de Mars et Phobos," *Air et Cosmos*, No. 1019 (Oct. 20, 1984), p. 80.

Figure 4-1.—Soviet Proton Launch Vehicle

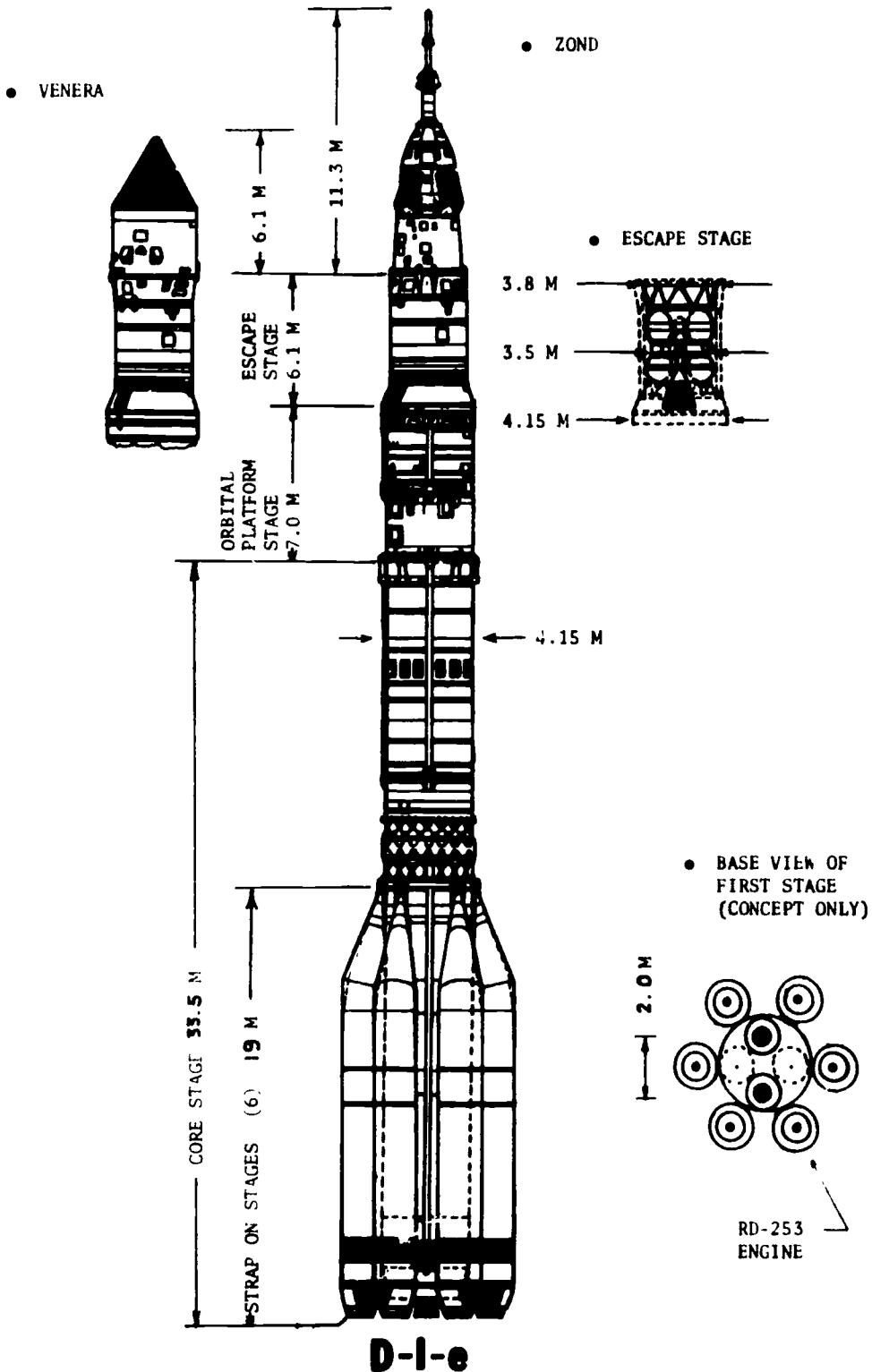

D-1-e Proton launch vehicle, offered by the U S S R for the launching of various geosynchronous spacecraft, is also being used in cooperation with France and other countries with the Venus/Halley's Comet mission

SOURCE Cherris P. Vick, 1982-85

ican counterparts. Access to data and information also appears to have been better than for other Western countries. And French planners believe that the informal contact established between the two scientific communities is also beneficial for the longer term.

Nonetheless, French cooperation with the U.S.S.R. has not escaped other problems which challenge other Western countries cooperating with the U.S.S.R., and substantial difficulties remain in implementing cooperative agreements. Chief among these are the many barriers in gaining access to people and information. The French stress, however, that these barriers are not only

an outgrowth of Soviet politics and the closed nature of Soviet society, but are also a function of bureaucratic problems endemic to the Soviet system. For example, whereas scientists in the West tend to see all aspects of a scientific problem, they underscore that Soviet scientists, by virtue of a more compartmentalized scientific establishment, are often confined to a more limited view. The French therefore do not see access problems as primarily political issues, and feel it is worth the effort to keep cooperation alive with hopes that the U.S.S.R. will become increasingly easier to work with.

KEY ISSUES AND POLICY APPROACHES

Because of a somewhat different approach towards cooperation with the U.S.S.R., the issues concerning Franco-Soviet space cooperation today are quite different from those facing U.S. planners. Whereas in response to the Soviet invasion of Afghanistan and the declaration of martial law in Poland U.S. planners allowed space cooperation with the U.S.S.R. to lapse, French planners decided that such cooperation should be sustained. Whereas the key issue in the United States today, therefore, is whether space cooperation should be *reestablished*, the key issue in France has concerned the degree to which space cooperation with the U.S.S.R. should be *maintained*. Perhaps because of this, the issue of Franco-Soviet space cooperation has not been as much a focus of public debate in France as it has been in the United States.

This is not to suggest that Franco-Soviet cooperation in space has been without controversy. Some joint projects have been the target of opposition in the past, and others are the focus of French internal debate today. Probably the greatest controversy, for example, surrounded the flight of Jean-Loup Chretien in 1982, when a large segment of the French scientific community opposed the flight of a French spationaute on a Soviet spacecraft at the same time that the Soviets were flagrantly violating human rights at home and abroad. As illustrated above, French scientists or other communities may well oppose

another potential joint flight in the future. And at present, there is also evidence that some scientists may be declining to travel to the U.S.S.R., and may be withholding from Soviet scientists invitations to their own laboratories.

Opposition to cooperation has generally stemmed from humanitarian concerns, i.e., expressing support for Sakharov, opposition to the Soviet invasion of Afghanistan, etc. Opponents of joint manned missions, for example, have argued that the implicit acquiescence of French scientists to Soviet violations of scientific integrity and human rights at home, and the political profits which the U.S.S.R. inevitably accrues on the international stage more than offset any possible benefits of such projects. Others contend, however, that the scientific and economic benefits of such missions far outweigh the political costs, and that France should pursue as many joint manned missions as possible, regardless of whom the partner may be. Europeans in general, these proponents argue, are looking forward to several joint manned missions before the end of the century, not only with the U.S.S.R., but with the United States and potentially with the European space station *Columbus*. The French are also looking forward to their own manned vehicle called *Hermes*, a small space plane which could be used in association with satellite deployment or space station maintenance and operation. The more exposure French scientists can get to manned space flights and training, these

proponents argue, the more they can apply that to the development of their own programs.

Despite these working level debates, however, a fairly consistent policy approach has been pursued in France regarding interaction with the U.S.S.R. in space activities in particular, and in scientific and technical cooperation generally. Cooperation with the U.S.S.R. was begun essentially with political aims paramount. French planners viewed scientific and technical cooperation generally, and space cooperation in particular, as a means of broadening relations with the U.S.S.R. and offsetting political tensions in other areas.

As the political climate has become less opportune for promoting such cooperative efforts, however, and as the scientific requirements of the French space program have grown, scientific and economic aspects have been increasingly emphasized. Today, the scientific and economic benefits of cooperation in space are stressed as the central reason for continued cooperation, although French planners agree that it is impossible to ignore the political background against which cooperation occurs.

Current French policy decisions, therefore, represent a mixture of political, scientific, and economic aims, which have varied in relative importance, but together have created a mainly stable and consistent policy approach. Today, French planners are attempting to maintain the political will for cooperation in spite of political differences, but are trying to keep cooperation itself on a scientific level.

Scientific and Economic Issues

In light of the existing structure and present level of funding of the French space program, French planners assert that their space research requires cooperation with other countries, and that the U.S.S.R. is a good partner for answering those needs. The force of this argument was intensified with the cutbacks in NASA's budget in the early 1980s and the consequent curtailing of NASA's participation in some international projects. The French—interpreting the cutback in U.S. participation in the International Solar Polar Mission

(ISPM)⁹ in political rather than budgetary terms—reasserted their view of the U.S.S.R. as a viable partner for many areas of space cooperation. Regarding a possible joint Franco-Soviet mission to Venus, for example, one French scientist stated:

This has been the only possibility for French scientists to go into the planetary programs. There are some individuals like me who have had instruments on U.S. spacecraft but we'd like to have a larger constituency and the only way for our scientists to go to the planets is through this cooperation with the Soviets.¹⁰

Although Chretien's flight was politically controversial, it was viewed as an important step for the French space science program: France did not have its own craft for sending a man into space, so required a joint mission with another country which did. The mission was considered beneficial for developing the life sciences in France, and provided new data for further space research unavailable elsewhere.

From cooperation with the U.S.S.R. today, France continues to obtain payload opportunities that it might not otherwise be able to acquire. And even though, as mentioned above, French scientists have sometimes opposed cooperation with the U.S.S.R. on humanitarian grounds, they have generally favored cooperative efforts such as the present mission to Halley's comet, where French participation has been on a low level and the potential scientific benefits are large.

The economic benefits of cooperation with the U.S.S.R. have also been substantial. Being able to place experiments on another country's spacecraft, and sharing costs in joint ventures have reduced French expenditures considerably. According to *Le Figaro* (Oct. 5, 1983), for example, the *Sigma* project, if conducted by France alone, would have cost the French at least 400 million French francs, or about \$50 million. In cooperation with the Soviets, who will be mainly respon-

⁹See Robert Reinhold, "U.S. Dismays Allies by Slashing Funds for Joint Science Projects," *The New York Times*, May 10, 1981, p. 1.

¹⁰Thomas O'Toole, "France and Soviets Will Aim Wind Balloons at Venus," *Washington Post*, Dec. 17, 1978, p. A 31.



Photo credit: Charles P. Vick, Paris Air Show, 1985

French Atmospheric Balloon carried on Soviet Venus-Halley Mission

sible for the launching operations, it is now expected to cost France only about 80 million French francs, or about \$10 million for the first 5 years until 1987 or 1988 when the satellite is projected to be placed into orbit.

Foreign Policy Issues

Although France today emphasizes scientific and economic benefits as the basis for cooperation with the U.S.S.R., French-Soviet cooperation in space has consistently been buttressed by the foreign policy community. Decisions have consistently been made at the higher political levels for cooperation to continue, emphasizing the conviction that such cooperation can be useful in attaining certain foreign policy goals as well as scientific ones, and that little would be gained from curbing or terminating it.

A key goal of French-Soviet cooperation in space, for example, concerns the position of France on the international stage, i.e., maintaining and reinforcing French independence.¹¹ As the French space program grows and becomes more sophisticated, cooperation with both superpowers allows France to avoid the dependency which French planners fear could result from relying on just one or the other for payload capabilities and expertise. By maintaining a balance between the U.S.S.R. and the United States, or by playing one superpower off against the other, the French believe that they occupy a better bargaining position in determining the shape of future cooperative ventures.

French planners also view Franco-Soviet cooperation in space as important in working towards a number of more elusive objectives, such as reducing tensions worldwide, and keeping communication open with the U.S.S.R. As in other areas of Franco-Soviet relations, they have found it difficult to evaluate just how effective space cooperation may be in achieving these ends. But even if cooperation does not minimize tensions, they argue, the alternative—curtailing or terminating dialog—would isolate the U.S.S.R. from the world community, force it to expand its own indigenous capabilities, and ultimately increase tensions worldwide. In the French view, therefore, cooperation is a means of keeping channels of communication open, perhaps of most importance when the overall political climate is so dismal.

Another French objective of cooperation in space is the opportunity to learn more about the U.S.S.R. A key example is the intimate view the two French spationautes, Jean-Loup Chretien and Patrick Baudry, believe they acquired of both the Soviet space program and of Soviet society while training with Soviet cosmonauts in preparation for the joint manned mission in 1982.

If cooperation in space is indeed beneficial in these ways, then in a certain sense cooperation

¹¹See, for example, testimony of Hubert Curie, President, CNES, in hearings before the House Science and Technology Committee, *International Space Activities*, May 16, 17, 18, 1978 [No. 74] (Washington, DC: U.S. Government Printing Office, 1979), pp. 2-3:

It is a policy which strives to ensure our independence to the full extent necessary and to establish ties of effective cooperation with the space powers, especially the United States.

with the U.S.S.R. is also viewed as a means of simply sustaining the mechanisms for cooperation itself. Bureaucratic and political constraints have impeded all areas of Franco-Soviet cooperation—selecting areas for cooperation, negotiating agreements, and implementing them efficiently and effectively. Because it was so difficult for France and the U.S.S.R. to reach the present level of cooperation, French planners assert that it would be counterproductive to destroy the fruits of these efforts—especially if the French were to want to rebuild to this level sometime in the future when the climate may be more opportune. Some degree of consistency is regarded as important, if only to ensure that the window for cooperative activities remains open.

"Every country," one French planner stated, "must find areas for cooperation." The French, he added, "through prudent and determined effort" have decided on space as an area of cooperation which can be kept insulated from the dangers of technology transfer (see below), but which can offer mutual benefit to the countries involved.

Despite this overarching commitment to continuing cooperation with the U.S.S.R. in space science research, concern over two issues was expressed by some in the French foreign policy community. One of these issues concerns the degree to which such cooperation may affect French relations with other Western countries. Although the French believe that Franco-Soviet cooperation so far has not affected relations with other coun-

tries in any lasting way, there was some concern expressed that it could affect relations in the future, especially with the United States. This view was buttressed by the belief expressed by several French planners that NASA's curtailed participation in the International Solar Polar Mission (ISPM) was motivated more by political than budgetary concerns. But French planners hope that continued cooperation with the U.S.S.R. will not affect their relations with the United States—and argue that it should not.

A second issue concerns the degree to which Franco-Soviet cooperation in space should be "linked" to other foreign policy considerations, either to affect or to protest Soviet behavior which they may consider politically or morally egregious. French planners discussed the moral attractiveness of using cooperation as a lever to effect change in Soviet society, or to send a moral message to protest Soviet actions which might have some bearing on Soviet behavior in the future. But scientific and technical cooperation, they believe, can only have an impact if the cooperative project is something which the U.S.S.R. perceives as important to its own interests, and the majority of French programs in space cooperation do not fall into this category. According to one French official, some scientific and technical cooperative programs with the U.S.S.R., such as in nuclear physics, were curtailed or stopped in response to the Soviet invasion of Afghanistan and the exile of Andrei Sakharov, and other potential future areas of cooperation have been "put on the back burner." But whether the intent is to affect Soviet behavior or to protest, they argue that curtailment or termination of cooperative projects in space would have little impact on Soviet policy at large while having a large negative impact on the French space program. They therefore believe that space cooperation should not be held hostage to Soviet actions in other areas, and that any displeasure with Soviet actions should be shown in other ways.

Indeed, some planners asserted that cooperation may even make it easier for France to protest Soviet actions, by providing a mechanism through which displeasure can be conveyed. Just as French President Mitterrand, when visiting Moscow in the spring of 1984, was provided more



Photo credit: Centre Nationale d'Etudes Spatiales

Cosmonauts and spationauts onboard Salyut 7

of an opportunity than many other Western leaders for voicing his concern over the persecution of Andrei Sakharov, some French scientists argue that by being involved in cooperative projects, they may find it easier to discuss questions of political and humanitarian concern than if there were no interchange at all. There is no evidence, however, to indicate whether this approach may have been any more successful in affecting Soviet behavior than that of others in the West who terminated cooperative ventures.

In short, although the link between scientific cooperation and political relations with the U.S.S.R. cannot be ignored, French planners are attempting to "de-link" the two by downplaying the use of science for political ends. While no area of cooperation with the U.S.S.R. can be totally de-politicized, French planners argue that it is important to seek an area for cooperation where political considerations are reduced as much as possible, but where mutual scientific benefit can be substantial.

Military Technology Issues

In light of the overall policy to pursue substantive cooperation with the U.S.S.R. in space research, questions of the potential transfer of militarily sensitive technology loom large. While France enjoys many scientific, economic, and political benefits from cooperation, the French agree that the Soviets are vigorously pursuing an aggressive campaign to gain access to Western technology and know-how, and that they are undoubtedly acquiring technical capabilities from space cooperation with France beyond those which they already possess. This was highlighted by the expulsion of 47 Soviet technological spies in 1983, and by the 1985 "leak" by French intelligence services of secret Soviet documents which illustrate the breadth and scope of Soviet industrial espionage activities in the West, especially in the aeronautic sector.¹² In interviews with OTA, French planners stated that the Soviets may gain some technical know-how via space coop-

eration—e.g., from French data processing—and are also able to use French instrumentation that they otherwise might not have had.

The key question for French policymakers, however, is the actual *value* of these new capabilities to the U.S.S.R., and it is here where they differ markedly from present U.S. policy. Defining "militarily sensitive" technologies as only those with direct military application—as opposed to more extensive U.S. definitions*—they argue that stringent controls are in place to avoid their transfer into Soviet hands. As in the United States, a list of sensitive technologies—the Missile Technology Control List—governs technology exports from France, and an interministerial group of specialists is assigned to examine every new project proposal—in the space field as well as in others—to ensure that no violations of the list occur. With input from the *Secrétariat Général de la Défense Nationale* (SGDN) and various ministries, this interministerial committee, the *Commission Interministérielle d'Examen des Exportations du Matériels de Guerre* (CIEEMG), reviews technology transfer possibilities in space-related areas and is charged with the final approval of proposed projects. Thus, each project proposal in France is evaluated for its technology transfer potential, and depending on the ultimate assessment, access to people, techniques, and/or equipment may be curtailed.

Once a project has been accepted, moreover, French planners argue that still other systems of verification remain in place. According to officials in the Ministry of Foreign Affairs, "certain procedures guarantee that any potentially sensitive equipment is protected, and information flow is carefully monitored." For example, protective packaging may be used to prevent the Soviets from gaining access to particular items that may be sensitive. And French scientists and partici-

*The United States is the only OECD country that defines strategic goods as including products and technologies with only indirect military implications, that views the weakening of the Soviet economy as an appropriate factor in determining policy, and that includes "foreign policy criteria" in export licensing or the imposition of embargoes and sanctions. See John P. Hardt and Donna L. Gold, "Trade Sanctions and Controls," in *East-West Technology Transfer: A Congressional Dialog With the Reagan Administration*, a dialog prepared for the use of the Joint Economic Committee (Washington, DC: U.S. Government Printing Office, 1984), p. 99.

¹²These were published in part in two editions of the French newspaper *Le Monde*. See Edwy Plenel and Christian Batifoulrier, "Un document secret soviétique," *Le Monde*, Mar. 30, 1983, p. 8; and Edwy Plenel, "L'Espionage soviétique à l'ouest. Les mystères de la VPK," *Le Monde*, Apr. 2, 1985, p. 7.



Photo credit: Charles P. Vick, Paris Air Show, 1985

VEGA I and II type spacecraft with French equipment, scheduled to rendezvous with Halley's Comet

pants in cooperative projects are generally briefed before a project begins on the "myth" of the separation of the Soviet civilian and military space programs, and on precautions to be taken in cooperative projects to counteract Soviet efforts to acquire Western technology and know-how. "If international cooperation," one such briefing concludes, "presents numerous advantages (rather inexpensive access to sophisticated space equipment, knowledge of Soviet technology), it also presents risks. It is necessary to recognize these risks of transferring sensitive know-how, so as to take the precautions that are necessary in exchanges with the U.S.S.R."

Key criticisms from supporters of a more stringent U.S. policy are that the French definition of what may be "militarily sensitive" is not extensive enough—i.e., it does not include dual-use

IMPLICATIONS FOR U.S. POLICY

French planners emphasize that their approach to cooperation with the U.S.S.R. cannot and should not be perceived as a model for U.S. planners. They believe that French policies would not be appropriate for another country with more financial and human resources invested in an already sophisticated space program of its own, and with superpower status. U.S. space requirements and political relationships are too different from

technologies but is limited to technologies with direct military applications—and that French mechanisms for limiting Soviet access to Western technologies, such as protective packaging, are not always effective. But French planners stated strongly, if not defensively, that "while there will always be some transfer, we do not believe the Soviets are acquiring any militarily significant technology as a result of this cooperation." Especially in the realm of space, French planners assert that France has not aided Soviet military capabilities "because of their [Soviet] advanced state of development" in certain of these areas, and because of French "vigilance" in others.

Disagreements with the United States over technology transfer, the French believe, do not stem from a fundamental difference of opinion, but only of degree. In the grey area of technology where the degree of military sensitivity is in question, these disagreements stem from the fact that the French yardstick tends to be more liberal, often guiding French planners to draw the "technology transfer line" in a different place from their American counterparts. These "yardsticks" have been the subject of considerable discussion, both within COCOM and in other forums. But the French feel certain that their yardstick is an appropriate one and, as in the area of commercial trade, question the wisdom of American planners in evaluating the technology transfer potential of individual French-Soviet projects more harshly.¹³

¹³For a discussion of these issues in the commercial realm, and debates within COCOM, see OTA's *Technology and East West Trade: An Update* (Washington, DC: U.S. Government Printing Office, OTA-ISC-209, May 1983), esp. pp. 63-72

France's for French policies to work for the United States. Scientifically, the American space program does not have the same needs as the French space program, which is newer, less extensive, and operates on a smaller scale. The U.S. space program does not face the same financial limits as the French program. The United States at present does not have the same governmental communications mechanisms in place for sharing information with

the U.S.S.R. on a steady basis, as illustrated by the direct lines for transmitting data between the Toulouse Space Center and Moscow. And from a political vantage point, the French believe that whatever the project, it is by nature easier for France to cooperate with the U.S.S.R. than the United States: U.S.-Soviet cooperation, they believe, automatically has a much higher political significance attached to it simply by virtue of the two countries' competitive status as world superpowers.

But even though individual French planners were reluctant to draw lessons from their own experience for U.S. planners, a few common views emerged during discussions there. These include the view that, while U.S.-Soviet space cooperation is potentially beneficial, it should be approached soberly and with lower expectations than in the past; the United States should not focus on large-scale joint projects, which both countries would want to use for political ends, but should focus on small-scale projects where scientific and/or economic concerns are paramount; and that space cooperation should be de-linked from politics as much as possible, so that regardless of what happens in the political arena, cooperation and channels of communication can be sustained. Some suggestions included more joint projects in the area of planetary research and compatibility between space stations and transportation systems—areas in which there have already been some preliminary discussions. "The more scientific you are, the more successful you'll be," one planner noted. They also stressed the importance

of being involved in the planning stages at the very beginning of any particular cooperative mission; the importance of keeping joint efforts stable, without disruptions due to unrelated events; and the importance of diminishing the drama which has sometimes accompanied U.S.-Soviet exchanges.

French planners would look with favor on renewed U.S.-Soviet cooperation in space, for the broad reasons of promoting world peace. In addition, some suggested that increased U.S.-Soviet space cooperation might also be in France's own interest, in that it would allow France to cooperate with the Soviet bloc in a freer atmosphere, and reap the benefits of both the U.S. and Soviet space programs more easily. Some concern was expressed on the part of some French officials that there could be drawbacks to U.S.-Soviet cooperation: Some feared that U.S.-Soviet cooperation might carve out space as a superpower domain; others, that further French-Soviet cooperation in space could hurt French-U.S. relations. But neither of these ideas appears to be widespread.

The official French point of view expressed most often is that there is always some uncertainty in relations with the U.S.S.R. The lesson for any country to learn from this, however, is not to terminate cooperation. Instead, it should be to approach cooperation soberly, with caution, without grandiose expectations, but still with the hope that it will contribute to the pursuit of space research in a positive manner, and perhaps to achieving broader objectives as well.

Chapter 5
U.S. Policy Issues



The planet Mars

Chapter 5

U.S. Policy Issues

On October 30, 1984, President Reagan signed a Joint Resolution of Congress (S.J. Res. 236) in support of renewing cooperation in space with the U.S.S.R. Introduced by Senator Matsunaga and initially cosponsored by Senators Mathias and Pell,¹ the resolution, now Public Law No. 98-562, states that "the President should: 1) endeavor, at the earliest practicable date, to renew the 1972/77 agreement between the United States and the Soviet Union on space cooperation for peaceful purposes; 2) continue energetically to gain Soviet agreement to the recent U.S. proposal for a joint simulated space rescue mission; and 3) seek to initiate talks with the Government of the Soviet Union, and with other governments interested in space activities, to explore further opportunities for cooperative East-West ventures in space."²

This Public Law is one of a number of overtures made by both this Administration and Congress towards cooperation with the U.S.S.R. A speech delivered by President Reagan in June 1984 announced a renewed U.S. effort to revive or strengthen economic, cultural, and consular as well as scientific contact with the U.S.S.R., and called for efforts to renew U.S.-Soviet cooperation in areas other than space—for example, in the areas of environmental protection, fishing, housing, health, agriculture, and in discussions of maritime problems and joint oceanographic research.³ An amendment sponsored by Senator Nunn to the Department of Defense Authorization Act of 1985 (signed into law on October 19, 1984, as Public Law 98-525), calls for expanding confidence-building measures between the United

States and the U.S.S.R., including the establishment of nuclear risk reduction centers in Washington and Moscow linked with modern communications. And as of May 1985, the 99th Congress has before it several bills directed towards increasing U.S.-Soviet cooperation in space as well as in other areas. In February 1985, for example, Senator Matsunaga introduced S. Res. 46 calling for coordinating already scheduled Soviet and U.S. missions to Mars (for 1988 and 1990, respectively), and for examining ways to coordinate future Mars-related activities. Bills are presently pending in both the House and the Senate (sponsored by Congressman Huckaby in the House and Senator Proxmire in the Senate) calling for a joint U.S.-Soviet study of the long-term climatic effects of nuclear war. A House resolution sponsored by Congresswoman Schneider calls for an exchange of travel between leaders of the United States and the U.S.S.R. And a joint resolution of both houses, sponsored by Senator Warner and cosponsored by Senator Nunn, authorizes the Secretary of Defense to provide equipment and services necessary for an improved U.S.-Soviet "Hot Line."

Public Law 98-562 marks the outcome of several years of debate on the merits and demerits of cooperation with the U.S.S.R. in other areas as well as in space. As it is primarily a statement of intent rather than a plan for resuming cooperation, however, the law has not resolved the policy issues surrounding its implementation. Instead, it has raised more questions, which must now become the subject of intense scrutiny.

The purpose of this chapter is neither to determine whether cooperation should be pursued, nor to prescribe optimal methods for crafting an agreement to achieve any particular set of goals. Instead, it is intended only to sketch out the broad issues surrounding the implementation of U.S.-Soviet cooperation in space, and to clarify the different viewpoints as a basis for discussing guidelines and specific policy approaches in the future.

¹After the resolution was introduced in February 1984, an additional 13 senators became cosponsors: Senators Cranston, Hart, Inouye, Tsongas, Levin, Kennedy, Bingaman, Stafford, Leahy, Bumpers, and Hatfield. The House version of the resolution was introduced in March 1984 by Representative Mel Levine with 75 cosponsors.

²For a copy of the full text, see app. B.

³See President Reagan's speech, "Conference on U.S.-Soviet Exchanges," White House, June 27, 1984, and proceedings of the Conference on U.S.-Soviet Exchange, Kennan Institute of Advanced Russian Studies, The Wilson Center, June 1984. See also President Reagan's "Address Before the 39th Session of the General Assembly," United Nations, Sept. 24, 1984, in *Weekly Compilation of Presidential Documents*, Sept. 24, 1984, especially pp. 1357-1359.



Photo credit: National Aeronautics and Space Administration

The issue of U.S.-Soviet cooperation in space has been a subject of congressional hearings since the beginning of the Space Age in the 1950s. Here Astronaut Thomas P. Stafford, Commander for ASTP, addresses the Members of the Senate Space Committee during the 1973 hearings on the NASA budget. Seated at the table are; left to right; Astronaut Charles Conrad, Jr., James C. Fletcher, George M. Low, and Astronaut Stafford

BACKGROUND

The signing of Public Law 98-562 and the debate concerning renewed U.S.-Soviet cooperation in space is occurring against a background of strained, unpredictable, and ambiguous relations between the two superpowers. Increased tension since the détente of the 1970s reflects such factors as: the imposition of martial law in Poland; the shooting-down of KAL 007; the continued Soviet presence in Afghanistan; the slaying of an American officer in East Germany in March 1985; the internal exile and uncertain condition of Soviet Nobel laureate Andrei Sakharov; the Soviet Union's continued persecution of dissidents at home; expressed Soviet concern over "aggressive" "imperialist" policies of the Reagan Administration in Nicaragua and elsewhere, and a continued military buildup in both countries. The beginning of 1985 produced accusations by the Reagan Administration of Soviet violations of almost every arms control treaty signed in the past quarter cen-

Chapter 3 lists several potential areas and levels for cooperation, primarily from a scientific point of view. But as in France, the issue of U.S.-Soviet space cooperation is not only—or even primarily—a scientific one. These scientific considerations must be considered along with political messages the United States may or may not want to send, and the potential technological benefits and losses such cooperation might entail. After a brief background discussion of the policy questions as a whole, this chapter examines the scientific, foreign policy, and national security issues surrounding U.S.-Soviet cooperation in space, Soviet perceptions and behavior, and key challenges which will face U.S. planners in shaping any future U.S.-Soviet cooperation in space.

tury,⁴ and hostile invective on the part of Soviet officials towards the United States, especially concerning the U.S. "Strategic Defense Initiative." On the other hand, this hostile atmosphere has been imbued with cautious optimism by the resumption of the stalled U.S.-Soviet negotiations on arms reductions, the first high-level Soviet-American trade and economic talks in 5 years, and explicit U.S. overtures for renewing overall U.S.-Soviet cooperation.

The debate is also occurring at a time when U.S.-Soviet scientific and technical cooperation and the various uses of space are raising more complex and contentious issues in their own right.

⁴For a detailed listing of these accusations of Soviet treaty violations see *A Quarter Century of Soviet Compliance Practices Under Arms Control Commitments: 1958-1983* (Washington, DC: General Advisory Committee on Arms Control and Disarmament, October 1984). These accusations remain controversial.

The U.S. scientific community has shown renewed interest in international scientific and technical cooperation in the 1980s, in areas outside of space research per se. "The constraint on domestic resources and growing scientific excellence abroad suggest strongly the need for the United States to enter into cooperative arrangements with other technically advanced nations."⁵ This increased interest in international cooperation, however, has been countered by opposing, and sometimes irreconcilable factors, including two key concerns: 1) science and technology have become increasingly important instruments of foreign policy, so that foreign policy interests have led to the reshaping, termination, and/or curtailing of scientific and technical cooperation; and 2) growing sensitivity of technology transfer questions has led to greater concern over the potential dissemination of "militarily sensitive" hardware or information through cooperative projects in the 1980s.⁶

Controversy in international and bilateral forums over both civilian and military space activities have also made space a particularly sensitive arena in which to encourage cooperative activity. In both the United States and the U.S.S.R., the high budgets directed towards uses of space essential to military programs—for satellite reconnaissance, communications, predicting weather, verification of arms control, and even for protection of these satellites—underline that space is, and will remain, an area of sensitive militarily related activities. Each country has consistently accused the other of pursuing policies which will "militarize" or "weaponize" space to an unacceptably dangerous level. U.S. press and government reports are filled with information regarding a possible "massive" Soviet buildup of militarily oriented space systems, including space weapons and an already operational ASAT capability.⁷

⁵Mitchell B. Wallerstein, "U.S. Participation in International S&T Cooperation: A Framework for Analysis," *Scientific and Technological Cooperation Among Industrialized Countries*, Mitchell B. Wallerstein (ed.) (Washington, DC: National Academy Press, 1984), p. 6.

⁶For detailed discussions of the growing debate on S&T cooperation generally, see two recent reports by the National Academy of Sciences and National Research Council: *Scientific Communication and National Security* (Washington, DC: National Academy Press, 1982), commonly known as the "Corson Report" after its panel chairman, Dale Corson; and Wallerstein, *op. cit.*

⁷See, for example, "Soviets Develop Heavy Boosters Amid Massive Military Space Buildup," *Aviation Week and Space Technol-*

Only tacitly admitting that they have a military space program of their own,⁸ Soviet officials have decried the U.S. Strategic Defense Initiative (SDI) and have consistently stated that the U.S. SDI will be a serious, if not insurmountable, obstacle to any major U.S.-Soviet cooperation in space.⁹ In civilian areas of space as well, international disputes over such issues as controlling radio frequency and orbital slot allocations have highlighted how difficult it can be to reach agreement even with our allies. Space by nature is an environment which extends beyond any one country's borders, making disputes likely.

Given all of these conflicts, the question of what type of bilateral U.S.-Soviet space cooperation should be pursued has created a good deal of controversy. Some believe that the United States should pursue a large-scale joint mission largely insulated from the ups and downs of U.S.-Soviet relations and world politics. Others support pursuing space cooperation only on a very low and strictly scientific level, if at all. And others hold different views, including pursuing scientifically valuable cooperation (such as joint data exchange and analysis, or hosted experiments on one another's spacecrafts) that is insulated from the ups and downs of world politics; pursuing cooperation on any level, but linking it to politics, so that such cooperation would be turned on and off in protest to any egregious Soviet behavior; or pur-

ogy, CCXXII, No. 11 (Mar. 18, 1985), pp. 120-121; *Soviet Military Space Doctrine* (Washington, DC: Defense Intelligence Agency, 1984), p. 31; and annual issues of the U.S. Department of Defense, *Soviet Military Power*, 4th ed. (Washington, DC: U.S. Government Printing Office, 1985).

⁸For a discussion of Soviet positions on the "militarization" of space, see "Appendix A: The 'Militarization' Issue at Unispace '82," in *Unispace '82: A Context for International Cooperation and Competition—A Technical Memorandum* (Washington, DC: U.S. Government Printing Office, OTA-TM-ISC-26, March 1983). For a discussion of evidence that the Soviets have a "Star Wars" program of their own, see "Soviet Directed Energy Weapons—Perspectives on Strategic Defense" (Washington, DC: Central Intelligence Agency, March 1985).

⁹See, for example, "U.S.-Soviet Mission in Space is Sought," *New York Times*, Jan. 8, 1985; Walter Pincus, "Soviet Scholar Warns Against Space Arms," *Washington Post*, Jan. 13, 1984; and interviews conducted by OTA in Moscow, June-July 1984. See also V.S. Avduievskii, "Space Should Be Peaceful," in Russian in *Zemlia i Vseleennaia*, No. 5 (September-October 1984), pp. 6-11, translated in Foreign Broadcast Information Service (FBIS), *U.S.S.R. Daily Report*, May 6, 1985, pp. 94-100; and "Academician on Cooperation," TASS in English, Moscow, May 20, 1985, reprinted in FBIS, *U.S.S.R. National Affairs*, May 22, 1985, p. U3.

suings a series of relatively low-level cooperative efforts of gradually increasing complexity, to lead to larger joint projects and commitment in the future.

A related issue concerns the renewal of an intergovernmental bilateral agreement for cooperation in space, regardless of the level of cooperation. Soviet leaders have made it clear that cooperation in space *on any level* is exceedingly difficult without an overarching agreement which would provide a formal framework for cooperation. But the signing of an agreement itself would be a major event in U.S.-Soviet relations overall, even if it were to call for only low levels of exchange.

SCIENTIFIC AND PRACTICAL ISSUES

One key issue in U.S.-Soviet cooperation in space is whether it is valuable to the United States—either from the standpoint of gaining access to data and information, or from a cost-savings perspective—and whether these benefits offset the costs. Does cooperation with the U.S.S.R. in space research and applications open more research opportunities than we would be able to gain from our programs alone? Can it provide opportunities for cost-savings through reduced duplications of missions and/or shared costs of cooperative missions? And do the Soviets gain far in excess of what the United States does?

The scientific issues in U.S.-Soviet space cooperation are discussed extensively in chapter 3, based on the proceedings of a workshop held at OTA in May 1984 on U.S.-Soviet cooperation in the space sciences. The workshop and the record of past experience suggest that scientific gains can indeed be substantial from cooperation with the U.S.S.R. in many areas of space research.¹⁰ In brief, OTA's workshop suggested that:

- Past U.S.-Soviet cooperation in the space life sciences area has been substantive and valuable, especially in: 1) the exchange of flight

¹⁰"U.S.-Soviet Space Cooperation," proceedings of workshop held at OTA on May 8, 1984. staff paper compiled by the staff of the Science, Transportation, and Innovation Program, OTA.

Each of the viewpoints on how to cooperate involves a combination of scientific, foreign policy, and national security concerns. Each also involves subjective judgments about broader issues of world tensions, Soviet objectives and the course of U.S.-Soviet relations. U.S. planners and the public have demonstrated a multiplicity of views concerning the goals of U.S.-Soviet space cooperation, and it is unlikely that U.S. policy as a whole will pursue a consistent, unified set of objectives. But the objectives the policy reflects, and the way inconsistencies among them are reconciled, will shape any U.S.-Soviet space cooperation in the future—or determine whether such cooperation will be possible.

experimental data regarding human response to spaceflight conditions; 2) joint ground-based simulations of spaceflight conditions; and 3) animal (biological) research.

- While somewhat more problematic, cooperation in planetary science has also been valuable, especially in the exchange of data in lunar studies, the exploration of Venus, and solar terrestrial physics.
- The success or failure of U.S.-Soviet cooperation in the space sciences may depend on such factors as: 1) a focus on well-defined and specific scientific objectives; 2) selection of areas of complementary capability; 3) the selection of projects where the required instrumentation is generally not of a type raising technology transfer concerns.
- The future offers numerous possibilities for U.S.-Soviet cooperation in space which should be scientifically valuable in areas including: "global habitability;" exobiology; the joint demonstration and testing of advanced life support systems; integration of Soviet data into the International Solar-Terrestrial Physics Program (now being developed); joint missions in very long baseline interferometry (VLBI); and cooperative ventures in the planetary field relating to the Moon, Venus, Mars, the comets and outer planet exploration.

These and other views underlying the potential scientific gains of U.S.-Soviet cooperation in space were reiterated in subsequent Congressional testimony.¹¹ In the space sciences, cooperative activity in planetary research and the life sciences has provided U.S. space scientists with long-duration flight opportunities for experiments, and with data and information unavailable elsewhere; National Aeronautics and Space Administration (NASA), the National Oceanic and Atmospheric Administration (NOAA), and other agencies and individuals continue to seek cooperative activities on the basis of scientific merit alone.

At the level of applications, the experience of cooperation in search and rescue operations has also been beneficial. As described in appendix C, during the course of the approximately 3 years since the first launch in the COSPAS/SARSAT system, close to 400 lives have been saved, and efforts are now being made to standardize emergency locator beacons. The signing of an agreement in October 1984 to extend the program through 1990 indicates that all four parties to the search and rescue agreement consider it beneficial.

In balancing scientific and practical gains against potential losses, however, U.S.-Soviet space cooperation is more controversial. Argu-

¹¹See, for example, statement of Thomas M. Donahue, Chairman, Space Science Board, National Research Council, in *East-West Cooperation in Outer Space, Hearings Before the Senate Committee on Foreign Relations of the 98th Congress on S.J. Res. 236* (Washington, DC: U.S. Government Printing Office, Sept. 13, 1984).

ments against renewing space cooperation with the U.S.S.R. based on its scientific and technical aspects alone are threefold. One is the belief that the United States is so far ahead of Soviet efforts that the U.S. space program as a whole has little to gain from renewed cooperation.* A second belief is that—while cooperation may provide benefits in specific areas of space research—whatever the U.S. might gain from such cooperative efforts is hardly worth the enormous amount of time, money, energy, and frustration involved in acquiring it, and that cooperation might draw funds away from other, more scientifically important projects.

A third argument against cooperation is that what we learn may be out of balance with what Soviet scientists gain, and, therefore, it may be in our best interests to severely restrict space cooperation. Scientifically and technically, some believe, cooperation provides a greater boost to the Soviet space program overall than to our own; thus, Soviet scientists may learn more about the U.S. space program from interaction with U.S. scientists than the reverse, and may gain access to potentially sensitive technology or technical know-how in the process. They also argue that in light of the U.S. technological edge, the Soviets should not be "subsidized" to improve their space program and related military capabilities at the United States' expense.

*OTA's studies on *Cooperation and Competition in Space and Civilian Space Stations* do not support this conclusion.

ОКБ МЭИ МИНВУЗ СССР
ИППИ АН СССР

ВЕНЕРА-16
СЪЕМКА 12-23 ЯНВАРЯ 1984
ОБРАБОТКА 27.02.1984

0090
22 01
0090
21 01
0078
20 01
0044
17 01
0050
18 01
0046
17 01
0030
16 01
0024
15 01
0010
14 01
0006
13 01
0000
12 01

27.02.1984 005F 07-10

27.02.1984 0070 07-10

27.02.1984 0071 07-10

Photo credit: Institute of Space Research, U.S.S.R. Academy of Sciences

Despite the lapsing of the intergovernmental agreement, some exchange of data and information continues today. This Soviet photo of Venus, taken from Venera 16, was shared with OTA during a recent visit with members of the Soviet Academy of Sciences

Supporters of cooperation for scientific reasons, however, believe that U.S.-Soviet space cooperation is important not only in specific areas of space research and applications, but in enhancing our insight into the Soviet space program and scientific knowledge generally. Because of the high level of secrecy in the U.S.S.R., cooperation provides the United States greater access to information not only in one specific area of space research, but in the Soviet space program as a whole. Because of the poor mechanisms for communication among people and institutes within the U.S.S.R., cooperation provides the United States a fuller picture of what Soviet scientists and researchers are working on—often a fuller picture than Soviet scientists themselves have. And since certain aspects of the Soviet space program have been different from those in the United States, cooperation also provides U.S. scientists with the opportunity to learn from different technological roots. Soviet scientists have different experiences to share and a range of scientific experience that the United States does not have, and from which the United States can draw valuable information. In economic terms, U.S.-Soviet space cooperation is viewed as an opportunity for significant cost savings (although there is no assurance that a joint project would be less costly to the United States than a separately funded project) and perhaps as a catalyst for the United States to initiate certain projects or programs which would not otherwise be undertaken. Indeed, several scientists have commented that such cooperation is also beneficial because it works to garner more funding and public support and interest for particular programs.

In terms of the balance of what American and Soviet scientists may gain from such cooperation, proponents of space cooperation assert that the question should not be phrased in terms of "who gets more," but rather "who gets more of whatever they wouldn't have gotten otherwise." Since so much more information about U.S. space programs than about Soviet space programs is available in the open literature, Soviet planners are as-

sumed to have ready access to enormous amounts of information whether or not cooperation takes place. Yet scientific and technical cooperation is one of the few mechanisms available for the United States to assess what the U.S.S.R. is doing in certain areas.¹² In this sense, many observers argue, the United States may actually "gain more" than the U.S.S.R. A State Department study submitted to the Senate Foreign Relations Committee in 1982 described space cooperation as one of four agreements where the United States was seen as benefitting more than the U.S.S.R.¹³

* * * * *

What emerges from these arguments is twofold: It is clear that scientific and practical benefit can be gained from U.S.-Soviet cooperation in space. But the degree to which the "gains" may be offset by scientific or technical "losses" is still a matter of debate. The possibility of scientific and technical "losses" is not necessarily a factor of the type or level of the project. Depending on the nature of the project, a low-level effort (on joint data analysis, for example) could present greater risks than a larger effort carefully crafted to minimize them. A key challenge, therefore, will be to select areas for cooperation that prove beneficial from a scientific and/or practical point of view, but minimize the risks of transferring sensitive information or technology to the U.S.S.R. Specific scientific issues are discussed in chapter 3. Technology transfer issues are discussed below.

¹²It has been estimated that about 90 percent of the science and technology information the United States receives from the Soviets occurs via official exchange agreements. See Genevieve Knezo, "American-Soviet Science and Technology Agreements," *East-West Technology Transfer: A Congressional Dialog With the Reagan Administration*, prepared for the use of the Joint Economic Committee, Congress of the United States (Washington, DC: U.S. Government Printing Office, 1984), pp. 117-120.

¹³See U.S. Department of State, "Report to Congress: Scientific Exchange Activities With the Soviet Union, Fiscal Year 1981 and Fiscal Year 1982," Department of State Authorization Act, Sec. 126 (a) and (b)

FOREIGN POLICY ISSUES

The issue of U.S.-Soviet space cooperation is fundamentally one of foreign policy. Administration statements and annual reports of the President to Congress illustrate how extensively scientific and technical cooperation as a whole has come to be viewed as a component of U.S. foreign policy.¹⁴ High visibility and drama make this especially true in the space arena.¹⁵ Congress has consistently viewed U.S.-Soviet cooperation in space as a means for improving relations in general and for enhancing U.S. prestige. The primary objective of present U.S. overtures for a joint U.S.-Soviet space rescue mission is explicitly one of foreign policy: to act as a focal point for renewed dialog and cooperation between the two superpowers. Issues of foreign policy have been the motivation sustaining space cooperation with the U.S.S.R.—and also the chief impediment to its successful implementation. It was for foreign policy reasons that cooperation in space with the U.S.S.R. was begun, and for foreign policy reasons—to express U.S. abhorrence of the declaration of martial law in Poland—that the space cooperative agreement was allowed to lapse in 1982.

Controversy arises, however, in determining precisely what our foreign policy objectives are, and on the appropriateness of using cooperation in space to meet political goals at the expense of scientific or technical objectives. Foreign policy concerns related to U.S.-Soviet cooperation in space embrace many different elements. Some of these objectives are mutually contradictory; others are contentious in themselves. These objectives include using cooperation in space as a mechanism to: reduce tensions between the two countries; reverse a perceived trend towards the "weaponization" of outer space; send positive



Photo credit: National Aeronautics and Space Administration

ASTP crew commanders Astronaut Thomas P. Stafford, left, and Cosmonaut Aleksei Kubasov meet in Moscow about one year after ASTP

symbolic messages to the rest of the world; alter Soviet behavior in a way which would be favorable for U.S. or Western interests; manifest displeasure with any reprehensible Soviet behavior; and keep lines of communication open with the U.S.S.R. even—or perhaps especially—when relations are strained.

Reduce Tensions

The driving force behind efforts to renew U.S.-Soviet cooperation in space—and the area of most controversy—is the belief that space cooperation can reduce tensions between the two superpowers and contribute to world peace. With a fundamentally adversarial relationship, few expect that U.S.-Soviet conflicts can somehow be "solved." But the spirit of Public Law 98-562 is the belief that space cooperation can reduce the danger of superpower confrontation, perhaps eventually allowing each country to divert some of its resources from military to civilian purposes. This belief was expressed in the resolution's original title: "A Joint Resolution Relating to Cooperative East-West Ventures in Space as an Alternative to a Space Arms Race." The belief that cooperation

¹⁴See, for example, the annual "Title V" reports entitled *Science, Technology, and American Diplomacy*, submitted to Congress by the President Pursuant to Sec. 503(b) of Title V of Public Law 95-426, the Foreign Relations Authorization Act for Fiscal Year 1979, which requires the President to provide annual reports to Congress on the U.S. Government's international activities in the fields of science and technology.

¹⁵See, for example, Harry R. Marshall, Jr., *U.S. Space Program: Cooperation and Competition From Europe*, Current Policy No. 695 (Washington, DC: U.S. Department of State, May 1985), esp. pp. 2 and 5.

can reduce tensions has been buttressed by the reports of several visitors to the U.S.S.R., including that of a delegation of eight senators, led by Senator Pell, to the Soviet Union in September 1983. These senators recommended that:

... scientific and technical agreements which have been allowed to languish or expire should eventually be returned to a full level of cooperative activity. It is not only self-defeating, but a failure of world responsibility to forego the humanitarian and ecological achievements that can emanate from such superpower cooperation.¹⁶

Proponents of this view see significant benefits in encouraging greater dialog and understanding between the two superpowers, perhaps creating a "web" of interactions—as stressed during the period of detente—which could make U.S.-Soviet relations more stable and interdependent.

Others have taken this issue further. In the press and in congressional testimony, some have asserted that such cooperation can offset the momentum of "Star Wars," whose attraction, they believe, lies largely in the exciting, futuristic, and technologically challenging image it presents of man's future in space, as well as in the high level of funding and number of people employed. Some view a large-scale, equally spectacular and challenging cooperative U.S.-Soviet effort in space as providing an alternative means for utilizing the high levels of funding and manpower which the SDI requires.¹⁷

From a directly opposing vantage point are arguments that such beliefs may not only be misleading, but counterproductive. Some observers are deeply skeptical of efforts to reduce tensions with the U.S.S.R., as they believe that any apparent reduction in tension will be illusory. They believe it is unlikely that cooperation in space—on any level—will lead to any genuine concessions

¹⁶See *Dangerous Stalemate: Superpower Relations in Autumn 1983, A Report of a Delegation of Eight Senators to the Soviet Union, to the United States Senate, September 1983* (Washington, DC: U.S. Government Printing Office, 1983), p. 3. The eight Senators were Senators Pell (Delegation Chairman), Long, Bumpers, Leahy, Metzenbaum, Riegle, Sarbanes, and Sasser.

¹⁷See, for example, Daniel Deudney, "Forging Missiles Into Space-ships," *World Policy Journal*, spring 1985, pp. 271-303, and prepared Statement of Dr. Carol S. Rosin, "East-West Cooperation in Outer Space," *Hearings Before the Senate Committee on Foreign Relations of the 98th Congress on S.J. Res. 236* (Washington, DC: U.S. Government Printing Office, September 1984), pp. 43-50.

by or permanent changes in the U.S.S.R. And in the absence of such changes, they are wary that such efforts might lead the United States to "lower its own guard," creating an atmosphere which would allow the Soviets to gain greater access to U.S. technology and concessions on other fronts. In addition, some studies on U.S.-Soviet cooperation in space imply that even if successfully completed, greater understanding and mutual accord may not be automatic outgrowth of such cooperative efforts.¹⁸ Observers from this vantage point tend to be skeptical that real benefits grew out of the detente of the 1970s, and believe that efforts to renew cooperation in space will ultimately represent another instance where expectations for reducing tensions may be raised high and once again not fulfilled.¹⁹

A third viewpoint is that cooperation in space will have little effect on overall U.S.-Soviet relations in any arena, so that these objectives in themselves do not comprise an adequate rationale for pursuing cooperation. According to this view, U.S.-Soviet cooperative efforts have fluctuated greatly over the past two decades, along with expectations, but we have not seen any fundamental change in the U.S.-Soviet relationship. They believe that there is nothing to suggest that cooperative activities in space on any level will have an impact on the overall U.S.-Soviet relationship, or on space-related military developments in either country in the future.

There is little agreement on how the lessons of past cooperation can be applied to the future. A

¹⁸For example, one study on the benefits and dilemmas of an international space station notes that because of cultural differences between Soviet and American citizens, certain types of cooperation in space could be strangled by a whole array of unanticipated and complex sociocultural problems. See B. J. Bluth, "The Benefits and Dilemmas of an International Space Station," *Acta Astronautica*, II, No. 2 (1984), pp. 149-153. Another study conducted some years earlier suggested that "there is no ground for the common assumption that the promotion of international understanding automatically promotes international good will," and that it is misleading to think that "face-to-face meetings and personal associations between people from different countries are the most obvious way to engender sympathy and mutual accord" (Charles Frankel, *The Neglected Aspect of Foreign Affairs: American Educational and Cultural Policy Abroad* [Washington, DC: The Brookings Institution, 1965], quoted in Bluth, "The Benefits and Dilemmas of an International Space Station," p. 152.)

¹⁹Some of these views are discussed in Richard Pipes, "Can the Soviet Union Reform," *Foreign Affairs*, LXIII, No. 1, fall 1984, pp. 47-62.

reduction in tension and in the military buildup of both sides was one of the hopes behind the initiation of space cooperation in the 1960s and 1970s and the Apollo-Soyuz mission in 1976.²⁰ Yet the decade of the 1970s was characterized not only by U.S.-Soviet space cooperation, but by Soviet belligerence abroad and severe U.S.-Soviet strains in other areas. And during the same decade, both countries were still placing a great deal of strategic and tactical importance on military space systems, and exhibited significant growth in militarily related space capabilities. The mid-1970s saw not only the launching of the joint U.S.-Soviet Apollo-Soyuz mission, but also the beginning of the Soviets' second phase of testing of their anti-satellite weapons and the development of Soviet nuclear-reactor powered radar ocean reconnaissance satellites (RORSATs); and the number of Soviet space launches which were exclusively military or joint military/civilian missions remained

²⁰See, for example, Jack Manno, *Arming the Heavens* (New York: Dodd, Mead, 1984). At the time of ASTP, he notes, it was hoped that "Soviet-American cooperation in space might just be the first step toward international cooperation on earth" (Manno, p. 136). A *New York Times* editorial also expressed the hope that "Soviet American detente is only the beginning toward more broadly based cooperation in space efforts involving the personnel and talents of every nation for the benefit of all humanity." "Meeting in Space," *New York Times*, June 15, 1975, p. 32.

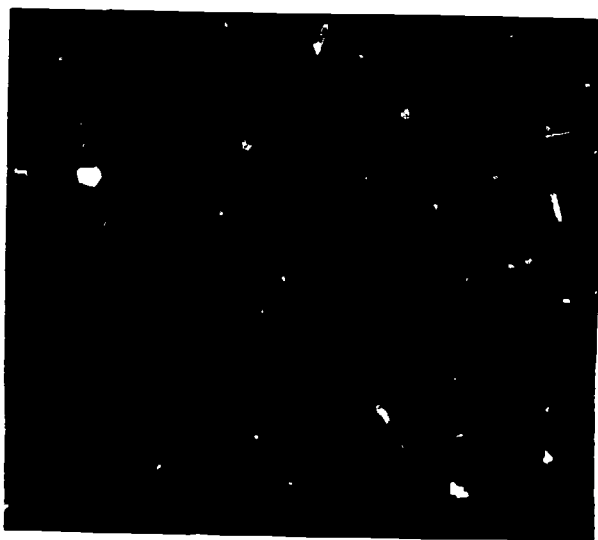

Photo credit: U.S. Department of Defense

While the United States and U.S.S.R. both share stated policies that space should be a peaceful domain, military uses of space also absorb high budgets in both countries. The above artist's conception depicts a Soviet Operational Anti-satellite Interceptor

high.²¹ In the United States as well, there was little linkage between a large-scale cooperative effort with the U.S.S.R. in space and U.S. military space programs. Military space programs in both countries have gained their own technological momentum. But there is little agreement on whether U.S.-Soviet relations might have been worse without such cooperation, or, alternatively, whether the United States may have become too conciliatory during past cooperative efforts. There is also little agreement on whether the future might provide a more or less promising context for cooperation than the past.

Two questions lie at the heart of these debates. The first concerns how foreign policy and space cooperation affect each other. Deep conflicts of interest form the foundation of U.S.-Soviet relations; it is a subjective judgment as to whether space cooperation can significantly change that level of conflict, and lead each superpower to redefine its relation to the other. Foreign policy has generally affected the direction of U.S.-Soviet cooperation, in space as elsewhere. Cooperation in space has usually been an outgrowth of good relations. There is little evidence, however, that space cooperation can lead to detente, or can improve overall U.S.-Soviet relations in any substantial way.

A second question is whether space cooperation may be viewed in either/or terms. At the time of the Apollo-Soyuz Test Project, for example, it was assumed that space would become either more internationalized, or an arena of greater competition and eventual conflict.²² History has proved otherwise: countries can and do cooperate and compete simultaneously. Thus, while

²¹See Marcia Smith, "Overview of Unmanned Space Programs: 1957-83," *Soviet Space Programs: 1976-80; Part 3, Unmanned Space Activities*, prepared for the use of U.S. Congress, Senate, Committee on Commerce, Science, and Transportation (Washington, DC: U.S. Government Printing Office, May 1985), pp. 761-766; and *Soviet Military Space Doctrine*, op. cit. (RORSATs are the only Soviet military space system for which there is no U.S. equivalent).

For a discussion of the heavy military orientation of the present Soviet space program, see, for example, Craig Covault, "Spaceplane Called a Weapons Platform," *Aviation Week and Space Technology*, CXXI, No. 4 (July 23, 1984), pp. 70, 75; Craig Covault, "U.S.S.R.'s Reusable Orbiter Nears Approach, Landing Tests," *Aviation Week and Space Technology*, CXXI, No. 23 (Dec. 3, 1984), pp. 18-19; and *Soviet Military Space Doctrine*, op. cit.

²²See for example, Jack Manno, *Arming the Heavens*, op. cit., p. 136.

cooperation may provide an alternative vision of the future or a more positive backdrop for negotiations—in arms control, space weapons, or other areas—it may represent only a complement to efforts to improve relations generally.

Symbolism

Symbolic value has always been a principal characteristic of the U.S. and Soviet space programs. Both countries have used their space programs to increase national prestige, project national influence, display technological leadership, and enhance the image of each country's respective governmental system—the United States, through emphasizing the openness of democratic systems; the U.S.S.R., by linking its space achievements with the superiority of the socialist system over capitalism. The U.S.S.R. has dispatched cosmonauts to other countries to link their celebrity with particular political ideas and policy lines, or with historic Communist traditions; and both countries have invited foreign "visitors" to fly on their spacecrafts to strengthen international ties.²³ The idea of U.S.-Soviet cooperation in space has also played a symbolic role to offset any aggressive image of either superpower, and to demonstrate each country's goals of using space for peaceful scientific purposes.

The symbolic value of any prospective U.S.-Soviet cooperative mission today would be equally central. Renewed U.S.-Soviet space cooperation on any level would send to the world a symbolic message of the willingness of the two countries to attempt to work together to reduce tensions or achieve common goals. Even on lower levels of cooperation, joint efforts can carry with them positive symbolic benefits and significant psychological value. The concept of "peace" in space is especially appealing to those who view peaceful use as an alternative to, rather than a spin-off from, the military use of space.

While the symbolic value of renewed U.S.-Soviet space cooperation could be positive, however,

²³James E. Oberg, "Windows for Space Detente," *Aerospace America*, XXII, No. 11 (November 1984), pp. 86-87; excerpted from *The New Race for Space* (Harrisburg, PA: Stackpole Books, 1984), and Harry R. Marshall, Jr., *U.S. Space Programs, Cooperation and Competition From Europe*



Photo credit: National Aeronautics and Space Administration

Cosmonauts receive grand reception in Moscow

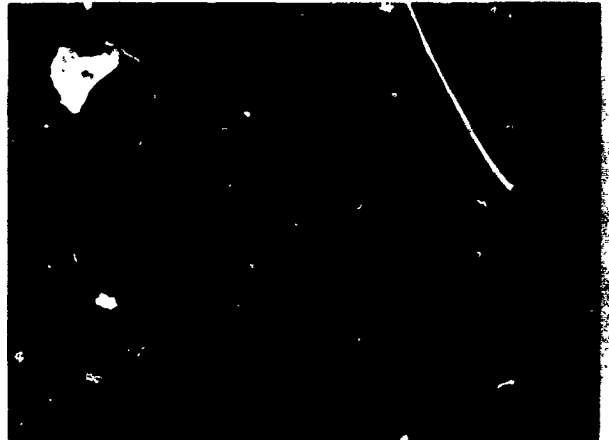

Photo credit: National Aeronautics and Space Administration

U.S. exhibits model of Explorer I following successful flight

some U.S. observers point to more negative messages. They believe that if cooperation were to break down, the positive symbolic benefits would be negated, and the United States might appear more belligerent than before. They also believe that U.S.-Soviet space cooperation on any level appears to cast the two superpowers as equals, a status which they feel the Soviets would abuse; the more visible the level of cooperation, the more negative the symbolic message. The launch of the Apollo-Soyuz Test Project is cited as a case in point. Despite the fact that U.S. reports described

the Soyuz spacecraft as technically primitive, Soviet media nonetheless reported that U.S. specialists spoke of "the high technical qualities of the Soyuz." The Soviet press consistently implied that the U.S.S.R. led the United States in space flight, attributing its lead to Marxist ideology.²⁴ Along with strong, positive, symbolic messages, then, renewed U.S.-Soviet cooperation could give Soviet planners another opportunity to assert technical parity with the United States.

The potential positive and negative symbolic messages from U.S.-Soviet cooperation in space would increase with the size, scale, and visibility of the cooperative effort. On a low level of exchange, both the risks and benefits are small. As the level of exchange, and thus the potential risks and benefits increase, however, the cooperation becomes more controversial. While some emphasize that a joint "spectacular" would provide substantial symbolic benefit for the United States, others emphasize that the risks are also great: should the project "fail," or should the United States find it in its interest to withdraw, the losses to U.S. prestige could be damaging.

"Linkage"

Another foreign policy issue associated with U.S.-Soviet cooperation in space is the question of "linking" such cooperation to other aspects of Soviet behavior. For example, some observers question the wisdom of having allowed U.S.-Soviet space cooperation to lapse in 1982 in response to an unrelated event, the declaration of martial law in Poland. Others argue that that was an appropriate action and, further, that such cooperation should not be reinstated before the Soviets demonstrate a willingness to make concessions on other fronts—in policies regarding emigration abroad, human rights at home, or concessions in arms control negotiations.

The use of scientific and technical (S&T) cooperation as a lever for altering Soviet behavior has become the subject of debate similar to that of U.S.-Soviet trade. The theory and practice of trade leverage are discussed in detail in previous

OTA reports.²⁵ The conclusions of these reports is that trade leverage can work only under very limited conditions, and that past experiences have demonstrated its weakness when used against the Soviet Union. Assessments of the potential impact of S&T cooperation in altering Soviet behavior have been no more positive. A recent study by the National Academy of Sciences states:

While there is little doubt that S&T agreements have helped on some occasions to move relations onto a more positive basis, and on others to signal United States displeasure regarding certain behavior, there would appear to be little conclusive evidence that the signing or termination of an agreement has been very influential in persuading another nation to pursue or desist from a particular policy position.²⁶

The effect may be further diluted as, based on past behavior, the Soviets generally expect the United States to seek renewed cooperation after a relatively short amount of time.

The real question is whether S&T cooperation, including space cooperation, is an appropriate mechanism for showing displeasure with Soviet actions, regardless of whether it alters Soviet behavior. One set of opinions argues that in the absence of other foreign policy levers, S&T cooperation is one of the most effective means for protesting egregious Soviet actions and demonstrating U.S. resolve. According to this view, when a superpower does something which the other views as fundamentally "abhorrent or inimical to our interests,"²⁷ there is pressure to respond. In these cases, "Soviet activity sometimes demands responses stronger than rhetoric but more prudent than military action."²⁸ In the absence of other measures, canceling an ongoing cooperative program has been viewed as an appropriate response; the financial costs are hard to identify and in any case are deferred, the effect

²⁴*Technology and East-West Trade* (Washington, DC: U.S. Government Printing Office, OTA-ISC-101, November 1979); *Technology and Soviet Energy Availability* (Washington, DC: U.S. Government Printing Office, OTA-ISC-153, November 1981); and *Technology and East-West Trade: An Update* (Washington, DC: U.S. Government Printing Office, OTA-ISC-209, May 1983).

²⁵ Vallerstein, op. cit., p. 19.

²⁶ See George P. Shultz, "New Realities and New Ways of Thinking," *Foreign Affairs*, LXIII, No. 4 (spring 1985), p. 707.

²⁷ William Root, "Trade Controls That Work," *Foreign Policy*, No. 59 (fall 1984), pp.61-90.

is immediate, and the intended moral message is sent. Moreover, proponents of this view argue that "business as usual" in S&T exchange would be immoral under these circumstances anyway. As stated in the President's Title V report to Congress, 1984:

Science and technology exchanges between the United States and the Soviet Union . . . are of critical concern to this Administration. We must respond adequately to Soviet actions adverse to our own interests and contrary to the basic principles of civilized behavior within the community of nations. For example, during 1983 the United States, among other actions, stopped discussions on extension of a Transportation S&T Agreement with the Soviets as a result of their deliberate destruction of Korean Airlines flight 007.²⁹

Few people argue that the threat to cancel, or actual cancellation of a cooperative program in space, would really affect Soviet behavior on a matter of substance. The idea is to protest, not to deter.

Opponents of this view assert that little is accomplished by terminating S&T cooperation as a mechanism of protest, while the benefits from cooperation are diluted or lost. Cancelling cooperative efforts already underway entails some human and dollar costs, and may give the United States a reputation as an unreliable partner. And some observers argue that more can be achieved *through* cooperation than without it. In the words of one historian of science involved in cooperative projects with the U.S.S.R.:

Personal links to Soviet scientists lead Americans to learn more about who is being arrested or persecuted and to more readily react against it than in the past . . . Almost all Soviet scientists have favored the improvement of communication, and the dissidents in particular have stressed that their security is greater because of their links to the West . . . It seems clear that the worst fate for unorthodox Soviet scientists would be to lose their contacts with the West.³⁰

²⁹U.S. Congress, House Committee on Foreign Affairs and Committee on Science and Technology, *Science, Technology, and American Diplomacy 1984*, 5th Annual Report Submitted to the Congress by the President Pursuant to Section 503 (b) of Title V of Public Law 95-426. (Washington, DC: U.S. Government Printing Office, 1984), p. 3.

³⁰Loren R. Graham, "How Valuable Are Scientific Exchanges With the Soviet Union?" *Science*, CCII, No. 4366 (Oct. 27, 1978), p. 387.

Proponents of this view argue that S&T cooperation comprises a relatively minor tool in foreign policy, and that terminating scientific and technical cooperation is no more an effective means of showing displeasure than other symbolic gestures (such as speeches of condemnation at international forums, or termination of cultural visits) which carry fewer negative and long-lasting consequences.

The difficulty in reconciling these viewpoints has consistently been expressed by the Reagan Administration in annual reports to Congress:

We must respond adequately to Soviet actions adverse to our own interests and contrary to the basic principles of civilized behavior within the community of nations . . . At the same time, we do not want to jeopardize joint S&T efforts which may be of substantial benefit. We will continue to observe Soviet behavior carefully and to adjust our S&T cooperative agreements accordingly.³¹

The effect of not reconciling these issues, however, was perhaps best expressed in the congressional testimony of James Morrison, Deputy Director of International Affairs, NASA, who suggested guidelines for future U.S.-Soviet cooperative efforts in space. Noting that any such guidelines must be applied in a political context, but also stressing the costs of terminating cooperative efforts once they are underway, Morrison stated:

Obviously, guidelines such as these will be applied in a political context, because of the high visibility of this type of cooperation. Nevertheless, there should be an appreciation that if a major project should be interrupted while in progress, it is likely that the human and dollar resources would have been utilized better in other space endeavors, i.e., once undertaken, there are good reasons why a project should be allowed to proceed to completion, barring some major disruption in relations between the two countries.³²

³¹*Science, Technology, and American Diplomacy 1984*, op. cit., pp. 3-4. See also Shultz, op. cit., for a discussion of the issue's complexities in a broader context: "Whether important negotiations ought to be interrupted after some Soviet outrage will always be a complex calculation."

³²Statement of James R. Morrison, Deputy Director, International Affairs Division, National Aeronautics and Space Administration, before the U.S. Senate Committee on Foreign Relations, Sept. 13, 1984, p. 8.

Maintaining Channels of Communication

Perhaps the simplest foreign policy objective of renewed U.S.-Soviet cooperation in space is to keep channels of communication open, even—or especially—during times of increased tensions. At a time when overall U.S.-Soviet relations are poor, some believe that cooperation on any level can provide an important conduit for communication. Aside from its value as a way of learning about the U.S.S.R., cooperation provides a mechanism for making U.S. views more widely known in the U.S.S.R. While acting as a kind of barometer for U.S.-Soviet relations generally, it maintains a continuing dialog on a governmental level when other avenues may not be as active. And some level of cooperation also keeps alive the possibility of expanded cooperation in the future.

These objectives, however, run counter to the policy of linkage described above. The tension between the two objectives is illustrated by the Reagan Administration's stated emphasis on "maintaining the framework" of the agreements "so that beneficial exchanges can be expanded if the political situation improves" while at the same time



Photo credit: National Aeronautics and Space Administration

East-West Cooperative Effort—Soviet Cosmonaut Filipchenko and U.S. Astronaut Slayton on the banks of the Little Blanco River in central Texas as a break from training for ASTP

choosing to severely reduce S&T exchange with the U.S.S.R. and allow the space, science and technology, and energy agreements to lapse.³³ The 1984 Presidential report to Congress also underlined the importance of keeping lines of communication open, but stressed the need to respond to "Soviet actions adverse to our own interests."

A key question, then, is whether the option for renewing cooperative activities can in fact be exercised once an agreement has been abrogated or allowed to lapse. Past experience suggests another basic asymmetry: it is easier to kill cooperation than to restart it. Several observers—from NASA and elsewhere—have commented that it is difficult, once ties are broken, to keep them in a state where they can be repaired.

It is difficult to assess the degree to which the framework of U.S.-Soviet space cooperation has been maintained since 1982. The institutional apparatus remains in place and has not been dismantled, and one could argue that the low level of cooperation which continues to occur has left a door open. But events themselves have changed and complicated the context in which cooperation occurs. Administration's statements in 1984 suggest some questions as to whether the framework for renewed space cooperation is still viable.³⁴

* * * * *

Foreign policy objectives form the foundation for decisions on U.S.-Soviet space cooperation. One main challenge is to define more precisely and soberly what U.S. foreign policy objectives from space cooperation actually are, address internal inconsistencies among them, and establish criteria to evaluate the ways in which coopera-

³³See U.S. Congress, House Committee on Foreign Affairs and Committee on Science and Technology, *Science, Technology, and American Diplomacy 1981*, 2nd Annual Report Submitted to the Congress by the President Pursuant to Section 503(b) of Title V of Public Law 94-426 (Washington, DC: U.S. Government Printing Office, 1981), p. 180. "Despite the sharp curtailment in exchange activity, the framework of the agreements is being maintained so that beneficial exchanges can be expanded if the political situation improves."

³⁴See *Science, Technology, and American Diplomacy 1984*, op. cit., pp. 33-34; and "Committee Questions and Administration Responses," *East-West Technology Transfer: A Congressional Dialog With the Reagan Administration* op. cit., p. 29.

tion in space may be helpful in achieving broader foreign policy goals.³⁵

A second major foreign policy challenge concerns the relationship of foreign policy to scientific and technical objectives in cases where pur-

³⁵The difficulties of spelling out specific foreign policy objectives, and of then establishing criteria to evaluate the effects of S&T cooperation on foreign policy, are highlighted in the Title V Report for 1984 and the subsequent critique by the Congressional Research Service. See G. J. Knezo, "Congressional Research Service Critique of the 1984 Title V Report," *Science, Technology, and American Diplomacy 1984*, op. cit., pp. 165-167.

MILITARY TECHNOLOGY ISSUES

A final set of issues concerns the extent to which the U.S.S.R. may gain access to militarily sensitive technology and technical know-how through U.S.-Soviet space cooperation, and thus the extent to which cooperation should be controlled or limited. These "technology transfer" concerns are part of a much larger debate concerning all commercial and cooperative relations with the U.S.S.R. At the heart of the debate is the trade-off between two important national interests: the importance of minimizing the use of American scientific and technological expertise in the buildup of Soviet military strength; and the importance of maintaining and promoting open communication in science and technology, both within the borders of the United States and across international boundaries. The highly technical and sensitive nature of space research and technology makes the question of renewed or expanded U.S.-Soviet cooperation in space especially controversial.³⁷

Few would argue against caution in U.S.-Soviet cooperation in space. Rather, the main areas of contention are the limits and mechanisms of control, i.e., determining what should be controlled, when, by whom, under what circumstances, how it should be controlled, and finally, how the effects of controls can be evaluated.³⁸

³⁷For a brief discussion of the problems associated with transferring potentially sensitive space technology even to U.S. allies, see Stuart Auerbach, "Great Britain Joins U.S. in Space Station Effort," *Washington Post*, Jan. 18, 1985, and William Drozdiak, "Bonn Joins in U.S. Led Space Base," *Washington Post*, Jan. 17, 1985.

³⁸For a discussion of these issues especially as related to commercial exports, see OTA's *Technology and East-West Trade: An Up-*

suing the former may be detrimental to the latter. The issue of "how to effectively integrate science and technology concerns into the overall development of American foreign policy"³⁶ has become a fundamental issue in all aspects of international scientific and technical cooperation. The history of U.S.-Soviet cooperation suggests this will remain a central issue in any future cooperative endeavors in space.

³⁶*Science, Technology, and American Diplomacy 1984*, op. cit., p. 6.

Some observers argue in favor of severe restrictions on all levels of cooperative space activity with the U.S.S.R. The underlying assumptions of this view are that the U.S.S.R., while extremely strong militarily, is making important military gains through the acquisition of Western technology; that cooperation is an important mechanism through which these gains occur;³⁹ that space is a particularly sensitive area of S&T cooperation; and hence, that renewed cooperation will doubtlessly enhance Soviet capabilities to gain even more militarily sensitive technology and know-how from the West. Reports on Soviet acquisition of Western technology have singled out space as a key "target" of Soviet acquisition efforts in

date, op. cit.; and Panel on East-West Technology Transfer, Science and Technology Committee, "Securing Technological Advantage: Export Controls in an Era of Strategic and Economic Competition," Center for Strategic and International Studies, Georgetown University, September 1984. For a discussion of these issues as related to the exchange of scientific information, see the forthcoming CTA technical memorandum, *The Regulatory Environment for Science*, anticipated publication date October 1985.

³⁹According to several observers, this has tended to be a working assumption of the Reagan Administration—i.e., that "non-trade transfers—espionage, people-related, scientific communications—have played a significant role in the qualitative improvement in the Soviet military arsenal." See John P. Hardt and Donna L. Gold, "Background Facts About East-West Trade," *East-West Technology Transfer: A Congressional Dialog with the Reagan Administration*, p. 76. See also Report of the Defense Science Board Task Force on University Responsiveness to National Security Requirements, January 1982, p. 4-7 as cited in Harold Relyea, "Controls and Scientific Communication," *East-West Technology Transfer: A Congressional Dialog With the Reagan Administration*, op. cit., p. 110, and remarks of Richard Perle, Undersecretary of Defense for International Security Policy, at the National Press Club, "Roundtable on National Security and Scientific Inquiry," May 3, 1985.

the West, especially in this country.⁴⁰ These observers fear that cooperation may only facilitate an extensive Soviet effort to obtain space-related technology and technical know-how, and will contribute to sophisticated Soviet military capabilities. They believe the dangers are greatest in large-scale cooperative projects, but that even lower levels of cooperation—data exchange, joint data analysis, coordination of missions, etc.—may result in transfer of sensitive technical information.

Other observers—while recognizing the enormous Soviet military strength and significant advances the U.S.S.R. has made in the military uses of space—believe that space cooperation, like other areas of scientific and technical cooperation, is a relatively ineffective way for the Soviets to gain access to Western technology and know-how;⁴¹ that little militarily sensitive technology has been transferred through past cooperative projects; that other Western countries with sophisticated space programs of their own are cooperating with the U.S.S.R., providing the Soviets with much of the same technology and know-how; and that controls are difficult to enforce without sacrificing the free interchange of ideas which is at the heart of scientific and technological progress in this country. Consequently, they believe the imposition of increasingly stringent controls will unnecessarily offset the real scientific, economic, humanitarian, and potential foreign policy gains which can follow from cooperation with the U.S.S.R. "A national strategy of 'security by secrecy,'" the Corson panel con-

⁴⁰See, for example, *Assessing the Effect of Technology Transfer on U.S.-Western Security* (Washington, DC: Office of the Undersecretary of Defense for Policy, Department of Defense, February 1985), which cites the expansion of the Soviet space program as one of six major goals in present and future Soviet weapons programs (pp. 1-4).

⁴¹The report prepared by the National Academy of Sciences under the chairmanship of Dale Corson, and OTA's *Update on East West trade* reach two conclusions regarding scientific and technical cooperation generally. First, it has not been demonstrated that the potential security danger to the United States of exchange programs outweighs the benefits of maintaining open channels of communications with the U.S.S.R. Second, it is generally believed that such passive mechanisms of technology transfer are less likely to result in Soviet ability to absorb, diffuse, and improve on technological acquisitions than are more active commercial channels. No study, however, has been prepared specifically on U.S.-Soviet cooperation in space. See *Scientific Communication and National Security*, op. cit.; and *Technology and East-West Trade: An Update*, op. cit.



Photo credit: National Aeronautics and Space Administration

Visiting Soviet aerospace engineers discuss a docking mechanism with a member of the ASTP space team in Houston, Texas

cluded regarding international scientific and technical cooperation generally, "would weaken American technological capabilities, because there is no practical way to restrict international scientific communication without disrupting domestic scientific communication."⁴² These observers believe that technology transfer concerns may be especially exaggerated with regard to lower levels of cooperation, where Soviet access to data, equipment, and information can be carefully monitored. But they believe that even large-scale projects could be crafted to make technology transfer a minor concern as well.

⁴²See *Scientific Communication and National Security*, op. cit., and Mitchell Wallerstein, "Scientific Communication and National Security in 1984," *Science*, CCIV (May 4, 1984), pp. 460-66.

The debate concerning the potential transfer of militarily sensitive technology and technological know-how so far has not been a highly visible issue in U.S.-Soviet space cooperation, because so little interchange has been occurring, because cooperation has been on a very low level, and because technology transfer concerns have led to significant internal review and self-censorship on the part of individual scientists and government agencies prior to formal review. Since the expiration of the cooperative agreement in 1982, there have been few cooperative space proposals submitted for review, as official State Department policy is to complete ongoing projects but not initiate new ones. As illustrated in chapter 3, most instances of U.S.-Soviet space cooperation to date have consisted of exchanges of scientific data gathered through experiments by one country or through separate but related missions. Any expansion of U.S.-Soviet cooperation in space will inevitably lead to greater controversy, and technology transfer issues may be the most difficult issues to resolve.

In space, as in many other areas of U.S.-Soviet interchange, three issues are central to the technology transfer debates: determining how "military sensitivity" should be defined in the first place; assigning jurisdiction among people and agencies for making and implementing decisions; and determining the ways sensitive technology may or may not be used in any given cooperative exercise.

Defining Military Sensitivity

The nature of scientific or technical cooperation means that some technology transfer will always be involved in bilateral S&T exchange. But defining what precisely may be "militarily sensitive" has proved to be an exceedingly ambiguous exercise. As shown in the box, a number of regulatory mechanisms have been established to control the transfer of militarily sensitive technology or information abroad. These mechanisms and lists which specify what is "militarily critical," especially in the category of "dual use" technology, have themselves become the subject of enormous controversy.

Two sets of regulations govern the assessment of what may be militarily sensitive in any space activity: one for equipment which has been specially designed or modified for use in space, the other for that with potential "dual use"—i.e., civilian and military—applications. The Munitions List, incorporated into the *International Traffic in Arms Regulations* (ITAR) which control the export of military systems, defines all space technology* as an "implement of war." Unlike commercial exports to the U.S.S.R., therefore, space equipment is assumed to be militarily sensitive until it is shown not to be. The ITAR list includes all "military and space electronics,"** "all aircraft, spacecraft and associated equipment,"*** "fire control, range finder, optical and guidance and control equipment, spacecraft guidance, control and stabilization systems, astro compasses and star trackers," and other categories.

From the standpoint of data and information, the ITAR list also restricts the transfer of technical data related to space technology and know-how, including an extensive and sometimes vaguely worded list of all technical data and information related to articles on the Munitions List. As defined in the ITAR, technical data include both classified data and unclassified information "directly related to the design, engineering, development, production, processing, manufacture,

*Defined as equipment that has no terrestrial use or which has been specially designed or modified for use in space.

**This category includes such items as: a) space electronics, including both electronic equipment specifically designed or modified for spacecraft and spaceflight, and electronic equipment specifically designed or modified for use with nonmilitary communications satellites; b) very high speed unstrated circuit semiconductor devices that are specially designed for military applications; and c) "components, parts, accessories, attachments, and associated equipment specifically designed for use or currently used with equipment listed in other parts of this category, except for such items as are normal commercial use."

***Including: 1) spacecraft, including manned and unmanned, active and passive satellites; 2) nonmilitary communications satellites (except for ground stations and equipment for them); 3) spacecraft engines specifically designed or modified for use with the spacecraft; 4) airborne equipment (e.g., refueling equipment) specifically designed for use with the spacecraft; 5) launching and recovery equipment if specifically designed for use with the spacecraft specified above; 6) power supplies and energy sources specifically designed for spacecraft; 7) components, parts, etc. (including ground support equipment specifically designed or modified for all the articles specified above).

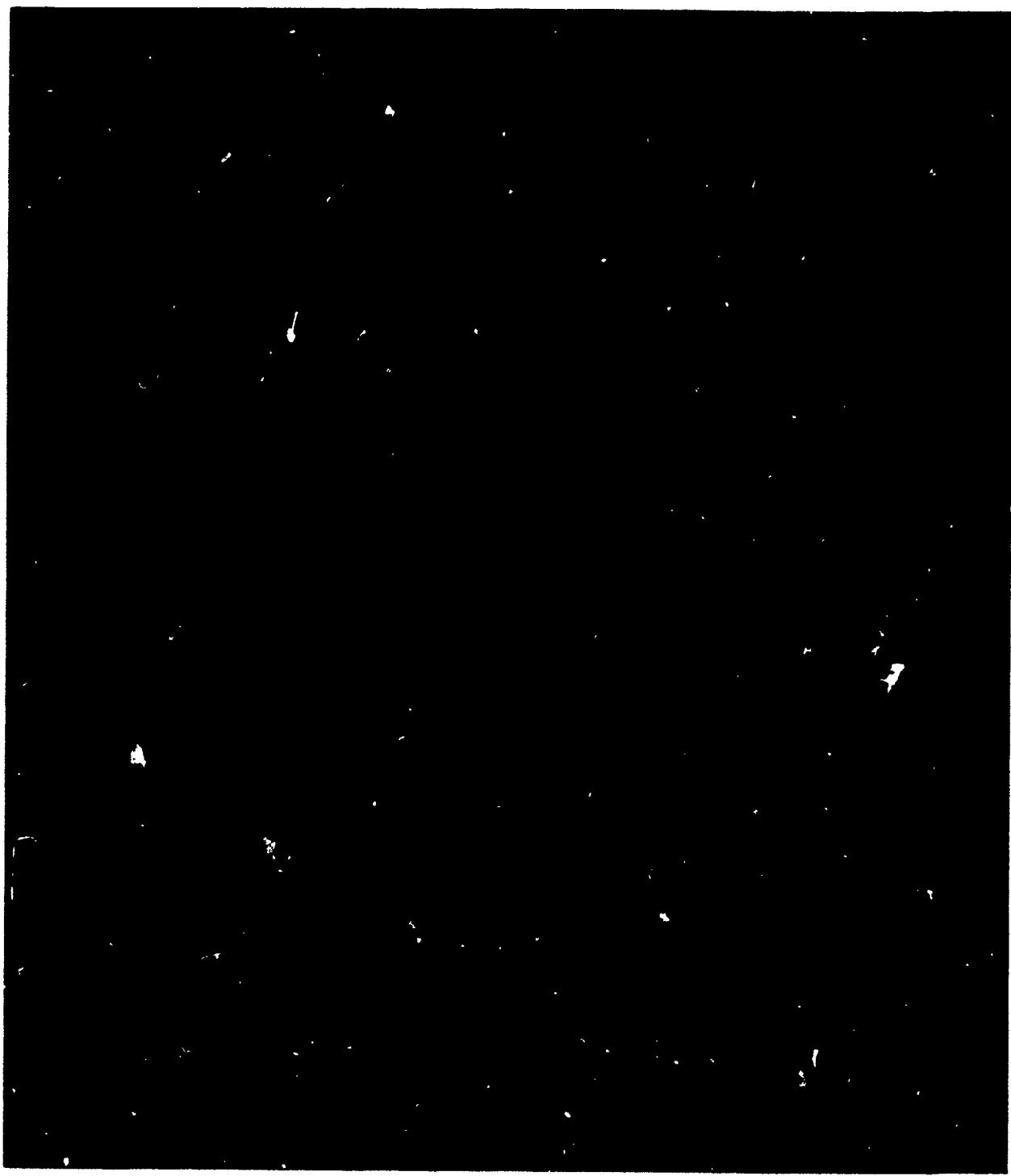

operation, overhaul, repair, maintenance, or reconstruction of defense articles, including blueprints, computer software, drawings, etc." and "any information which advances the state of the art of articles on the Munitions List."⁴³ Other areas, such as training for Soviet scientists and/or cosmonauts in the use of space equipment, also require careful consideration.

Equipment and information which is not specifically "space technology" but has been specially modified for use in space is often considered equally sensitive, falling into a "gray" area which may be subject to review according to the Commodity Control List under the *Export Administration Regulations* (EAR) which govern commercial exports. This category includes ground-based equipment involved in space cooperation, as well as any equipment used in space, and technical data that can be "used, or adapted for use, in the design, production, manufacture, utilization, or reconstruction of articles or materials."⁴³ In many cooperative ventures, this potential "dual use" area—such as computers or certain types of information—may be deemed more sensitive or controversial than specifically "space-related" technology itself. But it has become increasingly difficult to distinguish dual-use from single-use technology.⁴⁴

⁴³Information considered to be in the "public domain," however (i.e., published and generally available to the public), is not controlled. See Part 120.21 of the ITAR regulations, which also defines technical data as classified information directly related to defense articles and services and information covered by an invention secrecy order.

⁴⁴The data may take a tangible form, such as in models, prototypes, blueprints, or operating manuals, or an intangible form, such as in the case of technical data. See "NASA Management Instruction," NMI 2230 1B, Dec. 24, 1984.

⁴⁵"There are almost no militarily significant technologies which do not also have important peaceful uses. Indeed, in the highly industrialized modern world, while arms and ammunition can still be identified, the distinction between implements of war and peaceful goods as well as the technologies for their manufacture has become so blurred that whether an item is a sword or a plowshare depends today not so much on how it is made but on how and by whom it is used . . . So common is this dual-use characteristic that it is almost impossible to draw up a list of items, whether goods or technology, whose embargo will inhibit weapons development without including some items whose embargo will also inhibit the peaceful trade activities . . ." Maurice Mountain, *Issues in East-West Commercial Relations*, a compendium or papers submitted to the Joint Economic Committee, Congress of the United States (Washington, DC: U.S. Government Printing Office, 1979), p. 30, as cited in *East-West Technology Transfer: A Congressional Dialog with the Reagan Administration*, op. cit., p. 83.

In addition, a number of other regulations and directives govern the transfer of space-related information to foreign nationals. On December 24, 1984, NASA issued such a "NASA Management Instruction" to control the availability of NASA developed or supported scientific and technical information. The Instruction, *The NASA Scientific and Technical Document Availability Authorization*, provides discretionary authority for the Administrator of NASA to protect certain unclassified data and information, parallel to authorities granted the Secretary of Defense in the 1984 Defense Authorization Act. The Instruction "establishes policies, procedures, and responsibilities for the authorization process to assure the appropriate distribution, bibliographic processing and announcement of availability of NASA sponsored or authorized information,"⁴⁵ to be implemented in accordance with existing Management Instructions concerning the production and distribution of information. It is intended to be "responsive to administration directives to develop plans and procedures to help stem the flow of advanced Western space technology to the Soviet Union and other countries."⁴⁶

The exceedingly broad and comprehensive range of definitions of what may be proprietary and/or militarily sensitive technology or information has become quite controversial, often leaving wide room for interpretation in any given assessment. Efforts to make more precise definitions have been reflected in such exercises as the design of a Militarily Critical Technologies List (MCTL) by the Department of Defense to assist in identifying items which may be of significant value to potential adversaries and which should be controlled. But the MCTL has been criticized on several counts—many believe it is too long, overly broad and comprehensive, and that it lacks sufficient clarity and specificity to be usefully applied⁴⁷—and remains controversial today. More

⁴⁵"NASA Management Instruction," op. cit., p. 1.

⁴⁶Ibid.

⁴⁷For example, a 1982 report by the National Academy of Sciences and the National Research Council recommended "a drastic streamlining of the MCTL by reducing its overall size to concentrate on technologies that are truly critical to national security." In *Scientific Communication and National Security*, op. cit., p. 67. The MCTL was mandated by the Export Administration Act of 1979. For a description of the MCTL and the controversy surrounding it, see *Technology and East-West Trade: An Update*, op. cit. The MCTL was declassified in 1984.

than 2 years of efforts to renew the *Export Administration Act*—with no agreement thus far in Congress and no coordinated Administration position—highlight the lack of consensus on how technology exports should be controlled. This same lack of consensus is reflected in international cooperative programs.

Evaluating technology transfer from past cooperative efforts *in space* is also controversial. Experts differ over the significance of technology or technical know-how that may have been transferred during past cooperative projects, perhaps especially during the Apollo-Soyuz Test Project. Some observers believe that despite the low level of interchange, the Soviets gained access to valuable command and control information and U.S. management techniques, such as experimental data relay systems (employed for the safety of the astronauts), and insight into U.S. management of highly complex systems. Others believe that the Soviets gained little from Apollo-Soyuz that could have been detrimental to U.S. interests. A 1980 report by the Congressional Research Service, for example, states that there was "no evidence to date of any harmful effects from any technological giveaway to either side from these joint space efforts."⁴⁸

The central role of the technology transfer issue in U.S. cooperation today with Western European allies on the space station shows how difficult an issue it could become if space cooperation with the U.S.S.R. were to be expanded. The secretary of the backbench parliamentary space technology committee of the British House of Commons, Spencer Batiste, stated in February 1985 that the European Space Agency (ESA) views the Pentagon's fear of technology "leaks" to the Soviet bloc as one of the biggest problems in joint U.S.-ESA work on the space station project.⁴⁹ According to Batiste, strict U.S. export controls greatly restrict the transfer of American know-how to its partners in the project, and could greatly hamper European and Japanese collaboration in the project. According to press reports,



Photo credit: U.S. Department of Defense

The extent to which space cooperation may enhance Soviet military programs in space is the subject of debate and presently, stringent control. The above represents an artist's concept of a possible Soviet space complex with significant military applications

a recent internal West German government report suggests that U.S. restrictions on space-related as well as other high technology areas comprise "one of the prickliest thorns in transatlantic relations at the moment."⁵⁰ The paper reportedly documents two instances of a German company being denied access to important U.S. space findings, and suggests that the whole idea of cooperation can work only if the United States eases its restrictions. And recent disputes in the U.K. over the possibility of using the Soviet Proton rocket as a satellite launch vehicle for INMARSAT—an international organization that operates communications links between ships—have highlighted the sensitivity in the West towards allowing Soviet engineers to work closely with Western engineers involved in other militarily-sensitive projects.⁵¹ Sharpening the definition of what may be militarily sensitive in space without stifling scientific inquiry will be a major challenge if U.S.-Soviet bilateral space cooperation is expanded.

⁴⁸CRS Report to the United States Senate Committee on Foreign Relations, Report 87-389 (Washington, DC: Government Printing Office, 1980).

⁴⁹See Christian Tyler, "U.S. Warned on Hi-Tech Controls," *Financial Times*, Feb. 15, 1985, p. 5.

⁵⁰See Peter Gumbel, "Europeans See Space Project With U.S. as Way to Bolster Political Ties and Share Technology," *Wall Street Journal*, Dec. 7, 1985, p. 33.

⁵¹See, for example, Peter Marsh, "Marconi Ends Soviet Satellite Deal After Warning," *Financial Times*, Feb. 17, 1985, p. 1.

Delineating Responsibilities

Because of the murkiness of the definition of sensitive space hardware and information, deciding the level of control for a particular item or body of information is a question of judgment.

A second key issue, therefore, concerns not only the criteria for determining what may be militarily critical, but who should make these judgment calls for instituting and implementing technology transfer controls. This question has proved to be a very difficult one throughout the area of export control, one which Congress has yet to fully resolve. At a May 1985 Roundtable on National Security and Scientific Inquiry at the National Press Club, Assistant Secretary of Defense Richard Perle suggested that much of the criticism concerning technology transfer has little to do with the principle of export controls, or with the substance of those controls, but with the "scandalously inept administration of those controls that has been characteristic of a succession of administrations." Hearings conducted between 1982 and 1984 by Senator Nunn, Ranking Minority Member of the Permanent Subcommittee on Investigations, Senate Committee on Governmental Affairs, and general debates over renewing the Export Administration Act of 1979, highlighted the intra- and inter-agency jurisdictional disputes over responsibility for making technology transfer determinations in various areas of commercial exports, and the particular difficulties involved in instituting and implementing a set of controls in the area of commercial exports to the U.S.S.R.⁵² Similar disagreements have occurred between government agencies and the scientific and technical communities.

It is likely that expanded U.S.-Soviet cooperation in space would create similar conflicts. As space activities are usually multidisciplinary, U.S.-Soviet space cooperation inevitably creates coordination problems for various offices within the Department of State, within and among other agencies, and individual experts. The process for evaluating projects is often an informal one.

⁵²See U.S. Congress, Senate Permanent Subcommittee on Investigations, *Transfer of Technology* (Washington, DC: U.S. Government Printing Office, 1984).

Project proposals are evaluated to assess the degree to which they may involve the transfer of equipment, production/operational know-how, and/or sensitive technical data or information, first within the sponsoring agency,* and then in formal or informal interagency meetings. Knowing the unease surrounding the subject, both scientists and individual agencies engage in a considerable degree of self-censorship before the interagency review process begins.⁵³ Objections to the transfer of particular pieces of equipment or areas of technology are sometimes resolved by downgrading the equipment's technical specifications or by substituting different equipment. This informal process largely reflects the personalities involved.

Recent experience in exceedingly low-level space cooperation with the U.S.S.R. and the U.S. space program itself highlights the importance of clarifying procedures and responsibilities should U.S.-Soviet space cooperation be expanded. For example, all of the participants in the VEGA mission with whom OTA spoke underlined the enormous problems they had working through the "maze" of people and conflicting agencies responsible for evaluating their proposed activities—despite the fact that all of their proposals carried few possibilities for technology transfer and all were ultimately accepted. The overlap between military and civilian space activities, and between NASA and DOD responsibilities, has begun to fuel greater tension among the defense and scientific communities.⁵⁴ And serious concern has been expressed on the part of the scientific community over the extent to which DOD has exercised seem-

*The overwhelming proportion of U.S.-Soviet cooperation in space occurs through NASA. Other cooperative efforts occur, however, with the participation of other U.S. Government agencies and individuals, such as the National Oceanic and Atmospheric Administration, the Department of Agriculture, the National Science Foundation, the National Academy of Sciences (through their interacademy exchange program), and other agencies, universities, and on an individual basis depending upon the nature of the cooperation. NASA is the implementing agency for the intergovernmental bilateral agreement for cooperation in space.

⁵³See, for example, Robert L. Park, "Intimidation Leads to Self-Censorship in Science," *Bulletin of Atomic Scientists*, XLI, No. 3, March 1985, and OTA interviews.

⁵⁴For example, see Craig Covault, "Shuttle Earth Imagery Spurs Censorship Debate," *Aviation Week and Space Technology*, CXXII, No. 17 (Oct. 22, 1984), pp. 18-21. The literature on space cooperation has been weak in addressing the extent to which U.S. military capabilities and responsibilities have been associated with NASA.

ingly unilateral control on the communication of certain types of scientific information. Many U.S. participants in past space cooperation with the U.S.S.R. have noted that proposals for larger efforts would have met with possibly "insurmountable" resistance from some parties in charge of evaluating technology transfer concerns. This suggests that if space cooperation were to occur on a larger or more substantive scale, these disputes might only be magnified.

Utilization of Sensitive Technology

A third issue involves determining how sensitive technology or information can actually be used in cooperative projects with the U.S.S.R. Some have argued, for example, that at certain times it may be in the U.S. interest to allow some potentially sensitive technical know-how to be utilized. They believe that the U.S.S.R. has limited capability for absorbing Western technology and gaining production know-how, and they believe that the United States may acquire valuable information in return.⁵⁵ Others argue that however limited they may be, we cannot afford to underestimate Soviet capabilities in absorbing technical information, copying U.S. technology, and incorporating particular items of technology into their military effort even without the ability to reproduce them.⁵⁶

Similarly, there are major differences of opinion on the issue of how well sensitive technology necessary for particular missions can be "protected." As discussed in chapter 4, United States and French planners differ regarding how effectively "black boxes" or other types of packaging may protect potentially sensitive instrumentation or devices. On a more individual basis, there is also disagreement over whether briefing the Western participants prior to international symposia or other cooperative efforts is an effective mech-

anism for reducing the transfer of sensitive know-how to the Soviet bloc. These, too, will be important considerations should U.S.-Soviet space cooperation be significantly expanded.

* * * * *

In the area of national security concerns, three issues will remain central should U.S.-Soviet cooperation in space be greatly expanded. First, it will not be possible to gloss over concerns about the potential transfer of militarily sensitive technology or technical know-how. Such concerns will remain central and controversial on any level of cooperative activity, so that U.S. policymakers will have to address the trade-off between the potential scientific and/or foreign policy gains that may be attained from U.S.-Soviet space cooperation, and the questions that such an interchange might pose for national security. Any project proposal will require intense scrutiny and review, and will undoubtedly generate controversy.

Second, any large-scale U.S.-Soviet cooperative space project could provoke reevaluation of the ideological thrust behind the present U.S. trend towards increased controls over exports and the flow of information, technical data, and ideas. The Reagan Administration has imposed more controls over international interchange in science and technology than its predecessors. The spirit of openness and cooperation in which a joint proj-



Photo credit: OTA staff

OTA staff member meets with leading Soviet officials and Academicians in Moscow during research for this study

⁵⁵The degree to which the U.S.S.R. can successfully assimilate Western technology has been the subject of widespread debate. See J. Hardt and D. Gold, "The Eastern Economies," *East-West Technology Transfer: A Congressional Dialog With the Reagan Administration*, op. cit., p. 83.

⁵⁶See, for example, Office of the Undersecretary of Defense for Policy, *Assessing the Effect of Technology Transfer on Western Security—A Defense Perspective*, (Washington, DC: U.S. Department of Defense, February 1985); and *Soviet Acquisition of Western Technology* (Washington, DC: Central Intelligence Agency, April 1982).

ect with the U.S.S.R. might be undertaken could lead to calls for a re-evaluation of the line between what is considered militarily sensitive and what is made widely available. It could also make it more difficult to pressure U.S. allies to be more stringent in the area of export controls if U.S.-Soviet cooperation is so prominent.

Finally, the mechanics of dealing with technology transfer decisions will have to be addressed. This might require a more effective delineation

THE SOVIET APPROACH

Cooperation with the U.S.S.R. in any endeavor is a two-sided affair, and U.S. planners cannot unilaterally make decisions concerning the amount, type, and scope of cooperation which should take place. Although Soviet designs and objectives are themselves a matter of widespread controversy in the West, OTA's interviews in the United States and in Moscow suggest that Soviet perspectives on prospects for U.S.-Soviet cooperation in space are generally quite different from our own.⁵⁷

Soviet official policy has always expressed, and continues to express, a commitment to cooperation in space:

The potential value of [Soviet-American cooperation in space] seems very significant on the economic, scientific and technical plane, since the U.S. and U.S.S.R. space programs are mutually complementary in many of their parameters. The significance of this cooperation would also be great on the political psychological plane—from the point of improving the entire atmosphere of Soviet-American relations and ensuring trust between the people and leaders of the two great powers.⁵⁸

While there are certainly differences among Soviet scientists and planners, Soviet scientists have shown great interest in expanding cooperative efforts with the United States, pooling knowledge and sharing in outer space discovery. Like their

of responsibilities among individuals and agencies for determining and implementing controls, utilizing personnel with sound knowledge in both technical and foreign policy areas to conduct such deliberations. It might also involve a more in-depth assessment of possible technology transfer through past cooperative projects in space, the criteria used to assess such technology transfer, and a clearer evaluation of the ways in which technology can be protected or used to U.S. advantage.

political counterparts, they emphasize that the goals of such cooperative efforts are not only, or even mainly, scientific, but rather are to enhance prospects for "peaceful coexistence" on Earth and to keep outer space as a peaceful domain.

The issue of space cooperation, however, is an integral part of Soviet foreign policy, and its objectives extend beyond a desire for peace to competition as well.

International cooperation in the study of space is inextricably linked with the foreign policy of governments, and it depends on the general state of political relations between them . . .⁵⁹

The Soviet view of U.S.-Soviet relations is overshadowed by a basic competitiveness not only between two space or military programs, but between two political and social systems. Marxist-Leninist doctrine—the ideological foundation of the U.S.S.R.—expresses an irreconcilable conflict of interest between the Socialist and non-Socialist worlds; today, the Soviet concept of "peaceful coexistence" represents more of a continuing struggle than a state of equilibrium, as it is generally defined in the West.⁶⁰

Thus, Soviet political leaders have consistently used their space program not only to enhance cooperation, but to pursue other foreign policy objectives more competitive or confrontational in nature: using space as a propaganda tool to en-

⁵⁷OTA interviews in Moscow, June-July 1984.

⁵⁸A. Kokoshin, "Space-Based Anti-Missile Defense. Illusions and Dangers," *Moscow News*, No. 23 (1984), p. 5.

⁵⁹S. V. Petrunin, *Sovetsko-frantsuzskoe sotrudnichestvo v kosmose* (Moscow: "Znanie," 1980), p. 7.

⁶⁰See Paul H. Nitze, "Living With the Soviets," *Foreign Affairs*, LXIII, No. 2 (winter 1984), pp. 368-369.

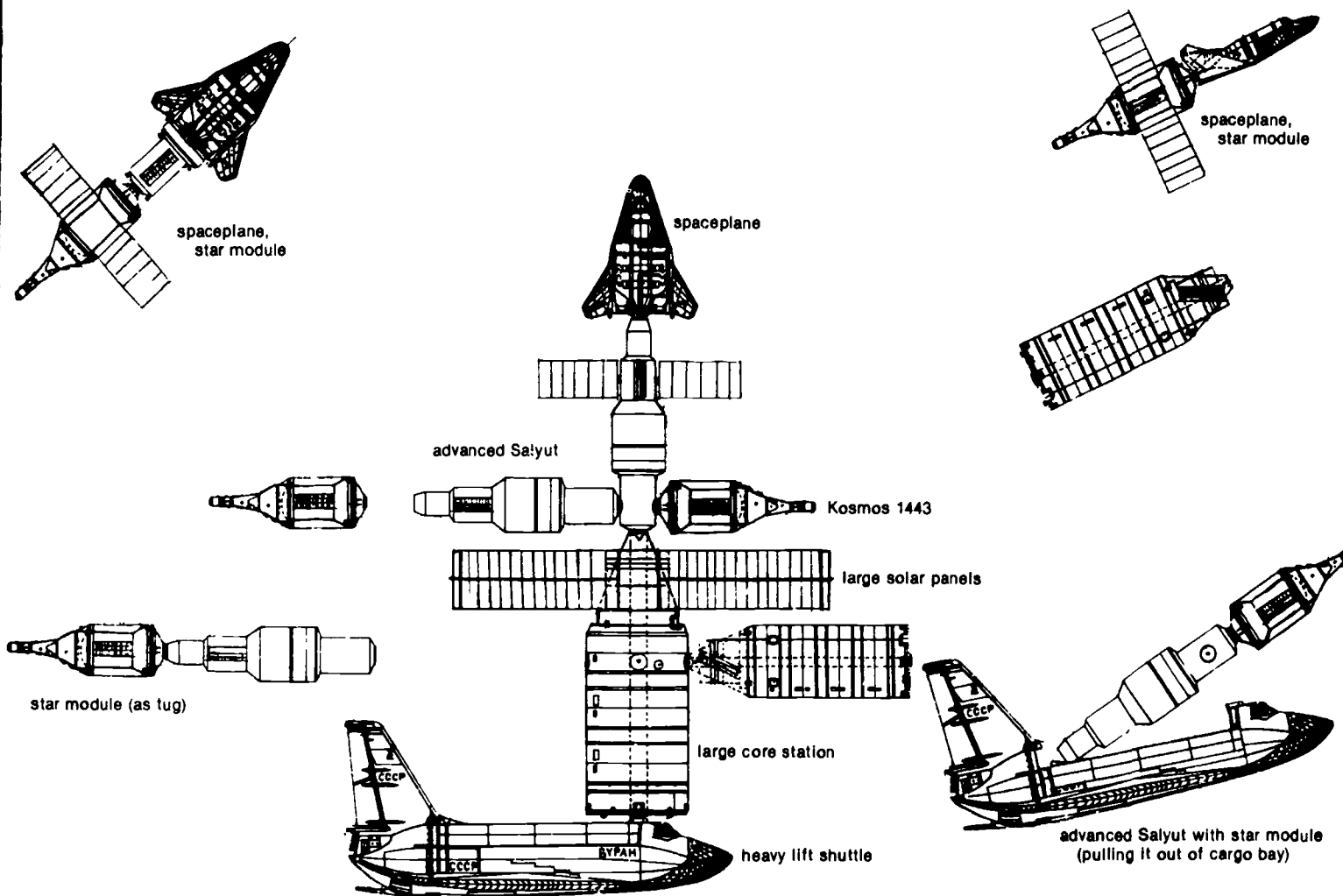

Conceptualized illustration of Soviet space programs possibly under development

SOURCE Charles P. Vick 1984

hance national prestige and influence; weakening the prestige and influence of the United States by portraying it as a threat to international peace and security; belittling the impact of U.S. space accomplishments; and deflecting attention from the military character of the Soviet space program onto that of the United States.

Today, therefore, tensions in U.S.-Soviet relations are reflected in an official Soviet hard-line, albeit somewhat ambiguous, approach towards space cooperation with the United States. Soviet officials consistently stress the viewpoint that past U.S.-Soviet cooperation was beneficial, and lay the blame for its termination squarely on the shoulders of the United States; and yet they have not responded officially to any recent overtures to renew such cooperation. Despite publicity in the United States surrounding American experiments on VEGA, the Soviet press has either avoided mentioning or denied that there is any U.S. participation in this mission.⁶¹ The Soviets have consistently decried the U.S. policy of "linking" the issue of cooperation to other political events; but they have also politicized the issue by emphasizing the severe, if not insurmountable constraints the U.S. Strategic Defense Initiative places on initiating or renewing U.S.-Soviet cooperation in space. Official Soviet policy on space cooperation tends to follow the overall state of U.S.-Soviet relations.

The political dimensions of Soviet participation in space cooperation extend to implementing the agreements as well. Access to people and information in the U.S.S.R. is closely monitored and controlled by the government. This has resulted in a high level of secrecy surrounding many areas of research and other activities, a highly compartmentalized bureaucracy, and a high degree of control placed over its citizens and scientists in all of their interactions with foreigners.

All of these factors inevitably constrain the implementation of a U.S.-Soviet cooperative agreement in space. The high level of secrecy in the

U.S.S.R. is compounded in space matters by military domination of Soviet space activities. The Soviet space program is run primarily by the military—the Air Force is responsible for cosmonaut training and vehicle recovery, the Strategic Rocket Force for conducting all space launches—and most of the known high officials in Soviet space organizations have strong military or defense industry backgrounds and exercise dual responsibilities in civilian and military space activities. The thoroughgoing compartmentalization of the Soviet bureaucracy, and the difficulties Soviet scientists face in meeting with foreigners—from being allowed to travel and mix at international scientific meetings, to gaining permission to mail technical letters and papers—also greatly constrain substantive interchange. At the same time, space cooperation is viewed (at least as much as it is in the United States) as an effective means for intelligence gathering and gaining insight into the U.S. space program and Western technology.

The experience of U.S. scientists involved in cooperation in space research has varied enormously. Some have registered surprise at the frankness and openness with which particular Soviet institutes and individuals have shared data and information. Others have complained that the Soviets bring little data or information to meetings and conferences, do not send their best scientists, do not provide their papers in advance, and often treat results as state secrets, making them available only to a select few. Sometimes the disparity in the success or failure of individual experiences has been affected by knowledge or lack of knowledge of the Russian language among U.S. scientists, sometimes by personal style. More often it has been affected by Soviet decisions or behavior patterns which extend beyond the cooperative arrangement itself to broader aspects of Soviet domestic or foreign policies.

In the U.S.S.R., then, the issue of U.S.-Soviet cooperation in space is tied up with both domestic and foreign policy concerns in ways often unfamiliar to the Western observer. In a society where ideas and contacts are tightly controlled, foreign cooperation always implies some loss of control, however limited, for the Soviet regime. For this reason the Soviets tend to set the criteria for judging the merits of cooperation very high.

⁶¹See, for example, the report of a Moscow television broadcast, "Obvious But Incredible," by Professor S. P. Kapitsa on the VEGA probes, Jan. 12, 1985, translated in Foreign Broadcast Information Service, *U.S.S.R. Daily Report*, Jan. 16, 1985, pp. U1-3; "Soviet Denies U.S. Participation in Soviet Halley Mission," *Soviet Aerospace*, Jan. 7, 1985, p. 8, and *Defense Daily*, Jan. 8, 1985, p. 39.

Soviet planners seriously calculate the potential foreign policy and technological benefits and costs of any particular endeavor, and act accordingly.

Should U.S.-Soviet space cooperation be expanded or renewed, then, this will place upon U.S. planners a special burden of having to be alert to factors and attitudes affecting cooperation that are quite different from those of other foreign partners.

... Soviet-American relations over the years have been plagued by the tendency, especially on the American side, of public and even official opinion and expectations to fluctuate between naive euphoria and angered disillusionment . . . We must understand realistically, what was done, what was not done . . .⁶²

In pursuing renewed U.S.-Soviet cooperation in space, the United States will be dealing not only with an adversarial partner, but with one whose framework for judging the gains and costs of cooperation is quite different from our own. In the words of two participants in U.S.-Soviet cooperative efforts in space:

⁶²See Foy D. Kohler, "An Overview of U.S.-Soviet Space Relations," in Dodd L. Harvey and Linda C. Cicconetti, *U.S.-Soviet Cooperation in Space* (Miami: Center for Advanced International Studies, University of Miami, 1974), p. xv

When all is said and done, however, Soviet attitudes and performance, and, indeed, personal relationships with their representatives, all have come a long way since the early days of the International Geophysical Year . . . The prescription for the future can only be patience and persistence on both sides.⁶³

At the same time, we should not overlook the vast difficulties of space cooperation in the past, difficulties which must arise from the contrasting roles and duties of citizens in the U.S.S.R. compared to in the United States.⁶⁴

More than in other cooperative ventures with foreign partners, U.S. policymakers will have to reconcile Soviet decisions and behavior with the United States' own objectives. And this will make it all the more important for U.S. planners to sort out precisely what U.S. objectives are. In the words of yet another observer, "Policy, like charity, begins at home."⁶⁵

⁶³Arnold W. Frutkin, *International Cooperation in Space* (Englewood Cliffs, NJ: Prentice-Hall, 1965), p. 120.

⁶⁴From a letter to OTA from L.J. Lanzerotti, Nov. 5, 1984.

⁶⁵James Cracraft, "U.S.-Soviet Relations," *Bulletin of the Atomic Scientists*, XLI, No. 1 (January 1984), p. 8.

SUMMARY AND CONCLUSIONS

In light of conflicting currents in U.S.-Soviet relations, balancing competing objectives and different perceptions of the U.S.S.R. will be a major challenge in determining the shape and magnitude of future U.S.-Soviet cooperation in space. Four issues are central:

- the scientific and practical benefits that can be gained from space cooperation,
- the potential transfer of militarily sensitive technology or know-how between the two countries,
- the effect of space cooperation on foreign policy, and
- perceptions about Soviet motivations and behavior and the course of U.S.-Soviet relations overall.

From a scientific and practical point of view, past experience has shown that cooperation in

space can lead to substantive gains in some areas of space research and applications, and can provide insight into the Soviet space program and Soviet society as a whole. As discussed in chapter 3, scientists in OTA's workshop concluded that the scientific return from U.S. space exploration activities could be expanded significantly by cooperation with the Soviet Union. The scientists also suggested that cooperation be initiated with modest exchanges of solid scientific substance and that the possibility of a large-scale mission might be held out as a long-term goal, provided that it, too, offered solid scientific rewards.

Past experience also suggests that technology transfer will remain a major countervailing concern in any future space cooperation with the U.S.S.R. Should cooperation be renewed or expanded, the challenge facing U.S. planners will

be to minimize these concerns; but concerns will continue to arise regardless of the scale or level of cooperation. Most people agree that caution should be exercised against transferring militarily sensitive technology and know-how to the U.S.S.R. The difficulties will lie in determining what should be considered militarily sensitive, who should be authorized to make such decisions, and the extent to which potentially sensitive technology or know-how can be protected in any particular exercise.

Past experience, both in low level cooperation with the U.S.S.R. and more extensive cooperation with our allies, suggests that this will be a difficult and controversial challenge. The Soviets have no doubt been pursuing an aggressive campaign to acquire Western technology and know-how, particularly in the area of space systems and technology; severely limiting cooperation in space is one way of protecting Western security against such efforts. But Soviet scientists are also conducting innovative and high caliber work in certain areas of space research and applications. Overly stringent controls could threaten the free interchange of scientific and technical ideas and information in areas complementary to, but not always addressed in, the U.S. space program; and since the Soviets are already cooperating with other Western countries in space research and applications, the United States could find it increasingly difficult to control the flow of information to the U.S.S.R. without isolating itself from the rest of the world space community. A key challenge, then, will be to craft cooperative arrangements that diminish the possibility of aiding Soviet military capabilities but that keep space cooperation substantive and viable.

Perhaps the most difficult challenge will be to assess how space cooperation can be effectively used to support or further U.S. foreign policy objectives. Space cooperation, on both low and high levels, is inherently symbolic. The main areas of controversy concern whether space cooperation can alter Soviet behavior, and so ease U.S.-Soviet conflicts; and whether starting and/or stopping space cooperation is an appropriate political symbol to underscore other U.S. foreign policy objectives.

The extent to which space cooperation can alter Soviet behavior, and in that way reduce tension in U.S.-Soviet relations overall, is hard to predict. One viewpoint suggests that this is entirely plausible, and cooperation should be pursued toward this end. An opposing viewpoint suggests that there is no reason to believe the Soviets would alter their behavior as a result of U.S.-Soviet cooperation in space and that cooperation might even be dangerous: from this perspective, any reduction in tension would be superficial, and would only lead the United States to lower its guard against an adversary that uses cooperation solely for its own purposes. In between are a range of views, including the belief that a low level of interchange among scientists at a working level, removed from the realm of superpower politics, can be the most effective way for keeping channels of communication open and reducing tensions between the two countries in the long run. Another belief is that space cooperation has no fundamental positive or negative effect on U.S.-Soviet relations, and must be weighed simply on its own merit. Although there is no evidence from past experience that space cooperation can affect foreign policy in any far reaching way, many believe the future can be different.

Regardless of whether space cooperation can alter Soviet behavior, another question is whether it is smart to exploit its symbolic value to achieve other U.S. interests. Symbolic value has always been a key component in both the U.S. and Soviet space programs, on low as well as high levels of cooperation. The question of whether cooperation should be initiated or terminated primarily to pursue symbolic goals has generated a controversy of its own.

Creating a large-scale cooperative effort in space, for example, could bring positive benefit to the United States, by illustrating to other countries the U.S. desire to work with our adversaries to promote peace. But it could also bring risks: 1) it may provide the U.S.S.R. with a great deal of symbolic benefit by casting them as technological equals; and 2) should a large-scale joint project fail, the symbolic cost could be damaging to U.S. interests. The symbolic benefits and risks from U.S.-Soviet cooperation in space would increase with the size, scale, and visibility of any cooperative effort.

Similarly, severely curbing or terminating cooperation may be an appropriate symbolic measure to show displeasure with egregious Soviet behavior, but also carries risks. U.S.-Soviet cooperation in space inevitably occurs in the context of U.S.-Soviet relations overall, and the tendency of U.S. policy in the past has been to utilize space cooperation for foreign policy ends. The assumption has been that an abrupt reduction in space cooperation can be an effective means of protesting Soviet behavior: when the Soviets do something morally reprehensible at home or abroad, some believe the United States has a moral responsibility to respond and space cooperation is an effective way of doing so. But as this will generally result in scientific and practical losses, many have questioned this approach, preferring other methods of protest that show displeasure at less cost. They believe that curtailing or terminating space cooperation with the U.S.S.R. brings little benefit and in fact may harm scientific inquiry and/or U.S.-Soviet relations overall. There is a notable lack of agreement on how past experience might clarify these debates, and the degree to which past experience may be useful in assessing potential future cooperation.

Underlying all of these viewpoints are different assumptions about Soviet objectives and behavior. The Soviet approach to cooperation has tended to mirror its overall approach to U.S.-Soviet relations, reflecting both an official commitment to cooperation in space, and a basic competition between the two superpowers. Soviet leaders have consistently used their space program not only to enhance cooperation, but also to pur-

sue other foreign policy objectives more competitive and confrontational in nature (such as weakening the prestige and influence of the United States while enhancing that of the U.S.S.R., and developing a strong militarily related space capability of their own). This has led to vastly different interpretations of Soviet motivations and actions among U.S. observers, and different interpretations of the lessons of past U.S.-Soviet cooperation. A central U.S. foreign policy challenge, therefore, will be to assess how U.S. objectives may be attained independent of Soviet intentions.

Because of several factors then—the conflicts between the gains of cooperation and the risks of technology transfer; disagreement over the relative importance of scientific and practical benefits and foreign policy goals; and possible inconsistencies among foreign policy objectives—there will always be a multiplicity of views about East-West cooperation in space. The ways in which these viewpoints are reflected in policy will determine the size, shape, scope, and effectiveness of any potential space cooperation with the U.S.S.R.

It would clearly be useful to further examine the costs and benefits of past cooperation, as a basis for considering the establishment, cancellation or continuation of cooperative arrangements in the future. At the same time, however, it is important to recognize that views on how much cooperation to pursue will necessarily reflect judgments about broader issues of world tensions, Soviet objectives, and the overall course of U.S.-Soviet relations at least as much as they will reflect judgments about the costs and benefits of U.S.-Soviet space cooperation itself.

Appendix

U.S. Cooperative Projects in Space Science and Applications

Launch year	Mission name	Cooperating countries	Science/ applications	Objectives
<i>Part 1: Joint Development</i>				
1962	Airel-I	US/UK	S	Measure energy spectrum of cosmic rays, solar x-rays
1962	Ariel-II	US/UK	S	Measure galactic radio noise, micrometeoroid flux
1978	Int'l Ultraviolet Explorer (IUE)	US/ESA/UK	S	UV spectroscopy
1982	COSPAS/SARSAT	US/Can/Fr/USSR	A	Satellite-aided global search and rescue system
1983	Infrared Astronomical Satellite (IRAS) ¹	Neth/US/UK	S	Conduct IR sky survey
1984	Active Magnetospheric Particle Tracer Explorer (AMPTE)	US/FRG	S	Study solar wind, identify particle entry windows, energization and transport processes into magnetosphere
1985	Space Telescope	US/ESA	S	High-resolution coverage of optical and UV wavelengths
1986	Galileo	US/FRG	S	Broad investigation of Jupiter environment
<i>Part 2: Hosted Experiments</i>				
1964	Explorer-20	UK ^a	A	Measure ion mass composition and temperature
1965	Explorer-31	UK ^a	A	Measure ion mass composition and temperature
1965	Alouette-II	Can ^b	A	Measure electron densities and VLF noise
1965	Orbiting Geophysical Observatory-2 (OGO-2)	Fr ^a	A	Measure airglow
1967	OGO-4	Fr ^a	A	Measure airglow
1967	Orbiting Solar Observatory-4 (OSO-4)	UK ^a	S	Measure solar x-ray distribution, He emission
1968	Orbiting Geophysical Observatory-5 (OGO-5)	UK, ^a Fr, ^a Neth ^a	S	Determine direction of incidence of primary cosmic rays, density, and temp. of H in geocorona, and CR, flux/energy spectrum
1969	OGO-6	Fr ^a	A	Spectrometry in airglow and aurora; atmospheric temperature and excitation
1969	International Satellite for Ionospheric Studies (ISIS-1)	Can ^b	A	Ionospheric sounders
1969	OSO-5	UK, ^a Fr ^a	S	Measure solar x-ray flux and self-reversal of Lyman-Alpha line
1969	OSO-6	UK, ^a It ^a	S	Study solar He resonance, x-ray and gamma radiation
1969	Apollo-11	Switz ^a	S	Measure composition of solar wind
1969	Apollo-12	Switz ^a	S	Measure composition of solar wind
1971	Ariel-IV	UK ^b	S	Measure low energy proton and electron intensities
1971	Barium Ion Cloud Probe	FRG ^b	S	Barium release to stimulate action of solar wind on comet tail
1971	Apollo-14	Switz ^a	S	Measure composition of solar wind
1971	Apollo-15	Switz ^a	S	Measure composition of solar wind
1971	Ariel-IV	UK ^b	A	Proton and electron densities
1971	ISIS-II	Can ^b	A	Ionospheric sounders

Launch year	Mission name	Cooperating countries	Science/ applications	Objectives
1971	San Marcos-III	It ^b	A	Density of elements in equatorial upper atmosphere
1971	Nimbus-4	FRG ^a	A	Stratospheric height and temperature measurements using UV
1972	Apollo-16	Switz ^a	S	Measure composition of solar wind
1972	Orbiting Astronomical Observatory-3 (OAO-3)	UK ^a	S	Study stellar ultraviolet and x-ray emissions (project also known as Copernicus)
1972	AEROS	FRG ^b	S	Measure solar extreme UV and correlate with upper atmosphere components
1972	Apollo-16	FRG, ^a Fr ^a	S	BIOSTACK I (effects of CR on selected biosystems)
1972	Apollo-17	FRG, ^a Fr ^a	S	BIOSTACK II (effects of CR on selected biosystems)
1972	Nimbus-5	UK ^a	A	Water vapor, cloud, and atmospheric temperature soundings
1973	Skylab	Bel ^a	A	Smelting silver in space
1973	Skylab	Fr, ^a Switz, ^a Jap ^a	S	Sky survey, distribution of galaxies and ionized hydrogen; solar wind analysis; and manufacturing of composite metals in space
1974	Astronomical Netherlands Satellite (ANS)	Neth ^b	S	UV photometry and x-ray emissions
1974	Ariel-V	UK ^b	S	Conduct x-ray sky survey and locate sources
1974	Helios-1	FRG ^b	S	Measure micrometeoroid flux, study solar x-rays and mass, and planetary orbits
1974	San Marcos-III-2	It ^b	A	Measure composition and temperature of equatorial thermosphere
1974	AEROS-B	FRG ^b	A	Neutral atmosphere temperature experiment
1975	Apollo-Soyuz Test Project (ASTP)	US/USSR	S	Rendezvous and docking test included joint biological studies
1975	Apollo-18 (U.S. ASTP Craft)	FRG ^a	S	BIOSTACK-III (CR effects on biosystems), blood electrophoresis
1975	Cosmos 782	USSR ^b	S	Eleven U.S. experiments aboard (including centrifugation)
1975	OSO-8	Fr ^a	S	Spectrographic study of solar chromosphere
1975	Radio Beacon	India ^a	A	Applications technology satellite experiment to measure electron content and scintillation phenomena
1975	Nimbus-6	UK ^a	A	Upper atmosphere temperature sounding
1976	Communications Technology Satellite (CTS)	Can ^b	A	Broadcast experiments
1976	Helios-2	FRG ^b	S	Measure micrometeoroid flux, study solar x-rays and mass, and planetary orbits
1977	Int'l Sun-Earth Explorer-1 (ISEE-1)	ESA, ^a Fr, ^a FRG, ^a Switz, ^a UK ^a	S	Coordinated spacecraft studied magnetosphere, interplanetary space, and their interaction
1977	ISEE-2	ESA ^b	S	Coordinated spacecraft studied magnetosphere, interplanetary space, and their interaction
1977	Cosmos 936	USSR ^b	S	Seven US biological experiments
1978	ISEE-3 (NASA Helio-centric Mission)	FRG, ^a Fr, ^a Neth, ^a UK ^a	S	Solar wind composition, behavior and mapping; comet flyby
1978	Pioneer Venus-2	FRG, ^a Fr ^a	S	Atmospheric and cloud studies of Venus
1978	Cosmos 1129	USSR ^b	S	Fourteen U.S. biological experiments
1978	TIROS-N	Fr ^a	A	Demonstrate Satellite Data Collection System (ARGOS)
1978	Nimbus-7	UK ^a	A	Stratospheric and mesospheric sounding

Launch year	Mission name	Cooperating countries	Science/ applications	Objectives
1979	High Energy Astronomical Observatory-3 (HEAO-3)	Fr, ^a Dk ^a	S	Study galactic CR composition
1979	Hakucho	Japan ^b	S	Optical and radio observations of x-ray stars
1980	Solar Maximum Mission (SMM)	US-Neth-UK ^a	S	Solar hard x-ray imaging spectrometry
1983	Spacelab-1	Jap ^a	S	
1983	San Marco-D/L	It ^b	S	Effects of solar activity on meteorological processes
1983	Cosmos-1514	USSR ^b	S	U.S. providing medical research devices for primate mission; U.S. biological experiments
1983	San Marcos-D/L	It ^b	A	Atmosphere/ionosphere electrodynamics
1983	SARSAT	Can, ^a Fr ^a	A	Demonstrate emergency signal receiver
1984	Blood Rheology Experiment	US ^a	S	Shuttle mid-deck study of hemoagglutination under microgravity
1984	Spacelab-2	UK ^a	S	Galactic x-ray imaging and determination of He abundance in solar corona
1984	Long-Duration-Exposure Facility (LDEF)	FRG, ^a US-Ire-ESA; ^a Switz, ^a UK, Fr ^a	S	Investigations of space environment and effects
1985	Giotto	ESA ^a	S	Multi-parameter characterization of cometary environment
1985	Spacelab-3	India ^a	S	Study solar/galactic CR ionization states
1985	Spacelab-D-1	US/Can ^b	S	"Space Sled" to conduct neurophysiology research
1986	Int'l Solar Polar Mission (ISPM)	ESA ^a	S	Observations of sun and interplanetary medium out of the ecliptic plane
1987	Roentgen-Satellite (ROSAT)	FRG-US-UK ^b	S	X-ray sky survey and sources study
1988	Gamma Ray Observatory (GRO)	FRG ^a	S	Wide-range gamma ray detection
1988	Venus Radar Mapper (VRM)	Fr ^a	S	Venus gravity and atmospheric tides
1989	Starlab	US-Aus-Can ^a	S	1-m optical/UV telescope for deployment on Shuttle or free flying platform
Part 3: Collaborative data collection/analysis				
1961	TIROS	US/(42 others)	A	Compare weather photographs and ground observations
1962	Echo-2	US/USSR	A	Experiments using US passive communications satellite, antennas at Soviet facility
1964	Int'l Satellite Geodesy Experiment (ISAGEX)	US/COSPAR	A	Laser and optical observation of US and French satellites
1966	GEOS/PAGEOS	US/Fr	A	Analyze data obtained by laser tracking of US and French satellites
1969	Lunar sample studies	US/(21 others)	S	Analyze lunar materials returned by Apollo missions
1972	Bering Sea Experiment	US/USSR	A	Coordinate sea, air, and space collection of microwave measurement data
1974	Position Location and Communication Experiment (PLACE)	US/Can/ESA	A	Determine feasibility of aircraft and satellite operation in L-band
1974	Large Area Crop Inventory Experiment (LACIE)	US/Can/USSR	A	Collect/compare agricultural remote sensing and ground truth data
1974	ARGOS	US/Fr	A	Collect environmental data from surface platforms via satellites equipped with French detectors
1975	Search and Rescue	US/Can/FRG/ESA	A	Stage search and rescue incident using ATS-6 satellite

Launch year	Mission name	Cooperating countries	Science/ applications	Objectives
1975	Satellite Instructional Television Experiment (SITE)	US/India	A	Broadcast of programs to remote Indian villages via ATS-6 satellite
1975	Advanced Satellite for Interdisciplinary Communications (SACI)	US/Bra	A	Broadcast of educational programs to Brazilian students via ATS-6
1976	Int'l Applications Demonstration (AIDSAT)	US/(27 others)	A	Broadcast programs to 27 developing countries
1977	ISEE	US/ESA	S	Coordinated spacecraft studied magnetosphere, interplanetary space, and their interaction
1978	Applications Explorer Mission-A	US/ESA	A	Study earth surface/subsurface phenomena
1979	Ocean Dynamics Study Project	US/Jap	A	Relate Seasat data regarding ocean surface features to measured subsurface features
1979	Cloud Height Study Project	US/Jap	A	Stereographic measurements of cloud height by US and Japanese satellites
1980	Winds and Waves Study Project	US/Jap	A	Correlation of Seasat data with sea surface truth data
1980	Snow Properties Study Project	US/Jap	A	Using satellite and surface truth data, explore use of satellites in determining snow characteristics
1980	Evaporation Study Project	US/Jap	A	Using satellite and surface truth data, explore use of satellites in estimating evaporation
1980	SMM/Astro-A Collaborative Observations Program	US/Jap	A	Coordinated observation/data analysis of solar flares from 2 spacecraft
1981	Agronomic Radiometry Research Project	US/Mex	A	Study electromagnetic radiation characteristics of grains via satellite and ground truth data
1981	Shuttle multispectral infrared radiometer (SMIRR)	US/Mex/Sp/Egy	A	Verify SMIRR data with ground truth data
1982	Agronomic Remote Sensing Activities	US/Aus	A	Estimate crop production via satellite and ground truth data
1982	Satellite laser tracking data project	US/Jap	A	Joint laser tracking
1982	Crustal Dynamics Study	US/Fr/It/FRG/Neth/Isr	A	Satellite laser ranging (US and French satellites) to determine plate tectonics, polar motion, and earth rotation
1982	COSPAS/SARSAT	US/Can/Fr/USSR/UK/Nor/Swe/Bul/Fin	A	Demonstrate global search and rescue system
1983	Int'l Satellite Cloud Climatology Project (ISCCP)	US/Jap/India	A	Collect cloud climatology data via global satellite coverage
1983	Spacelab-1	ESA/US	S	Multinational experiments include biology, medicine, botany, astronomy, and solar physics
1985	Halley Missions	ESA/USSR/Japan/US	S	Spacecraft and mission design are being coordinated for ESA's Giotto, USSR's Vega (2), and Japan's Planet-A. US providing tracking and coordinating ground-based and near-Earth observations
1985	VEGA	US/Fr	S	Track French balloons in Venus' atmosphere and determine position/velocity using very long baseline interferometry

Launch year	Mission name	Cooperating countries	Science/ applications	Objectives
1985	Int'l Halley Watch	US/(8 others)	S	Coordinate ground-based observations of Halley's Comet
1988	Mobile Satellite (MSAT)	US/Can	A	Two-way voice/data communication with mobile users
1989	Int'l. Solar-Terrestrial Physics (ISTP) Program	USA/ESA/Jap	S	Coordinated solar-terrestrial physics measurement using 9 spacecraft

^aForeign experiment (foreign payload) on U S mission

^bU S experiment on foreign spacecraft

NOTES (1) Table includes only projects involving spacecraft. It does not include cooperative sounding rocket, balloon, and groundbased projects, also excluded are incidents of data exchange of launch services only

(2) Table includes, in the case of future missions, only those officially approved

(3) Multilateral joint ventures among ESA member countries are considered as ESA missions. However, national project activities involving ESA members with non-ESA countries are considered as national cooperative ventures

(4) Fr = France, UK = United Kingdom, It = Italy, Switz = Switzerland, FRG = Federal Republic of Germany, Neth = Netherlands, Aus = Australia, Dk = Denmark, Ire = Ireland, Bel = Belgium, Mex = Mexico, Spa = Spain, Egy = Egypt, Bra = Brazil, Nor = Norway, Swe = Sweden, Bul = Bulgaria, Fin = Finland, Isr = Israel, COSPAR = Committee on Space Research

Text of Public Law 98-562, Originally Senate Joint Resolution 236, and Presidential Statement

Ninety-eighth Congress of the United States of America

AT THE SECOND SESSION

*Begun and held at the City of Washington on Monday, the twenty-third day of January,
one thousand nine hundred and eighty-four*

Joint Resolution

Relating to cooperative East-West ventures in space.

Whereas the United States and the Soviet Union could soon find themselves in an arms race in space, which is in the interest of no one;

Whereas the prospect of an arms race in space between the United States and the Soviet Union has aroused worldwide concern expressed publicly by the governments of many countries;

Whereas the 1972-1975 Apollo-Soyuz project involving the United States and the Soviet Union and culminating with a joint docking in space was successful, thus proving the practicability of a joint space effort;

Whereas, shortly after the completion of the Apollo-Soyuz project, and intended as a followup to it, the United States and the Soviet Union signed an agreement to examine the feasibility of a Shuttle-Salyut program and an international space platform program, but that initiative was allowed to lapse;

Whereas the United States signed a five-year space cooperation agreement with the Soviet Union in 1972, renewed it in 1977, then chose not to renew it in 1982;

Whereas the United States recently proposed to the Soviet Union that the two Nations conduct a joint simulated space rescue mission;

Whereas the Soviet Union has not yet responded to the substance of this proposal; and

Whereas the opportunities offered by space for prodigious achievements in virtually every field of human endeavor, leading ultimately to the colonization of space in the cause of advancing human civilization, would probably be lost irretrievably were space to be made into yet another East-West battleground: Now, therefore, be it

Resolved by the Senate and House of Representatives of the United States of America, in Congress assembled, That the President should—

(1) endeavor, at the earliest practicable date, to renew the 1972-1977 agreement between the United States and the Soviet Union on space cooperation for peaceful purposes;

(2) continue energetically to gain Soviet agreement to the recent United States proposal for a joint simulated space rescue mission; and

(3) seek to initiate talks with the Government of the Soviet Union, and with other governments interested in space activities, to explore further opportunities for cooperative East-West ventures in space including cooperative ventures in such areas as space medicine and space biology, planetary science, manned and unmanned space exploration.

Speaker of the House of Representatives.

*Vice President of the United States and
President of the Senate.*

THE WHITE HOUSEOffice of the Press Secretary

For Immediate Release
October 30, 1984

STATEMENT BY THE PRESIDENT

I am today signing Senate Joint Resolution 236, relating to cooperative East-West ventures in space.

Space represents a challenging opportunity for the United States and for all of mankind; a challenge that, I am determined, we will meet. We stand today on the threshold of a great adventure. Beyond are vast opportunities — for the production of new materials, new medicines, and the expansion of our knowledge of the universe and of ourselves.

This must be a cooperative effort. We have worked with many other nations in our own space program and this cooperation will strengthen and grow. Many countries have taken part in the successful spacelab program, and I have invited other nations to take part in the development of a space station.

I find portions of the language contained in the preamble to the Joint Resolution very speculative. However, I have stated several times our desire to increase contacts with the Soviet Union, and we are prepared to work with the Soviets on cooperation in space in programs which are mutually beneficial and productive. As part of this effort, the United States has offered to carry out with the Soviet Union a joint simulated space rescue mission. We believe this and similar cooperative programs offer practical benefits for all mankind. It is in that spirit that I today sign this Joint Resolution.

COSPAS/SARSAT: A Brief Case Study

Description of the COSPAS/SARSAT System

COSPAS/SARSAT is an international cooperative program to demonstrate the use of satellite technology to detect and locate aircraft or vessels in distress. The United States, Canada, France, and the U.S.S.R. developed the system, based on a "Memorandum of Understanding" which was signed in 1979 and entered into effect in 1980.¹ Since that time five more countries—Norway, the United Kingdom, Sweden, Finland, and Bulgaria—have become participants. Brazil and Denmark are expected to join in the near future. There are four participating U.S. agencies: the National Oceanic and Atmospheric Administration (NOAA) administers the system; the Coast Guard and Air Force are referred to as "user agencies;" and the National Aeronautics and Space Administration (NASA) conducts technical evaluation and support. COSPAS is administered by the Soviet Merchant Marine (MORFLOT).

The acronym COSPAS refers to the Soviet component of the system (from the Russian for "Space System for the Search of Vessels in Distress"). SARSAT is the joint U.S.-Canadian-French component (from Search and Rescue Satellite-Aided Tracking). The project involves the use of multiple satellites to detect distress signals emitted on the ground by emergency transmitters aboard ships and aircraft in distress. The signals received by a satellite are relayed to a network of dedicated ground stations where the location of the emergency is determined by measuring the Doppler shift of the signal as received by the satellite. This information is then relayed to the appropriate search and rescue forces in the country nearest the emergency location.

The system thus consists of a number of separate but linked components:

- **Transmitters:** Emergency Locator Transmitters (ELTs) aboard aircraft in distress, and Emergency Position Indicating Radio Beacons (EPIRBs) aboard marine craft.
- **Satellites:** Detectors are mounted on U.S. NOAA and Soviet Cosmos satellites occupying medium-altitude, near-polar orbits to maximize coverage and detection sensitivity of the system.
- **Local User Terminal (LUT):** Dedicated ground stations within each participating country that re-

ceive satellite signals and perform initial processing.

- **Mission Control Center (MCC):** Data are relayed by the LUTs to the MCC, which is responsible for system control within that country as well as for coordination with MCCs of other nations.
- **Rescue Coordination Center (RCC):** The RCC is alerted by the MCC, and is responsible for coordinating the actions of local search and rescue forces.

Figure C-1 illustrates a COSPAS satellite. Figure C-2 depicts the various components of the COSPAS/SARSAT system and their interrelationships.

Within this general system, two experiments are being performed. The first is directed at aircraft and vessels equipped with commercially available emergency transmitters operating at 121.5 and 243 MHz. Signals emitted by these transmitters are relatively weak, and their frequency and modulation characteristics are not ideal for detection by spacecraft. The transmitters, however, are widely used and therefore offer the opportunity to test the concept in actual emergency situations.

The second experiment uses transmitters designed especially for satellite detection and operating at 406 MHz. These systems have been used successfully in meteorological data collection for many years, and in a number of SAR-type experiments. The 406 MHz transmitters have higher power and better frequency stability than current off-the-shelf emergency transmitters, and the frequency itself was designated at the

Figure C-1.—Soviet COSPAS Satellite

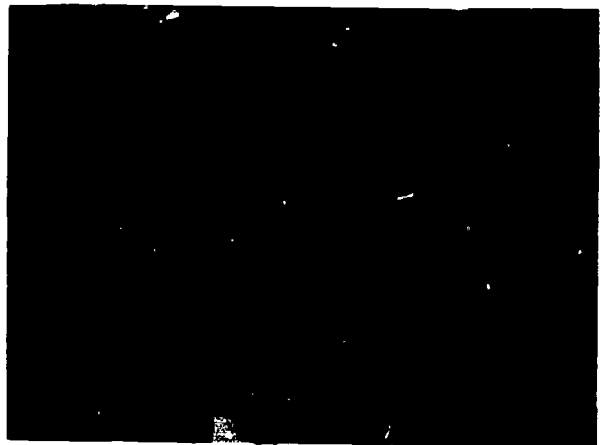

Soviet COSPAS satellite, as displayed at 1985 Paris Air Show

SOURCE Charles P. Vick, 1985.

¹The agencies that signed the "Memorandum of Understanding" were: United States—NASA, Canada—Department of Communications (DOC), France—Centre National d'Etudes Spatiales (CNES), and the Soviet Union—Ministry of Merchant Marine (MORFLOT). A COSPAS/SARSAT Coordinating Group (CSCG) was established to manage the joint efforts.

Figure C-2.—Basic Operational Configuration of the COSPAS/SARSAT System Components

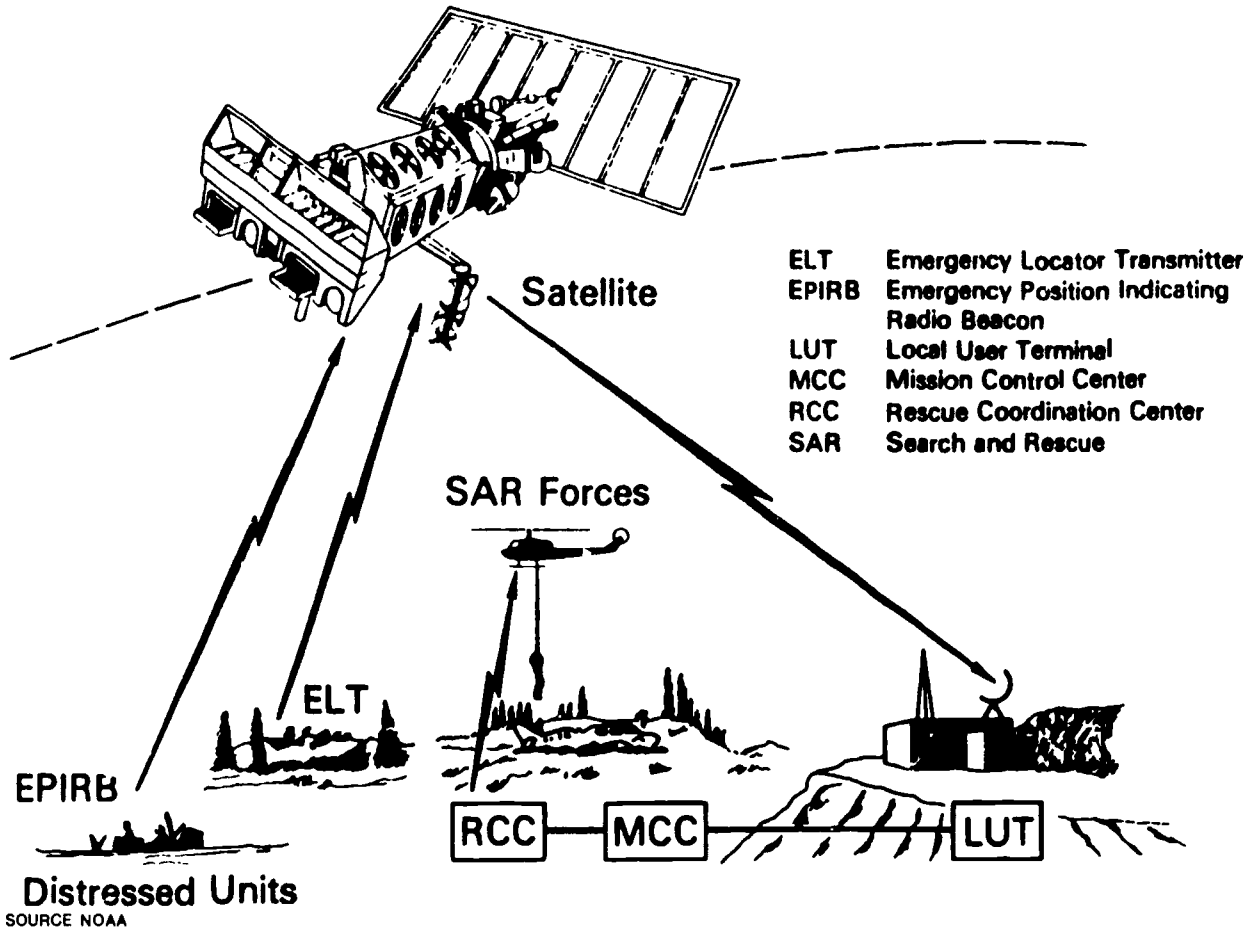

World Administrative Radio Conference (WARC) of 1979 for use in satellite-aided emergency communication worldwide.

Unlike the 121.5/243 units, these 406MHz transmitters can include in their data message information on the type of aircraft or vessel, its identification and country of origin, the nature of the emergency or elapsed time since an accident, and even the location of the emergency. In addition, some of the signal processing can be performed by an onboard processor and either relayed to the LUT in real-time or stored for later transmission. This feature not only simplifies the ground operations but also eliminates the requirement for simultaneous visibility to the satellite of both the emergency signal source and the LUT while a signal is being relayed. As a result, full global coverage can be achieved with a smaller number of lower cost LUTs.

To accommodate both experiments simultaneously, two data systems and two coverage models are employed in COSPAS/SARSAT. A "repeater data system" relays received signals directly to the LUT for processing, while a "processed data system" is utilized to process and relay, as well as store and later transmit, the 406 MHz data. The first type of system permits regional (line-of-sight) coverage. The latter system provides a global coverage capability, since signals received when no LUT is in view can be stored until the satellite can transmit directly to an LUT.

The key to the effectiveness of the repeater system—especially in remote regions—is the number of LUTs. There are currently three of these stations in the United States, three in the U.S.S.R., and one each in Canada, France, Norway, and the United Kingdom. Each participating country has one MCC, with the

Figure C-3.—Through a Network of Satellite-to-Ground and Ground-to-Ground Communications Linkages, COSPAS/SARSAT Affords Coverage of the Entire Globe

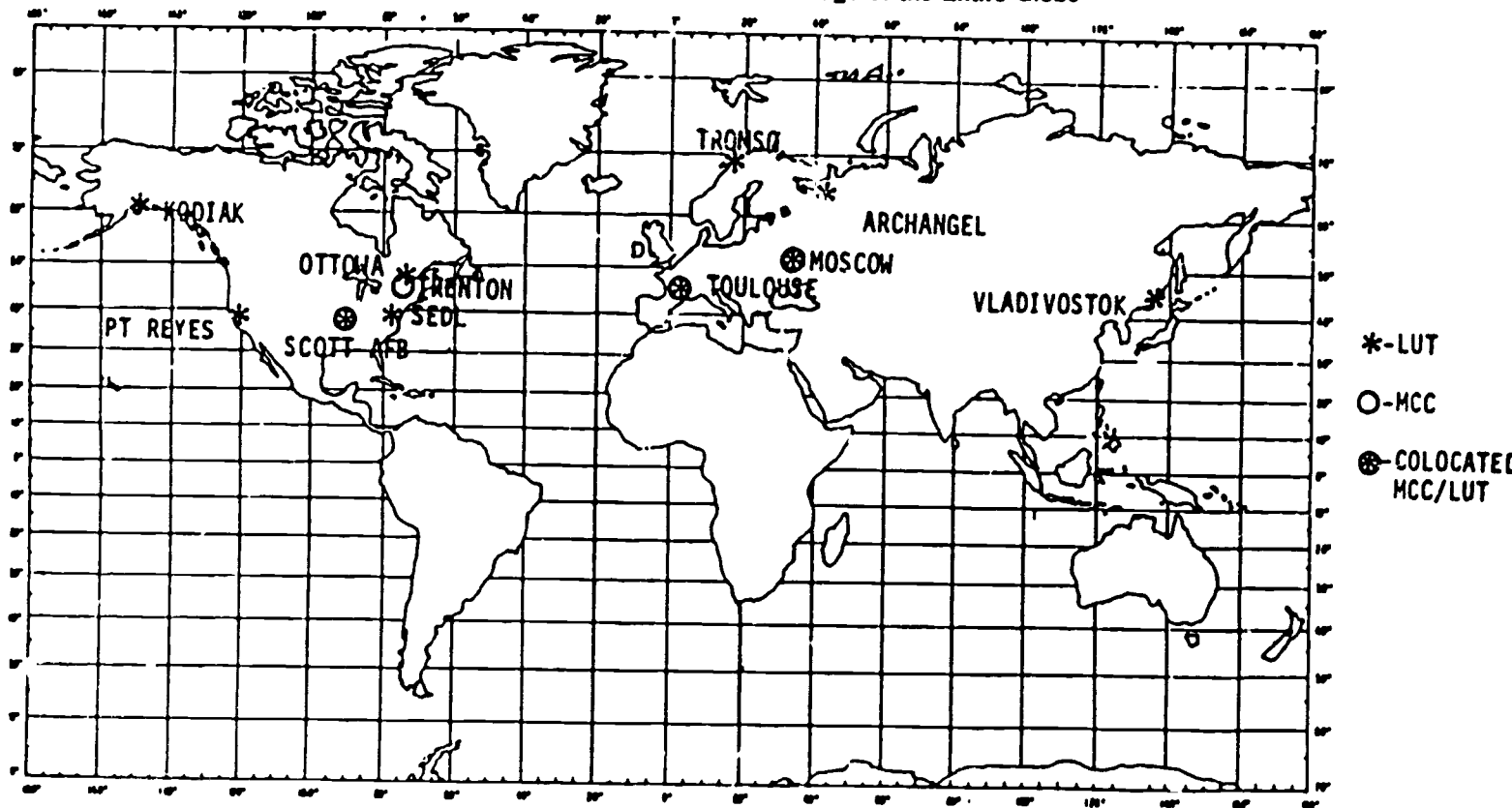

U.S. MCC acting as the single point of contact for all Sarsat parties in coordinating system operations with the COSPAS MCC. Figure C-3 depicts the geographical layout of COSPAS/SARSAT ground components.

Demonstration and Evaluation

The first COSPAS satellite (Cosmos 1383) was placed in orbit in June 1982, followed in March 1983 by the first Sarsat satellite (NOAA-8) and a second Soviet satellite (Cosmos 1447). In June 1984 NOAA-8 prematurely failed; in the same month the Soviets added a third satellite, Cosmos 1574, to the system. NOAA-9, the newest U.S. addition, was placed in orbit in December 1984. Thus, the Sarsat system has relied heavily (and often exclusively) on Soviet satellites. The next four NOAA satellites will be equipped with Sarsat instruments, and two additional COSPAS satellites have already been built. The goal is to provide four-satellite coverage throughout the 1980s.

When system effectiveness had been adequately demonstrated, COSPAS/Sarsat began initial operational status; a new Memorandum of Understanding to that effect was signed by the participating nations in October 1984. This agreement establishes a commitment to provide operational services on the basis of the actual operating capability of the system through 1990. Authority for U.S. leadership in the program was transferred from NASA to NOAA at that time.

As a new initiative, the United States is now planning to put Sarsat equipment on future U.S. geostationary meteorological satellites. These satellites will provide instant alert capability for 406 MHz beacons in the Western hemisphere. The polar-orbiting NOAA satellites will continue to provide location of incidents and alert for 121.5 and 243 MHz beacons, as well as 406 MHz beacons not in the line of sight of the geostationary satellites.

Performance and Prospects

Thus far, the performance of the combined satellite/ground system has been effective. NASA officials report that "target" levels of locating accuracy have been achieved at both experimental wavelengths (i.e., 20 km at 121 MHz, and 2.5 km at 406 MHz), and sensitivity of reception is good. For example, even though the ELTs and EPIRBs transmit a signal no stronger than that of a garage-door opener, about 85 percent of the transmissions are detected on the first pass of the satellite.

Technical problems remain, but these generally have not stemmed from the COSPAS/Sarsat system itself. For example, illegal interference on the 406 MHz frequency (mostly in Europe) has been a continual problem, but strict enforcement is now reducing this interference. A 98 percent false alarm rate on the 121.5/243 MHz frequency—the result of faulty or damaged transmitters that operate intermittently without being turned on—has also been a major problem. Improved unit designs, however, are beginning to reduce false alarms. In the meantime, the strategy has been to wait until a signal is received on two successive passes and, if possible, to verify the information with Coast Guard, Civil Air Patrol, or other reports. As of April 1985, approximately 374 people have been saved from both aircraft and ships by rescue operations facilitated by the COSPAS/Sarsat system. Table C-1 shows a breakdown of rescues by country and category through October 17, 1984.

The COSPAS/Sarsat system has been successful because it consists of two separate projects joined because of their common objectives. Sarsat was originally a cooperative project involving the United States, Canada, and France. COSPAS reflects a Soviet interest to develop a system compatible with Sarsat, especially for use in the maritime fleet. The systems are not dependent on one another, yet they are mutually supportive in providing wider and more frequent coverage, and permitting a faster response time for emergencies. The coordination of spacecraft characteristics permits interoperability among the various satellites and ground stations, while coordinating launch dates and orbital parameters provides optimal coverage across time. The recent failure of NOAA-8 demonstrated the importance of the backup provided by satellites of other countries.

At the same time, security concerns seem to be minimized by the nature of the COSPAS/Sarsat operation. However sensitive the technology involved may

Table C-1.—Total Rescues to Oct. 17, 1984

	Incidents	Persons
United States:		
Aeronautical incidents	61	85
Maritime incidents	23	71
Canada:		
Aeronautical incidents	22	47
Maritime incidents	2	7
Europe:		
Aeronautical incidents	10	22
Maritime incidents	19	77
Total	137	312^a

^aTotal includes three hikers, not reflected in "Incidents" column

SOURCE NOAA data

be,² the fact that COSPAS and SARSAT are two separate systems has led to little, if any, direct interaction with the U.S.S.R. other than the communication between MCCs and the periodic planning meetings. Agreements have been made concerning broadcast frequencies, but no U.S. assistance has been provided, for example, in the development of non-U.S. ground stations, and no technology has been exchanged between the two systems.

While the COSPAS/SARSAT system boasts a significant number of rescues, it should be pointed out that none of those rescued have been Soviet or East bloc citizens. This is due to the fact that the Soviet Union does not routinely carry operational ELTs/EPIRBs on its own aircraft/ships at this time. By contrast, the United States alone has emergency locator transmitters on more than 200,000 civilian aircraft and 6,000 ships.

Regarding the cooperative interaction itself, however, participants report that there has been a "spe-

cial spirit" in the project. Due largely to its humanitarian and multilateral nature, interaction between the SARSAT and COSPAS elements of the system has gone smoothly despite some ups and downs in launchings and funding, and despite negative events in U.S.-Soviet relations which have resulted in the termination of other space activities. For example, although the number of U.S. SARSAT satellites has fallen below the number planned—the U.S.S.R. has launched three satellites to the United States' two, and for a considerable period of time the system relied entirely on the Soviet satellites—cooperative activity has not appeared to suffer, even in light of the recent highly publicized debate in the United States over whether one or two (SAF:SAT-equipped) polar satellites should be funded.³ Many observers have construed the COSPAS/SARSAT experience as an indication that U.S.-Soviet cooperation can be useful and viable in space activities with a practical purpose, equitable sharing of costs, and for the benefit of many people and countries.

²Technical areas of potential military sensitivity include such areas as information on signal frequencies and formats, satellite-mounted receivers, processors, and transmitters, ground-based data processing and communications capabilities, and spacecraft orbital ephemeris and general performance data

³See, for example, "U.S. Will Negotiate With Soviets on Search and Rescue Satellite," *Aviation Week and Space Technology*, vol. CXXI, No. 13 (Sept. 24, 1984), p. 22

