

DOCUMENT RESUME

ED 259 130

CE 0410754

TITLE Engineer Equipment Operator.
 INSTITUTION Marine Corps Inst., Washington, DC.
 REPORT NO MCI-13.31h
 PUB DATE 15 Oct 84
 NOTE 278p.
 PUB TYPE Guides - Classroom Use - Materials (For Learner) (051)

EDRS PRICE MF01/PC12 Plus Postage.
 DESCRIPTORS Construction (Process); Construction Materials; Correspondence Study; Equipment Maintenance; *Equipment Utilization; Hazardous Materials; Independent Study; *Mechanical Equipment; Military Personnel; *Military Training; *Motor Vehicles; *Operating Engineering; Postsecondary Education; Power Technology; Tractors; *Trade and Industrial Education

ABSTRACT

This student guide, one of a series of correspondence training courses designed to improve the job performance of members of the Marine Corps, deals with the skills needed by engineer equipment operators. Addressed in the seven individual units of the course are the following topics: introduction to Military Occupation Specialty (MOS) 1345 (engineer equipment operator); power flow (engines and power trains); fundamentals of earthmoving; tractors and tractor-drawn equipment; materials handling and sectionalized equipment (operation of sectionalized equipment, rough-terrain forklifts, scoop loaders, and sectionalization); rollers, distributors, air compressors, and rock crushers; and associated subjects (following decontamination procedures, fording, and working with wire rope). Following each unit is a section containing a study assignment, a lesson objective statement, and a written assignment consisting of a series of review questions for that unit. (MN)

 * Reproductions supplied by EDRS are the best that can be made *
 * from the original document. *

UNITED STATES MARINE CORPS
MARINE CORPS INSTITUTE, MARINE BARRACKS
BOX 1775
ARLINGTON, VA. 22222

13.31h
OCT 15 1984

1. ORIGIN

MCI course 13.31, Engineer Equipment Operator, has been prepared by the Marine Corps Institute.

2. APPLICABILITY

This course is for instructional purposes only.

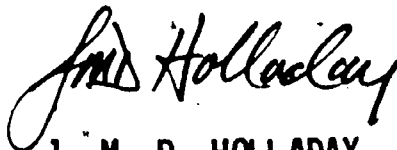

J. M. D. HOLLADAY
Lieutenant Colonel, U. S. Marine Corps
Deputy Director

INFORMATION

FOR

MCI STUDENTS

Welcome to the Marine Corps Institute training program. Your interest in self-improvement and increased professional competence is noteworthy.

Information is provided below to assist you in completing the course. Please read this guidance before proceeding with your studies.

1. MATERIALS

Check your course materials. You should have all the materials listed in the "Course Introduction." In addition you should have enough envelopes to mail all lessons back to MCI unless your lesson answer sheets are of the self-mailing type. If your answer sheets are of the preprinted type, check to see that your name, rank, and social security number are correct. Check closely, your MCI records are kept on a computer and any discrepancy in the above information may cause your subsequent activity to go unrecorded. You may correct the information directly on the answer sheet. If you find a discrepancy and correct it, ensure that you correct this information on all your answer sheets. If you did not receive all your materials, use the enclosed Student Request/Inquiry (MCI-R14) to notify MCI of this fact and what you require. (Note: The MCI-R14 may be mailed to MCI without envelope or stamp).

2. LESSON SUBMISSION

Submit your lessons on the answer sheets provided. Complete all blocks and follow directions on the answer sheet for mailing. In courses in which the work is submitted on blank paper or printed forms, identify each sheet in the following manner:

DOE, John J. Sgt 332-11-9999
44.1, Procedures of Legal Administration
 Lesson 3
 Military or office address
 (RUC number, if available)

Otherwise, your answer sheet may be delayed or lost. If you have to interrupt your studies for any reason, contact your training NCO who will request a single six month extension of time, which is added to the original Course Completion Deadline (CCD) date. If you are not attached to a Marine Corps unit you may make this request by submitting the enclosed MCI-R14, or

by calling the Registrar Division on AUTOVON 288-4175/2299/6293 or commercial (202) 433-5174/2299/2691. You are allowed one year from the date of enrollment to complete this course. Your commanding officer is notified of your status through the monthly Unit Activity Report. In the event of difficulty, contact your training NCO or MCI immediately.

3. ENROLLMENT/MAIL TIME DELAY

Presented below are the Enrollment/Mail Time delays. Column I represents the First Class mail time from MCI to the designated geographical location or from your location to MCI. All correspondence is sent via First Class mail. Course materials are sent via Special Fourth Class Book Rate.) You should add five working days for our processing. Example: Eastern U.S. - 3 days mailing time to MCI + 5 working days MCI processing + 3 days mailing time back to the unit = 11 days. Column II represents Regular Mail from the time when the enrollment application is mailed until the unit receives the course. Example: Eastern U.S. - Enrollment application 3 days mailing time to MCI + 5 working days MCI processing + 6 days mailing time to the unit = 14 days.

<u>GEOGRAPHIC AREA</u>	<u>COLUMN 1</u>	<u>COLUMN 2</u>
EASTERN U.S.	3	14
WESTERN U.S.	4	19
FPO NEW YORK	5	21
DEPT. OF STATE MARINE SECURITY GUARD	7	24
HAWAII (NON-FPO)	5	12
FPO SAN FRANCISCO	7	27
FPO SEATTLE	6	23

Note: These times represent the service standard. The actual times may vary. If the delay you are experiencing is excessive, please contact the MCI Registrar by phone, message, or letter, so that we may take action.

4. GRADING SYSTEM

<u>LESSONS</u>		<u>MEANING</u>	<u>EXAMS</u>	
<u>GRADE</u>	<u>PERCENT</u>		<u>GRADE</u>	<u>PERCENT</u>
A	94-100	----- EXCELLENT	----- A	94-100
B	86-93	----- ABOVE AVERAGE	----- B	86-93
C	78-85	----- AVERAGE	----- C	78-85
D	70-77	----- BELOW AVERAGE	----- D	65-77
NL	BELOW 70	----- FAILING	----- F	BELOW 65

You will receive a percentage grade for your lessons and for the final examination, along with a reference sheet (MCI R69), indicating the questions incorrectly answered. All lessons must be COMPLETED AND PASSED before you will be administered an exam. The grade attained on the final exam is your course grade.

5. FINAL EXAMINATION

ACTIVE DUTY PERSONNEL: When you submit your LAST LESSON, your exam will be mailed automatically to your commanding officer. The administration of MCI final examinations must be supervised by a commissioned or warrant officer, or a staff NCO (equivalent or higher), and it must be validated by the administrator.

INACTIVE DUTY OR CIVILIAN EMPLOYEE: The exam may be supervised by a director of civilian personnel, civilian training officer, clergyman, or local school official.

6. COMPLETION CERTIFICATE

The completion certificate will be mailed to your commanding officer. For non-Marines, it is mailed to your supervisor or directly to you, as appropriate.

7. RESERVE RETIREMENT CREDITS

Reserve retirement credits are awarded to inactive duty personnel only. Credits awarded for each course are listed in the "Course Introduction" and are only awarded upon successful completion of the course. Reserve retirement credits are not awarded for MCI study performed during drill periods if credits are also awarded for drill attendance.

8. DISENROLLMENT

Only your commanding officer can request your disenrollment from an MCI course since this action will adversely affect the unit's completion rate.

9. ASSISTANCE

Consult your training NCO in the event of course content problems. If he is unable to assist you, MCI is ready to help you whenever you need it. Please use the enclosed Student Course Content Assistance Request (T&E-1) or call the Autovon telephone number listed below for the appropriate course writer section.

PERSONNEL/ADMINISTRATION/LOGISTICS/CORRECTIONS	288-3259
COMMUNICATIONS/ELECTRONICS/AVIATION/NBC	288-3604
INFANTRY	288-3611
ENGINEER/MOTOR TRANSPORT/UTILITIES	288-2275
SUPPLY/FOOD SERVICES/FISCAL	288-2285
TANKS/ARTILLERY/SMALL ARMS REPAIR/AAV	288-2290

For administrative problems call the MCI Hotline: 288-4175

For commercial phone lines, use area code 202 and prefix 433 instead of 288.

10. STUDY HINTS

By enrolling in this course, you have shown a desire to improve the skills you need for effective job performance, and MCI has provided materials to help you achieve your goal. Now all you need is to develop your own method for using these materials to best advantage.

The following guidelines present a four-part approach to completing your MCI course successfully:

- Make a "reconnaissance" of your materials;
- Plan your study time and choose a good study environment;
- Study thoroughly and systematically;
- Prepare for the final exam.

a. MAKE A "RECONNAISSANCE" OF YOUR MATERIALS

Begin with a look at the course introduction page. Read the **COURSE INTRODUCTION** to get the "big picture" of the course. Then read the **MATERIALS** section near the bottom of the page to find out which text(s) and study aids you should have received with the course. If any of the listed materials are missing, see paragraph 1 of this pamphlet to find out how to get them. If you have everything that is listed, you are ready to "reconquer" your MCI course.



Read through the table(s) of contents of your text(s). Note the various subjects covered in the course and the order in which they are taught. Leaf through the text(s) and look at the illustrations. Read a few lesson questions to get an idea of the types that are asked. If MCI provides other study aids, such as a slide rule or a plotting board, familiarize yourself with them. Now, get down to specifics!

b. PLAN YOUR STUDY TIME AND CHOOSE A GOOD STUDY ENVIRONMENT

From looking over the course materials, you should have some idea of how much study you will need to complete this course. But "some idea" is not enough. You need to work up a personal study plan; the following steps should give you some help.

① Get a calendar and mark those days of the week when you have time free for study. Two study periods per week, each lasting 1 to 2 hours, are suggested for completing the minimum two lessons required each month by MCI. Of course, work and other schedules are not the same for everyone. The important thing is that you schedule a regular time for study on the same days of each week.

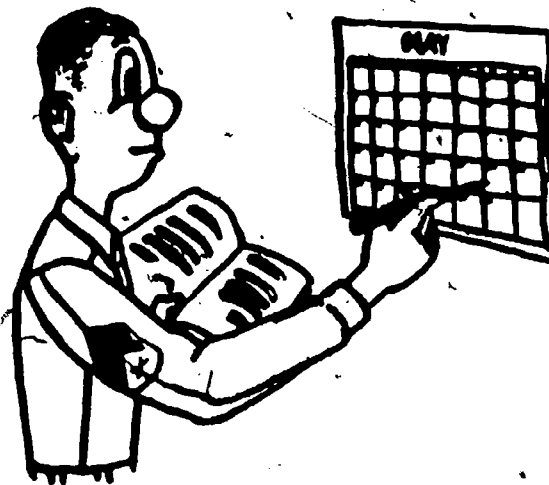

② Read the course introduction page again. The section marked **ORDER OF STUDIES** tells you the number of lessons in the course and the approximate number of study hours you will need to complete each lesson. Plug these study hours into your schedule. For example, if you set aside two 2-hour study periods each week and the **ORDER OF STUDIES** estimates 2 study hours for your first lesson, you could easily schedule and complete the first lesson in one study period. On your calendar you would mark "Lesson 1" on the appropriate day. Suppose that the second lesson of your course requires 3 study hours. In that case, you would divide the lesson in half and work on each half during a separate study period. You would mark your calendar accordingly. Indicate on your calendar exactly when you plan to work on each lesson for the entire course. Do not forget to schedule one or two study periods to prepare for the final exam.

STUDY GUIDE

① Stick to your schedule.

Besides planning your study time, you should also choose a study environment that is right for you. Most people need a quiet place for study, like a library or a reading lounge; other people study better where there is background music; still others prefer to study out-of-doors. You must choose your study environment carefully so that it fits your individual needs.

e. STUDY THOROUGHLY AND SYSTEMATICALLY

Armed with a workable schedule and situated in a good study environment, you are now ready to attack your course, lesson by lesson. You will find your first study assignment and your first written assignment on page 1 of lesson 1. On this page you will also find the lesson objective, a statement of what you should be able to do after completing the assignments.

DO NOT begin by reading the lesson questions and flipping through the text for answers. If you do so, you will prepare to fail, not pass, the final exam. Instead, proceed as follows:

① Read the study assignments carefully. Make notes on the ideas you feel are important and mark any portion you have difficulty understanding.



② Reread the portions you marked in step ①. When you have mastered the study assignment, start to work on the written assignment.

③ Read each question in the written assignment carefully.

④ Answer all questions that you are sure of and leave the others blank.

① Reread the portions of the study assignment that explain the items you left blank.

② Complete the written assignment and send it to MCI for grading.

③ Go on to the next lesson.

Follow the same procedure for each lesson of the course. If you have problems with the text or lesson questions that you cannot solve on your own, ask your section OIC or NCOIC for help. If he cannot aid you, request assistance from MCI on the MCI Student Course Content Assistance Request included in this pamphlet.

When you have passed the final lesson, the final exam will be sent to your training officer or NCO.

d. PREPARE FOR THE FINAL EXAM

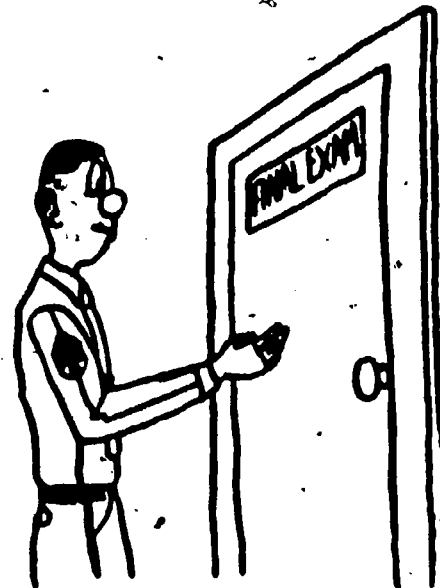

How do you prepare for the final exam? Follow these three steps:

① Review each lesson objective as a summary of what was taught in the course.

② Reread all portions of the text that you found particularly difficult.

③ Review all the lesson questions, paying special attention to those you missed the first time around.

If you follow these simple steps, you should do well on the final. **GOOD LUCK!**

ENGINEER EQUIPMENT OPERATOR

Course Introduction

ENGINEER EQUIPMENT OPERATOR is designed to teach LCpl's and below the theory required for the effective operation, maintenance, and employment of selected items of engineer construction equipment. Although the actual operation of construction equipment is primarily a physical skill which you must obtain through actual field experience, the course will teach you the fundamentals that you must understand before you can acquire the necessary performance skills.

ORDER OF STUDIES

<u>Lesson Number</u>	<u>Study Hours</u>	<u>Reserve Retirement Credits</u>	<u>Subject Matter</u>
1	4	1	Introduction to MOS 1345
2	5	2	Power Flow
3	4	1	Earthmoving Fundamentals
4	4	1	Tractors and Tractor-Drawn Equipment
5	4	2	Materials-Handling and Sectionalized Equipment
6	4	1	Miscellaneous Equipment
7	3	1	Associated Subjects
	<u>2</u>	<u>1</u>	FINAL EXAMINATION
	<u>30</u>	<u>10</u>	

EXAMINATION: Supervised final examination without textbooks or notes; time limit, 2 hours.

MATERIALS: MCI 13. 31h, Engineer Equipment Operator.

Lessons sheets and answer sheets.

RETURN OF MATERIALS:

Students who successfully complete this course are permitted to keep the course materials.

Students disenrolled for inactivity or at the request of their commanding officer will return all course materials.

* * *

PREFACE

ENGINEER EQUIPMENT OPERATOR has been designed to provide engineer equipment operators; MOS 1345, lance corporals and below, with a source of study material on the operation of engineer construction equipment. The course will be beneficial to those Marines who are desirous of becoming, or are being trained as engineer equipment operators. ENGINEER EQUIPMENT OPERATOR provides broad coverage of the operation, maintenance, and effective employment of a variety of engineer construction equipment normally operated by lance corporals and below, and certain related subjects. Throughout the text, selected items of equipment are discussed for illustration purposes. However, the principles are the same and the techniques are similar on all makes and types of equipment.

SOURCE MATERIALS

- | | |
|---------------------------------|---|
| MCO 4700.1E | <u>Unsatisfactory Equipment Report DD Form 1686, 28 Dec 1970</u> |
| MCO 4710.2D | <u>Engineer Equipment Repair Criteria, 19 July 1973</u> |
| MCO P4790.2 | <u>MIMMS Field Procedures Manual, 4 Feb 1974</u> |
| MCC 5215.14B | <u>Subj: Marine Corps Technical Publications Systems, Nov 1970.</u> |
| NavPers 10640-F | <u>Equipment Operator 3 & 2, Department of the Navy, Bureau of Naval Personnel, 1970</u> |
| NavPers 10644-F | <u>Construction Mechanic 3 & 2, Department of the Navy, Bureau of Naval Personnel, 1971</u> |
| FM 5-34 | <u>Engineer Field Data, w/Ch 1, Dec 70, w/Ch 2 May 71</u> |
| TM 3-220 | <u>Chemical, Biological, and Radiological (CBR) Decontamination, w/Ch 1-2, Nov 1967</u> |
| TM 5-330 | <u>Planning, Site Selection, and Design of Roads, Airfields, and Heliports, w/Ch 1, 6 Sep 68</u> |
| TM 5-331 vol A, B, C, D, & E | <u>Management: Utilization of Engineer Construction Equipment, Vol-A Aug 67, Vol-B May 68, Vol-C Nov 68, Vol-D April 69, Vol-E Feb 69</u> |
| TM 5-725 | <u>Rigging, w/Ch 1, Oct 68</u> |
| TM 5-4310. -250-15 | <u>Compressor, Rotary: Air; Diesel-Engine-Driven; 250-CFM 100-PSI; Trailer-Mounted (Davy Model M250RPV), Nov 1965</u> |
| TM 9-8000 | <u>Principles of Automotive Vehicles, Jan 1956</u> |
| Marine Corps technical manuals: | |
| TM/ENG 1850 | <u>Distributor, Bituminous Material, Tank Type, 1000-Gallon, Truck-Mounted, Forced-Feed, Gasoline-Engine-Powered. E. D. Etnyre & Co., Oregon, Ill, Apr 1959</u> |
| TM/ENG-00992-15 | <u>5-8 Ton Tandem Road Roller, Diesel-Engine-Driven, Model R6760M, Mar 1967</u> |
| TM 01023C-15 | <u>Scraper, Earthmoving, Towed, Model H-82 (M-62) Apr 64</u> |
| TM 02550B | <u>Truck, Lift, Fork, Rough Terrain; RKF-060, May 1962, Ch 001, Apr 63</u> |
| TM 03197B-15 | <u>Crane, Wheel-Mounted, Model M-60, Nov 66, Ch 001 Sep 69</u> |
| TM-04060B-15 | <u>Truck, Forklift, Case MC 4000, Feb 1975</u> |
| TM 07078A-15 | <u>Tractor, Diesel-Engine-Driven, Model 100, Dec 1964</u> |
| TM 06129A-15 | <u>Compressor, Trailer-Mounted, 250-CFM, 100-PSI, Sept 69</u> |
| TM-07075A-15 | <u>Supplement 1 Forklift, Oscillating for Tractor, 72-31MP</u> |
| TM-07542A | <u>Loader, Scoop-Type, Full-Track, J.I. Case MC 1150, Oct 1972</u> |
| TM-0780B-15 | <u>Tractor, Wheeled, J. I. Case MC 580B, 1 Jul 1974</u> |
| TM-4700-15/1B | <u>Tactical Equipment Record Procedures, Mar 1977</u> |
| Marine Corps Stock Lists: | |
| SL-2-2400 | <u>End Items List for Tractors, Mar 1960</u> |
| SL-3-03197 | <u>Components Lists for Crane, Wheel-Mounted: Model M-60, Aug 69</u> |
| SL-3-03417A | <u>Components List for Skid Assembly, Sectionalization, Jan 72</u> |
| Operator's manual | <u>BLH Austin-Western Portable Crushing and Screening Plant</u> |

Terex Maintenance Manual for Front End Loaders, The Service Department, Terex, Division of General Motors, Hudson, Ohio March 1967

Terex Maintenance Manual for 82-30M Crawler-Tractor, The Service Department, Terex, Division of General Motors, Hudson, Ohio Ohio, April 1966

Operator's Handbook for Terex Front End Loaders, The Service Department, Terex, Division of General Motors, Hudson, Ohio June 1967

Operator's Handbook for Terex Crawler Tractor Model 82-30M, The Service Department, Terex, Division of General Motors, Hudson Ohio, April 1966

Operation and Maintenance Instruction Manual for MRS Model I-100 M71, MRS Manufacturing Company, Flora, Miss.

Operation and Maintenance Manual for MRS Model 105 SM71 Scraper, MRS Manufacturing Company, Flora, Miss.

ACKNOWLEDGMENT

Grateful acknowledgment is made to BLH, Lima Plant, Lima, Ohio, for permission to use illustrations and text material from their publication. The material used from the above is found in paragraph 6-6.

CONTENTS

	<u>Para</u>	<u>Page</u>
Preface		i
Table of contents		iii
 Chapter 1. INTRODUCTION TO MOS 1345		
Section I. The operator		
History	1-1	1-1
MOS 1345, Engineer equipment operator	1-2	1-3
 Section II. Engineer equipment		
Introduction	1-3	1-5
Tractors	1-4	1-6
Towed equipment	1-5	1-12
Tandem roller	1-6	1-14
Materials-handling equipment	1-7	1-14
Air compressor	1-8	1-16
Miscellaneous equipment	1-9	1-18
 Section III. Maintenance		
Maintenance system	1-10	1-18
Operator's maintenance	1-11	1-20
Preventive maintenance services	1-12	1-21
Records and forms	1-13	1-37
Publications	1-14	1-34
Fuels and lubricants	1-15	1-37
Your responsibility for lubrication	1-16	1-42
Summary	1-17	1-42
 Chapter 2. POWER FLOW		
Section I. Engines		
Engine principles	2-1	2-1
Engine systems	2-2	2-11
 Section II. Power trains		
Basic power trains	2-3	2-35
Engine clutches	2-4	2-39
Tracked vehicle steering system	2-5	2-43
Tracks	2-6	2-45
Operating clutches and brakes	2-7	2-47
Hydraulic system	2-8	2-53
 Chapter 3. EARTHMOVING FUNDAMENTALS		
Introduction	3-1	3-1
Operator efficiency	3-2	3-1
Construction sequence	3-3	3-2
Grade stakes	3-4	3-10

	Para	Page
Soil	3-5	8-15
Natural road and airstrip material	3-6	3-16
Compacted earth	3-7	3-17
Military roads	3-8	3-17
SATS and helicopter landing sites	3-9	3-22
Combat support construction	3-10	3-23
 Chapter 4. TRACTORS AND TRACTOR-DRAWN EQUIPMENT		
Section I. Tractors		
Introduction	4-1	4-1
Crawler-tractors	4-2	4-1
Rubber-tired tractors	4-3	4-15
Dozer blades	4-4	4-28
Dozer employment techniques	4-5	4-32
Construction operations	4-6	4-33
Drott 4-in-1 skid-shovel front end attachment	4-7	4-36
Tractor and dozer safety precautions	4-8	4-39
 Section II. Tractor-drawn equipment		
Scrapers	4-9	4-40
Rooter	4-10	4-48
Rollers	4-11	4-49
 Chapter 5. MATERIALS-HANDLING AND SECTIONALIZED EQUIPMENT		
Section I. Introduction		
General	5-1	5-1
Instruments and controls	5-2	5-3
Starting the engine	5-3	5-3
Stopping the engine	5-4	5-5
Operation under unusual conditions	5-5	5-5
 Section II. Rough terrain forklift		
Introduction	5-6	5-7
RKF-060 forklift operation	5-7	5-8
OS-3354 forklift operation	5-8	5-11
MC 4000 rough-terrain forklift	5-9	5-12
 Section III. Scoop loader		
72-31MP Terex tractor	5-10	5-15
 Section IV. Sectionalization		
Introduction	5-11	5-19
Skids and tools	5-12	5-19
Disassembly	5-13	5-20
Reassembly	5-14	5-21
 Chapter 6. MISCELLANEOUS EQUIPMENT		
Section I. Rollers and distributors		
Introduction	6-1	6-1
Five- to eight-ton tandem roller	6-2	6-1
Asphalt distributors	6-3	6-4

Section II. Air compressors and rock crusher

	<u>Para</u>	<u>Page</u>
Air compressors	6-4	6-8
Compressor operation	6-5	6-10
Rock crusher 75-TPH model 2036/101-9	6-6	6-14

Chapter 7. ASSOCIATED SUBJECTS

Decontamination	7-1	7-1
Chemical and biological decontamination	7-2	7-1
Nuclear decontamination	7-3	7-3
Fording	7-4	7-4
Before-fording procedures	7-5	7-4
After-fording procedures	7-6	7-4
Wire rope	7-7	7-5
Handling wire rope	7-8	7-7
Seizing wire rope	7-9	7-8
Cutting wire rope	7-10	7-8
Care of wire rope	7-11	7-9
Wire rope attachments	7-12	7-9
Reeving	7-13	7-10

Chapter 1

INTRODUCTION TO MOS 1345

Section I. THE OPERATOR

1-1. HISTORY

Engineer units of some form have always been attached to major land forces, but it has only been in recent years that engineer construction equipment, as we know it today, has been used to any great extent. The development of the Fleet Marine Force during the mid-1930's saw separate engineer companies attached to the landing force. These early experiments in amphibious landing techniques led to the formation of a balanced landing force, with engineers becoming an integral part of the newly formed Marine divisions. During World War II, Marine divisions at one time had integral engineer regiments. Each regiment consisted of an engineer battalion, a pioneer battalion (shore party), and a naval construction or Seabee battalion. Separate engineer and aviation engineer battalions were formed as needed and attached to divisions for a particular assault landing. Toward the end of the war, the engineer regiments were disbanded. Seabee battalions once again were released to the Navy, and individual divisions had their own integral engineer and pioneer battalions.

Engineer equipment operators played a considerable role in the successful assault across the Pacific. Moving artillery through the jungles, constructing airfields and roads, and building base camps are a few of the many jobs performed by these engineers. These jobs were performed with equipment which is considered primitive when compared to the power and versatility of the equipment in use today. During the first Marine landings on Guadalcanal, only one crawler tractor was brought ashore before the ships of the amphibious force were forced to withdraw. LtCol Henry W. Crockett expressed his thoughts about this tractor and its operator in a letter to the Commandant. "One R-4 bulldozer--actually an angledozer--was landed by the 1st Pioneer Battalion, and the yeoman service performed by this lone piece of power equipment in the hands of one Corporal Cates, its skilled proprietor--no one else was allowed to operate it--seems worthy of a place in the record. Cates drove that dozer from morning till night. He automatically ceased whatever task he was performing when condition RED sounded and headed for the airfield ready to fill bomb craters on the strip. He buried dead Japs, worked the roads and prepared bridge bank seats, cleared the Kukum beach for unloading operations, pulled, tugged, and towed all manner of things. That lovely R-4 finally fell apart like the one hoss shay, never to run again, some time late in October."

Even though they landed without their heavy equipment, this did not prevent the Marines of the 1st Engineers from completing the construction of Henderson Field with captured Japanese equipment. This "can do" spirit was much in evidence during the remainder of the war in the Pacific.

This tradition was carried on by another generation of Marines in the same 1st Engineer Battalion a few years later in the rugged mountains of North Korea (fig 1-1). The Chosin Reservoir Campaign has its own history of self-sacrificing equipment operators. In early November, 1950 as the Marines of the 7th Regiment were advancing toward the Reservoir through a narrow valley, they came under the surprise fire of a Communist Chinese division. Casualties were heavy, and the aid station was exposed to enemy fire. An equipment operator from "D" Co, 1st Engineer Battalion saved the day by pushing a parapet of earth around the wounded. His action in helping to save the lives of his fellow Marines, while operating from the exposed seat of the dozer under enemy fire called for courage of the highest order. For his actions, this equipment operator was awarded the Bronze Star Medal, with combat "V."

This can-do attitude was further enhanced a few weeks later when the engineers were able to construct a temporary airstrip at Hagaru while working in subzero weather on frozen ground. After working man- and equipment-killing hours and assisting in perimeter defense at night, they could feel a great measure of personal pride in the fact that over 5,000 wounded comrades were flown out from this crude airstrip. That so many Marines lived to tell the tale and fight again another day, is a tribute to their efforts.

As the division fought its way out of the trap, toward the sea, their path was blocked by a blown-out bridge on a narrow mountain road, thousands of feet above the valley. A bridge was air-dropped and Marine engineers at the head of the long column of vehicles successfully bridged the gap in the road. At one point the advance was halted and the fate of a large portion of the convoy was in doubt when a dozer almost destroyed the bridge. Hanging by a hairbreadth, thousands of feet above a sheer drop, the cool courage and skill of one equipment operator was demonstrated as he cautiously maneuvered the tractor back onto the bridge. One mistake on his part would have doomed him and destroyed the bridge, stranding the remaining vehicles on the narrow mountain road. He succeeded in saving the bridge and the advance toward the sea continued with the bulk of the division's equipment. There was no turning back for the Marines of the "Fighting First" as they drove through six enemy divisions and subzero cold, a complete combat unit, battered but victorious.



Fig 1-1. A Marine bulldozer of "D" Company, 1st Engineer Battalion, makes a road out of a former mountain trail near Chunchon, Korea.

Marine engineer units in Korea and through the mid 50's continued to use the same basic organization which had been developed during World War II. This changed in the latter 1950's with the advent of the reorganized "M" series Marine divisions. Division engineer battalions were redesignated "pioneer battalions." They were reduced in manpower and equipment to make

them more compatible with helicopterborne operations. Force engineer battalions remained basically the same during this reorganization. The pioneer battalions were tried and tested in training exercises and Marine landings in Lebanon, Cuba, and Thailand during the late 50's and early 60's.

After this period of evaluation, it was decided to beef up these pioneer battalions and return to them the organization title of "Engineers." This redesignation was accomplished during 1964 and once again Marine engineers and their heavy equipment were landing in support of the assault elements of each Marine division.

1-2. MOS 1345, ENGINEER EQUIPMENT OPERATOR

a. MOS description. The Marine who operates Fleet Marine Force engineer construction equipment is known as an engineer equipment operator and has military occupational specialty number 1345. He is commonly referred to as a heavy equipment operator or as an operator of a particular type of equipment, such as crane or dozer operator. His responsibilities include the inspection of equipment before operation, operation of all types of equipment, performing preventive maintenance and lubrication services, and making all authorized first echelon repairs. The equipment in his care may be gasoline- or diesel-engine-powered, self-propelled, skid-mounted, or towed. Generally, this equipment runs the full range of normal civilian construction work including: earthmoving, grading, excavating, drilling, paving, producing aggregate, logging, clearing, operating sawmills, and operating cableways and tramways. In addition to the normal construction operations, he must be familiar with the military aspects of operations conducted by FMF units.

b. Qualification requirements (see appendix I). The description of an engineer equipment operator's responsibilities is quite general. These general responsibilities are divided into qualification requirements which vary according to rank and experience. Naturally, how well an operator meets some of these requirements will depend on what type of equipment his unit has. Generally, a man who serves in an engineer organization will come in contact with the full range of construction equipment. He is more apt to be able to operate a greater variety of equipment than the operator in an artillery unit which has only one specialized type of equipment. The general knowledge portions of the qualification requirements, and effective employment of selected items of equipment will be covered in this course.

c. Promotion (fig 1-2).

- (1) Related MOS's. The engineer equipment operator is just one of the three MOS's in the Construction, Equipment, and Shore Party field which deal with engineer construction equipment. The other two MOS's are the engineer equipment mechanic (1341) and the engineer equipment chief (1349). Mechanics take care of repairs while the equipment chief, GySgt and above is primarily a supervisor, platoon sergeant, or section chief.
- (2) Operator assignments. Once you are assigned to a unit you may become an assistant operator, or the organization may conduct or send you to an operator's training course in order to qualify you for an MOS. Normally, you will be assigned a particular MOS within 6 months. After passing tests on particular items of equipment, you will be issued a Government operator's license for this equipment. You will retain the same MOS, 1345, as you advance in rank from PFC through SSgt. Your responsibilities will gradually increase as you acquire more experience and rank.

- (3) Affects of T/O and T/E on assignments. As a private or Pfc, you will probably be assigned as the assistant operator of a specific item of equipment such as a crawler-tractor. It is your responsibility to learn how to operate and maintain that item. It is also your responsibility to learn about the operation and maintenance of other items, but never neglect the item to which you were assigned. Promotions through the rank of Cpl are dependant upon the table of organization (TO) and your individual initiative and ability. After you have gained experience or have been promoted, you may be assigned as the senior operator for a specific item of equipment or to one of the other jobs related to engineer equipment operation. For example, a Cpl is expected to be able to operate crane-shovel equipment and Sgt's and above operate graders and other more complicated equipment. After becoming an NCO, you may be assigned as the senior equipment operator or section chief. You may also be assigned as company or battalion dispatcher. The dispatcher maintains equipment records, and schedules the operational commitments of all equipment. As a staff sergeant equipment operator, you will usually fill the billet of equipment foreman at a job site, section chief, or platoon sergeant of a heavy equipment platoon or section. Staff sergeant is the highest rank in the 1345 MOS.
- (4) Obtaining a new MOS. After completing recruit training, you will be assigned to a unit and given a basic MOS or to a school that will train you for a specific MOS. The basic MOS for the engineers is 1300. After successful completion of certain schools, certain correspondence courses, or a period of on-the-job training (usually 90 days), privates and above are assigned one of the primary MOS's in the 1300 occupational field (OF). For the purposes of this course, it would be MOS 1345. Once the primary MOS has been assigned, it is retained until the individual qualifies for a higher MOS, is promoted to a rank eligible for a higher MOS, successfully completes a formal school that qualifies him for a higher MOS, or a board of investigation finds him incompetent. After promotion to gunnery sergeant, you change MOS and become an Engineer Equipment Chief, 1349. A chief is capable of filling either an equipment maintenance or operation billet. He is generally the maintenance chief, or platoon sergeant, of a large equipment organization.

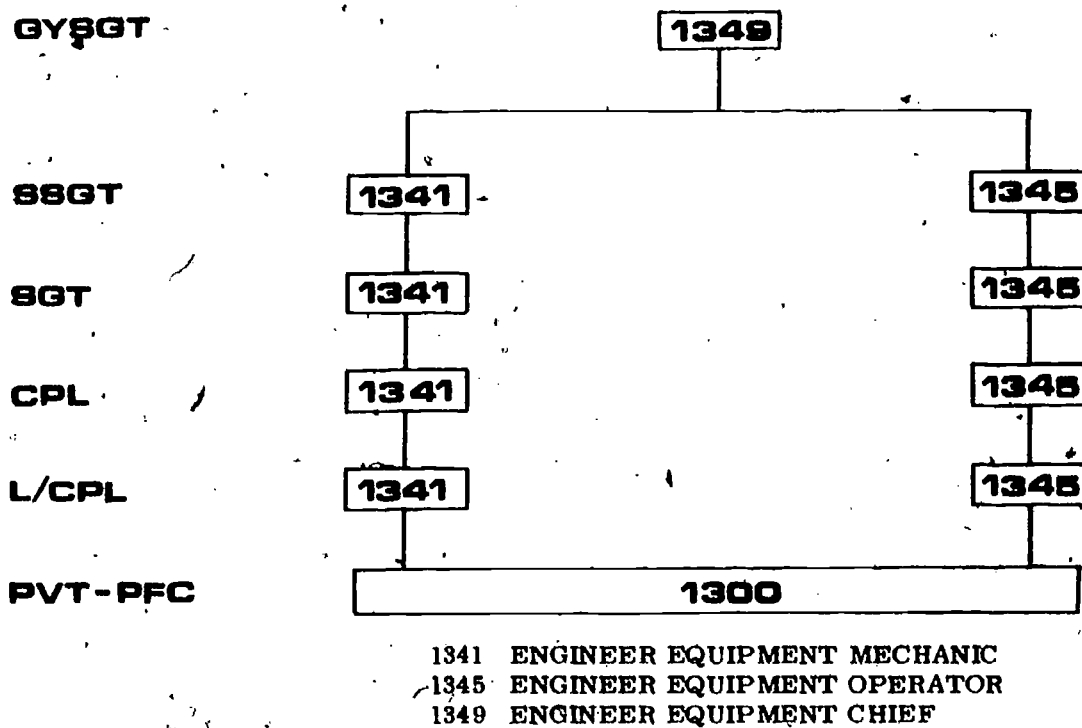

Fig 1-2. Engineer equipment MOS's.

d. Possible duty assignments. There are many units of the Marine Corps that require engineer equipment operators. There are ten typical T/O billet titles to which you may be assigned. Most of these billets for operators are located in the FMF units such as division and force engineer battalions. There are also equipment operator billets in the Marine Corps base units such as base maintenance and Marine Corps Engineer School.

- (1) Division. Each Marine Division has an organic engineer battalion to provide direct engineer support of a temporary nature. You could be assigned to the division to fill any one of the ten typical T/O billets.
- (2) Force troops. There are several units within force troops that require engineer equipment operators. You may be assigned to any of the billets in any of the force units. A force engineer battalion has the largest requirement for engineer equipment operators. This battalion provides general engineer support of a deliberate nature. It usually performs the heavier, more permanent type construction in the rear areas. Force troops usually expand the division engineer jobs and also assist the division engineers when and where needed. Although you will not be assigned to the Navy construction battalions (Seabee's), you may be working with them. They also provide engineer support.
- (3) Marine Corps base. Most of the Marine Corps posts, stations, camps, and bases have personnel to perform the housekeeping duties (maintain them). Some of these have requirements for engineer equipment operators. Some base units also provide training for other equipment operators and require operators for instructors. Some develop and test equipment and require operators to perform the operational tests. You may also meet the requirements needed to perform other type duties at some of the posts and stations.
- (4) Miscellaneous assignments. There are certain duties within an organization for which no specific personnel are assigned. These duties include mess duty, guard duty, and area police. You should perform all duties assigned with enthusiasm, remembering that you are a Marine first and an engineer equipment operator second.

Section II. ENGINEER EQUIPMENT

1-3. INTRODUCTION

Marine Corps engineer construction equipment has kept pace with the constant improvement of similar civilian equipment used in large-scale earthmoving projects. The equipment that you operate may be the same as civilian equipment or it may be further developed, modified, and improved, to meet the requirements of the Marine Corps. Although the equipment and operating principles are the same, you will find that a Marine division generally is assigned lighter equipment than the force troop units. A Marine division moves rapidly and the division engineers will perform only limited construction of a pioneer nature consistent with the mission of the division. The supporting force troop units use heavier engineer equipment and perform more permanent type construction.

a. Developing engineer equipment. Headquarters Marine Corps is responsible for the development of engineer items of equipment for the Marine Corps. The Marine Corps Landing Force Development Center, Quantico, Virginia, under the direction of Headquarters Marine Corps, is responsible for testing the capabilities and developing the techniques for employment of equipment. Data is gathered during the development phase to help determine what equipment will be the most efficient in combat.

b. Modifications and improvements of equipment. Many items of equipment require further changes after delivery to the field to improve their safety, maintenance, or combat performance. A change that will improve a machine is recommended to the Commandant of the Marine Corps (CMC) through the chain of command. A quality deficiency report (QDR) is submitted by the individual that discovers a deficiency, be he Marine or civilian, operator or commanding officer. All personnel are responsible for reporting deficiencies and making recommendations. No modifications will be made until the reports have been analyzed and the modifications authorized by CMC. Such authorization is generally in the form of a modification instruction (MI). An individual who has the ability and initiative to recommend worthwhile equipment improvements reflects credit on himself and the Marine Corps. QDR's and letters recommending improvements are received, analyzed, and considered, but the effect they will have throughout the Marine Corps determines the action CMC takes. Improvement recommendations are desired, but they must be authorized before they are applied to the equipment.

c. TAM and T/E. The table of authorized materiel (TAM) lists all items of equipment and the table of equipment (T/E) lists those items of equipment authorized to a unit to perform its mission. A higher authority may authorize other items, if necessary. There are many items of equipment that you are expected to be able to operate. You cannot comprehend the degree of knowledge and skills that an engineer equipment operator must possess until you have studied the TAM, T/E, and the engineer equipment operator's MOS in detail. For example, the MOS requires that you be able to operate all tractors. There are two basic tractors, the crawler type and the wheeled type. You are also required to operate air compressors, distributors, rollers, and other items of equipment. Plus, for each item that you are required to operate, there may be several makes and models.

d. Types operated by LCpl's and below. Certain items of equipment such as graders, cranes, and sawmills require Cpl's and above for operators. However, the commanding officer may have you assigned to one of these items and trained until you become a qualified operator if a shortage of personnel dictates this. In this course we will discuss only those items required by the MOS and the general information, rather than specific information, pertaining to a specific item of equipment.

1-4. TRACTORS

a. Crawler-tractors. Crawler-tractors are probably the most widely used item of construction equipment. They are rugged, powerful machines which are used in a wide variety of operations, particularly during the early stages of construction. Crawler-tractors in the Marine Corps are divided into two categories, medium and small. The Case MC 1150 scooploader and the Terex 82-30M are classified as mediums and the Case MC 450 is classified as the small tractor.

- (1) Case MC 1150 Scooploader (fig 1-4). This is the latest model of the medium crawler-tractors being used by the Marine Corps. The Case Model MC 1150 full-tracked scooploader is powered by a 2-stroke, 4-cylinder diesel engine manufactured by Detroit Diesel. A single-stage, hydrokinetic-type torque converter is coupled directly to the engine and attached to the transmission by a universal joint drive shaft. All gears are in constant mesh and shifting between gears is accomplished by selective engagement of multiple-disk clutches. A hydraulically controlled 1 3/4-cu yd multipurpose bucket performs excavating and materials-handling jobs. The bucket may also be used as a dozer or scraper in addition to loading operations. The loader is equipped with hydraulic controls and connections for operating a towed scraper. The loader has a 60-in. fording capability.

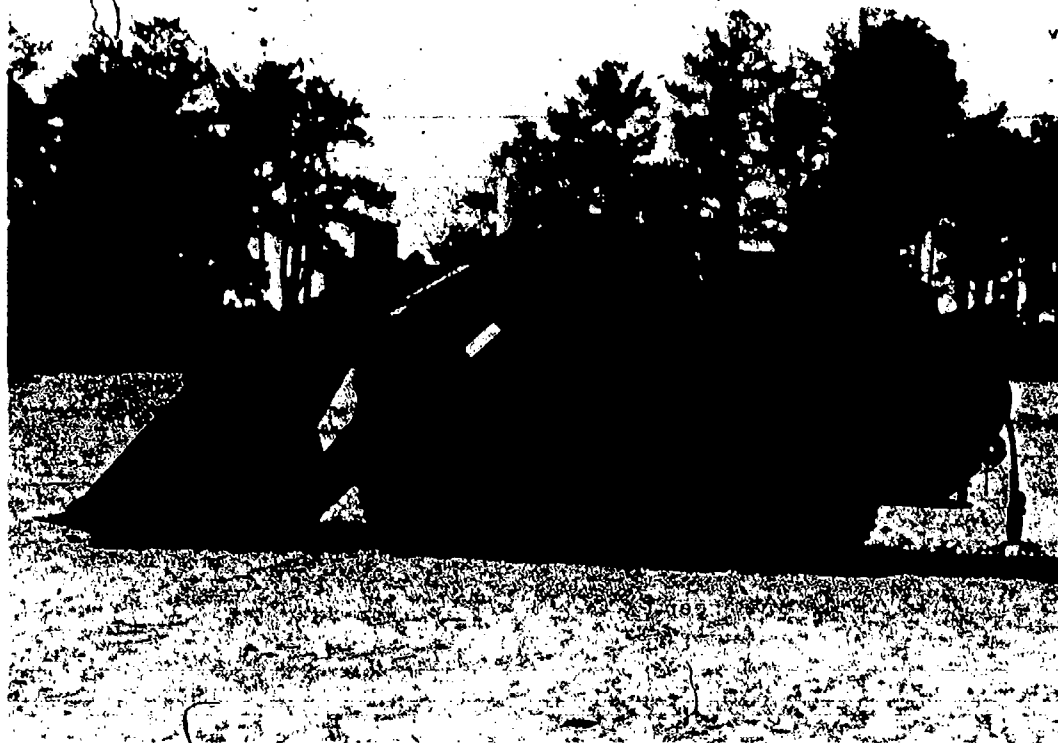

Fig 1-3. Case MC 1150 scooploader.

- (2) Terex 82-30M (fig 1-4). The Terex 82-30M is powered by a 2-stroke-cycle, 6-cylinder, series 71, Detroit diesel engine. The power is delivered to the power train by an Allison Torqmatic transmission which is controlled by mechanical linkage and hydraulics. This tractor uses multiple-disk, oil-cooled, hydraulically controlled steering clutches and brakes; the brakes also have mechanical linkage for engaging. The operating weight of the bare tractor is approximately 43,000 lb. The tractor can be equipped with either of two rear attachments: a hydraulic ripper or a single drum winch (SDW). It is equipped with a bulldozer blade that can be tilted or removed.

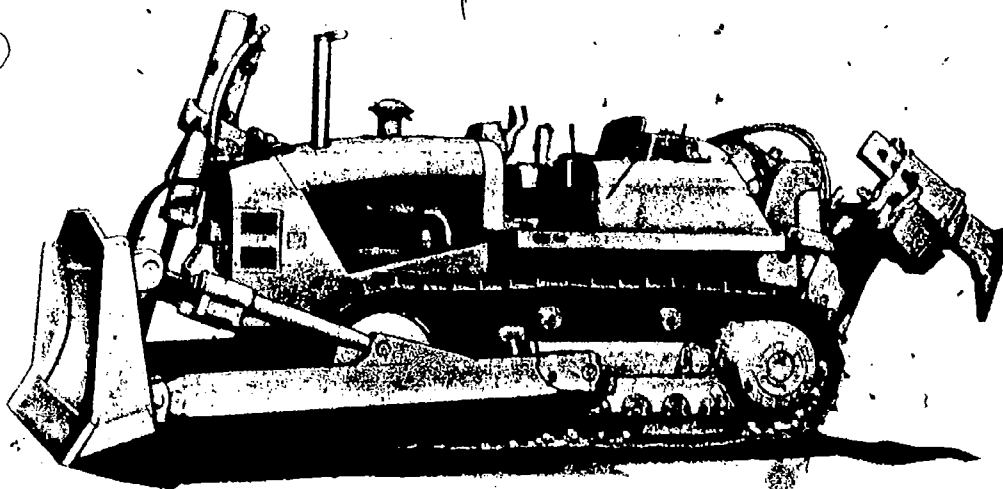

Fig 1-4. Terex model 82-30M crawler-tractor with bulldozer and rippe

- (3) Case MC 450 tractor (fig 1-5). The Case MC 450 tractor is a full-tracked type equipped with a hydraulically operated angle and tilt blade. It is powered by a 4-cylinder, 4-stroke-cycle diesel engine. The tractor may be used as a dozer, power angling dozer, or power tilt dozer. The tractor has a fording capability of 36". Four lifting eyes and ten tiedown loops are welded to the track frame.

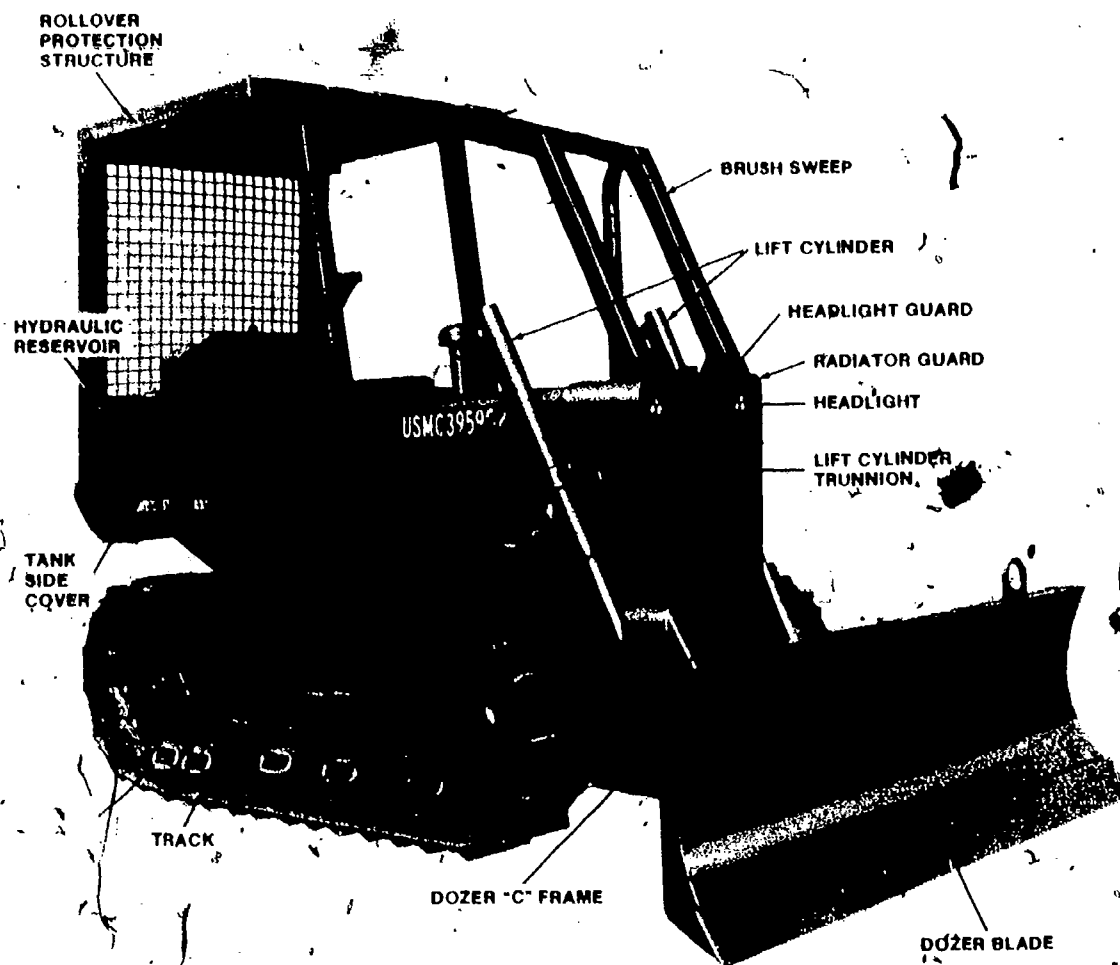

Fig 1-5. Case MC 450 tractor.

b. Wheeled tractors. Following the lead of the civilian construction industry, military construction equipment is showing an increase in the number of rubber-tired tractors. These high-speed tractors can be used for bulldozing, but their primary function is to act as prime movers for towed scrapers. These rigs are employed when it is necessary to move large quantities of earth for relatively long distances.

- (1) MRS-100 (fig 1-6). The MRS-100 is designed specifically for Marine Corps use. It is a 4-wheel-drive, 4-wheel-steer vehicle with a weight transfer. It is designed for general purpose use as a prime mover in combination with a 4-wheel hydraulically operated scraper, and for light dozing, winching, and towing. The vehicle is equipped with an automatic transmission and a ^{71, 4914} diesel engine. It has a hydraulically powered, single-drum winch. It has a limited deep-water fording capability, and can be sectionalized in five units for air transport by helicopter. The tractor is used mostly by division and force engineer battalions. It provides them with a high-speed earthmoving capability when it is teamed with an 8-cu yd scraper.

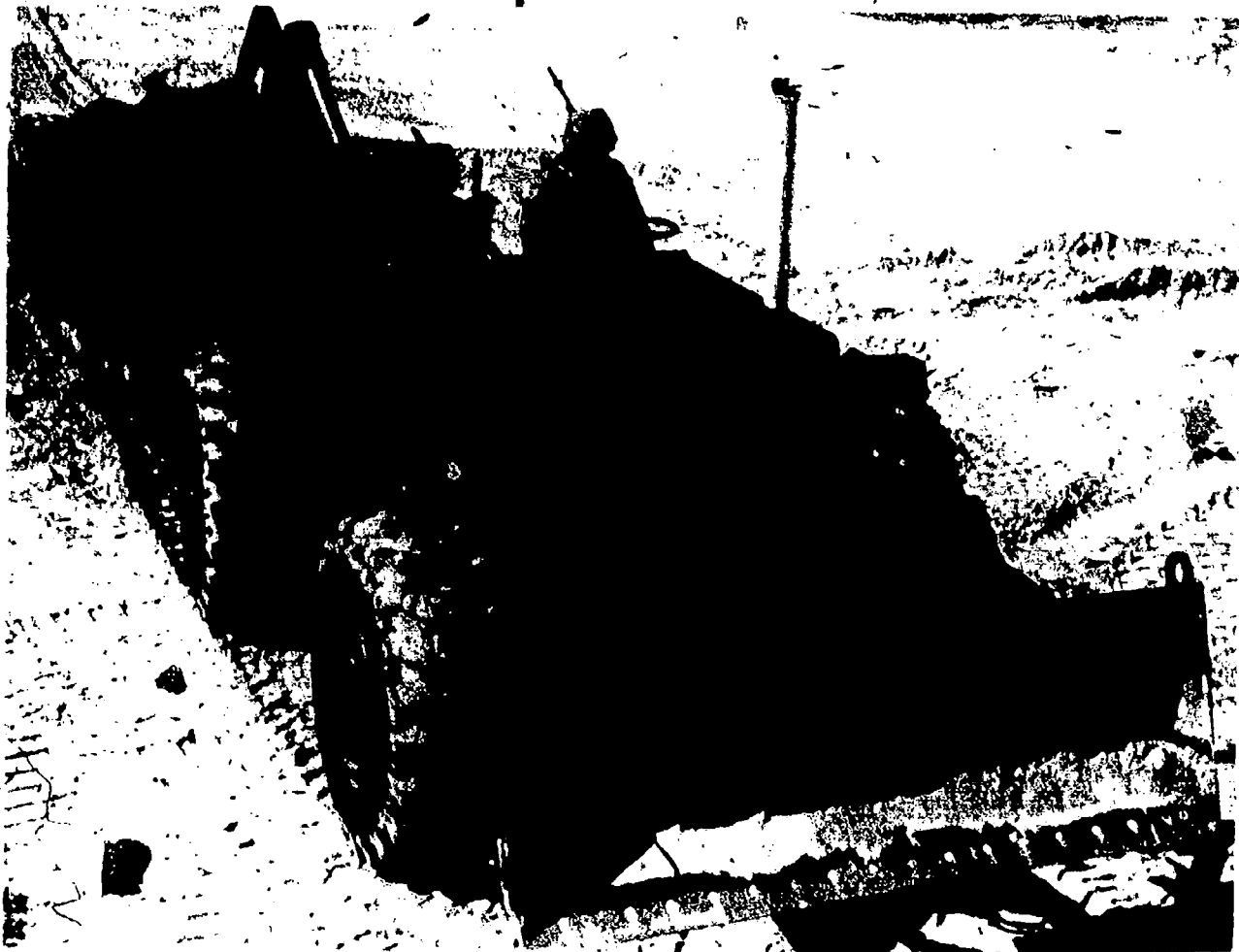

Fig 1-6. MRS-100 tractor and towed scraper.

- (2) MRS-I-100 tractor (fig 1-7). The MRS-I-100 is the latest wheeled tractor in the Marine Corps. This tractor is a four-wheel-drive, four-wheel-steer, 8-cylinder diesel engine, pneumatic-tired tractor designed primarily as a prime mover for towing and in combination with the MRS-105 SM71 scraper. The tractor is capable of being used in fording operations up to a depth of 60 inches. It is equipped with a reinforced pusher block and pottle hook. The tractor may be used as a push tractor for loading operations or as a tow tractor for other towed equipment.

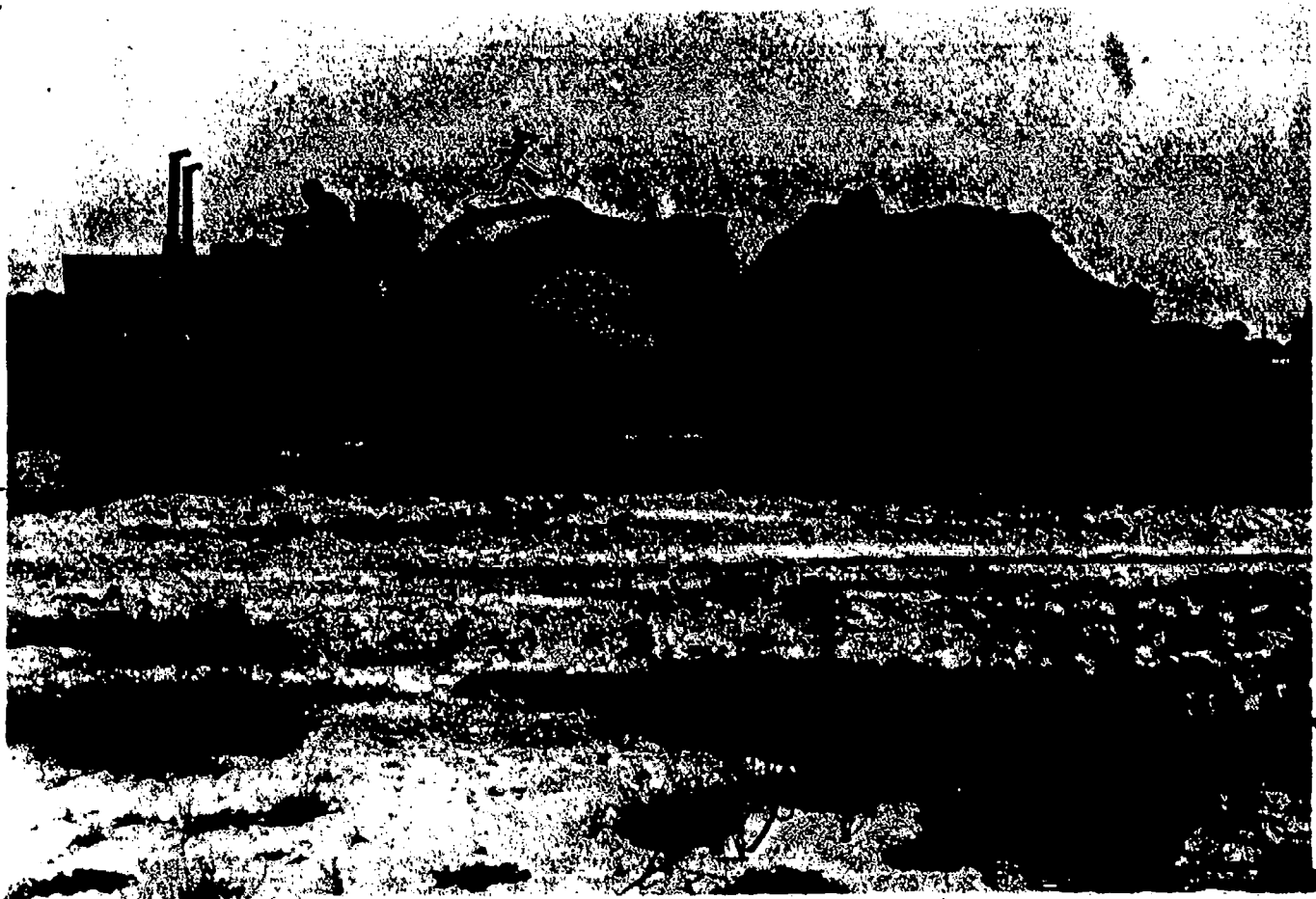

Fig 1-7. MRS-I-100 M71 tractor w/MRS-105 SM71 scraper.

- (3) Case MC 580B tractor (fig 1-8). This rubber-tired tractor is equipped with a hydraulically operated loader and a backhoe. A hydraulically operated earth drill (fig 1-8a) is an attachment that can be used when the backhoe is removed. The tractor can ford 36" of water. This tractor is powered by the same engine as the Case MC 450.

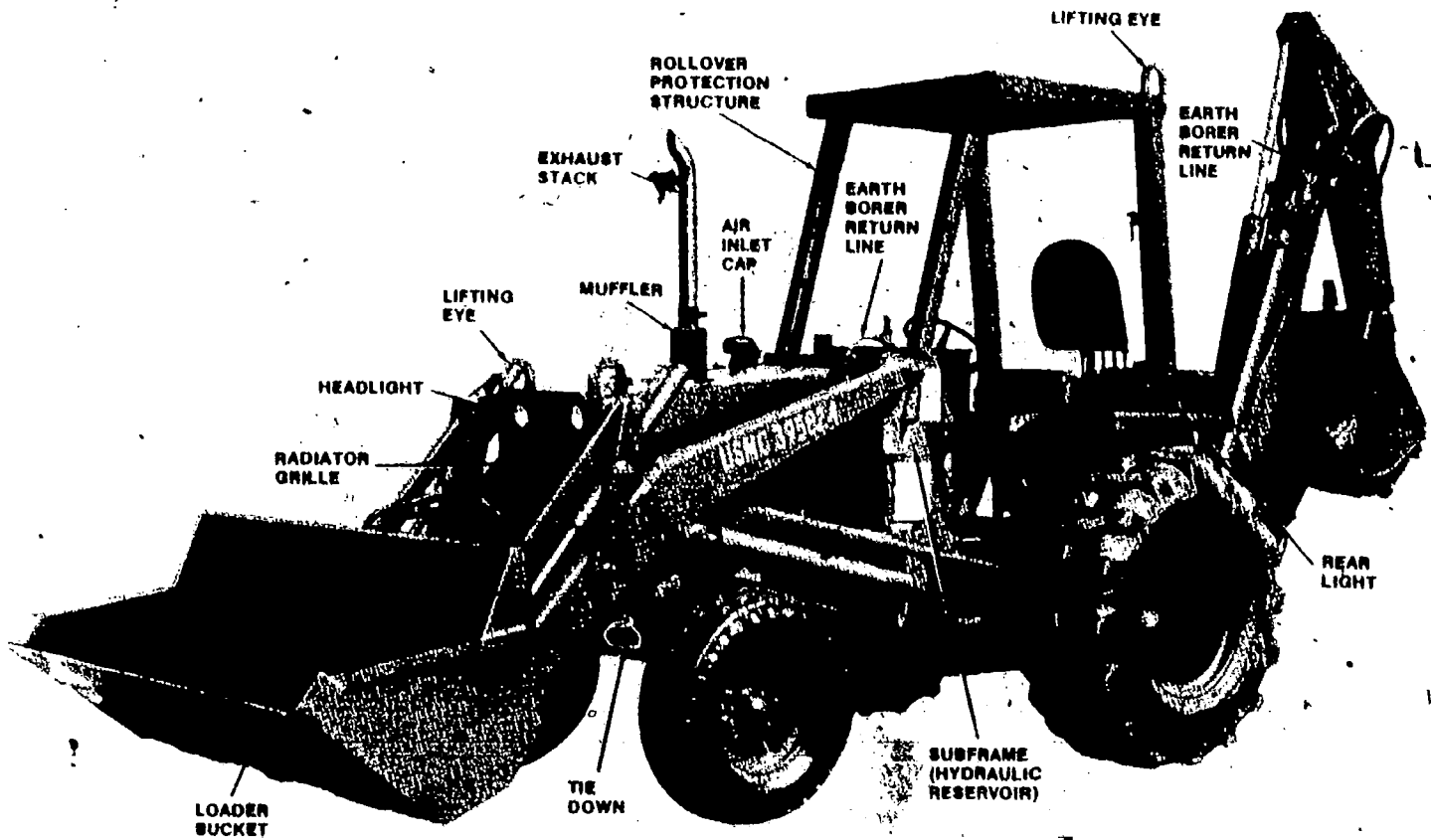

Fig 1-8. Case MC580B tractor.

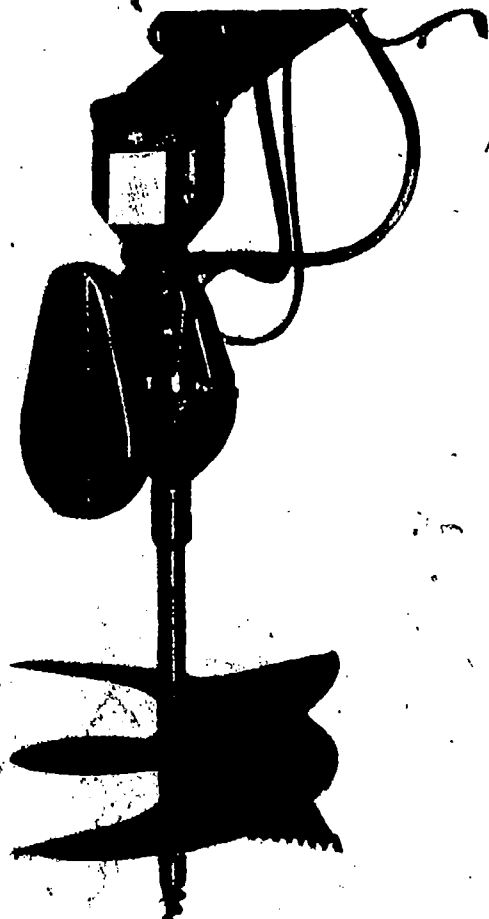

Fig 1-8a. MC580B earth drill attachment.

1-5. TOWED EQUIPMENT

a. Scrapers.

- (1) Introduction. Scrapers are large earthmoving machines which are capable of loading, hauling, and spreading large quantities of earth. The scrapers in use in the Marine Corps are the towed type which must be drawn and operated by either a crawler or rubber-tired tractor. Scrapers and tractors are teamed in various combinations depending on the hauling capacity of the scraper and the pulling power of the tractor. Scrapers are often referred to by their struck carrying capacity, such as 8-yd, 10-yd, and 16-yd (fig 1-9). "Struck" means level with the sides; "heaped" means that the earth is piled higher than the sides on a 1 to 1 slope.



Fig 1-9. Scraper capacities.

(2) Types.

- (a) Model H-82, hydraulically operated towed scraper (fig 1-10). The H-82 has a capacity of 8-cu yd struck or 10 1/2-cu yd heaped and is found primarily in division engineer battallions and force engineer battallions. It may be teamed with either the Case MC 1150 scooploader or the MRS-100 rubber-tired tractor. The scraper is equipped for weight transfer operations and has airbrakes. An additional feature of the scraper is that it has been designed for sectionalization into helicopter-transportable units.

- (b) MRS model 105 SM71 scraper (fig 1-7). This scraper is designed to operate only with the MRS-1-100 M71 tractor, and is hydraulically operated. It is capable of loading, hauling, dumping, and spreading 15 cubic yards struck, and 20 cubic yards heaped. It consists of three main functioning components; bowl, apron, and ejector. It is also equipped with air-over-hydraulic brakes.

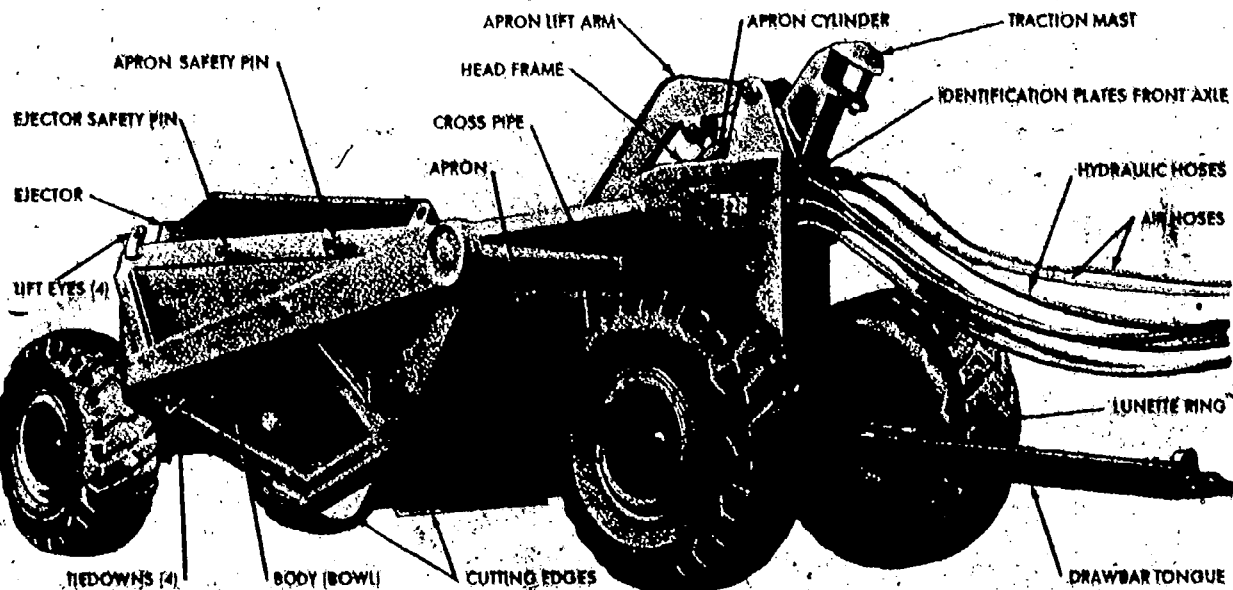

Fig 1-10. Model H-82 scraper.

b. Rollers. Rollers are used for compaction of different types of materials. Each roller compacts different soils at different depths, speeds, and bearing pressures. The types of towed rollers that you will come in contact with are the tamping (sheepsfoot) roller, the 13-wheel rubber-tired (wobble-wheel) roller, and the grid roller.

- (1) Sheepsfoot roller (fig 1-11). This roller consists of a drawbar and a box frame within which two hollow drums with protruding feet are mounted. The drums may be filled with water, fuel oil, used oil, or sand for additional weight.



Fig 1-11. Sheepsfoot roller.

- (2) Pneumatic-tired roller (fig 1-12). The 13-wheel rubber-tired roller consists of a steel box mounted on rubber-tired wheels. There are seven wheels at the rear and six in the front, so arranged that the rear wheels do not track the front wheels. It is also called "wobble-wheel" roller because the wheels do not run true but wobble from side to side. The tires do not have any tread; even new tires are smooth. The open top steel box may be filled with ballast material for additional weight.

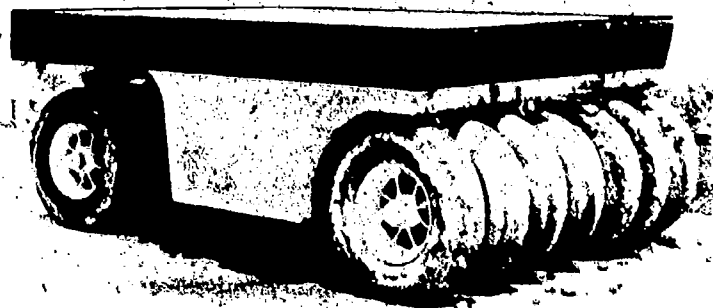

Fig 1-12. Pneumatic-tired roller.

- (3) Grid roller. The grid roller consists of a drawbar and box frame within which two open-face-mesh drums are mounted. Ballast is contained in two containers mounted fore and aft of the rollers.

1-6. TANDEM ROLLER

In addition to the three towed rollers just discussed, the Marine Corps also has a self-propelled, 2-axle, 5- to 8-ton, tandem roller (fig 1-13). It has a single large-diameter drive roll at the front and a single smaller-diameter guide roll at the rear. A 2-cylinder, Detroit diesel engine, located between the rolls, provides the power for roller operation. Dual operating clutch controls are located on each side of the seat to control the direction of travel. It is steered by hydraulics controlled by a lever in the operator's compartment. It also has a 2-speed transmission and dual foot pedal clutch controls. The item weighs approximately 5 tons, but water or other ballasting material can be added to the rolls to increase the weight to 8 tons.

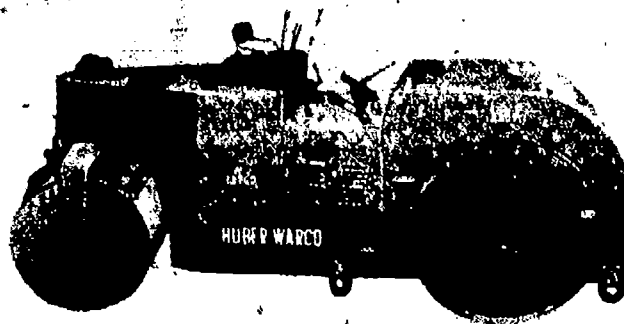

Fig 1-13. Huber-Warco model R6760M 5- to 8-ton tandem roller.

1-7. MATERIALS-HANDLING EQUIPMENT

Materials-handling equipment is used to move bulk or packaged materials. Equipment such as the scooploaders and forklifts are included in this category:

a. Forklifts. There are several types of forklifts used by the Marine Corps and all are designed to handle and warehouse materials. Some are designed to be used over rough terrain and others are designed for use in relatively close areas over smooth, level terrain. Some, such as the Case MC 4000, the RKF-060, and the OS-3354 were designed especially for military use over rough terrain. The other forklifts are commercial types used mostly by supply units.

- (1) Forklift, Case MC 4000 (fig 1-14). This forklift is a rubber-tired forklift designed for handling, transporting, and stacking gear on various types of terrain. It is powered by a 3-cylinder, 2-stroke-cycle diesel engine. It has a lifting capacity of 4000 pounds and can lift up to a height of 68".

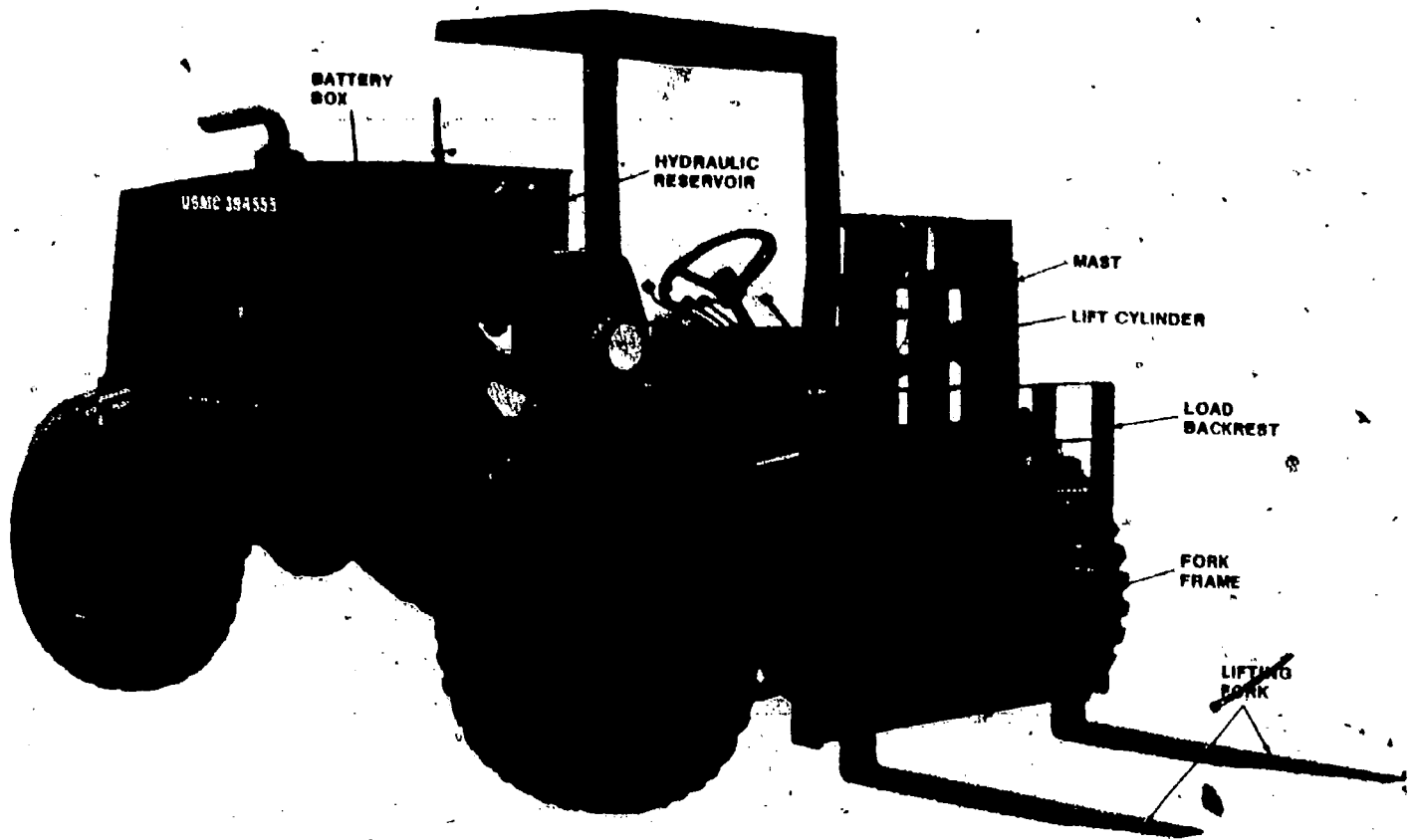

Fig 1-14. Case MC 4000[®] forklift.

- (2) Forklift, 6,000-lb (fig 1-15). The RKF 060 and the OS-3354 are 6,000-lb forklifts for use in landing operations, helicopter operations, and general materials handling under field conditions. They are relatively easy to operate and are extremely helpful in combat situations where large volumes of palletized supplies are being handled. They are not multi-purpose machines; they were designed to be used as forklifts only. They have 3914 series 71 Detroit diesel engines, torqueomatic transmissions, and power steering. They are designed to operate in water up to 5 ft deep. Both the RKF-060 and the OS-3354 have a lift-height capability of 144 inches. While they are similar to the new family of rubber-tired sectionalized construction equipment, they cannot be sectionalized and must land over the beach or by large transport type aircraft.

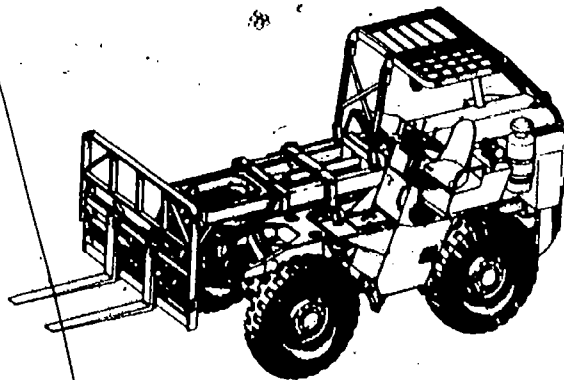

Fig 1-15. Rough-terrain forklift.

(3) Forklift, commercial. The commercial forklifts are supplied by many manufacturers in many different sizes and capacities. An operation and maintenance publication printed by the manufacturer is available for each make and model forklift; be sure to read and understand these publications before attempting to operate or service the commercial type forklifts.

b. Scooploader--Terex 72-31MP tractor w/bucket loader (fig 1-16). This is a 4-wheel drive, hydraulically operated front-end loader powered by a 4-cylinder, series 71, Detroit diesel engine. The 72-31MP scooploader is equipped with articulated steering. Power is transmitted from the engine to the power train through an Allison Toromatic transmission. It is equipped with the Drott 4-in-1 bucket and can also be equipped with the forklift attachment capable of lifting 10,000 lb. Thus this tractor can handle either bulk or palletized material.

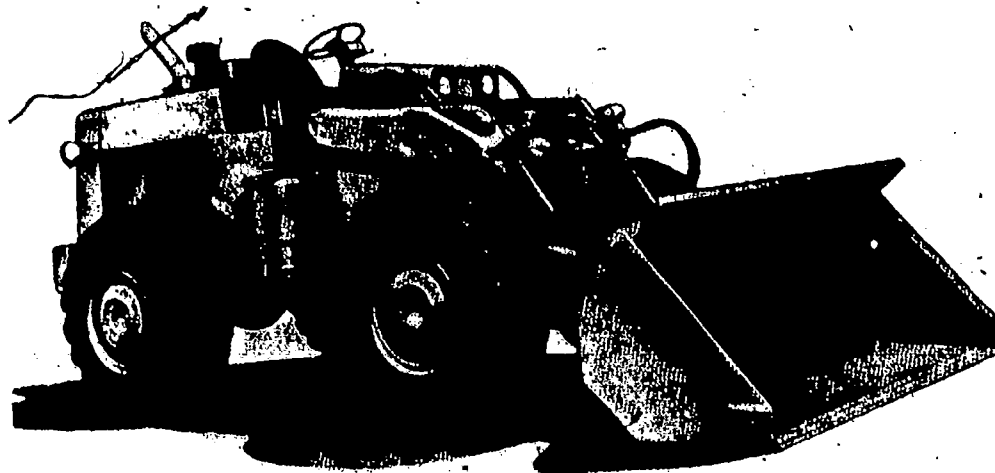

Fig 1-16. Terex 72-31MP tractor w/bucket loader.

1-8. AIR COMPRESSOR

An air compressor is an efficient and versatile tool which can be used during almost all stages of military construction. Compressed air may be used for such jobs as sawing, drilling, spraying, and inflating. It is probably one of the first items of construction equipment that you will come in contact with.

a. Davey rotary 250-cfm air compressor (fig 1-17). This compressor is basically skid-mounted, but it can be, and is, mounted on trailers and trucks. It is powered by a series 53, Detroit diesel engine. It will provide 250 cfm at a discharge pressure of 100 psi. It is an oil-cooled, single-stage, sliding-vane, rotary-type compressor which has fewer moving parts than the reciprocating compressor. This compressor is equipped with a thermoswitch assembly which is located on the discharge side of the Compressor. This thermoswitch is connected to an automatic shutdown control which will stop the engine if the discharge air exceeds 230°F.

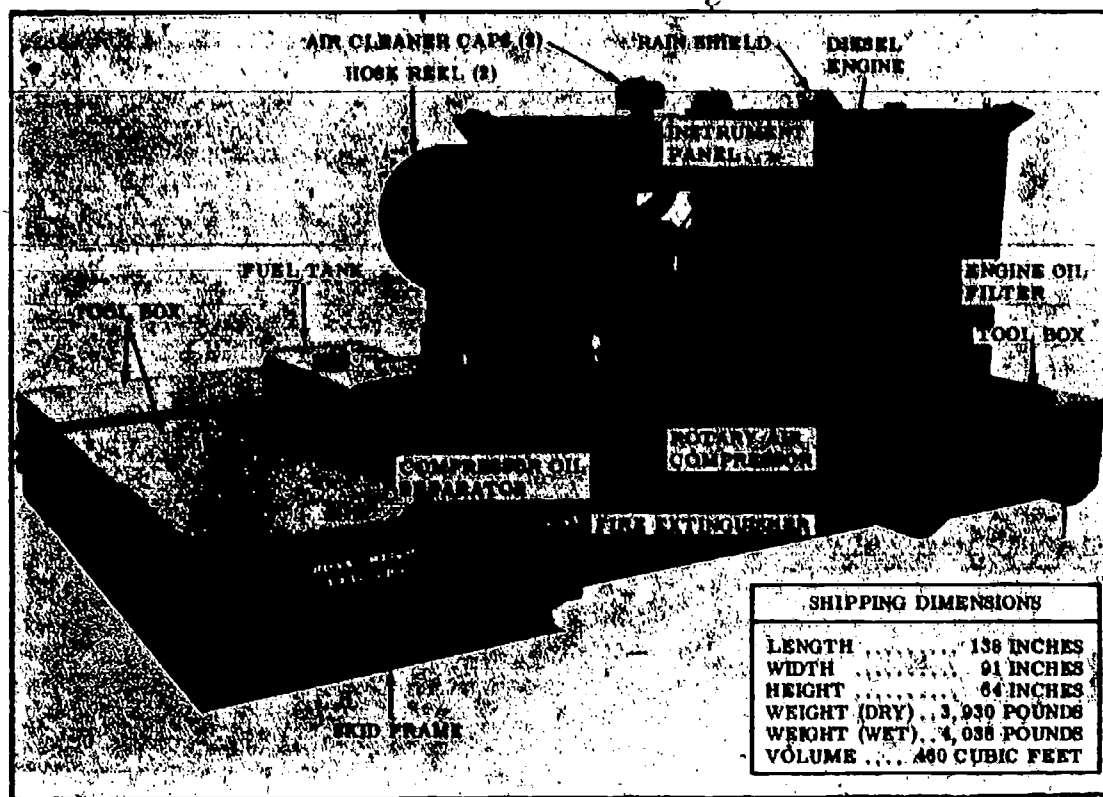

Fig 1-17. Skid-mounted Davey 250-cfm rotary air compressor.

b. Worthington 600-cfm rotary air compressor (fig 1-18). This is one of the latest models of air compressors used by the Marine Corps. It is wheel-mounted, and powered by a Detroit Diesel series 71 engine. It is capable of providing 600 cfm at a discharge pressure of 100 psi for continuous service, or a maximum discharge pressure of 125 psi for intermittent service. The compressor is a single cylinder, sliding-vane, oil-cooled, positive-displacement rotary compressor and is connected to the engine through a friction-disk clutch. An electrically operated shut-down system will stop the engine in case of malfunctions of the engine or compressor. It is equipped with a minimum pressure device to prevent the discharge pressure from dropping below 70 psi. A thermostatic bypass valve assures rapid warmup and optimum performance over a wide range of ambient temperatures.

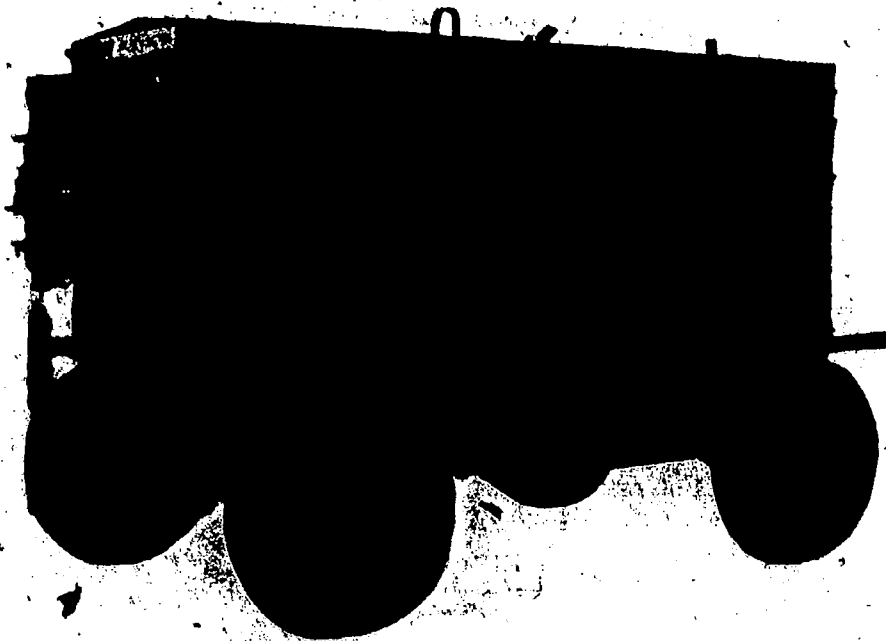

Fig 1-18. Worthington 600-cfm rotary air compressor.

1-9. MISCELLANEOUS EQUIPMENT

There are many more items of equipment that you will come in contact with while serving as an engineer equipment operator in the Marine Corps. Items such as graders and cranes are operated by Cpl's and Sgt's, but you may be assigned to assist them, especially in a combat area where an item is seldom sent out on a job without two men.

Section III. MAINTENANCE

1-10. MAINTENANCE SYSTEM

a. Introduction. The successful accomplishment of engineer missions in garrison, in the field, and in combat depends to a great extent on the proper maintenance of assigned equipment. Maintenance can be described as the action taken to keep material in, or restore material to, a serviceable condition. It includes inspection, testing, servicing, serviceability classification, replacement, repair, rebuilding, and reclamation of equipment.

Every Marine and every unit has certain responsibilities for the maintenance of individual and organizational equipment. The Marine Corps maintenance system establishes a maintenance structure which is designed to assist both the individual Marine and the various units in the Marine Corps in accomplishing their responsibilities in a timely and effective manner. You, as an engineer equipment operator, are a member of the maintenance team, consequently, you should know your responsibilities and their relation to the overall system.

b. Categories and echelons of maintenance: The Marine Corps maintenance system (fig 1-19) is organized into three categories of maintenance: organizational, intermediate, and depot, which are further broken down into five echelons.

(1) Organizational maintenance is the responsibility of, and is performed by, the using unit. Its responsibilities include correct operating, inspecting, servicing, lubricating, adjusting, and replacing of parts, minor assemblies, and subassemblies. Organizational maintenance is the foundation upon which the remainder of the system rests. If using unit maintenance is effective, equipment availability will be good. If organizational maintenance is neglected, equipment availability will be low and it will place a heavy demand on the maintenance capability of higher echelons. Organizational maintenance is broken down into two echelons: 1st, performed by the operator and 2d, performed by the unit mechanics.

(a) First echelon is performed by the user, wearer, or operator. It consists primarily of correct operation, servicing, inspecting, lubricating, and performing minor adjustments. Just as organizational maintenance is the foundation of the whole maintenance system, so 1st echelon or operator services are the foundation of good organizational maintenance. The equipment operator and the services he performs are two of the most important factors in the success of the maintenance system.

(b) Second echelon is performed by specially trained personnel in the using organization, the unit mechanics. It consists primarily of inspecting, performing major scheduled lubrication services, making major adjustments, and replacing parts and minor assemblies. Depending on the organization, 2d echelon maintenance services may be performed either at company level or in centralized battalion maintenance shops. While the mechanic is responsible for parts replacements, both the operator and mechanic will generally combine their efforts in performing scheduled preventive maintenance services and making adjustments.

(2) Intermediate maintenance is authorized and performed by a designated maintenance activity in direct support of the using organization, or by higher echelon maintenance units supporting the direct-support maintenance activity. It is normally limited to the replacement and repair of parts, subassemblies, and major assemblies. When necessary, intermediate maintenance units support lower echelons by providing technical assistance, mobile repair crews, and repair parts. Intermediate maintenance consists of 3d and 4th echelons of maintenance.

Third and fourth echelon is performed by the Force Service Support Group in direct support of the Division, Wing, and Force Engineer Battalion. Third echelon maintenance shops have the necessary special tools, machine shops, mechanics, and repair parts to perform more specialized maintenance than the using units. Fourth echelon maintenance is the highest level of intermediate maintenance, and any equipment requiring more specialized repair or complete rebuild is forwarded to the last category of maintenance, depot.

- (3) Depot maintenance consists of a single echelon of maintenance, 5th. It normally supports the supply function by rebuilding and returning to stock, parts, subassemblies, assemblies, or the whole item of equipment on a scheduled basis. Fifth echelon maintenance is generally performed at the two Marine Corps Logistic Support Bases located at Albany, Georgia and Barstow, California or by civilian contractors. Specific authorization may be granted for deployed organizations to perform limited 5th echelon repairs.

CATEGORY	ECHOLON	UNIT	PERSONNEL	RESPONSIBILITIES
ORGANIZATIONAL (USING UNIT)	1 st	COMPANY	OPERATOR	INSPECTION, LUBRICATION, ADJUSTMENT OPERATION
	2 ^d	CO. OR BN.	MECHANIC	REPAIR OR REPLACE PARTS, MINOR ASSEMBLIES; INSPECTION, SCHEDULED PM, MAJOR ADJUSTMENT
INTERMEDIATE	3 ^d	FORCE SERVICE SUPPORT GROUP	MECHANIC	REPAIR OR REPLACE PARTS, SUBASSEMBLIES OR MAJOR ASSEMBLIES
	4 th		MECHANIC	REPAIR OR REPLACE PARTS, SUBASSEMBLIES OR MAJOR ASSEMBLIES
DEPOT	5 th	LOGISTIC SUPPORT BASES	MECHANIC	OVERHAUL AND REBUILD, RETURN TO STOCK

Fig 1-19. Maintenance System.

c. Factors affecting maintenance echelons. The echelon of maintenance at which a particular repair or replacement is going to be performed depends on a number of factors. These include the combat situation, the nature of the repair, the time available, the number and skills of the available mechanics, and the availability of tools, test equipment, and repair parts. Repair is performed by the lowest echelon of maintenance which is capable of performing it. Higher echelons of maintenance perform the category of maintenance which is assigned to their units. They also perform, within their capabilities, the overflow maintenance of the supported using units. The lower echelons of maintenance should not attempt to perform repairs which are assigned to a higher echelon. This generally leads to cannibalization of equipment and usually

causes the lower echelon to neglect the work that is their primary responsibility. The effectiveness of the maintenance system depends on how well the men at the various echelons know and perform their own responsibilities. The breakdown of individual responsibilities within the system provides for a balanced workload, and there is generally more than enough work at all levels to keep everyone busy.

d. Example of maintenance system operation (fig 1-20). An equipment operator from engineer support company, division engineer battalion, noticed that when he inspected his Terex B3-30M crawler-tractor for the past few mornings that there has been a puddle of heavy dark oil beneath his tractor. He records the information about the leak on his operational record, and also verbally informs his section chief and the dispatcher. The dispatcher notifies the maintenance chief and the unit mechanics inspect the tractor, confirm a leaking seal, and write up a work order. The tractor is serviced, all organizational maintenance performed, and then is forwarded to 3d echelon maintenance, the division service battalion. Knowing that the work is beyond their capability, they in turn forward the tractor and work order to the FSR, which performs the work and returns the tractor and completed work order back through the various echelons of the maintenance system to the using unit.

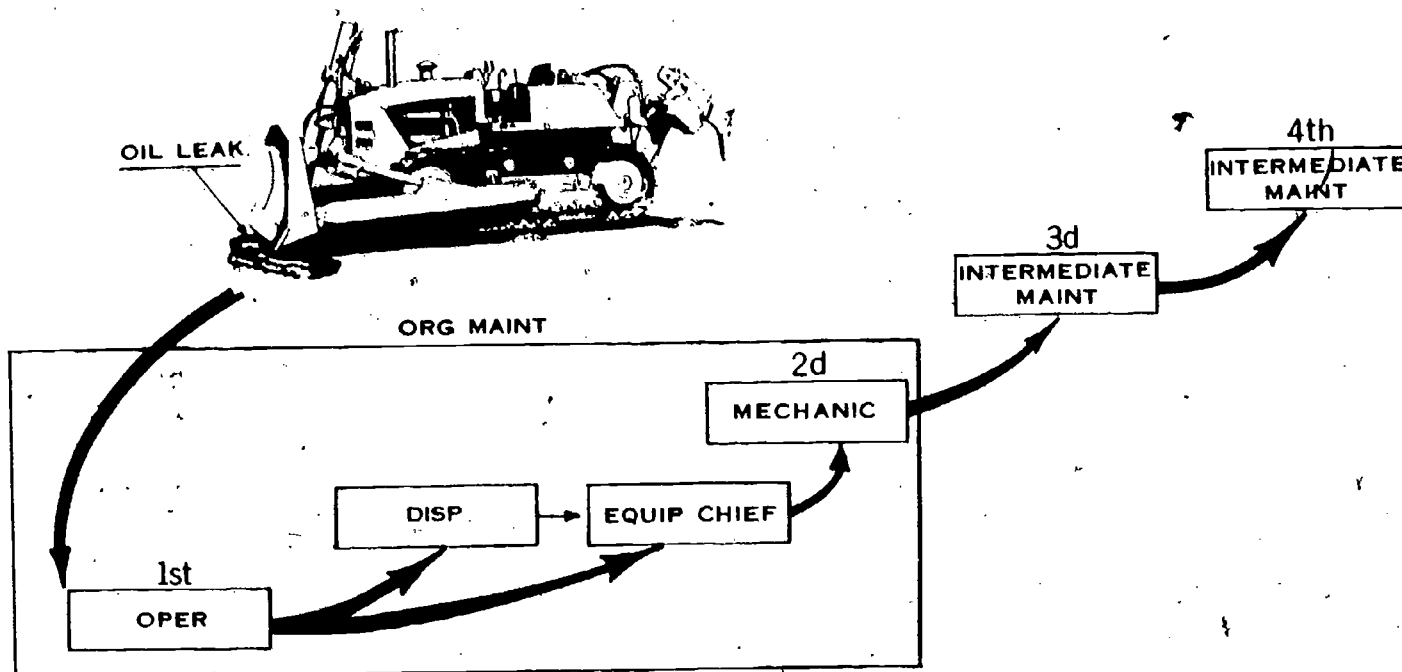

Fig 1-20. Equipment repair flow.

1-11. OPERATOR'S MAINTENANCE

a. Importance. The operator of engineer equipment is the most important person in the accomplishment of proper preventive maintenance. The maintenance system will be effective only when it rests upon a firm foundation, and it is the operator through his 1st echelon maintenance who provides this foundation. Operators must take the same care of their engineer equipment as they do their individual equipment. The successful accomplishment of engineer missions in support of combat units depends on the availability of engineer equipment. If the equipment is deadlined because of a lack of operator preventive maintenance, engineer support capability will be correspondingly reduced. The supply routes and airstrips which are not completed when needed may cause the loss of the battle.

b. Operator's assignment and knowledge of equipment. If at all possible, a regular operator is assigned to each piece of equipment. Generally, new or inexperienced operators will be assigned as an assistant to qualified operators and, after they have mastered the operation and preventive maintenance procedures for a particular type of equipment they will be assigned their own piece of equipment. An operator must become as familiar with the nomenclature, functioning,

operation, lubrication, and adjustment of his equipment as he is with his rifle. Operator training will generally proceed from the equipment which is easily mastered (tractors and stationary equipment) to the equipment which requires a greater degree of skill and experience (crane shovels and motor graders). If it is not possible to assign one operator to each piece of equipment, one operator may be responsible for the preventive maintenance of several items of equipment. Each item of equipment must have one person who is responsible for its maintenance.

c. Operator's responsibilities. It is the operator's responsibility to perform specific daily and scheduled preventive maintenance services on his assigned equipment and to insure that it is in proper operating condition. Proper operation takes in not only the actual working of equipment, but also the observance of safety rules and traffic regulations. Improper operation and disregard of these regulations are abuses of equipment. Excessive speed ("cowboying") is an example of this. Bouncing and bumping over rough terrain causes undue strain on the equipment and endangers the operator and other men working in the same area. If the operator notices something wrong with his equipment, he is responsible for stopping operation and bringing the defect to the attention of his immediate superior. Operator's preventive maintenance procedures include daily services, scheduled lubrication services, and assisting the unit mechanics in performing quarterly services. To insure that these services are performed at the proper time, a system of records and forms is used by the operator to record his services to his equipment. The completion of these forms is one of the operator's primary duties.

1-12. PREVENTIVE MAINTENANCE SERVICES

a. Lubrication and maintenance intervals. Each item of engineer equipment will have recommended normal intervals for servicing, inspecting, lubricating, adjusting, and cleaning of specific points. Always remember that the recommended intervals designate only the normal intervals at which particular maintenance or lubrication procedures are to be performed. Under abnormal conditions, storage, or continuous heavy service, the using organizations are responsible for adjusting these intervals as experience indicates. Although the recommended intervals may vary between different models and types of equipment, they will usually consist of two categories: calendar and operating time.

(1) Calendar intervals. Calendar intervals may be designated by various symbols but basically they all indicate the minimum frequency of performance of particular services at specified calendar intervals. These usually consist of daily, weekly, monthly, quarterly, semi-annual, and annual intervals. One method of indication is by the letter symbols shown at the right.

Calendar Intervals

D	Daily
W	Weekly
M	Monthly
Q	Quarterly (every 3 mo)
S	Semiannually (every 6 mo)
A	Annually

(2) Operating time intervals. Operating time intervals are designated by the hourmeter or actual operating time. The numbers indicate the minimum frequency for performing particular services. One method of indicating operating time intervals is shown at the right.

Operating Time Intervals

8	8 hr
25	25 hr
50	50 hr
100	100 hr
125	125 hr
150	150 hr
175	175 hr
200	200 hr
300	300 hr
500	500 hr



- (3) Combination calendar and operating time intervals. You will usually find that many individual services or lubrication points will be assigned both a calendar and an operating time interval. When two symbols are assigned to a service, it will be accomplished promptly upon the expiration of whichever interval elapses first. For example, if the engine crankcase oil change was assigned a calendar interval of quarterly and an operating time interval of 100 hours, and the piece of equipment is operated 100 hours in 2 months, the crankcase oil would be changed at the 100-hour interval. If the piece of equipment operates only 50 hours during the 3-month calendar interval, the crankcase oil would be changed upon the expiration of the calendar period.

b. Types of service.

- (1) Daily "A" service. Daily preventive maintenance services are the responsibility of the individual equipment operator (the user). They are performed in accordance with the checklist on the back of the Engineer Equipment Operational Record, NAVMC 10523 and the information contained in the equipment technical manual (TM). Specified services are performed before, during, and after each operating period. Services are scheduled and performed on standby or stored equipment at periodic intervals (weekly) to make sure it will be ready when needed.
- (a) Before-operation services. These services are performed on equipment before it is started. The purpose of this check is to determine whether or not the condition of the equipment has changed since the equipment was last operated. Many things can happen between service checks. Tires may be deflated; freezing may have occurred; or engine oil, water, or fuel may have leaked out. This service should never be omitted no matter what piece of equipment you are assigned to. It only takes a few minutes to insure that the equipment is ready to go. The man who runs out of fuel while out on a job has no one to blame but himself. If you find that your equipment is defective or damaged, you should report it to the dispatcher immediately.
- (b) During-operation services. During the time the equipment is being operated you should be alert to detect any unusual or unsatisfactory performance. Unusual noises or odors, abnormal gage readings, and steering irregularities are examples of things which should be reported on the Operational Record. If there is an indication that your equipment is not functioning properly, you should stop operation immediately. Check out the malfunction and either correct it or report it to the equipment foreman or dispatcher. Reporting malfunctions promptly will enable the equipment to be repaired before more extensive damage occurs, thus saving both man-hours and money.
- (c) After-operation services. These services are performed in order to make sure that the equipment is ready to go at a moment's notice. The operator refills the fuel tanks and then inspects the equipment to determine if any damage occurred during operation. Any assemblies that require inspection or service while still at operating temperature are taken care of as soon as possible after parking the equipment. All defects and irregularities that developed during operation are noted on the Operational Record. It is good practice to inform the dispatcher of these troubles when you turn in the Operational Record at the end of the day. This will assist the mechanics in correcting small troubles before they become big problems. An operator should become so used to performing these daily "A" services, that they become second nature to him.
- (2) Lubrication "I." service. Construction equipment, military and civilian, requires extensive lubrication at prescribed intervals. These services are performed by the equipment operator with the assistance of the unit mechanics, if necessary (such as when the operator does not have the necessary tools). The lubrication services are performed in accordance with lubrication instructions contained in the individual equipment TM. Because these lubrication services are so extensive and time intervals for lubrication of specific points vary, it is good operator practice to have a TM on hand whenever you lubricate your equipment. After operating one type of equipment for a long time, you will become thoroughly familiar with these lubrication points and time intervals. Remember, however, that every time you are assigned to a different type of equipment that the TM should become your lubrication guide.

(a) Scheduling of "L" services. Lubrication intervals vary between different models and types of equipment. Because of this, the services are scheduled on the Consolidated Engineer Equipment Operational Log and Service Record (NAVMC 10524), which is maintained for each piece of equipment. Space is provided on the form for recording and scheduling oil changes and lubrication services which are due weekly, monthly, or after specific periods of operating time.

(b) Procedure. Before dispatching any equipment, the dispatcher checks the Operational Log and Service Record to see if a lubrication service is due. If so, he enters the necessary information on the Operational Record (Trip Ticket). Then, you, as the operator are responsible for performing the scheduled service on the equipment before leaving the equipment pool. After performing the required services, make sure you record the fact on the trip ticket. This will enable the dispatcher to maintain accurate lubrication schedules, preventing either over- or under-lubrication. Effective lubrication service scheduling depends on accurate records.

(c) Lubrication Information.

1. Technical manuals. The equipment TM contains lubrication instructions and charts, and a detailed explanation of the services to be performed on a particular item. Information includes the point of lubrication, hour or time interval, and the type and quantity of lubricant to be used at different temperatures. You should always use the TM as a guide when lubricating your equipment.
2. Lubrication instructions (fig 1-21). The upper portion of the lubrication instructions, sometimes called the lube order (LO), is devoted to lubricating oils. It provides you with information concerning the uses of various military specification oils, their application, filling and changing intervals, capacity, and the grade or weight of oil to be used during different temperature ranges. The lower portion covers the various types of greases, the points at which they are used, the interval at which they are applied and, in some cases, the number of grease fittings (2). Information concerning filter element changing is provided at the lower left of the instruction. On the LI are two charts (see fig 1-22) showing the location of the service points, hourly service schedule, and the type of lubricant. It is worth noting at this point that the engine oil filter elements are changed at the same hourly intervals that the engine oil is changed. This will be true for most of the equipment you will be operating.

KEY

SYMBOL	LUBRICANT AND APPLICATIONS	EXPECTED TEMPERATURES			INTERVALS		NOTES
		ABOVE +32°F	+40°F TO 0°F	+10°F TO -25°F	SYMBOL	INTERVAL	
OE	OIL, Engine Main engine crank- case	SAE30 MIL-L-2104B NS 9110			D 25 50 100 200 600 1500	Daily 25 hours 50 hours 100 hours 200 hours 600 hours 1500 hours	
	Transmission, torque converter, hydraulic system	SAE 10 MIL L-2104B NS 9110		OES Oil, Lubrication, engine, Sub zero MIL-L-10295A			
	Winch gear box and adapter	SAE50 MIL-L-2104B NS 9110	SAE10 MIL-L-2104B NS 9110				
GAA	GREASE, Automotive and Artillery Drain plugs, wire ropes, controls, tracks, pivot axle	MIL-G-10924B					
GO	LUBRICATION OIL, Gear Final drive gear boxes	SAE 90 MIL-L-2105B					
HB	BRAKE FLUID, Automotive Brake cylinders	FED-VV-H-910					

NOTES

1. CRANKCASE. Drain only when oil is hot. Refill to "FULL" mark on oil level gauge. Run engine a few minutes and recheck level. Add OE if necessary. Check level daily and fill as necessary. Replace oil filter element each time oil is changed.

2. TRANSMISSION. Check oil level daily. Add OE as necessary. Drain only when oil is hot. Clean suction screen and breather filter and replace pressure filter cartridge at 600-hour intervals and at each oil change. Remove oil level gauge to promote faster drainage.

3. UNIVERSAL JOINTS. Open floor plate and rotate drive shaft for access. Do not use high pressure gun on these fittings. Seals will rupture under pressure.

4. HYDRAULIC RESERVOIR: Check level daily and add OE as necessary. Clean area around filler cap thoroughly before removing. Drain only when oil is hot. Clean filter screen and replace return filter cartridge at 600-hour intervals and with each oil change.

5. WINCH BRAKE SHAFT BEARINGS: Three lube points, two external and one internal. Rotate brake shaft so plugs in each bearing guard are accessible from below winch drum. Remove plugs, install fittings and pump in grease until clean grease shows around bearing guard. To grease third shaft bearing, release winch brake, remove cover and gasket from left side of winch and remove brake drum. Grease bearing in same manner as external bearings. Wipe away all excess grease and replace plugs.

Fig 1-21. Lubrication instructions for the Case MC1150 Scooploader.

LUBRICANT • INTERVAL

INTERVAL • LUBRICANT

LUBRICANT • INTERVAL

INTERVAL • LUBRICANT

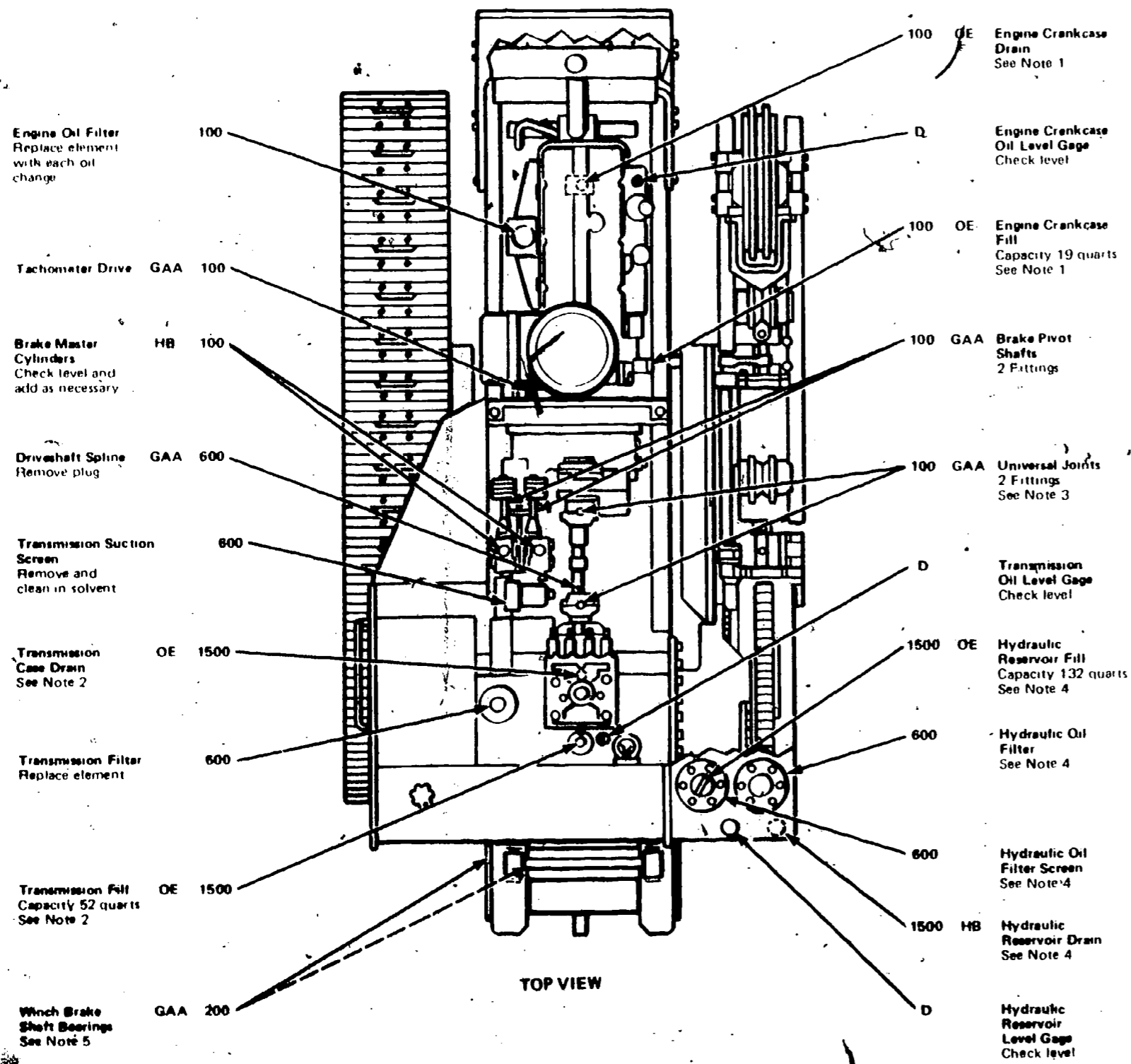

TOP VIEW

KEY

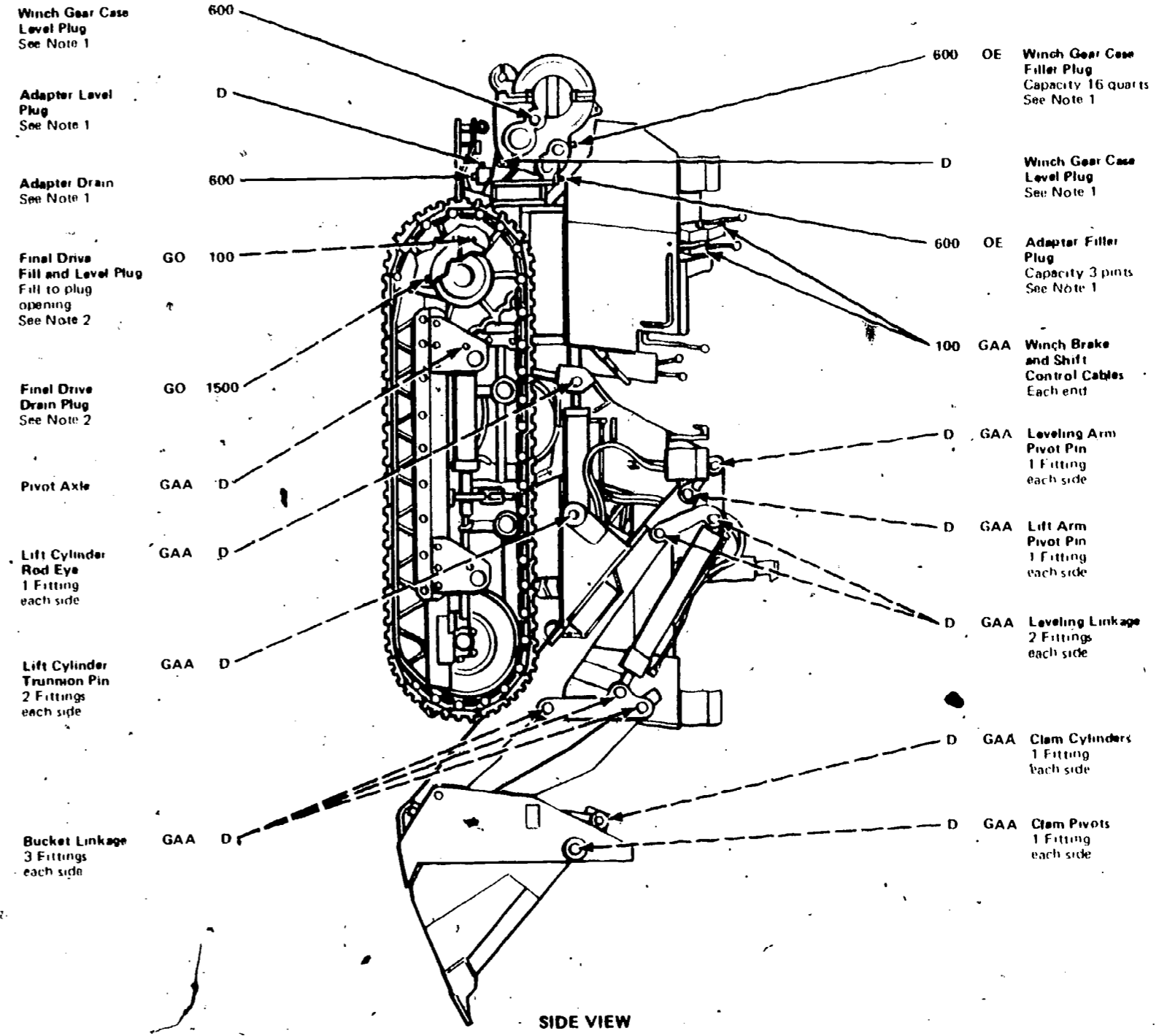

SIDE VIEW

NOTES

1. WINCH GEAR CASE AND ADAPTER: After initial 40 hours of operation, drain oil from both locations and refill with new oil (16 qts. in gear case and 3 pints in adapter). Thereafter, change oil in both locations every 600 hours. Check level daily by removing level plugs. Add or refill through plugs at top of housings, while level plugs are removed.

2. FINAL DRIVES: Check level every 100 operating hours and add GO as necessary to level of filler opening. Drain only when oil is hot.

Fig 1-22. Lubrication Chart.

(3) Quarterly "Q" service.

- (a) Purpose. This service provides for a detailed inspection and the cleaning, tightening, adjusting, and lubrication of each piece of equipment to insure trouble-free operation until the next quarterly check. The service is quite extensive and will generally be performed in the area of the maintenance shop. The equipment operator assists the mechanics in making the check because he is the one who is most familiar with the particular item of equipment. Many of the services which are performed during the check come primarily under the operator's responsibility. Also, during the check, the operator will become familiar with performing those adjustments and repairs which are normally handled by the unit mechanics. This experience will be extremely valuable when he is operating his equipment alone or when he is attached to a deployed unit. An experienced equipment operator should be capable of installing his "mount out" spare parts when attached to a deployed unit.
- (b) Description and recording of quarterly service. Quarterly services are scheduled preventive maintenance services which are performed by 2d echelon maintenance personnel, the unit mechanics, assisted by the operator. This service is performed in accordance with the checklist on the Work Sheet for Preventive Maintenance and Technical Inspection of Engineer Equipment (NAVMC-10562) and the data provided by the equipment TM. As the maintenance is performed it is checked and/or noted on the form. The form is filed in the record folder and maintained as a record until the next quarterly service is performed and recorded. The preventive maintenance roster (NAVMC 10561) is also updated as the maintenance is performed.

1-13. RECORDS AND FORMS

a. Introduction. In the preceding paragraph we discussed the various classifications of preventive maintenance services and mentioned how important it is that these services be accurately scheduled and recorded. This paragraph will briefly cover those records and forms which you will be dealing with as an engineer equipment operator. More information can be obtained by taking MCI course Engineer Forms and Records.

b. Operator's license (fig 1-23). The operator's license, Standard Form 46, states the type of equipment you are qualified to operate. No engineer equipment may be operated by any person who does not have a valid operator's license for that particular item of equipment. Student operators should be issued a learner's permit consisting of an SF 46 with "LEARNER" indelibly stamped across the face, and the specified equipment placed on the reverse side. After passing the required organization test, written and/or oral and practical, the operator will be issued a regular SF 46 stating what equipment he is now qualified to operate. Military licenses are valid for 3 years and must be renewed at the end of that time. The front portion of the license must be signed by both the licensing officer and the operator. The rear portion of the license must be signed in the appropriate space by the qualifying official, generally the equipment foreman or chief. You must have your operator's license in your possession whenever you are operating or performing preventive maintenance on your assigned equipment. The license may be revoked at the discretion of the commanding officer.

U.S. GOVERNMENT MOTOR VEHICLE OPERATOR'S IDENTIFICATION CARD				007097
NAME OF OPERATOR				DATE ISSUED
COL. ROBERT D.				2 Sept. 75
SEX				DATE EXPIRES
M				2 Sept. 78
BIRTH DATE	COLOR OF HAIR	COLOR OF EYES	HEIGHT	WEIGHT
25 Nov. 40	Flord	Hazel	74"	183
BIRTHPLACE		SOCIAL SECURITY NO.		
GEORGIA		435 56 7779		
The holder of this card is authorized to operate U.S. Government vehicles and/or equipment specified on the reverse side. This license is valid for the period shown on the reverse of this card.				
SIGNATURE OF OPERATOR				
R.A. CHEEVER				
NAME AND LOCATION OF ISSUING UNIT				
SPT CO H&S BN MTC FLT 3rd FSR				
NOT TRANSFERABLE				
Card must be carried on all items of the equipment specified on the reverse of this card.				
Signature of Issuing Official				
[Signature]				

Front

VOID IF LAMINATED		
QUALIFIED TO OPERATE		
TYPE VEHICLE AND/OR EQUIPMENT	CAPACITY	QUALIFYING OFFICER
RKT - 060	6,000 lbs	[Signature]
KOEHRING CRANE, 2N		[Signature]
ROAD GRADER	1254550	[Signature]
OTHER RECORDS (OPTIONAL)		

Back

Fig 1-23. Standard Form 46.

c. Engineer Equipment Operational Record, NAVMC 10523 (Rev 10-64) (fig 1-24).

- (1) Purpose. The operational record or trip ticket, as it is often called, is the operator's authorization for the use of a particular piece of equipment, on a specific date, at a specific time, and at a definite location for a particular task or job. The rear portion of the form is used to record the performance of daily "A" operator preventive maintenance services. Lubrication "L" services are recorded on the front.
- (2) Dispatcher's responsibility. The unit dispatcher prepares the operational record and logs the equipment out. He will fill in the columns pertaining to the date, equipment, USMC No., and organization. He will also fill in the operator's name, time out, and the location to which the operator reports. After completing the upper front of the record, the dispatcher will check the Equipment Operation Log and Service Record to see if any lubrication services are due. If so, he will enter the required information on the form and then sign in the appropriate blank.
- (3) Operator's responsibility. The operator takes the trip ticket, and after checking the equipment hourmeter, places this figure in the "hours start" column. Any lubrication services which are due must be performed before the equipment leaves the equipment pool and the appropriate information recorded on the form. The operator performs his daily "A" services in accordance with the rear portion of operation record and the information in the TM, using the marking legend at the top of the form.

While operating the equipment, the operator performs his during-operation services and records the information. While on the job, he also enters the type of worked performed (clearing, road maintenance, loading trucks with clamshell, etc.)

Upon completion of the job, the operator obtains a "released by" signature and the time of release from the job supervisor.

- (4) Completion and filing. When he returns to the equipment pool, the operator performs his after-operation services, signs the form on the bottom rear, and lower right front, and fills in the "in" time and "hours." He then subtracts the "out" from the "in" and enters the difference in the "total" column.

When the form has been completed, he obtains his equipment foreman's or section chief's signature on the front and turns the completed operational record over to the dispatcher, the dispatcher. This procedure assists the equipment foreman in keeping abreast of the operational commitments and the performance of preventive maintenance on the equipment in his charge.

During many construction operations, the equipment will remain on the job site. In this case, the equipment will be serviced in the field and only the dispatching and turning in of the completed operational record will take place in the equipment pool. Whatever the case, the records must be maintained in a uniform and accurate manner in order to effectively schedule both commitments and lubrication services. Remember, if your equipment is not operating properly, you should make it a matter of policy not only to record it on the operational record, but also to call it to the attention of the equipment foreman and dispatcher, verbally. The dispatcher completes his records and files the form in the vehicle record folder.

DATE: 25 APR 1977 EQUIPMENT: CASE MC 1150 Scoop Loader 384717 USMC OR SERIAL NO: ORGANIZATION: EMV Support Co.

OPERATIONAL	1ST OPERATOR 2ND OPERATOR	TIME		HOURS OR MILES		REPORT TO. (Location)	RELEASED BY (Signature - Time)
		IN	OUT	STOP	START		
	Carl Rogers	15:10	17:30	468	462	G-7, ANTILANA RANGE	Carl Rogers 1315
	1ST OPERATOR 2ND OPERATOR	TOTAL	TOTAL	TOTAL	TOTAL		
		8	6				
WORK PERFORMED		Cleaning tracks for fire break					

SERVICE	FUELS		LUBES		OIL CHANGE		LUBRICATION		PM SERVICE			
	HOURLY (GALS)	GAS (GALS)	NO. (GALS)	NO. (GALS)	HOURLY (GALS)	HOURLY (GALS)	HOURLY (GALS)	HOURLY (GALS)	TYPE PM DUE	HOURLY (GALS)	HOURLY (GALS)	
	70		2		1		19	462	462	10	462	462

1ST OPERATOR'S SIGNATURE: Carl Rogers
2ND OPERATOR'S SIGNATURE: [Signature]
EQUIPMENT FOREMAN'S SIGNATURE: [Signature]

ENGINEER EQUIPMENT OPERATIONAL RECORD (11245) NAVMC 10523 (REV. 12-72) PREVIOUS EDITIONS ARE OBSOLETE

DAILY 5A PM SERVICE

Legend for marking:
 A - Adjust S - Service X - Adjustment/Repair Required
 C - Check V - Verify O - Defect Corrected
 L - Lubricate / - Not applicable

ITEM NO.	COVERAGE	OPERATION			10 HOUR
		BEFORE	DURING	AFTER	
1	DAMAGE, PILFERAGE, LOSS	C		C	
2	LEAKS, GENERAL	C		C	
3	FUEL OIL, WATER	V		S	
4	ENGINE WARNING	C		C	
5	INSTRUMENTS	C		C	
6	SAFETY DEVICES	C		C	
7	TOOLS AND EQUIPMENT	C		C	
8	PUBLICATIONS	V		C	
9	CLUTCH	V		C	
10	STEERING	C		C	
11	ENGINE OPERATION	C		C	
12	UNUSUAL NOISES	C		C	
13	LIGHTS AND REFLECTORS	C		C	
14	AIR TANKS	S		S	
15	DRIVE BELTS	C		C	
16	BATTERY ELEC. LEVEL	C		C	
17	ANTIFREEZE TEST TO DEF	V		S	
18	SERVICE BRAKES	V		C	
19	TRANSMISSION	C		C	
20	AIR FILTER	V		S	
21	FUEL FILTERS	C		S	
22	TIRES TRACK	C		C	
23					
24					
25					

REMARKS: [Blank]

Fig 1-24. Engineer Equipment Operational Record.



d. Consolidated Engineer Equipment Operation Log and Service Record, NAVMC-10524
(rev 4-70)(fig 1-25).

- (1) Purpose. A duplicate of this form serves as the operational authority and maintenance log for stationary equipment (water pumps, well rigs, rock crushers) that remains at a job site for long periods of time. In other words, no operational report or trip ticket is required for operation of this equipment; the form serves a twofold purpose. The form will also serve as a maintenance log to record and schedule preventive maintenance on all other items of engineer equipment. It is from this form that the dispatcher obtains the information concerning lubrication "L" services which may be due on equipment. Pertinent operational, service, and repair information will be taken from the completed operational record and transferred to the appropriate spaces.
- (2) Completion and filing. The recommended PM schedule may be obtained either from the TM or the manufacturer's manual. Oil change and lubrication information is carried over from previous forms and kept up to date with information extracted from operational records. Operation and service information is recorded on a daily basis. Repair information can be obtained from the unit maintenance shop. After the form has been filled, appropriate information is placed on a new form. The old form should be disposed of in accordance with local regulations.

When an item of stationary equipment is to remain at a project site for a long time, the dispatcher makes up a duplicate form with all required information recorded on it. The duplicate form is issued to the operator and will serve as his operational authority for the duration of the job. The form remains with the equipment and the operator is responsible for making the necessary entries and performing the required services as they become due. The date of issue, the hours or mileage on the equipment, and the name of the operator are entered in the "Remarks" column of the original log which is kept by the dispatcher. When the job is completed and the equipment is returned, the duplicate log is turned in to the dispatcher. He transfers the appropriate entries to the original log and destroys the duplicates.

The above procedures regarding the duplicate copy of the log are often used when equipment is attached to small units, such as engineer platoons, which make up one of the reinforcing elements of a battalion landing team. This provides the operator with operational authority, eliminates paper work, and permits the operator to effectively schedule the preventive maintenance and lubrication of his equipment during the time he is deployed.

As you can see, depending on the circumstances, the responsibility for keeping this form up to date will rest either with the operator or the dispatcher. In either case, accuracy and completeness are a must if equipment is to be maintained properly.

NAVMC 10524 (Rev 3-70) Previous edition is obsolete. **CONSOLIDATED ENGINEER EQUIPMENT OPERATION LOG AND SERVICE RECORD (4700)**

EQUIPMENT NOMENCLATURE Tractor, Full-tracked, TEREX R2-30M		10 NO 065354	USMC OR SERIAL NO. 305874	DATE RECORD OPENED 3 Mar 70	DATE RECORD CLOSED	CONTROL NO OR UNIT M21310								
REFERENCES: OPERATION/MAINTENANCE-TM TEREX MM 67524/TEREX Ops 67525		PARTS - S4 TEREX Parts Shop		RECORDS - TM 4700 - 10/1										
SECTION A	PM DUE (If no period enter)	2-2	2-2	10-2	LAST QUARTERLY (Enter Date Performed)	NEXT QUARTERLY (Enter Date Due)	LUBRICATION DUE NEXT QUARTERLY (Enter Type)							
	SCHEDULED PM	10 hr	50 hr	100 hr	3 Mar 70	13 Jun 70	Q							
OPERATION		SERVICE												
DATE	SPEEDOMETER OR HOURMETER READING STARTED	SPEEDOMETER OR HOURMETER READING STOPPED	TOTAL HR./MI OPER	SCHEDULED PM DUE	GAS (GAL)	DIESEL (GAL)	OIL (QT)	OIL (QT)	OIL (QT)	AIR FILTER CLEANED/CHANGED	HR./MI PM COMPLETED	TIERO NO.	UNIT	SIGNATURE
3 Mar 70	001	005	7	001	56	264				001				
4 Mar 70	008	014	6	010	48					008	008			
5 Mar 70	014	020	6	020	48					020	020			
6 Mar 70	020	027	7	030	56									

NOTE: When this form is completed, transcribe all information from Section A and last entry from Section B to new NAVMC 10524.

Fig 1-25. Consolidated Engineer Equipment Operation Log and Service Record.

BEST COPY AVAILABLE

e. Operator's Report of Motor-Vehicle Accident, Standard Form 91 (fig 1-26).

- (1) Introduction. This form accompanies each item of equipment when it is being operated, and is used by the operator to provide a detailed report of any vehicle accident in which he is involved. The report is to be completed, regardless of the extent of damage caused by an accident, and is to be filled out by the operator at the time of the accident. If the operator is injured and unable to complete the form, it will be completed at the next earliest date possible. The report will be completed and submitted to the equipment officer for review and forwarding. It will be used by the investigators of the accident.
- (2) Completion instructions. The need for accuracy and attention to details when completing a standard form 91 cannot be overemphasized. The operator should attempt to obtain as much information about the accident as possible and enter it on the report. The report should tell WHAT, WHEN, WHERE, WHO, and WHY. Particular attention is paid to information concerning the other vehicle, its driver or owner, and the names and addresses of any witnesses. In case the operator cannot complete the report because of injury or death, the next senior military person will complete the initial report.
- (3) Miscellaneous instructions. An operator involved in an accident will render assistance to the injured and attempt to notify the proper military authorities as soon as possible. He will comply with State and local laws, rules, and regulations pertaining to the reporting of vehicle accidents. He will NOT express opinions regarding the accident nor complete any civilian insurance company accident forms. The motor vehicle accident report is forwarded for action, but a copy of the report and the Engineer Equipment Operational Record are maintained in the organizational files.

THIS FORM IS TO BE FILLED OUT BY THE OPERATOR OF THE MOTOR VEHICLE INVOLVED IN AN ACCIDENT

OPERATOR'S REPORT OF MOTOR-VEHICLE ACCIDENT

DEPARTMENT OR AGENCY: UNITED STATES MARINE CORPS
 NAME AND LOCATION OF AGENCY OR BUSINESS TO WHICH YOU ARE ASSIGNED: 5th MFG Support Co, 1st MFG Bn, 14th MAR Div Camp Pendleton, Calif

NAME AND RATING OR TITLE: PECK, RAYMOND L. 21 4CPL
 VEHICLE NUMBER OR SERIAL NUMBER: 556-51-2412 DISTRICT OR POLICE NUMBER: E-0012-72
 HOME ADDRESS (Include city, state, ZIP Code): 16194 BURNING WOOD LOS ANGELES, CALIF 90044 TELEPHONE (Area): 441-1056
 DATE AND TIME OF ACCIDENT: 21 June 1977 1330 HT

PLACE OF ACCIDENT (If different from the Department or Agency address, include street name, city, state, and ZIP Code):
Outfall Training Area, 14th MAR Div Camp Pendleton, Calif
Performing work in training area
REGULAR DUTY

TYPE OF VEHICLE: 7.3-31 TRAX TRACTOR TYPE: Excavator REC. INSTR. NUMBER OR OTHER IDENTIFICATION: 18MCA1000
 PARTS OF VEHICLE DAMAGED (Check one):
 BENT FRONT AXLE
 BROKEN EXHAUST PIPE

IF THIS IS A RECURRING ACCIDENT, HAS DAMAGE REPAIRED? YES NO
 IF AVAILABLE, HAS DAMAGE REPAIRED? YES NO

NAME OF OTHER VEHICLE INVOLVED: _____
 OPERATOR'S STATE PLATE NUMBER: _____ VEHICLE LICENSE NUMBER AND YEAR: _____
 OPERATED BY (Name): _____ VEHICLE OWNED BY: _____
 OPERATOR'S HOME ADDRESS (Name, No., Street): _____ OWNER'S ADDRESS (Name, No., Street): _____
 PARTS OF VEHICLE DAMAGED (Check one): _____
 OTHER PROPERTY DAMAGED (Check one): NONE

NAME	HOME ADDRESS
<u>1/Cpl Rb. Peck</u>	<u>16194 BURNING WOOD LOS ANGELES, CALIF</u>
<u>NONE</u>	
<u>SSgt AZ Dozier</u>	<u>5th MFG Support Co, 1st MFG Bn, 14th MAR Div Camp Pendleton, Calif</u>

POLICE OFFICER: _____ NAME NO.: _____ PRECINCT OR DISTRICT: _____

YOUR VEHICLE: _____ OTHER VEHICLE: _____

DIRECTION OF TRAVEL: _____ DIRECTION OF TRAVEL: _____

SIZE OF STREET OR HIGHWAY: _____ SIZE OF STREET OR HIGHWAY: _____

APPROXIMATE SPEED (Mph. per hour): 5 APPROXIMATE SPEED (Mph. per hour): _____

CONDITION OF ROADWAY (Pavement, etc.): DAMP

WEATHER (Show time, date, etc.): Rainy TYPE OF TRAFFIC (Specify direction of travel): COMPACTED DIRT

OTHER INFORMATION (Include date, time, place, public observations, etc.): _____

STANDARD FORM 91 (Revised April 1973)

IF MEDICAL AND NERVOUS STATE BY A PHYSICIAN HAS BEEN TAKEN: Medical Duty Officer Exemption on Dispensary

IF OTHER DRIVER OR PERSONS INVOLVED HAVE STATEMENTS AS TO CAUSE OF ACCIDENT AND EXTENT OF PERSONAL OR PROPERTY DAMAGE, RELATE CONTRIBUTION AND NAME AND ADDRESS OF WITNESSES AS TO SUCH STATEMENTS:

NAME: _____ TIME: _____ YEAR: _____

OPERATOR'S STATE PLATE NUMBER: _____ VEHICLE LICENSE NUMBER: _____

OPERATED BY: _____ OWNED BY: _____

ADDRESS (Name): _____ OWNER'S ADDRESS (Name): _____

PARTS OF VEHICLE DAMAGED (Check one): _____

OTHER PROPERTY DAMAGED (Check one): _____

ON Wednesday afternoon I was loading fill material on trucks in the training area. As I was moving to dump a load of fill, the embankment I was driving on gave way, causing the loader to tip over into the ditch on its right side. I managed to leap clear over the left side as it was overturning. Sgt Dozier took me to the dispensary, where I was treated for a sprained left ankle and a cut on the right arm.

DATE: 21 June 1977

Signature: Raymond L. Peck

U.S. GOVERNMENT PRINTING OFFICE: 1973 O-296-100-0

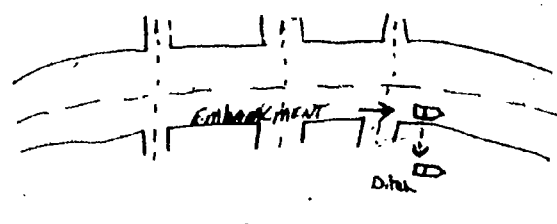

Fig 1-26. Operator's Report of Motor-Vehicle Accident, Standard Form 91.



f. Quality Deficiency Report (QDR) SF368 (Formerly Referred To As UER) Fig 1-27

- (1) Purpose and responsibilities. The SF368 is an administrative form used to report equipment and material failures and equipment design deficiencies. It is the responsibility of all individuals who come in contact with defective equipment to submit a SF368 through their unit.
- (2) Categories of reports. To insure that serious defects are quickly acted upon, the forwarding procedures for the SF368 have been broken down into two different categories. When a discrepancy is discovered, a decision must be made as to which category it fits into using the guidelines described below.
 - (a) Category I report. If a deficiency is discovered that could cause an injury to someone or could hurt the combat capability of a unit, a Category I Quality Deficiency Report should be sent in standard message format directly to CMC (Code LMO-2). This report must be sent within 24 hours after the discrepancy is discovered. If the discrepancy is very serious, it may first be reported by phone or even in person and then later confirmed by message.
 - (b) Category II report. All deficiencies that do not need to be immediately reported are sent in a Category II Quality Deficiency Report. Category II QDR's must be submitted within 5 calendar days after the discrepancy is discovered.

It should be the responsibility of the equipment officer to determine whether the deficiency is of such a nature as to require a Category I or Category II report. In either case, an SF368 should be completed and submitted to the equipment officer for this decision. If, in his opinion, the discrepancy requires immediate action, the information on the SF368 can readily be used in submitting the message because the message format is keyed to the entries on the SF368.

- (3) Filing and disposition. When reporting Category II deficiencies, three copies must be sent to the screening point (CMC code LMO-2). One copy will be maintained on file by the unit maintenance management officer.

Report to: 1st Army, Co. 1st Cav. Div. Camp Pendleton, California		Commandant of the Marine Corps (Code LMO-2)	
Your name, rank, duty station and date		Your name, rank, duty station and date	
1. Equipment No. 2. Description of Equipment	3. Location 4. Date of Report	5. Category 6. Hours of Operation	7. Remarks 8. Signature
9. Make, Model and Equipment No. 10. Serial No.	11. Hours of Operation 12. Hours of Use	13. Hours of Operation 14. Hours of Use	15. Remarks 16. Signature
During operation of this tractor, the left track slipped off. Upon inspection I found that the left track idler had excessive wear as compared to the right track idler thus causing the track to slip off. This tractor had only 384 operating hours. Upon inspection of the other three tractors in my company I found one more with excessive wear on the left track idler. This tractor is being held on deadline awaiting action on this QDR.			
17. Name of Reporting Officer 18. Signature		19. Name of Reporting Officer 20. Signature	
21. Name of Reporting Officer 22. Signature		23. Name of Reporting Officer 24. Signature	

Fig 1-27. Completed SF368 (Quality Deficiency Report).

1-14. PUBLICATIONS

a. Introduction. It is the responsibility of all personnel concerned with operation, maintenance, and supply to secure and use all available and current publications which apply to engineer equipment. The Marine Corps technical publications system will provide you with the detailed information necessary for effective operation and maintenance of your equipment. The Index of Authorized Supply and Maintenance Publications (Stocklist 1-2) will provide you with the information regarding the Marine Corps or civilian manufacturer's publications on the operation and maintenance of a particular piece of equipment. The Marine Corps publications will be explained below.

b. Types of technical publications.

- (1) Technical manual (TM). A TM contains a description of equipment and instructions for effective use which may include the following: instructions covering initial preparation for use; operating, maintenance, and overhaul instructions; related technical information and procedures.
- (2) Technical instruction (TI). A TI adds technical information not included in a TM, such as:
 - (a) Special professional techniques and maintenance procedures for supply personnel.
 - (b) Supplementary TM information which will be incorporated into the next TM change or revision.
 - (c) Administrative technical details primarily for equipment maintenance which can be more suitably distributed by an instruction. (Examples are forms to use, special safety measures, and serviceability standards.)
 - (d) Urgent instructions to distribute critical information to assure proper use, operation, and maintenance of equipment and materiel.
 - (e) Nonurgent instructions for changing or altering equipment. These instructions may affect physical, technical, operational, or military characteristics; however, this kind of TI will:
 1. Not include a kit.
 2. Not be reported.
 3. Ordinarily use production material or common hardware if material is needed.
- (3) Modification instruction (MI). An MI modifies equipment to add certain tactical and technical advantages. It is usually the type instruction and authorization received after submitting a Quality Deficiency Report. It sets forth authentic and uniform instructions to correct the weakness in an equipment design. Its importance requires a strict reports control by equipment serial number. The MI will include instructions which meet any of the following conditions:
 - (a) Urgency.
 - (b) Indispensability to an item's or a system's operation or effectiveness.
 - (c) Inclusion of kits or costly parts which the Marine Corps closely manages.
- (4) Lubrication instruction (LI). An LI prescribes lubrication instructions for equipment, including the lubricants for proper servicing. It sets up required intervals and explains methods and procedures for lubrication and maintenance.
- (5) Stocklist, type 3 (SL-3) - (Components List). The SL-3 consists of information on collection-type items (tools, accessories).
- (6) Stocklist, type 4 (SL-4) - (Repair Part List). The SL-4 furnishes information for repair parts required for maintenance and support of equipment.

(7) Marine Corps orders (MCO's). These directives are printed in manual- or letter-type form. They are of a continuing nature and contain the specific information needed to carry out some particular instructions. They are reviewed periodically to reduce the possibility of conflicting instructions and to insure that they are applicable and appropriate. A listing of effective Marine Corps orders is distributed quarterly so that using units can inventory their directives. They are usually filed in the company office under the numerical subject classification system.

(8) Miscellaneous publications.

(a) Marine Corps Supply Manual (MCO P4400.19). This is a 5-volume publication that outlines the responsibilities of supply and maintenance personnel. It contains general instructions of a permanent nature which may be supplemented by other directives. It contains the regulations that govern the allocation of funds for procuring new equipment and supplies and is one source of information that will assist your seniors in keeping records, turning in excess spares or equipment, and turning in recoverable items. The complete set (all volumes) is usually maintained by the battalion supply office.

(b) Marine Corps bulletins (MCB's). These directives are printed in letter-type form and have the same force as a Marine Corps order, but they are either primarily informative or temporary in authority. Bulletins will include a self-cancellation date. Instructions contained in a bulletin should be followed carefully because they may be canceled before they have been completely carried out. For example, if you receive a bulletin that instructs you to turn in all excess tools during the month of June, do so at that time or you will not have a reference for your action and supply can refuse to accept the excess tools. Bulletins are usually filed in the same location and under the same system as Marine Corps orders.

c. Numbering system (fig 1-28). The number of any technical publication is its identification. These numbers may consist of four elements: type letters, basic number, maintenance echelon number, and sequence number.

(1) Type letters. The first element of any number will tell you what type of technical publication you are dealing with. It will consist of two letters, such as TM, SL, TI, or MI. Stocklists will have two letters and a number, SL-4.

(2) Basic number. The basic number identifies the particular piece of equipment or subject with which this publication is concerned. One of three different kinds of basic numbers will be assigned.

(a) Item designator or ID number. This is a 5-digit number followed by a letter (excluding O and I) assigned to a system, major item, or multiple-use major component. The 5-digit identifying number is taken from the Table of Authorized Materiel, a supply document, which identifies all organizational equipment in the Marine Corps. The letter which follows the number will be used to indicate different makes and models of one piece of equipment. For example, TM 00872A covers the earlier Bay City, model M37 cranes, while the latest models (M63) are covered by TM 00872B. If the publication covers more than one model of the same equipment, the suffix letter(s) will be dropped and reference made on the cover sheet concerning the specific models covered. A TI covering both models of the M37 would be numbered TI00872.

(b) Federal supply classification number. This is a 4-digit number based on the group and class of material rather than the ID number. For example, the first four numbers of any crane National stock number are 3810 and the TI pertaining to general crane safety would be numbered TI 3810.

(c) Standard subject identification code (SSIC). This number, used for a variety of subjects, applies when general information covering a wide range of equipment, such as electronic, motor transport, and engineer, is discussed (example: MCR 4700).

(3) Maintenance echelon number. The third element of a publication is the echelon of maintenance indicator. This consists of a 2-digit number and tells to what echelons of maintenance the publication pertains. So far we have a technical publication which might have a number like this: TM 00872B-15, Technical Manual for the Crane-Shovel, Crawler-Mounted, model M37 (M63), 1st through 5th echelon maintenance. Possible echelon of maintenance indicators are:

- (a) -10 1st echelon only. Operator or crew instructions.
- (b) -20 2d echelon only. Organizational maintenance instructions.
- (c) -30 3d echelon only. Direct support of field maintenance instructions.
- (d) -40 4th echelon only. Field maintenance instructions.
- (e) -50 5th echelon only. Depot maintenance instructions.
- (f) Any combination of these echelons to which a publication would apply:

- | | |
|-----------------------------|----------------------------|
| <u>-12</u> 1st and 2d. | <u>-24</u> 2d through 4th. |
| <u>-13</u> 1st through 3d. | <u>-25</u> 2d through 5th. |
| <u>-14</u> 1st through 4th. | <u>-34</u> 3d and 4th. |
| <u>-15</u> 1st through 5th. | <u>-35</u> 3d through 5th. |
| <u>-23</u> 2d and 3d. | <u>-45</u> 4th and 5th. |

Note: When two consecutive numbers are used, such as 12, they apply only to the echelons which are specified. When two nonconsecutive numbers are used, such as 15, they include the echelons which come between them. In the case of the numerical designator 15, the publication would apply to 1st through 5th echelon maintenance.

- (4) **Sequence number.** If more than one publication is issued pertaining to a particular piece of equipment, a sequence number is added. This fourth element of a publication number is separated from the maintenance echelon indicator by a slash mark (/). The sequence number will generally be used on those publications, such as MI's and TI's where more than one is usually published.

ELEMENTS			
1st	2d	3d	4th
TYPE	BASIC NUMBER	ECHELON OF MAINTENANCE	SEQUENCE NO.
TM	(ID OR CLASS)		
TI			
MI	04078A	15	/1
LI			
SI			
SC			
SL-3			
SL-4			

Fig 1-28. Numbering system.

d. Single-and multiple-unit publication systems. The Marine Corps system relates publications to specific equipment and to major components which are used on more than one piece of equipment.

- (1) Single-unit system. Most of the Marine Corps technical publications will come under the single-unit system. This system incorporates all the echelons of maintenance into a single TM. Generally, they will include information concerning operation, organizational, field and depot maintenance of the complete end item of equipment. The maintenance support of components and parts of the end item will be covered in the end item publications. All MI's, SI's, SL's, etc. have the same basic number (5-digit ID number) as the end item.
- (2) Multiple-unit system. The multiple-unit system is used for complex equipment and weapons systems such as vehicles, self-propelled weapons, and radar. This system is used for equipment which has several major components or auxiliary equipment which is used on two or more end items. Examples of this are the GMC series 71 engines and Allison 3331-1 Torqmatic transmissions which are used in a variety of engineer equipment. Instead of duplicating the information in each individual equipment TM, separate TM's were made for the engines and transmissions, and the end item TM simply refers to these manuals for overhaul and repair information of these components.

e. Multiple-unit system technical manuals. Technical manuals are arranged as follows:

- (1) Organizational maintenance manual. This manual will provide the complete organizational maintenance support of the major end item or weapons system. This includes the organizational maintenance of all components or auxiliary equipment even when these are covered in separate TM's.
- (2) Field and depot maintenance manual. A separate TM will be prepared, when necessary, covering the field and depot maintenance for components or auxiliary equipment of end items or weapons systems. This separate manual can be used for all items of equipment having like components, thus reducing the number of publications required on a Marine Corps-wide basis.

1-15. FUELS AND LUBRICANTS

a. Introduction. Storage, handling, and use of the proper fuels and lubricants can affect the maintenance program as much as untrained operators and mechanics. Fuels and lubricants (POL supplies) are requisitioned through the supply system by National stock number (NSN). Like other supplies, fuels and lubricants with a specific NSN must meet military specifications. Since supply personnel provide POL supplies by NSN, operators and mechanics are concerned only with their proper storage, handling, and use. Containers for the fuels and lubricants will affect the NSN. For example, the NSN for an 18-gage 55-gal container of 30 weight oil is not the same as that of a 16-gage 55-gal container of 30 weight oil. Therefore, operators and mechanics must rely on symbols, appearance, feel, and smell to identify fuels and lubricants.

During landings, most supplies are moved across the beach and stored in supply dumps by shore party and bulk fuel personnel. POL supplies are normally stored near the flank that is opposite to the ammunition storage area. The POL supply dump is usually marked by a large yellow square panel with a black funnel shape in the center. (Note: No smoking is allowed near the POL supplies at any location even if the NO SMOKING signs are not in place.) At the equipment park and in maintenance areas, the POL supplies are normally stored in some convenient place away from the parked equipment and maintenance shop. In all storage areas, precautions are taken to prevent contamination by water, dust, and other debris and also to prevent fire hazards. The supplies are stored in shaded areas or covered where possible, and those supplies in small containers are stored upright and tilted to prevent water seeping by the caps. Bulk storage tanks have drains to remove water caused by condensation or seepage.

POL supplies come in sealed containers and it is the responsibility of operators and maintenance men to keep them clean and use them properly. Most fuels and lubricants become contaminated because they are transferred in dirty containers or the container is left open. Keep the service equipment such as fuel pumps, measuring cans, and lubricators clean. Clean the handling and service equipment before using it and store it in a clean place. Close all containers when they are not being used. Remove water and dirt from the top of containers before opening. Use pumps which will not draw the container contents from the bottom; water usually settles to the bottom. When a faucet is used, tilt the container so that any water will be below the drain. Some containers are reusable; store and protect them to prevent contamination and damage. Fuels and lubricants should not be transferred from one container to another any more than is necessary. Thus don't draw a five gallon container of fuel, use two gallons, and return the rest to the original container; instead measure out the two gallons you need and use it before it becomes contaminated. Each time a fuel or lubricant is handled or transferred it accumulates foreign matter.

The hardest job for the user of fuels and lubricants is to determine what is in a container which has many numbers and letters, some of which do not correspond with the numbers shown on the lubrication instructions (LI) or in the technical manual (TM). Shipments marked by contractors will show the following information: NATO symbol (if applicable); product symbol; nomenclature; product specification; grade, type, or class; National stock number; filling date; and other information. Containers marked within a theater of operation are marked as illustrated in fig 1-29. If the container is used for anything other than its original contents it should be cleaned and remarked.

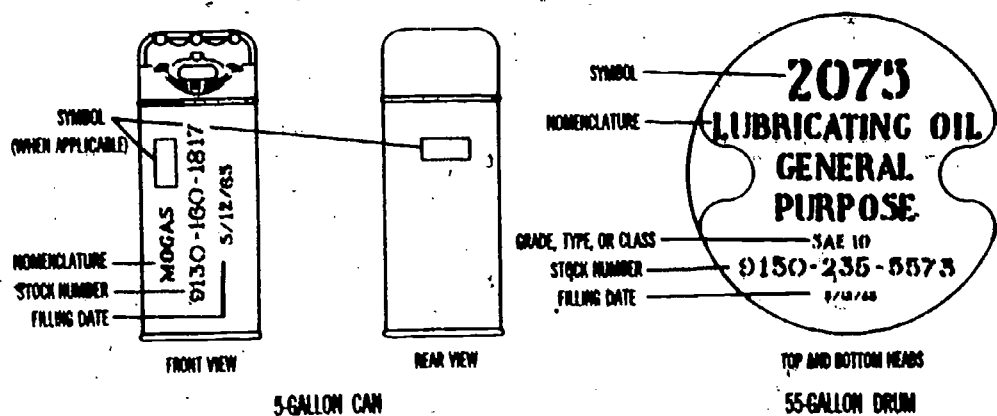

Fig 1-29. Can and drum markings within a theater of operations.

Fuels and lubricants are issued in bulk quantities or in one of the standard size containers. The standard size containers for oils are: 5 cc, 2 oz, 4 oz, 1 pt, 1 qt, 1 gal, and 55 gal. The standard size containers for greases are: plastic tube that will fit in a rifle butt, 8 oz, 1 lb, 5 lb, 25 lb, 100 lb, and 400 lb. Figure 1-30 is a partial listing of the fuels and grease used for equipment maintenance showing the military specifications, grade or type, and the military symbol.

Description	Specification	Grade	Military symbol
Gasoline, Unleaded	Fed VV-G-109	62ASTM	62
Turbine Fuel, Aviation	MIL-J-5624	JP-5	JP-5
Fuel Oil, Diesel	Fed VV-F-800	DF-1	DF-1
		DF-2	DF-2
Grease, Aircraft High Temperature	MIL-G-3545A		GH
Grease, Automotive and Artillery	MIL-G-10924B		GAA
Grease, Ordnance, Extreme Pressure		MOLYKOTE type G	
Grease, Aircraft	MIL-G-25760		
Lubricating Oil, Engine	MIL-L-2104	10	OE-10
		30	OE-30
		50	OE-50

Fig 1-30. Partial list of petroleum products showing specifications, grade, and military symbol.

Lubricating Oil, Engine	MIL-L-9000	10	9110
		20	9170
		30	9250
		50	9500
		Blended	9250&9500
Lubricating Oil, Engine	MIL-L-10295		OES
Lubricating Oil, Engine	MIL-L-45199	10	HDO-10
		30	HDO-30
Lubricating Oil, Gear	MIL-L-2105B	80	
		90	
		140	
Lubricating Oil, Gear	MIL-L-2105	75	GO-75
		80	GO-80
Brake Fluid, Automotive	MIL-H-13910		HBA
Brake Fluid, Automotive	Fed VV-H-910		HB

Fig 1-30 --contd

b. **Fuels.** Most fuels and lubricants are derived from crude oil which is run through a distillation or cracking process during refining. The different products are separated and certain additives blended in to improve them.

- (1) **Gasoline.** Gasoline is one of the first products used in engineer equipment that is removed from crude oil. The same type of fuel that is used in the internal-combustion engine of motor-transport-type vehicles is used in the gasoline engine of engineer equipment. It is blended with additives (tetraethyl lead) and is for use in spark-ignition, internal-combustion engines only. Gasoline has such poor lubricating qualities that when used alone it would do severe damage to the fuel system components of a compression ignition engine. Gasoline will also cause unsatisfactory operation in diesel engines because of the low flashpoint; gasoline requires very little heat to ignite as compared to diesel fuel. Gasoline also evaporates rapidly and the fumes are more dangerous than the fuel in its liquid state. The rate of evaporation increases as the temperature rises.

Gasoline is issued in bulk, 55-gal drums or 5-gal cans. When gasoline is issued in 55-gal drums, it is usually placed on a rack and drawn through a faucet. A 3/4-in. standard faucet will fit the small hole in the top of a drum. If the quantity of gasoline used is sufficiently large, it will probably be pumped from the drums or delivered by tank truck. Safety regulations restrict the size of the container and the amount of gasoline which can be kept inside a maintenance shop to 5 gal. or less. During refining, gasoline is filtered and stored as clean as possible and precautions should be taken to keep it that way. Store it in an area that is a safe distance from other facilities and protect it from the weather and foreign matter if possible. Gasoline is lighter than water and oil and it will rise to the top in a short time if not disturbed. The gasoline can then be pumped or siphoned off or the water drained.

Gasoline has a strong odor and is blended with dye for color. Although the color has no effect on quality, it does assist in determining the quality of a fuel when there are no test instruments. As gasoline evaporates it loses some of its color and is not as clear. By checking the filling date on the container, the color of the contents, and the odor produced, an experienced mechanic can make a fair judgment about the quality of the gasoline.

Gasoline spreads and evaporates rapidly when spilled. If spilled or splashed on the skin, it will cause the skin to feel cool and dry as it evaporates. Clean dry skin has a silky feeling when rubbed, but gasoline will remove the body oils and cause a dry rough feeling. Continuous applications of gasoline on the skin may cause a tingling sensation or irritation. It is possible to receive lead poisoning as a result of gasoline entering the blood stream.

- (2) Diesel fuel. The second product used in engineer equipment and refined from crude oil is diesel fuel. It is also produced by distillation and cracking and is filtered and blended with additives. It is produced in several different grades, but the Marine Corps uses grade No. 2 in most of its engineer equipment diesel engines. The fuels used meet the specifications recommended by the manufacturer of the engine who takes into consideration the volatility, cleanliness, viscosity, ignition quality, and antiknock quality of the fuel. Diesel fuel is less volatile than gasoline. This means that it does not change from a liquid to a gas as rapidly as gasoline. It is also more viscous (more resistant to flow) than gasoline. It has some lubricative qualities, but the higher viscosity helps hold some of the foreign matter such as sulfur and water during the refining process. All of the foreign matter cannot be removed. The lighter fuel (grade No. 1) is less viscous than the heavy fuel (grade No. 3). One of the requirements for a desirable diesel fuel is that it be light enough to flow freely, but heavy enough to lubricate the injection system components.

The ignition quality of diesel fuel is its readiness to ignite and the ease with which it ignites after it is injected into the compressed air. The ignition quality is measured by the cetane rating, which is obtained by comparing diesel fuel with a reference mixture (which is difficult to ignite) and with cetane. Cetane is added to the reference mixture until it will ignite the same as the diesel fuel in a test engine. The rating indicates the percentage of cetane required in the reference mixture, not the diesel fuel. The lower the cetane number, the harder the fuel is to ignite. In addition to the cetane rating, flashpoint and firepoint affect the fuel's ignition and antiknock qualities. The flashpoint is the temperature to which the fuel vapor must be heated to ignite. The fire point is that temperature at which the fuel vapor will continue to burn. The fire point is usually 50° to 120° higher than the flashpoint. A light fuel has a lower flashpoint than a heavy fuel.

Diesel fuel is usually supplied in the bulk or 55-gal drums. A hose or spout can be attached to a drum and the contents poured into the equipment tank or the fuel can be pumped from an upright drum. Like other fuels, diesel fuel must be protected to prevent further contamination. Use clean equipment for transferring and keep the containers closed when not in use.

The odor of diesel fuel is not as pronounced as gasoline. It has dye added which does not affect its qualities and it contains some wax elements which will freeze in extremely cold climates. Diesel fuel spreads and evaporates slowly when spilled and leaves an oily spot when evaporated. Diesel fuel feels oily when rubbed between the fingers. It is lighter than water and will rise above the water if a mixture of the two is allowed to settle undisturbed.

c. The theory of lubrication is that a layer of oil prevents the surfaces of two parts from making contact and creating friction. A layer of oil will split into layers of molecules. The lighter the viscosity of the oil, the smaller the molecules. The operating clearance between the parts will determine what viscosity will provide the best lubrication. Figure 1-31 illustrates the five molecule layer theory. The outside layers adhere to the parts and the inner layers act as bearings to reduce friction. The principle of oil film and wedge theory is applied for shafts and bearings. Figure 1-32 illustrates the effects of oil viscosity when used on a shaft.

bearings to reduce friction. The principle of oil film and wedge theory is applied for shafts and bearings. Figure 1-32 illustrates the effects of oil viscosity when used on a shaft.

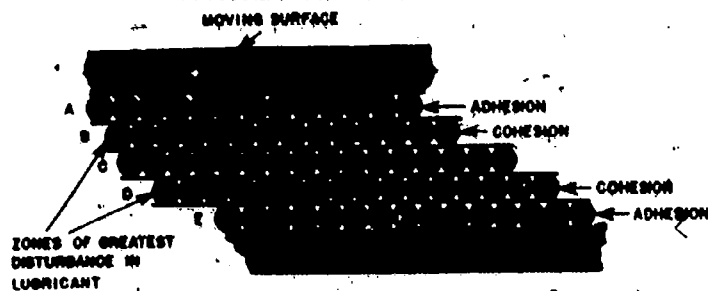
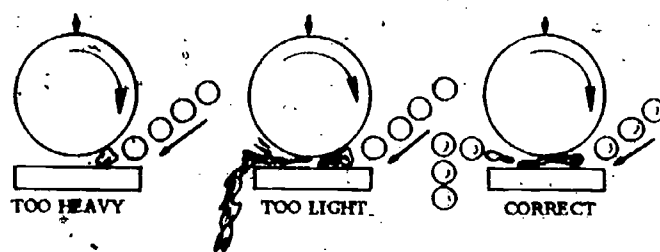

Fig 1-31. Oil molecule layer theory.



If the oil is too heavy for the bearing clearance, it can't get in. If the oil is too light for the bearing load, it can't support it. If the oil is correct for both clearance and load, the bearing is properly lubricated.

Fig 1-32. Oil film and wedge theory.

The SAE (Society of Automotive Engineers) has standardized specifications and references for the viscosity of oils. SAE numbers in multiples of 10 (such as 10, 20, and 30) are used to denote viscosity. The lighter the oil, the lower the number. The viscosity of the lubricant is very important for proper lubrication. To meet SAE standards and to provide proper lubrication, manufacturers blend the filtered and stored oils to obtain the correct viscosity. They also consider the effects of temperature change and put in additives to combat this and other undesirable effects. For example, "10 W" means that oil and additives have been blended to obtain an SAE 10 viscosity oil that is winterized to allow easier starting. Depending on the intended use, oils are blended with additives which will combat viscosity changes, heat seizures, oxidation, corrosion, tars and varnishes, as well as suspend impurities. During the mixing, distilling, and blending, the oil manufacturers produce a lubricant that will meet rigid specifications. The foaming tendencies are controlled, acid content reduced, gums and resins eliminated, and all harmful factors reduced before the product is packaged.

The oils are supplied in any of the standard size containers. For engineer equipment use, most oils are furnished in 5- and 55-gal containers. The oil may be any color depending on the type of additives, but new oil will be clear. Oil that is not clear indicates oxidation, dirt, or other contamination. Water globules can be seen and foreign matter will cause it to feel gritty. Contaminated oil should not be used as it can result in serious damage to the equipment.

Grease is oil suspended in soap; the soap acts as a sponge to hold the oils in the desired location. The type of soaps used are selected for certain qualities. Some are soft and water-soluble and others are hard and waterproof. Greases also contain additives to reduce undesirable effects and improve their lubricating qualities. Synthetic (nonpetroleum products) lubricants represent about 20% of the total lubricants consumed. Some synthetic lubricants are added to the petroleum products to improve their desired qualities.

Some forms of contamination in greases are hard to detect and extra precautions must be taken to prevent their use. Keep the container covers tightly closed and use clean equipment to reduce the possibility of contaminating the grease.

1-16. YOUR RESPONSIBILITY FOR LUBRICATION.

a. To give good service, automotive and construction equipment must be properly lubricated. Lubrication requirements for construction equipment are usually gaged according to hours of operation which are indicated by an hourmeter. Each engine-driven piece of construction equipment is usually fitted with this device. Hourmeters register operating or clock hours, depending on whether they are gear-driven or electrical.

b. Before you start to perform a particular hourly lubrication service, check the TM and lubrication instructions. Make sure you know which fittings require lubrication, and the type and amount of lubrication to be used. All grease fittings must be wiped clean before you apply the lubricant. If fittings are not cleaned, sand and dirt may be forced into the bearing surface, causing scoring and extensive damage. Take care not to overlubricate fittings which are located near clutch and brake surfaces or which are connected to surfaces protected by seals. Blown seals, requiring prolonged deadlining of equipment, are generally caused by overlubrication.

c. After lubrication, wipe any excess grease off the fitting. This will help to keep dust and dirt from collecting on the fitting. Be sure to wipe up any grease or oil which may be spilled on the surface of the equipment. This is a safety hazard. Keep your equipment as clean as possible.

1-17. SUMMARY

The airstrip that is not completed in time, the landing that fails due to congestion on the beach, or the 105-mm howitzer that is hit by incoming counterbattery fire costs the lives of your fellow Marines and reduces the overall combat effectiveness of the Marine Corps. You and your equipment play a vital role as part of the Marine Corps team. You and your first echelon maintenance services are the foundation for the entire system. How well you perform these services determines how well the Marine Corps can meet its worldwide commitments!

ENGINEER EQUIPMENT OPERATOR

Lesson 1

Introduction to MOS 1345

STUDY ASSIGNMENT: Information For MCI Students.
Course Introduction.
MCI 13. 31h, Engineer Equipment Operator, chap 1.

LESSON OBJECTIVE: Upon successful completion of this lesson you will be able to identify, by general nomenclature, tractors, scrapers, rollers, air compressors, and materials-handling equipment. You will also be able to identify the publications, records and forms required to inspect, operate and perform preventive maintenance on this equipment. In addition, you will be able to recognize the fuels and lubricants used to service and maintain it.

WRITTEN ASSIGNMENT:

A. Multiple Choice: Select the ONE answer which BEST completes the statement or answers the question. After the corresponding number on the answer sheet, blacken the appropriate box.

Value: 1 point each

1. During World War II, engineer regiments were composed of what type battalions?
 - a. Engineer, shore party, and service
 - b. Pioneer, Seabee, and service
 - c. Pioneer, engineer, and Seabee
 - d. Service, shore party, and Seabee
2. What is the military occupational specialty number of an engineer equipment operator?
 - a. 1341
 - b. 1345
 - c. 1349
 - d. 1381
3. An engineer equipment operator becomes an engineer equipment chief when promoted to the rank of.
 - a. Cpl.
 - b. SSgt.
 - c. GySgt.
 - d. MGySgt.
4. Which tractor used by the Marine Corps is powered by a 2-stroke cycle, 6-cylinder diesel engine?
 - a. 72-31 MP Terex
 - b. MRS-100
 - c. Case MC 1150 scooploader
 - d. 82-30M
5. Which of the full-tracked tractors currently in use in the Marine Corps is equipped with a 4-stroke-cycle, 4-cylinder diesel engine?
 - a. Terex 82-30M
 - b. Case MC 1150
 - c. MRS-I-100
 - d. Case MC450

6. The full-tracked tractor currently in use in the Marine Corps which can be used as a power tilt dozer is called the
- Case MC 1150
 - Terex 82-30M
 - Case MC 450
 - Case MC 580
7. Which of the following tractors has the capability of being sectionalized for helicopter transport?
- MRS-I-100
 - Case MC 450
 - 82-30M
 - MRS-100
8. Which of the following tractors is equipped with an 8-cylinder diesel engine?
- MC 580
 - 82-30M
 - MRS-I-100
 - MRS-100
9. Which of the following tractors can be equipped with a loader, backhoe, and drill attachment?
- 72-31MP
 - MC 580
 - MC 450
 - MRS-100
10. Which scraper is designed to be sectionalized for transporting by helicopter?
- 4S-85
 - H-82
 - 105 SM71
 - B-170A
11. Which model scraper is used in conjunction with the MRS-I-100 tractor?
- H-82
 - 105 SM71
 - 4S-85
 - B-170A
12. What is the identifying feature of the sheepsfoot roller?
- Two smooth metal drums
 - Two hollow metal drums with protruding feet
 - Two open-mesh drums
 - Two rows of thick tread tires
13. Which roller is self-propelled?
- 5 to 8-ton tandem roller
 - Sheepsfoot roller
 - Pneumatic-tired (wobble-wheel) roller
 - Grid roller
14. Which rough-terrain forklift is designed to lift materials to a height of 68 inches?
- OS-3354
 - MC 4000
 - RKF-060
 - 72-31MP
15. Which item of equipment can be used to handle either bulk or palletized materials?
- RKF 060
 - MRS-100
 - 82-30M
 - 72-31MP
16. What is the capacity in cfm of the Davey rotary air compressor?
- 125
 - 250
 - 315
 - 600

17. On the Worthington air compressor, what device is designed to assure rapid warmup of the unit?
- a. Friction-disk clutch
b. Thermostatic assembly
c. Thermostatic bypass valve
d. Thermostat
18. How many categories are there within the Marine Corps maintenance system?
- a. 3
b. 4
c. 5
d. 6
19. How many echelons are there within the Marine Corps maintenance system?
- a. 3
b. 4
c. 5
d. 6
20. Which organization has a 3d echelon maintenance capability?
- a. Engineer battalion
b. Force engineer letter company
c. Landing Support battalion
d. Force Service Support Group
21. What echelons of maintenance make up the organizational maintenance category?
- a. 1st and 2d
b. 2d and 3d
c. 3d and 4th
d. 4th and 5th
22. Who is responsible for performing 1st echelon maintenance services?
- a. Unit mechanics
b. Equipment chief
c. Equipment operator
d. Equipment officer
23. Who is the most important person in the accomplishment of proper preventive maintenance?
- a. Dispatcher
b. Equipment operator
c. Maintenance chief
d. Unit mechanic
24. Which echelon of maintenance performs major overhauls or complete rebuild?
- a. 2d
b. 3d
c. 4th
d. 5th
25. Who is responsible for performing 2d echelon maintenance?
- a. Dispatcher
b. Unit mechanics
c. Equipment operator
d. Equipment chief
26. What category of maintenance consists of a single echelon?
- a. Organizational
b. Intermediate
c. Depot
d. Organizational
27. Performing daily services, scheduled lubrication services, and assisting with quarterly services are responsibilities of the
- a. unit mechanic.
b. dispatcher.
c. equipment foreman.
d. equipment operator.

28. Who performs quarterly "Q" services?
- Unit mechanic, assisted by the dispatcher
 - Operator, assisted by the unit mechanic
 - Unit mechanic, assisted by the operator
 - Equipment foreman, assisted by the operator
29. What form is the operator's authorization for the use of engineer equipment?
- NAVMC 10523
 - NAVMC 10293
 - Standard Form 46
 - Standard Form 91
30. What form lists the equipment that an operator is qualified to operate?
- Standard Form 46
 - Standard Form 91
 - NAVMC 10523
 - NAVMC 10524
31. Who is responsible for performing lubrication "L" services?
- Dispatcher
 - Operator
 - Mechanic
 - Equipment chief
32. A duplicate of what form serves as the operational authority and maintenance log for stationary equipment which remains at a project site?
- Standard Form 46
 - NAVMC 10523
 - Standard Form 91
 - NAVMC 10524
33. Daily preventive maintenance performed in accordance with the checklist on the back of the Engineer Equipment Operational Record and information in the TM, is known as _____ service.
- "L"
 - "Q"
 - "A"
 - "B"
34. What form is used for scheduling lubrication "L" services?
- NAVMC 10562
 - NAVMC 10245
 - NAVMC 10524
 - Standard Form 91
35. If a lubrication service is entered on the Engineer Equipment Operational Record when should the service be performed?
- Before the equipment leaves the equipment pool.
 - After the equipment returns to the equipment pool.
 - At the convenience of the operator.
 - After the equipment reaches the job site.
36. Which publication should be used as a primary source of lubrication information for engineer equipment?
- LI
 - TM
 - TI
 - LO
37. If a lubrication point is assigned both a calendar and an operating time interval, when should that point be serviced?
- Upon expiration of the calendar interval.
 - Upon expiration of the operating time.
 - Upon expiration of the clock time.
 - When either the calendar or operating time interval has expired.

38. The operator's report of motor-vehicle accident, Standard form 91, is to be completed by the operator
- only if his vehicle is seriously damaged.
 - only if the other vehicle involved is seriously damaged.
 - only if serious injury occurs.
 - regardless of the extent of damage or injury.
39. Who is responsible for scheduling lubrication services on equipment attached to a deployed unit?
- Dispatcher
 - Platoon sergeant
 - Operator
 - Platoon commander
40. Information concerning the repair parts required for maintenance and support of equipment would be found in the
- SL-3.
 - SL-4.
 - MI.
 - TI.
41. The item designator consists of a(an) _____ number followed by a letter.
- 4-digit federal supply classification
 - 5-digit ID
 - SSIC
 - 5-digit FSN
42. Which type of publication will provide you with a list of the special tools required for a particular piece of equipment?
- TI
 - SC
 - SL-3
 - SL-4
43. Additional equipment safety precautions would be published as a(an)
- LI.
 - TI.
 - MI.
 - SI.
44. The third element of a technical publication number is the
- type letter.
 - sequence number.
 - basic number.
 - maintenance echelon number.
45. What type of publication sets forth authentic and uniform instructions to correct weaknesses in equipment design?
- LI
 - MI
 - SL-3
 - TI
46. The letter of the alphabet following a 5-digit ID number identifies the
- type of publication.
 - sequence of the publication.
 - particular model of the basic equipment.
 - supply classification code.
47. Which echelons of maintenance are covered by the maintenance echelon indicator 15?
- 1st through 3d
 - 2d through 4th
 - 1st and 5th
 - 1st through 5th

48. Most Marine Corps Technical publications come under the _____ publication system.
- a. single-unit
 - b. double-unit
 - c. multiple-unit
 - d. sequence-number
49. POL containers that are stored upright should be tilted to
- a. prevent water seeping by caps.
 - b. allow water to settle.
 - c. prevent fuel from leaking.
 - d. prevent stacking containers.
50. What is the military symbol for high-temperature grease with MIL-G-3545A specification?
- a. Go
 - b. GAA
 - c. GH
 - d. OE
51. The ignition and antiknock qualities of a diesel fuel are affected by
- a. its cetane rating.
 - b. its octane rating.
 - c. its low viscosity.
 - d. its high volatility.
52. If the Case MC 1150 scooploader requires a grade 30 oil with a MIL-L-2104, what military symbol should you look for on the container?
- a. DF-2
 - b. OES
 - c. OE-30
 - d. 9250

Total Points: 52

* * *

13.31
lsn 1; p. 6

Chapter 2

POWER FLOW

Section I. ENGINES

2-1. ENGINE PRINCIPLES

a. **Engine construction.** The first step in understanding engine construction and operation is to know what goes on inside an engine cylinder. No matter how many cylinders an engine has, whether 1, 2, 6, or 12, the same actions take place in each cylinder. Since the diesel engine is mechanically similar to the gasoline engine, we can learn about engine construction and operation by studying a single-cylinder engine. This is a 4-stroke-cycle, internal-combustion, gasoline engine.

- (1) **Cylinder and piston (fig 2-1).** In the cutaway of a single-cylinder gasoline engine, the upper, or head end of the cylinder is closed by a cylinder head, but the lower end is open. The piston is a hollow metal tube with the top end closed. It has a close-sliding fit in the cylinder, which means it can move up and down. This up-and-down movement, produced by the burning of fuel in the cylinder, provides engine power.

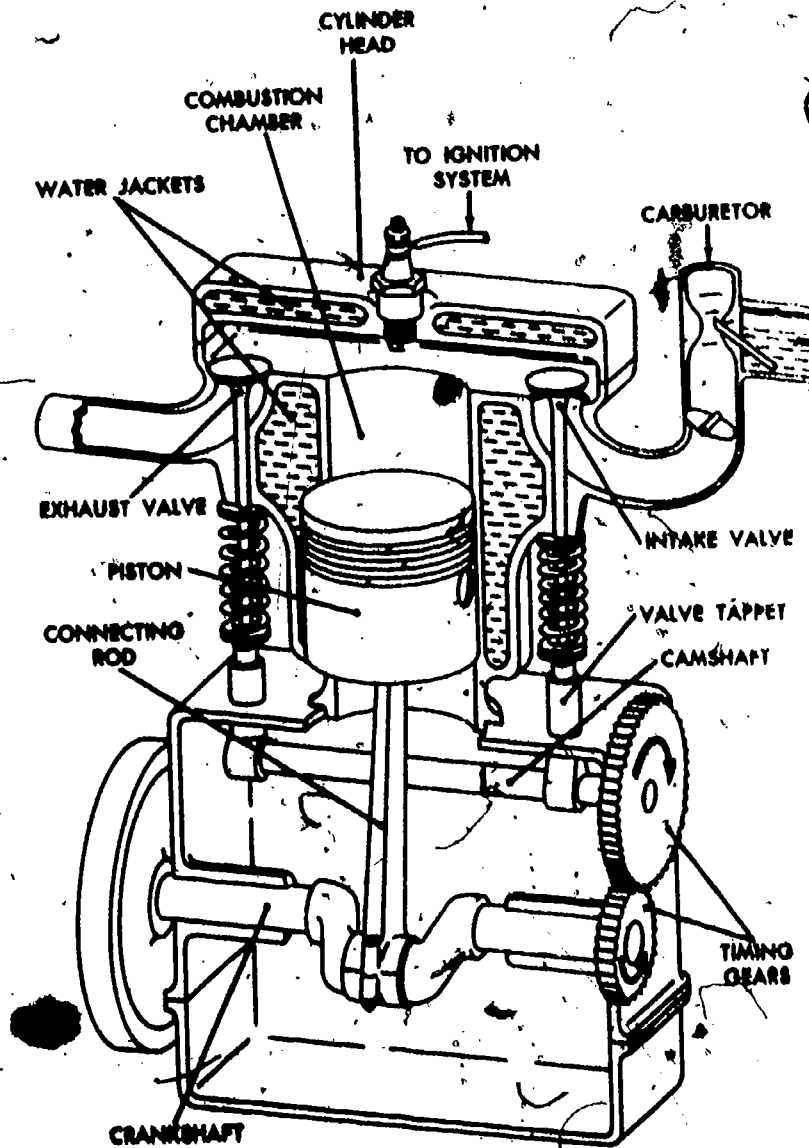

Fig 2-1. Single-cylinder, 4-stroke-cycle, gasoline engine.

- (2) Connecting rod and crank (fig 2-2). The up-and-down movement of the piston is called reciprocating motion. This reciprocating motion must be changed to rotary motion so the wheels of the vehicle can be made to turn. The change is accomplished by a crank on the crankshaft and a connecting rod which connects the piston to the crank. The connecting rod is connected to the piston by a piston pin which passes through bearing surfaces in the piston and the connecting rod. The lower end of the connecting rod is bolted to the crankpin on the crankshaft. As the piston moves up and down in the cylinder, the upper end of the connecting rod moves with it. The lower end of the connecting rod also moves up and down, but because it is attached to the crankshaft, it must also move in a circle with the crankpin. Each movement of the piston from top to bottom or from bottom to top is called a stroke. The piston takes two strokes as the crankshaft makes one complete revolution, an upstroke and a downstroke. When the piston is at the top of a stroke, it is said to be at top dead center (TDC). When it is at the bottom of a stroke, it is said to be at bottom dead center (BDC). These are called rock positions.

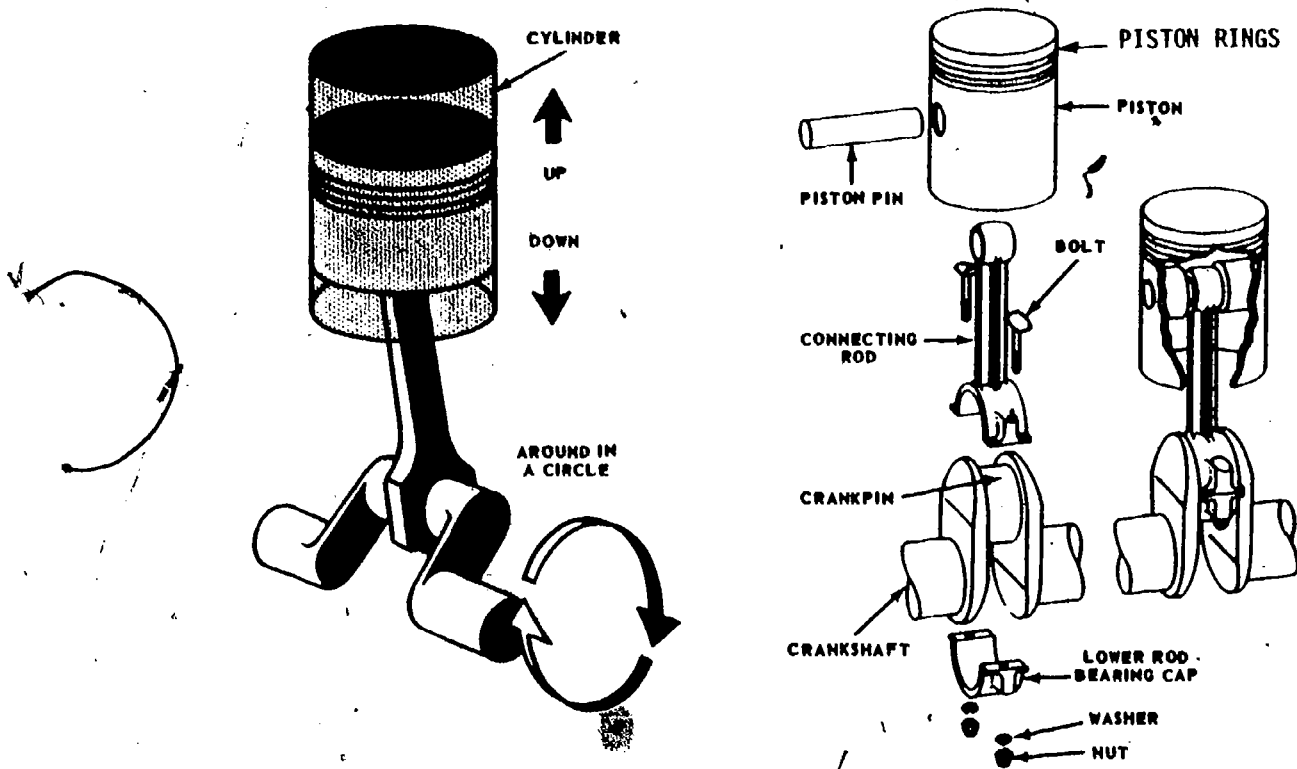

Fig 2-2. Cylinder, piston, connecting rod, and crankshaft for a simple one-cylinder engine.

- (3) Valves. There are two valves at the top of the cylinder. A valve is an accurately machined plug that fits into a machined opening at the top of the cylinder. When the valve is resting in this opening, it is said to be seated. When a valve is seated, it is closed and the opening is sealed off. When a valve is pushed off its seat, it is opened. The two valves in the cylinder are closed part of the time and open part of the time. One of the valves, called the intake valve, opens to admit a mixture of fuel and air into the cylinder. The other valve, called the exhaust valve, opens to allow the escape of burned gases.
- (4) Valve mechanism action. There are various ways of causing the intake and exhaust valves to open and close. One method is shown in figure 2-1. Here, a gear on the crankshaft is in mesh with a second gear on another shaft called the camshaft. The camshaft has a number of cams on it which are simply raised sections, or collars with high spots on them. When the camshaft rotates, the high spots (called lobes) move and push away anything they are in contact with. Riding on each cam is a cylindrical valve tappet. As the lobe moves up under the valve tappet, the tappet is raised. This upward movement causes the valve above it to be raised off its seat. When the lobe on the cam moves on around out of the way, the pressure of the spring under the valve forces the valve to move down and reseat. At the same time, the valve tappet is also forced downward so

that it remains in contact with the cam. The gear on the camshaft is twice as large as the crankshaft gear which means the camshaft will turn half as fast as the crankshaft. In other words, the crankshaft must turn twice for the camshaft to turn once. Thus, the valves are opened only once every two crankshaft revolutions.

- (5) Engine accessory systems. A discussion of accessory systems can begin with the fuel system. The fuel system contains the carburetor which supplies vaporized fuel to the air passing into the engine cylinder on the intake stroke. Another accessory system is the ignition system which ignites the compressed fuel-air mixture in the cylinder of gasoline engines at the end of the compression stroke. A third accessory system is the lubrication system; this supplies lubricating oil to the various moving parts in the engine. The oil lubricates all parts such as the piston, bearings, crankpin, and valve stems, that rotate or slide in or on other parts. This oil permits the parts to move easily so that little power is lost and engine wear is kept to a minimum. A fourth system is the cooling system which circulates water through jackets around the cylinder and in the cylinder head. This water removes part of the heat produced during combustion and prevents the engine from overheating. A detailed explanation will be given later in the chapter.

b. Gasoline engines. To produce sustained power, an engine must accomplish a definite series of operations over and over. This series of events is called a cycle. The cycle of an engine is designated by the number of strokes in a cycle: either 2 strokes, or 4 strokes. Most gasoline engines used by the Marine Corps are the 4-stroke-cycle type. Let us see what happens in a 1-cylinder gasoline engine during one complete cycle.

(1) Four-stroke cycle in sequence (fig 2-3).

- (a) Intake stroke. When you turn the ignition key, you throw a switch which connects the battery to the ignition system. Pushing the starter button or turning the ignition key still farther causes the starter to turn the flywheel and crankshaft which are linked to the piston by the connecting rod. The movement of the crankshaft causes the piston to move up or down, depending on its position. On the intake stroke, as the piston moves down, a vacuum is created in the cylinder, the intake valve opens, and air rushes in. This air enters the cylinder by passing through the carburetor and picking up and vaporizing a spray of gasoline which enters the intake manifold. As the crankshaft continues to rotate, the piston moves down and the air-gas mixture fills the cylinder. At the bottom of the intake stroke, the intake valve is closed. When the piston reaches BDC, both the exhaust valve and the intake valve are closed.
- (b) Compression stroke. As the crankshaft continues to rotate, the piston begins to rise, and the compression stroke begins. As the piston rises, the mixture of air and gasoline vapor cannot escape since both valves are closed. The mixture is therefore compressed in the space at the top of the cylinder, making it still more combustible. Compression causes the air-fuel mixture to move around in the cylinder; providing better mixing. As air is compressed, it creates heat which also aids in mixing and prepares the mixture for igniting. Just before the piston reaches TDC at the end of the compression stroke, a charge of electricity is delivered to the spark plug. This electricity jumps across the gap between the spark plug electrodes. The spark of electricity ignites the compressed gas-air mixture which burns rapidly and builds up tremendous pressures.
- (c) Power stroke. The great pressure in the cylinder forces the piston, which is at TDC, to start down. This is the beginning of the power stroke. The force (or thrust) of the piston is carried from the piston by the connecting rod to the crankshaft, which turns the flywheel. As the piston approaches BDC, the exhaust valve is opened. Part of the burned gases are forced out of the exhaust valve opening by the pressure still remaining in the cylinder.
- (d) Exhaust stroke. The piston moves past BDC and begins to rise, forcing the remaining burned gases out the open exhaust valve on the exhaust stroke. The exhaust valve closes when the piston reaches TDC and the cycle is completed. The four strokes (intake, compression, power, and exhaust) are continuously repeated as the engine runs. These four strokes take place very rapidly; the greater the speed of the engine, the more rapid the strokes.

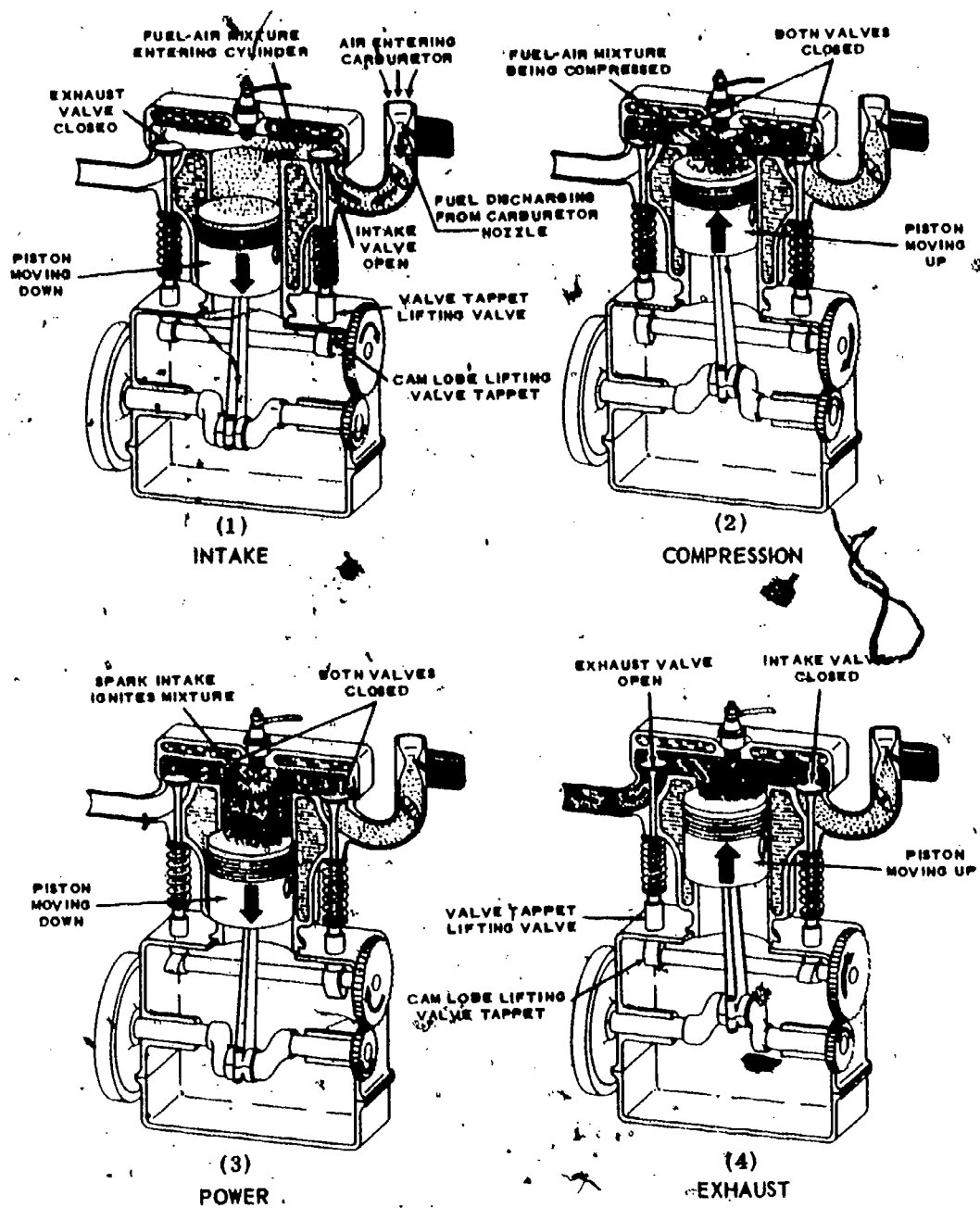

Fig 2-3. Four-stroke cycle in a gasoline engine.

- (2) Two-stroke cycle. As previously mentioned, the 2-stroke-cycle gasoline engine is not as common as the 4-stroke-cycle engine. In the 2-cycle engine, the entire series of events (intake, compression, power, and exhaust) takes place in 2 strokes of the piston. Intake and exhaust ports are cut into the cylinder wall rather than being placed at the top of the combustion chamber, as in a 4-cycle engine. As the piston moves down on the power stroke, it first uncovers the exhaust port to let burned gases escape and then uncovers the intake port to allow a new fuel-air mixture to enter the combustion chamber. On the upward stroke, the piston covers both ports and compresses the new mixture in preparation for ignition and another power (down) stroke. Every down stroke in a 2-cycle engine is a power stroke:
- (3) Comparison of 2-cycle and 4-cycle engines. It might appear that a 2-cycle engine could produce twice as much horsepower as a 4-cycle engine of the same size, operating at the same speed. However, this is not the case. In order to scavenge the burned gases at the end of the power stroke and during the time both the intake and exhaust ports are open, the fresh fuel-air mixture rushes into and through the cylinder. A portion of the fresh fuel-air mixture mixes with the burned gases and is carried out through the exhaust port. Also, due to the much shorter period the intake port is open (compared

to the period the intake valve in a 4-cycle engine is open), a smaller amount of fuel-air mixture is admitted. Hence, with less fuel-air mixture, less power per power stroke is produced as compared to a similar 4-cycle engine. To increase the amount of fuel-air mixture, auxiliary devices (blowers or air pumps) are used on 2-cycle engines.

c. Diesel engine.

(1) Comparison of diesel engine to gasoline engines. The diesel engine is mechanically similar to the gasoline engine, but is somewhat heavier. Both engines utilize air, fuel, compression, and ignition. Intake, compression, ignition, power, and exhaust occur in the same sequence; arrangements of pistons, connecting rods, and crankshafts are similar. Both are internal-combustion engines which use either a 2- or a 4-stroke cycle. They mainly differ in the way that fuel is delivered to the engine cylinders, and in the way that the air-fuel mixture is ignited. You will recall that in a gasoline engine the air and gasoline are mixed together in the carburetor; the vaporized mixture enters the cylinder through the intake manifold. The mixture is ignited by a charge of electricity across the gap in the spark plugs. As we shall see, the diesel uses neither a carburetor nor spark plugs; only air is drawn into the cylinder through the intake valve and manifold. On the compression stroke, the air is compressed to an extremely high pressure, and the temperature in the cylinder rises. At the proper instant, diesel fuel is injected into the cylinder by a fuel injection system, which usually consists of a pump, fuel lines, and an injector or nozzle. The high temperature of the compressed air in the cylinder ignites the fuel.

(2) Four-stroke cycle (fig 2-4).

- (a) Intake stroke. With the engine turning over, the piston is moving down and the intake valve is open. Instead of a mixture of air and gasoline entering the cylinder (as was the case in a gasoline engine), only air is entering. When the piston reaches BDC, the intake valve closes, and the piston starts up.
- (b) Compression stroke. As the piston moves up, the air is compressed to as little as 1/16 of its original volume. During compression, the temperature of the air rises to about 1,000° F. Shortly before the piston reaches the top of the stroke, the correct amount of fuel is injected into the cylinder. When the diesel fuel is injected into the cylinder, it has already been broken up into very fine particles by the nozzle of the fuel injector. It ignites when it comes in contact with the heated air in the cylinder.
- (c) Power stroke. As with the gasoline engine, the expanding, burning gases put pressure on the piston and force it down on the power stroke. Though it burns more slowly than the air-fuel mixture in a gasoline engine, the diesel fuel develops more thrust and power within the cylinder. As the piston approaches the bottom of the power stroke, the exhaust valve is opened and part of the burned gases escape.
- (d) Exhaust stroke. As the crankshaft continues to turn, the piston moves up in the cylinder forcing out the remaining exhaust gases. When the piston approaches the top of its stroke, the exhaust valve is closed, and the intake valve is opened. Then the entire cycle begins again.

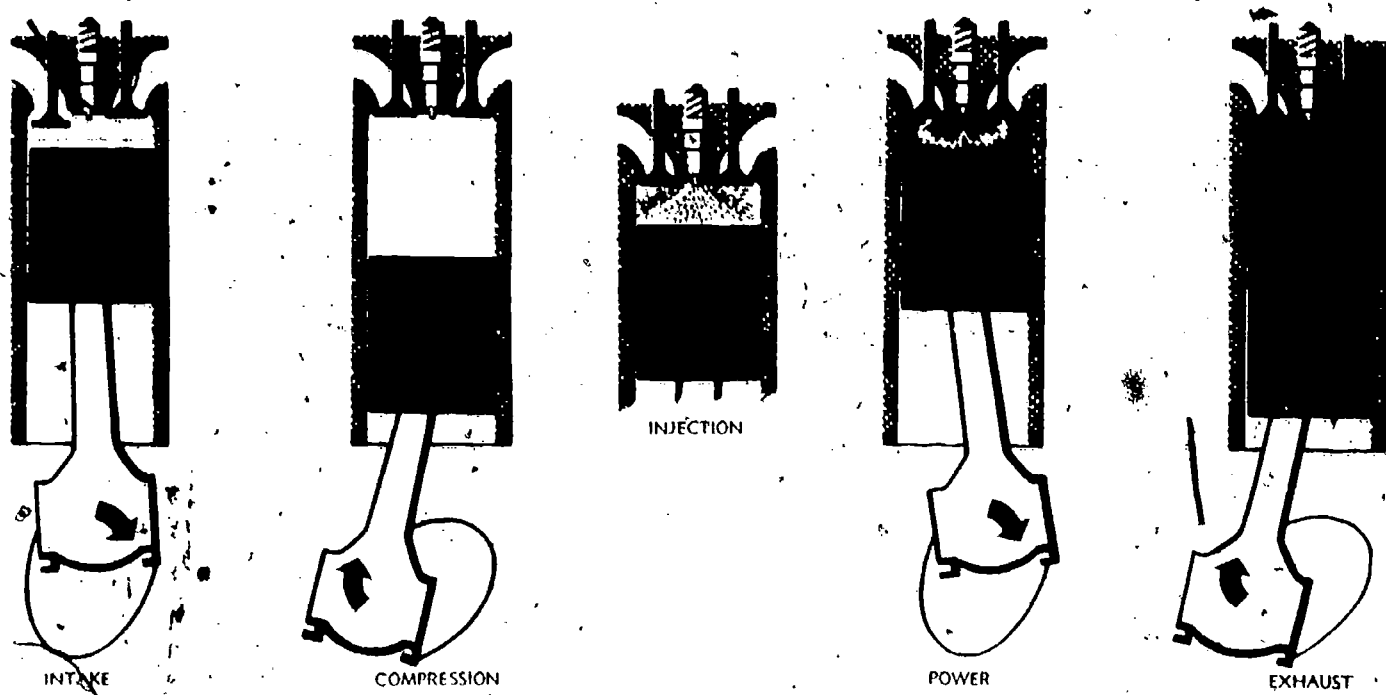
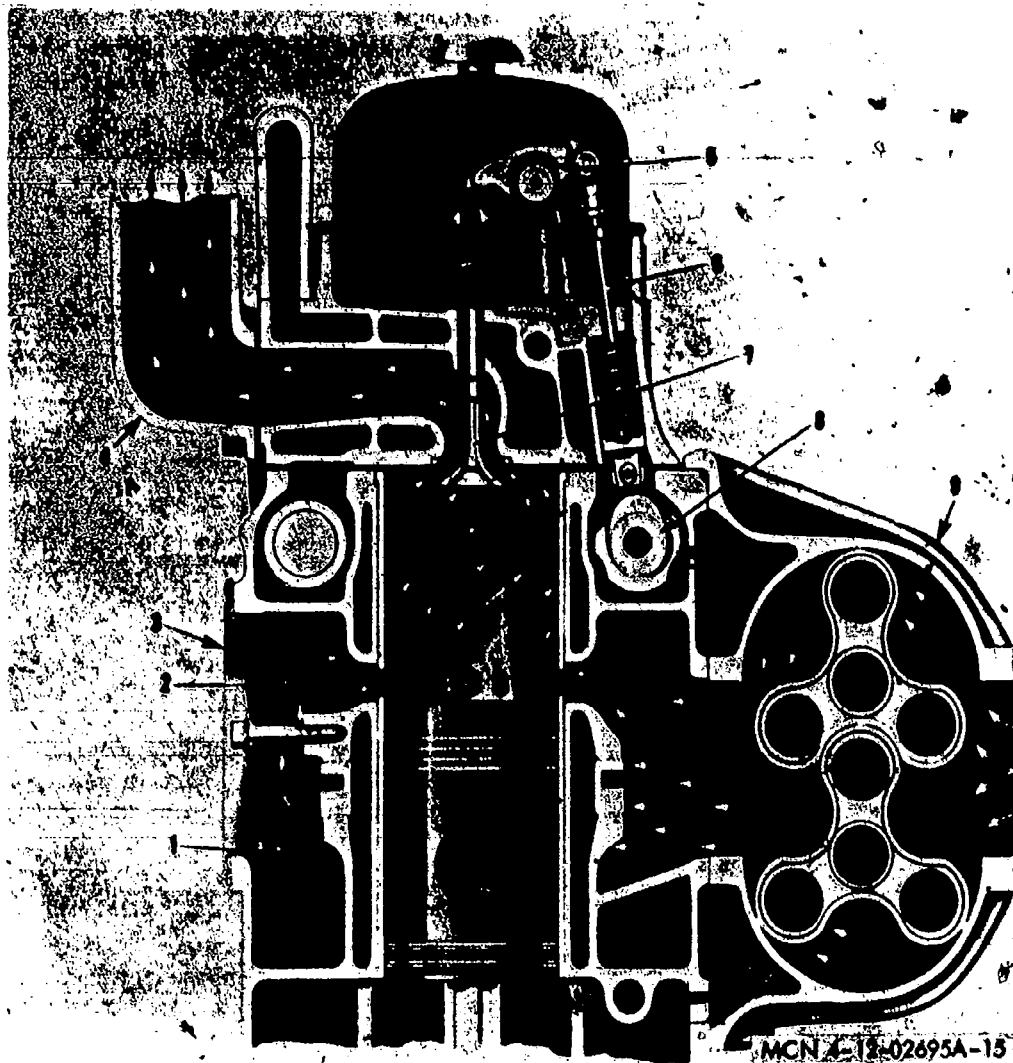

Fig 2-4. 4-stroke-cycle diesel engine.

(3) Two-stroke cycle. Two-stroke-cycle diesel engines are more widely used than the 2-cycle gasoline engines mentioned previously. One of the more common types that you will come in contact with is the 2-cycle Detroit diesel engine. Let us examine the operation of the typical 2-cycle, valve-in-head (overhead) engine. This engine uses a rotary blower to supply air, at a low pressure of 5-7 psi (pounds per square inch) to an air chamber surrounding the cylinders (fig 2-5). The cylinder walls contain a row of holes, or ports, which are above the piston when it is at the bottom of its stroke. These inlet ports admit air from the blower into the cylinder as soon as the piston uncovers the ports near the bottom of its stroke. Although there are two valves in the cylinder head, as in a 4-cycle engine, both are exhaust valves. The flow of air from the inlet ports in the bottom of cylinder toward the exhaust valves in the top (unidirectional) produces a scavenging effect, leaving the cylinders full of clean air when the piston again covers the inlet ports.

(a) Scavenging. Figure 2-6a shows the piston at the bottom of its stroke with the inlet ports uncovered and the exhaust valves open. The blower is forcing fresh air into the bottom of the cylinder, and this air is forcing the exhaust gases out through the exhaust valves in the cylinder head. As the piston continues its upward movement, the inlet ports are covered and then the exhaust valves close. Compression begins.

(b) Compression. The compression phase of the upward stroke of a 2-cycle diesel engine raises the fresh air charge to the high temperatures required for ignition of the fuel (fig 2-6b). Shortly before the piston reaches TDC, the required amount of fuel is sprayed into the combustion space by the unit injector. The intense heat generated during the high compression of the air ignites the fine fuel spray immediately.



- | | | |
|-----------------------------------|-----------------------------|-------------------|
| 1. Air box | 4. Exhaust manifold | 7. Exhaust valve |
| 2. Inlet ports | 5. Exhaust valve rocker arm | 8. Camshaft |
| 3. Cylinder block hand hole cover | 6. Push rod | 9. Blower housing |

Fig 2-5. Engine air intake system.

- (c) **Power.** Burning and expansion take place just as they did in the 4-cycle engine; and the resulting pressure forces the piston down on its power stroke (fig 2-6c).
- (d) **Exhaust.** When the piston is about halfway down, the exhaust valves are opened again, allowing the burned gases to escape into the exhaust manifold (fig 2-6d). Shortly thereafter, the downward movement of the piston uncovers the inlet ports and fresh air is again blown into the cylinder. Just as before, this helps to get the exhaust gases out, or scavenges them; it also fills the cylinder with fresh air. This entire combustion cycle is completed in each cylinder for each revolution of the crankshaft, or, in other words, in 2 strokes; hence the 2-stroke cycle.

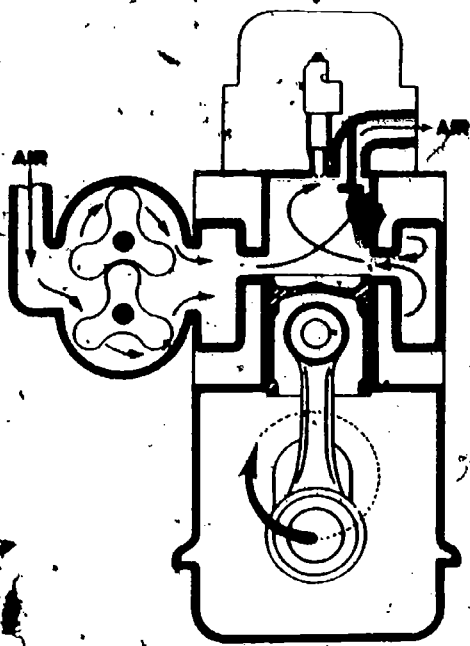

Fig 2-6a. Scavenging phase of upward stroke of engine piston.

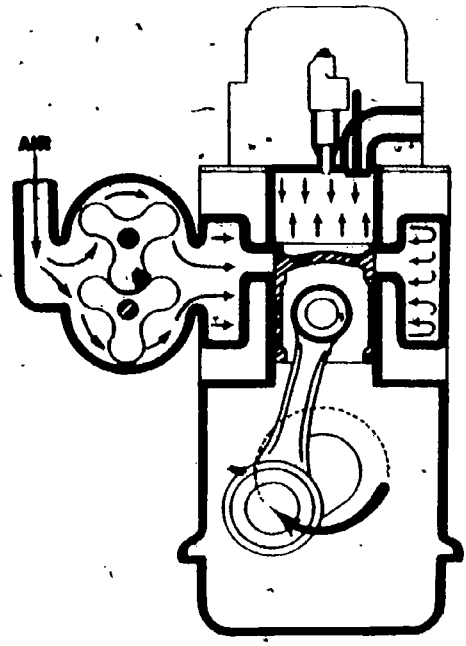

Fig 2-6b. Compression phase of upward stroke of engine piston.

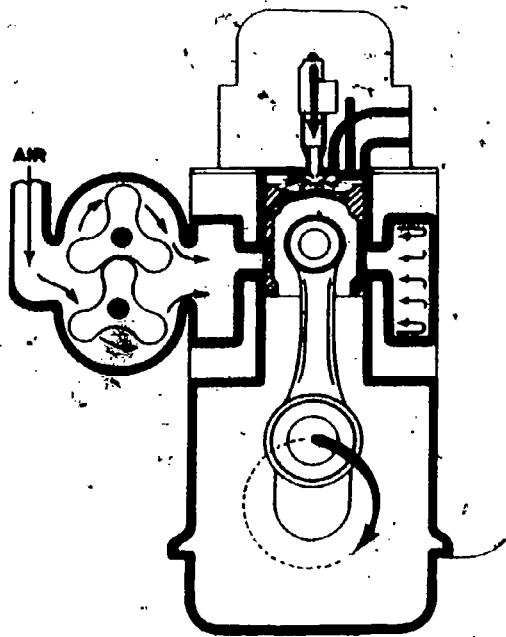

Fig 2-6c. Power phase of downward stroke of engine piston.

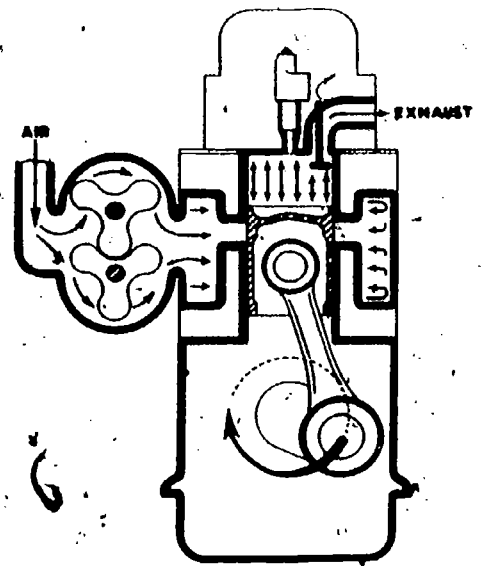

Fig 2-6d. Exhaust phase of downward stroke of engine piston.

d. Filtering devices. The proper operation of an engine depends on the air, fuel, and oil being free of any particles that will clog, restrict, or cause excessive wear on the parts. Manufacturers require that strainers, filters, and cleaners be used in the engine systems to remove any objectional materials in order to increase engine life.

- (1) **Fuel strainers.** Most fuel strainers (see fig 2-7) have a removable element which should be cleaned at regular intervals. This element consists of either close-fitting disks or some other materials. The element should be handled carefully so as not to damage it. The strainer should be drained and the element removed and washed carefully in CLEAN solvent or fuel oil. For specific directions for the removal and cleaning of the strainer element, consult the manufacturer's manual or TM for your piece of equipment.

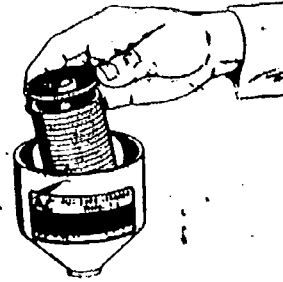

Fig 2-7. Fuel strainer.

- (2) **Fuel-oil filters.** In addition to the metal strainer mentioned above, most diesel-fuel systems also contain a filter to remove any remaining small particles of dirt that might clog the injectors. Fuel-oil filters are manufactured in various models by a number of manufacturers. All fuel entering the injectors first passes through the filter elements. The filter elements are made of cotton fiber or mineral wool and glass cloth. After continued use, these filters will become packed with dirt filtered from the fuel, and the flow of fuel to the engine will be reduced to a point where the engine ceases to function properly or stops. Most types of heavy equipment have fuel-pressure gages which will indicate when filters are dirty. Filter elements are easily removed and must be replaced with new elements when they start to restrict the flow of fuel to the engine.

- (3) **Lubricating-oil filters.** Most internal combustion engines are equipped with an oil filter. This device filters out the dust, dirt, and grit that enters the oil during operation of the engine and carbon and other materials that come from engine operation. Lubricating-oil filters (fig 2-8) depend upon a filtering element for their filtering action. When this filtering element is saturated with solid particles, it ceases to function. It is a good practice to replace the element with a new one every time the crankcase is drained and new oil is added. By such replacement you are assured of clean oil and a minimum of wear on engine parts.

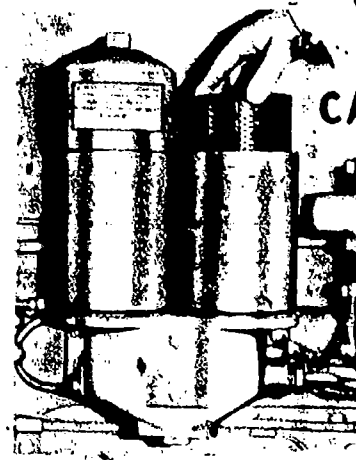

Fig 2-8. Lubricating-oil filter.

- (4) **Air cleaners.** Engineer equipment is equipped with air cleaners to filter air as it enters the engine. The air cleaner removes dirt, dust, and other material that might cause internal damage to the engine. About 50% of engine wear is caused by abrasive particles entering the engine through the air intake. There are two main types of air cleaners: the DRY type and the OIL-BATH or wet type.

(a) Dry-type air cleaners. The dry-type cleaner (fig 2-9) draws the air through a cleaning element which generally consists of cotton fabric, specially treated paper, or wire screens (specially wound copper crimp). The cleaning element (filter) collects the dust and other abrasive particles from the air as it passes down through the central duct. The hollow housing supporting the cleaning element also serves as a silencer to lessen the whining noise of the air entering the air cleaner. The dry-type air cleaner is used on many newer makes of construction equipment.

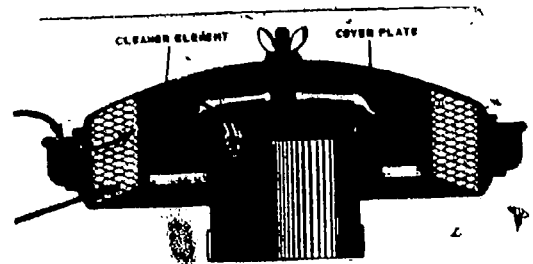

Fig 2-9. Dry-type air cleaner.

(b) Oil-bath or wet-type air cleaner. The wet-type air cleaner (fig 2-10) is an oil-bath cleaner, consisting of a main body and a cover. A reservoir of oil and a filter element made of copper gauze or fine mesh threads are within this unit. Air entering the cleaner passes through the small ports at the top of the body, then past the oil-filled reservoir, picking up drops of oil and carrying them into the filter element. The oil returns to the reservoir, carrying with it particles of dust that have accumulated in the filter. The air finally hits the cover plate and is deflected down through a passage to the carburetor.

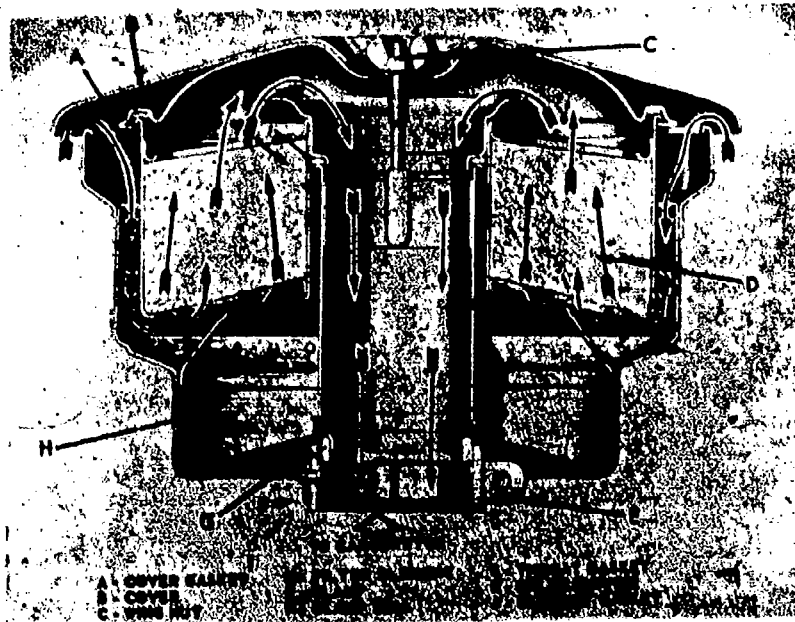

Fig 2-10. Wet-type air cleaner.

2-2. ENGINE SYSTEMS

a. Cooling system. Engines are cooled by having a liquid or air pass around the hot engine parts, absorbing heat and carrying it away. Most large engines in use today are liquid-cooled. Essential parts of a liquid-cooled system are the water jacket, water pump, thermostat, fan, and radiator. The water removes excess heat from the engine by circulating through the engine water jacket and dissipating the heat from the coolant to the surrounding air through the radiator. In air-cooled engines, the cylinders are cooled by conducting the heat to metal fins located on the outside of the cylinder and head. The essential parts of an air-cooled system are the fan, fins, and baffles. Air is circulated between the fins to effect cooling. When possible, the engine is exposed to the air stream of the vehicle, and baffles direct the air to the fins. If the engine cannot be mounted in the air stream, a fan is employed to force the air through the baffles. The liquid-cooled system is the more complicated of the two and will require the greater amount of operator preventive maintenance. Proper preventive maintenance or servicing largely depends on your knowledge of the individual components and how they function. This will be covered in the remainder of the paragraph.

(1) Liquid.

(a) Components and functioning (fig 2-11).

1. Water jacket. The water passages in the cylinder block and cylinder head form the engine water jacket. In the cylinder block, the water jacket surrounds all cylinders along their full length. In the cylinder head, the water jacket covers the combustion chambers at the top of the cylinders, and contains water passages around the valve seats when they are located in the head. The coolant flows from the block up into the cylinder head through passages called water transfer ports. A tight seal at the ports between the block and the head is important. The watertight seal at the ports, and the gastight seal at the combustion chamber openings, are both obtained with one large gasket called the cylinder-head gasket. A drain cock or removable plug in the block may be used to drain water from the system.

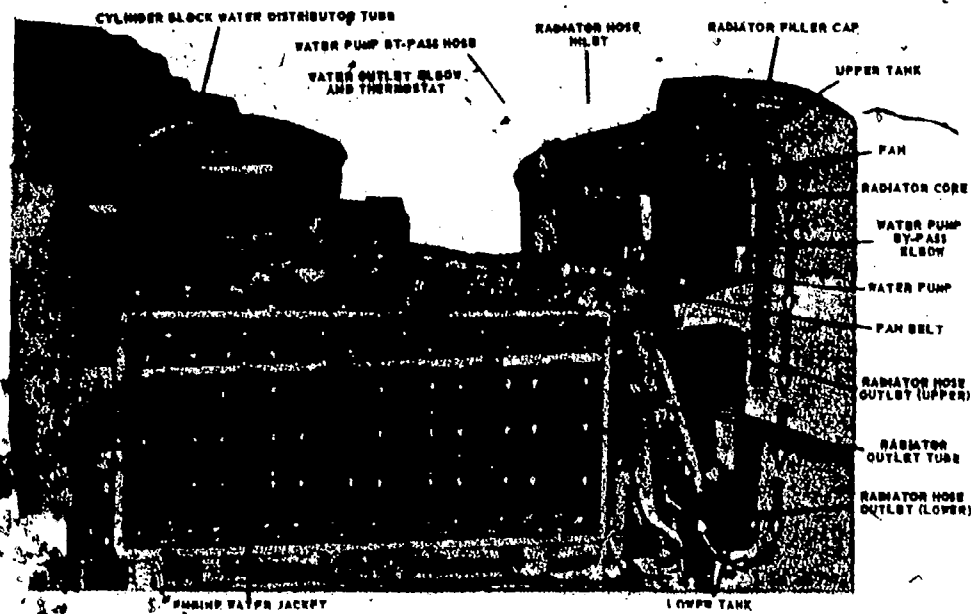

FIG 2-11. Liquid-cooled circulation system.

2. **Radiator.** The radiator assembly consists of two tanks with a core between them to form the radiating element.

- a. The top tank collects the incoming water and distributes it across the top of the radiator core. Baffles in the tank assist in distributing the water to the tubes or cells of the core and prevent water from being thrown out of the radiator. An overflow pipe provides an opening for the escape of water or steam that might cause excessive pressure which would rupture the thin metal walls of the radiator. The bottom tank collects water flowing from the core and discharges it through the radiator outlet. Usually, a drain cock or removable plug in the bottom of the lower tank permits draining water from the radiator.
- b. Some cooling systems are sealed and use a pressure radiator cap to close off the overflow pipe opening. If the overflow pipe was open, the movement of the water would cause some of it to overflow into the pipe and be lost. The pressure cap prevents this and also allows a certain amount of pressure to build up. This pressure buildup raises the boiling point of the water and permits the engine to operate at higher temperature without overflowing. The cap contains two valves: a pressure valve which acts as a safety valve to relieve any extra pressure in the system, and a vacuum valve which allows air to enter the system when the pressure within the system drops as the engine cools off.

3. **Water pump and fan (fig 2-12).** The pump is a centrifugal type having an impeller with blades which force the coolant outward as they rotate. The pump and fan are usually driven through a V-belt and pulley arrangement which is driven by a pulley at the front end of the crankshaft. The pump draws water from the bottom of the radiator and forces it up through the engine water jacket. The fan circulates a large volume of air through the radiator core. In addition to removing heat from the radiator, this flow of air also provides some direct cooling of the engine. The fan usually rotates within a shroud, which is a funnellike structure to direct the flow of air for most effective cooling.

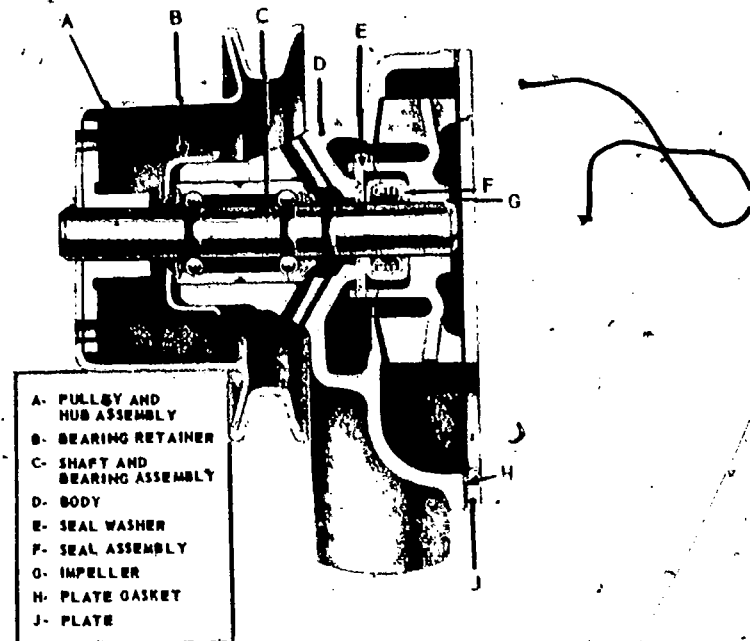

Fig 2-12. Water pump.

4. **Thermostat (fig 2-13).** An internal-combustion engine will operate more efficiently and economically when hot than when cold. The best operating temperature for an engine is just over the boiling point of water, 212° F, but to allow for margin of safety, it is usually controlled to a maximum temperature of 185° F. Normal operating temperatures range between 160°-185° F. The water pump starts circulating water through the system as soon as the engine is started, no matter how low the temperature, so a thermostat must be installed to insure quick warmup and to prevent overcooling in cold weather. The thermostat controls engine temperature by regulating the amount of water flowing from the block to the radiator.

- a. The thermostat is a heat-operated unit which controls a valve between the water jacket and the radiator. Attached to the valve is a flexible metal bellows, which is expandable. The sealed bellows contains a volatile liquid or gas. When the liquid is cold, the bellows is contracted and the valve is closed. As the engine warms up, the liquid is vaporized and expands the chamber, opening the valve. When the engine is cold, the valve remains closed and the water is recirculated, bypassing the radiator.

- b. The thermostat is usually located in the housing of the cylinder-head water outlet elbow. It is constructed so that if it fails to function it will remain in the open position allowing free circulation of the water.
- c. Some military vehicles are equipped with radiator shutters which are used to supplement the thermostat in cold weather. The shutters restrict the flow of air through the radiator and thus help in warming up the engine.

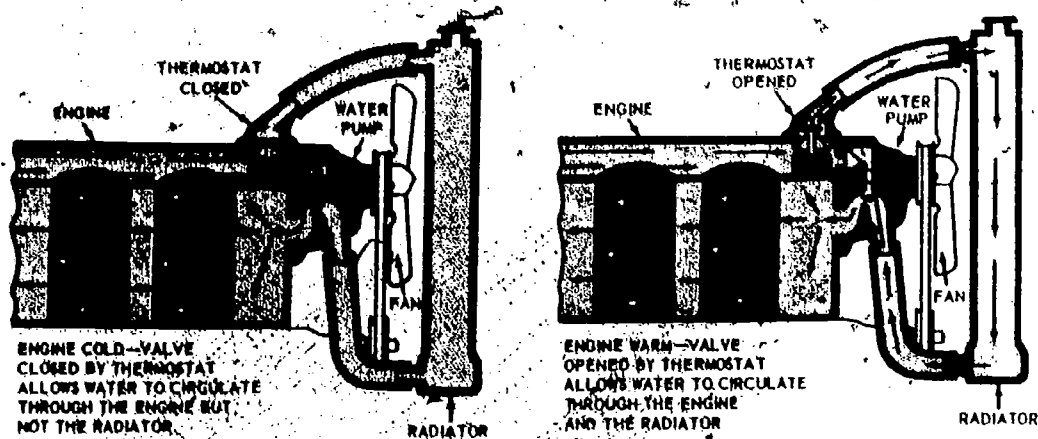

Fig 2-13. Operation of thermostat.

(b) Servicing.

1. Cleaning and flushing of the radiator is necessary to prevent excessive accumulations of rust and other corrosive deposits. Generally, it should be done at least twice a year, in fall and spring. Begin the flushing procedure by opening the drain cocks and allowing the water to drain out. Refill the system with new water and an approved cleaning compound. (Note: Check pertinent Marine Corps orders (MCO's) before adding cleaning compounds.) Run the engine for at least 1/2 hour and drain the system again. Refill with water, run the engine for 5 minutes, and then drain this water. Refill with clean water, adding a rust inhibitor or antifreeze solution if the weather requires it.
2. While cleaning and flushing the cooling system, clean insects, dirt, and other foreign matter out of the radiator air passages. Water or compressed air may be used to clean out the passages. When operating equipment under extremely dusty conditions, or when clearing brushy areas, check the radiator passages frequently to prevent overheating the engine.
3. When servicing the cooling system, check the condition of the hoses and all connections. If there are leaks, or if a hose collapses when grasped with the hand, it should be replaced. In replacing hoses be sure that they are of the proper length and diameter. The diameter (inside dimension) is usually marked on the outside of the hose.
4. An overheated engine is easy to recognize by the temperature gage reading, radiator boiling, or by knocking and laboring of the engine. Probable causes include: insufficient water in the system, a defective pressure cap, slipping fan belts, or a partly clogged radiator. Do not add water to an overheated engine until the engine has cooled enough to prevent cracking the cylinder block or head. When refilling the radiator, pour the water in slowly with the engine running at a high idle.
5. Worn, loose, or slipping fan belts often cause overheating. To check excessive looseness or tightness, push in on the belt midway between the fan and crankshaft pulleys. Individual equipment TM's will specify the amount of slack that should exist (usually between 3/4 and 1 in.). If it is necessary to adjust the fan belt, first look at the type of device used to provide the fan belt takeup. Two methods of adjusting fan belts are illustrated in figure 2-14. Never adjust the belt too tightly, as this will cause unnecessary strain on the fan and generator bearings.
6. Water pump bearings may be either sealed, requiring no lubrication, or open, requiring lubrication at specific intervals. Lubrication of the water pump bearing is accomplished either through a special grease fitting, incorporating a relief valve, or by removing a pipe plug and filling the housing with grease.

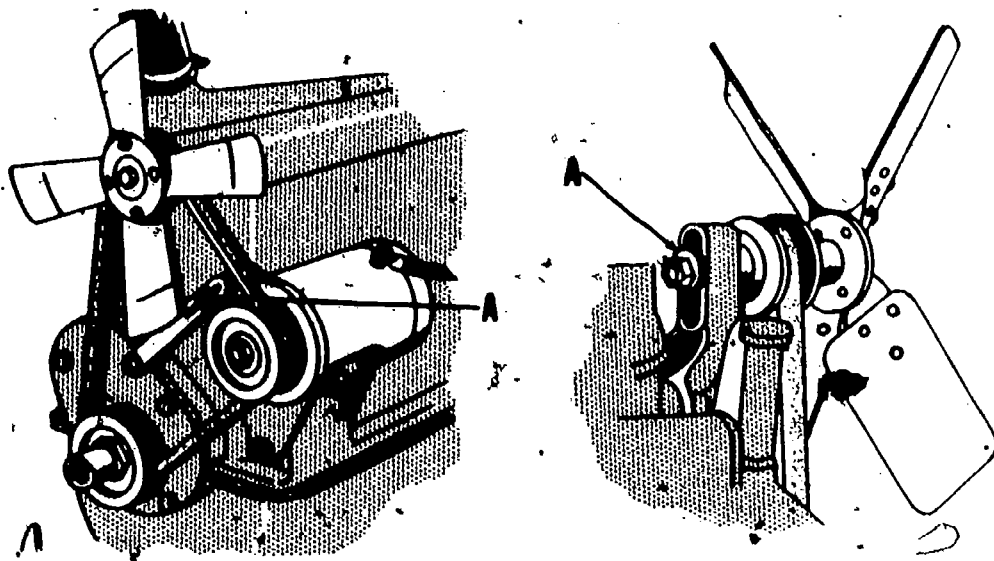

Fig 2-14. Two methods of adjusting fan belts (A-adjusting nut).

(c) Additives.

1. Antifreeze.

- a. A vehicle operated in temperatures below 32° F requires an antifreeze solution in its cooling system. Without this solution, the water in the cooling system freezes and sometimes cracks the cylinder head or block.
- b. Ethylene glycol is the most commonly used permanent-type antifreeze. It has an extremely high boiling point, does not evaporate in use, is noncorrosive, and gives complete protection when used in the proper amount. Maximum protection (-65°F) is obtained when a solution of 40% water and 60% ethylene glycol is used. Adding more ethylene glycol will only raise the freezing point of the solution. If 100% ethylene glycol compound is used, the freezing point is not much below that of water.
- c. Hydrometers (fig 2-15) are used for testing antifreeze solutions. The time intervals for testing, generally weekly, are established by local orders. Hydrometers usually come with instructions for their use. Their principle of operation is based on the fact that the specific gravity of the solution in the cooling system varies with the temperature at which the solution freezes. Tests should be made after the engine reaches its normal operating temperature. The hydrometer suction bulb is used to draw a sample of the solution from the radiator. Care should be taken to draw only enough solution to float the float. The temperature of the solution is matched to the specific gravity, and a conversion table indicates the temperature at which the solution will freeze. When making the test, it is a good practice to take two or more readings to insure accuracy.
- d. A good antifreeze solution mixes readily with water, but tends to penetrate openings and connections more readily than water. Before antifreeze is added in the fall, and periodically thereafter, hose connections should be checked for tightness.

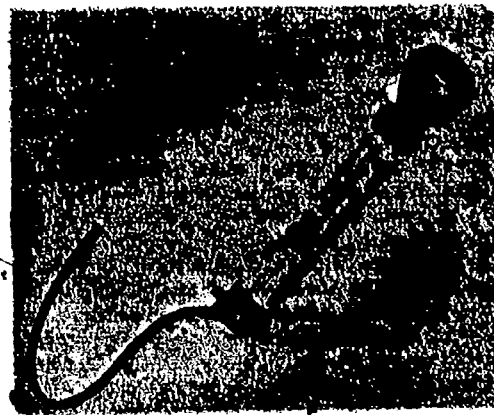

Fig 2-15. Hydrometer.

2. Rust inhibitors. The cooling system must be free of rust and scale to maintain its efficiency. The use of inhibitors or rust preventives will reduce or prevent corrosion and the formation of scale. Inhibitors are not cleaners and do not remove rust and scale already formed; they merely prevent rust or corrosion. Most antifreeze solutions contain an inhibitor. If water alone is used as the coolant, an inhibitor should be added.

(2) Air.

- (a) Components and functioning. Air-cooled engines have fins around the cylinders and on the cylinder heads to expose more of the surface to the cooling air. Some of the air-cooled engines also have these parts surrounded by a cowling (light metal air ducts) with a fan to blow the air across the fins. Some engines with cowling have a heat-controlled piece of metal that will open and close the air passage to allow for engine warm-up. The fan that circulates the air is usually a part of the engine flywheel.
- (b) Servicing. Cleanliness is the most important part of servicing the air-cooled-type system. Leaves and other debris are removed from the screen protecting the flywheel fan daily before cranking the engine. The cowling is removed periodically, depending upon the operating conditions, to remove any dirt or debris lodged in the fins. If the engine is collecting a lot of dirt on other parts, the cowling should be removed and the cooling areas cleaned.

b. Lubrication system.

(1) Purpose. Engine lubricating oils have a fourfold purpose: to reduce friction, to assist in cooling the engine, to clean the engine parts, and to prevent blowby in the engine cylinder.

- (a) The primary purpose of engine lubricating oil is to reduce friction between moving parts. Lubrication supplies a thin film of oil which prevents metal-to-metal contact, thus greatly reducing friction. The crankshaft, connecting rods, bearings, pistons, valve mechanisms, gears, and accessory drives are the principal parts which must be lubricated to guard against friction.
- (b) Helping to cool the engine is another purpose of the lubricating oils. As the oil circulates through the engine, it absorbs a portion of the engine heat, raising the temperature of the oil. The heated oil is carried back to the oil pan where the flow of air past the oil pan cools it. Some engines use an oil cooler, which is a functional part of the water-cooling system, to assist in cooling the heated lubricating oil.
- (c) As oil circulates through the engine, it tends to wash off and carry dirt, carbon, and foreign matter into the crankcase where the larger particles drop to the bottom of the pan. Oil filters are used to remove the smaller particles which remain in the oil.
- (d) Piston rings must form a gastight seal with the cylinder walls. The lubricating oil on the cylinder walls not only reduces friction but also provides a seal, preventing combustion gases from blowing by the piston rings.

- (2) **Components and functioning (fig 2-16).** Most modern engines employ a full-force feed lubrication system. The oil supply is carried in the oil pan from which it is forced through a network of drilled passages, tubes, and pipes to the valve mechanism, crankshaft, camshaft, connecting rods, and piston pins.
- (a) **Oil strainer.** This is a fine-mesh bronze screen through which the oil enters the oil pump from the oil pan. It keeps large dirt and sludge particles from entering the system.
 - (b) **Oil pump.** The oil pump is the heart of the lubrication system. Depending on the design of the engine, the pump is mounted either inside or outside the crankcase. One of the most common oil pumps is the gear-type which is generally driven by the camshaft. A pressure relief valve is provided to regulate the pressure within the pump. This valve contains a spring-loaded ball that rises when the desired pressure is reached and allows excess oil to be delivered to the inlet side of the pump.
 - (c) **Oil gages.** Normally, there are two oil gages in an engine. One indicates the pressure of the oil in the system, the other indicates the oil level in the oil pan.
 - 1. **Pressure gage.** The pressure gage, mounted on the instrument panel, is calibrated in psi or in some other comparative system to indicate the pressure in the lubrication system. The normal oil pressure varies from 30 to 50 psi. This is the most important gage for an operator to check during the course of a day's work. The gage should register within 30 seconds after the engine is started. If it does not register, shut the engine down and notify your section chief. New or cold oil may take a little more time to register, and then (while still cold) may produce high-pressure readings. If some part of the system is clogged, the pressure on the gage will also rise abnormally. A sudden drop in oil pressure indicates a failure in some part of the lubrication system and the engine should be shut down immediately.
 - 2. **Oil-level gage.** The oil-level gage is a rod or dipstick which is inserted into the side of the engine and extends down into the oil pan. It is generally marked to show LOW and FULL oil levels. Some diesel engines have markings on both sides of the dipstick; the upper markings indicate the oil level with the engine stopped, the lower markings (on the opposite side) indicate the oil level with the engine running. To assure accurate readings, first remove the stick, wipe it clean and replace it, then remove it again and observe the oil level.
 - (d) **Oil filters.** The oil filter is placed in the oil line above the oil pump. It removes most of the small impurities that have not been caught by the strainer. Two types of oil filters are used: the bypass filter, which filters only a portion of the oil and returns it to the crankcase; and the full-flow filter which handles the full output of oil from the oil pump before it is circulated through the engine. The full-flow filter is generally provided with relief or bypass valves which allow the oil to flow around the filter when it becomes clogged. The typical oil filter element is a replaceable cartridge which is usually changed at the same time that the engine oil is changed. Oil changes are generally scheduled at intervals of 100 hours.
 - (e) **Oil cooler.** Some engines employ an oil cooler which uses the liquid in the cooling system to prevent the oil temperature from rising too high in hot weather. It provides a more positive means of controlling oil temperature than does cooling by radiation from the oil-pan walls. The cooler is made up of a core through which the oil circulates, and a housing through which the cooling water passes. The cooler is located on the side of the engine. Cool water from the bottom tank of the radiator passes through it before being circulated through the engine water jacket.

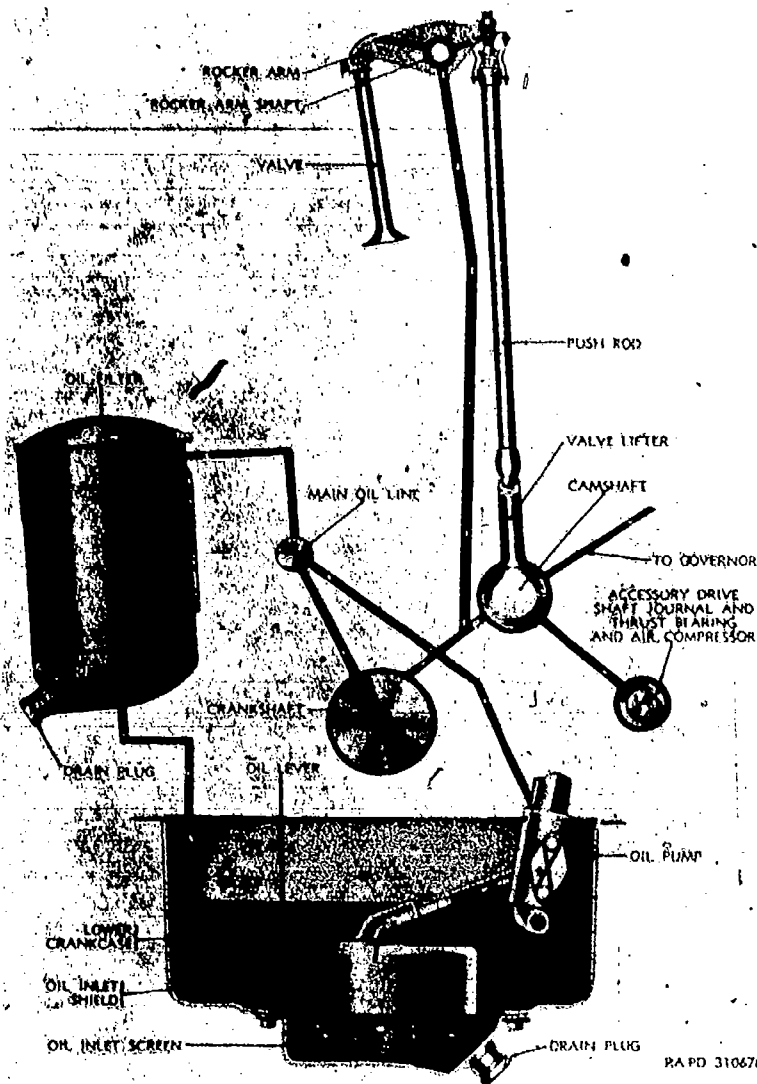

Fig 2-16. Lubrication system of in-line and V-type engines.

(9) Servicing.

- (a) The oil level should be checked prior to starting the engine and, if necessary, additional oil should be added to obtain a FULL dipstick reading. The grade of oil to be used during varied temperature ranges will be specified in the applicable TM and also on a plate or chart on the equipment. The TM will list the time or calendar interval at which the lubricating oil should be changed. In cold weather or extremely dusty conditions, the oil should be changed more frequently.
- (b) Drain the oil only after the engine has been warmed up. This warmup period will thin the oil and stir up the sludge and foreign matter in the crankcase.
- (c) Oil filter elements are generally changed at the same time the oil is changed. In changing the element, first remove the drain plug from the filter housing. Then remove the filter cover and lift out the old element. Clean the inside of the housing, install a new element, and replace the drain plug. Fill the housing with new oil and reinstall the cover, using a new gasket. Make sure the gasket seats correctly and is not crimped by the cover. After completing the oil and filter change, run the engine for a short time and check the filter for leaks. Recheck the oil level when you secure the engine.

c. Intake and exhaust systems. The intake system includes all those parts through which air must travel to enter the engine cylinder. The exhaust system contains the parts through which the exhaust gases are expelled into the atmosphere. From the discussion on engine principles you learned that the fuel is mixed with the air before it enters the cylinder on gasoline engines and that only air enters through the intake of diesel engines. The unrestricted flow of air to the engine is very important for proper engine operation. The air must be clean or abrasives will cause rapid wear of the internal engine parts. Most of the dirt and debris is trapped by the air cleaner, but some small particles may enter the piping through leaks or small holes in the filter or loose connections. These small particles soon build up on the walls of the passage and restrict the flow of air. The intake system parts from the manifold or the carburetor should be removed and cleaned periodically depending upon the operating conditions. The air cleaner is checked daily and serviced according to the manufacturer's recommendations as shown in the TM. The exhaust must also be unrestricted in order to allow all the burned gases to escape. Check the system daily to insure that it is not bent or clogged.

d. Electrical system.

(1) Introduction. The electrical system provides the direct current (dc) electricity to operate the engine, its electrical accessories, and the vehicle electrical components. It consists of a battery, a charging system, an ignition system for gasoline engines, and a starting system.

(2) Battery.

(a) Introduction. The lead-acid storage battery is the most common battery used for starting, lighting, and ignition purposes. It consists of three or more cells, depending on the voltage required. Each cell has a rated output of approximately 2 volts. A battery of three cells (2 volts each) connected in series is known as a 6-volt battery. To get higher voltage from a battery, more cells are connected in series. Storage batteries come in multiples of 2 volts (and three cells), such as 6-volt and 12-volt.

(b) Construction (fig 2-17). Each cell contains a number of positive and negative lead plates, separated from each other by a suitable insulator. The plates are joined together in positive and negative groups and are permanently joined to the connecting post strap. Each cell is located in a hard-rubber jar or compartment and is submerged in a sulfuric acid solution (electrolyte). The connecting post strap to which the plates are attached contains a cylindrical terminal which forms the outside connection for a cell. A hard-rubber cover with two terminal openings and a vent plug is placed on each cell. The cells are then sealed and connected in series by burning cell connectors on the terminals. The vent plug serves as a means for checking and filling the battery. It also allows the heat and gas caused by the chemical reaction within the cell to escape and prevents electrolyte from splashing outside the battery.

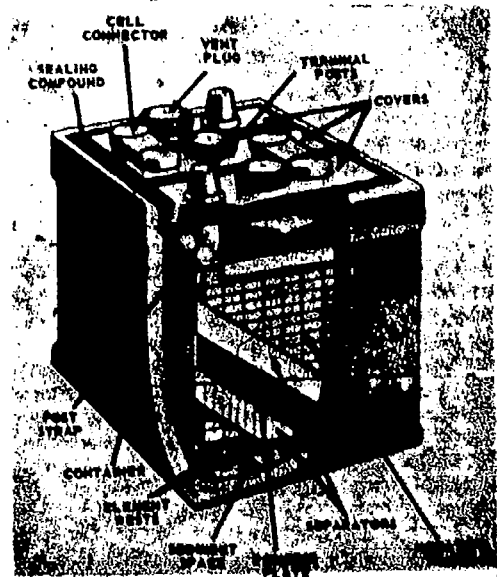

Fig 2-17. Cell construction of a storage battery.

(c) Electrolyte. An electrolyte is a liquid which readily conducts electricity and decomposes when an electric current passes through it. The electrolyte in a battery has a specific gravity of 1.280, and is composed of 1 part sulfuric acid to approximately 2 3/4 parts distilled water. Premixed electrolyte is normally available and is used for activating dry-charged storage batteries.

(d) Chemical action. When the battery delivers current to a load, it discharges; the sulfuric acid is absorbed into the plates, weakening the electrolyte. When the battery is being charged, it receives current from the generator in a reverse direction. The reverse chemical reaction restores the sulfuric acid to the electrolyte. Thus we may say that the amount of sulfuric acid and the specific gravity of the electrolyte changes with the amount of electrical charge. This provides a convenient way of measuring the degree of charge in a battery.

(e) Testing.

1. Specific gravity (fig 2-18).

a. Specific gravity can be measured by a hydrometer. A reading is taken by drawing enough electrolyte into the hydrometer to raise the float. For convenience, the readings are spoken of as being 1150, 1200, and 1280, instead of 1.15, 1.2, and 1.28, which are the true specific gravities.

b. Relationship between specific gravity readings and state of charge.

1275	fully charged
1235-1260	three-fourths charged
1205-1230	one-half charged
1170-1200	one-fourth charged
1140-1165	barely operative
1110-1135	completely discharged

When electrolyte readings indicate that the battery is nearing a discharged condition, the battery should be recharged immediately, otherwise serious damage will result.

c. Temperature correction. All hydrometer readings are stated at a normal electrolyte temperature of 80° F. It is not usually necessary to make allowance for temperature variations, unless the temperature range is great. Temperature corrections are made by adding 1 to the hydrometer readings for every 2.5° above 80° F, and subtracting 1 for every 2.5° below 80° F.

d. Tropical operation. When batteries are operated in tropical climates, the specific gravity of the electrolyte should be lowered to between 1200 and 1225 by diluting with water. A tag indicating the full-charge specific gravity should be attached to the battery.

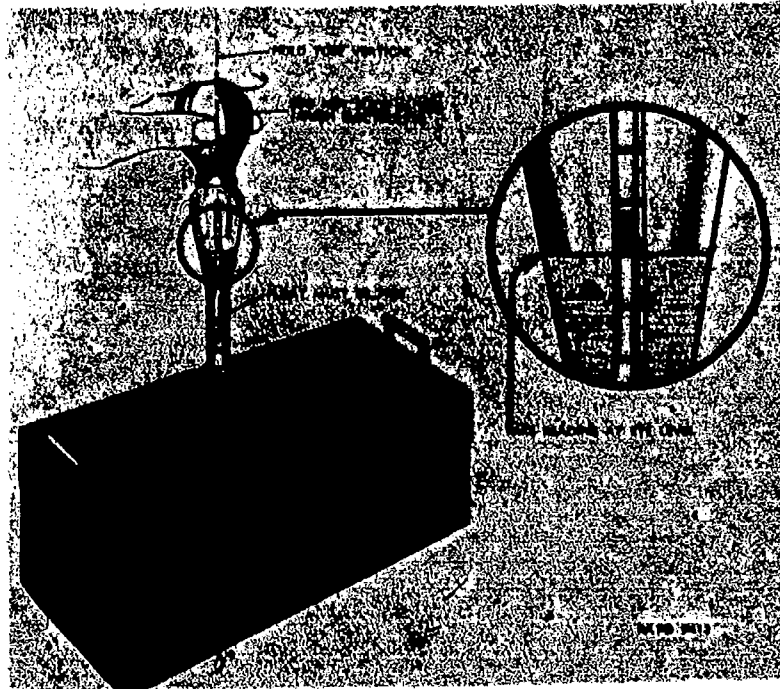

Fig 2-18. Taking specific gravity reading of a battery with hydrometer.

2. **Battery-capacity test.** While specific gravity tests give an indicator of the battery's state of charge, the actual effectiveness of the battery to supply electrical energy is determined by a battery-capacity test. This test is generally performed by mechanics or battery shop personnel. If the battery does not meet specifications, it should be replaced.

(f) Servicing.

1. Battery water level should be checked at least once a week, and clean water added, if required. When possible, use distilled water. Do not overfill the cells. Add water carefully and wipe away any water which spills on the battery top. During freezing weather, add water after the engine has been started, prior to beginning operation.
2. Check the battery terminal clamps and battery holdowns, and tighten them if necessary.
3. Acid fumes from the battery cells react with metal to form a hard greenish-white deposit on terminals and clamps which results in corrosion. This deposit also gets between the terminal posts and clamps, and hampers the flow of current. A bicarbonate of soda (baking soda) and water solution should be used to remove the deposits. Use about 3 tablespoons of soda to a pint of water. When cleaning the battery, remove the cable clamps and apply the solution with a stiff brush. Do NOT permit the soda solution to enter the cells. After the solution has softened the acid deposits, scrape them away with a stiff brush or knife. When clean, rinse the parts with clean water and wipe dry; then reconnect the battery clamps.
4. New or replacement batteries are dry-charged and only require the addition of a suitable electrolyte in order to be placed in service. Premixed 1280 electrolyte is available through the supply system. Adding electrolyte to a battery is a dangerous job. You have probably seen holes appear in utilities for no apparent reason. Later, you remember replacing a battery and having carelessly brushed against it. Remember, when handling electrolyte you are dealing with sulfuric acid which can burn clothing and severely burn your hands and face. Always wear rubber gloves, an apron, and goggles for protection against splashes.
5. If you are accidentally burned by acid, keep calm and apply first aid. First, douse the burned area with large amounts of water to remove most of the acid. Then apply a solution of baking soda and water, or ammonia and water, to neutralize any remaining acid. Check in at the nearest sick bay for further treatment.
6. When mixing electrolyte, never pour water into acid. ALWAYS POUR ACID INTO WATER. If water is added to concentrated sulfuric acid, the mixture may explode and spatter in all directions, causing severe burns. Pour the acid into the water slowly, stirring gently but thoroughly all the time.
7. When replacing batteries or cleaning terminals, make sure that you reconnect the clamps to the proper terminals. When removing the cables, disconnect the grounded terminal (the terminal lead that is connected to the vehicle frame) first and install it last when replacing. Batteries and electrical systems have different types of grounds. For the various electrical systems to function properly, the batteries must be hooked up correctly. Use your equipment TM whenever you work on the batteries and battery cables. All batteries have a positive (+) and a negative (-) terminal or post. The appropriate signs are stamped either on top of the post or on the battery case next to the post. As a general rule, the larger of the two posts will be the positive post. If in doubt about installing the battery, check the equipment TM.

(3) Charging circuit (fig 2-19).

- (a) **Purpose.** The charging circuit consists of the generator or alternator, generator regulator, and ammeter. This circuit recharges the battery and supplies electrical current to operate the electrical load of the vehicle (lights and ignition). The battery and generator both supply electrical current to operate the vehicle electrical system, but never at the same time. The battery supplies current for starting and for operation at low idle speeds when the generator is not turning fast enough to generate sufficient electricity. At speeds above low idle the generator takes over and supplies electrical current for accessory operation, and also recharges the battery.

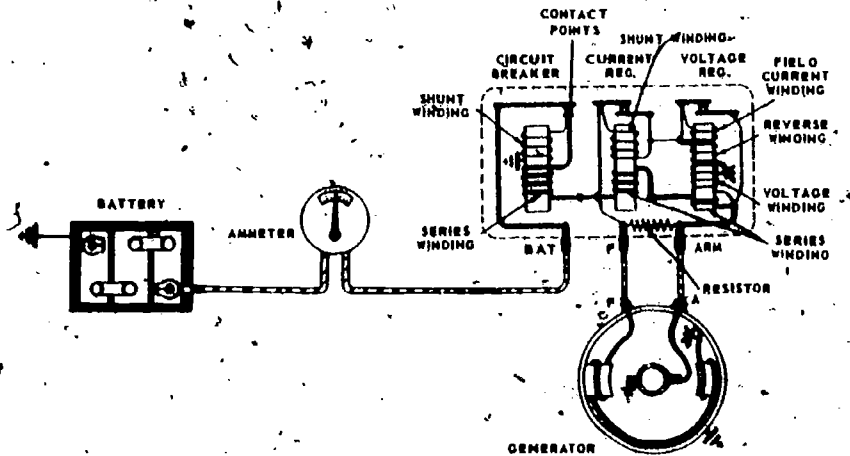

Fig 3-19. Charging circuit.

(b) Components and functioning.

1. Generator/alternator. The generator or alternator are devices which change mechanical energy into electrical energy. Generators are capable of supplying more electrical current than the electrical system can use. For this reason a generator regulator is employed in the charging circuit.
2. Regulators.
 - a. Generator regulator. Heavy-duty generator regulators, containing three regulating devices, are used extensively on military construction equipment. A voltage regulator unit protects electrical units by limiting generator voltage to a maximum safe value. A current regulator protects the generator by limiting generator output to a maximum rated value. The current regulator functions to protect the generator when load demands are heavy (as, for example, when many electrical devices are turned on and the battery is in a discharged condition). The last unit in the regulator is the cutout relay or circuit breaker. This is the device which makes and breaks the circuit between the generator and the battery as needed. During starting, or at low idle speeds, the breaker is open and the battery is supplying power to the electrical system. As engine speed increases, generator output increases and the cutout relay closes. Then the generator supplies the power and also recharges the battery.
 - b. Alternator regulator. The alternator regulator and the generator regulator perform the same function; protect the assembly producing the current. Although they look the same, they are different. The alternator regulator controls only the current flow in the alternator field (rotor), and diodes in the alternator perform the function performed by the cutout relay. Diodes are special parts mounted in the alternator to convert the alternating current to direct current; they permit the electricity to flow in only one direction. The manner in which they are connected prevents current from flowing from the battery through the alternator. A new type of alternator is presently being tested. It does not require any type of outside regulating system. It has only one external connection which leads from the alternator to the ammeter to the battery.
3. Ammeter. The ammeter, a device for measuring electric current, is placed in the charging circuit between the regulator and the battery. The battery-charging rate is indicated on the ammeter. When the battery is being charged (engine operating above idle speed, cutout relay closed), the ammeter needle registers "Charge." When the battery is supplying current (low idle, cutout relay open), the ammeter needle registers "Discharge."
 - a. The ammeter will tell you a great deal about the charging circuit. It registers discharge when the battery supplies power for the electrical system. After the engine starts, the generator should take over and supply power and also recharge the battery. The more discharged the battery, the higher the charging rate will be. As the battery approaches full charge, the charging rate will gradually decrease, but should always remain slightly on the charge side of the gage.
 - b. If the ammeter shows no charge or discharge, or if the needle on the gage fluctuates between discharge and charge with the engine operating above idle speed, there is something wrong in the system. Prolonged operation in this condition will completely discharge the batteries.

c. The charging rate should drop as the batteries are recharged. If the gage continues to register an excessive charging rate when the batteries are fully charged, it will cause rapid evaporation of battery water, overheating, and possible fire or explosion.

d. In all cases, when you notice abnormal ammeter readings, record the fact on the Equipment Operational Record and notify the dispatcher and section chief.

(c) **Servicing.** Operator services to the charging circuit are limited primarily to making sure that electrical connections are tight and to maintaining the specified amount of slack in the generator drive belt. Loose or slipping belts will cause excessive belt wear and a low charging rate. Belts which are too tight will place too great a strain on the generator and fan bearings. At the unit or organizational maintenance level, repairs are generally limited to replacement of complete assemblies by the unit mechanics.

(4) Starting circuits. (fig 2-20).

(a) **Purpose.** Heavy-duty, sealed starting systems are generally used on construction equipment. Since most construction equipment is diesel-powered, it means that the starting motor must turn the engine over against the high compression ratios used in diesel engines. The starting motor receives its power from the batteries, and you will generally find that 24-volt starting systems are used. In most applications, this voltage is obtained by connecting two 12-volt batteries in series. The starting motor may be engaged either manually by a lever, or by a switch or key which activates a magnetic switch or solenoid.

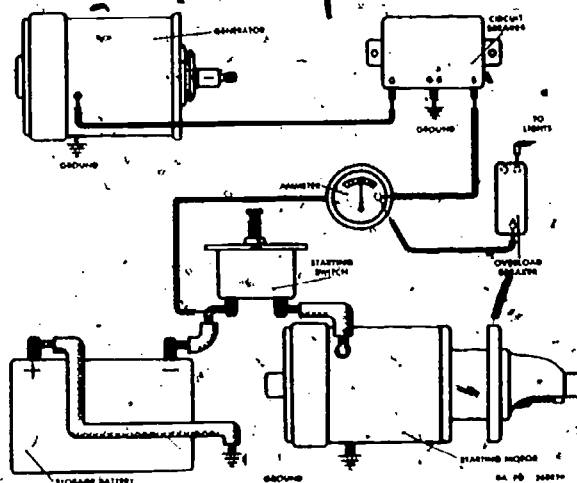

Fig 2-20. Simplified electrical circuit.

(b) Components and functioning.

1. **Conductors and current flow.** The electrical wires and cables are conductors of the electricity produced by the battery or the generator or alternator. They serve as pipes to direct the current to the desired part. The current will continue to flow through the conductors as long as there is sufficient voltage to overcome any resistance. Electricity will always take the path of least resistance. Switches, circuit breakers, and resistors are installed to control current flow, but loose connections, corrosion, and broken or frayed conductors provide resistance that hinders operation of electrical parts. Insulation that is cracked or worn through allows the conductor to short or ground out; the electricity goes directly to ground because it offers the least resistance.
2. **Starting switch.** Figure 2-21 illustrates a starting switch which is manually activated by the operator through a starting lever. Depressing the lever moves the drive mechanism forward and causes the drive gear to engage the teeth on the flywheel before the starting switch allows electric current to activate the cranking motor.
3. **Solenoid.** A remote control switch or solenoid may also be used to engage the drive gear and supply power to the cranking motor. The operator turns a key or switch which causes the magnetic switch to move the drive mechanism forward and then supplies battery electrical power to start the motor turning.

4. **Starting motor (fig 2-21).** The starting motor is just the opposite of the generator which converts mechanical energy to electrical energy. It is a device which converts electrical energy from the battery into the mechanical energy needed to turn the engine over. As such, the starting motor is made up of a conventional motor and a drive mechanism. Different types of drive mechanisms can be used, but all must permit the starter drive gear to be disengaged from the flywheel automatically once the engine starts. The overrunning clutch in figure 2-21 is one of the most widely used disengaging mechanisms.

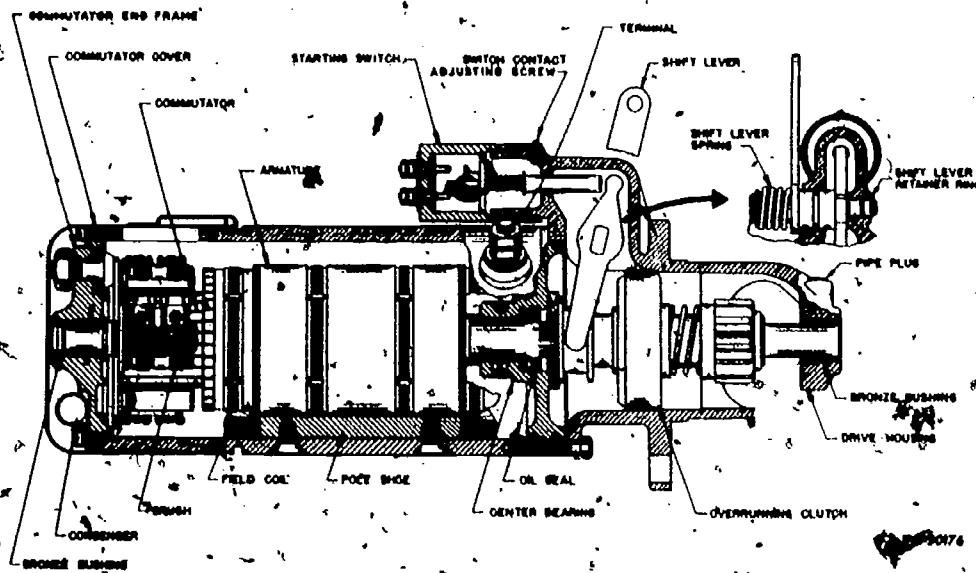

Fig 2-21. Starting motor and switch.

(c) **Servicing.**

1. The starting circuit requires very little operator service. It, like the other circuits, is part of the military standard, heavy-duty, radio-suppressed, and fungus-proof electrical systems. The operator should check electrical connections and make sure that they remain tight.
2. When the starter fails to turn the engine over, check for loose connections and corroded terminals, especially battery terminals which insert a resistance in the electrical circuit and reduce or prevent current flow. This resistance is similar to putting a tight bend or kink in a garden hose which reduces water flow.
3. Another problem, particularly when equipment is not run regularly, is that the batteries may be so run down that there is not enough power available to turn the engine over. On solenoid-equipped circuits, there may be enough current to move the drive gear forward, but not enough to turn the engine over. When this is the case, you will often hear a clicking noise from the starting motor as you attempt to turn the engine over.
4. The starting motor runs for only a few seconds each time it is used and carries great overload when it is running. To carry such a heavy load, it draws high current which causes the starter motor to heat up quickly. To keep the starter motor from overheating, never run it longer than 30 seconds at a time. If the engine does not start within that time, let the starter motor cool off for several minutes before engaging it again.

5. The starting motor requires little maintenance if used properly. Most of the motors you will come in contact with will be sealed units requiring no lubrication. Others may be provided with small lubrication cups. A few drops of oil should be put in the cups at regular lubrication intervals. Starting motors and switches will be replaced by unit mechanics if they are defective.

(5) Ignition systems.

(a) Introduction. Gasoline engines use an electric spark to ignite the fuel-air mixture near the top of the compression stroke. A spark ignition system provides a method of using electrical energy to ignite the mixture at the proper instant. An engine may use either a battery distributor-type ignition or a magneto ignition. They are basically the same; they step up the low voltage to a high voltage and distribute the voltage to a spark plug at the proper time. The high voltage spark jumps the gap between the spark plug electrodes and ignites the mixture.

(b) Battery-distributor type. The battery-distributor type ignition system consists of a primary circuit and a secondary circuit. The battery or generator/alternator delivers low voltage through the coil to the breaker points. Each time the breaker points open, a high voltage (as much as 30,000 volts) created by the coil, is induced in the secondary circuit. The primary and secondary circuits and a schematic of the wiring are illustrated in figure 2-22. The primary circuit is represented by the heavy dark line and the secondary circuit is represented by the lighter line.

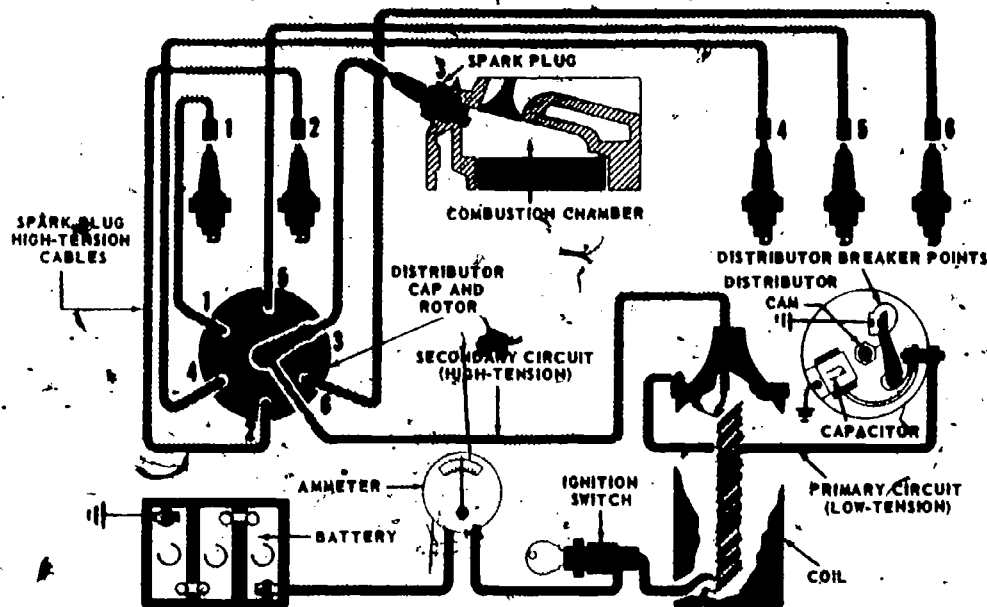

Fig 2-22. Battery ignition circuit.

1.- Components and functioning.

a. Distributor (fig 2-23). The heart of the battery ignition system is the distributor. It functions in both circuits, making and breaking the low-voltage circuit and distributing high voltage to the right cylinder at the right time.

1. **Breaker cam.** The breaker cam will generally have as many cam lobes as there are engine cylinders. A 4-cylinder engine will have four lobes and a 6-cylinder engine will have six lobes. Therefore the contact points on a 6-cylinder engine will open and close six times for each revolution of the distributor shaft. Each time the points open, the primary circuit will be broken and a high voltage will be induced in the secondary circuit. The breaker cam and rotor rotate together, and the rotor is aligned with the proper sparkplug contact each time a cam lobe opens the primary circuit, producing a high-voltage surge in the secondary circuit.
2. **Contact points.** The contact points used in conjunction with the cam lobes to form the make-and-break device consist of a fixed and a movable point. A spring-loaded breaker arm with a rubbing block which rides on the breaker cam forms the movable contact surface. The fixed adjustable contact point surface is the contact support. The 2-piece points come as a set and are always replaced as a set. Notice the two screws in the contact support in figure 2-23, the one on the right is the locking screw and the one on the left (with elongated hole) is the adjusting screw.

Condenser. The condenser or capacitor is placed in the distributor to prevent arcing across the contact points. As the points are opened, the flow of current in the primary circuit tends to continue to flow, jumping the gap or arcing. To prevent arcing, which would quickly burn out and damage the contact points, the condenser is wired in parallel with the contact points and grounded through the distributor housing. The condenser absorbs the current from the primary circuit as the points open, preventing arcing and also aiding in a rapid buildup of secondary voltage in the ignition coil.

4. **Distributor cap.** Figure 2-22 shows how secondary voltage enters the distributor cap through the center terminal to the rotor. The rotor in turn distributes the electrical current to the spark plug leads. Note that the spark plug leads are arranged in a standard pattern or engine firing order. This firing order insures that the spark is delivered to the right cylinder at the proper time. The firing order varies with different makes and models of engines and is generally stamped on the side of the engine block. A commonly used firing order for 6-cylinder engines is 1-5-3-6-2-4.

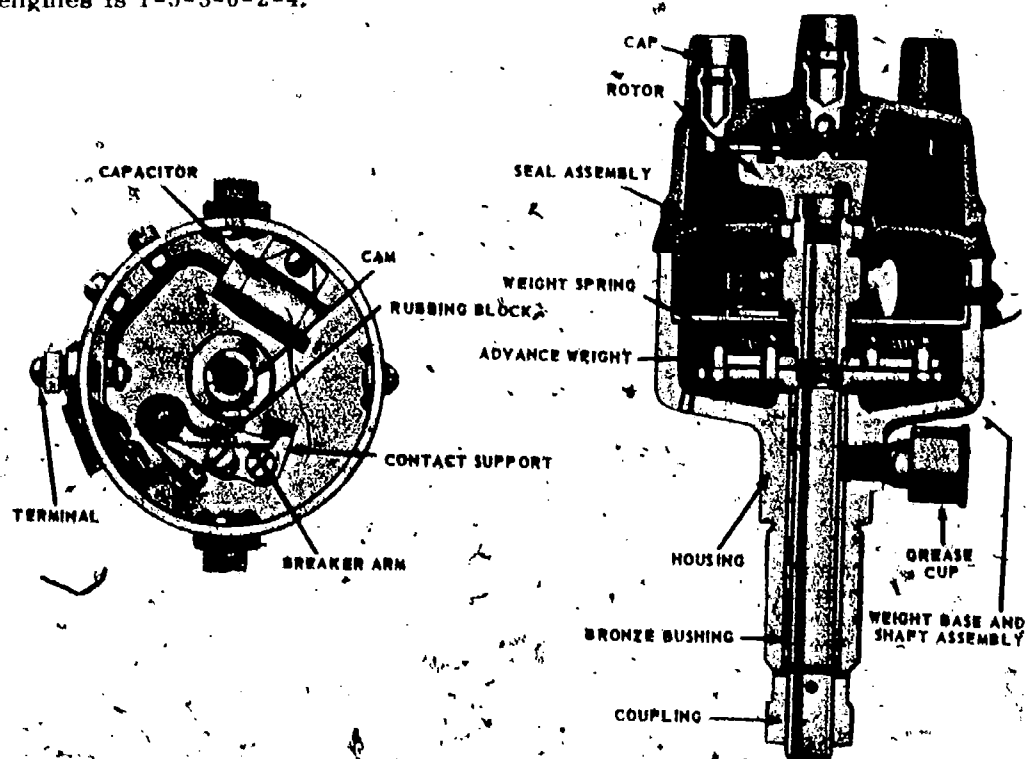

Fig 2-23. Sectional view of a standard-type distributor.

b. Ignition coil. The ignition coil acts as a magnetic step-up transformer, changing the low voltage of the primary circuit into the high voltage needed for ignition in the secondary circuit. When the ignition points are closed, current is flowing through the primary circuit. When the points are opened, a high voltage (as much as 20,000 volts) is induced into the secondary windings of the coil.

c. Spark advance. As engine speed varies, the time at which ignition occurs in the individual cylinders must also vary if the engine is to operate at maximum efficiency. The faster an engine runs, the sooner the spark must occur if combustion is to be completed at the most effective time in the operating cycle. There are two types of automatic spark-advance mechanisms which are built into distributors: centrifugal and vacuum. They may be used separately or together, depending on the application. Most automotive distributors employ both types: the vacuum-advance for low speed, and the centrifugal advance for high speed.

1. Centrifugal advance (fig 2-23). The centrifugal-advance mechanism is operated by a pair of weights that are thrown out against spring pressure as the engine speed increases. The movement of the weights advances the spark through a linkage to the breaker cam. As speed increases, the spark is advanced. As speed decreases, the spark is retarded.

2. Vacuum advance. The vacuum-advance mechanism uses a spring-loaded diaphragm connected by a linkage to the distributor plate, and by a vacuum passage to the carburetor. The opening to the carburetor is on the atmospheric side of the throttle when the throttle is in the idling position. As the throttle is opened, the spark-advance mechanism is exposed to the lower pressure of the intake manifold. The pressure acts on the diaphragm, moving the spark-advance linkage. The linkage rotates the breaker plate and contact points to an advanced position.

2. Serviceing. An operator is very limited in the amount of work he can do to service the battery-distributor ignition system because the tools required for adjustment are not available. He can keep the conductors (wires) clean and the connections tight. He can replace broken or defective secondary leads. The distributor cap towers and the coil tower should be cleaned periodically to prevent the buildup of corrosion. The covers and connections of waterproofed systems should be kept tight; they are removed and serviced by the engineer equipment mechanic. If the distributor is not waterproofed, the operator can remove the distributor cap and clean and lubricate the internal parts if necessary.

(c) Magneto ignition (fig 2-24). The magneto is a self-contained ignition unit. With the exception of the spark plugs and wires leading to them, the magneto includes or substitutes for all units usually found in the battery ignition system. The magneto provides electricity for ignition alone and is often used on industrial and handcranked engines.

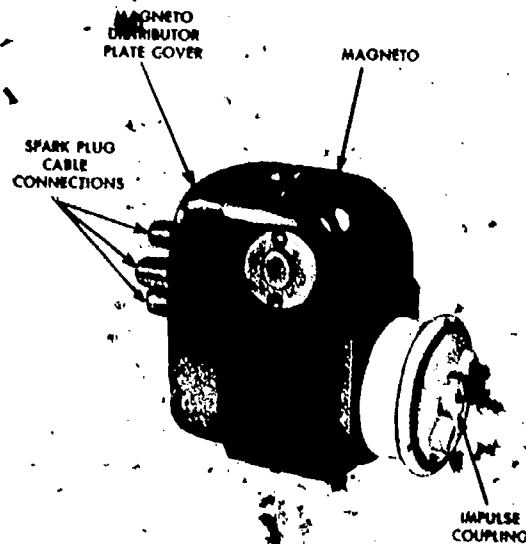

Fig 2-24. Automotive magneto.

1. Principles of operation (fig 2-25).
A magneto is very similar to a generator. The primary and secondary ignition windings are wound on an armature which rotates within the magnetic field created by the horseshoe magnet and pole pieces. As the armature revolves, an alternating current of low voltage is generated in the primary windings. When this current reaches its highest value, the breaker points open, and high voltage is induced in the secondary winding, just as it was in the battery ignition system's coil. The high-voltage charge is then directed to the magneto distributor and on to the spark plugs in the proper firing order.

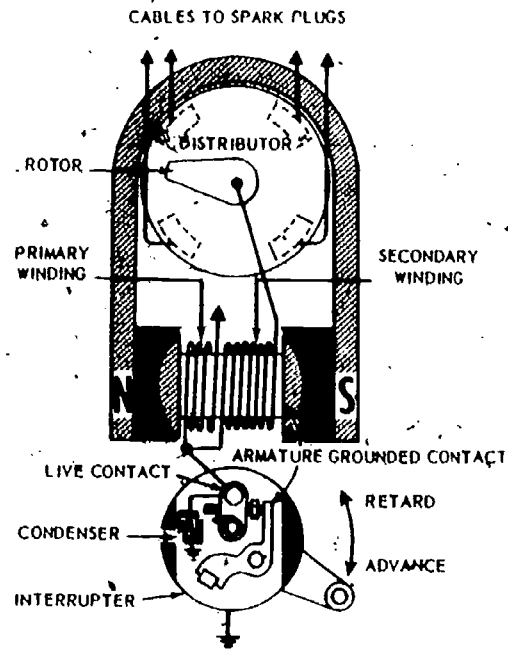

Fig 2-25. Circuits of a high-tension magneto.

2. Impulse coupling.

- a. The magneto must be turned fast enough to generate a primary current with enough strength to enable the engine to fire and to keep it running. This speed varies with different types of magnetos, but the average is about 100 rpm. When starting the engine, it is difficult to rotate the crankshaft fast enough to obtain this speed. An impulse coupling is used to obtain sufficient speed to cause an initial starting current from the magneto.
- b. The impulse coupling is mounted between the magneto drive from the engine and the magneto-driven shaft. It consists of a spring and ratchet drive. When the engine is turned over, the spring in the coupling is wound up against a spring and trigger arrangement. As the piston reaches firing position, the trigger releases automatically. The spring, which is connected to the magneto drive shaft, flips it with enough speed to produce the primary current. This operation continues until the engine fires and starts to run. As engine speed increases, the impulse coupling locks out at approximately 800 rpm and the magneto is driven at engine speed.

- (d) General maintenance.

1. Introduction. Operator maintenance to the ignition system is primarily limited to making sure that all electrical connections are tight. Visual inspections will reveal any bare wires, loose connections, corrosion, or cracks in insulating material. Unit mechanics will generally test, replace, or repair ignition system components. Normal wear will require that periodic checks and adjustments or replacements be made to spark plugs, breaker points, and engine timing. A knowledge of these maintenance procedures will be a great help to equipment operators.

2. Spark plugs (fig 2-26).

- a. The spark plugs, which must operate under severe conditions, require periodic cleaning and adjusting. The extreme heat, high voltage, and high compression occurring within the cylinder cause the electrode tips to burn, increasing the distance between the electrodes. Spark plugs may be tested under pressure. They are cleaned with a special sandblasting machine.
- b. Engine specifications provide for a specified gap between the spark plug electrodes. To adjust spark plug gaps, it is always better to use a round rater than a flat feeler gage. Always bend the ground electrode which is attached to the spark plug shell to get the proper gap. Never bend the center electrode as this may crack the core insulator.

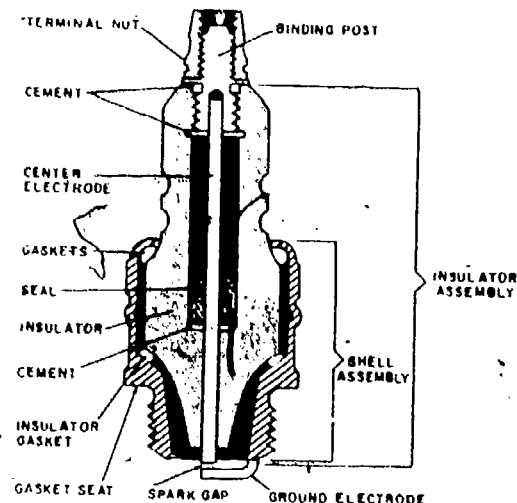
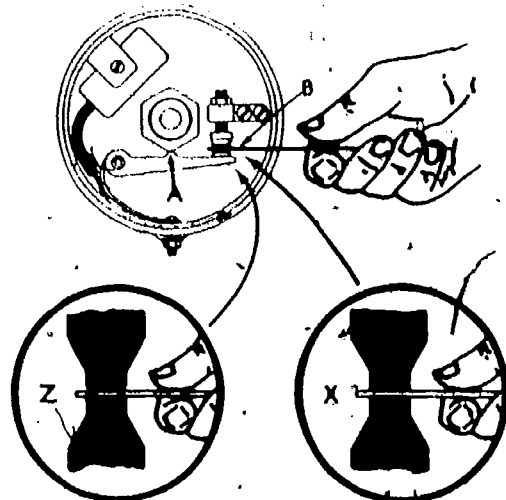

Fig 2-26. Sectional view of a typical spark plug.

3. Breaker points.

- a. When adjusting breaker points, remember that a spark occurs at one of the spark plugs at the instant that the breaker points open when the ignition switch is on. Also, unless the points close properly to complete the primary circuit, no voltage can be induced in the secondary circuit. Therefore, it is important to clean and align the points to insure good contact. When fully opened, the points must have the recommended gap clearance to insure proper timing. The breaker points are fully opened when the rubbing block of the movable points is resting on the highest point of the cam lobe.
- b. Before removing the distributor cap to adjust points, be sure to check the position of the spark plug wire that leads to No. 1 cylinder. Many caps have the number "1" marked on the cap surface adjacent to the No. 1 spark plug wire. If not, you can scratch an appropriate mark on the cap with a screwdriver tip. After removing the cap, notice the direction in which the rotor turns. If you know the position of No. 1 spark plug wire, the direction of rotation, and the firing order, you can always rewire the cap without any trouble.
- c. With the ignition switch on and the engine turned so the points are in a closed position, you can check to see if the points are making and breaking. When you break the points, you should see a small spark every time they are separated. If the points are burned or dirty, the spark will not be noticeable. By visual inspection you can tell if the points need renewing. If badly pitted and burned, they should be replaced. Although it is not recommended when new points are available, you can clean burned contact points with a point file or stone and then readjust them. Never use emery cloth to clean points because particles may become embedded and burn on the points or fall into the distributor housing and cause short circuits.

- d. The rubbing block of the movable point must be resting on the high point of the cam lobe for you to adjust the breaker point gap (fig 2-27). Specification are given in the appropriate TM. With a feeler gage of the recommended thickness, you can adjust the gap by changing the position of the stationary point. Two screws are generally provided, an adjustment screw and a lock screw. Loosen the lock screw and turn the adjusting screw as needed. Hold the feeler gage lightly and obtain a slip fit on the gage with the points. Tighten the lock screw and then recheck the gap. Very often you will have to reset it. When you are satisfied that the gap is correct, put a drop of oil on the felt wick in the center of the cam, and place a small smear of grease or lubriplate on the cam surface. Never overlubricate the distributor. Excessive grease and oil will combine with dirt and dust to cause short circuits. After installing new contact points and adjusting the gap, you should check the ignition timing.



(A) RUBBING BLOCK ON CAM LOBE
(B) GAGING THICKNESS BETWEEN CONTACTS
(X) CONTACT POINTS IN CONDITION FOR GAGING
(Z) CONTACT POINTS BURNED AND FITTED

Fig 2-27. Adjusting breaker points.

- e. Whenever you remove the distributor cap, clean and inspect it carefully for cracks or other damage. A crack reaching the center terminal may permit the high voltage from the coil to ground through the distributor body. Check the rotor for cracks, corrosion, and burned terminals.

4. Ignition timing (fig 2-28). In almost all engines, the timing marks are found on the flywheel (A), or the vibration damper (B) located next to fan belt pulley. Specifications in the TM will tell you at what instant ignition should occur, usually in relation to TDC of the piston stroke (such as 2° before TDC or 0°). A neon timing light is generally used when adjusting engine timing. To use the light, connect one lead to the No. 1 spark plug wire and connect the other lead to a suitable ground. (Some manufacturers also recommend that the vacuum line from the distributor vacuum-advance unit be disconnected. Then start the engine. The timing light will light every time the spark plug fires. Therefore, you aim the timing light at the timing marks; when the timing light comes on, the timing marks should be lined up, and momentarily appear to stand still. If the timing marks do not line up according to specifications, the distributor or magneto can be turned slightly after the locking bolt or screw has been loosened. By turning the unit, you can bring the timing marks exactly into line. When they are correctly lined up, lock the distributor or magneto in place, and remove the timing light.

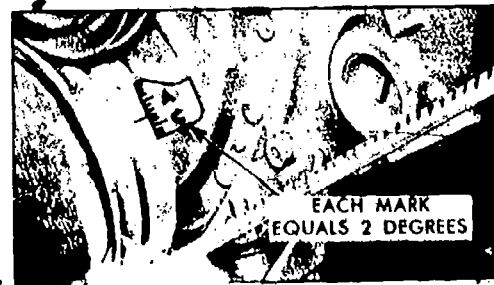
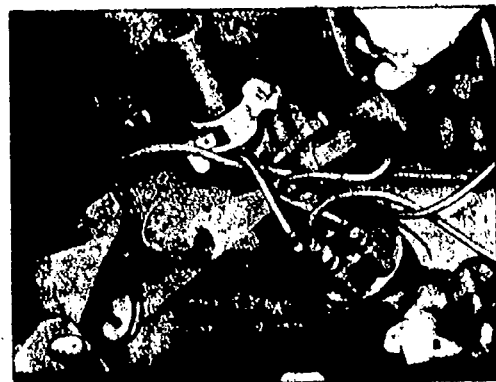

Fig 2-28. Ignition timing marks on flywheel and vibrator damper.

e. Fuel systems.

(1) Components and functioning.

(a) Gasoline. Most large engine equipment is powered by diesel engines, however, you will also be working with gasoline-engine-powered chain saws, compressors, concrete mixers, and generators. These small, stationary applications do not require a complicated fuel system such as those employed on modern automobile engines. The same components must be used, but they are of simpler construction. The operator's responsibilities for the care and servicing of the system deal primarily with using clean fuel, and cleaning filter elements at periodic intervals. Figure 2-29 illustrates a typical fuel system. In stationary applications, the fuel system takes up considerably less space and the fuel tank is often located higher than the carburetor. This application of gravity fuel flow eliminates the need for a fuel pump.

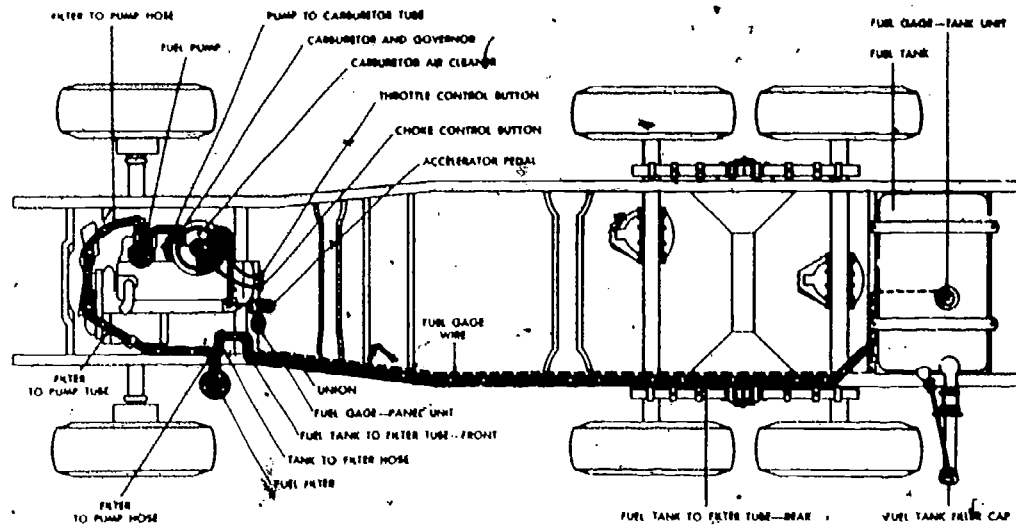

Fig 2-29. Fuel system of the gasoline engine.

1. Fuel tank. Most fuel tanks are made of thin-gage sheet metal, and have an inlet or filler pipe and an outlet. The outlet line is usually placed about 1/2 inch from the bottom of the tank to prevent any sediment in the tank from entering the carburetor. Tanks are generally provided with electric fuel gages (sending units). Drain plugs are located on the bottom of the fuel tank and when the tank supplies fuel by gravity flow, a shutoff valve is generally provided.
2. Fuel filter and strainer. The fuel filter or strainer may be located at any point between the fuel tank and the carburetor. When a fuel pump is used in the system, the strainer generally comes between the fuel tank and the pump and a filter between the pump and the carburetor. The sediment bowl (fig 2-30) is a common type of strainer and is often combined with the fuel pump. Fuel enters the glass bowl and passes up and out through a filter screen. Any water or solid matter caught by the screen falls to the bottom of the bowl where it can be easily seen. Dirt in fuel generally comes from rust scale in tanks and drums, and from dust and dirt in expeditionary cans. Water comes from condensation of moisture in metal containers or tanks. Thumbscrews or spring-wire clips hold the sediment bowl in place against a cork gasket. Another type of filter is made of a series of laminated disks placed in a large metal bowl which acts as a settling chamber for the fuel.

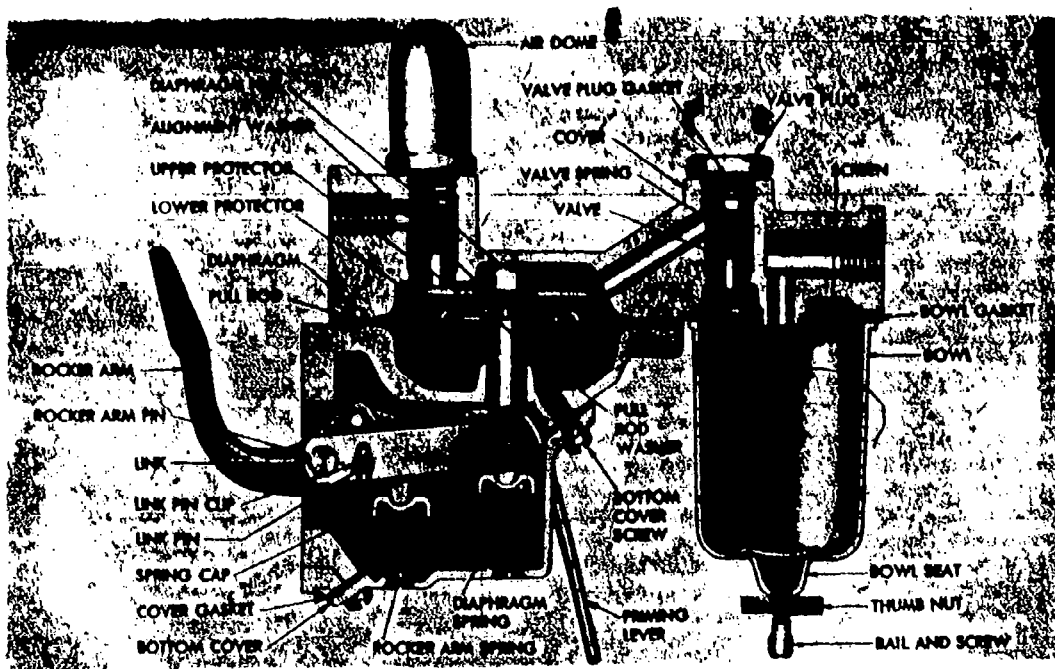

Fig 2-30. Fuel pump and sediment bowl.

3. Fuel pump. One of the most common fuel pumps is the mechanically activated nonpositive, diaphragm type (fig 2-30). Rotation of an eccentric on the engine camshaft actuates the rocker arm, which pulls the diaphragm down against the pressure of the diaphragm spring. This reduces the pressure in the pump chamber and permits gasoline to enter. The diaphragm is moved up on its return stroke by the pressure of the diaphragm spring, and gasoline is forced to the carburetor. When the carburetor bowl is filled, a back pressure is created in the fuel pump chamber, holding the diaphragm down against the spring pressure. It remains down until the carburetor needs more gasoline. The rocker arm and the pump lever (link) are in two pieces which operate as a single unit when the diaphragm is moving up and down. However, when the diaphragm is held down, only the rocker arm operates in the normal way. This is possible because the rocker arm operates against the link only in the downward direction. Upward movement of both parts is by spring pressure. It is this operation which makes the pump nonpositive. The principal problem encountered with fuel pumps is the wear and deterioration of the diaphragm, which is composed of several layers of especially-treated cloth that is not affected by gasoline. Some fuel pumps are equipped with hand-operated priming levers which may be used to pump fuel to the carburetor after the engine has been idle for a long time. This reduces the drain on the battery caused by using the regular fuel pump action to prime the fuel system and deliver fuel to the carburetor.

4. Carburetor (fig 2-31). The carburetor is that component on a gasoline engine that meters the fuel and mixes it with the air. The opening through which air enters is called the air horn. The carburetor illustrated is an updraft type so called because it is located below the intake manifold and air travels upward through the carburetor. In the air horn, you see the choke valve. The decrease in size of the air passage, or restriction, is called the venturi. This causes the air passing through it to flow with greater speed than it would without the restriction. The discharge nozzle connected to the float chamber by a fuel passage permits liquid fuel to enter the air stream. The throttle valve is located in the carburetor throat between the discharge nozzle and the intake manifold which delivers the fuel-air mixture to the individual cylinders. The choke valve allows the operator to vary the richness of the fuel-air mixture as an aid in cold-weather starting. Under normal operating conditions, the choke valve is wide open as shown in figure 2-32. When starting the

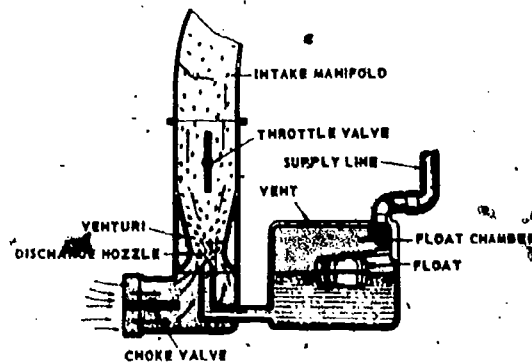

Fig 2-31. Simple carburetor.

engine, you can obtain a richer fuel-air mixture (more fuel) by closing the choke valve as much as necessary. This reduces the flow of air through the carburetor and increases the amount of fuel flowing from the discharge nozzle. A "full" choke (valve completely closed) will stall an engine in a few seconds unless the choke is gradually opened either manually or by a semi-automatic safety valve or spring-loaded choke. Fuel must have oxygen to burn. The throttle valve is very similar to the choke valve but, as its name implies, it is used to throttle or control the speed of the engine. It does this by varying the speed of the air flowing through the venturi of the carburetor. This in turn controls the amount of fuel drawn into the air stream from the discharge nozzle. Under normal operating conditions, the throttle valve is the only carburetor control used. Throttle operation is generally controlled by a foot accelerator, a hand throttle, or a governor. Most throttle linkages are adjustable, and a throttle stop screw is generally provided for adjusting the engine idle speed. The float and needle valve combine to maintain a constant fuel level in the carburetor during engine operation. The float is adjusted to a predetermined level during manufacture. When the float drops due to low fuel level, the needle valve is lowered from its seat, allowing fuel to enter under pressure of the fuel pump. As the fuel level rises, the float also rises. This brings the needle valve up into its seat, closing off the flow of fuel.

5. Maintenance.

a. **Adjustment.** Most of the carburetors that you will come in contact with will be similar to the downdraft carburetor in figure 2-32. It has two carburetor circuits. An idle- and low-speed circuit, and a main nozzle for normal operation. The main nozzle is nonadjustable, but the idle circuit is provided with an external adjustment screw. The idle-speed screw is adjusted to provide the correct mixture to enable the engine to idle smoothly. TM's provide detailed instructions on adjustment of the idle screw. As a general rule, the screw is turned all the way in, then opened approximately 1 full turn. Correct adjustment is obtained by turning the screw in until the idle is rough from fuel "leanness," then turning the needle out to the richest setting at which the engine idles the smoothest. The engine idle speed may be increased or decreased for best idle speed by adjusting the throttle stop setscrew.

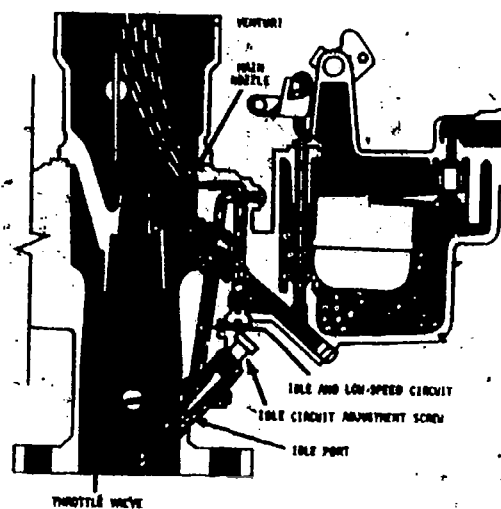

Fig 2-32. Constant-speed, downdraft carburetor.

b. Troubleshooting gasoline fuel systems.

- Excessive fuel consumption can result from a high float level, a leaky float, or too rich an idling mixture.
- A sluggish engine may result from a low float level, dirty or gummy fuel passages, or a clogged air cleaner.
- Poor idling, often characterized by the stalling of the engine, usually is due to too much fuel, a defective choke, or an incorrectly adjusted idle-speed screw.
- Failure of the engine to start may be caused by clogged fuel lines, an incorrectly used choke, or air leaking into the intake manifold.
- Slow engine warmup may indicate a defective choke.
- A smoky, black exhaust indicates a very rich air-fuel mixture.
- Stalling of the engine as it warms up could be caused by a defective or closed choke valve.
- A backfiring engine may be due to an incorrect, often lean, air-fuel mixture reaching the engine. This condition may be caused by clogged fuel lines or a fluctuating fuel level.

- (b) **Diesel.** Diesel engine fuel systems do not mix the fuel and air before they enter the engine cylinder. The fuel injection system is designed to deliver only fuel to the proper cylinder at the correct time. Operator services to the fuel system are limited primarily to the servicing of the fuel filters and strainers. Diesel-fuel systems are complicated mechanisms, but will generally provide excellent service if clean fuel is used and the filtering devices are serviced properly. In the Detroit diesel engine fuel system (fig 2-33), a positive-displacement, gear-type fuel pump draws fuel from the fuel tank, through the fuel strainer. The strainer is equipped with a check valve which prevents fuel from flowing back to the tank when the engine is shut down. A relief valve in the fuel pump bypasses fuel from the outlet to the inlet side of the pump whenever excessive pressure develops. This valve opens at a pressure of 65-70 psi. After leaving the fuel pump, the fuel oil passes through the fuel filter, into the inlet manifold, and then the individual injectors, through the jumper lines. Unused fuel is returned to the fuel tank through the jumper lines and the outlet manifold. A restricted elbow in the outlet manifold combines with the pressure relief valve in the fuel pump to maintain a specified pressure in the fuel system. More fuel is pumped through the system than can be used by the engine, thus cooling and lubricating the injectors and providing the engine with a self-bleeding capability.

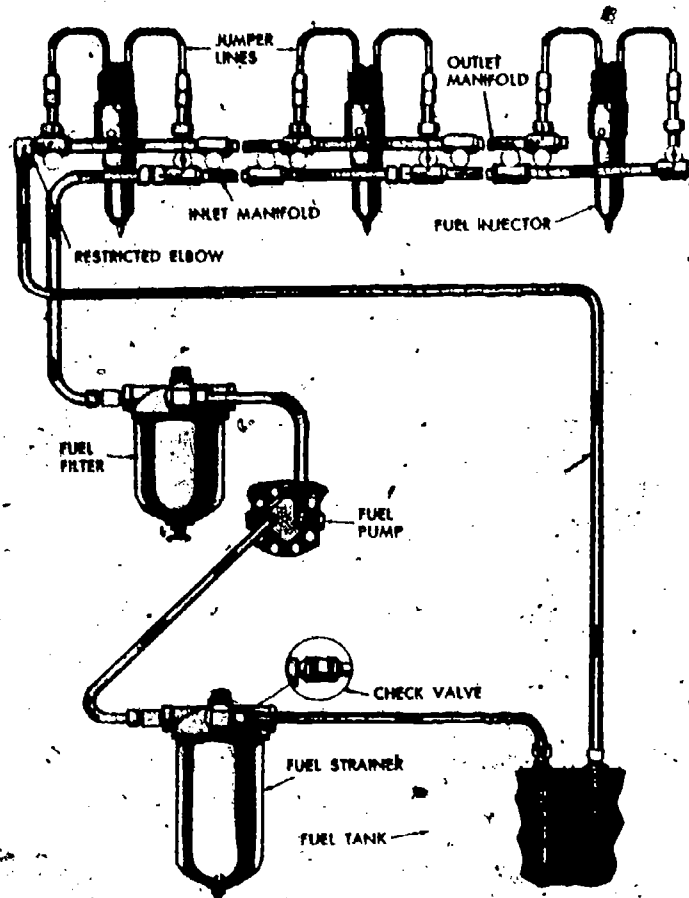

Fig 2-33. Diagram of a typical Detroit diesel engine fuel system.

(2) Service. To insure that there is an adequate supply of fuel, the operator must use great care when servicing the vehicle. Use only clean, approved fuels for the type engine being serviced. Keep the fuel clean; use clean containers to transfer the fuel and keep the openings closed when not in use. Keeping the vehicle tank full will help reduce condensation. The proper servicing of the water trap, strainer, or filters at prescribed intervals will prevent foreign materials from entering the engine. Different systems require some specific maintenance that is peculiar to that type of system.

(a) Gasoline. Most carburetors have a strainer or a ceramic type filter located behind the nut where the gas line connects to the carburetor in addition to those discussed earlier. This filter will eventually become clogged with dirt and debris and shut off the fuel supply for the engine. A slight leak on the suction side of a fuel pump may be sufficient to cause the gasoline engine to lose power. Worn fuel pump parts will also cause a loss of power and, in some cases, gasoline can leak into the crankcase, creating danger from crankcase explosion.

(b) Diesel. Cleanliness of the diesel fuel system is also very critical. The fuel injection parts are machined to such precision that, when separated, the heat from body temperature will prevent their fitting together. Imagine what dirt and rust can do to these parts. This is one of the reasons that the diesel system uses so many filters. The water traps and strainers are drained daily before attempting to crank the engine. This procedure will drain off any accumulated water or dirt that has settled, thereby prolonging filter life and providing clean fuel to the injection system. The fuel filter and strainer elements are usually replaced on an hourly schedule but if conditions warrant they are changed when necessary. When changing the filter, strainer, or cleaning the sediment bowl, be sure the parts are thoroughly clean, new gaskets installed, and that parts are tight. Some systems such as the Detroit diesel require that the strainer be filled with fuel. This is to reduce the cranking time and also to insure lubrication of the injection parts.

f. Governor. This is a device that will automatically control, within specified limits, the speed of the component for which it was designed. The engine speed governor controls or limits engine speed or output in two steps. It first measures engine speed and then changes the fuel control to bring the engine to the desired speed. There are several types of governors, but for the purposes of this course only the mechanical engine speed governors will be discussed.

(1) Principles. Any change in the load on an engine immediately changes the engine speed. An engine receiving a constant amount of fuel will operate at a constant speed if the load is constant. If the load changes, the fuel must change or the engine speed will change. The time required for an engine to change from one speed to another is affected by the inertia of the engine's flywheel and other moving parts. A large heavy flywheel requires more time to change speeds than a smaller light flywheel. Governor flyweights connected to a rotating shaft will produce a centrifugal force proportionate to the speed. As the shaft rotates, the weights tend to move away from the center. You can demonstrate this principle by using your ID, "dog tags." Place the chain over your finger and swing in a circular motion. Notice that the faster you swing the more horizontal the tags become and that there is more pull on your finger. These basic principles are employed by mechanical and hydraulic engine speed governors.

(2) Mechanical governor (fig 2-34). The first action of the governor is to accurately measure the speed. This is performed by the ballhead (flyweight) mechanism which is rotated by gears at speeds proportionate to the engine speed; any change in the engine speed will affect the rotation speed of the ballhead. To oppose and balance the centrifugal force, a spring is used. As the centrifugal force causes the weights to move out, the speeder spring is compressed. When the centrifugal force and the speeder spring tension are balanced, the engine speed is normal for that governor. The toe of the ballarm has moved a certain distance and the flyweights have taken a definite position in relation to the axis of rotation. The second step of the governor is to control the fuel. This is accomplished by placing a fuel control rod in contact with the ballarm toe and the spring. Any movement caused by their action is transmitted to the fuel control. Study fig 2-35 and you should see that if the flyweights move outward, the speeder rod (fuel control rod) will be lifted, and if the flyweights are forced inward by the spring tension, the speeder rod will move down. Through linkages, the speeder rod is attached to the engine fuel

control (throttle). Spring tension causes the engine to receive more fuel and to speed up. The flyweights try to slow it down.

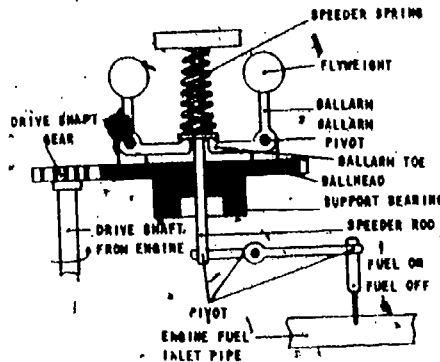

Fig 2-34. Schematic of mechanical governor.

Section II. POWER TRAINS

2-3. BASIC POWER TRAINS

a. **Purpose.** The mechanism that transfers engine power to the driving wheels or tracks of a vehicle is known as the power train. This power train is made up of gears, shafts, and bearings combined into various assemblies which enable the operator to control the speed and direction of the vehicle. Power trains are generally classified as either wheeled vehicle or tracklaying. Operator services to most components consist of visual inspection for leaks, maintaining correct oil levels within the various housings, and proper operation. Correct lubrication is a must, but proper operation is equally important. Construction equipment is rugged, but operator abuse (clashing gears, slipping clutches) will materially shorten the effective life of any piece of equipment. A good operator knows his equipment and makes it work for him, not against him.

b. **Wheeled vehicle.** The development of wheeled-vehicle construction equipment has made tremendous strides in recent years. Military construction equipment has kept pace with civilian efforts and an increasing proportion of the equipment you will operate will have power trains similar to that in figure 2-35. Examine the figure closely and trace the flow of power from the engine to the wheels.

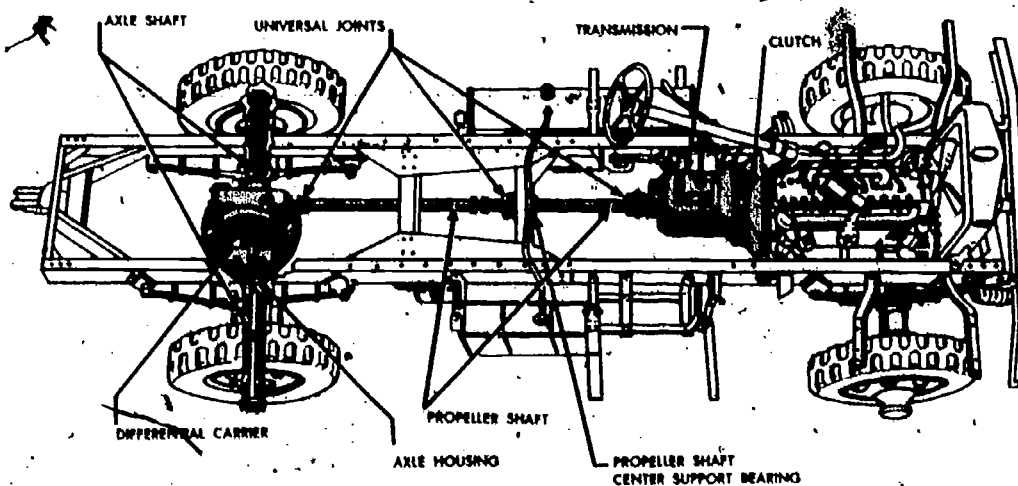

Fig 2-35. Wheeled-vehicle power train.

- (1) **Clutch.** The first element in the power train is the clutch, located between the engine and the transmission. By means of the clutch, the operator can disconnect the engine from the remainder of the power train. This is necessary for starting the engine, for allowing the vehicle to stand still while the engine is running, for gradual engagement of the engine to the power train, and for permitting the operator to change transmission gear ratios to meet varying road conditions. Clutch operation and adjustment will be discussed in detail later in the chapter.

- (2) **Torque converters (fig 2-36).** Torque converters, a form of fluid coupling which takes the place of the clutch assembly, have come into wide use in conjunction with automatic transmissions. For some applications the torque converter is used with a clutch. The principle of fluid drive can best be illustrated through the use of electric fans which are facing each other. If power is connected to one fan, the air blast from this fan will cause the other fan to rotate until both are running at approximately the same speed. This same action takes place in fluid drive,

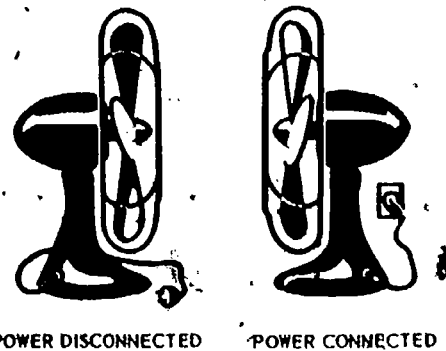

Fig 2-36. Principle of fluid drive.

except that oil instead of air is used to transmit the power. Torque converters consist of three basic elements: the pump (driving member), the turbine (driven member) and the stator (reaction member). Varying numbers of stators are employed to provide different degrees of torque multiplication within the unit.

- (3) **Transmission.** The transmission is the next unit in the power train. Basically, the transmission is a set of gears enclosed in a metal housing. It provides the operator with a selection of speeds, and permits the disengaging and reversing of the flow of power from the engine to the wheels. The transmission provides the mechanical advantage that allows the engine to move the vehicle under varying load conditions.

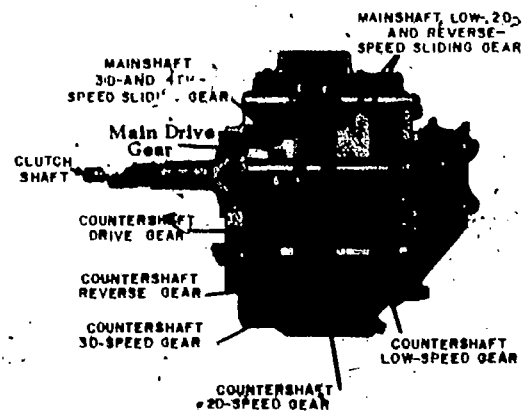

Fig 2-37. Four-speed truck transmission.

- (a) **Sliding-gear (fig 2-37).** The spur gear, constant mesh, and synchromesh type transmissions are used in the different items of engineer construction equipment. The operator must disengage a clutch, select the gear ratio, and slowly engage the clutch to cause the power to flow.
- (b) **Torqmatic.** The torqmatic transmission is becoming more popular in the newer items of equipment. It is a planetary gear system that uses hydraulic pressure to engage and disengage the different planetary parts for the desired gear ratio and direction. By using the torqmatic, which is an automatic transmission with a torque converter, greater torque multiplication is achieved. Speed and direction is easily selected by the operator.
- (4) **Auxiliary transmission and transfer case.** An auxiliary transmission and transfer case is usually used in construction equipment to provide an additional gear reduction, to provide power to the front wheels on all-wheel drive vehicles, and to furnish power for auxiliary devices, such as a winch. It is connected to the main transmission by a short propeller shaft (jack shaft) and universal joints. Basically, it is an additional gear train which provides a low-speed range, and permits power to be applied to the front wheels when necessary. It is sometimes referred to as a "drop box," because it provides a means of lowering the power train enough for the front propeller shaft to clear the engine.

- (5) **Propeller shaft.** Power is transmitted from the transmission to the rear ends of vehicles by the propeller shaft. The means of transmitting power must be flexible, because the driving axle of the vehicle is attached to the springs and is free to move up and down while the transmission is attached to the frame and cannot move. Any upward movement of the wheels, as when the vehicle travels over rough ground, would shorten the distance between the rear end and the transmission. To compensate for this changing distance, the propeller shaft is fitted with a slip joint (spline) that is free to move back and forth (fig 2-38). Another device used on the propeller shaft is the universal joint which permits power to be transmitted through an angle. The angle between the engine crankshaft axis and a line to the axle will change as the vehicle moves over rough ground and as the load is increased or decreased. The universal joint provides the flexibility needed in the power train.

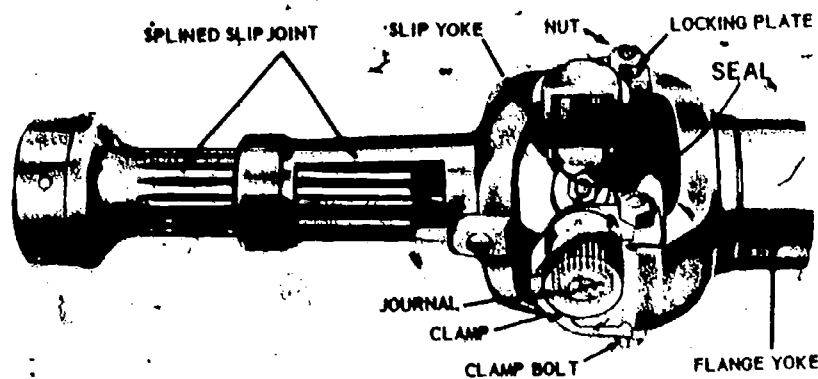

Fig 2-38. Slip joint and common type of universal joint.

- (6) **Differential (fig 2-39).** The differential, or the rear end as it is generally called, is enclosed and attached to the axle housing. It changes the direction of the power flow 90° and transfers the power to the axles. It divides the power to the two driving axles. Due to its construction, it also permits a difference in rotational speeds of the axles. It permits the wheel with the least resistance to spin or rotate faster.

Final drive. This device transmits the power flow from the propeller shaft to the differential and, at the same time, provides a further gear reduction. The final drive is encased in the carrier housing and consists of two gears: the bevel drive pinion and the bevel drive gear. The pinion receives the power flow from the differential and transmits it to the bevel drive gear which is bolted to the differential case.

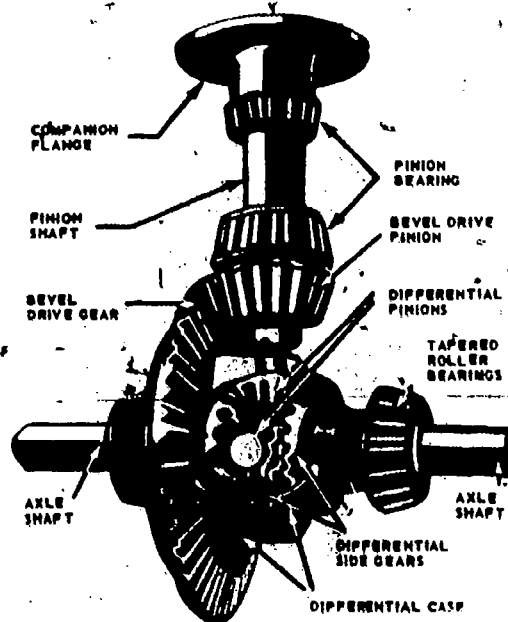

Fig 2-39. Differential with part of case cut away.

Tracked vehicles.

- (1) Comparison to wheeled vehicle. Power trains of tracklaying or crawler equipment (fig 2-40) perform the same function as those on wheeled vehicles. The difference is that crawler power trains are designed to provide greater gear reduction, withstand more rugged treatment, and are heavier and sturdier in construction. Some track vehicle power trains do not use propeller shafts and differentials. This reduces power train length, and power flows directly from the engine, through the clutch and transmission, to the bevel drive gear. When there is no propeller shaft or universal joints the components must be kept tight and aligned. The power is distributed to both tracks through the steering clutches to the sprocket drive (final drive), the sprocket, and finally to the track chain.

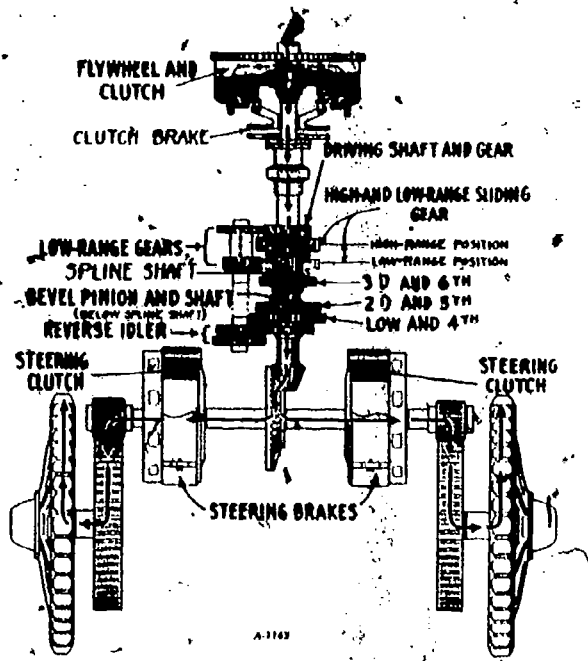

Fig 2-40: Power flow in a crawler-tractor.

(2) Steering.

- (a) Steering of tracked vehicles can be accomplished by any method which will stop or slow one track. Some tracked vehicles, such as the M37 crane-shovel, use a differential and brakes while others may use clutches and brakes or planetary systems. The M37 crane-shovel can be turned by applying the brake to one propelling shaft, stopping that track, and causing the differential to react. The 2N crane-shovel and the 82-30M crawler-tractor do not have a differential. They use a clutch to break the power flow to a track and a brake to stop and hold it.
 - (b) Some of these steering systems are a part of another power train component. The steering clutches used to steer the 82-30M tractor are a part of the reduction gearing. The Case MC 1150 scooploader steering system is a part of the transmission. It is a planetary type system that provides a method of breaking the flow of power and on this particular tractor it is also used to reverse the rotation of the power flow to one or both tracks. It is possible to power one track in reverse while the other is being powered forward or to break the flow of power and hold one or both tracks.
 - (c) There are as many methods of actuating the steering system as there are types of systems. The tracked vehicles used by the Marine Corps are actuated by mechanical, air, hydraulic, or hydraulic boosted methods.
- (3) Final drive. Final gear reduction takes place in the tractor final drive which drives the sprocket that drives the track chain. A small drive pinion gear transmits the flow of power from the steering clutch to a large drive or bull-gear which in turn drives the sprocket.

2-4. ENGINE CLUTCHES

As an engineer equipment operator, you will come in contact with two types of engine clutches: the automotive or foot clutch, and the hand-operated snap-over center clutch used on crawler and stationary equipment. The components and the functioning of both types are similar. However, adjustment of the clutches to compensate for normal wear is different and will be discussed separately.

a. General.

- (1) Operation (fig 2-41). Clutches generally transmit power by bringing one or more rotating drive members, attached to the crankshaft, into gradual contact with one or more driven members (plates) secured to the unit being driven (transmission, gear train). Contact is made and held by strong spring pressure which is controlled by the driver with the clutch pedal. With only a light spring pressure, pedal depressed, there is little friction between the plates which permits a great deal of slippage. As spring pressure increases, friction also increases, and less slippage occurs. When the operator removes his foot from the clutch, and full spring pressure is applied, all slippage stops, and the speed of the driving and driven plates is the same. There is then a direct connection between the driving and driven members.

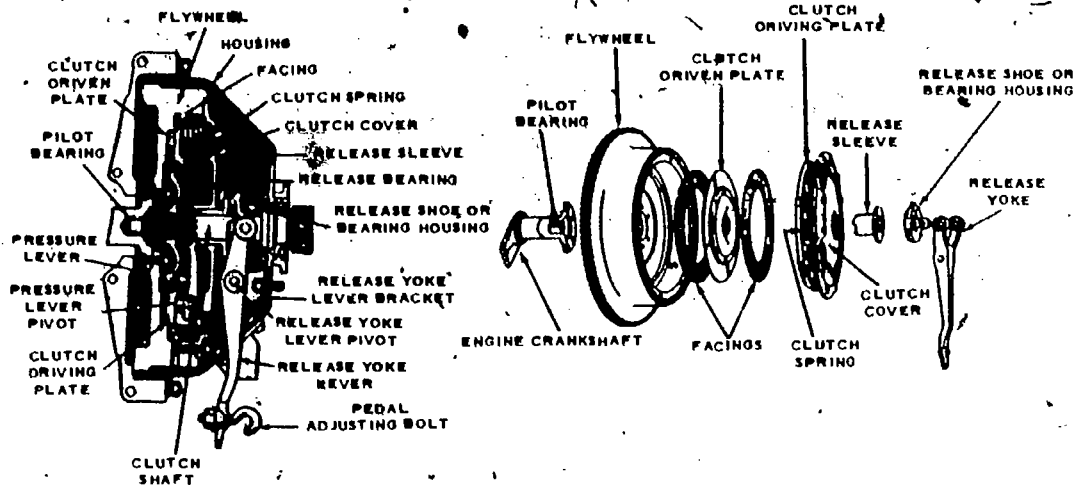

Fig 2-41. Exploded and cross-sectional views of disk clutch.

- (2) Driving members. The driving members of a clutch usually consist of two cast-iron plates or flat surfaces machined and ground to a smooth finish. One of these surfaces is usually the rear face of the flywheel. The other, a heavy flat ring known as the pressure plate, is a part of the clutch assembly which is bolted to the flywheel.
- (3) Driven member (fig 2-42): The driven member, commonly called a clutch plate, consists of a steel disk with linings riveted or cemented to it. It is these linings or facings which wear during normal operation. Periodic clutch adjustments are necessary to compensate for this wear. Abnormal operation, as when the operator rides or slips the clutch, will rapidly wear out the clutch facings and require continual clutch adjustment and eventual replacement of the driven member.

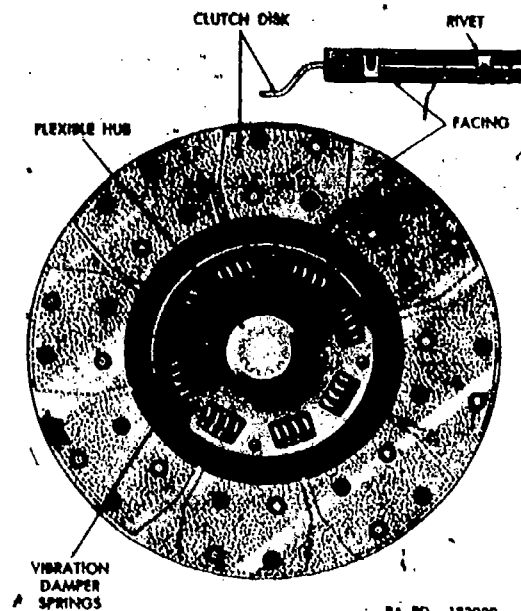

Fig 2-42. Clutch driven plate with flexible center.

B. Maintenance. Proper operation and service are the best insurance that an operator will get good service from the clutches on the vehicle assigned. Like all mechanical parts, the clutch will wear. However, the rate of wear decreases when serviced and used properly. The rate of wear is very slow on a clutch that has been properly lubricated and properly used. If it is not lubricated, the lubricant will get on the parts that should not be lubricated. If it is not lubricated, the bearings will wear rapidly. If lubricants get on the friction surfaces (item 1, figure 2-43 A and B) of the clutch plate, it will slip causing rapid wear, overheating, and other clutch problems. Resting your foot on the clutch pedal or partially engaging the snap over center clutch control lever will cause the release bearing (item 7, fig 2-43) to contact the clutch levers (item 5, fig 2-43). This will partially disengage the clutch causing it to slip and cause the clutch disk, release bearing, and levers to wear more rapidly. An improperly adjusted clutch is about the same as resting your foot on the clutch pedal; the free travel is not enough to allow the release bearing to move back away from the clutch levers so that the clutch springs (item 3, fig 2-43) can force the pressure plate (item 2, fig 2-43) against the clutch plate. As stated previously, the clutch disk will wear; as it wears, the free travel decreases to the point that the clutch fails to fully engage. Study figure 2-43A and 2-43B and visualize how the clutch is engaged and disengaged through the linkage. Pay particular attention to the levers, their pivot points, the direction of travel on each side of the pivot, and the parts that must move or come in contact. Note the pedal and its pivot point (12) and visualize the direction the linkage will travel when the pedal is depressed and when released. Note how the linkage (10) is connected to the lever and the yoke to the release bearing (7); visualize the direction that the release bearing will move and that the lever pivots (8) when the pedal and linkage are moved. Note the clutch levers (5) in the clutch assembly, how they connect to the pressure plate (2), and how they pivot (6) when moved from the clutch disk (1) wear or when contacted by the release bearing. Visualize how the distance between the flywheel and the pressure plate can decrease as the clutch disk wears. This will allow the pressure plate to move closer to the flywheel, moving the clutch levers attached to it, causing them to pivot and the free ends to move closer to the release bearing. When the free ends contact the release bearing, there is no free travel at the clutch pedal. As long as there is sufficient free travel and the clutch is properly used and serviced, the clutch springs (3) will force the pressure plate toward the flywheel and squeeze the clutch disk. Note how the pressure plate is held back in figure 2-43B because there is insufficient clutch pedal free travel. It must be emphasized that some clutches are different from the simple linkage illustrated in figure 2-43, but the principles are the same. By studying illustrations and information in the TM's, you can determine the correct amount of free travel and where to make the adjustment.

(CHAPTER CONTINUED ON NEXT PAGE)

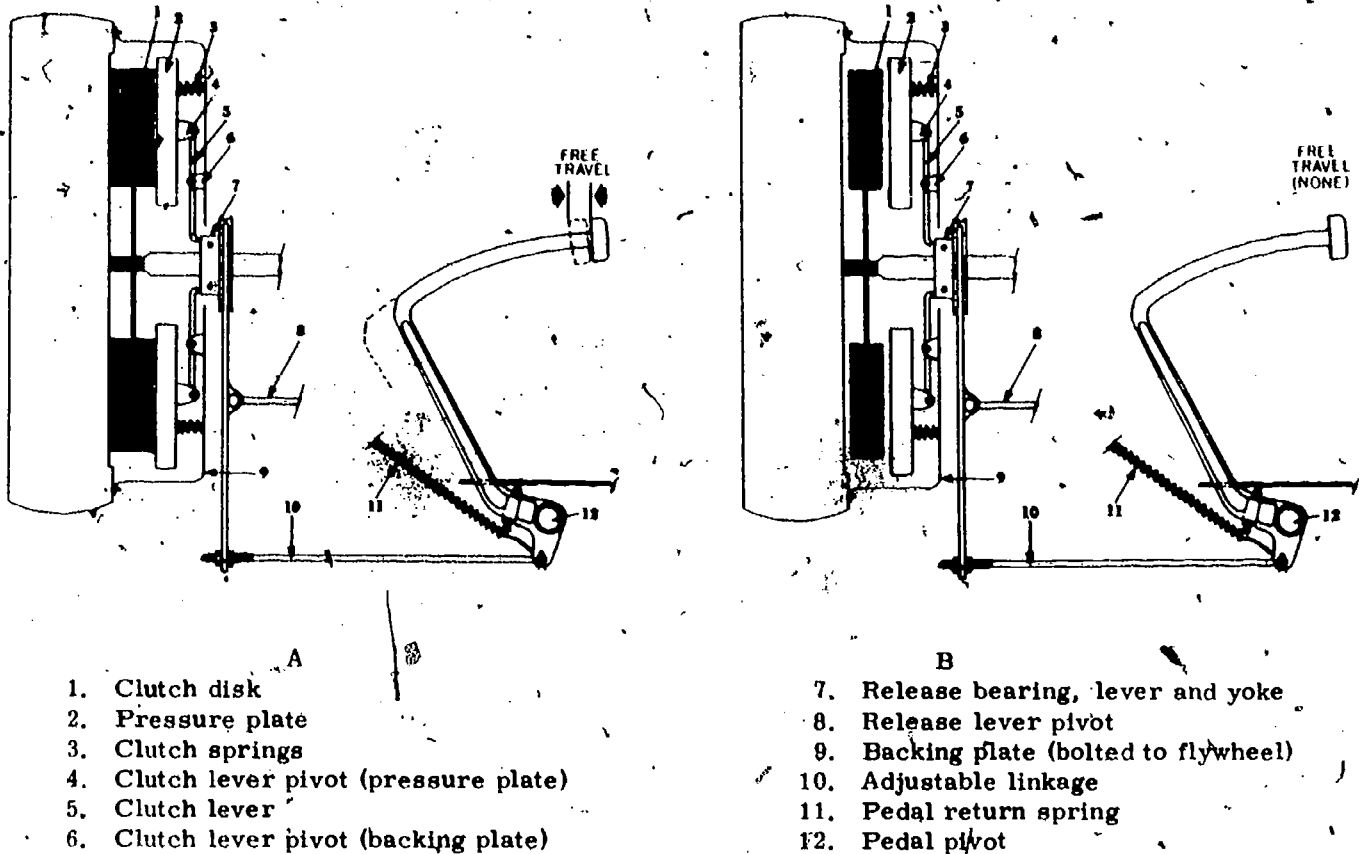

Fig 2-43. Illustration of correct and incorrect clutch pedal free travel.

(1) Clutch-pedal adjustment.

(a) Clutch-pedal adjustments make up for normal clutch facing and linkage wear. Most clutches will have adjusting devices similar to those illustrated in figure 2-44.

(b) The toeboard clearance screw, shown in the diagram, should be adjusted so that the pedal arm has 1/2 to 3/4 in. free play from the underside of the pedal to the toeboard. A clutch-pedal return spring returns the pedal to the normal engaged position.

(c) The screw adjustment in the tie rod between the pedal and throwout lever, is where the adjustment is made for clutch facing wear. After loosening the locking nut and unfastening one end of the tie rod, the length of the rod can be increased or decreased by turning the loose end. The amount of free play or correct pedal adjustment is usually designated by a specified distance, 3/4 in., or by minimum and maximum adjustment holes in the pedal arm. You can feel the point where free movement ends by the increased foot pressure required to depress the pedal. If you leave the clutch pedal with too little free play, it will cause the throwout bearing to ride on the pressure plate fingers, causing clutch slippage and damage to the pressure plate and throwout bearing. Too much free movement may keep the clutch from completely disengaging, making it hard or impossible to shift gears. After you make the adjustment, be sure to tighten the locknut and refasten the clevis pin.

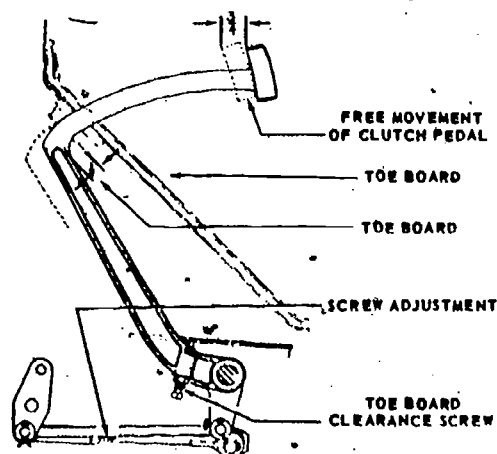

Fig 2-44. Clutch-pedal adjustment.

(d) You undoubtedly will encounter variations of the linkage adjustments discussed above, but they are not difficult to understand. Equipment TM's provide specific instructions. A few points to remember include:

1. Free travel becomes less as the clutch linkage wears or, in other words, the clutch pedal has to be released farther before the vehicle will move.
2. Do not slip the engine clutch. Select transmission speed which will permit you to move a heavily loaded vehicle without racing the engine and slipping the clutch.
3. Do not "ride the clutch." Keep your feet on the floorboard, not the clutch.

(2) Hand-operated clutches.

(a) Adjustment.

1. As an equipment operator you will come in contact with a variety of makes and models of hand-operated clutches in tractors, cranes, and stationary equipment. The internal working parts, the driving and driven members, are similar to the automotive clutch, but the operation and adjustment are slightly different.
2. The clutch is engaged and disengaged by a clutch lever. The clutch mechanism has a snap-over center action which will hold the lever in either position when the operator removes his hand. Correct clutch adjustment is usually specified as either a distinct snap-over-center action or as so many pounds of pull required to engage the clutch. The clutch should be adjusted when it fails to meet these specifications or when noticeable slippage takes place when the equipment is operating under load. Continued operation with a "loose" or slipping clutch will cause excessive clutch plate wear and may permanently damage the pressure plate and flywheel surface. Most clutches of engineer crawler equipment are adjusted inside the clutch compartment.
3. To adjust the clutch, remove the clutch cover and slowly crank the engine until the adjusting locking device appears (fig 2-45). Loosen the locking device and using a pry bar, (or if necessary, a hammer and brass drift), turn the adjusting ring in the appropriate direction to tighten the clutch. This direction will vary with different makes of clutches. When the clutch has been adjusted, reposition and retighten the locking device and replace the clutch cover.

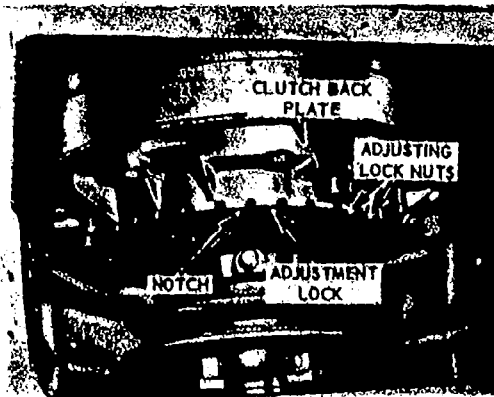

- (3) Lubrication. Engineer equipment clutches will generally require some type of lubrication. This lubrication consists of applying grease to either external or internal grease fittings (fig 2-46). The externally located fittings pose no particular problem, however, the internal fittings are located on the clutch itself. To lubricate these fittings, the clutch compartment cover must be removed and you must crank the engine over to lubricate all the fittings. Care must be taken to lubricate every fitting on the clutch assembly. Do not overlubricate these fittings! Excessive lubrication may cause a slipping or grabbing clutch action. Clutch compartments are equipped with drain plugs for removing excessive oil that finds its way into the compartment from either the engine or the transmission. If oil is leaking into the clutch compartment, it indicates worn or damaged engine or transmission oil seals and you should note this on your Operational Record and inform your equipment foreman.

Remove operator's platform and engine clutch cover. Crank engine to reach each fitting. Lubricate every 50 service hours. NOTE: The following numbers refer to figure 2-46.

1. Camshaft bearings: Crank engine to reach each of the three fittings and apply one or two strokes of the lubricator.
2. Release sleeve: Apply three or four strokes of the lubricator.
3. Release bearing: Apply three or four strokes of the lubricator.
4. Pilot bearing: Apply five or six strokes of the lubricator.
5. Universal-joint bearing: Apply three or four strokes of the lubricator.

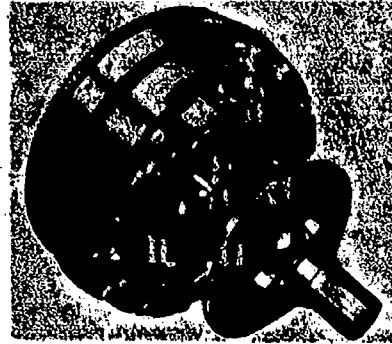

Fig 2-46. Engine clutch lubrication points.

2-5. TRACKED VEHICLE STEERING SYSTEM

a. General. To turn a tracked vehicle, one of the tracks must be stopped. This can be done by disengaging the steering clutch to stop the power from going to the track and then applying a brake to hold the track, keeping that side of the machine from moving.

The principles of operation are similar between brakes and clutches. The major differences between the two are that the clutch transmits power and both friction surfaces are free to move, while a brake stops rotation and one friction surface is stationary. Some of the later models of tracked vehicles use a planetary gear system to stop the flow of power, to reduce the gear ratio, or to reverse the output. For example, some tracked vehicles have a steering system that the operator can place one track in low range while the other is in high range or he can reverse one track while the other track is moving forward.

b. Steering clutch.

- (1) General. A multiple-disk clutch is one having more than three plates or disks. Some have as many as 11 driving disks and 10 driven disks. The multiple-disk type of clutch has a greater frictional area than a plate clutch, and is best suited as a steering clutch on crawler-tractors. Operation is similar to a typical automotive clutch. It is spring-loaded so that it is normally in the engaged position. Steering clutch levers enable the operator to disengage the clutches and stop the flow of power to either or both tracks.
- (2) Crawler controls. Steering of the Case MC 1150 scooploader is accomplished through clutches located within the power shift transmission. On this vehicle the clutches are called crawler controls because they control the direction of travel (forward and reverse) and the steering of the tractor (right or left). There are two clutches and one brake to control each track. The clutches are multiple-disk type that are engaged by hydraulic pressure and released by spring pressure. The clutches operate in the transmission oil and are wet type. Since they are engaged by hydraulic pressure and cooled and lubricated by oil, there is very little wear and no adjustments are provided. The steering brakes are located to the front of the tractor and also operate in oil. There are no operator adjustments for the brakes even though they are controlled through mechanical linkage.

- (3) Steering controls. The steering of the 82-30M crawler tractor is accomplished through steering clutches located in the reduction gearing case. The steering control levers actuate a master cylinder which transmits hydraulic pressure to a clutch and brake control valve to disengage the clutch and engage the brake. Hydraulic pressure from the torque transmission engages the clutches which operate in oil. The steering control hydraulic system is a separate system from the hydraulic system that engages the clutch. The steering control system replaces the mechanical linkage as used on other crawler tractors. There are no operator adjustments on the steering clutches or the parking brakes.
- (4) Steering clutch booster. Considerable effort on the operator's part would be needed to disengage the steering clutch levers unless some form of booster or aid were used. It may be either a spring or a hydraulic booster. Booster springs were used extensively on older model tractors. Adjustment of the springs was relatively simple and was usually done only one time. Hydraulics are used widely today and require relatively little adjustments and servicing. It is very important that care be taken to use clean oil when servicing the units. The adjustments to the booster only affect the ease with which the control levers are moved, not the action within the steering clutch assemblies. Adjustments for the Case MC 1150 scooploader and the 82-30M are performed by specially trained personnel.
- (5) Maintenance. The steering clutches and brakes of the newer crawler-tractors require little or no operator adjustments, but the hydraulic systems must be carefully maintained. They must be kept filled to the proper level with the correct oil at all times. The system must be protected from foreign matter such as dirt, water, and small particles that would damage the system. The clutch compartments must be kept as dry as possible and the parts lubricated as specified by the TM. Other tractors are similar and specific instructions can be found in the TM's.

c. Brakes and functions. Brake types, classifications, and principles of operation are similar to clutches. As stated earlier, the major difference between a brake and a clutch is that a clutch transmits power, while a brake stops rotation. There are disk, internal-expanding, and external-contracting brakes. The most commonly used types of brakes are the external-contracting and internal-expanding. The principal parts of a brake are the shoes which have a nonmetallic lining riveted or bonded to them. They are normally anchored to the vehicle to serve as the stationary member. The other friction surface is usually a machined metal surface on a rotating part. The parts of one type of internal-expanding brake are shown in figure 2-47.

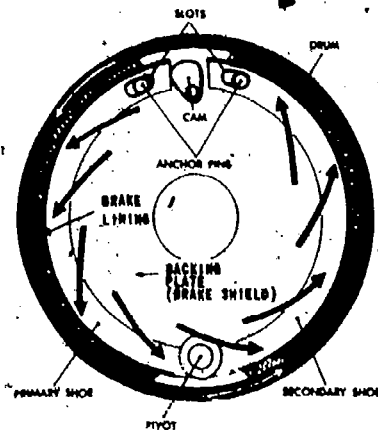

Fig 2-47. Internal-expanding brake.

- (1) Brake control and operation. A brake can be controlled by the same methods as a clutch. As indicated in figure 2-47, some brakes are designed to add additional pressure through their action. Brake systems are often referred to as service, parking, transmission steering, and operating. Service brakes are those used by stopping or controlling vehicle speed under normal conditions. Parking brakes, used to hold the machine when stopped, are sometimes called emergency brakes. Transmission brakes are used to slow or stop the transmission and power train parts for easier and faster shifting of transmission gears. Operating brakes are those used to control equipment and its attachments. Steering brakes are those used to steer crawler type equipment.
- (2) Steering brake adjustment. The brake adjustments for the Case MC 1150 are located under the rear floor plate. First remove the rear floor plate, then adjust the pedal free travel as shown in figure 2-48. The free travel should be $1/16''$ measured at the floor plate. After adjusting the push rod, check the travel of the adjusting nuts on the brakes by placing a 24" rule on top of the adjusting nut and depressing the brake pedal. The travel should be measured at the seat frame. It should be $1/8''$ ($+1/16''$ or $-1/32''$).

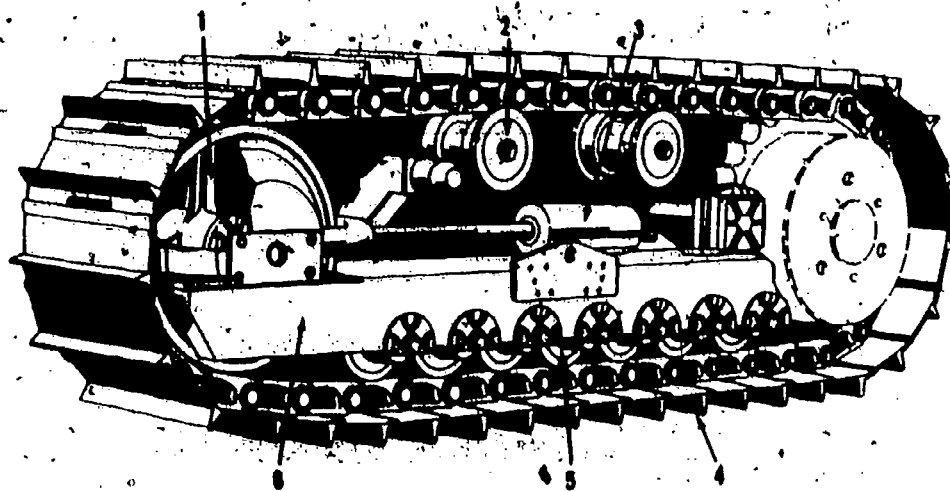

Fig 2-48. Steering brake adjustment.

- (3) Servicing. Servicing the brakes of engineer equipment is probably the easiest part of the operator maintenance. All that he has to be concerned with is that they are properly adjusted, that the linkage is free, that the hydraulic system is maintained to the proper level with the correct clean fluid, and that the compartments of those brakes that operate dry are kept free of oil and water. The hydraulic systems of the Case MC 1150 scooploader and the 82-30M crawler-tractor are easily maintained by keeping fluids at proper levels. Four or five drops of oil in the proper place on the linkage pins will keep them free and prevent binding. A thorough cleaning of the tractor will keep the dirt, grease, and debris from building up and causing the linkage to bind.

2-6. TRACKS

a. Introduction. A tracklaying vehicle does just what its name implies: it lays its own road, then picks it up and lays it again. Because springs alone are too flexible to support the weight of tracklaying equipment, their suspension system (fig 2-49), differs from automotive type vehicles. Tracklaying construction equipment has a track roller frame assembly which provides a mounting for the track rollers, front idler, sprocket, track recoil mechanism, and equalizer spring. The weight of the tractor is carried through the frame to the rollers. The diagonal brace or some other part on the inside of the frame maintains correct track frame alignment. Some arrangements allow each track frame to operate independently and to move up and down in relation to one another by pivoting at the sprocket shaft; others are rigidly connected to the vehicle. The front idler, track rollers, idlers, and sprocket are used to keep the track up out of the suspension mechanism, to guide the track, and to maintain track tension. Large track springs or other systems such as gas cylinders absorb shocks to the track assembly by permitting the front idler to recoil when it is subjected to heavy shock or load.



- 1-Front Idler Assembly
- 2-Carrier Roller
- 3-Recoil Cylinder
- 4-Track Chain
- 5-Track Rollers
- 6-Track Frame

Fig 2-49. Tracklaying vehicle suspension system.

b. Service and maintenance.

- (1) Checking slack in track chain. When backing the tractor, if the track chain is too loose, it will tend to climb the sprocket. If the chain is either too tight or too loose, it will cause undue wear on the track links, pins, and bushings, and also on the front idler bearings. Track chain tension can be checked by measuring the sag in the tracks between the track idlers. When this sag is measured, the track should be stretched tight. To remove all slack from the chain, place a wooden block under the foremost track shoe lug and, with the tractor in low gear, engage the engine clutch just enough so that the sprocket drive tightens the track along the ground and around the sprocket. Then apply and lock the brakes and stop the engine. All remaining slack in the tracks can be obtained between the track idlers by having a man stand on the track between them, or by using a sledge hammer, to drive the track down. Lay a straightedge along the track lugs. The track should have a clearance of about 3/4 to 1 in. or 1 to 1 1/2 in. (depending on the model tractor) between the straightedge and the track lug. If the clearance is more or less than specified in the TM, the tension should be adjusted. Greater slack may have to be allowed in certain soils, such as beach sand, which tend to build up on front idlers and sprockets, thus tightening the track chain excessively. When this happens, it lugs the engine down and reduces available pushing power. Too loose a track chain not only causes excessive wear, but may cause the track to leave the suspension system or be thrown. This is particularly true when the tractor is working on a slope.
- (2) Adjusting track chain tension (fig 2-50). The front idler is moved forward by forcing chassis grease into a hydraulic cylinder with a standard lubricator or by pressure of compressed nitrogen gas. Those units that use gas to force the front idler out to tighten the track are loosened by forcing chassis grease in the front part of the cylinder. To tighten the track, the grease is bled off until the correct track tension is obtained. The lubricant and the gas used in these systems are under extreme pressure. When adjusting tracks with these systems, you must be extra careful because the force behind the bleeder plugs and grease fittings is sufficient to blow them out like a bullet. Check the specifications, procedures, and safety precautions in the TM and service manuals before adjusting tracks on the Case MC 1150 and the 82-30M crawler-tractors. Figure 2-50 illustrates how the Case MC 1150 tracks are adjusted.

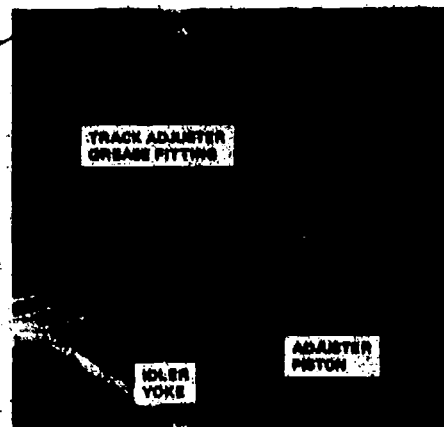

Fig 2-50. Track adjustment.

2-7. OPERATING CLUTCHES AND BRAKES

a. **General.** Operating clutches and brakes are those clutches and brakes which are used to control the various shafts and cable drums on winches, power control units, and components of other machines. Operating clutches and brakes are similar to the wheel brakes of your car and operate on the same principles as the engine clutch. The majority of the clutches and brakes you will come in contact with on engineer construction equipment will be part of a mechanical control system. Each clutch and brake will have a specific name, but they are usually grouped under operating clutches on inspection forms. Operating clutches and brakes have been grouped together here because of the way they are used. For example, a type of brake can be used to hold one part of a planetary system and it will be called a clutch. The difference between a clutch and a brake is that a brake is used to slow down or completely stop rotation by friction, while the clutch engages or disengages the power flow between the engine and/or power train components. The clutches and brakes discussed earlier in this course were used primarily on crawler-tractors while the clutches and brakes discussed here can be used anywhere in the power train. The clutches are placed in the power train at any place there is a need to break the flow of power. A brake will also be used if the part must be stopped or the free-wheeling action controlled.

- (1) Within this mechanical control system, two adjustments will generally be provided. One adjustment is used to position the control lever or foot pedal so that it can be reached easily by the operator during normal operations. Operating construction equipment for long periods of time is hard and exhausting work. You should position the levers and pedals so that you can operate the machine with a minimum of effort, increasing both operating efficiency and safety. The second adjustment is located within the mechanical linkage between the lever and the clutch band, generally at the "live" (movable end) of the clutch band. This adjustment determines the holding power of a brake band or pulling power of a clutch band.
- (2) As an equipment operator you will often hear clutch or brake action referred to as either being "dragging" or "slipping." Dragging means that the band is dragging or rubbing against the drum when it should be free. This can be caused by a warped band, too tight an adjustment, or a buildup of oil or grease on the lining. Slipping means that when the clutch is engaged the band is not being held tightly against the drum. This permits slippage to occur between the lining and the drum, often causing a burning action. The smell of a slipping clutch is readily apparent. The heat generated by a slipping clutch will cause rapid lining wear, possible warpage of the band, and the need for frequent clutch adjustments.
- (3) Two terms you will hear quite often are the "live end" and the "dead end" of a band. Since most operating clutches, both internal expanding and external contracting, are circular bands, the end which is anchored or fixed in the clutch assembly is known as the dead end. The other end is movable and is connected to the operating linkage. This end of the band is known as the live end. It is here that most adjustments are made.
- (4) Depending upon their application, clutches may or may not be adjusted to backlock, knuckle-in, or snap-over-center. This over-center action is used to keep a lever in the engaged position when the operator removes his hand. An example of this would be the drag cable lever of a crane or the hoist line on a shovel front. Most clutches such as those on power control units and hookblocks on cranes are not adjusted to snap-over-center and will return to the neutral or disengaged position when the operator releases the lever.

b. **Types used.** There are several types of clutches and brakes that can be used as operating clutches and brakes. The type used depends upon the manufacturer, its location and space, and the operation it is to perform.

- (1) **Internal-expanding or external-contracting.** These are the most common type of operating clutches that the operator will come in contact with. The internal-expanding-type clutch (fig 2-51) expands and contacts a rotating member, or the clutch rotates and expands to cause the drum to rotate. The external-contracting-type clutch (fig 2-52) fits around the outside of the drum and contracts to cause the two parts to move as one.

With these clutches there is only one friction surface on the drum and one on the clutch band. These same type components can also be used as brakes if one of the members is held stationary. For example, by anchoring the clutch band, a rotating drum could be stopped by applying the band to the drum with sufficient pressure. These clutches and brakes are the type usually found on concrete mixers to control the skip.

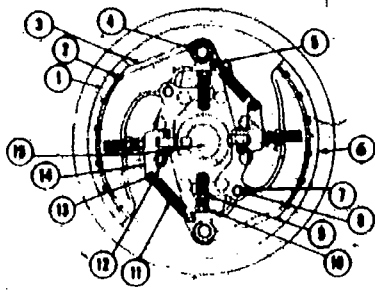

1. Lining
2. Rivets
3. Clutch shoe
4. Anchor pin
5. Anchor pin
6. Drum
7. Pivot pin
8. Snap ring
9. Jam nut
10. Adjusting bolts
11. Clutch spring
12. Roller pin
13. Anchor pin
14. Lever arm
15. Shaft

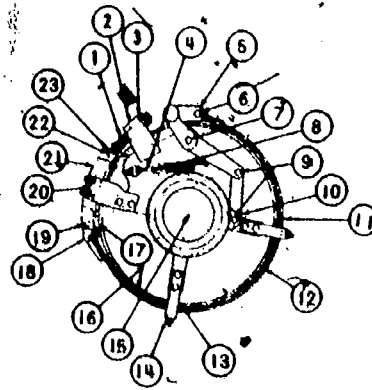

1. Compression spring
2. Clutch carrier
3. Jam nuts
4. Eyebolt
5. Lever
6. Pin
7. Pin
8. Tension spring
9. Pin
10. Link
11. Clutch band
12. Lining and rivets
13. Bar
14. Bolt
15. Shaft
16. Drum
17. Shoe lining
18. Band dead end
19. Pin
20. Bar
21. Shoe
22. Pin

Fig 2-51. Internal-expanding clutch.

Fig 2-52. External-contracting clutch.

- (2) **Cone.** Some machines use the cone type clutch which has one friction surface shaped like a cone. The drum also has one friction surface that is shaped like a cone to receive the cone shaped clutch.
- (3) **Jaw.** These clutches are constructed similar to gears; they have metal-to-metal friction surfaces. They can be used to engage or disengage power through linkage controlled by an operator, or they can be spring loaded and serve as an overload clutch. The jaws are usually designed so that an overload will force them apart. However, some machines such as cranes, have jaw clutches which are positively engaged and will remain there until moved by the operator. Unlike the other type clutches, the jaw clutch is seldom used as a brake. It can be used to hold a component after it has been stopped.

c. **Service.** For the clutches and brakes to operate properly, they must receive proper care and maintenance. Those exposed to the elements must be kept as clean and as dry as possible. Rust will cause them to stick or drag. Dirt that accumulates will act as an abrasive and wear the clutch band rapidly. Grease and oil that accumulate on the clutch parts can cause slipping and will also cause dirt to accumulate and stick. Some of these clutches operate in oil to keep them cool and the linkage operating freely. They require that the oil be kept at the proper level. Those that do not operate in oil require certain parts to be lubricated to prevent binding and seizing. However, over-lubrication will cause dirt and dust to accumulate and can possibly get on the clutch friction surfaces. Proper adjustment of clutches is very important. They must be adjusted so that when fully engaged there is no slippage. Some of the clutches must be adjusted so they will not toggle in (snap-over-center) while others are designed to operate properly when they toggle in. Always check the TM for the machine to determine how a specific clutch should be serviced and maintained.

d. **Brakes.** Basically, there are two kinds of brakes: external-contracting brakes and internal-expanding brakes. The methods and devices used to apply the braking effort are called braking systems. On construction equipment, you will find all systems: mechanical brakes, hydraulic brakes, air brakes, and electric brakes. Booster devices and vacuum brakes are sometimes used with other brake systems to increase the initial brake action. Although the steering brakes were discussed previously, some of the material discussed below will also apply to them and some of the material covered previously will be repeated for emphasis.

- (1) External-contracting brakes (fig 2-53). These are used for parking brakes on wheeled vehicles, for steering brakes on crawler equipment, and for controlling the speed on auxiliary equipment drive shafts. In operation, the brake band is tightened around a rotating drum by moving the brake lever. The brake band is made of flexible steel, shaped to fit the drum, and has a frictional lining riveted or bonded to its inner surface. External-contracting brakes are generally applied by mechanical linkages. They are often referred to as mechanical brakes.

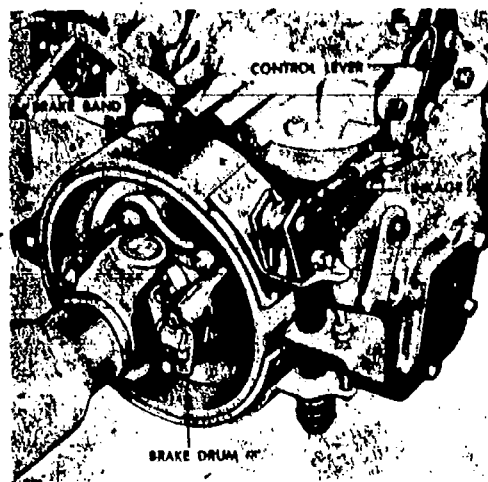

Fig 2-53. External-contracting parking brakes.

(2) Internal-expanding brakes (fig 2-54).

- (a) Internal-expanding brakes are used primarily as wheel brakes. This type of brake permits a more compact and economical construction. The brake shoes and brake operating mechanism are supported on a backing plate or brake shield which is attached to the axle housing. The brake drum, attached to the rotating wheel, acts as a cover and provides a frictional surface for the brake shoes.
- (b) In operation, the brake shoes are forced outward against the drum to produce a braking action. One end of each shoe is hinged to the backing plate by an anchor pin while the other end is unattached and can move in its support with the operating mechanism. When force from the operating mechanism is applied to the unattached ends of the shoes, they expand and brake the wheels. Retracting springs return the shoes to their original positions when braking action is no longer required.

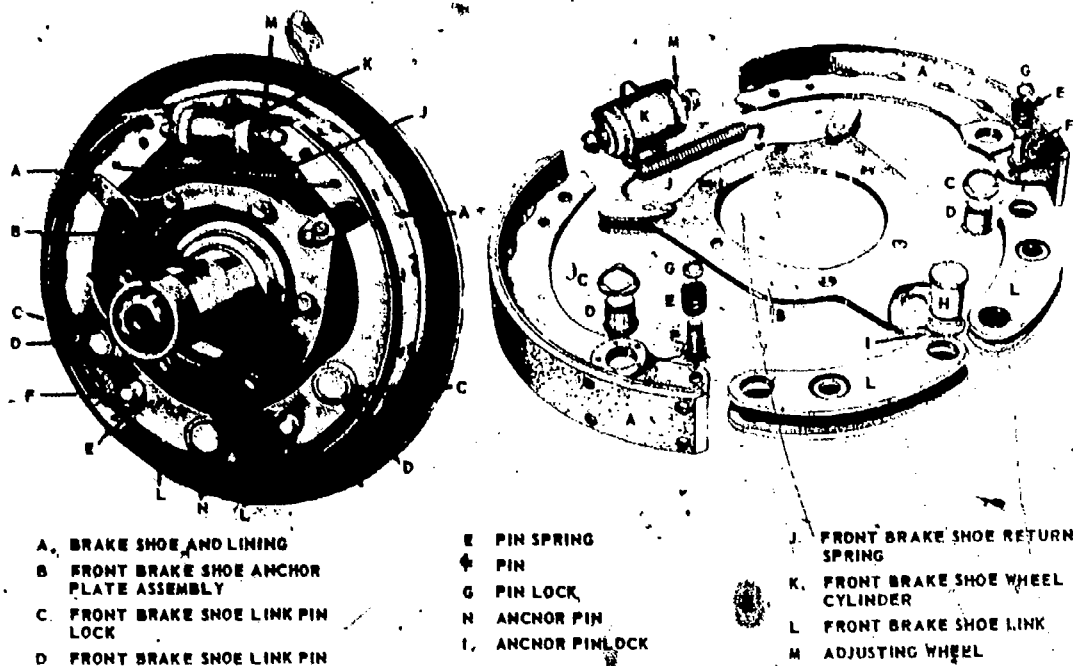

Fig 2-54. Internal-expanding wheel brake.

(3) Adjusting brakes.

- (a) Brakeshoe adjustments are made to remedy lining wear. If the vehicle pulls to one side when the brakes are applied, individual brakes must be adjusted to equalize them. If the front wheels should lock before the rear wheels are stopped, the operator may lose steering control. It is important, therefore, that brake adjustments be made to provide equal distribution of braking action to all wheel brakes. A single parking brake or emergency brake on a drive shaft, must be adjusted so it will hold.
- (b) With properly adjusted brakes, the linings attached to the shoes fit evenly against the drums when the brakes are applied. The lining should not rub on the drum when no brake action is required. Linings must not drag, but they must be near enough to the drum to give proper leverage between the operating mechanism and the friction surface. Wheel brakes are adjusted separately and externally at each individual wheel.
- (c) A cam adjusting bolt or an adjusting wheel (fig 2-55), which can be reached through a hole in the backing plate, will permit you to move one end of the enclosed brake shoes. This adjusting device is usually located at either the top or bottom of the backing plate. Turning the adjusting device in one direction will move the brake shoes toward the drum to compensate for lining wear. Turning the adjusting device in the other direction will move the shoes away from the drum. Proper adjustment is usually specified as so many thousandths of an inch clearance between the lining and the drum, or backing off the adjusting wheel a certain number of clicks after it has been turned all the way in against the drum. When the wheel is jacked up, you can tell by spinning it whether the brake is free or dragging.

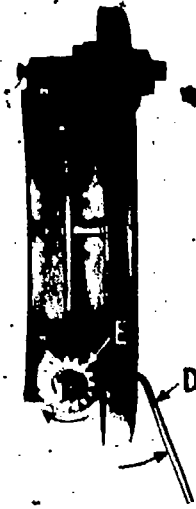

Fig 2-55. Brake adjusting wheel.

- (d) You will find a slack adjuster (fig 2-56) instead of brakeshoe cams used to adjust airbrakes. This adjusting device has an adjusting nut and a locknut which must be loosened before making an adjustment. Turning the adjusting nut rotates a worm gear that takes up the slack in the adjuster. Back off the adjusting nut just a little after tightening it, then retighten the locknut. Push rod travel at all wheels should be exactly the same so braking action is equal. It should be at a minimum from fully applied to fully released with the shoes not dragging in the released position.

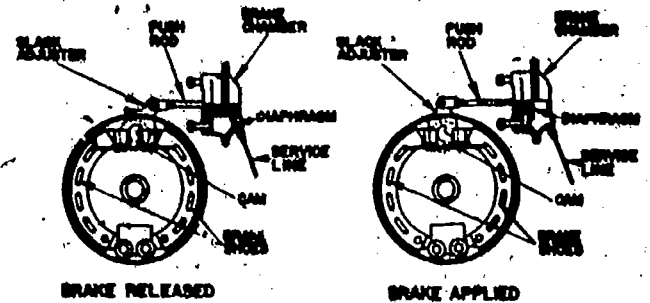

Fig 2-56. Operation of brake shoes from brake chamber.

- (e) Electric brakes are self-adjusting. As the lining wears, the electromagnet which applies the brakes must move a little farther to force the brake shoes against the drums. An automatic stop on the brake shoes prevents the rivets from contacting the drums after excessive wear.
 - (f) External-contracting parking brakes are adjusted either through adjustable mechanical linkage or an adjusting device at one end of the brake band.
- (4) **Brake inspection.** Brake band linings should be inspected at periodic intervals and at the time when wheel bearings are being repacked. Brake shoes should be replaced before the rivets or the metal part of the shoe come in contact with the brake drum. Metal-to-metal contact will score the surface of the brake drum. A badly scored brake drum will have to be replaced or turned down, unnecessarily increasing the cost of repairs and vehicle "down" time. Keep oil and grease off brake linings. If the brakes fail to hold, or will not equalize after adjustments are made, or if they are excessively oily, the brake linings or shoes must be replaced.

c. Serviceing brake systems.

(1) Hydraulic brakes.

- (a) A hydraulic brake system is primarily a liquid connection between the brake pedal and the individual brake shoes. Principal parts of the brake system are the master cylinder and the wheel cylinders (fig 2-57). When the brake pedal is depressed, the brake fluid forces the pistons in the wheel cylinders against the brake shoes. The shoes expand against the brake drum and stop the vehicle.
- (b) Principal operator service to hydraulic brakes consists of keeping the proper level of brake fluid in the master cylinder reservoir, checking the system for leaks, and "bleeding the system."
- (c) Use only approved hydraulic brake fluid when adding to or refilling the brake system. See that all dust and dirt are removed around the filler cap opening on the master cylinder before adding fluid. Add enough fluid so that the level reaches just below the filler cap opening (fig 2-58). After filling the reservoir, see that the vent at the top of the reservoir is open and the filler cap is tight. If the brake pedal goes to the floor-board when pushed down, the first things to check are the brake fluid level in the master cylinder and signs of leaks around the wheel cylinders.

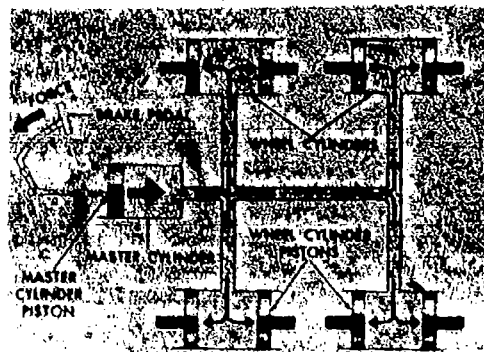

Fig 2-57. Operation of a hydraulic brake system.

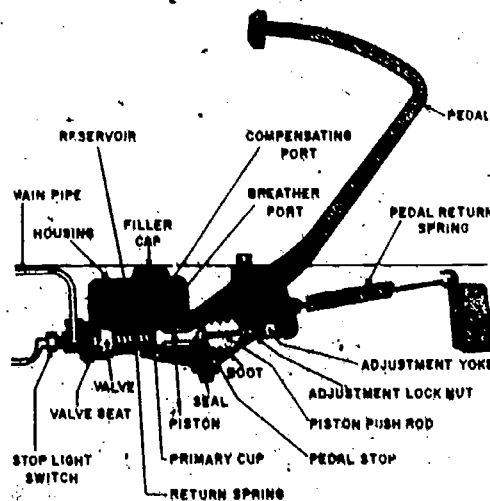

Fig 2-58. Hydraulic brake master-cylinder and brake-pedal connections

(d) Continual refilling of the master cylinder is a sure sign of leakage in the wheel or operating cylinders, the master cylinder, or a loose fitting or a broken line in the system. Fluid lost at these places can be easily detected. Wipe the system clean and dry, and then have someone step on the brake. In this way, you can be sure you have found the leak and that others have not been overlooked. Leaks and loose joints not only allow fluid to escape from the system, but also permit air to enter. Air in the system can be felt by the soft, springy action of the brake pedal; it must be removed by "bleeding" before you can obtain a solid pedal.

(e) Each hydraulic brake wheel cylinder (fig 2-59) has some kind of bleeder screw device or valve, extending from the backing plate. To bleed the lines, clean all dirt from around this valve and proceed as follows:

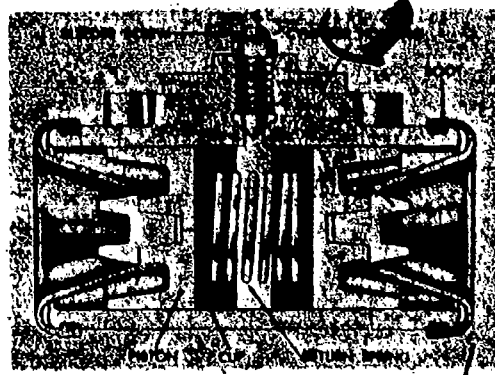

Fig 2-59. Cross section of a wheel cylinder.

1. Fill the reservoir with brake fluid to 1/4 in. from the top and keep it full during the bleeding operation. Replace the cap after each filling to prevent loss of brake fluid and to keep dirt from entering the system.

2. Attach a short length of rubber hose to the bleeder screw and place the loose end in a clean glass container (fig 2-60). Most bleeder screws have a capscrew to protect the threaded opening to which you attach the hose.

3. Now, have an assistant push in the brake pedal to put pressure on the brake system while you operate the bleeder screw, and watch for air bubbles in the glass container. The pedal may have to be pumped to build up pressure in the system. The assistant should push down on the pedal slowly, as far as it will go. This forces fluid out of the bleeder valve through the hose into the glass container. With the fluid comes the air that may be trapped in the line. It may be necessary to pump the brake pedal six or seven times before fluid without air can be seen entering the glass container. Do not let the master cylinder run dry during the bleeding operation.



1. BLEEDER SCREW 2. BLEEDER HOSE
Fig 2-60. Bleeding brake lines.

4. Bleed one wheel at a time, starting with the one farthest away from the master cylinder. This will remove all the air possible at the first bleeding operation. When all air has been bled from the line, close the bleeder screw tightly, remove the bleeder hose, and reinstall the bleeder capscrew.

(2) Airbrake systems (fig 2-61).

- (a) In servicing airbrake systems, your biggest problem is to keep the air in the lines. The airline hoses and couplings should be checked for leaks and wear, particularly those connecting a prime mover and trailer. Worn hoses and couplings should be replaced. In an emergency, several turns of tape may stop an air leak for a short time. The high pressure within the lines, normally between 80 and 105 psi, will soon force an opening unless the taped section is replaced. The cutout cocks provided at the tractor hose connections are often responsible for air loss. These tapered valves should be closed tightly when no trailer is being towed, but they often jar open.
- (b) Another problem with any compressed-air system is condensation. The drain cocks at every air reservoir should be drained daily to remove water that accumulates from condensation. Make sure that these valves work freely and are closed before starting the vehicle.
- (c) Some compressors receive their lubrication from the engine, while others have self-contained lubrication systems which must be checked daily. The oil should be drained each time the engine oil is drained.

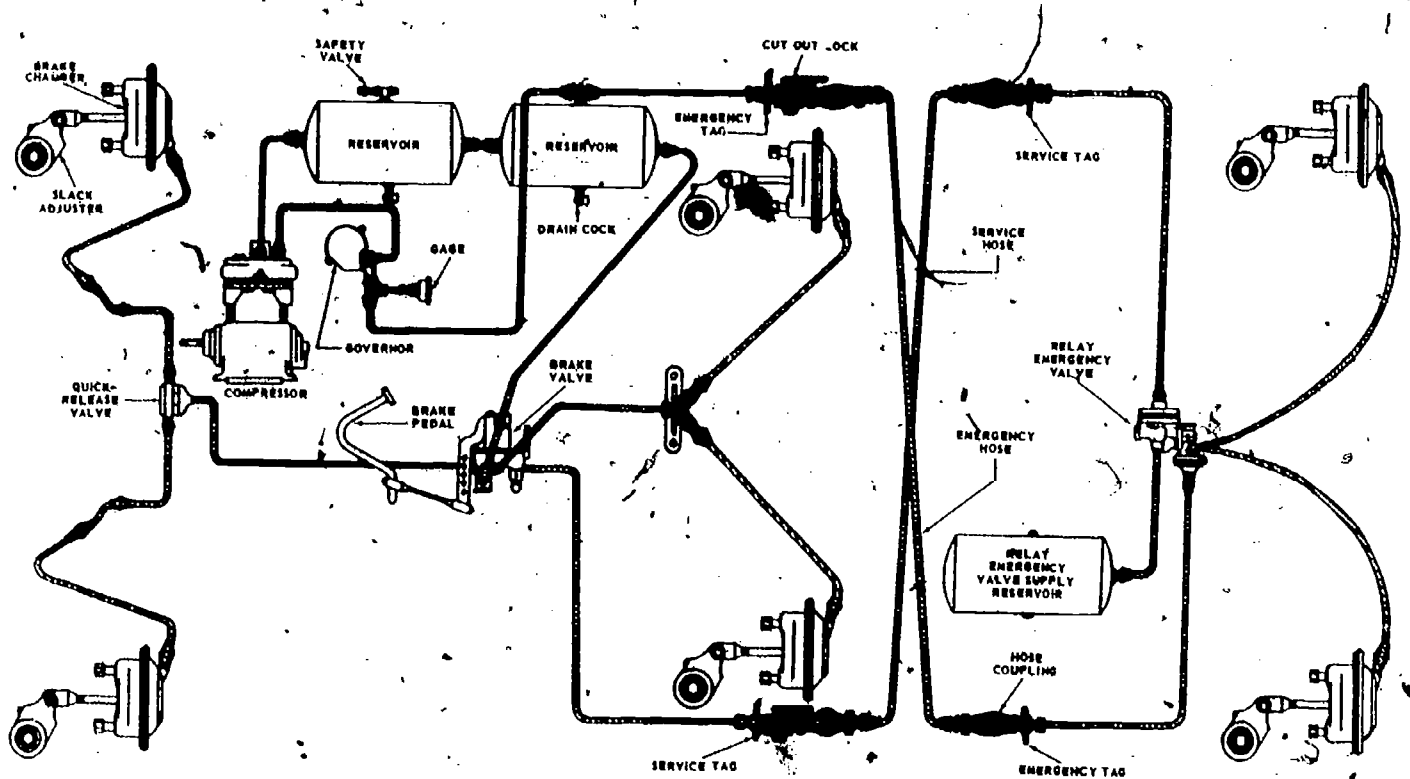

Fig 2-61. Diagram of an airbrake system in a tractor-trailer combination.

9. HYDRAULIC SYSTEM

a. Purpose. A hydraulic system is used on engineer equipment for many reasons. It is one of the easiest methods of transferring power around a corner. It makes it easier for the operator to control the many different components. When used and maintained properly, there is less maintenance time required to keep it operating. Hydraulics can also be used in many places that a gear system would require too much space to be efficient. Hydraulics are used for brakes, transmission operation, attachment control, to assist mechanical controls, and as motors to operate gear-driven components.

b. **Components.** The number, type, and nomenclature of the components depends on the application. The components shown in figure 2-57 are used for a simple hydraulic brake system and some clutch release mechanisms. It consists of a master cylinder and one or more operating cylinders which are similar to the wheel cylinders. The 82-30M crawler-tractor uses a part of this type system to control the hydraulic steering. Another type system used on many items of engineer equipment is illustrated in simple form in figure 2-62. It consists of a supply tank, pump, strainers, filters, control valves, relief valves, lines and fittings, and one or more ram cylinders. The pump provides the amount of fluid required at the pressure needed to perform the work. The control valve and lines direct the pressurized fluid to the desired points. The ram cylinder performs the actual work of raising and lowering the blade or operating the other attachments. The relief valve protects the system from excessive pressure that the pump is capable of building up. The internal parts of a hydraulic system have a close fit and are protected from abrasives and other debris by the strainers and filters. Most hydraulic systems provide a mechanical advantage which is the reason that the operator's job is made easier.

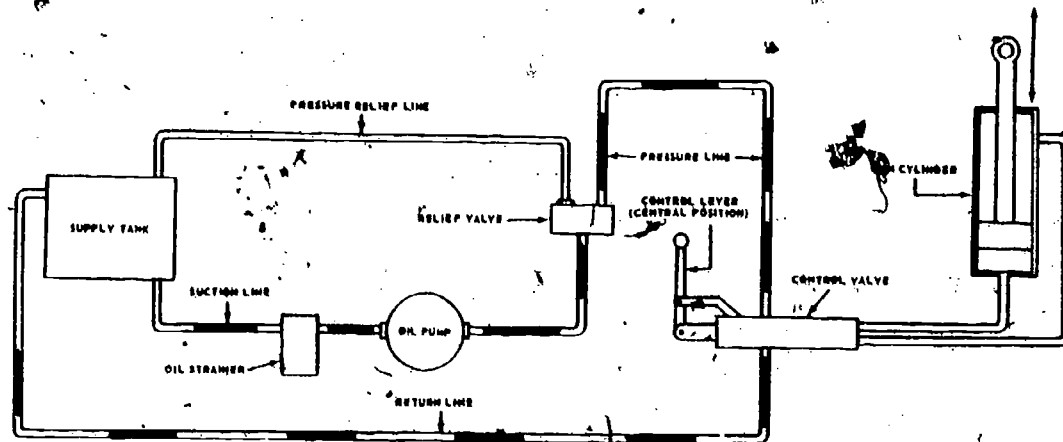

Fig 2-62. Components and flow of a basic hydraulic system.

c. **Servicing.** The operator service to the hydraulic system is limited to keeping the system full of the correct fluid, keeping all foreign material out, some minor adjustments to the control linkage, and bleeding air from the system. Because of the various types of systems and equipment, it is important that you check the TM to determine the type fluid to use in a particular system. The system should be kept clean and tight and the fluid maintained at the proper level to keep out dirt and air. The fluid used must be clean, the correct type, and the correct viscosity to provide proper lubrication, cooling, and to prevent sluggish operation. Hydraulic systems were designed to react faster and with less operator effort than mechanical systems. Improper care and maintenance will keep it from performing as intended. Some control linkage has adjustments which can be made by the operator to position the operating levers and pedals in a more convenient location. There are also some adjustments to properly position the control valves. These adjustments can also be made by the operator. However, the control valve adjustments are normally made by the mechanic. When checking or making a any adjustment, always refer to the TM for the specific machine and the particular control.

ENGINEER EQUIPMENT OPERATOR

Lesson 2

Power Flow

STUDY ASSIGNMENT: MCI 13. 31h, Engineer Equipment Operator, chap 2.

LESSON OBJECTIVE: Upon successful completion of this lesson you will be able to recognize the theory and principles of operation, the nomenclature and classification of components and systems that provide, transmit, or control power flow in an item of engineer construction equipment. You will be able to identify the procedures and methods of operating and servicing these components and systems.

WRITTEN ASSIGNMENT:

A. Multiple Choice: Select the ONE answer which BEST completes the statement or answers the question. After the corresponding item number on the answer sheet, blacken the appropriate box.

Value: 1 point each

1. What changes the reciprocating motion of the piston into rotary motion?
 - a. Camshaft
 - b. Valve mechanism
 - c. Crank on the crankshaft and a connecting rod
 - d. Slip fit cylinder liner

2. What opens the engine valves?
 - a. Crankshaft
 - b. Camshaft
 - c. Connecting rod
 - d. Piston

3. In what sequence do the strokes of a 4-stroke-cycle engine occur?
 - a. Intake, power, compression, and exhaust
 - b. Exhaust, power, compression, and intake
 - c. Compression, power, intake, and exhaust
 - d. Intake, compression, power, and exhaust

4. During which two strokes of a 4-stroke-cycle engine are both the intake and exhaust valves closed?
 - a. Power and intake
 - b. Power and compression
 - c. Exhaust and compression
 - d. Intake and exhaust

5. In a 4-stroke cycle engine, the camshaft gear is _____ the size of the crankshaft gear.
 - a. 1/2
 - b. twice
 - c. 3 times
 - d. 4 times

6. What ignites the fuel in a diesel engine?
 - a. Magneto ignition
 - b. Low-voltage spark
 - c. Heat of compressed air
 - d. High-voltage spark

7. When is fuel injected into the cylinder of a diesel engine?
- Just before TDC of the compression stroke
 - Just after TDC of the compression stroke
 - At TDC on the exhaust stroke
 - At BDC on the intake stroke
8. The 2-stroke-cycle Detroit diesel engine employs exhaust valves in the head and intake
- valves in the block.
 - valves in the head.
 - ports in the head.
 - ports in the cylinder wall.
9. What are the components of an air-cooled cooling system?
- Fan, fins, and baffle
 - Radiator, baffle, shroud
 - Fan, radiator, hose
 - Fins, water jacket, fan
10. What is the normal operating temperature of an internal-combustion engine?
- 130° - 155°F
 - 150° - 185°F
 - 160° - 185°F
 - 170° - 212°F
11. Which part of a water-cooling system controls the engine temperature?
- Radiator
 - Water pump and fan
 - Thermostat
 - Pressure radiator cap
12. At what interval should antifreeze solutions be tested?
- Daily
 - Weekly
 - Every 2 weeks
 - Monthly
13. When antifreeze solutions are tested, the coolant should be _____ normal operating temperature.
- below
 - at
 - above
14. When adding water to an overheated engine, you should pour the water in _____ with the engine operating at _____.
- quickly--low idle
 - slowly--fast idle
 - quickly--full throttle
 - slowly--low idle
15. As a general rule, how much slack should there be in the engine fan belts?
- 0-1/2 in.
 - 1/2-3/4 in.
 - 3/4-1 in.
 - 1-2 in.
16. If there is a sudden drop in engine oil pressure, you should
- continue to operate.
 - continue to operate and record the information on the operational record.
 - shut the engine down.
 - stop the vehicle and check the radiator.
17. Oil and filter changes are generally scheduled at intervals of _____ hours.
- 10
 - 50
 - 100
 - 250
18. Which type of oil filter handles the full flow of oil before it is circulated through the engine?
- Full flow
 - Bypass
 - Recirculating

19. Which specific gravity reading indicates a fully charged battery?
- a. 1100 c. 1250
b. 1170 d. 1275
20. During freezing weather, when should water be added to a battery?
- a. At the end of daily operation
b. At the end of a week's operation
c. Before the engine is started
d. After the engine is started, prior to beginning operation
21. What solution should be used as a first aid measure when electrolyte is accidentally spilled on the body?
- a. Gunk c. Baking soda and water
b. Carbon tetrachloride d. Cleaning solvent
22. The positive post of a battery is generally _____ the negative post.
- a. smaller than c. larger than
b. the same size as
23. Which unit in a heavy-duty generator regulator makes and breaks the circuit between the battery and generator as needed?
- a. Voltage regulator c. Current regulator
b. Cutout relay
24. When the engine is operating at low idle speed, which part of the charging circuit supplies the current to the vehicle electrical system?
- a. Generator c. Generator regulator
b. Battery d. Ammeter
25. To keep a starting motor from overheating, it should never be run longer than _____ at a time.
- a. 10 sec c. 30 sec
b. 20 sec d. 1 min
26. What part of the ignition system acts as a step-up transformer?
- a. Capacitor c. Rotor
b. Distributor d. Coil
27. Which is a part of the primary ignition circuit?
- a. Rotor c. Spark plug
b. Distributor cap d. Breaker points
28. Which part of the ignition system is used to prevent arcing across the contact points?
- a. Coil c. Rotor cap
b. Condenser d. Rotor button
29. When adjusting the spark plug gap, which electrode should you bend?
- a. Ground
b. Center
c. Either, depending on how wide the gap is

30. To properly adjust the breaker points, the rubbing block of the movable point should be resting on the
- a. flat portion of the cam lobe.
 - b. high point of the cam lobe.
 - c. stationary point.
 - d. condenser contact post.
31. Engine timing marks can be lined up by adjusting the
- a. coil.
 - b. battery voltage.
 - c. generator
 - d. distributor.
32. What is the principal problem encountered in fuel pumps?
- a. Clogging of the filter
 - b. Wearing of the linkages
 - c. Deterioration of the diaphragm
 - d. Air in the lines
33. As an aid to cold-weather starting, which part of the carburetor enables the operator to vary the richness of the fuel-air mixture?
- a. Float
 - b. Choke
 - c. Throttle
 - d. Venturi
34. When adjusting the carburetor idle circuit, approximately how far should the idle screw be opened on the initial adjustment?
- a. 1/2 turn
 - b. 3/4 turn
 - c. 1 turn
 - d. 2 turns
35. On a Detroit diesel engine, fuel flow through the fuel filter is accomplished by
- a. pressure of the fuel pump.
 - b. gravity from the fuel tank.
 - c. high injection pressures.
 - d. gravity flow from the injection pump.
36. When should the operator drain water from the filter and strainer housings of a Detroit diesel fuel system?
- a. Daily, after operation
 - b. Daily, before operation
 - c. Weekly
 - d. Monthly
37. After installing the filter and strainer elements in a Detroit diesel fuel system, the operator should
- a. bleed the system of air.
 - b. prime the housings with clean diesel fuel.
 - c. run the engine at full throttle.
 - d. open the drain cocks on the housings.
38. Which part of the vehicle power train provides for an additional gear reduction and furnishes power for auxiliary devices?
- a. Clutch
 - b. Transmission
 - c. Differential and propeller shaft
 - d. Auxiliary transmission and transfer case
39. When a vehicle is making a turn, which part of the power train permits the wheel with least resistance to rotate faster?
- a. Clutch
 - b. Propeller shaft
 - c. Differential
 - d. Final drive

40. As the friction surface of the clutch driven member wears, what happens to clutch-pedal free travel?
- a. Decreases
b. Increases
c. Remains the same
41. A clutch pedal with too much free play will cause
- a. the throwout bearing to ride on the pressure plate fingers.
b. damage to the pressure plate.
c. clutch slippage.
d. hard gear shifting.
42. The major difference between a brake and a clutch is that the brake stops rotation and the clutch
- a. transmits power.
b. releases energy.
c. starts power.
d. assists movement.
43. How much slack should there normally be in the track chain of a crawler-tractor?
- a. 1/4 to 3/4 in.
b. 3/4 to 1 1/2 in.
c. 1 1/2 to 2 1/2 in.
d. 2 1/2 to 4 in.
44. Too much pressure in the hydraulic slack adjuster could cause
- a. bleeder plug and grease fitting blow out.
b. hydraulic valve leak.
c. grease and nitrogen gas gasket leak.
d. bleeder plug seepage.
45. A slack adjuster is used to adjust the brake bands of a(an) _____ brake system.
- a. air
b. hydraulic
c. electric
d. air-over-hydraulic
46. When bleeding hydraulic brake systems, which wheel cylinder would you bleed first?
- a. The one closest to the master cylinder
b. The one farthest from the master cylinder
c. The right front
d. The left front
47. A soft, springy hydraulic brake-pedal action indicates
- a. excessive hydraulic fluid.
b. worn brake linings.
c. air in the system.
d. low air pressure.
48. What is one of the principal problems encountered in an airbrake system?
- a. Underlubrication
b. Overlubrication
c. Excessive air pressure
d. Condensation
49. Adjustments to compensate for normal operating clutch lining wear are generally made at the
- a. operating control lever.
b. dead end of the band.
c. live end of the band.
d. compensator spring.

Total Points: 49

* * *

Chapter 3

EARTHMOVING FUNDAMENTALS

3-1. INTRODUCTION

Roads, airfields, buildings, bunkers, and other types of construction projects must be built within definite limits of grade and alignment. Irregularities of the ground must be removed or lessened by cutting off the high spots and filling the low places. In the construction of gun emplacements and storage areas below ground level, the excavated material is often used to form parapets around the perimeter. This cutting and filling is known as earthmoving or earthwork. Before earthmoving begins, it is often necessary to remove overgrowth, boulders, and other obstructions. It is sometimes necessary to construct a drainage system so that construction can proceed with little interference from adverse weather. These operations are performed with the most suitable item of engineer equipment available for the job. Because most of the Marine Corps engineer equipment was designed to perform more than one type job, it is seldom necessary to improvise in order to do a specific job. The required machine may not be at the job site at the particular time when needed, but with the mobile equipment available it can be requested and arrive there in a reasonable length of time. In most engineer construction, especially during combat, time is of the utmost importance. Therefore, time must be considered when requesting the proper machine or improvising with the equipment on hand.

3-2. OPERATOR EFFICIENCY

a. General. There is more to earthwork operations than just moving the earth. Knowing what the finished job will be, reading stakes correctly, hauling full loads, knowing the terrain and type of earth being moved, and knowing your equipment, are important factors that will help you to move earth efficiently.

b. Knowing your equipment. In order to become an efficient operator, you must know your equipment, its limitations, and its operating characteristics. You should know what jobs it was designed to do and for what jobs it can be used as an expedient. After having operated equipment for a while, you will be able to tell whether you have picked up a full load, and whether or not you are losing it. You will know when you are digging too deeply, and when you are cutting smoothly. You will learn to depend upon your sense of feel and on the sound of the engine in controlling your equipment. No matter what the equipment, knowing its characteristics will help you to become a good operator.

c. Knowledge of terrain. Get off the machine and study the terrain and the type of job that is to be performed. Locate the large boulders, stumps, soft spots, or other obstacles that could slow the operation. Learn the location of friendly forces and what type of enemy action is to be expected. Decide or find out what you are to do in case of enemy action while you are performing the job. Check the lay of the land (topography) and decide which would be the best direction to move the earth. Your equipment will produce more when moving the load downhill. However, there may be some slopes or areas where the load must be moved uphill for safety reasons or because of the enemy situation. In some cases, the earth removed from one site may be needed to fill an area at another place nearby. Determine how the job can be done in the least amount of time, maintaining as much of the natural camouflage as possible.

d. Reading stakes correctly. You must know what each grade stake means and read it correctly. If the marking on a stake is not clear because of mud or dirt, do not guess at it, but get down from your equipment and check the stake. If you should knock a grade stake down or if it has been moved by others, contact the surveyors to have it put back in place. Don't try to guess what is on a grade stake or where it should be. Move to another area if possible until the stake is replaced or stop work until it is replaced. In the long run, this checking will save you extra work.

e. Taking full loads. When you are moving earth, take a full, heaped load and make it count. In earthmoving operations, travel can be one of the most time-consuming factors. Suppose you are operating a tractor-drawn, 8-cubic-yard scraper. It will carry about a 10-cubic-yard heaped load (fig 3-1). If you carry only a struck (level) load of 8 cubic yards, you lose 2 cubic yards of load each trip. To move 40 cubic yards takes five trips, hauling 8 cubic yards each time. Hauling full heaped loads, you could move the same amount of earth in four trips.



Fig 3-1: Heaped load.

f. Knowing the finished job. Before beginning an earthmoving job, you should visualize its purpose and how it will appear when finished; otherwise, you will be proceeding without a plan and working without an aim. To help you visualize how a finished road or airfield will look, you will have grade stakes (discussed later) to serve as guides. Often, a rough sketch or blueprint of the job will be available, or you may find it helpful to prepare a rough sketch of your own to help visualize the job (fig 3-2). Such a sketch should show which sections are to be cut, which are to be filled, and the level of the finished job in comparison with the terrain at the beginning of the operation. Learn to estimate height and distance. This will help to visualize how the job will look when it is finished. It will also aid in locating grade stakes, markers, and the grade you have cut. For example, if you are to cut a pit 50 ft long and 4 ft deep, you should know about when the length and depth is right without having to get off and measure. You should be able to estimate how deep you must cut for what distance to get a full load. If a grade stake calls for .5 ft cut, you should be able to estimate a 6 in. cut and be close when the surveyors check the job. The more experience you have, the closer you can grade to the desired level, but you should be able to grade to within 2 in. on a 100 ft square area by estimating from grade stakes. In other words, the 100 ft square area should not have a place that is more than 2 in. from being level.

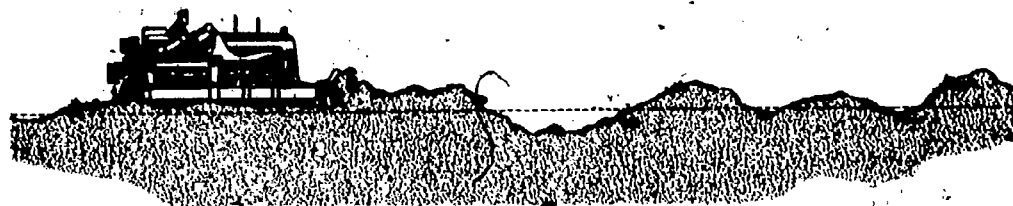

Fig 3-2. Sketch of a proposed road.

3-3. CONSTRUCTION SEQUENCE

a. Introduction. As mentioned before, there is more to earthwork operations than merely moving earth. Experience has proven that certain jobs must be performed before others can proceed. Some jobs can also be performed at the same time and in some cases a job may be left out of the sequence. Clearing, grubbing, stripping, pioneering, and establishing a drainage system are parts of the job which are usually completed before cutting and filling begin. These operations are discussed in the following paragraphs.

b. Clearing and grubbing.

(1) Clearing.

- (a) Definition. Clearing is ridding an area of trees, brush, vegetation, and rubbish, and disposing of all these materials. Climate, terrain, and soil conditions will affect clearing procedures and operations. Clearing may be best accomplished by pushing uprooted trees, stumps, and brush in both directions from the center of the area to be cleared. Clearing should be done so that debris (spoil material) is placed in a designated spot with only ONE handling. When clearing landing strips, for example, it is

generally necessary to dispose of material along each side of the strip outside the construction site. If the site is located where burning may be done, the haul distance can be reduced by piling brush, stumps, and trees on the site and burning them there.

- (b) Equipment used. In addition to the handtools used mostly by the combat engineer personnel (MOS 1371), tractors and their attachments or towed equipment are very effective in clearing operations. The 82-30M has a shear blade which can be attached in the dozer blade position to cut large trees. It will shear trees at the level desired, but is best used to cut them at ground level so that the stump does not interfere with other operations. The hydraulic ripper attachment can be used to cut the roots of trees and stumps so that they can be pushed over with the dozer blade and towed away. Demolitions, when properly employed, can be used to cut trees and remove the stumps so that they can be pushed or towed away. Boulders can sometimes be removed by the scraper, but the crawler-tractor and the rooter are normally used for clearing an area.
- (c) Procedures.
1. Time can be saved by concentrating first on large trees. Very large trees may require blasting to break the roots. As large trees are pushed away, they will carry with them smaller trees, brush, and grass. Trees should be felled in a predetermined order to prevent them from lodging against one another and thus causing a difficult removal problem. Felling and removing trees with a bulldozer requires precautions to avoid injury to persons and damage to equipment. You should take special care when removing dead trees. Although their weakened roots allow easier removal than green trees, dead trees are more dangerous to remove. Dead limbs may snap off and strike you, resulting in severe injury. A large dead tree could fall with a force strong enough to upset your tractor.
 2. Uprooting trees near pavements and structures is a harder job. To prevent structural damage, first dig trenches around the trees and chop the roots away with hand implements. Uprooting may be easier if the trees are killed some time before the uprooting operation by girdling (cutting deeply through the outer bark), poisoning, or burning.
 3. The shear blade is similar to the angledozer except that the leading edge has a long point on it and the cutting edge is almost level. The operator drives the point into large trees and shears them off a little at a time. For smaller trees, when tractor power and traction are sufficient, the tree is contacted just to the side of the point and sheared off.

(2) Grubbing.

- (a) Definition. Grubbing is the uprooting and removal of roots, stumps, and boulders. This operation is sometimes performed at the same time clearing is being performed, especially if the trees are uprooted rather than cut.
- (b) Equipment used. There are several methods used for grubbing stumps; some which you will perform and others which will be performed by combat engineer personnel or other personnel working at the job. You, as the engineer equipment operator, can perform most of the grubbing work more rapidly with the crawler tractor and its attachments. The dozer blade, the winch, and the ripper attachment can be used for grubbing. Stumps which are difficult or impossible to pull out, even with winches, should be burned or blasted. The amount of time allotted to complete the job will determine the method used if the job cannot be done with the equipment.
- (c) Procedures. The hydraulic ripper attachment is used to cut the roots around a stump and it may be possible to split large stumps with it. Once the roots have been cut, dig the blade under the stump and as you push forward, raise the blade to roll the stump up and out. It may be necessary to dig around the stump before pushing and prying it out. Boulders are dug around and pushed and pried out. After the stump or boulder has been removed, the hole should be filled in so that it will not slow the operations to follow. When the stumps and boulders are left in place, it will not be possible to grade below the ground surface. Stumps will rot over a period of years

and the surface can settle if they are not removed. The person in charge of the project will decide whether to leave the stumps or not. He will also determine if they are to be blasted or burned if they cannot be removed by machine.

c. Stripping.

- (1) Definition. Stripping is the removal of objectionable top soil, sod, rocks, and any hard substances embedded in the ground prior to excavation (fig 3-3). Stripping may either follow or be done together with clearing and grubbing. Actual earthmoving begins with stripping; surface soil and rocks are removed from the area to be excavated. Deeply embedded rocks and large boulders may have to be blasted before they can be removed. The material removed by stripping is called spoil. Unless otherwise directed, you should dump spoil along the area to be excavated, within range of the earthmoving equipment. If the spoil will not be put to use, such as turbing or finishing a road or runway, it should be wasted along the edges of the project or in stockpiles depending on the situation.
- (2) Equipment used. The equipment used most in stripping is the dozer. The use of dozers in removing trees was mentioned above. If the haul distance is over 300 feet, it is more efficient to strip with a scraper. A scraper may be used also on fine soils where shallow stripping is desired. A motor grader is used mainly for shaping and finishing a stripped surface. It is adaptable also for ditching, for sidecasting, and for sloping banks. Grading and related operations will be described in connection with drainage systems later.
- (3) Procedures. When you check the job and terrain, you should learn where the spoil is to be disposed of. Remember that its location may affect the camouflage plan. Most military construction will be performed on foreign soil and you should practice now in stripping and disposing of the spoil without damaging the usefulness of any more of an area than is absolutely necessary. Unless necessary, you would not dump the spoil from a road site on some farmer's crops. However, the mission may dictate that you do the job as quickly as possible. A dozer or scraper is usually used to cut to a depth that will remove the objectional material and then push it to the desired location. An angled dozer may be used to windrow the material along the sides of a road clearing so that it can be used later on road shoulders. The depth of the material and the width of the area will determine the method to use and the number of passes required. For example, the method illustrated in figure 3-3 may be the fastest method to use for a particular type job, but if the material was to be hauled for long distances, it should be stockpiled and a scoop loader and trucks or scrapers should be used. The Drott 4-in-1 can be used to cut and load on trucks or to load from stockpiles.

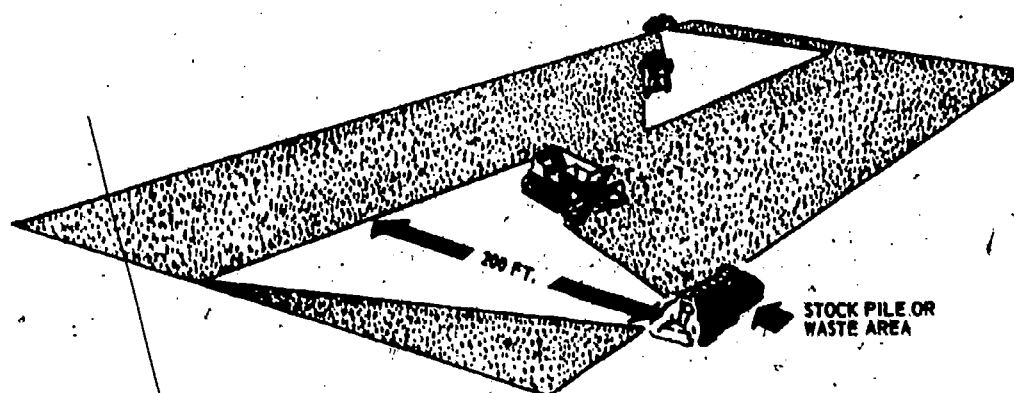

Fig 3-3. Stripping.

d. Pioneering.

(1) Introduction. Pioneering means the first working over of an area that is overgrown or rough. In pioneering, the operations of clearing, stripping, grading, and providing for drainage are all done practically at the same time rather than as separate operations. A dozer starts out along a predetermined route and leaves a road behind it. This may be a haul road, on which trucks and equipment will move in later operations. In some mountain road pioneering, a crane shovel may be used to dig and cast material over the side.

(2) Procedures.

(a) Suppose you, as a dozer operator, are given the job of cutting a road on the side of a mountain to be used for access to a proposed airstrip site, or to reach a mountain stream which is to be developed into a water supply system. Where should you start and how should you proceed? The route your mountain road is to follow will be staked out by the survey party. You should start your road at the highest point possible. First, clear the stretch of ground immediately in front of you then cut out the earth to give your tractor a firm footing. When you make this cut, start it into the mountain (fig 3-4) and follow this same plan on the rest of the road.

(b) In clearing on sidehill cuts, brush and trees should be cast far enough to the side of the road site so that they will not be covered with the earth. It is even better if you can cast them over the edge when the road is cut. When you are cutting the road, do not watch the grade stake immediately ahead of you or you will find yourself below grade. Instead, watch the third or fourth stake down. It is better to be above grade and come back and cut down to grade than it is to be below grade and have to come back and fill. A sidehill cut is one of the places where it is more efficient to move part of a load rather than attempting to take a full load. Take only part of a load and cut it out over the bank. If you attempt to take a full load, you will soon find you have a bank of earth in front, and are working uphill. Another reason for taking only part of a load is that it is easier to control the tractor and cast over the bank with a partial load than with a full load.



Fig 3-4. Start your road right.

e. Drainage systems. A drainage system is a network of ditches, culverts, bridges, and other devices used to remove the water from an area.

(1) Purpose. The purpose of a drainage system is to remove all water from operating areas, to intercept and dispose of surface water from adjoining areas, and to intercept and remove detrimental rain or ground water seepage. The areas where construction is to be performed must have a system of removing rainfall, water that may be trapped in low areas, or water below the surface that may interfere with construction progress. Properly designed and constructed drainage systems are one of the most important parts of a construction project, particularly airstrips, revetted supply dumps (especially ammo),

and campsite construction. Without proper drainage, rain and water running off surrounding ground would turn the area into a lake. Water that would soak the subgrade or seep into bunker complexes must also be drained off. In certain areas, water below the surface will freeze in the winter causing frost action or erosion which will weaken the surface during the summer rainy season. With a properly designed drainage system, this rainfall and other water can be controlled and diverted to an area that will prevent construction delays or destruction of the construction which has been completed.

- (2) **Types.** There are three main types of water that hinder construction operations (fig 3-5): rainfall, surface, and subsurface. The amount of rainfall is different throughout the world. Some areas such as Vietnam receive several inches of rain in a very short period of time during certain seasons (the monsoon season). Other parts of the world, such as Vieques, Puerto Rico, receive a little rain almost every day. This is water that falls directly on the project site. Surface water can be from many sources. Most of the surface water that will effect you and your equipment operation will be that which is trapped in low areas after a heavy rain, rivers and streams, runoff from surrounding hills after a rain or when snow from the mountains is melting, and swamps or irrigated farm land such as the rice paddies in some Asian countries. Water from these sources can flood an area in a short period of time. Ground surfaces in areas that are flooded will not support the weight of your equipment. Subsurface water is the last type that will probably affect the construction and it is the hardest to control. It lies below the surface at different depths and is referred to as the water table. In some parts of the world it rises to the surface as a spring. There are some places where the water table is very close to the surface. For example you may dig a storage pit six feet deep along the coastal area of an Asian country and return a few days later to find it half full of water. In these areas, it is best to avoid cutting. The water problem will be considered by those persons drawing up the plans, but you, the operator, must know how to follow their plan for controlling it. Where possible, planners will avoid performing extensive construction in areas where water will be a great problem. However, combat situations may dictate some construction regardless of the water problem. The planners then must design some type of drainage system which will reduce the problem. This can be accomplished by diversion ditches, outfall ditches, sloping, culverts, and subsurface drains. Figure 3-6 illustrates some of the ways that water can be controlled.



A
RAINFALL

Fig 3-5. Types of water that can hinder construction.

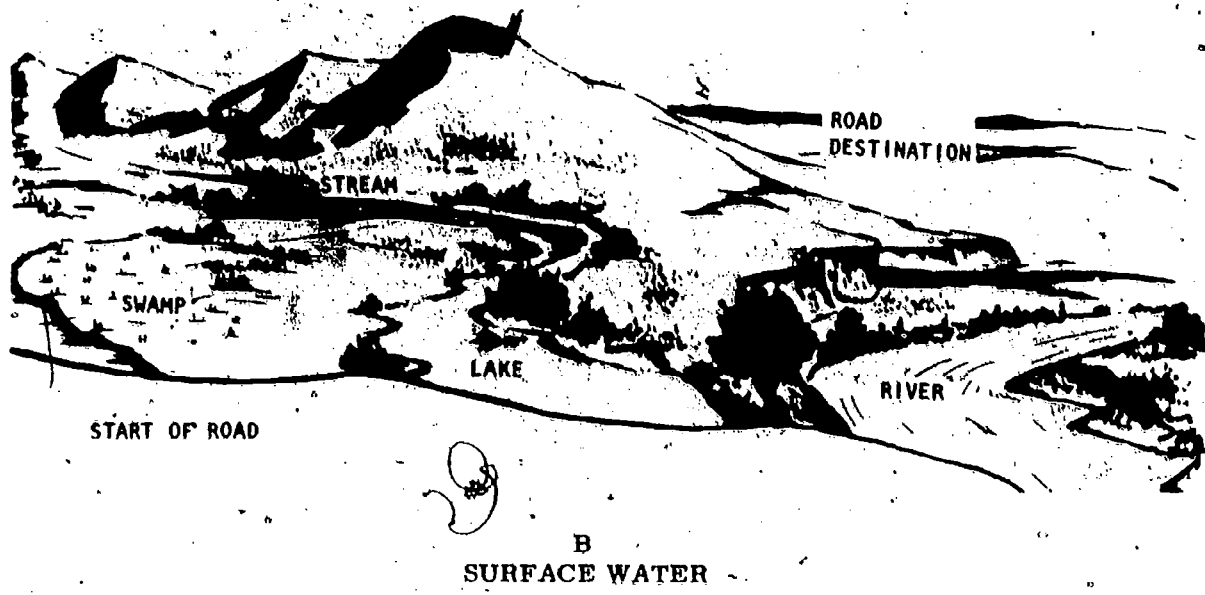
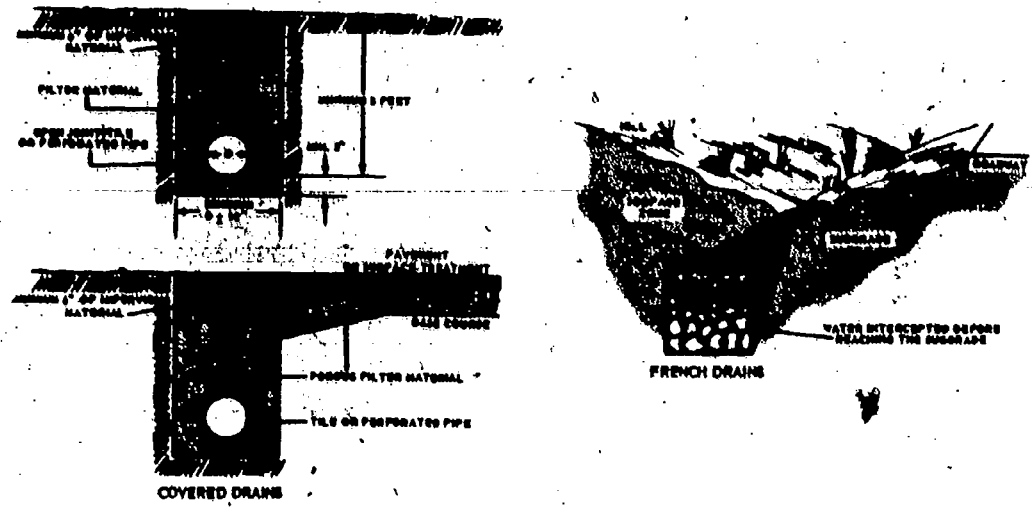

Fig 3-5. -- Contd

- (a) Ditches. This is the primary method that you will be concerned with. You may or may not be told when and where to dig a ditch. You may need authorization to dig a ditch because of the time required to construct the drainage or because of the location and the damage it would do to surrounding property. However, a drainage ditch should be recommended when water is hindering the progress of the construction project. Ditches are dug along the sides of a road so that the water will run toward a culvert and into a stream, canal, or lake away from the road. Ditches are also dug on hill-sides to divert water running off the hill toward a project site to prevent it getting close enough to the construction to slow the progress or damage the construction. A tractor with an angledoxer is a good item of equipment for constructing ditches at the beginning of construction. Bulldozers can be used to dig a ditch, but it is harder to control the depth and location of the ditch than with an angledoxer. To start a V ditch with a bulldozer, dig a trench or drive one track of the tractor on a log or some other high surface so that the opposite corner of the blade will start digging into the ground. Once the ditch is started keep one track in the ditch and one on the high ground. For diversion ditches around the side of a hill cast the dirt toward the low ground so that the runoff won't wash it back into the ditch and keep it from doing its job. Towed scrapers can also be used to dig V ditches by starting them in the same manner as starting with a bulldozer. When constructing ditches, it is very important that they will not interfere with future construction operation. Some may be improved for permanent drainage systems. Although V-type ditches have been discussed here, there are others which can be dug with the angledoxer, bulldozer, and with scrapers. A ditch is nothing more than a trench dug to direct the flow of water.
- (b) Sloping. Once the earthwork is started, you will always be concerned with slopes. During the cutting and filling operations, the slope must be maintained one way to assist in controlling the equipment, but the slope must be changed when securing operations, in order to control any water problems that may arise. For example, the center of a fill area is slightly lower during filling operations so that the scrapers and tractors will not slide over the side, but the center is filled in at securing time and slightly crowned to prevent water settling in the low area if it should rain at night. Ditches are also sloped so that water falling into them does not form pools and so that the water running through the ditch does not run so fast that it cuts the ditch deeper. Cuts around a hillside are sloped toward the high side so that the water will run back toward the hill. This prevents the fill material on the low side of the hill from being washed away. However, the cut and the fill are sloped along the long axis so that the water will not collect on the low side of the cut (high side of the hill). One thing to remember about sloping is that the steeper the slope, the greater the possibility of erosion (earth washing away). A gentle slope will slow the flow rate and give the water a chance to soak into the ground. Soaking can produce undesirable affects depending on the type soil you are working with. Figure 3-6B illustrates how a slope is used to remove the water from an airfield into a ditch or through a culvert.
- (c) Subsurface drains. As an equipment operator you will construct surface drains (slopes and ditches) and you may be called on to help put in subsurface drains. These are drainage systems that are put in below the surface to control the water.
1. Culverts. Culverts are the type of subsurface drain normally used in military construction. They are used to transfer the water from one side of a road or airfield to another. For example, water drained toward the high side of a hill into a ditch around the hill may require some method of crossing the cut and fill area to be disposed of. A culvert can be installed at the lowest point to drain the water from the ditch to the low side of the hill far enough away from the fill to prevent damage to the roadway. Culverts are usually constructed from pipe (iron, concrete, etc), wood, or oil drums which are placed in trenches across the fill or cut and covered with fill material. They usually receive the water from an open drain (ditch or slope) and dispose of it into another open drain on the opposite side of the fill or cut. You and your equipment will normally be used to prepare the trench for the culvert, and backfill to cover the culvert. The bulldozer and the Drott 4-in-1 attachments are the best suited equipment for performing these operations. The scoop loader and other equipment can be used, but the two mentioned above are the best of the type equipment to which you will be assigned. Here again the depth of the trench and the slope of the trench are very important. If the trench is too shallow, the water may seep under the culvert and erode the area. If the slope of the culvert is too steep,

the water running through it will flow out the low end with enough force to erode the soil which may cause damage to the project. There are other types of covered drains similar to the culvert to carry the water over long distances, but they are seldom used in military construction.

2. **Covered drains.** Figure 3-6A illustrates some of the covered drains which you may be called on to dig trenches for. French drains may be used in camp sites, for air-field drainage, and for removing subsurface water. Storm drains like those used in the built up areas in the United States are also considered to be covered drains. Water flows down the slope of a street or other surface, falls into a pit or trap and is drained off through large underground pipes. This system is used mostly for permanent installations. The trenches for their construction are usually dug by trenchers, crane-shovels and attachments, or other equipment not normally assigned to operators with your rank and experience. However, tractors and scrapers can be used for clearing the right-of-way and for digging very large trenches. The equipment normally assigned to you will be used to backfill the drain.



A
Typical sections of covered and French drains.

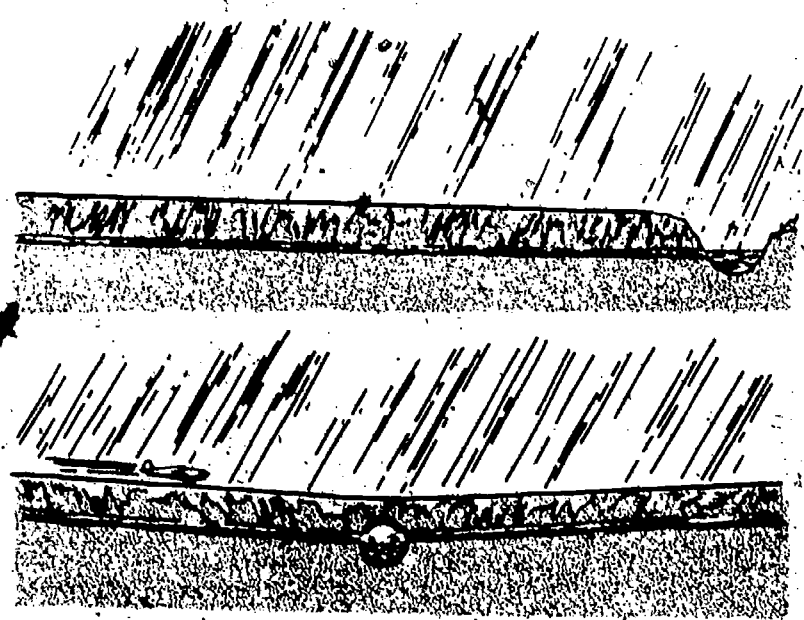

B
Longitudinal drainage of runways.

Fig 3-6: Types of drains.

- (3) Establishing drains. The proper consideration of drainage during all phases of the construction will often eliminate costly delays and possible construction failures due to saturated subgrades. It is impossible to prescribe set rules for installing a drainage system. However, some drainage should be established or considered before clearing and grubbing begins. Equipment and personnel are not as proficient when working in water as they are when working on dry ground. Whenever possible use the existing drainage and improve it if necessary. For example, if you are to construct an airfield that has a pond in the middle of it or a small stream that crosses it, they must be drained or rerouted. You can drain the pond or a swampy area by trenching or ditching along the route that the overflow normally takes. A stream can be diverted toward the lower side of the proposed airfield. Some of the ditching and trenching may be of a temporary nature; just to dry the area so that it can be prepared for earthwork construction. The installation of culverts, permanent ditches, and French drains or other drainage systems is usually accomplished during the rough grading. For example, you know from the plans that a culvert will be installed between two hills; the culvert should be put in place after the fill material has been placed deep enough that the weight of the equipment will not damage it as the fill operations continue. However, you would not dig the trench and install a culvert for a hillside cut until the surface was cut down to grade level. So plan to use existing drains if they are adequate or to construct temporary drainage at the beginning of the project, and maintain and improve them as the project progresses or until the permanent drains are installed.

f. Grading and excavating. After the area is cleared, stripped, and a drainage system established, the job is to cut the high points to grade and to fill in the low points. In cutting down the high spots, enough suitable fill material may be removed to fill the low spots. However, it may be necessary to develop other sources of fill material. If it is necessary to borrow fill material, usually a shovel or scooploader is used to dig up the material, and dump trucks or dump wagons are used to haul it to the fill point. If the site is on hard and rocky terrain, it will be necessary to loosen and break the soil by using the ripper attachment. Dozers will handle all short-haul (up to 300 feet) excavations. For hauls of 300 to 1,500 feet, crawler-type tractors and scrapers are more efficient. For longer hauls, trucks and shovels or motorized scrapers are used. Before fill material can be placed in low spots, a suitable foundation must be prepared. It may be necessary to place fill on a side of the hill, therefore suitable benches are cut before the fill is placed. Drainage must be provided under the fill. In general, all fills are built up in compacted layers. In construction work, these layers are called lifts. These lifts are from 6 to 12 inches high, depending upon compaction necessary and the material used for the fill. In constructing a fill, each lift is spread by dozer or scraper and then compacted. The fill material must have the right moisture content before it can be compacted; therefore at times it is necessary to wet the fill before it is compacted. After preliminary cutting and filling have been completed, the job is brought to final grade by motor graders. Further smoothing and compacting are obtained by using smooth rollers.

3-4. GRADE STAKES

a. Introduction. Grade stakes are the guides and markers used in earthwork operations; they mark the alignment, the limits, and the dimensions of the project. They are usually a piece of 1 x 3 in. lumber, 2 or more feet long, set in place by a surveyor. Since you will use the grade stake as guides in earthmoving operations, you must be able to identify, read, and interpret the markings. At the beginning of the project and for some hasty construction, you may have only the centerline stakes and possibly the slope and offset stakes to guide you. These will tell you the width, length, and direction of the area to be cleared. They may or may not be marked with cut and fill markings. In addition to the 1 x 3 in. lumber used to mark the project, small trees may be blazed or color coded to indicate the centerline and other stakes. After clearing, grubbing, and stripping, the grade stakes with cut, fill, and other marks will be set by the surveyors if the project warrants. Understanding stake markings will help you take the proper amounts of cut and fill to bring the ground to the desired level. You must be able to estimate the amount of cut or fill and the distance in relation to the grade stakes to keep from having to move the earth twice. For example, if you cut too deep, dirt will have to be hauled in to fill that area to the proper level. It is better to leave it too high than to cut it too low. Once the surveyor has set the grade stakes they must be kept in good condition until they have served their purpose. Running over them or knocking them down will only delay the project completion and cause extra work for the survey crew. Work around the stakes until you are down to the desired grade and then remove the earth surrounding the stake. If a grade stake is accidentally moved, don't try to guess where it is supposed to go or the depth that it was driven; let a surveyor reset the stake. There are other grade stakes of sizes different from those discussed above, but they are for the

surveyor's use or the final grade stakes used to guide the more experienced operators who will perform the final grading.

b. Centerline grade stakes. You must be able to read the station markings and the cut and fill directions on grade stakes. In surveying, the term "station" means points at which definite measurements are made. You need not be concerned too much with the station markings, but if your foreman should send you out to station 6+50 to do some work, you should know how the stations are numbered in order to go in the right direction. Station numbers are marked on the front of each centerline stake.

(1) Station numbers.

- (a) Let's look at the stakes on the centerline of a roadbuilding job. The starting point is the first station in the survey; this station is numbered 0+00. The next station is normally 100 feet farther and is marked 1+00; the third station is another 100 feet farther and is marked 2+00; and so on. On sharp curves or on rough ground the stakes may be closer together (fig 3-7). If a station is located 50 feet farther along than station 3+00, it is marked 3+50. After the survey has gone 1,000 feet, the station markings will read 10+00, 11+00, and so forth; the station markings face the starting point. The mark ∇ , which is also on the side facing the starting point, is used to indicate that the stake is a centerline stake.
- (b) A cut is designated by the letter C, and a fill is indicated by the letter F. Numerals follow the letters to indicate the amount that the grade should be cut or filled. Look at the back of the stake shown in figure 3-8. The letter C, of course, stands for the word "cut." The numerals 1⁵ (note that the tenths of a foot are underlined) following the dash indicate that the grade should be cut 1.5 feet below that V mark on the stake. That V is called a "crow'sfoot." The crow'sfoot mark is used in surveying so that the line is easier to see. The V may point to a line across the stake in which case the cut or fill depth is from the line. If the line is missing, the cut or fill depth is from the present ground level at that point and the point of the V is almost or touching the ground.
- (c) In earthwork, measurements are made and written by the decimal system, as used in construction engineering. Most of your markings on grade stakes will be in feet and tenths of a foot. Occasionally, finished grade stakes will be marked in hundredths of a foot. If you are in the habit of thinking in terms of feet, inches, and fractions of inches, it may be helpful to know that a tenth of a foot is approximately $1 \frac{3}{16}$ inches; or that .25 foot = 3 inches; .50 foot = 6 inches; and .75 foot = 9 inches.
- (d) The front of the stake in figure 3-8 shows the location of the station. As you can see, station is abbreviated STA. The station shown in figure 3-8 is located 550 feet from the starting point. The stake shown in figure 3-9 indicates that fill operations are to be performed at station 6+00. The letter F at the top of the stake stands for fill. The numerals 2⁷ indicate that 2.7 feet of fill are required to bring the construction up to grade. The 2.7 feet is measured from the crow'sfoot marked on the back of the stake.
- (e) Some grade stakes indicate that no cutting or filling is required. Figure 3-10, for example, shows a grade stake that is on the proper grade. The word "grade" is on the back of the stake, and the crow'sfoot is even with the ground. As with the stakes shown in figures 3-8 and 3-9, the station is marked on the front of the stake. If the three stakes shown in figures 3-8 and 3-9, and 3-10 were on the same survey construction job--a road, for instance--the contour of land to be graded might look like figure 3-11. Surveyors call this kind of contour a "centerline profile." Since the haul distance is short (50 feet between these two stations), the grading from station 5+50 to 6+50 would be a good job for a dozer.



Fig 3-7. Station markings.

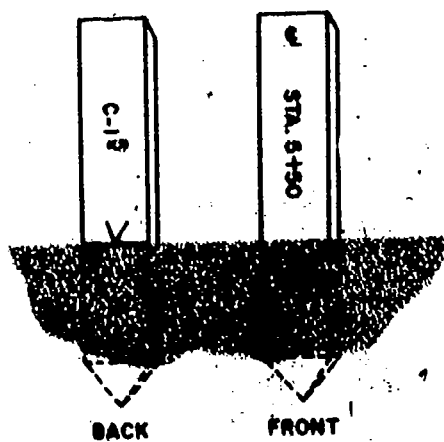

Fig 3-8. Cut stake.

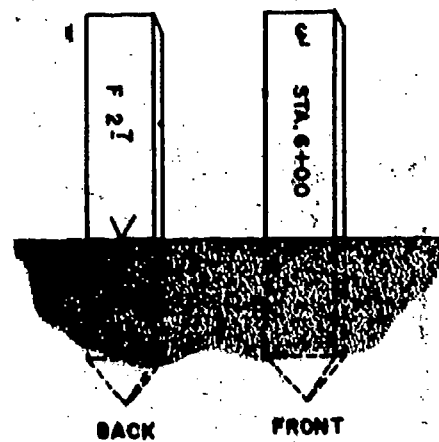

Fig 3-9. Fill stake.

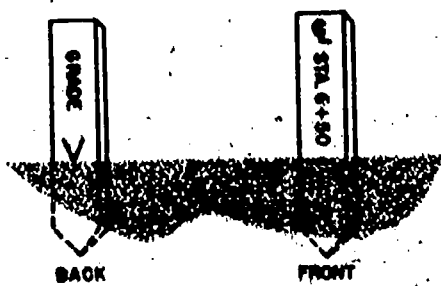

Fig 3-10. Stake on proper grade.

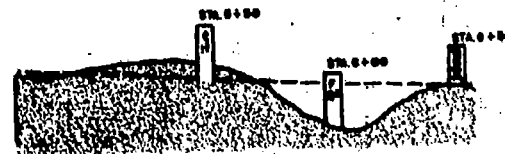

Fig 3-11. A profile of land.

(2) Example of use. Suppose the foreman told you to take your dozer out to station 5+50 and to clear and grade to station 6+50. Do you know where you are to go, what equipment you will use, and what kind of job you will be doing? The foreman wants you to go down the centerline 550 ft from the start of the project and clear and grade 100 ft to a station 650 ft from the start of the project. If the foreman has the plans or has seen the area he can tell you how wide an area you are to clear and grade; otherwise you will have to check the grade stakes after you get there. He can tell you what to do with the trees, underbrush, and spoil that you remove before starting the cut or fill operation. He has already told to take your dozer; the item of equipment to which you are assigned. When you get to the starting point (station 5+50), get off the tractor and locate the stakes and check their markings for the complete area that you are to work in. Also check the ground for any obstacles that may cause an accident or slow the output of your equipment. You will be working alone and a falling limb from a dead tree could hurt you badly, or a soft spot in the ground may cause you to get your tractor stuck; both would prevent you from completing the job in the time allotted. After you have checked the area thoroughly and also the markings on the grade stakes, visualize what the finished job will look like. The area may look like that illustrated in figure 3-7 when you start, but the particular area that you are to grade will be level when finished. The grade stake at station 6+50 may be marked for a cut of 1.5 ft the width of the area; station 6+00 may be marked for a cut of 2.7 ft on one side, 2.1 ft at the center and 1.5 ft on the other side of the area; station 6+50 may be marked for a fill of 1.5 ft. After you have cleared and stripped the area, you would cut the high area where it was marked cut, and you would fill in the low area marked fill. Any excess fill material would be saved and used in other areas along the project or disposed of as directed. The 100-ft strip would be cut and filled to the grade specified on the grade stakes. The grade markings may leave the area level or it may be sloped from side to side or lengthways.

c. Shoulder stakes. Shoulder stakes mark the outer edges of the shoulders (fig 3-12). They are set at right angles to the centerline on the shoulder line. Shoulder stakes are set with the board side facing the centerline of the road. The same station numbers are placed on the back of shoulder stakes as are on the centerline stakes. The amount of cut or fill is marked on the side of the shoulder stake facing the centerline; this mark represents the amount of cut or fill at that location in relation to the finished grade of the outside edge of the shoulder or ditch. The horizontal distance from the shoulder stake to the centerline may be placed underneath the cut or fill figure on the shoulder stake. In figure 3-12, the stakes marking the shoulder line are alignment (hub) and finished grade (blue top) stakes rather than ordinary cut and fill stakes. Hubs and blue tops are discussed later.

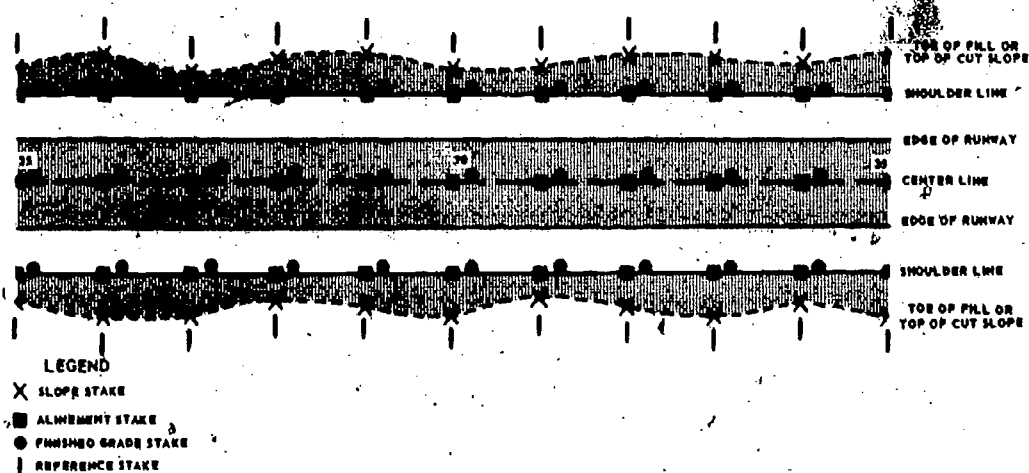

Fig 3-12. Plan view of stake placement.

d. Slope stakes. Slope stakes are set at the intersection of the planned slope with the original ground. They indicate the earthwork limits on each side of the centerline. Minimum areas to be cleared and grubbed extend outward about 6 feet from the slope stakes. Figure 3-13 shows a slope stake set on the edge of a cut. (A centerline stake, marked \ominus , is also shown.) The dotted lines indicate the outline of a cross section of a road and its banks. The slope marked on

the stake is 3 to 1. Slopes are given in ratios of horizontal distance to vertical distance. Thus, in the cut in figure 3-13, for every 3 feet that the bank is cut in the direction of the centerline of the road, the bank goes down 1 foot toward the shoulder of the road, or 3 feet horizontal for 1 foot vertical. If the same 3 to 1 slope were placed at the bottom of a fill, it would mean that for every 3 feet out from the shoulder, the height of fill should drop 1 foot below the top of the shoulder of the road. If a slope stake does not specify the slope to be carried on a bank or fill, you will slope from the edge of the construction to the point at which the stake meets the ground. Figure 3-13 shows the slope on only one side of the road at a particular point. Another slope stake will be on the opposite side of the construction site (fig 3-12). The slopes are not necessarily the same on both sides of the construction site.

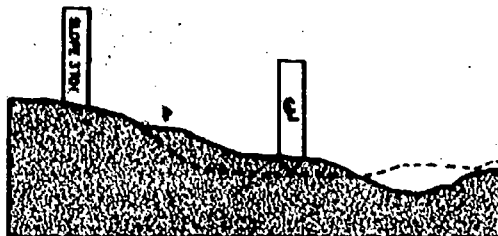

Fig 3-13. Slope stake.

e. Offset stakes. Grade stakes that are set out of the way of the excavation are called offset stakes (fig 3-14). The markings on an offset stake identify the distance of the stake from the centerline of the construction and the cut or fill data to finish centerline grade. In figure 3-14, for example, the markings on the stake indicate that the stake is offset (OF), that the stake is 40 feet from the centerline of construction and that the area directly in line with the stake, inside the construction area, is to be cut 2 feet. During earthmoving operations, center stakes may be dug out or covered up; offset stakes may be used as reference control points in reestablishing the centerline of the construction. They are also used to indicate the banked portion of a curve which lies above the regular grade.

f. Finish grade stakes. The more experienced operators will normally do the final grading. They are likely to work with stakes called blue tops. These stakes are driven into the ground until the top is at the exact elevation of the finished grade, as determined by the surveying crew. When the top of the stake is at the desired finish grade elevation, it is colored with blue lumber crayon to identify it as a finish grade stake. (Other colors may be used, but blue is the usual color.) Stakes colored in this manner are for finish grade only.

g. Hub and guard stakes. A hub or hub stake (fig 3-15) is placed to show the exact location of survey line and station. The stake is driven even with the ground, and a tack is driven into the top to help the surveying crew in alinement work. A guard stake may be placed near the hub stake to help identify the hub and to protect it. Station identification is placed on the face of the guard stake.

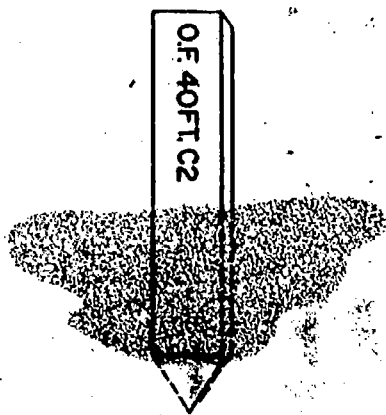

Fig 3-14. Offset stake.

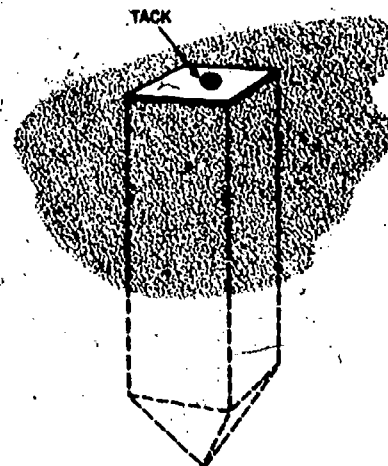

Fig 3-15. Hub stake.

h. Reading stakes properly. As mentioned earlier, reading stakes correctly is one step in doing an efficient job of grading. Failure to read a stake correctly can cause you extra work and delay an entire job. If you see a stake that does not mean anything to you, or if you are in doubt about the markings on a stake, do not go ahead blindly; stop and get squared away. If necessary, ask the foreman in charge of the job for instructions. Figures 3-12 and 3-16 show a cross section of construction work (which could be either a road or an airfield) with stakes and markings. Study these illustrations carefully; they show the placement of the main types of stakes discussed in this section.

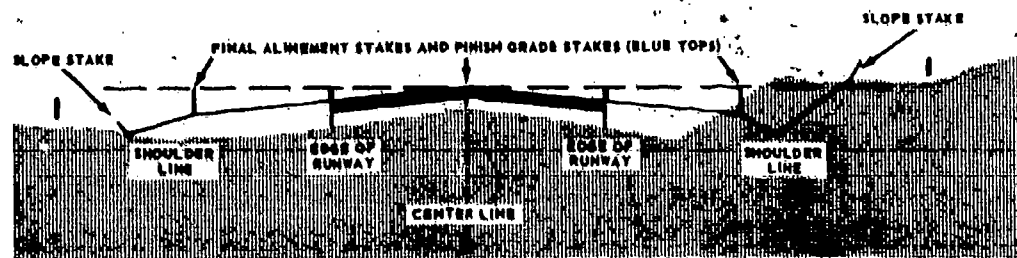

Fig 3-16. Cross section of runway showing stakes and markings.

i. Working around grade stakes. All of the stakes discussed in this part of the course are set by the surveyor so that the operators and the rest of the construction crew can build a road, airfield, or some other project to grade specifications. They should not be disturbed until the earth around them is to the specified grade level. It is your duty to keep from running over the stakes, pushing them out of place, or allowing the earth falling into a fill area to knock them over or out of alignment. If one of these things happens, work on that part of the project must be stopped until the survey crew can come out and reset the stake. After the surrounding area has been cut or filled to grade, the earth where the grade stake is can be cut away to the same level. Notice how civilian contractors seem to leave little mounds of dirt in spots where tractors and scrapers are working. Those little mounds are where the grade stakes are located.

j. Judging distance. For many years man has relied on his eyes for judging distance. He goes hunting and estimates the distance from him to his target before shooting. He will plan a trip and estimate the distance. You, as an equipment operator, will be more efficient if you learn to judge distance at close and long ranges. You must be able to estimate both horizontal and vertical distances. After you learn to estimate these distances with a fair amount of accuracy, you will begin to get more production from your equipment during earthwork operations. To help you to learn to estimate, stick a yardstick in the ground near the corner of your dozer blade and notice how far and how fast the blade moves up and down. Perhaps by just bumping the control lever, the blade will raise 1 in., or it may take 2 seconds for the blade to raise 2 in. when operating at an rpm similar to that of a fully loaded tractor. Make what you judge to be a 2 in. cut across an area, then lay a board over the cut and measure the depth. Don't expect to be perfect every time or to be an expert in a short time. There are many jobs that you will perform that will not have grade stakes and you can save yourself time by being able to make a good estimate. You can judge long distance by knowing the speed of your equipment and the traveling time.

3-5. SOIL

a. General. Since you are going to be working with earth and earthmoving equipment, you should know something about the material you are to handle. The study of earth or soil is termed soil engineering or soil mechanics. It is a complicated subject, but for your purpose it is not necessary to go into it in great detail. For identification and classification purposes, all soil can be grouped into five principal types: gravel, sand, silt (rock flour), clay, and organic soil. Each type has distinctive properties which can be identified in the field. Each type of soil also has distinct engineering characteristics. Let's take a look at the soil with which you will work.

b. Gravel. You are probably familiar with gravel. In soil terminology, any bulk mineral grain larger than 1/4 inch is classed as gravel. Gravel is made up of rocks of various sizes. As a rule, the rocks are worn smooth by water action. Next to solid bedrock, well graded and compacted gravel with enough fine material to fill the voids between the gravel is the most stable and natural foundation material. It is desirable material for base and surface courses for airfields and roads, since it is easy to drain, easy to compact, not affected greatly by moisture, and not subject to frost actions.

c. Sand. Mineral grains ranging in size from about 0.10 millimeter (mm) to 2 mm in diameter are classified as sand. (There are about 25 mm in an inch.) Well-graded angular sand is a desirable foundation material if it can be confined. It is relatively easy to compact, easy to drain, little affected by moisture, and ordinarily not affected by frost action. Confined sand provides an excellent subgrade and for this reason, it works well under landing mats. If sand is uniformly very fine, it approaches silt and has many undesirable characteristics.

d. Silt. Silt consists of mineral grains much finer than sand. These grains are between 0.002 mm and 0.05 mm in diameter. Silt is sometimes termed "rock flour." It is not plastic and does not hold together when dry. It can be distinguished from fine sand because it feels smooth, not gritty, to the touch. Silt may also be identified by making a small mud pie of it and shaking it in your hand. If the sample is silt, water will come to the surface, causing it to look glossy and soft. Squeezing the sample causes the water to disappear. Silts are treacherous, due to their instability. Slight disturbances in the presence of water (such as traffic vibrations transmitted to a wet silt subgrade) may cause them to become soft or to change into a quicksand condition. When ground water or seepage is present, silts are subject to ice accumulation and consequent heaving when exposed to frost actions. Silts are difficult to compact and difficult to drain.

e. Clay. Clay consists of particles 0.002 mm in diameter or smaller. Clays, when they have the proper moisture content, are sticky. This is their most important characteristic. If a piece of clay is kneaded with enough water to moisten it, it can be squeezed through the fingers to form a ribbon that does not break under its own weight. This test may be used to differentiate clay from silt. Clay is difficult to drain when there is ground water. It can be compacted when the moisture content is right. It varies in consistency from slippery to sticky, depending on moisture content. Hard clay is difficult to excavate and may require the use of a ripper.

f. Organic soils. Organic soils are of two types: peat soils, consisting largely of partly decomposed vegetation and finely grained mineral sediments, containing various amounts of finely divided vegetable matter. Peaty soils can be identified by visual inspection. In organic clays and silts, the organic matter is so finely divided that it cannot be detected easily. You may be able to identify organic material by the smell. Peaty and organic soils are unsatisfactory subgrades. In general, they should be removed.

g. Soil mixtures. Soils seldom exist naturally separated as gravel, sand, silt, clay, or organic material, but are found as mixtures with varying proportions of the five principal types. Each type of soil contributes its characteristics to the mixture. Some combinations make excellent subgrade, base, or surfacing materials. A very good example is a mixture of the right proportions of gravel, sand, silt, and clay. Another example is loam, a soft mixture of sand, silt, and clay. Such mixtures are sometimes found in nature. However, it is frequently necessary to combine separate soils by mixing to produce a satisfactory combination. Identification of combined soils depends upon recognition of the individual soils in the combination.

3-6. NATURAL ROAD AND AIRSTRIP MATERIAL

Most permanent roads and airstrips are surfaced with concrete or some bituminous material like asphalt. Certain other materials, however, can be used to surface roads and airstrips. These materials include coral, caliche, and decomposed granite. At an advanced base, any of these materials may be used because of the importance of using materials that are readily available. During World War II, for example, Seabees in the Pacific often used coral for construction purposes. Coral, caliche, and decomposed granite ordinarily do not require blasting. These materials can usually be loosened with ripper attachments and can be picked up with tractor-drawn scrapers, or they can be loaded into trucks with power shovels.

a. Coral. Coral consists of the skeletons of tiny sea animals which have solidified into a stony mass. It varies in color from pure white to reddish. Coral is found in the banks and the hills of Pacific and Caribbean islands. It may be excavated with a shovel, or it may be dredged from the ocean floor with a dragline or clamshell. It is excellent subgrade and surfacing material, since it is easily drained. Live coral has natural cementing properties. Hard dense coral may be crushed and mixed with bituminous binders for blacktop finishing of roads and airstrips.

b. Caliche and decomposed granite. There are a number of other good natural subgrade and surfacing materials. Among those you are most likely to find and use are caliche and decomposed granite.

- (1) Caliche is a hard, cemented soil layer located on or near the earth's surface. It does not soften when wet. Caliche is usually found in semi-arid regions like Arizona. A reddish brown material, it may be fine in texture, or it may resemble coarse grains of sand cemented together. Larger stones may be lodged in caliche. It is sometimes found on the building site, or it may be excavated from pits and banks. Like coral, caliche is easily compacted, drained, and has natural cementing properties.

- (2) Decomposed granite, as its name implies, is granite that has become soft from long weathering. In color, it varies from reddish brown to black. Like caliche, it may be found in place on some jobs. Otherwise, it is excavated from pits and banks. Decomposed granite has the same compacting and draining characteristics as caliche and coral. You may hear someone referring to "DG" in a conversation about road or airfield construction. He is talking about decomposed granite.
- (3) Learn to recognize these natural roadbuilding materials; they are hard to find. If you cut into a bank of coral, caliche, or decomposed granite, your discovery may mean valuable savings to the Marine Corps.

3-7. COMPACTED EARTH

Compaction, as used in earthwork operations, means pressing together soil particles to form a smooth, even surface. Compaction helps the soil to shed rainwater and also makes the soil more resistant to soaking up moisture from below. Coral and caliche, as well as soft soils, may be compacted. Compaction can be accomplished by rollers, pneumatic-tire units, and similar equipment, to obtain a soil surface hard and firm enough to support loads without settling or buckling. Tracked vehicles are very poor items of equipment to use for compaction. Wheeled vehicles can be used if regular compaction equipment is not available. A loaded jeep will do better for compacting than a large crawler-tractor. The tractor weight is distributed over a larger square area through the tracks than the weight of a jeep through the four wheels.

a. Compaction principles. There are no uniform procedures for compacting earth, because soil types, operating conditions, and available equipment vary from area to area. Still, there are a few principles of compaction that can be applied generally: soil particles must fit together tightly, the soil must have enough moisture content to form into a smooth surface, and the earth must be placed in layers thin enough to permit excess air and water to be expelled easily.

b. Visible signs to look for. While you need not know the tests for adequate compaction, you must learn to recognize poor surfaces. Soggy surfaces indicate the presence of excess moisture; uneven, lumpy surfaces indicate too little moisture.

3-8. MILITARY ROADS

The criteria or specifications for military roads are established to insure that the roads will be able to fulfill the purpose for which they are built. Though it is possible to construct roads with very narrow traffic lanes and with excessively steep grades, and although these roads could actually carry traffic, roads so built have a reduced capacity and are far less effective for sustained operations than one for which the specifications are within desirable bounds. A road built to adequate specifications will seldom present continuing problems of maintenance and expansion, both of which require a large expenditure of critical engineer construction effort that could be better used on new construction. It must be borne in mind that the specifications set forth in succeeding paragraphs are generally quite liberal. These criteria are based on maintaining a traffic flow of about 2,000 vehicles per day at a design speed of 25-35 mph. Tactical conditions of localized construction problems may require certain changes in the suggested criteria.

a. Structural parts of a road. Figure 3-17 illustrates a cross section of a road at a point where the construction is along the side of a hill, normally referred to as a "sidehill cut." The following discussion refers to this figure.

- (1) Cut. The term "cut" has two general meanings in road construction. It refers to an excavation through which the road passes, below the original ground level. A portion of a road can be described as a cut section, indicating that the necessary earthwork consists of earth removal below the original ground line. The left side of figure 3-17 is a cut section. Cut is also used to express the difference in elevation between the final grade line and the original ground line or the line to which construction has progressed. Thus the phrase "cut of 10 feet" would indicate that an excavation of 10 feet is required to attain final elevation.

- (2) **Fill.** A "fill" section is one at which the original ground line must be raised in order to bring the road up to final elevation. The right side of figure 3-17 is a fill section. The material used for this filling operation must conform to certain requirements of compaction and must be emplaced according to proper procedures which will give the load-bearing results required. "Fill" is also used to indicate the difference in elevation between the present ground line and desired final elevation. Fill needed to complete a road but not available from cut sections is known as "borrow".

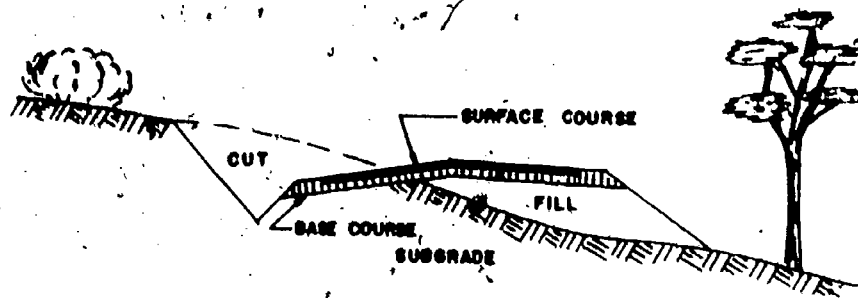

Fig 3-17. Structural parts of a road.

- (3) **Subgrade.** The subgrade is the foundation of a road and can be either the original ground or fill material placed on top of the original ground. The function of the subgrade is to support all loads that the road is required to carry. The load-bearing capacity of the soil can best be determined by appropriate tests made in the field. Certain types of soils in place already have the capability of carrying the loads applied. However, in fill sections, and in cut sections where the natural ground is inadequate for this purpose, suitable material must be emplaced and compacted to provide this strength. The depth of the subgrade depends on the type of soil present or available to be emplaced. To maintain the strength of the subgrade, adequate drainage must be provided. Final grade elevations given on a profile most commonly refer to the subgrade elevations.
- (4) **Base course.** The base course of a road consists of select materials placed in a layer over the subgrade for the purpose of distributing the load to the subgrade. Within practical limits, the thicker the base course the greater the amount of distribution. However, the thickness depends on the properties of the subgrade. When properly prepared and placed, traffic can move satisfactorily over the base course of the road. In the summer, however, and particularly in hot arid areas, the loss of moisture in the base course may result in an unpleasant dust condition. In wet weather, the porous base course absorbs much water, and deterioration may result without an adequate surface above it. Also, the pounding of heavy loads will ultimately cause disintegration of the base course, and its prolonged use as a surface is not usually recommended.
- (5) **Surface course.** The surface course provides a smooth, hard surface on which the traffic moves. It can be constructed of several types of material--asphalt or tar products, concrete, gravel, or compacted earth with certain types of binders. The surface course should be all-weather and should provide for the rapid removal of any surface water. The use of treated surface roads is economically limited to those which have a relatively long life expectancy. In general, a divisional road with a life expectancy of 6 months will require only an earth or gravel surface.
- b. **Other nomenclature and specifications.** Figure 3-18 shows a typical road section with the parts named according to standard military terminology.

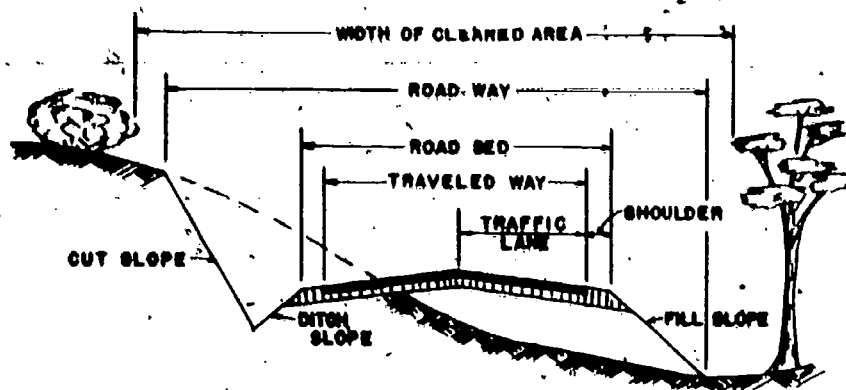

Fig 3-18. Road nomenclature.

- (1) **Traffic lane.** A traffic lane consists of that portion of the road surface over which a single line of traffic traveling in the same direction will pass. For single-lane roads where the traffic must move in one direction, the traffic lane would be at least 12 feet wide. For a multilane road, each lane should be at least 11 feet wide. Widths somewhat less than these will actually carry most military traffic, but the capacity of the road will be correspondingly decreased.
- (2) **Traveled way.** The traveled way is that portion of a road surface upon which all vehicles move or travel. For a single-lane road, the traveled way is the same as the traffic lanes. Therefore, for a 2-lane road, the traveled way will normally be 22 feet wide. If a surface course is provided, it extends only across the traveled way.
- (3) **Shoulders.** The shoulder of a road is the additional width provided beyond the traveled way. The minimum width of shoulders on a military road should be 4 feet. Shoulders have three general purposes. They provide a space for emergency parking of vehicles or for the movement of marching troops. This is particularly important for military operations and underscores the necessity for wide shoulders. They provide a gradual transition from the fairly flat surface of the traveled way to the much steeper ditch slopes, thus assisting in the removal of surface water, and because of the additional width they help prevent erosion. Finally they provide a safety zone along the edges of the traveled way. Shoulders are compacted but seldom surfaced.
- (4) **Roadbed.** The roadbed is designated as the entire width of surface on which a vehicle may stand or move. It consists of the traveled way and the shoulders. Thus, for a 1-lane road the roadbed is 20 feet wide, while for the standard 2-lane road it is 30 feet wide.
- (5) **Slopes.**
 - (a) **Classification of slopes.** There are three types of slopes referred to in road construction.
 1. **Cut slope.** Cut slope is the incline extending upward from the ditch line or bottom of the ditch to the natural ground. It is often referred to as the back slope.
 2. **Ditch slope.** The ditch slope is the slope of the ditch which extends from the outside edge of the shoulder to the bottom of the ditch. This slope would be relatively flat to avoid damage to vehicles which may drive into it and to permit the escape of vehicles which may have become trapped. It is sometimes referred to as a fore slope.

3. Fill slope. The fill slope is the incline extending from the outside edge of the shoulder to the toe or bottom of a fill. The fill slope is a type of fore slope.

(b) Function of slopes. The primary function of slopes is to provide for drainage and to prevent shifting of soil.

(c) Measurement of slopes. Slopes are commonly specified in terms of a ratio when referring to a cross section, and a percent or degree when referring to the length or alignment. These are a measure of the relative steepness of the slope. The slope ratio is expressed as the ratio of horizontal distance to vertical distance. Thus a 2:1 slope ratio (fig 3-19A) signifies that for every 2 feet horizontally there has been a rise or fall of 1 foot. The choice of the slope ratio used in construction depends almost entirely on the properties of the soil involved. Ditch slopes may also be governed by the quantity of water to be run off and the possibility of ditch erosion. Alignment slope percentage is illustrated in figure 3-19B. Degrees pertain to angle of incline from horizontal. In the absence of other criteria the following are recommended minimum slope ratios for road construction:

Cut slope	1:1
Ditch slope	3:1
Fill slope	1 1/2:1
Alignment grade	10% maximum except under extreme topographical conditions (Slopes, in rock cut, may be much steeper.)
Alignment grade	6% or less preferred.
Slope degree	Lowest maximum of vehicles for which the road is built.

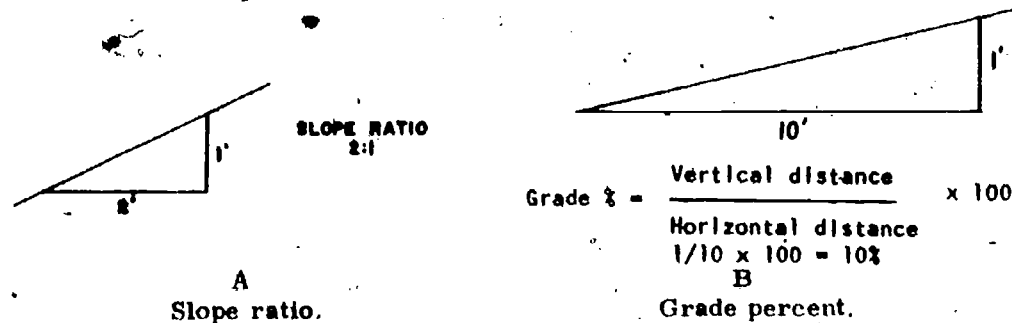

Fig 3-19. Slopes and grades.

(6) Roadway. The roadway is the entire width which lies within the limits of earthwork construction. It is measured between the outside edges of cut or fill slopes. Roadway width normally does not include interceptor ditches if these ditches fall outside of the slopes. The width of the roadway will vary from section to section depending on the height of cut or fill, depth of ditches, and slope ratios used.

(7) Ditches. Ditches are constructed at the same time as roads to provide channels for the removal of water, either surface or subsurface, from the road site. There are several types of ditches that may be constructed. Lateral side ditches carry water parallel to the road and receive water running off the surface, interceptor ditches catch water before it reaches the subgrade or road proper, and culverts provide for the movement of water from one side of a road to the other.

(8) Clearing. Clearing is the removal of such material as trees, brush, buildings, and fences from the roadway site. This must be done before earthmoving operations can begin. To provide sufficient room for construction operations, clearing is normally carried to a width of 6 feet outside the roadway on both sides of the road. This width of clearing will provide adequate construction room and will improve sight distance around horizontal curves. The total width of clearing will vary from section to section,

but will generally be 12 feet greater than the roadway width. Local conditions may require a greater width, whereas real estate limitations may force a reduction in this figure. Figure 3-20 illustrates a typical section at which the width of clearing is to be determined.

Given: Standard 2-lane military road
 Cut at construction limit..... 4 feet
 Fill at edge of shoulder..... 6 feet
 Ditch depth below shoulder..... 1 1/2 feet
 Recommended minimum slope ratios used

Find: Total width of clearing

Solution:

Traveled way $2 \times 11 = 22$ ft
 Roadbed $22 + (2 \times 4) = 30$ ft
 Horizontal distance from outside edge of right shoulder to bottom of fill
 $1 \frac{1}{2} \times 6 = 9$ ft
 Horizontal distance from outside of left shoulder to top of cut = $(1 \frac{1}{2} \times 3) +$
 $(1 \times 5 \frac{1}{2}) = 4 \frac{1}{2} + 5 \frac{1}{2} = 10$ ft
 Roadway $30 + 9 + 10 = 49$ ft
 Width of clearing $49 + (2 \times 6) = 61$ ft

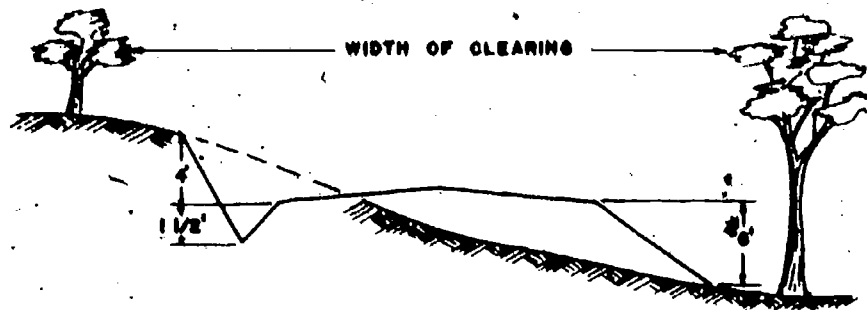

Fig 3-20. Determining width of clearing.

- (9) **Crown.** The crown of a road is the difference in elevation between the centerline and the edge of the traveled way. Crown is provided to insure the removal of rain water which falls on the road. The amount of crown provided primarily depends on the surface used. Surfaces such as concrete or bituminous materials require little crown because of their impermeability, whereas permeable (porous) surfaces such as earth or gravel require a relatively high crown. Crown is normally specified as the number of inches rise per horizontal foot measured from the edge of the surface to the centerline. For concrete and bituminous surface, the crown is normally from 1/4 to 1/2 inch per foot; for earth and gravel surfaces, from 1/2 to 3/4 inch per foot.
- (10) **Superelevation.** When traveling on a horizontal curve, vehicles have a tendency to tip over or slide toward the outer edge of the curve. This is caused by centrifugal force. The greater the speed of the vehicle and the sharper the curve, the larger this force becomes, thus increasing the hazard to safe vehicle operation. This force may be counteracted by raising the outer edge of the road to an elevation greater than the other side (fig 3-21). This difference in elevation is referred to as superelevation. Superelevation, like crown, is specified as the number of inches rise per horizontal foot. The value varies with the type of surface and with the design speed of the road. The minimum value for earth or gravel surface must be 1/2 inch per foot. Superelevated roads should be widened as well. When going around a sharp curve the back wheels of a vehicle do not necessarily follow in the tracks of the front wheels, and for this reason a greater width of traveled way is needed, as shown in figure 3-21.

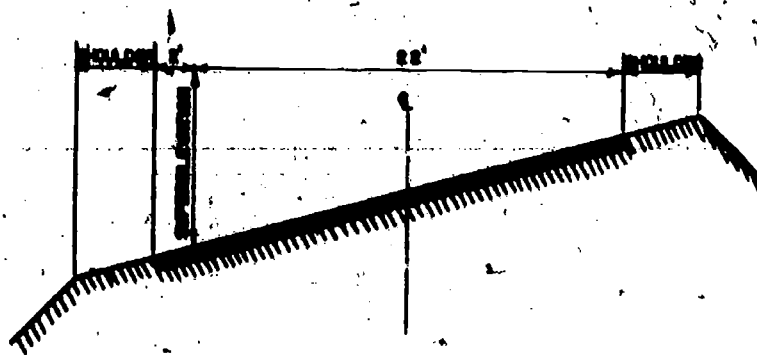

Fig 3-21. Superelevated road.

- (14) **Shoulder slopes.** The slope of the shoulder can be the same as that of the traveled way, but a little greater slope is desirable since the shoulder is more porous than the surface course. In general, it should be approximately 3/4 to 1 1/2 inches per foot.
- (12) **Overhead clearance.** A minimum clearance is specified between the road surface and any overhead construction such as a bridge or overpass. Though this is dependent upon the height of the vehicle, a minimum figure of 14 feet should be provided.
- (13) **Turnouts.** Turnouts are provided on 1-lane roads where traffic must be routed in both directions and on 2-lane roads where there is a necessity for vehicles to stop frequently. On 1-lane roads, turnouts should be provided at least every 1/4 mile to avoid excessive jamming of the road due to traffic traveling in opposite directions.

3-9. SATS AND HELICOPTER LANDING SITES

a. **General.** As an engineer equipment operator, you will also find yourself involved in the preparation of airfields and helicopter landing sites. The Marine Corps has developed a sophisticated system for handling high performance jet aircraft involving runways as short as 2000 to 3000 feet long. This is known as SATS (Short Airfield for Tactical Support). Also, because helicopters are now used a great deal, you will quite often find yourself carving out helipads and landing sites to support these aircraft. Both SATS and helipads require a bit of skill and accuracy on the part of the equipment operator.

- (1) **SATS.** The terrain in the area to be used for a SATS complex must be leveled and rolled to provide a compact matting base. Adequate drainage must be provided to remove surface and rainwater from the field area. The soil should be disturbed as little as possible in obtaining the prescribed finish in order to provide maximum bearing capacity. Any area under the matting requiring installation of service or drain pipes or other objects must be sufficiently level so that the mats will not vary more than 1/4 inch in height over a 12-foot distance. Hand raking may be required to accomplish this condition, but it is the heavy equipment that does the bulk of the preparation and achieves the tolerances that can be finished with the rake.
- (2) **Helicopter landing sites.** These are initially improved by expedient methods such as use of demolitions, handtools, and small, self-contained power equipment. Depending on the planned use and time available, helicopter landing sites may be further improved by such work as completely clearing the area of brush and trees, clearing approach lanes, improving drainage, and preparing parking areas for dispersal and camouflage of helicopters. These tasks usually fall to the equipment operator. The size of the landing sites and helipads will depend upon the tactical requirements, the number and size of helicopters to use the area, and other factors that are decided upon by the supported unit. The things that must be remembered by the equipment operator is that the slope of the helipad should not exceed 14% or 8°. Also, for pioneer helipads in particular, the surface must be clear of all debris, stumps, rocks, holes, and trenches that exceed 10 inches in height or depth. Upon further improvement, of course, these will all have to be eliminated.

3-10. COMBAT SUPPORT CONSTRUCTION

a. **General.** As an engineer equipment operator in the Marine Corps, you may serve in various combat support and service support units, and perform strictly combat-type construction in a forward battle area. Speed is the most important factor in this type of construction. When a road or a bypass around a blown-up bridge is needed, it is needed right away. Because of this, many of the fine points of more permanent rear-area earthwork are eliminated. Projects are completed in the shortest time with the least amount of earthwork that will accomplish the mission. Much of this work comes under the classification of hasty or pioneer construction. Projects are not physically laid out, but are selected by reconnaissance only. Remember, in order to complete a project satisfactorily, you must know what the finished product is supposed to look like. When you and your equipment are sent out on a job, talk to the man in charge. Find out exactly what he wants, physically check the construction area for any potential problem areas, and quickly determine the best way to do the job. Remember that you can always come back later and enlarge or improve on your pioneer construction if the unit is going to remain in one area for a considerable period of time.

b. **Roads.** There are several factors to consider during the location of any new road, even a pioneer road.

- (1) **Existing facilities.** When possible, locate along or over existing roads, or trails. The use of existing facilities shortens construction time and, in many cases, provides better roads than can be built in the short time available in combat operations. Usually it will be fairly easy to widen footpaths into suitable 1-lane roads.
- (2) **Drainage.** Locate the road on stable, easily drained soil. Avoid swamps, marshes, organic soil, and low areas which may become waterlogged during rainy weather. For good drainage, locate the road along ridges and stream lines.
- (3) **Curves.** Select a route that eliminates curves at the bottom of hills and on steep grades. Avoid curves whenever possible; if you cannot, make them as wide as possible.
- (4) **Topography.** Locate the road along natural contour lines to avoid unnecessary earthwork. Avoid rockwork. Pick an area that does not require extensive clearing.
- (5) **Miscellaneous factors.** Locate the road on the sunny (south) side of hills and canyons. Take advantage of natural concealment. In addition, the final grade should be at least 4 feet above ground (subsurface) water level.
- (6) **Future expansion.** Even when the road is made with one pass of a dozer blade, it is possible to locate it so that it can be improved, expanded, and used during future operations.

c. **Airstrips.** An airstrip for light liaison-type aircraft is generally a clear area of land, not more than 1,000 feet in length. Normally, the construction of an airstrip consists of minor clearing and leveling only. Often a suitable pasture or secondary road will be found that requires little or no construction work except possibly removing a fence or occasional tree, or leveling a ditch. Sod should be disturbed as little as possible. When too rough, cut and fill as little as possible to make the strip usable.

- (1) **Layout.** The long axis of the landing strip should lie in the general direction of the prevailing wind, if possible. The minimum runway dimensions are 1,000 feet long by 50 feet wide. The width may have to be increased when variable wind conditions exist. Temperature, altitude, slope of the ground, and wind conditions will cause the length of the strip to vary. If grass is more than 6 inches high, the length of the strip should be increased 300 feet. Do not burn grass, stubble, or brush from a possible airstrip site. Burning leaves the ground bare and causes dust, which is a flying hazard. Trees, poles, and objects at the ends of the airstrip which might interfere with landing or take-off, must be cleared.
- (2) **Grading and drainage.** Landing strips must be reasonably level and free from holes, stumps, rocks, and similar obstructions. Grading is limited to the minimum necessary for removing obstacles, smoothing humps, filling local depressions, and providing surface drainage. Drainage must be adequate or the airstrip will be useless.

- (3) **Surfaces.** The usual airstrip has a sod or earth surface. If the field is rutted, it may be smoothed by a scraper, grader, or by back-blading with a dozer. Sod provides a good wearing and easily drained surface. Care should be taken to disturb the earth as little as possible. Other forms of runway surfaces are not required except under unusual wet-weather conditions. In this case, some surfacing of low spots or soft spots with sand or gravel may be needed. Landing mat or special treatment of the surface may have to be used to provide all-weather capability to airstrips subject to inclement weather.

d. **Bypasses.** This refers to hasty roads which are built around blown up bridges, destroyed equipment, heavily mined sections of road, and antitank ditches or obstacles. An important factor to consider in any of these operations is that the enemy will usually place land mines in the most probable bypass routes. Make sure that combat engineers check the area for mines before you begin construction.

- (1) Remember, you want to get traffic moving as quickly as possible. Construct a 1-lane bypass first. You can then widen and improve the bypass after traffic begins moving.
- (2) When crossing a river, make the approaches slope gradually so that traffic will not have to slow down unnecessarily. During construction, do not try to dam the river. A ford of rock or river gravel should be constructed so that water will run over it. Do not use soft earth fill. If necessary, take gravel from the upstream and downstream sides of the ford to construct the bypass. After constructing a ford, make sure that the outer edges of it are marked.
- (3) While constructing bypasses, remember to keep drainage in mind. Construct the bypass as quickly as possible, then make sure that the area is improved and drainage provided for. A bypass that turns into a sea of mud after the first rain isn't going to help anyone. The surface of a temporary bypass can be built up with thin layers of earth. Normal road traffic can be used to compact it. It is a good idea to station a man at the bypass to instruct truckdrivers not to travel in the same wheel tracks. Nothing damages and ruts a hasty surface, particularly damp areas, more than a convoy of vehicles traveling in one path.
- (4) Remember, speed is the most important factor in combat-type construction. Choose the path that will be simplest and easiest to build, making sure that it is checked for mines.

e. **Fording.** Many times during combat operations you will have to assist vehicles in crossing a deep stream while other equipment is being used to construct a bypass. A crawler-tractor equipped with a single-drum winch is ideal for this. If the stream is narrow, the tractor can be parked on the far shore and the winch can be used to pull vehicles through the stream. If the stream is wide, the tractor can be used as a towing vehicle and continually cross and recross the stream bed. The method of conducting fording operations depends on the tactical situation and the depth and width of the stream.

f. **Beach operations.** During an amphibious landing, large numbers of engineer equipment are employed on the landing beaches to support the shore party. Cranes, dozers, and materials handling equipment will be used for general road construction, beach development, unloading-point operations, towing and salvage, and construction of sand ramps for unloading landing ships. Around-the-clock operations in salt water place a heavy demand on the individual equipment and its operator.

- (1) When constructing ramps, make sure you start pushing sand far enough away from the ship that you will not leave a depression at the edge of the ramp. Wheeled vehicles, have enough problems in soft beach sand.
- (2) When involved in towing and salvaging vehicles, keep a short sling or tow cable on the tractor. An assistant can attach the sling to the towing pintles, or lifting eyes, or wrap it around the bumper on the vehicle in such a way that the strain of the towing operation will not damage the vehicle bumper. Do not use the large hook on the winch line for this purpose. It is not only hard to handle underwater, but will place the pulling strain at one point on the bumper. This could cause you to pull the bumper off the stalled vehicle. Once you are ready to pull, take up the slack in the towing line gradually to prevent the tow hook from slipping off the sling, and to prevent damage to the towed vehicle. Once you get the vehicle on the beach, pull it far enough from the surf so that it will not interfere with future operations.

- (3) When helping the naval beach party to salvage boats, and in assisting landing craft to retract from the beach, be particularly careful not to damage the boats. Many of the landing craft are constructed primarily of wood. It is very easy to punch a hole in them with the corner of a dozer blade. Use the wide part of the blade for pushing. Make contact gradually and then apply full power when both the dozer and boat are ready. Tractors with single drum winches can also be used to assist some of the larger landing ships in beaching. The lines can be connected to the ships for direct pull, or to tow the bow anchor ashore so that the ships can pull themselves. In rough surf, the tractors can be used to stabilize the landing craft and to prevent broaching. Cooperation between boat crews and dozer operators is essential.
- (4) Watch the surf conditions. As the tide rises or falls, equipment will have to move accordingly. Test your equipment's propelling and steering mechanisms during normal operation so that a rising tide will not catch you unable to move.
- (5) Salt water is extremely damaging to equipment, and will affect clutch and brake action. Preventive maintenance and observance of safety precautions are a "must."

g. Artillery positions. The division artillery regiment has some engineer items of equipment such as the Case MC 1150 scooploader. You may be assigned to an artillery unit for duty. Each 105-mm firing battery has equipment attached to it for digging-in the pieces and preparing storage areas for ammunition. Digging-in is essential. It provides protection from enemy air attack and counterbattery fire. Depending on the tactical situation, the length of time the pieces are going to remain in one position, and whether or not the pieces are set up before the equipment reaches the firing position, emplacements may be either hasty or deliberate.

- (1) **Hasty position.** Hasty positions are constructed when the equipment arrives at the firing position after the pieces have been set up or when they are not expected to remain in position for a long period of time. A dozer can be used to push up an earth parapet around the front and sides of the piece, leaving the rear open for the exit of the piece. For a 105-mm howitzer emplacement, the parapet should be 3 1/2-ft high and approximately 4-ft thick near the top. The outside of the parapet should slope gradually to the ground line. Overall width of the parapet at ground line should be approximately 10 ft. Overall diameter of the inside of the emplacement is 24 ft. All earthmoving is done from the outside toward the firing position. Do not tear up the ground unnecessarily. Back-blade the area when you are completed to help camouflage the firing position.
- (2) **Deliberate position (fig 3-22).** Deliberate positions are prepared in stable situations when the pieces are going to remain in position for a long period. The equipment arrives at and begins construction of the emplacements before the pieces arrive. These emplacements are similar to the hasty position except that they are partly below ground. This reduces the overall height of the parapet. The equipment prepares an entrance ramp and excavates a circular area 24 ft in diameter, moving the earth into a parapet. The position is 2 ft below ground level and there should be enough earth to complete the parapet without dozing from the outside of the position. The parapet for a deliberate emplacement is 1 1/2 ft above ground level. Later, the crews can improve the positions as needed with sandbags and logs. The weather may affect the construction of deliberate emplacements. During the rainy season, it may be impractical to dig below ground level.

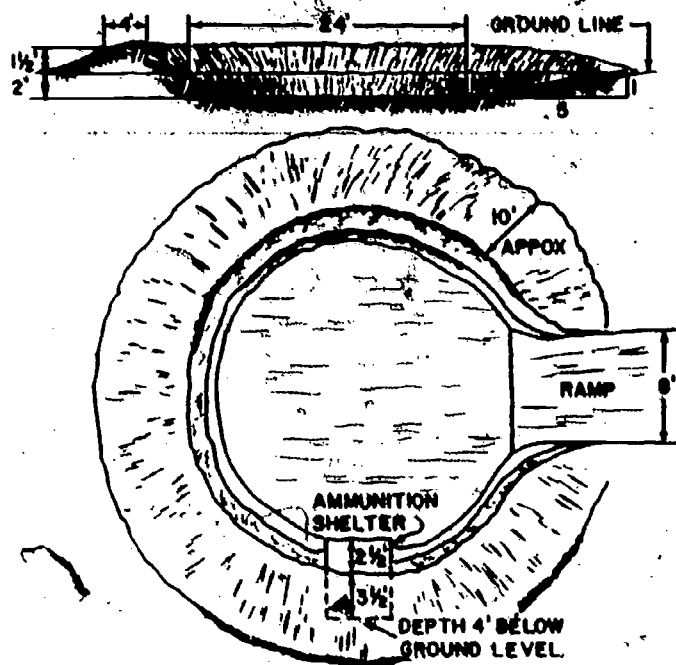

Fig 3-22. Deliberate 105-mm howitzer emplacement.

h. Storage areas and command posts (CP's). The extent to which these areas are dug-in will vary, just as they do for gun positions. Camouflage considerations will materially affect the extent of construction work. Drainage of dug-in areas is essential.

- (1) In deliberate construction, the equipment arrives at the site first and digs positions below ground level. Large-scale ammunition and fuel storage areas are generally placed a few feet below ground level, and the excavated earth used to form a parapet. The side of the area toward the enemy will form the highest part of the parapet. Areas should be constructed on the side of hills or sloping ground to provide for drainage of the storage pit.
- (2) In hasty construction, the supplies are already stored at ground level and the equipment is used to push up a parapet, higher than the supplies, from the outside.
- (3) Firebreaks, usually 1-dozer-blade wide, may have to be constructed around fuel storage areas in grassy and wooded areas.
- (4) Mobile load storage of ammunition and digging-in of communications vehicles at CP's can usually be taken care of by constructing a deep, gradually sloping, pit into which these vehicles can back. This will keep them well below the level of the parapet and permit them to drive out at a moment's notice.
- (5) Deliberate digging-in of CP's poses no particular problem; however, when the equipment arrives after the CP has been established, particular care will have to be taken not to damage communications wire which is laid throughout the CP area. When digging-in a CP, it is a good idea to have a communications man or a helper on the ground to move any wires in the construction area. Remember, check the area before you begin to work.

ENGINEER EQUIPMENT OPERATOR

Lesson 3

Earthmoving Fundamentals

STUDY ASSIGNMENT: MCI 13. 31h, Engineer Equipment Operator, chap 3.

LESSON OBJECTIVE: Upon successful completion of this lesson you will be able to identify grade stakes and their use, the sequence of construction operations, and the type of equipment employed on certain jobs.

WRITTEN ASSIGNMENT:

A. Multiple Choice: Select the ONE answer which BEST completes the statement or answers the question. After the corresponding number on the answer sheet, blacken the appropriate box.

Value: 1 point each

1. In most engineer construction, especially during combat, _____ is of the utmost importance.
 - a. durability
 - b. camouflage
 - c. drainage
 - d. speed

2. If an operator knocks over a final grade stake, what should he do?
 - a. Call the survey crew and continue his work.
 - b. Stop work in that area and call survey crew.
 - c. Reset the stake as close as possible to its original position.
 - d. Disregard the mistake and continue the work.

3. Learning to estimate height and distance will help an operator to know
 - a. what the finished job will look like.
 - b. grade stake markings.
 - c. the capabilities of his equipment.
 - d. when the equipment is fully loaded.

4. The removal of objectionable top soil before excavation begins is known as
 - a. clearing.
 - b. grubbing.
 - c. stripping.
 - d. pioneering.

5. During clearing operations, what type of trees should be removed first?
 - a. Brush
 - b. Small
 - c. Medium
 - d. Large

6. Clearing can be best accomplished by pushing stumps, brush, and debris
 - a. from one side to the other
 - b. diagonally from one side to the other
 - c. from the center toward both sides
 - d. parallel to the centerline

7. The uprooting and removal of roots and stumps is called
 - a. stripping.
 - b. clearing.
 - c. pioneering.
 - d. grubbing.
8. How should the ripper be employed when removing stumps?
 - a. To loosen the earth
 - b. To pull out the stump
 - c. To cut the roots
 - d. None of the above
9. Actual earthmoving begins during
 - a. grubbing.
 - b. clearing.
 - c. stripping.
 - d. grading.
10. When the haul distance is over 300 feet, which type of equipment should be used for stripping?
 - a. Dozer
 - b. Scraper
 - c. Motor grader
 - d. Shovel
11. When pioneering a road with a dozer, you should start at the
 - a. highest point possible.
 - b. lowest point possible.
 - c. most level area possible.
12. When pioneering side hill cuts, where should you cast the brush and trees?
 - a. On the uphill slope
 - b. At the edge of the downhill slope and use as fill
 - c. Over the downhill slope far enough that they will not be covered
 - d. In a windrow at the edge of the downhill slope
13. When cutting a road, which grade stake should you watch?
 - a. The one immediately ahead of you
 - b. The third or fourth stake down
 - c. The one immediately behind you
14. Why should you avoid digging storage revetments in areas where the water table is high?
 - a. Water from the ground may flood the revetment.
 - b. Rising flood water may fill the revetment.
 - c. There is no way to provide drainage.
 - d. Run off after a rain can not be controlled.
15. Which type of drainage system is usually used to drain water across a road?
 - a. Open channel
 - b. French drain
 - c. Covered drain
 - d. Culverts
16. What type drainage system is used to intercept water running down a hill toward a construction site?
 - a. Covered drains
 - b. Culverts
 - c. Ditches
 - d. French drains

17. Crawler-type tractors and towed scrapers are most efficient on hauls of
- 0 to 300 ft.
 - 300 to 1,500 ft.
 - 900 to 3,500 ft.
 - 1,500 to 5,000 ft.
18. Fills are generally constructed in _____ layers _____ inches high.
- loose -- 12
 - loose -- 18
 - compacted -- 6 to 12
 - compacted -- 18
19. The stake at the beginning of a road site is marked station
- 0+00.
 - 1+00.
 - 00+1.
 - 0.
20. Survey stations are normally how far apart?
- 25 ft
 - 50 ft
 - 100 ft
 - 200 ft
21. From what point on a grade stake is the depth of cut or fill measured?
- Top
 - Bottom
 - Centerline (C)
 - Crowsfoot (V)
22. A grade stake marked with the letter "F" and the numerals $3\frac{75}{16}$, indicates a fill of
- 3 ft $\frac{3}{4}$ in.
 - 3 ft $7\frac{1}{2}$ in.
 - 3 ft 9 in.
 - 3 yd 9 in.
23. A centerline stake marked $13 + 75$ would be how far from the starting point of the survey?
- 1,375 ft
 - 1,380 ft
 - 1,375 yd
 - 1,380 yd
24. The horizontal distance from the shoulder stake to the centerline is recorded on the
- centerline stake.
 - hub stake.
 - finished grade stake.
 - shoulder stake.
25. What stakes are used to indicate the earthwork limits on each side of the centerline?
- Shoulder stakes
 - Slope stakes
 - Offset stakes
 - Centerline stakes
26. The minimum area to be cleared and grubbed extends approximately how far outward from the slope stakes?
- 3 ft
 - 3 yd
 - 6 ft
 - 6 yd
27. A slope of 2 to 1 indicates a ratio of
- 2 feet of horizontal distance to 1 foot of vertical distance.
 - 2 feet of vertical distance to 1 foot of horizontal distance.
 - 1 foot of horizontal distance to 2 yards of vertical distance.
 - 1 foot of vertical distance to 2 inches of horizontal distance.

28. What is indicated by a stake that has a tack driven into the top of it?
- Finish grade
 - Slope ratio
 - The banked portion of a curve which lies above the regular grade
 - The exact location of survey line and station
29. What type of soil makes the most stable foundation material?
- Well-graded and compacted clay
 - Well-graded and compacted sand
 - Well-graded and compacted gravel containing little or no fine materials
 - Well-graded and compacted gravel containing enough fine material to fill the voids between the gravel
30. Which type of soil feels smooth, but is not plastic and will not hold together when dry?
- Clay
 - Peat
 - Silt
 - Sand
31. The ribbon test is used to identify
- sand.
 - clay.
 - silt.
 - peat.
32. What structural part of a road is designed to support the load?
- Surface course
 - Subgrade
 - Base course
 - Shoulder
33. What is the purpose of the base course?
- Support the load placed on the subgrade.
 - Support the load placed on the road.
 - Distribute the load to the subgrade.
 - Distribute the load to the road shoulder.
34. What is the minimum width of the traffic lane of a multilane road?
- 10 ft
 - 11 ft
 - 12 ft
 - 13 ft
35. The roadbed of a 2-lane road should be _____ ft wide.
- 11
 - 12
 - 22
 - 30
36. The normal crown for a gravel-surfaced road is from _____ in. to _____ in. per foot.
- $1/4$ -- $1/2$
 - $1/2$ -- $3/4$
 - $3/4$ -- 1
 - 1 -- $1\ 1/2$
37. The minimum superelevation value for earth- or gravel-surface roads is _____ inch per foot.
- $1/4$
 - $1/2$
 - $3/4$
 - 1

38. You are part of a crew that is preparing a field for installation of a SATS complex. The area under the mats must be sufficiently level so that the mats will not vary more than _____ in height over a 12-ft distance.
- | | |
|--------------|--------------|
| a. $1/4$ in. | c. $3/4$ in. |
| b. $1/2$ in. | d. 1 in. |
39. What is the maximum allowable slope for a pioneer helipad?
- | | |
|--------|--------|
| a. 10% | c. 14% |
| b. 12% | d. 16% |
40. On a military road, the minimum width of the shoulder on each side is _____ feet.
- | | |
|------|-------|
| a. 2 | c. 6 |
| b. 4 | d. 11 |
41. The traveled way of a 2-lane military road normally is _____ ft. wide?
- | | |
|-------|-------|
| a. 11 | c. 22 |
| b. 12 | d. 30 |
42. What is often referred to as the back slope?
- | | |
|----------------|---------------|
| a. Fill slope | c. Cut slope |
| b. Ditch slope | d. Fore slope |
43. The site for a pioneer road should be located along natural contour lines to avoid
- | | |
|---------------------------|---------------------------|
| a. poor soil. | c. unnatural concealment. |
| b. unnecessary earthwork. | d. curves. |
44. The site for a pioneer road should be located on a route which eliminates curves on
- | | |
|-------------------------|------------------|
| a. long gradual grades. | c. steep grades. |
| b. top of hills. | d. level ground. |
45. The long axis of a landing strip should be laid out in what direction?
- | | |
|----------------|---|
| a. North-south | c. General direction of the prevailing wind |
| b. East-west | d. Into the sun |
46. An airstrip for light liaison aircraft is generally not longer than _____ feet.
- | | |
|--------|----------|
| a. 500 | c. 1,000 |
| b. 750 | d. 1,500 |
47. The parapet for a 105-mm heavy gun position is approximately _____ feet high.
- | | |
|------------|------|
| a. $2 1/2$ | c. 4 |
| b. $3 1/2$ | d. 5 |
48. What is the most important factor in combat-type construction?
- | | |
|---------------|-------------|
| a. Camouflage | c. Drainage |
| b. Cover | d. Speed |

49. When constructing a bypass, what should be done first?

- a. Construct 1 lane
- b. Construct drainage system
- c. Construct a dam
- d. Provide traffic control

50. Which should you avoid when selecting a site for a pioneer road?

- a. Existing roads
- b. Extensive clearing
- c. Ridge and stream lines
- d. Natural concealment

Total Points: 50

13.31
Isn 3; p. 6

Chapter 4

OPERATING TRACTORS AND TRACTOR-DRAWN EQUIPMENT

Section I. TRACTORS

4-1. INTRODUCTION

A tractor is one of the most versatile items of engineer equipment in the Marine Corps. It may be used as a prime mover, if compatible with towed items of equipment such as scrapers and towed rollers, and it can be used to push and assist another vehicle such as a scraper. A tractor may be equipped with several different types of attachments, such as the bulldozer, angledozer, forklift, shear blade, and winch. With one or more of these attachments connected, it is a self-contained item of engineer construction equipment. The Marine Corps uses both crawler- and wheel-mounted tractors. There are several different makes, models, and sizes. Your first assignment to an earth-moving item of equipment will probably be to one of the tractors. Learn all you can about a machine before trying to operate it. The best and most complete source of information on the operation and maintenance of any particular tractor is the technical manual or the operator's manual for that tractor. Study the manuals and you will help to reduce the "down time" of your assigned equipment caused by improper lubrication, adjustment, and operation. The TM or operator's manual will explain how the item should be serviced and lubricated, how and when the adjustments are made, and how to properly operate it. As you gain experience and proficiency, the jobs you can do with your tractor will become more and more varied.

4-2. CRAWLER-TRACTORS

a. General. Although the Marine Corps is trying to standardize its engineer construction equipment, there are still several models, makes, and sizes of crawler-tractors being used. At the present time there are crawler-tractors made by Terex and Case manufacturers. They are classified as medium and small (the overall size, weight, and drawbar pull are considered when assigning the classification). The operating principles and techniques of the crawler-tractors are about the same regardless of size and make. They are all mounted on tracks and designed to push or tow. Steering is accomplished by stopping, slowing, or reversing one track and skidding the tractor around to the proper direction.

b. Terex 82-30M crawler-tractor. The description, weight, and other logistical data were presented in the first chapter of this course.

- (1) Controls (fig 4-1). The first thing you should do before trying to start the tractor is become familiar with the controls and instruments. Learn their location and how they are used. For example, you must push on the decelerator pedal, which looks like an accelerator pedal, to slow the engine. Experience with similar machines shows that some serious accidents have resulted because the operator released the decelerator pedal when he should have pushed it. The necessary controls are located within easy reach of the operator while sitting in the seat. The indicators are located on the dash in front of the operator and on the fuel tank. Learn the location and use of controls so that you can use them without seeing them.

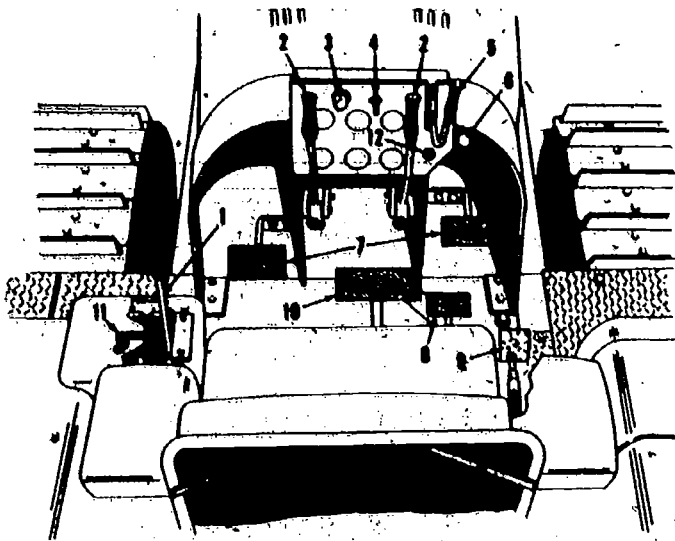

- | | |
|-------------------------------------|----------------------------|
| 1. Transmission shift control lever | 7. Foot rest |
| 2. Steering levers | 8. Decelerator pedal |
| 3. Dash light | 9. Parking-emergency brake |
| 4. Light switch | 10. Brake pedal |
| 5. Hand throttle lever | 11. Shift lock catch |
| 6. Throttle stop lever | 12. Starter switch |

Fig 4-1. 82-30M crawler-tractor controls.

- (a) **Transmission shift control lever.** The long lever located to the left of the operator is the transmission shift control lever used to select the desired direction and speed range. Moving the lever forward will provide forward gear, to the rear will provide reverse. When the lever is set for either forward or reverse direction, pushing it to the far left provides high speed range, centered is intermediate or second speed range, and to the right is low range. Neutral is midway between forward and reverse. When changing directions, slow the engine speed momentarily before shifting into the new direction. Upshifts from low to high can be made without slowing the engine, but downshifting requires slowing of the engine and the machine. Do not downshift to brake or slow the tractor; use the brakes.
- (b) **Steering levers.** The long levers located on each side and near the indicators are the steering levers. To turn right, pull the right lever and to turn left, pull the left lever. If the load is pushing the tractor, such as a loaded scraper going downhill, reverse the steering; pull the left lever to turn right and the right lever to turn left. Pulling the lever slightly disengages the steering clutch only and pulling it all the way to the rear engages the steering brake. For gradual turns, disengage the clutch. For pivot turns, disengage the clutch and engage the brake. The steering brakes can be used to stop the tractor when the engine is running, but not when it is stopped. To stop the tractor with the steering brakes, pull both levers to the rear. Movement of these levers applies pressure on the fluid in the steering control master cylinders located near the lower end of the levers. Two things that will prevent the steering clutches from operating properly are air in the master cylinder or lines and lack of fluid.
- (c) **Dashlight.** A light is mounted over the indicators to illuminate them for easy reading during darkness. Although the light is shielded, it is bright enough to be observed by an enemy.
- (d) **Light switch.** The light switch is located on the dash. It has a button and a switch. The button is to prevent the lights from being turned on accidentally. There are several positions on the switch for turning on the floodlight, blackout lights, and other lights. To turn the lights on, the button must be depressed and the lever moved to the desired position, but they can be turned off by movement of the lever only.

- (e) **Hand throttle lever.** The lever located on the extreme right of the dash is used to control engine speed. When the lever is raised, it will increase engine speed. Idle position is down to the throttle stop lever.
- (f) **Throttle stop lever.** This is a small lever located to the right of the throttle lever which prevents the throttle being moved to the engine-stop position. To stop the engine, the stop lever knob must be pushed in and the throttle lever moved down. The throttle lever can be moved to the run position without moving the stop lever.
- (g) **Foot rest.** Mounted on each side of the tractor below the dash are foot rests. Most operators like to rest their feet on one of the pedals. The foot rest is placed there to eliminate that habit which could cause damage to the operating controls.
- (h) **Decelerator pedal.** Mounted in the right floor is the decelerator pedal which is used to control engine speed. To slow the engine, push the pedal down, to increase the engine speed, release it. The pedal will slow the engine speed independently of the throttle lever, but when released, the engine speed will only increase to the throttle lever setting. For example, you can control the engine speed throughout the speed range by foot when the throttle lever is in the full throttle position. If it is set at half throttle, you can only control the speed below half throttle with the foot.
- (i) **Parking brake.** The parking brake is located on the far right near the seat. Push down on the pedal to apply the mechanical brake. The lever can be pulled up by hand or foot to release the brake.
- (j) **Brake pedal.** This is located near the center on the floor and is used to slow or stop the tractor. It is also connected to the engine throttle. Depressing the pedal will reduce engine rpm and by pushing it further, it will apply the brakes. The engine will return to the throttle lever speed setting when the brake is released. This pedal actuates both power steering brakes. This brake does not function when the engine is stopped.
- (k) **Shift lock catch.** The short lever located to the left of the transmission shift control lever is used to prevent accidental movement of the shift lever and to prevent starting except when the transmission is in neutral. The shift lever should be locked in the neutral position before attempting to crank the engine.
- (l) **Starter switch.** This is located on the dash with the indicators just below the throttle lever. The push button or key activates the solenoid and cranks the engine. The engine should not be cranked longer than 30 seconds. Allow the cranking motor to cool for 2 minutes after each 30-second cranking.
- (2) **Indicators (fig 4-1).** As stated before, the gages are mounted on the dash and the fuel tank. Those most important for tractor operation are located on the dash and can be easily read by the operator. Their specific arrangement on the dash is unimportant, but after cranking and periodically (at least every 15 minutes) during operation:
- (a) **Engine oil pressure gage.** This is the first gage that should be located and checked after cranking the engine. The gage should indicate satisfactory oil pressure within approximately 30 seconds after the engine cranks. Normal oil pressure is 45 psi, but during cold weather the readings may be higher until the engine reaches operating temperature. The oil pressure may vary some with the speed of the engine, but less than 20 psi at idle speed is insufficient oil pressure for proper lubrication. Do not confuse engine oil pressure with transmission oil pressure.
- (b) **Ammeter.** The ammeter should be checked next after the oil pressure. It will indicate whether the generator is charging or not and if the battery is being discharged (except for starting motor current). It should indicate a high rate of charge immediately after cranking and gradually decrease to near zero as the battery is recharged. A continuous high rate of charge indicates trouble in the charging circuit or with the batteries. A continuous discharge with the engine running at operating speed indicates a defective charging system, short or grounded wires, or an electrical overload.

- (c) Transmission oil pressure. The transmission oil pressure gage, located on the dash, should show a satisfactory reading when operating the engine at one-half throttle within a short period of time after the engine cranks. Do not confuse transmission oil pressure with engine oil pressure.
- (d) Temperatures. Both the engine coolant and the transmission (converter out) oil temperature gages are located on the dash. They should slowly rise as the engine and transmission warms up. The time required for them to reach normal operating range depends on the weather. It will take longer to warm up in colder climates. The engine temperature operating range is between 170°F and 180°F. The converter temperature range is approximately 200°F and should never be allowed to go over 250°F. The converter temperature will rise during operation under heavy loads.
- (e) Hourmeter. This is located on the dash and indicates the total hours the engine has run. There are two types of hourmeters being used by the Marine Corps; one operates from the engine rpm and the other is electrical. Neither meter will agree with the number of hours that you actually work. For example, you may work on a particular job for 8 hours, but the hourmeter will only show 7 hours. The difference is caused by the way they are calibrated. The engine is supposedly operated at full throttle while under full load for the full 8-hourmeter reading to agree with an 8-hour job. Regardless of the watch and hourmeter difference, the hourmeter is the indicator used to perform the service and maintenance. It is checked prior to pranking the engine and the hours are recorded on the proper forms. One of the meters is similar to an odometer; the first four numerals from the left are full hours and the last number on the right is tenths of an hour. This type may also be combined with a tachometer, which makes it look like a speedometer; the needle indicates engine rpm. The other hourmeter looks like the face of a clock with three hands. One hand measures in 1-hour increments, one in 10-hour increments, and one in 100-hour increments.
- (3) Miscellaneous gages.
- (a) Fuel gage. The fuel gage is located on top of the fuel tank to the left of the operator. It indicates the level of fuel in the tank.
- (b) Transmission oil level. This is a glass window located on the rear of the transmission drive case which allows the operator to see the oil level if it is up to the window. The proper oil level is the center of the gage with the tractor engine operating and the vehicle parked on level ground. Oil should be visible in the window before the engine is cranked.
- (c) Bayonet gage. A metal rod type gage is used to indicate the engine oil level. It is located near the blower on the engine and is checked before the engine is cranked. With the engine stopped, remove the gage and wipe it clean, replace it, and pull it out again to determine the oil level. Be sure the gage is pushed down to the stop when checking the oil or you will get a false reading and possibly overfill the engine with oil.
- (4) Attachment controls. Although the attachment may be removed, the control for that attachment (especially hydraulic attachments) is normally left in place.
- (a) Dozer control. This lever, which controls the position of the blade, is located to the right of the operator. There are four positions: float, lower, hold, and raise. When the lever is all the way forward, the blade will be in the float position; the next position to the rear will force the blade down; the next position to the rear will hold the blade in the position set; and the last position, all the way to the rear, will raise the blade. In addition to the up and down control, the 82-30M is also equipped with a tilt control. It is a pedal located on the forward left side of the operator's compartment. It has three positions: tilt up, hold, and tilt down. The pedal pivots from side to side.
- (b) Ripper control. The ripper control lever is attached to the upper left part of the dash near the instrument panel. It has three positions: raise, hold, and lower.

- (5) **Operation.** After you have learned where the controls are located, how and when the equipment is serviced, and some of the operating procedures and safety precautions, you are ready to start operating. As stated before in the discussion of records and forms, you must have a valid operator's permit, an Engineer Equipment Operational Record or other authorization, and a motor vehicle accident report form. Some parts of these forms will be filled in by the dispatcher; you are required to complete the rest of the form. Certain information must be entered on the form prior to starting the equipment, some during the time it is used, and some after the engine has been stopped. The form will show what services are due. It has a list of checks that must be made prior to operation; these are in addition to those checks listed in the TM. The hourmeter reading is recorded by the operator in the proper space on the Engineer Equipment Operational Record.

Note: The Engineer Equipment Operational Record has been mentioned several times in this paragraph. This was done to emphasize the importance of having in your possession authorization to operate the vehicle and the importance of maintaining a record of the services performed and the condition of the item. **Never,** for your own legal protection, operate a vehicle without a permit, authorization, and an accident report form.

The before-operation services must be performed to insure that the vehicle is safe, properly serviced, and ready for operation before you attempt to crank the engine. Inspect the equipment and attached units for leaks, damage, and any personnel in the area that could be injured by cranking and moving it. Check to insure the vehicle has been properly lubricated and has plenty of fuel, oil, and water. Any services shown as due on the Engineer Equipment Operational Record must be performed prior to leaving the equipment park.

(a) **Starting the engine.**

1. Be sure the parking brake is down. Place all attachment control levers in the neutral or hold position. Raise the throttle lever to the idle position. In some cases, you may have to raise it to a higher speed, but not over one half throttle.
2. Release the neutral start lock and move the transmission selector lever to the start position.
3. Press the starter button or turn the key to activate the cranking motor. Do not crank the engine for longer than 30 seconds at a time. Allow the cranking motor to cool for two minutes between each cranking period. Release the starter button or key immediately after the engine starts.
4. Check the oil pressure indicator after the engine starts. When it shows a satisfactory reading, check the transmission oil pressure, the ammeter, and other instruments. After the internal parts have had time to receive lubrication, the throttle lever may be moved to about half throttle and the engine run until it warms up. Do not operate the throttle up and down which will cause the engine speed to change suddenly. Allow a cold engine to run at a steady speed. Watch the exhaust and listen to the engine. The engine should run smoothly with no unusual noises and have a clear exhaust shortly after it starts.

5. While the engine warms up you should get off the tractor and inspect it again. Check it for oil, water, fuel, and hydraulic leaks while the engine is operating. Check the fan, pulleys, belts, and shafts for proper operation and alignment. After the engine warms up and before moving the tractor, check the tractor and attachment control operation. Do the steering levers operate properly and feel like they are performing their job? Does the decelerator operate and does the engine respond properly? Does the dozer control operate and the blade respond as it should? Are all indicators functioning and does the engine operation indicate they are correct? For example, does the radiator show steam while the indicator reads normal?

(b) Operating the tractor. After the engine has warmed up, the controls and indicators appear to function properly, and it is safe to move the tractor and any attached equipment, you are ready to operate the vehicle.

1. Raise the attachment to the desired position.
2. Move the throttle lever to the idle position; down to the throttle stop.
3. Place the transmission selector lever in the direction and range position desired.
4. Carefully raise the parking brake lever with the right foot or hand.
5. Increase the engine speed by steadily moving the throttle control lever up. Continue to increase the engine speed as the tractor moves and until the desired rpm is reached. Do not increase the engine speed suddenly; this will create a shock on the engine and the power train. The rpm can be decreased by pushing the decelerator pedal with the foot, applying the brake, or by moving the throttle lever. You can safely decrease the engine rpm suddenly. Remember that the transmission speed range will affect the engine rpm.
6. If it is necessary to turn the tractor, pull the steering lever on the side of the vehicle in the direction a turn is to be made. Pulling the lever back about half way will provide a gradual turn. Pulling it all the way to the rear applies the steering brake and the tractor will make a pivot turn. You must learn the feel of each tractor to determine just how far to move the steering lever for the turn desired. If the engine begins to lug (sound like it will stall from overloading), both levers can be pulled back to disengage the clutches and then released when the engine gains rpm. This is also the right thing to do when operating in unfamiliar soil and the tracks begin to spin. Stop the tracks as soon as possible to prevent getting stuck.
7. Pushing on the tractor brake will slow the engine rpm and stop the tractor. It is used to control vehicle speed when traveling downhill and no turns are desired. Remember that releasing the steering clutches disengages the power train, and releasing one clutch at a time with a load pushing the tractor will provide opposite steering. For sudden stops and straight downhill speed control, use the foot brake.
8. Transmission gear selections can be made while moving. It can be shifted from low to intermediate to high range without changing engine speed. To change direction or to shift from high to intermediate to low range, you should decelerate the engine momentarily (slow the engine speed while moving the transmission selector lever). The tractor can be moved from a stop in any speed range that will allow the engine to operate properly. For example, you can start off in high range if the engine is not overloaded.
9. Once the tractor is moving, the attachment can be lowered for work. Operation of the attachment controls requires coordination and use of the senses. Lower the attachment to do the job, but control it to prevent it from going too low or going up and down. For example, lower the dozer to start the cut. When it reaches the desired depth, raise it slightly. You will have to move the lever

from hold to raise and lower almost continuously to make a smooth cut. Move the control lever with short, quick jerks while making the cut or pushing the load. To lower or raise the blade, the control can be held in position until the correct height or depth is reached. While making the cut, you must be able to feel the tractor movement up and down and determine the load from the engine sound. You must watch the attachment, the area in front of the tractor, and glance at the indicators periodically.

10. If the engine shows signs of overloading while pushing a load with the dozer or while loading a scraper, raising the attachment slightly will relieve part of the load. However, the site location and other circumstances may make it necessary to continue loading at the same depth. In this case, releasing the steering clutches is desired. Also check the transmission speed range. Low range is normally used for pushing with a bull dozer, but higher speed ranges are sometimes desirable for loading scrapers.
 11. To stop the tractor, idle the engine, move the transmission selector lever to the neutral position, and push the parking lever down. Lower all attachments to the ground before dismounting. If you are going to be away from the tractor for a long period of time, stop the engine. Do not idle a diesel engine for long periods; the incomplete burning of fuel causes carbon build up. It is also possible for the engine to develop a leak and damage itself.
- (c) Stopping the engine. Many "so called" operators park their equipment, stop the engine, and secure for the day. This is wrong. The engine is still hot and stopping it without slowly cooling it can do severe damage. It must cool slowly and evenly. Park the tractor and run the engine at 1,000 rpm and gradually decrease the speed to low idle over a five minute period. Let it idle for at least two more minutes before stopping it. If you follow this method of stopping the engine, you are less likely to have engine trouble with your tractor. Slowly cooling the engine helps prevent warping, cracking, internal seizing, and other damage. This method will also eliminate the need to recrank the engine to perform a service check or to check a suspected problem. For example, the engine must be running to check the transmission oil level at the sight glass. Check it while the engine cools. Check for loose parts that may be vibrating while the engine is still running. There are other checks that can be made, but the important point is to cool the engine slowly before stopping it.
1. Park and stop the tractor as discussed in paragraph (b) 11. above.
 2. Cool the engine slowly. After it has cooled, push the throttle stop lever and move the throttle lever down to the off position. Turn off ignition switch.
 3. Perform the after-operation service (cleaning, lubricating, and replenishing of fuel, oil, and water) and the inspection.
 4. Complete the Engineer Equipment Operational Record and return it to the dispatcher. Verbally report any problems to the dispatcher and the equipment chief even if they are noted on the Engineer Equipment Operational Record.
 5. Cover the exhaust and protect the seat from water and you are ready to secure. Your tractor will probably be ready to operate on a moment's notice while the other operators are rushing to service and prepare theirs.

c. Case MC 1150 scooploader. This is one of the latest medium tractors used by the Marine Corps. The technical data was presented in the first chapter of this course. This tractor is different from other crawler-tractors used by the Marine Corps. Some of the differences are listed below:

The Drott 4-in-1 bucket is standard equipment on the Case MC 1150.

It has a power shift transmission which allows changing from one speed or direction to another while under full power, directional control is through the steering clutches. The tracks can be made to turn opposite each other; one forward and one reverse.

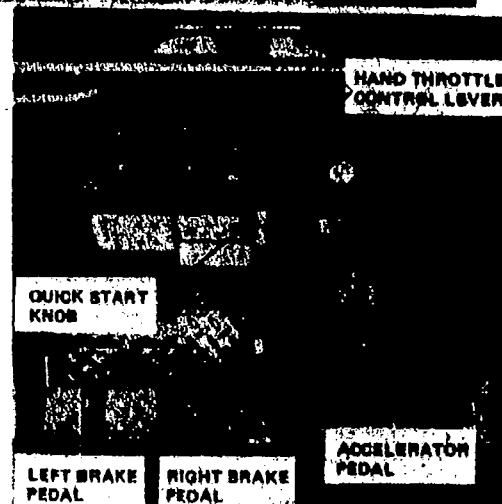
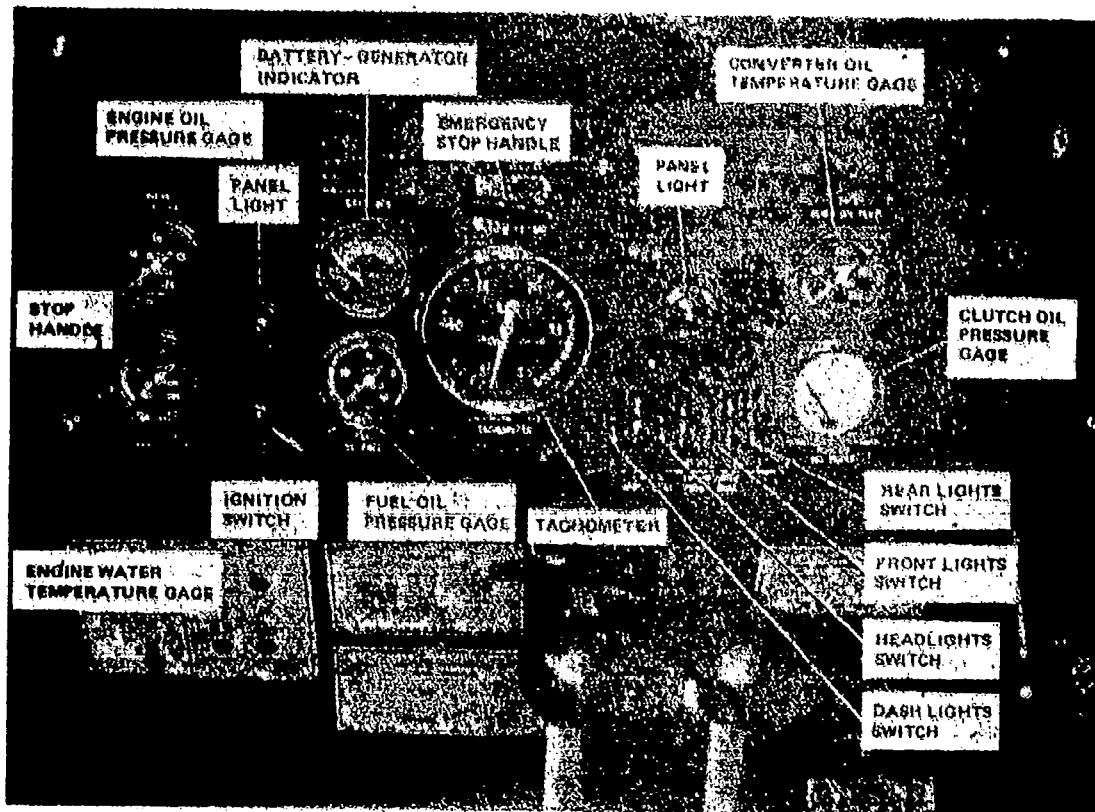

- (1) Instruments and controls (fig 4-2). As stated earlier in this course, you must learn the location of the controls so that you can make them function without seeing them. You must be able to check the correct indicator at a glance.

- (a) Engine oil pressure gage: This gage, marked ENGINE OIL PRESS, indicates the pressure of the engine lubricating oil. Gage range is 0 to 120 with markings at 10 psi intervals. Normal reading is 40 to 60 psi.

Fig 4-2. Case MC 1150 instruments and controls.

- (b) Battery generator indicator. This gage, marked BATT-GEN, indicates the voltage being supplied to the electrical system. The meter scale consists of a band of four colored blocks. From left to right the block colors are red, yellow, green, and red. The two colors to the left of the center are marked BATTERY and those to the right are marked GENERATOR.
- (c) Emergency stop handle. The handle, marked EMERGENCY ONLY, is attached to a push-pull type cable. The other end of the cable is connected to an actuating mechanism for the air shut off valve located between the engine air inlet housing and the blower.
- (d) Converter oil temperature gage. This gage, marked CONV. OIL TEMP., indicates the temperature of the oil in the torque converter. It has a range of 100° to 280°. The temperature of the oil should not be allowed to rise above 250°.
- (e) Clutch oil pressure gage. This gage, marked CLUTCH OIL PRESS, indicates the transmission operating oil pressure. The gage range is 0 to 400 psi with markings at 10 psi intervals. Normal operating pressures should be 260 psi to 290 psi.
- (f) Light switches. Four toggle switches control the panel lights and the loader lights. Each switch controls a pair of lights.
- (g) Tachometer. The tachometer indicates the engine revolutions per minute (rpm) in hundreds of rpm. Range is 0 to 30. Normal full operating speed is 2100 rpm.
- (h) Ignition switch. This switch controls the engine electrical system.
- (i) Stop handle. This handle is marked PULL TO STOP. It is connected by a push-pull type cable to the governor. When the handle is pulled, the injector racks are placed in the no fuel position, stopping the engine.
- (j) Water temperature gage. This gage is marked ENGINE WATER TEMP, and indicates the water temperature of the engine coolant. Range of the gage is 100° to 250°. Normal operating temperature should be 180° to 185° F.
- (k) Hand throttle control lever. This lever is located on the right side of the control panel and is connected by linkage to the fuel injector linkage for controlling the engine speed.
- (l) Accelerator pedal. This pedal, located below and to the right of the control panel, is connected to the same linkage as the hand throttle.
- (m) Foot brake pedals. The right and left brake pedals are used to stop or steer the loader. When the pedal is depressed, it neutralizes the transmission on that side so no power is delivered to the track and brakes the track at the same time.
- (n) Parking brake handle. The parking brake handle is located in the heel plate on the right side of the control pedestal. When the handle is pulled up the brakes are set for parking.
- (o) Quick start control. The quick start knob is used for cold weather starting. When a quick start cartridge is in place in the holder, pulling the quick start knob out allows starting fluid to enter the air intake housing.
- (p) Transmission control levers (steering controls) (fig 4-3). The left and right control levers are located on the control console. The levers operate independently, each controlling one track, thus permitting the tracks to operate in opposite directions.
- (q) Track speed control levers. The right and left track speed control levers, located on the operator's console, control the track speed. Each lever has three positions: the rear position is low, the center position is neutral, and the forward position is high range.

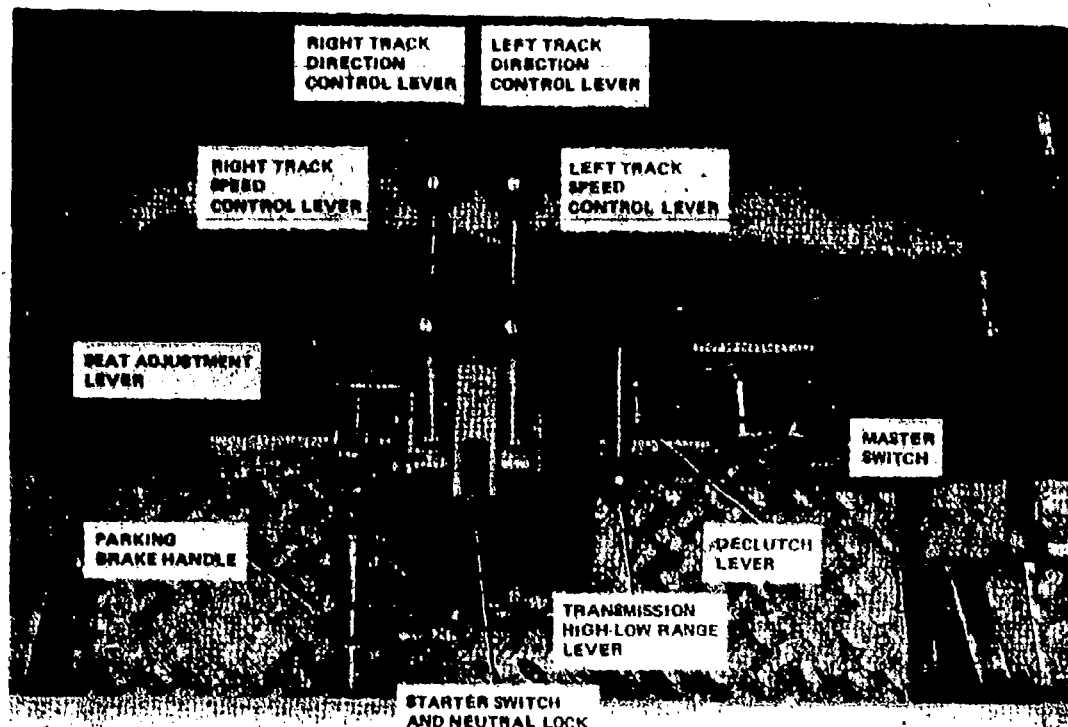

Fig 4-3. Case MC 1150 control levers.

- (r) Starter switch and neutral lock. The starter switch and neutral lock hold the track speed control levers in neutral when they are in use.
 - (s) Master switch. The master switch controls all the electrical circuits except the slave receptacle. The switch is on only when the handle is horizontal.
- (2) Bucket control levers (fig 4-32). These levers operate the hydraulic control valve which applies hydraulic pressure to one end of the corresponding cylinders and provides a return from the other end of the cylinders. The center position for each lever is a hold position for the corresponding cylinder.
- (a) Lift cylinders control lever (fig 4-32). This lever controls the flow of hydraulic oil to the lift cylinders to raise or lower the bucket.
 - (b) Dump cylinders control lever (fig 4-32). This lever controls the flow of hydraulic oil to the dump cylinders.
 - (c) Clam cylinders control lever. This lever controls the flow of hydraulic oil to the clam cylinder.
- (3) Winch controls (fig 4-32). The winch forward and reverse control lever is mounted behind the right arm rest. The outer position for the lever is neutral. The outward position is forward and the inward position is reverse. A shift lock holds the lever in position.
- (a) Brake control lever. This lever is mounted to the rear of the direction control lever. When the lever is in the outward position, the brake is off. As the lever is moved inward the brake is applied.
 - (b) Free spool control. The winch free spool control knob is located on the left side of the winch. When the control knob is pulled outward, the spool is free. The knob must be pushed in to operate the winch.
- (4) Operation. As with the other items of equipment, you must perform the before-operation inspection and service. Be sure the item has sufficient fuel, oil, and water and that it is safe to start.
- (a) Starting the engine. The Case MC 1150 scooploader cannot be towed to start it. If the batteries are low, an external source of 24-volt power can be connected through the auxiliary (slave) power receptacle. Crank the engine by following the procedures outlined below:

- Set the transmission high-low range control in high or low depending on the type of work to be done.
- Check to see that the direction control levers and the track speed control levers are in neutral and locked.
- Set the parking brake.
- Open the hand throttle approximately one-third of the way.
- Check to see that the stop handle is pushed in. If the emergency stop has been used, it is necessary to manually reset the lever on the engine air inlet housing.
- Turn ignition switch to the on position. The starter button is under the neutral lock. Push down firmly on the lock to crank the engine.
- If the temperature is below 40° F., use the cold weather starting aid (quick start).
- When the engine starts, release the starter immediately. While the engine is being turned over with the starter, white or black exhaust smoke should be observed at the exhaust pipe. If no smoke is observed and the engine will not start, it is an indication that no fuel is getting into the cylinders.
- Immediately after starting the engine, check the instruments for readings. If there is no oil pressure in 10 to 15 seconds, stop the engine to investigate the cause. After the engine has warmed up, check the temperature gage for the correct reading; also check the oil pressure.
- Operate the engine at part throttle and no load for about five minutes allowing it to warm up.

(b) Operating the loader. After the engine has warmed up, throttle it down to idle speed and release the parking brake. Then shift the track speed control levers forward into high or backward into low. To go forward, push the direction control levers forward or pull them back to reverse the direction. Do not operate the loader at or near stall speeds as this may cause the transmission-torque converter oil to overheat and damage the system. The loader may be shifted from high to low speed at any time using the track speed control levers; however, if it becomes necessary to change from high to low range, stop the loader and move the high-low range lever to the desired position. To change the direction of travel, reduce engine speed and shift the direction control levers to the desired position.

(c) Stopping the loader. To stop the loader, depress both foot brakes simultaneously. This cuts power to the tracks. Then, shift the direction control levers and the track speed control levers to the neutral position and set the parking brake. Before shutting off the engine, let it idle approximately 5 minutes to cool it down. To shut off the engine, push the hand throttle all the way down, and pull out the fuel stop handle. When the engine stops, push in the stop handle.

d. Case MC 450 tractor. The description, weight, and other technical information were discussed in the first chapter of this course.

(1) Controls and instruments. Figure 4-4 locates, illustrates, and furnishes the operator with information pertaining to the various controls and instruments for proper operation of the tractor.

(a) Hourmeter. This gage records the time that the engine has operated. Elapsed time is indicated in hours and tenths of hours.

(b) Air cleaner indicator. This indicator is factory set to signal when the filter element requires servicing.

- (c) Engine oil pressure gage. This gage indicates the pressure of the lubricating oil with a range of 0 to 80 psi. Normal reading with a warm engine should be 50 to 75 psi at 2000 rpm.
- (d) Ammeter. The ammeter indicates the charging rate of the batteries. It should show a high charging rate when the engine is first started and then go gradually back near zero as the battery becomes recharged.
- (e) Light switch. This switch controls the front lights, rear lights, and panel light. The ON position is 40 degrees clockwise from the OFF position.
- (f) Power switch. This switch is a two-position OFF and ON switch.
- (g) Transmission oil pressure gage. This gage indicates the transmission oil pressure with a range of 100 to 400 psi. During normal operation the gage should indicate 225 to 260 psi.
- (h) Torque converter temperature gage. This gage indicates the converter oil temperature in one of 3 zones: green for normal, yellow indicates the converter is being overworked and caution must be used during continued operation, red indicates high temperature and requires that work be stopped and the engine be operated at half-speed in neutral to cool the oil.
- (i) Torque converter pressure gage. This gage has a range of 0 to 100 psi. While warming up the engine, the gage may register high. After reaching normal temperature the gage should read 35 to 55 psi.
- (j) Engine temperature gage. This gage indicates the temperature of the coolant, the tractor can operate safely with temperatures up to 230° F.
- (k) Engine shutoff knob. This knob shuts off the engine fuel supply when pulled out. It must be pushed in to start the engine.
- (l) Throttle control lever. This lever, which is located in front of the driver's seat, controls the engine speed. Moving the throttle forward increases speed and backward slows the engine down.
- (m) Accelerator pedal. The pedal controls variations in engine speed above specific engine speed set by the hand throttle.
- (n) Brake pedals. These pedals are used to stop or steer the tractor and can be used together or independently. The left brake pedal disconnects the clutch on the left side of the transmission so that no power is delivered to the left track and the left track is braked at the same time. The right pedal has the same function for the right track. A latch is used to lock the two pedals together so that when one pedal is depressed they both go down together and stop the tractor.

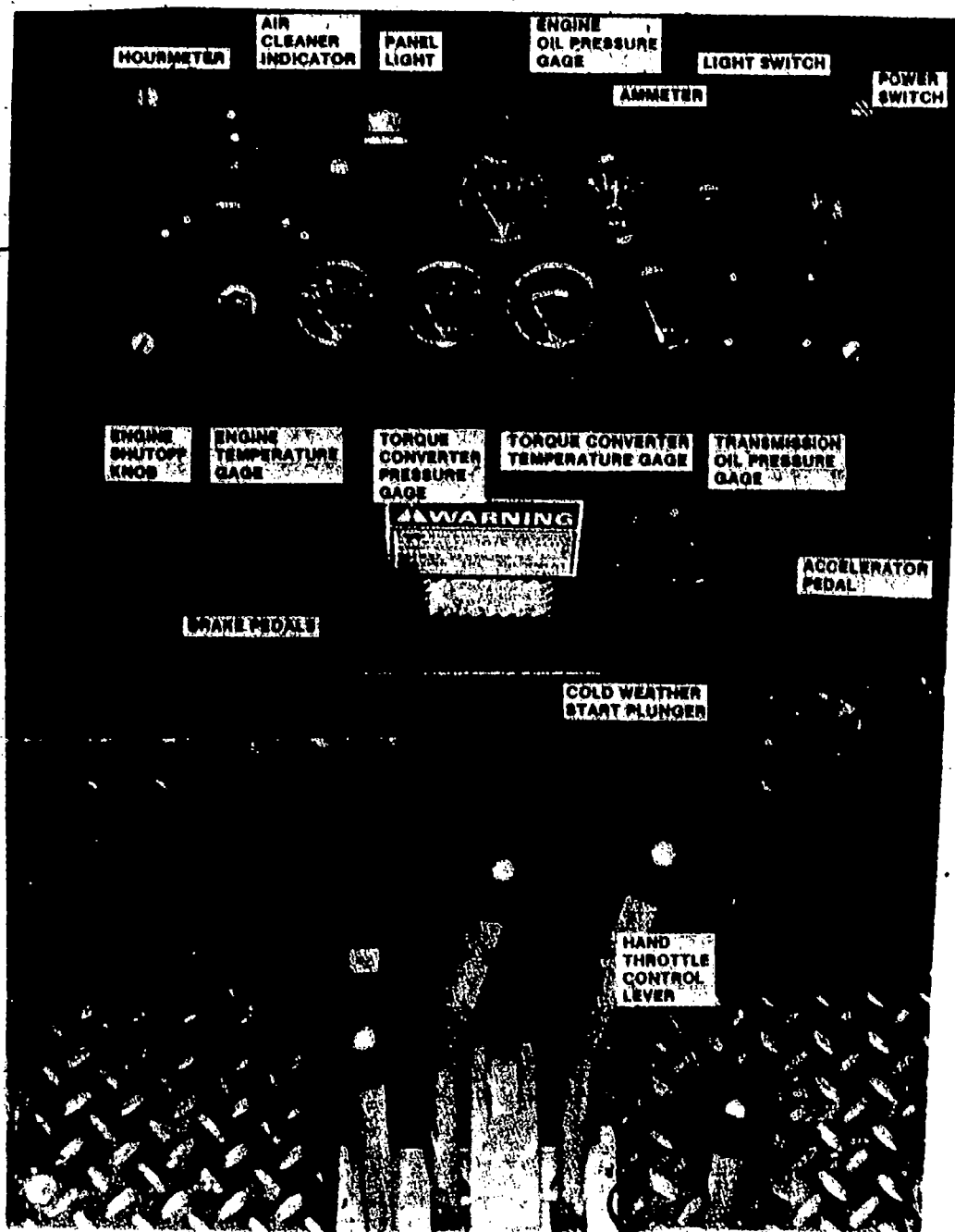

Fig 4-4. Controls and instruments.

- 2) **Operation.** In addition to knowing how to start and stop the tractor, the operator must know how to coordinate the basic motions to perform the specific tasks for which the equipment is designed.
- (a) **Starting the tractor.** As with other items of equipment, you must perform the before-operation inspection and service. Be sure that the tractor has sufficient fuel, oil, and water, and that it is safe to start. Crank the engine by following the procedures outlined below:
- Set the transmission dual range control (fig 4-5) in high or low, depending on the work to be done.
 - Check to see that the direction control lever (fig 4-5) and track speed control levers (fig 4-5) are in neutral. (The neutral lock (fig 4-5) should be in place on the track speed control levers.)

- Set the parking brake (fig 4-5).

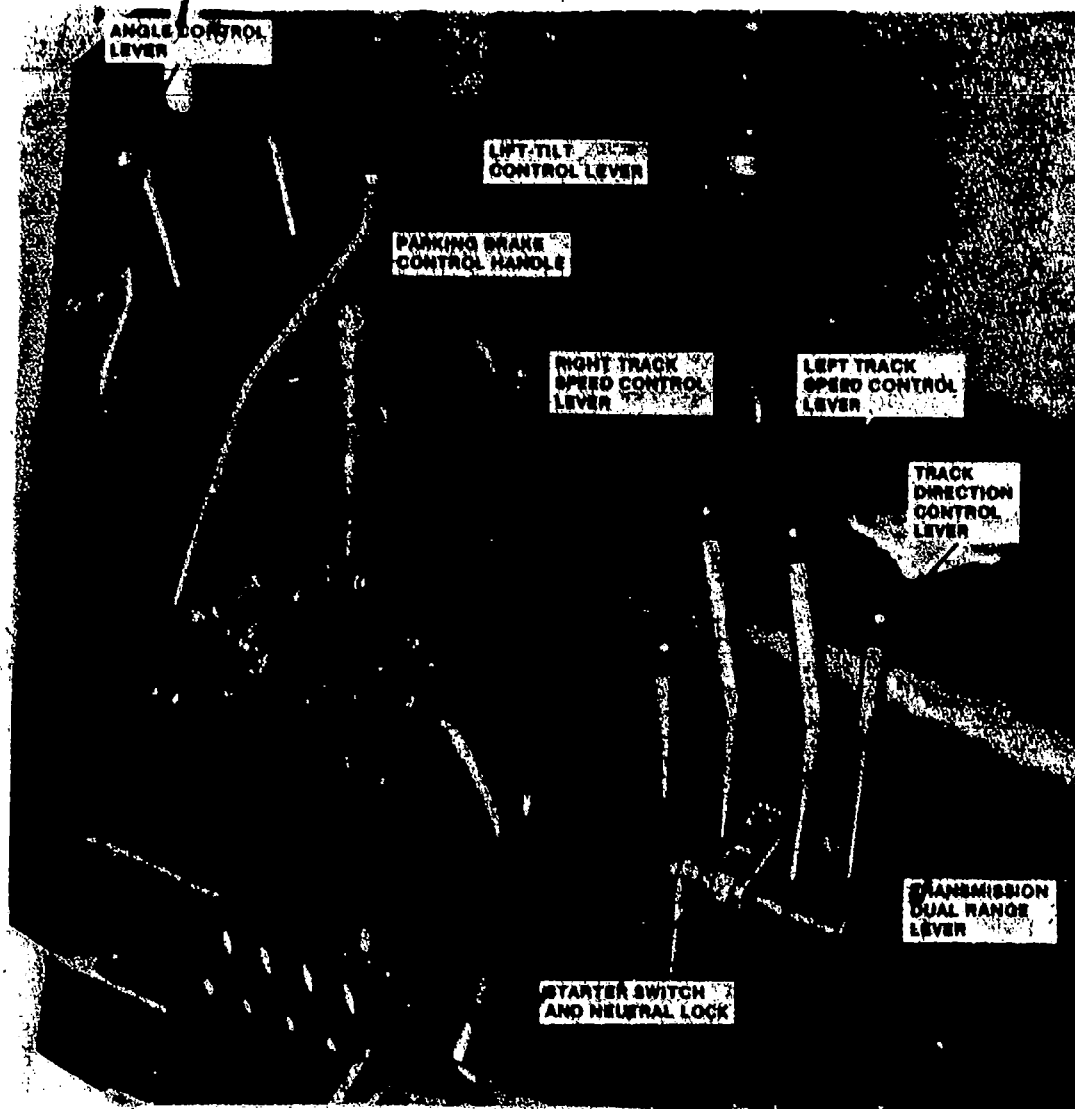

Fig 4-5. Operator's console and adjacent controls.

- Open the hand throttle by pushing lever forward approximately one-third of the way.
- Check to see that the engine shutoff knob is pushed in.
- Turn ignition switch to ON position. The starter button is under the neutral lock. Push down firmly on the lock to crank the engine. Do not operate the starter more than 30 seconds.
- If the temperature is below 40° F, use the cold weather starting aid.
- When the engine starts, release the starter immediately. While the engine is being turned over with starter, white or black exhaust smoke should be observed at the top of the exhaust pipe. If no smoke is seen and the engine will not start, it is an indication that no fuel is getting into the cylinders.
- Immediately after starting the engine, check the instruments for readings. After the engine has warmed up, check the engine temperature gage (fig 4-4) for the correct reading.
- Operate the engine at part throttle and no-load for approximately 5 minutes, allowing it to warm up before operating.

(b) Operating the tractor. After the engine has warmed up, bring it to idle speed and release the parking brake. Be sure to raise the dozer blade before moving. Then shift the track speed control levers forward into high speed or backward into low speed. To go forward, push the direction control lever forward. To reverse, pull the lever back. Do not operate tractor at or near stall speed as this may cause the transmission torque converter oil to overheat and damage the system. You may shift the tractor from high to low or low to high speed at any time, using the track speed control levers; however, if it is necessary to change from high to low range or low to high range, stop the tractor and move the dual range lever to the desired position. To change the direction of travel, reduce engine speed and shift the direction control lever to the desired position.

(c) Stopping the tractor. Depress both foot brakes together (this disengages the power to the tracks in addition to applying braking action). Then shift the direction control lever and the track speed control levers to neutral and set the parking brake. Once this has been completed, pull the hand throttle all the way back and pull out the engine shutoff knob. When the engine stops, push in the shutoff knob.

4-3. RUBBER-TIRED TRACTORS

a. Introduction. Rubber-tired tractors have been found to be more efficient and economical than crawler types under certain conditions. They are used for earthmoving when haul distances are long and a stable haul road can be maintained, or when crawler-tractors would harm the surface of the road or runway. Wheeled tractors have less traction than crawler types, and therefore will not pull as heavy a load in sand or mud because of tire slippage. This disadvantage is partly overcome by using a weight-transfer device which transfers a portion of the weight from the towed load to the rear drive wheels of the tractor. This device is especially useful on a tractor towing an earthmoving scraper. Rubber-tired tractors are more complicated to operate than crawler-tractors. Although many of the instruments and controls are the same as those on crawler-tractors, the differences in engines, transmissions, steering, and the addition of a weight transfer require a greater number of controls and instruments. The technical manual for the tractor will provide you with the detailed information on operation and maintenance. Because of their greater speed and maneuverability, wheeled tractors require that an operator be extremely safety-conscious. When you are operating a wheeled tractor, proceed slowly and carefully over rough or bumpy ground. The wheeled tractor bounces more than a crawler-tractor and has less stability.

b. MRS-100 wheeled tractor. You may come in contact with three rubber-tired tractors in the Marine Corps, the Case MC 580, the large MRS-I-100, and the much smaller MRS-100. The MRS-100 (fig 1-6) found in engineer battalions will be described in the remainder of this paragraph. The tractor is a 4-wheel-drive, 4-wheel-steer prime mover. It is equipped with a hydraulic dozer, rear-mounted single drum hydraulic winch, rear drawbar, rear-mounted pintle hook, hydraulic power control unit, and weight-transfer device. The tractor is designed to be sectionalized into five units which permit it to be disassembled, transported by air, and then rapidly reassembled at the point of intended use. In addition to normal dozing, towing, and winching operations, the tractor is designed to be used with a hydraulically operated 4-wheeled scraper. It is capable of fording in water up to 5 feet deep. The vehicle is equipped with a GMC 4914, 4-cylinder diesel engine and an Allison CRT-3531-1 Torqmatic transmission.

(1) Controls and instruments. The tractor is equipped with the normal engine instruments which are similar to those described in the paragraphs on crawler-tractors. The battery-generator, hourmeter, engine-oil-pressure gage, engine-coolant temperature gage, and fuel level gage perform their normal engine functions.

Note: The numbers below refer to the numbers on figure 4-6.

1. Rear-steering pedal. Linked to the rear-steering hydraulic control valve. Used to steer the tractor's rear wheels.
2. Rear-steering directional indicator. Located to the right of the rear-wheel steering pedal. Indicates the steering attitude of the rear wheels.
3. Weight-transfer pedal. Linked to the hydraulic control valve spool. Used to operate the weight-transfer device. The pedal has three positions: HIGH, NEUTRAL, and LOW. Caution: Use only at slow travel speeds.

4. Front-wheel-drive shift lever. Located just forward of the steering column. Used to engage or disengage the front-wheel drive. Caution: Always stop the tractor before engaging or disengaging the front-wheel drive.
5. Trailer-brake control lever. Mounted on steering column. Used to operate the brakes of the towed vehicle independently of the tractor wheel brakes.
6. Steering wheel. The conventional automotive steering wheel, equipped with a horn button. Used to steer the tractor's front wheels.
7. Horn button.
8. Transmission-oil-temperature gage. Indicates the temperature of the transmission oil which should be 180° F when operating at full throttle under normal conditions. Caution: Do not allow transmission temperature to exceed 250° F. If it overheats, stop the tractor, shift into NEUTRAL, and rev the engine up to full rpm. Temperature should start to drop in 15 seconds and drop rapidly to normal. If the temperature drops slowly, a malfunction in the torque converter is indicated and should be reported.
9. Transmission-oil-pressure gage. Indicates the transmission main oil pressure and should show a constant reading during normal operation. An erratic reading may indicate low oil level or a malfunction. With the transmission warmed up to 180° F, the tractor in high range and forward, with the brakes applied, and operating at full throttle, the reading should be 110 to 120 psi.
10. Engine-coolant-temperature gage.
11. Engine-oil-pressure gage. Normal reading is 40 to 60 psi with engine warmed up and running at 2,100 rpm.
12. Panel lamps (3).
13. Starter pushbutton switch. Used to crank the engine.
14. Fuel level gage.
15. Battery-generator indicator.
16. Hourmeter.
17. Light switches. Three light switches are provided. The left switch controls the dash worklight, the right switch controls the right headlight and rear worklight, and the center switch controls the left headlight and the taillights.
18. Engine primer (ether). Located on right side of dash. Used as a cold-weather starting aid (below +40° F). Requires an ether bulb cartridge which is inserted into the primer body, punctured, and discharged into the engine air intake.
19. Emergency-stop control. Used to shut down when normal shutdown procedure fails.
20. Air-pressure gage. Normal air pressure in the airbrake system is 80-85 minimum and 100-105 maximum.
21. Low-air-pressure warning light. Located directly above the air-pressure gage, it glows red when the air-pressure in the airbrake system is too low for effective braking.
22. Ignition switch. Provides an ON and OFF control for electrical current to the instruments and starter switch.
23. Service brake pedal. Used to apply brakes to all four wheels of the tractor, and to a towed vehicle.
24. Accelerator pedal. Used to control engine speed.

25. Dozer-control lever. Controls the operation of the dozer blade and has the same four positions as the crawler-tractor control lever: FLOAT, LOWER, HOLD, and RAISE.
26. Dozer-blade-tilt control lever. Located to right of the dozer operating lever. Used to control the tilt of the dozer blade.
27. Differential-lock indicator light. Mounted on the rear of the transmission shift tower, the light remains ON when the differential locks are engaged.
28. Transmission "Forward-Reverse" lever. Located to right of operator's seat. It is the right-hand lever in the shift tower. It has three positions: FORWARD, NEUTRAL, and REVERSE. Caution: The tractor must be brought to a complete stop when changing direction of travel. Never change directions with the vehicle moving.
29. Transmission range lever. The left-hand lever in the shift tower. Used to select the transmission speed range; HIGH, INTERMEDIATE, or LOW. Caution: Do not downshift from INTERMEDIATE to LOW at speeds over 3 mph. Downshifting at excessive speed will overspeed the engine.
30. Transmission shift tower.

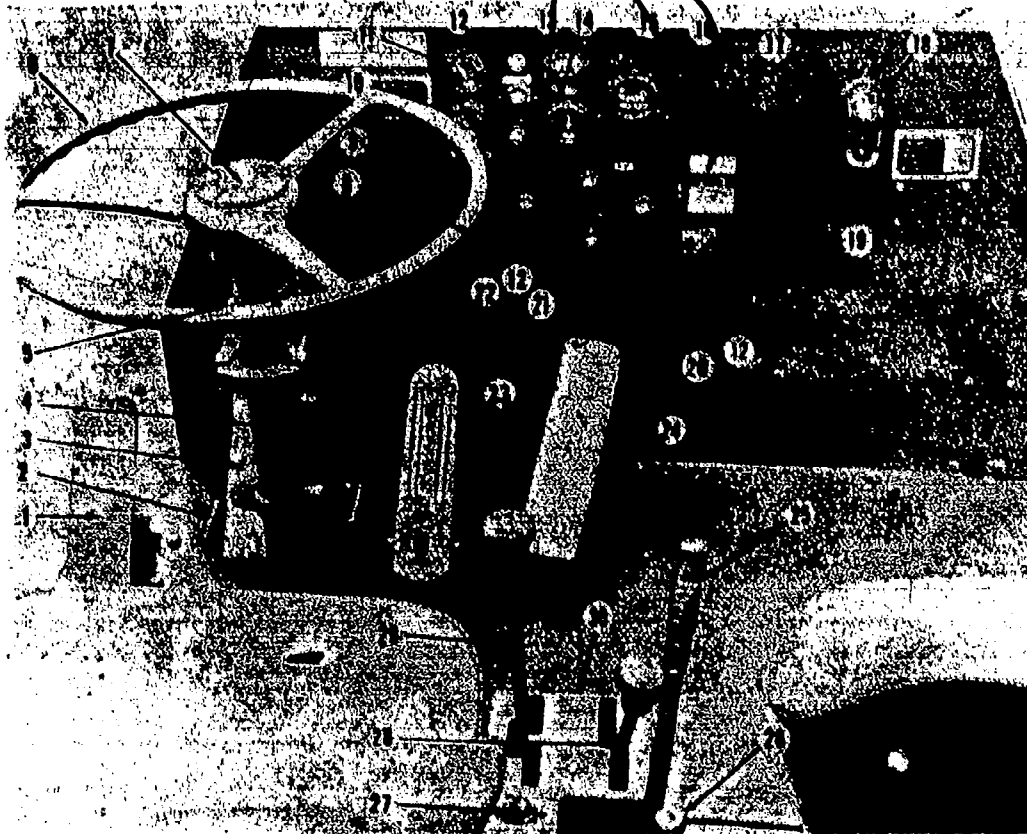

- | | | |
|--------------------------------------|-------------------------------------|--|
| 1. Rear-steering pedal | 11. Engine-oil-pressure gage | 21. Low-air-pressure warning lamp |
| 2. Rear-steering indicator | 12. Panel lamps (3) | 22. Ignition switch |
| 3. Weight-transfer foot pedal | 13. Starter push-button switch | 23. Service brake pedal |
| 4. Front-wheel-drive shift lever | 14. Fuel-level gage | 24. Accelerator pedal |
| 5. Trailer-brake control lever | 15. Battery-generator indicator | 25. Dozer-control lever |
| 6. Steering wheel (front wheels) | 16. Hourmeter | 26. Dozer-blade-tilt control |
| 7. Horn button | 17. Light switches | 27. Differential-lock indicator light |
| 8. Transmission-oil-temperature gage | 18. Engine primer (cold weather) | 28. Transmission forward-reverse lever |
| 9. Transmission-oil-pressure gage | 19. Emergency-stop control (engine) | 29. Transmission range lever |
| 10. Engine-coolant-temperature gage | 20. Air-pressure gage | 30. Transmission shift tower |

Fig 4-6. MRS-100 instruments and controls.

Note: The numbers below refer to the numbers on figure 4-7.

- 1, 2, 3. Scraper (or implement) control levers. The three foremost levers on the first hydraulic control bank are used to control a hydraulic implement or machine which has been connected to the tractor. During scraper operations, the levers are used to control the following:
 - Scraper bowl
 - Scraper apron
 - Scraper ejector
4. Parking brake lever. Used to apply the tractor parking brake. It has a knurled handle which is used to adjust the brake.
5. Winch-motor-control lever. The rearmost lever, mounted on the first hydraulic control bank. Used to control the operation of the hydraulic winch motor. It has three positions: FORWARD, NEUTRAL, and REVERSE.
6. Floodlight. Has its own switch and a universal-type mount.
7. Cutoff cocks, trailer brake line. Located on the scraper connection panel, these two cutoff cocks are used for cutting off or turning on the air supply to the trailer brakes as needed.
8. Winch-brake-control lever. Used to apply the winch brake. Has a ratchet and pawl which holds it in position. It is the longer of the two winch control levers.
9. Winch-gearshift lever. Used to select either a high or a low winch speed. Has three positions: FORWARD (fast), NEUTRAL, and REARWARD (slow).
10. Winch-free-spool knob. The knob may be pulled out to permit the cable drum to unwind freely. It may be used when playing out cable.
- 11, 12. Rear-steering lever and lockout. Located to left of operator's seat, the lever (11) may be used as a hand control to steer the rear tractor wheels. The lockout (12) consists of a clip on the floorboard and a pin that locks the lever to the clip.
13. Differential-lock-control lever. Used to shift the differential locks into and out of engagement. Do not use differential locks at high speed.

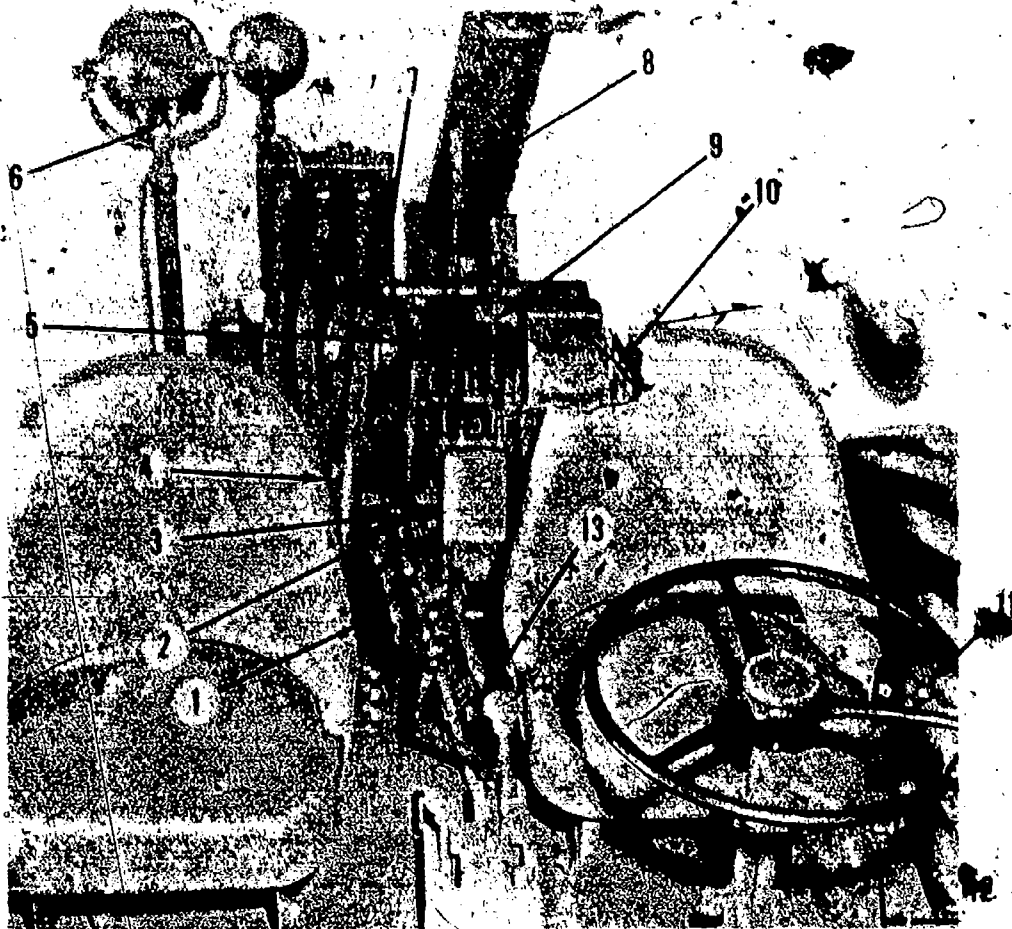

- | | |
|---|---|
| 1. Scraper "BOWL" control lever | 8. Winch-brake-control lever |
| 2. Scraper "APRON" control lever | 9. Winch-gearshift lever |
| 3. Scraper "EJECTOR" control lever | 10. Winch-free-spool knob |
| 4. Parking brake lever | 11. Rear-steering control lever
(linked to rearsteering control pedal) |
| 5. Winch-motor-control lever | 12. Rear-steering lever lockout |
| 6. Floodlight switch | 13. Differential-lock-control lever |
| 7. Cutoff cock (trailer air supply) (2) | |

Fig 4-7. MRS-100 rear controls.

(2) Starting the engine.

(a) Normal conditions.

1. Place the transmission shift levers in NEUTRAL and engage the parking brake. Make sure the emergency stop control is all the way in against the dash and turn the ignition switch to ON. Then depress the accelerator pedal to half throttle and engage the pushbutton starter switch. After the engine starts, release the starter switch and control the engine speed as needed to assure correct warmup. Check the oil-pressure gage after the engine starts.
2. Run the engine at part throttle and no load for approximately 5 minutes, allowing the engine to warm up. While the engine is warming up, check the gages and make sure they are registering as they should. If not, check to see why and either correct or report it.
3. The air brake system pressure gage should always read above 60 psi while the engine is operating above idling speed. If pressure remains low, troubleshoot the system. Do not drive the tractor until the brake low pressure indicating light goes out. When the light glows, pressure in the system is below the minimum required for full braking power.
4. The tractor is equipped with an automatic transmission. It should not be started by towing. If battery output is too low to crank the engine, connect an external source of 24-volt direct current to the tractor electrical system by means of the electrical receptacle on the left side of the tractor.

- (b) Cold-weather starting. Perform the normal before-operation procedures, then prepare to use the ether starting aid. Unscrew the primer cap, insert the ether capsule and replace the cap. Depress the accelerator pedal to three-quarters throttle position. Engage the starter button, and after the engine is turning over at full cranking speed, discharge the ether capsule by swinging the actuating lever through 180° to the opposite side of the primer. The engine should start within a few seconds. If the engine fails to start after several attempts, troubleshoot the engine and correct the defect.

(3) Stopping the engine.

- (a) Normal. Ground the dozer blade, place all controls in neutral position, and apply the parking brake. Decrease engine speed and allow the engine to run at half speed for 4 or 5 minutes to permit gradual and uniform cooling. To cut off the fuel supply, release toe pressure from the accelerator pedal and apply heel pressure to the bottom of the pedal. Turn the ignition switch to OFF. Be sure the switch is off before leaving the tractor; if the switch is left on, the constant drain of current to the instrument panel gages will run the batteries down.
- (b) Emergency. If the normal shutdown procedure fails to stop the engine, pull the emergency-stop control handle out as far as it will go. This will stop the engine by cutting off the air supply from the blower. After the engine has stopped, push the handle all the way in. Before restarting the engine, check to see why the normal shutdown procedure failed, and either correct or report any defects.

(4) Operating the tractor.

(a) Moving the tractor.

1. To move the tractor, release the parking brake, raise any attachment, and with the engine operating at idle speed, shift both of the transmission speed and direction levers to the desired position. Now all you need to move the vehicle is to depress the accelerator pedal.

2. The transmission is full-power shifting. It is possible to upshift or downshift the transmission at wide-open or at part throttle. Shifting to and from all speeds must be done manually. Do not downshift at speeds in excess of the maximum allowable range speeds. For traveling at fast speeds, use 2-wheel drive and lock out the rear steering.

(b) Steering.

1. General. The tractor is equipped with independent front and rear hydraulic power steering. The steering wheel is used to steer the front wheels. The rear wheels can be steered by either the rear wheel steering pedal or lever. Since the systems are independent of each other, the front and rear wheels can be steered continuously and in different directions. Four distinct methods of maneuvering are provided (fig 4-8 A, B, C, D).
2. Independent-front-wheel steering (A). This type of steering is similar to regular automobile or truck steering. If traveling a considerable distance or at fast speeds, the rear wheels should be locked in the straight-ahead position to avoid rear-end drift or accidental rear wheel steer.
3. Independent-rear-wheel steering (B). By using the rear-steering-control lever (or pedal), only the rear wheels are affected. This type of steering is helpful when backing or positioning a towed vehicle. The front axle steering may also be locked out, but this feature is only used for sectionalization, not for normal operations.
4. Articulated steering (C). By coordinating both the front- and rear-wheel steering, the tractor can be turned in a much shorter radius, whether moving forward or backward. The wheels are simply steered in opposite directions.
5. Crab steering (D). By cross-controlling the steering wheel and the rear-steering control lever, the tractor can be made to travel in an oblique direction, with no two wheels moving in the same tracks. This is a useful method of steering when operating at the edge of a shoulder or when positioning the tractor for another dozer pass.

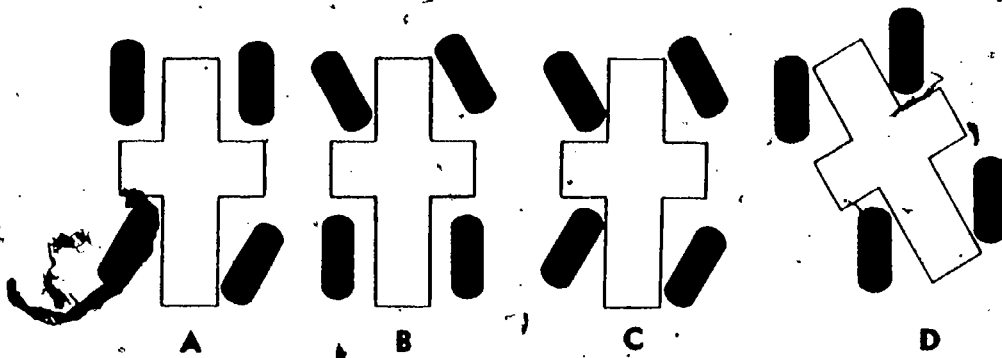

Fig 4-8. Methods of steering the MRS-100 tractor.

(c) Braking.

1. Service brakes. Depressing the brake pedal applies the tractor wheel brakes on all four wheels, and also the brakes of a towed vehicle. The best way to apply the brakes is to depress the pedal as hard as tractor speed and road conditions permit, and then gradually reduce pressure as speed decreases. As the stop is completed, there should only be sufficient air pressure in the brake chamber to hold the tractor stationary. Never apply the brakes lightly at first and increase brake pressure as the speed decreases; this results in a very rough stop. Never "fan" the brake pedals. This only wastes compressed air. Except in cases of emergency, do not fully depress the brake pedal. This causes full braking force to be delivered to

the wheels and should not be necessary in ordinary conditions.

2. Trailer brakes. The trailer brakes can be controlled independently of the tractor brakes by a trailer-brake lever. The lever will remain in any set position until moved by the operator. Trailer brakes are primarily used when going downhill, with the trailed unit (scraper) pushing the tractor. The trailer brakes must be applied first in order to prevent jackknifing the unit. If the service-brake pedal is pressed while the trailer brakes are being applied, the valve which is applying the greatest force will override the other. Thus both valves may be used at the same time and the trailer brakes applied harder than the tractor brakes.

(d) Parking.

1. When parking the tractor on a slope, set the parking brake and lower the dozer blade or scraper to the ground. If there is a bank or ditch close by, turn the tractor into it. This will prevent any possibility of the tractor rolling off should the parking brake be accidentally released.
2. When parking a tractor-scraper combination on a grade, always set the parking brake and lower the scraper bowl to the ground, allowing the full weight of the scraper to rest on the ground.

(5) Dozer-blade operation.

- (a) Dozer-blade operating positions. The dozer-blade control lever operates in the same way as the previously described one for the 82-30M crawler-tractor. Four positions are used: FLOAT, LOWER, HOLD, and RAISE.
- (b) Dozer-blade side tilt. The dozer blade can be tilted by using the tilt control lever which controls an offset tilt cylinder. Three positions are provided: RAISE, HOLD, and LOWER.
- (c) Dozer-blade pitch. The pitch of the dozer blade is adjusted by a single upper strut. Generally the blade is tilted back for soft ground and forward for hard ground.
- (d) Scarifier. Three scarifiers are attached to the dozer blade for back ripping operations. During dozing operations they are held up by pins.
- (e) Sliding-shoe operation. The blade is equipped with two sliding shoes which assist in controlling the blade. The blade can be raised or lowered slightly by adjusting the relative positions of the sliding shoes.
- (f) Travel locks. Two cables are provided to hold the blade in the travel position.

(6) Winching operations.

- (a) The rear-mounted single drum winch is used where powerful, well-controlled line pull is needed, such as freeing bogged equipment. The winch is underwound (pulls from the bottom of the drum) to permit greater line pull without raising the front end of the tractor. When the drum is almost bare, the smaller effective diameter reels cable in more slowly, but with greater power. As the cable spools onto the drum, the line speed increases and pulling power is reduced proportionately.
- (b) Use caution when winching heavy loads, especially if the tractor is driven to move the load and more so if the pull is uphill. Generally, the winch should not be used for towing because there is a possibility of overturning the tractor. It is best to anchor the front end of the tractor and let the winch do the pulling. When using an anchor, chain or cable, keep in mind that the winch cable will seek a straight line between the anchor and the load. In case of a low pull, the rear end of the tractor will be pulled downward and the rear tires may be blown unless blocking is placed under the tractor frame. Do not pull from an angle; align the tractor so that the load is directly behind it to prevent overturning the tractor or unnecessary strain on the winch, winch mounting, or cable. If it cannot be aligned, use snatch blocks and anchor to provide a straight pull from the winch.

(7) Weight-transfer operation.

- (a) The weight transfer is operated by the weight-transfer pedal. When foot pressure is released, the pedal returns to neutral. Two stages of weight transfer are provided, HIGH WEIGHT and LOW WEIGHT. The low-weight position is used during the initial loading of a scraper. As the scraper becomes fully loaded (heavier), the high-weight stage should be used. Do not use the weight transfer while in third-speed range nor in reverse gear. Do not operate the transfer for more than 10 minutes at one time nor more than 30 minutes per hour intermittently. Excessive use of the weight transfer causes overheating of the hydraulic oil and may damage the hydraulic system.
- (b) The weight transfer should be used:
 - When loading a scraper.
 - To prevent wheel spin. Advance recognition of bad traction conditions and use of weight transfer before wheels begin to spin will avoid loss of traction and momentum of the tractor.
 - To provide additional traction on steep grades, slippery roads, and soft roads or fills, use LOW when empty, HIGH when loaded.
- (c) Use caution when making turns with the weight transfer applied. Such turns should be made at slow speeds only. Do not use the transfer in a turn if the stability of the trailing vehicle is noticeably affected or if the tractor is turning sharper than 90° in relation to the scraper.

c. Case MC 580B tractor. Some technical data on this tractor was given in chapter one. We will now describe and locate for you the various controls and instruments for proper operation of the tractor. The case MC 580B tractor is equipped with the normal instruments which are similar to those described in the paragraphs on other tractors.

(1) Instrument panel instruments and controls (fig 4-9).

- (a) Water temperature gage. This gage has three color zones--amber, green, and red. When the pointer is at amber the engine is still cool and not up to normal operating zone. When the pointer is in the green you are at normal operating temperature. The green band has a temperature zone which can vary between 170° F and 220° F. When the engine is too hot the pointer will be in the red.
- (b) Engine oil pressure warning light. This warning light will light when the ignition switch is turned to the ON position and should go off when the engine starts. When the light comes on during operation it is an indication of low or no oil. This is a warning to stop the engine and check for the cause.
- (c) Ammeter. This meter indicates whether the batteries are charging or discharging. It has a red zone for discharge and a green zone for charge. The center between the two indicates 0 amperes.
- (d) Air cleaner indicator. This indicator is a factory-set signal which indicates when the air cleaner filter element requires servicing. As dirt is trapped, the air flow through the air cleaner is reduced, causing a red signal to rise in the indicator. When the red signal is fully exposed, it is locked in position, indicating that air filter element service is required. A reset button, on top of the indicator, must be pressed to reset the the indicator after air cleaner service.
- (e) Tachometer and hourmeter. The tachometer indicates the rpm the engine is turning and the hourmeter registers the number of hours the engine has run.
- (f) Cold weather start control knob. This knob is used to inject starting fluid (ether) into the air intake system to aid in starting.

- (g) Ignition switch. This switch controls the starting circuit and the gage circuit. There are three positions--OFF, ON, and START. The START position has a spring return, so that when the switch is released, it returns to the ON position.
- (h) Transmission oil pressure gage. This gage indicates the clutch oil pressure. If the pointer is in the red zone, the engine should be stopped at once and checked out.
- (i) Transmission oil temperature warning light. This light will come on when the transmission oil is above normal. If the light stays on after a period of idling with all controls in neutral, the engine must be stopped and the cause must be checked out.
- (j) Light switch. This switch controls the tractor lights and panel lights.
- (k) Engine shutoff knob. The shutoff knob is marked STOP. When pulled out, it shuts off the fuel. The knob must be pushed in all the way for the engine to start.
- (l) Fuel gage. The fuel gage indicates the amount of fuel remaining in the fuel tank.

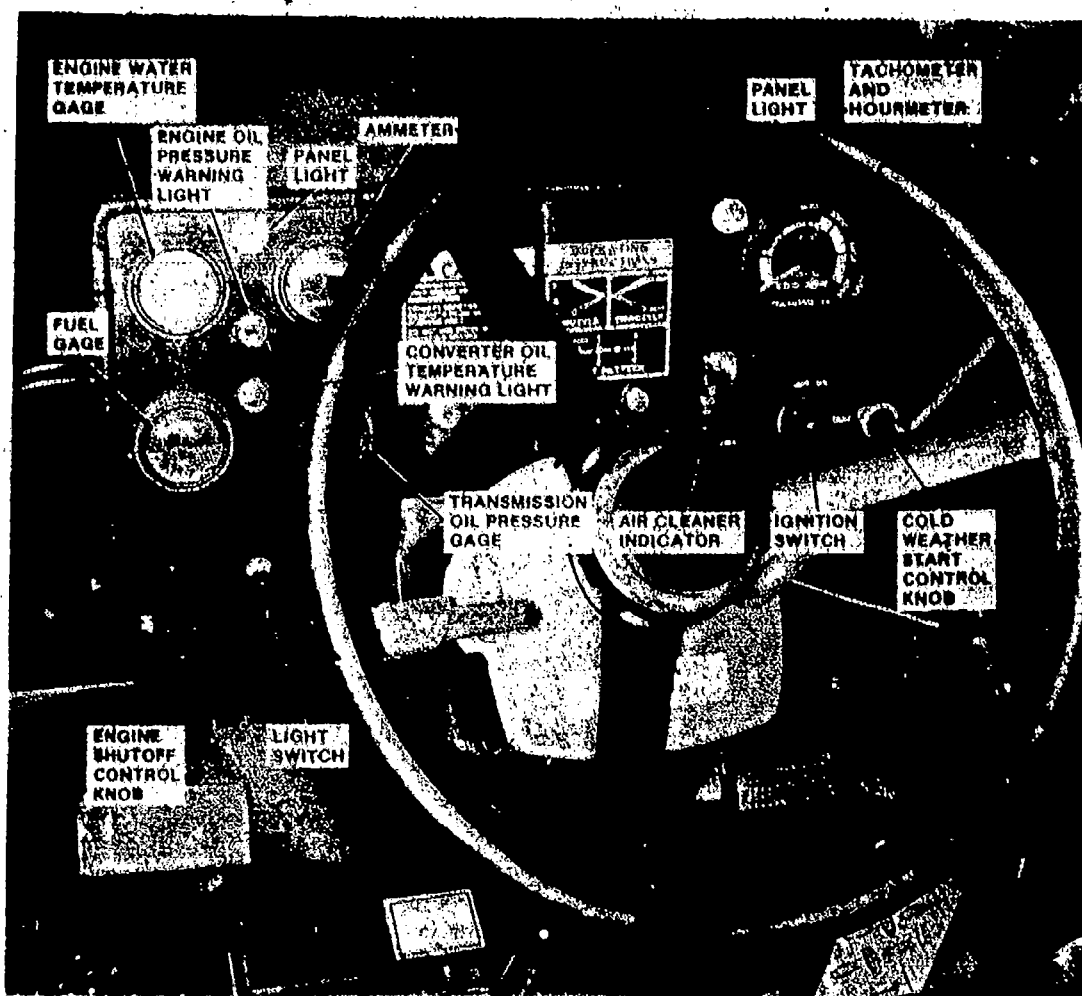

Fig 4-9. Control panel instruments and controls.

(2) Driver's compartment controls (fig 4-10).

- (a) Hand throttle control lever. This lever is mounted on the right side of the steering column, and increases the engine speed when pulled backward and decreases speed when pushed forward.
- (b) Accelerator pedal. This pedal increases engine speed when depressed.

- (c) Clutch-brake pedal. Depressing this pedal will disengage the power clutches within the first 1 1/2" of pedal travel and the remainder of pedal travel applies braking force to the tractor. The pedal must be depressed when selecting gear shift work range. Release the pedal to engage power clutch to operate the tractor.
- (d) Foot brake pedals. These pedals may be used individually for turning assistance or locked together for safe travel or parking.
- (e) Parking brake control lever. This lever applies the brakes for parking when the lever is pulled up.
- (f) Power shuttle control lever. This lever controls the direction (forward or reverse) of movement of the tractor.
- (g) Transmission gear shift lever. This lever is used to select the gear range desired for operating the tractor. Gear ranges apply to both forward and reverse as direction of travel is controlled by the power shuttle. The tractor must be stopped and the foot clutch-brake pedal depressed before shifting into any gear range (fig 4-11). The gear shift lever must be shifted to start the tractor. A neutral start switch, which is located in the transmission, prevents the engine from starting unless the transmission gear shift lever is in the START position.
- (h) Loader control lever. This lever controls all the operation of the loader. Moving the lever back raises the bucket, moving it forward lowers the bucket. When the lever is fully forward the bucket is in float position. Moving the lever to the left causes the bucket to roll back and moving it to the right dumps the bucket. Moving the lever far left and forward automatically returns the bucket from a dumped position to a digging position.
- (i) PTO control lever. The PTO lever is located under the driver's seat. The lever is moved up to engage the PTO and down to disengage.

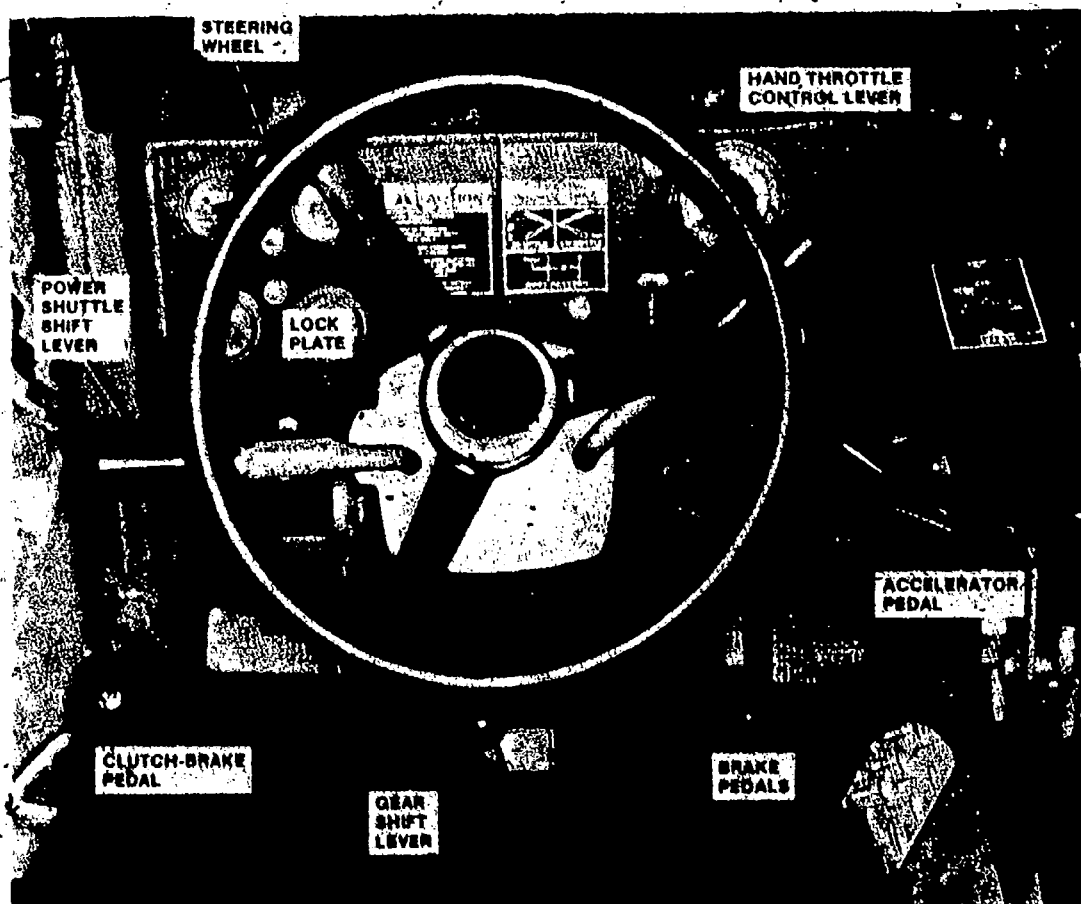

Fig 4-10. Driver's compartment controls.

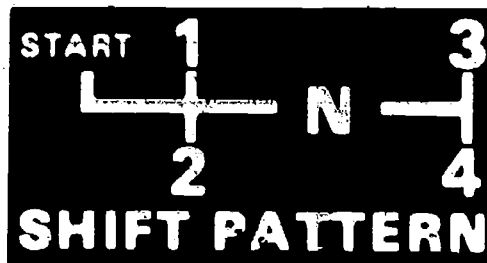

Fig 4-11. Transmission shift pattern.

- (3) Backhoe controls (fig 4-12). These controls consist of five levers located on the backhoe control tower.
- (a) Stabilizer control lever. Moving this lever toward the boom lowers the stabilizer on that side. Pulling the lever back retracts the stabilizer.
 - (b) Bucket control lever. When the control lever is moved toward the boom, the bucket moves to dump position. When the lever is pulled back, the bucket moves to load position.
 - (c) Dipper arm control lever. Moving the control lever toward the boom, moves the dipper arm outward. Pulling the lever back moves the dipper arm in.
 - (d) Boom control lever. Pushing the control lever towards the boom lowers the boom. Pulling the lever back moves the boom up.
 - (e) Swing pedals. These pedals control the swing of the backhoe to right or left. Depressing the right pedal swings the boom to the right; depress the left pedal and the boom swings left.

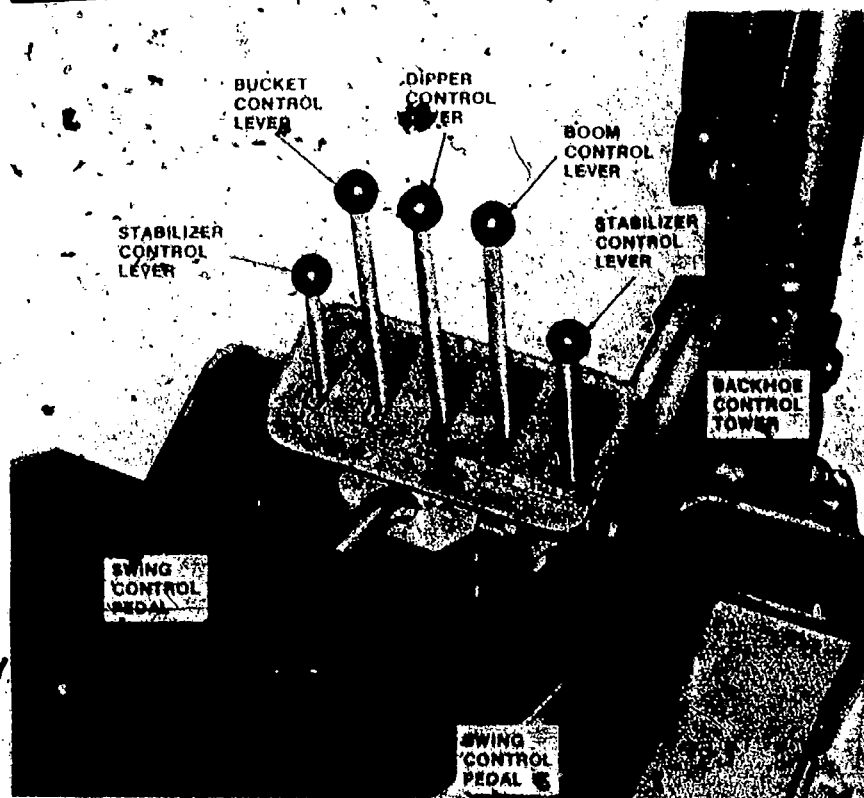

Fig 4-12. Backhoe controls.

(4) Three-point hitch controls (fig 4-13). The three-point hitch is equipped with four hydraulic controls. The lift, pitch, and tilt levers are used to position the hitch. The implement lever is used to control the attachment. The lift control lever is mechanically held when in the float position.

- (a) Lift control lever. Moving the lever to the right lowers the hitch. Full right is the float position. Moving the lever to the left lowers the hitch.
- (b) Pitch control lever. Moving the lever to the right moves the hitch back. Moving the lever to the left moves the hitch forward.
- (c) Tilt control lever. Positioning the tilt control lever to the right causes it to tilt to the right. Moving it to the left will cause the hitch to tilt to the left.

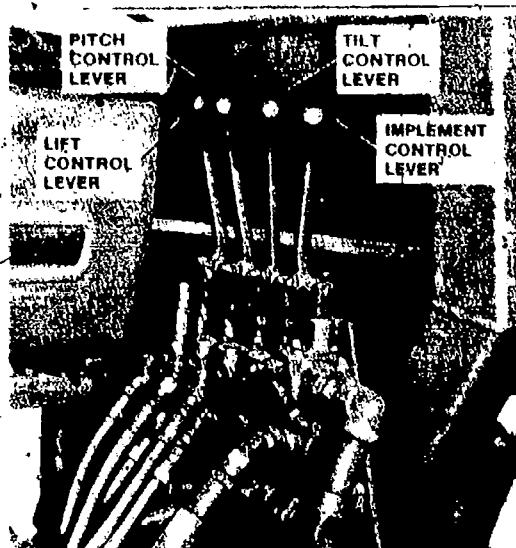

Fig 4-13. Three-point hitch controls.

(5) Starting the engine.

- (a) Perform the operation checks and services before starting the engine.
- (b) Set the parking brake.
- (c) Be sure the power shuttle control lever is in neutral.
- (d) Check to see if the engine shutoff knob is pushed in.
- (e) Open the hand throttle by pushing lever forward about half the way.
- (f) Move the transmission gear shift lever to START position.
- (g) Turn ignition switch to start.
- (h) If the temperature is below 40°F, use the cold weather starting aid.
- (i) Immediately after starting the engine, check the instruments for readings.
- (j) Operate the engine at part throttle and no load for about 5 minutes.

(6) Moving the tractor.

- (a) After the engine has warmed up, throttle it down to idle speed and release the parking brake.
- (b) Depress the clutch-brake pedal and move the transmission shift lever to desired work range.

- (c) To go forward, release the clutch-brake pedal and move the power shuttle control lever forward. To reverse, pull the lever back. Increase the engine speed as required. Direction can be reversed without depressing the clutch-brake pedal.
- (d) To change transmission gear range, stop the tractor, depress the clutch-brake pedal and shift to the desired range.
- (7) Stopping the tractor. Stop the tractor by depressing both foot brakes simultaneously. This cuts power to the wheels and applies braking power at the same time. Then shift the power shuttle control lever and the transmission gear shift lever to the neutral position and set the parking brake. Shut off the engine by pushing the hand throttle all the way forward, and pull out the engine shutoff knob. When the engine stops, push in the shutoff knob.

4-4. DOZER BLADES

a. Classification and use. The most common tractor attachment is the dozer blade, a heavy rectangular steel blade which is mounted on the front of the tractor. The blade is used for pushing earth either straight ahead or clearing trees. Drifting the earth to one side is called "side-casting." The general classification of dozer blades are the bulldozer, the angledozer, and the shear blade (land-clearing).

- (1) Bulldozers. The bulldozer blade is mounted at a right angle to the long axis of the tractor. The blade can be raised or lowered, tilted slightly or tipped forward or backward, but it cannot be angled (figs 4-14 through 4-16). The pitch braces provide a means of tilting and/or tipping the blade. Some tractors are equipped so that the tilt can be changed hydraulically. Adjustment of the blade to soil conditions will greatly increase dozer production. Bulldozer side-plates help retain a maximum load (fig 4-14). The bulldozer is suitable for straight drifting of material and for trenching or back-filling.

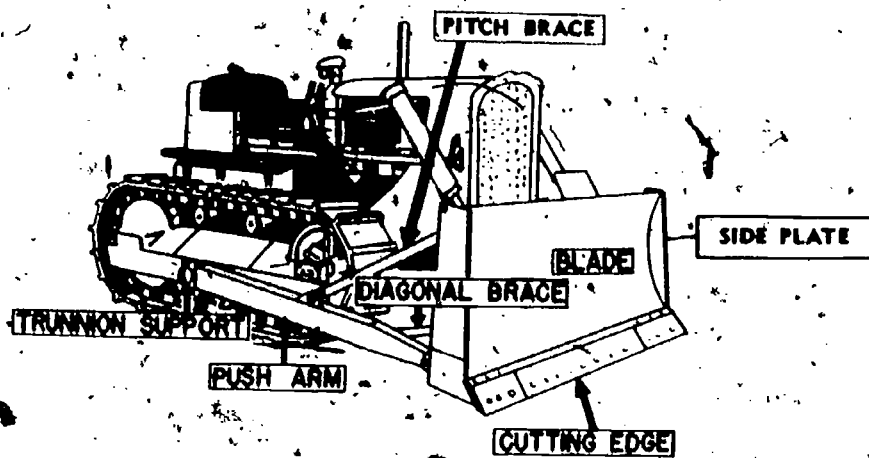

Fig 4-14. Parts of straight blade bulldozer.

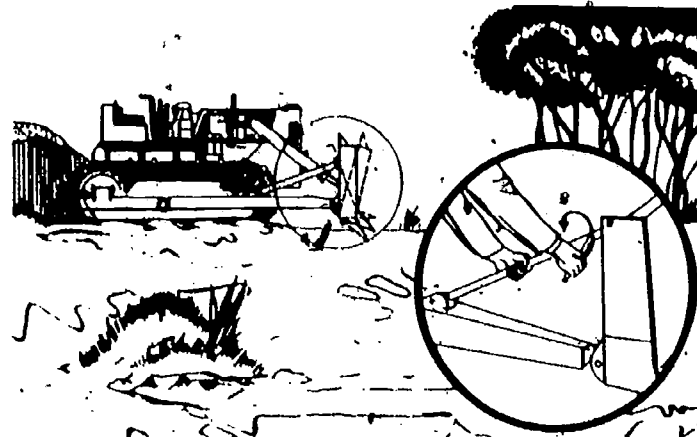

Fig 4-15. Tipping bulldozer blade.



Fig 4-16. Straight drifting of material with bulldozer.

- (2) **Angledozer.** The angledozer (sometimes called a bullgrader) can be both angled and tilted (figs 4-17 through 4-19). The blade is designed so that it can be angled approximately 30° to the right or left for sidecasting. The blade may also be tilted up to 12 inches. The angledozer is the best piece of equipment for pioneering roads and for constructing sidehill roads. Angledozer work should be planned so the operator does not have to stop frequently to adjust the position of the blade.

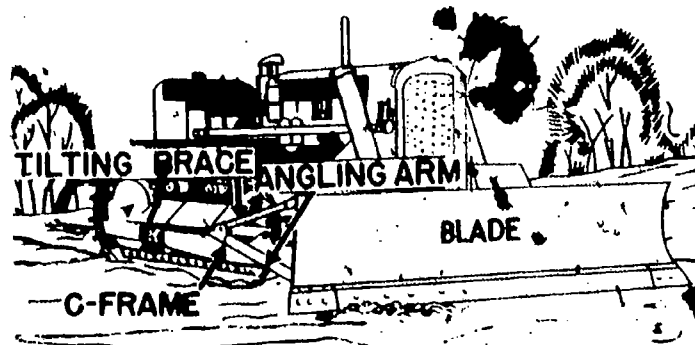

Fig 4-17. Parts of angledozer.

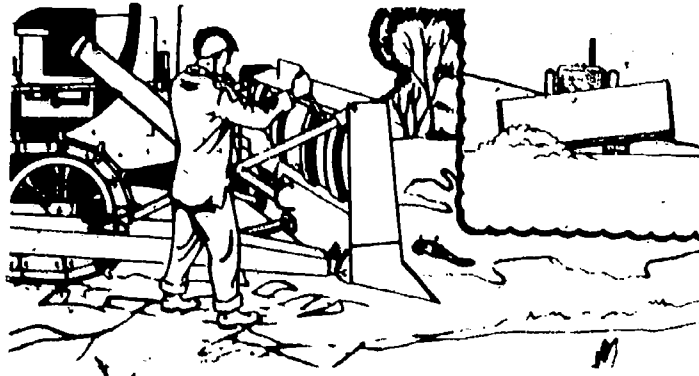

Fig 4-18. Adjustment of angledozer blade.

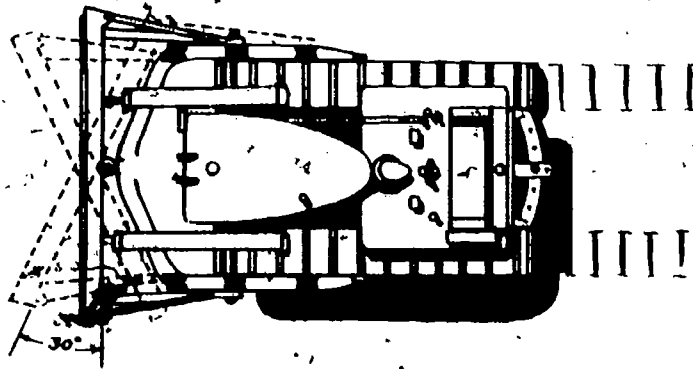

Fig 4-19. Tilting angledozer blade.

- (3) Land-clearing (shear) blade (fig 4-20). An attachment available for use with the 82-30M tractor is the land-clearing blade which is used to clear an area of trees. It is similar to the angledozer, but has a long spearlike part mounted on the leading corner of the blade. The blade is curved more than either the bulldozer or the angledozer and the cutting edge is almost parallel to the deck. The blade angles to the right with the spearlike part attached to the left lower corner. It is capable of cutting trees up to four feet in diameter. The operator controls the height of the cutting edge as he would the cutting edge of the bulldozer or angledozer.



Fig 4-20. Land-clearing blade.

b. Dozer control.

- (1) All of the dozers you will operate in the Marine Corps are hydraulically operated. One key factor in blade control is the speed with which the blade control lever is moved from the hold position to either the raise or lower position, and back to the hold position. The faster you move the lever, the less the blade will move up or down. With the tractor moving forward, the operator should gradually feed (lower) the dozer blade into the ground until it starts to cut. This should be done by lowering the blade in small amounts, until the engine starts to labor. Then raise the blade in small amounts, until the engine ceases to labor. At this time your tractor and the blade should be on the same plane, and you will be taking the maximum possible cut.
- (2) Another key factor to watch for here is the point at which the tractor tilts forward into the path cut by the blade. The blade must be raised in small amounts so that both tractor and blade will be on the same plane (fig 4-21). Remember: it is easier to control a fully loaded blade than a partly loaded one.

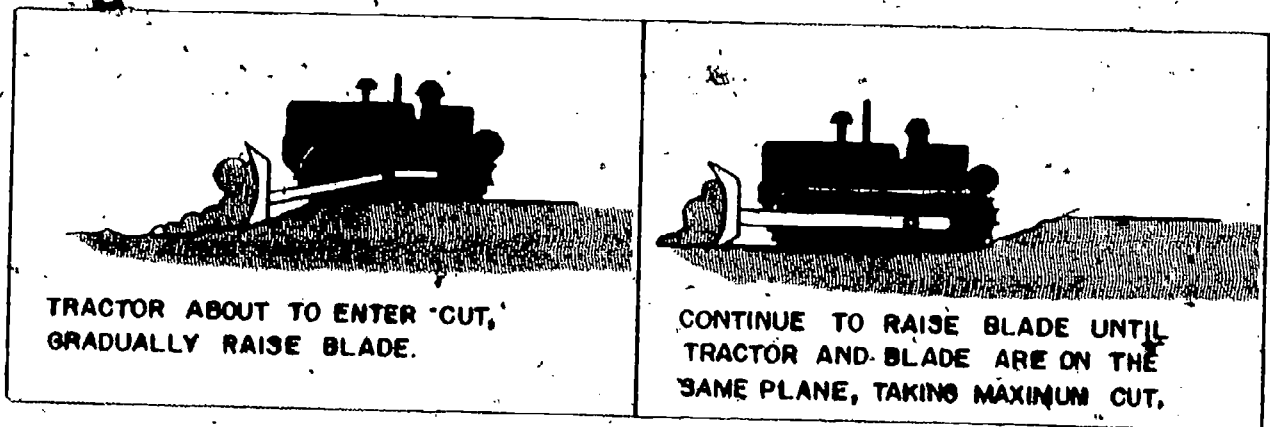

Fig 4-21. Steps in starting a cut.

4-5. DOZER EMPLOYMENT TECHNIQUES

a. Introduction. The dozer is usually the first piece of equipment to arrive on a construction project and the last to leave. The economical hauling distance for a dozer ranges from 25 to 300 feet. Dozers are most effective when operated at maximum practicable speed and in soils which tend to remain in front of the blade during travel. The techniques that will be discussed will save time and increase production, if conditions permit their use.

b. Blade-to-blade or side-by-side dozing. In blade-to-blade dozing (fig 4-22) two or more dozers work abreast, with the blade edges as close together as possible. This prevents spillage around one blade edge on each dozer. Blade-to-blade dozing requires time-consuming maneuvering of the dozers and is therefore not practical for hauls of less than 50 feet.



Fig 4-22. Side-by-side dozing.

c. Slot dozing. In slot dozing (fig 4-23) the dozer makes several passes in the same tracks which builds up a pair of windrows. These windrows form a trench, preventing spillage around the ends of the dozer blade. Cut sections, where possible, should be "slotted" alternately, leaving narrow uncut sections between slots. The narrow uncut sections can then be removed by normal dozing.

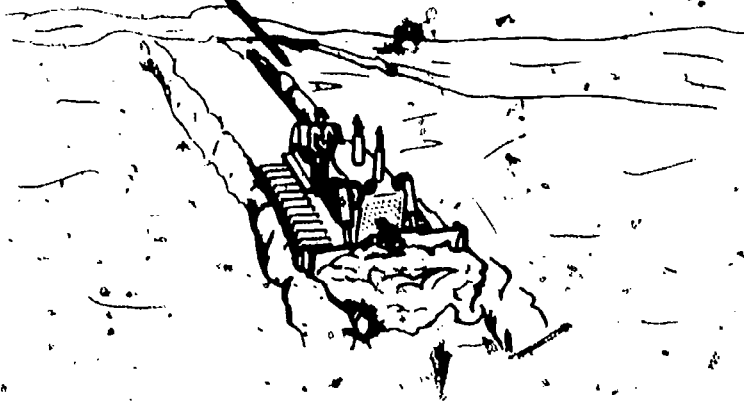

Fig 4-23. Slot dozing.

d. Downhill dozing. Another method of increasing production is to work downhill whenever possible. With the assistance of gravity a dozer can push a far greater load downhill than it can push on level ground. When dozing down a steep hill, pile several loads at the brink of the hill and then push them all to the bottom in a single pass.

4-6. CONSTRUCTION OPERATIONS

a. Clearing.

(1) Brush and trees. To clear brush and small trees, travel forward in low speed with the blade lowered a few inches into the ground to cut the roots (fig 4-24). You can make one pass knocking over trees and brush, back up, and make another pass to clear them away. The land-clearing blade can also be used to cut the trees and brush at or above ground level.

(a) Small and medium. Medium trees from 4 to 10 inches in diameter should be pushed over with the blade raised as high as possible to gain extra leverage (fig 4-25). Push the tree over slowly and back up as the tree falls, to keep the tractor free from the rising roots. You can now lower the blade, move forward and dig the roots free with a lifting pushing action. Cut medium trees by lowering the land-clearing blade to the desired height and driving the tractor forward so that the land-clearing blade will contact the tree near the left edge. Cutting the tree will leave a stump and caution must be exercised to prevent damage to tractor or injury to operator. Push the felled tree to the disposal area.

(b) Large. For trees over 10 inches in diameter, the removal is slower and more difficult. A preliminary contact should be made with the tree, inspecting for dead limbs which might break off and fall on the operator. Contact should be made gently with the dozer blade high and centered for maximum leverage. Before pushing over a huge tree, the direction of fall (which is usually the direction of lean) should be determined. If the tree cannot be pushed over, it must be removed by another method, one of which is shown in figure 4-26. First, the roots are cut on the side opposite the direction of fall. Then the roots on both adjacent sides are cut. The excavated earth is used to form a ramp above the first cut so that greater pushing leverage can be obtained. The tree is then pushed over. The operator should reverse the tractor quickly as the tree starts to fall in order to get away from the rising root mass. It may sometimes be necessary to cut the roots on the fourth side when large or well-rooted trees are being removed. When the trees are removed, the area should be filled and leveled to prevent water from accumulating. To cut these trees with a land-clearing blade, drive the tractor forward so that the spear-like part will split the tree and shear off a portion at a time. Start the cutting at any level desired above ground level. Observe some general safety precautions as outlined for pushing trees over with the bulldozer.

(c) Stumps. Stumps are removed in much the same manner as trees. Stumps and trees should be removed from the construction site individually. Piling is avoided because of the difficulty of removal when they become entangled. Care should be taken when pushing the trees and stumps, that the dozer blade does not ride over them and "hang up" the tractor. Dozers are never worked close together when clearing trees; one machine may push a tree over on another. The land-clearing blade can be used to push trees and stumps out of the area after they have been removed from the ground.

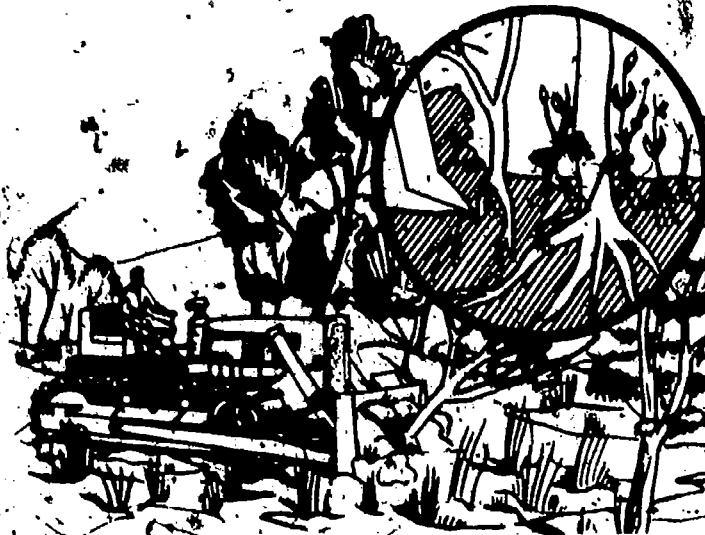

Fig. 4-24. Bulldozer removing brush and small trees.



1. Raise blade and push tree over.
2. Back up, drop blade, lift roots free.

Fig 4-25. Bulldozer removing medium-sized trees.

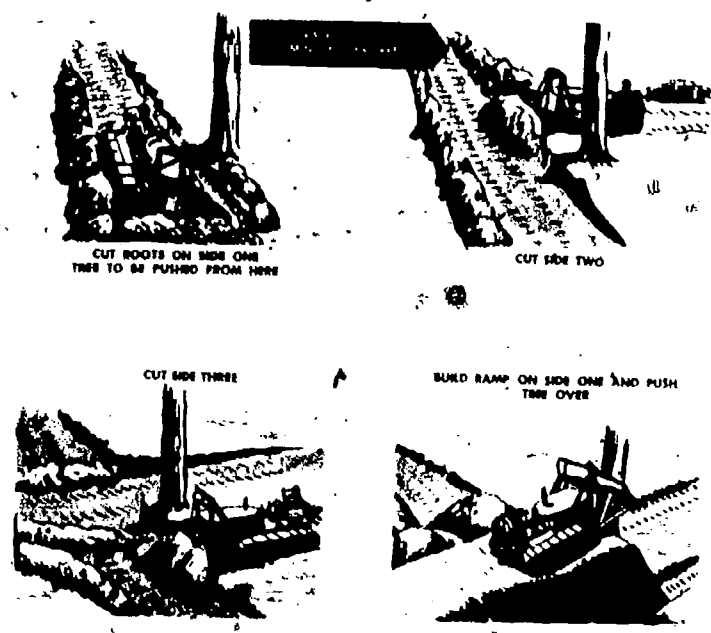

Fig 4-26. Four steps for removing large trees with bulldozer.

(2) Rocks and boulders. A dozer with a tilted blade is the most effective piece of equipment for removing rocks and boulders. With the blade tilted, remove the earth from three sides of the rock. The dozer should then push from the uncut side, letting the blade penetrate deep enough to get under a portion of the rock. The dozer moves forward, pushes the rock and lifts it with the blade. This combined pushing and lifting action is similar to stump removal, and provides a means of rolling the rock, boulder, or stump.

b. Sidehill cutting. The angled dozer is the best piece of equipment for this operation because of its sidecasting action. A sidehill cut should be worked from the top of the proposed road downward, if possible. After getting to the top of the hill, the angled dozer proceeds to form a level shelf or bench as shown in A, figure 4-27. After the bench is formed, the tractor starts working parallel (B, fig 4-27) to the centerline of the road. Work is started, if possible, at a point close to the slope stakes on the high side of the hill. With the blade angled and tilted to keep the dozer digging low on the inside (against the hill), the dozer begins to work its way downhill, sidecasting material to the outside edge of the road. Care should be taken to continue the cut along the uphill slope stakes, keeping the road low on the inside. This should eliminate potentially dangerous overhangs. Work the material gradually to the outside, being particularly careful when working close to the soft, downhill side of the cut.

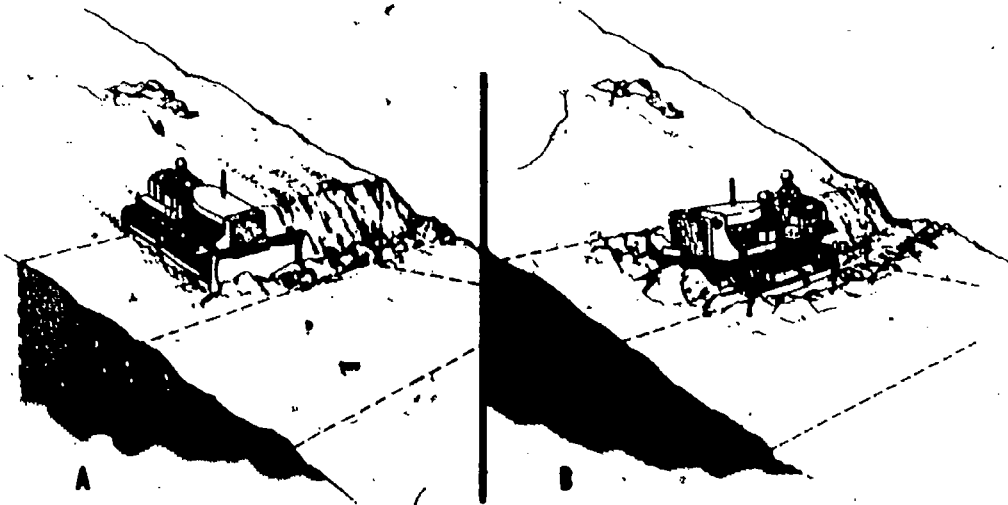

Fig 4-27. Starting sidehill cut on gentle slope.

c. Finishing side slopes. Two common methods of finishing a side slope are shown in figure 4-28 and figure 4-29. In finishing side slopes by working parallel to the right-of-way (fig 4-28), the dozer starts at the top and makes a series of overlapping passes along the slope. Irregularities in the ground will be filled as the windrow is worked down the slope. In finishing side slopes by working diagonally, the dozer starts at the bottom and works diagonally up the slope (fig 4-29). A windrow is formed and is continually drifted to one side by a series of overlapping passes, filling in low spots or irregularities. This is one of the few instances where a dozer may be most effectively employed by cutting uphill. You must know the capabilities of your equipment to perform these operations safely. Learn what degree of slope your tractor can negotiate safely under different soil and weather conditions.

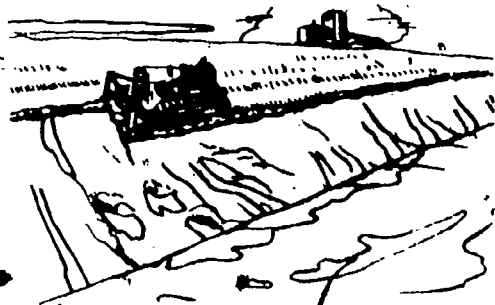

Fig 4-28. Parallel method of finishing a side slope with a dozer.

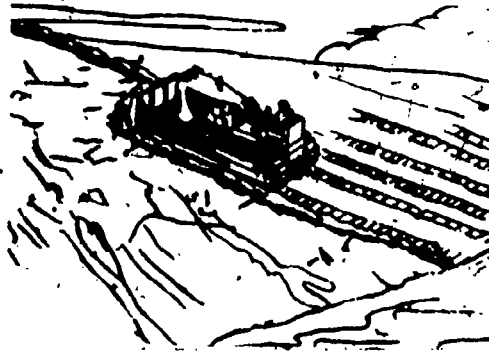

Fig 4-29. Diagonal method of finishing a side slope with a dozer.

d. Backfilling. Dozers are the best pieces of equipment for backfilling, because material is pushed directly ahead of the machines over banks into ditches, or directly against a structure. When backfilling culverts, crawler tractors should not cross over the culvert unless there are 12 inches of solid material on top of the culvert (fig 4-30). The operator should raise the blade as the dozer nears the trench or abutment, permitting the fill material to be placed with a minimum of force. This will tend to leave an excess of material, which will allow for the compaction or settling of the fill material. It will also tend to keep the dozer from applying too much pushing force against a structure, causing it to collapse.

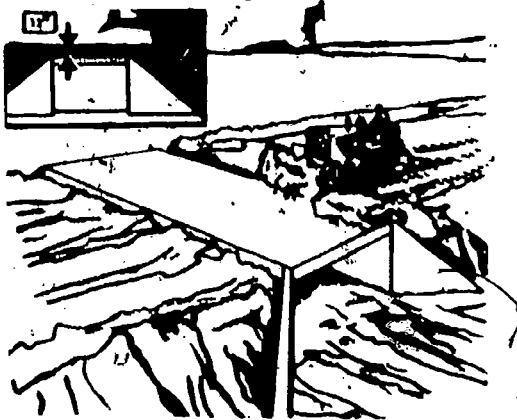

Fig 4-30. Backfilling a culvert with a dozer.

e. Ditching. Although the grader is better suited for ditch work, the angled dozer can efficiently construct V-type ditches. The blade should be angled and tilted. Line up the tractor parallel to, and about 2 feet from the stakes marking the ditch. Make a light cut the length of the ditch. Back up and get the outside track on the windrow. Make as many cuts as necessary to bring the ditch to grade. By keeping the cuts light, you will have better control of the blade. After the first pass, you will probably have to readjust the amount of tilt on the blade. After finishing one side of the ditch, turn the tractor around and cut the other side of the V-ditch in the same way.

4-7. DROTT 4-IN-1 SKID SHOVEL FRONT END ATTACHMENT

a. General. The 2-piece, hinged, Drott 4-in-1 front-end attachment (fig 4-31) makes it possible to use the Case MC 1150 scooploader and the 72-31MP Terex tractor as a skid shovel, bulldozer, scraper, or clamshell. As a skid shovel, the tractor is capable of breaking out stubborn materials with an applied force three times the lifting capacity of the tractor. As a bulldozer, the clam is opened, revealing an efficient bulldozer with radius control moldboard for smooth dirt-rolling action. By opening the clam slightly, the tractor becomes a scraper, and it is possible to control a smooth slicing action designed to accurately strip sod, topsoil, or clay. With positive hydraulic action it is possible to operate the tractor as a clamshell for removing stumps and trees and carrying them to trucks. This highly versatile attachment is standard equipment on the Case MC 1150 scooploader and the 72-31MP Terex tractor.

b. Controls (fig 4-32). The bucket hydraulic control levers on the Case MC 1150 scooploader actuate spools in the hydraulic control valve to apply hydraulic pressure to one end of the corresponding cylinders and to provide a return from the other end of the cylinders. The center position for each lever is a hold position for the corresponding cylinders.

c. Operation.

- (1) Skid shovel. As a skid shovel, the loader can dig, transport materials, back fill, load trucks, and level uneven ground. To pick up and transport objects on the Case MC 1150 scooploader, move the loader control lever forward or backward as required until the indicator rod on the tilt cylinder (fig 4-33) points to the skid shovel position. Then use the clam-opening lever to fully close the bucket. Lower the bucket until it comes in contact with the ground. As the tractor moves forward you can control the depth of cut by moving the loader control lever to the right or left. When the bucket is filled, tilt it back, lift the load slightly, and semi-skid on the skid shoes. The bucket should be tilted all the way back when transporting a load.

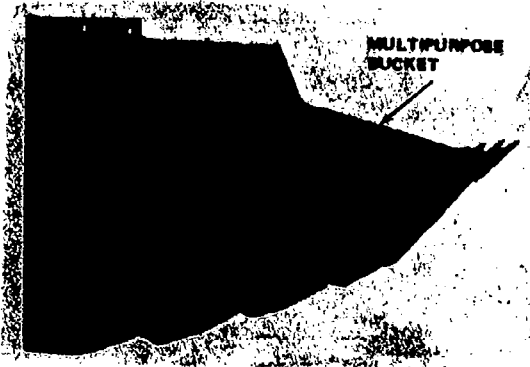

Fig 4-31. Drott front end attachment.

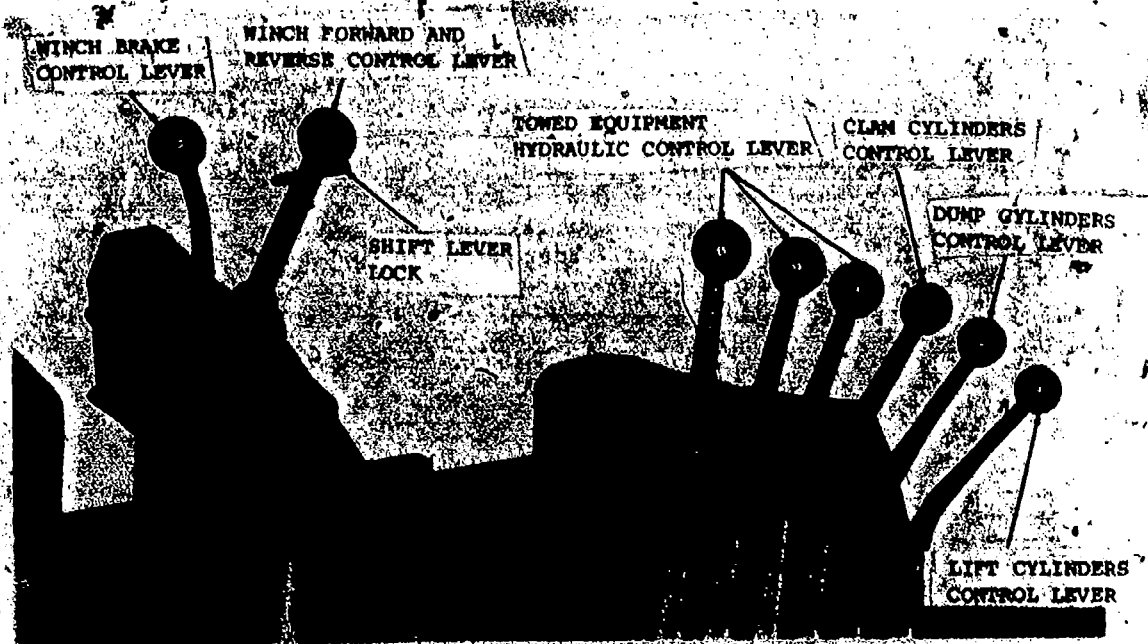

Fig 4-32. Case MC 1150 control levers.

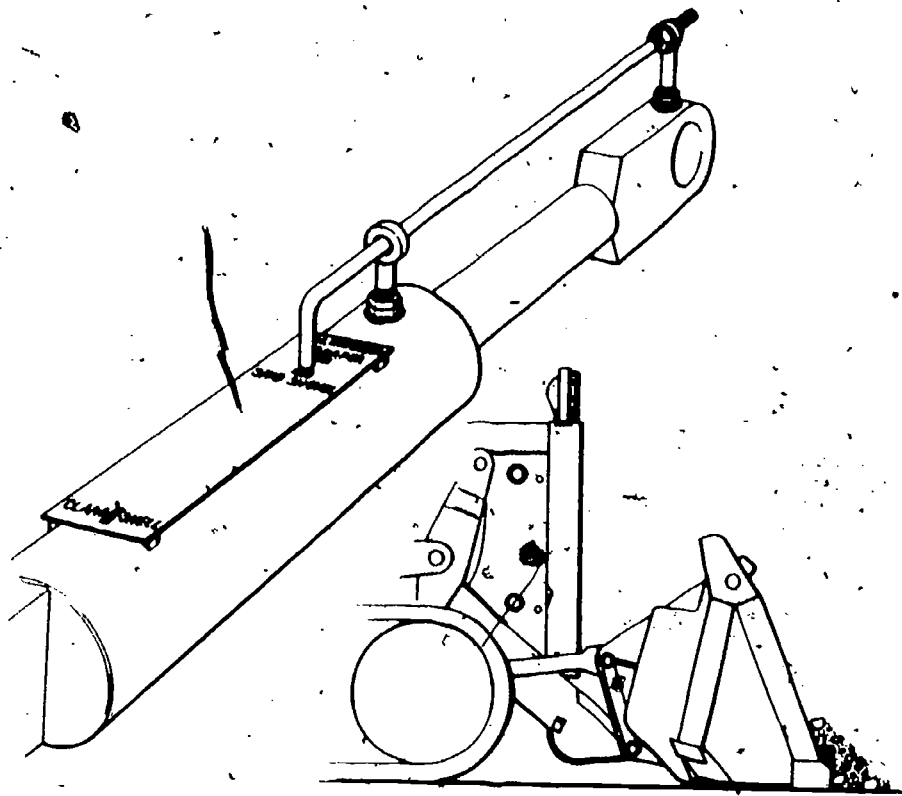

Fig 4-33. Tilt cylinder in skid shovel position.

The bucket may be dumped by either of two methods. First, the conventional forward skid shovel dumping action, and second, the bottom dumping action of the 4-in-1 bucket. Moving the loader control lever to the right will forward dump the load. To bottom dump the load, position the floor of the bucket horizontal with the ground and then use the clam-opening lever to open the clam. When you are loading trucks make sure the bucket does not strike the side of the truck, and allow enough room for the dumping action of the bucket. After you have dumped the load, raise and/or tilt the bucket so that it will not strike the sides of the truck as you reverse the tractor.

- (2) **Scraper.** As a scraper, the loader is capable of stripping, to a carefully controlled depth, a layer of topsoil or other material from the ground. It may also be used for leveling rough ground in this position. Use the loader control lever to position the indicator rod at the scraper position. Also move the clam-opening lever to the right for the desired cut. The clam-opening indicator, on the right rear of the 4-in-1 (fig 34) indicates the exact cut that will be obtained. When moving forward, the moldboard cutting edge will enter the ground until the compaction plate makes contact, thus giving a cut to the depth indicated on the plate on the rear of the moldboard (fig 4-34).

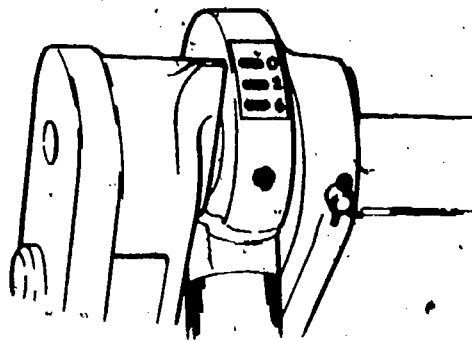

Fig 4-34. Clam-opening indicator.

- (3) **Bulldozer.** As a bulldozer, the loader is capable of moving, smoothing, and spreading large volumes of dirt for a short distance. Use the loader control lever to move the indicator rod on the tilt cylinder to the bulldozer position and use the clam-opening lever to open the bucket completely. Lower the bucket until the left-arm shoes are on the ground. You can regulate the depth of cut by moving the loader control lever to the right or left while you are moving forward.
- (4) **Clamshell.** Clamshell operation of the loader is especially efficient for handling stockpiles of loose material or for handling sticky, cohesive materials. Position the indicator rod on the tilt cylinder at the clamshell position and open the bucket completely. To pick up objects or load as a clamshell, pull both levers to the left. This will close the clam and roll the bucket simultaneously. When stockpiling, lower the fully opened bucket onto the pile by using the float position of the loader control lever.

4-8. TRACTOR AND DOZER SAFETY PRECAUTIONS

a. **General.** Each item of equipment has specific safety precautions listed in the technical manual and/or operator's manual. In addition, every organization in the Marine Corps has safety rules and regulations which you are required to know. Safety depends on you. Know and practice the safety rules and regulations for your particular piece of equipment. Safety is primarily commonsense, and the best rule when operating equipment is: **WHEN IN DOUBT, SLOW DOWN.**

b. Precautions.

- (1) Keep your equipment clean. Wipe up excess grease and oil. Tools should be kept clean and in their proper places.
- (2) Shut down the engine when refueling the tractor. Keep the funnel or hose nozzle in contact with the metal rim of the fuel tank. This will provide a ground as a safeguard against static electricity.
- (3) When dismounting from or securing your dozer, rest the blade on the ground, place the transmission in neutral, and engage the tractor master clutch. The 82-30M and the Case MC 1150 scooploader require that the attachments be grounded, the controls placed in neutral, and the brakes engaged.
- (4) If the tractor is parked on a slope, lock the steering brakes.
- (5) Do not attempt to perform any unnecessary repairs, adjustments, or preventive maintenance services with the engine running. If the engine must be running, make a preliminary adjustment with the engine stopped, then the final adjustment. If at all possible have one man that has been instructed on how to stop the engine stand by while making an adjustment with the engine running.
- (6) Slow down when traveling over rough terrain or obstacles. High speed is hard on the equipment and the operator.
- (7) Sit--do not stand--when operating.
- (8) When operating at night, in congested areas, or close to buildings, have a signal man on the ground to direct you.
- (9) Watch your terrain closely. If you have any doubts about it, stop, dismount from the tractor, and go ahead on foot. Don't go over the crest of a hill blindly.
- (10) When removing trees, check for dead limbs before you start to work. Be especially careful when felling dead trees.
- (11) When towing another piece of equipment with a tow cable or chain, take up the slack slowly. Sudden jerks cause unnecessary strain on equipment and may break the chain or cable.
- (12) When towing equipment such as compressors, trailers, and scrapers, you must be especially careful when making turns. It is possible to turn so sharply that the towed vehicle cannot follow. When this happens the tongue of the towed vehicle may be bent or broken.

- (13) If maintenance must be performed on the dozer blade while it is raised in the air, the blade must be blocked up to keep it from accidentally falling.
- (14) Do not operate too near the edge of a fill; the edge may give way, overturning the machine. When pushing earth over a steep embankment, raise your blade and keep a large pile of earth at the brink. This will serve as a guide and help keep the dozer from dropping suddenly.

Section II. TRACTOR-DRAWN EQUIPMENT

4-9. SCRAPERS

The scraper is one of the largest earthmoving machines. Scrapers are capable of digging, loading, hauling, dumping, and spreading large amounts of material. They are particularly useful on large earthmoving jobs, such as airfield construction and road projects located in rolling terrain containing many cuts and fills. They make shallow cuts while loading, transport large loads for considerable distances at relatively high speeds, and spread material in thin, uniform layers. Crawler-tractor-drawn scrapers should be used on hauls between 300 and 1,500 feet. Rubber-tired-tractor-drawn and motorized scrapers are more efficient for distances between 900 to 5,000 feet because of their speed. Heavy or consolidated soils may require the use of tractor-drawn rippers and of pusher tractors to assist in obtaining maximum loads, particularly when scrapers are drawn by rubber-tired tractors.

a. Scraper mechanism. The Marine Corps uses several models of scrapers; however, the scraper mechanism is basically the same. The movable parts of the mechanism are the bowl, the apron, and the ejector plate (tailgate).

- (1) Bowl. The raising and lowering of the scraper body or bowl is controlled by hydraulic cylinders.
- (2) Apron and ejector. The apron and ejector are controlled by the hydraulic components. When material is being dumped the apron rises first. When the apron reaches top position, the ejector plate starts to move forward. Return springs are used to assist in returning the ejector plate to its rear position, after which the apron will return to its closed position (fig 4-35).

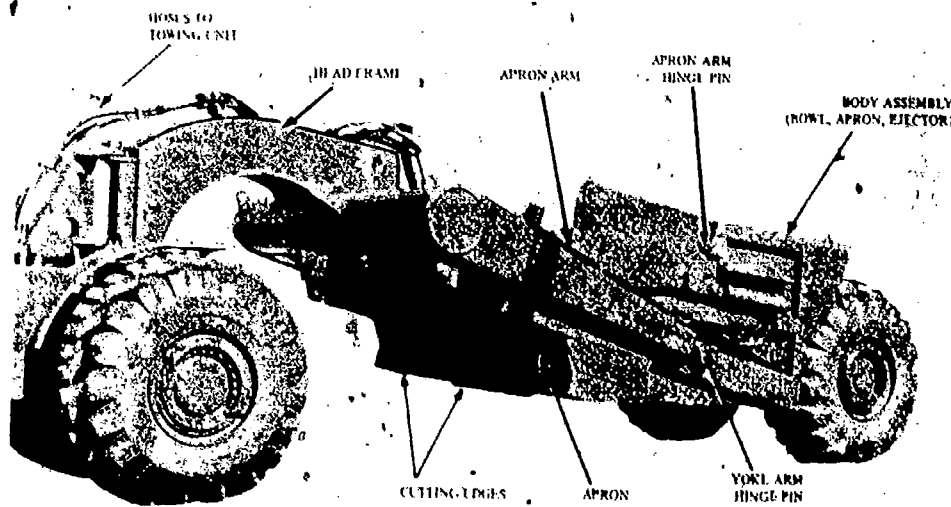

Fig 4-35. Towed scraper.

- (3) Cutting edge. The leading edge of the bowl is equipped with reversible, replaceable cutting edges (fig 4-36). The center portion (stinger bit) extends lower than the end sections. This aids in loading the material into the center of the scraper. The two outer sections are known as end sections. The leading edge of the bowl is also equipped with routing bits which assist in controlling scraper cuts. All cutting edges should be reversed or replaced before they are worn down to the bowl frame.

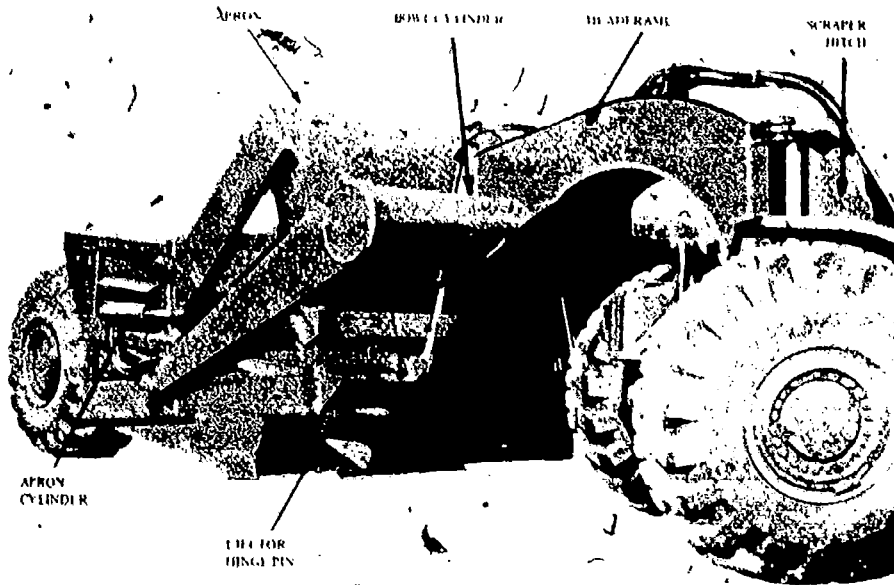

Fig 4-36. Scraper with apron open.

b. Maintenance. The operator's manual or TM will give complete instructions for a particular model scraper. It will give lubricating, operating, servicing, adjusting, inspecting, and maintaining instructions. It will also give any special procedures that should be followed when connecting the scraper to a tractor.

- (1) Inspection. Before attempting to attach a tractor to a scraper, examine it carefully for loose, broken, misaligned, or worn parts. Be sure the hydraulic components are in operating condition. It is often easier to replace these items before complete failure. Remember, the hydraulic scrapers do not have the facilities to lift the drawbar; you will need to block it up. Back the prime mover (tractor) close to, and in line with, the scraper drawbar and insert the drawbar pin when the holes are lined up. The hydraulic hoses and weight transfer cylinder are connected after the tractor and scraper are connected. Be sure the correct lines are connected and that the connections are tight. Although the connections are protected, the joints should be inspected and cleaned if necessary before making the connection. Any dirt at the connection will cause a leak and/or enter the hydraulic system to cause internal damage. Walk around and inspect the equipment before moving it.
- (2) Lubricating. The scraper should be lubricated at the same time the prime mover is serviced. The majority of moving parts are lubricated every 10 working hours. Check the lubrication guide for your particular piece of equipment.
- (3) Tire service. Correct tire inflation is essential to obtain maximum tire service life. Underinflation causes uneven wear, sidewall radial cracks, ply separation, and loose or broken cords inside the tire. Overinflation causes high cord stress, which in turn reduces resistance to impact blowouts and increases the danger of rock cutting. Air pressure should be checked during a prestarting check. Do not check or bleed the air from hot tires to reduce the pressure to that prescribed in the manual. If you do so, the air pressure will drop to dangerous underinflation when the tires cool at the end of the day. The tire pressure must be equal in all tires, or the scraper will not cut evenly.

c. Scraper operation.

- (1) Scraper operating cycle. The major steps in a usual scraper operating cycle are as follows: 1, loading in the cut (an area which needs to be cut down to grade is called a cut); 2, hauling the load to the fill (an area which needs to be brought up to grade is called a fill); 3, unloading and spreading the load in the fill; and 4, returning to the cut.
- (2) Loading. Enter the cut with the ejector plate to the rear and the apron raised 4 to 8 inches above the cutting edge. This will leave an opening large enough for the material to enter without piling up in front of the apron, while keeping the apron low enough to retain the material in the bowl. If material starts to pile up, open the apron wider.

Note: The nature of the material being loaded and the condition of the loading area will determine which gear should be used during the loading operation. For light, loose material, you can use a relatively high gear; for heavy, compact material you will have to use a lower one. Lower the cutting edge into the ground gradually to insure a smooth, regular cut. A cut of 2 to 4 inches is normal. Raise the bowl slightly as the rear scraper wheels enter the cut zone to maintain an even cut (fig 4-37).

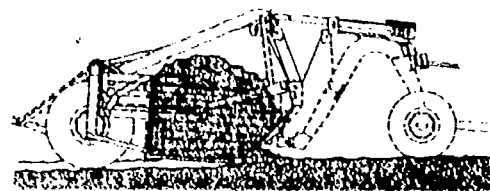
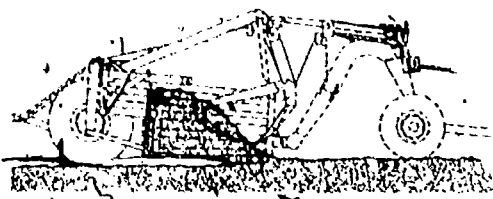

Fig 4-37. Partly loaded scraper.

Fig 4-38. Fully loaded scraper.

As the scraper moves forward, the cutting edge will dig into the material and force it up into the scraper bowl. As the bowl fills, the material will pile up first against the ejector plate (fig 4-38), and finally against the back of the apron. When the bowl is filled to capacity, place the ejector power control unit lever in the "free" position; this will allow the weight of the material to gradually close the apron as the scraper bowl is raised. Raise the bowl 1 to 2 inches above the surface of the ground while continuing the forward motion of the scraper. This procedure will spread any loose material piled in front of the bowl, and thus leave a smooth, uniform grade for entry to or exit from the cut.

Note: Maintaining a moderate crown in the cut will permit the scraper to work nearer to the side or edge without sliding away from it. If possible, cuts should be planned and worked so that they provide natural drainage.

- (a) Wet material. When loading wet, sticky material where traction is bad, best results will be obtained by taking a thin cut. Keep the apron as low as possible to prevent material from backing up in front.
- (b) Sand and gravel. Loose sand is difficult to load because the material has a tendency to float ahead of the blade instead of entering the bowl (fig 4-39). This tendency may be overcome by a procedure called "pumping." Pumping is done by raising the apron about 3 feet and lowering the bowl while traveling in a high gear, thus taking advantage of momentum. Load until the engine lugs down. At this point sand will be pushed up in a pile ahead of the blade. Shift into low gear, lower the apron into the pile of sand and continue loading. The bowl is alternately raised and lowered, allowing engine rpm's to pick up as needed to maintain forward movement (fig 4-39). The operation is repeated until the scraper is loaded. Gravel is handled in a similar manner. However, at times it may be difficult to close the apron. If this should happen, back the scraper a few inches, lower the apron, and raise the bowl.

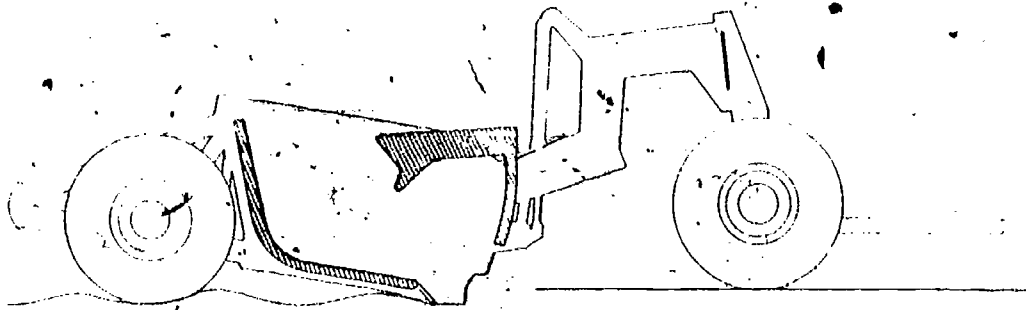

Fig 4-39. Scraper loading sand with pumping action.

- (c) **Rocks and stumps.** Figure 4-40 illustrates the method of bringing a scraper blade against a rock or stump which is too large to be passed over by the prime mover. To unload a rock or stump, stop the scraper, raise the apron, and pull the ejector plate forward. After the object has fallen out, turn the prime mover and back up so you can pull away without contacting the object with the scraper.

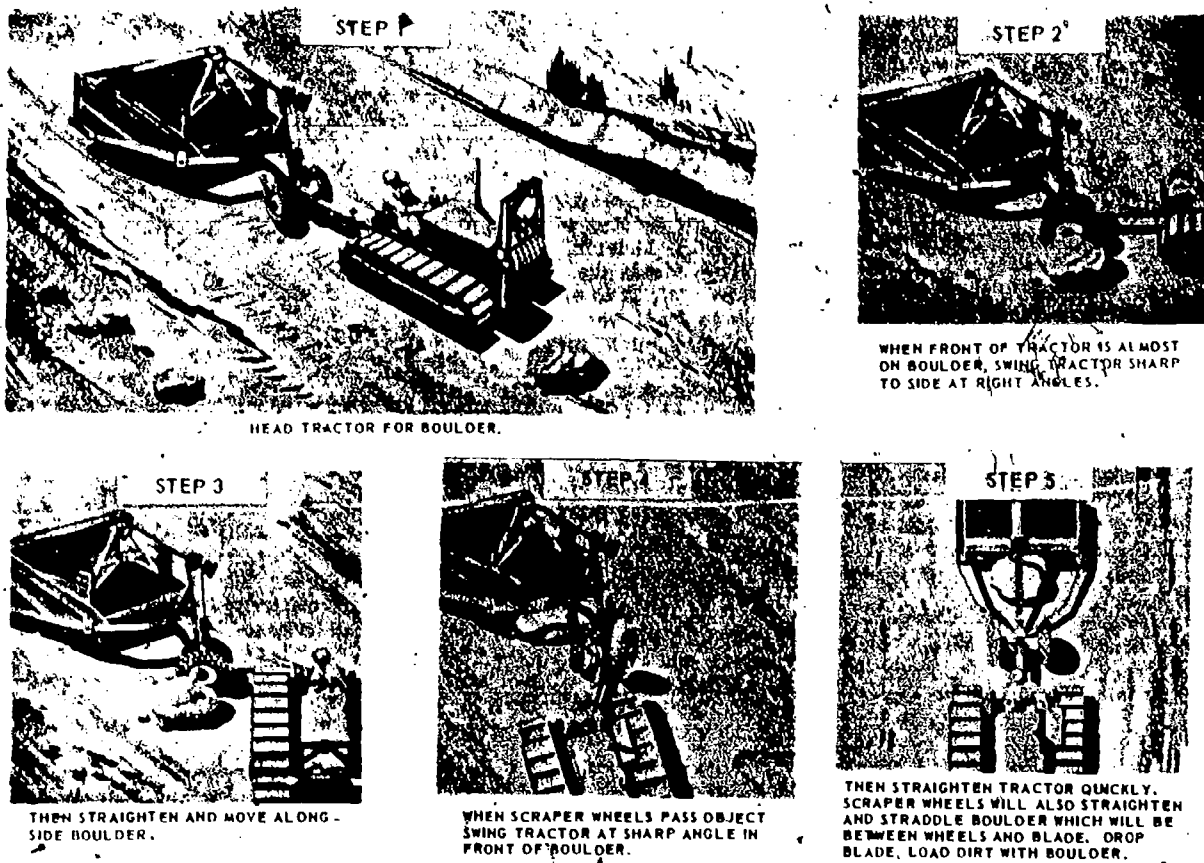

Fig 4-40. Scraper loading boulder.

- (d) **Sidehill cuts.** The best way to start a sidehill cut for a scraper is to use a bulldozer as described previously. If you do not have a bulldozer, you can start a sidehill cut as illustrated in figure 4-41. Raise the apron 6 or 8 inches and climb the slope at right angles to the line-of-slope stakes. When the front end of the prime mover is within a few inches of the stakes, swing the prime mover around parallel with the line of stakes, while at the same time lowering the blade into the ground. The scraper will follow the prime mover through the turn and, as it does, the blade will cut into the hillside. To get a level bench suitable for starting the lengthwise cut, it may be necessary to make several passes in this manner. Use caution when working on slopes; it is possible to turn the tractor and scraper over or have them slide down the hill sideways.

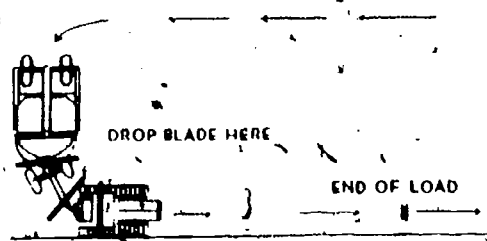

Fig 4-41. Opening sidehill with scraper.

- (e) Side sloping. Figure 4-42 shows a method of side sloping with a scraper. The use of this method of side sloping will enable the scraper to maintain the correct slope ratio.



- 1 WORK IN LAYERS ACROSS AREA TO BE SLOPED
- 2 WORK FROM TOP OF SLOPE DOWN
- 3 AFTER EACH LAYER IS CUT, START NEXT CUT AGAINST SLOPE, ALLOWING BLADE TO CUT TO GRADE
- 4 STEPS WILL REMAIN TO BE FINISHED BY OTHER METHODS OR EQUIPMENT

Fig 4-42. Side sloping with a scraper.

- (f) Downhill loading. Downhill loading uses the force of gravity on the tractor, scraper, and load to get larger loads in less time. This method should be used in a cut whenever possible.

- (g) Straddle loading. When it is necessary to load on the level as in light cuts and stripping, straddle loading (fig 4-43) is used to increase yardage hauled. This method gains yardage on every third trip, because the center strip loads with less resistance to improve performance. Maximum efficiency is obtained when downhill loading and straddle loading are combined.

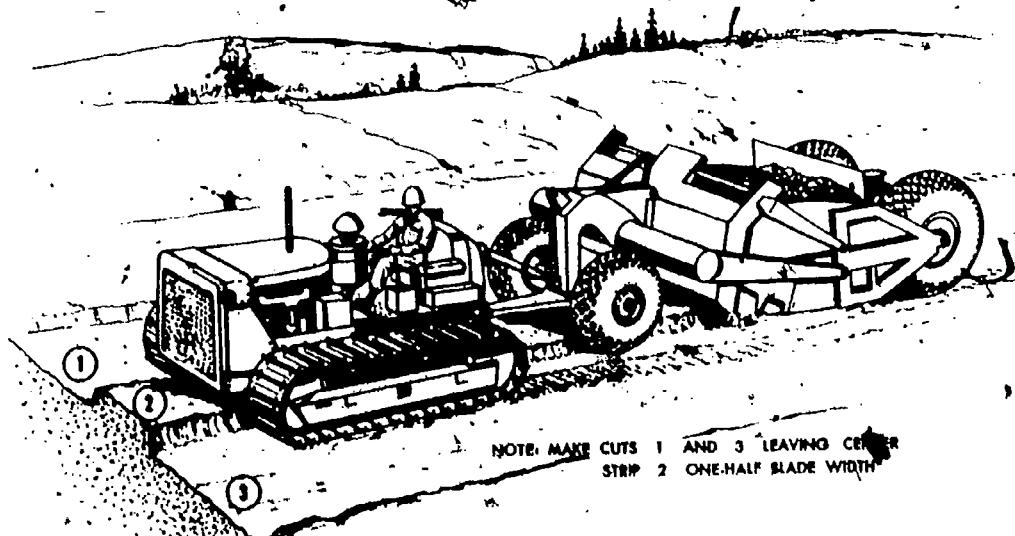

Fig 4-43. Straddle loading with scraper.

- (h) Loading with the help of a pusher dozer. A pusher dozer is one of the best methods of increasing production. Average loading time is from 1 to 1 1/2 minutes, depending

on the size of the scraper. A pusher, when one is available, will enable you to load within this average-time limit and will provide heaped loads. The pusher dozer operator is the guide and spotter for the loading units. To keep the pusher dozer in continuous operation, each scraper must be near the dozer when the dozer is ready to push. The scraper operator determines this position by looking at the cut and at the preceding scraper being loaded by the pusher. Close coordination is required between the dozer operator and the scraper operator to reduce damage to the push blocks and tires. The pusher should continue to push the scraper until the scraper bowl is raised clear of the ground and the scraper is shifted into high gear for hauling. The pusher tractor may be equipped with a standard push block or a dozer blade. When pushing with a hydraulically controlled dozer, you should place the control in the float position after the pusher contacts the scraper push block.

- (3) **Hauling.** The closer the bowl of a traveling, loaded scraper is to the ground, the more stable it will be and the less danger of its turning over. You should therefore travel with the bowl as close as possible to the ground, but high enough to clear any protruding objects on the haul road. Travel to the fill with the prime mover in the highest gear possible without the engine lugging down. Haul roads should be as smooth as possible to eliminate vibration, shock, and wear on both operators and machines. Haul roads should be wide enough for 2-way traffic or a 1-way loop road with frequent turnouts to permit the faster moving units to pass the slower ones. All unnecessary turns should be eliminated. Figures 4-44 through 4-46 illustrate methods of eliminating unnecessary turns and increasing production.

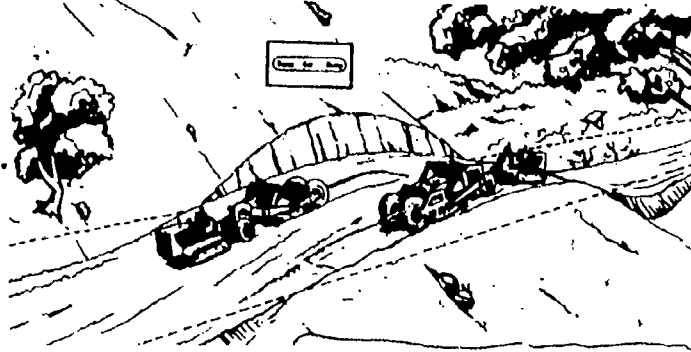

Fig 4-44. Scrapers working from a single cut in two directions to eliminate extra time consumed in turning.

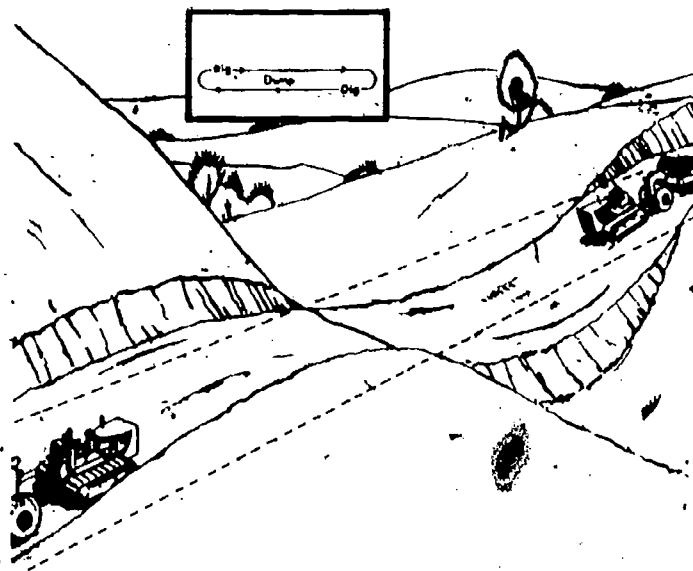

Fig 4-45. Scrapers working two cuts with a common fill between them eliminates a turn on the fill.

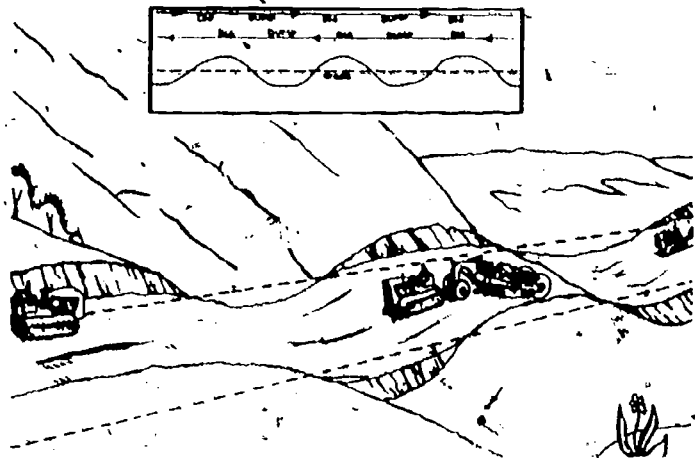

Fig 4-46. Scrapers opening a series of cuts alternating with fills. This eliminates turns and saves time.

(4) Unloading and spreading.

(a) Normal. As you enter the fill, raise or lower the bowl to the desired thickness of spread. Thickness of spread should not exceed 9 inches. Unload and spread at the highest possible speed consistent with the smooth ejection and flow of the material.

1. First, raise the apron to maximum height and allow the material in it to fall out. When most of this material has been spread, bring the ejector plate forward gradually; about a foot at a time, forcing more material out of the bowl. Do not force the material out too rapidly; if you do, you will place too heavy a strain on the cable. This may cause the earth to pile up ahead of the scraper, causing the engine on the prime mover to lug down.
2. If you are starting a new spread, lower the bowl slightly as the rear wheels of the scraper rise on the newly spread material. This will prevent the layer from thickening.
3. If material sticks to the ejector plate it can be dislodged by allowing the ejector plate to return about a foot and then bringing the plate forward sharply. As the material leaves the bowl it will be spread to the desired thickness by the bottom of the bowl. When the bowl has been emptied, return the ejector plate to its rearmost position, lower the apron, and raise the bowl to the required height for return to the cut. NEVER travel over rough surfaces or make sharp turns with the ejector plate all the way forward. With the plate in this position the ejector cable has no "give", and it will break if the scraper takes a bounce or a sharp turn on the haul road.

(b) Sticky material. The best way to eject wet, sticky material is to bring the ejector plate forward a foot at a time and retract it 6 inches after each foot of advance. Do not force the material out too fast; if you do, it will ball up and you may break the cable.

(c) Grading. Finishing can be done with the scraper, particularly when low spots require material to be hauled in, or when excess material is to be cut. Finishing is usually done in low gear because faster speeds make it difficult to control the bale for a smooth finish. Raise the apron all the way up and then pull the ejector plate three-quarters forward and leave it in that position. When these adjustments are set, the operator's only job is to control the blade accurately. As the work nears completion, finishing is done at a higher rate of speed, because

the area is smoother. Fine grading or "drag down" is performed with the ejector plate all the way forward and the blade set flush with the ground.

- (d) **Fill techniques:** Figure 4-47 illustrates the proper technique for building a fill with a scraper. Keep the shoulders (outside edges) of a fill higher than the center; this prevents the scraper from sliding over the edge when dumping close to the edge, and also helps to maintain the proper slope angle as the fill is built up. The correct procedure for dumping material in the center of the fill until you approach the area where you desire to dump; then swing the tractor and scraper diagonally out onto the shoulder of the fill. Swing the tractor parallel to the edge of the fill and begin to dump the scraper. This will cause the material to be spread high on the outside and low on the inside of the fill. This procedure is effective in maintaining both the correct concave (low in the center) cross-sectional area of a fill and in maintaining the convex (high in the center) cross-sectional area of a through cut. When the shoulders have been brought up to the prescribed grade elevation, the center can be quickly filled in just before final leveling and finishing. Before closing down the job for any substantial period, fill in the low center to provide adequate drainage in the event of rain.

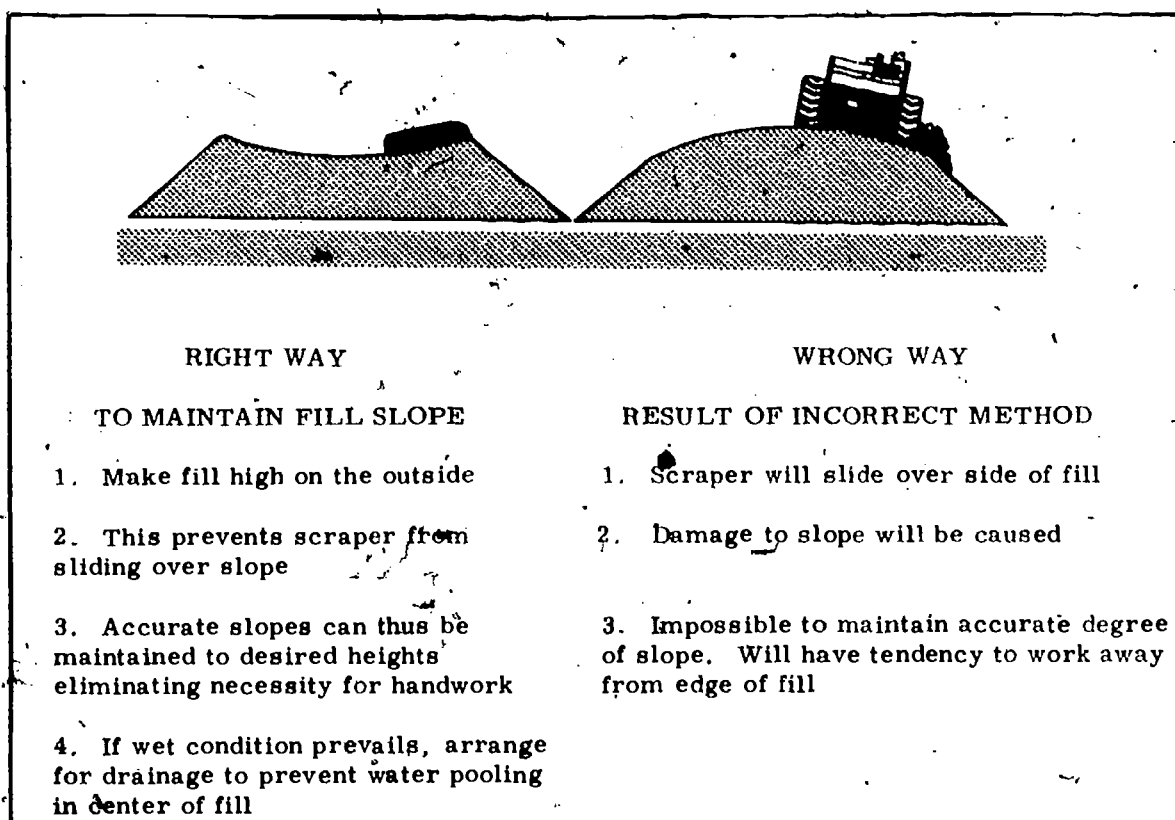

Fig 4-47. Method of spreading to maintain fill slopes.

- d. **Scraper safety.** Standard safety precautions for scrapers are as follows:

- (1) Don't drive faster than is safe and reasonable under existing job conditions.
- (2) Drive off a shoulder at slow speed. On some machines, the sudden dropping of one wheel causes a violent tilt; this might throw you off the machine or against a wheel or lever and injure you seriously.
- (3) Always block up the bowl and apron when replacing the blades or when doing any type of maintenance work that requires a man to be exposed to the hazards of a falling apron or bowl.
- (4) Keep the operating platform of the scraper clear of debris, grease, oil, and mud.

- (5) Never kick your prime mover out of gear when going downhill; the increase in speed will make control very difficult. Leave the machine in gear and use your brakes to control speed. If the brakes fail to hold the load, lower and drag the scraper bowl.
- (6) Always set the bowl of the scraper on the ground when the machine is not in operation.

4-10. ROOTER

a. Introduction. The rooter, often called the ripper, is used to break up material which is too compact to be broken by dozers, scrapers, and graders, to uproot boulders and stumps; and to cut the roots of trees which are to be dozed down. The Marine Corps has one type of rooter, which is a rear-mounted attachment (fig 4-48). The mounted-type ripper for the 82-30M crawler-tractor is hydraulically controlled. Lubrication, inspection, service, and maintenance of the ripper is covered in the TM for the specific item or the tractor TM. The rooter attachment is normally equipped with three teeth, which are removable.

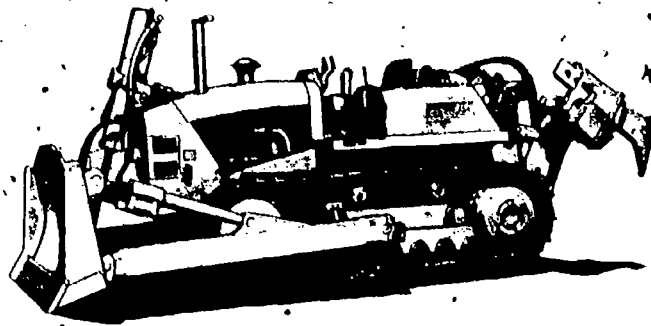

Fig 4-48. Side view of rear-mounted-ripper crawler-tractor attachment.

b. Employment techniques. The rooter is always used at its maximum penetrating depth to reduce the strain on the frame and the hydraulic system. Lower the teeth to the ground gradually. After they penetrate, they will pull themselves into the ground to the maximum depth.

- (1) Avoid rooting too much. Material which is too fine is often harder to load than coarser material. One or two passes in each 10-foot width will be sufficient.
- (2) Never make a turn or back up except to free the teeth with the teeth in the ground. This may break the teeth.
- (3) In most cases, teeth should be balanced. If you are using only a single tooth, it should be the center one; if you are using two teeth, they should be the two outer ones. However, when constructing a side ditch, install one tooth in the outside bracket and work carefully to avoid ripping too much.

- (4) When starting to rip, start next to the slope line and work toward the center. This will keep the cut low on the sides and crowned in the center.
- (5) When breaking concrete, dig the teeth of the rooter under the concrete slab and then lift to obtain a breaking action. Do not use the rooter to break reinforced concrete; nor to break concrete slabs more than 6 inches thick. To do so will cause excessive wear or strain on the control systems.
- (6) When rooted material is to be loaded in scrapers, the rooter work in a given area is completed before scrapers begin loading.
- (7) When cutting roots around trees, use two or three teeth and cut the roots on all four sides of the tree.

4-11. ROLLERS

Rollers are used for compaction of different types of materials. Each roller compacts different soils at different depths, speeds, and bearing pressures. Three types of towed rollers that you will come in contact with are the sheepsfoot roller, and the grid roller, and the 13-wheel rubber-tired (wobble-wheel) roller. Towing a roller is a monotonous but extremely important and necessary job. The effectiveness of a road or airfield depends on the load it will carry. This loading-carrying ability depends on the load-bearing capacity of the subgrade and base-course material, which is determined to a great extent by the degree of compaction attained during construction.

a. Sheepsfoot roller. Sheepsfoot rollers (fig 1-11) are best used for compacting soils other than sand, gravel, or crushed rock. They are efficient on most base-course materials containing sufficient soil binder. The sheepsfoot roller consists of a drawbar and a box frame, within which two hollow drums with protruding feet are mounted. The drums may be filled with water, fuel oil, used oil, or sand for additional weight. When water is used in cold climates, anti-freeze must be added to prevent freezing and cracking of the drums. The roller can be towed by either crawler or wheeled tractors.

- (1) The length of the feet limits to 9 inches the depth of the layers of loose material to be compacted. The sheepsfoot differs from other types of rollers because it compacts from the bottom up. As a material is compacted, the feet will not penetrate as far, and will gradually "walk" themselves out of the ground. The sheepsfoot roller will not compact the upper 2 inches of material due to the irregular pattern of the feet.
- (2) Maintenance of a roller is relatively simple. Generally there will be a lubrication fitting on the tongue, two fittings on both front and rear of the frame, and a fitting for each roller drum bearing (two per drum). The technical manual will give you detailed lubrication instructions. On the rear of the roller is a cleaning rake which should be inspected daily and from which any debris should be removed. When turning, you should take care to prevent the roller tongue from hitting the dozer tracks.

b. The grid roller. The grid roller is an all-purpose, self-cleaning compactor, particularly effective in clay or sticky materials, since it does not tend to throw material even at high operation speeds. It is also effective in the compaction of shale, sandstone, soft limestone, coral, caliche, and cinders because of the cutting and breaking action of the open face grids. This roller can be towed by either a tracked or wheeled tractor. Maintenance on the grid roller is very similar to that on the sheepsfoot roller.

c. 13-wheel rubber-tired roller. A rubber-tired roller (fig 1-12) consists of a steel box (for ballast) mounted on rubber-tired wheels. There are seven wheels at the rear and six in front, so arranged that the rear wheels do not track the front wheels. It is also called a "wobble-wheel" roller because the wheels do not run true but wobble from side to side. This provides a kneading action which increases the compaction of granular material such as crushed stone. This roller is usually towed by a wheeled tractor.

- (1) The wobble-wheel roller is the best roller to use when compacting sand-clay-gravel courses and layers of soft crushed rock, limerock, shell, and coral where lateral movement is needed to adjust and pack the particles. It is also effective in compacting thin layers of loose soil, particularly that left on top of an embankment by the sheepsfoot roller.
- (2) Lubrication fittings will be found on each wheel. Tire pressure should be checked daily to insure equal depths of compaction and prevent equipment breakdown. The tires on this roller do not have tread like automotive tires.

Roller employment. The job foreman will make decisions concerning the time when rolling shall begin, the methods to be applied, and the number of passes to be made. However, you should know something about the main considerations which guide some of these decisions. The following operational techniques are those which are customarily applied under ordinary circumstances.

- (1) Depth of loose material. The depth that loose material can be compacted effectively by rollers of different types in a given number of passes, is usually determined in the field by tests. The following information is intended to serve as a general guide only. For a sheepsfoot roller, the depth of loose material should not exceed 9 inches. Six to twelve passes are usually required to obtain adequate compaction in soil which is neither too wet nor too dry. When the number of passes is not specified, the usual practice is to repeat passes until the feet have "walked" themselves almost entirely out of the ground. For 13-wheel rubber-tired rollers the depth of loose material should not exceed 4 inches and the depth of bituminous material should not exceed 3 inches.
- (2) Number of passes. The number of passes required for a given roller to compact a given type of soil effectively is also determined in the field by tests. The following information is intended to serve as a general guide only. For soil with optimum moisture content (neither too wet nor too dry), a sheepsfoot roller should compact a 9-inch layer of soil to 95% compaction in from 10 to 12 passes. Percent compaction is the percent of modified density according to a scale devised by the American Association of Highway Officials. Specifications generally stipulate a certain percentage of compaction in accordance with this scale. In soil of optimum moisture content, a 13-wheel, 10-ton, rubber-tired roller should compact a 4-inch layer of loose soil to 95% compaction in 2 to 4 passes. It should compact a 3-inch layer of cold-laid bituminous mix in from 3 to 5 passes.
- (3) Overlapping. To insure thorough coverage of a rolled surface, each pass should overlap the preceding pass by at least 1 foot. For deep, loose fill material, the overlap should be wider.
- (4) Crowns and banked turns. In compacting crowned surfaces or banked turns on a road, work up the slope. For example, on a crowned road subgrade, make the first pass along the shoulder, then work up to the centerline in successive passes. Then pull out to the shoulder on the other side and work up to the centerline again. On a banked turn, start on the low shoulder and work up to the higher one.
- (5) Turning. Rollers should not turn on a compacted surface unless absolutely necessary, and then as slowly and as gradually as possible.

ENGINEER EQUIPMENT OPERATOR

Lesson 4

Tractors and Tractor-Drawn Equipment

STUDY ASSIGNMENT: MCI 13. 31h, Engineer Equipment Operator, chap 4.

LESSON OBJECTIVE: Upon successful completion of this lesson, you will be able to identify by general nomenclature, crawler-tractors, rubber-tired tractors, and tractor-drawn equipment, such as the scraper, roter, sheepsfoot roller, and pneumatic-tired roller. You will be able to identify the employment techniques, safety precautions, and methods of operating major accessories, such as the bulldozer, angledozer, shear blade, and the Drott 4-in-1 attachment.

WRITTEN ASSIGNMENT:

A. Multiple Choice: Select the ONE answer which BEST completes the statement or answers the question. After the corresponding number on the answer sheet, blacken the appropriate box.

Value: 1 point each

1. On the Terex tractor, when the decelerator pedal is released, what, if anything, happens to the engine speed?
 - a. It speeds up to the throttle setting.
 - b. It cuts off.
 - c. It slows the engine speed to an idle.
 - d. Nothing, the throttle must also be released.
2. After the engine is started, which indicator should be checked first?
 - a. Ammeter
 - b. Fuel-oil pressure indicator
 - c. Heat indicator
 - d. Engine oil-pressure indicator
3. What is the important point to remember when stopping the engine of a crawler-tractor?
 - a. Shut the master switch off to stop the engine.
 - b. Cool the engine slowly.
 - c. Run the engine at half throttle for 5 minutes.
 - d. Set the parking brake.
4. Being able to turn its tracks opposite each other (one forward, one reverse) is a capability of which crawler-type vehicle?
 - a. 2N crane
 - b. Case MC 1150 scooploader
 - c. 82-30M (Terex)
5. If the batteries are too low to turn the engine of the Case MC 1150 scooploader, how should you start it?
 - a. Pull the tractor in low range.
 - b. Pull the tractor in high range.
 - c. Connect an external source of dc electrical power to the slave receptacle.
 - d. Pull the tractor in intermediate range.

6. The Drott 4-in-1 bucket is standard equipment on the _____ tractor.
- Case MC 1150
 - Case MC 450
 - MRS-100
 - Terex 82-30M
7. When starting the Case MC 450, the starter should NOT be operated more than _____ seconds at one time.
- 15
 - 20
 - 30
 - 40
8. Before stopping the Case MC 450, the direction control lever and track speed control lever should be placed in _____.
- high.
 - neutral.
 - low.
 - second.
9. The transmission oil gage on the Case MC 450 tractor should read _____ psi during normal operation.
- 225 to 260
 - 190 to 200
 - 150 to 170
 - 100 to 140
10. What are the four distinct methods of maneuvering the MRS-100?
- Front wheel, back wheel, articulated, and crab steering
 - Front wheel, back wheel, cross controlling, and crab steering
 - Oblique, crab, cross controlling and articulated steering
 - Oblique, crab, cross controlling, and front wheel steering
11. If the normal shut-down procedure fails to stop the MRS engine, what would be the next step?
- Put the blade down and stall the engine.
 - Return the starter switch to off.
 - Push the emergency shut-off handle.
 - Pull the emergency shut-off handle.
12. On the MRS-100, the three foremost levers on the first hydraulic control bank control what parts of the scraper operation?
- Scraper bowl, scraper apron, and weight transfer
 - Scraper bowl, weight transfer, and rear steering
 - Scraper apron, scraper ejector, and scraper bowl
 - Scraper ejector, scraper bowl, and weight transfer
13. What is the purpose of the weight-transfer device that is used on some rubber-tired tractors?
- Transfers traction to the towed load.
 - Transfers a portion of the tractor weight to the front axle of the tractor.
 - Transfers a portion of the towed load to the rear drive wheels of the tractor.
 - Aids in the operation of the DDPCU.
14. On the MC 580B tractor when the water temperature gage indicator points to the amber zone, it indicates that the engine is _____.
- running at normal operating temperature.
 - in need of oil.
 - not warmed up to normal operating temperature.
 - running at an excessive temperature.

15. On the Case MC 580B the power shuttle control lever controls the
- a. movement of the tractor.
 - b. earth auger.
 - c. three point hitch.
 - d. backhoe and boom.
16. To stop the Case MC 580B tractor, you must,
- a. disengage the 3 point hitch.
 - b. depress the accelerator.
 - c. press both brakes together.
 - d. engage the speed control lever.
17. The shear blade (land-clearing blade) attachment is capable of cutting trees up to _____ ft in diameter.
- a. 3
 - b. 4
 - c. 5
 - d. 8
18. What is the best piece of equipment to use for constructing sidehill roads?
- a. Tiltadozer
 - b. Bulldozer
 - c. Angledozer
 - d. Motor grader
19. What blade position cannot be used on the bulldozer?
- a. Tilted slightly
 - b. Tipped forward
 - c. Raised or lowered
 - d. Angled
20. What is the most economical hauling distance for a dozer?
- a. 25 to 30 ft
 - b. 25 to 300 ft
 - c. 50 to 300 ft
 - d. 300 to 500 ft
21. When finishing side slopes by working diagonally, what method of operation should the operator use?
- a. Start at the top and work diagonally down the slope.
 - b. Start at the top and work parallel to the right of way.
 - c. Start at the bottom and work diagonally up the slope.
 - d. Start at the bottom and work straight up the slope.
22. Which piece of equipment is the least suited for cutting a "V" type ditch?
- a. Motor grader
 - b. Towed grader
 - c. Angledozer
 - d. Bulldozer
23. Crawler-tractors should not cross a culvert unless it is covered by at least _____ inches of compacted material.
- a. 6
 - b. 12
 - c. 18
 - d. 24
24. After cutting the roots on three sides of a large tree, from which side should the dozer attempt to push the tree over?
- a. The side on which the roots have not been cut
 - b. The side opposite the uncut roots
 - c. The side to which the tree is leaning
 - d. Any side of the tree

25. What are the four uses of the Drott 4-in-1 attachment?
- Skid shovel, bulldozer, scraper, and clamshell
 - Skid shovel, bulldozer, clamshell, and angledozer
 - Skid shovel, clamshell, angledozer, and forklift
 - Skid shovel, clamshell, forklift, and scraper
26. What should an operator do before dismounting from a dozer?
- Ground the blade, place the transmission in neutral, and disengage the master clutch.
 - Ground the blade, place the transmission in gear, and engage the master clutch.
 - Block the blade, place the transmission in neutral, and engage the master clutch.
 - Ground the blade, place the transmission in neutral, and engage the master clutch.
27. Rubber-tired, tractor-drawn scrapers are most efficient on hauls between
- 0 and 25 ft.
 - 0 and 300 ft.
 - 300 and 1,500 ft.
 - 900 and 5,000 ft.
28. What is the probable cause when the scraper is cutting unevenly?
- Dull cutting edges
 - Loose routing bits
 - Unequal tire pressure
 - Incorrect cable reeving
29. What is the usual operating cycle of the scraper?
- Loading, hauling, unloading, and returning
 - Loading, hauling, unloading, spreading
 - Loading, hauling, grading, returning
 - Loading, hauling, unloading, loading
30. How deep is a normal scraper cut?
- 1 to 2 in.
 - 2 to 4 in.
 - 4 to 6 in.
 - 4 to 8 in.
31. The term "pumping" the scraper is generally used in what type of soil?
- Clay
 - Organic
 - Sand
 - Peat
32. Material stuck to the scraper ejector plate can be dislodged by
- blocking the apron, and shoveling out the lodged material.
 - banging the sides of the bowl.
 - refilling with rock and sand.
 - allowing the ejector to return about a foot, and then bringing the plate forward sharply.
33. What are the movable parts of a scraper?
- Bowl, apron, and ejector plate
 - Bowl, apron, and routing bit
 - Apron, ejector plate, and routing bit
 - Apron, cutting edge, and ejector plate
34. How is maximum loading efficiency obtained with the scraper?
- Sidehill and straddle loading
 - Downhill and slot loading
 - Uphill and straddle loading
 - Downhill and straddle loading

35. On the scraper, the stinger bit serves what purpose?
- Aids in side hill cuts.
 - Aids in keeping the material in the center of the scraper.
 - Aids in keeping the materials into the sides of the scraper.
 - Aids in finish scraping.
36. The roter should be used at what penetrating depth?
- Minimum
 - Maximum
 - Depends on terrain
 - At whatever penetrating depth the tractor pulls best
37. Routers should not be used to break concrete slabs that are thicker than _____ inches.
- 4
 - 6
 - 10
 - 12
38. To avoid over rooting, make a pass every _____ feet in width.
- 10
 - 15
 - 20
 - 22
39. When rolling a compacted area and it becomes necessary to turn around, how should this be accomplished?
- Drive off the area, turn around.
 - Do not turn, roll in reverse.
 - Turn gradually and slowly.
 - Turn only on the hard surface, preferably the center.
40. Who determines when and where the compact rolling will be accomplished?
- Commanding officer
 - Equipment officer
 - Equipment chief
 - Job foreman
41. Sheepsfoot rollers are most effective in compacting what type of materials?
- Gravel and sand
 - Clay and sand
 - Crushed rock and gravel
 - Fill dirt and clay
42. The depth of loose material that will be compacted by a sheepsfoot roller should not exceed _____ inches.
- 2
 - 4
 - 9
 - 12
43. If you are using the wobbly wheeled roller on bituminous materials, the material rolled should be how thick?
- Should not exceed 3 in.
 - 5 in.
 - 9 in.
 - 12 in.

Total Points: 43

* * *

Chapter 5

MATERIALS-HANDLING AND SECTIONALIZED EQUIPMENT

Section I. INTRODUCTION

5-1. GENERAL

The items of equipment covered in this chapter have many similar design characteristics. The equipment includes the Case MC 4000 forklift (fig 5-1); the sectionalized 3-ton hydraulic Anthony crane (fig 5-2); and the model RKF-060, rough-terrain, forklift truck (fig 5-3). The vehicles are all wheel-mounted and self-propelled. The 3-ton hydraulic crane has the additional capability of being sectionalized for transport by helicopter or other small aircraft having a lift capacity of approximately 6,000 pounds. Similarities among these items of equipment include the use of a 2-cycle, 3-cylinder, series 71, Detroit diesel engine as the powerplant; an Allison Torqmatic transmission; hydraulic power steering; 4-wheel drive; planetary, double-reduction axle groups; power brakes; and hydraulically operated attachments. Another item of materials-handling equipment is the 72-31MP Terex tractor (fig 5-4). This loader pivots in the center for steering and is equipped with the Drott 4-in-1 bucket as is the Case MC 1150 scooploader which we discussed in chapter 4. The technical manual for a particular piece of equipment will provide you with the detailed operation and maintenance information for that item. Since many of the instruments and controls are similar, as well as the starting, stopping, and operating procedures, they will be covered in general in the remainder of this section. The specific controls, operation, and safety precautions for a particular machine will be covered in the respective sections.

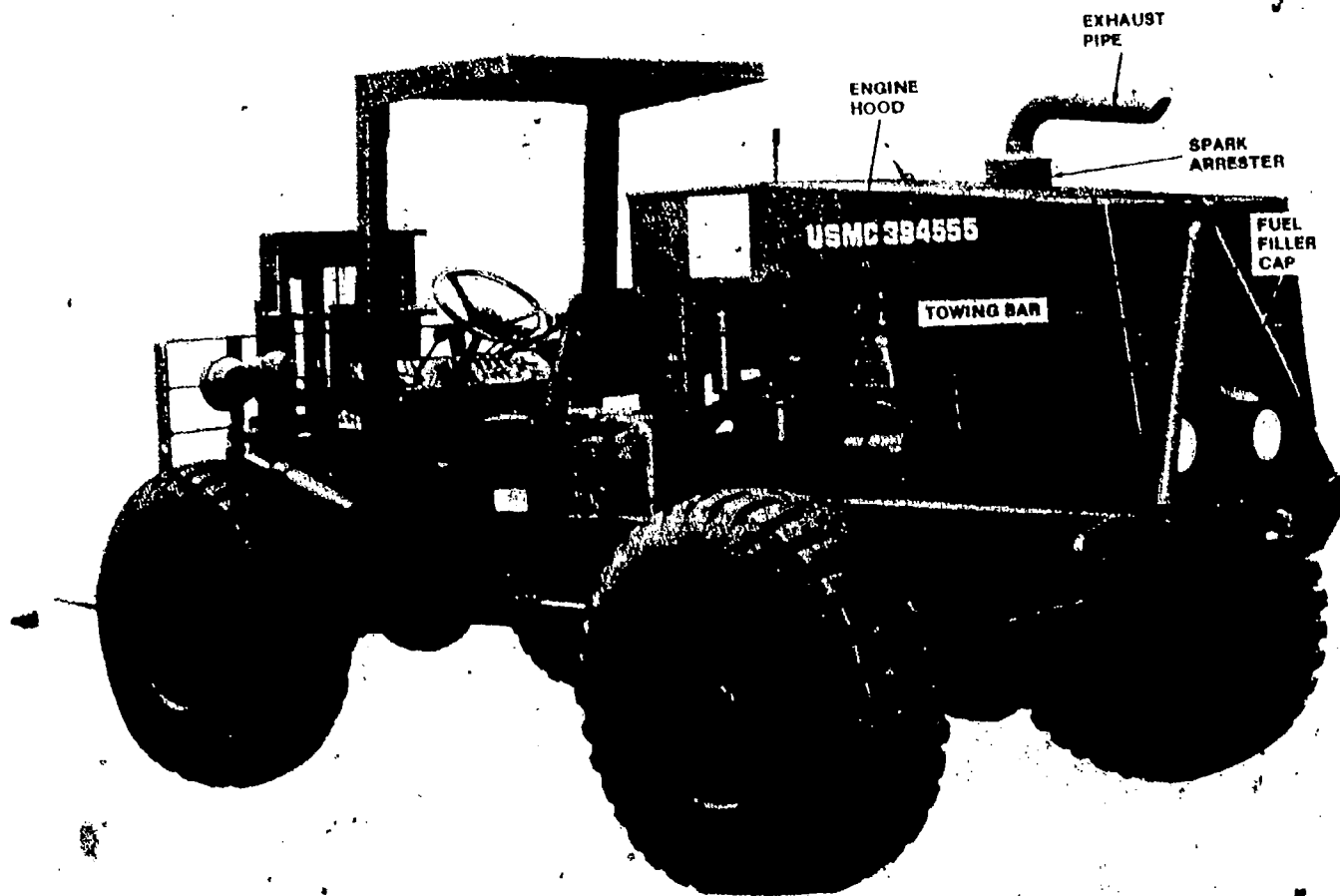

Fig 5-1. Case MC 4000 rough-terrain forklift.

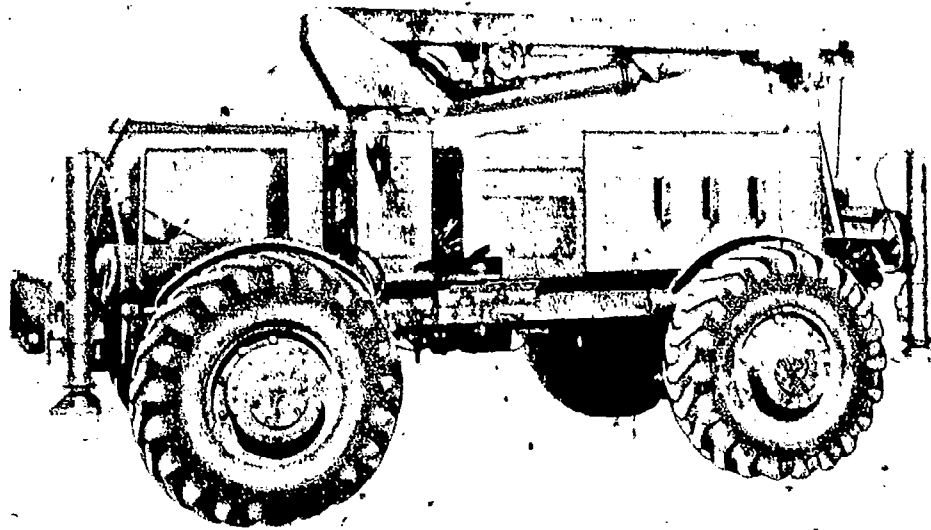

Fig 5-2. 3-ton hydraulic Anthony crane.

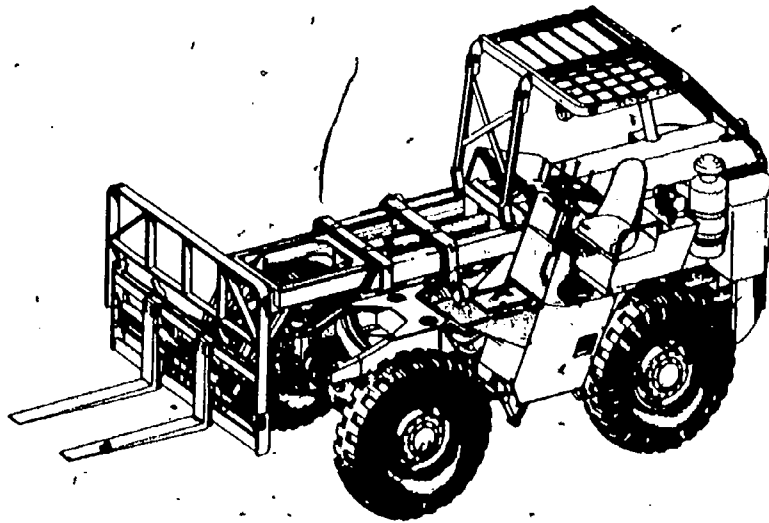

Fig 5-3. Model RKF-060 rough-terrain forklift truck.

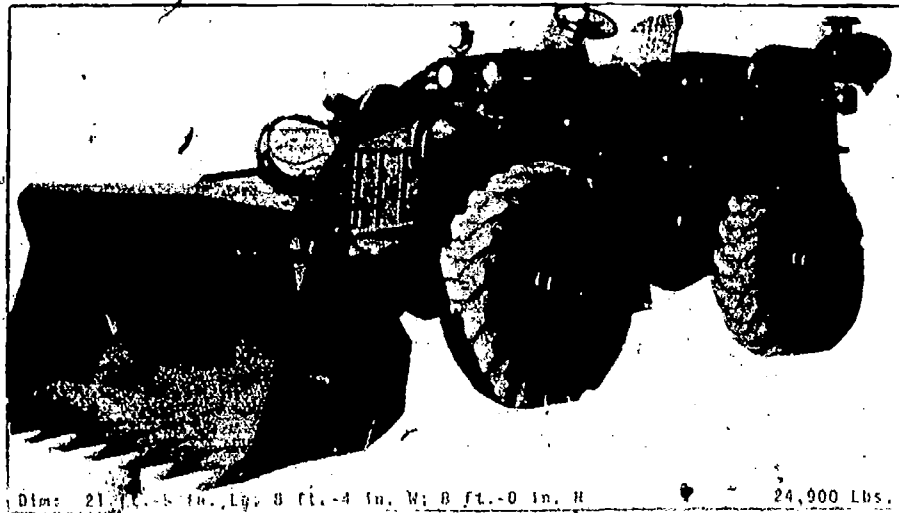

Fig 5-4. Model 72-31MP Terex tractor w/bucket loader.

5-2. INSTRUMENTS AND CONTROLS

a. Engine instruments and controls. The engines are equipped with many of the same instruments and controls as those previously described in detail in the chapters on tractors. The instruments include: an engine oil-pressure indicator, battery-generator indicator (ammeter), hour meter, fuel-level gage, and water-temperature gage. Controls include: an ignition switch, starter button and throttle control, accelerator pedal, and the engine emergency shutoff lever. The engines are provided with an ether capsule, cold-weather starting aid.

b. Vehicle instruments and controls.

- (1) The vehicles are provided with dashlights, service lights, and flood lights. Vehicle indicators include a low air-pressure warning light which lights up when the air pressure drops below a predetermined level. The crane has an air-pressure indicator in addition to the warning light. Normal air pressure is 60 psi (pounds per square inch) or higher.
- (2) Two transmission indicators are used. The first, a transmission oil-temperature indicator, indicates the converter oil "out" temperature, which should not exceed 250° F. The second indicator is the transmission oil-pressure indicator. After the engine has run at medium speed for 2 or 3 minutes, the transmission oil pressure should not drop below 100 psi.
- (3) The vehicles are steered with a conventional automotive steering wheel which has a horn button in the center. Conventional automotive brake pedals are used to apply the service brakes. The vehicles may be equipped with one brake pedal, or two pedals attached to a common shaft which provides braking action with either foot. A hand lever is used to control the emergency or parking brake.
- (4) The transmission speed and direction selectors are all slightly different. However, they all provide for a low, intermediate, or high range in either a forward or reverse direction. The transmission is full power shifting which makes it possible to upshift or downshift at wide-open or partial throttle. Shifting to and from all ranges must be done manually. Do not downshift from intermediate or high range to low range at speeds higher than the maximum rated low speed of the vehicle. Do not downshift from high range to intermediate range at speeds in excess of the maximum rated intermediate speed of the vehicle. Downshifting at excessive speeds will cause overspeeding of the engine. Never reverse direction when the vehicle is in motion. Bring the vehicle to a halt and then shift.

5-3. STARTING THE ENGINE

a. Normal starting. Always perform a visual check and the necessary maintenance services before operating the vehicle. Place transmission in neutral, engage parking brake lever and set all attachment control levers in the "hold" or neutral positions. The vehicle is now ready for starting. Turn on ignition switch. Open throttle nearly halfway, then depress starter button until engine starts. Release starter button as soon as engine starts and ease off on the throttle as the engine warms up. Never operate the starter continuously for more than 30 seconds. If the engine does not start in that time, wait at least 60 seconds before attempting to restart. As soon as the engine starts, look at the engine oil-pressure indicator. If no oil pressure is shown after 15 seconds, stop the engine and check the lubricating system. Correct any failures before restarting the engine. Run the engine at part throttle and no load for about 5 minutes, allowing the engine to warm up before moving the vehicle. During the warmup period, check the readings of the instrument panel indicators to see if the vehicle is operating correctly. Instrument readings should be as follows:

- (1) Engine oil-pressure indicator. When a cold engine is first started, the heavy consistency of the cold oil may cause a sharp rise in the oil-pressure reading. As the engine warms up at idling speed, the oil pressure should drop to a normal reading of 30 to 45 psi. If the oil pressure drops below 30 psi in normal operation above idling speed or if the oil pressure varies erratically during operation, stop the engine and investigate the cause.
- (2) Battery-generator indicator. When the engine is running at or above medium speed and the generator and generator regulator are operating satisfactorily, the battery-generator indicator (ammeter) should show a reading in the green range. If the indicator registers well into the yellow or red ranges during operation, the batteries are not being charged. If this occurs, stop the engine and investigate the cause. If it is equipped with an ammeter, the indicator pointer should move back to zero as the battery is charged. If the battery-generator indicator shows a continuous high rate of charge, stop the engine and investigate the cause.
- (3) Engine water-temperature indicator. When the engine has had time to reach normal operating temperature, the water-temperature should range between 160° and 185° F. Whenever possible, allow the engine water temperature to reach 160° F before moving the vehicle.
- (4) Transmission oil-temperature indicator. The transmission oil temperature should read between 160° and 185° F after the engine has been warmed up. Transmission converter oil "out" temperature should not exceed 250° F. If it does, stop the vehicle and determine the cause of the overheating. If no leaks can be seen, shift the transmission to neutral and operate the engine at 1,000 to 1,300 rpm. The temperature should drop rapidly to engine coolant temperature.
- (5) Transmission oil-pressure indicator. After the engine has been run at medium speed for 2 or 3 minutes, the transmission oil pressure should not drop below 100 psi. The transmission main oil pressure should read between 110 and 120 psi at full engine throttle with the vehicle brakes applied. If the oil pressure is not within specifications, stop the engine. Do not let the transmission oil temperature exceed 250° F when you are making the oil-pressure check.
- (6) Air-pressure indicator. After 2 or 3 minutes of engine operation, the reading of the brake system air-pressure gage should always be above 60 psi while the engine is running at or above fast idling speed. If not, troubleshoot the system.
- (7) Low air-pressure warning light. Do not attempt to drive the vehicle until the brake low air-pressure warning light goes out. When the light is on, pressure in the brake system is below the minimum required for full power braking. If the light does not go out after idling the engine for 2 or 3 minutes, troubleshoot the air brake system. Avoid unnecessary engine idling. Prolonged engine idling will result in low operating temperatures which cause incomplete combustion. Poor combustion of fuel in a cold engine causes crankcase dilution; lacquer deposits on valves, pistons, and rings; and rapid accumulation of sludge within the engine.

b. Cold-weather starting. An ether cold-weather starting aid is provided to assist in starting the engine at temperatures below 40° F or when other circumstances make starting difficult. To start the engine with the help of the starting aid, proceed as follows:

- (1) Prepare the vehicle for normal starting.
- (2) Insert a primer cartridge (ether capsule), neck down, into the discharger body and screw the discharger cap onto the body.
- (3) Turn the ignition switch on and open the engine throttle to about 3/4.
- (4) Press the starter button. After the starter motor has brought the engine up to cranking speed, discharge the pressure primer by swinging the actuating lever through 180° to the opposite side of the primer. The primer cartridge takes about 15 seconds to discharge fully. If the engine fails to start after several attempts, troubleshoot it to locate the defect.

- (5) When handling primer cartridges, observe the following safety precautions: Insert primer cartridges in the primer only when they are to be used immediately. Since ether fumes are toxic and flammable, do not discharge primer bulbs in a confined area or near an open flame.

5-4. STOPPING THE ENGINE

a. Normal. Ground or place the attachments in their normal resting place. Place all attachment and vehicle controls in the hold or neutral position. Engage the parking brake lever. Decrease engine speed and allow it to run at half speed for 2 or 3 minutes, then slowly decrease to idle speed. This allows the engine to cool gradually and uniformly. The engine can then be stopped with the engine shutoff lever and the hand throttle. Turn off the ignition switch before leaving the vehicle. Leaving the ignition switch on will discharge the batteries due to the constant drain of current to the instrument panel indicators.

b. Emergency engine shutdown. If the engine shutoff lever fails to stop the engine, pull the emergency shutoff control handle out as far as it will go. This will stop the engine by cutting off the air supply at the blower. After the engine has stopped, push the handle all the way in again and reopen the blower shutter with the shutter lever. Before restarting the engine, determine the cause of the failure of the normal shutdown mechanism and correct it.

5-5. OPERATION UNDER UNUSUAL CONDITIONS

a. Extreme-cold weather.

(1) Conditions.

(a) General. Extensive preparation of mechanical equipment is required when extremely cold weather is expected. Extreme cold generally causes lubricants to thicken, may freeze batteries and reduce their electrical efficiency, and can cause short circuits by cracking electrical insulation. Cold also prevents fuel from vaporizing readily to form the combustible mixture necessary for starting. Various materials become hard, brittle, and easily damaged from extreme cold. The cooling system should be drained, flushed and refilled with antifreeze compound to protect the system against subfreezing temperatures.

(b) Storage, handling, and use of fuel, lubricants and antifreeze compound. The efficient operation of equipment at arctic temperatures will depend greatly on the suitability of the fuels, lubricants, and antifreeze solutions used in the equipment. The effects of careless storage and handling or improper use of such materials are not always immediately apparent, but deviations from the recommended procedures may cause major trouble at any time. Contamination of fuels and lubricants with moisture is the source of many difficulties in subfreezing temperatures. Moisture can be the result of snow getting into the material or condensation in partly filled containers.

(2) Operation.

(a) General. You must always be on the alert for the effects of cold weather on the vehicles. You must be very cautious when putting the vehicle into operation after a shutdown. Congealed lubricants may cause parts failures. Wheels may be frozen to the ground. After warming up the engine thoroughly, shift the transmission into low range, and drive the vehicle for about 100 yards, taking care not to stall the engine. This should warm up the transmission to a point where normal operation can be expected. Check the engine and transmission temperature gauges constantly. If either gauge consistently shows a high temperature, stop operating, determine the cause, and correct the defect.

(b) Parking. When stopped for short shutdown periods, the vehicles should be parked in a sheltered spot out of the wind. If no shelter is available, park the vehicles facing the wind to retard the loss of heat from the engine and radiator. For longer shutdown periods, park the vehicles on hard, dry ground. If none is available, prepare a footing of planks or brush. When you are preparing the vehicles for a shut-

down period, place the transmission shift levers in neutral to prevent their freezing in the engaged position. Clean all parts of the vehicles of snow, ice, and mud as soon as possible after operation. Be sure to protect all parts of the engine and operator's controls from drifting ice and snow. Cover the operator's compartment and radiator. Refuel the vehicles immediately to reduce the amount of air in the fuel tank and thereby minimize condensation. Before refueling, drain off any condensation or sediment from the bottom of the tank through the drain cock. Whenever the cooling system is being drained, make sure that the drain openings are not obstructed. This is particularly important when draining a vehicle to prevent damage due to freezing. If a drain opening is plugged with sediment, clear it with a short length of soft wire. Draining of the cooling system will be necessary only when antifreeze solution is not available. If the vehicles are to be shut down for a long period, remove the batteries and store them in a warm place.

b. Extreme-hot weather.

- (1) General. Continuous operation of the vehicles on steep grades or in soft ground may cause overheating. Watch the engine temperature gage, and stop the vehicle for a cooling-off period whenever necessary. The best way to cool the engine is by allowing it to run at a low idle. Inspect and service the cooling system, oil filters, and air cleaner more frequently than normally required. If the engine temperature frequently rises above 185° F, look for obstructions in the radiator fins from accumulated dust, sand, or litter. Obstructions can be cleaned out with compressed air or a stream of water. Flush the cooling system if necessary. If the transmission oil temperature rises beyond 250° F, stop the vehicle, shift into neutral, and run the engine at a fast idle. The temperature should drop to the normal operating range in 2 or 3 minutes. If it doesn't, troubleshoot the transmission.
- (2) Parking. Do not park the vehicle in the sun for long periods of time. When practicable, park it under cover to reduce damage and deterioration from sun, sand, and dust. If possible, cover the operator's compartment, and use whatever means are available to protect the engine compartment from windblown dust or sand. Vehicles that are not used for long periods of time in hot, humid weather should be cleaned and lubricated frequently to reduce rusting and damage from insects and fungus.

c. Fording. Because the Marine Corps is involved in many amphibious operations, it must have equipment capable of operation while partially submerged. It must be able to move from landing craft to shore through the surf and cross shallow streams under its own power.

- (1) Vehicle condition. The vehicles used are equipped with the necessary components for fording. The fording components are installed by the factory, but close inspection and proper maintenance is required to insure satisfactory operation during fording. A quarterly preventive maintenance service and inspection is performed to insure that the vehicle is properly serviced and is in satisfactory operating condition. It is lubricated to keep water from entering the joints. Any leaks are repaired and loose parts are tightened. All openings below the expected water level are sealed or vented above the water level. The engine and the power train components must be operating satisfactorily or trouble can be expected while fording.
- (2) Fording depth. With the factory installed equipment and the vehicle operating satisfactorily, it will ford 60 inches (5 ft). This is the total depth of mud and water. Extensions can be added to the exhaust system, the intake system, and component breather tubes, but the operator could not control the equipment if the water rises above the 60 in. level on the vehicle. Always check the depth and do not attempt to ford water deeper than 60 inches, no matter how narrow the body of water.
- (3) Fording speed. The operator drives the vehicle into the water slowly and gradually increases the engine rpm as the water gets deeper. Once the vehicle is in the water, it is operated at full engine governed rpm with the transmission set in the lowest forward speed range. Entering the water too fast may damage the fan as it strikes the water, damage the vehicle, or injure the operator by the sudden shock of hitting the water. The vehicle speed should not exceed 3 to 4 mph.

- (4) Immediate maintenance if vehicle stalls. Should a vehicle stall while submerged, re-start it and drive it out immediately if possible. If the vehicle fails to start or to move, tow it out as soon as possible, determine the cause of failure, and repair it. After leaving the water, adjust the fan belt to prevent overheating of the engine. As soon as possible, clean the vehicle with fresh water, lubricate, and perform a quarterly preventive maintenance service. Check all compartments and components for evidence of water; drain and refill if necessary.

d. Towing the vehicles. If it becomes necessary to tow the vehicles for a relatively long distance, both drive shafts must be disengaged. This is necessary to prevent damage to the transmission from lack of lubricant pressure when the engine is not running. The 4-wheel drive selector lever can be used to disengage one of the propeller shafts, but the other propeller shaft must be disconnected. Do not tow the vehicle to start the engine; the engine cannot be cranked by towing. If the battery output is not sufficient to start the engine, connect an external source of 24-volt, direct current to the vehicle electrical system with an electrical extension cable (slave cable). The vehicles are equipped with slave receptacles for use with the slave cable.

Section II. ROUGH-TERRAIN FORKLIFT

5-6. INTRODUCTION

a. Types. At the present time the Marine Corps has two types of rough-terrain forklifts: The 6,000-lb capacity RKF-060 and OS-3354 which are very similar in design and are self-contained, rider-type, mechanized pieces of material handling equipment and the 4,000-lb capacity MC 4000 manufactured by J. I. Case.

b. Common mechanisms. The forklift mechanism (fig 5-5) of these vehicles consists of three assemblies: the carriage and fork assembly; upright tilt cylinder and inner slide assembly; and the upright outer boom assembly. The carriage and fork assembly mounted at the extreme front of these vehicles consists of the roller chains, sprockets, two lift forks, slide shift cylinder assembly, and the fork carriage. The upright tilt cylinder and inner slide assembly is mounted at the front of the vehicle. It is attached to the carriage and fork assembly and is mounted within the upright outer boom assembly. It consists of the tilt cylinder and inner slide assembly. The upright outer boom assembly is attached at a pivot point in approximately the center of the vehicle, just ahead and slightly to the right of the operator's compartment. It attaches to the inner slide assembly and consists of the extension cylinder assembly and the outer boom assembly. The vehicle hydraulic system consists of the hydraulic supply tank assembly, hydraulic pump and the following functional systems: brake system, steering system, and forklift system.

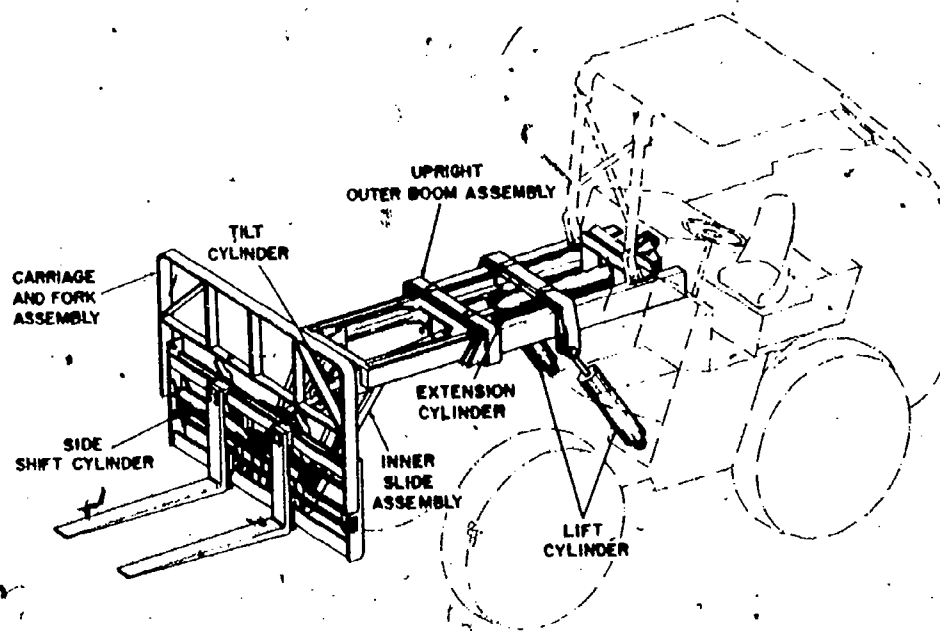

Fig 5-5. Forklift mechanism.

c. Purpose. Rough terrain forklifts were designed to move palletized material from one place to another over rough terrain. They can be tilted from side to side so that the vehicle can pick up loads on uneven terrain. Forklifts of this type can be used on beaches to unload landing craft, in supply dumps to load or move supplies, and at forward airfields to load or unload aircraft.

d. Other items with forklift attachments. In addition to the two rough-terrain forklifts, the 72-31MP Terex tractor, described in para 5-10 can be equipped with a fork attachment and can be used over rough terrain. The Marine Corps is also trying to find a multiple pallet forklift; one that will lift more than one pallet at a time from the ground or other places and load them one at a time. A suitable replacement for the many various makes of commercial forklifts is also being sought.

5-7. RKF-060 FORKLIFT OPERATION

a. Instruments and controls. The RKF-060 forklift truck instruments and controls are illustrated in figure 5-6 and 5-7. In figure 5-7, note that the vehicle is equipped with a low-air pressure warning light but is not equipped with an air-pressure gage.

- (1) The brake lock pushbutton switch has not yet been described. The brake lock is used only when the vehicle is being used in operations requiring periodic momentary stops. To apply the brake lock, step on the brake pedal. While holding the brake pedal, depress the brake lock pushbutton switch. This will trap the pressurized hydraulic brake fluid at the rear wheel lines, thus keeping the brakes engaged. Then the driver can relax and remove pressure from the brake pedal. To release the brakes, push the brake pedal in, at least as far as you did when activating the brake lock. Do not touch the brake lock switch when removing brake lock action.
- (2) Figure 5-6 illustrates the engine and vehicle controls, many of which were covered in section I. Note that the vehicle is equipped with two interconnected brake pedals and that the transmission shift levers are located directly below the steering wheel. The speed selector provides a means of selecting any one of the three transmission speeds. The direction selector provides a means of selecting either a forward or reverse direction. The drive selector enables the operator to select either 2- or 4-wheel drive. When the drive selector is pulled back, only the two rear wheels are powered.
- (3) The steering selector enables the operator to steer the vehicle with either the two front wheels or all four wheels. Two types of steering can be selected in the 4-wheel steering range: crabbing and 4-wheel. When the steering selector is pushed forward to crab, the vehicle will move slightly sideways. When the selector is pulled downward to 4-wheel, the vehicle will be in 4-wheel steering. In 4-wheel steering, the two rear wheels will turn in the opposite direction from the front wheels, causing the vehicle to pivot or make a sharp turn. When the selector is in the middle position, the vehicle will be in front wheel steering position.

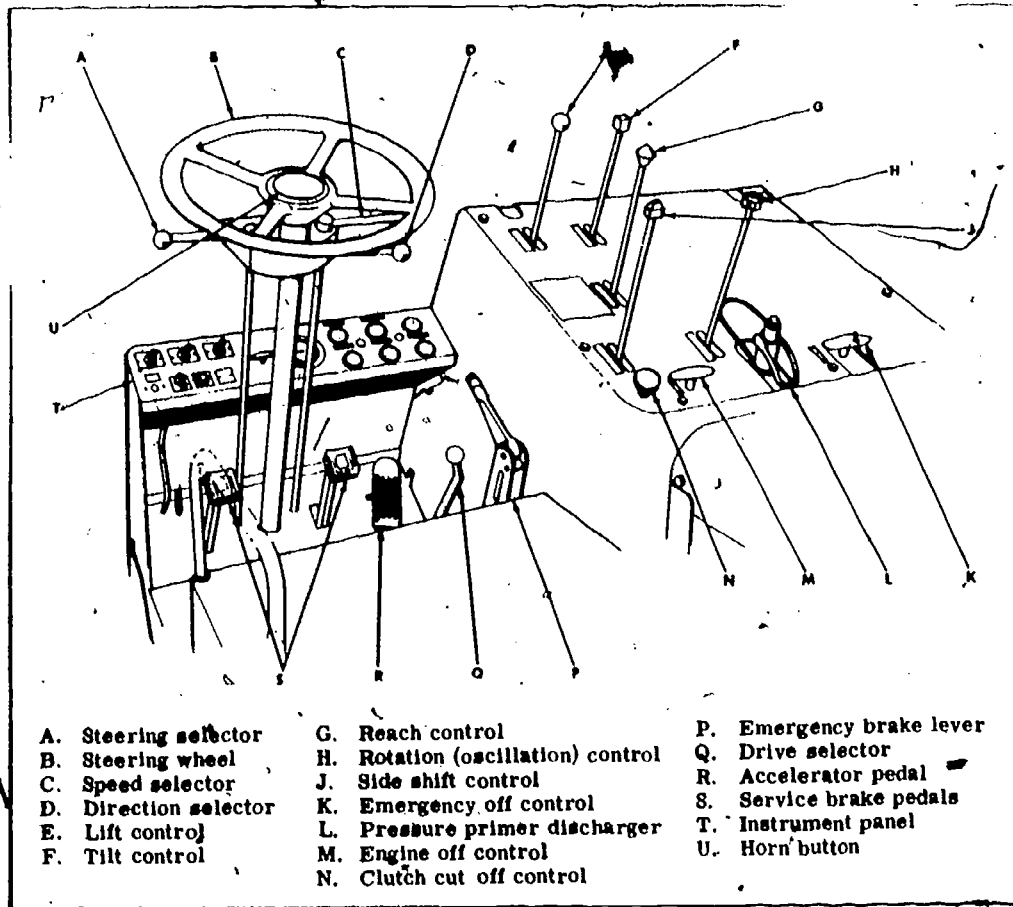
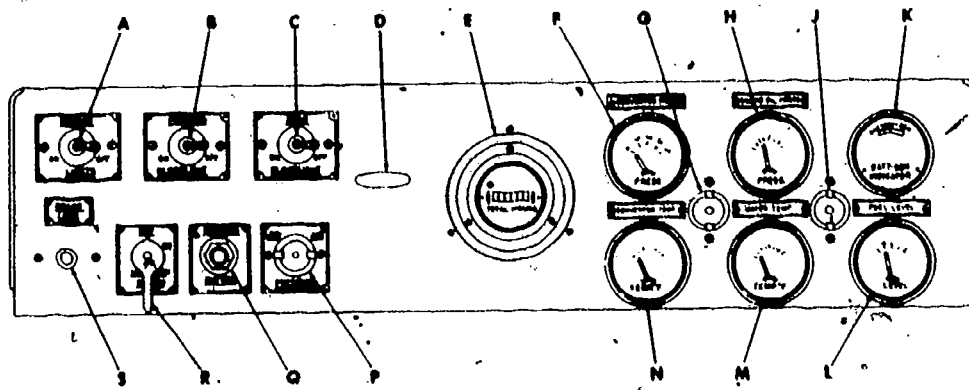

Fig 5-6. Driver's compartment arrangement.



- | | |
|---------------------------------|-------------------------------|
| A. Service light switch | J. Panel light |
| B. Forward floodlight switch | K. Ammeter |
| C. Rear floodlight switch | L. Fuel-level gage |
| D. Throttle | M. Water-temperature gage |
| E. Engine hour meter | N. Converter temperature gage |
| F. Converter pressure gage | P. Low-air-pressure light |
| G. Panel light | Q. Starter button |
| H. Engine oil-pressure gage | R. Ignition switch |
| S. Brake lock pushbutton switch | |

Fig 5-7. Instrument panel arrangement.

- (4) The manually operated clutch cutoff control, when engaged, allows the operator to speed up the engine, thus increasing hydraulic pump capacity without moving the vehicle. The control is pulled out to engage the transmission valve and pressed in to disengage it. When the control is pulled out, the brake system is connected to the transmission valve for "inching."
- (5) The forklift mechanism is provided with a number of hydraulic control levers which are easily accessible to the operator. The spacing of the forks themselves must be manually adjusted by the operator. The side shift control is used to shift the forks either to the right or left. The lift control is used to raise or lower the carriage and fork assembly. The tilt control is used to tilt the carriage and fork assembly forward or rearward. The reach control is used to extend or retract the carriage and fork assembly as needed. The rotation (oscillation) control permits the vehicle to tilt (dip) 10° to the right or left. The center position on these levers is a stop position for any previously selected movement.

b. Operation.

- (1) The starting and stopping of the engine was explained in section I. Normal operation of the vehicle will be discussed here. For normal smooth-terrain operation, the vehicle should be placed in front wheel steer and rear, or 2-wheel, drive. The transmission speed selected will depend on the operating conditions. However, low range is very seldom required under ordinary operating conditions, even with full rated loads on ordinary grades. It is used only for ascending steep grades, in very rough terrain, or in mud, sand, or snow. Low range is always used for descending steep grades where more or less continuous braking would otherwise be required. Release the emergency parking brake before moving the vehicle. The desired road speed can be obtained by simply depressing the accelerator pedal.
- (2) To stop the vehicle, release pressure on the accelerator pedal and depress the brake pedal. Do not pump the brake pedals, but apply even pressure. This permits the drive train to assist in braking the vehicle. If the stop is momentary and the direction of travel is not going to be reversed, the direction selector does not have to be shifted to neutral. Light pressure on the brake pedal will hold the vehicle stationary. If the vehicle is to remain stopped for more than several minutes, place the direction selector in neutral. Either the hand brake or brake lock can then be used to keep the vehicle stationary.
- (3) When changing direction, stop the vehicle and have the engine at a slow idle speed. When shifting from neutral to reverse, shift the direction selector into forward first and then shift without pause through neutral to reverse. When shifting from reverse to forward, leave the shift lever in neutral position for at least 3 seconds before shifting into forward. Never allow the vehicle to coast downhill in neutral. The speed selector must be in gear at all times when the vehicle is traveling under its own power.
- (4) The operation of the forklift itself is relatively simple, but there are a few operating precautions which forklift operators should observe:
 - (a) Do not load the forklift beyond its rated capacity.
 - (b) Lift, lower, and haul loads with the fork assembly upright or tilted back. Tilting is preferable because it steadies the load for safer hauling.
 - (c) Never butt loads with the fork; you might damage the cargo.
 - (d) Do not stack a load too high; it will block your view and increase the chances of toppling the load. If you must haul a high-tiered load, drive the forklift backward slowly, watching overhead clearance, to avoid hitting projections which could cause a bad spill and a serious accident.
 - (e) Carry the load just high enough to clear the ground.
 - (f) Since the forklifts are usually operated in close quarters, with reduced visibility, a good rule to follow is to play it safe and slow down.

5-8. OS-3354 FORKLIFT OPERATION

The operation of the OS-3354 and the RKF-060 are very similar. Figures 5-8 and 5-9 show the slight difference between the two in the driver's compartment and instrument panel. Compare these figures with figures 5-6 and 5-7.

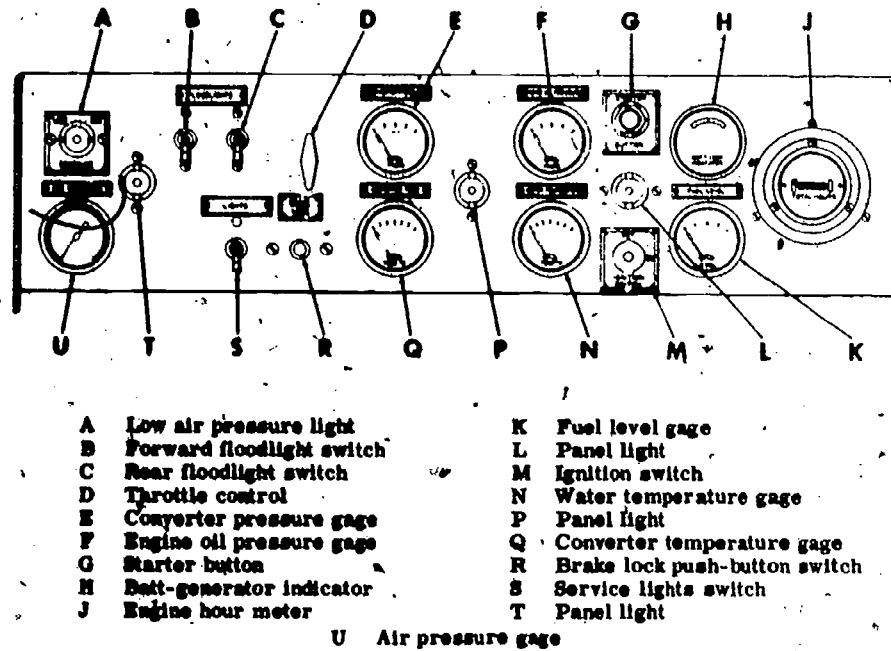

Fig 5-8. Instrument panel arrangement.

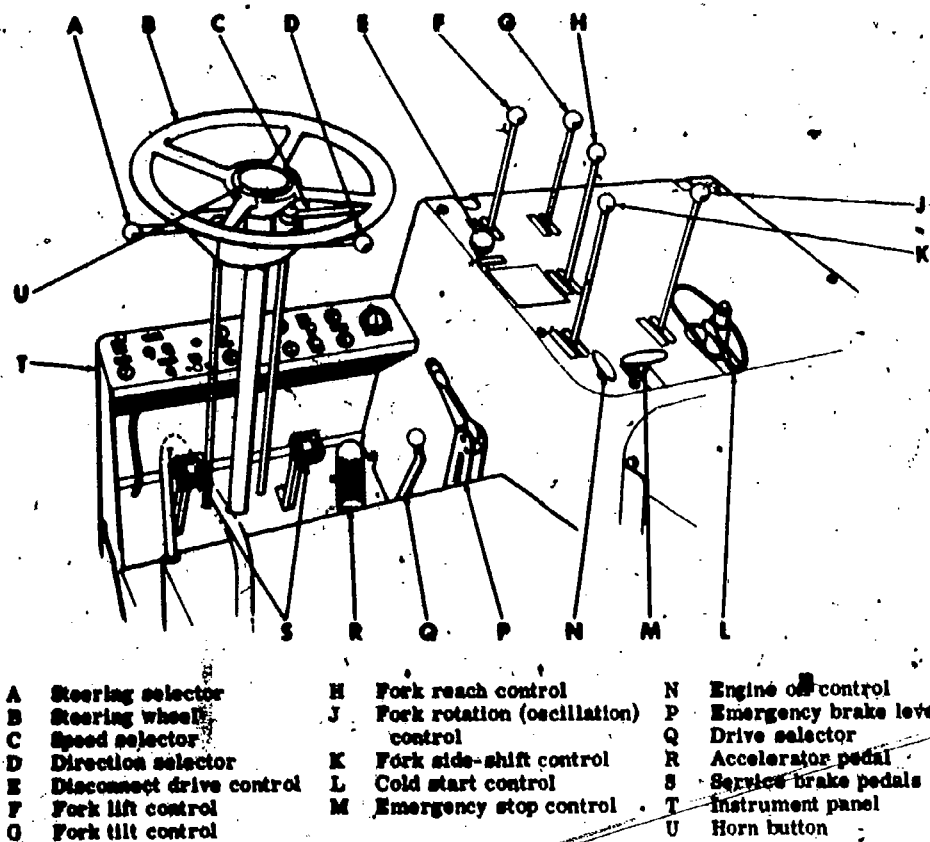
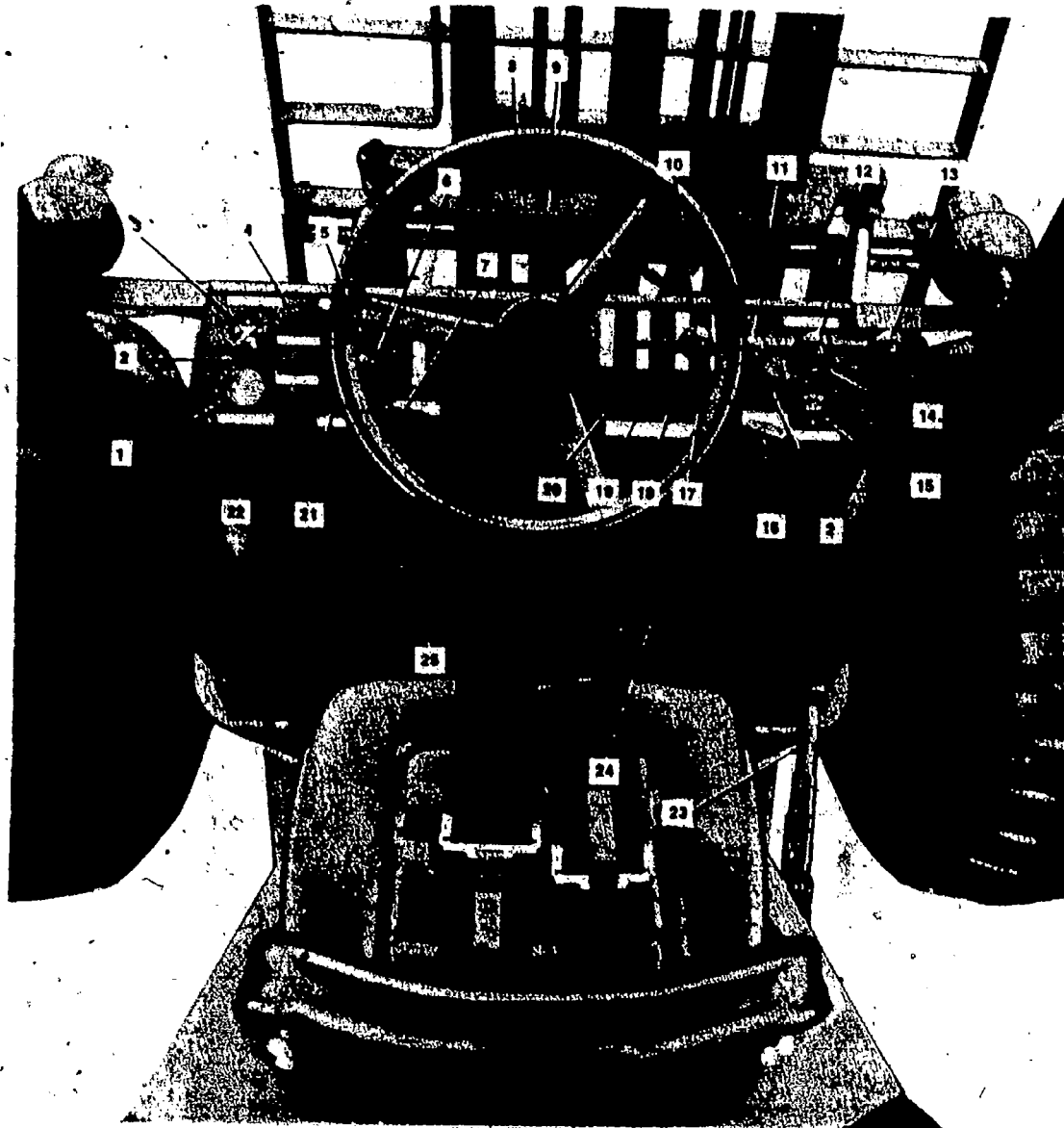

Fig 5-9. Driver's compartment arrangement.

5-9. MC 4000 ROUGH-TERRAIN FORKLIFT

a. Controls and Instruments (fig 5-10).

The control panel and the console on which it is mounted contains many of the engine and electrical system controls and instruments. These controls and instruments perform functions similar to others described with the exception of the master switch (fig 5-11), which is not mounted on the control panel but is located beside the cold start aid knob. Turning this switch clockwise cuts all power to the instrument panel and starter.



- | | | |
|----------------------------------|------------------------------------|-------------------------------|
| 1. ENGINE WATER TEMPERATURE GAGE | 10. ROTATION CONTROL LEVER | 18. REAR FLOOD LIGHT SWITCH |
| 2. DASH LIGHT | 11. SHIFT CONTROL LEVER | 19. HEAD AND TAILLIGHT SWITCH |
| 3. ENGINE OIL PRESSURE GAGE | 12. LIFT CONTROL LEVER | 20. DASH LIGHT SWITCH |
| 4. STARTER SWITCH | 13. TILT CONTROL LEVER | 21. FUEL OIL PRESSURE GAGE |
| 5. BATTERY-GENERATOR INDICATOR | 14. CONVERTER OIL TEMPERATURE GAGE | 22. IGNITION SWITCH |
| 6. TRANSMISSION SHIFT LEVER | 15. CLUTCH PRESSURE GAGE | 23. PARKING BRAKE CONTROL |
| 7. FUEL SHUTOFF CONTROL HANDLE | 16. EMERGENCY STOP HANDLE | 24. ACCELERATOR PEDAL |
| 8. STEERING WHEEL | 17. BLACKOUT LIGHT SWITCH | 25. FOOT BRAKE PEDAL |
| 9. HORN BUTTON | | |

Fig 5-10. Controls and Instruments.

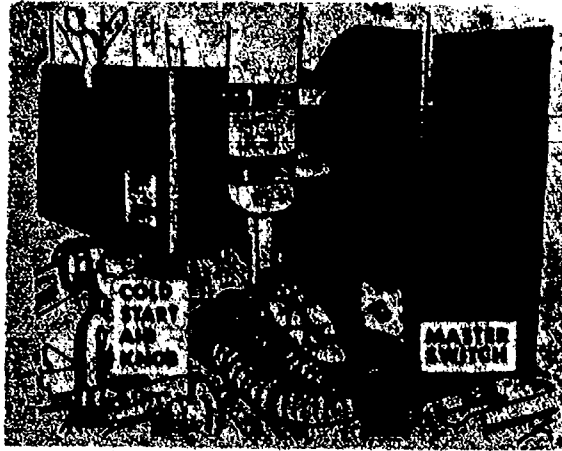

Fig 5-11. Master switch and cold start aid knob.

- (1) **Starting the engine.** The operator must perform the daily before-operation checks and services (Table 5-1).
 - (a) Be sure the transmission shift lever is in neutral and set the parking brake.
 - (b) The accelerator pedal should be at idling speed (setting of the hand throttle takes care of this).
 - (c) You must always check to see that the stop handle and emergency stop handle (fig 5-12) are in. If the emergency stop has been used it must be manually reset.

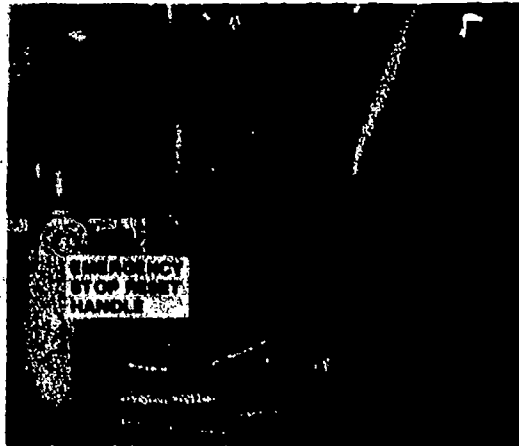

Fig 5-12. Emergency stop reset handle.

- (d) **Now** turn the master switch to the ON position and turn the ignition switch on and press the starter button.
- (e) When the engine starts, immediately release the starter button and check the instruments.
- (f) Operate the engine at part throttle and no load for about 5 minutes so it will be warmed up before applying a load.

Table 5-1. Operator's Daily Services.

Intervals			Procedure
Before Operation	During Operation	After Operation	
X		X	FUEL. Inspect the fuel supply. See that the fuel tank is full.
X			COOLANT. Inspect the coolant level in the radiator. Add coolant if necessary.
X		X	OIL. Inspect the oil level in the crankcase. Add oil if necessary.
X			DRIVE BELT. Check belt tension. Check condition of drive belt.
		X	AIR CLEANER. Empty air cleaner dust bowl. Check air cleaner indicator. Service air cleaner if necessary.
X			FUEL FILTERS. Drain water and sediment from fuel filter and strainer.
X			STEERING LOCK PIN. Check to ensure lock pin has been removed from locking hole.
X			STEERING RELEASE VALVE. Check to ensure valve is closed so truck can be steered.
X		X	TRANSMISSION OIL. Check level. Add oil if necessary.
X			HYDRAULIC OIL. Check level. Add oil if necessary.
X		X	LEAKS, GENERAL. Inspect for leaks, paying particular attention to the engine cooling system, oil and fuel lines, and connections. Correct all deficiencies noticed or report them to organizational maintenance.
X		X	VISUAL INSPECTION. Make a general inspection of the entire truck for damage, loose or missing screws or nuts, and loose connections.
X			PUBLICATIONS AND TOOLS. Check for forms, manuals, tools and equipment assigned to the forklift truck. Ensure that they are in serviceable condition and properly stowed.
	X		INSTRUMENTS. Ensure that all instruments indicate within required ranges.
	X		CONTROLS. Check operation of controls.
	X		UNUSUAL NOISES. Listen for unusual noises and check for excessive vibration. If present, shut off engine and report to organizational maintenance.
		X	TIRES. Clean off all mud and dirt. Inspect the tires for cuts or other damage.
		X	RADIATOR. Clean bugs, dust, or other foreign matter from radiator.

- (2) Starting the forklift. Always be sure that the steering lock pin has been removed, steering cutout valve is closed, and the rear axle drive is engaged.
- (a) Release the parking brake and raise the forks off the ground.
- (b) Now shift into the desired range and push the accelerator to move the forklift.
- (3) Stopping the forklift. First apply the foot brake. After the forklift has stopped, shift into neutral, set the parking brake, and put the forks on the ground.
- (a) Do not shut off the engine but allow it to run at half speed for 5 minutes so it will cool. Then shut off the engine by pulling out the fuel shutoff control handle.
- (b) Now turn off the ignition switch and master switch and push in the fuel shutoff handle.

Section III. SCOOPLOADER

5-10. 72-31MP TEREX TRACTOR

a. General description.

- (1) The model 72-31MP tractor is a 4-wheel-drive, pneumatic-tired (rubber-tired), hydraulically operated, articulated-steering vehicle. The Marine Corps version may be equipped with a Drott 4-in-1 bucket or forklift attachment (fig 5-13). The weight of the tractor varies with the application. The term articulated-steering means that the entire front end of the vehicle turns on a pivot point rather than just the front wheels turning in a given direction.
- (2) The hydraulic system which operates the Drott 4-in-1 and forklift attachment is an independent system powered by its own gear type pump mounted on the torque converter housing. The 72-31MP tractor uses an independent hydraulic oil supply and hydraulic pump for the steering and the front end attachment controls.
- (3) Two control levers, at the right of the operator's seat, control all functions of the attachment hydraulic system. The lift control lever has four different positions: float, lower, hold, and raise. The tilt control lever will dump, hold, or tilt back when moved front to rear or open and close the clam bucket when moved left or right. Clam and blade position indicators are located on the Drott 4-in-1 attachment to aid the operator in setting the attachment for the desired type use.

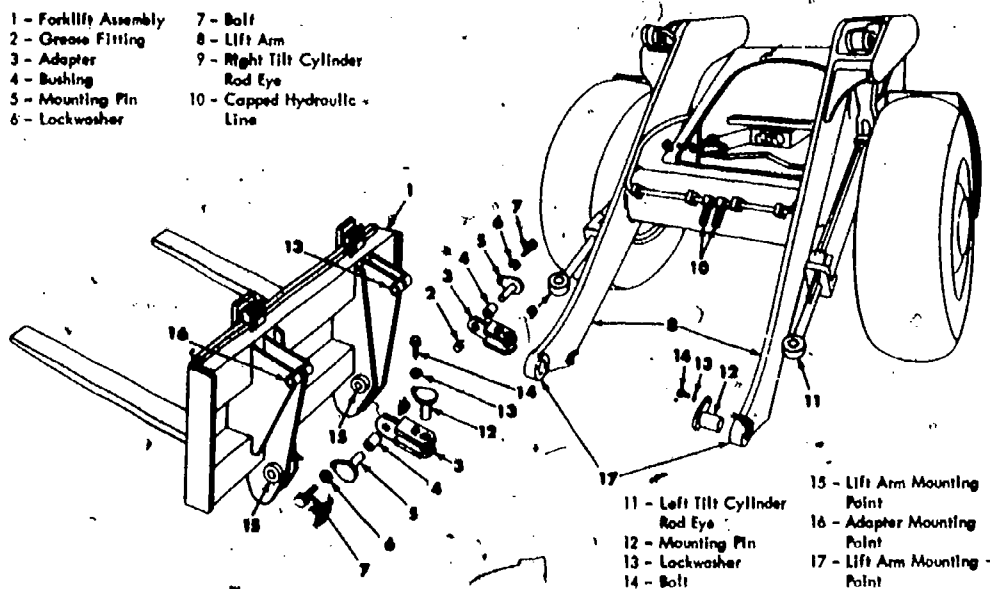
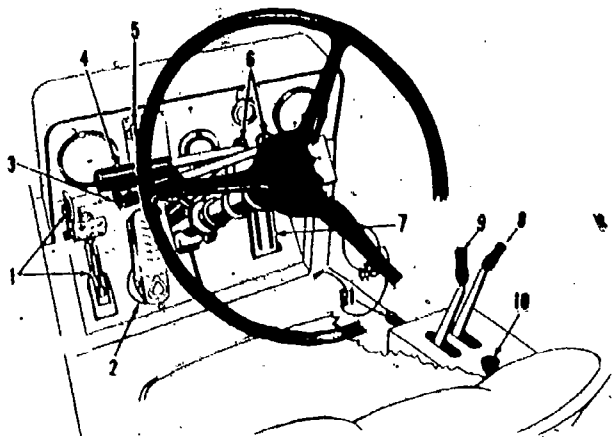

Fig 5-13. Forklift assembly.

b. Instruments and controls.

- (1) The 72-31MP tractor is equipped with a transmission control lever located under the steering wheel on the left side. It controls the transmission range-selector valve. It has four positions: reverse, neutral, 1st forward, and 2nd forward.
- (2) Figure 5-14 illustrates the 72-31MP tractor controls and instruments. Notice that this vehicle is not equipped with an automatic clutch release lever. However, fully depressing the brake pedal applies the brake and actuates a transmission declutch valve to disengage the transmission and provide full engine power for operating the front end attachment.



- | | |
|---------------------------------------|------------------------------|
| 1. Parking brake | 6. Light switches |
| 2. Service brake pedal | 7. Accelerator pedal |
| 3. Transmission control lever | 8. Bucket lift control lever |
| 4. Transmission forward-reverse lever | 9. Bucket tilt control lever |
| 5. Starter key | 10. Rear axle disconnect |

Fig 5-14. 72-31MP Terex tractor controls.

- (3) The rear axle disconnect lever is used to engage the rear axle for 4-wheel drive. Use 4-wheel drive when working the vehicle and 2-wheel drive when traveling from one job to another. Pull up on the control to disengage the rear wheels.
- (4) The indicators are similar to those listed for the 82-30M crawler-tractor.

c. Operation. The work cycle for loaders can be divided into four phases: loading, carrying, dumping, and returning. The most common operation is removing material from stockpiles and loading it in hauling units. The Drott 4-in-1 attachment or clam bucket permits the loader to perform a variety of jobs, in addition to standard loading functions. The separately controlled clam can be opened and closed to operate as a clam type bucket or a standard bucket by sideways movement of the bucket tilt control lever. A clam position indicator and a blade pitch indicator (fig 5-15) are attached to the blade to aid in positioning the bucket components as required to perform its various functions.

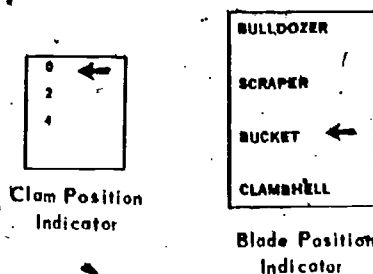

Fig 5-15. Clam and blade position indicators.

- (1) **Standard loading and dumping operations.** When using the clam-type bucket as a standard bucket for loading material from a stockpile into a hauling unit, position the hauling unit as illustrated in figure 5-16.

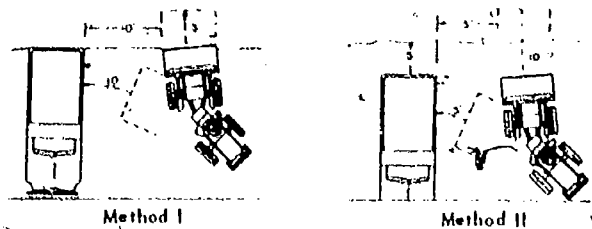

Fig 5-16. Correct positioning of hauling unit for loading from a stockpile.

- (a) With the loader adjacent to the stockpile, lower the bucket to the ground.
 - (b) If the clam is open, move the tilt control lever to the right until the pointer is on "0" of the clam position indicator (fig 5-15).
 - (c) Tilt the bucket backward or forward until the blade indicator pointer is at bucket position (fig 5-15).
 - (d) Engage the 4-wheel drive by pushing down on the control, release the parking brake, and shift the transmission into 1st forward range. Accelerate the engine so that the bucket is forced into the stockpile. Turn the steering wheel right or left as the bucket is loaded. Move the tilt control lever back and forth as the bucket crowds into the stockpile until the bucket is full. When full, move the tilt control lever back to the tilt back position and tilt the bucket all the way back. The bucket loading operation should end with the bucket to the rear of the hauling unit as illustrated in figure 5-16 and tilted back against the stops. If the stockpile is low, particularly with free flowing material, leave the lift control lever alone. Keep the bucket one or two feet off the ground.
 - (e) Shift the transmission to reverse range and back away from the stockpile with the steering wheel turned to the maximum away from the hauling unit. Start raising the bucket while backing away from the stockpile. While decelerating and shifting to forward range, start a full turn toward the hauling unit. The turn should be completed while changing direction. Allow the bucket to continue to raise during the reverse and forward movement so that it will be high enough to clear the hauling unit.
 - (f) The bucket can be dumped in the standard method by tilting it forward to the dump position or by opening the clam by moving the tilt control lever to the right to the open position. When tilting forward, the brake action will assist in throwing the load farther into the hauling unit. Moving the tilt control lever back and forth will help spread the load. After dumping the load, pull the tilt control lever back to the tilt back position and release to allow the automatic bucket leveler to level the bucket for the next load. Shift the transmission to reverse and back away from the hauling unit, turning the steering wheel fully away from the hauling unit. While backing away, move the lift control lever to the float position. While decelerating to change transmission range and changing direction of travel, the turn into the stockpile should be started and completed. Allow the bucket to drop to about one foot above the ground to start the loading phase of the cycle.
- (2) **Scrape loading.** The Dred 4-in-1 clam-type bucket can be used for smooth, accurate scraper-type loading such as stripping topsoil or sod.
- (a) Position the blade by moving the tilt control lever until the pointer is aligned with the scraper on the blade pitch indicator and with 2 or 4 on the clam position indicator (fig 5-15).

- (b) Lower the bucket to the ground, shift the transmission into 1st speed range, and accelerate the engine to load the bucket. The cutting edge should dig in until the outside of the clam makes contact with the soil. This provides a boiling action as the bucket is loaded. With the blade pitch set on 2, the cutting edge will cut down 2 inches; on 4, it will cut down 4 inches.
 - (c) Close the clam and tilt the bucket back to the carry position when it is loaded. Lift the bucket to the required carry height.
 - (d) Dump the bucket in the same manner as described for standard loading and dumping operation.
- (3) Dozing. The Drott 4-in-1 clam-type bucket can also be used as a dozer.
- (a) Lower the bucket to the ground and open the clam until the pointer is below the 4 on the clam indicator (fig 5-15).
 - (b) Tilt the blade until the pointer is at bulldozer on the blade pitch indicator (fig 5-15). For level grading, the blade moldboard should be perpendicular to the ground. To dig in, the moldboard should be tilted forward; for no digging, tilt the moldboard back.
 - (c) For dozing a greater volume, close the clam and tilt the bucket forward until the clam cutting edge digs in. Move forward in this position until the bucket is loaded. Raise the bucket and open the clam to spread the load while on the move.
- (4) Clamshell loading and dumping. Using the Drott 4-in-1 clam-type bucket as a clamshell is another operation that can be performed with this versatile item of equipment.
- (a) Position the pointer so that it is aligned with clamshell on the blade pitch indicator (fig 5-15).
 - (b) Open the clam until the pointer is below the 4 on the clam position indicator (fig 5-15).
 - (c) Lower the bucket over the material to be loaded until contact is made.
 - (d) Close the clam while backing away from the stockpile. When the clam is closed, tilt the bucket back to the carry position.
 - (e) The bucket can be dumped as described earlier.
- (5) Handling miscellaneous material. In addition to the uses described above, the Drott 4-in-1 clam-type bucket can be used to backdrag, remove large rocks, remove loose stumps, and to pull posts. Some of these operations are illustrated in figure 5-17. Use caution when performing these operations to prevent excessive shock on the clam or the hydraulic system.

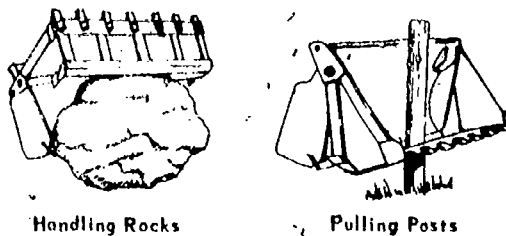

Fig 5-17. Handling rocks and pulling posts with the Drott 4-in-1 attachment.

d. Safety precautions. The loader, like all power equipment, is dangerous if not handled properly. The following suggestions are intended as a general outline of safety habits to be developed by the operators and all personnel working around the loader.

- (1) Always perform a visual check and the necessary maintenance services before you operate the loader.
- (2) Before starting the engine, put the transmission lever in the neutral position and the bucket and boom levers in their holding positions.
- (3) Never get on or off the loader while it is in motion.
- (4) Never leave the loader without first lowering the attachment to the ground.
- (5) Always set the parking brake when the loader is not in operation.
- (6) Never operate the bucket or boom controls when the boom is in a raised position unless the engine is running.
- (7) Make sure that no personnel or obstructions are underneath or in the path of the loader before putting it in motion.
- (8) Use the low-speed range when descending a steep grade.
- (9) Never transport loads with the boom in the fully raised position. Carry the bucket as close to the ground as possible; best overall balance is obtained in this position.
- (10) Never stand or work under the bucket or boom unless they are properly supported by timbers or an overhead support with at least a 1-ton capacity.

Section IV. SECTIONALIZATION

5-11. INTRODUCTION

The 3-ton hydraulic Anthony crane and the MRS-100 tractor are designed to be readily transportable by air to otherwise inaccessible working locations. In the absence of large aircraft and airfields suitable for landing them, these machines may be transported by helicopter or other small aircraft having a capacity of approximately 6,000 pounds. This is achieved by disassembling the machines in five sections, which may be readily reassembled in the field by a crew of men using no special tools other than those provided in the sectionalization skid assembly. Detailed procedures for the sectionalization of each machine are contained in the applicable technical manual. These procedures will be covered in general in this section. The design characteristics and sectionalization procedures are generally the same for all machines. The sectionalization of equipment may also be used during maintenance operations to facilitate accessibility.

5-12. SKIDS AND TOOLS

In order to facilitate the disassembly of the machines into sections, the handling of the sections, and the reassembly of the machines, the Marine Corps has adopted a standard sectionalization skid assembly (fig 5-18). Two assemblies are required to make up one set. One complete set is required for sectionalizing a piece of equipment.

a. Two Griphoist assemblies (fig 5-19) are also required for each sectionalization. The two Griphoists are used to manhandle the disassembled sections. They may be secured to any terrain feature such as a tree or boulder or to an iron stake, enabling two men to drag the sections to a desired location. Each Griphoist is rated for a 3,300-lb direct pull and can readily move any individual sections. When both hoists are connected to a single section, the section can be quickly "jockeyed" into any desired position, over relatively level terrain. Do not use the wire-rope assembly as a sling or draw it over sharp corners. Broken strands of the wire rope may snag in the clutch of the hoist and will be troublesome for the operator.

b. Each sectionalization skid assembly will support one of the two vehicle main sections. The assemblies are equipped with aligning driftpins, one 24-inch adjustable wrench, one 5-ton hydraulic jack, four screw-type jacks with extensions and adapters, guy assemblies, coupling bars and spreader bars, and an assortment of pins and nuts. Using a General Mechanics Tool Kit in addition to the sectionalization skid assemblies and the Griphoists, two men can sectionalize and reassemble either piece of equipment.

5-13. DISASSEMBLY

No elaborate preparations are required to prepare the vehicles for sectionalization. However, they must be in operating condition prior to disassembly. Check the sectionalization skid assemblies before disassembling the machines. Locate the vehicles on level terrain if possible.

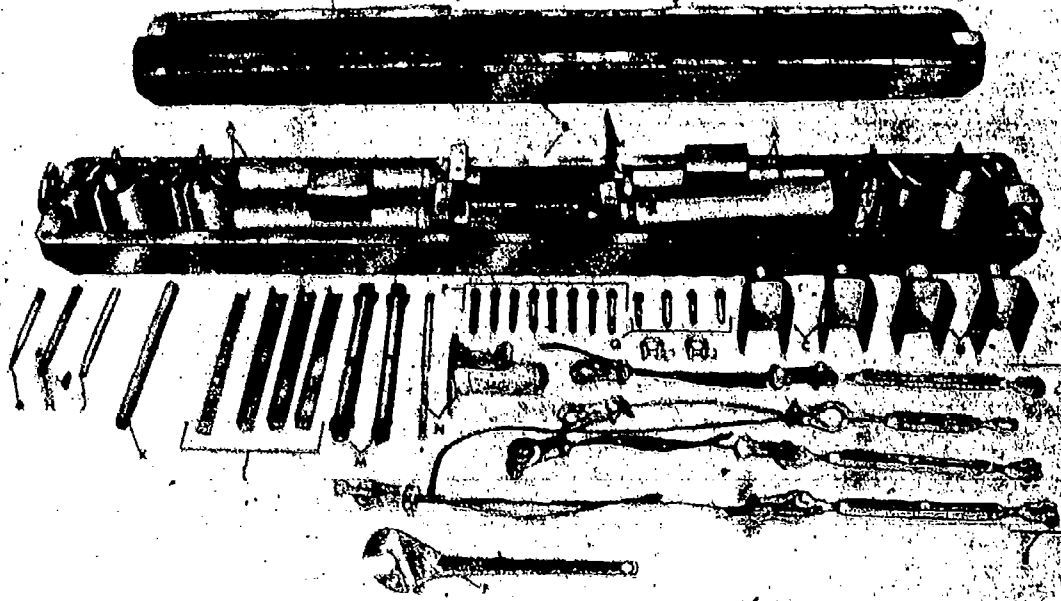

- | | |
|--------------------------------|--------------------------|
| A. Jack assembly | H. Jack extension handle |
| B. Sleeve extension | J. Jack extension handle |
| C. Short weld assembly adapter | K. Hydraulic jack handle |
| D. Long weld assembly adapter | L. Coupling bar |
| E. Guy assembly | M. Spreader bar assembly |
| F. Adjustable open-end wrench | N. Hand hydraulic jack |
| G. Driftpin | P. Straight-headed pin |
| | Q. Straight-headed pin |

Fig 5-18. Skid assembly, sectionalization.

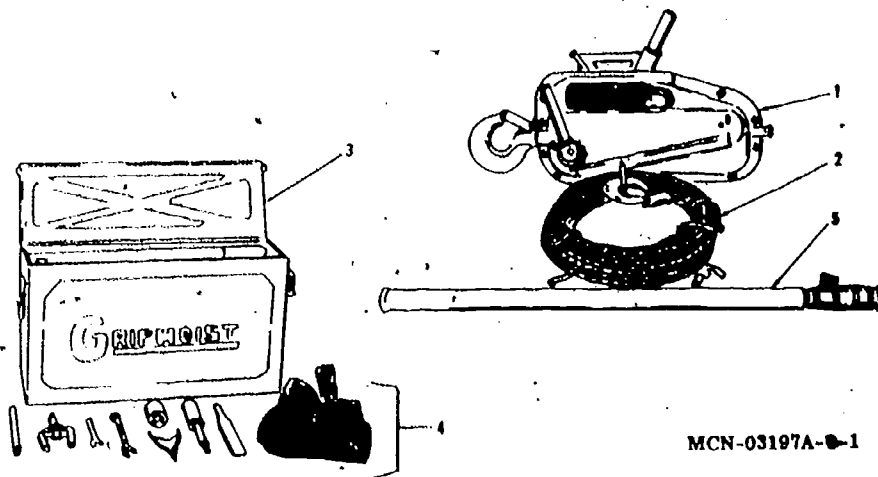

MCN-03197A-0-1

- | | |
|--|-------------------------------|
| 1. Griphoist | 4. Maintenance tools with bag |
| 2. Wire rope with hook (60 ft x 1/2 in.) | 5. Telescopic handle |
| 3. Steel carrying box | |

Fig 5-19. Griphoist assembly.

a. The vehicles were designed with a 2-piece, or section, frame which is bolted together in the center. Figure 5-20 illustrates the two separated main sections of the 3-ton M60 crane. Examine the illustration closely and you will notice how the vehicle is raised and supported with the screw-type jacks. The adjustable guy assemblies and spreader bar assemblies are used to provide additional security and stability. From this illustration you can see that the axle groups of the vehicles will generally be removed. This means that the propeller shafts and any steering or braking lines or linkages must be disconnected before removing the axle sections. The axle assemblies are simply rolled out from under the vehicle after they are disconnected.

b. To separate the main sections of the vehicles, all the electrical connections, air or hydraulic lines, fuel lines, and control linkages between the two must be disconnected. Quick-disconnect couplings with self-sealing action are used on the air and hydraulic lines. The ends of all disconnected lines should be covered with dust caps or other protection to prevent dirt or moisture from entering the air or hydraulic system and to protect the couplings from dirt and damage. Protective dust and moisture caps are included as a component part of a piece of sectionalized equipment. The electrical wiring harness is provided with standard military electrical connections which permit quick disassembly. All wiring, lines, controls, and linkages should be secured to prevent damage.

c. When all connections between the front and rear main sections have been disconnected, the 6 bolts on the junction plates on each side of the crane which join the front and rear main sections of the crane can be removed. Make a careful check to insure that all connections between sections of the vehicle have been removed and that the disconnected linkages, hoses, tubes, and wires are free and secured out of the way of further operations. The two hydraulic hand jacks should then be propped between the bases of the center pairs of screw jacks (fig 5-21). Work both jacks simultaneously to separate the skid-mounted front and rear main sections of the vehicle (fig 5-20).

d. During disassembly of the vehicle, the screw-type jacks supporting the vehicle main sections should be raised and lowered alternately and evenly. The guy assemblies are installed between the ring in the base of the screw jack and the diagonally opposite corner of the frame. The guy assemblies are equipped with turnbuckles for tightening or loosening the assemblies.

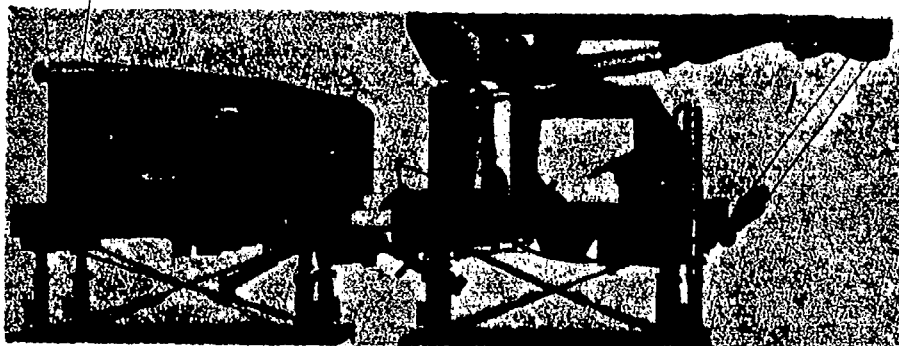

Fig 5-20. Front- and rear-end sections separated.

5-14. REASSEMBLY

The front and rear main sections of the vehicles can be drawn together with the two Griphoists. The sections should be positioned on any firm, level spot and then assembled, reversing the disassembly procedures.

a. The guys should be loosened and the screw jacks alternately and evenly raised or lowered as needed to align the two sections. Care should be taken to avoid damaging any disconnected linkages, hoses, or wiring. The sections can then be bolted together and all hoses, wiring, and controls reconnected. The axle groups and other components which were removed during disassembly can then be reassembled.

b. During reassembly, take your time, align and reconnect the assemblies correctly. When you finish, recheck all reassembly operations. The plastic dust caps which are removed from

the lines should be collected and stored in the vehicle toolbox. The sectionalization tools should be collected, cleaned, inspected, and repacked into the skid assemblies. Some trial-and-error efforts may be required to stow everything in the skids to permit bolting the second skid in place without distorting it.

c. The vehicles should receive a complete maintenance check before resuming normal operations. The technical manuals provide step-by-step disassembly and reassembly instructions. During sectionalization, use your manuals, follow instructions, and work safely.

ENGINEER EQUIPMENT OPERATOR

Lesson 5

Materials-Handling and Sectionalized Equipment

STUDY ASSIGNMENT: MCI 13.31h, Engineer Equipment Operator, chap 5.

LESSON OBJECTIVE: Upon successful completion of this lesson, you will be able to identify, by general nomenclature, materials-handling equipment. You will be able to identify the instruments and controls and the methods of starting and stopping under normal and adverse conditions. You will be able to identify the correct procedure for fording and towing, and the disassembling and re-assembling of the sectionalized equipment, along with the necessary inspections, servicing, and safety procedures.

WRITTEN ASSIGNMENT:

A. Multiple Choice: Select the ONE answer which BEST completes the statement or answers the question. After the corresponding number on the answer sheet, blacken the appropriate box.

Value: 1 point each

Note: The four vehicles referred to in this lesson are: (1) Case MC 4000 forklift; (2) sectionalized 3-ton hydraulic Anthony crane; (3) model RKF-060, rough-terrain forklift truck; and (4) model 72-31MP Terex tractor.

1. Normal air pressure for the Anthony crane is at least _____ psi.
 - a. 30
 - b. 50
 - c. 60
 - d. 80
2. If the transmission oil temperature rises above 250° F, the operator should
 - a. continue to operate, keeping a close check on the engine water temperature.
 - b. continue to operate and notify the dispatcher when he secures.
 - c. stop the vehicle and determine the cause.
 - d. stop the vehicle and check the radiator for external leaks.
3. The batteries are being recharged when the battery indicator shows a reading in the _____ range?
 - a. green
 - b. yellow
 - c. red
 - d. orange
4. How many speeds, forward or reverse, can be selected on the materials-handling equipment?
 - a. Three speeds in either forward or reverse.
 - b. Three speeds forward and one reverse.
 - c. Four speeds forward and one reverse.
 - d. Four speeds forward and four reverse.

5. If the converter oil "out" temperature rises to 250° F, what should be done to lower it to normal?
- Drain the transmission oil.
 - Shift the transmission to neutral and operate the engine at 1,000 to 1,300 rpm.
 - Shift the transmission to neutral and operate the engine at 1,800 to 2,000 rpm.
 - Drive forward in low range and operate the engine at 1,000 to 1,300 rpm.
6. In what manner will extreme cold weather effect the equipment?
- It increases the electrical efficiency of batteries.
 - Materials become soft and pliable.
 - Lubricants thicken or congeal.
 - It increases the vaporization of fuel.
7. The engine starter should not be operated continuously for more than _____ seconds.
- | | |
|-------|-------|
| a. 15 | c. 30 |
| b. 20 | d. 45 |
8. Which is the correct method of using an ether primer cartridge?
- Store the cartridge in the primer until used.
 - Discharge it into the exhaust manifold.
 - Insert it into the primer and use immediately.
 - Discharge it into the air breather for cold weather starting only.
9. The vehicles are designed to ford bodies of water up to a depth of _____ inches.
- | | |
|-------|-------|
| a. 48 | c. 60 |
| b. 50 | d. 72 |
10. When stopping the engine, it should be allowed to run at half speed for 2 or 3 minutes to allow the
- transmission to cool gradually and uniformly.
 - engine to cool gradually and uniformly.
 - hydraulic system to cool gradually.
 - radiator to cool gradually.
11. When securing your vehicle in extremely cold weather, you should park
- | | |
|-------------------------------|--------------------------|
| a. facing into the wind. | c. on soft, damp ground. |
| b. facing away from the wind. | d. in an open area |
12. The best way to cool an engine when operating in extremely hot weather is to
- | | |
|-------------------------|--|
| a. run it at 1,500 rpm. | c. shut it off. |
| b. run it at low idle. | d. drain and flush the radiator daily. |
13. Which vehicle, if any, is equipped with a brake lock that may be used to hold the vehicle during periodic momentary stops?
- | | |
|--------------------------|--------------------------|
| a. 3-ton hydraulic crane | c. RKF-060 forklift |
| b. Case MC 4000 forklift | d. 72-31MP Terex tractor |

14. What should be done to start the engine when the battery output is NOT sufficient?
- The vehicle should be towed in low range.
 - The vehicle should be towed in high range.
 - The slave cable should be used to connect the vehicle to an external source of 12-volt direct current.
 - The slave cable should be used to connect the vehicle to an external source of 24-volt direct current.
15. How many levers are used to control all functions of the 72-31MP Terex tractor hydraulic system?
- 2
 - 3
 - 4
 - 5
16. When the vehicles are being towed for a relatively long distance, what preparation MUST first be completed?
- The transmission must be in neutral.
 - Both drive shafts must be disengaged.
 - The transmission must be in high range.
 - The front drive shaft must be disengaged.
17. Which adjustment must be made manually by the 6000-lb forklift truck operator?
- Tilting forward of the carriage and fork assembly
 - Spacing of the forks
 - Shifting of the forks
 - Retraction of the carriage and fork assembly
18. When hauling a load, the operator should tilt the fork assembly
- forward and carry the load just high enough to clear the ground.
 - backward and carry the load 3 feet off the ground.
 - backward and carry the load just high enough to clear the ground.
 - forward and carry the load forward 3 feet off the ground.
19. When stopping the 6000-lb forklift truck, you should
- release pressure on the accelerator and apply even pressure to the brake pedal.
 - apply the emergency brakes.
 - shift the transmission to neutral and apply even pressure on the brakes.
 - shift the transmission to neutral and apply the brake lock.
20. To energize all electrical circuits except the slave receptacle, the case MC 4000 forklift is equipped with a
- throttle control.
 - ignition switch.
 - master switch.
 - circuit switch.
21. Which of the following items is part of the before-operation service on the MC 4000 forklift?
- Air cleaner
 - Radiator
 - Drive belt
 - Tires
22. Before starting the MC 4000 forklift, check to see that the parking brake is set and make sure that the transmission shift lever is in the _____ position.
- locked
 - engaged
 - neutral
 - rearward

23. What type of steering does the 72-31 MP Terex tractor use?
- a. Rack and pinion
 - b. Articulated
 - c. Air assist
 - d. Four-wheel
24. The model 72-31 MP Terex tractor (Marine Corps version) may be equipped with either a
- a. bulldozer blade or bucket.
 - b. Drott 4-in-1 bucket or a forklift attachment.
 - c. bucket or snowplow.
25. On the 72-31 MP Terex tractor, what are the four lift control lever positions?
- a. Float, lower, raise, and tilt back
 - b. Float, lower, raise, and dump
 - c. Float, lower, hold, and raise
 - d. Float, lower, raise, and L-R shift
26. On the 72-31 MP Terex tractor, what is located on the Drott 4-in-1 attachment to aid the operator?
- a. Clam and blade position indicators
 - b. Transmission instructions
 - c. Sectionalization instructions
 - d. Lubrication instructions
27. The screw-type jacks in the sectionalization skid assembly are used to
- a. separate the main sections of the vehicles.
 - b. draw the main sections together.
 - c. support the axle assemblies.
 - d. support the two main sections.
28. Prior to sectionalizing a vehicle, you should NOT
- a. locate it on level terrain.
 - b. check the sectionalization skid assemblies.
 - c. drain the hydraulic systems.
 - d. make sure it is in operating condition.
29. The guy assemblies should be installed between the ring in the base of the screw-type jacks and _____ opposite the corner of the frame.
- a. horizontally
 - b. vertically
 - c. diagonally
30. In sectionalizing the equipment, if all connections have been disconnected, what is removed next?
- a. The laminated gaskets
 - b. The 6 bolts
 - c. The 12 cap screws
 - d. The splined shaft

Total Points: 30

* * *

MISCELLANEOUS EQUIPMENT

Section I. ROLLERS AND DISTRIBUTORS

6-1. INTRODUCTION

There are two types of road and airfield construction equipment on which you will receive very little practical application training except when performing actual construction. The self-propelled roller and the asphalt distributor are seldom used during routine training periods. However, they must be maintained in operating condition and ready for use when needed. You may be assigned as the operator for one of them and you should be prepared. Although training on these items is seldom scheduled, you can learn how to inspect, service, and operate them properly if you will use your initiative. You can study the TM's and operator's manuals, seek instruction from the dispatcher and equipment chief, and request permission to operate them when you are not busy with other jobs. Very seldom does the Marine Corps lay an asphalt surface, but when it does you will be depended on to be able to operate the equipment.

6-2. FIVE- TO EIGHT-TON TANDEM ROAD ROLLER

a. General. Rollers are used mainly for compacting road and airfield subgrades and for compacting and smoothing paving materials other than portland cement concrete. A smooth-steel roller is used for both compacting and smoothing. The 2-axle tandem roller (fig 6-1) has a single large-diameter drive roll at the front and a single smaller-diameter guide roll at the rear. Rollers usually weigh from 5 to 8 tons. Tandems are the best machines for initial and finish rolling of cold-laid bituminous paving and for finish rolling of hot-laid bituminous paving. Finish rolling with a 2-axle tandem requires lengthwise, diagonal, and crosswise rolling. Tandems may also be used for compacting thin layers of soil. They should not be used for compacting base courses of hard, angular material because their roll surfaces are easily dented.

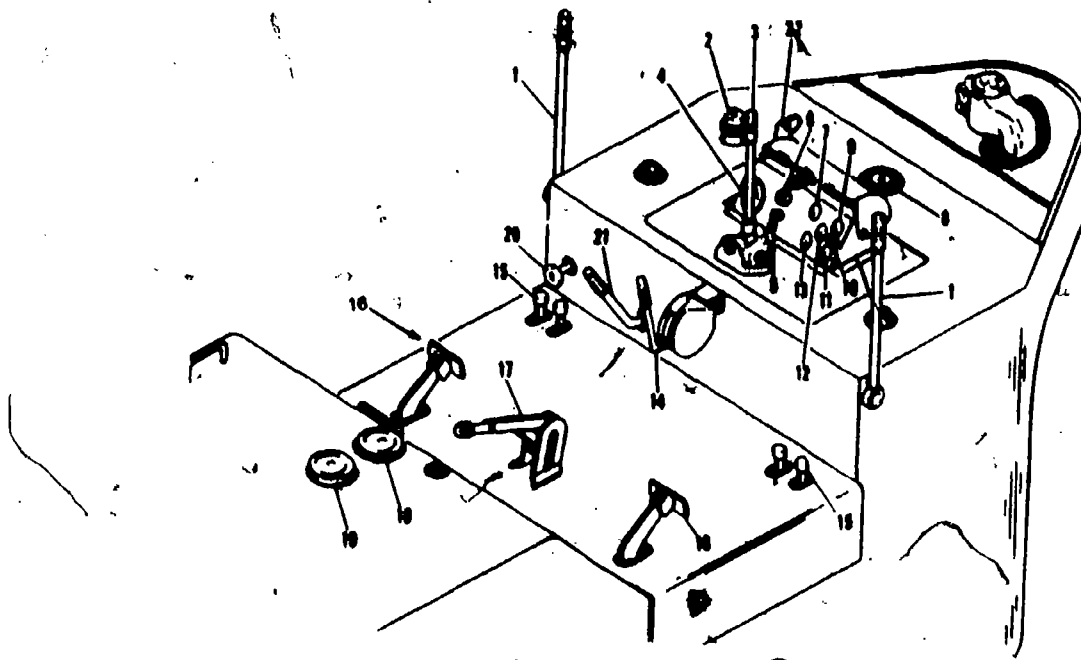

Fig 6-1. Huber-Warco model R6760M 5- to 8-ton tandem road roller.

- (1) **Ballasting.** Most power rollers with enclosed, drum-type rolls can be ballasted for additional weight by filling the rolls with sand, water, or a combination of sand and water. Sand is the least desirable method due to the difficulty of putting it in and removing it. Antifreeze must also be used in the water in cold climates since the rollers will burst if water is used and freezes. A 2-axle tandem which weighs 5 tons empty will weigh about 8 tons when ballasted with water.
- (2) **Scrapers.** On most smooth-steel power rollers, each roll is equipped with a pair of scrapers. When the scrapers are set, they are held in light contact with the roll surface, so that they scrape off material which would otherwise build up and mar the rolled surface. When desired, the scrapers can be locked out of contact with the roll.
- (3) **Sprinkler systems.** To prevent certain types of materials from sticking to the roll surfaces, moist roll surfaces are required. Most power rollers are equipped with sprinkler systems for this purpose. A sprinkler system consists of a water tank, from which water is piped to a cocoa mat (brush-like device) on each roll. The sprinkler system is used for operating on black top or hot-laid bituminous surfaces.

b. **Operating controls.** The controls and instruments are shown in figures 6-1 and 6-2. The machine is powered by a GMC 2-cylinder diesel engine which is equipped with the customary diesel engine instruments and controls. These are: the ignition switch, ammeter, fuel oil-pressure gage, emergency stop lever, and the engine throttle lever (14, fig 6-2).

- (1) The roller is equipped with dual operating controls for either right or left seat positions (fig 6-2). The clutch control levers (1) provide a forward and reverse direction. Move the lever forward to engage the forward clutch and the machine will move forward. Move the lever backward and the machine reverses direction. When the clutches are properly engaged, there will be a distinct "snap-in" feeling.
- (2) The steering control lever (3) is mounted in the top center of the frame. Move the lever to the right and the roller will turn right; move it left and the roller will turn left.
- (3) The gearshift lever (21) is located in the center of the frame below the operator's seat. Move the lever forward for low range and backward for high range. The operating clutch lever must be in neutral before you shift gears.
- (4) The service brake is operated through dual foot pedals (16) one at each side of the operator's platform. The water sprinkling pedals (15) should be depressed to start the sprinkling valves when you want to spray water on the rolls.
- (5) The emergency or parking brake lever (17) is located in the center of the operator's platform. To set the brake, pull the lever up or toward the operator. The hydraulic valve selector stem (20) is used to regulate the speed of steering. Turn the valve clockwise to increase the steering speed and counterclockwise to reduce the steering speed.



- | | |
|------------------------------|-----------------------------------|
| 1. Clutch control lever | 12. Fuel level gage |
| 2. Hydraulic tank filler cap | 13. Ammeter |
| 3. Steering control lever | 14. Engine throttle lever |
| 4. Tachometer | 15. Water sprinkling pedals |
| 5. Ignition switch | 16. Service brake pedal |
| 6. Starter | 17. Parking-emergency brake lever |
| 7. Fuel oil pressure gage | 18. Fuel tank filler cap |
| 8. Radiator filler cap | 19. Sprinkling system filler cap |
| 9. Coolant temperature gage | 20. Steering speed selector |
| 10. Engine stop control | 21. Gear shift lever |
| 11. Engine oil pressure gage | 22. Cold weather starting aid |

Fig 6-2. Controls and instruments.

c. Operating the roller.

- (1) Before you start the engine, make the usual prestart checks. Place the gearshift lever and the operating clutch lever in the neutral position. Open the throttle to the half-speed position, turn the ignition switch to the "on" position, and press the starter button. After the engine starts, check the engine oil-pressure gage for proper pressure.
- (2) To start the roller moving, move the gearshift lever to the desired position. Advance the engine throttle to half speed and move the operating clutch lever forward or backward, depending on the desired direction of travel, until a distinct "snap-in" is felt. Always start gradually from a dead stop to avoid straining the machine and marring the rolled surface. When changing from forward to reverse motion, or vice versa, put the operating clutch lever in neutral and allow the roller to drift to a dead stop before engaging the lever in the opposite direction. When rolling bituminous surfaces, you must have smooth "starts" and "stops" to avoid causing depressions in the surface. You do this by engaging the operating clutch gradually--not with a jerk-in motion.
- (3) Keep the sprinkling mats wet to prevent the rolls from picking up the bituminous material and causing pockets in the surface. On hot mix surfaces, avoid excessive steering to eliminate the swirls caused by the guide roll. On hot mix surfaces, operate the roller at low speeds until the surface has "setup," then roll out the ridges at high speed. Overlap the previous path by about 1 foot to avoid leaving a ridge. On all dirt or stone, operate the roller without the sprinkler. When rolling, start at the ditch line and work in toward the center.
- (4) The service brakes may be used to stop the roller. If the roller is to be parked on a slope, set the emergency brake. To stop the engine, set the engine throttle. Turn the ignition switch to the "off" position and turn off the fuel shutoff valve.

d. Roller safety. A roller is easier to overturn than most other pieces of construction equipment. Rolling on a side slope should always be done at right angles or diagonally rather than lengthwise. Steer carefully when rolling at a shoulder, to avoid capsizing into the ditch, and never bring a roller near the edge of a cut. If you are rolling in cold weather, be careful to avoid any sheets of ice. As soon as the drive roll on a roller hits a sheet of ice, the operator completely loses control of the machine.

6-3. ASPHALT DISTRIBUTOR

a. Purpose. The asphalt distributor (figs 6-3 and 6-4) is used in the construction of surface treatments, road mix surfaces, and penetration macadam. Its basic function is to apply the bituminous material to the surface accurately and uniformly in the desired amount and width. The application rate of the distributor is controlled by the width of the spraybar, the pump output, and the forward speed of the truck.

- (1) Normal functions. The circulating system (pipe and valve arrangement) is designed to perform several jobs that are necessary to a well-balanced unit. These functions include the following:
 - (a) Fill the distributor tank from a tank car, transport, or storage tank.
 - (b) Act as a transfer unit. It is capable of filling a supply tank from a tank car transport or storage tank without having the bitumen enter the distributor tank.
 - (c) Circulate the bitumen in the tank while it is being heated.
 - (d) Pump bitumen through either or both spraybar feed lines.
 - (e) Cut off the spray at the nozzle and return material in the spraybar and distributing lines to the tank.
 - (f) Supply materials to a hand-spray unit.

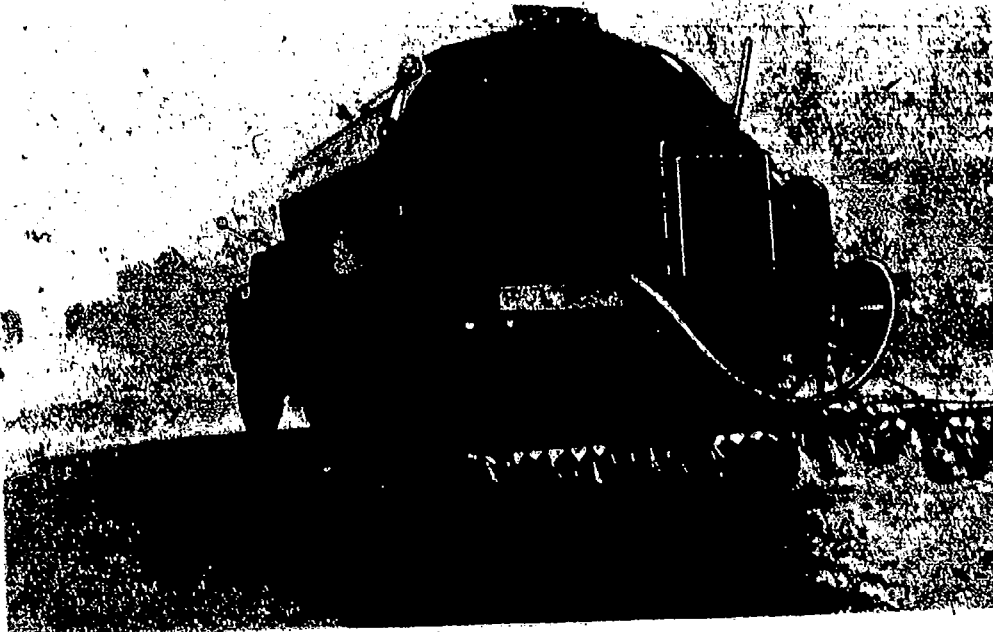

Fig 6-3. Asphalt distributor.

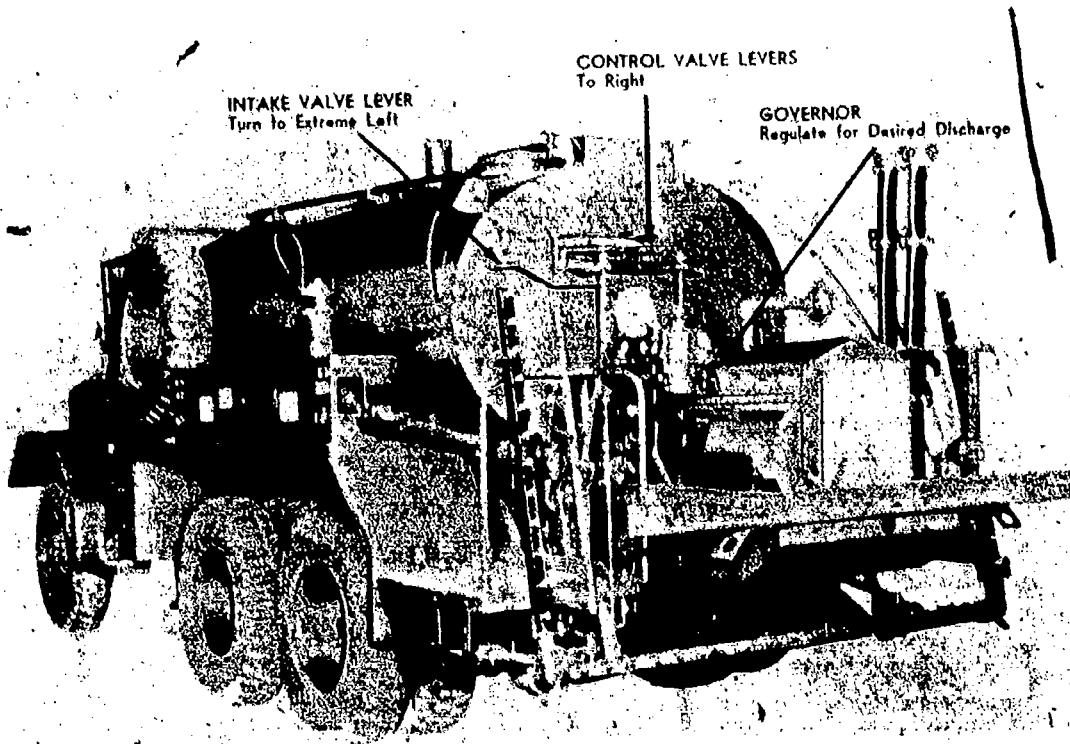

Fig 6-4. Distributor controls.

6-5.

(2) Auxiliary functions. Several other useful functions that the asphalt distributor can perform are:

- (a) Transport tank for bituminous materials, water, or other liquids which are not contaminated by, or will not contaminate, the distributor.
- (b) Act as a circulating heater.
- (c) Act as a water sprinkler.

b. Operation. This paragraph will cover the distributor, bituminous material, tank-type, 1,000-gallon, truck-mounted, forced-feed, gasoline-engine-powered, Etnyre model MX-RE. The distributor has the necessary controls and gages to control the functions listed in paragraph 6-3a. The principal components and some operating suggestions are covered briefly in this section; for detailed operating instructions, consult the technical manual for the distributor.

(1) Major components.

- (a) Tank. The asphalt tank is made of steel and welded inside and out for double security. Two surge plates are used inside the tank to prevent sudden shifting of the material. The tank is equipped with handrails, overflow, manhole, inside valve, thermometer well, lifting rings, tank gage, heating flues, and a stack outlet for the heating system.
- (b) Operator's platform. The platform is located at the left rear for convenient operation of all controls. A bell signal system is provided between the distributor operator and the truckdriver.
- (c) Tank gages. The amount of material in the tank may be read from the ball float-type tank gage or by using the measuring stick which is graduated in 25-gallon increments. A thermometer which registers to 600° F is used to give a true average temperature of the material in the tank.
- (d) Pump. The pump is a heavy-duty, rotary-gear type. It is capable of supplying bitumen to the 26-foot spraybar with enough pressure to produce an even, fanlike spray from all nozzles, at any range of application, within the distribution range of from 1/10 to 3 gallons per square yard. Capacity is 375 gpm (gallons per minute).
- (e) Burners. The distributor has two atomizing-type, low-pressure burners, complete with blower and fuel pump. The burners will burn all grades of diesel fuel. The blower and fuel pump are engine-driven.
- (f) Transmission. Two-speed, low gear for light application and pumping heavy material, high gear for heavy application with the full-length spraybar. A hand-operated, snap-over-center type of clutch is used to make or break the flow of power between the engine and transmission.
- (g) Spraybar. The spraybar is a turn-up, folding extension type on which the end sections are pivoted. It is quickly adjustable in increments of 1 and 2 feet to any length up to 26 feet. The bar height is adjusted by stops under the operator's platform. The spraybar can be shifted laterally 14 inches, 7 inches each side of center, making it easy to follow a given line. The end sections may be folded for traveling. The spray nozzles are nonclogging, Uni-Flo type. They are spaced on 4-inch centers for triple tap. Blanking nozzles (1/2-inch pipe plugs) are provided to stop spray from any given section of the spraybar.
- (h) Bitometer. The bitometer or fifth wheel located on the left side of the truck chassis drives the bitometer which furnishes the operator with the exact speed of the unit in feet per minute and also the number of feet traveled. The fifth wheel is raised or lowered by the operator and it should be lowered only while distributing.
- (i) Portable burner. The unit is equipped with a Hauck fire-gun, complete with carrying strap, hose, and preheating pan. A tip is provided for burning gasoline.

- (j) Hand spray. A 25-foot section of 1-inch, asbestos-packed, metallic hose, with a hand spray gun, is provided. The hand spray operates off the distributor.
- (2) Operating suggestions.
- (a) Nozzles should be turned so that the angle between the nozzle slot and the spraybar centerline is approximately 22° . Increase or decrease the angle slightly if cross streaks appear on the road.
 - (b) For triple lap, the spray nozzles should be approximately 12 inches above the road surface.
 - (c) Pump speed should be sufficient to give a sharp, straight-edged spray from the nozzle. Increase pump speed or material temperature if the sprays are not sharp.
 - (d) Clean the intake and discharge strainers periodically.
 - (e) When filling the tank, operate the pump at the rate of about 150 gpm, or at the speed that the pump runs most quietly.
 - (f) To accurately determine the amount of material in the tank with the tank gage or measuring stick, make sure that the distributor tank is level.
 - (g) If the distributor has been previously filled with tar or bituminous material, do not refill it with the other unlike material without first thoroughly washing out the unit.
 - (h) Do not fill the distributor until all flushing oil is drained from the tank and the circulating system.
 - (i) Allow 5% for expansion when filling the tank if the material is to be heated in the distributor.
 - (j) Do not force the pump when it is bound by cold material until you thoroughly heat it.
 - (k) Material may be stored in the distributor provided that the flues are covered to permit reheating.
- c. Safety precautions. Most of the safety precautions concern the operation of the burners.
- (1) Heat should not be applied until the flues are covered with a minimum of 6 inches of material.
 - (2) Open the stack cover before lighting the burners.
 - (3) Do not leave lighted burners unattended.
 - (4) If the flame goes out, turn off the burners immediately.
 - (5) Never use gasoline in the burners.
 - (6) Do not heat material above recommended spraying temperature.
 - (7) Do not put gasoline in the engine fuel tank while the burners are operating.

Section II. AIR COMPRESSORS AND ROCK CRUSHER

6-4. AIR COMPRESSORS

a. Introduction. Usually, one of the first pieces of construction equipment that an equipment operator comes in contact with is the air compressor and its wide variety of pneumatic tools. The air compressor is an efficient and versatile tool which can be used during almost all stages of military construction. Compressed air is used extensively for such jobs as sawing, drilling, spraying, and inflating. Basically, an air compressor is a machine for compressing air from a low initial intake pressure to a higher exhaust pressure through a reduction in volume. It consists of a driving unit, a compressor unit and their accessories. The driving unit may be either a gasoline or diesel engine. Although there are many different makes and models of compressors, most of them are quite similar. They are governed by a pressure control system which is adjusted to compress air to a maximum pressure of about 100 psi.

b. Rotary compressor.

(1) Introduction. In recent years the Marine Corps has purchased two sizes of rotary-type compressors, the 250 cfm and the 600 cfm. One is skid mounted and the other is wheel mounted. The rotary compressor unit is a self-contained unit connected to a gasoline or diesel engine through a direct coupling, belt system, or clutch.

(2) Components and function.

(a) Compressor (fig 6-5). This unit consists of a cast single stage stator, compressor rotor, rotor blades, end covers, flywheel housing adapter, and coupling. The rotor is mounted in the stator slightly off center. It is supported by the end covers and rotates on two roller bearings. As the rotor rotates, the rotor blades are forced out against the stator by centrifugal force. An air-oil mixture is trapped between the blades, the rotor, the stator and end covers. Because the rotor is slightly off center, the trapped air is compressed as the rotor turns and is forced out the discharge opening to the oil separator. There the oil is separated from the air by means of a filter. The air is passed on to the service valves for use and the oil is recirculated through the system. A minimum pressure valve on the oil separator assembly maintains a pressure in the assembly to aid in air-oil separation and recirculation of the oil from the separator through the compressor.

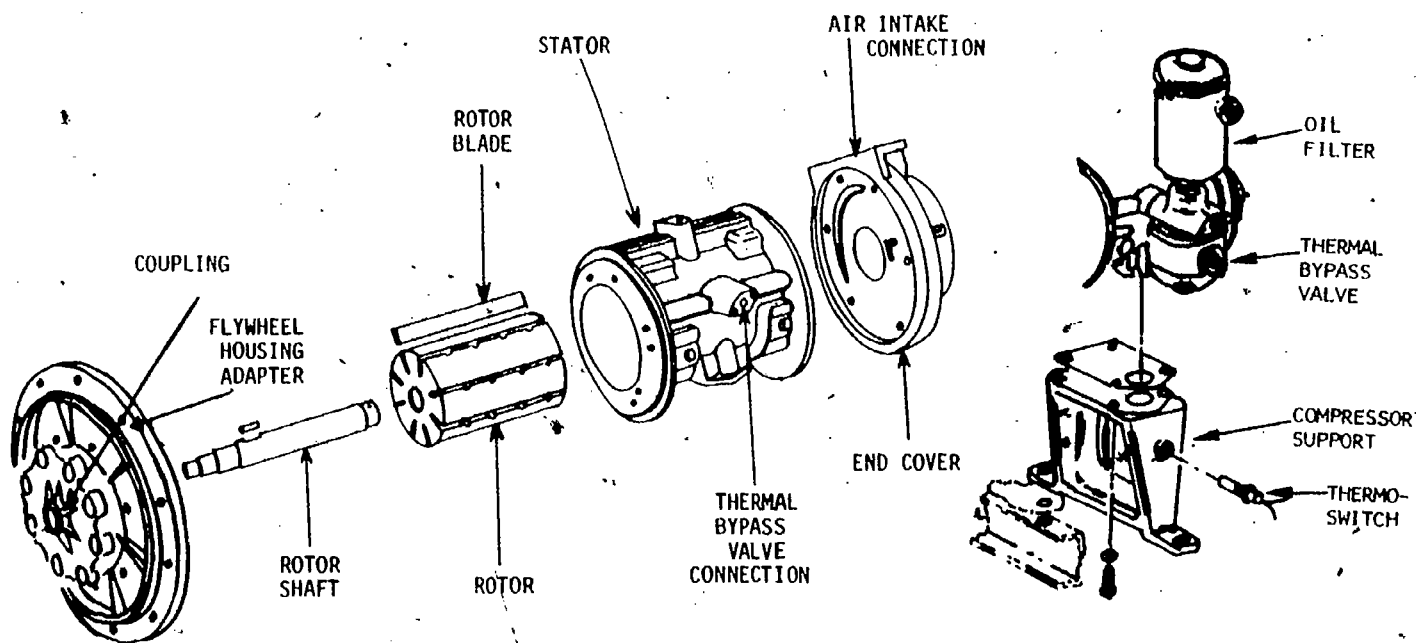

Fig 6-5. Exploded view of the the 250-cfm rotary compressor and thermal bypass valve.

(b) Thermal bypass valve (fig 6-5). This valve is mounted to the compressor stator and controls the oil flow from the separator assembly to the filter and compressor. All the oil is filtered before being circulated through the compressor. When the oil is

cold, the thermal bypass valve directs the oil through the filter and into the compressor. After the oil reaches approximately 150° F, a part or all of the oil, depending on temperature, is directed through the oil cooler before being filtered. The valve will mix hot oil from the separator and the cool oil from the oil cooler to maintain a constant oil temperature. A thermostatic switch, which operates because of heat from the oil, is mounted in the compressor support just below the thermal bypass valve. It opens and closes an electrical circuit that is connected to engine components that will stop the engine if the compressor oil overheats. The oil filter is mounted on top of the thermal bypass valve.

- (c) Air intake-unloader assembly. This component is mounted to the intake port of the stator housing and works in conjunction with the speed control assembly to control the loading and unloading of the compressor and the engine rpm. An adjustment on the speed control determines the pressure at which the intake-unloader assembly will function. When the air in the separator assembly reaches the desired pressure, the intake-unloader will close the intake. The compressor cannot get any air to compress when it is closed off. When the intake-unloader closes, the speed control functions to idle the engine. The intake-unloader also closes off the intake when the machine is shut down, preventing oil and air mixture from the rotor stator assembly being vented to the atmosphere.

c. Capabilities and limitations.

- (1) Capacity. The capacity of an air compressor is determined by the amount of air (at sea level) that it can compress to a specified pressure, usually 100 psi, in 1 minute, under atmospheric conditions of 68° F and 38% relative humidity. This amount is expressed in cubic feet per minute (cfm) and is usually included in the nomenclature of the compressor. The number of pneumatic tools that can be operated at one time from an air compressor depends on the air requirements of the tools. For example, a 55-pound class rock drill requires 95 cfm of air at 80 psi. A 250-cfm compressor can easily supply enough air to operate two of the drills since their combined requirements will be 190 cfm. However, if a third such drill is added to the compressor, the combined demand will be 285 cfm, thus overloading the compressor and causing serious wear. When the pressure and volume of air to a pneumatic tool is reduced to 10% below the set minimum, the efficiency is lowered by 41%.
- (2) Altitude. Altitude must also be considered when you use air compressors. A single-stage, reciprocating air compressor will lose approximately 2% of its initial capacity per 1,000 feet of elevation up to 10,000 feet. Above this, the loss will increase more rapidly. Figure 6-6 shows the percentage of volumetric efficiency for a single-stage reciprocating compressor at different altitudes based on 100% efficiency at sea level and 100 pounds pressure. The efficiency of rotary compressors is not affected by altitude as much as reciprocating compressors.

<u>Altitude</u>	<u>Percent of efficiency</u>
2,000 feet	98.7
5,000 feet	92.5
8,000 feet	87.3
10,000 feet	84.0

Fig 6-6. Efficiency of air compressors at various altitudes.

- (3) Compressor mounting. Compressors for military construction may be mounted in one of four ways: truck, trailer, skid, or wheel. Each has advantages and disadvantages.
 - (a) Truck-mounted. An advantage of the truck-mounted compressor is its mobility. It is well suited for projects which require frequent moves, such as road work. The disadvantage is that two units are tied up for the use of one. When the compressor is deadlined, the truck is not in use, and vice versa.
 - (b) Wheel- and trailer-mounted. Wheel- and trailer-mounted units have the advantage of not tying up an extra unit while operating. A prime mover is required to move these units from one site to the other, but once in place the prime mover may be dis-

connected and used for other purposes. Wheel-mounted compressors have several disadvantages: The frame or chassis is weak and it is possible to pull the front end out from under the unit by hitting a bump at a high rate of speed. Most wheel mountings have a turning radius of about 30° and an operator can turn too sharply and damage the tongue. The older model wheel-mounted air compressors are top heavy and do not track well behind the prime mover. Most of the air compressors in the Marine Corps are wheel- or trailer-mounted.

- (c) Skid-mounted. This compressor is primarily designed for permanent-type jobs where mobility is not important.
- (4) Friction line losses. A rubber hose is generally used to connect the tool to the air compressor and convey the compressed air to the tool. The hose lining resists the flow of air, therefore the pressure at the tool is less than at the compressor end. The air line friction increases as the diameter of the hose decreases and the length of the hose increases. Through practice it has been determined that a 200-foot, standard 3/4-inch diameter hose is the maximum length to which a handheld tool can be connected without requiring you to calculate the friction loss to determine if the tool will operate efficiently.

6-5. COMPRESSOR OPERATION

a. Davey 250 cfm. The operation of the Davey air compressor, 250 cfm, skid mounted, with a diesel engine power unit (fig 1-19) will be discussed here to give you an idea of how one of the several types of air compressors used by the Marine Corps is operated. Remember that the sole source of complete and authentic information is the operator's manual or technical manual for the particular air compressor you happen to be operating.

- (1) Instrument and control panel. The instruments and controls for starting the engine and operation of the compressor, except setting the operating pressure, are located on a panel on the right rear of the engine. The location and function of the instruments and controls on the panel are illustrated and described in figure 6-7. The adjustments for setting the pressure and engine speed in relation to air demands are made at the engine speed control located just behind the instrument panel on the left side of the engine.

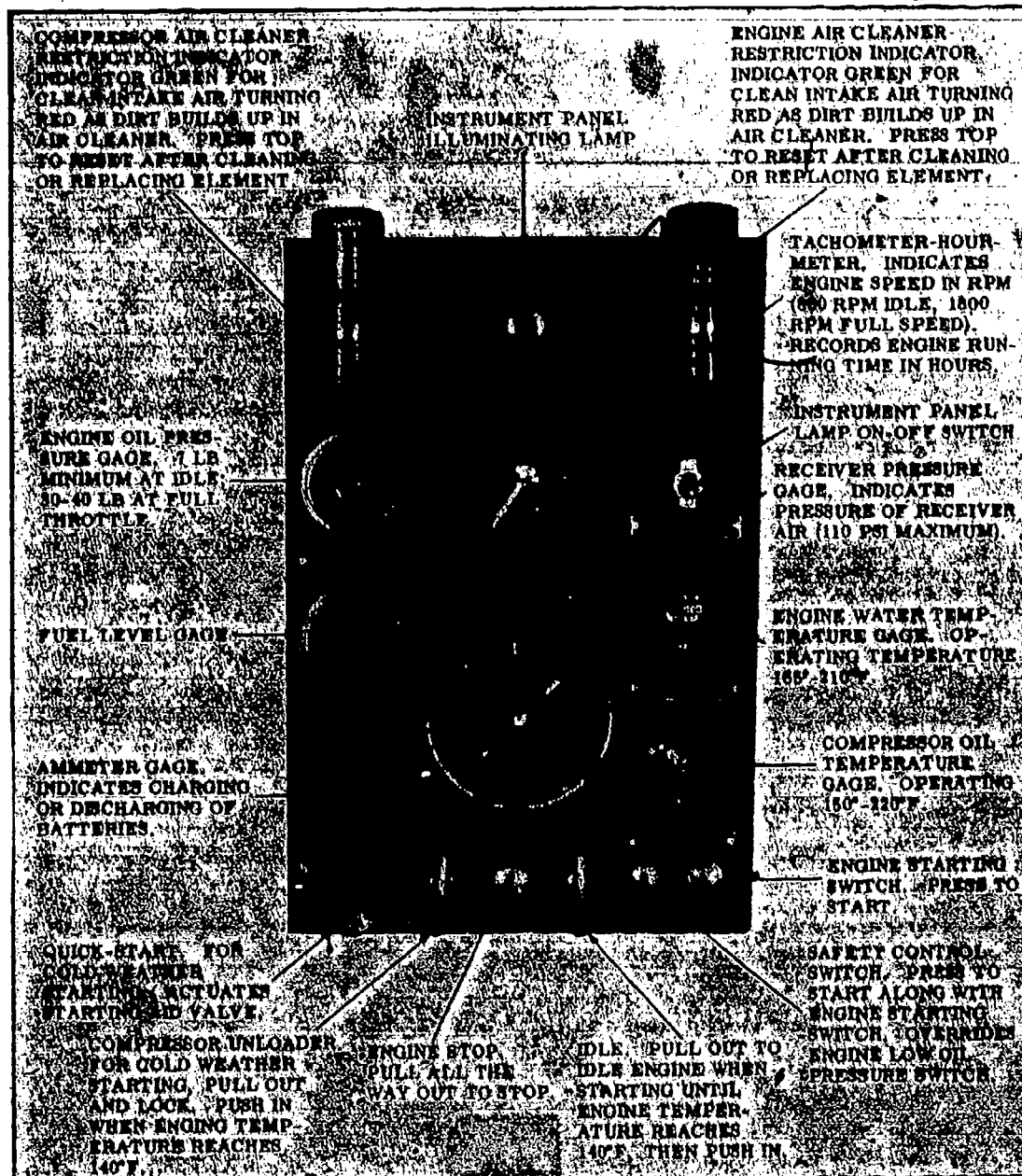

Fig 6-7. Davey 250-cfm rotary air compressor instruments and controls.

(2) Operation.

(a) Starting. Perform all the before operation services listed on the Engineer Equipment Operational Record and those items listed in the TM. After the compressor has been inspected, and is safe to operate, follow the procedures outlined below to crank the engine and begin operation.

1. Turn the instrument panel lamp switch on and open the outlet valve on the hose reel and the service valve.
2. Pull the engine stop cable out to the stop position and crank the engine over for approximately three seconds by pressing the starter button.
3. Now push the stop control cable in and pull the idle control cable out.

4. With the controls in this position, press both the starter button and the safety switch button at the same time. Do not crank the engine longer than 30 seconds at one time. Allow the cranking motor to cool for approximately two minutes after each 30-second cranking period. If the engine fails to start after three or four attempts, have it checked to determine the cause. Release the starter button immediately after the engine cranks. Release the safety switch button after the engine oil pressure gage shows a reading. Stop the engine if the oil pressure fails to show a satisfactory reading within 15 seconds after the engine cranks.
 5. When the engine starts, adjust the idle control so that the engine will run at a fast idle (1,000 rpm). Let the engine operate at this rpm until the temperature gage reaches approximately 140° F.
 6. After the engine has warmed up, push the idle control cable in and close the service and hose reel valves. Check the readings of all instruments and inspect the compressor while it is building up pressure. The pressure will build up to the pressure set at the speed control and the equipment is ready for use.
- (b) Operating adjustments. The location of the adjusting points and the steps to follow when making the adjustments are shown and described in figure 6-8. While the compressor is operating, continue to check the instruments and the equipment.

(CHAPTER CONTINUED ON NEXT PAGE)

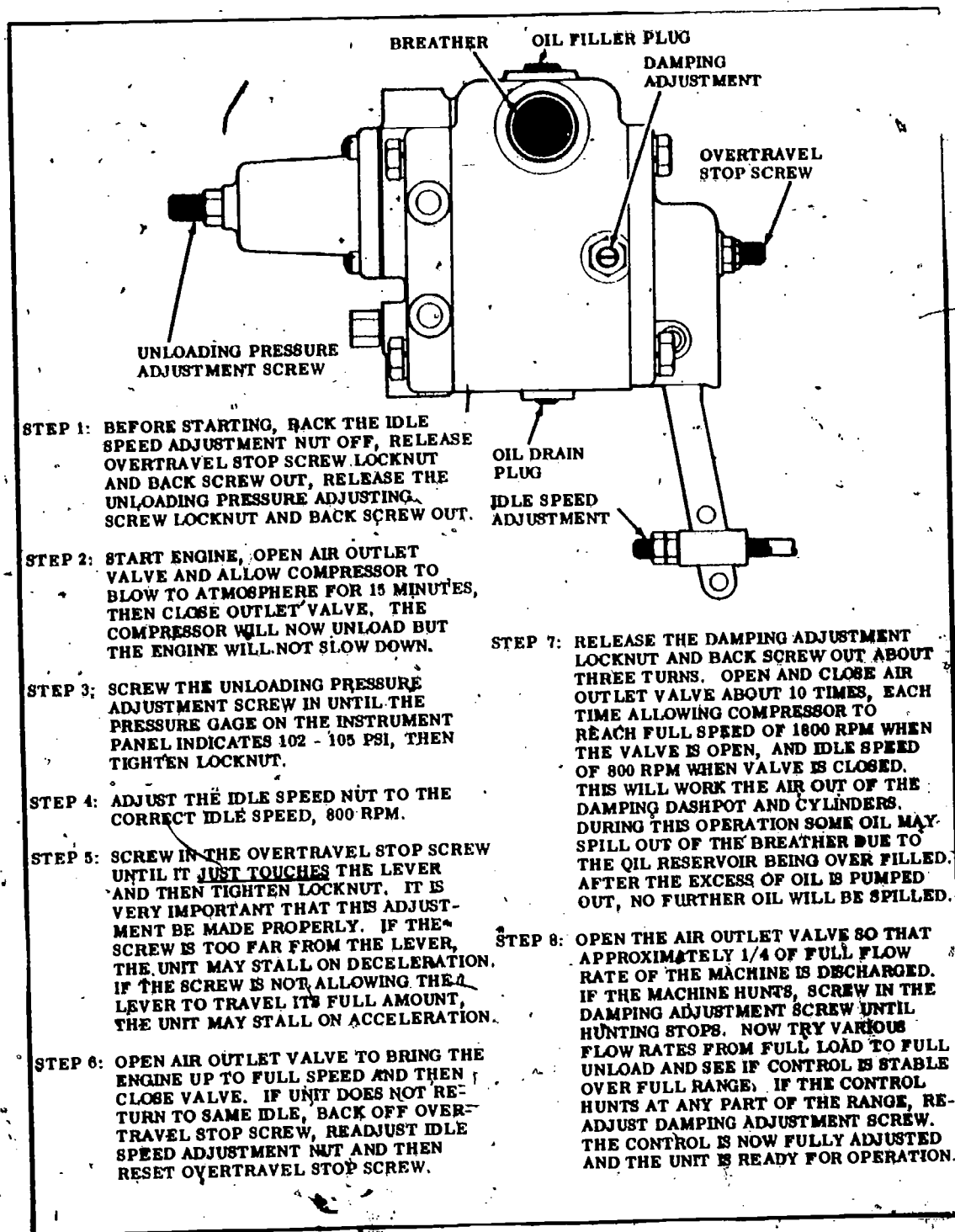

Fig 6-8: Engine speed control adjustments for the 250-cfm rotary compressor.

- (c) Stopping the compressor. To stop the compressor, close the service or hose reel valves and let the compressor operate for five minutes unloaded. Then pull the engine stop cable and hold until the engine stops. Turn the instrument panel lamp switch off and perform the after operation service as outlined in the TM and on the Engineer Equipment Operational Record. Secure the tools, hose, and the compressor before turning in the records and forms to the dispatcher.

c. Operating techniques.

(1) Equipment location.

- (a) The compressor should be located upwind from the work site to keep dust and sand out of the air intake.
- (b) The compressor should be positioned so that the prevailing wind will assist in cooling. Open the side panels during warm-weather operation and close them during cold weather.
- (c) The compressor should be kept as level as possible during operation and should never be operated when tilted more than 15°. Make sure that the compressor is on firm ground.
- (d) The compressor should be placed as near as possible to the work to reduce air-line length.
- (e) Locate the compressor so that it can provide air for the entire operation with a minimum amount of moving.

(2) Overloading. Overloading shortens the compressor life span considerably. Overloading occurs when the total air requirements of the attached tools exceed the rated capacity of the compressor. When compressors are overloaded for prolonged periods of time they are damaged by overheating and the attached tools function inefficiently or improperly. When low tool efficiency seems to indicate overloading, but there are not enough tools attached to cause such overload, air lines should be checked for leaks.

(3) Maintenance.

- (a) All drain cocks should be periodically opened during prolonged operations to drain condensation, thus eliminating rust or danger of freezing.
- (b) Always drain the receiver tank of air when shutting down the compressor.

6-6. ROCK CRUSHER 75-TPH MODEL 2036/101-S

a. General. This paragraph is designed to familiarize you with the 75-TPH rock crusher, the Marine Corps' newest rock crusher. The complete detailed operation and maintenance procedures can be found in the technical manual for this piece of equipment.

b. 75-TPH rock crusher, model 2036/101-S (fig 6-9 through 6-19). The 75-TPH rock crusher consists of a primary unit and a secondary unit. Each is a self-contained unit capable of crushing rock and gravel of particular sizes. Each plant is composed of the following basic components:

- (1) Jaw crusher. (The item numbers in this subparagraph refer to fig 6-11). This consists of one stationary and one movable jaw. The stationary jaw is mounted on the front cross-tie and held in place by cheek plates. The movable jaw is secured to a pitman by wedges. The pitman is connected at one end of an eccentric shaft. As the shaft turns, it moves the pitman and jaw connected to it. The lower end of the pitman is connected to a tension rod with a spring on the opposite end (13, 14, 15). This rod (15) pulls the movable jaw away from the stationary jaw. A toggle between the pitman and the rear cross-tie holds the movable jaw in crushing position close to the stationary jaw. The jaw openings can be changed by adding shims between the toggle and frame toggle seat (16, 17). When uncrushable material passes between the jaws, the toggle breaks, allowing the tension rod to pull apart. This prevents the jaws from being damaged.

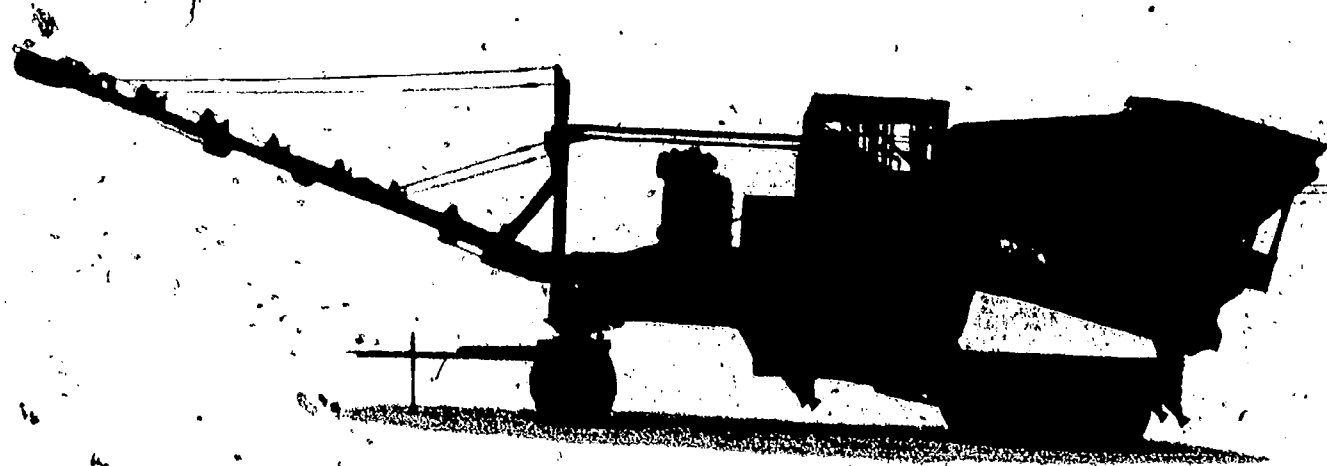

Fig 6-9. Rock crusher, 75-TPH, primary unit, model 2036.

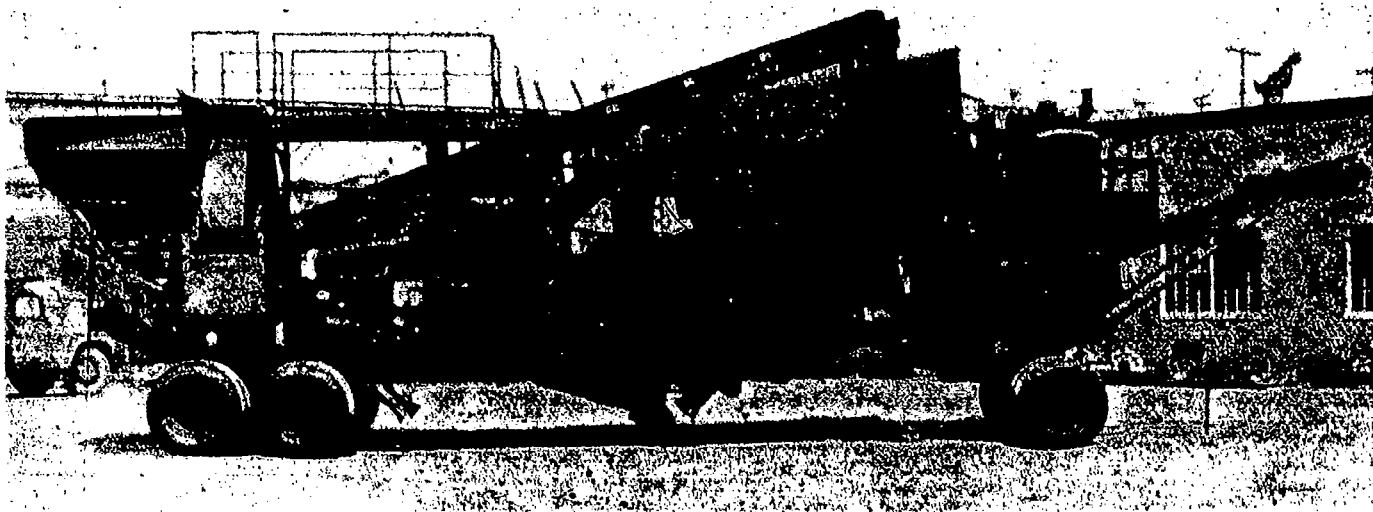
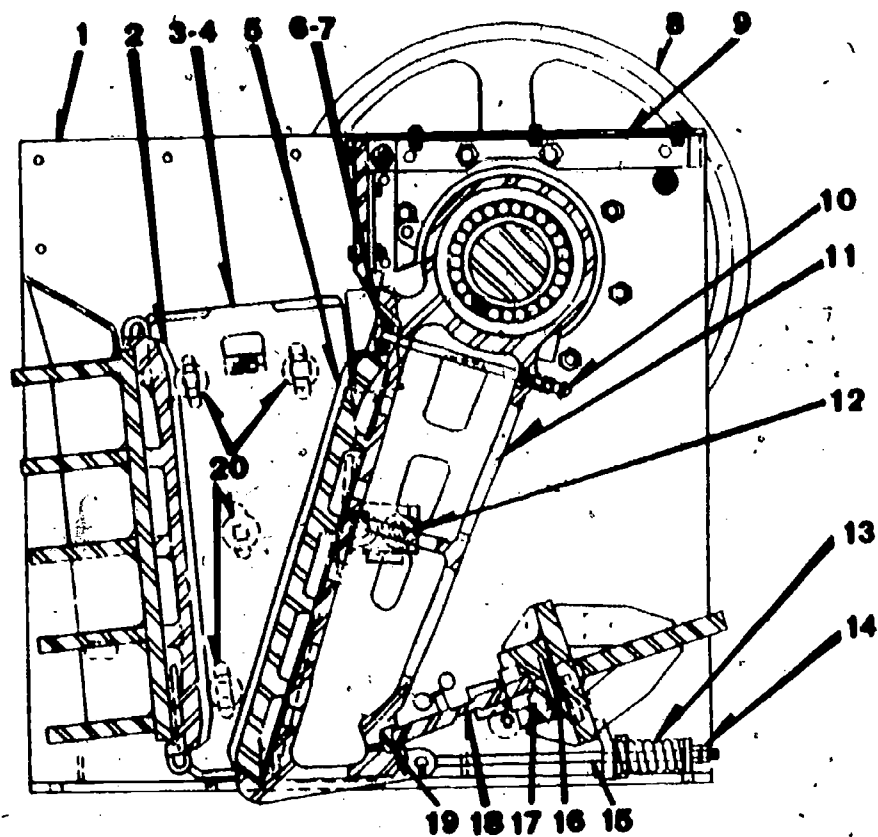

Fig 6-10. Rock crusher, 75-TPH, secondary unit, model 101-S.

250



- | | | |
|----------------------|---------------------|------------------------|
| 1. Main frame | 8. Flywheel | 15. Spring tension rod |
| 2. Stationary jaw | 9. Rear cover plate | 16. Shim plate |
| 3. R. H. cheek plate | 10. Jaw wedge bolt | 17. Frame toggle seat |
| 4. L. H. cheek plate | 11. Pitman | 18. Toggle |
| 5. Movable jaw | 12. Locknut | 19. Pitman toggle seat |
| 6. End jaw wedge | 13. Spring | 20. Cheek plate bolt |
| 7. Center jaw wedge | 14. Tension rod nut | |

Fig 6-11. Jaw crusher.

- (2) **Roll crusher** (figs 6-12 & 6-13). The roll crusher is simply two heavy manganese shells that revolve on stationary shafts. The surface of the shells can be smooth or stepped, or may be a combination with one smooth and one stepped. The shells are driven by star gears. The openings between the shells are changed by shims held in place by compression springs. These springs act as safety releases when uncrushable material enters the roll crusher (fig 6-12).
- (3) **Screen unit.** The screen unit consists of a number of screen decks, usually two, although there may be more or fewer inside a screen body. This body, in turn rests inside a main frame. An eccentric shaft, much like the one on the jaw crusher, is connected to the screen body. The body, in turn, vibrates all screen decks at one time. An equalizer assembly rigidly connects the opposite ends of the screen body and gives the body the controlled circular action established by the eccentric shaft. One end of the screen body is set lower than the other. As material is dropped onto the deck, it either falls through to the next screen level or goes to the jaw crusher. The material that goes to the second deck either falls through to the next deck or goes to the roll crusher. The material that goes to the lower deck is ready for the final separation. Material smaller than the correct size falls through the screen, while correct-size material goes to the final product conveyor (fig 6-12).

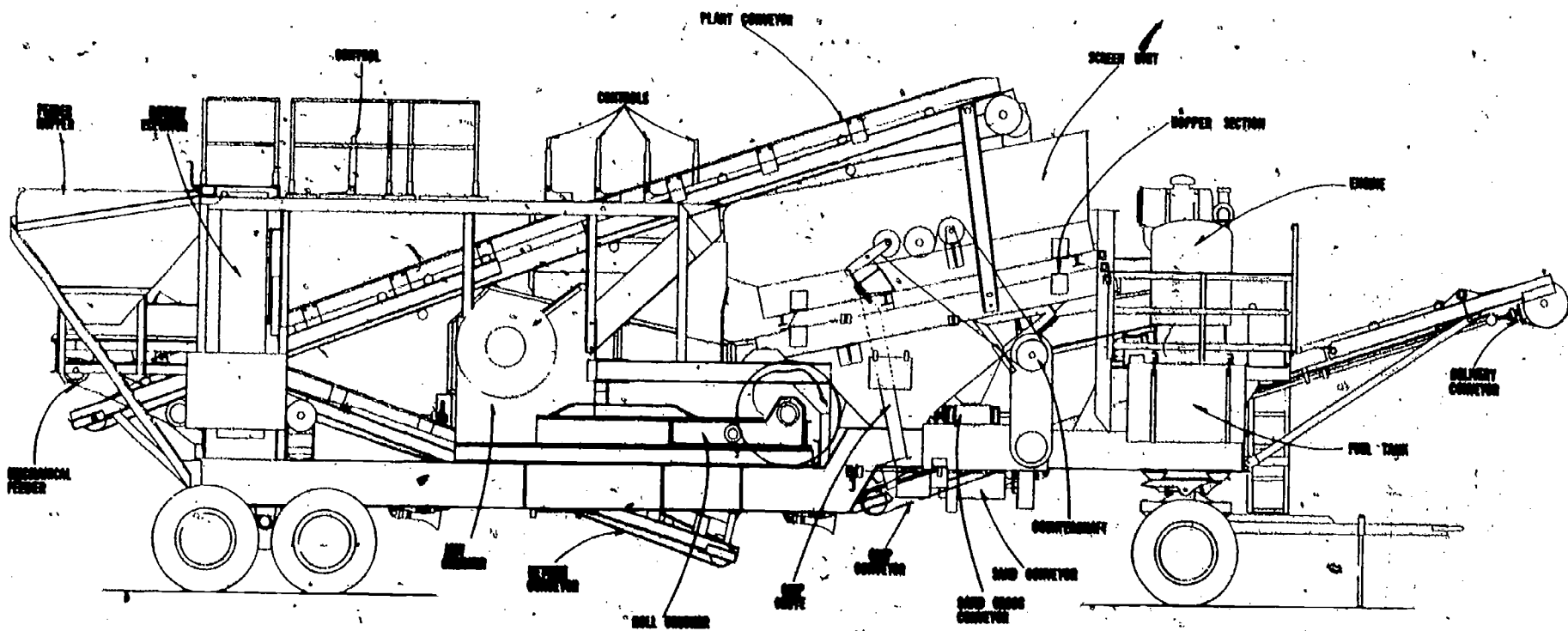

Fig 6-12. Model 101-S secondary plant--component parts.

BEST COPY AVAILABLE

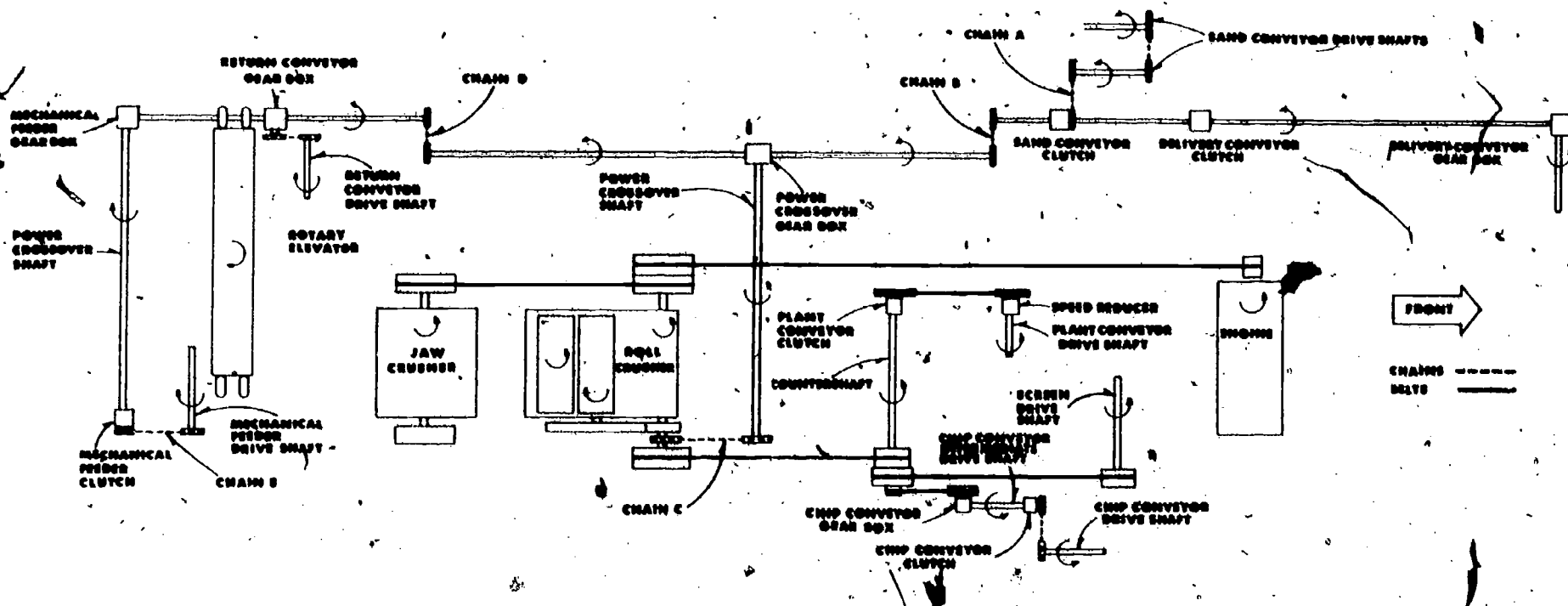
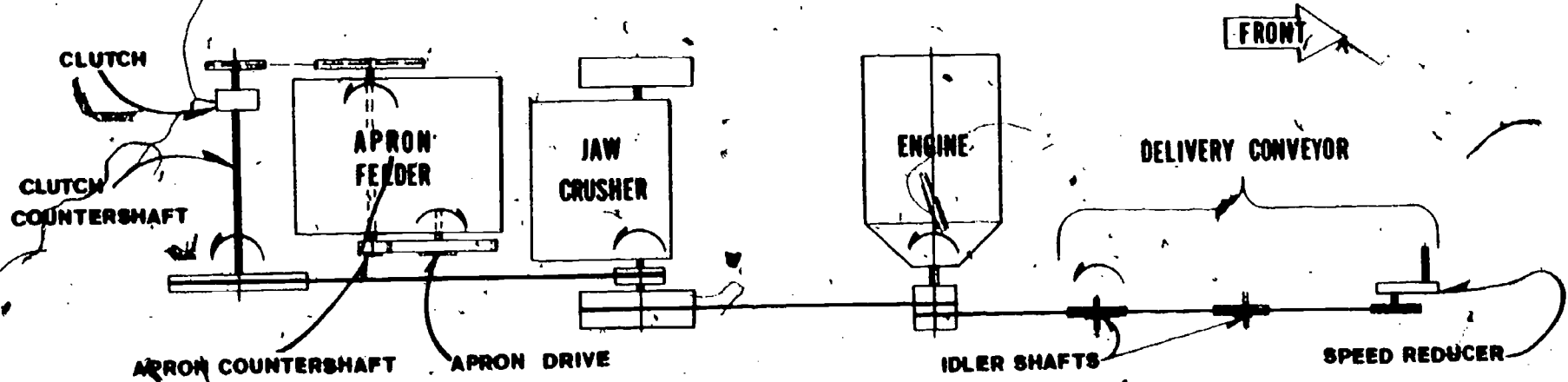

Fig 6-13. Model 101-S secondary plant--power flow diagram.

- (4) Hopper section. The hopper section is immediately below the final screen deck (fig 6-12), and receives the finished products. A pair of adjustable vanes permit either total separation of correct-size stone from undersized material or a mixing of the two in any proportion. The hopper delivers the final products to the delivery or reject conveyor, or both, depending on the vane setting.
- (5) Power units. The power units set crosswise on the plant frame and provide the power to run all drives. A GM 6-71 6914BN engine powers each unit.
- (6) Apron feeder. The apron feeder is the starting point for material in the primary plant. Material in the hopper is carried toward the crusher by a slow-moving steel apron. The operator can control the amount of material going into the crusher by starting and stopping the apron, and thus eliminate overloading of the crusher jaws. As the material reaches the end of the apron, it falls onto the grizzly (a screen made of heavy bars). Material too large to pass through the grizzly slides down into the crusher. Material that passes through the grizzly is small enough to be handled by a secondary plant and therefore need not be crushed by the primary plant (fig 6-14).
- (7) Conveyors. Conveyors are used for transporting material to and from the plants as well as from one point to another within the plants (figs 6-12 & 6-14).
- (8) Rotary elevator. The rotary elevator, found on the secondary plant, is simply a large wheel with steps around its inner circumference. Material from a conveyor is dumped into it while it is turning. The material is caught in a step and carried upward as the wheel revolves. At the top of the revolution the material falls out of the wheel, by gravity, onto another conveyor (fig 6-12).
- (9) Mechanical feeder. The mechanical feeder can be used on the supplying conveyor for either a primary or a secondary plant. As the material is dumped into the hopper, it in turn is evenly distributed on the feed conveyor. The amount of material supplied to the conveyor is controlled by a swinging gate. It will open wide to allow large rocks to pass and return to its original position to regulate the flow of material.

POWER FLOW DIAGRAM - MODEL 2036 PRIMARY PLANT



COMPONENT PARTS - MODEL 2036 PRIMARY PLANT

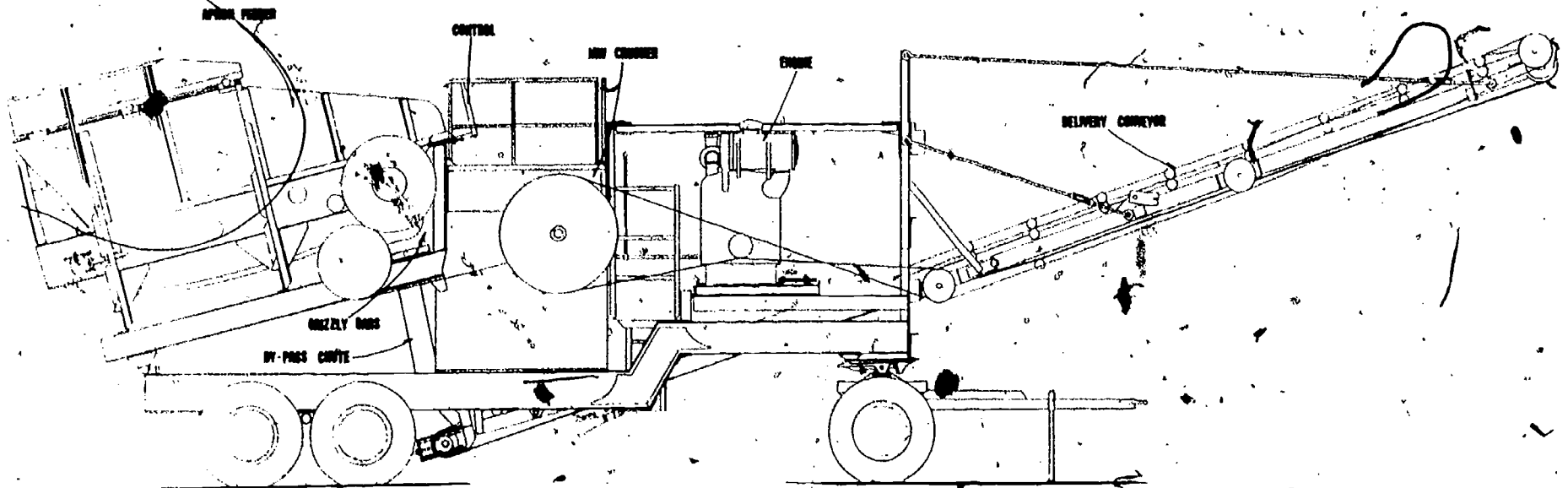

Fig 6-14. Model 2036 primary plant.

c. Setting up the plant. The plant site should be leveled and ready for the plant when it arrives. After the plant has been located, it should be jacked from the ground and securely blocked with 8 x 8's or other suitable blocking. This blocking should be placed beneath the axles and directly under the frame rail. Cross braces should be applied to the blocking to prevent it from turning. After the blocking has been completed, check to make sure that the plant is completely level and that the blocking will not interfere with the conveyors when they are attached to the plant. Finally, attach the front axle stay-bolts on each side of the plant and tighten securely. Recheck these bolts after the plant has been in operation several hours.

d. Initial operation checks. Before the plant is put into operation for the first time, the following checks and procedures must be performed.

- (1) Fill the fuel tank with a clean fuel of the proper quality. Always use a filter when filling the tank.
- (2) Check the radiator to be sure it is properly filled.
- (3) Be sure the various gages begin to register as soon as the engine is started.
- (4) Before engaging the engine clutch, examine the machinery to make sure that no obstruction prevents normal operation.
- (5) Momentarily engage the clutch and turn the machinery slowly. If all parts are operating properly, engage the clutch.
- (6) Allow the engine sufficient time to reach operating temperature before putting it to work.

e. Controls.

- (1) Clutch controls (fig 6-15).

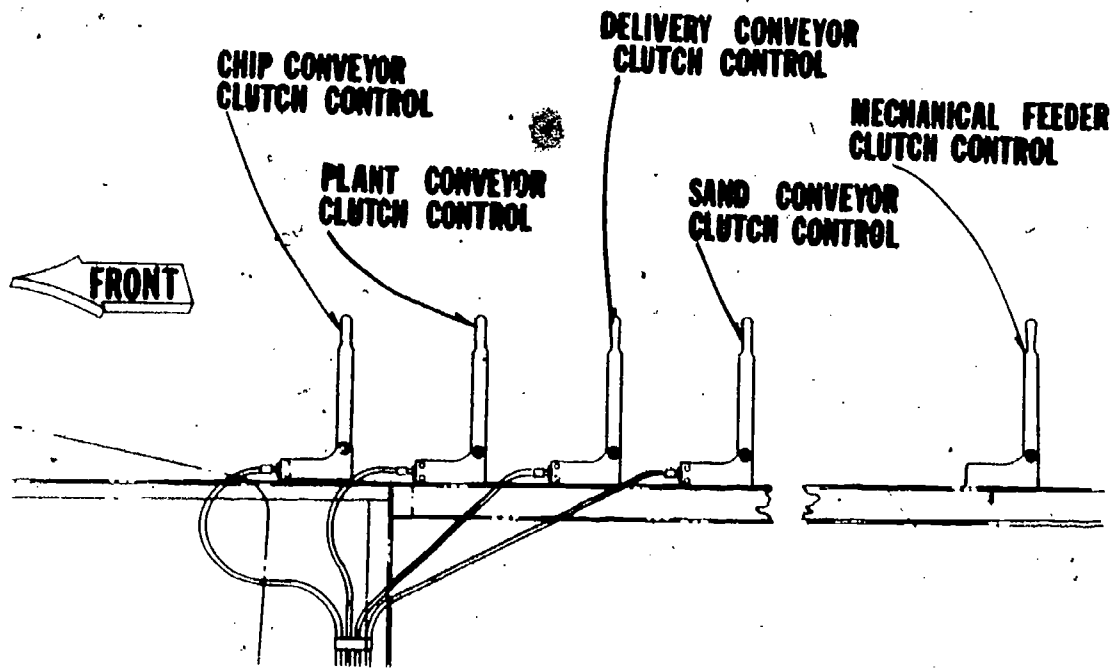

Fig 6-15. Clutch controls.

- (2) Apron feeder clutch control (fig 6-16). This control regulates the amount of feed going to the jaw crusher. The operator can keep the crushing chamber filled to capacity without overloading by engaging and disengaging the clutch, thus starting and stopping the apron feeder.

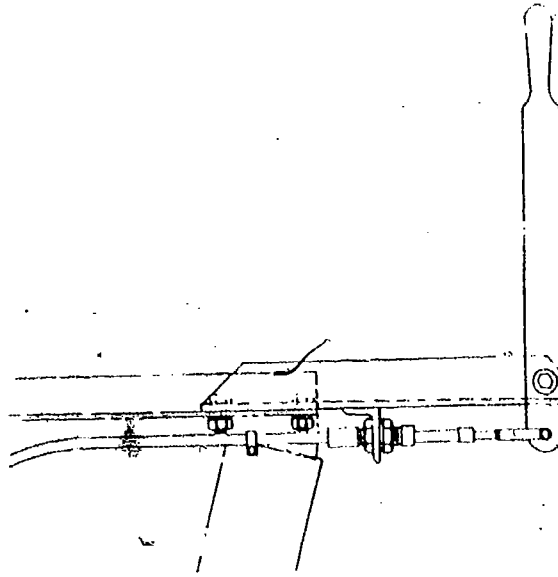

Fig 6-16. Apron feeder clutch control.

- (3) Chip chute control (fig 6-17). A handle on the outside of the chip chute operates a vane on the inside. When the plant is set to produce stone chips, the vane is opened to allow the chips to pass from the screen to the chip conveyor. When chips are no longer needed, the vane is closed and the conveyor clutch is disengaged.

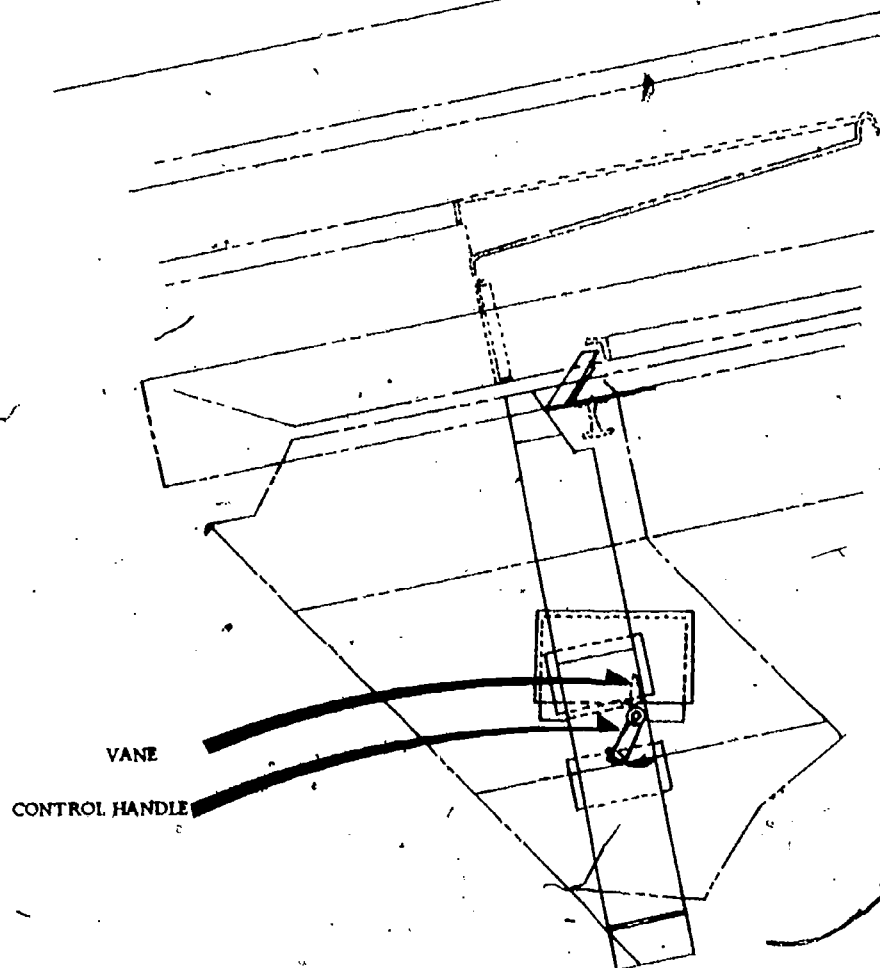

Fig 6-17. Chip chute control.

- (4) Hopper vane controls (fig 6-18). The hopper section is equipped with a pair of adjustable vanes that run longitudinally-with the screen directly below the sand deck. They are controlled by handles on the outside of the hopper. The vanes can be set to mix 100% of the sand with the crushed material by placing them in position A or can remove 100% of the sand by placing them in position C. Position B shows the vanes making a 50-50 split of the sand.

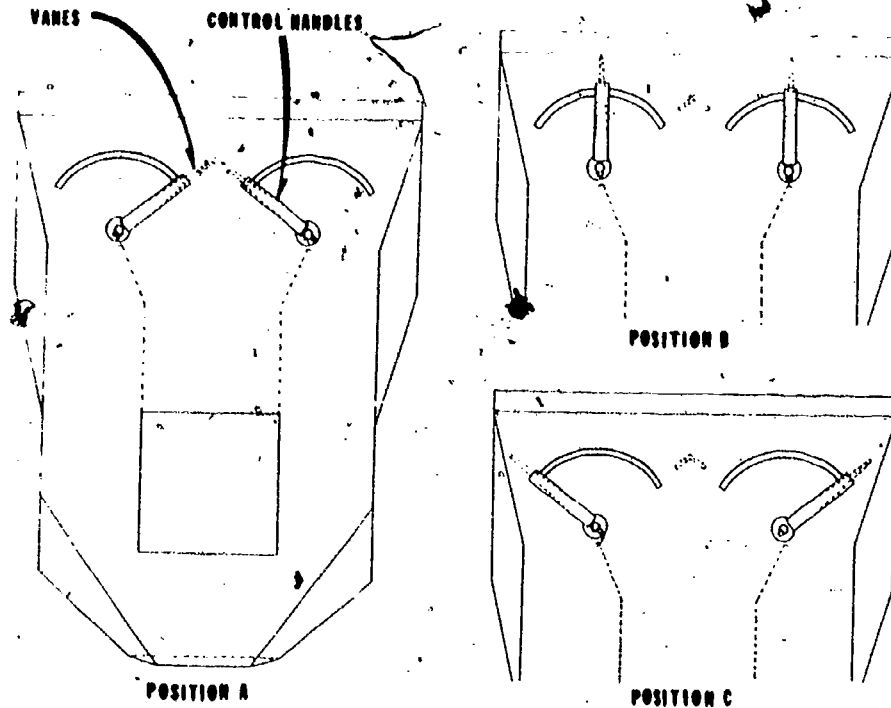

Fig 6-18. Hopper vane controls.

- (5) Mechanical feeder gate control (fig 6-19). The control gate can be set to deliver a uniform flow of material by adjusting it up or down with the adjusting rod.

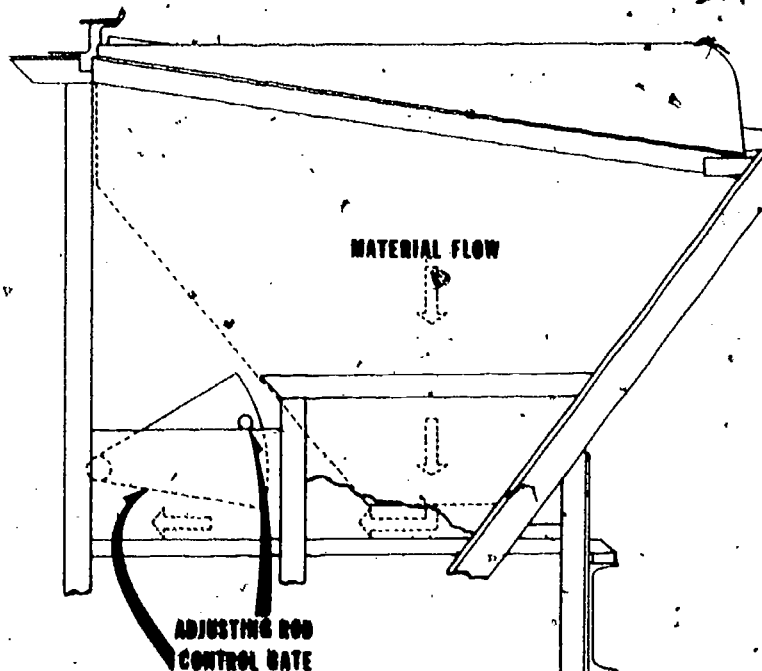

Fig 6-19. Mechanical feeder gate control.

f. Selection of screen cloth. After the product size and crusher settings have been determined, the proper-size screen cloth can be selected. The top deck of the screen should have openings approximately the same size as the 1036 jaw setting. These openings should not vary more than 1/8". The screen cloth on the discharge end of the second deck should be approximately the same size as the 3020 roll setting. These openings also should not vary more than 1/8". The selection of the other screen sizes will be determined by the desired split of the product size.

g. Feeding operation. A continuous, unsupervised feeding system is not practicable. The presence of large rocks mixed with smaller pieces means that a certain amount of skill must be exercised in regulating the feeding operation so that the crushers and screen can be constantly fed at their proper capacity. The operator can control the amount of material going to the crushers by stopping and starting the conveyors. He does this by engaging and disengaging the clutches that operate the conveyors. It is his responsibility to put into practice the following procedures:

- (1) The operator should have sole charge of the feeding operation and should direct the dumping of material into the feeder hopper. He should make sure that a cushion of material always remains in the feeder hopper for its protection from impact by large rocks being dumped from a high point.
- (2) The size of material being fed to the crushers has a definite effect upon production. For highest production, the operator should make sure that the largest stones being fed to the crushers are not over 3/4 of the crusher's rated capacity. While a crusher could handle material as large as its rating, it would not be nearly as efficient as when handling the smaller size material.
- (3) The actual crushing of material takes place only between the roll shells or jaws. The operator, therefore, should see to it that the crushers are never permitted to run empty. Also, he should avoid overloading the crushers as this has no beneficial effect on the quantity of output.
- (4) When the operator observes a large rock progressing on the feeder toward the crusher, he should stop the feeder until the crusher is nearly empty. He should then restart the feeder, dropping the rock into the crusher opening. When this is done the elongated rock falls end first. On the other hand, if the operator feeds a large rock on top of materials already in the crusher, the rock will move downward in a horizontal position and bridge itself across the crusher opening, thus stopping all operations.

h. Preventive maintenance. Preventive maintenance means making routine checks and repairs of possible trouble spots. Finding and eliminating trouble before it starts saves time, work, and money. A new piece of machinery can be kept like new by keeping it clean, well adjusted, and lubricated.

i. Preventive maintenance while operating. In addition to the checklist, there are some commonsense operating practices to follow that will help avoid machinery failure. They are as follows:

- (1) Don't operate the plant without correcting any known defect that may cause further damage to the unit.
- (2) Don't attempt to start the plant when the crushers are loaded with rocks.
- (3) Don't allow crusher jaws to strike each other.
- (4) Don't allow toggle plate to clatter.
- (5) Don't operate plant if crusher jaws are loose.
- (6) Don't operate plant if bearings overheat.
- (7) Lubricate more frequently under extremely sandy or dusty conditions.
- (8) When feeding the plant wet materials, stop the operation frequently and remove clay from the crusher jaws.

(9) Stop the feeding operation and allow the crushing chambers to empty before stopping the plant.

j. Preventive maintenance checks (table 6-1). Establish a preventive maintenance schedule and check sheet along the lines listed below. Make the schedule fit the job conditions and then stick to it closely.

Table 6-1. Preventive Maintenance Checks

Daily intervals			Weekly interval	Procedure
Before operation	During operation	After operation		
X				Check jaws and rolls for wear.
X				Check conveyors for wear and proper tension.
X				Check screen for wear and loose tiedown bolts.
			X	Check hopper side plates for wear.
X				Check all gear cases for proper lubricant level.
X	X			Check all bearings for proper heat and lubrication.
			X	Check all tires for proper inflation.
			X	Check and tighten all bolts on entire plant.
X				Check coolant level in radiator; add as necessary.
X	X			Check fuel level; add as necessary.
X				Check batteries for proper fluid level.
X				Check lube fittings; see lubrication chapter.
X		X		Remove excess dirt and grease from crusher and trailer.
			X	Keep all hopper and conveyor flashings properly adjusted.
X				Check plant blocking for any signs of shifting.
X	X			Check for correct tension on pitman.
			X	Check condition of all V-belts.
X		X		Keep all tools in their proper place. Make sure an adequate reserve supply of oil and lubricants is on hand. Check all lids and caps for a tight fit.

UNITED STATES MARINE CORPS
MARINE CORPS INSTITUTE, MARINE BARRACKS
BOX 1775
WASHINGTON, D.C. 20013

ENGINEER EQUIPMENT OPERATOR

Lesson 6

Miscellaneous Equipment

STUDY ASSIGNMENT: MCI 13. 31h, Engineer Equipment Operator, chap 6.

LESSON OBJECTIVE: Upon successful completion of this lesson, you will be able to identify, by general nomenclature, tandem rollers, air-compressors, and the rock crusher. You will be able to identify the procedures and methods of operating the major components and their accessories.

WRITTEN ASSIGNMENT:

A. Multiple Choice: Select the ONE answer which BEST completes the statement or answers the question. After the corresponding number on the answer sheet, blacken the appropriate box.

Value: 1 point each

1. The Huber-Warco 5- to 8-ton tandem roller is equipped with dual
 - a. service brake pedals, water sprinkling pedals, and clutch levers.
 - b. service brake pedals, steering control levers, and clutch levers.
 - c. steering control levers, emergency brake levers, and clutch levers.
 - d. steering control levers, gearshift levers, and service brake pedals.
2. When rolling bituminous surfaces, what is the method used for changing rolling direction?
 - a. Put the clutch in neutral, drift to a stop, and change direction.
 - b. Shift down to the lowest gear, stop, and change direction.
 - c. Put the lever in the opposite direction, stopping gradually, and change direction.
 - d. Slow down, then engage clutch to the opposite direction.
3. When compacting a road surface, you should start rolling at the
 - a. ditch line and work in toward the center.
 - b. center and work out toward the ditch line.
 - c. shoulder and work diagonally across the road.
 - d. center and work diagonally across the road.
4. Which type roller is best used for finish rolling of both cold- and hot-laid bituminous pavement?

a. Sheepsfoot	c. Two-axle tandem
b. Three wheel	d. Wobble wheel
5. When operating on black top or hot-laid bituminous pavement, what is used to keep the material from sticking to the surface of the rollers?

a. Scrapers	c. Walking beams
b. Sprinkler system	d. Fixed guide rolls

6. What material is least desirable to use for ballasting a roller?
- Water
 - Fuel oil
 - Sand
 - Drain oil
7. What is the function of the bitumeter located on the asphalt truck chassis?
- Indicates how much material is left
 - Indicates the exact amount being sprayed
 - Indicates the speed and distance the unit has traveled
 - Indicates when the material is too thick to spread
8. What is the basic function of the asphalt distributor?
- Transport bituminous materials.
 - Apply accurate, uniform, amount of bituminous material.
 - Supply small units with heated materials.
 - Mix the bituminous material.
9. To provide a triple lap, the distributor spray nozzles should be approximately 3 inches above the road surface.
- 6
 - 12
 - 18
 - 24
10. When the tank is being filled with material which is going to be heated in the distributor, how much should you allow for expansion?
- 2%
 - 5%
 - 10%
 - 15%
11. The distributor burners should not be started until the flues are covered with a minimum of inches of material.
- 4
 - 6
 - 8
 - 12
12. What should be the approximate angle of the nozzle slot to the distributor spraybar?
- 12°
 - 14°
 - 18°
 - 22°
13. On the rotary air compressor, what device aids in air-oil separation and recirculation of the oil from the oil separator to the compressor?
- Stator
 - Minimum pressure valve
 - Bypass valve
 - Rotor
14. On the rotary air compressor, what device acts as a safety mechanism to shut off the engine in case the compressor oil overheats?
- Thermal bypass valve
 - Safety valve
 - Thermoswitch
 - Automatic cutoff switch

15. You have just moved to a new job location. It is 4,000 feet higher than your previous location. What affect will this move have on the capacity of your single-stage, reciprocating air compressor?
- Increase its capacity by 8% compared to sea level
 - Decrease its capacity by 6% compared to previous location
 - Increase its capacity by 6% compared to previous location
 - Decrease its capacity by 8% compared to previous location
16. What is the purpose of the safety control switch on the 250-cfm air compressor?
- To cause the engine to stop when oil pressure is too low
 - To override the engine low oil pressure switch
 - To cut off the engine in case the coolant overheats
 - To cut off the engine in case the oil overheats
17. What is the correct idle speed for the 250-cfm air compressor?
- 600 rpm
 - 700 rpm
 - 800 rpm
 - 1,000 rpm
18. What should the operator always do after shutting down the compressor?
- Open the safety valve
 - Drain the receiver tank
 - Engage the engine clutch
 - Open the side panels
19. The compressor should be kept as level as possible during operation and should never be operated when it is tilted more than _____ degrees.
- 2
 - 5
 - 10
 - 15
20. On the 75-TPH rock crusher, what protects the crusher jaws from being damaged when an uncrushable item passes through?
- The toggle breaks, allowing the tension rod to pull apart.
 - The tension rod breaks, allowing the toggle to pull apart.
 - The grizzly diverts the item to the secondary unit for ejection.
 - The mechanical feeder drops the item into the rotary elevator for rejection.
21. On the 75-TPH rock crusher, which control regulates the amount of feed going to the jaw crusher?
- Apron feeder clutch control
 - Plant conveyor clutch control
 - Delivery conveyor clutch control
 - Mechanical feeder clutch control
22. On the 75-TPH rock crusher, the hopper section is located _____ the final screen deck.
- above
 - below
 - in front of
 - in back of
23. On the 75-TPH rock crusher, checking the hopper side plate for wear is which preventive maintenance check?
- Daily before-operation check
 - Daily during-operation check
 - Daily after-operation check
 - Weekly check
24. Checking all gear cases for proper lubricant level is which preventive maintenance check?
- Daily before-operation
 - Daily during-operation check
 - Daily after-operation check
 - Weekly check

Total Points: 24

Chapter 7

ASSOCIATED SUBJECTS

7-1. DECONTAMINATION

a. Detection. The nature and extent of contamination must be known so that the proper decontamination procedure may be used. There are devices which can rapidly detect chemical and radiological contamination, but there is no rapid detection device for biological agents. When the operator realizes that his vehicle is contaminated, he should put on his protective mask and continue the mission until the tactical situation permits a short stop for decontamination. When the situation permits, expedients such as gasoline and diesel fuel, scrubbing with mud, dry sand, or earth, followed by exposure to wind and sun, will eventually decontaminate a vehicle. Complete decontamination can be attained by using STB solutions, hot soapy water, and clear water.

b. Priority for decontamination. First priority is given to immediate personnel decontamination and second priority is given to weapons and vehicles which are to be used immediately. Lower priority is given to equipment and surfaces for which there is no immediate need.

c. Site selection. In the selection of a site for second and third echelon decontamination operations which require the use of a large quantity of water, accessibility to a source of water is an important consideration. Care must be taken to avoid selection of areas which friendly troops will soon use. The location should be downstream and downwind from troops in bivouac, and should offer adequate camouflage possibilities.

d. Protection of personnel. The individual Marine performing NBC (nuclear, biological, and chemical) decontamination should wear his mask and his normal clothing buttoned at the neck and tied at the wrists and ankles with string. The head should be covered and gloves worn. If standard protective clothing is available, it should be worn.

7-2. CHEMICAL AND BIOLOGICAL DECONTAMINATION

a. General. Most decontaminants and procedures used in chemical decontamination are also effective for biological decontamination. The decontaminants which will be discussed are effective for both chemical and biological decontamination.

b. Types of decontaminants.

(1) Natural decontaminants.

- (a) Weathering. Weathering is the simplest method of decontamination, and is used whenever possible. However, lack of time, unfavorable weather conditions, or proximity of contamination to unprotected personnel may require use of a faster method. Weathering is best accomplished on windy, hot, humid, and sunny days.
- (b) Water. Although plain water may be used to flush chemical agents from surfaces, hot water, hot soapy water, or water and standard decontaminating agents are more effective.

(2) Standard decontaminants.

- (a) Decontaminating agent, STB. This agent is commonly referred to as "supertropical bleach." It is a decontaminant not only for chemical agents but also for biological agents.
 1. Characteristics and use. STB is a white powder. It is a chlorinated lime consisting of calcium oxide and bleaching powder. It is corrosive to most metals and injurious to most fabrics. Approximately 50 pounds of STB are packaged in an 8-gallon drum.
 2. Chemical action. STB destroys mustard, lewisite, and G-agents (nerve agents) by converting them into harmless or less toxic compounds. The vapor given off in reaction with GA (one of the G-agents), however, is toxic. Bleach reacts violently with liquid mustard, and the reaction usually produces enough heat to cause flames. Mixing bleach with water or earth reduces the heat and increases the area coverage of the decontaminating agent.

3. Bleach mixture. STB may be mixed with water to form a wet mix called "slurry," or it may be mixed with dry earth, sand, or ashes to form a "dry mix."
- Slurry (wet mix). There are two types of slurry--one for manual application and the other for application by means of a decontaminating apparatus. For manual application with swabs, brushes, or brooms, the most effective slurry consists of approximately equal parts (by weight) of STB and water, and is prepared by mixing six shovelful of bleach with one 14-quart pail of water. For use in a power-driven decontaminating apparatus, slurry is composed of 40 parts (by weight) of bleach and 60 parts of water.
 - Dry mix. The proportion by volume is two parts (shovelful) of bleach to three parts (shovelful) of earth or other material.
 - Use in cold weather. Bleach mixtures do not decontaminate mustard gas effectively at temperatures below 40° F.
4. Procedure following decontamination. STB may be left on most surfaces (except metal) after use. STB should be rinsed immediately and thoroughly from metal surfaces, which should then be oiled or greased to prevent corrosion.

(b) Decontaminating agent, DS2.

- General characteristics. DS2 is a general-purpose decontaminant which is effective against all toxic agents.
- Preparation and use. DS2 is available in 1 1/3-quart cans and 5-gallon drums in ready-to-use solutions. The 1 1/3-quart cans are for filling the M11 portable decontaminating apparatus. DS2 can be applied easily with the M11 apparatus, a broom, or a swab. The solution is effective at temperatures of -25° to +125° F. Make one application to the contaminated surface and flush with water after 30 minutes. DS2 is noncorrosive to most metals, but will soften leather.
- Safety. DS2 is flammable and must NOT be used on a running engine. DS2 can be removed from the skin by flushing with water.

Note: Care should be taken not to confuse the M11 apparatus with a fire extinguisher.

(3) Miscellaneous decontaminants.

- Caustic soda (lye). Effective against lewisite and G-agents. A 5% solution may be prepared by dissolving 5 pounds of lye in 12 gallons of water. Water is used to flush the surface after it is decontaminated. Extreme care should be used when handling lye, as it is highly damaging to skin, eyes, and clothing.
- Sodium hypochlorite (household bleach). Effective against blister agents and V-agents. Normally a full-strength solution is used. If possible, avoid contact with clothing and skin.
- Washing soda (sodium carbonate). Effective against G-agents but acts rather slowly on blister agents and V-agents. A 5% solution of washing soda and hot water is usually used. It is dangerous to the eyes and skin and should be flushed off immediately with large quantities of water.
- Organic solvents. Common organic liquids such as gasoline, diesel fuel, kerosene, alcohol, and tetrachloride may be used as solvents for many chemical agents. They act as cleaning agents and do not destroy the chemical agents. Safety precautions must be followed and the swabs and solvent used to wash off the chemical agents must be destroyed or buried.
- Degreasing solvent (gunk). This noncorrosive solvent should be applied in the normal manner and flushed with water or steam after 15 minutes.

7-3. NUCLEAR DECONTAMINATION

a. General. Radioactive fallout is the main source of radioactive contamination on the battlefield. When a nuclear explosion occurs on or near the surface, the fission products resulting from the burst adhere to dirt particles carried into the air. Later these dirt particles carrying the fission products fall back to earth as a fine radioactive dust (fallout) and settle on the ground and unprotected personnel and equipment. Trained personnel use radiacmeters to determine the extent of radioactive contamination. Decontaminants which have good cleansing characteristics are normally used for radiological decontamination because the contamination is primarily from radioactive dust which adheres closely to other surfaces and tends to settle into pores and crevices. In most military operations, nuclear contaminants are satisfactorily removed by flushing with water, by the use of steam, and by brushing. During decontamination operations, personnel must wear dosimeters, which record the amount of radiation they have received. By checking their dosimeters, they can guard against staying too long in a radioactive area.

b. Decontamination methods.

(1) General. Two general methods of nuclear decontamination are removal and aging. Most decontamination is accomplished by removal, although, if time permits, aging is the most efficient. When speed in the decontamination of equipment is necessary, brushing should be done first. If brushing proves ineffective, then washing should be performed. Monitoring will indicate the need for further decontamination.

(2) Removal.

(a) Principles. In all removal operations, three general principles are involved:

1. Radioactive contamination CANNOT be neutralized or destroyed, but only removed to an area where it will be less hazardous. After removal operations, the radioactive contamination must be disposed of.
2. Different types of surfaces require different decontamination procedures. Nonporous surfaces, such as steel and hard, painted surfaces, should be decontaminated with procedures using large amounts of water. Porous surfaces, such as wood and canvas, should be decontaminated whenever possible with procedures which do not require large quantities of water, because water tends to drive the fallout farther into the pores, making removal more difficult.

2. Decontamination should proceed from easier to more difficult methods.

(b) Wet methods.

1. Water. Water is the primary decontaminating agent for nuclear contamination. Soaps and hot water increase the cleansing action. High-pressure equipment should be used. In flushing operations, the operator should be upwind and 15 to 20 feet from the surface being sprayed. The equipment should be sprayed from the top down and the angle of spray between the pressure stream and the surface being decontaminated should be 30° to 40°.
2. Steam. Steam is faster acting than hot water in dissolving materials, liquefying grease, and cleaning. The steam jenny, which is standard Marine Corps equipment, furnishes a satisfactory high-pressure jet for radiological decontamination. Hot water and soap should be used to aid in washing the contaminant off the surface.
3. Scrubbing. Scrubbing should be done only on "hot spots" which remain following flushing, hosing, or steaming. Detergents save time by reducing the amount of scrubbing necessary.
4. Organic solvents. For small-scale operations, kerosene, gasoline, diesel fuel, alcohol, turpentine, and paint thinner are useful in removing heavy, hard-grease coatings. They are fast acting and are suitable for wiping "hot spots" left after large-scale decontamination.

(c) Dry methods.

1. Abrasion. When contaminants are clinging so closely to a surface that other methods are ineffective, removing the surface itself by abrasion is an effective method of radiological decontamination.
 - a. Vacuum-blasting is the most effective method of abrasive decontamination. Though rapid and simple, it is the safest method because it picks up practically all loosened particles.
 - b. Hand methods of abrasion such as planing, sanding, chipping, filing, and grinding are suitable for small areas or "hotspots".
2. Brushing. Brushing will usually remove contamination to a safe-level. However, more effective means are required for complete removal of contamination.
- (3) Aging. If time is not an important factor, aging will reduce the contamination to a negligible amount. The time required depends upon the decay rate and the amount of radioactive material. The equipment should be marked and set aside and the progress of the aging method determined by monitoring.

7-4. FORDING

When fording with any piece of equipment, be careful of hidden boulders or dangerous holes. Enter the water slowly, using low gear, and increase engine speed to avoid stalling. Equipment should be thoroughly inspected and lubricated as soon as possible after fording. Whenever possible, equipment should be washed with fresh water after operating in salt water. If the vehicle is to operate in water that is deep enough to interfere with the movement of the engine fan, the generator drive belts should be loosened. This will provide for slippage which will prevent damage to the radiator and fan and reduce the amount of water spray on the engine.

7-5. BEFORE-FORDING PROCEDURES

- a. Inspection. A thorough inspection must be made to insure that the unit is properly equipped and in serviceable condition. Check nuts, bolts, and plugs, and tighten if necessary. Whenever parts such as gaskets, oil seals, and wiring are defective, replace them.
- b. Lubrication. Completely lubricate unit according to the lubrication instruction. If the crankcase and gear oils are due to be changed shortly, it is generally advisable to drain and refill these compartments at this time. Perform a quarterly PM on the item before fording. Carefully check the instructions in the TM for the particular vehicle and if a fording kit is necessary, follow the directions carefully when mounting it on the vehicle.

7-6. AFTER-FORDING PROCEDURES

- a. After fording or deepwater operation has been completed, wash the vehicle with clean fresh water. The solid drain plugs in the engine clutch and steering clutch compartments must be replaced with vented plugs.
- b. Check all lubricating oil compartments to determine if they have been contaminated by water. If they have, the old oil must be drained and replaced with new oil.
- c. As soon as possible, the vehicle should receive a quarterly PM; it should be completely lubricated and inspected for damage. The operator should inspect the oil seals daily for at least the next 100 hours of operation. If they have been damaged by sand, they will develop leaks and should be replaced.

7-7. WIRE ROPE

Many of the movable parts on equipment described in this book are operated by means of wire ropes wound on winch drums. As an equipment operator who will frequently be working with these wire ropes, you must know their characteristics, how to take care of them, and how to use them.

a. Construction. Wire rope is classified according to the type of center (core), the number of strands, the number of wires per strand, the lay, and the fabrication.

- (1) Center. A wire rope consists of a number of strands (usually 6) twisted around a center, or core. This may be an independent wire-rope center or a hemp center. The wire-center rope is less flexible than a hemp-center rope, but is stronger. A hemp center will provide a means of continuous lubrication.
- (2) Strands. A wire rope is designated by the number of strands it contains and by the number of individual wires twisted together to form each strand (fig 7-1). A 6 x 19 wire rope, for example, contains 6 strands, and each strand contains 19 wires (fig 7-2).

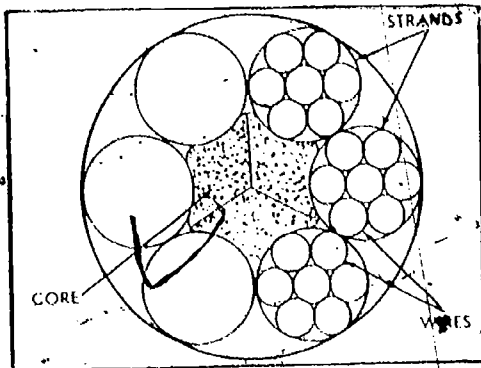

Fig 7-1. Parts of a wire rope.

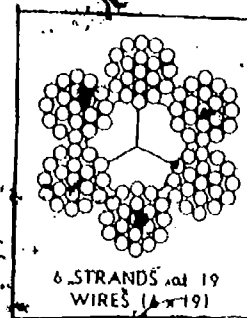

Fig 7-2. Strand arrangement.

(3) Lay.

(a) A wire rope is further designated by the "lay," or direction in which the strands and wires in each strand spiral around the center of the rope. The terms "right lay" and "left lay" refer to the direction in which the strands spiral as you look along the rope. In a right-lay wire, they spiral clockwise; in a left-lay wire, counterclockwise (fig 7-3). The terms "regular lay" and "lang lay" refer both to the direction in which the strands spiral and to the direction in which the individual wires in each strand spiral.

(b) In a regular-lay rope (fig 7-4), the strands and the individual wires in each strand spiral in opposite directions, while in lang-lay rope they spiral in the same direction. The complete designation of a wire rope with respect to the lay is right (or left) regular (or lang) lay. However, since right-lay wire is much more common than left-lay wire, manufacturers' specifications often omit the designation "right." If you see a specification for regular lay or lang lay, the word "right" is to be understood, and you should read it as "right regular lay" or "right lang lay."

(4) Fabrication. Wire rope is designated by its method of fabrication as "preformed" or "nonpreformed." In preformed wire rope, the strands and wires are shaped to conform to the curvature of the finished rope and lie together naturally. Preformed rope does not tend to untwist when the rope is cut, and is more flexible. In nonpreformed rope, the unshaped strands are simply twisted around the core, and will untwist at the ends if they are not tightly seized.

b. Composition. Wire rope is made of various metals, but most of the wire rope used on heavy equipment is made of steel. The most common grades of steel wire rope, in ascending order of strength, are: mild plow steel, plow steel, and improved plow steel. Plow steel or improved plow steel will usually be specified for your equipment.

c. Size. A wire rope is always designated as to size by its diameter in inches, measured as shown in the right-hand view of figure 7-5.

d. Strength. The strength of wire rope varies with the size, type, material, and method of construction. The strength can be stated as the breaking strength or safe working load. As a rule of thumb, the diameter of wire rope in inches can be squared and multiplied by 8 to obtain the safe working capacity in tons ($T = 8D^2$).

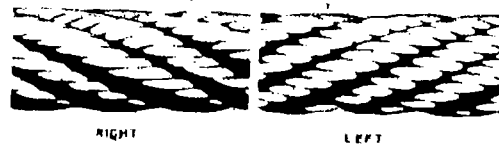

Fig 7-3. Right lay and left lay wire ropes.

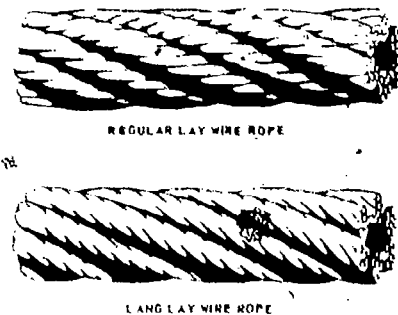

Fig 7-4. Regular lay and lang lay wire ropes.

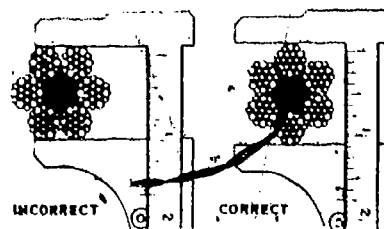

Fig 7-5. Wrong and right ways of measuring size of wire rope.

7-8. HANDLING WIRE ROPE

a. Unwinding. Wire rope may come either on a wooden reel or in a plain coil tied with rope or metal banding. In either case, the rope has been wound into a coil, and to remove it from the coil you must unwind it as shown in the top view of figure 7-6. If you pull it from the stationary coil, as shown in the bottom view, there will be a kink in the rope for every turn in the coil.

b. Transferring. If you have occasion to transfer wire directly from a reel to a winch drum or to another reel, pass the wire from top to top or from bottom to bottom as shown in the upper view of figure 7-7.

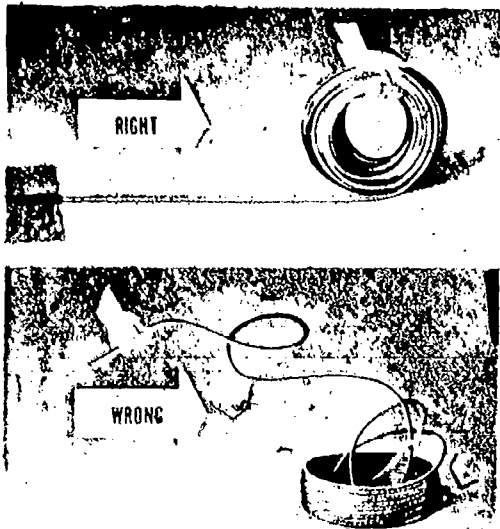

Fig 7-6. Right and wrong ways of removing wire from manufacturer's coil.

c. Need for gloves. Any wire rope--even a new one--may contain an occasional "fishhook" or protruding end of a wire. If a fishhook should slide through your bare hand, it will give you a very nasty cut. Always wear gloves when handling wire rope.

d. Winding. Turns of wire should not overlap when wound on a drum, but should be wrapped in smooth layers. Overlapping will result in binding, causing snatches on the line when the rope unwinds. The rope should be started against the flange and wound close together. Tension should be kept on the rope during winding and a wooden stick used to force the turns closer together. Succeeding layers are wound so that the turns lie in the grooves formed by preceding layers (fig 7-8).

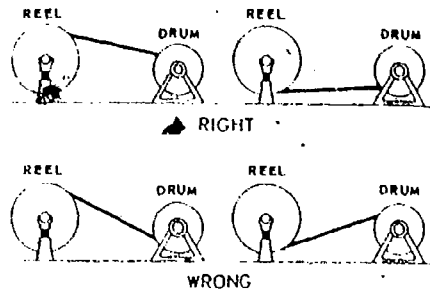

Fig 7-7. Right and wrong ways of transferring wire from reel to winch drum.

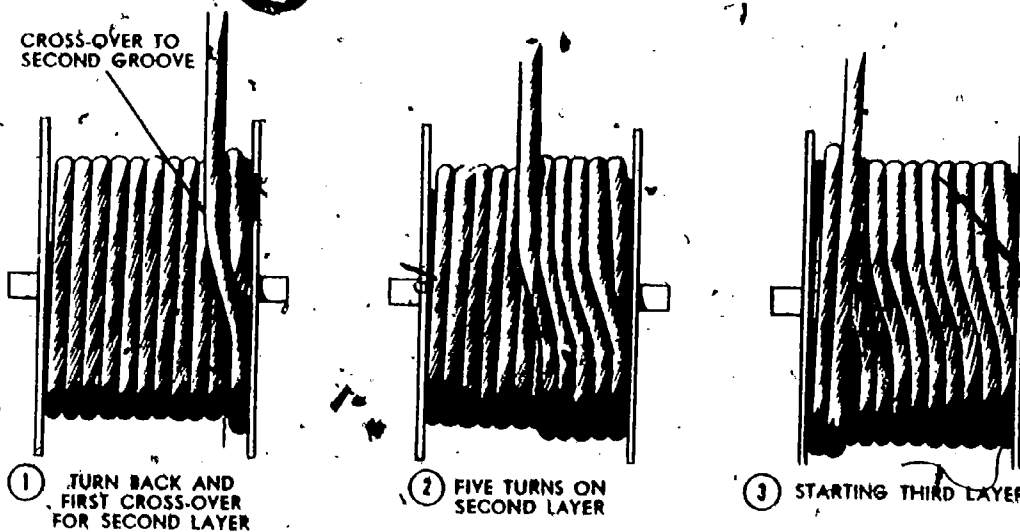

Fig 7-8. Winding wire-rope layers on drum.

7-9. SEIZING WIRE ROPE

a. Purpose of seizing. All wire rope, especially nonpreformed, must be seized at the ends (fig 7-9) to prevent the strands from unlaying. The material used for seizings is an annealed low-carbon wire called seizing wire. The recommended length and number of seizings and the correct distances between seizings are listed in figure 7-10.

b. Steps in seizing. To put a seizing on a wire rope, five steps are used (fig 7-9):

Step 1. Wind by hand, as tightly as possible, as many turns of the seizing wire around the rope as are required to make up the recommended length of seizing.

Step 2. Twist the ends counterclockwise so that the twist is at the center of the seizing.

Step 3. Twist the ends with the cutter just enough to take out the slack. Do not try to tighten the seizing by twisting the ends.

Step 4. Tighten the seizing by prying the twist away from the axis of the wire rope.

Step 5. Again take out the slack by twisting the ends with the cutter. After the seizing is tight, cut off the ends of the wire and pound the twist down flat on the seizing.

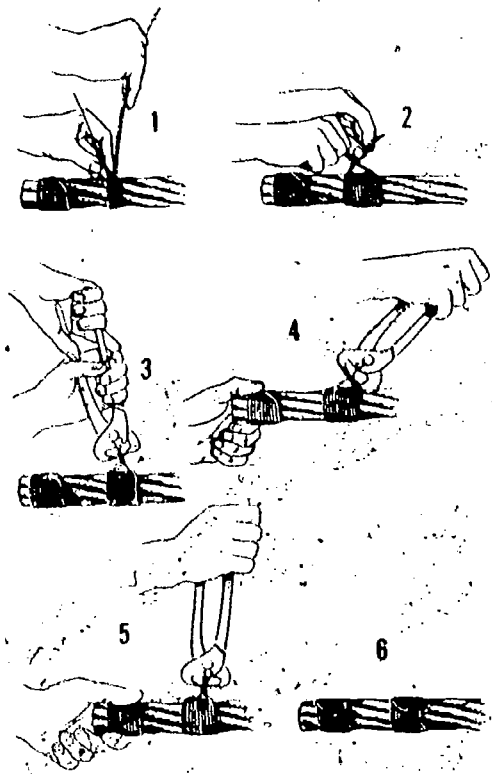

Fig 7-9. Seizing a wire rope.

Rope diameter (inches)	Number of seizings		Length of seizings (inches)	Distance between seizings (inches)
	Regular lay	Lang lay		
1/2 and less	2	3	1 1/2	1
9/16 to 7/8	3	3	1	2
1 to 1 1/4	3	4	1 1/2	2
1 3/8 to 1 5/8	4	4	2	2
1 3/4 to 2	4	4	3	2
2 1/8 and more . . .	4	4	4	3

Fig 7-10. Recommended seizings.

7-10. CUTTING WIRE ROPE

The best way to cut a wire rope is with an oxyacetylene torch. The next best way is with a hammer-type, wire-rope cutter (fig 7-11). Be sure to seize the wire so that there is a seizing on either side of the place to be cut. In the absence of a torch or cutter, wire rope can be cut with a cold chisel or a hacksaw.

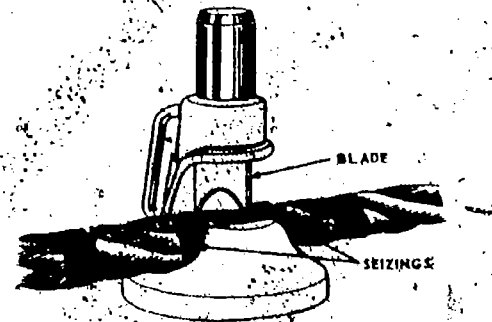

Fig 7-11. Hammer-type wire-rope cutter.

7-11. CARE OF WIRE ROPE

- a. Importance of proper care. Wire rope running around winch drums and sheaves will wear like any other metal article, and for this reason lubrication is just as important to an operating rope as it is to any other piece of working machinery. The proper functioning of a rope depends upon freedom of movement, with a minimum of friction, of the individual wires and strands in relation to one another. Friction caused by lack of lubrication, corrosion, or both will seriously shorten the service life of a rope.
- b. Inspection to detect deterioration. Deterioration caused by corrosion is more dangerous than that caused by wear, simply because it is more difficult to detect. Deterioration caused by wear can be detected by examining the outside wires of the rope, because these wires become flattened and reduced in diameter as the rope wears. Any rope in which the outside wires are worn to less than 60% of their original diameter should be replaced.
- c. Lubrication. Both internal and external lubrication are required to protect a wire rope against wear and corrosion. Internal lubrication of the wires and core is taken care of during the manufacturing process. Lubrication applied in the field is designed not only to maintain surface lubrication, but also to prevent the dissipation of the internal lubrication provided by the manufacturer. Consult your equipment technical manual or operator's manual for the type of lubricant required. Frequency of application depends on service conditions; as soon as the last coating has appreciably deteriorated, it should be renewed.
- d. Reversing. After a wire rope has been in service for some time, it is a good idea to reverse it end-for-end. This distributes the wear and fatigue caused by bending (over sheaves and around drums) over different sections of the rope, and thus prolongs its service life. Breaking in a new rope with a light load, or even with no load, for a short period of time allows the rope to become adjusted, under minimum strain, to operating conditions.
- e. Avoiding abuses. Abuses which will shorten rope service life are kinking, lack of lubrication, and overloading. Also, as a general rule, the wrong type of rope will deteriorate much more rapidly than the correct type.

7-12. WIRE-ROPE ATTACHMENTS

a. Wedge sockets. There are many different types of attachments which can be fitted to the end of a wire rope to provide a means for connecting the end to a pad eye. The one most frequently used to dead end wire rope on earthmoving equipment is the wedge socket (fig 7-12). To install a wedge socket, remove the pin and knock out the wedge. Pass the rope up through the socket and lead enough of it back through the socket to allow 2 inches of the dead end to extend below the socket. Next, replace the wedge and pull the live end of the rope to force the wedge into the socket. Take a strain on the live end to securely seat the wedge. Make sure that the socket is installed on the equipment so that the live end of the wire rope will form a nearly direct line to the clevis pin (fig 7-13). To remove the rope, simply drive the wedge from the socket.

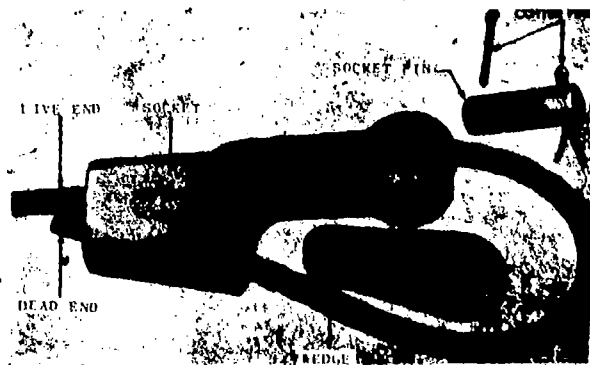

Fig 7-12. Wedge cable socket.

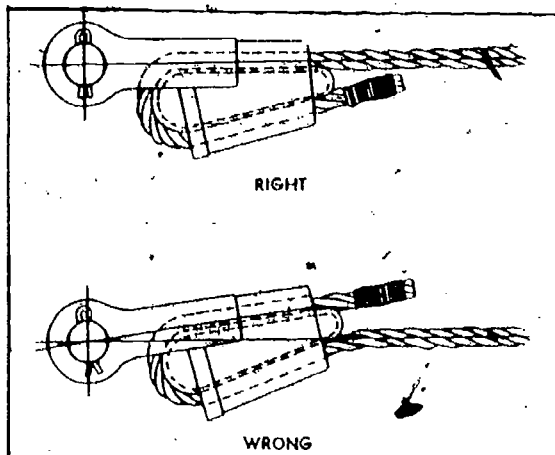

Fig 7-13. Wedge socket and fitting.

b. Wire-rope clips. A common method of making up tow cables, slings, or eyes in the ends of wire rope is by the use of wire-rope clips. Figure 7-14 illustrates the correct method of installing the clips. The number of clips to be installed is equal to 3 times the diameter of the rope, plus 1 (No. clips = $3d + 1$). When the calculation results in a fraction, use the next larger whole number. The clips should be spaced about six rope diameters apart for best service. After all clips are initially installed, tighten the clip farthest from the thimble with a wrench. Place the rope under tension and tighten the remaining clips in order, working towards the thimble.

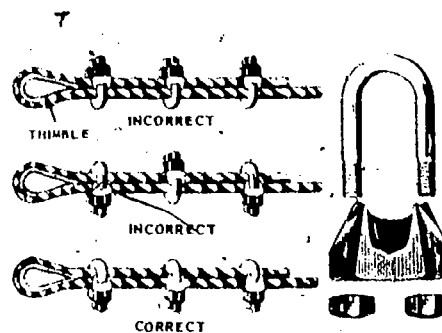

Fig 7-14. Wire-rope clips.

7-13. REEVING

The technical manual or operator's manual for your particular piece of equipment will give you detailed instructions on reeving as well as cable specifications. Check the specifications to make sure you are using the correct type, size, and length of wire rope. Follow the reeving diagrams closely and double check your progress to avoid time-consuming mistakes. Select the necessary tools and lubricants and have them at the job site before starting to reeve the equipment. Select a level spot with plenty of working room. If you are changing attachments, clean, lubricate, tag, and coil all reusable cables for future use. Take your time and work safely.

U.S. GOVERNMENT PRINTING OFFICE: 1980 - 311-471/S-87

U.S. GOVERNMENT PRINTING OFFICE: 1980

UNITED STATES MARINE CORPS
MARINE CORPS INSTITUTE, MARINE BARRACKS
BOX 1775
WASHINGTON, D.C. 20013

ENGINEER EQUIPMENT OPERATOR

Lesson 7

Associated Subjects

STUDY ASSIGNMENT: MCI 13. 31h, Engineer Equipment Operator, chap 7.

LESSON OBJECTIVE: Upon successful completion of this lesson you will be able to identify methods of decontaminating equipment after an NBC attack; procedures for preparing, fording, and servicing of equipment after fording operations; and procedures for the proper care and use of wire rope.

WRITTEN ASSIGNMENT:

A. Multiple Choice: Select the ONE answer which BEST completes the statement or answers the question. After the corresponding number on the answer sheet, blacken the appropriate box.

Value: 1 point each

1. What has the highest decontamination priority?

a. Weapons	c. Personnel
b. Equipment	d. Terrain
2. What is an important consideration in the selection of a site for second and third echelon decontamination?
 - a. Availability of protective clothing
 - b. Accessibility to a source of water
 - c. The area should be upwind from troops in bivouac.
 - d. The area should be upstream from troops in bivouac.
3. Which natural decontaminant is used whenever possible?

a. Fire	c. Earth
b. Water	d. Weathering
4. Which standard decontaminant is corrosive to most metal?

a. STB	c. DS2
b. DANC	d. Washing soda
5. The most effective slurry mix for manual application is prepared by mixing _____ shovelfuls of STB to a 14-quart pail of water.

a. 3	c. 6
b. 4	d. 7
6. Which decontaminant gives off a toxic vapor when used against GA?

a. STB	c. DS2
b. DANC	d. Gunk
7. Because of being flammable, which decontaminant must NOT be used on a running engine?

a. Caustic soda	c. STB
b. DANC	d. DS2

8. The two general methods of nuclear decontamination are
- a. Burning and weathering.
 - b. weathering and removal.
 - c. removal and aging.
 - d. removal and burning.
9. What is the primary decontaminant for nuclear decontamination?
- a. Gun
 - b. DS2
 - c. Slurry
 - d. Water
10. Which decontaminant is applied by an apparatus resembling a fire extinguisher?
- a. DS2
 - b. DANC
 - c. STB
 - d. Steam
11. Which agent CANNOT be destroyed, only removed?
- a. G-agents
 - b. Radioactive fallout
 - c. Biological agents
 - d. Mustard gas
12. If a vehicle will be operating in water that is deep enough to interfere with the movement of the engine fan, you should
- a. remove the generator drive belts.
 - b. loosen the generator drive belts.
 - c. run the engine at low idle.
 - d. run the engine at full throttle.
13. If lubricating-oil compartments have been contaminated by water, what should the operator do?
- a. Wait at least 100 hours before changing oil.
 - b. Drain the old oil and replace it with new oil.
 - c. Drain the old oil after operating for 8 hours.
 - d. Install vented plugs in the compartments.
14. What should be done to a vehicle as soon as possible after fording?
- a. Wash with salt water
 - b. Thoroughly inspect and lubricate
 - c. Loosen the fan belts
 - d. Adjust track chains as tight as possible
15. When fording with any piece of equipment, you should enter the water in
- a. high gear.
 - b. low gear and reduce engine speed to avoid stalling.
 - c. high gear and increase engine speed to avoid stalling.
 - d. low gear and increase engine speed to avoid stalling.
16. Before fording water with a piece of equipment, the equipment should be
- a. inspected and cleaned with salt water.
 - b. inspected and lubricated.
 - c. decontaminated and inspected.
 - d. cleaned and inspected.
17. Which type of wire rope tends to untwist at the ends unless it is seized?
- a. Independent wire-rope center
 - b. Left lang lay
 - c. Nonpreformed
 - d. Preformed

18. When winding cable on to a drum, you should
- a. not wear gloves.
 - b. overlap the turns of wire.
 - c. keep tension on the rope.
 - d. use your hands to force the turns closer together.
19. Any wire rope in which the outside wires are worn to less than _____ % of their original diameter should be replaced.
- a. 60
 - b. 70
 - c. 80
 - d. 90
20. How many wire-rope clips should be installed on one end of a 3/4-inch wire rope to make a tow cable?
- a. 2
 - b. 3
 - c. 4
 - d. 5
21. The U-bolt portion of a series of wire-rope clips should be installed
- a. on alternate sides of the wire rope.
 - b. over the short end of the wire rope.
 - c. over the long end of the wire rope.
22. Wire-rope clips should be installed _____ rope diameters apart.
- a. 4
 - b. 6
 - c. 8
 - d. 10
23. Using the rule of thumb for obtaining the safe working capacity of wire rope, determine the capacity in tons of 1/2 in. diameter wire rope?
- a. 1
 - b. 2
 - c. 3
 - d. 4
24. Which is the best method of cutting wire rope?
- a. Cold chisel
 - b. Wire-rope cutter
 - c. Oxyacetylene torch
 - d. Hacksaw

U.S. GOVERNMENT PRINTING OFFICE: 1984 461 643 10041

Total Points: 24

13. 31
1st 7; p. 3

276

COURSE NUMBER	COURSE TITLE
---------------	--------------

COMPLETE ALL PORTIONS OF SECTION 1

Section 1. Student Identification

Rank	Initials	Last Name	MOS
MILITARY ADDRESS			INSTRUCTIONS: Print or type name, rank, and address clearly. Include ZIP CODE. Only Class III Reservists may use civilian address.
ZIP CODE			

Section 2. CHECK THE APPROPRIATE BOX AND FILL IN THE APPROPRIATE SPACES.

FOR REGULAR AND CLASS II RESERVE MARINES THIS FORM MUST BE SIGNED BY THE COMMANDING OFFICER OR HIS REPRESENTATIVE, I.E. TRAINING MCO.

- EXTENSION - Please grant an extension. (Will not be granted if already on extension.)
- NOTICE OF COURSE COMPLETION - Final Exam Sent On _____ (New exam will be sent if exam not received at MCI.)
- REENROLLMENT - Student has course materials (See para. 4003 of Vol. 7 of MCI Catalog for information on reenrollment.)
- OVERDUE FINAL EXAM - Last (Review) lesson sent on _____. Please send exam.
- Please send new ANSWER SHEETS.
- Please send missing course materials (Not included in course package.)
Lessons _____ Manual _____ Other _____
- CHANGE - Rank _____ Name _____
Social Security Number [] [] [] [] [] [] [] []
MTC _____
- OTHER (explain) _____

FOR MCI USE ONLY	
1.	D _____
2.	On SEP _____ K _____ L _____
3.	C _____
4.	L _____
5.	Q _____
6.	P _____
7.	E _____
8.	_____
DATE COMPLETED _____	
ORIGINATOR CODE _____	

Note: This form will not be returned by MCI. If request is valid, transaction will show on next UAR or on MCI-RI form.

SIGNATURE-TITLE OR RANK
(MUST BE CO OR REPRESENTATIVE)

STUDENT: Detach and retain this portion.

DATA REQUIRED BY THE PRIVACY ACT OF 1974
(5 U.S.C. §22A)

- AUTHORITY:** Title 5, USC, Sec. 301. Use of your Social Security Number is authorized by Executive Order 9397 of 22 Nov 43.
- PRINCIPAL PURPOSE:** The Student Course Content Assistance Request is used to transmit information concerning student participation in MCI courses.
- ROUTINE USE:** This information is used by MCI personnel to research student inquiries. In some cases information contained therein is used to update correspondence courses and individual student records maintained by the Marine Corps Institute.
- MANDATORY OR VOLUNTARY DISCLOSURE AND EFFECT ON INDIVIDUAL NOT PROVIDING INFORMATION:** Disclosure is voluntary. Failure to provide information may result in the provision of incomplete services to your inquiry. Failure to provide your Social Security Number will delay the processing of your assistance request.



NO POSTAGE
NECESSARY
IF MAILED
IN THE
UNITED STATES



BUSINESS REPLY MAIL
FIRST CLASS PERMIT NO 12488 WASHINGTON D. C.

POSTAGE WILL BE PAID BY U.S. MARINE CORPS

**UNITED STATES MARINE CORPS
MARINE CORPS INSTITUTE
P. O. BOX 1775
ARLINGTON, VA 22223**

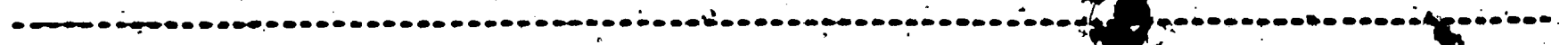
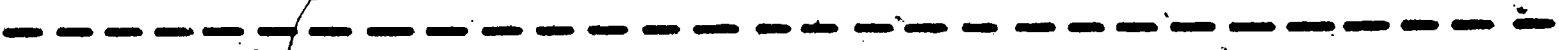

DETACH BEFORE MAILING

278