

DOCUMENT RESUME

ED 258 049

CE 041 794

TITLE Light Vehicle Preventive Maintenance.  
INSTITUTION Marine Corps Inst., Washington, DC.  
REPORT NO MCI-35.23  
PUB DATE 11 Apr 79  
NOTE 182p.; For related documents, see CE 041 790-796.  
PUB TYPE Guides - Classroom Use - Material: (For Learner) (051)

EDRS PRICE MF01/PC08 Plus Postage.  
DESCRIPTORS Adult Education; \*Auto Mechanics; Behavioral Objectives; Continuing Education; \*Correspondence Study; Course Content; Engines; Independent Study; Learning Activities; \*Mechanics (Process); Military Training; \*Motor Vehicles; \*Prevention; Programed Instructional Materials; Study Guides

ABSTRACT

This correspondence course, originally developed for the Marine Corps, is designed to instruct students in the performance of preventive maintenance on motor vehicles. Instructional materials are presented in three chapters as follows: (1) Major Maintenance Areas (maintenance system, tires, batteries, cooling systems, and vehicle lubrication; (2) Driver's Preventive Maintenance (daily maintenance, weekly maintenance, and batteries); and (3) Field Expedient Repairs. The course contains four lessons covering the maintenance system and tires; batteries, cooling system, and vehicle lubrication; daily and weekly maintenance; and field-expedient repairs. Each lesson begins with a general objective, which is a statement of what the student should learn. Written assignments follow based on the instructional materials presented. (KC)

\*\*\*\*\*  
\* Reproductions supplied by EDRS are the best that can be made \*  
\* from the original document. \*  
\*\*\*\*\*

MCI 35.23

ED 258049

BEST COPY AVAILABLE

U.S. DEPARTMENT OF EDUCATION  
NATIONAL INSTITUTE OF EDUCATION  
EDUCATIONAL RESOURCES INFORMATION  
CENTER (ERIC)

This document has been reproduced as  
received from the person or organization  
originating it.

Minor changes have been made to improve  
reproduction quality.

Points of view or opinions stated in this docu-  
ment do not necessarily represent official NIE  
position or policy.

# LIGHT VEHICLE

# PREVENTIVE MAINTENANCE

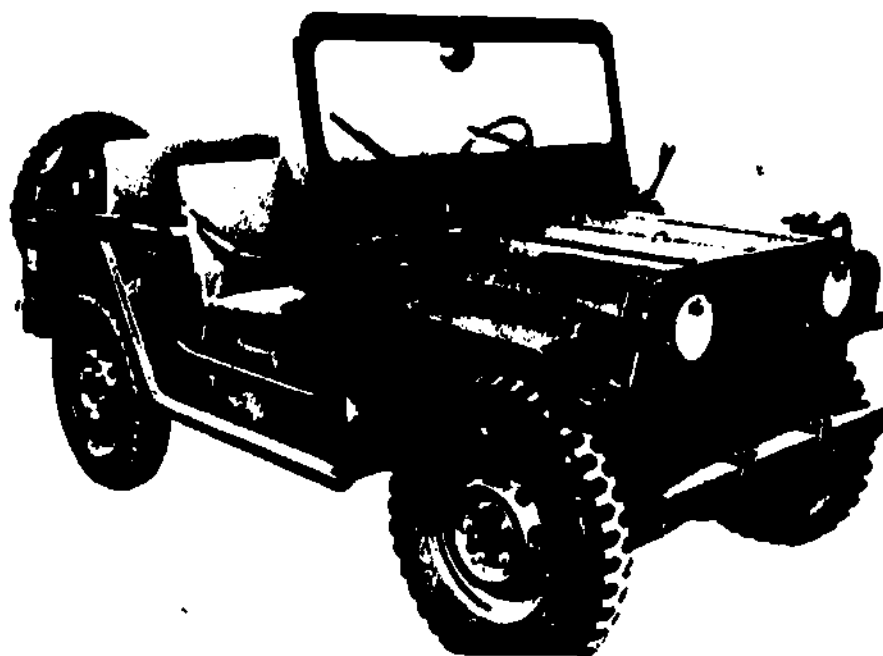

MARINE CORPS INSTITUTE  
MARINE BARRACKS  
WASHINGTON, D.C.

ED 258049

UNITED STATES MARINE CORPS  
MARINE CORPS INSTITUTE, MARINE BARRACKS  
BOX 1775  
WASHINGTON, D.C. 20013

35. 23  
11 April 1979

**1. PURPOSE**

This publication has been prepared by the Marine Corps Institute for use with MCI course, Light Vehicle Preventive Maintenance.

**2. APPLICABILITY**

This manual is for instructional purposes only.

*M. P. Caulfield*  
M. P. CAULFIELD

Lieutenant Colonel, U. S. Marine Corps  
Director

## PREFACE

LIGHT VEHICLE PREVENTIVE MAINTENANCE is designed to develop competent military motor vehicle operators in their performance of U. S. Marine Corps preventive maintenance goals. This course contains specific daily and weekly operation checks, but is not limited to any one type of vehicle.

The purpose of this course is to show the operator what to check, how to check, how to repair, and the procedure used for reporting discrepancies that he cannot correct.

### SOURCE MATERIALS:

TM 9-2320-218-10	<u>Operator's Manual, Truck, Utility, 1/4-Ton, 4 x 4, M151;</u>
TM 9-2320-223-10	<u>Truck, Ambulance, Frontline, 1/4-Ton, 4 x 4, M718, Sep 1971</u>
TM 9-2320-242-10	<u>Supp (USMC) #1, Operator's Manual for Carrier, Cargo, Full</u>
TM 9-2320-244-10	<u>Tracked, Amphibious, Unarmored, M116A1, April 1968</u>
TM 9-2320-246-10	<u>Operator's Manual, Truck, Cargo, 1 1/4-Ton, 6 x 6, M561,</u>
TM 9-2330-202-14P	<u>Truck Ambulance, 1 1/4-Ton, 6 x 6, M792, Mar 1970</u>
TM 9-2330-251-14	<u>Operator's Manual for Truck, Cargo 1 1/4-Ton, 4 x 4, M715</u>
TM 9-2610-200-20	<u>Truck, Ambulance, 1 1/4-Ton 4 x 4, M725, Aug 1968</u>
TM 9-6140-200-14	<u>Operator's Manual, Truck, Platform, Utility, 1/2-Ton M-274A2,</u>
TM 9-8030	<u>April 1967 w/ch 1</u>
TM 21-305	<u>Trailer, Cargo, 3/4-Ton, 2 Wheel, M101A1, Aug 1962 w/ch 1</u>
TM 750-254	<u>Operator's Manual for Trailer, Cargo, 1/4-Ton, 2 Wheel, M416;</u>
	<u>Trailer Chassis, 3/4-Ton, 2 Wheel, M762, Oct 1970</u>
	<u>Organizational Care, Maintenance and Repair Pneumatic Tires</u>
	<u>and Inner Tubes, Nov 1972</u>
	<u>Operator's Manual for Storage Batteries, Lead-Acid Type, Aug 1971</u>
	<u>Operation and Organizational Maintenance, Truck, Ambulance,</u>
	<u>3/4-Ton, 4 x 4, M43, M-43B1; Truck, Cargo 3/4-Ton, 4 x 4,</u>
	<u>M-37, M-37B1, May 1965 w/ch 8 &amp; 9</u>
	<u>Manual for the Wheeled Vehicle Driver, Nov 1965 w/ch 2 Dec 1969'</u>
	<u>Cooling Systems: Tactical Vehicles, Mar 1972</u>

## CONTENTS

	Para	Page
Preface . . . . .	i	
Source materials . . . . .	i	
Table of contents . . . . .	iii	
 <b>Chapter I. MAJOR MAINTENANCE AREAS</b>		
<b>Section I. Maintenance system</b>		
Introduction . . . . .	1-1	1-1
Categories defined. . . . .	1-2	1-1
Echelons defined. . . . .	1-3	1-1
 <b>Section II. Tires</b>		
Effects of mechanical irregularities on tires . . . . .	1-4	1-3
Effects of vehicle operation on tires . . . . .	1-5	1-4
Performance and equal wear . . . . .	1-8	1-7
Removal from the vehicle. . . . .	1-7	1-11
Demounting and mounting tires . . . . .	1-8	1-14
Tube repairs. . . . .	1-9	1-23
Storage of tires . . . . .	1-10	1-26
 <b>Section III. Batteries</b>		
Introduction . . . . .	1-11	1-27
Description . . . . .	1-12	1-27
Functions. . . . .	1-13	1-28
Potential hazards . . . . .	1-14	1-28
Safety. . . . .	1-15	1-29
Removal and installation. . . . .	1-16	1-33
Hydrometers. . . . .	1-17	1-37
Activation procedure . . . . .	1-18	1-42
Cleaning . . . . .	1-19	1-44
Charging . . . . .	1-20	1-45
 <b>Section IV. Cooling systems</b>		
General . . . . .	1-21	1-48
Types of cooling systems . . . . .	1-22	1-48
Function of components in the liquid-cooled system . . . . .	1-23	1-48
Maintenance . . . . .	1-24	1-50
Detection of leaks . . . . .	1-25	1-52
Areas most likely to leak . . . . .	1-26	1-53
Protection against freezing . . . . .	1-27	1-54
 <b>Section V. Vehicle lubrication</b>		
Purpose of lubrication . . . . .	1-28	1-60
Lubrication order . . . . .	1-29	1-60
Grease fittings . . . . .	1-30	1-68
Oilcan maintenance. . . . .	1-31	1-70
Winch. . . . .	1-32	1-70
Inspecting during lubrication. . . . .	1-33	1-71

## Chapter 2, DRIVER'S PREVENTIVE MAINTENANCE

### Section I. Daily maintenance

	Para	Page
Introduction . . . . .	2-1	2-2
Guide lines for using/completing trip ticket checklists . . . . .	2-2	2-2
Before-operation checks . . . . .	2-3	2-4
During-operation checks . . . . .	2-4	2-18
After-operation checks . . . . .	2-5	2-20

### Section II. Weekly maintenance

Inspection guidelines . . . . .	2-6	2-23
Engine compartment . . . . .	2-7	2-24
Cooling system . . . . .	2-8	2-29
Body and cab . . . . .	2-9	2-33
Suspension . . . . .	2-10	2-42
Power train . . . . .	2-11	2-44
Wheels . . . . .	2-12	2-47
Fuel system . . . . .	2-13	2-48
Electrical system . . . . .	2-14	2-51
Steering system . . . . .	2-15	2-58
Exhaust system . . . . .	2-16	2-60
Gages and instruments . . . . .	2-17	2-61
Tools and equipment . . . . .	2-18	2-62
Summary . . . . .	2-19	2-65

### Section III. Batteries

Abuse of equipment . . . . .	2-20	2-65
Misuse of tools . . . . .	2-21	2-70

## Chapter 3. FIELD EXPEDIENT REPAIRS

Introduction . . . . .	3-1	3-1
Fan belt and fan . . . . .	3-2	3-1
Loose or broken battery clamp . . . . .	3-3	3-2
Broken terminal post . . . . .	3-4	3-2
Repairing hoses . . . . .	3-5	3-3
Repair of radiator core . . . . .	3-6	3-3
Thermostat . . . . .	3-7	3-4
Accessories . . . . .	3-8	3-5
Repairing leaks in the fuel system . . . . .	3-9	3-5
Propeller shaft . . . . .	3-10	3-7
Axles and springs . . . . .	3-11	3-7
Summary . . . . .	3-12	3-8

## Chapter 1

### MAJOR MAINTENANCE AREAS

#### Section 1. MAINTENANCE SYSTEM

##### 1-1. INTRODUCTION

Marines of today rely as much as ever on the swift mobility provided by light military vehicles. The thought that only those with a 3500 MOS operate these vehicles has long since been left by the wayside. Marines of virtually any MOS can be assigned additional duties as light vehicle operators. Such an assignment includes many more responsibilities than those which are generally associated with "driving" a vehicle. It is intended that this course will aid all light vehicle operators in identifying and understanding just what those responsibilities are. A major part of an operator's responsibility can be placed under one category, maintenance. Maintenance should be just as important to the operator as actually driving a vehicle. To enable us to picture an operator's responsibilities and his relationship to the maintenance system, let us briefly discuss the three categories and five echelons that make up the maintenance system. Then we will get into exactly those procedures that a driver must know.

The Marine Corps maintenance system applies to all types of equipment. It varies from the all important daily and weekly preventive maintenance performed by you the operator/user to the complex repair and rebuilding techniques performed by the depot maintenance facilities. The Armed Services have adopted three broad categories of maintenance to aid in the assignment of maintenance missions. The categories are: ORGANIZATIONAL, INTERMEDIATE, and DEPOT. Further flexibility of the maintenance system has been provided by subdividing the three broad categories into five echelons which are numerically numbered one through five.

##### 1-2. CATEGORIES DEFINED

a. Organizational maintenance. This is maintenance that is authorized, performed by, and the responsibility of the using unit on its own equipment. This maintenance includes cleaning, inspecting, tightening, adjusting, lubricating, and replacing. This category is broken down into first and second echelons.

b. Intermediate maintenance. This is maintenance that is performed in support of the using unit at an authorized maintenance activity. This category normally will be limited to the replacement of unserviceable parts, subassemblies or assemblies. This category consists of two echelons, third and fourth.

c. Depot maintenance. This is maintenance that is performed on equipment that requires major overhaul or complete rebuild of parts, subassemblies, assemblies, and/or the entire vehicle. Work done here is in a fixed shop by highly skilled technicians using a larger variety of equipment than is found at any of the lower echelons. This category is made up of one echelon, the fifth.

##### 1-3. ECHELONS DEFINED

a. Organizational maintenance. This maintenance is performed by the user/operator of the equipment to provide the proper operation and care including cleaning, inspecting, tightening, adjusting, lubricating, reporting, and minor replacement of parts as set forth by applicable technical publications.

b. Second echelon. This is maintenance performed by technically trained personnel assigned to the using unit. Besides having specifically trained personnel, second echelon maintenance also possesses the additional tools, test equipment, and the necessary repair parts to perform those maintenance tasks beyond the capabilities of first echelon. Scheduled maintenance (quarterly and annual PM) is also performed by second echelon mechanics.



c. Third echelon. This maintenance is performed by specially trained units which provide direct support to the using organizations. Third echelon maintenance is sometimes referred to as direct support maintenance. In special cases third echelon maintenance may be performed by second echelon mechanics in the using unit. Third echelon has a larger selection of parts, more tools, and test equipment than second echelon. They repair subassemblies, assemblies, and at times assist in repairing the overflow from the second echelon. They also provide technical assistance to both lower echelons.

d. Fourth echelon. This maintenance is performed by units operating in a semifixed or permanent-type shop in support of lower echelon maintenance. Fourth echelon maintenance is sometimes referred to as general support maintenance. Fourth echelon has a larger selection of parts, subassemblies, and assemblies and has more precision tools and test equipment than lower echelons have. The main objective of fourth echelon maintenance is to repair subassemblies, assemblies, and major items for lower echelons and also to repair unserviceable components for reissue by supply.

e. Fifth echelon. This is maintenance that is performed which requires major overhaul or complete rebuild of major items, assemblies, and parts. This echelon uses the assembly line method wherever possible, and equipment repaired is used to support supply stocks. Fifth echelon is the highest echelon in the maintenance system. Now that we have discussed the categories and echelons, there should not be any doubt which category and which echelon you, the operator, fit into. Ask yourself which category and echelon you would be a part of and then look at figure 1-1 to see if you are right.

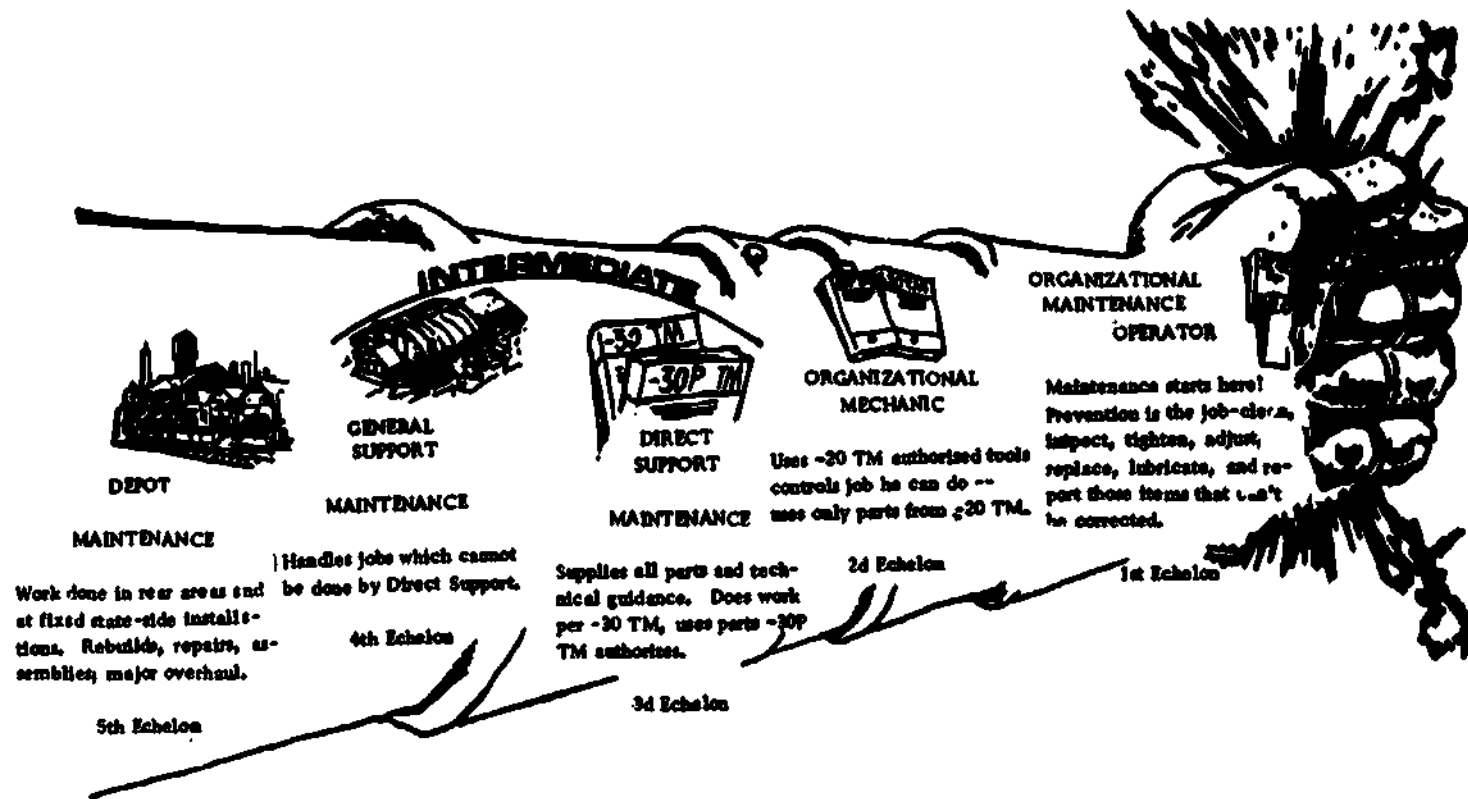

Fig 1-1. Echelons of maintenance.



## Section II. TIRES

### 1-4. EFFECTS OF MECHANICAL IRREGULARITIES ON TIRES

The presence of mechanical irregularities reduces tire life and changes the vehicle's handling characteristics. When this happens, the vehicle is considered to be out of alignment, which means all of the interrelated parts of the wheels are not properly adjusted. It is necessary that the operator be able to detect mechanical irregularities which cause improper alignment so that they can be promptly reported and corrected.

a. Excessive toe-in. This is the measurement, in inches, that the wheels point inward. Front wheels should toe-in slightly in accordance with the specifications for a particular vehicle. It is when excessive toe-in occurs (A, fig 1-2) that abnormal tire wear results. Early detection of excessive toe-in can result if the tires are inspected for feathered edges. A feathered edge will develop on the inner edge of the tread design. An example of how a feathered edge would look on a commercial tire tread is shown in B, figure 1-2.



Fig 1-2. Signs of toe-in.

b. Excessive toe-out. Abnormal tire wear is also the result of this mechanical irregularity (A, fig 1-3). Early detection can result if the tire is inspected for feathered edges on the outer edge of the tread design (B, fig 1-3).



Fig 1-3. Signs of toe-out.

Alignment, as mentioned, if out of adjustment  $1/2$ " will cause the tire to be dragged sideways (fig 1-4).



Fig 1-4. Tire wear caused by incorrect alignment.

c. **Other mechanical irregularities.** There are other mechanical irregularities that affect tire wear and handling characteristics. All irregularities are not necessarily corrected by some type of adjustment; in some cases a part may have to be replaced. Examples of some other irregularities are: loose or worn wheel bearings, incorrectly adjusted brakes, bent rims, and weak or broken springs. All irregularities mentioned will prevent the tire from rolling properly. Detection of a specific irregularity may be very difficult; therefore, we, as operators, should be primarily concerned with early detection of any irregularity. You can do this by inspecting each tire for uneven, spotty, or excessive wear prior to operation. Consideration as to the condition of a tire when it was put on the vehicle must be given, because it could be possible that the tire was switched from a vehicle with an undetected mechanical irregularity. If you detect a tire irregularity, you should start the corrective action by notifying your supervisor.

#### 1-5. EFFECTS OF VEHICLE OPERATION ON TIRES

The manner in which a vehicle is operated has a direct effect on the wear and tear of the tires as well as other mechanical components.

a. **Flat tire operation.** A vehicle should never be operated with a flat or near flat tire. To do so creates a hazardous condition because it changes the vehicle handling characteristics considerably. This situation may become worse if the load shifts because of the condition of the tire. In operating a vehicle with a flat or near flat tire, there is a good chance that the tire and tube will be completely ruined (fig 1-5) and damage to the rim will occur. Although a combat tire has been designed to operate without air, this should be done only in an emergency combat situation.



Fig 1-5. Tire ruined by running "flat."

b. **Excessive speed.** Speed grinds off rubber, particularly while cornering. Continuous high speed also increases tire deterioration because:

- heat is generated by internal friction as the tires flex (the higher the speed, the higher the rate of flexing).
- tread and cord body are weakened.
- separation occurs between plies or between the tire carcass and tread.

It may surprise you to learn that as little as 5 mph difference in your vehicle speed causes you to lose 14% of the normal tire wear. To emphasize this point, figure 1-6 is included for you to use as a reference. Note that the left hand column is expressed in percentages in relation to normal tire wear. The bottom row of numbers is expressed in mph. To compute the percentage of tire wear, let us say we are traveling at a 35 mph (bottom numbers). Follow the vertical line up until it intersects the broken line. Now look to the left (percentages) and we are just a little below 100% or approximately 98%. So traveling at 35 mph you could expect to get 98% of normal tire wear. Try and compute the percentage if we were traveling at a speed of 50 mph. Do you think you have the right answer? If your answer indicates that we only receive 81% of the normal tire wear, you are correct. I think you will agree there is a direct relationship between speed and tire mileage.

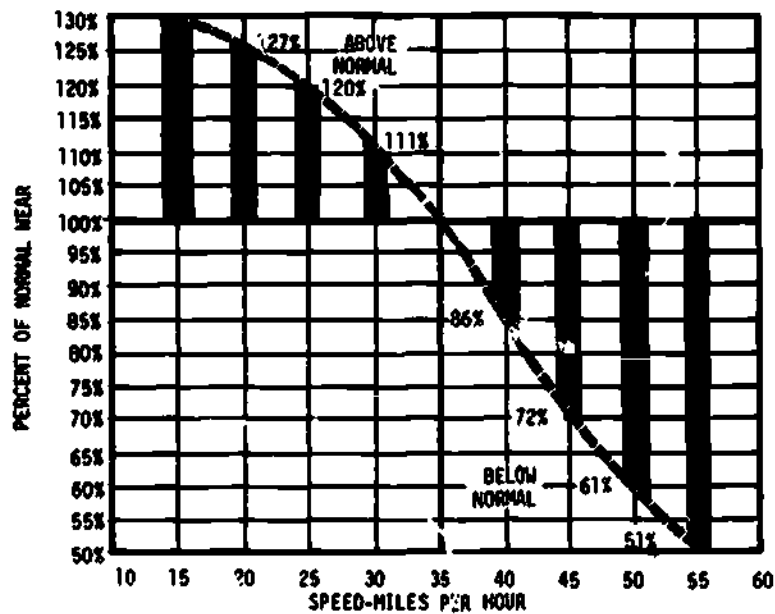

Fig 1-6. Effect of speed on tire wear.

c. **Improper loading.** In describing improper loading, the first reaction is to think that a vehicle was loaded beyond its rated capacity. This is a common cause of tire failure, especially if the vehicle is then driven at a high rate of speed. We should also be aware that tire failure due to improper loading will occur even when the load does not exceed the rated capacity of the vehicle. Tire failure can occur as a result of an unevenly distributed load which would put an overload on certain tires and vehicle components (A and B, fig 1-7).

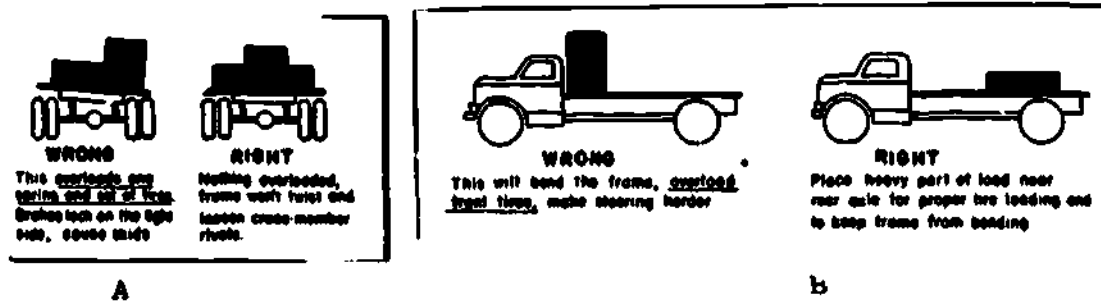

Fig 1-7. Distributing loads.

We have discussed the relationship between vehicle speed and tire wear, but what relationship does the vehicle loading have to tire wear? To emphasize that overloading of the vehicle reduces tire mileage considerably, figure 1-8 is included for reference. On the left of the chart are percentages that refer to the normal or expected mileage of the tire. For example, a tire that would normally give us 40,000 miles of wear would equate to 100% on the chart. If a tire was expected to last 20,000 miles, that would equate to 100% on the chart. The bottom percentage numbers are the tire load in relation to its rated capacity. The rated tire capacity is normally described as being in a certain range. If a load placed on a tire is 50% more than its normal capacity, it would have a 150% load on it. As can be seen in figure 1-8, a 50% overload would result in a tire getting but 40% of its normal mileage. If the load carried equals 100% of the rated capacity of the tire, what percent of normal mileage can we expect? Locate the 100% figure on the bottom row; go upward until the broken curved line crosses the vertical line representing 100%. Follow across to the left and you should be on line with the 100% figure. What has been determined is that, if the load is 100% of the rated capacity of the tire, then we could expect to receive 100% of the normal mileage. The mileage we expect to get from a tire will change considerably if we carry a load beyond the rated capacity. Overloading the capacity of the tire by only 10% we can expect to get only about 82% of the normal mileage. To compute this 10% overload, refer to the bottom row. Locate the figure 110%; again follow the vertical line upward until the broken line intersects. Reading across to the left, we can determine that the reading is just a little above 80% or about 82%. What has been determined is that with a 10% overload, we will get only 82% of the normal mileage. Refer to the insert and where the word overload appears read from left to right. You should understand it to read in this manner. With an overload of 10%, normal tire mileage is decreased by 18%. If you consider that 30,000 miles is normal mileage for a certain tire, this would mean that now you will only get 24,600 miles of wear, a substantial drop.

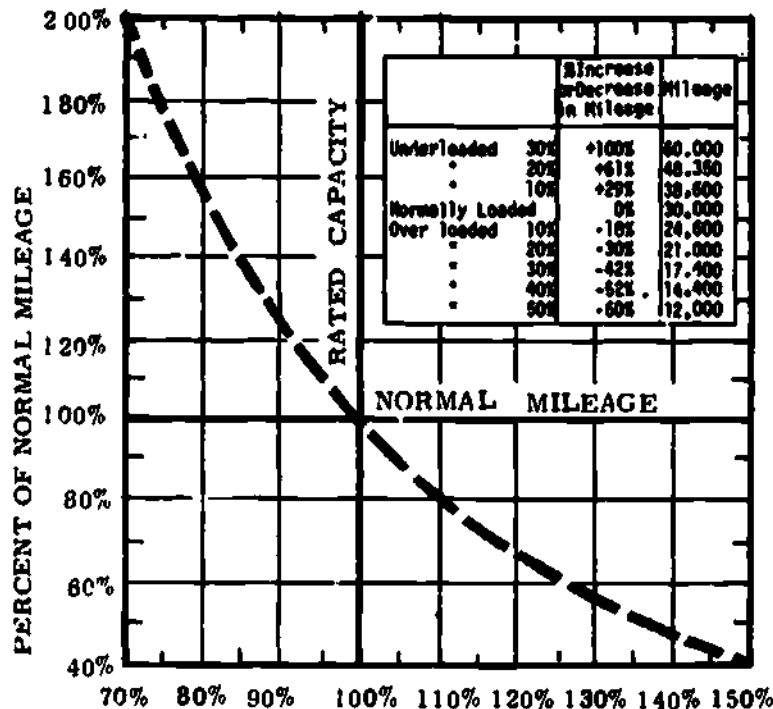

Fig 1-8. Effect of load on tire life.

## 1-6. PERFORMANCE AND EQUAL WEAR

To achieve the best performance and most wear from tires, operators must give consideration to the characteristics designed into the tire such as tread design, load capacity, and the pressure at which it should operate. A nondirectional tread design is used extensively by the military. This type tread gives good traction in either direction, is excellent for cross-country use, and practical for hard surface roads.

a. **Pressure.** Correct air pressure is the basis for reliable tire performance. Tires are designed to operate at specific pressures according to their load range. This not only improves the tire wear, but helps in maintaining the proper handling characteristics of the vehicle. Correct tire pressure should be shown on the vehicle data plate or it can be found in the applicable TM for that vehicle. If irregular tire wear is detected during an inspection, check immediately for incorrect pressure. If no tire pressure correction is necessary, notify your superior so that the cause can be determined and corrected.

- (1) **Deflation.** For the purpose of air pressure adjustment, tires should not be deflated during or immediately after operation. Tires generate heat during operation. This causes the air in the tire to expand, thus increasing air pressure. Tires that are deflated while hot could be dangerously underinflated when the tire cools off.
- (2) **Underinflation.** Tires that are underinflated cannot be expected to carry the load they were designed for without causing harm to the tire. This is because the tire will not make proper ground contact (A, fig 1-9). Underinflation will cause more heat to be generated which weakens the cords, scuffs the tread edges, and causes uneven tire wear (B, fig 1-9).

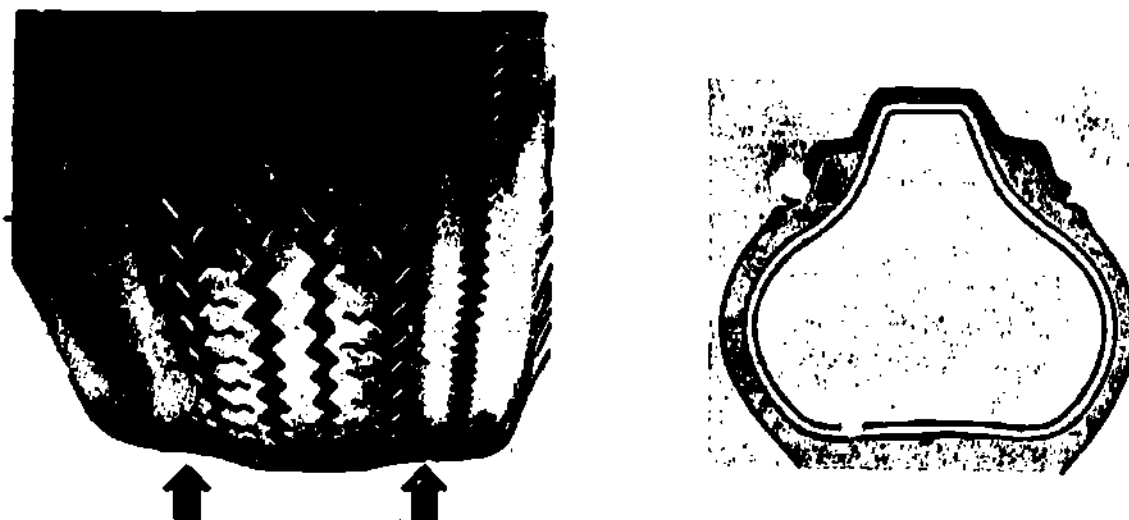

Fig 1-9. Underinflated tire on road and showing wear.

- (3) **Overinflation.** Too much pressure also prevents the tire from making proper ground contact (A, fig 1-10). It also prevents the tire from flexing enough. Since flexing is reduced, the tire is constantly subjected to hard jolts. As a result the cords in the tire could snap when the tire is jarred by ruts or irregular spots in the road. Uneven tread wear will result (B, fig 1-10) because the tire will wear rapidly in the center. Overinflation also causes hard riding for the vehicle occupants and increases wear and tear on the rest of the vehicle. Notice in A, figure 1-10 that the center of the tire is taking all the weight and that the edges are not touching. Have you noticed that this is exactly the opposite from underinflation?



Fig 1-10. Overinflated tire in road and showing wear.

- (4) Proper inflation. For the best tire performance, correct ground contact, proper flexing of the tire, and correct inflation are necessary. If even tread wear and good handling characteristics are expected, tire pressure must be checked frequently. Inflation should always be checked with an accurate gage (knowing the correct pressure for that size of tire is helpful too). A properly inflated tire should make contact with the ground as in figure 1-11 below.

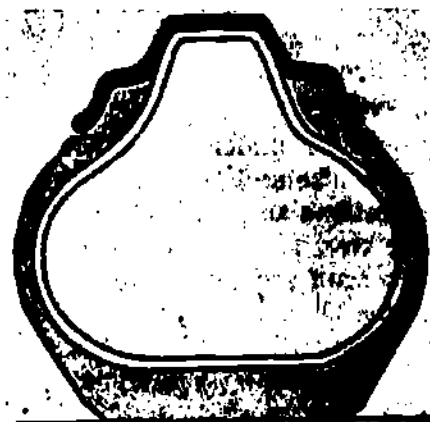
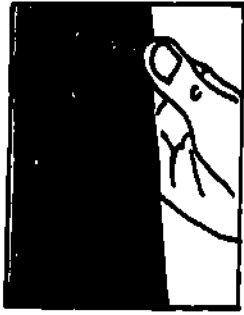

Fig 1-11. Properly inflated tire showing correct ground contact.

b. Tire inspection. During your periodic tire inflation checks, or during matching and/or rotation, give your tires the once-over. Start with the valve stem; it should be centered in the valve hole in the rim. Valve stems that are not centered have more pressure applied to one side than the other, which could cause the rim to chafe through the stem. Cuts and foreign objects are another reason why tire inspections are necessary. Nails and bits of glass or wire may not appear to have enough length to puncture a tire but other conditions may exist that could make it possible. A small object imbedded in the tire is forced inward to the tube by the flexing of the tire. That is why areas of the tread that reflect small cuts should be probed gently with a tool such as a pocket knife, screw driver, or similar tool. If the object is still imbedded, you should try to work it out. All cuts should be checked for depth to determine if they are into the cord body. A, figure 1-12 shows a cut into the cord body which may require the tire to be replaced. B, figure 1-12 shows a minor cut that should not affect the performance of the tire. Other types of injuries can occur to tires and your inspection should include indications of loose tread or an internal injury such as shown in figure 1-13 below.





A. Cut in cord body

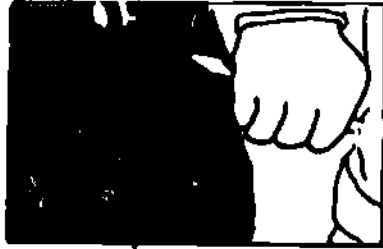

B. Minor cut

Fig 1-12. Cuts in tire.



Fig 1-13. Bulge indicating internal injury.

In order to get maximum wear out of tires and also avoid driving on badly worn, unsafe tires, the operator should have a good feel for when tires should be removed and replaced. It is wasteful to remove tires too soon (A1, fig 1-14). A tire removed just as the treads are beginning to fade allows you to get the most wear (A2, fig 1-14). A tire which is badly worn (A3, fig 1-14) and is not removed presents a very dangerous situation. For the operator to determine visually the amount of tread may be difficult, so here are some tips. A tire tread depth gage (B1, fig 1-14) is the most accurate; however, this tool may not be readily available. As a field expedient, we can use a penny as a gage as is shown in B2, figure 1-14. The lettering "one cent" is approximately 1/8 of an inch. Use this side for truck tires. If the lettering can be seen when the coin is pushed into the tread, it is about time to replace the tire. Using the other side of the coin (Lincoln head), if the top of the head shows, it indicates that the tire should be replaced. Some commercial tires also have tread wear indicators as shown in A4, figure 1-14. The military does use tires that have been retreaded, and they may not always be perfect; therefore, you should carefully inspect them before you mount them on rims. Look for cracks in the tread, bad tread design, bad splice or bond (C, fig 1-14). Retreaded tires are NOT to be used on emergency vehicles such as ambulances, MP trucks, wreckers, or vehicles transporting explosives.



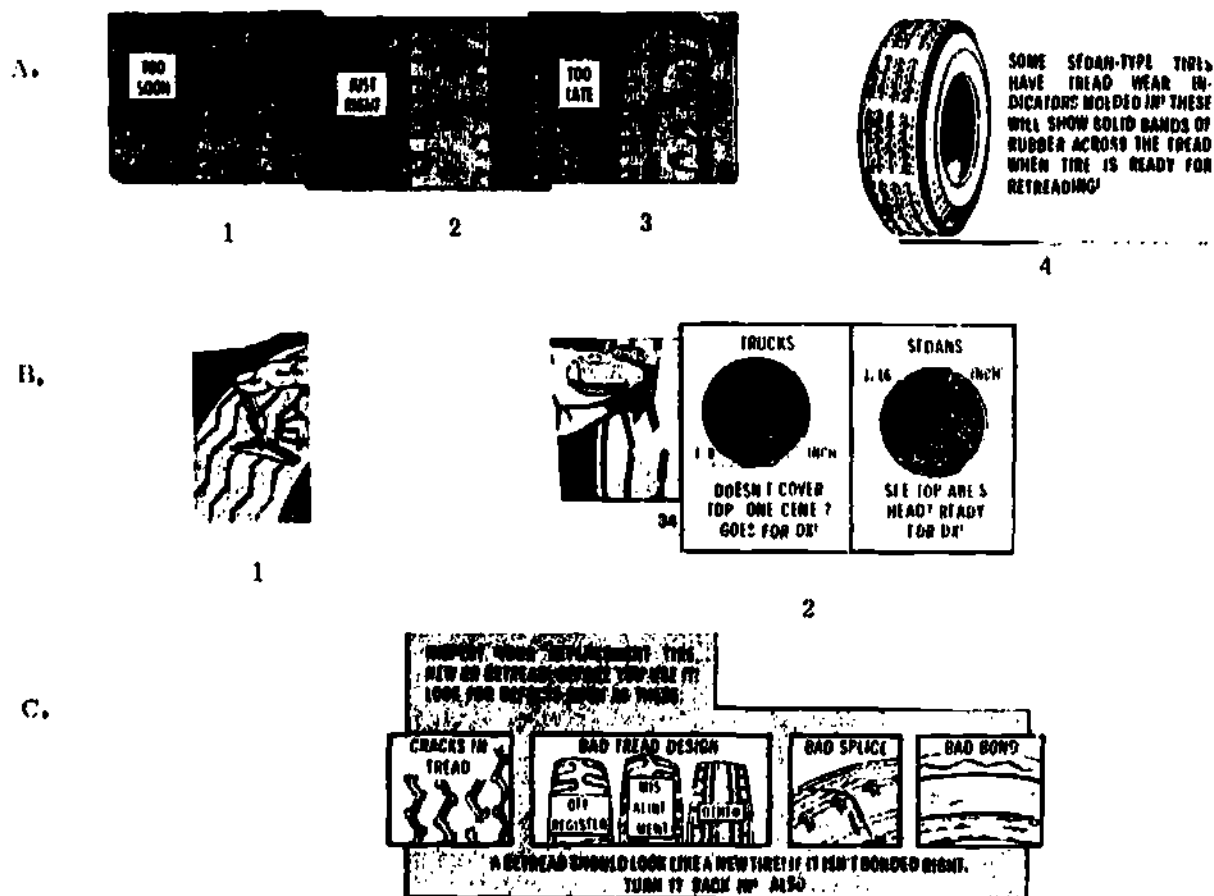

#### Legend

#### A. Tire wear

1. Removed too soon
2. Just right
3. Too late
4. Tread wear indicator

#### B. Measuring tread depth

#### C. Inspecting replacement tires

Fig 1-14. Determining tire replacement.

c. **Matching tires.** When you are matching all of the tires on a vehicle, tread design, amount of tread wear, and size are prime considerations. Improperly matched tires could cause problems that you may not have considered. Having different sized tires on a vehicle with all-wheel drive puts a strain on the transfer and differential. Why? Since all wheels rotate at the same speed, if a tire is smaller or larger than the rest, the amount of ground it covers in one complete revolution will not be the same and a strain will be put on the mechanical components. Matching of tires is required on all type vehicles. If not matched, tire life, as well as the handling characteristics of the vehicle, is affected.

d. **Rotating.** The purpose of tire rotation is to equalize wear. Because of terrain, road conditions, and loads carried, all tires do not wear the same. Knowing when to rotate them depends mostly on what the results of your tire inspections are. Rotation every 6000 miles is normal, but this is not a hard and fast rule. Rotation may be warranted earlier, and if it is not done, the tire may be ruined. The procedure for rotating tires for a 4 x 4 truck with single tires is shown in A, figure 1-15. For a 6 x 6 truck with single tires, the procedure is shown in B, figure 1-15. When rotation is performed, consideration should be given to the spare tire.

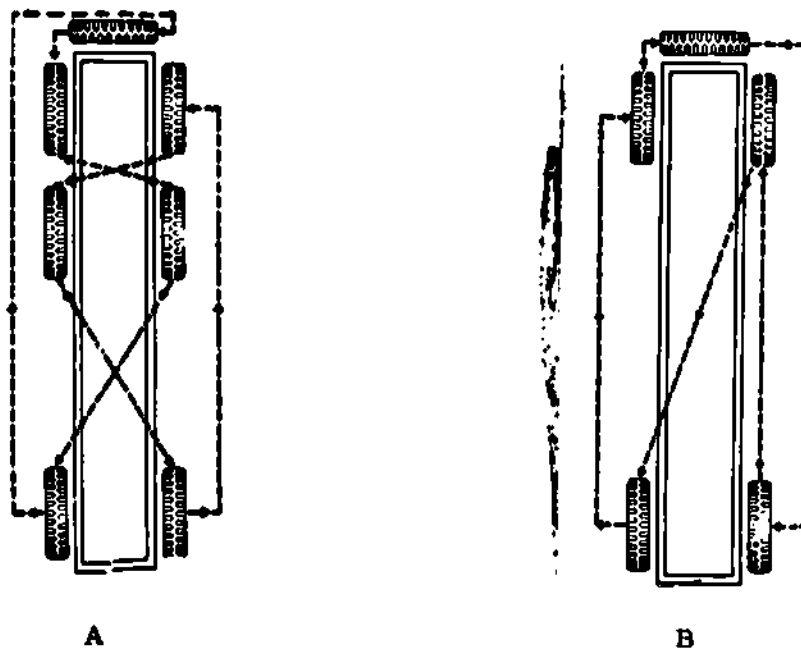

Fig 1-15. Procedure for rotating tires.

#### 1-7. REMOVAL FROM THE VEHICLE

Removal of tires from the vehicle is a fairly easy task if a few general rules are followed. The following removal procedures are applicable to single tire axles.

a. **Safety.** The first thought must be given to safety in order to avoid injury to yourself, others, and your equipment. Prior to jacking up the vehicle, choose an area that is as level and firm as possible to prevent the vehicle from rolling and to prevent the base of the jack from sinking into the ground from the weight of the vehicle. Set the parking brake, and find something suitable to chock the wheels. To chock a wheel means to place a block of wood or some other suitable object either behind or in front of a tire to prevent it from rolling. Placement of the chock depends on which direction the vehicle is inclined to roll. If traffic is such that the location is a hazard to yourself or other traffic, post some type of warning device down the road several hundred feet (flares, lights, etc.). Personnel aboard should disembark and stay well off the shoulder of the road. Available personnel should also assist in warning oncoming traffic. Remove the tools and the spare tire from their position so they are readily available. Lift the vehicle only to that height necessary to remove the tire. Normally an inch or two of clearance between the tire and the ground is enough. The higher you lift the vehicle, the more unstable and dangerous it becomes.

b. **Lifting.** Positioning of the jack is very important in lifting a vehicle for tire removal. A jack not placed properly could damage your vehicle. A technical manual for the operator is supplied with each vehicle. This manual supplies the data as to the location where the vehicle may be lifted. Different vehicles have different lifting points, as well as different type jacks (such as the scissor, screw and bumper jack) that may be used on them. Figure 1-16 shows the correct positioning of these different jacks at the front of a vehicle. Figure 1-17 shows the positioning of the jacks at the rear of a vehicle.

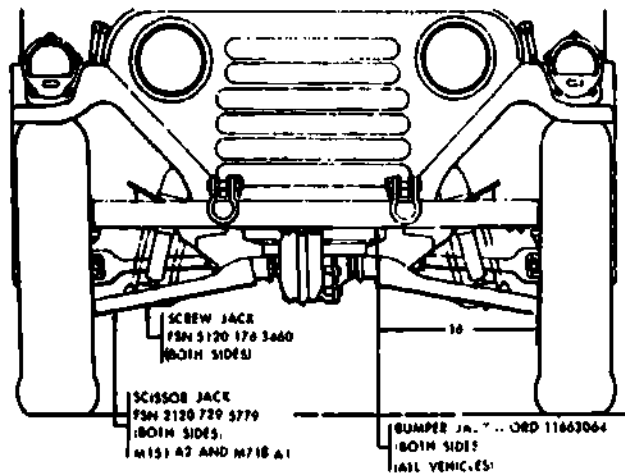

Fig 1-16. Positioning jacks at front of vehicle.

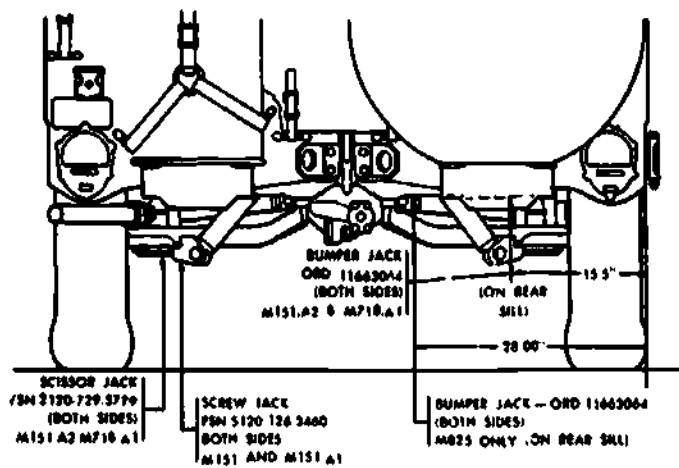

Fig 1-17. Positioning jacks at rear of vehicle.

The Gama Goat also has specified positions for lifting. If this vehicle is lifted in the wrong place, damage to the hull could easily occur which could affect its waterborne capabilities. Figure 1-18 shows the proper jack position for the center wheels of the Gama Goat. Figure 1-19 shows the proper position for both the front and rear wheels. With the jack in the proper position we are ready to start lifting. The vehicle should be lifted just enough at first to put a good strain on the jack.

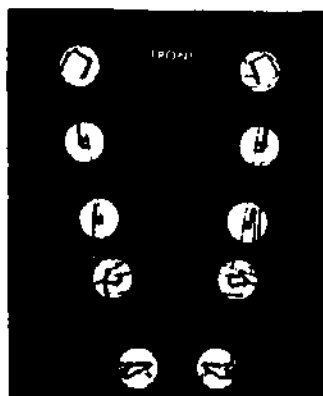

Fig 1-18. Center wheel--jacking point.

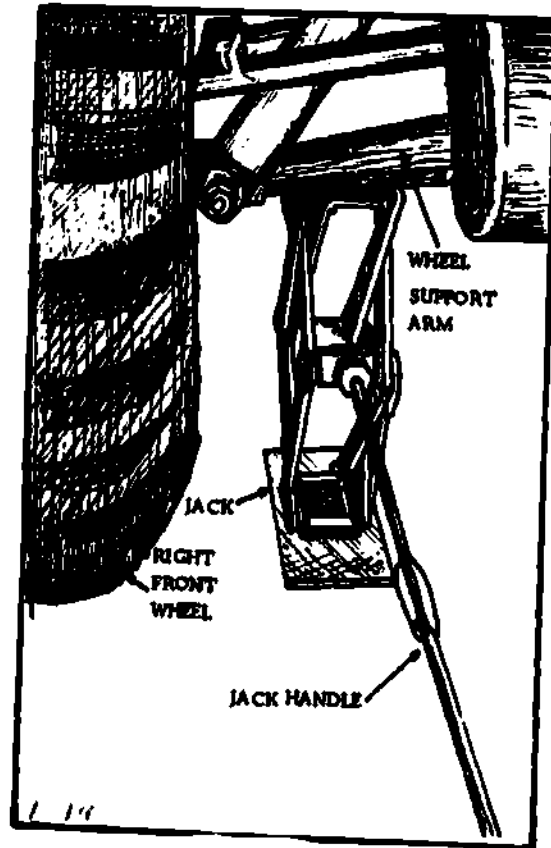

Fig 1-19. Front and rear wheel jacking points (typical).

c. **Removal.** You should consider loosening the wheel nuts slightly while the wheel is still on the ground. This will simplify the loosening process because the wheel will not turn while it is on the ground. Some vehicles are equipped with wheel nuts that have left or right handed threads on the wheel lug (fig 1-20).



Fig 1-20. Left and right wheel nuts.

Determination can easily be made because the lugs are marked on the end with an "L" or "R." In some cases the "L" or the "R" may not be visible because of the paint or dirt. Keep in mind that M-series tactical vehicles have left hand threads on the left side and right hand threads on the right side. Now that the wheel nuts are loose the vehicle can be lifted. With the wheel clear of the ground, the nuts can now be removed. Prior to the wheel clearing the ground, the nuts should remain on so that, if the jack did slip, the tire would still hold the vehicle up and the jack could be repositioned without much difficulty. Place the wheel nuts so that they are in easy reach and out of the dirt. The tire is ready to be removed. You should gently lift the tire as it is removed to prevent the wheel rim from scraping across the threads of the lugs. Position the new or spare tire on the hub and replace the lug nuts with the beveled edge of the nut pointing towards the rim (fig 1-21)

and centered in the holes in the rim. Finger tighten all the nuts and then use the wrench to snug them up, lower the vehicle, and finish tightening. Once again the weight of the vehicle will prevent the wheel from turning. Secure the damaged tire and replace your tools and you're ready to continue.

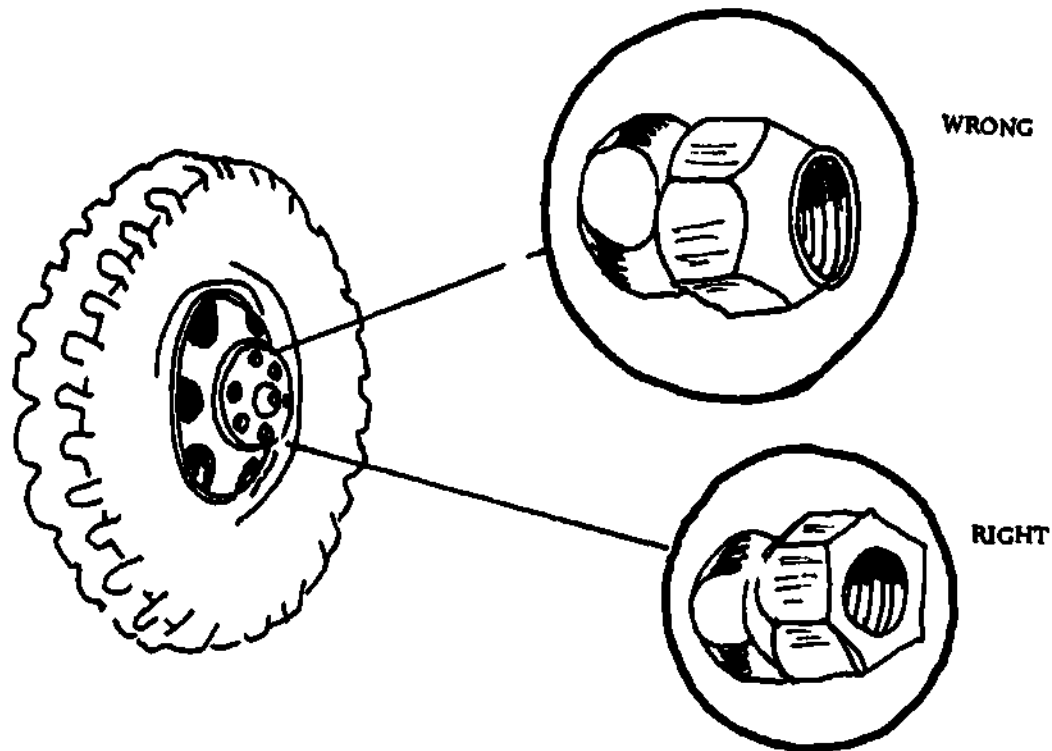

Fig 1-21. Beveled edge of nut points toward beveled edge of rim.

#### 1-8. DEMOUNTING AND MOUNTING TIRES

Removing (demounting) a tire from a rim can be a difficult job. In some cases tires remain on rims for years. Corrosion builds up on the rim and rubber from the tire adheres to the rim also. At times you'll think the tire was welded to the rim but with the right knowledge and tools they all loosen up.

a. **Safety.** Certain safety rules must be carried out if injury is to be avoided. We wouldn't abuse or handle roughly a cylinder of oxygen used in welding operations, knowing what would occur if the valve should get broken with all that pressure in the cylinder. A tire could be considered as the same thing. It has terrific pressure inside and is mounted on steel and certain parts are capable of flying off. Always deflate the tire by slowly and carefully removing the valve core. Always use the proper tools to avoid burring the rim, springing lock rings out of shape, or damaging the tire or tube. Always inspect the rim for cracks, burrs, and broken welds. Inspect all locking type devices to insure they are not sprung and that the part of the lock that engages in the rim has not been damaged. This is a particularly dangerous item as you can see in figure 1-22.

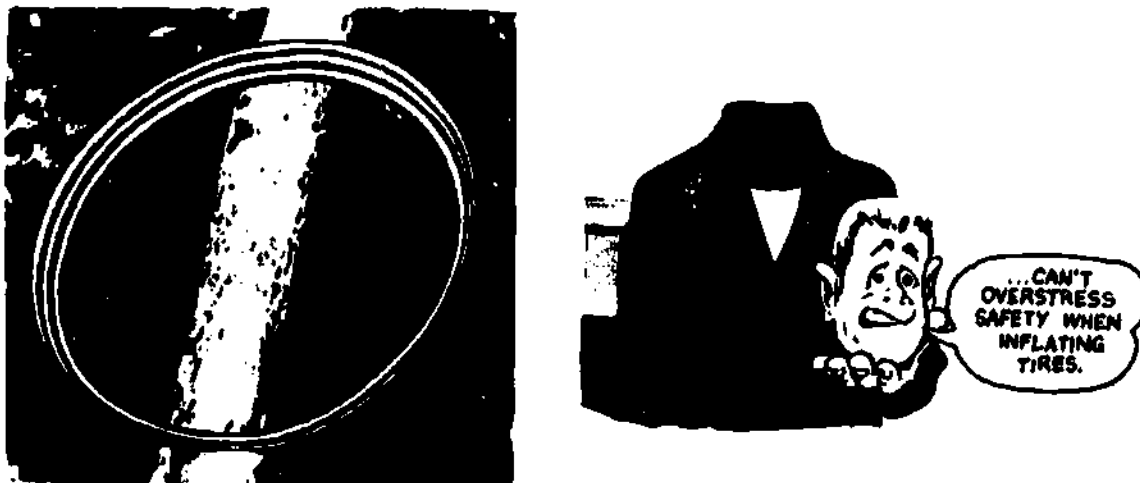

Fig 1-22. Improperly seated ring blown on tree.

Always use a safety cage when inflating tires that require a locking device. The ideal situation is shown in figure 1-23 below. That may not always be possible but there is another alternative which is shown in figure 1-24 below.



Fig 1-23. Safety cage.

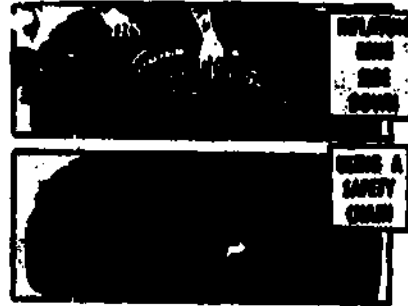

Fig 1-24. Precautions when safety cage cannot be utilized.

b. Types of rims. There are numerous types of rims, but we will discuss three of the most common types and their basic design.

- (1) Flat base. This type of rim has a removable lock type ring (fig 1-25) which holds the tire on. There isn't any stretching of the tire bead (shown in fig 1-26) when mounting it because the tire slides right onto the rim. Figure 1-27A shows the locking ring and the manner in which it seats in the rim. Rims of this type can be found on 3/4 ton vehicles and larger. There are variations to the locking devices. Some may have two rings, one used as a flange and one used as the locking ring. In this case the locking ring may not be a split type as shown, but a solid type ring which is forced into the seat in the rim.

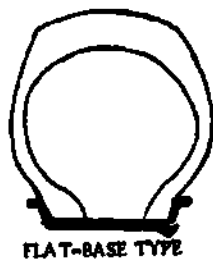
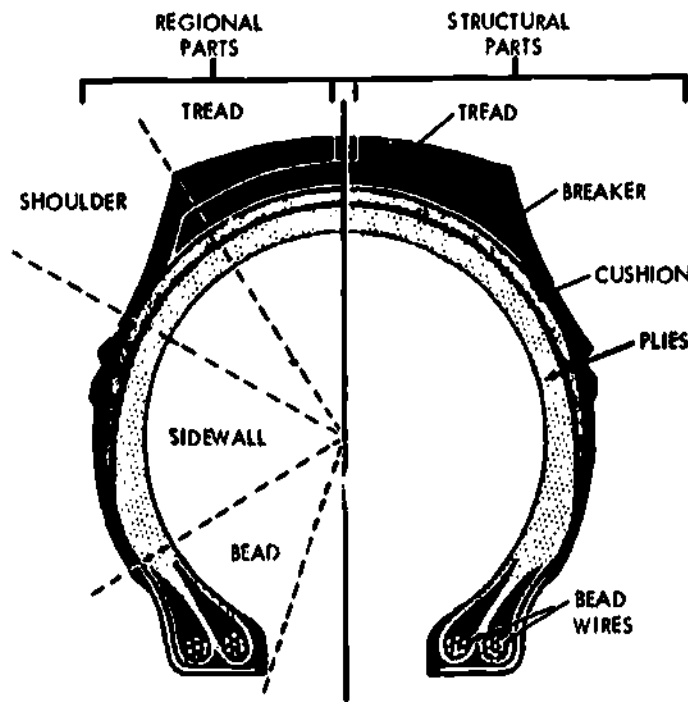

Fig 1-25. Flat base rim and locking ring.



B - CROSS-SECTION OF TIRE

AT

Fig 1-26. Tire construction--sectional view.

When a tube type tire is installed on a flat base rim, a tire flap should be installed. A flap is normally made of semihard rubber formed in a circle. The flap protects the tube from the edges of the tire bead and the base of the rim. An example of this is shown in figure 1-27 below.

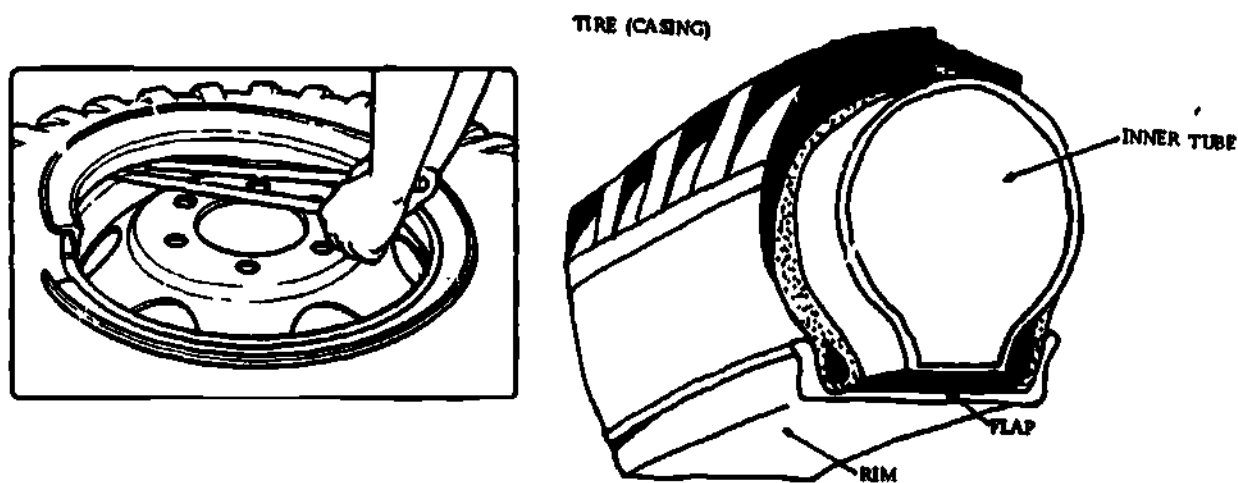

A. Locking ring

B. Tire flap

Fig 1-27. Tire flap installed on flat base rim.

- (2) **Drop center and safety.** These types of rims are used on 1/4 and 1/2 ton size vehicles. Rims of this type are one piece. The important feature of these types of rims is the "well" which is the deepest portion of the rim. The "well" (figs 1-28 and 1-29) permits mounting and demounting of the tire. The safety type rim, even though it too has a drop center, is slightly different. Safety rims have slight humps (fig 1-29) at the bead edges which hold the tire in place when the tires go flat.



DROP CENTER TYPE RIM



SAFTY TYPE RIM

Fig 1-28. Drop center type rim.

Fig 1-29. Safety type rim.



c. Tools. To demount or mount a tire successfully requires the use of certain tools. Some tools are designed for one specific purpose and others are designed for dual purposes. Some of the tools talked about are made in different lengths but the purpose remains the same.

- (1) Valve repair tool. This is a four way tool (fig 1-30). Its functions are: (1) removal of the valve stem, used in the same manner as the standard slotted valve cap (fig 1-31); (2) rethreading of outside threads on the valve stem, using the die end (fig 1-32); (3) rethreading of the inside of the valve stem, using the tap end (fig 1-33); (4) milling/smoothing out the ends of valve stems, using the valve stem end miller portion (fig 1-34).

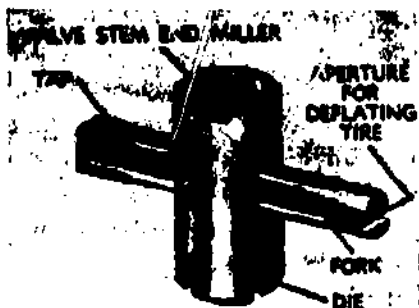

Fig 1-30. Valve repair tool.



Fig 1-31. Standard slotted valve cap.



Fig 1-32. Rethreading outside threads of damaged valve stem.



Fig 1-33. Rethreading inside threads of valve stem.

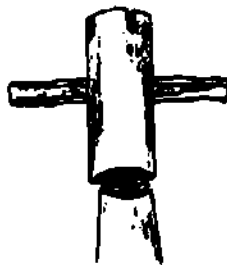

Fig 1-34. Using the milling end to remove rough end on top of valve stem.

- (2) Tire iron (fig 1-35). Tire irons are used to break the tire bead away from the rim. They are also used to remove the locking ring. Tire irons are found in varying lengths but normally will have a flat end.
- (3) Tire wedge (fig 1-36). This is used to break the bead away from the rim. Normally tire wedges are used in pairs. They are driven in between the bead and rim.
- (4) Fishing tool (fig 1-36). This prevents the tube stem from slipping back into the hole in the rim during tire inflation. Inflation can be accomplished with the tool attached to the stem.
- (5) Other tools. An accurate tire gage, stiff wire brush, and a heavy hammer may also be required.



Fig 1-35. Tire irons.



TIRE WEDGE

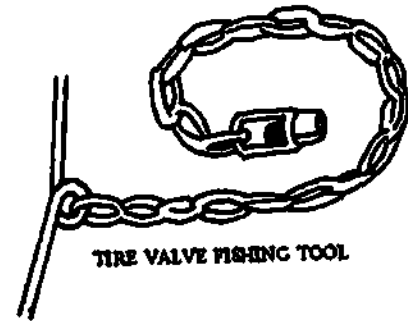

TIRE VALVE FISHING TOOL

Fig 1-36. Tire wedge and tire valve fishing tool.

d. Demounting and mounting procedures (drop center rim). A total of five basic steps must be performed to remove and replace a tire on a drop center type rim. These steps are in addition to the safety procedures that were mentioned earlier.

Step #1. Break the bead away from the rim on both the top and bottom side. Normally the use of tire irons or wedges is required. Point 1 of figure 1-37 A shows how the bead is against the sides of the rim. When the bead is broken away from the rim, it can be forced down into the well of the rim as at point 2 of figure 1-37A and figure 1-37B which will allow the bead to be lifted over the rim edge.



A

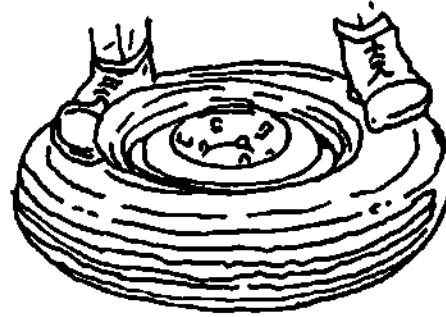

B

Fig 1-37. Positioning bead in well of rim.

Step #2 (fig 1-38). Lift bead over the edge of the rim, using a tire iron inserted between the bead and the rim, and apply pressure downward. With a portion of the bead over the rim, insert a second tire iron about 4 inches away from the first end repeat the procedure until the entire bead is over the rim.

**Note:** The weight of the knee on the opposite side from which you are prying is important. It will force the tire down into the well, making it easier to lift the bead on the other side.

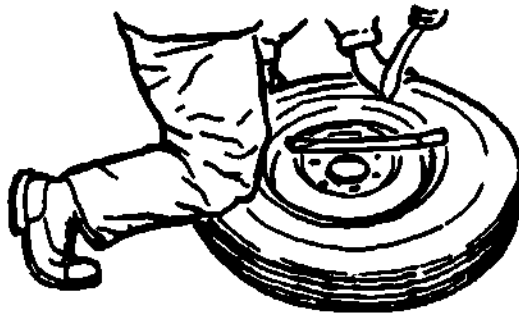

Fig 1-38. Lifting outside bead over rim.

Step #3. Now that the front bead is over the rim, remove the tube. Using the iron, remove the inside bead (fig 1-39). The tire is now free of the rim.

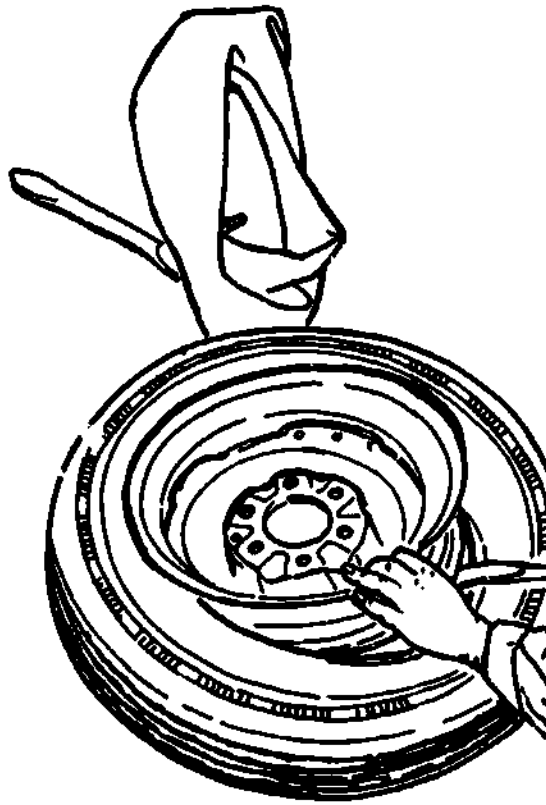

Fig 1-39. Removing inside bead.

Step #4. Replacing the tire on the rim is basically the same procedure in reverse. You must position a portion of the inside bead (fig 1-40) in the well. The portion of the bead that is left must be pried over the rim. It is acceptable to use a rubber mallet for this purpose. Now you should install the tube (this is also an excellent time to attach the fishing tool).

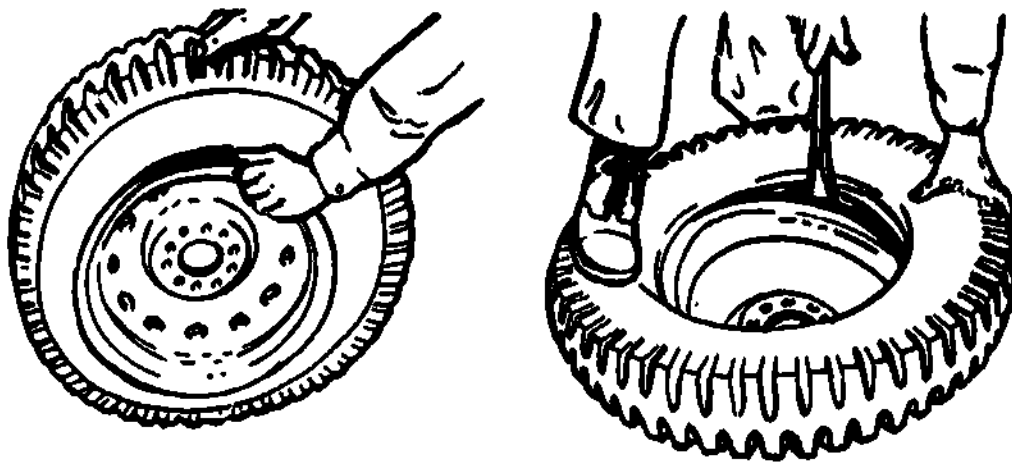

Fig 1-40. Positioning inside bead on rim.

Step #5. Pry the outside bead into the well (fig 1-41) and the tire is mounted. During both the removal and replacing process, you must take care not to pinch the tube or the tire bead.

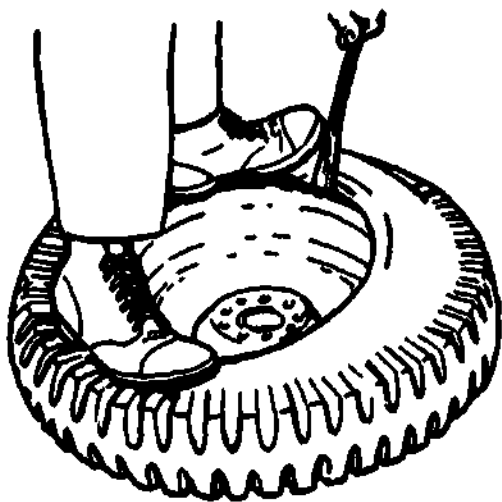

Fig 1-41. Placing outside bead in well.

e. Demounting and mounting procedures (flat base rim). To remove or replace a tire on a flat base rim requires four basic steps. The safety procedures previously discussed are not included again.

Step #1. The tire bead must be broken away from the locking ring. The use of wedges in most cases is required. With the bead free of the locking rim, removal of the locking ring can take place as shown in figure 1-42. Removal must start at the point where the ring is split. At this point the lock has a notch made for prying it away from the rim. Pry the lock up by moving the irons around the rim a few inches at a time. Grabbing the lock ring by hand and trying to pull is not advisable as it could bend the locking device.

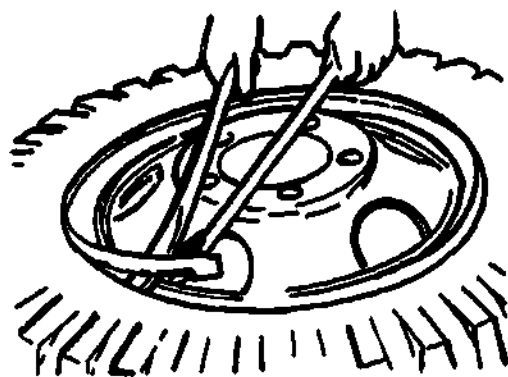

Fig 1-42. Removing lock ring.

Step #2. Turn the tire over and break the bead away from the other side. The valve stem must now be tucked into the hole in the rim. Because the tube and tire will come off the rim as one unit, there is danger the stem will be sheared off or that the threads will be damaged. The tire is now ready to be removed. The easiest way is to place a block of wood as shown in figure 1-43. The tire is held upright with the locking ring side (ring is now removed) facing the block. Drop the tire carefully so that the rim will hit the block forcing the rim back and allowing the tire to drop to the ground. The tire flap and tube can then be removed from the tire. Normally the flap can be removed without any trouble, but occasionally the tube may be stuck to the inside of the tire and will require some pulling to free it from the tire.

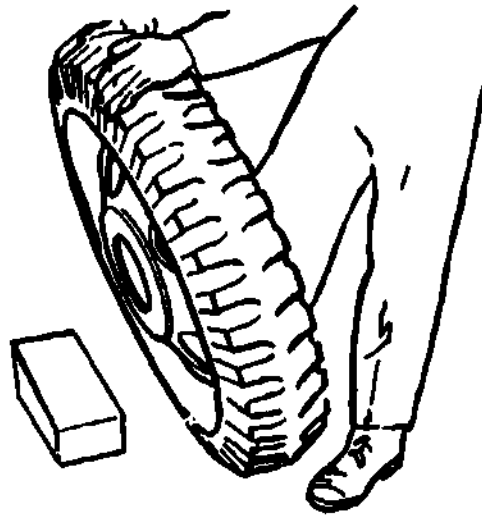
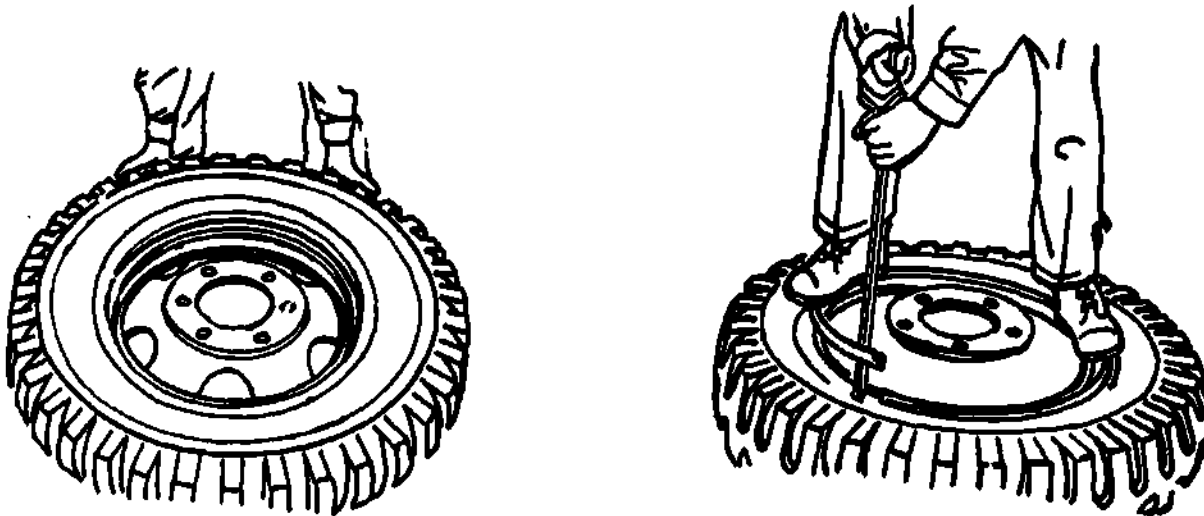

Fig 1-43. Preparing to remove the tire from the rim.

Step #3. To replace the tire, insert the tube in the tire; inflate the tube just enough to shape it. Now install the flap. Place the tire on the rim (fig 1-43) and insure the valve stem is pushed through the slot in the rim.



A. Placing tire on wheel.

B. Installing one-piece split ring.

Fig 1-44. Mounting tire on flat base rim.

Step. Start the locking ring from one end and work around the ring. The section that is started first will be easy but you should place your foot on the portion that has been started (fig 1-44). This prevents it from jumping out of the rim seat. As more of the ring is forced on the rim, the more difficult it will become to pry the remainder on. This situation can be eased somewhat if you will pry a small section at a time. The lock ring must be properly seated and locked before inflation.

f. Tire beads. If tire beads are damaged to the extent shown in figure 1-45, the tires are of no further value. Tire beads can be ruined by the operator who is careless. Bead damage can be caused by the following:

- A bent locking ring (fig 1-45A).
- The tire mounted on the wrong rim (fig 1-45B).
- The incorrect use of tools.
- Using the wrong tools, like using a pick mattock instead of a tire wedge.



A

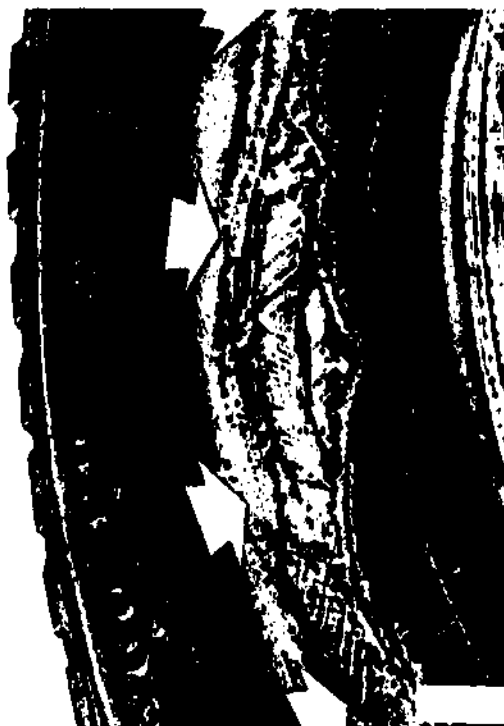

B

Fig 1-45. Tire bead damage.

### 1.9. TUBE REPAIRS

a. Punctures. Some items that cause punctures remain in the tire and some make the puncture but are not picked up by the tires. Punctures are easily handled if certain steps are followed (let us consider that the tire has been removed from the vehicle). Examine tire for location of item that caused the puncture. If item is found, the location of the valve stem and the puncture should be marked (fig 1-46). This makes it easier to locate the hole in the tube. If the puncture cannot be located, the location of the valve stem should still be marked. When the hole is found in the tube, the tube can be laid on top of the tire in the exact position from which it came apart. You can use the hole in the tube to locate the position of what caused the puncture.



Fig 1-46. Marking location of valve stem and puncture.



A pin-hole type puncture can be found more easily if the tube is inflated enough to fill it out. Submerge the tube in water; air bubbles will indicate the location of the puncture. In place of submerging, a soaked rag or sponge can be used, or running water from a hose will give the same results. If you were successful in locating the puncture, the entire inside of the tire should still be inspected. Perform a visual inspection for broken cords. Then using a rag or something similar run it completely around the inside of the tire. This will snag on just about anything that may be protruding through the tire. Your bare hands should not be used as severe cuts can result. Insure that the rubber dust is removed from the inside of the tire; it too can cause chafing. If inspection of the tire reveals cord damage, consult with your supervisor. Cord damage could make the tire unsafe. It will also pinch the tube and cause it to wear through.

b. **Patching.** Patching preparations are the same for all tire tubes. The size of the puncture must be considered prior to patching. Some holes are too large for patching by the operator but may be repaired if forwarded to a higher echelon. Tubes should be prepared as described below.

- (1) **Prevent enlargement.** Punctures in tubes, especially synthetic ones, have a tendency to enlarge even after patching (A, fig 1-47). To prevent this, the ends of the puncture may have to be rounded or buttonholed. To round or buttonhole a puncture means to put a small hole at each side of the cut (B, fig 1-47). These little holes take most of the existing pressure off of the puncture and prevent the expansion of the cut.

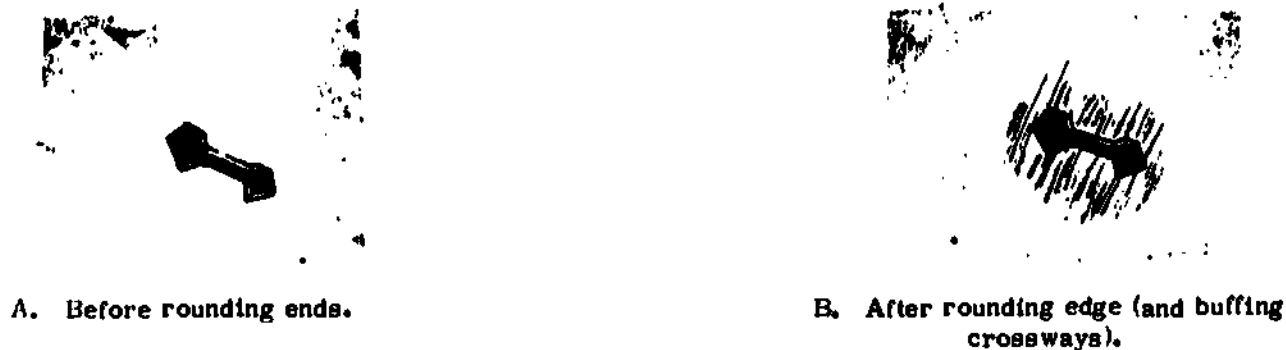

Fig 1-47. Preventing tube puncture from enlarging.

- (2) **Buff area.** The area must be buffed about 1/2 inch beyond the edge of the puncture so that the patch will stick better. Buffing should be done across the cut as shown in B, figure 1-47. Items suitable to use for this purpose are sandpaper, a stiff wire brush, a file, and similar items. Do not make grooves in the rubber; just rough it up.
- (3) **Apply patch.** There are basically two methods for applying patches.
  - (a) **Heat curing method.** The patch in this case is applied by heat. It can be electric heat or the patch itself can be lighted to generate its own heat. In both cases the patch must be clamped to the tube with a device made for this purpose (known as a vulcanizer) while heat is being applied (fig 1-48). Although a heat type patch is normally wrapped in a protective covering to keep the moisture out, it is often spoiled due to age.

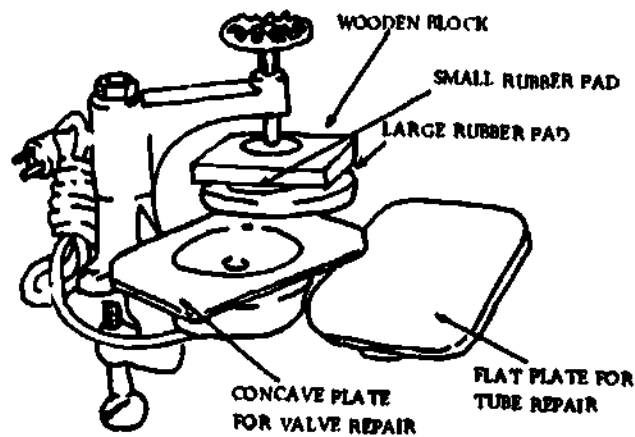

Fig 1-48. Electric-type vulcanizer.

- (b) Chemical curing method. This method requires that a chemical cement be applied to the patch to hold it to the tube. The patch itself reacts to the chemical which make it stick to the tube. This method is sometimes referred to as cold patching. Both methods require that the portion of the patch which is next to the tube have the protective covering removed before applying it to the tube. This portion must be exceptionally clean if the patch is to stick.
- (c) Valve stems. The valve stem must be protected. This is accomplished by:

- insuring the tube is properly installed, and that the valve does not chafe (rub).
- insuring each valve stem is protected with a cap. This prevents damage to the threads, keeps dirt out, and is actually a seal to prevent air from escaping.

If a valve is found to be defective, it doesn't mean it cannot be repaired (fig 1-49). You do not have the capabilities but higher echelon does. Consult with your superior before a determination is made.

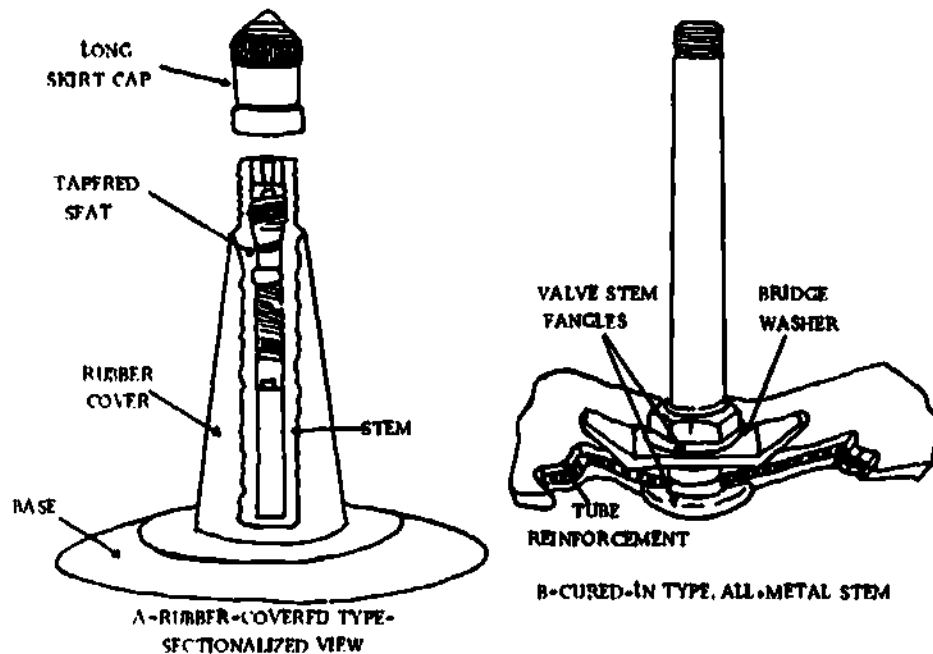

Fig 1-49. Replaceable stems.

1-25

d. Valve core. The valve core is located in the stem of the tube (fig 1-50). It allows air to be put into, and prevents air from escaping from the tire. The core is non-reparable and must be replaced if found defective. A defective core will normally cause a slow leak, and a simple check can be performed to discover a defective core. Remove the valve cap and apply a dab of spit to the top of the valve stem. If bubbles appear, the core is leaking; try tightening it. If bubbles still appear, it should be replaced. A valve core not protected with a valve cap could develop a leak because dirt could push the core down.

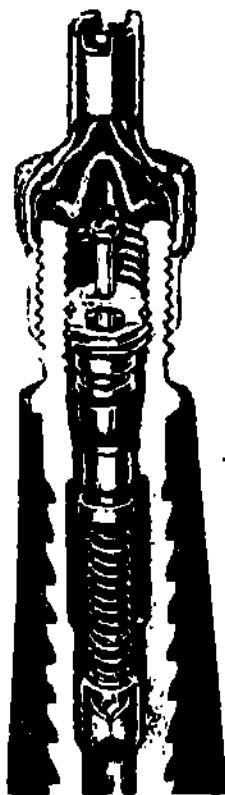

Fig 1-50. Valve core and cap.

#### 1-10. STORAGE OF TIRES

Tires in storage must be protected from deterioration. The causes of tire deterioration are the same as those that deteriorate canvas in storage. Tire and canvas deterioration result from the presence of a combination of light, heat, oil, water, dirt, and ozone. Ozone is a gaseous form of oxygen caused by the silent discharge of electricity into ordinary oxygen. Ozone causes cracking or checking which is sometimes called weathering. To protect tires in storage from cracking, they should be covered. This will help protect them from dirt and light. An interesting note is that military tires are specifically made of certain oils and waxes which protect the tire from ozone, but these chemicals are efficient only when the tire is being exercised (used on vehicle which causes flexing of the rubber).

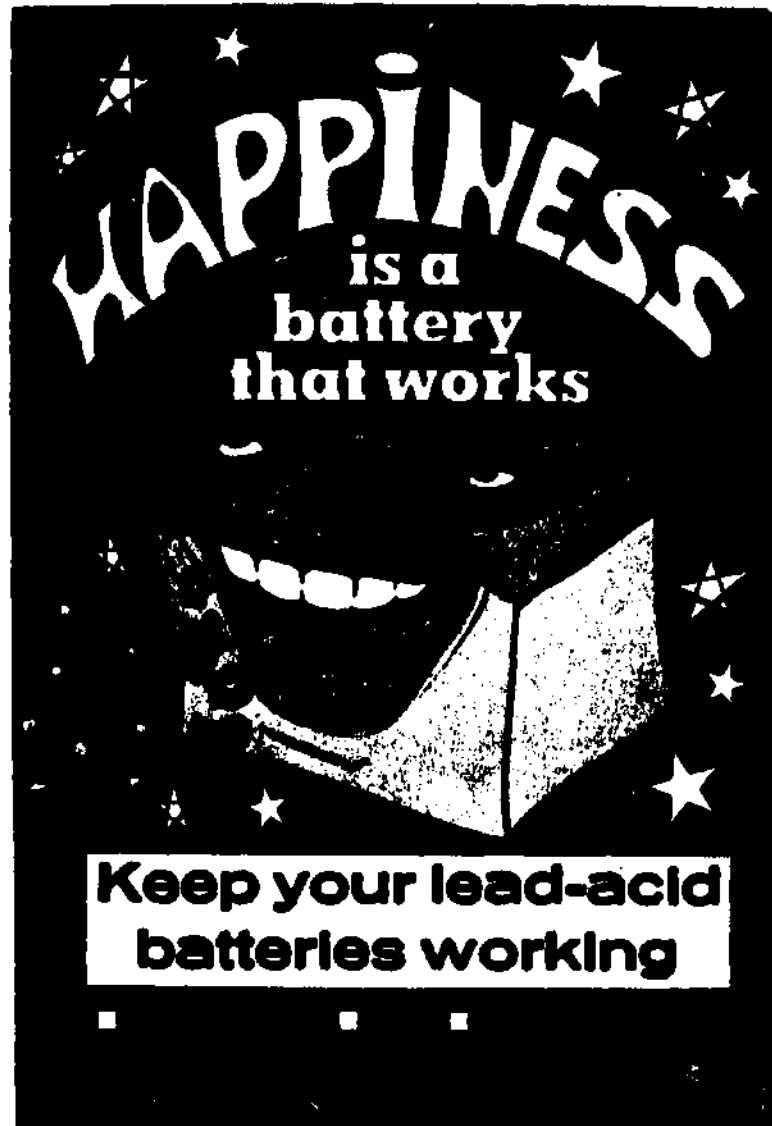

Fig 1-51. Happiness is a battery that works.

### Section III. BATTERIES

#### 1-11. INTRODUCTION

The batteries discussed here are the lead-acid storage type. All military vehicles and most civilian vehicles use this type. They may vary in physical size as well as output of electrical energy.

#### 1-12. DESCRIPTION

The battery in figure 1-52 is the lead-acid type which is normally used for vehicles. It stores up energy in chemical form through a chemical reaction between liquid electrolyte and metal plates so that it can be released as electricity. The batteries vary in electrical capacity but the most common are either 6 or 12 volts. A typical battery is constructed as shown in figure 1-52. A battery is made up of several cells which are like separate compartments which produce

1-27

electrical energy from chemical energy. The cells are connected to one another and together make up one battery. A vent plug covers the opening to each cell and it is through this opening that the cell is checked, more water is added, etc. An operator should mostly be concerned with the terminal posts (to which the cable clamps are connected), vent plugs (caps), and the casing. The manner in which he performs the basic maintenance on these items affects the entire structure and life of the battery. In order for the battery to function properly, the liquid must be kept at the proper level, terminals must be kept clean, and all connections must be kept tight.

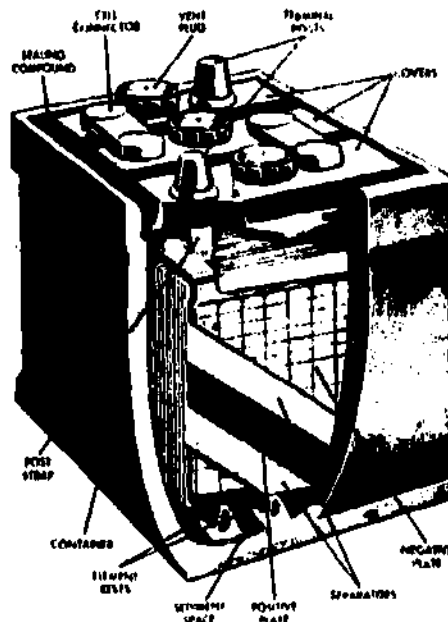

Fig 1-52. Typical battery construction.

#### 1-13. FUNCTIONS

The battery has four basic functions:

- Supplies energy for engine starts
- Supplies energy for short term overload demands in excess of generator output (as when using cables to start another vehicle)
- Supplies limited amount of emergency power when generator is not working
- Acts as a voltage stabilizer in the electrical system (when the generator produces more energy than required, the surplus (under certain conditions) goes to the battery. When the generator is not producing the necessary energy, the battery can supply the energy required in the electrical system).

#### 1-14. POTENTIAL HAZARDS

Due to its physical and chemical characteristics a battery presents several possible hazards which can cause serious injuries:

- Weight. The weight alone will crush a toe or finger.
- Chemical. The liquid inside, being a form of acid, will cause severe burns to the skin and deteriorate clothing, metal, and paint.
- Electrical. Severe burns can result from the electrical energy stored in the battery. For this reason jewelry, such as rings and watches, should not be worn when working around batteries.

- **Explosive.** This type of battery gives off two types of gas, hydrogen and oxygen. When these gases collect in high concentration, a spark is all that is needed to cause an explosion. This condition is more severe in a place where batteries are charged.

#### 1-15. SAFETY

a. **Equipment.** Several items are available to provide protection against injury from batteries. Listed below is the equipment and its usage.

- (1) **Rubber apron (fig 1-53).** The apron should be worn at all times when working with battery acid (liquid). It is recommended that it be worn when cleaning or carrying batteries. The apron should be cleaned periodically with a solution of baking soda and water to remove acid. To avoid both sides being exposed to acid, one side should be stenciled battery side or clothing side.

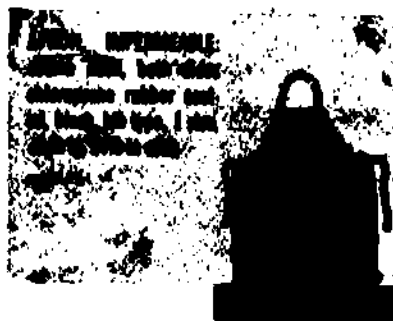

Fig 1-53. Rubber apron.

- (2) **Rubber gloves.** Rubber gloves should be worn at all times when mixing acid or filling batteries (fig 1-54).

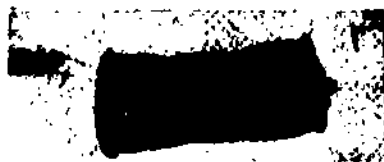

Fig 1-54. Rubber gloves.

- (3) **Goggles and face shield (fig 1-55).** Goggles are ideal protection for the eyes when cleaning batteries. When mixing battery acid, a face shield offers better protection for the entire face.



Fig 1-55. Eye protection--goggles and face shield.

- (4) **Battery filler.** The gravity flow filler (fig 1-56A) is ideal for refilling batteries because the amount of flow is easily controlled and the container will not cause a spark. The syringe (fig 1-56B) is used with the gravity flow container and can be used for either filling or removing small amounts of liquid.



A. Gravity flow filler.



B. Syringe filler

Fig 1-56. Battery fillers.

- (5) Carrying strap (fig 1-57). The carrying strap will fit all batteries. It enables you to keep the battery away from your clothes. Some batteries are equipped with handles (fig 1-58A) and others are not (fig 1-58B). The strap is very useful when a battery must be removed from a battery compartment since batteries are normally installed very close together. For this reason batteries, as well as tools, should not be carried on the seats of vehicles (fig 1-59). Acid will cause extreme deterioration.

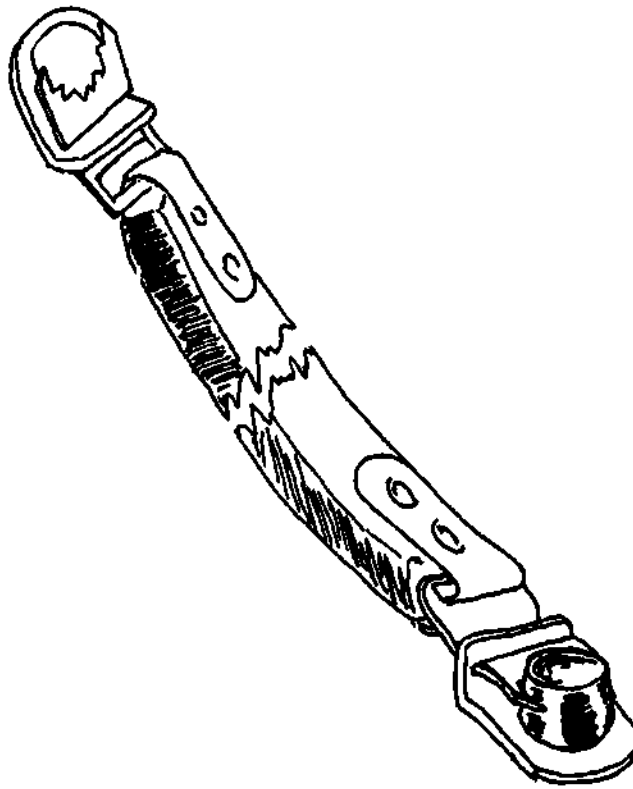

Fig 1-57. Battery carrying strap.



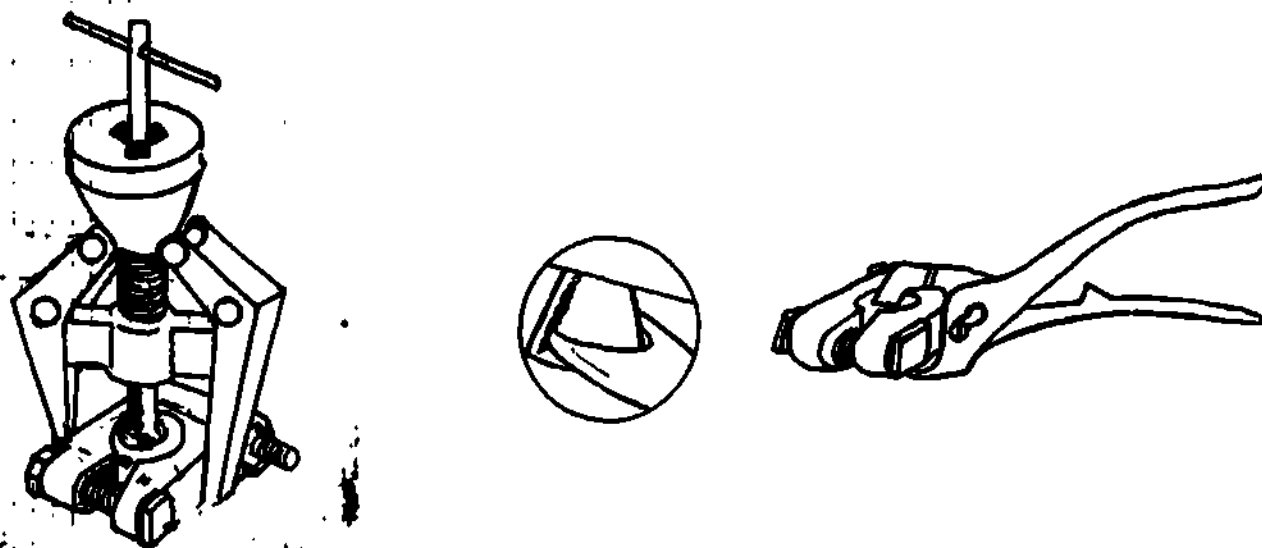

Fig 1-58. Batteries with and without carrying handles.



Fig 1-59. Safety precautions.

- (6) **Battery clamp puller and lifter.** Both tools are ideal for removing those stubborn battery clamps. Figure 1-60A demonstrates the use of the puller, and figure 1-60B the lifter. Both tools will prevent the post from being pulled out of the battery and damage to the battery clamp.



A. Puller.

B. Lifter.

Fig 1-60. Battery clamp tools.

- (7) **Battery pliers** (fig 1-61). These pliers are designed to be used on battery connections. They have an angled nose which allows for more swing room. The jaws have deep teeth to grip so that the pliers do not turn on the nut. These pliers are very efficient for removing nuts that are rounded over or otherwise deformed.



Fig 1-61. Battery pliers.

b. **Safety measures.** There are certain measures that you should consider when working with batteries and when mixing solution to fill batteries. Some are for consideration for work that is performed in a battery room (shop) environment and others are for the work performed in an operator's environment.

- (1) **Water.** Familiarize yourself with the nearest area for running water for flushing the eyes or skin. A battery shop should be equipped with a shower that is easily turned on by standing on a plate or a platform as opposed to one turned on by the use of faucets.
- (2) **Ventilation.** This is mostly a problem for areas used for charging or mixing battery solution. These areas must be well ventilated by the use of exhaust fans or sufficient windows. Fumes must not be allowed to build up as they are poisonous and combustible.
- (3) **Fire.** Fire extinguishers must be of the correct type with a capability for use on electrical fires.
- (4) **Markings.** Any containers that are used for mixing electrolyte solution should be plainly marked and shop areas should be marked also to warn unfamiliar persons that it is a danger area.
- (5) **Battery room.** The battery room should be used strictly for working on batteries. Administrative work should not be done there. Tools and paint should not be stored there. In short, the less time spent in the battery room, the safer you will be.

## 1-16. REMOVAL AND INSTALLATION

The task of installing or removing batteries is performed by an operator. This is one of the more important first echelon maintenance jobs that he must perform. So that you may avoid mistakes that are common and benefit from others' experience, let's discuss ways to avoid these mistakes. There are four items that normally cause problems when installing or removing batteries:

- **Cables.** Cables must be inspected for cracks in the insulation, especially where the cables pass through holes in the frame of the vehicle. Cable ends should be checked for tightness (fig 1-62). Cable ends are soldered on, but corrosion can work into the end, causing it to come loose or make a poor connection. Cable ends must be spotless if good contact is to be made. Cable ends that are loose or broken should be reported so that repair or replacement can be provided. Keep in mind that one cable will be for the positive connection to the battery while the other is for the negative connection. The two cables may look physically similar, but their purpose is quite different and they must not be interchanged.



Fig 1-62. Cable end.

- **Battery clamps.** There are two types of battery clamps and they both perform the same job. They make the connection between the battery post(s) and battery cable(s). Here's the difference; the positive clamp (fig 1-63) has a bigger hole than the negative clamp (fig 1-64). The reason for this is to help avoid installing the wrong cable(s) on the wrong battery post(s).

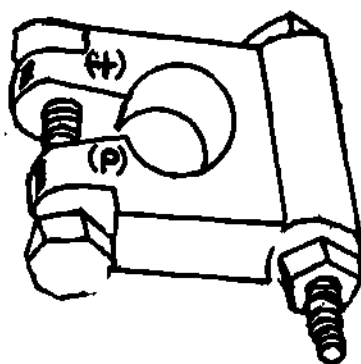

Fig 1-63. Positive battery clamp.

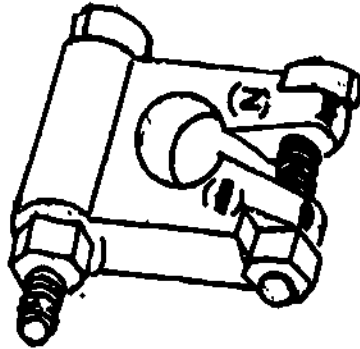

Fig 1-64. Negative battery clamp.

The positive post is larger in diameter than the negative post. Most clamps also have a symbol to help distinguish the difference. For the positive clamp a mark such as this (+) or the letter P is used (fig 1-63) and for the negative a mark like this (-) or the letter (N) is used. Clamps should NOT be interchanged. It is physically possible to do so but here's what may occur. The clamps, being of different sizes, will not fit properly, causing a poor connection. More important, if a positive clamp were interchanged with a negative clamp, we have set the stage for possible injury and/or damage to the vehicle's electrical system. An operator will use the markings on the clamps + or - to assist in correctly installing the cables. We have defeated that purpose by using the wrong clamp. Regardless of what type marking is on the clamp it does not change the purpose of the cable. So we have a negative cable with a positive clamp which to be correctly installed must be attached to the negative post on the battery. Will the operator connect it this way? Since he has at all other times connected the clamp marked + to the positive post, why would he now do it differently? If the wrong connection is made, the battery may spark, injury may result, and possible damage may be done to the generator, regulator, and wiring. Clamps can also be installed upside down. This is possible because clamps are designed with a tapered hole (A, fig 1-65). The widest portion faces down towards the battery. When installing the clamp in this manner, you will match the taper on the battery posts. If installed upside down as in B of figure 1-65, the tapers do not match; the widest point of the clamp will be up which means it has to match the narrowest point of the post. It cannot, so there will be a portion of the clamp that does not touch the battery post (C, fig 1-65), resulting in a poor connection. Clamps are also subject to becoming broken, cracked, or otherwise deformed and the bolts which hold them are subject to corrosion. Clamps should never be installed by using a hammer to beat them on. This method will result in cracking the battery in the area where the bottom of the post is flush with the battery.



A. Tapers correctly matched.

B. Clamp upside down; tapers do not match.



C. Clamp upside down will not make contact at top of post.

Fig 1-65. Battery clamp and post tapers.

- **Battery post(s).** To avoid a reverse hookup, the battery post(s) are different. The positive post is larger in diameter than the negative post (fig 1-66). Both posts are normally identified in the same manner as the battery clamps, which is a symbol designating "+" or "-". If these symbols are not used, the letter "N" (negative) or "P" (positive) may be used instead. In some cases the post may not be marked but the battery case itself will have a designation as to which post it is. Battery posts can become loose if the correct procedures are not followed when you are putting on or taking off the battery clamps.

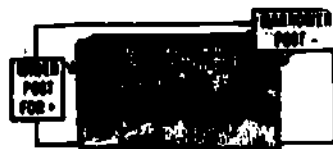

Fig 1-66. Battery post designation and difference in diameter.

- **Holddown brackets.** These brackets are necessary for proper positioning of the battery. Hold-downs insure that the battery remains stationary. Even though batteries are installed in a box or compartment there is still room for them to shift. Clamps cannot be expected to prevent movement as they are electrical connections and are not designed to keep the battery stationary. The holddown bracket is subject to corrosion, especially at the bottom of the battery box or compartment.

a. **Removal procedures.** The following procedures should be followed in removing batteries. Remember that a continuous inspection must take place when removing batteries to prevent reinstalling defective parts.

- ALWAYS remove the negative clamp before you remove the positive clamp. Protect the ground cable from accidental contact with the battery post. This procedure will prevent tools from causing a direct short which can produce an arc. An arc can heat tools causing severe burns. It can also affect the vehicle's charging system. To do this, loosen the bolt and twist the clamp free by hand in either a clockwise or counterclockwise motion. If a clamp is stubborn, use a battery clamp puller.
- Never try to pry the clamp off in the manner shown in figure 1-67.

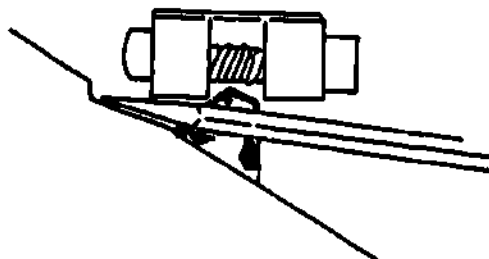

Fig 1-67. Improper removal of battery clamp.

- Remove the positive clamp using the same procedure as above.
- Remove the cable connecting the two batteries together.
- Remove the holddown bracket by loosening the bolts. Once all cables have been removed, it will be free.
- Lift the battery clear of the battery compartment. The easiest method is to use a carrying strap.

b. **Installation Procedures.** Place the battery in the compartment in such a manner that the negative post will be near the negative cable and the positive post will be near the positive cable (fig 1-68). Once again, a carrying strap is recommended to make the battery much easier to handle.

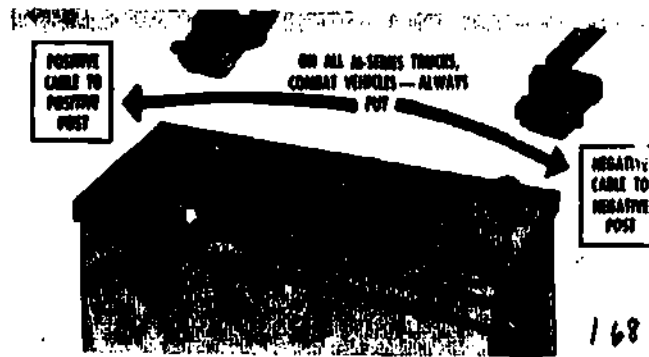

Fig 1-68. Positioning battery so that cables and battery posts correspond to each other.

Replace holddown bracket, insuring bracket bolts are engaged in the bottom of the compartment. Tighten the bracket securely, but not so tight that the bracket is forced into the battery case. Connect the positive cable clamp first. It may be necessary to spread the clamps, which is easily done with a clamp spreading tool (fig 1-69). Clamps should be installed so that the top of the battery post is flush with top of the clamp (1-70). Do not use a hammer or similar tool to beat the clamps down and avoid overtightening (fig 1-71).

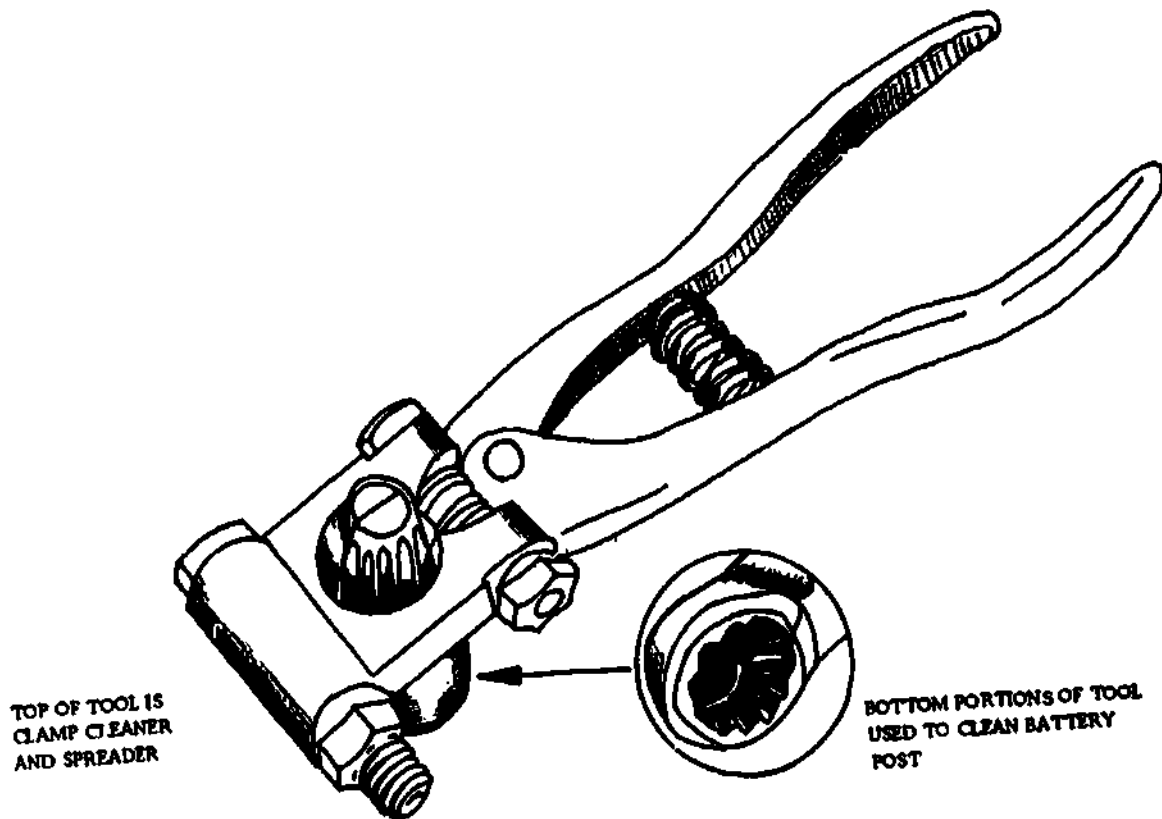

Fig 1-69. Battery clamp spreading tool.

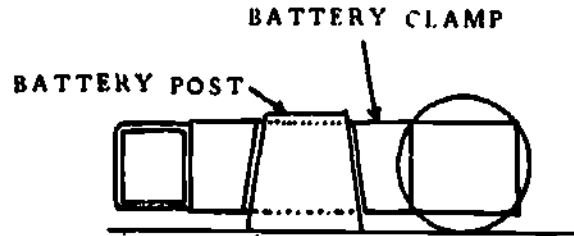

Fig 1-70. Battery clamp flush with top of post.



Fig 1-71. Results of overtightening battery clamp.

Connect the clamps that connect the two batteries together. Connect the negative clamp. This is always the last cable to be connected.

Double check your work:

- Holddown secured?
- Cable ends tight on clamp? (fig 1-72)
- Clamps tight on battery post? (fig 1-72)
- Clamps positioned so that all vent caps can be removed?

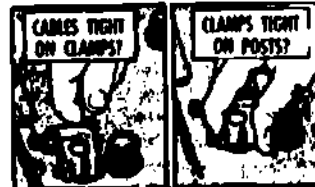

Fig 1-72. Double check your work.

## 1-17. HYDROMETERS

a. General. Hydrometers are used to measure the specific gravity of liquids. All liquids have a specific gravity. Water has a specific gravity of 1.000. Sulfuric acid has a specific gravity of 1.835. A combination of water and sulfuric acid makes up the liquid which is needed in the battery. This liquid battery mixture is called electrolyte and should have a specific gravity of about 1.280 (under standard conditions) to do its intended job in the battery.

Note: If the battery is to be used in a tropical climate, the standard specific gravity of 1.280 is reduced. When the standard specific gravity is reduced because of climate, it is called a tropical mixture and normally will have a specific gravity reading between 1.200 and 1.225. The electrolyte with this specific gravity used in a tropical climate will function better than a standard mixture. The main reason for the lower specific gravity is to prevent damage to the battery due to overreacting of the electrolyte which would be caused by a standard mixture (1.280) used in tropical climates.



Incorrect mixing, physical changes, and chemical reactions in the battery could raise or lower the specific gravity from the desired level. In certain cases we will need to adjust the specific gravity to adjust for different climatic situations.

b. Types. There are three types of hydrometers that you will probably be working with. Figure 1-73 shows a battery syringe hydrometer used to check the specific gravity of liquids in batteries. The hydrometer in figure 1-74 shows an antifreeze syringe hydrometer used to check the specific gravity of liquids in a radiator. We will discuss this one in greater detail when we talk about cooling systems. The third hydrometer shown in figure 1-75 is a newer, dual-purpose model which is expected to take the place of other types of syringe hydrometers. It is known as an antifreeze and electrolyte tester.

HYDROMETER, syringe,  
lead acid stor btry, w/2  
identical floats, minus  
65°F to plus 165°F temp  
Range

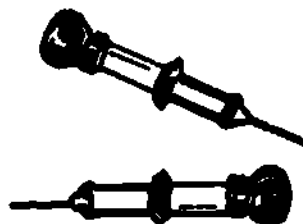

Fig 1-73. Battery hydrometer.



Fig 1-74. Antifreeze hydrometer.

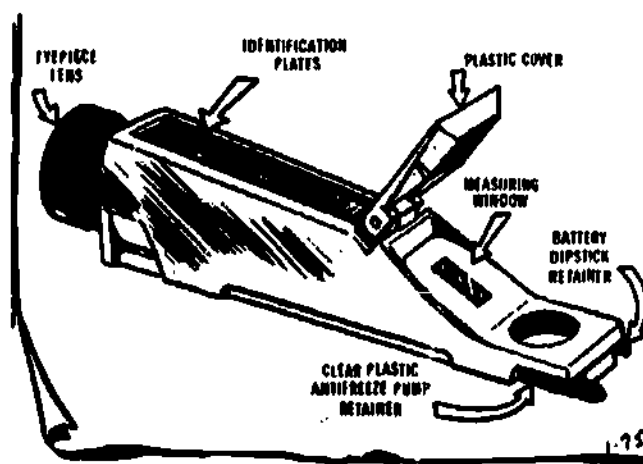

Fig 1-75. Antifreeze and electrolyte tester.

c. Headings. There are times when a specific gravity reading could lead us to believe that we have a defective battery, which may not in fact be the case. A reading should not be attempted if water has just been added to the battery, because the water must have time to mix. Otherwise the reading will not be correct. A reading should not be attempted if heavy discharge (use) of the battery has just taken place, as in heavy cranking (turning the engine over). The reading will probably show a higher state of charge than is actually present. While the electrolyte at the bottom of the battery which is around the plates is weak, the electrolyte on the top will be strong, so the reading will reflect a higher charge. You should allow time for it to mix back for a true reading. As a guideline, a specific gravity reading of any cell that falls in the range between 1.225 and 1.250 is an indication that the battery requires charging.

- (1) Battery syringe hydrometer (fig 1-73). Following is the procedure for obtaining a reading with the battery syringe hydrometer.
  - Remove the vent plug covering one cell.
  - Place the nose end of the hydrometer into one of the battery cells.

- Holding the hydrometer vertical, squeeze the bulb end gently and then release it. This is intended to draw enough liquid into the tube so that the float is free of the bottom but not so much that the top of the float goes into the bulb end.
- At eye level, read the number on the float where it meets the level of the liquid.
- Repeat this procedure until each cell has been checked. For example, the insert shown in figure 1-76 shows that the electrolyte level registers on the float at the number 1,260. This means that the cell has a specific gravity reading of 1,260 without temperature correction.

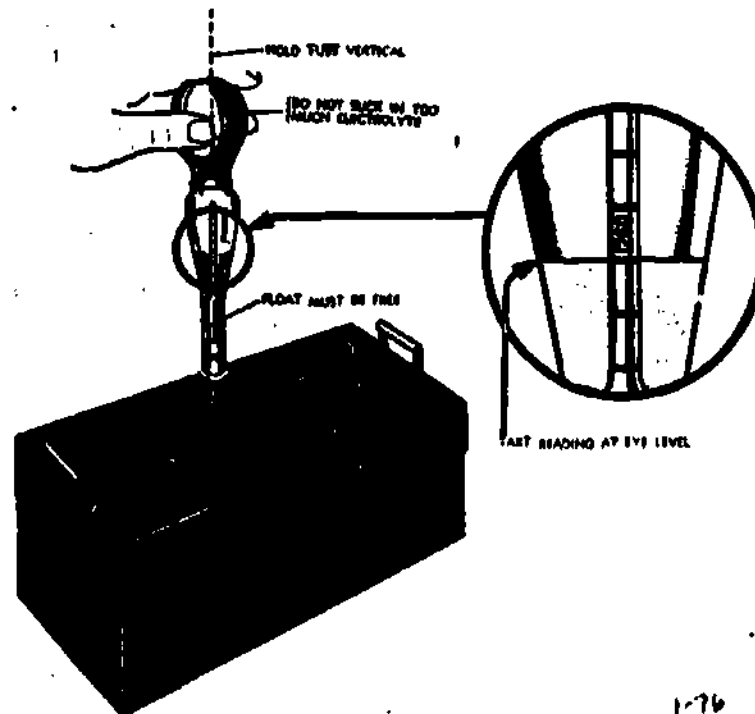

Fig 1-76. A specific gravity being taken of one cell. The reading indicates a specific gravity of 1,260 without temperature correction.

- Correct all readings. The temperature used as a standard for calibrating batteries is 80°F. This means that the specific gravity reading of a battery whose electrolyte is at 80°F is used to compare with the readings of other batteries. This does not mean that all specific gravity readings must be taken at 80°F. Readings taken at other temperatures are corrected, using 80°F as a standard. The battery syringe hydrometer has a thermometer built in to give you a temperature reading as well as a specific gravity reading. (The antifreeze and electrolyte tester automatically adjusts for temperature and requires no correction). These corrections are made because electrolyte expands in hot weather and contracts in cold weather. This expansion and contraction will affect the density of the electrolyte and thus the specific gravity reading of the battery. The further the electrolyte temperature is from 80°F, the greater will your chances be of getting an improper reading. To insure that we get a proper reading, we adjust the specific gravity reading that we get. We said earlier that the specific gravity for a standard electrolyte is around 1,260 if taken under standard conditions, which means that the electrolyte temperature is 80°F. Now, what if that reading had been taken instead with the electrolyte temperature at 90°F? We should expect it to be slightly different. How much different? A correction rule has been made up to help determine the amount of difference.

### Correction rule

For every  $10^{\circ}$  that the electrolyte temperature is above  $80^{\circ}\text{F}$ , ADD .004 to the specific gravity reading.

For every  $10^{\circ}$  that the electrolyte temperature is below  $80^{\circ}\text{F}$ , SUBTRACT .004 from the specific gravity reading. So if we find that a specific gravity reading of 1.280 is taken and the electrolyte temperature is  $90^{\circ}\text{F}$ , we would have to add .004 to the reading to end up with 1.284 (1.280 plus .004). If that same reading had been taken at  $70^{\circ}\text{F}$ , we would have needed to subtract .004 +, end up with 1.276 (1.280 minus .004). Since the correction rule deals with the decimal .004, which is read as "four thousandths," it is often abbreviated by referring to .004 as "4 points." Thus the correction rule can be restated as: for every  $10^{\circ}$  above (or below)  $80^{\circ}\text{F}$  you should add (or subtract) 4 points to the specific gravity reading. A hydrometer correction chart is shown in figure 1-77.

**Example:** A specific gravity reading of 1.296 was taken at  $110^{\circ}\text{F}$ . What is the corrected specific gravity reading?

**Answer:** You should have seen that you were  $30^{\circ}$  above  $80^{\circ}\text{F}$  so that you must ADD 4 points x 3 or 12 points to 1.296 to get 1.308. (1.296 plus .012 equals 1.308).

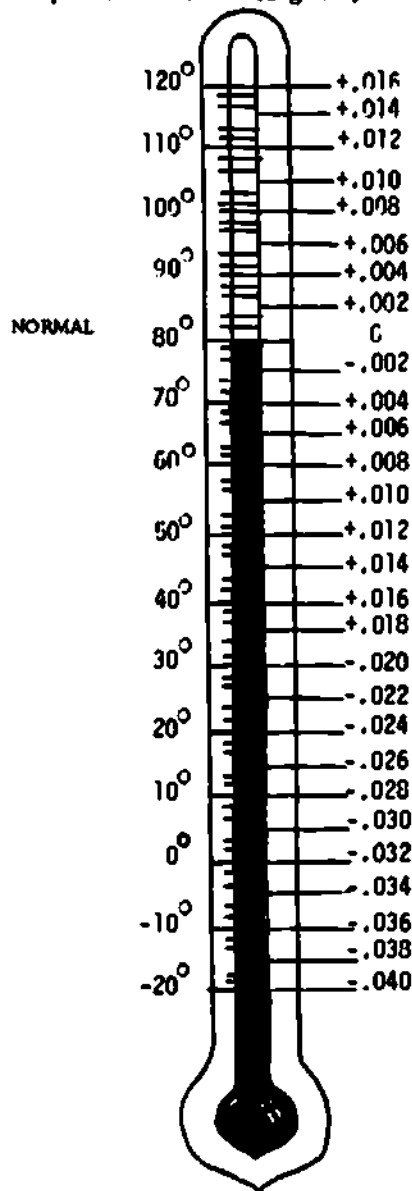

Fig 1-77. Hydrometer correction chart.

(2) Antifreeze and electrolyte tester (fig 1-78).

- (a) Remove vent cap.
- (b) Insert dipstick used for battery testing (fig 1-78) into one cell of the battery (fig 1-79).

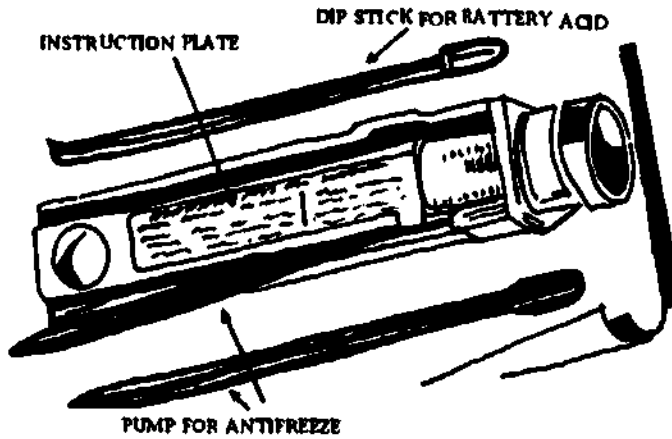

Fig 1-78. Antifreeze and electrolyte tester.

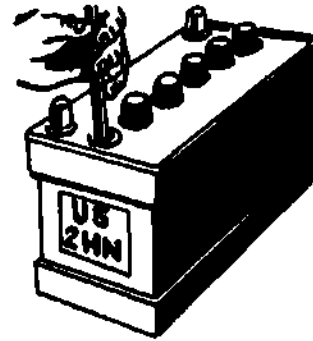

Fig 1-79. Using dipstick to draw sample of electrolyte.

- (c) Place a few drops on the measuring window (fig 1-80).

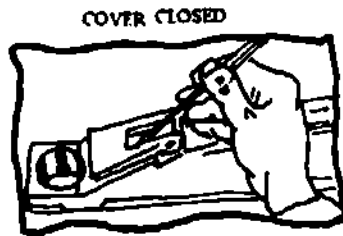

Fig 1-80. Close cover and place electrolyte on the measuring window.

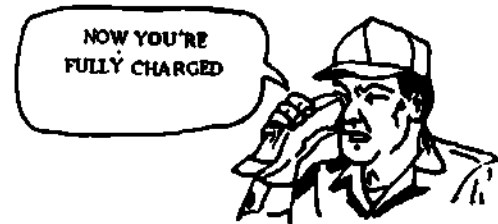

Fig 1-81. Sighting through the eyepiece.

- (d) Sighting through the eyepiece (fig 1-81), you will see the scale (fig 1-82). Take the reading from the point where the light and dark area meet. **NO TEMPERATURE CORRECTION IS NECESSARY.** Remember the left side of the scale is used for batteries and that the four short lines between the numbers are ten thousandths. For example, figure 1-82 shows that the light and dark area meet on the third line up from 1,250. Each line being .010, the reading would be  $1,250 + .030$  ( $.010 \times .030$ ) or 1,280.



b. Mixing sulfuric acid. Never attempt this task if proper SAFETY EQUIPMENT IS NOT AVAILABLE.

- (1) Quantity. Estimate the amount of electrolyte that you will require. Determine what specific gravity is desired for this electrolyte. Table 1-3 has been included for this purpose. Further testing will be necessary to obtain the exact mixture desired. To use the table to estimate the specific gravity, you must use the same number of proportions as shown in the table. For example, if you were mixing sulfuric acid and water to have a specific gravity of 1.290, you must have eight parts of water and three parts of acid. The amount of mixture is determined by the size of the measuring container. For example, if you desired a mixture of 1.290 and used a pint measuring container, you would have 11 pints or 5.5 quarts. If you used a gallon measuring container, you would have 11 gallons of solution.

Table 1-3. Proportions of Sulfuric Acid and Water

Specific gravity	Using 1.835 specific gravity acid	
	Parts/Water	Parts/Acid
Desired		
1.400	3	2
1.345	2	1
1.300	5	2
1.290	8	3
1.275	11	4
1.250	13	4
1.225	11	3
1.200	13	3

- (2) Mixing container. The container must be resistant to extremely high heat and acid. Glass, earthenware, or lead type containers are ideal for this. The container should be of sufficient size so that at least one battery can be filled. It would take approximately 1-1/2 gallons to fill a 2 HN battery.
- (3) Mixing. Fill an acceptable container with the appropriate amount of water. Table 1-3 can be used for an estimate. Then add the acid. NEVER POUR WATER INTO ACID. Acid is always poured into water to prevent splattering which will cause severe burns. As the acid is mixed, it should be stirred gently but thoroughly with a nonmetallic rod and poured slowly. Do not rush the job. This is no time to hurry even though mixing large quantities may take hours for dilution. A specific gravity reading taken frequently will determine when the dilution period is complete.
- (4) Filling. When the dilution period is finished, you are ready to fill the battery. The battery syringe or the gravity flow container works well. Put enough liquid in to make sure each cell is filled and that there is sufficient liquid to cover the plates. When filling, the temperature of the battery and electrolyte must be between 60° and 100°. This can be determined if batteries or electrolyte have been stored at room temperature for any length of time. Under these conditions batteries can be considered in the temperature range for filling. For best results after the battery is filled, it should be fully charged following the procedure contained in paragraph 1-20. If charging is impractical because of time or equipment, the battery could be used as long as one of the conditions below does NOT exist:

- If any cell, with a corrected reading, is below 1,250.
- Specific gravity differences between the cells exceed .040.
- Temperatures are below 0° F.

#### 1-19. CLEANING

- Inspect.** Check for cracks in the battery casing. Check closely around the positive and negative posts for cracks caused by the improper installation of battery clamps. Batteries found with cracks should not be charged and you should report this immediately to your supervisor.
- Clean.** Prior to charging, tighten all caps and clean the battery as shown in figure 1-84.

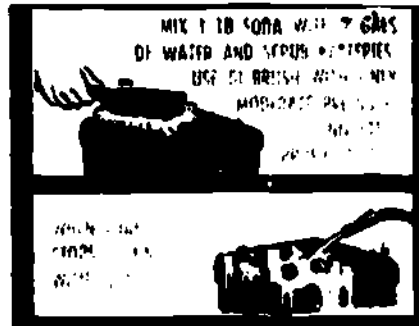

Fig 1-84. Cleaning battery.

If there are cracks in the battery or the caps are not on tight, some of the soda may get into the battery and damage it. This cleaning process should remove any electrolyte which may have built up on the battery posts. If not removed, the electrolyte will build up to such a degree that it will actually carry some current between the posts and cause what is called external discharge to take place. Check the battery caps carefully (fig 1-85), clean them as required, and tighten them back up.

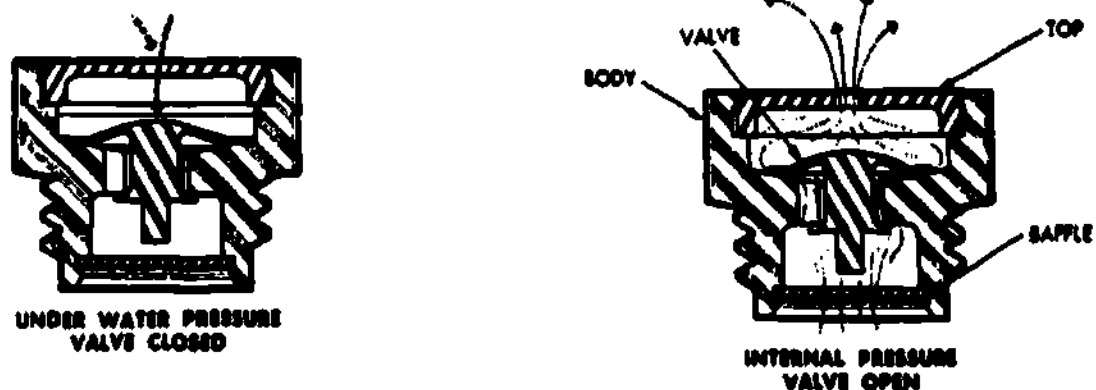

Fig 1-85. Functioning and cleaning of the battery cap.

**Note:** Check the top of vent cap to ensure vent holes are not plugged, so the vent cap valve can operate properly.

- Check level.** Insure that the battery has the correct amount and type of electrolyte in it (fig 1-86).



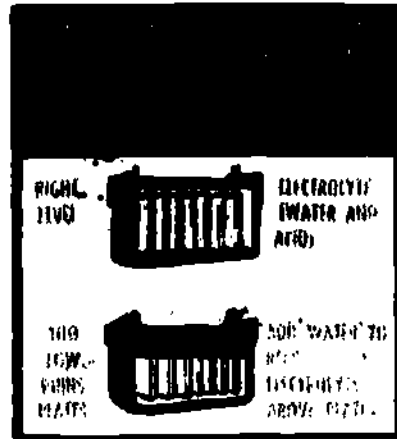

Fig 1-86. Keep battery at proper level.

## 1-20. CHARGING

a. **General.** Batteries may become rundown for one or more reasons. The extended use of the vehicle's lights, an improper mixture of electrolyte, or a faulty electrical system can all cause a battery to be at less than a "full charge." A good battery may be brought back to a "full charge" using what is known as a battery charger. There are many sizes and types of battery chargers. Some can charge a battery faster than others and some have an automatic shut off. While they all basically do the same thing, they can each be expected to have separate operating instructions. Be sure to follow the specific instructions which come with the charger.

b. **Place on charge.** The positive end of the charging cable goes to the positive battery post while the negative end goes to the negative battery post. There are three basic rates used to charge batteries: high rate (fast charge), moderate rate (slow charge), and a trickle charge. Each rate has its good and bad points.

- (1) **High rate.** A battery which needs a charge but is otherwise in sound condition can be brought back to three-fourths of a full charge in less than an hour. Considerable heat will be generated with this method so the length of the charging period and the temperature of the electrolyte should be closely watched. The instructions on the charger will tell you how long to charge the battery and what voltage should be used. It will normally be around 15 volts and just slightly higher if the outside air temperature is under 50°F. The temperature of the electrolyte should be kept below 120°F or it may ruin the battery. While this method provides the quickest charge, it also is the most wearing on the battery.
- (2) **Moderate rate.** This is normally considered to be the best all around method. It may take more time but it is less wearing on the battery. You would normally start a moderate rate charging on a battery at a voltage equal to 10% of the battery's rated ampere-hour capacity and gradually complete the charging at about 5% of the battery's rated ampere-hour capacity. The two most common 12 volt batteries which you will be dealing with are designated 2HN and 6TN and have rated ampere-hour capacities of 45 and 100 respectively. Using the 10% and 5% rule discussed above, we would start the 2HN battery out on a 4.5 volt charge and gradually end up with 2.25 volt charge. What would the start and finish charge voltages be for the 6TN battery? . . . I hope you came up with a starting voltage of 10 and end with 5.
- (3) **Trickle charge.** This is a very slow type of charge which uses low voltage over a long period of time. It is used to charge batteries slowly and it is not uncommon to find several batteries kept in storage to be on a trickle charge so that they are kept ready to use. While the charging process is slow using a trickle charge, checks should be made on the specific gravity of the battery so that it is not overcharged. You should carefully watch the battery during the first few minutes of charging. If the electrolyte begins to bubble excessively (called gassing), you should reduce the charging rate and check it again after a few minutes. Gassing may cause some water to evaporate from the battery, so add water if necessary to keep the electrolyte above the plates. Also check the specific gravity occasionally during charging and as the battery nears full charge, check it at least every hour. A battery which is constantly kept discharged or undercharged or one in which the LEVEL of the electrolyte is ALLOWED TO REMAIN BELOW THE LEVEL OF THE PLATES may become sulfated (fig 1-87). A sulfated battery has a white crystalline formation on the plates which prevents them from working properly. A sulfated battery may be

brought back into serviceable condition by following the procedures stated in the current technical manual on lead-acid storage batteries.

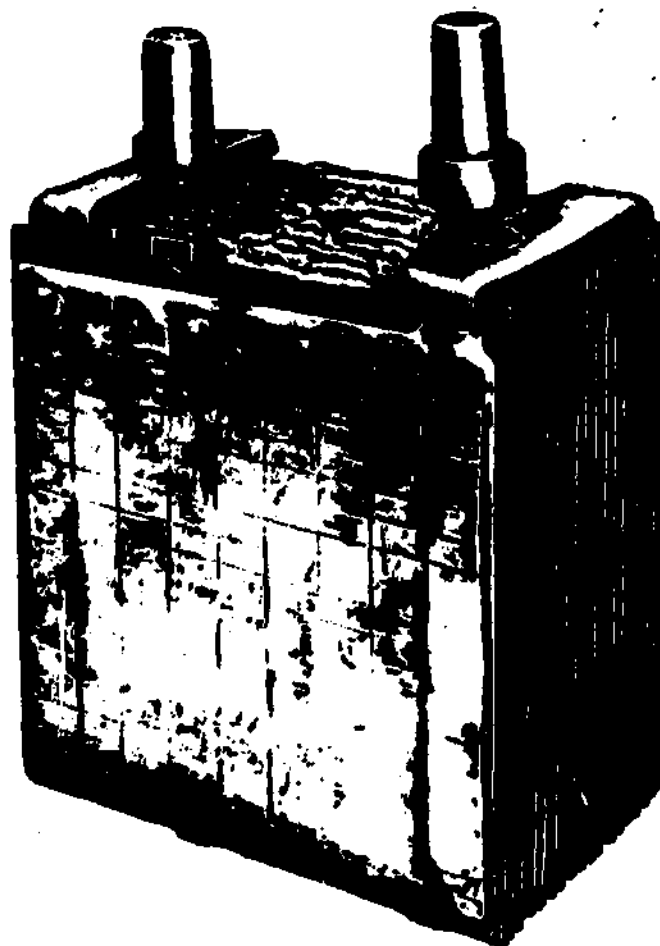

Fig 1-87. Sulfated elements.

#### Section IV. COOLING SYSTEMS

##### 1-21. GENERAL

All internal-combustion engines are designed with some type of cooling system. The tremendous amounts of heat that are generated by the combustion going on in the engine would rapidly damage the engine's working parts if the heat were not somehow carried away. A cooling system removes this excessive heat from the engine. While the lubricants and exhaust in an engine carry away some heat from the engine, it is a small amount compared to the amount which is carried away by the cooling system itself. There are two basic types of cooling systems, liquid-cooled and air-cooled.

##### 1-22. TYPES OF COOLING SYSTEMS

a. Liquid-cooled system. A liquid-cooled system uses a liquid to absorb heat from the engine. After passing through the engine, the liquid passes through the radiator where it is cooled off and sent back to the engine to pick up more heat. A liquid-cooled system will normally consist of a radiator, water pump and fan, thermostat, radiator cap, and various hoses and clamps.

b. Air-cooled system. An air-cooled system relies upon the air circulating around the engine to cool it. To do this efficiently, air-cooled engines are designed so that they allow a maximum

amount of air to come in touch with the engine. The cylinder fins shown in figure 1-88A allow air to circulate around the engine and remove heat. The effect of air channeled around the engine of a moving vehicle may by itself remove enough heat to keep the engine at the proper temperature. A fan may also be used as shown in figure 1-88B to blow air onto the engine. Figure 1-89 shows the process of hot air being carried away from the cylinder.



Fig 1-88. Cylinder fins to carry away heat.

## AIR-COOLED ENGINES

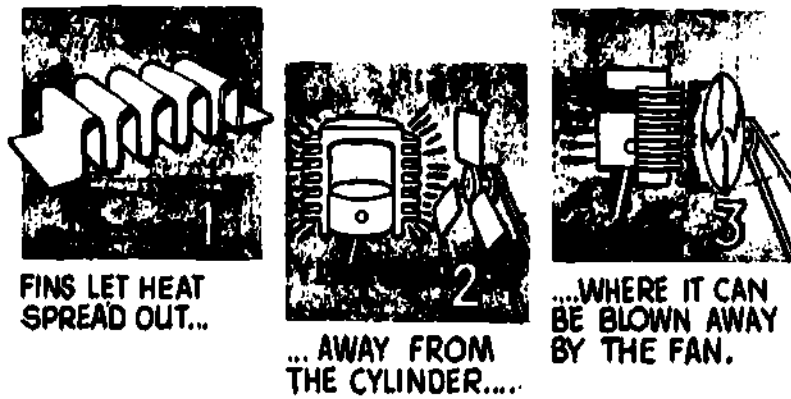

Fig 1-89. How cylinder fins carry away heat.

### 1-23. FUNCTION OF COMPONENTS IN THE LIQUID-COOLED SYSTEM

a. **Radiator.** A rear view of a typical radiator is shown in figure 1-90. Coolant is placed into the system through the filler neck. The coolant goes into the top tank where it slowly filters through the radiator core (a series of thin tubes), where it is cooled by air passing through, to the bottom tank. The coolant is forced from the bottom tank and through the engine. It is then returned through the inlet (top tank). This cycle is repeated over and over.

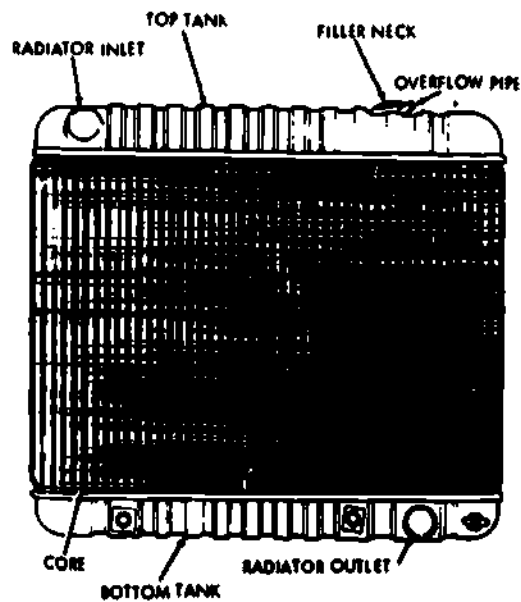

Fig 1-90. Components of the radiator.

b. **Water pump and fan (fig 1-91).** The water pump pumps the coolant through the cooling system. The fan is situated behind the radiator and pulls air through the radiator core. The radiator core channels the coolant into narrow channels where it is exposed to air moving past it (pulled by the fan), thus cooling it off. The fan also provides some direct cooling to the outer part of the engine itself. The fan is partially enclosed by a covering, called a shroud, which directs the flow of air from the fan to provide the most effective cooling (fig 1-92). The water pump, fan, and generator/alternator are normally driven by drive belts which transmit power from the engine to drive these components.

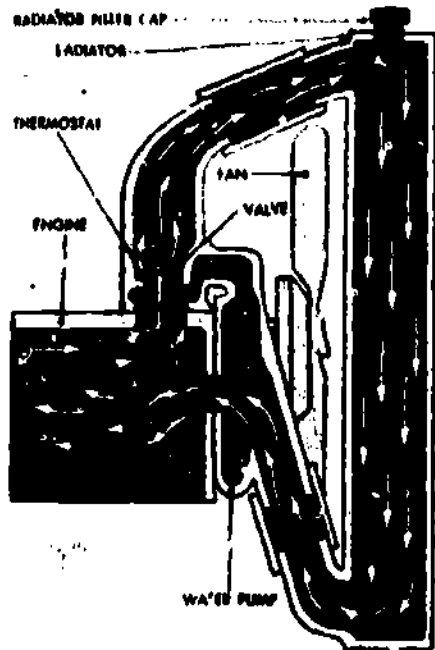

Fig 1-91. Direction of circulation provided by the water pump.



Fig 1-92. Shroud and fan.

c. **Thermostat.** The thermostat controls the amount of heat that is removed from the engine by controlling the circulation of coolant between the engine and the radiator. When an engine is cold, the thermostat prevents the coolant from going into the radiator (fig 1-93). By doing this, the thermostat allows the engine to heat up more quickly. When the engine warms up, the thermostat opens and permits water to flow to the radiator to be cooled off and then return to cool the engine (fig 1-94). The thermostat thus helps control the temperature of the engine which is vital. If an engine operates "colder or hotter" than it is intended to, it is hard on the engine and poor gas mileage can result.

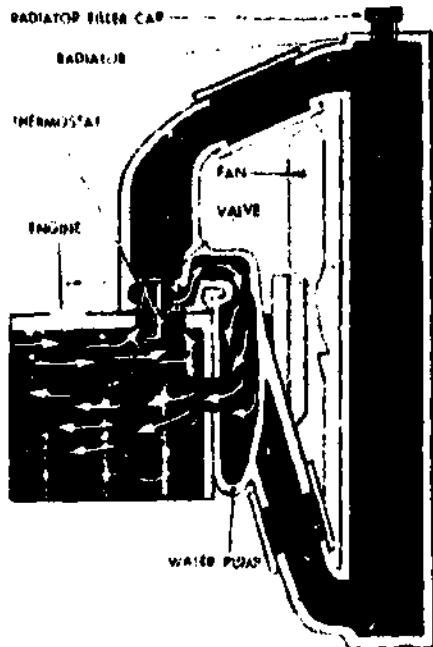
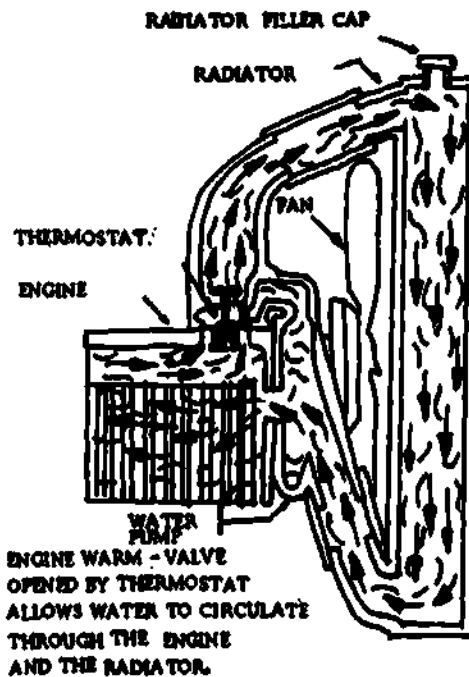

Fig 1-93. Thermostat closed.



ENGINE WARM - VALVE OPENED BY THERMOSTAT ALLOWS WATER TO CIRCULATE THROUGH THE ENGINE AND THE RADIATOR.

OPENED

Fig 1-94. Thermostat open.

d. Radiator cap. A radiator cap covers the filler neck and provides a pressure-tight seal for the cooling system. It was found that as engines heated up, they would actually boil the coolant in the cooling system. The boiling coolant would expand, bubble out, and evaporate out of the radiator. When the engine cooled, there would then be less coolant in the system. Liquids under pressure can be heated to a much higher temperature than those not under pressure without having to worry about boiling. Thus a pressurized cooling system is capable of operating efficiently at much higher temperatures than a nonpressurized system. Should the system become greatly overheated, the radiator cap is designed to lift off slightly and allow some of the pressure and coolant to leave the cooling system through the overflow pipe (fig 1-95). Keep in mind that different radiator caps are designed for different pressures. An alternate means of relieving the excess pressure in the cooling system is through the use of a surge tank (fig 1-96). A surge tank accepts the excess pressure and coolant from the radiator, cools the coolant down, and returns it to the cooling system.

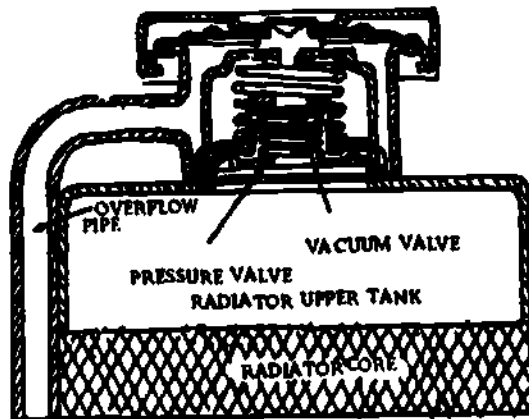

Fig 1-95. Radiator cap.



Fig 1-96. Surge tank.

e. Hoses and clamps. The radiator is connected to the cooling passages in the engine by means of hoses. These hoses carry the coolant under pressure through the system. Clamps are used to insure a pressure-tight fit at connecting points.

#### 1-24. MAINTENANCE

a. General. In performing preventive maintenance to the cooling system, it will become necessary for you to drain, clean, and refill the system. There is a procedure involved for these tasks, which need not necessarily be performed in order, because some depend on the condition of the cooling system. The operator performing these tasks should always be aware of the danger of burns that can be caused from steam or extremely hot water.

##### b. Draining.

- (1) Temperature. Prior to draining the coolant, the temperature of the engine should be well below 200° F.
- (2) Radiator cap. Remove radiator cap. This will allow air into the system so that the coolant can drain freely.



- (3) Draincocks. Location of the draincocks do vary but not to any great extent. There is one located on the bottom or near the bottom (fig 1-97) on the radiator. The second one is located on the block of the engine (fig 1-98). It is this one that may not be located in the same place on all vehicles. So if you have trouble locating it, check the appropriate TM for your specific vehicle.



Fig 1-97. Radiator draincock.



Fig 1-98. Cylinder block draincock.

To open a draincock, it must be screwed into the radiator or block. It is screwed out to shut it off. If a draincock is in the open position and coolant will not flow, take a piece of wire (small diameter welding rod is great) and push it into the hole into the draincock. The drain on the engine block is the one that usually requires this. To tighten the draincock, just turn it clockwise until it is snug. It can break off if overtightened.

c. Cleaning. The cooling system contains, among other things, water and air. These are the things that produce rust. The radiator is affected by rust to the extent that 90% of solid matter that clogs radiators is rust. To clean out the radiator, a cleaner and a neutralizer are used. Do not confuse the cleaner and neutralizer with inhibitor compound which is used to prevent rusting (covered later). The cleaner is put into the radiator to react with all the loose rust particles in the system. Because this cleaner is very strong, a neutralizer is added after the cleaning compound has had a chance to do its job to stop the cleaning action. Neither the cleaning compound nor the neutralizer should ever be mixed with antifreeze or inhibitor compound. The cleaning compound should not be mixed together with the neutralizer and then put into the cooling system. Be careful about spilling the cleaning compound on your skin or painted surfaces. If some does get spilled, you should immediately wash it off with clean water. The cleaning procedure is outlined below:

- With the temperature below 200°F, drain the cooling system.
- Fill system with water to approximately 1/2 inch below base of filler neck. **COLD WATER CAN CRACK ENGINE BLOCK OR HEAD IF THE ENGINE IS TOO HOT.**
- Start engine and run at idle speed until temperature reaches above 180°F but not more than 200°F.

Note: The engine develops very little heat without a load. This may cause the thermostat to remain partially closed, restricting the flow, which will affect the cleaning process. It may be necessary to place a restriction (such as a piece of cardboard) in front of the radiator to raise the temperature. **DO NOT LEAVE YOUR VEHICLE UNATTENDED!**

- Add compound. Remove cap only to relieve pressure, then add compound in the amount specified on the container; replace cap.
- Cleaning time. Allow engine to run between 30 and 60 minutes. Some cleaners may require less time.



- **Drain.** Stop engine. Temperature rise can be expected after shutdown; insure engine temperature is below 200°F. Remove cap and open drains.
- **Fill.** Fill system with water and add neutralizer; allow engine to run the amount of time specified on container. Drain system.
- **Normal flushing.** For normal flushing, the temperature requirements are the same. With the engine running and the drains open, keep a continuous supply of water flooding the system. The flushing process should continue for approximately 25 minutes. At the end of this period, shut off and close the draincocks. Refill to proper level.
- **Inhibitor.** If water instead of antifreeze is used for a coolant, then an inhibitor should be added. This will protect the system from corrosion. It is not a permanent type compound. It does lose strength; therefore, it must be replaced occasionally. Inhibitor is added in proportion to the capacity of the cooling system.
- **Antifreeze.** If antifreeze is to be used, the inhibitor is not needed since most antifreeze has the inhibitor included in the mixture. The rust inhibitor can lose its strength. It should be tested with a test kit made for this purpose (fig 1-99).



Fig 1-99. Test kit.

#### 1-25. DETECTION OF LEAKS

a. **General.** Leaks in a cooling system bring about a loss of coolant which can cause an engine to overheat and possibly be damaged. Leaks can be caused by many things.

- Stresses and strains in joints and connections.
- Engine vibration and road shock.
- Normal deterioration of gaskets and hoses.
- Metal parts that become defective due to wear or corrosion.

b. **Detection tips.** Here are some tips on how to detect leaks in a cooling system:

- (1) **Proper level.** If coolant level drops between the time of the before-operations check and the after-operation check or if the temperature gage reflects a temperature above normal, inspect for leaks. A malfunction of a component could be the cause, but leaks would be the first item to look for.
- (2) **Discoloration.** Inspect for signs of discoloration on the metal parts. The color may be a rusty looking or grayish white stain. This is because of the reaction of the coolant to the metal.
- (3) **Dampness.** Inspect for signs of dampness which indicate a leak. This indicator does not work very well on small leaks, especially if the engine is hot because the coolant evaporates too quickly for easy detection.

1-26. AREAS MOST LIKELY TO LEAK

a. **Radiator.** The radiator is a common area for leaks to appear. Leaks can appear any place on the radiator but have a tendency to appear at the joints of the upper and lower hose connections (fig 1-100). The next area is along the whole length of the top and bottom tanks, usually starting in a corner. The tubes that make up the core may also leak.

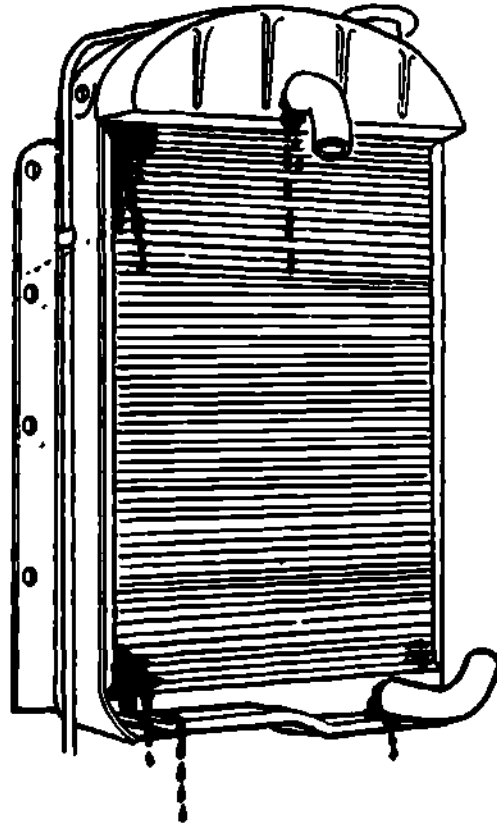

Fig 1-100. Radiator leakage.

b. **Water pump.** Leaks occur on the water pump where the shaft extends out through the water pump (fig 1-101).

c. **Engine block.** Leaks can also develop at the engine block where the freeze plugs have been installed (fig 1-102).

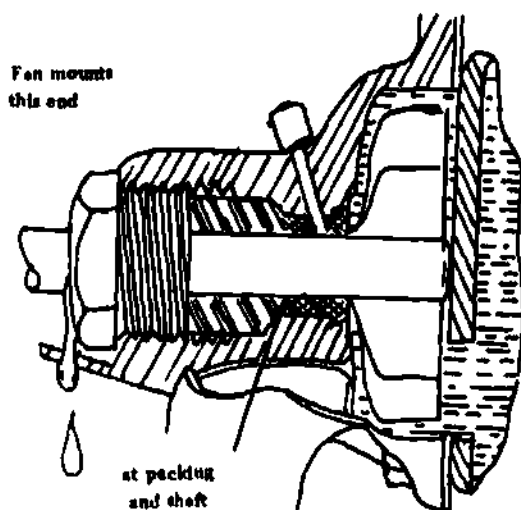

Fig 1-101. Water pump leak.

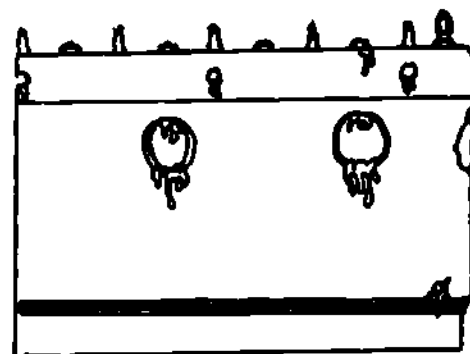

Fig 1-102. Engine blocks leaking at freeze plugs.

d. Hoses and clamps. Hoses deteriorate not only from the outside, but also internally (fig 1-103). Visual inspection alone will not detect a faulty hose. In some cases the hose may have to be removed for inspection. If you have any hose that looks like those in figure 1-104, it should be replaced. Number seven may not need replacing all the time; it may possibly be corrected. Improper positioning and tightening of clamps cause their share of leaks as well as ruining the hose.



Fig 1-103. Internal deterioration of radiator hose.

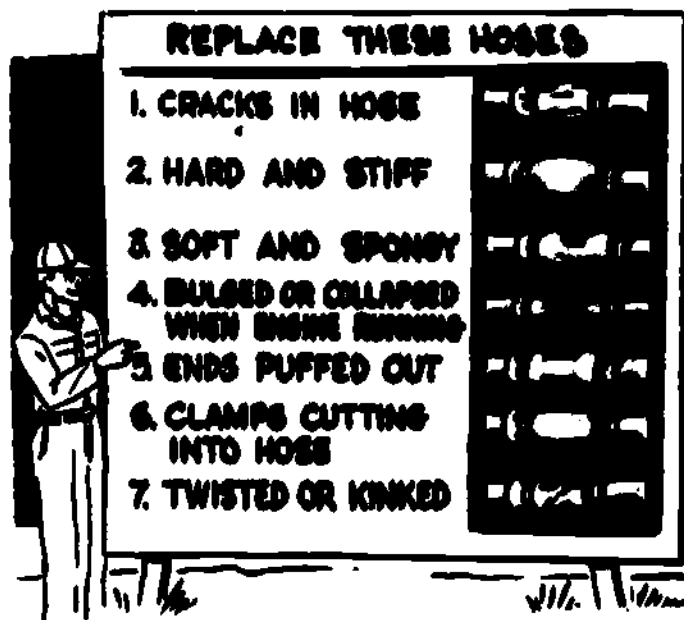

Fig 1-104. Characteristics of faulty hoses.

#### 1-27. PROTECTION AGAINST FREEZING

a. Antifreeze. All vehicles with a liquid-cooled system must be protected against freezing if temperatures of plus 32°F or less are common to that area. Water used alone as a coolant will freeze and expand, possibly cracking the block (fig 1-105).

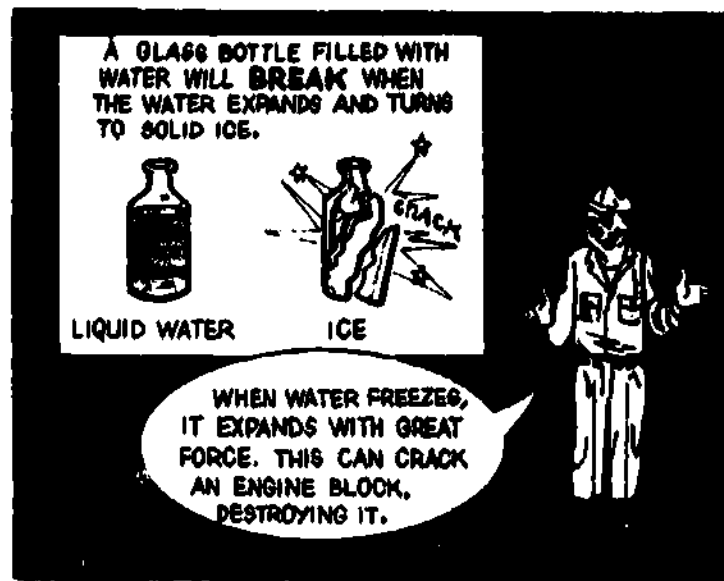

Fig 1-105. Water expands when frozen.

To prevent an engine block from cracking as a result of water freezing in the cooling system, an antifreeze solution is used in cooling systems. An antifreeze solution is simply a solution that will not freeze very easily. A certain amount of antifreeze is added to water to form this solution. The amounts of antifreeze and water to be added will determine the temperature which the solution can take without freezing. You determine what the lowest possible temperature to be expected in your area is and then you mix the antifreeze solution so that it will not freeze down to that temperature. You should not add an antifreeze solution to a dirty cooling system. The antifreeze solution (commonly referred to simply as antifreeze) should be tested frequently and at least during the normal weekly preventive maintenance (PM). Insure that it is giving you freezing protection down to the temperature desired. If the coolant level falls, do not add only water. This will reduce your freezing protection because you are diluting the solution. Add more of the antifreeze solution which has been previously mixed. You may want to suggest that your unit mix up large amounts of antifreeze in a 50-gallon drum with a spigot attached. When operating in temperatures below  $-55^{\circ}\text{F}$ , a specially designed antifreeze is used. This antifreeze must not be mixed with water. It is used in the strength in which is issued. This is called arctic antifreeze.

b. Hydrometer reading. We need to test the antifreeze solution to determine its strength (or protection from freezing). It is quite similar to testing the electrolyte solution in a battery. We use basically two types of hydrometers. One is called an antifreeze syringe hydrometer while the other is called an antifreeze and electrolyte tester and is in fact the exact same tester that was used to test battery strength.

(1) Antifreeze syringe hydrometer. The hydrometer shown in figure 1-106 is a typical antifreeze syringe hydrometer. It contains a long tube with a float with letters on it inside and a separate tube which is a thermometer. To take a reading, you would carry out the following procedures:

- Place the lower rubber tube into the antifreeze solution.
- Squeeze the bulb at the top and slowly release it allowing enough antifreeze to enter the tube to allow the float with letters on it to float freely.
- Record the letter where the level of the water crosses the float. Also record the temperature indicated on the thermometer.
- Take the letter indicated and the temperature recorded and refer to the chart (shown in the insert in figure 1-106) to determine the freezing point of the solution. The solution can be considered as being protected from freezing down to the temperature indicated by the intersection of the thermometer reading and the float scale letter.

Refer to figure 1-106 insert, antifreeze syringe hydrometer.

**Example:** You have just taken a hydrometer reading of some antifreeze and the water level in the hydrometer tube met the float at the letter C. The temperature reading showed  $110^{\circ}\text{F}$ . What is the freezing point of the solution?

**Answer:** You should have read across the chart from  $110^{\circ}\text{F}$  and found where it intersected the column coming down from the letter C. The freezing point of the solution is shown in the block as +18. This means that the system is protected from freezing as long as the temperature is  $19^{\circ}$  above zero. A plus (+) sign indicates above zero and a minus (-) sign indicates below zero.

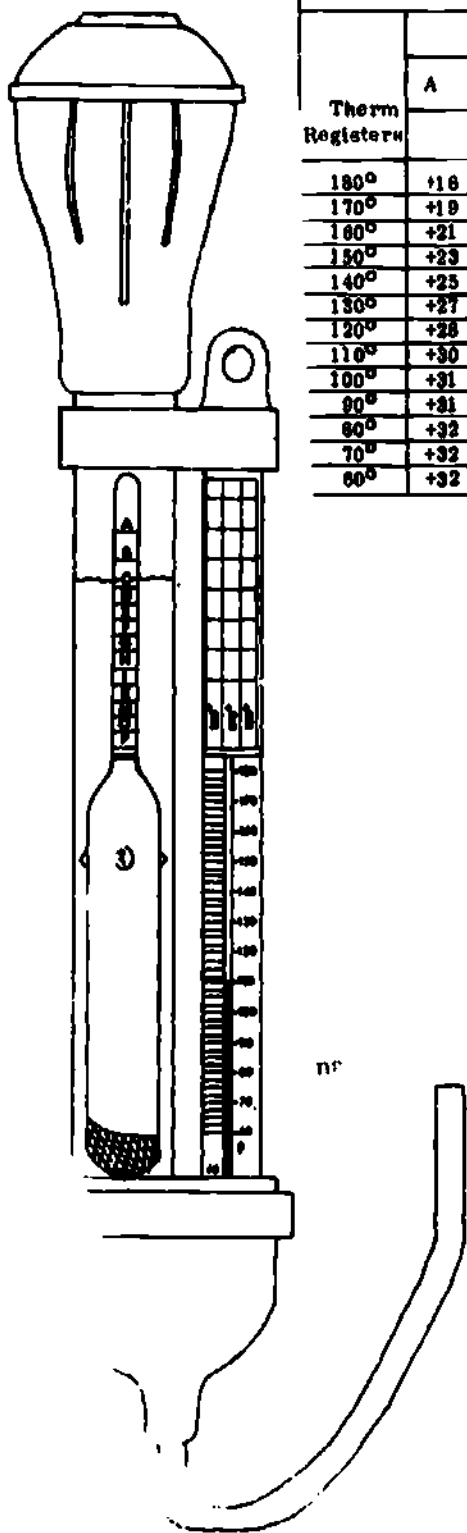

"Prestone" Brand Ethylene Glycol													
Therm Registers	Float Scale Reads												
	A	B	C	D	E	F	G	H	I	K	M	O	P
Freezing Point of Solution													
180°	+18	+8	-2	-9	-16	-26	-37	-50					
170°	+19	+12	+2	-4	-11	-19	-29	-40					
160°	+21	+14	+6	0	-6	-13	-21	-31	-42				
150°	+23	+17	+8	+4	-2	-8	-15	-24	-34	-46			
140°	+25	+19	+11	+7	+2	-4	-11	-16	-26	-37	-50		
130°	+27	+21	+14	+10	+5	0	-6	-13	-20	-29	-40		
120°	+28	+23	+16	+12	+8	+3	-2	-8	-15	-23	-33	-44	
110°	+30	+24	+18	+14	+10	+6	+1	-5	-11	-18	-27	-36	-49
100°	+31	+25	+19	+16	+12	+8	+4	-1	-7	-14	-22	-30	-41
90°	+31	+26	+21	+17	+14	+10	+6	+2	-4	-10	-17	-25	-34
80°	+32	+27	+22	+19	+16	+12	+8	+4	-1	-6	-13	-20	-28
70°	+32	+28	+23	+20	+17	+14	+10	+6	+1	-4	-9	-15	-23
60°	+32	+29	+24	+21	+18	+15	+12	+8	+4	-1	-6	-12	-19

Fig 1-106, Syringe type hydrometer showing the system protected to +19°.

(2) Antifreeze and electrolyte tester. The antifreeze and electrolyte tester is easier to use than the syringe type. Here's all you have to do. Without removing the clear pump from its saddle housing, release the pump tip from its retainer clip. Squeeze the pump bulb and insert pump end (A, fig 1-107) into the radiator so that it is below the level of the liquid. Now release the pump bulb to suck up a sample of the coolant. Bend the pump tube around the tester (this prevents it from draining out) and point the end of the pump tube through the slot on the plastic cover. Place a few drops of the sample on the measuring window (B, fig 1-107). Sight through the eyepiece and point it towards a bright source of light. As you look through the eyepiece, you will see a scale as shown in C, figure 1-107. The reading to use is the point where the light and dark areas meet. When testing antifreeze, the scale on the right must be used. Notice that the scale is upside down from the scale on a standard thermometer. This is no problem; use the plus (+) or minus (-) signs. The protection temperature of the coolant tested in C, figure 1-107 is  $-20^{\circ}\text{F}$ .

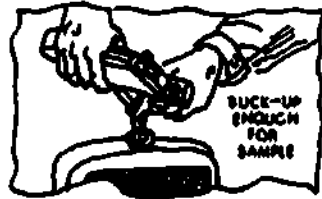

A. Drawing a sample.

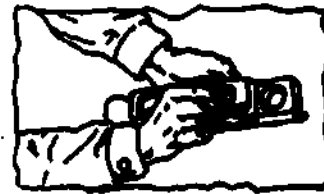

B. Placing sample on measuring window.

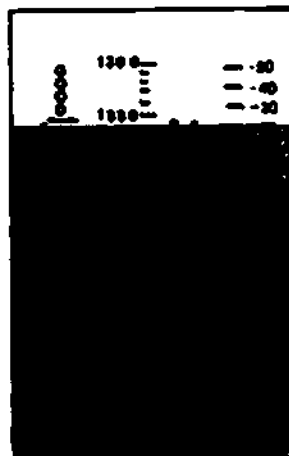

C. Scale as seen sighting through the eyepiece.

Fig 1-107. Taking a hydrometer reading with the antifreeze and electrolyte tester.



**NORMAL CONDITIONS**

**BUT, UNUSUAL CONDITIONS LIKE THESE**

**CALL FOR MORE FREQUENT LUBING, CLEANING AND CARE.**

**SEE YOUR TM FOR THE WORD.**

The advertisement features a dark background with several elements: a document at the top with the heading 'NORMAL CONDITIONS' and a handwritten number '11619-2320-100-12'; a central image of a mechanical component; and four circular inset images at the bottom showing various environmental conditions: a skull, a desert landscape, a snowy mountain, and a rocky terrain.

1-59

65

## Section V. VEHICLE LUBRICATION

### 1-28. PURPOSE OF LUBRICATION

a. General. The main purpose of lubrication is to reduce wear. Metal parts which rub against each other would quickly wear out if they were not lubricated. Lubrication has other important uses depending on the type of lubricant used and the specific area it is used on.

b. Engine lubrication. When used in the engine, a lubricant performs these functions:

- Slows down wear by making the moving parts slippery.
- Cools the engine by carrying the heat away from the hot metal parts.
- Cleans the engine by carrying dirt away to the oil filter.
- Seals in power by filling in the spaces between the piston and cylinder.

c. Lubrication of other moving parts. Lubrication in other areas, for the most part, reduces friction, which in turn reduces wear. Of course, by performing these two functions, the moving parts are able to operate more smoothly. Specific areas which require lubrication are the suspension system, power train, gear cases, hinges, and latches. As a general rule, most areas that have metal to metal contact should have a little lubrication to reduce wear and prolong life.

d. Lubricant as a preservative. Lubricants also make good preservers because they have excellent water repellent characteristics. Lubricants adhere (stick) to most surfaces. Just any type of lubricant does not work on all items. For the best results, the proper lubricant must be determined. A petroleum-base lubricant works well to preserve metal surfaces. For example, grease is applied to winch cables to protect them and give them longer life.

### 1-29. LUBRICATION ORDER

a. General. In order to provide the operator with specific instructions on how to lubricate his vehicle, a lubrication order (LO) is published for each vehicle. This lubrication order (sometimes referred to as a lube order or a lube chart) is normally found with the technical manual (TM) for that specific piece of equipment. A sample lubrication chart is shown in figures 1-106, 1-109, 1-110, and 1-111. A lubrication chart will provide information on the location of lubrication points, lubrication intervals, types of lubricants, etc.

b. Lubrication points. The diagrams included in the lube chart pinpoint the exact location on the vehicle that requires lubrication.

c. Interval. The interval is the maximum allowable period (expressed in time or miles) which is recommended between lubrication. In other words, it tells you how often that specific lubrication is required. The Marine Corps standards are slightly different. Our equipment is lubed every quarter (every 3 months) or 3000 miles whichever comes first. This interval may also vary depending on operating conditions. To determine the interval for a specific point, you read the number off the diagram and refer back to the key provided to find out what that number represents.

d. Type lubricant required. There are various types of lubricants required to meet various lubricant needs. The lube chart will specifically tell you what type of lubricant is to be used at a certain lubrication point.

e. Name of lubrication point and special instructions. The lube chart will give the technical name for the part requiring lubrication and will provide brief, special instructions or possibly refer you back to a more detailed note (fig 1-110) giving specific instructions for lubricating that point.

Let's look at one lubrication point to insure that you have a thorough understanding of how to interpret a lube order. To do this, follow the steps listed below.

- Step 1. Refer to figure 1-108 and the first lube point. It is the front steering gearbox.
- Step 2. The sketch diagram shows the location. At the end of the line it shows the numeral six for interval. Now refer to the key for interpretation of that interval (fig 1-108). It says 6 months or 6000 miles whichever occurs first.
- Step 3. Figure 1-108 states that GO lube is the correct lube to use. Refer to the key (fig 1-109) and looking down the left hand column you will see Front Steering Gear Box. Reading from right to left you can determine the capacity (1 pint) and, depending on what temperatures you will be operating in, a recommended lubricant is given.
- Step 4. The first item at the upper left hand corner of figure 1-108 reads as follows: A-Fig 3-2. Front steering gearbox. This means that a picture of the front steering gearbox fill and level plug can be found as photo A in figure 3-2. We have taken the figures from the lube order and included them in the course. In the process we had to renumber them so that figure 3-2 from the lube order is figure 1-111 in this course. If you will now refer to figure 1-111, you will see a clear picture of exactly which item they are referring to.
- Step 5. If the first lube point had had a "see note" (fig 1-110), then all that we would have to do is refer to that specific note prior to lubing which would give you specific instructions. This is the procedure for reading a lube order, but a few points still have to be made clear. They are:
  - The top of the lube order will designate the vehicle it is for. Insure that you have the correct one.
  - The lube order can have changes; insure that you have any changes that are effective. The lube order may require the taking apart of certain items. Before this is attempted, check with your supervisor. This is normally an organizational mechanic's job.
  - Lubrication is not performed by memory so use the lube order. It has a plastic coating so you can use it right at the job.

# LUBRICATION CHART

TRUCK, CAFPO: 1-1/4 TON, 6X6, M561  
 TRUCK, AMBULANCE: 1-1/4 TON, 6X6, M792

INTERVALS ARE BASED ON NORMAL HOURS OF OPERATIONS. REDUCE TO COMPENSATE FOR ABNORMAL OPERATIONS AND SEVERE CONDITIONS. DURING INACTIVE PERIODS, SUFFICIENT LUBRICATION MUST BE PERFORMED FOR ADEQUATE PRESERVATION.

CLEAN FITTINGS BEFORE LUBRICATING

CLEAN PARTS WITH SOLVENT, DRY-CLEANING, OR WITH OIL. FUEL DIESEL. DRY BEFORE LUBRICATING. DRAIN FROTH CRANKCASE, TRANSMISSION AND CRAP CASES WHILE STILL HOT FROM OPERATION. FILL AND CHECK LEVEL.

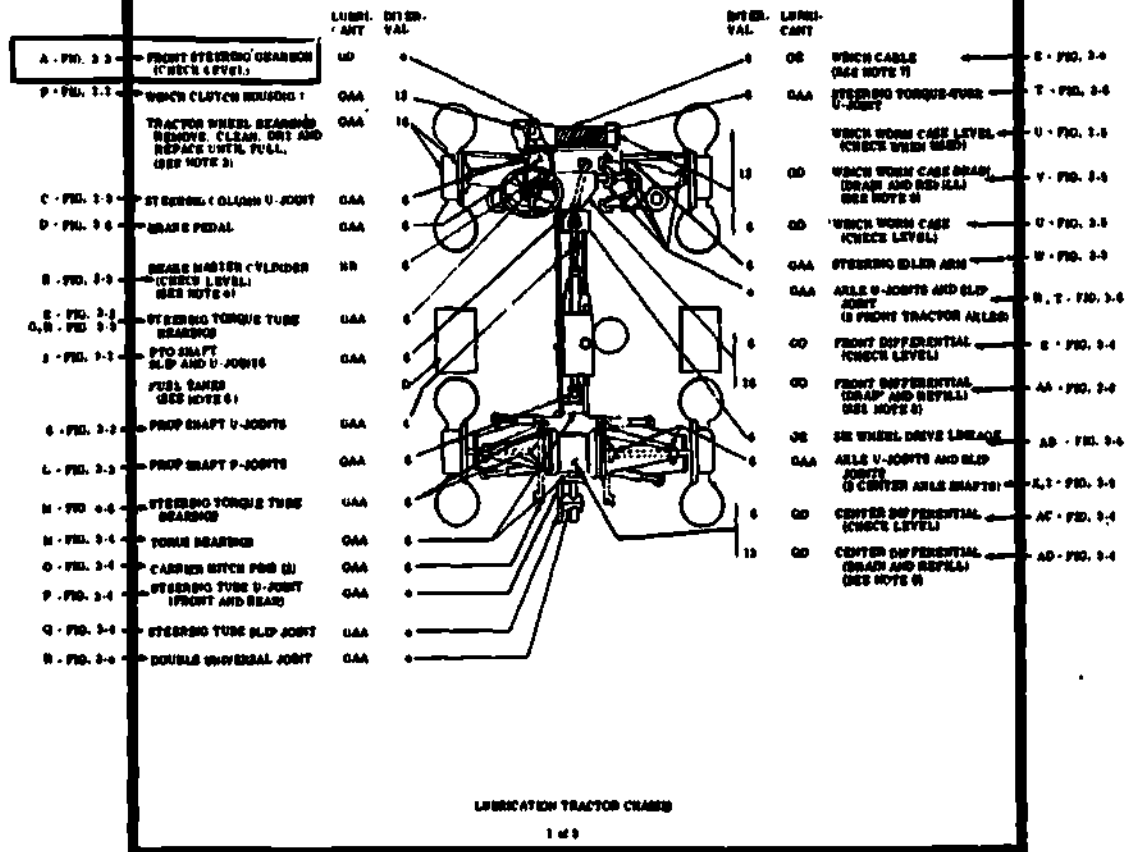

Fig 1-108. Location of plugs and fittings.

**KEY**

FUEL, LUBRICANTS, AND COOLANT	CAPACITY	EXPECTED TEMPERATURES			INTERVALS
		ABOVE +33°F	+40°F to +10°F	5°F to -66°F	
<b>OO - LUBRICANT, Gear, Universal</b>		OO 00	OO 00	OO 00	D - Daily  1 - month or 1,000 miles whichever occurs first  6 - 6 months or 6,000 miles whichever occurs first  12 - 18 months or 12,000 miles whichever occurs first
Front Differential	4 Pints				
Center Differential	12 Pints				
Rear Differential	6 Pints				
Winch Worm Case	4 Pints				
Transfer Case	4.5 Pints				
Transmission	5.5 Pints				
Front Steering Gear Box	1 Pint				
Rear Steering Gear Box	0.5 Pint				
<b>OOB - LUBRICATING OIL, Gear, Sub-zero</b>					
<b>OE - OIL, Engine, Heavy Duty</b>		MIL-L-68199			FOR ARCTIC OPERATIONS REFER TO TM 9-307
Engine Crankcase with Filter Change	8 QTS	Alternate MIL-L-2104 OE-20	OE-10	OE 00	
<b>OE 00 - OIL, Engine, Sub-zero</b>					
<b>OAA - GREASE, Automotive and Artillery</b>			All Temperatures		
<b>HB - FLUID, Hydraulic, Brakes</b>		HB	HB	HBA	
<b>CW - LUBRICANT, Chain, Sprocket Gear and Wire Rope</b>			All Temperatures		
<b>ENGINE COOLANT</b>	10 QTS	MIL-C-A-144	Type 1 OR equal parts of water (to -6°F)		
MIL-C-11766	10 QTS		Below -40°F - Not Diluted		
<b>FUEL - See Note Below</b>	40 GALLONS		(20 GALLONS PER ENGINE)		

**NOTES:**

MILITARY SPECIFICATIONS FOR THE APPLICABLE LUBRICANTS ARE AS FOLLOWS:

LUBRICANT	MIL-SPEC.
OAA	MIL-G-10024
OO	MIL-L-2106
OOB	MIL-L-10024
OE 00	MIL-L-10296
HB	VV-B-800
HBA	MIL-H-12010
OE	MIL-L-2104

**FUEL REQUIREMENTS**

Grade DF3 Fuel (of Spec VV-F-800)  
 Grade DF1 Fuel (of Spec VV-F-800)  
 Grade DFA Fuel (of Spec VV-F-800)  
 Jet (MIL-J-6824)  
 CITE Fuel (MIL-F-68181A)

**TEMPERATURE LIMITS**

- Do not use below 33°F  
 - Do not use below -10°F  
 - All temperatures  
 - All temperatures  
 - All temperatures

Fig 1-109. Lubrication chart key.

**BEST COPY AVAILABLE**

- NOTES -

1. OIL CAN POINTS  
EVERY 6,000 MILES LUBRICATE LAT (HEB, HENUB, SHIPT LUBRAIC (TRANSMISSION TRANSFER) AND THE DOWN SHACKLES WITH OIL. BRAKE AND CLUTCH LUBRAIC
2. LUBRICATE  
LUBRICATE AFTER FORDING OR SWIMMING OPERATIONS.
3. WHEEL BEARINGS  
REMOVE, CLEAN AND REPACK WHEEL BEARINGS AT 12,000 MILES OR 12 MONTHS, WHICHEVER OCCURS FIRST. AFTER FORDING OR SWIMMING OPERATIONS, REMOVE PLUG ON OUTER RIM OF BRAKE DRUMS TO CHECK FOR LEAKAGE OF WATER INTO BRAKE CAVITY. IF PRESENCE OF WATER IS EVIDENT, CLEAN AND REPACK WHEEL BEARINGS.
4. BRAKE MASTER CYLINDER  
(USE HYDRAULIC BRAKE FLUID (HB) NON-PETROLEUM ONLY.
5. FUEL LEVEL  
CHECK LEVEL DAILY ON BOTH TANKS AND ADD FUEL AS PER KEY NOTE.
6. LUBRICATED AT TIME OF DISASSEMBLY  
STARTER, CLUTCH PILOT BEARINGS, SPEEDOMETER, STUD AXLE PNEUMOLIC BUSHINGS.
7. WINCH CABLE AND SNATCH BLOCK  
AFTER EACH OPERATION CLEAN AND OIL WITH OIL. EVERY 6,000 MILES OR SEMIANNUALLY, WHICHEVER OCCURS FIRST, IF CABLE IS NOT GENERALLY USED, UNWIND CABLE, CLEAN WITH OIL, Wipe OFF EXCESS AND COAT CABLE AND WIND DRUM WITH OIL. REWIND CABLE. LUBRICATE SNATCH BLOCK EVERY 6,000 MILES OR SEMIANNUALLY WITH OIL.
8. GEAR CASES  
DRAIN EVERY 12,000 MILES OR ANNUALLY, WHICHEVER OCCURS FIRST. DRAIN ONLY WHEN NOT AFTER OPERATION. FILL TO PLUG LEVELS (EXCEPT TRANS. PER CASE). USE DOWTICKI.
9. TRANSMISSION  
CHECK LEVEL EVERY 6,000 MILES OR SEMIANNUALLY, WHICHEVER OCCURS FIRST. DRAIN EVERY 12,000 MILES OR ANNUALLY, WHICHEVER OCCURS FIRST. DRAIN ONLY WHEN NOT AFTER OPERATION. FILL TO PLUG LEVEL.
10. ENGINE FUEL FILTERS  
DRAIN ONE-HALF CUP OF FUEL FROM EACH FUEL FILTER DAILY BEFORE STARTING ENGINE. IF PRIMARY FILTER CONTAINS LARGE AMOUNTS OF WATER THE ELEMENT SHALL BE REPLACED. IF SECONDARY FILTER CONTAINS EVIDENCE OF WATER, THE ELEMENT SHALL BE REPLACED. REPLACE FILTER ELEMENTS AND GASKETS EVERY 6,000 MILES OR 6 MONTHS, WHICHEVER OCCURS FIRST, OR AT THE DISCRETION OF THE MAINTENANCE OFFICER, AS LOCAL CONDITIONS WARRANT.
11. ENGINE COOLANT  
EVERY 12,000 MILES OR 12 MONTHS WHICHEVER OCCURS FIRST, DRAIN AND FLUSH ENGINE COOLANT SYSTEM. FOR EXPECTED TEMPERATURES ABOVE -40 F, FILL WITH MIL-D-155 EQUAL PARTS WITH WATER FOR EXPECTED TEMPERATURES BELOW -40 F, FILL WITH MIL-C-11793 (UNDILUTED).
12. ENGINE CRANKCASE  
DRAIN EVERY 6,000 MILES OR AT DISCRETION OF MAINTENANCE OFFICER, AS LOCAL CONDITIONS WARRANT. FILL WITH 6 QUARTS OF OIL. RUN ENGINE SEVERAL MINUTES AND RECHECK OIL LEVEL. TO CHECK OIL LEVEL, STOP ENGINE AND WAIT AT LEAST ONE MINUTE TO ALLOW OIL TO DRAIN INTO CRANKCASE. OIL OPERATING RANGE BETWEEN "ADD" and "FULL". DO NOT OVERFILL.
13. AIR CLEANER - (PART TYPE)  
REPLACE AIR CLEANER FILTER ELEMENT EVERY 1,000 MILES. CLEAN OR REPLACE FILTER ELEMENT WHEN AIR RESTRICTOR INDICATOR SHOWS RED. FOR DESERT OR EXTREMELY DUSTY OPERATION, CLEAN OR REPLACE AIR FILTER ELEMENT AS OFTEN AS REQUIRED.
14. ENGINE OIL FILTER  
EVERY 6,000 MILES OR 6 MONTHS WHICHEVER OCCURS FIRST WHILE CRANKING IS BEING DRAINED REMOVE FILTER DRAIN PLUG AND ELEMENTS, CLEAN INSIDE OF CASE, INSTALL DRAIN PLUG, NEW ELEMENTS AND GASKETS.
15. ENGINE GOVERNOR SHAFT  
LUBRICATE LIGHTLY WITH OIL. AVOID EXCESSIVE LUBRICATION.
16. WHEEL SPINDLE  
APPLY UNTIL OIL COMES OUT BETWEEN HUB AND SPINDLE.
17. DO NOT LUBRICATE:  
CLUTCH RELEASE BEARING, BALL JOINTS, SUSPENSION ARM BUSHINGS OR SHOCK ABSORBER BUSHINGS.
18. MAINTENANCE CHECKS AFTER FORDING OR SWIMMING  
CHECK FOR WATER CONTAMINATION AFTER SWIMMING OR FORDING (BRAKE DRUM, DIFFERENTIALS AND STEERING GEAR BOXES).
19. TEMPERATURE RISES  
IF AMBIENT TEMPERATURE RISES TO +10 F FOR NO MORE THAN ONE WEEK, USE OF OIL IS PERMISSIBLE. IF AMBIENT TEMPERATURE RISES TO -50 F FOR NO MORE THAN ONE WEEK, USE OF OIL IS PERMISSIBLE.

Fig 1-110. Lubrication instructions.

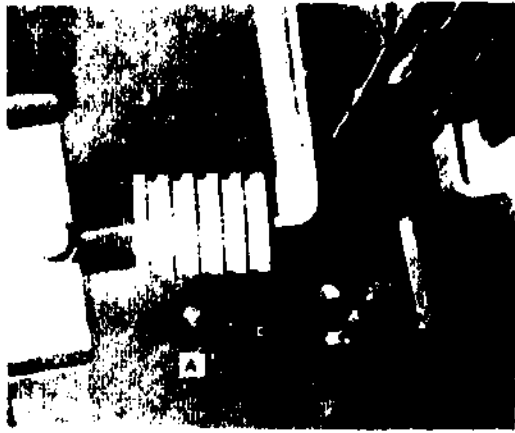

A. FRONT STEERING GEAR BOX FILL AND LEVEL

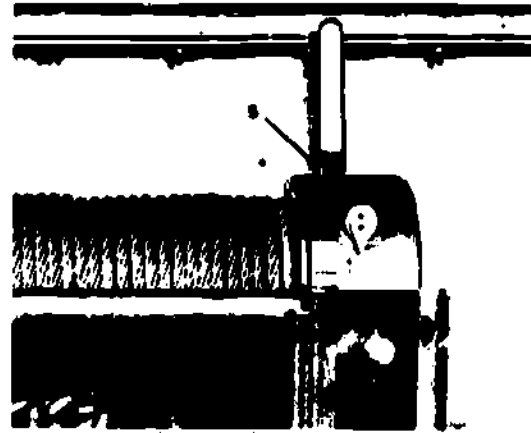

B. WINCH CLUTCH HOUSING FILL PLUG

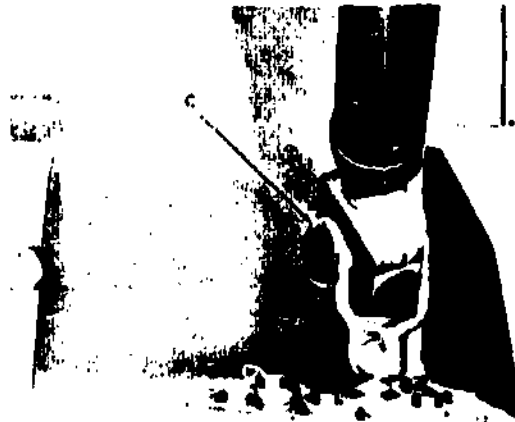

C. STEERING COLUMN UNIVERSAL JOINT

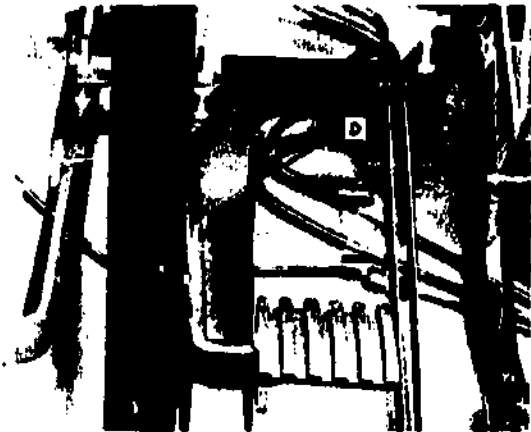

D. BRAKE PEDAL

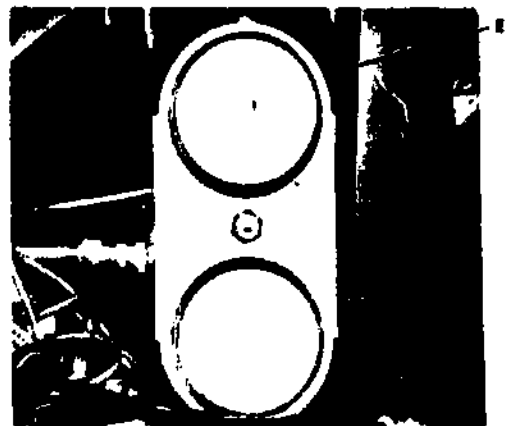

E. BRAKE MASTER CYLINDER FILL AND LEVEL

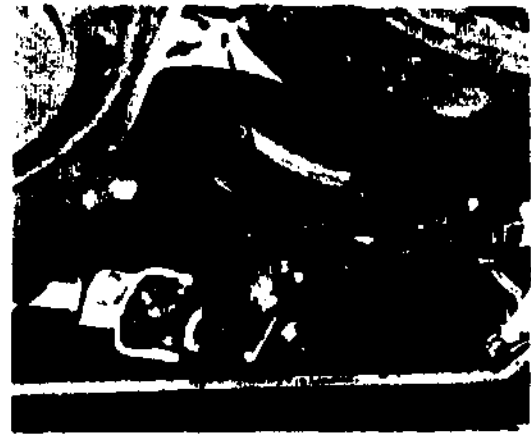

F. STEERING TORQUE TUBE BEARING

Fig 1-111. Localized lubrication points A thru F.

1-65



## 1-30. GREASE FITTINGS

a. **General.** Certain places on a vehicle require grease to be placed inside a small enclosure where it will provide constant lubrication to the moving parts. This enclosure is sealed off to prevent the grease from escaping and to keep out dirt, dust, water, and salt which could interfere with the proper movement of the parts. A grease fitting is placed into this enclosure to allow grease to be forced into the enclosure, but it also acts to seal off the enclosure to help prevent the loss of grease. There are various types and shapes of fittings for use in different types of places requiring grease. They are made in different shapes so that they can be easily reached when it is time to put grease into them (fig 1-112).

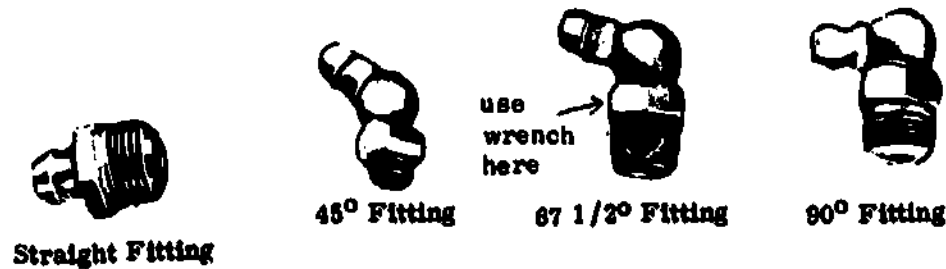

Fig 1-112. Grease fittings.

b. **replacing.** There are times when you may want to replace or change a fitting. It may be missing, bent, or broken. It might be plugged up, which can be checked by removing the fitting, attaching it to the grease gun and applying grease to it. If grease comes through, the fitting is not plugged. Finally, you may want to put a fitting in with a different angle to make it easier for you to position the grease gun on it. To replace a fitting, you should use a wrench of the proper size and simply unscrew the fitting like you would loosen a nut. Use the wrench on the portion of the fitting which has the flat sides. The new fitting can then be screwed right back in. A fitting tool (fig 1-113) is a handy tool that performs four different functions that may be necessary when working with grease fittings.



Fig 1-113. Lubrication fitting tool.

**Wrench end.** This is used just like a wrench to remove a fitting (fig 1-114).



Fig 1-114. Wrench end.

**Remover end.** This is used to try to screw out a broken fitting (fig 1-115).



Fig 1-115. Remover end.

**Die end.** This is used to straighten out the threads on the grease fitting (fig 1-116).



Fig 1-116. Die end.

**Tap end.** This is used to straighten out the threads at the point where the fitting was removed (fig 1-117).

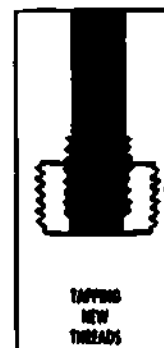

Fig 1-117. Tap end.

c. **Grease gun operation.** Grease is forced into the fitting using what is called a grease gun. There are air-operated and hand-type guns. Before putting grease into the fitting, clean off the tip of the fitting so you do not force any dirt into the fitting. The tip of the grease gun (either air or hand pressure) should be held tight and straight onto the fitting as shown in figure 1-118 until after you have stopped applying pressure.



Fig 1-118. Placing the tip of the grease gun on the fitting.

Do keep a rag handy in order to wipe up any grease that drips. When you are finished, take the gun off the fitting at a slight angle, not straight back (fig 1-119). That's because the jaws in the tip of the gun take a tight grip on the fitting when the gun is straight on.



Fig 1-119. Removing the tip of the grease gun from the fitting.

If you discover that the grease is not going into the fitting, you should make a few quick checks. The coupler jaw in the tip of the grease gun may be worn (fig 1-120). If the jaws are worn, they will not properly hold on to the tip of the grease fitting. On some grease guns you can unscrew the tip and turn the jaws around. On others you may need to replace the entire tip. Another reason for the grease not being able to go into the fitting might be that the fitting is clogged. Clean it off with a cloth and try to unclog the hole at the tip of the fitting with a small diameter piece of wire. One more reason might simply be that the areas that the grease would go between are very tight. You may be able to loosen the joint or that fitting enough to allow the grease to enter by shaking or moving it back and forth. In figure 1-121 a spring shackle bar is being used to shake the spring leaves in the hope that it will loosen up the joint enough to allow some grease in.



Fig 1-120. Grease leaking between fitting and gun could be caused by worn coupler jaws.

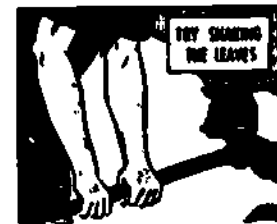
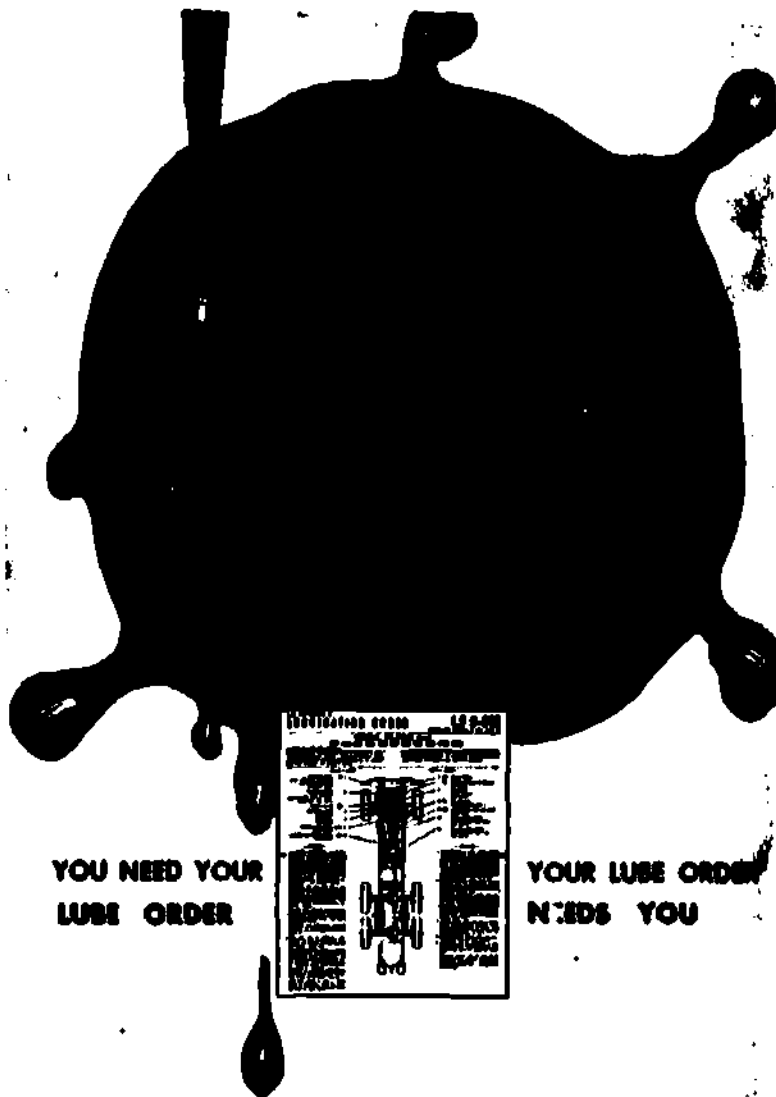

Fig 1-121. Some components may need a little shaking.



**YOU NEED YOUR  
LUBE ORDER**

**YOUR LUBE ORDER  
NEEDS YOU**

1-60

**BEST COPY AVAILABLE**

75

### 1-31. OILCAN MAINTENANCE

Oilcan maintenance is a type of lubrication which is done with an oilcan. It is simple to do but quite important to a long life for your vehicle. Do not squirt oil all over the place though, because it will deteriorate rubber, rot canvas, and cause dirt to collect. A wipe rag should be carried to wipe off any excess oil that may drip. Following is a list of some of the items which require oilcan maintenance.

- Controls such as the choke, throttle, and fording controls should be oiled by pulling them out and applying oil to the part that slides back in.
- Hinges should have some oil worked into them by moving the door or compartment while the oil is being placed on the hinge.
- The accelerator linkage can use a drop or two of oil at the points of contact.
- Moving parts on a seat need oil (a seat that slides back and forth could have a light coat of grease on the rails).
- Most hand brakes will have a small hole in the top end of the handle for a drop or two of oil to be added so that the adjusting knob will work freely.

Generally speaking, oil and other lubricants will keep parts moving freely, help prevent rusting, and reduce wear. A sloppy job of applying oil could cause problems because dirt and dust will collect on that area much faster than other places. You can probably spot many places where rust can be prevented by applying a light coat of oil. But remember to keep oil away from drive belts, canvas, rubber components, and electrical wiring and components.

### 1-32. WINCH

a. General. Vehicles equipped with a winch will require additional lubrication. Before attempting to lubricate the winch, study your lube order. The winch we will discuss can be found on Gamma Goat M-561. The first thing that you should do is to check the level of the lube present in the winch.

b. Checking lubrication level in winch housing. Figure 1-122 shows the right side of the winch, as if you were sitting in the vehicle. This side contains the winch worm gear. This side uses a GO type lubricant. To check the lubricant level in the winch worm case, perform these steps:

- Remove the plug at point B. If oil seeps out, it is at the proper level. If oil does not seep out, it is low. If oil is to be added, leave plug B out.
- To fill, remove the combination vent and fill plug (A, fig 1-122) and add the proper lubricant until it starts to seep out at the plug B opening. Then replace both plugs.

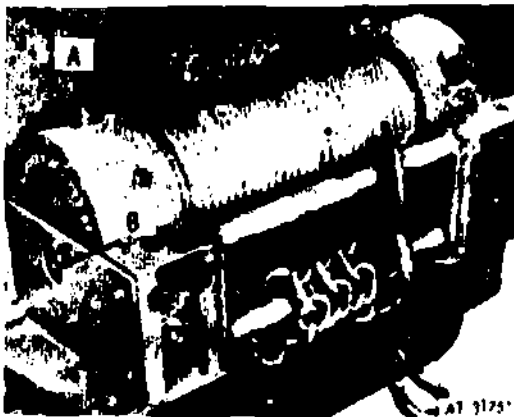

Fig 1-122. Winch worm case, points A + B.

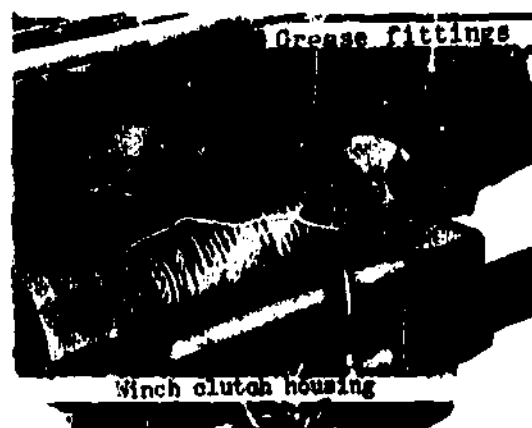

Fig 1-123. Winch clutch housing and fittings.

The winch clutch (fig 1-123) located on the left side of the winch is equipped with grease fittings which use a GAA type lube. Most winches, transfers, differentials, and transmissions (except for automatic) do not have dipstick type gages. Correct level is determined by removing the correct fill plug. If lubricant seeps out, it is considered at the proper level.

c. **Lubricating the winch cable.** The winch cable itself must also be lubricated. Find an area where you will be able to run out the cable and not be disturbed. Attach one end of the cable to a stationary object or a vehicle of at least equal weight as the one which has the cable on it. If a vehicle is used, the wheels should be chocked. (Chocking means placing wooden blocks or bricks in front/or rear of the tires to prevent the vehicle from rolling.) Slowly unwind the cable down to the last winding on the drum. Clean the cable using rags and a lubricant (designated OE). Be sure to wear gloves while doing this (fig 1-124).



Fig 1-124. Cable handling requires gloves.

Clean cable should be lubricated by coating it with a lubricant (designated CW). You may find it easier to clean, lubricate, and rewind thirty or forty feet of cable at a time rather than the entire length of cable. The cable should be rewound on the drum in even layers. The driver of the vehicle containing the winch can control the direction of the winding by turning his wheels in one direction or another as the cable is wound in. To be able to do this winding with any real degree of accuracy, the driver should have someone standing near the winch giving him specific turning directions.

### 1-33. INSPECTING DURING LUBRICATION

You may not realize it but when you are lubricating a vehicle you have an ideal opportunity to look it over carefully. Look at these advantages:

- The vehicle is fully exposed underneath by being on a lift, a ramp, or a pit. You can very simply and easily check out the entire underbody. If you discover that repairs are needed, you can start right in on them.
- The vehicle is probably not committed because it is having a lubrication job done and you would have the time to correct any deficiencies found.
- The necessary tools, equipment, and technical advice should be readily available at the lube site.
- The last advantage is probably the most important. By taking a few minutes to check over the vehicle you have demonstrated a true concern for your vehicle and you have taken positive action to discover a problem or a potential problem in your vehicle. The early detection of a problem makes a tremendous difference in the cost and effort required to make the necessary repairs. You may not appreciate how good a time this is to

**inspect your vehicle until you find yourself on the side of the road in the middle of nowhere, without any tools, trying to figure out what the clanging noise is under your vehicle. Detailed tips on what to look for can be found in chapter 2 under Weekly Maintenance.**

1-72

78



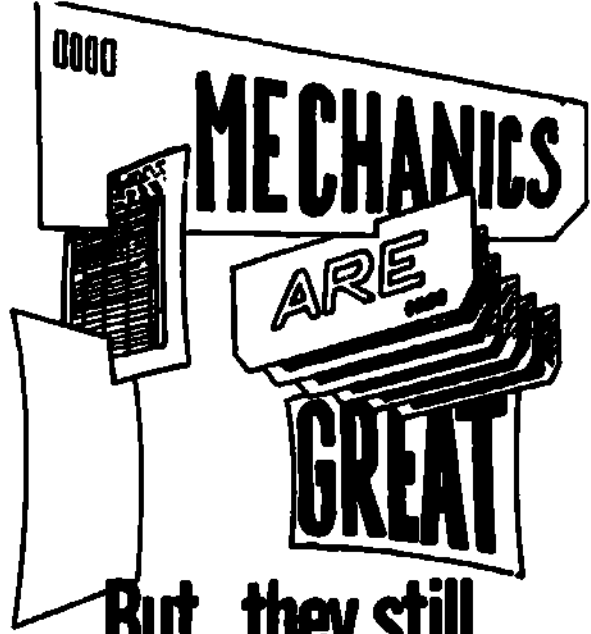

But...they still  
**NEED YOU**



## Chapter 2

### DRIVER'S PREVENTIVE MAINTENANCE

#### Section I. DAILY MAINTENANCE

##### 2-1. INTRODUCTION

General guidelines for performing of daily maintenance checks on a vehicle are provided on a NAVMC 10627. The NAVMC form 10627, normally referred to as the trip ticket, is issued by the dispatcher. The trip ticket provides a licensed operator the authority to operate the vehicle. In addition to providing a listing of daily maintenance, it can also serve as a weekly preventive maintenance checklist although individual units may have a weekly form that is more detailed.

##### 2-2. GUIDELINES FOR USING/COMPLETING TRIP TICKET CHECKLISTS

When the trip ticket is received from the dispatcher, it will have the information in the blocks as shown in figure 2-1. The operator is then responsible for filling in additional information. He should fill in the areas that are indicated with an asterisk (\*). He is also responsible for the middle portion but it will not be covered at this time. The bottom portion of the trip ticket (fig 2-1) contains guidelines for the daily maintenance checks. There are three basic types of checks to perform, which are (1) BEFORE OPERATION, (2) DURING OPERATION, and (3) AFTER OPERATION. To enable the operator to show if the item checked is all right or is defective, there are two symbols used. These symbols look like this (✓) and (X). A (✓) indicates that the item is OK. An (X) indicates that the item is defective. An explanation of these symbols can be found on the left hand side of the bottom portion of figure 2-1 beside the word legend. In using the symbols to indicate your findings of the item checked, it works this way. A (✓) as stated means OK and that is all that is necessary. If an (X) is used which indicates that the item is defective, you must explain the defect. For your explanation, space is provided on the lower portion of the back side of the trip ticket under the title of REMARKS (fig 2-2). Remarks should be stated in a specific manner to enable the supervisor to use your information to correct the discrepancy. For example, if an (X) were placed in the block for DAMAGE, PILFERAGE, then an explanation such as that shown in the remarks section must be made (fig 2-2). Statements in the remarks section such as leaking throughout and dents throughout are not specific and provide little useful information. Common sense must also be exercised when performing the daily checks. For example, if the brakes are found to be defective on the vehicles and an (X) is placed under safety devices with an explanation entered in the remarks section, you must report this type of defect to your supervisor. Simply because you have it noted on the trip ticket does not relieve you of the responsibility of operating an unsafe vehicle. Another instance could be the tires. If your inspection turns up a flat tire, simply indicating a defect does not relieve you of the responsibility. In both instances the defect must be corrected prior to using the vehicle. We, as operators, have the responsibility of keeping the vehicle in its best operating condition. To assist in this, it is important that the operator evaluate and record the condition and performance of the vehicle. We should consider the trip ticket as a very important maintenance tool used by the operator to alert his supervisor to items requiring attention. The bottom portion of the trip ticket is kept until all discrepancies can be checked out further and corrected. In some cases the vehicle may have to be scheduled for maintenance to correct the discrepancies.

If we, as operators, expect improvement in the maintenance condition of our vehicle, then we must provide first hand information. The best means possible for this is at your fingertips and it is called a trip ticket. Let us now discuss the different operation checks and some of the items to look for.

**VEHICLE AND EQUIPMENT OPERATIONAL RECORD  
(ADMINISTRATIVE AND TACTICAL MOTOR VEHICLES)**

DATE <b>14 MAY 1972</b>	TYPE <b>MILSIA1</b>	REGISTRATION NO. <b>334789</b>	ADMINISTRATION NO. <b>4</b>
DISPATCHING ORGANIZATION <b>HSS Co, 3d TANK BN</b>		ACTION	MILES
1ST OPERATOR <b>CPL John DAE</b>		IN	
OPERATOR'S SIGNATURE		OUT <b>0730*</b>	
2ND OPERATOR		TOTAL	
OPERATOR'S SIGNATURE		IN	
3RD OPERATOR		OUT	
OPERATOR'S SIGNATURE		TOTAL	

DESTINATION	TIME		ARRIVAL RELEASE	CARGO CODE OR WEIGHT	NO. PASSENGERS	* CARGO LOAD UNUSUAL TONS	* WAITING TIME	* STANDBY TIME	USER SIGNATURE
	ARRIVE	DEPART							
FROM									
TO									
TO									

DATE <b>14 MAY 1972</b>	TYPE <b>MILSIA1</b>	REGISTRATION NO. <b>334789</b>	ADMINISTRATION NO. <b>4</b>		
1. BEFORE OPERATION		2. DURING OPERATION		3. AFTER OPERATION	
OPERATOR		OPERATOR		OPERATOR	
1st 2d 3d		1st 2d 3d		1st 2d 3d	
DAMAGE, FILTERAGE		INSTRUMENT BRAKES		LIGHTS AND REFLECTORS	
LEAKS, GENERAL		DRUMS		SAFETY DEVICES	
FUEL, OIL, WATER		CLUTCH		BRAKES	
ENGINE, WARMUP		STEERING		AIR TANKS (Drain)	
INSTRUMENTS		ENGINE OPERATION		FUEL, OIL, WATER (In/Out)	
SAFETY DEVICES		UNUSUAL NOISES		* DRIVE BELTS	
TOOLS AND EQUIPMENT				* BATTERY LEVEL	
				* ANTI-FREEZE	
				* TIRES DAMAGE (GAGE)	
				* CLEAN (AS REQUIRED)	

LEGEND: -/OK      X-DEFECTIVE      \* WEEKLY SERVICE

NAVMC 10827 (REV. 8-70) (PREVIOUS EDITION WILL BE USED.)

Fig 2-1. Trip ticket (front side).

24							
23							
22							
21							
20							
19							
18							
17							
<b>TOTALS</b>							
PRIME SHIFT *	TOTAL HOURS ON DISPATCH *		TOTAL IDLE TIME *		TOTAL PRODUCTIVE TIME *		
1ST OPERATOR	2ND OPERATOR						
3RD OPERATOR							

NOTE: Signature of the dispatcher, operator, and user indicates that vehicle was dispatched and used for Official Government Business ONLY. Operator's signature also indicates that daily before and after operation preventive maintenance service was accomplished.  
\* Not applicable to operators of tactical vehicles.

REMARKS  
1. Left front fender dented near Blackout Drive. J.D.

Fig 2-2. Trip ticket (back side).



**2-3. BEFORE-OPERATION CHECKS**

a. General. The before-operation checks serve the purpose of determining the condition of the vehicle. Something may have happened to it even there in the motor pool since it was last driven. There may be a tendency on your part to let the checks slide, saying to yourself, "I just drove the vehicle yesterday and it was fine when I left it." You should guard against this feeling and perform the checks as though your life depended on them (it very well could). Shown at the right is the block of the trip ticket containing the before-operation checks. The material below will give detailed examples to guide you in making the checks.

I. BEFORE OPERATION	OPERATOR	
	1ST	2ND
DAMAGE, PILFERAGE		
TIRES, GENERAL		
FUEL, OIL, WATER		
ENGINE, WARM-UP		
INSTRUMENTS		
SAFETY DEVICES		
TOOLS AND EQUIPMENT		

b. Damage, pilferage. Sixteen points have been shown in the following figures as general guidelines for checking your vehicle for pilferage (stolen parts) or damage. You may know of several other items which you may want to check.

**Lights Front and Rear**

- (11) Lights broken, cracked, moisture on inside lens, lens painted over, bent out of alignment, wires loose, frayed

- (1) Canvas torn/holes, snaps, tie-down straps or line loose/missing

- (12) Windshield cracked, discolored, severe scratches caused by missing wiper blade, weatherstripping torn/missing hinges cracked bolts loose/missing

- (10) Lifting fixtures stuck/bent or safety pin missing

- (9) Inspect for obstruction in front of radiator

- (8) Serial number faded/unable to read, hood latches missing/broken

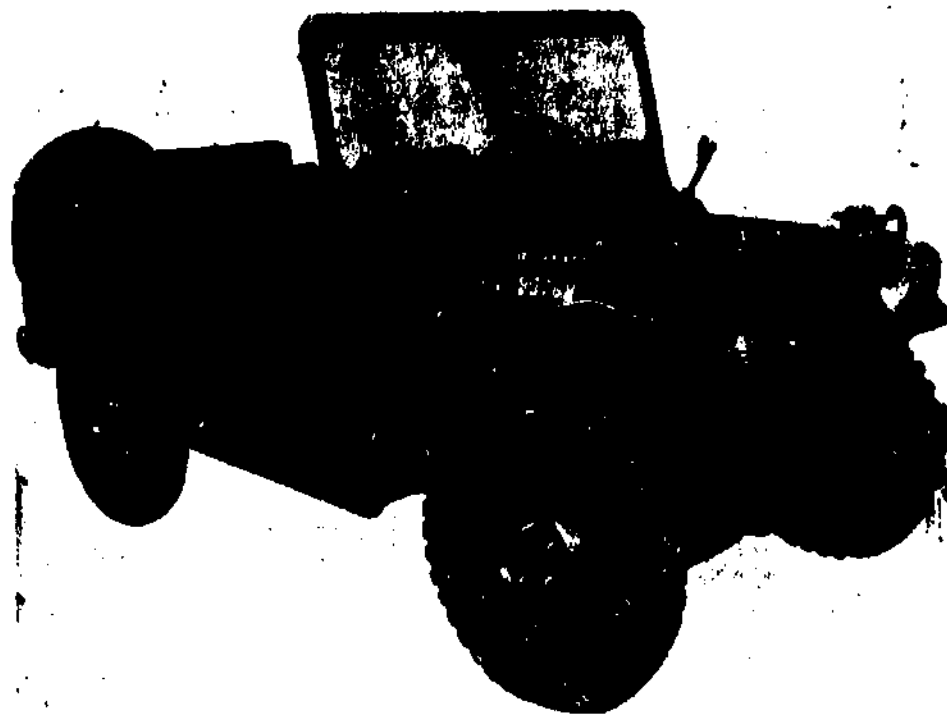

- (2) Reflectors painted over, cracked, incorrect color, bolts loose/missing

- (3) Canvas rods bent, chains and retaining pins missing, rivets missing

- (7) Fuel filler strainer clean, no holes, missing gasket on cap, cap chain missing, not attached; also support brackets are tight and tank not dented

- (4) Walk around inspection, look for dents, bent bumpers, corrosion/rusted through areas

- (5) Mirror broken, clouded, bracket not adjustable

- (6) Inspect (all wheels) for bent/cracked rims, loose/missing wheel lugs, cut/unevenly worn tires, lubrication/brake fluid leaks, valve caps missing

**Fig 2-3. Operation check--damage, pilferage (check points 1 to 12).**

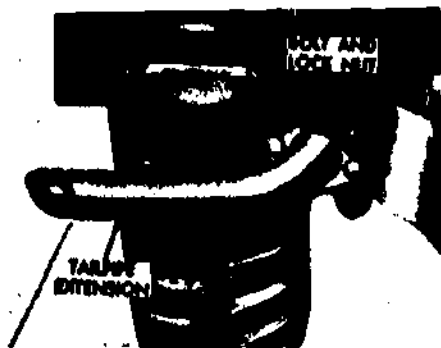

(13) Bent, eaten away, or plugged tailpipe

(14) Trailer coupling receptacle-Cap missing or sprung, male prongs don't make contact, dirty, outer ring damaged



(15) Pintle-Missing, loose, bent, not lubed, can't be opened, won't lock, spring broken, cotter pin broken or missing grease fitting broken

(16) inspecting spare tire for inflation, and inspecting for missing valve cap and secure mounting.

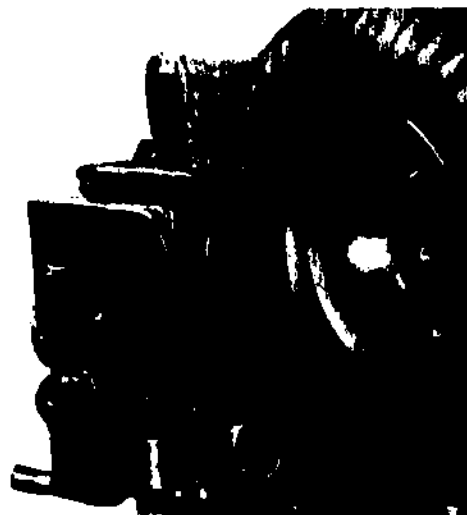

Fig 2-4. Damage, pilferage (check points 13 to 16).

c. Leaks, general. We are looking for water, lubricant, fuel, and exhaust leaks.

- (1) Check hoses for rotting and weather cracking. Check for loose clamps, leaking water pump or radiator core, core fins bent/mashed or covered with leaves or dirt (fig 2-5).

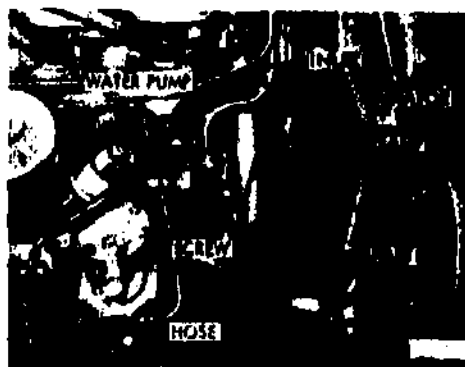

Fig 2-5. Hoses, clamps, water pump, and radiator core.

- (2) Make sure that the drain cock is fully closed and not dripping. Rubber insulators to protect the radiator against vibration must be in place under the metal washer (fig 2-6).



Fig 2-6. Drain cock.

- (3) Check for valve cover gasket leaking; tightening too much may warp the cover, causing a bad seal. Give the oil filter a good look to make sure it is not leaking (fig 2-7).

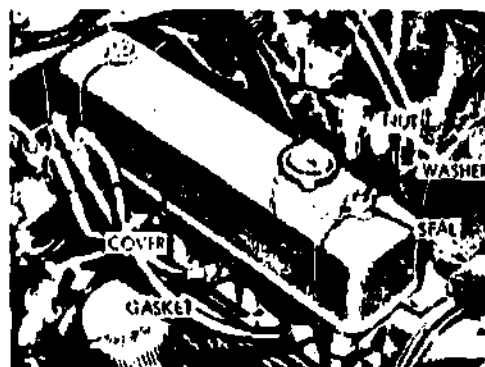

Fig 2-7. Valve cover.

- (4) Fuel lines and fittings should be checked to make sure that they are not leaking. Lines that cross over or which are close to each other should be checked to make sure that they are not chafing against one another. Inspect for missing/loose clamps that keep lines from working loose and cracking. The clamps greatly reduce the amount of vibration in the lines (fig 2-8).

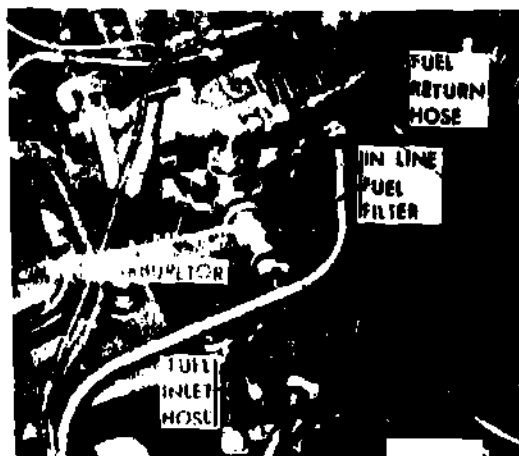

Fig 2-8. Fuel lines and fittings.



- (5) A wet or damp appearance on the backing plate indicates brake fluid leakage. This could mean a faulty wheel brake cylinder, loose bleeder valve or loose/broken brake line. Usually, if the backing plate is wet, the odor of brake fluid will be strong (fig 2-9).

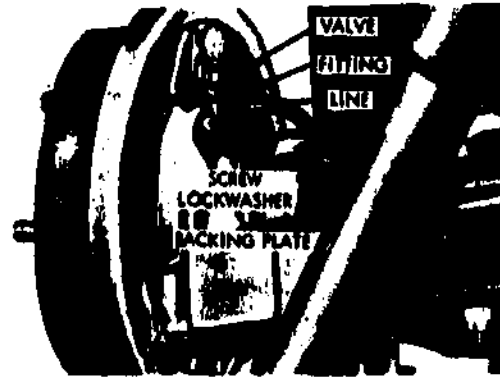

Fig 2-9. Brake fluid leakage.

- (6) Exhaust leaks can be fatal. During a before-operation check, listen for noises that would indicate a faulty exhaust manifold, muffler, or tailpipe. One way to check the system is shown in figure 2-10. There are other indications of exhaust leaks such as an odor or irritation of the eyes. If any of the above indications are present, have that system checked by a mechanic or you could end up as shown in figure 2-11.

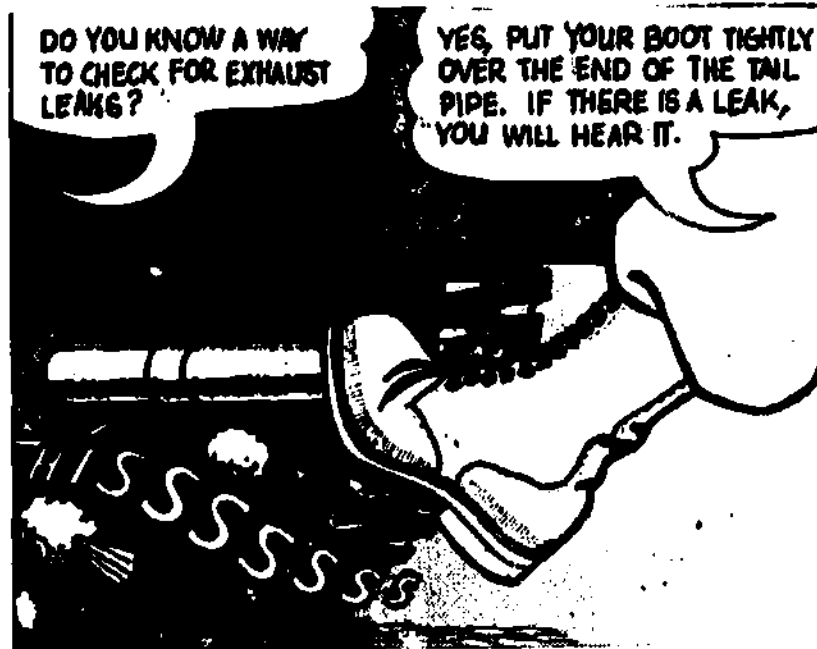

Fig 2-10. Checking for exhaust leaks.



Fig 2-11. A puffing noise is one indicator of a faulty exhaust system.

- (7) Front, rear, and intermediate differentials (fig 2-12) will be checked. Normally, leaks occur where the cover is bolted. Leaks are generally caused by loose bolts, too much lubrication being added, the gasket could be defective, or the vent valves are not working properly. During a before-operation check, see if they are dripping. If the vehicle has been parked for any length of time, there may be an oil puddle on the pavement or ground. This is not a foolproof technique but if it is fresh lubricant that is reason enough to inspect it more carefully.



Fig 2-12. Differential leakage.

- (8) When bending down to check those differentials, give those shocks, figure 2-13, a quick glance. If they are dark/wet, there is a good chance they are leaking and should be replaced. Defective shock absorbers will affect the handling characteristics of the vehicle.



Fig 2-13. Shock absorber leaks.

(9) Inspecting for leaks can be very misleading; for example, a leak in a fuel line at point A, figure 2-14, could be leaking and flowing down the line, which at first glance may lead you to believe the lower fitting is leaking. A good procedure is to make sure first which fitting needs the tightening, tighten it, and then check the rest. Fittings, for the most part, will probably be brass; they will round over very easily if the proper size wrench is not used, and break or twist off if too much pressure is exerted. During your before-operation check, use your nose. You will probably smell brake fluid and gas before you determine where the leak is. Look at the situation, and pay particular attention to any discoloration around the engine and radiator as discoloration is a good tip that something is leaking. There may be times when it is hard to determine if there is a leak; for example, if the previous operator was required to add oil and was sloppy in doing so, oil could run down over the valve cover, figure 2-15, and possibly give the appearance that the valve cover is leaking. The excess oil in that area should be wiped dry and rechecked at the earliest opportunity. Do not get in the habit of accepting leaks without checking them out. A slight seepage, for instance, around the oil pan could mean a rock bruise that has penetrated the oil pan or pan bolts could be missing or be extremely loose.

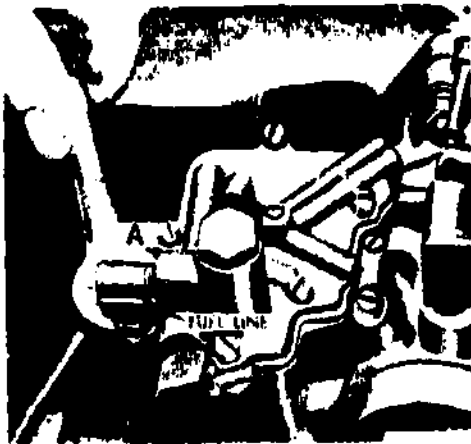

Fig 2-14. Fuel lines loose.

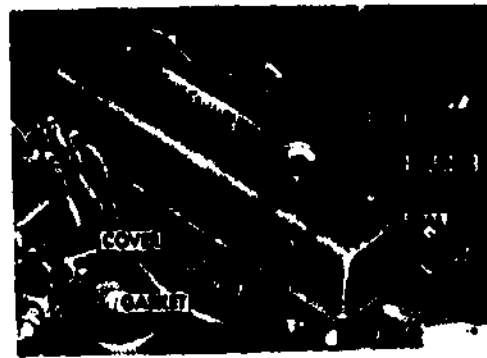

Fig 2-15. Oil leaks.

d. Fuel, oil, water. This particular check is made to insure that each of the items is at the safe operating level. Fuel should be at its full or maximum level (A, fig 2-16). The proper level for engine oil would be exactly on the full mark, (B, fig 2-16). This is an ideal condition and should be met whenever possible. However, most dipsticks (used to measure amount of engine oil) will have at least a line indicating "add oil" and "full." For a true reading, the vehicle should be allowed to sit with the engine off for 2 or 3 minutes, which allows all the oil to drain from the engine to the oil pan. Coolant level should be checked and brought to the proper level (C, fig 2-16).

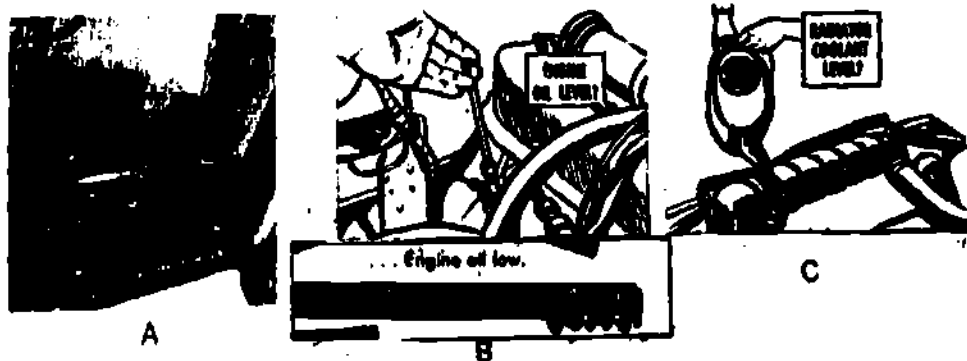

Fig 2-16. Fuel, oil, water levels.

The vehicle should not be operated if oil is at the "add" mark until it is brought to the correct level. The level of the oil should not exceed the "full" mark at any time. If this situation occurs, you must determine the cause. Did the previous operator overfill the crankcase with oil? Is water (coolant) leaking into the crankcase? If the coolant is entering the crankcase, the oil on the dipstick will be a milky gray color. If your inspection indicates this, the vehicle should be scheduled for repair by shop personnel. If there is no evidence of water, excess oil should be drained out so that the oil is at the correct level. The correct water level is approximately one inch down from the top of the filler neck. A false reading could be obtained if you are not careful. It is difficult to judge depth when looking down the filler hole, and the water level may appear to be correct when in fact it is low. The coolant level should be checked physically. Providing the engine coolant is not hot, the best way to check is to insert your finger into the filler neck about one inch to see if you can touch the coolant. Coolant should be added when the engine is cool. If the engine is hot (not empty or boiling), the coolant should be added slowly with the engine running.

**Note:** While you have the hood up, it is a good time to check a few other things. It is a good idea to check the headlight (fig 2-17), temperature sending unit (fig 2-18), and horn connections (fig 2-19). They do become disconnected, so give them a good close look. If the connector has pulled out (fig 2-17), line the prongs up and just push it in. Since the connections are encased in rubber which makes them waterproof, it may be difficult to push them in. If this is the case, apply a little spit and it should slide right in. If the situation arises when several connections become disconnected (fig 2-20), check the numbered metal tags that correspond with numbers on the wires coming from the body and make sure that the numbers match when connecting the wires.

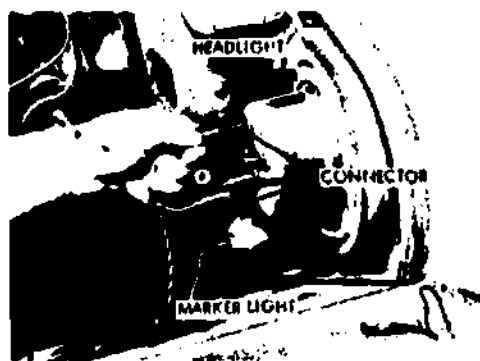

Fig 2-17. Headlight connector.



Fig 2-18. Temperature sending unit.



Fig 2-19. Horn connection.



Fig 2-20. Wiring is numbered.

Grommets (fig 2-21) may be pulled out or be missing. Their specific purpose is to prevent such things as the throttle cable and wiring from chafing (fig 2-22) as they pass through different areas of the body. Grommets that have been pulled out can be reinstalled; missing grommets should be replaced.



Fig 2-21. Loose grommet.

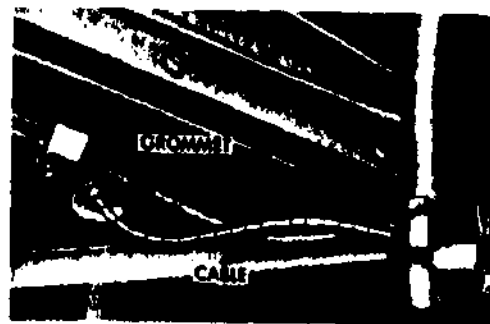

Fig 2-22. Properly installed grommet.

Give the belts a check; see if they are loose and not frayed. Then grasp the fan to see if there is any wobble in the water pump shaft. Also check for bent fan blades, loose bolts, or missing rivets. Any of these conditions could cause the blades to hit the radiator core or radiator shroud (fig 2-23).



Fig 2-23. Belts, fan blades, and shroud.

Lastly, check the batteries (fig 2-24) to insure that the cables are tight, clean, and not frayed. Insure that all vent caps are in place and the battery is clean. Check holddown clamps to insure that they are doing their job. At times a terminal clamp may be installed incorrectly, in that it does not allow a vent cap to be unscrewed (the bolt or clamp is turned so that it is tight against the cap). If you find this condition, take the time to loosen and readjust the clamp. Be sure you check that cell, because there is a chance that it has not been checked for some time.

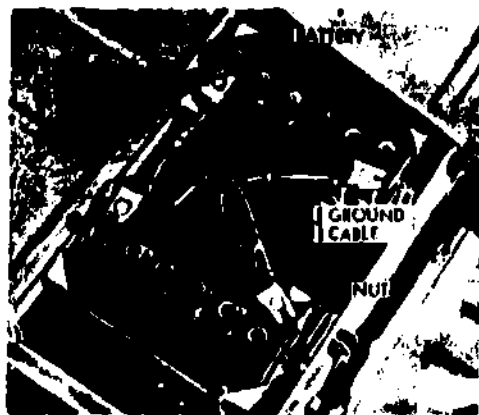

Fig 2-24. Holddowns, clamps, and cables tight.

e. **Engine warmup.** This check gives the engine a chance to reach operating temperature before a lot of stress is put on the engine. Warmup is not done by revving the engine needlessly; a fast idle is sufficient. Listen for odd noises such as a knock, ping, metal rubbing, and other irregular noises that would tip you off that something is not right. During this time you can make sure that the foot accelerator is responding correctly; also try the hand throttle, emergency brake, and make sure that the fording valve handle is in the proper position. If the fording valve handle is left in the fording position, it allows pressure to build up which could cause the seal to leak. Make sure that the vehicle is NOT engaged in four-wheel drive if you are going to operate on a hard surfaced road. In the cab area itself, check for missing bolts, check the condition of the dust boots on shifting levers (fig 2-25), and check for missing knobs (fig 2-26).



A—Parking brake lever	F—Starter switch
B—Transmission shift lever	G—Throttle
C—Choke	H—Accelerator pedal
D—Ignition switch	J—4-Wheel drive lever
E—Clutch pedal	K—Brake pedal

Fig 2-25. Inspecting the cab area.

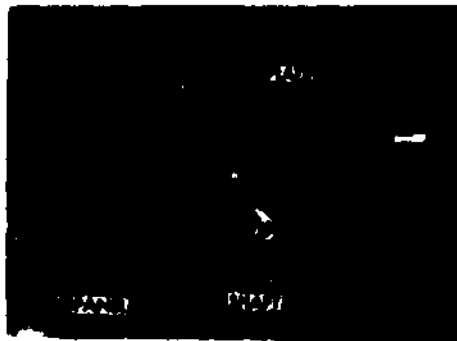

Fig 2-26. Missing knobs.

f. **Instruments.** The instrument check is performed while the engine is warming up. During the warmup period you should monitor all the gages on the panel. When you start the engine for the warmup period, you should automatically insure that there is oil pressure. If the oil pressure gage does not reflect pressure, immediately stop the engine and determine the problem. As mentioned before, if you are not familiar with the particular vehicle you are operating, the fuel level should be visually checked by actually looking into the tank. Then when you check the fuel gage, you can determine if the gage is accurate. The battery-generator indicator needle should normally be somewhere in the first HALF of the green section. The notes shown in figure 2-27 give you a hint as to what you should look for when the battery is at rest (A, fig 2-27), when the battery is charging or under a starter load (B, fig 2-27), and when the engine has been running at maximum charging speed (C, fig 2-27). The critical indications for both a three and four color panel battery-generator indicator are shown in figure 2-28.

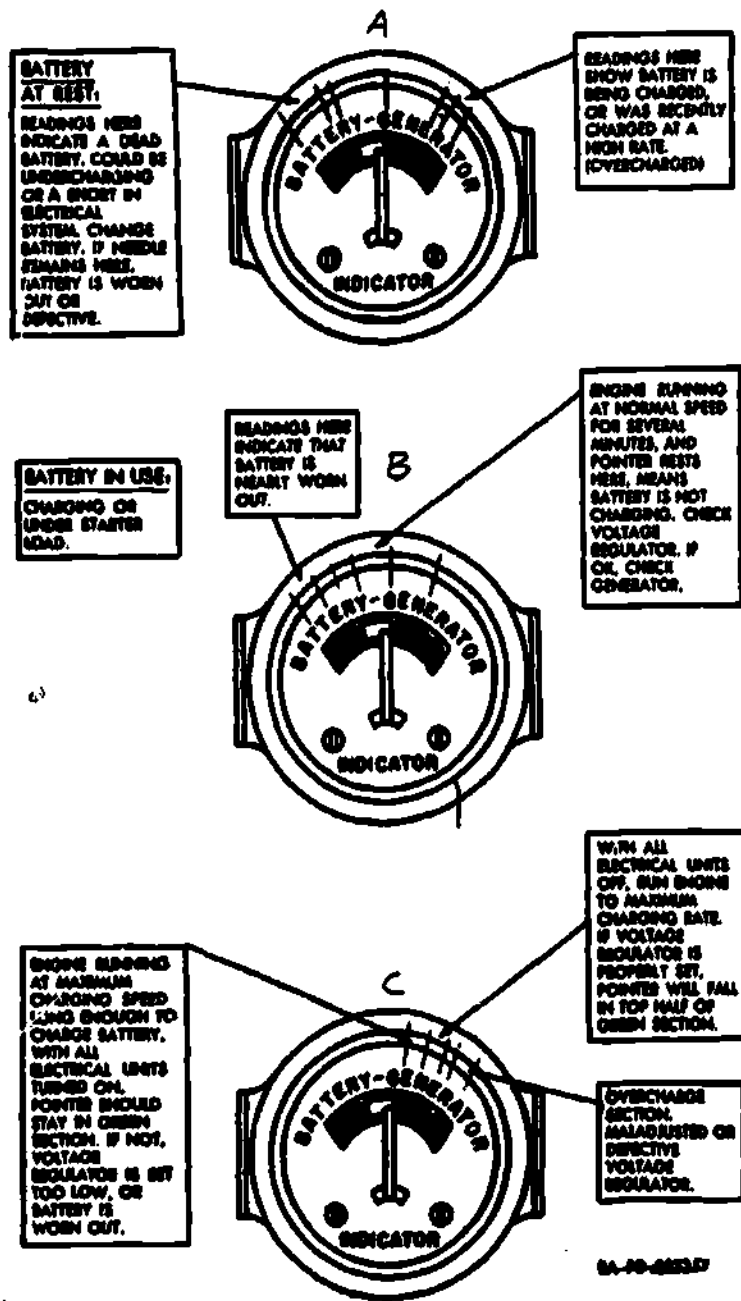

Fig 2-27. Battery-generator indicator operation.



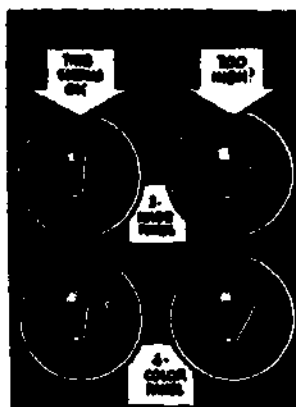

Fig 2-29. Battery-generator indicator.

After the engine has had sufficient time to warm up, the temperature gage will normally register approximately 170° F to 200° F. (This will be slightly higher if the vehicle is diesel.) Be alert for an excessively low temperature reading as well as for a high temperature reading. Both extremes may mean a defect in the cooling system. Gages are designed to alert you of possible defects, and they should be constantly monitored. For example, if the oil level is correct but the oil does not reflect pressure, do not take for granted that the gage is broken. It could be broken or it may have become disconnected. On the other hand, the oil pump may be defective or a clogged or broken oil line could be the cause. Do not take a chance. Have the particular gage that indicates a malfunction checked out.

It is not uncommon for the screws that hold the instrument cluster to work loose (fig 2-29). There are two special types which have a locking device on the back. If a screw appears loose, just push it in the hole and turn it with a screwdriver about a quarter of a turn. It is also possible that moisture could enter a gage if the lens is cracked or the seal is disturbed, so give the gage a good visual inspection. The instrument panel is equipped with lights (fig 2-29) for lighting up the instruments. The left and right panel lights illuminate the gages so that they can be monitored. The gage housings have slits through which the light passes to reflect on the face of the gages. Because a portion of the lens cover is red, the light reflected to the gages is a soft red, resulting in a light that is difficult to detect from outside the vehicle. The light in the center (fig 2-29) is the high beam indicator. The very small area directly in the center (see insert) is the only portion that will let light through.

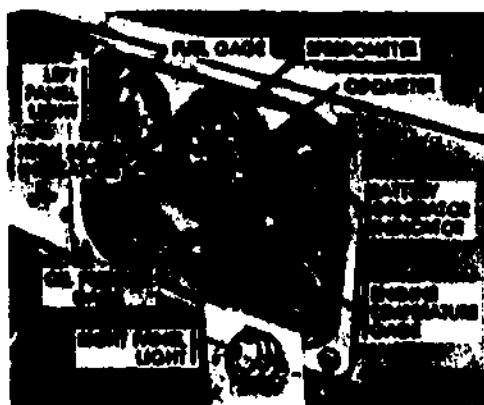

Fig 2-29. Instrument panel.



Fig 2-30. High beam indicator light.

Because of negligence when spot painting, the lens opening is often painted over, restricting the light which will make it difficult to see. If the lens or bulb should be missing, a replacement can be easily screwed in (fig 2-30). Check the dimmer switch (fig 2-31) and at the same time make sure that the high beam indicator reflects that the lights are on high beam. When checking the light switch (fig 2-32), you will see three levers. The bottom right lever is a lock which must

be pushed up to unlock so that the top and bottom left lever can be moved. The straight up position for the top lever is OFF and no light will work. Moving it one click to the right allows the stop light only to function; two clicks down means that it is in service drive which includes stop, tail and headlights. If the lever is moved to the left, the first click will light the blackout marker (BO marker) (A and C, fig 2-33) both front and rear; two clicks to the left turn on both the BO marker and BO drive (A, B, C, fig 2-33), as well as the blackout stop light (C, fig 2-33).

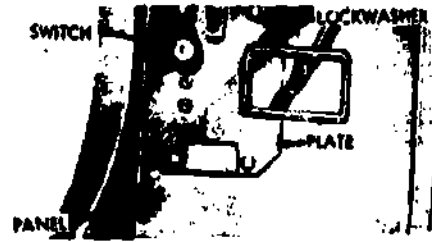
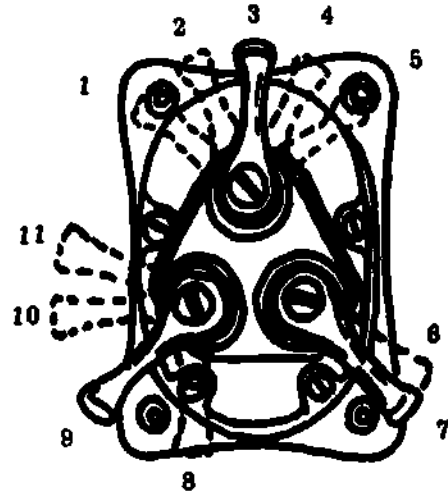

Fig 2-31. Headlight dimmer switch.



KEY:

- |  |   |
|--|---|
| 1. Upper lever in blackout drive position  | 7. Lower right lever in locked position             |
| 2. Upper lever in blackout marker position | 8. Lower left lever in park position                |
| 3. Upper lever in off position             | 9. Lower left lever in off position                 |
| 4. Upper lever in stoplight position       | 10. Lower left lever in dim panel light position    |
| 5. Lower right lever in unlocked position  | 11. Lower left lever in bright panel light position |

Fig 2-32. Light switch.

These lights do not emit a lot of light and if you are performing a before-operation check in daylight, it will probably be necessary to shield the lights with your hand to make sure that they are working. Using the buddy system when checking out the lights is the easiest method.

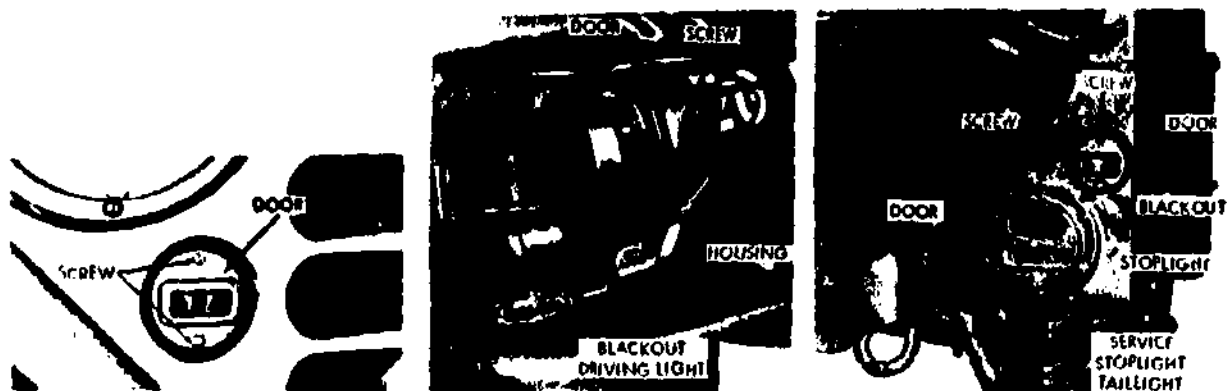

A. Front blackout marker      B. Blackout drive      C. Blackout stop light and marker

Fig 2-33. Blackout lights and markers.

g. **Safety devices.** Check the steering wheel (fig 2-34) for cracks and excessive play. Test your horn. Try the windshield wipers; look at the wipers to make sure that the wiper blades are attached. If a blade is missing, get a replacement--do not allow the wiper arm without a blade to go back and forth on the glass because it will cause scratches which will obstruct your vision. Make sure that the emergency brake (fig 2-35) is operating, and that it will hold the vehicle. Most emergency brakes are mechanical; in other words, they use rods/linkage, not hydraulic pressure. If the vehicle is equipped with directional signals, check to insure proper operation. Do not forget to check the indicator on the control (fig 2-36), which alerts you that the directional lights are on.

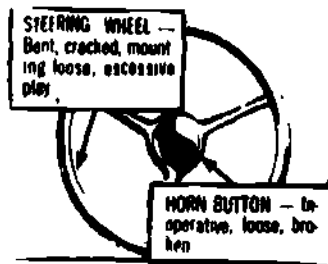

Fig 2-34. Steering wheel.



Fig 2-35. Emergency brake handle.



Fig 2-36. Directional signal indicator.

If your vehicle is equipped with a tailgate (fig 2-37), inspect the tailgate chains to make sure the hook on the end of the chain is not broken and that the hook will go through both slots, the one on the tail gate and the one attached to the body. Vehicles equipped with safety straps (seat belts) either for the front (fig 2-38) or rear (fig 2-39) should be inspected to make sure that the hooks on both ends are serviceable, that the eyelets that fasten it to the body are secure, and that the belts are adjusted to permit easy hookup. You will find that if the belts are easy to hook up (adjusted properly), passengers, especially in cargo areas, will fasten them. To encourage the use of seat belts, it is a must that they be kept free of dirt and grease.



Fig 2-37. Tailgate safety strap.



Fig 2-38. Seat belts.



Fig 2-39. Seat belts (rear).

h. Tools and equipment. Visual inspection of the tools and equipment is necessary for accountability. Some units may require you to carry just a jack and lug wrench. Other items are kept so that they may be issued as needed. Regardless of what you are required to have, it must be serviceable and ready to perform its job when needed. Check to make sure that the lug wrench does fit the lugs and that the jack will operate.

i. Summary. The key to a good before-operation check is to allow yourself enough time to do it. It is not difficult to determine what type of check will be performed if we arrive at the motor pool only 5 minutes before the run is due out. A poor, hurried check will be done and this is a real injustice to the vehicle and to your supervisors who have entrusted you with the care, operation, and maintenance of a vehicle.

#### 2-4. DURING-OPERATION CHECKS

a. General. The check is conducted continuously. In all stops, turns, and changing of the gears the operator should really consider it a test and note any unusual or unsatisfactory performance. At the right is the During-Operation block of the trip ticket--examples are given below. An alert driver monitors his instrument panel, looks, and listens (fig 2-40) for any noises that may indicate engine, wheel, or power train trouble. Malfunctions can also be detected by the particular odors (fig 2-40) that they produce. Electrical odors are distinct and are readily distinguishable. Overheating of the engine is also easily distinguishable because of the smell, the same as brake fluid. There is also a fourth area to consider, and that is feeling. Does the steering feel loose, does it seem to pull right or left, or are you receiving excessive vibration? Under certain conditions does it feel as if there is a loss of power, even if you are not heavily loaded or the terrain is such that a loss of power is not due to abnormal conditions? Let's now take a look at the specific checks conducted for the during-operation check.

2. DURING OPERATION	OPERATOR	
	101	00 00
INSTRUMENT BRAKES		
BRAKES		
STEERING		
ENGINE OPERATION		
UNUSUAL NOISES		



Fig 2-40. During-operation check--look, listen, and smell.

b. Instrument brakes. This check is for vehicles that are equipped with air brakes and the necessary controls. The vehicles discussed in the text are not so equipped. For this reason this check will not be discussed.

c. Brakes. During operation, brakes should feel firm and have sufficient free travel. Free travel as shown in figure 2-41 is the distance from where you start to depress the pedal to the point at which you first feel resistance (resistance being the point at which brakes are actually starting to stop the vehicle). Free travel is a must. Too much free travel will cause a loss of braking power. Too little free travel will cause the brakes to drag. When the brakes are applied, all wheels should stop together and not make the vehicle pull to the right or left. The brake pedal should return back to its normal position after your foot comes off it. This is caused by the brake return spring. Specific free travel adjustment can be found in the applicable TM for your particular vehicle. This adjustment is not performed by the operator, but early detection is the operator's responsibility. Brakes should also have the correct amount of brake pedal reserve (fig 4-42). This is the distance from the floor board to the pedal when the brakes are on. Incorrect pedal reserve may be caused by improper brake adjustment, worn brake linings, or loss of brake fluid.

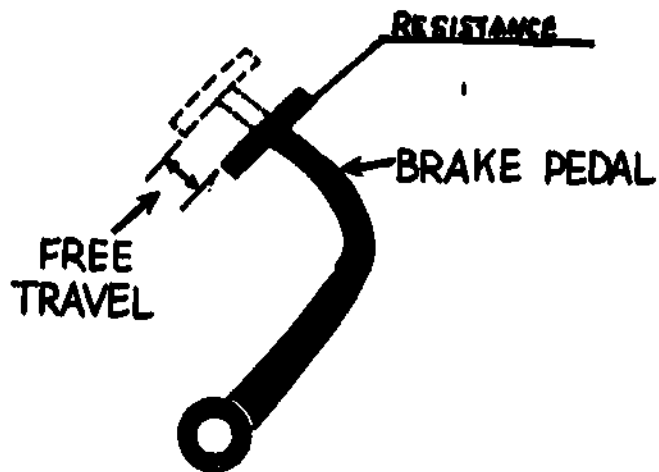

CHECK THE **TM** FOR THE AMOUNT OF FREE TRAVEL.

Fig 2-41. Brake free travel.

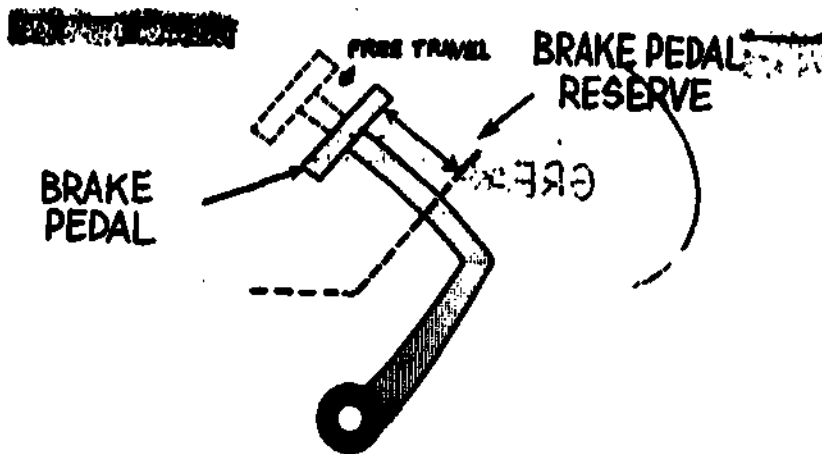

Fig 2-42. Brake pedal reserve.

d. **Clutch.** The clutch pedal, used to engage and disengage the transmission properly, must also have free travel as shown in figure 2-43. Proper adjustment insures that when the pedal is depressed, the transmission can be engaged without the grinding of gears. The clutch pedal also has a return spring that will return the pedal to its normal position when your foot is removed.



Fig 2-43. Clutch free travel.



e. **Steering.** Check for free play (looseness) in the steering wheel. When the steering wheel is turned, the wheels should react. If you have to turn the steering wheel excessively before the wheels react, it should be checked. This situation causes the operator to turn the steering wheel back and forth constantly to keep the vehicle from wandering off the road.

f. **Engine operation.** This check will uncover symptoms of poor performance. During this check your speed will vary, and the vehicle is normally under load. Does the vehicle accelerate properly? Does the engine sound as if all cylinders are firing or is it sluggish? Does it sound rough? Does it backfire? When the vehicle is stopped, does the engine idle too fast? This could also make it difficult to shift gears.

g. **Unusual noises.** This during-operation check is just as important as the rest. It is not a catchall-type check, but one that will help you avoid more serious trouble. Any unusual noise should be considered as a warning to you, and its origin should be pinpointed. A noise which sounds like metal is touching metal when the brakes are applied could indicate that the brake linings are worn and metal is touching the brake drum. A spring or brake shoe connector could have worked loose and be rubbing. A grinding type noise just when the vehicle is moving could indicate a defective wheel bearing. A whining noise could indicate that lubricant in the transmission or differential is low or dry. A slapping sound could indicate that a fan belt has started to separate and is hitting as it goes around. If an unusual noise is heard, it may be difficult to pinpoint it. One of the easiest ways to locate the noise is to use the buddy system. Have somebody stand on the side from which you think the sound is coming and move the vehicle slowly to determine the location of the noise. DO NOT allow someone to hang on to the vehicle while it is moving. Common sense must be exercised. If the unusual noise sounds as if it may be coming from the engine and the oil pressure is low or nonexistent, the vehicle must be shut down to decrease the possibility of internal damage to the engine. The problem must be pinpointed and then determination can be made as to whether the vehicle can be operated without causing damage.

## 2-5. AFTER-OPERATION CHECKS

a. **General.** The after-operation check (see block at right) is the basic daily service for vehicles. It insures that the vehicle has been serviced and is ready to go again. If the operator has not listed any discrepancies that would deadline the vehicle, it is considered ready and operational. To your supervisor (who must always know what equipment is ready so that he can schedule the daily commitments), this is important information. We should not consider a thorough before-operation check a reason to pencil in the after-operation check. Items can and do become defective between the time of the before-operation check and the after-operation check. Do not assume everything is all right. Thoroughly perform all operation checks.

2. AFTER OPERATION	OPERATOR		
	1st	2nd	3rd
LIGHTS AND REFLECTORS			
SAFETY DEVICES			
BRAKES			
AIR TANKS (PSI)			
FUEL, OIL, WATER (GALL)			
*DRIVE BELTS			
*BATTERY LEVEL			
*ANTI-FREEZE			
*TIRES (DAMAGE) (GAGE)			
*CLEAN (AS REQUIRED)			

b. **Lights and reflectors.** All lights should function properly. Inspect for cracked lenses and obstructions that would block the light. Proper adjustment of the headlights is also a must. If they are adjusted too low, you will not be able to see far enough in front of the vehicle. If they are adjusted too high, it will be a safety hazard for other drivers. Inspect for loose or missing screws on light retaining rings. Check reflectors for missing or loose bolts. Make sure that the reflectors are not painted over because this will void out the safety factor of visually alerting drivers to your vehicle.

c. **Safety devices.** The safety equipment listed below must be checked to insure that it is functioning properly:

- Horn - Must be audible.
- Wipers - Blades and arms intact and operating. The rubber portion of the blade should be free of nicks and gouges.
- Seat belts - Should be fastened or folded. This will help keep them clean and the hooks from being damaged.

d. **Emergency brakes.** Either the foot or hand brake should be able to hold the vehicle from rolling and the foot brake should have free travel and be hard and firm.

e. **Air tanks.** This item is not found on light vehicles.

f. **Fuel, oil, and water.** These items should be brought up to the correct level. The amount of the fuel and oil must be recorded in the space provided in the upper right hand corner of the trip ticket.

g. **Asterisked items.** The five items listed on the bottom of the trip ticket (fig 2-1) which are marked with an asterisk (\*) are considered part of the weekly check. The five items are drive belts, battery level, antifreeze, tires, and cleaning. Checking these items weekly is not to be considered as a hard and fast rule. Drive belts should be checked daily for proper tension and frayed areas. This is easily accomplished at the same time that you check the oil. It is true that a battery does not use much water, and the water would remain at the proper level until a weekly is due, but can we be sure that it was properly filled on the last weekly? There's a possibility that it was neglected and the battery is bone dry. It only takes a minute to check. One antifreeze reading weekly should be sufficient if we have not added water or had some type of cooling system problem. As far as cleaning once a week, you do a more thorough job on the weekly cleaning, but most units require you to clean the vehicle as part of the daily after-operation check.



Fig 2-44. Oil check.

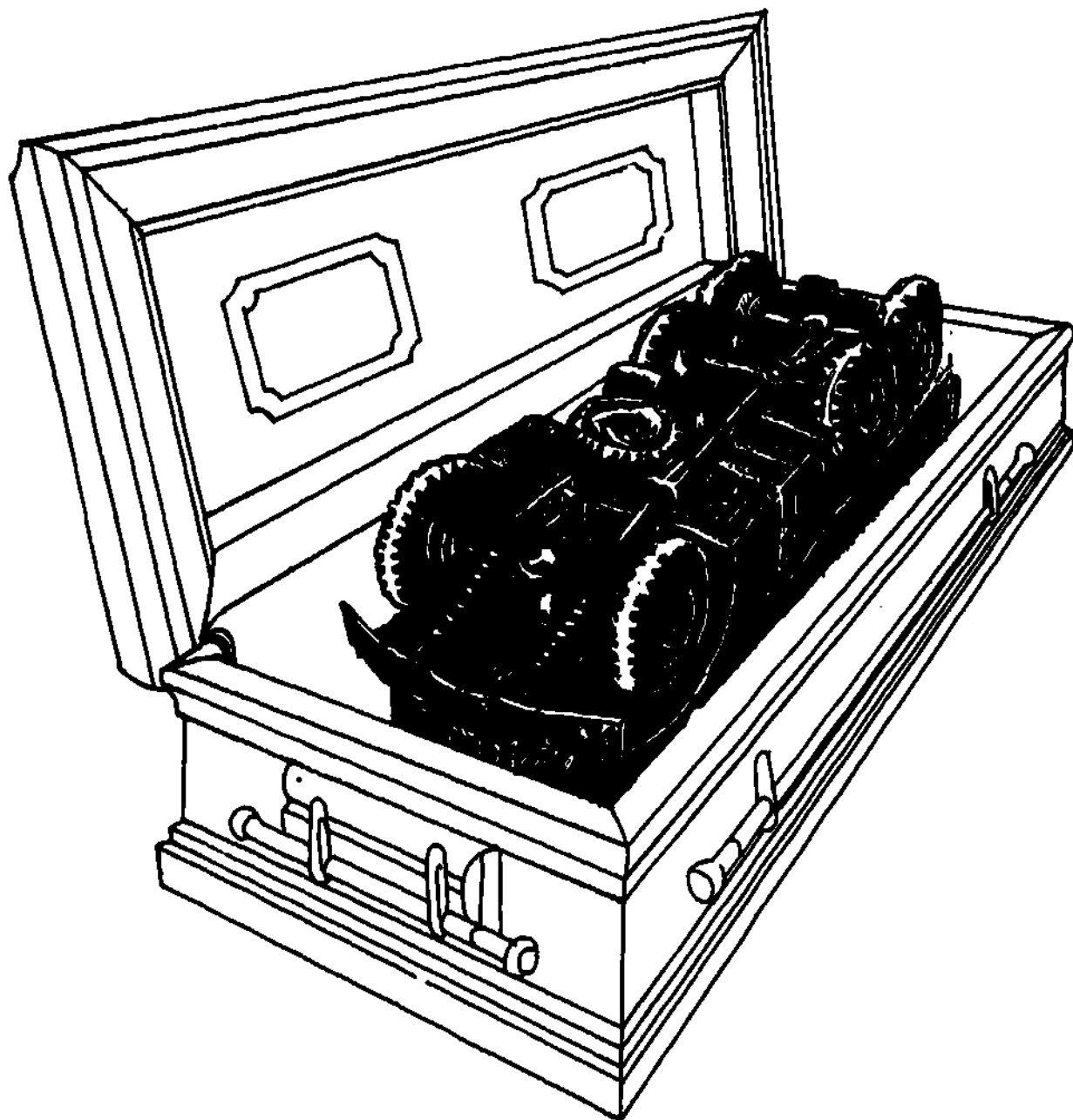

## WHODUNIT ?

Fig 2-45. Properly conducted operation checks insure longer vehicle life.

2-22



h. Summary. We have provided you with some solid guidelines to follow for before-, during-, and after-operation checks. It may seem that some of these checks are long and detailed. I think that you will find that after you have carefully gone through them on your vehicle several times, you will be able to do them quickly and efficiently. They should never be disregarded. You have been or will be entrusted with a vehicle costing a lot of money. This vehicle can be made to last almost indefinitely and kept in the safest possible condition if proper daily care is given to it. These things are important because the lives of the personnel you may be required to transport are priceless.

## Section II. WEEKLY MAINTENANCE

### 2-6. INSPECTION GUIDELINES

The weekly maintenance check requires more time than do the daily checks simply because it is more thorough and you will be performing more corrective maintenance.

The first step in preparing to perform your weekly is to allow sufficient time to perform your check. Next pick a good location to perform your tasks. Points to consider are location of the tool/parts room and the movement of traffic which could require you to move the vehicle. For example, if you were removing the batteries and chose the wash rack to perform this task, the washing facility would be minus a space for other drivers to perform their cleaning. Being relatively close to the tool/parts room will save you many trips back and forth for different tools.

Traffic movement is important, especially if you have to work with winch cables. If you do not plan ahead and you block the normal traffic area, it just means the cable will have to be lowered. This may require recleaning the cable. Interruptions like this will require you to take more time.

Prior to covering the first check, let's discuss some of the general procedures for the weekly service and inspection. The general procedures listed below apply to all preventive maintenance services and inspection and are as important as specific procedures. Items should be inspected to determine if they are in good condition, correctly assembled or stowed, secured, not worn excessively, not leaking (previously discussed), adequately lubricated (previously discussed), and properly adjusted. These checks will apply to most items during the preventive maintenance procedures, including attached items such as canvas and bows.

- Inspecting for good condition will normally be an external visual inspection to determine damage and/or serviceability which may cause an unsafe condition. This could mean: checking to see that the item is not bent or twisted, not chafed or burned, not broken or cracked, not bare or frayed, not dented or collapsed, and not torn or cut or deteriorated.
- Inspecting for correctly assembled or stowed items is usually a visual check to see if the item is in the normal position on the vehicle and that all parts are properly secured.
- Inspection to determine if an item is secure is usually a visual examination or a check by hand, wrench, or appropriate tool to determine if the item is loose. This inspection includes brackets, locknuts, cotter pins, locking wires, clamps and connecting tubes, and hoses and straps.
- Excessively worn is a term which means that an item is worn beyond serviceable limits to a point which could result in a failure if the item is not replaced before the next scheduled service. Parts such as linkage, cables, and wiper blades should be checked for excessive wear. This would also include faded or worn tactical markings and data and caution plates.
- What does the word tighten mean? Since the word tighten means different things to different people, and because the human element is involved, let's discuss it. We have operators that are tall or short, fat or skinny, strong or weak. We also have all kinds of wrenches. So we end up with bolts falling out because they are too loose and others that snap off from being too tight. This would indicate we have many standards of tightness or that there are differences in operation and tools. As a guide, let's use figure 2-46 and a little common sense.

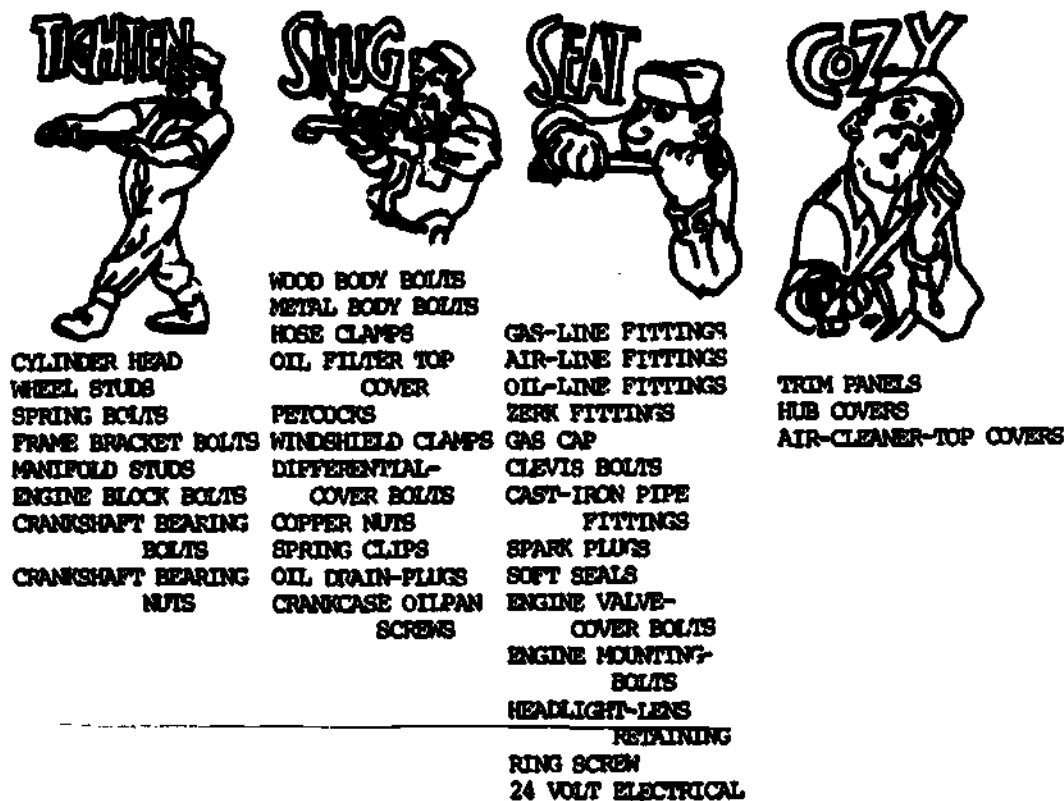

Fig 2-46. Guide for standard of tightness

- If the term adjust or check for proper adjustment is used, it is understood that the appropriate TM will be used to find the correct specifications and the actual adjustment. If repairs or replacement are required, they will be done by appropriate personnel. This type of check includes lubricants, coolant, and fuel levels.
- If the word clean is used, it should be understood that dirt, lubricants, excess gear, and trash will be removed using appropriate cleaning tools and compounds. The operator is to be protected, if necessary, by the use of appropriate safety equipment.

## 2-7. ENGINE COMPARTMENT

a. General. Many items located in the engine compartment will be discussed later in greater detail in the specific systems, but a glance at an engine compartment will often tell you the general condition of the engine. Is the engine dirty? Are screws, nuts, or bolts missing? Are any parts missing? Do you observe any parts vibrating excessively when the engine is running?

b. Oil and water checks. Check for proper oil level, remembering that too much oil can also cause harm. The oil on the stick should be visually checked to insure that water or fuel has not entered the crankcase, which would indicate engine problems. Check coolant for proper level. If required, test coolant for freezing point.

c. Master cylinder check. When you are checking the master cylinder for correct fluid level, you must first wipe away all dirt so that when the plug is removed, dirt will not fall into the master cylinder. If the master cylinder has a vent line attached, then the vent line fitting has to be loosened and removed at the connection going into the master plug before the plug can be loosened. If the vent tube is not loosened first, it will be crimped or broken when the plug is removed. To check the master cylinder, insert your finger to a depth of about the fingernail (do not just use a visual inspection). Add fluid as required, replace master cylinder cap, and be sure to reconnect the vent line.

d. Cable and connector checks. Check throttle, fording, and choke cables to make sure that the cable stop (fig 2-47) is secure and that the controls are in proper adjustment and working order. Check sending units to insure that they are connected (fig 2-48). Check return springs to insure they are connected (fig 2-49).



Fig 2-47. Cable stop.



Fig 2-48. Check sending units.

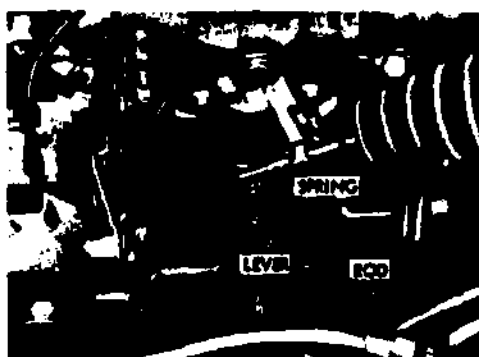

Fig 2-49. Return springs.

e. Motor mount check. Motor mount bolts (fig 2-50) should be checked to make sure they are secure. Also check motor mounts for cracks. They can break and cause the engine to shift.



Fig 2-50. Motor mount bolt.

f. Leaks.

- (1) Exhaust leaks can occur between the exhaust manifold and the exhaust pipes (2 and 3, fig 2-51) and the area where the exhaust manifold gasket (1, fig 2-51) is located. The engine must be running to check this but do not touch these areas. They get extremely hot. Leaks here should be noted and corrected by shop personnel.

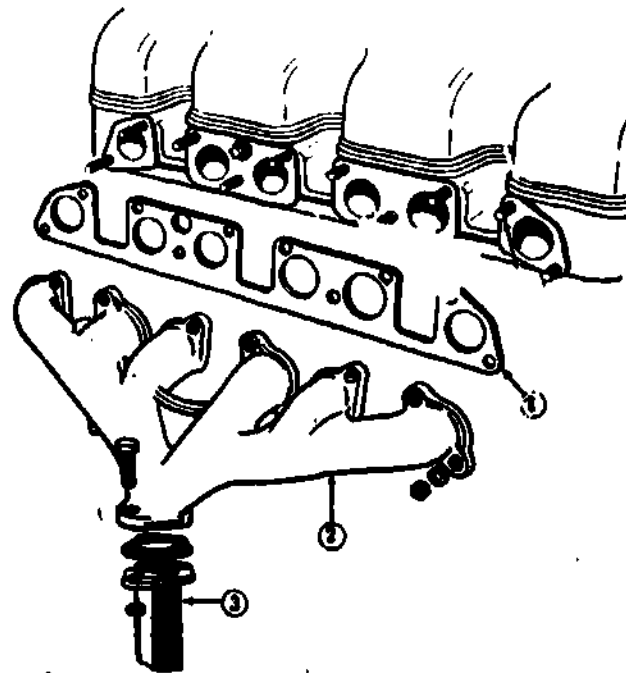

- 1 Exhaust manifold gasket.
- 2 Exhaust manifold
- 3 Exhaust pipe

Fig 2-51. Manifold exhaust leak.

- (2) Valve covers (fig 2-52) are a possible source of leaks. The gasket may be the cause or the valve cover bolts could be loose. These bolts are designed to be seated. Over-tightening deforms the cover and it will not seat properly. If bolts are seated and leakage still occurs, note discrepancy for supervisory personnel to take action.



Fig 2-52. Valve cover and gasket.

g. Air filters. Air filters are normally either wet or dry. The wet type is the one that uses oil to trap the dirt and dust.

- (1) Wet type (fig 2-53). This type of air cleaner has two parts. The top portion filters the air for the engine, and the bottom portion is the oil reservoir which collects the dirt. If the element is dirty, it should be cleaned using appropriate solvent and then shaken out and left out to air dry. Empty the oil in the bottom portion into an appropriate waste oil container; clean the bottom portion, and refill with clean oil. There is an oil level line on the inside of the bottom portion. A higher oil level than what is indicated could result in the excess entering the carburetor.



Fig 2-53. Wet air filter with element and oil reservoir.

- (2) **Dry type.** An air filter with a dry element (fig 2-54) can also be cleaned. Remove the air cleaner from the vehicle, take the filter out of the shell, and wipe the inside of the shell clean. Check the seal to insure that it prevents air from entering without being filtered. Using air pressure (fig 2-55), do not exceed 100 psi and direct air from the inside out. If air pressure cannot be used, the filter may be washed in a nonsudsing detergent and water (temperature of the water should not be hotter than 120°). Rinse the filter in clear water and allow to dry. Do not replace the filter until it has dried off. Do not use gasoline or solvents to clean the dry type air filter.

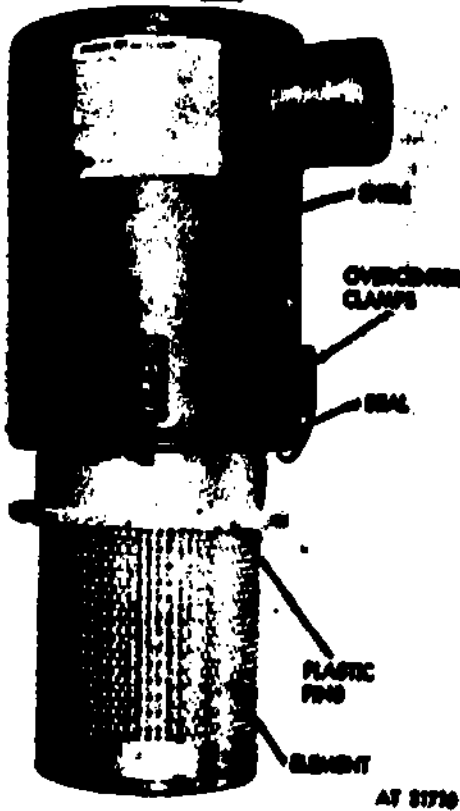

Fig 2-54. Dry type air filter.

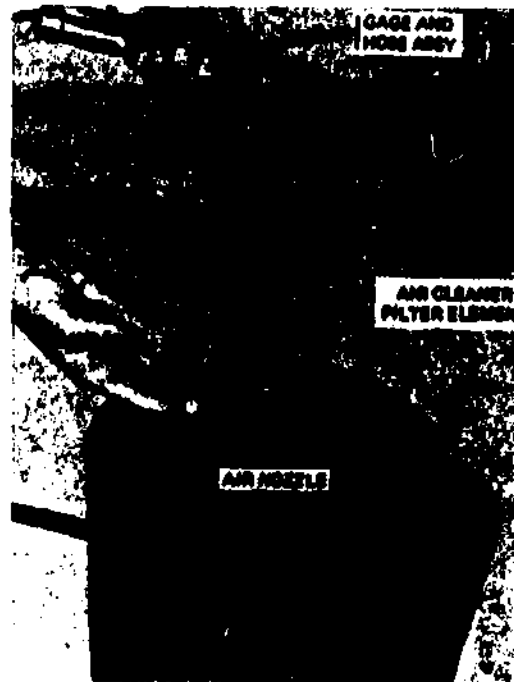

Fig 2-55. Direct air pressure from the inside.

Some vehicles (gamma goat & M-715) have a rubber type valve called the vacuator valve (fig 2-56), the purpose of which is to extend the operating life of the cleaner. This valve remains closed (it is made of soft rubber) until engine speed (or vacuum) is reduced or until sufficient weight of dirt/moisture forces the valve open, allowing the buildup of dirt to unload.



Fig 2-56. Air cleaner base and vacuator valve.

h. **Drive belts.** Drive belts must be inspected for excessive wear, proper tension, and alignment. An operator can normally visually inspect and test the tension as shown in figure 2-52 and determine if any belts are going to interfere with the operation of the vehicle. This check is an operational check, not a measured mechanical adjustment. Some vehicles are equipped with more than one belt. When replacing belts, you should replace them in sets. This procedure prevents the new belt from carrying all the load (fig 2-58).

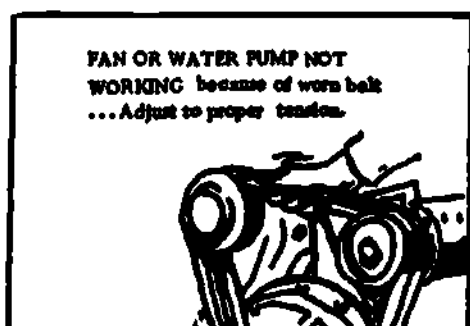

Fig 2-57. Check for proper tension.

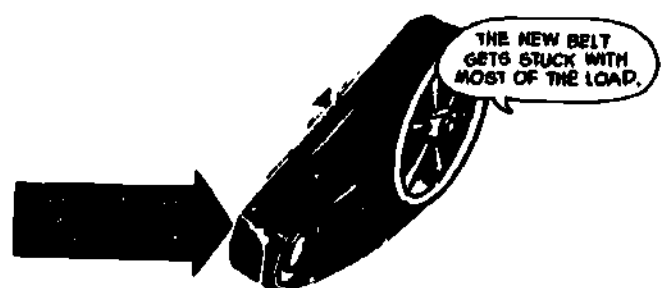

Fig 2-58. Belts should be replaced in sets.

As an operator you are required to replace drive belts. In order to determine the proper adjustment, refer to the applicable TM for that vehicle. Tension adjustment is referred to as deflection. Deflection is the distance that the belt will drop away from a straightedge that is placed across the pulleys as shown in figure 2-59. Figure 2-59 shows the deflection for the gamma goat and states that you should have a 1/8-inch deflection for a new set of belts and a 1/4-inch deflection for a used set of belts. This means that the belts will be either 1/8-inch or 1/4-inch below the line made by the straightedge. Figure 2-60 shows 1/2-inch deflection for the M-151 and indicates that the proper deflection for the belts is 1/2-inch below the line formed by the straightedge resting on the pulleys. Too much tension causes undue stress to be put on the pulley bearings and on the belts themselves.



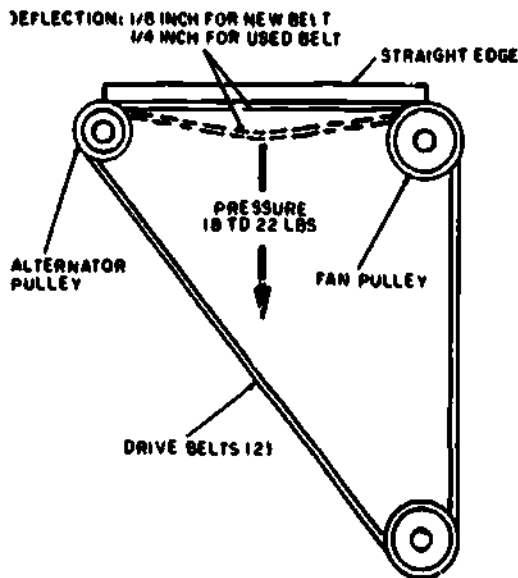

Fig 2-59. Drive belt deflection for the M-561 and M-792.

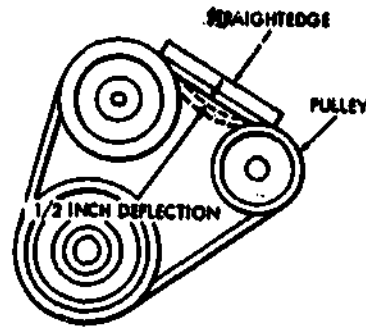

Fig 2-60. Measuring drive belt tension for the M-151.

## 2-8. COOLING SYSTEM

a. **Hoses and clamps.** While you are working on the engine compartment, give that cooling system a good inspection. Start with the hoses and clamps. If a hose looks like any of those in figure 2-61, it's time to change or adjust the hoses or clamps.

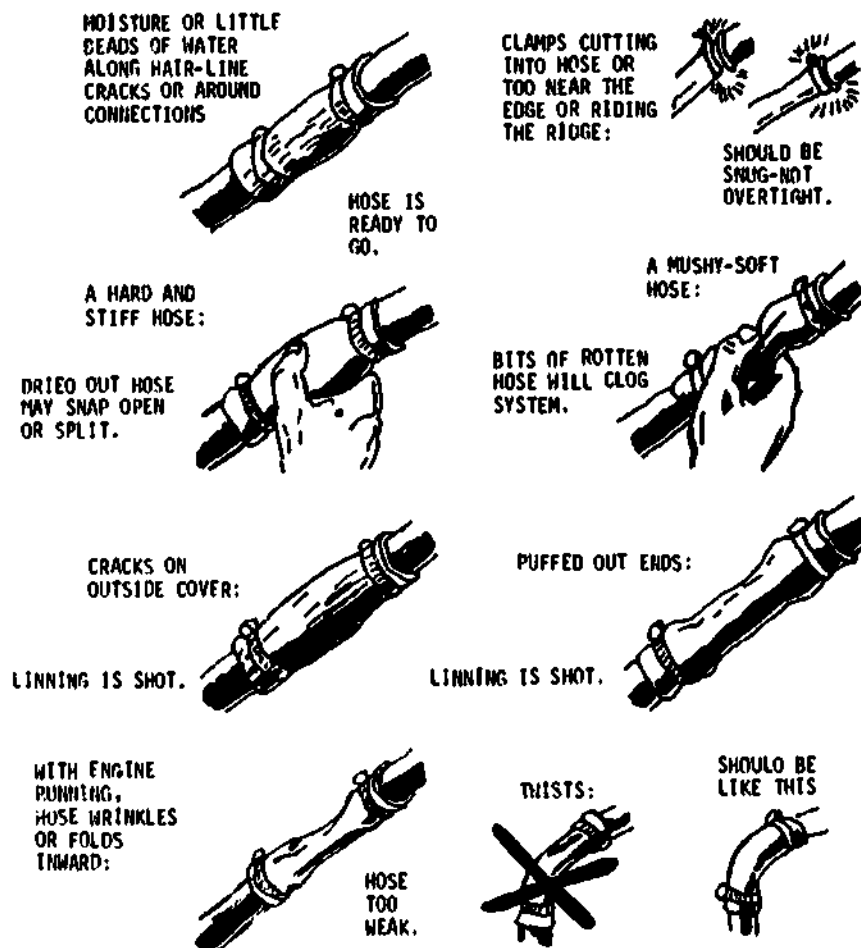

Fig 2-61. Defective or improperly installed hoses.

b. Obstructions blocking air flow to radiator. The radiator front (fig 2-62) should be visually inspected for leaves, mud, and insects, or bent cooling fins. These obstructions will reduce the cooling efficiency. If dirt is imbedded, first make sure the engine is cool, then use low water pressure to soften the mud. When the mud is soft, it can be removed more easily. It may require the use of air pressure to blow the dirt out. No matter whether air or water or a combination of both is used, they should be directed from the engine side toward the front bumper.

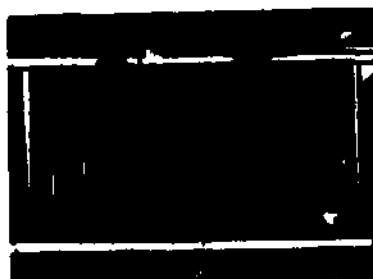

Fig 2-62. Check radiator for obstructions.

c. Coolant surge tank (fig 2-63). The surge tank not all vehicles are equipped with one) mounting brackets should be checked for tightness and cracked or broken supports. The radiator cap seal should be clean. The radiator cap should be checked to insure that both locking positions are functioning. The first locking position is roughly a quarter of a turn. When the cap is turned to this first position, the system is not airtight nor can it become pressurized here. This position is used to prevent the cap from flying off when it is necessary to relieve pressure from the system. The second position, roughly half a turn past the first position, seals the cap down in the filler neck so that the system is pressurized.

The overflow tube (fig 2-62), which may be a hose or tube, should be checked to insure that it has not deteriorated or been crimped, and that solder joints are tight. A crimp in this hose or tubing will prevent the discharge of coolant in the event the surge tank builds up excess pressure. Radiator caps are equipped with a light chain which must be connected to the cap and eyelet in the surge tank.

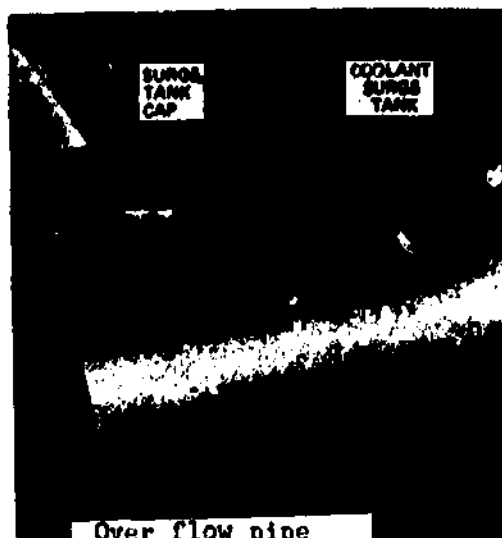

Fig 2-63. Surge tank and overflow pipe.

d. Radiator supports. Shroud bolts (fig 2-64) should be checked for tightness. The shroud is used to channel the air around the engine. A loose shroud could wear through the radiator or the fan may hit it and cause serious damage. Braces or struts that hold the radiator must be checked for tightness (figs 2-64 and 2-65). Some are rubber mounted and act as insulators to absorb the vibration (fig 2-66). Do not tighten them so much that they will be unable to absorb any vibration.





Fig 2-64. Shroud and radiator brace bolts.



Fig 2-65. Radiator strut/brace

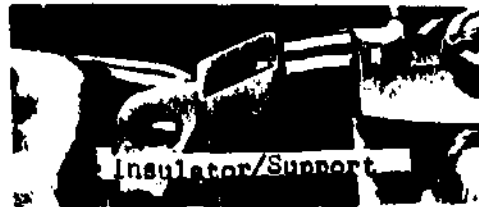

Fig 2-66. Rubber insulator used in the same manner as a radiator brace.

Normally, radiators have either rubber or spring insulators (fig 2-67) in the bottom to help take up vibration. Bolts that are so equipped must not be tightened to the extent that the rubber or spring is totally compressed, since this would tend to make the radiator rigid and very susceptible to leaks caused by vibration and movement of the vehicle body.

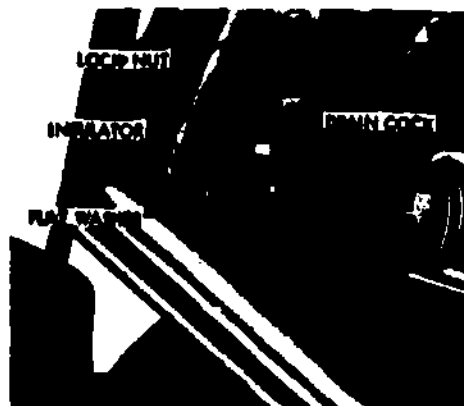

Fig 2-67. Radiator insulators.

e. Fan. Check fan for tightness by grasping the fan blades (CAUTION, make sure no one could accidentally hit the stator) and with slight pressure from front to rear, check for looseness of the shaft (fig 2-68) in the water pump. If you find looseness in the shaft, it may indicate a problem in the water pump and you should indicate a problem in the water pump and note it in the weekly for supervisory action.

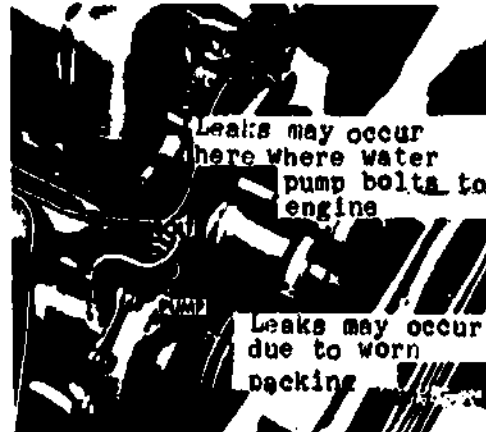

Fig 2-68. Use the fan blades to check water pump shaft.

f. Water pump. The water pump (fig 2-69) could be a source of leaks. Leaks can occur in the areas where the water pump joins the engine and where the shaft extends through the pump.



Fig 2-69. Water pump with fan removed.

g. Radiator leaks. The radiator should be inspected for broken or loose solder joints located on both sides of the radiator (1 and 2, fig 2-70). Although the core can spring a leak anywhere, leaks are more apt to appear where the upper and lower tanks are connected to the radiator core. Also leaks are likely where the inlet and outlet (fig 2-71) fittings are joined to the tank. Small leaks are difficult to see because the coolant evaporates quickly, but if you find discoloration and corrosion, this will indicate there is a leak.

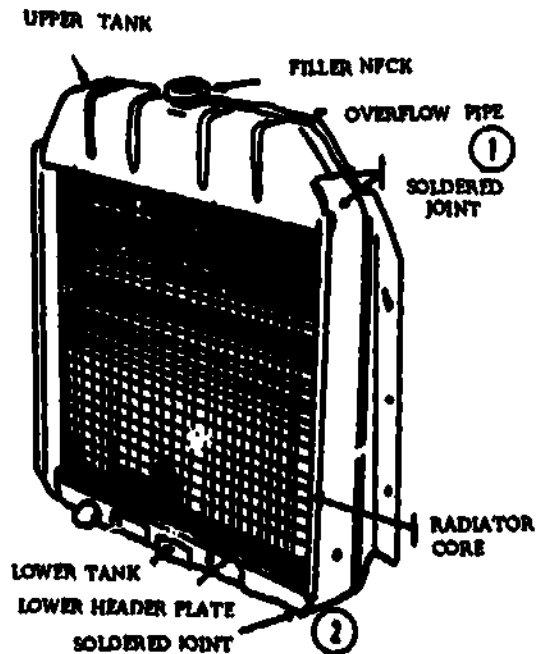

Fig 2-70. Location of common radiator leaks (front view).

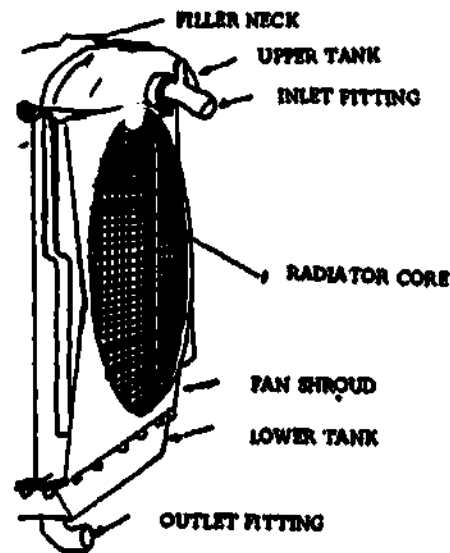

Fig 2-71. Location of common radiator leaks (rear view).

## 2-8. BODY AND CAB

a. Cleaning and spot painting. Cleaning and spot painting are more extensive when performed for the weekly preventive maintenance check than for the daily check. Cleaning is not limited to just washing the vehicle down. Dirt and trash should be removed and excess forms or forms that are soiled or unreadable should be removed. The gathering places for these items are the glove box (fig 2-72), oab storage compartments (fig 2-73) under seats, behind seats, and cargo bed (fig 2-74). When these areas are clean of dirt, give them a really hard look to see if rust/corrosion has started.



Fig 2-72. Glove box.

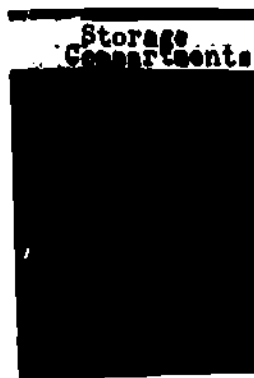

Fig 2-73. Storage compartment.



Fig 2-74. Cargo area.

The engine (fig 2-75) and the bottom of the vehicle (undercarriage) may require cleaning to remove dirt and grease. Steam cleaning may be available, but do not direct steam or water into air filters or oil caps. Do not direct steam and hold it in one specific area too long either, since extreme heat is generated which tends to remove lubrication from items such as spring shackles and tie rod ends.



Fig 2-75. Engines may need cleaning.

When cleaning vehicles, water should not be directed throughout the cab area. Due to the construction of the cab, certain areas retain water, especially in the corners. This water will remain for quite some time and will cause corrosion to begin. The canvas on the seats will also be more susceptible to mildew if water is sprayed all around. Never use gasoline (fig 2-76) for cleaning purposes. The danger is great and it does not do as good a job as authorized and safe cleaning solvents or detergents. Use caution when cleaning engines. Allow the engine to cool down. If cold water is directed at a hot engine (especially the manifold (fig 2-77)), cracking or warpage of the parts may occur.

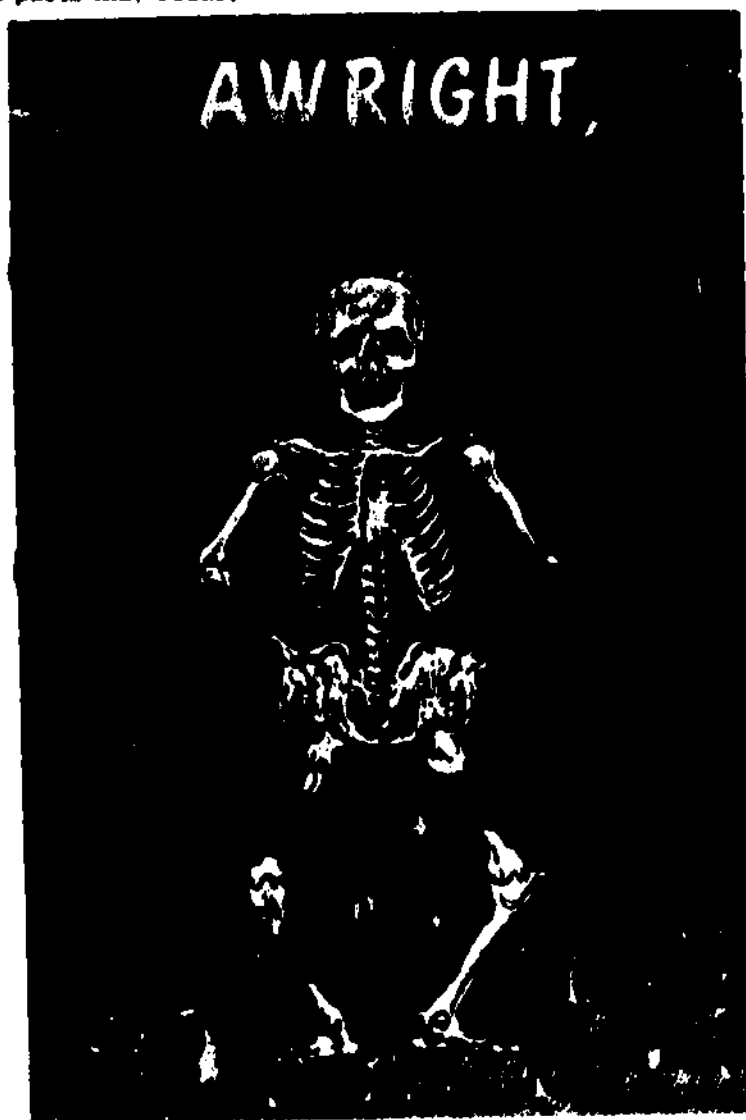

Fig 2-76. Never clean with gasoline.

2-34

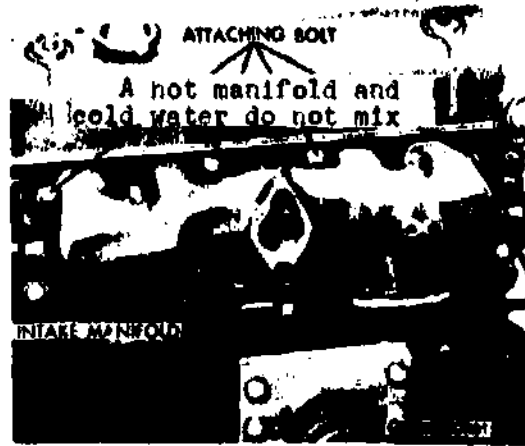

Fig 2-77. Allow engine to cool before cleaning.

Spot painting is performed after the vehicle has had a good cleaning and is free of moisture. Make sure that the areas that need spot painting are dry. This can be done by wiping the area dry, using air pressure for difficult corners, or by letting the area air dry. Small areas of the floorboards (fig 2-78) and cargo bed areas will require spot painting from time to time. These types of areas are not hard to prepare. They are flat and fairly easy to get at. Corrosion may be present but it is normally very light. Areas such as those shown in figures 2-79, 2-80, and 2-81 are the ones normally neglected. They are harder to clean and prepare but, because they are the most neglected, they are really the ones that you need to take care of. Spot painting is performed to arrest the spreading of corrosion. To prepare the surface, use appropriate tools/materials such as sand paper or wire brush.

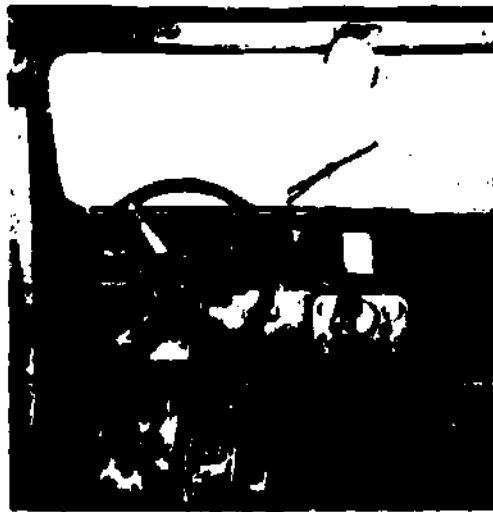

Fig 2-78. Floorboard areas.

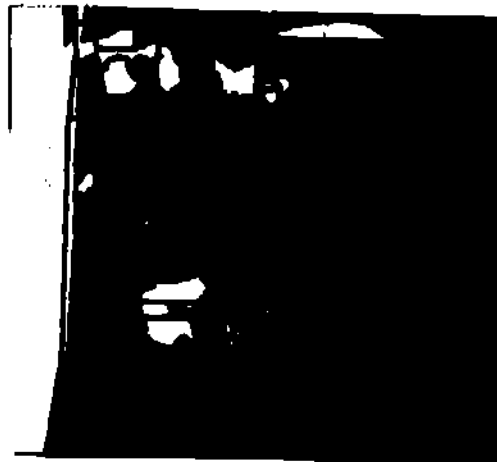

Fig 2-79. Spot painting neglected areas.

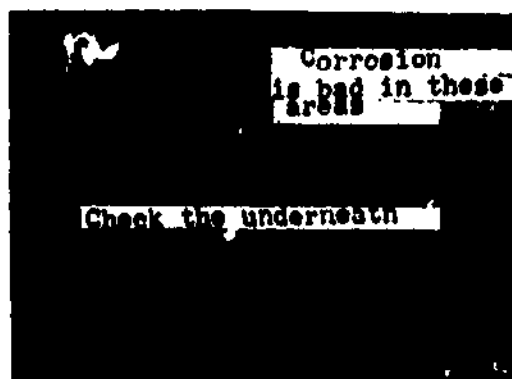

Fig 2-80. Difficult to remove corrosion.

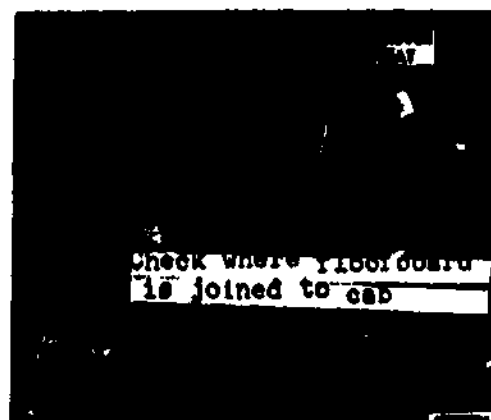

Fig 2-81. Difficult to prepare properly.

The most important part of spot painting is that all corrosion must first be removed. If rust is painted over, it will still continue to rot away. If the area is located where the moisture settles, it should be primed with a lead base/rust inhibitor type primer. The primer must be allowed to dry and then you may apply appropriate paint for the item. When applying primer and finish paint (especially in corners and channels), do not put it on too thickly. Two or three light coats will stand up longer than putting it on like syrup. Allow time for drying between coats.

b. **Dents.** When inspecting for dents (regardless of whether you start from the front, rear or side), make sure you do inspect all around. Be alert to the following items which are very likely to be dented:

- Front and rear bumpers.
- Brush guards for radiator, lights, and the radiator.
- Fenders.
- Hood.
- Fuel tanks.
- Sides of cargo bed or personnel carrier.
- Cargo bed (bent from loading with crane or forklift).
- Tailgate.

When inspecting, you should consider dents as being gouges/deep scratches that are below the normal surface of the metal. Statements such as dents throughout should not be made, since this may mean a lot of dents. Exact locations should be noted, for example, "right side, front fender directly over tire." You should give the supervisor good sound information so he can check it and plan accordingly.

c. **Canvas and bows.** Canvas can be easily neglected but, if you would, think of it in this manner: it helps keep both driver and passengers dry and warm; it protects the cargo from the elements; and it also helps cut down your maintenance. The cab, wooden troop seats, and cargo sides will require less maintenance if protected from exposure to the weather. Dry the canvas when inspecting. You should visually inspect for the items listed below:

- All bows (fig 2-82) should be even across the top. This adds to appearance and gives equal support to the canvas.

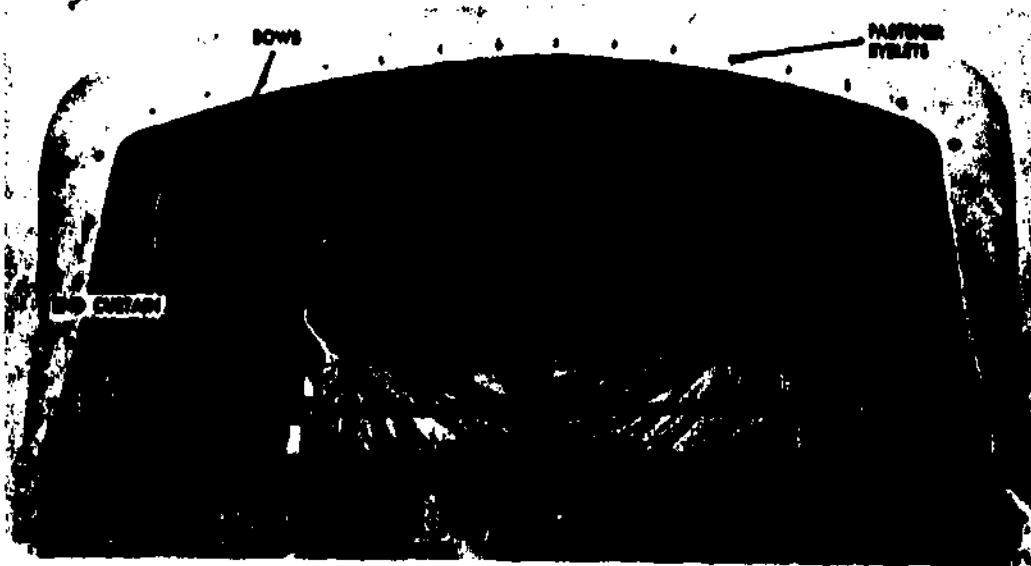

Fig 2-62. Bows should be the same height to support the canvas.

- If there is hardware pressing against the canvas as shown in figure 2-63, rips and holes will develop.



Fig 2-63. Inspect for hardware pushing against canvas.

- Tying of canvas can be done in many ways. The method illustrated in figure 2-64 enables the canvas to be tightened so that it will not flop and prevents the tiedowns from coming untied.

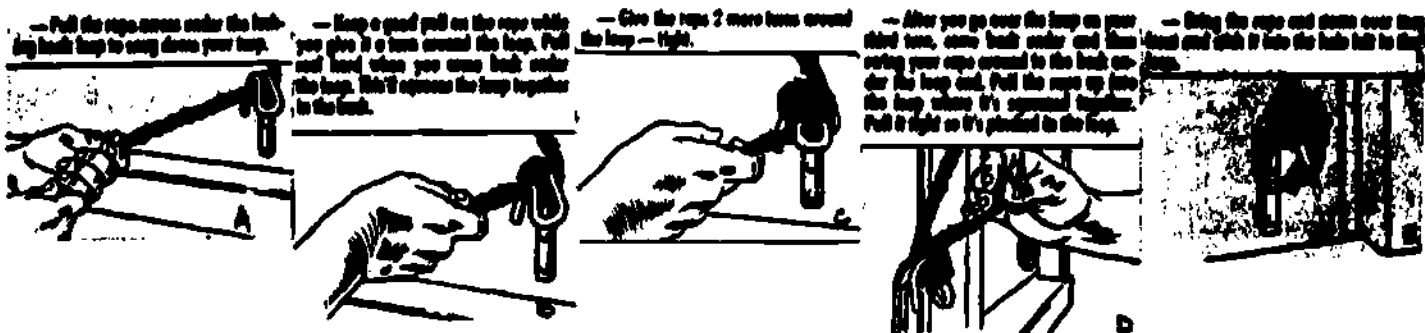

Fig 2-64. Lashing canvas.



- Eyelets (grommets) are metal supports (fig 2-85) that look like washers. They are inserted in canvas to strengthen it where tiedowns are installed. If the tiedown is inserted in the canvas without any eyelet, the canvas will tear when the tiedown is tightened.



Fig 2-85. Grommets will prevent the canvas from tearing.

- Bows and troop seats (wooden) (fig 2-86) must be checked for weather cracks, missing/loose bolts or seat pins that hinge the seat to the side. If seat pins are missing and personnel are being carried, seats could break because of the unequal support. Troop seat legs must be checked for missing bolts and free movement. Otherwise when the seats are raised to load cargo, the leg will not lie against the side.

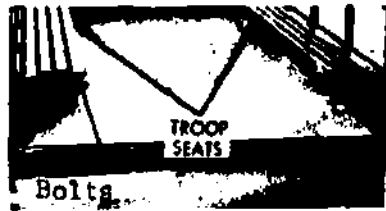

Fig 2-86. Troop seats require maintenance.

- Cab tarps are held in by a channel (fig 2-87) located on the top section of the windshield frame. This area should be checked to insure that the canvas is locked in the channel. Also check all fasteners (fig 2-88) to insure that they are serviceable. If brace rods are used, they should be straight and you should make sure that retainers (cotter pins/safety pins) are installed. Some vehicles also use straps (fig 2-89) for canvas tiedowns on the sides or rear. Insure that the straps are not rotting or not coming unscrewed from the canvas. Make sure that the buckle on the strap stays tight when it is tightened. Check the plastic windows for cracks and discoloration.

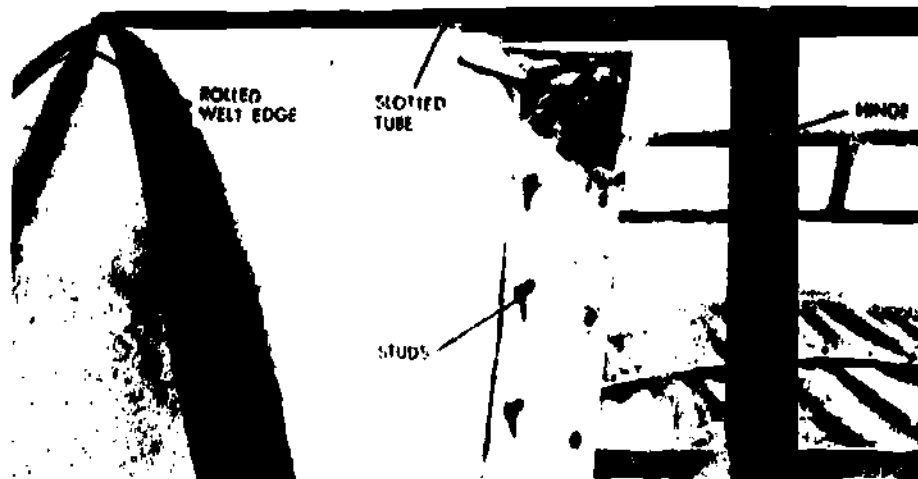

Fig 2-87. Sliding soft top beaded edge through channel.

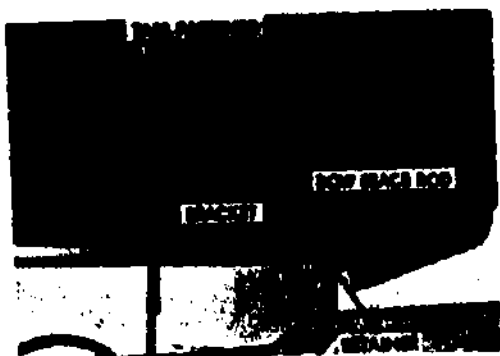

Fig 2-88. Canvas fasteners and supporting rods.

Fig 2-89. Tiedown straps.

- Our biggest enemy, when it comes to canvas, is mildew. Mildew can be prevented if canvas is kept clean and dry. This is sometimes hard to do, but we can still win the battle if we keep a few things in mind. Mildew thrives on a combination of heat, dirt, and water, so you can see that canvas doesn't stand much of a chance unless we give it plenty of help. Keeping canvas clean and exposing it to air and sunlight are the two biggest factors used to fight mildew. Air canvas as much as possible. When airing out, use a method such as the illustrated in A, figure 2-90. If at all possible, do not roll canvas tightly, because you will be helping mildew (B, fig 2-90). We realize that canvas does have to be rolled or folded at times, but you should never fold or roll wet canvas or leave it that way for any length of time. Hanging canvas out to dry as shown in figure C, figure 2-90 is dead wrong!

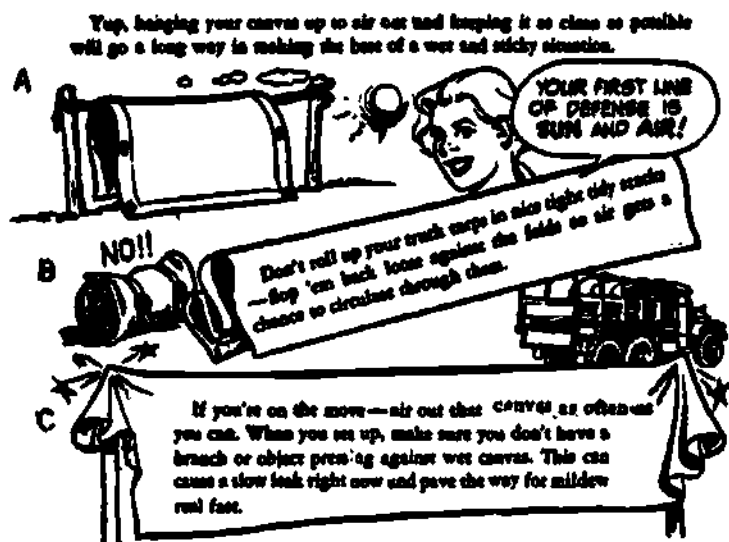

Fig 2-90. Fighting mildew.

- If you have a sluggish zipper, there is a special lubricant to use. It may be hard to find, so you could consider using a wax candle and rubbing both sides of the zipper as shown in figure 2-91.



Fig 2-91. Lubricating a zipper.

- Canvas should be dry before it is stored. Any spots caused by oil, grease, or just plain dirt should be removed. Wire brushing is an accepted method for doing this. Pay particular attention to folds and seams; they are prime areas for mildew to start. If you should have the job of maintaining stored canvas, here are a few tips.
- Stack canvas on clean, dry dunnage (wood pallets, boards). This will help the air circulate around the canvas. Keep canvas off damp floors and protected from exposure to rain.
- Tag all canvas. It would also help if you noted the day you put it in storage. This helps when issuing, because the one stored the longest should be issued first (fig 2-92).



Fig 2-92. Canvas stored the longest should be issued first.

d. **Glass.** Check for cracked glass in windshields and door glass. Visually inspect the weather seal for wear (fig 2-93). The weather seal not only seals the window around the frame, but also acts as a guide when the window is rolled up and down. If the seal/guide is badly worn, it can cause the window to be loose in the frame. When this happens, the glass is more likely to break, especially if the window is partially down and the door is slammed. If the seal is worn badly enough, it can also cause the window to slant left or right (not guided properly). If this happens, the window regulator (part that rolls the window up and down) will become bent and twisted and will prevent the window from going up and down. Windshields are incased in rubber but some also have a metal frame. Corrosion is ready to start rotting away at the frame if not prevented. If more than the removal of corrosion around metal frame is necessary after inspection, insure that it is noted on your maintenance form for supervisory action. Caution must be used when wire brushing or sanding near the edge of the frame. The glass could be scratched. Protect it with masking tape or heavy paper.

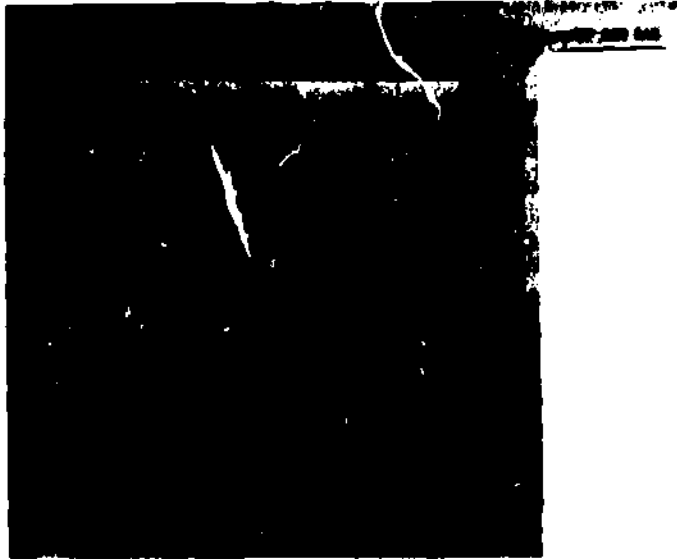

Fig 2-93. Door glass and frame.

e. Towing/tiedown fixtures. Check the nut (1, fig 2-94) and cotter pin (2, fig 2-94) to make sure they are in place on the pintle hook. The pintle hook must be able to turn, but not have too much front-to-rear play. The cotter pin must be installed. The upper jaw (3, fig 2-94) is designed to stay in the open position when opened until closed by the operator. If the top jaw will not stay open, you will find it very hard to hold the jaw open with one hand and lift the trailer with the other. Safety pin (4, fig 2-94) and chain (5, fig 2-94) must be attached to the pintle as a safety device to prevent the upper jaw from accidentally opening. Grease fittings (6, fig 2-94) insure proper lubrication of the pintle hook.

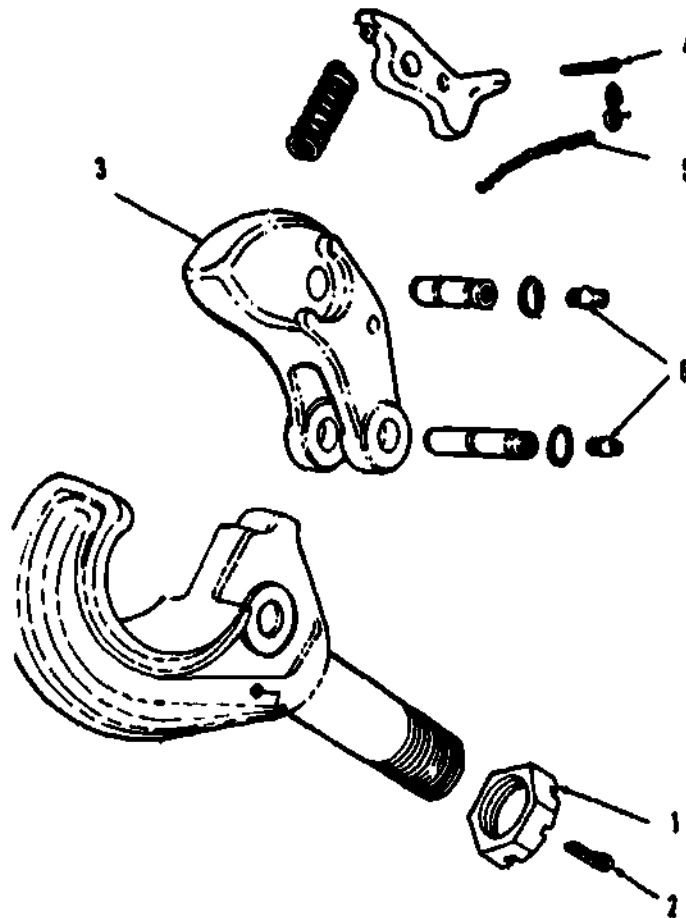

Fig 2-94. Exploded view of pintle hook.

2-41

Tiedown fixtures (fig 2-95) must be visually inspected to insure that the fixtures are properly assembled and safety pins installed. Fixtures that are bent and prevent the webbing or chain from being passed through the opening are useless and must be replaced. Fixtures should be checked by hand to insure that they move up and down freely. Figure 2-96 illustrates the use of tiedown fixtures.



Fig 2-95. Tiedown shackle,

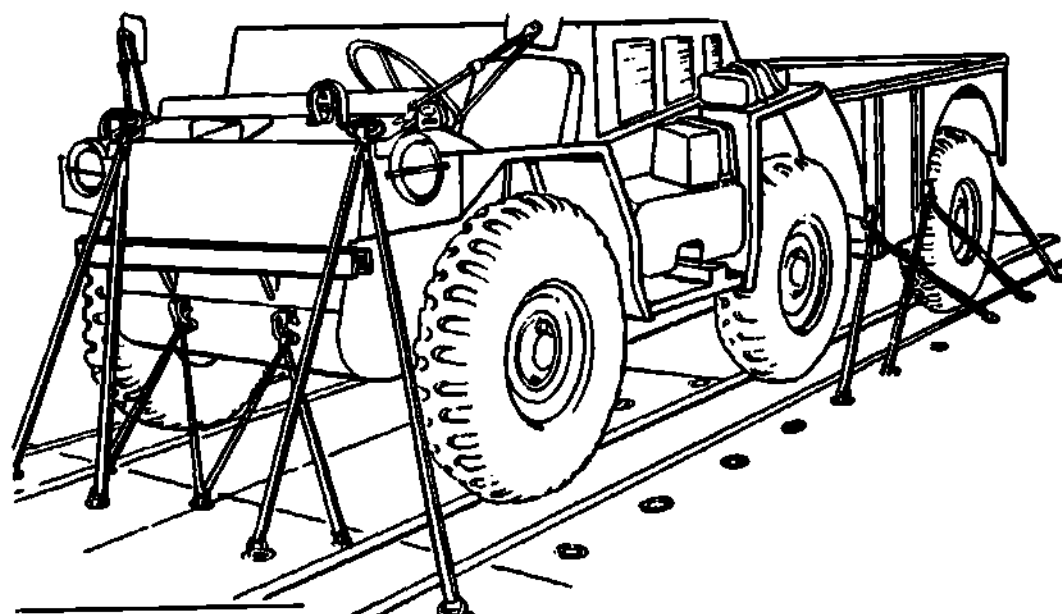
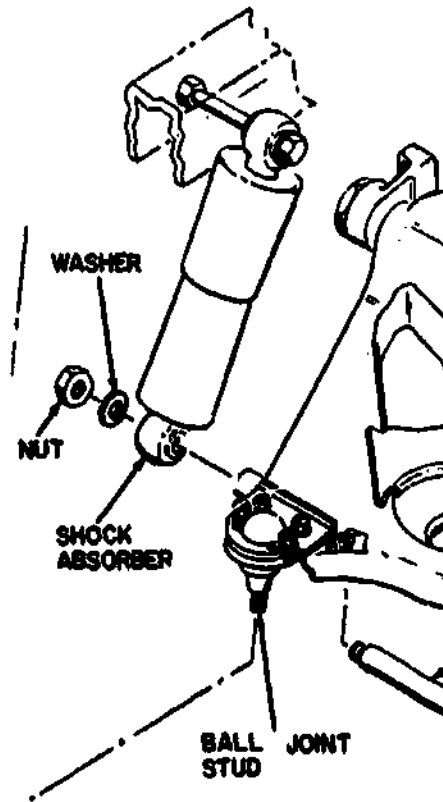

Fig 2-96. Use of tiedown fixture.

## 2-10. SUSPENSION

a. **General.** The suspension can be checked using a creeper, but a pit or ramp is much better. First, visually inspect the vehicle. Make sure that the vehicle is on relatively flat ground, that it is unloaded, and that the tire pressure is correct. Does it sag or appear to be lower in one corner than another? This is your first tipoff that something is wrong.

b. **Shock absorbers.** Let's start with the shock absorbers (fig 2-97). Insure that the rubber bushings are intact and not worn. Grasp the shock and try to wiggle it. There should not be any play at the point where the mounting bolt passes through the shock (fig 2-97). If the bushing is worn, the up and down motion of the shock will cause the mounting bolt to wear through the metal part of the shock. Mounting bolts must also be tight. If not, the movement of the bolt will enlarge the hole of the body bracket. A wet or damp appearance of the shock usually indicates it is leaking. If so, it should be replaced.



A. Top of shock.

B. Bottom of shock.

C. Exploded view.

Fig 2-97. Shock absorber.

If your vehicle has shocks mounted as in figure 2-98, they can be checked by pulling up or pushing down on the front bumper. If there is looseness at the top or bottom, the stem may need to be snugged up or the rubber bushing may be worn (fig 2-99). The shock can be tightened by holding the stem and turning the nut (fig 2-100). If the shock is still loose after tightening the nut, record it on the weekly for supervisory action. Shock absorbers are exceptionally important, especially when coil springs are used to prevent pitching and rolling.



Fig 2-98. Shock absorber passes through center of coil spring.



Fig 2-99. Shock could need tightening or the bushing could be worn.



Fig 2-100. Shocks can be tightened.

c. **Springs.** Springs are the next item. Check coil springs (fig 2-101) for cracks and sagging. Leaf springs must also be checked for cracks. For a good inspection make sure that the dirt is brushed off. A leaf spring may be cracked, and the vehicle may not sag but the rest of the leaves are being overloaded. Check both sides of all springs (fig 2-102). Check leaf clips to insure that they have not loosened. Reposition and tighten the clips if required. Check "U" bolts (fig 2-102) for signs of shifting and make sure that they are tight. The bottom leaf has a tit in the bottom that seats in a hole of the axle. Loose "U" bolts can cause it to slip out and the spring will shift. Remember, that leaves of a spring must work as a team; a cracked spring leaf means added stress to the others.



Fig. 2-101. Coil spring.

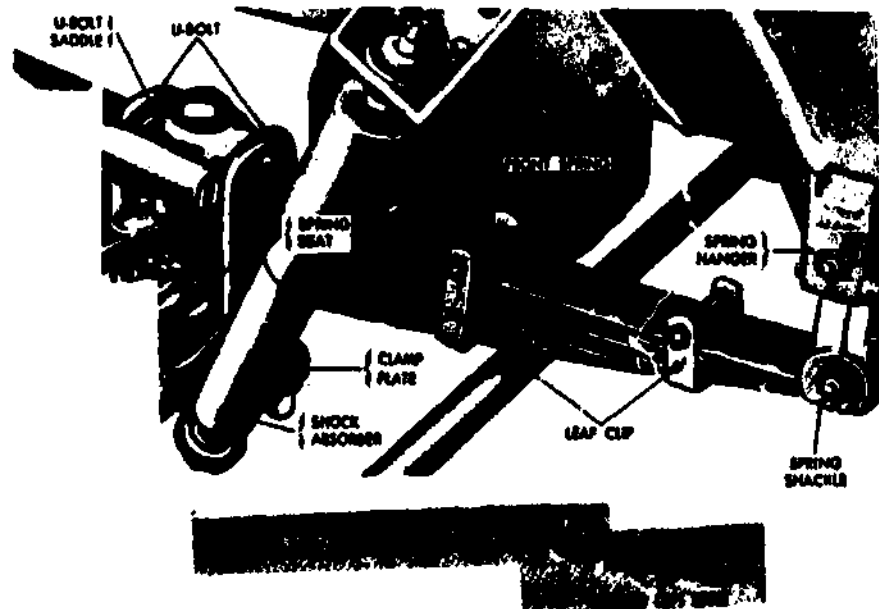

Fig 2-102, Leaf spring.

## 2-11. POWER TRAIN

a. **Propeller shafts and universal joint.** The propeller shafts shown in fig 2-103 are used to transmit power from the transmission and transfer to the front and rear axles. The propeller shafts are connected by a universal joint (fig 2-104). The propeller shaft (drive shaft) should be checked for dents and large amounts of mud. These conditions could affect the alignment and balance of the shaft which would cause vibration.



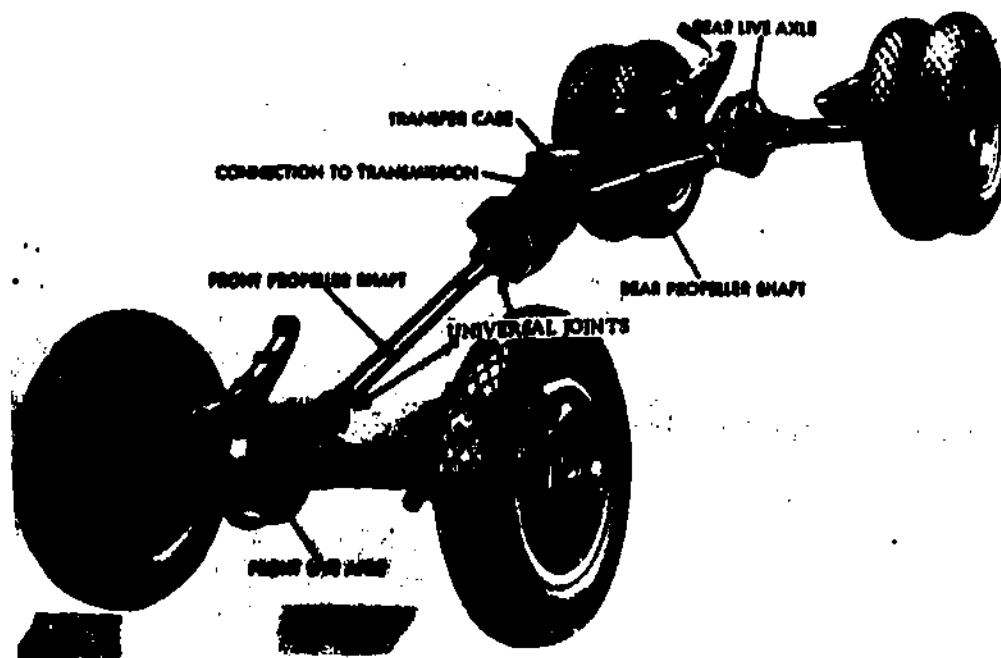

Fig 2-103. The propeller shafts.

The universal joints are subject to considerable stress. If the "U" bolts or flange bolts (fig 2-104) are not kept tight, the excess play will cause excessive wear and could even cause the drive shaft to fall out.



Fig 2-104. Universal joint; connects propeller shaft to axle and transmission.

When the shaft has been inspected and we are assured that the "U" bolts are tight, we must determine if the universal joint itself is worn. To do this, first insure that the transmission is in neutral so that the shaft can be rotated 360°. Next, grasp the shaft with one hand and the universal joint with the other as shown in figure 2-105. Now try to twist the shaft (not push or pull) to check for play (looseness). They should turn together. If there seems to be too much play, indicate that on the weekly sheet,



Fig 2-105. Checking for worn universal joints.

The power train mounting bolts (fig 2-106) should be checked for tightness. There's a lot of vibration and stress on these bolts and they do work loose. Most power train supports have rubber insulators between the components and the support bracket, the purpose of which is to absorb movement and vibration. When tightening these bolts, do not draw them down too much so that the rubber insulator is squeezed so tightly that it can't act as a cushion.



**POWER TRAIN MOUNTINGS** (engine, transmission, transfer) — Bolts missing, loose, bent.

**Fig 2-106.** Check power train mounting bolts for tightness.

b. **Transmission/transfer.** The transmission and transfer should be checked to see if they have the proper lubricant and that they do not leak. On some vehicles the transmission lubricant flows into the transfer case from the transmission. If the level of the lubricant in the transmission is at the proper level, then the level of the lubricant in housing and both the transmission and transfer must be checked separately. Before removing any plugs, be sure to check the appropriate TM or lube order. To see what is meant, look at figure 2-107, the M-151 transmission. The head of the shifter pin may look like the head of the oil level plug, but if it is removed by mistake, it means deadlining the vehicle. Make sure you know the location and remove the oil level plug, not the shifter pin. The shifter pin should have a tab installed, but it could be missing.

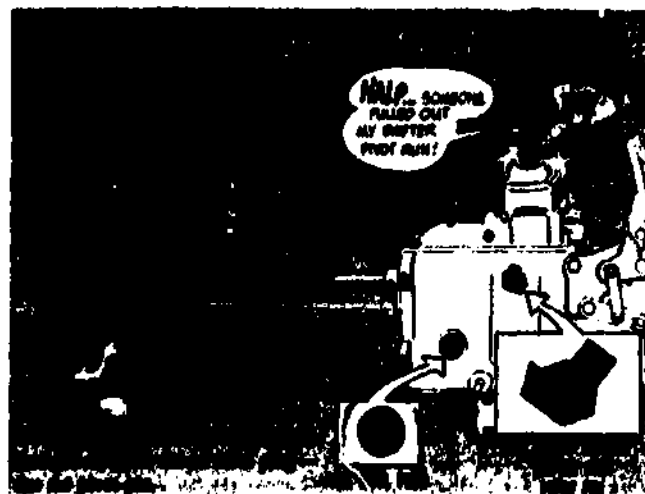

**Fig 2-107.** Accidental removal of the shifter arm pivot pin.

c. **Differentials.** The bolts that hold the differential covers on (fig 2-108) must be checked for tightness. Loose bolts will cause the lubricant to leak past the gasket which is between the cover and the face of the differential. Another common cause of leaking is a lubricant level that is too high.



**Fig 2-108.** Bolts must be kept tight to prevent leaking.

When the lubricant gets hot, it expands. If the level is correct, there is no problem, because there is room for it to expand. Now if the level is too high, there will not be enough room for the lubricant to expand when it gets hot, and no place for the pressure to go, so it forces past the seals and causes a leak. How can we tell if the lubricant level is too high? First, make sure the vehicle is sitting level and that the differential is cold. Next, remove the fill plug. Lube oil should NOT run out (fig 2-109). If the fill plug is removed and oil is not coming out the fill plug, we have determined it is not too high, but remember it could be too low. To check for the correct level, a general rule is to stick your finger in the filler plug hole to the first joint (fig 2-109) and if you can touch oil, you're OK. If you can't, the level should be brought up. We briefly discussed that lubricant will build up pressure when heated. On most tactical type vehicles, a breather is installed to relieve excess pressure (fig 2-110). We, as operators, must insure that they can function properly. To do this, twist the breather cap (fig 2-111). This insures that the cap is free and not filled with dirt. Next, push the cap down. It should spring back up. This insures that the spring-loaded valve inside is working.

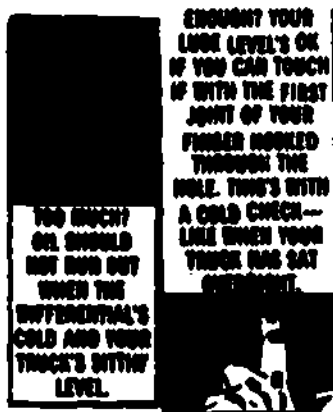

Fig 2-109. Differential oil level.

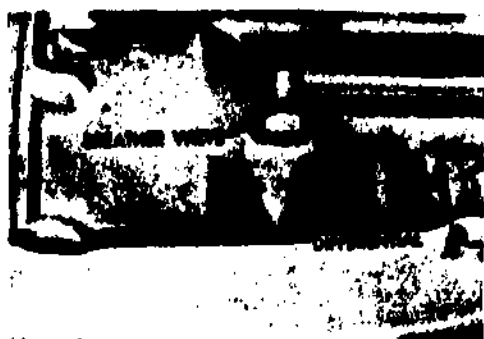

Fig 2-110. Differential breather valve.

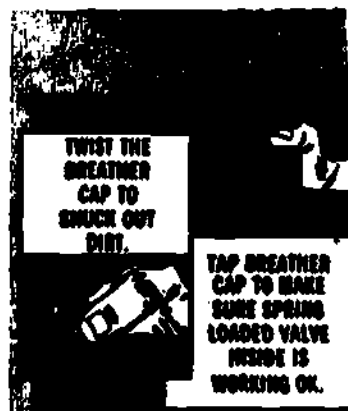

Fig 2-111. Make sure that the breather valve is working properly.

## 2-12. WHEELS

Start with the rim and insure that it is free of mud and dirt. This will make a visual inspection easier and more thorough. Check the rim for cracks, broken welds, and dents. If cracks are found, the rim should be replaced. Dents will cause the tire to run untrue, which is also a cause for replacing the rim. Lugs are checked next, keeping in mind that there are lugs which have left- and right-hand threads. The stud (lug) on the wheel is sometimes marked on the end (fig 2-112) with an L or R meaning left- or right-hand threads and the nut is marked in the same way. If just one or two lug nuts are loose, tighten them properly. If they are all found to be loose, jack up the vehicle, remove all the lug nuts, and check the holes in the rim to make sure they have not been made larger by the loose nuts. Insure that the beveled edge of the lug nut (fig 2-113) tightens against the rim and that the beveled edge is centered in the rim hole. You should first finger tighten all nuts to insure that they are centered in the rim holes and then tighten them with the appropriate tool. If you find elongated holes in the rim, replace the rim,

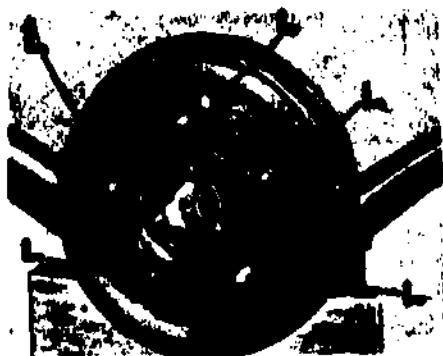

Fig 2-112. Wheel studs may be marked with an "L" or "R."



Fig 2-113. Beveled edge of nut faces into the rim and is centered.

If the wheel has a locking rim, visually inspect it to insure that it is seated. If any work on the lock rim is to be done, the tire must first be removed from the vehicle and deflated by removing the valve core. When the work is completed and you are ready to inflate the tire, be sure to place the tire in a cage to prevent an accident. Inspect tire thread and side walls for abnormal wear, wear beyond safety limits, and bulges and cuts that are through to the cord. Visually inspect for **MISMATCHED** tires with consideration to size, depth of tread, and design. Valve caps should be installed to protect the stem threads and keep out dirt. The stem should project through the rim, centered, and at the proper angle. This will prevent the stem from chafing.

### 2-13. FUEL SYSTEM

a. Tank. Let's start with the tank (fig 2-114) and its support brackets. Visually inspect for dents and creases in the tank. The support brackets should have some type of padding (fig 2-115) which prevents metal-to-metal contact between the tank and the support brackets. If padding is missing, there won't be any cushioning effect, and the movement of the vehicle could cause a puncture in the tank. Support straps and brackets must be tight. Record any defects noted on your weekly form for supervisory action.

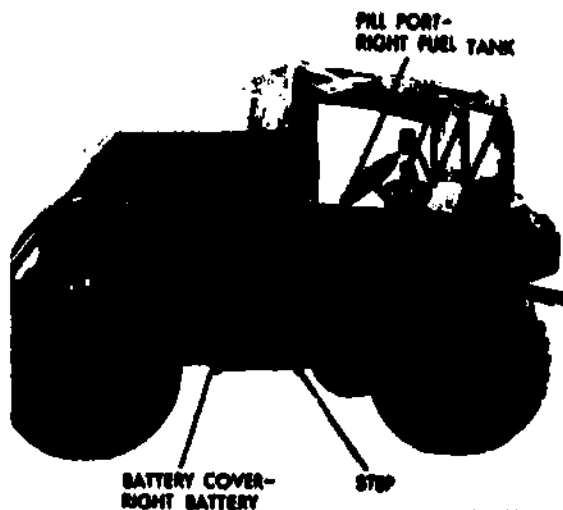

Fig 2-114. Fuel tank.

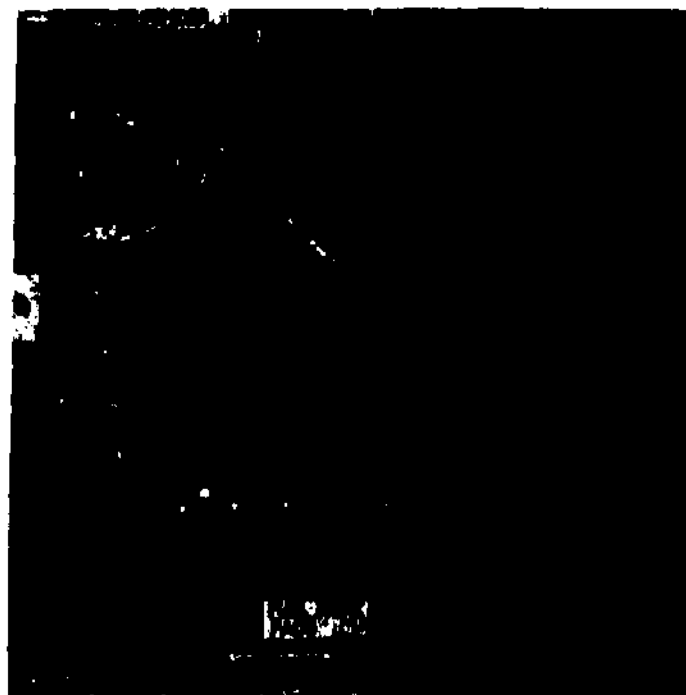

Fig 2-115. Fuel tank pads used to prevent wear.

Now take a look at the filler cap. Visually inspect the cap (1, fig 2-116) to insure that the small chain is attached to the filler pipe. The chain prevents loss of the cap. Next, look at the underside of the cap to insure that the gasket (2, fig 2-116) is in good shape. It insures a good tight seal between the filler neck and cap. The fuel filter (3, fig 2-116) can be removed from its normal position which is just a little below the top of the filler pipe (4, fig 2-116). When you remove it, visually inspect it for holes and clean it if there is any accumulation of dirt. The filter can be cleaned by using air pressure and directing it from the opposite end in which the fuel is put in the tank. All filters may not have the same shape but they all serve the very same important purpose, preventing foreign material from entering the tank. If holes appear in the filter, it should be replaced.

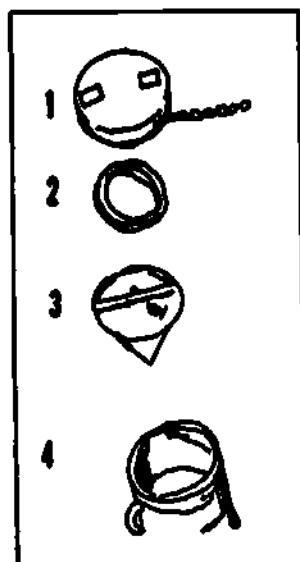

Fig 2-116. Fuel tank cap, filter, and filler pipe.

b. Fuel lines and fittings. Visually inspect fuel lines and fittings for signs of leaking. Caution should be exercised when tightening, because fittings may be made of a soft metal such as brass. Soft metals can be deformed very easily either by overtightening or by using an improper tool to tighten them with. Line clamps (fig 2-117) reduce vibration and keep the line from wearing due to rubbing against some other part of the vehicle.



Fig 2-117. Clamps are used to support the line.

c. Fuel filters. If dirt or other substances get into the fuel, your vehicle could be in trouble. Most vehicles have some type of fuel filter. It might start off with just a simple strainer in the gas tank filler neck (fig 2-116). Other vehicles have two filters, the first one being called the primary filter (fig 2-118) and the second one called a secondary filter (fig 2-119). Other vehicles have a glass bowl type filter (fig 2-120). The strainer type filter is easily cleaned of dirt and replaced as it starts to deteriorate. The primary and secondary filters should be drained (1/2 cup) daily before operations and on the weekly. If possible, the fuel drained should be drained into a container so that the fuel can be checked for water and other contaminants. In cases of high rust content or excessive foreign matter, filters may have to be changed. After visually inspecting the fuel if you think that the filter should be changed, notify your supervisor for corrective actions.

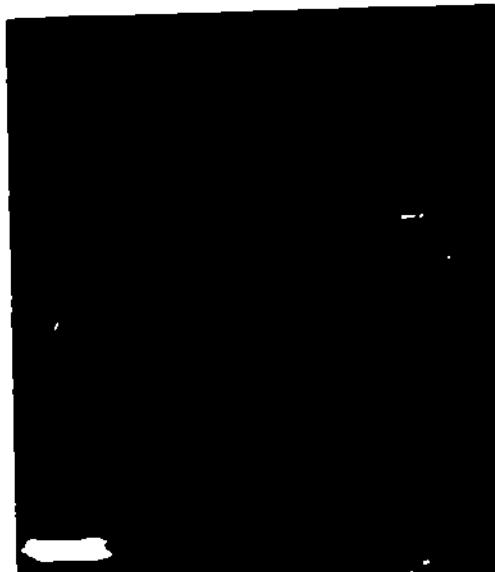

Fig 2-118. Primary fuel filter.

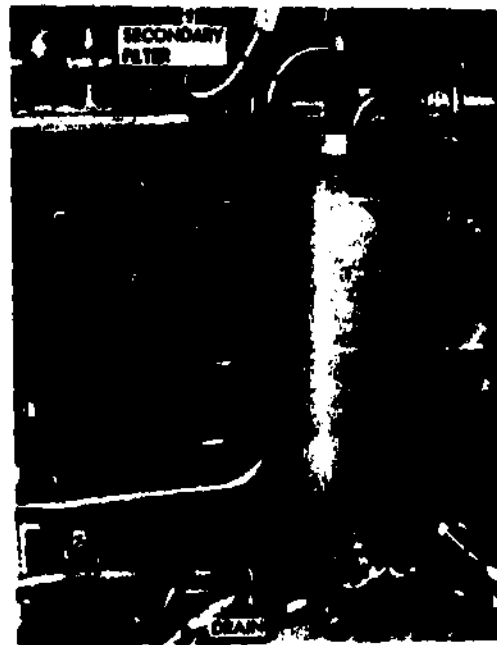

Fig 2-119. Secondary filter.

The glass bowl type fuel filter cleans the fuel by collecting dirt and sediment in the bottom of the bowl. To clean this type of filter, loosen the knurled nut at the bottom, swing the metal holding device to the side (hang on to the bowl because it could fall), gently wiggle the bowl free, dump the old fuel, and wash or wipe the bowl clean. Inside the bowl there may be a bronze or paper type element. The bronze filter can be checked by wiping it dry and blowing through it. If air does not pass through it freely, it has restricted air flow and may need replacing. The paper type element should be replaced if clogged up. When replacing the glass bowl, insure that it is properly seated into the housing, swing metal bowl supports in line with the bowl, and retighten the nut. Just snug it up, then check for leaking.



Fig 2-120. Sediment bowl type filter.

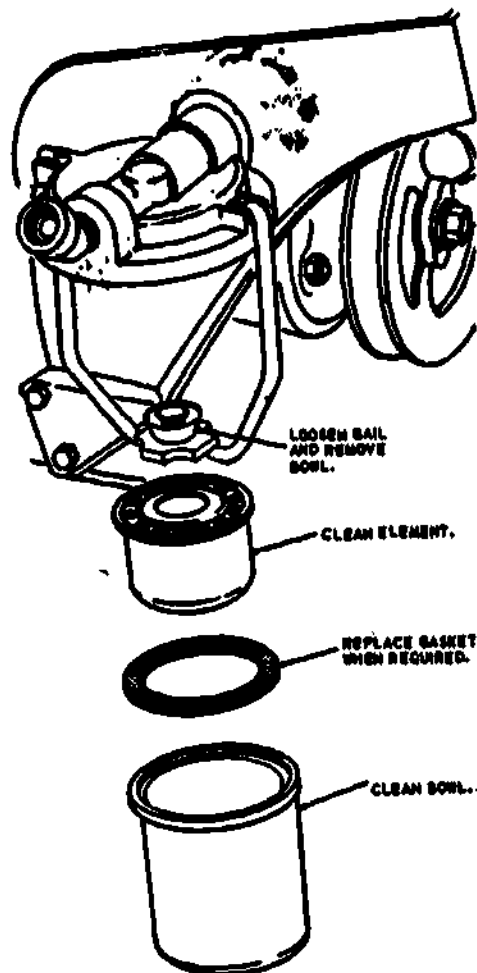

Fig 2-121. Fuel filter servicing.

2-14. ELECTRICAL SYSTEM

Our discussion of the electrical system will include the battery, battery tray, holddown, terminal lugs, cables, headlamp and bulb replacement, and drive belts.

Visually inspect the battery for signs of corrosion or improper installation. There are a couple of areas that you should check which will require removal of the battery. For instance the battery may have an excellent overall appearance, but is the area where the battery is actually sitting (battery box) free from corrosion? Is the inside of the terminal lug (fig 2-122) (the clamp that is pushed down on the battery post) clean? These are critical areas and the battery must be removed in order to check them.

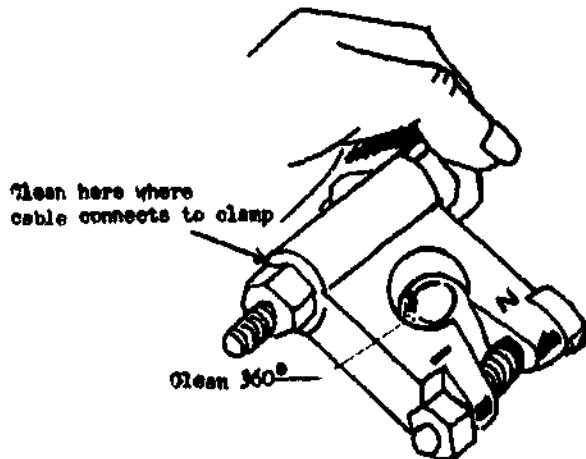

Fig 2-122. Terminal lug.



First remove the negative clamp, then remove the positive clamp. Use the proper tools or you can really ruin an otherwise good job. If the inside of the terminal lugs needs cleaning (fig 2-122), small pieces of sandpaper (a medium or fine grit would be easier to work with) wrapped around a pencil or similar object will do OK. If they are heavily corroded, brush on a solution of bicarbonate of soda and water. When the foaming stops, rinse it off. Then use sandpaper or a wire brush that is similar to a fifty cal. bore brush or the cleaner spreader tool which is made specifically for this purpose. In a pinch, a round file could be used, but do not enlarge the hole. Next, remove the battery holddown by removing holddown bracket rods (fig 2-123), and lift battery clear. Do not set the battery down where it can fall, because the ground can ruin a battery (the impact would probably cause damage). If the battery posts need cleaning, use any stiff brush (not a wire brush) on the top of the battery. If the battery posts or the battery top require a lot of cleaning, you should consider using a solution of bicarbonate of soda and water. Before you use that solution though, you should check the battery to insure that it has no cracks and that all vent plugs are on tight. The bicarbonate of soda and water solution is hard on battery electrolyte and will ruin it. Brush on the cleaning solution and when the foaming stops, wash it off. Next, inspect the bottom of the tray. This may require cleaning also. Clean with soda solution, rinse with clean water, and allow the tray to air dry. If corrosion is really bad, cleaning may have to be followed by wire brushing or light sanding. The surface should then be primed with a corrosive resistant paint and then painted with a finish coat of appropriate color. This task will take time, and the paint must be allowed to dry prior to reinstalling the battery. The retainer (holddown) bracket is treated in the same manner. If the retainer bracket is coated with a protective rubber-type substance and corrosion has started to work under the coating, it may be necessary to remove the coating and clean the retainer as you did the tray. When you are ready to install the battery(ies), make sure the holddown bolt is engaged at the battery tray end (fig 2-123).

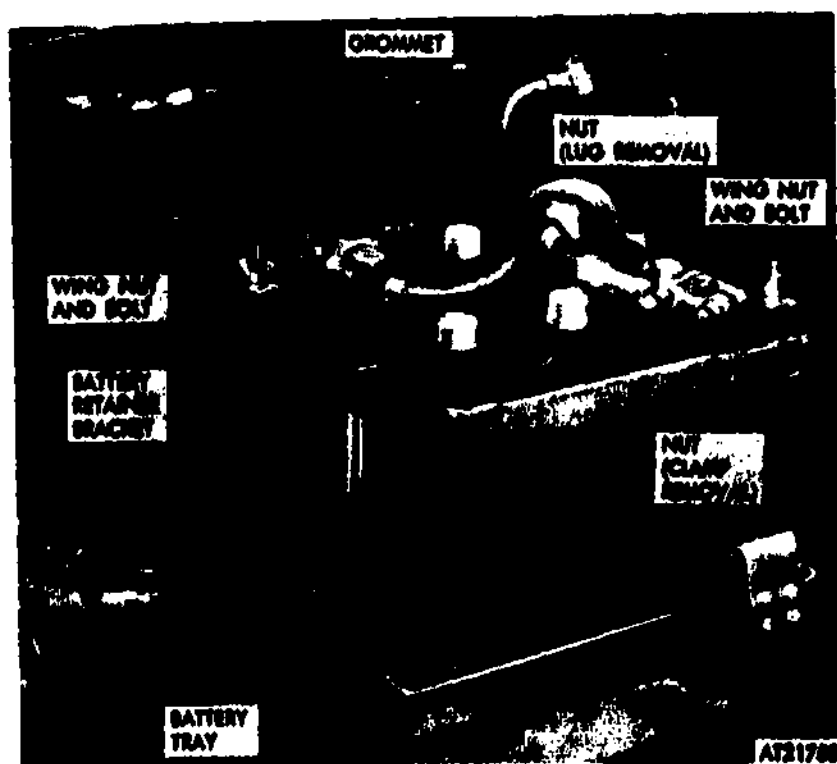

Fig 2-123. Battery holddown, rods, and tray.

Wiring must be visually inspected, including the connectors. If the connector is unplugged (figs 2-124 and fig 2-125), it will have an effect on your gages.



Fig 2-124. Oil pressure transmitter connector.

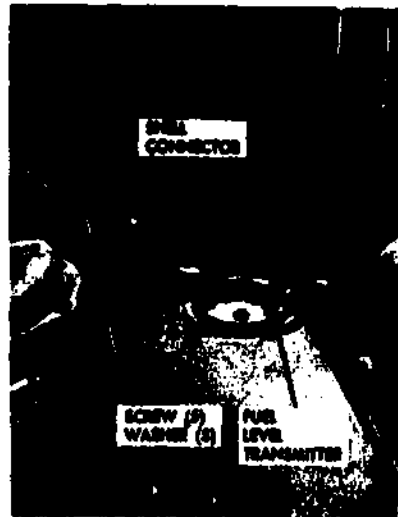

Fig 2-125. Fuel level transmitter connector.

Wiring must be checked for frayed insulation. In some cases, depending on the location and how badly the wire is damaged, electrical tape could possibly be used but you should consult your supervisor before attempting this method of repair. The reason for this is that the area taped will not be waterproof, although it could be used for a temporary repair. In figure 2-126 below, notice the rubber grommets. They must be installed if wiring is to be protected from the rough edges of the body of the vehicle.



Fig 2-126. Grommets protect wiring.

Connections that are held on with a nut (fig 2-127) must be checked for tightness and corrosion on both sides. If corrosion is present, both sides of the connector should be cleaned (insert, fig 2-127).



**Fig 2-127. Electrical connections.**

Harness connectors (fig 2-128) should be checked for tightness (fig 2-129), using just your hand. If the connector can be turned by hand, it is loose and should be snugged up to insure a waterproof connection. To tighten these types of connections, a spanner wrench is used (fig 2-130).



**Fig 2-128. Harness connection.**



**Fig 2-129. Disconnected harness connection.**



**Fig 2-130. A spanner wrench is used to tighten harness connection.**

When inspecting wiring, you must include the wiring underneath the vehicle. Make sure that the clips that are designed to keep wire from sagging (figs 2-131 and 2-132) are in place and doing their job. Also check the clips that are installed in a harness to relieve the stress on the connections. If they are missing, replace them. If they are loose and the wire has slipped out, reposition the wire and tighten.



Fig 2-131. Wiring clips must be kept tight.

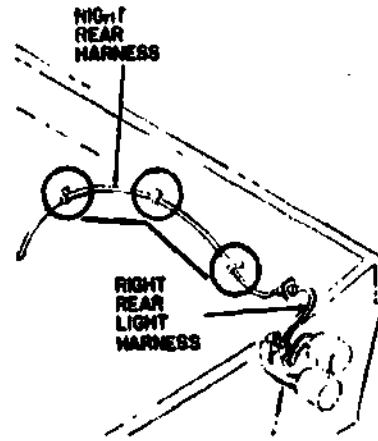

Fig 2-132. Wiring clips will keep wire up out of the way.

It may become necessary for you, as a driver, to change the headlight lamp or the bulbs used in the different lights such as the stop light/tail light. We will discuss the removal and installation of the headlight first. A standard lamp assembly is used on most tactical vehicles, and removal and installation will be the same. Prior to going through the removal procedures, you should be reasonably sure that a defective bulb is the problem. The only tool needed for this job will be a screwdriver, BUT it must be of the correct size and type. This is stressed because some retaining screws will be stubborn and using an incorrect screwdriver could result in damaging the slot in the screw head so that no screwdriver will work, or breaking the head of the screw completely off. If this happens, the vehicle will end up in the shop for the removal of the screw. Why? Well, without a watertight seal (where needed) the entire inside of the light will collect moisture and corrode, possibly causing the entire light assembly to be replaced. Let's now go through the removal procedures for the headlight.

Step 1. Remove the screws (normally there are three) that hold the headlight rim (fig 2-133) or headlight door as it may sometimes be called. Do not be concerned with the lamp falling out; it is still fastened in, but now the retaining ring screw will be visible.



Fig 2-133. Headlight assembly retainer.

Step 2. We can now remove the screws from the retaining ring (fig 2-134). These screws and the ring are what holds the lamp to the vehicle. Be cautious in performing these steps; there are other screws (fig 2-135) that are used for adjustment of the headlight. You should not attempt to make headlight adjustments. With the retainer ring screws removed, the ring and headlight can be removed.

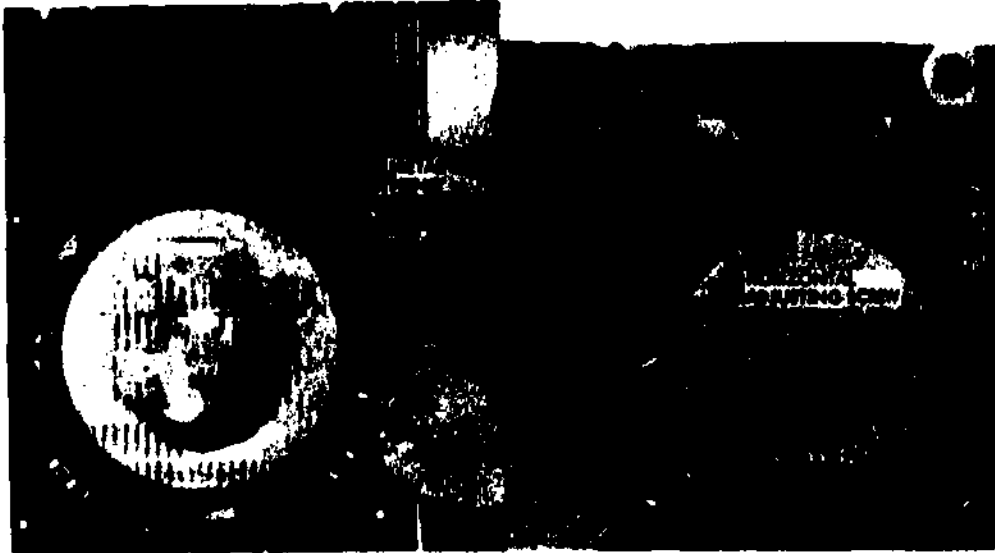

Fig 2-134. Removing the headlight retainer ring.



Fig 2-135. Horizontal and vertical adjustment screws.

Step 3. Gently pull the headlamp from the headlight body. This will expose the waterproof connectors (fig 2-136). Disconnect the connectors and the defective bulb (sealed beam unit) will be free of the vehicle. The new bulb will have connectors, and you simply connect them correctly by matching the number on the metal tag from the bulb to the one coming from the vehicle. At this point it's a good idea to test the lamp by putting on the headlight and hitting the dimmer switch.

Fig 2-136. Headlight waterproof connectors.



Step 4. Position the lamp and replace retainer ring and screws.

Step 5. Replace headlamp rim/door and screws. This will complete the installation procedures.

If a stop light or parking light bulb is determined to be defective, replacement is not too difficult but, as stated before, the proper tool is a must. On most tactical vehicles there will be two bulbs and sometimes three (blackout marker, parking light, and directional). For removal, follow these steps:

Step 1. Remove the door retaining screws (normally six) holding the door/cover to the light body (fig 2-137).

Step 2. Remove the door gently so that the preformed gasket is not ruined (fig 2-136). As previously mentioned, this makes the light assembly waterproof.

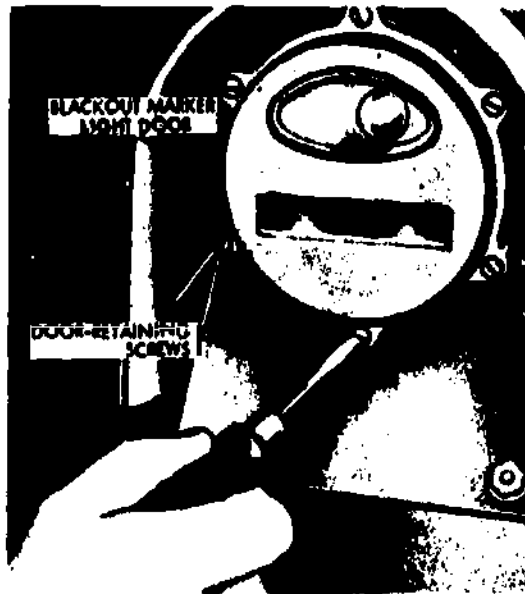

Fig 2-137. Removing the door retaining screws.

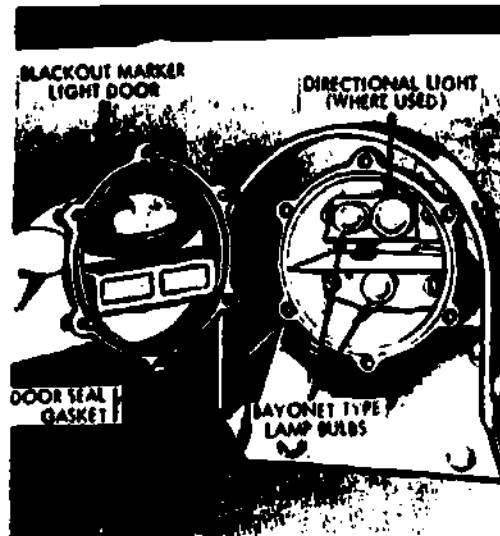

Fig 2-138. Removing the door to expose the bulbs.

Step 3. The bulbs are now exposed and can be removed. The type of bulb used is a bayonet type (fig 2-139). It has two small lugs, one on either side of the base. For removal, the bulb must be gently pushed in and turned counter-clockwise (to the left). A new bulb can be inserted in the socket and turned clockwise (to the right) so that the lugs will engage in the slots of the socket. At times, when removing a bulb, the glass portion may break off from the metal base. If this happens, the batteries should be disconnected. Use pliers to remove the base. Test the new bulb after it is installed prior to replacing the cover.



Fig 2-139. Bayonet-type base bulb.

Step 4. Insure that the gasket on the door is in place and position the door (make sure the red portion is at the top) and secure the screws. This completes the installation procedure.

A brief explanation of the drive belts is included here because they transmit power from the engine to drive the alternator/generator. The drive belts must be visually inspected to determine if they are frayed or excessively worn (fig 2-140). They must also be checked for proper adjustment (tension) (fig 2-141) and alignment. Most military vehicles are equipped with more than one belt. Upon inspection, if it appears that one belt has stretched more than another so that only one is taking all of the load, the belts may have to be replaced. When one belt needs replacing, the entire set should be replaced. Then all belts will share the load equally.

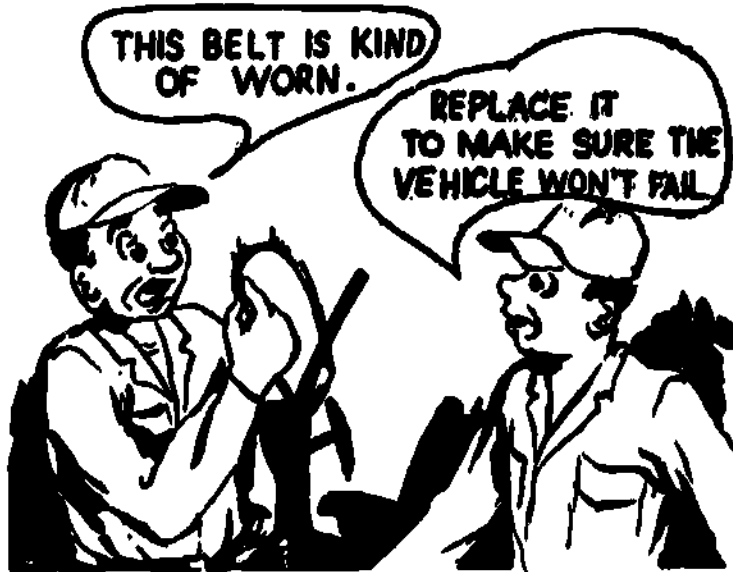

Fig 2-140. Visually inspect drive belts.



Fig 2-141. Belts may require adjustment.

2-15. STEERING SYSTEM .

a. Steering gear box. Check the steering wheel for looseness (push down and pull up). If it is loose, the nut under the horn (fig 2-142) could be loose or it could be a bearing in the steering gear box. The operator should not repair it, but he should report it. Check and see if the steering wheel column flange (fig 2-143) is tight. If it is loose, the whole steering wheel column will be loose.

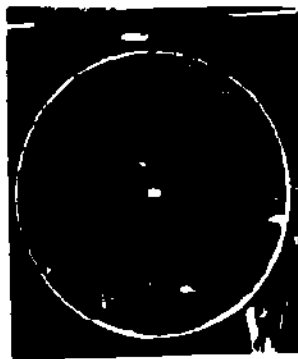

Fig 2-142. Steering wheel.



Fig 2-143. Steering wheel column flange.



Check the steering gear box mounting bolts to insure tightness (fig 2-144). When inspecting visually, the buddy system should be used. One person can turn the steering wheel back and forth while the other visually checks the steering gear to see if it moves away from the frame.



Fig 2-144. Steering gear mounting bolts.

b. Steering gear linkage. Using a little team work, have a man turn the steering wheel back and forth continuously. While he's doing that (it's best if vehicle is on a lift or over a pit), observe tie rod ends (fig 2-145). Being worn will cause them to be loose. If the wheel can be turned back and forth any great distance without causing the wheels to move and the tie rod ends are OK, the pitman arm may be worn (fig 2-146). If looseness is observed, report it for correction. The steering bellcrank may also be loose (fig 2-147). Adjustment and replacement are done by shop personnel.

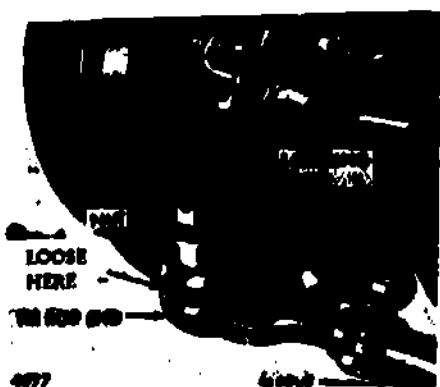

Fig 2-145. Tie rod end.



Fig 2-146. Worn pitman will cause looseness in the steering.



Fig 2-147. Bellcrank assembly.

## 2-16. EXHAUST SYSTEM

Perform a visual inspection on the exhaust system (figs 2-148 and 2-149). Look for loose or broken clamps; loose, cracked, or missing brackets or hanger (to keep the system up and clear of rough terrain and tight from vibration); dents (severe enough to obstruct exhaust), rust, or holes in the exhaust pipe, muffler, or tail pipe. Inspect the system to insure that it is not rubbing or chafing on parts of the frame or against wires and lines. If you should spot a shiny area, check it out. Chances are something is rubbing against it.

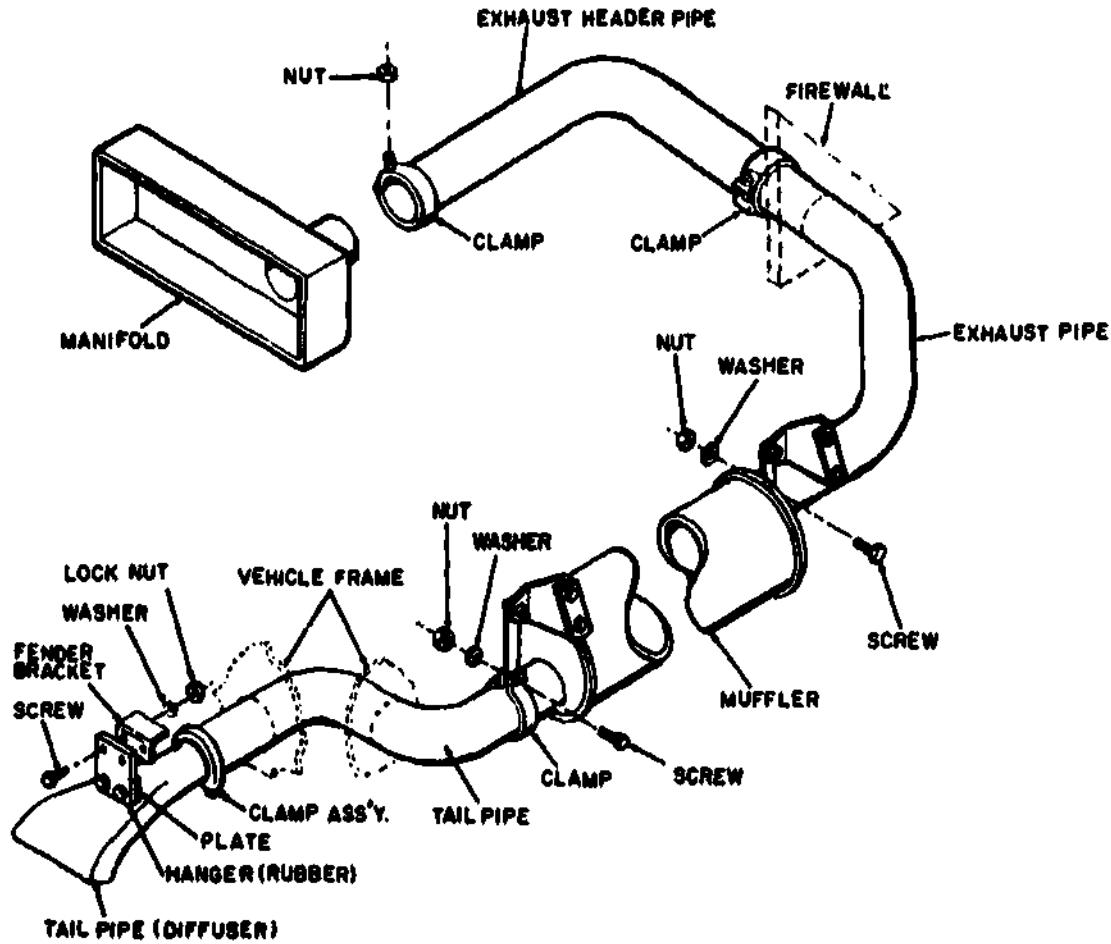

Fig 2-148. Exhaust system for the M-561 and M-702.

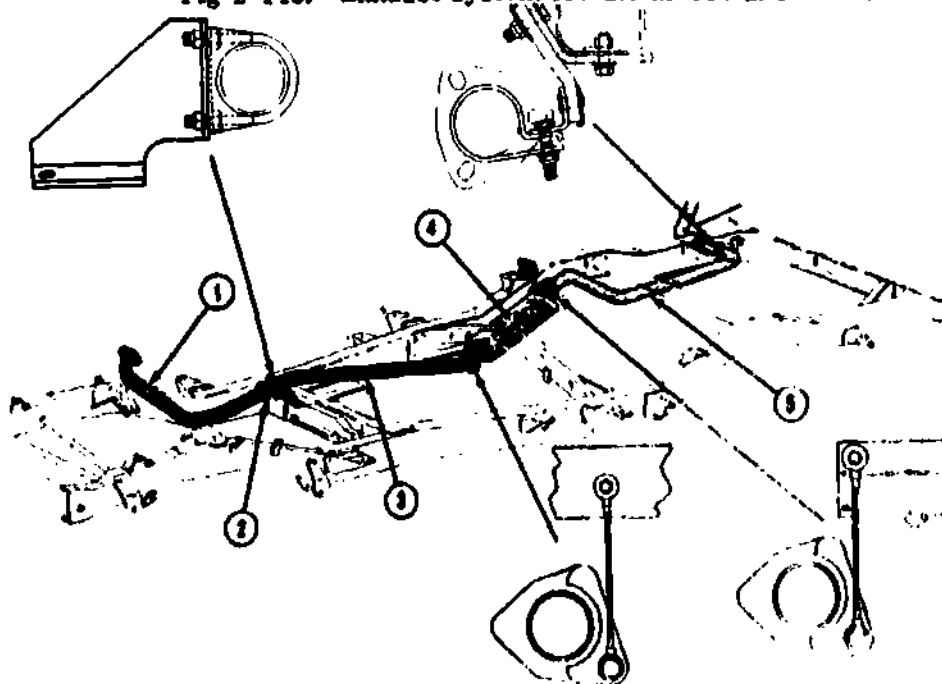

Fig 2-149. Exhaust system for the M-715.

As a final check, start the vehicle up and, using your foot or a rag, plug the exhaust pipe only for a couple of seconds. This method will detect most leaks. This is the final check and really is necessary. Exhaust leaks can also allow carbon monoxide to enter the cab area. This can be fatal, especially in cold weather when operators have the windows rolled up (fig 2-150). To prevent this, at least one window or vent should be partially opened to allow for the continuous flow of fresh air.



Fig 2-150. Don't roll windows up tight.

## 2-17. GAGES AND INSTRUMENTS

a. Visual inspections. First, visually inspect gages. Make sure that the glass is not cracked. Cracked glass allows moisture to enter the gage. Visually inspect for paint on the glass or a smoked condition which would decrease visibility. Gages may become loose in the panel (fig 2-151). The gage itself is held in by a bracket. Note that the standard type connectors are used to activate the gages.

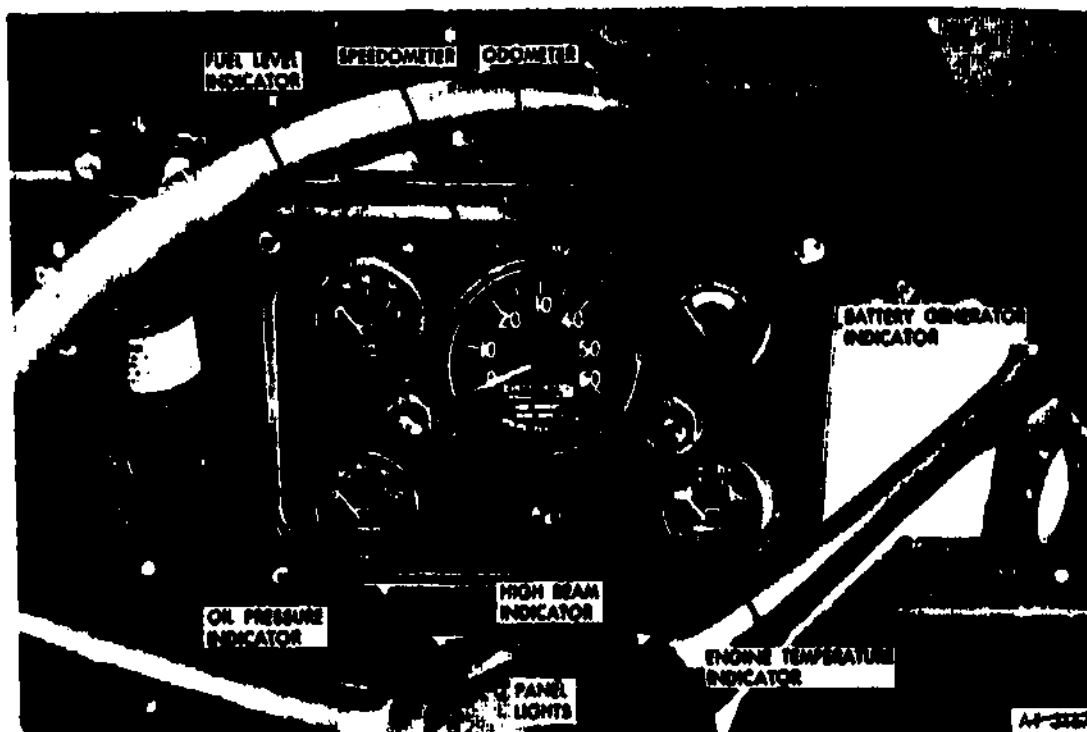

Fig 2-151. Check gages for cracked and painted over lenses.

b. Operational check. After the visual inspection, start the vehicle to make sure the gages are in proper working condition. Before a determination is made that gages are broken, make sure that the problem is not with something else. For example, the fuel gage does not register. Is the gage defective or could it be disconnected as in figure 2-152?



Fig 2-152. Rear of instrument panel showing typical bracket holding gage in.

The temperature gage reflects an extremely hot temperature. Is it the gage, or could the belts be loose, the radiator blocked, the water pump defective, or just plain low on coolant? Do not take for granted that a gage is defective. If the oil gage reflects a low reading or no reading at all, then stop the engine. Determine why the reading is low or non-existent before ruining the engine. Gages are your best friend, but they must be understood and monitored to help you prevent damage to your vehicle. They cannot tell you the exact problem, but they do alert you to the first sign of trouble.

#### 2-18. TOOLS AND EQUIPMENT

There will be some units that do not require the operator to carry any of his OEM/OVM equipment, such as shovel and pick mattock. They are maintained and inventoried periodically by someone in the operations section. But if your unit is one that requires the equipment to be on the vehicle, here are a few tips. Items with wooden handles should be treated with a wood preservative and not painted. Wood preservative will keep the wood alive and help prevent cracks caused by moisture entering the wood. (It is easier to inspect for cracks and other defects that could be easily overlooked if painted.) Inspect the cutting edges of the axe, pick, mattock, and shovel. Water and fuel cans (fig 2-153) must be inspected to make sure that they are not rusty and are free of trash. Both gas and water cans have seals in the cover that prevent spillage and keep out the dirt and dust. Do not use a water container to carry fuel or a fuel container to carry water. Cans are generally marked, but if not, there is a distinct difference. The gas can has a screw type cap which is attached with a chain (fig 2-154). The water can cap (fig 2-155) is equipped with a locking device which seals when the handle is in the down position. The water can is not fitted with a spout and the opening will be a lot larger than the gas can. Most water cans (fig 2-155) have a coating in the inside similar to a water trailer.

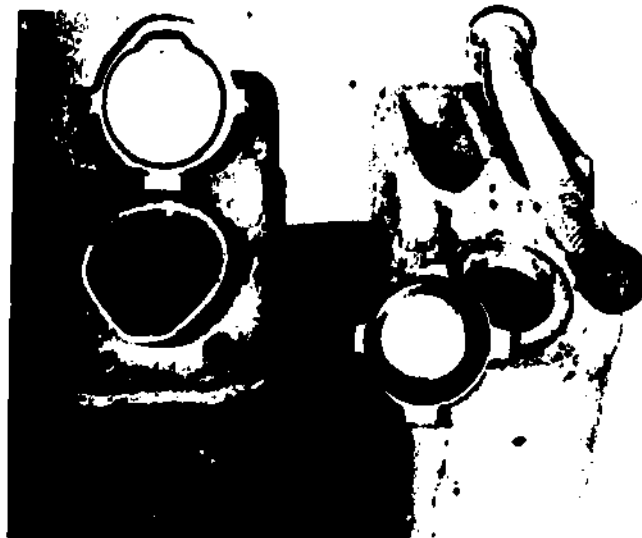

Fig 2-153. Water can and gas can with spout.



**Fig 2-154. Can used for fuel.**



**Fig 2-155. Water can.**

Your basic handtools (fig 2-156), if carried in the vehicle, should be checked. The tool bag should be clean and checked for mildew. Straps should be checked for fraying and also to see if the buckles are working. The drain plug wrench (straight bar) should be checked to see that it does not have burrs so that it will fit the plug hole. Check the screwdrivers for broken or rounded-off tips, loose handles or bent shanks (someone may have used it for a pry bar). Insure that the pliers can be adjusted and the teeth in the jaws have not been worn off. Inspect the wrenches to insure that adjustment can be made. Check wrench jaws to determine that they are smooth and flat. It is possible that they are sprung out of shape. The tire changing tools should be checked to insure that they are properly lubricated. Make sure that the jack will go up and down with reasonable ease. Check the tip on the jack handle (end that fits into jack) to make sure it has not been broken off. The lug wrench is manufactured with an angle to it so that when the socket end is on the wheel lug, the handle will clear the tire. If it is bent, it will not function properly.

Inspect the inside of the socket end of the lug wrench to insure that it has not been rounded off. If it has been rounded off and you attempt to use it, this may also cause the lug nut shoulders to round off.

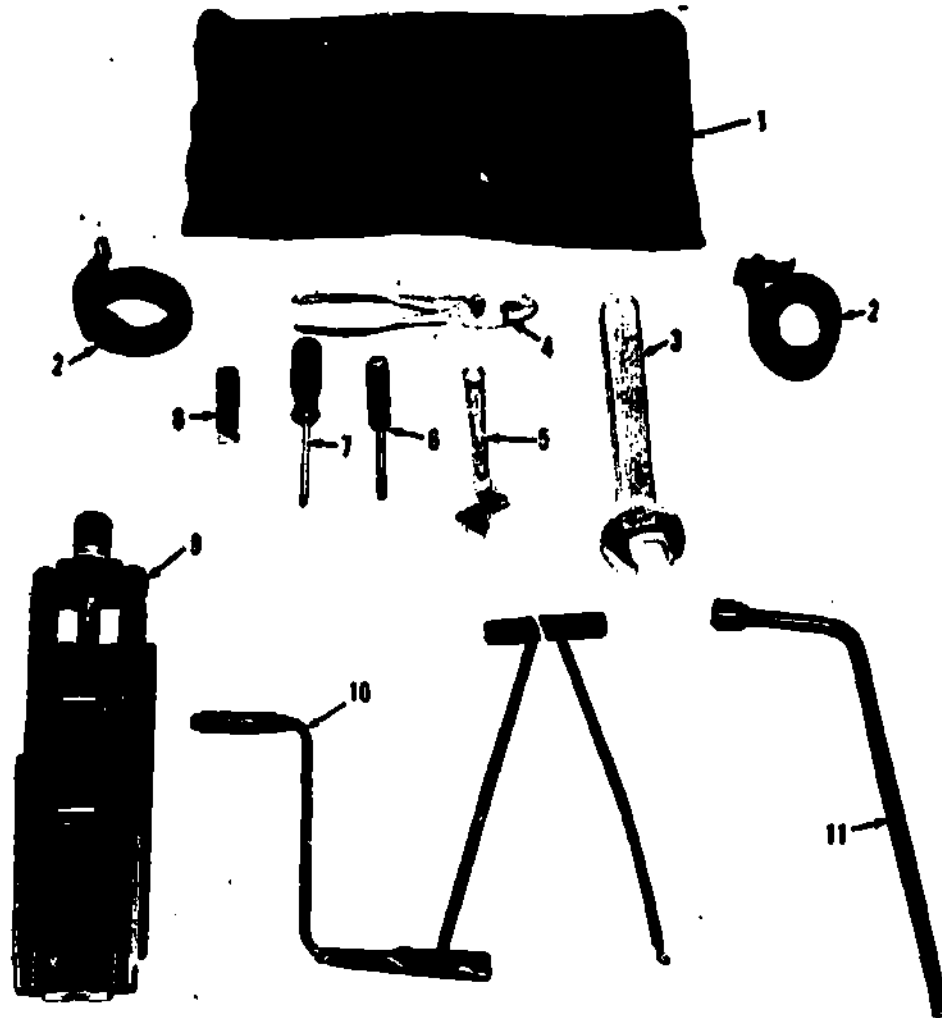

Fig 2-156. Operator's handtools.

Legend

- |  |                            |
|--|----------------------------|
| 1. Tool bag                              | 7. Screwdriver (cross tip) |
| 2. Web strap                             | 8. Wrench (drain plug)     |
| 3. Wrench (for servicing truss assembly) | 9. Scissors jack           |
| 4. Pliers, slip joint                    | 10. Jack handle            |
| 5. Wrench, adjustable                    | 11. Wrench (wheel nut)     |
| 6. Screwdriver (flat tip)                |                            |

All tools should be reasonably clean and free from rust. Let's not forget the tool compartment where this equipment is stored. It must be kept clean and dry, because it is an ideal place for mildew and rust to thrive.

## 2-19. SUMMARY

The items covered under weekly maintenance were not intended to cover each and every item. The items covered were areas that are commonly checked in the performance of a weekly. You, as an operator, can enlarge the list of items that require checking. A weekly is worth its weight in gold if performed properly. It's a tool that we have to make sure that our vehicle stays in the best possible condition.

### Section III. EFFECTS OF IMPROPER DRIVER'S MAINTENANCE

## 2-20. ABUSE OF EQUIPMENT

a. General. Abuse of equipment can be found in several forms. We may have the idea that abuse stems only from the manner in which the vehicle is driven, but a fair portion of abuse is caused by unknowledgeable operators who are trying to accomplish the job the best they know how. Examples of abuse from LACK of or IMPROPER driver's maintenance will be discussed and emphasized in this section. As you look at figures 2-157 to 2-162, ask yourself how many of these conditions that reflect abuse have you seen and possibly contributed to unknowingly.

### b. Tires.

- (1) Worn beyond use. Tire destroyed completely so that it is not even recappable. This abuse could have been avoided by frequent inspection of the tires to determine if the tire should be replaced or rotated. Even if a mechanical irregularity did exist, it still should have been detected.



Fig 2-157. Tire destroyed completely.

- (2) Worn but recappable. Tire destroyed by irregular wear, but could possibly still be good for recapping. To avoid this abuse, do the following:

- Inspect frequently.
- Maintain correct air pressure.
- Rotate or match tires.
- Notify your supervisor, since a mechanical irregularity could be causing this condition.
- Give a little thought to changing your driving habits.



Fig 2-158. Tire worn irregularly.

- (3) Driven when low or flat. A tire can be destroyed by running it when flat. This abuse causes the cords on the inside of the tire to break. This same condition can appear but not in as severe a form if the tire is run with extremely low air pressure. This abuse is uncalled for. You can prevent this by being



aware of a change in your vehicle handling characteristics, such as pulling to the right or left. If the vehicle is weaving uncontrollably, that is the time to STOP and investigate.



Fig 2-159. Tire cords broken.

c. Trailer.

- (1) Handbrake. It is the operator's responsibility to make minor handbrake adjustments. Improper maintenance or lack of operator's maintenance can cause the handbrake to become frozen because of rust. This is easily prevented because the top of the handle has a hole in it. A couple of drops of oil put in this hole during your weekly maintenance will solve the problem. The handle should turn freely.

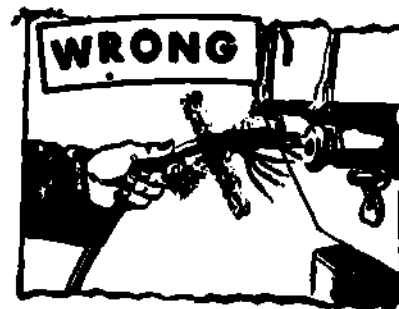

Fig 2-160. Handbrake adjustment.

- (2) Misuse. Lack of operator's maintenance can cause the trailer bed to become rusty (A) to the point where it has started to eat into the metal, especially where the bed meets the sides. The electrical cable (B) (also called whip) has been pulled out of its connections at either end. The electrical connector (C) has bent prongs and is rusty on the inside. The landing leg pin (D) cannot be pulled out without great difficulty. The data plates, reflectors, and even the tallight (E) are not entirely visible because they have been painted over.



A. Equipment bed rusty.



B. Improperly disconnected cable.

Fig 2-161. Lack of or incorrect driver's maintenance.



C. Improper storage of cable.



D. Landing leg pin will not pull out.

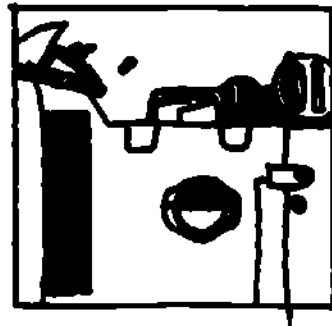

E. Painted data plates and reflectors.

Fig 2-161. Lack of or incorrect driver's maintenance--continued.

(3) **Corrective tips.** The lack of operator's maintenance that is shown in figure 2-161 A through E could easily be corrected and here's how, starting with figure 2-161 A:

- Insure drain valves are in the open position (fig 2-162).
- Park trailer (fig 2-163) with it slightly tipped either rearward or forward. This way the water can drain out of the front or rear valve.
- Inspect regularly for corrosion. If you find corrosion, remove it and spot paint the area. Check the drain valves to insure that they are not blocked by trash and are open.



Fig 2-162. Drain valve.



Fig 2-163. Remove all water.

- When removing any intervehicle electrical cable, grasp it at the neck (fig 2-164). Another cause that affects both ends of the cable is failure to disconnect it completely, leaving the cable to be disconnected when the vehicle is driven off. Most vehicle receptacles are protected by a cover. When the cover is flipped down to insert the cable, it also connects to the cable plug to hold it in the receptacle. If the electrical whip is stored properly, that will prevent most of the prong damage as well as the rust. Stored properly means hanging on the holder as shown in figure 2-165. This puts it out of the way, it won't get mashed into the dirt, and it also is hanging prongs down to prevent water from settling in it. Another reason for prong damage is if the prongs are not lined up with the holes on the vehicle receptacle when connecting; this will cause them to bend.



Fig 2-164. Correct removal of cable.



Fig 2-165. Proper storage of cable and chain.

- The landing leg pin can be cleaned easily with steel wool and a light coat of lubricant put on the pin, so retracting the leg is not a problem.
- When spot painting, if it happens to be near a light or data plate, either remove the item, mask the item, or if you cannot do this, coat the item with a light coat of grease. Paint will not stick to a greased surface; then, when the paint is dry, the grease can be wiped off.

d. Battery.

- (1) Holddown. Battery holddown frame is not doing its job because the flat washer under the nut is missing. The nut can drop through the hole in the frame. The battery(ies) can shift and loosen the battery clamps.



Fig 2-166. Battery holddown frame.

- (2) Battery compartment, Battery compartment has water sitting on the bottom which can also happen to the tool compartment. This is the best way to produce rust and corrosion. Since our mission is NOT to grow rust, get rid of the water. Check those drain holes (fig 2-167), to insure that they are open. Inspect frequently and spot paint if required.



Fig 2-167. Drain tubes.

- e. Radiator, Rubber insulator is broken or missing. Without it the fan can hit the radiator, resulting in a ruined radiator core. This insulator should be replaced with a like item, not a bolt. A bolt would hold it away from the fan, but it would be rigid. This could cause the solder connections to break.



Fig 2-168. Rubber insulator.

- f. Windshield wiper. If the wiper blade is missing, the end of the arm will cause a series of scratches. This normally occurs right at eye level, and in most cases the windshield is ruined. A light scratch can sometimes be buffed out with a special compound. If the vehicle must be operated, remove the other ARM and blade. Install this blade on the driver's side until a replacement is installed.

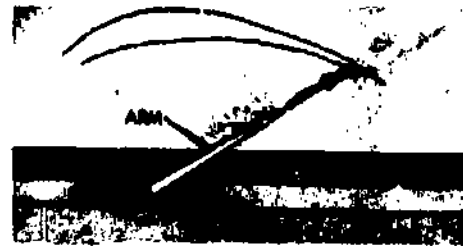

Fig 2-169. Blade missing from arm.

- g. Instrument panel, Instrument panel is loose because lock screws are missing or loose. Gages have moisture in them or cracked lenses. If this is the case, it should be reported so that the gage can be replaced. Instrument panel lights and gages have been painted over which is a sign that spot painting may have gotten out of hand. Normally there are other areas that really require spot painting a Lot More than the instrument panel.



Fig 2-170. Instrument panel.

2-21, MISUSE OF TOOLS

Tools are necessary for performing preventive maintenance. It is vital that tools be used properly and for the job for which they are intended. Misuse of tools does not always happen because an operator doesn't know how to use them properly, but because the proper tool is not readily available or is unserviceable. Here is where we contribute to the big circle. We need oil for our engine, so we should use a container such as shown in fig 2-171. This container is dirty and the flex spout is broken so that more oil goes over the engine than in it. We may not even be able to find it. So we use a container as shown in 2-172. There's no harm done, right? WRONG!! We have contaminated the container used to fill the radiator, so a radiator could end up with oil film in the coolant. This will deteriorate the rubber parts as well as help clog the system. Since the radiator can does not have any marks for use in measuring, we have to guess at the amount we draw from the oil drum. If that amount puts us at the correct oil level we make out, no waste. If we have drawn too much, will the excess be put back into the drum? Chances are, it won't. If the next driver comes along and uses that same oil, it may have so much contamination in it that it couldn't be used for a dusty road. This can happen to any of our equipment when it is not used and maintained properly (which includes returning the items to their proper place in a clean condition). If everyone does his part, the big circle will end; otherwise conditions such as shown in figure 2-173 will occur.



Fig 2-171. Oil container.



Fig 2-172. Water container.



A little extra effort and it could have been used many times over.



Bolt head rounded off so that no wrench will fit it.



Files are brittle and will break if used for prying.



Screwdriver that will end up going around corners it wasn't meant to.

Fig 2-173. Misuse of tools.

Tools will last a long time if properly maintained, used in the proper manner, and returned to the proper place. If we follow the tips in figure 2-174 we are on the way to being a success.



Fig 2-174. Proper treatment of tools.

## Chapter 3

### FIELD EXPEDIENT REPAIRS

#### 3-1. INTRODUCTION

Before we get into the actual repairs, let's make sure we have a full understanding of what expedient repairs are and what their purpose actually is. A field expedient repair is a temporary repair performed by the operator, using material that is available. This type of repair is for emergencies only, when it is vital that the vehicle be kept operating and normal maintenance facilities cannot be reached. Field expedients are performed when there is no other alternative. Safety precautions must still be met and the possibility of bodily injury is still of great concern. We will now discuss some of the field expedients that are of concern to the operator.

#### 3-2. FAN BELT AND FAN

a. General. A broken blade on the fan causes excessive vibration of the engine, making it dangerous to operate the vehicle. A fan belt can break or become loose on any vehicle at any time.

b. Broken blade. If a vehicle must be operated with a fan with one blade broken, cut or break off the blade on the opposite side as illustrated in figure 3-1. The vehicle can then be run as long as the engine does not overheat.

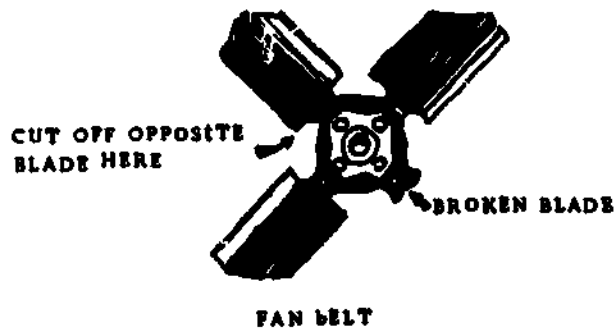

Fig 3-1. Fan blades.

c. Broken fan belt. Repair a broken fan belt by splicing it with wire as shown in figure 3-2. Lacing a belt together with leather shoelaces is another expedient.

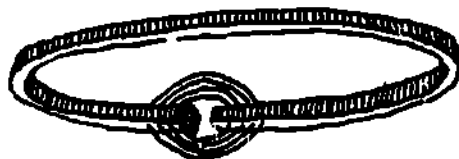

Fig 3-2. Repairing fan belt.

d. Loose fan belt. When a fan belt is too loose to work properly and no further adjustments are possible, wrap it with friction tape. The tape thickens the belt and allows adjustments to be made.

e. Substitute belt. If the belt cannot be repaired and no spare is on hand, make a substitute from a piece of rope, such as a fiber rope from the vehicle's tarpaulin or a piece of field telephone wire. Loop it around the pulleys three or four times and tie it with a square knot. Figure 3-3 illustrates how a substitute fan belt is installed around the fan, crankshaft, and generator pulleys.



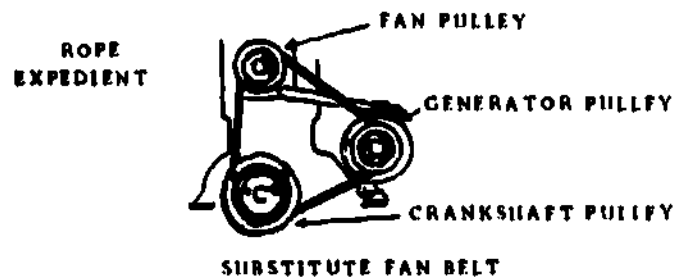

Fig 3-3. Substitute fan belt.

### 3-3. LOOSE OR BROKEN BATTERY CLAMP

A battery clamp may be loose around its terminal post, preventing it from making a good connection. If so, drive a nail or metal wedge between the clamp and the post as pictured in figure 3-4. This makes a fast connection, completes the circuit, and allows the vehicle to start and operate normally. On the other hand, the cable clamp may be broken. A break can be repaired by wrapping a strip of tin around the outside of the terminal post, punching holes in the ends of the tin, and then putting the bolt through both the broken clamp and the tin.

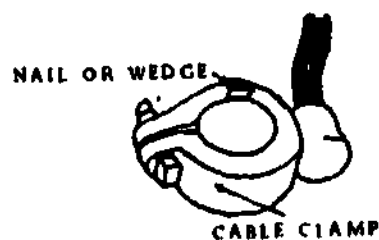

Fig 3-4. Loose battery clamp.

### 3-4. BROKEN TERMINAL POST

If one of the terminal posts appears dead when shorted with a piece of metal or wire, it may be broken. The insert in figure 3-5 shows how a nail or self-tapping screw can be driven through the center of the terminal post until it makes contact with the post's base inside the battery.

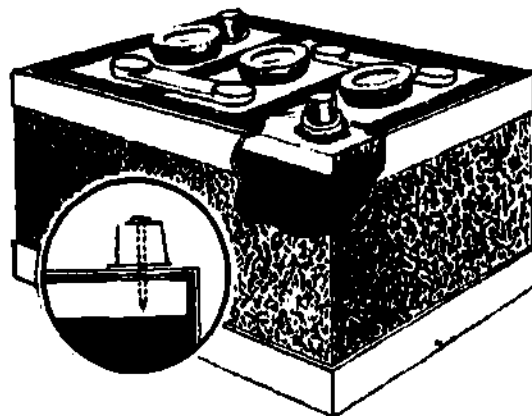

Fig 3-5. Broken terminal post.

### 3-5. REPAIRING HOSES

a. General. Radiator hoses connect the top tank to the cylinder head and the bottom tank to the water pump. Leaking and collapsed hoses can be repaired; substitute parts can be made for worn out hoses and broken hose clamps.

b. Leaks. Fix leaks by wrapping friction tape or any nonporous material, such as a piece of raincoat or rubber floor mat, tightly over them. Hold the patch in place with wire or string. Repair bad leaks with a piece of tin shaped into a cylinder with the same diameter as the inside of the hose. After strengthening the tin cylinder by bending the ends slightly toward the center, insert it inside the hose, being sure that it covers the damaged area. Wrap the outside of the hose with wire and seal it with tape or battery tar.

If a leak persists at a hose connection even when the clamp is fully tightened, remove the clamp, wrap tape or string around the hose at the connection, replace the clamp, and tighten it again.

c. Collapsed hose. When the lower hose becomes oil soaked and is subjected to engine heat, it gets soft and often collapses from the suction of the water pump. Overheating at high speeds results. Prevent the collapse by inserting a piece of heavy wire coiled to the same diameter size as the inside of the hose. Figure 3-6 shows a cutaway view of a hose with coiled wire inserted in it.

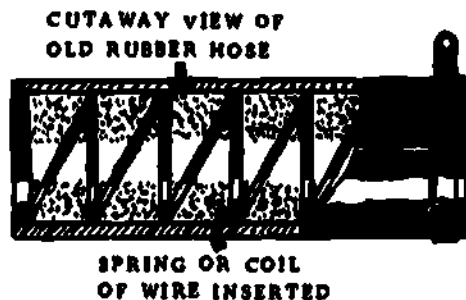

Fig 3-6. Cutaway view of hose.

d. Substitutes for hose. Make a substitute hose from a section of inner tube. Adjust it to the proper length by folding back both ends of the tube several times. Install the substitute hose on the connections; place the clamp on the folds and tighten it securely.

e. Substitute for hose clamp. Replace a broken hose clamp by using a piece of wire about 20 inches long. Tie a loop in one end of the wire, bring the other end around the hose and through the loop, and pull the wire as tight as possible, and tie it tightly.

### 3-6. REPAIR OF RADIATOR CORE

a. General. Holes may develop in the tanks or core; shellfire and flying debris may damage the radiator. Freezing may cause leaks in seams and joints. Expedients for repairing these defects are easy to apply.

b. Holes in tank. A small hole in a radiator tank may be stopped by plugging it with a match, pencil, or any piece of wood shaped to fit the hole. Wood expands when wet and seals off the leak. Cigarette tobacco sprinkled into the radiator while the engine is running may lodge in holes in the core and prevent water from running out.

c. Punctured core. If a tube in the core is punctured, cut through the fins to reach the damaged tube. After cutting the tube at the leaking spot, mash (crimp) the two ends with a pair of pliers; then double the ends back against the tube as shown in figure 3-7. This expedient may hold for a long time; however, if several tubes are repaired this way, the efficiency of the radiator is reduced and the engine may overheat.

d. Damage from freezing. A radiator damaged by freezing will probably develop leaks at the expanded seams and joints. Chewing gum is a handy repair material. When antifreeze is not available, a radiator and engine block should be drained when the vehicle is not in use; when operating, the lower part of the radiator can be partially covered. The temperature of the water can be controlled by increasing or decreasing the covered area.

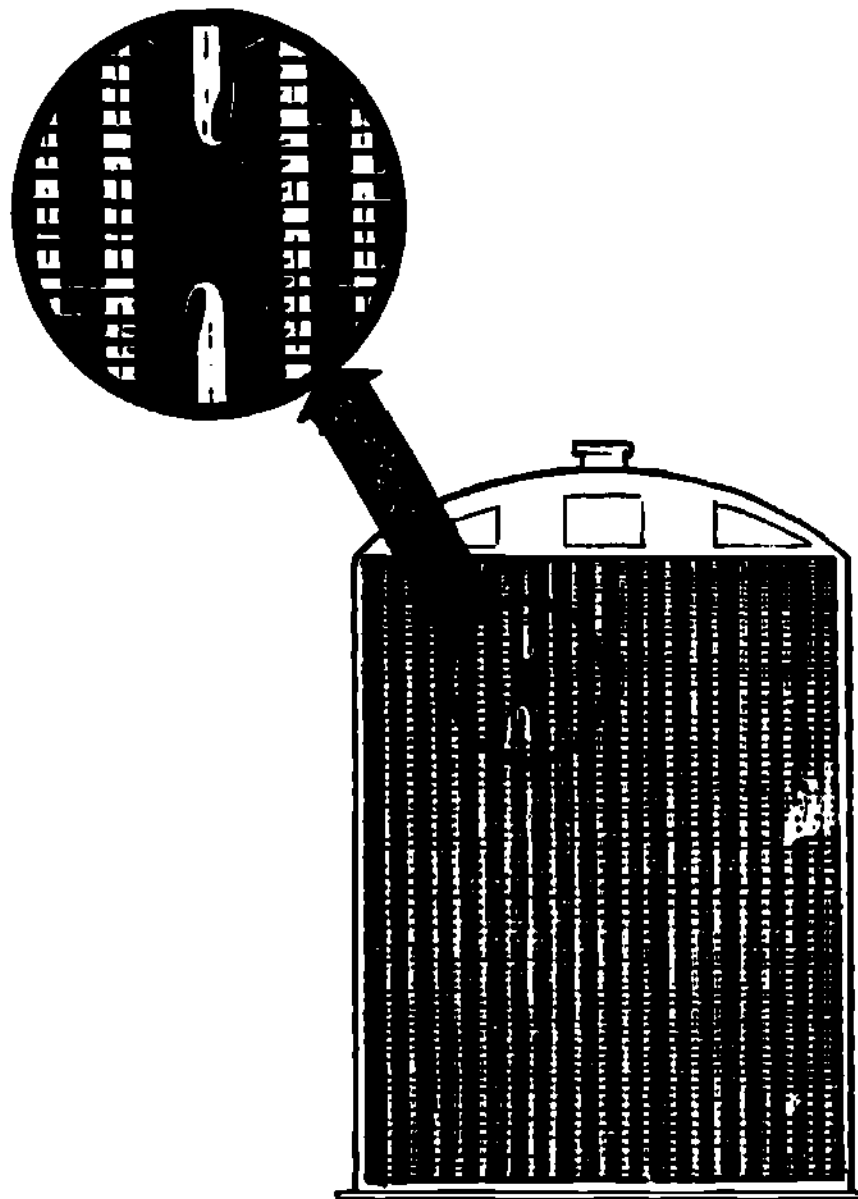

Fig 3-7. Repair of punctured radiator core.

### 3-7. THERMOSTAT

If the thermostat is stuck in the closed position and will not open (overheating), it can be removed and discarded. In cold weather, the radiator can be covered to keep the engine at normal operating temperature. A thermostat stuck in the open position will cause the engine to run cool. It should be replaced at the first opportunity to allow the engine to warm up to the operating temperature.

### 3-6. ACCESSORIES

a. General. Although accessories add to vehicle and driver safety, most of them are not needed in emergency driving. For example, there is no reason in combat to stop driving a truck because the horn won't work. On a dark night, however, the loss of headlights is almost as crippling as the loss of a wheel. A broken windshield wiper can make driving almost impossible in a severe rainstorm.

b. Headlights. Blackout lights can be used when the headlights are burned out. Remove the coverplate and lens from the blackout lights; they will give enough light to permit driving at reduced speed.

c. Windshield wiper. If the windshield wiper won't work, put a string around the wiper arm, bring it through the inside of the cab from one side to the other, and back to the wiper arm again. By pulling on the string, you have manual control of the windshield wiper.

### 3-9. REPAIRING LEAKS IN THE FUEL SYSTEM

a. General. Small pin-size holes and punctures in a fuel tank can be plugged to keep fuel from leaking out. A temporary gasoline container can be hooked up to take the place of a totally damaged tank.

#### b. Fuel tank.

- (1) Small hole or leak. A self-tapping screw, a washer, and a piece of some material to use for a gasket are all you need to seal a small pin-size hole in the gasoline tank. Self-tapping screws can be found on window or windshield frames inside the cab. A piece of leather from a tarpaulin strap or rubber from a tire makes a good gasket. Figure 3-8 shows how you place the washer under the screw's head and force the screw through a hole made in the gasket material down through the hole in the tank. The screw is then tightened securely. A leak in the seam of the fuel tank can be stopped by rubbing soap into the crack.

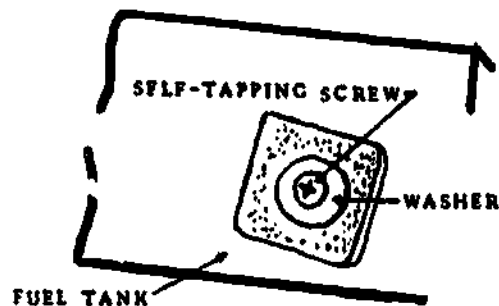

Fig 3-8. Repair for hole.

- (2) Puncture. A tank may be damaged by a sharp object piercing it and pushing the edges of the break to the inside. To repair such a puncture, cut a plug from a tire, rubber heel, or rubber hose about the size and shape of the hole. Remove a bolt and nut from the vehicle and force the bolt through a hole cut in the center of the plug. After installing a nut on the bolt, force the bolt and about half the plug into the hole in the tank; tighten the nut until the pressure on the rubber forces it to expand and plug the hole. Figure 3-9 shows how the rubber expands and fills the hole. A repair of this kind will last for an indefinite length of time.

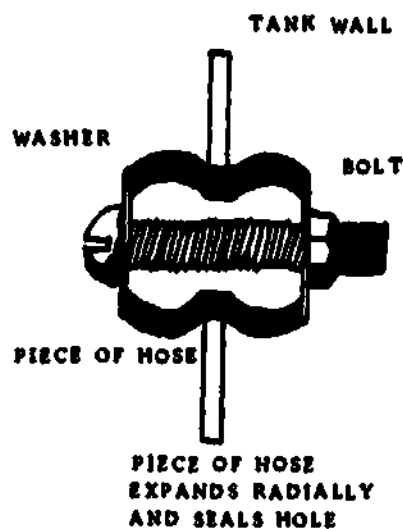

Fig 3-9. Repair for punctured tank.

- (3) **Unrepairable damage.** If a fuel tank is damaged beyond repair, mount a container higher than the carburetor in the engine compartment. A gasoline can makes the best substitute for a tank but anything will do, even an arctic boot. Cut the fuel line leading from pump to carburetor as far from the carburetor as possible. The line must now be bent but this must be done carefully; otherwise you may crimp the line and cause a stoppage. When the line is bent at the first point near the carburetor and prior to bending it the second time to go down into the tank, the line must be filled with fuel. Then hold your thumb or finger over the end to prevent the fuel from flowing out. Now bend the line (keeping the end blocked) so that it is as near the bottom as possible. Once the line is down in the container, your thumb or finger can be removed. If the line is too short, use the windshield wiper hose to lengthen it. As long as the container is kept filled with fuel, it will flow into the carburetor by force of gravity. Figure 3-10 illustrates how this kind of connection is made.

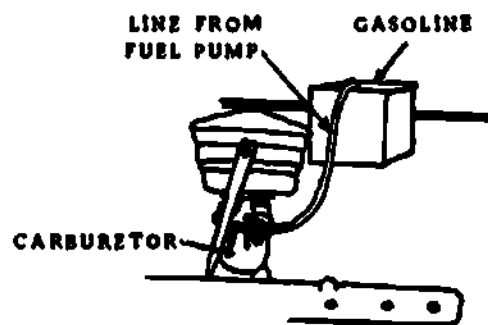

Fig 3-10. Substitute for unrepairable fuel tank.

c. **Fuel lines.** Although clogging in the fuel line causes trouble, the big problems are brought on by freezing, leaking, and vapor lock.

- (1) **Clogging.** A blocked or clogged fuel line often opens up when air is blown through it. Disconnect the line at the pump and blow toward the tank or the carburetor, depending on the location of the trouble.

- (2) **Leaking.** Soap is the best material to stop small leaks; string wrapped tightly over a leak and coated with soap is also an effective expedient. Leaking through a crack in the line may be stopped by wrapping the line tightly with friction tape held in place by wire. Figure 3-11 shows how a leak at a connection can be temporarily repaired. Remove the coupling flange nut, wrap string around the line ahead of the nut, push the nut and string up to the connection, and tighten the nut securely. This forms a soft gasket on the flange, stopping the leak.

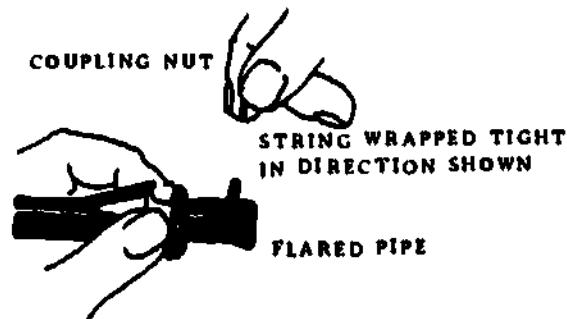

Fig 3-11. Field expedient repair of leaking fuel line connection.

A broken fuel line can be repaired by installing a piece of windshield wiper hose over the broken ends of the line and then taping the hose firmly in place.

- (3) **Vapor lock.** Occurring in hot weather, vapor lock is caused by the liquid fuel becoming so hot that it changes to vapor. Since the pump cannot pump vapor, no fuel will reach the engine. A simple expedient is to wrap a piece of burlap or rag soaked in water around the fuel pump. The evaporation of the moisture in the wet cloth lowers the temperature of the fuel enough to return it to a liquid state. If a cloth is not available, cold water may be poured over the fuel pump and lines.

### 3-10. PROPELLER SHAFT

If a vehicle has four- or six-wheel drive, a defective rear propeller shaft does not disable it. If the shaft is broken, the driver can remove it at the universal joints, engage the front-wheel drive, and continue driving at a reduced speed.

### 3-11. AXLES AND SPRINGS

On a vehicle with four-wheel drive, if the rear axle or wheel breaks or one of the tires goes flat, a pole approximately 4 inches thick and 6 to 8 feet long can be used as a substitute for one wheel. One end of the pole is put under the axle housing and tied securely to the frame; the other end rests on the ground. With the front-wheel drive engaged, the vehicle then moves under its own power. Starting may be difficult, but once the vehicle is moving, it rides and handles surprisingly well.

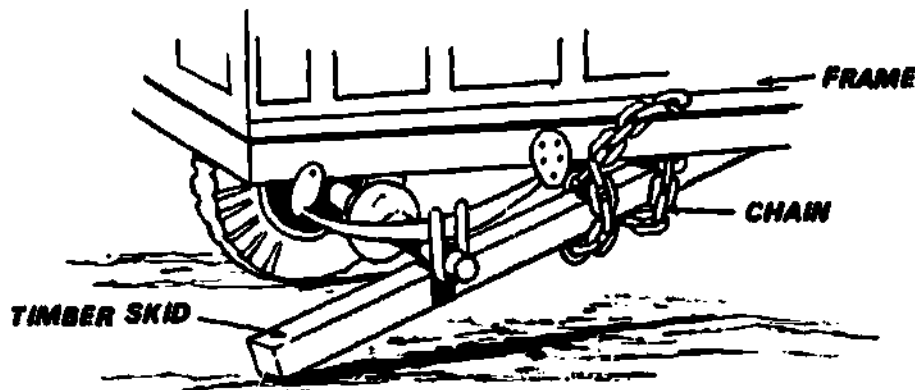

Fig 3-12. Skid arrangement.

Since driving a vehicle with a broken spring is dangerous, chain the axle securely in position to keep it from shifting and take the vehicle's weight off the spring by lashing a block of wood between it and the frame,

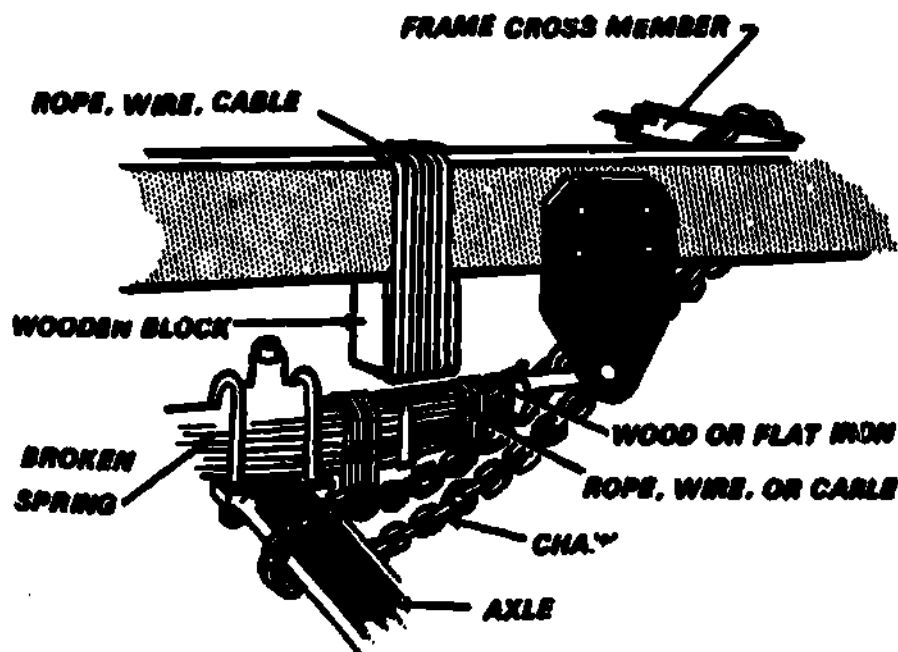

Fig 3-13. Broken spring.

### 3-12. SUMMARY

The field expedient repairs discussed were some common ones which have been put to use at one time or another. You may know of some others which might also be put to use. It is recognized that some of these expedient repairs may take as long or longer than a standard authorized type of repair. The point to remember is that field expedient repairs are done to overcome a serious vehicle problem when it is absolutely necessary to keep the vehicle going at that particular time. They are done using whatever is immediately available. They should never be done under normal operating conditions as they can lead to other types of vehicle failures. They should be considered in an emergency situation like combat or where a person's life is at stake and maintenance personnel and/or maintenance facilities are not available.



UNITED STATES MARINE CORPS  
MARINE CORPS INSTITUTE, MARINE BARRACKS  
BOX 1775  
WASHINGTON, D.C. 20013

**LIGHT VEHICLE PREVENTIVE MAINTENANCE**

**Course Introduction**

**LIGHT VEHICLE PREVENTIVE MAINTENANCE** is designed to instruct Marines, private through sergeant, in the performance of preventive maintenance. It is designed to increase the competency of Marines operating military motor vehicles. The course is specific in nature as to the preventive maintenance areas although it is not confined to any one type, make, or model of wheeled vehicle.

**ORDER OF STUDIES**

<u>Lesson Number</u>	<u>Study Hours</u>	<u>Reserve Retirement Credits</u>	<u>Subject Matter</u>
1	3	1	Maintenance System and Tires
2	3	1	Batteries, Cooling System, and Vehicle Lubrication
3	2	0	Daily and Weekly Maintenance
4	2	1	Field Expedient Repairs
	<u>2</u> 12	<u>1</u> 4	FINAL EXAMINATION

**EXAMINATION:** Supervised final examination without textbook or notes; time limit, 2 hours.

**MATERIALS:** MCI 35. 23, Light Vehicle Preventive Maintenance.

Lesson sheets and answer sheets.

**RETURN OF MATERIALS:** Students who successfully complete this course are permitted to keep the course materials.

Students disenrolled for inactivity or at the request of their commanding officer will return all course materials.

\* \* \*

UNITED STATES MARINE CORPS  
MARINE CORPS INSTITUTE, MARINE BARRACKS  
BOX 1778  
WASHINGTON, D.C. 20013

**LIGHT VEHICLE PREVENTIVE MAINTENANCE**

**Lesson 1**

**Maintenance System and Tires**

**STUDY ASSIGNMENT: Information for MCI Students.**

**Course Introduction**

**MCI 35.23, Light Vehicle Preventive Maintenance, chap 1, sections 1 and 2.**

**LESSON OBJECTIVE:** Upon successful completion of this lesson, you will be able to identify the different categories and echelons of maintenance. You will be able to identify the effect of mechanical irregularities and vehicle operation on tires. You will be able to identify what preventive maintenance measures are needed for good performance and equal wear of tires. You will also be able to identify the procedures for removal of wheels from the vehicle and demounting and mounting of the tires, using the correct tools.

**WRITTEN ASSIGNMENT:**

**A. Multiple Choice:** Select the ONE answer which BEST completes the statement or answers the question. After the corresponding number on the answer sheet, blacken the appropriate box.

Value: 1 point each

1. What is equipment maintenance called that is performed by and is the responsibility of of the using unit?
 

a. Depot	c. Intermediate
b. Organizational	
  
2. Organizational maintenance includes what two echelons?
 

a. First and third	c. First and second
b. Third and fourth	d. First and fifth
  
3. Which echelon of maintenance is performed by technically trained personnel assigned to the using unit?
 

a. First	d. Fourth
b. Second	e. Fifth
c. Third	
  
4. Specific mechanical irregularities may be difficult for an operator to detect. So, operators should be primarily concerned with
  - a. knowing how to make all adjustments.
  - b. early detection of any irregularity.
  - c. how much time the repair will take.
  - d. what parts may have to be replaced.

6. Using figure 1-8, if we overload the vehicle by 20% and 100% of the normal tire wear is 30,000 miles, how many miles will be lost because of the overload?
- a. 25,000 miles  
b. 9,000 miles  
c. 5,000 miles  
d. 2,000 miles
6. Using figure 1-6, what is the percentage of tire wear saved if your vehicle speed is reduced from 60 mph to 35 mph?
- a. 50%  
b. 20%  
c. 39%  
d. 15%
7. Which of the following would put an overload on certain tires?
- a. Operating the vehicle at speeds between 40 and 60 mph  
b. A load that could be less than the capacity of the vehicle, but is unevenly distributed  
c. A load that is within the capacity of the vehicle and evenly distributed
8. For the purpose of air pressure adjustment, you should not deflate tires
- a. when they are cold.  
b. during or immediately after operation.  
c. if you are going to overload the vehicle.  
d. if the vehicle is unloaded.
9. What is the purpose of tire rotation?
- a. Equalize tire wear  
b. Insure that the wheel lug nuts are tight  
c. Insure that tire pressure is correct  
d. Insure that tire locking rings are secure
10. If the jack is not properly positioned on the vehicle when lifting. It could cause
- a. the lifting capacity of the jack to be reduced.  
b. damage to the vehicle.  
c. the vehicle to be lifted to an improper height.
11. When replacing wheel nuts, the beveled edge of the nut should
- a. always point inward towards the rim.  
b. point inward only on the left side.  
c. point inward only on the right side.  
d. not point towards the rim, only the flat side.
12. Which of the following should you observe as safety precautions when demounting a tire from a rim?
- a. Make sure that the locking ring is on the underside, deflate the tire, remove tire from rim.  
b. Remove locking ring, deflate tire, remove tire from rim.  
c. Remove the valve core and inspect the rims, tire, and locking devices.  
d. Inspect locking devices and rims, and remove tire from rim.
13. What is the ideal safety measure to take when inflating a tire?
- a. Place it inside a cage made for the purpose.  
b. Lay the tire with ring facing up and place a heavy object on it.  
c. Inflate the tire to 50% of its correct pressure until it is mounted on the vehicle.  
d. Inflate the tire to 25% over the correct pressure.

14. A flat base rim is different from the drop center and safety rim because it
- needs a lock ring to hold the tire on.
  - has a well that the bead of the tire rests in.
  - uses a well and locking ring to hold the tire on.
  - has a flap to hold the tire on.
15. A semthard piece of rubber which protects the tube from the edges of the tire bead and the base of the rim is called a
- locking ring.
  - flap.
  - safety rim.
  - tire wedge.
16. Which item below is used to hold the tire on a flat base rim?
- The well designed into the rim
  - The locking ring
  - The tire bead
  - The valve slot designed into the rim
17. The four functions of the valve repair tool are removing the stem, rethreading outside threads, rethreading inside threads of the valve stem, and
- milling the end to remove rough edges.
  - crimping the end to hold the stem.
  - sealing the stem to prevent air leakage.
  - measuring the tire pressure.
18. When demounting a tire from a drop center or safety rim, the bead (top and bottom) must be free of the rim and one side forced down into the well so that the
- other side can be lifted over the edge of the rim.
  - tube is free of all air pressure.
  - valve core can be removed.
  - tire is balanced.
19. Prior to demounting a tire on a flat base rim, it must be deflated and then the
- tire bead (top and bottom) must be loosened from the rim.
  - tube can be removed.
  - tire flap and tube can be removed.
  - tire, flap, and tube can be removed.
20. You have found the object that caused a puncture in the tire. What method should you use to locate the hole in the tube easily?
- Mark the location of the puncture and valve stem on the tire.
  - Mark the location of the puncture on the tire.
  - Mark the location of the stem on the tire.
  - Mark the location of the tire at the point with the least amount of tread.
21. What is the purpose of inflating a tube and then submerging it in water, while visually inspecting for air bubbles?
- To insure that the valve cap is on tight
  - To detect pinhole type punctures
  - To clean the tube
22. An object that punctures the tire and is difficult to find can be located by
- running your hand around the inside of the tire.
  - filling the tire with water to locate the hole.
  - using a magnet to pinpoint the object.
  - running a rag around the inside of the tire so it will snag on it.

35,23

Isn 1; p. 3

23. When repairing a flat (before the tube is installed), the inside of the tires should be wiped free of rubber dust particles and
- a. visually inspected for cord damage.
  - b. the depth of tread measured.
  - c. cleaned with solvent.
  - d. the tire balanced.
24. What method is used to prevent enlargement of punctures in tubes (especially synthetic)?
- a. Round out/buttonhole the ends of the puncture.
  - b. Apply a patch at least three times as large as the puncture.
  - c. Buff the area around the puncture.
  - d. Make deep grooves in the rubber.
25. What is the purpose of buffing the area around a puncture in a tube?
- a. To keep the puncture from enlarging
  - b. To enable the patch to stick better
  - c. To make it easier to locate the puncture
26. What are two methods of patching a tube?
- a. Heat and chemical curing
  - b. Crossway buffing and coldpatching
  - c. Vulcanizing and crossway buffing
  - d. Pressure and clamping
27. All or a combination of the items below cause tire deterioration. Which one of the items causes cracking or checking sometimes called weathering?
- a. Light
  - b. Heat
  - c. Oil
  - d. Ozone
28. What is done to protect tires from deterioration when stored out-of-doors?
- a. Limit the number to five in a stack.
  - b. Stack them on the ground because of the moisture.
  - c. Cover them with canvas or something similar.

Total Points: 28

\* \* \*

35.23  
len 1: p. 4

UNITED STATES MARINE CORPS  
MARINE CORPS INSTITUTE, MARINE BARRACKS  
BOX 1770  
WASHINGTON, D.C. 20013

LIGHT VEHICLE PREVENTIVE MAINTENANCE

Lesson 2

Batteries, Cooling System, and Vehicle Lubrication

**STUDY ASSIGNMENT:** MCI 35. 23, Light Vehicle Preventive Maintenance, chap 1, sections 3 through 5.

**LESSON OBJECTIVE:** Upon successful completion of this lesson, you will be able to identify the functions, potential hazards, and the removal and installation procedures of the lead-acid battery. You will be able to identify the procedure for using the battery and battery/antifreeze hydrometers. You will be able to identify the activation, cleaning, and charging procedures for the battery. You will be able to identify the types of cooling systems, functions of cooling system components, and maintenance procedures for the cooling system. You will be able to identify the purpose of engine lubrication, use of the lubrication order, procedure for replacing grease fittings, and the procedure for performing oilcan maintenance.

**WRITTEN ASSIGNMENT:**

**A. Multiple Choice:** Select the ONE answer which BEST completes the statement or answers the question. After the corresponding number on the answer sheet, blacken the appropriate box.

Value: 1 point each

1. What are the three parts of a lead-acid storage battery that an operator will be most concerned with?
  - a. Vent plugs, separators, and casing
  - b. Vent plugs, casing, and cell connector
  - c. Terminal posts, vent plugs, and casing
  - d. Post strap, cell connector, and vent plugs
  
2. The chemical reaction between the liquid electrolyte and metal plates in the battery is released as
 

a. gas.	c. vapor.
b. electricity.	d. heat.
  
3. Which item below provides energy for engine starts, short term overload demands, and emergency power when the generator is not working?
 

a. Starter	c. Voltage regulator
b. Generator	d. Battery
  
4. Weight, acid burns, explosiveness, and electrical shock are potential hazards when working with a
 

a. battery.	c. voltage regulator
b. generator.	d. wiring harness.

5. A high concentration of hydrogen and oxygen gases is most likely to be found in what environment?
  - a. Storeroom where unactivated batteries are kept
  - b. Place where batteries are being charged
  - c. Areas where many vehicles are parked
  - d. Outdoor lubrication rack/pit
  
6. You should use rubber gloves, apron, and goggles or face shield when working with
  - a. batteries.
  - b. fuel.
  - c. lubricants.
  - d. cleaning solvent.
  
7. Knowing the location of the nearest water supply, providing adequate ventilation, and having ready access to a fire extinguisher are all
  - a. safety measures when working with batteries.
  - b. safety measures when refueling a vehicle.
  - c. safety measures when spot painting a vehicle.
  - d. necessary when performing weekly maintenance.
  
8. The battery clamp puller and lifter are ideal tools to remove battery clamps because they
  - a. are easy to operate.
  - b. also clean the battery post.
  - c. will prevent connecting the wrong clamps.
  - d. will prevent damage to the battery clamp and battery.
  
9. Which of the following items would NOT help the operator determine which post a battery clamp should be installed on?
  - a. The symbol (+)
  - b. The letter (N)
  - c. The diameter of the hole in the clamp
  - d. The length of the cable
  
10. So that the battery holddown bracket can function properly, the bracket bolts must be
  - a. tightened so that the bracket is forced down into the battery.
  - b. engaged at the bottom of the compartment and tightened securely.
  - c. kept loose to allow the battery to shift which prevents the cables from breaking.
  - d. made of aluminum to prevent grounding out.
  
11. It is possible for battery clamps to be installed upside down. When this occurs, a poor connection is made because the
  - a. tapered portion of the clamp and post do not match.
  - b. cable will not fit properly.
  - c. bolt used to tighten the clamp is too long.
  - d. clamps will corrode faster.
  
12. To prevent arcing when removing batteries from a vehicle, you must always remove the
  - a. battery holddown first.
  - b. positive clamp first.
  - c. negative clamp first.
  
13. The battery hydrometer and the electrolyte and antifreeze tester are used to measure
  - a. volts.
  - b. ampercs.
  - c. polarity.
  - d. specific gravity.



14. Why should a specific gravity reading NOT be taken just after adding water to the battery or after heavy cranking (turning over of the engine) has just taken place?
- Reading may not be correct.
  - Battery is too hot.
  - Vent caps should not be removed.
  - Battery should be charged.
15. What items will produce electrolyte when mixed together in the correct proportions?
- Water and sulfuric acid
  - Sulfuric acid and baking soda
  - Water and baking soda
  - Water, baking soda, and sulfuric acid
16. When taking a reading with the battery syringe hydrometer, you should draw only enough liquid into the tube so that the float
- is up into the bulb.
  - does not break contact with the bottom of the tube.
  - is exactly 1/4" from the top and bottom.
  - is free at the bottom and not into the bulb at the top.
17. Holding the device at eye level and reading the number on the float where it meets the level of the liquid is a technique for taking a reading with a battery
- syringe hydrometer.
  - charger.
  - syringe filler.
  - gravity flow filler.
18. What specific cells must be checked when taking the specific gravity reading of a battery?
- Only the two on the left
  - Every other one
  - All cells
  - Only the ones that are low
19. Using 80° as the standard and using the correction rule, what would the corrected specific gravity reading be if the specific gravity reading is 1.295 and the temperature is 90°?
- 1.180
  - 1.291
  - 1.299
  - 1.415
20. When you are using the antifreeze and electrolyte tester and the scale is not clear and sharp where the light and dark areas meet, it indicates that
- the tester is broken.
  - the measuring window needs cleaning.
  - the wrong dipstick was used to draw the sample.
  - a temperature correction is necessary.
21. When mixing water and sulfuric acid to make electrolyte, you should
- never take a specific gravity reading until the dilution period is over.
  - never stir the solution.
  - never use a glass or earthenware container.
  - never pour water into acid.
22. When activating a new battery, the temperature of the electrolyte and the battery must be between
- 60° and 100° and each cell should contain sufficient liquid to cover the plates.
  - 32° and 60° with sufficient liquid to cover the plates.
  - 100° and 110° with sufficient liquid in each cell to cover the plates.
  - 80° and 100° with sufficient liquid to cover the plates in at least two cells.

23. When activating a new battery and you have finished filling it to the proper level, for the best results it should be
- stored at room temperature overnight.
  - allowed to heat up for at least 1 hour.
  - placed on charge.
  - tagged designating the date and time of installation.
24. What is a good solution to remove corrosion from the battery?
- Soda (bicarbonate) and water
  - Solvent and thinner
  - Diesel fuel and solvent
  - Soda (bicarbonate) and solvent
25. As part of the cleaning process, the battery casing should be inspected for cracks and all caps should be on tight. What is the reason for this?
- To prevent baking soda from entering the battery which could cause damage
  - To prevent the electrolyte from becoming hot
  - To make the battery easier to clean
  - To prevent gassing of the battery
26. To determine at what voltage to start for a moderate rate of charge, you must know the rated ampere-hour capacity of the battery. You then start the voltage equal to
- 40% of the voltage and taper off to finish at 20%.
  - 50% of the voltage and taper off to finish at 30%.
  - 5% of the rated ampere capacity and gradually increase to 30%.
  - 10% of the rated ampere capacity and taper off to finish at 5%.
27. What should you do when charging a battery and excessive gassing occurs?
- Reduce the charging rate.
  - Increase the charging rate.
  - Reduce the level of the electrolyte.
  - Increase the temperature of the electrolyte.
28. A sulfated battery is the result of constantly being kept discharged or undercharged or one
- that has been stored at temperatures above 80°.
  - in which the level of electrolyte is too high.
  - in which the level of electrolyte is allowed to remain below the proper level.
  - that has not been activated.
29. Regardless of which rate of charge is used, you must check the specific gravity occasionally during charging. As the battery nears full charge, it should be checked every
- 10 minutes.
  - 15 minutes.
  - 30 minutes.
  - hour.
30. What is the purpose of the coolant in a liquid-cooled engine?
- To absorb heat from the engine
  - To insulate the engine from freezing
  - To prevent the hoses from rotting
  - To absorb heat from the radiator
31. In order for an air-cooled engine to operate efficiently, it is designed so that
- it must have movement to prevent it from overheating.
  - the hotter the engine becomes, the faster the coolant will circulate.
  - it cannot be overheated.
  - the maximum amount of air comes in contact with the engine.

32. The core of the radiator must be kept clean of dirt, mud, and obstructions to allow the
- thermostat to operate freely.
  - coolant level to be visually inspected.
  - maximum amount of air to pour through the core.
  - coolant to drain from the top tank to the bottom tank.
33. The purpose of the radiator core is to
- expose coolant to the air so that it can be cooled.
  - store excess coolant due to overflow.
  - provide pressure so that the coolant can be circulated.
  - allow for expansion if the coolant should freeze.
34. The water pump is normally driven by what method?
- Chain drive
  - Belta
  - Shaft
  - Centrifugal force
35. The main purpose of the fan is to
- pull air through the radiator core.
  - cool the water in the water jacket.
  - cool the water in the radiator.
  - provide a pulley for the drive belts.
36. As a driver, what should you check when you are inspecting the drive belts?
- Alinement, unusual wear, and proper adjustment
  - Balance, alinement, and proper adjustment
  - Proper strength, alinement, and balance
  - Correct color, alinement, and balance
37. Which component or combination of components is powered by the drive belt on a vehicle?
- Generator, oil pressure gage, and water pump
  - Generator, water pump, and temperature gage
  - Generator, fan, and water pump
  - Generator, thermostat, and water pump
38. When starting a cold engine, what effect does the thermostat have?
- Makes the vehicle easier to start
  - Allows the engine to heat up faster
  - Permits free circulation of the coolant
  - Makes it easier for the water pump to turn
39. The radiator cap provides a tight seal for the cooling system. This enables the system to be
- pressurized.
  - energized.
  - free circulating.
  - free of foreign chemicals.
40. Making sure that the engine temperature is well below 200° F is a step in the
- before-operation check.
  - flushing of the cooling system.
  - testing the freezing point of the coolant.
  - after-operation check.
41. When flushing the cooling system, the thermostat may remain partially closed (not enough heat). A restriction may have to be placed in front of the radiator to raise the temperature. When this method is used, what must the driver NEVER do?
- Smoke
  - Open the hood
  - Leave the vehicle unattended
  - Start the engine

42. The correct level of the engine coolant is reached when the coolant is
- even with the top of the radiator filler neck.
  - a minimum of 3 to 4 inches below the base of the filler neck.
  - at least 1/2 inch to 3/4 full depending on the capacity of the radiator.
  - one inch down from the top of the filler neck.
43. The cooling system in your vehicle needs flushing (normal). You must insure that the temperature is correct, that the cap is removed, and that the draincocks are opened. You then
- direct a continuous supply of water through the radiator for approximately 25 minutes.
  - allow the system to drain completely, close drain, and refill to proper level.
  - remove the thermostat and direct a continuous supply of water through the radiator for 5 minutes.
  - allow the system to drain completely, close drain, and add corrosion inhibitor.
44. What would be proper to use when your vehicle cooling system requires extensive cleaning ?
- Inhibitor
  - Cleaner and neutralizer
  - Stop leak
  - Air pressure
45. You are inspecting your vehicle and notice discoloration or staining in the vicinity of a freeze plug on the engine. What would this indicate?
- Coolant leak
  - Fuel leak
  - Loose radiator hose
  - Defective water pump
46. A high temperature gage reading, discoloration or staining, or a change in coolant level between operation checks are three items that would help the operator
- determine that the cooling system needs flushing.
  - detect leaks.
  - detect a cracked engine block.
  - determine that coolant is not at the correct protection level against freezing.
47. What do rusty or grayish stains around the top of the radiator indicate?
- A leak has developed.
  - The cooling system needs cleaning.
  - The drive belts are loose.
  - The water pump is defective.
48. Leaks will normally occur where the water pump shaft extends through the housing at engine block freeze plugs and also
- at the corner seams where the radiator top and bottom tanks are joined.
  - at the point where the overflow tube enters the surge tank.
  - on the top of the surge tank.
  - at the point where the radiator cap locks to the top of the radiator.
49. Antifreeze should be checked for freezing protection in what manner ?
- Visually tested frequently
  - Hydrometer tested frequently
  - Hydrometer tested only when installing
  - Visually tested daily
50. When testing with the antifreeze syringe type hydrometer, you must have two readings. These two readings are
- float scale and thermometer reading.
  - wet bulb and thermometer reading.
  - cell and voltage reading.
  - thermometer and cell reading.

51. Using figure 1-108 (page 1-57) and the insert, what would the antifreeze protection be if the liquid level crosses the float at the letter O and the temperature reading is 120° ?
- a. -49
  - b. -44
  - c. -36
  - d. -33
52. When you are testing antifreeze with the antifreeze and electrolyte tester and you have placed a sample on the measuring window, you would then sight through the eyepiece and where the light and dark areas meet you would read the scale. Which scale would you read?
- a. Left
  - b. Right
  - c. Both left and right and divide by two
  - d. Left or right as long as it is where the light and dark areas meet
53. The purpose of engine lubrication is to reduce wear, cool, clean, and
- a. allow the cooling system to circulate freely.
  - b. prevent corrosion in the cooling system.
  - c. increase fuel mileage.
  - d. seal in power.
54. Reducing friction and acting as a preservative are two main purposes of
- a. lubricant.
  - b. paint.
  - c. water.
  - d. steam.
55. What publication contains specific instructions on how to lubricate a vehicle?
- a. Marine Corps Order 4700/15A
  - b. Lubrication order
  - c. Standing operating procedures (SOP)
56. Using figures 1-108 through 1-111, what information would be determined if you were checking the brake master cylinder?
- a. It should be checked at 24 months/12,000 mile intervals and it uses 60 90 fluid only. What the cylinder looks like is not shown.
  - b. It should be checked at 6 months/6,000 miles intervals and it uses (HB) non-petroleum fluid only. What the cylinder looks like is shown in E, figure 1-111.
  - c. It uses (HB) petroleum fluid only and it is checked at intervals of 1,000 miles.
  - d. It uses lubricant HB and you check the level.
57. A vehicle may require special lubricating instructions because of the climatic conditions in the area where the vehicle is to be used. As an operator, where would you find this information?
- a. In the lube order for the particular vehicle
  - b. In the standing operating procedure
  - c. In the table of equipment for your unit
  - d. In the parts manual for the particular vehicle
58. When using the chart that contains specific instructions on lubrication, you should always check to make sure it is the one designated for
- a. your particular vehicle.
  - b. the particular climate.
  - c. the specific area of operations.
  - d. the type of loads you will be carrying.

59. Grease fittings vary in shapes such as 45° and 90° angles. These different shapes are used because
- some will take gear oil 90 (60 90) and others will not.
  - the 90° angle will not break off as easily.
  - the 45° angle prevents grease from running out and the 90° angle does not.
  - properly placed they are easily reached for greasing.
60. You are greasing a vehicle. What should you do prior to inserting the gun into the fitting?
- Clean the tip of the fitting off.
  - Remove the fitting to insure that it is not plugged.
  - Gently hit the tip end of the fitting to loosen it.
  - Heat the tip of the fitting to allow the grease to flow.
61. Deterioration of rubber and rotting of canvas are greatly increased when performing oilcan maintenance if
- the outside temperature is less than 60°.
  - the oil is the wrong weight.
  - the oil is not at the correct temperature.
  - oil is squirted or spilled on these items.
62. Which items normally require oilcan maintenance?
- Shock absorbers, electrical connections, and water pump
  - Horn button, fan belts, and ignition switch
  - Differential breather valve, directional signal control, and dimmer switch
  - Hinges, choke cable, and seat adjuster
63. The correct level of the lubricant for the winch worm gear must be determined. Which procedure below is correct?
- Remove the uppermost plug. If oil does not seep out, fill.
  - Remove the plug on the side and the top plug. Fill until oil seeps out at the top plug.
  - Remove the plug in the side. If oil seeps out, it is at the correct level.
  - Remove the two grease fittings and fill with 60 90.
64. To rewind a winch cable with any degree of accuracy, you should have
- a helper giving specific turning directions.
  - a rope as long as the cable attached to it and used as a guide.
  - a helper stationed in the cab to guide you in a straight line.
65. During the lubing process you should also include a good
- visual inspection of the undercarriage.
  - cleaning of the cab and compartments.
  - visual inspection of the cargo bed area.
  - visual inspection of the canvas.

Total Points: 65

\* \* \*



UNITED STATES MARINE CORPS  
MARINE CORPS INSTITUTE, MARINE BARRACKS  
BOX 1775  
WASHINGTON, D.C. 20013

**LIGHT VEHICLE PREVENTIVE MAINTENANCE**

**Lesson 3**

**Daily and Weekly Maintenance**

**STUDY ASSIGNMENT:** MCI 35.23, Light Vehicle Preventive Maintenance, chap 2.

**LESSON OBJECTIVE:** Upon successful completion of this lesson, you will be able to identify the procedures for completing the trip ticket as it pertains to the operation checks.

**WRITTEN ASSIGNMENT:**

**A. Multiple Choice:** Select the ONE answer which BEST completes the statement or answers the question. After the corresponding number on the answer sheet, blacken the appropriate box.

Value: 1 point each

1. Which of the following items gives authority to operate a vehicle?
 

a. Master log	c. Operator's identification card
b. Trip ticket	d. Unit's weekly PM form
  
2. The daily and portions of a weekly preventive maintenance checklist can be found on what form?
  - a. Unit's weekly PM form
  - b. Preventive maintenance schedule and record
  - c. Master log
  - d. Trip ticket
  
3. Which of the following symbols is used on a trip ticket to indicate that the item is OK?
 

a. *	c. x
b. ✓	d. 0
  
4. How does the driver evaluate the condition and performance of his vehicle on a daily basis?
  - a. Completes the before-, during-, and after-operation checks
  - b. Completes the weekly checklist form
  - c. Has the vehicle scheduled for daily lubrication
  - d. Remembers what's wrong with the vehicle and verbally notifies his supervisor
  
5. If the driver puts the symbol (x) on the trip ticket when performing the operation checks, what does it mean?
 

a. Weekly check	c. Is OK
b. Does not apply	d. Is defective
  
6. To enable your supervisor to use your information in the remarks section, the information should be written in a
  - a. general manner.
  - b. manner that includes terms such as all and throughout.
  - c. specific manner.



7. All vehicles in your unit are equipped with a jack and lug wrench. You are performing your before-operation check and find that yours are missing. Where on the trip ticket would you indicate this information?
- Under safety devices for the before-operation check
  - Under damage/pilferage for the after-operation check
  - Under damage/pilferage for the during-operation check
  - Under damage/pilferage for the before-operation check
8. You have secured your vehicle for the night. At that time all dents had been noted. The next morning before leaving you find a new dent. Where would you record this?
- Under damage/pilferage for the before-operation check
  - Under tools and equipment for the before-operation check
  - Under engine operation for the during-operation check
  - Under safety devices for the after-operation check
9. Which type of leak is most likely to cause engine overheating?
- Exhaust
  - Lubrication
  - Coolant
  - Fuel
10. Which item below is most likely to cause a coolant leak?
- Loose fan belts
  - Radiator draincock
  - Radiator fins partially plugged with dirt
  - Broken temperature gage
11. Other than by visual detection, what characteristic would help the driver detect a brake fluid leak?
- A vibration in the steering wheel
  - The inability of the emergency brake to function properly
  - The extra amount of force it would take to depress the pedal
  - The distinguishable odor it produces
12. Placing your boot tightly on the end of the tail pipe and listening for a puffing sound is a method for determining
- an exhaust leak.
  - an air leak.
  - the temperature of the tail pipe.
  - if all the exhaust system supports are tight.
13. What should be done when you check the oil level in your vehicle and you find it is well over the full mark?
- Operate the vehicle because the excess oil will do no harm.
  - Drain the excess oil out, check it for water contamination, and fill to correct level.
  - Operate the vehicle for at least a week and then check it.
  - Drain the oil and adjust the level to approximately 2 quarts below full.
14. Oil should be added if the reading on the dipstick indicates it is
- at or below the "add oil" mark.
  - at the full mark, if your vehicle uses oil.
  - between the "add oil" and full mark.

15. The specific purpose of a grommet is to prevent
- enlargement of holes drilled in the vehicle.
  - water from entering holes that have been drilled in the body.
  - cables and wiring from chafing.
  - corrosion at the point where cables and wiring pass through the vehicle body.
16. When conducting the engine warmup check, the engine speed should be kept at
- a fast idle.
  - the fastest speed the accelerator will permit.
  - the fastest speed the accelerator will permit for at least 5 minutes.
  - alternate speeds by high revving of the engine and fast idle.
17. When performing the engine warmup check, the operator should also listen for odd noises and
- load his vehicle with the necessary equipment.
  - clean the inside of his cab.
  - clean the windshield.
  - monitor the various gages.
18. When the temperature gage registers a high reading, the probable cause is an abnormal condition in the
- fuel system.
  - cooling system.
  - lube system.
  - electrical system.
19. By monitoring the temperature gage, the driver will be alerted early to a malfunction in the
- fuel system.
  - oil pressure system.
  - engine cooling system.
  - air system.
20. When monitoring the battery-generator gage, where should the needle point under normal conditions?
- In the first half of the green section
  - As far right in the green section as possible
  - In the red section
  - Pointing directly up
21. Monitoring gages, listening for unusual noises, and detecting unusual odors are three items to help
- in the early detection of malfunctions.
  - the operator from becoming drowsy.
  - determine if the vehicle is overloaded.
  - the operator maintain the correct speed.
22. If the brake pedal does not have enough free travel, the result will be
- a loss of braking power.
  - leakage of brake fluid.
  - a loss of steering control.
  - that the brakes will drag.
23. Too much free travel in the brake pedal will cause
- a loss of steering control.
  - the axle seals to leak.
  - leakage in the wheel cylinders.
  - a loss of braking power.

24. Proper free travel adjustment in the clutch pedal is necessary so that the transmission can be
- fully engaged and disengaged without grinding the gears.
  - used for coasting downhill.
  - shifted without using the clutch.
  - used to supply power to the power-takeoff unit.
25. Normally if a vehicle has too much free travel in the steering, it could be detected because of what condition?
- There will be a cracking noise when the wheel is turned.
  - The operator must constantly turn the wheel back and forth.
  - The vehicle pulls to the right.
  - The vehicle pulls to the left.
26. Which of the following would indicate too much free play in the steering system?
- The vehicle pulls to the right when the brakes are applied.
  - The steering gearbox makes a cracking noise when turning the steering wheel.
  - The steering wheel has to be turned excessively before the wheels react.
  - The wheels respond with just a slight turning of the steering wheel.
27. Because of the varying conditions (vehicle speed, terrain, and payload), which operation check would be most likely to uncover symptoms of poor engine performance?
- After operation
  - Engine warmup
  - Engine operation
  - Unusual noises
28. While you are operating your vehicle, you hear an unusual noise. You should consider this as a warning and
- forget about it until something happens.
  - have the vehicle towed back to the MT lot.
  - keep operating the vehicle to see if it will stop.
  - its origin should be pinpointed to determine what the cause may be.
29. Which operation check is intended to insure that your vehicle is fully serviced when you are finished?
- During-operation
  - Weekly PM
  - After-operation
  - Before-operation
30. Which of the items below is NOT considered as part of the eight general inspections that should either be visually or physically determined when performing preventive maintenance?
- Determine that the item is in good condition, correctly assembled, stowed, and secured
  - Determine that the item is not worn excessively or leaking
  - Determine that the item is adequately lubricated and properly adjusted
  - Determine the exact life of the item before it will need replacement and the amount of time it will take to replace it
31. The two types of air cleaners used on military vehicles are
- fiber and metallic.
  - wet and dry.
  - positive/nonpositive.
  - porous/nonporous.
32. When the operator is checking for proper alignment, unusual wear, and proper adjustment, which item below would he be looking at?
- Water pump
  - Headlights
  - Drive belts
  - Winch cable

35.23

lan 3; p. 4

33. As an operator inspecting the cooling system, which three items would you be inspecting?
- Hard stiff hoses, clamps positioned improperly, and loose struts or braces
  - Clamps positioned improperly, faulty thermostat, and loose struts or braces
  - Clamps positioned improperly, loose struts or braces, and radiator cap that has the improper pressure release
  - Hard stiff hoses, incorrectly pitched fan blade, and a faulty thermostat
34. What is the correct method of inspecting for dents?
- Inspect only the passenger's side.
  - Inspect only the driver's side.
  - Inspect around the entire vehicle.
  - Inspect only the front and rear.
35. What is done to protect canvas from mildew?
- Keep it damp and clean.
  - Keep it clean and expose it to air and sunlight.
  - Keep it tight and dry.
  - Keep it well supported and dry.
36. Which item below is a function that canvas would NOT perform?
- Helps keep personnel dry and warm
  - Protects cargo from the elements
  - Protects against carbon monoxide poisoning
  - Protects troop seats and seat canvas resulting in less maintenance
37. What procedure should be followed if you are required to maintain canvas in storage?
- Canvas should be clean and dry, stacked on dunnage, and the canvas stored the longest time should be issued first.
  - Canvas should be clean and fairly damp and stacked as tightly as possible.
  - Canvas should be stacked as tightly as possible to prevent the circulation of air, and the canvas stored the shortest time should be issued first.
  - Canvas should be rolled tightly and stored on dunnage, and dampened frequently to prevent it from drying out.
38. You are visually inspecting your vehicle. It is parked on fairly level ground, tire pressure is correct, and the vehicle is empty. What would you consider wrong if you noticed one corner of the vehicle sagging?
- Worn tie rod ends
  - Weak or broken spring
  - Loose axle flange nuts
  - Bent or loose drive shaft
39. What occurs if shock absorber mounting bolts are not kept tightened?
- The movement of the bolts will cause the spring to shift.
  - The tie rod ends will wear out faster.
  - The movement of the bolt will cause the steering gearbox to loosen.
  - The movement of the bolt will cause the mounting bracket hole to enlarge.
40. Shock absorbers used with coil springs are exceptionally important because they prevent excessive
- speeds when cornering.
  - overloading of the vehicle.
  - toe-in of the front wheels.
  - pitching and rolling.

41. What procedure is used to determine if the universal joint is worn?
- Grasp the shaft with one hand and the "U" joint with the other and twist them.
  - Grasp the shaft with one hand and the "U" joint with the other and pull.
  - Grasp the shaft with both hands and twist it.
  - Grasp the universal with both hands and twist it.
42. Because of the stress applied to the universal joints, what is likely to occur if the "U" bolts are not kept tight?
- The transmission will be difficult to shift.
  - There will be excessive wear to the "U" joint, which may even cause it to fall out.
  - The steering will not function properly.
  - The shock absorbers will not function properly.
43. When he is inspecting wheel rims, what are some of the items that the operator would be looking for?
- Cracks, broken welds, and dents
  - Out of balance rims and loose valve cores
  - Worn or out of round brake drums
  - Closed or bent cooling fins
44. What is likely to occur if the valve stem is not centered in the hole in the rim?
- The tire will not roll properly.
  - Chafing may occur, causing the stem to leak.
  - The hole in the rim may become enlarged.
  - The tire will be out of balance.
45. Line clamps, braces, and fuel tank supports, if kept tight and properly positioned, will reduce
- chafing and prevent leaking.
  - the intervals at which the fuel filter must be changed.
  - the intervals for scheduled maintenance.
  - the need for carburetor adjustment.
46. Which of the following items are most likely to become loose or corroded if not maintained regularly?
- Battery clamps, cables, posts, and the battery compartment
  - Battery clamps, cables, and battery gage
  - Cables, clamps, generator, and voltage regulator
  - Battery posts, battery compartment, clamps, vent caps, and casing
47. Which of the following items would you as an operator be looking for if you were visually inspecting the wiring on a vehicle?
- Loose, corroded connections, frayed wiring, loose or missing wire supports or retainers
  - Correct generator output, battery specific gravity, and frayed wiring
  - Correct voltage regulator output, frayed wiring, loose or corroded connections
  - Loose, corroded connections, correct wire size, frayed wiring, and battery specific gravity
48. When replacing a headlight, you must first remove the lamp door/headlight rim and
- unplug and remove the headlamp.
  - remove the rubber gasket and unplug the lamp.
  - grasp the headlamp so that it will not fall out.
  - loosen the retainer ring and remove it.

35.23

Isn 3: p. 6

49. Prior to replacing any securing devices to the headlamp, it should be
- a. tested.
  - b. adjusted.
  - c. synchronized.
  - d. pressurized.
50. When replacing the cover on a tail light, what precaution must you take to keep water and moisture from entering the assembly?
- a. Leave the bottom screw loose so that it can drain.
  - b. Insure that the bulb will generate enough heat to dry it out.
  - c. Have the cover spot-welded to the assembly.
  - d. Insure that the gasket is properly positioned and that the screws are tight.
51. Care should be taken when removing the retainer ring so that the
- a. adjustment screws are not moved by mistake.
  - b. watertight connection is not loosened.
  - c. headlight rim/door does not get bent.
  - d. screws do not become cross-threaded.
52. Tie rods, bell crank and steering gearbox, when worn or improperly adjusted, will affect the
- a. handling characteristics of the vehicle.
  - b. power train of the vehicle.
  - c. alinement of the differentials.
  - d. alinement of the drive shafts.
53. For the exhaust system to function properly, the operator must insure that the system is
- a. free from holes and that the clamps and hangers are tight.
  - b. properly pressurized and free from holes and that the clamps and hangers are tight.
  - c. properly lubricated, free from holes, and properly pressurized.
  - d. free from holes and that it is clean and operating at the correct temperature.
54. When an exhaust system is faulty, what must the driver be very much aware of?
- a. That the loud noise will affect his hearing
  - b. That he could be overcome by carbon monoxide gas
  - c. That the vehicle mileage will be reduced by 75%
  - d. That tire wear will be increased 30%
55. You have a fuel gage that does not register any reading (switch on); you are certain the tank has fuel; your next step would be to
- a. check to make sure the gage is not disconnected.
  - b. replace the gage.
  - c. pressurize the fuel system.
  - d. check the output of the generator.
56. Which should you do frequently to avoid letting a tire wear beyond use?
- a. Recap
  - b. Change
  - c. Inspect
  - d. Clean
57. A change in the handling characteristics of your vehicle such as pulling to the right or left usually indicates
- a. worn wheel bearings.
  - b. low tire pressure.
  - c. faulty handbrake.
  - d. faulty suspension.



58. Which is the driver's responsibility in maintaining a trailer?
- a. Wiring of electrical system  
b. Balancing of tires  
c. Adjustment of handbrake  
d. Adjustment of suspension system
59. How should a trailer be parked in order to prevent water from settling in the bed?
- a. On a slant  
b. On jacks  
c. On its end  
d. On its side
60. When disengaging an intervehicle electrical cable, you should grasp it
- a. below the neck.  
b. at the neck.  
c. above the neck.  
d. on the cable near the plug.
61. If lenses and data plates are left painted over, it is an indication of
- a. proper driver's maintenance.  
b. improper driver's maintenance.  
c. a manufacturer's defect.  
d. a mechanical defect.
62. Which should you inspect frequently in the maintenance of the battery area?
- a. Voltage output  
b. Holddown frame  
c. Specific gravity  
d. Insulation
63. Which may occur if you fail to replace a missing rubber insulator on a radiator?
- a. Blockage of coils  
b. Ruined radiator core  
c. Damaged fan  
d. Overheating
64. If a wiper blade is missing or broken, you should
- a. deadline the vehicle.  
b. report it to MT chief.  
c. replace it as soon as possible.  
d. repair it on next PM.
65. Which should you do in the proper maintenance of the instrument panel of a vehicle?
- a. Spot paint any rusty areas.  
b. Report gages with cracked lenses.  
c. Repair any burned-out instrument lights.  
d. Repair gages with moisture in them.
66. To use an oil can for a purpose other than pouring oil indicates that you have
- a. violated shop orders.  
b. misused the tool.  
c. followed the lube order correctly.  
d. performed proper driver's maintenance.
67. If a driver performs driver's maintenance properly, he will insure that all equipment is correctly
- a. surveyed.  
b. adjusted.  
c. stored.  
d. repaired.

Total Points: 67

\* \* \*

35.23  
len 3; p. 8



LIGHT VEHICLE PREVENTIVE MAINTENANCE

Lesson 4

Field Expedient Repairs

STUDY ASSIGNMENT: MCI 35. 23, Light Vehicle Preventive Maintenance, chap 3.

LESSON OBJECTIVE: Upon successful completion of this lesson, you will be able to identify what a field expedient is and the method used to perform field expedient repairs on certain components of the vehicle.

WRITTEN ASSIGNMENT:

- A. Multiple Choice: Select the ONE answer which BEST completes the statement or answers the question. After the corresponding number on the answer sheet, blacken the appropriate box.
1. A repair that is performed when it is vital that the vehicle be kept operating and when normal facilities cannot be reached using any material at hand is called
    - a. depot repair.
    - b. scheduled repair.
    - c. recorded repair.
    - d. field expedient repair.
  2. Which repair below would be considered an expedient repair?
    - a. Mounting a container higher than the carburetor for a substitute gas tank
    - b. Flushing the radiator before adding antifreeze
    - c. Lubricating the vehicle as scheduled
    - d. Rotating and matching tires
  3. What action would you take as a field expedient when one blade on your fan has broken?
    - a. Remove the fan belts.
    - b. Tape the broken blade back on.
    - c. Break or cut off the blade opposite from the broken one.
    - d. Break or cut off all remaining blades.
  4. Splicing with wire or lacing it together with a shoelace is a field expedient for repairing a broken
    - a. brake line hose.
    - b. fuel line.
    - c. tire bead.
    - d. fan belt.
  5. Wedging a nail or similar object between the battery post and clamp is a field expedient to
    - a. repair a broken cable.
    - b. increase generator output.
    - c. repair a loose battery clamp.
    - d. increase the specific gravity of the battery.
  6. Driving a nail or screw down through the battery post is the field expedient to repair a
    - a. plugged battery casing vent.
    - b. broken cable.
    - c. broken battery post.
    - d. broken clamp.

7. You are repairing a hose. You have bent the piece of tin into a cylinder. You should now
- wrap it around the outside of the hose.
  - insert it inside the hose.
  - discard the hose and use the cylinder.
  - use it as a bypass pipe.
8. The best substitute for a hose clamp would be
- wire.
  - tape.
  - rope or string.
  - glue.
9. You have determined that a radiator core tube is leaking. You are required to use the field expedient method. What is the first step?
- Cut through the fins.
  - Cut the core tube at the leak.
  - Remove the top and bottom hoses.
  - Loosen the drive belts.
10. When the field expedient of cutting and crimping a radiator core tube is done on several tubes, what result will this have on the cooling system?
- The distance the coolant travels is shortened causing the coolant to cool too fast.
  - It causes the water pump to circulate the coolant faster.
  - It prevents the thermostat from opening due to the coolant temperature.
  - The efficiency of the radiator is reduced and the engine could overheat.
11. Removing the cover plates on the blackout lights and driving at a reduced speed is a field expedient if
- the instrument cluster panel lights are burned out.
  - both headlights are broken or burned out.
  - the high beam indicator light is burned out.
  - you are required to drive closer than 10 feet behind the truck in front.
12. A self-topping screw and a washer with a piece of leather or rubber for a gasket is a good field expedient for plugging a small leak
- in the fuel tank.
  - in a coolant hose.
  - in a brake line.
  - in the fuel pump.
13. The field expedient shown in figure 3-12 is used under what conditions?
- When a wheel or axle breaks on a four-wheel-drive vehicle
  - When a spring is broken
  - When it is necessary to chock the vehicle to prevent it from rolling
  - When it is necessary to chock the vehicle so that the winch may be used
14. The field expedient shown in figure 3-13 is used under what conditions?
- When the vehicle is being overloaded
  - To prevent the axle from turning
  - When a spring is broken
  - When it is necessary to operate with a flat tire

15. When using the field expedient for a broken axle or a broken wheel, the skid timber works best if it is how long?

- a. 1-5 feet
- b. 6-8 feet

- c. 9-12 feet
- d. 13-14 feet

Total Points: 15

\* \* \*

35.23  
Item 4: p. 3

\* U.S. GOVERNMENT PRINTING OFFICE: 1963-O-381-315/627