

DOCUMENT RESUME

ED 256 614

SE 045 548

TITLE Science Unlimited: Teacher's Guide to the Intermediate Lessons.

INSTITUTION Pennsylvania State Dept. of Education, Harrisburg. Div. of Arts and Sciences.

PUB DATE [84]

NOTE 186p.; For related documents, see SE 045 547-548 and SE 045 550.

PUB TYPE Guides - Classroom Use - Guides (For Teachers) (052)

EDRS PRICE MF01/PC08 Plus Postage.

DESCRIPTORS Animals; Earth Science; *Educational Television; *Elementary School Science; Intermediate Grades; Lesson Plans; *Physical Sciences; *Science Activities; Science Education; *Science Instruction; *Teaching Methods

IDENTIFIERS *Pennsylvania

ABSTRACT

Science Unlimited (Pennsylvania Department of Education's elementary science effort) has developed a series of television programs for use in the primary and intermediate grades. These television programs form an integral part of science lessons which emphasize direct involvement of children with materials and ideas, provide for individual and group activities, are competency-based, use only easily available equipment and materials, and are keyed (via a curriculum matrix) to computer software and other resources. This guide contains the information necessary to teach lessons in which children in intermediate grades investigate: ice and water; chemistry; color; solids and liquids; geology; weather; sound; evaporation; floating things; simple machines; bouncing objects; electricity; energy; heat loss; and animals. This information includes (when applicable) lesson aims and competencies fostered, instructional strategies (including those related to use of the television programs), list of materials/equipment needed, background information, and resource materials for the teacher. General comments about the nature and use of Science Unlimited in teaching science and the instructional approaches used in the program are provided in an introduction. (JN)

 * Reproductions supplied by EDRS are the best that can be made *
 * from the original document. *

Commonwealth of Pennsylvania
Pick Thornburgh, Governor

Department of Education
Office of Basic Education
Margaret A. Smith, Commissioner

Bureau of Curriculum and Instruction
David Campbell, Director

Division of Arts and Sciences
Clyde M. McGeary, Chief
John J. McDermott, Senior Adviser, Science

Pennsylvania Department of Education
333 Market Street
Harrisburg, PA 17126-0333

The Pennsylvania Department of Education, an equal opportunity employer, will not discriminate in employment, educational programs or activities, based on race, sex, handicap, or because a person is a disabled veteran or a veteran of the Vietnam Era. This policy of non-discrimination extends to all other legally protected classifications. Publication of this policy in this document is in accordance with state and federal laws including Title IX of the Education Amendments of 1972 and Section 503 and 504 of the Rehabilitation Act of 1973. Inquiries should be directed to Susan Mitchell, Affirmative Action Officer, 503/504 Coordinator and Title IX Coordinator, Education Building, 333 Market Street, Harrisburg, PA 17126-0333 (717-787-1953).

IMPORTANT

IF YOU NEED HELP OR INFORMATION CONCERNING SCIENCE UNLIMITED:

CALL 1-800-TELESCI TOLL FREE

HOURS: 9:00 a.m. till 4:00 p.m.

Persons knowledgeable concerning SCIENCE UNLIMITED will be available to provide help, advice, and information to you should you experience difficulty in implementing SCIENCE UNLIMITED.

IF YOU ARE UNABLE TO REACH 1-800-TELESCI: Call (717) 783-6598

ACKNOWLEDGEMENTS

We wish to express our special thanks and appreciation to the following for their generosity in allowing us to use materials and lessons which they developed and tested with children in their classrooms.

Altoona Area School District

Capitol Campus

The Pennsylvania State University

Elementary Science Graduate Classes of Dr. Roy Allison

SCIENCE UNLIMITED COMMITTEE

**Roy W. Allison, Professor, Elementary Science
The Pennsylvania State University, Capitol Campus**

**William H. Bolles, Science Education Adviser
Pennsylvania Department of Education**

**William D. Chamberlain, Professor, Science Education (Ret)
Clarion University**

**Irvin T. Edgar, Regional Director for Long Range Planning
Pennsylvania Department of Education**

**Kenneth Mechling, Professor, Science Education
Clarion University**

**Donna Oliver, Intermediate Grade Teacher
Sharon City School District**

**Duane R. Smith, Professor, Elementary Education
The Pennsylvania State University, Capitol Campus**

**Robert L. Shrigley, Professor, Science Education
The Pennsylvania State University**

**Beverly Walker, Primary Grade Teacher
Harrisburg City School District**

**Paul W. Welliver, Professor, Science Education
The Pennsylvania State University**

All comments concerning these materials should be directed to the following individual, who directed the SCIENCE UNLIMITED Project:

**John J. McDermott
Senior Adviser, Science
Pennsylvania Department of Education
Bureau of Curriculum and Instruction
333 Market Street
Harrisburg, PA 17108
(717) 783-6598**

CLARION UNIVERSITY CENTER FOR SCIENCE EDUCATION

**Ken Mechling
Donna Oliver
Nancy Bires
Lynne Kepler
Bruce Smith**

SEQUENCE OF LESSONS

1. Investigating Ice and Water
2. Investigating Chemistry
3. Investigating Color
4. Investigating Strips and Liquids
5. Investigating Geology
6. Investigating Weather
7. Investigating Sound
8. Investigating Evaporation
9. Investigating Floating Things
10. Investigating Simple Machines
11. Investigating Bouncing Objects
12. Investigating Electricity
13. Investigating Energy
14. Investigating Heat Loss
15. Investigating Animals

SCIENCE UNLIMITED IS DIFFERENT

The televised program usually provide periods of silence during which the children and the teacher are interacting on such things as observations - interpretations - previous experiences - ideas.

The televised program, the teacher and the children comprise a three-way interacting group during the televised lesson.

- . The teacher is part of it. You guide student participation with the help of this Handbook.
- . The children are part of the TV program.
- . The TV program raises questions to stimulate pupil response.
 - leads children into hands-on experimentations.
 - is part of a rational teaching strategy.

Each TV program is keyed to specific student competencies.

SCIENCE UNLIMITED Lesson Characteristics

- . emphasizes direct involvement of children with materials and ideas.
- . provides for individual and group activities.
- . is competency based.
- . uses only easily available equipment and materials, which can be found in many classrooms, can be brought in by the children, or can be purchased inexpensively locally.
- . allows children to generally internalize and to modify their knowledge, rather than to acquire non-conceptual verbalizations.
- . is competency based.
- . is keyed via the Curriculum matrix to textbooks, computer software and other resources.

SCIENCE UNLIMITED is a resource to help teachers:

- . experience interesting and worthwhile science investigations with children.
- . gain insight into contemporary thinking about effective elementary science instruction.
- . choose and use existing programs and textbooks.
- . develop their own S.U. type lessons.

Using SCIENCE UNLIMITED

1. Know and use this SCIENCE UNLIMITED Handbook for Teachers. It will help to:
 - . Launch your children and you into one of the lessons.
 - . Introduce the complete lesson.
 - . Provide a teacher strategy guide for use before, during, and after the television program.
 - . Provide you with student hands-on experiences and other complete lessons.
2. Before the SCIENCE UNLIMITED Programs:
 - . Read the section in this handbook related to the program both to see the relationship between the program and the follow-up lessons, and to prepare for your role during the TV presentation.
 - . Collect the simple teaching materials you will need in the follow-up lessons.
 - . Prepare to teach the first follow-up lesson immediately following the TV program or as soon as possible.
3. During the SCIENCE UNLIMITED Programs:
 - . The children should be:
 - seated informally so they can easily view the TV screen.
 - feel free to respond to questions, react to observations on the TV screen, or do simple activities suggested by the program.
 - . The teacher should be:
 - located so as to view both the TV screen and the children.
 - equipped with the teachers guide or notes.
 - ready to ask appropriate questions where discussion intervals "bog down".
 - ready to analyze teaching strategies.
 - Ready to make mental or written notes which might be useful for the follow-up activities.
 - . The discussion breaks are designed:
 - to stimulate student responses.

- to provide the teacher with a chance to practice **SCIENCE UNLIMITED** strategies.

4. **After the SCIENCE UNLIMITED programs:**

- . respond to any spontaneous, relevant questions or comments from the children.
- . make notes for appropriate modifications in the lessons indicated by the children's responses during the program.
- . teach the related **SCIENCE UNLIMITED** lessons, varying them according to your professional judgement.

TEACHING STRATEGIES

A TEACHING STRATEGY IS DEFINED..."as a rationale used by the teacher as a basis for making professional decisions."

During any school day the classroom teacher makes many important professional decisions. Such decisions influence a teacher's questioning procedure, materials used, sequence followed and general classroom climate. Rational and consistent decision making require that the teacher develop strategies to use as a guide. Sound teaching strategies for the teaching profession should be based on principles of learning, philosophic points of view, empirical research or other rational bases.

Each Science Unlimited program utilizes one or more of six selected teaching strategies, each based on an educational foundation and believed to support the aims of SCIENCE UNLIMITED.

The strategies identified in this handbook are not peculiar to the teaching of science, making them useful in many areas of teaching and at many grade levels, including adult.

Involving you in the application of the six strategies is not for the purpose of making you proficient at applying the one and only discussion period in the programs where a single strategy can be selected as the only one applicable. However, you should begin to sense a strategy that is major, as compared to those which are minor, in making a decision.

The ultimate goal for including the six strategies as a part of this resource is to sensitize you to the need for a rationale, or reason, for most, if not all, decisions made in classroom teaching. It is our opinion that the basis used for decision-making in the classroom is probably the major characteristic that separates the professional from the paraprofessional.

STRATEGIES: an explanation -

Each televised program utilizes one or more of these strategies. When they occur, they are identified in the TV lesson guide sheet by a key symbol (in the Teacher's Guide to student-teacher-TV interaction).

1. Teacher questions require students to arrive at an answer by examining and manipulating the materials they are using.
2. Responses are accepted when students use evidence from their lesson activities in observing and responding.
3. Student interpretations are considered acceptable (even though they are partial or temporary conclusions), as long as the evidence from their investigations and experience supports their responses.
4. Reasonable time is provided during discussion for observation, thought and reflection.
5. Teacher questions and behaviors emphasize the use of the processes including observing, classifying, communicating, measuring, inferring and experimenting.
6. Teacher questions encourage wider student thought and suggestions for additional investigative behavior.

1. Teacher questions and statements require students to examine and manipulate the materials they are using to arrive at their answers.

SCIENCE UNLIMITED IS COMMITTED TO DIRECT EXPERIENCE, ACTIVITY CENTERED LEARNING IN SCIENCE.

Most of the science ideas that young children can conceptualize are those within the limits of direct experiences. The children's interactions with simple materials provide the source of their beginning knowledge and, in most cases, should define the limits of their knowledge. It is usually inappropriate to ask children to generalize beyond the scope of their experiences, to formulate abstractions, or to accept abstractions.

The learning in these lessons involves student interaction with materials as a means of generating both questions and answers by the student.

THE IDEAS (ANSWERS) OFTEN LEAD TO FURTHER ACTIVITIES IN AN EFFORT TO SEEK SUPPORTIVE OR MODIFYING EVIDENCE.

THE TEACHER SHOULD ENCOURAGE CHILDREN TO IDENTIFY AND PURSUE THE KINDS OF QUESTIONS THAT THEY WILL BE ABLE TO ANSWER BY "DOING SOMETHING" WITH "THINGS".

WE, AS TEACHERS, MUST ASK THE TYPES OF QUESTIONS YOUNG CHILDREN CAN ANSWER BY DIRECT OBSERVATIONS OF THINGS OR BY HOW THINGS INTERACT.

THE ABOVE THREE POINTS IMPLY:

- A. "WHY" QUESTIONS ARE RARELY APPROPRIATE TO USE WITH YOUNG CHILDREN
- B. TEACHERS MUST FREQUENTLY RESTATE QUESTIONS ASKED BY CHILDREN SO THAT THE QUESTIONS ARE IN A FORM WHICH LEADS THE CHILDREN BACK TO OBSERVING AND INTERACTING WITH MATERIALS.

EXAMPLES

Enabling

Tom, what did you do that was different from what Jean did? There must be a good reason for the different result you got.

.

Why don't you both do it again to find out what caused your different observations?

.

When you turn the big wheel once, what does the little wheel do?

.

What might you do with your mystery box to try to find out how many objects are in it?

.

(Child - Why doesn't my siphon work?)
‡

Watch me do it a few times to see if you can find out what you were doing that is different.

.

Ginny, you said the salt feels like sand. Could your hand lens help you find out more about the shape of salt and sand grains.

.

(Child - Why does the water drop roll around this piece of waxed paper and on the glass?)

Why don't you try some other materials to find out how drops act on them?

.

Inhibiting

Tom, you probably didn't leave the thermometer in the water long enough.

Jimmie got the right answer. Andy, you must have done something wrong.

Can you see how the big wheel is used to increase speed?

How many objects do you think the box contains?

You didn't get all the air out of the tube. Hold one end at the bottom of the jar and the other near the top.

That's right, they both have sharp corners.

Because glass has a stronger attraction for water than waxed paper does.

Jimmie says he is sure there is a rock in this mystery box. Let's list all our observations and see if they all fit Jimmie's conclusion.

It can't be a rock, Jimmie, because I didn't put any rocks in the boxes.

.....

Child - I think the salt is way up on the side of the jar because somebody must have shaken it.

Teacher - That could explain it - How could we find out if shaking caused it?

No - nobody shook it. That's not the reason.

2. Teacher fosters student support of their inferences by leading them to establish a direct relationship between their ideas and the observational evidence on which they are based.

SCIENCE KNOWLEDGE IS BUILT FROM AND UPON WHAT IS KNOWN.

Science investigation is a process of seeking evidence, i.e., that which can be known. To this end, we must continually encourage children to give concrete evidence to support an inference, statement of fact, or conclusion. Observations represent what we know. Inferences are tentative explanations, predictions or conclusions which fit our limited knowledge.

Instead of "wild guesses", children should be encouraged to make "educated guesses" based on what they know to be true, i.e., evidence.

The wise teacher avoids making authoritarian decisions as to whose ideas are right. In an investigation-centered science experience, children who make statements which are in conflict with the ideas of the teacher, the book, or other children can often be at least equally right. Differences in explanations may be due to differences in observations, amount of evidence available, communication skills, etc.

When children are challenged to produce the evidence to support a statement interesting outcomes may result, i.e.:

- A. They may revise their statement.
- B. They may justify their "different" interpretation.
- C. They may recognize a need to repeat their original activity.
- D. They may identify a careless observation.
- E. They gain insight into the interdependency between observations and inferences.

EXAMPLES

Enabling

Inhibiting

What did you observe that made you say that?

No, that's wrong (or that's right).

Show us what you did and what you observed that gave you that idea.

Try doing it again to check your observations.

.....

Do you have a reason for saying that?

Rejecting (or accepting) an idea without giving children a chance to present their evidence.

.....

What is your evidence for making guess (prediction, etc.)?

Allowing children to argue a point without using observations or other appropriate evidence to defend their point of view.

.....

Do we need more evidence before we can say that?

Accepting or inflicting abstract verbalization for which children have no experiential foundation.

.....

Have you had any experiences with ice changing to water or water changing to ice that might help you predict whether the water level will be higher, lower, or the same after the ice cubes melt.

Each of you make a guess whether the water level will be higher, lower, or the same after the ice melts.

.....

Let's match your list of observations with your conclusion and see if they all support that statement.

But, that's not the right answer. This experiment is to prove that

3. Student interpretations are considered acceptable (even though they are partial or temporary conclusions) as long as the evidence from their investigations and experiences support their responses.

SCIENCE IS SELF CORRECTING. THAT IS: ANY EXPLANATIONS (EVEN THOSE OF SCIENTISTS) ARE TENTATIVE AND SUBJECT TO CHANGE AS NEW EVIDENCE IS ACQUIRED.

Science knowledge is dynamic. Whenever scientists encounter new evidence, they reexamine related theories, conclusions, etc. The new evidence may cause them to strengthen, revise, or reject existing ideas.

So, too, with young children. Their science concepts evolve through a sequence of partial truths - those that are true within the limits of their experience.

Each of us can only be as right as our observations, past experience and reasoning power permit us to be. As long as we regard our ideas as dynamic - i.e. subject to modification when conflicting new evidence is encountered - knowledge evolves in a pattern that is meaningful, that reflects openmindedness, and which is in keeping with the spirit of science.

At the elementary level, the child's explanations may fit his limited evidence and experience yet not be in agreement with ideas of the "experts". Any child's idea, justified by his evidence should be accepted without condescension or qualifying statements such as "but...." or "however....", etc. Teacher Responses can reflect the idea of tentativeness by taking such form as:

1. That seems to explain what we now know.
2. Does that fit all we have observed?
3. Is there anything else we can do to check our idea?

EXAMPLES

Enabling

Inhibiting

Child - Magnets attract only nails and paper clips, nothing else.

Yes, magnets attract all iron and steel.

Teacher - That agrees with our observations, so far...

.....

Child - The dripping water goes down the drain into the ground.

Teacher - (No comment)

No, it goes through pipes to the septic tank.

(Perhaps arrange for children to visit a house under construction and revise this idea).

.....

Child - There are two marbles in the box because (state relevant observations).

You didn't observe very carefully. If you had you would have heard three objects bump against the side.

Teacher, "You have found some real good clues." (Later when children compare, three clicks may be demonstrated.)

.....

(Observations and Description Lesson)

Child - I think the answer is the aquarium.

No, that not the object I have in mind. Guess again.

Teacher - That fits all the clues I gave you, doesn't it. But it isn't the object I have in mind. I guess you need another characteristic. The object would fit in your desk.

.....

The candle in the jar went out because it didn't have enough air.

The real reason it went out was it didn't have enough oxygen (oxygen is merely a meaningless verbalization for young children).

Teacher, accept with approval.

.....

Child - All magnifiers must be made of something that has no coloring in it.

But if there is only a pale coloring in the lens it will work. Think of tinted eyeglasses.

Teacher - Accept or make neutral statement such as: It certainly seems that none of the colored objects we used were good magnifiers.

4. Reasonable time is provided during discussion for observation, thought, and reflection.

This practice involves what Mary Budd Rowe has titled "wait-time". Her research indicates that many teachers seem unable to tolerate periods of silence longer than one second during class discussion. If children are barraged with questions and pressured for immediate answers, they do not have time to involve themselves in the mental, observational and manipulative activities which are important to an investigative type science program.

BY INCREASING "WAIT-TIME" AFTER DISCUSSION QUESTIONS TO FIVE SECONDS, TEACHERS HAVE FOUND THAT MORE CHILDREN PARTICIPATE, THE QUALITY OF RESPONSES INCREASE, AND GREATER PUPIL TO PUPIL DISCUSSION OCCURS.

Children need time to think, to figure out, and to reconcile conflicting ideas. They need time to derive answers from observations. They need time to communicate their ideas. Discussion among children improves their communication skills. School is a place where children evolve their learning, not where they recite "right" answers.

Try to wait at least five seconds before calling on a child for a verbal contribution. Wait again, after the child's statement, to give the children in the group time to think about what has been said and to react with questions, additional information, statement of conflicting ideas, etc.

By increasing "wait-time" the talk pattern in a classroom often changes from:

Teacher-pupil-teacher-pupil, etc.

to

Teacher-pupil-pupil-pupil-teacher-pupil-pupil-teacher, etc.

Teachers might find statements similar to the following helpful in fostering effective use of wait-time.

1. I'm not going to call on anyone for a while so that each of you has a chance to think of what you want to say.
2. Think about it and raise your hand when you have an idea. I'll nod and you put your hand down until others are ready with ideas.
3. I'll tilt the mystery box slowly several times so you can really hear the sounds and think about what they help you to know.
4. Think about what Johnny said and decide why you agree or why you disagree with him.

5. Teacher questions and behaviors emphasize the use of processes including observing, classifying, communicating, measuring, inferring, predicting, and experimenting.

THE DEVELOPMENT OF SKILLS IN USING THE PROCESSES OF SCIENCE IS BASIC TO PRODUCTIVE INVESTIGATION IN SCIENCE.

The processes listed here are selected from those identified in the AIMS as being most appropriate for children in the elementary grades.

OBSERVING

Looking
Listening
Feeling
Smelling
Tasting

CLASSIFYING

Identifying likenesses
Identifying differences
Grouping into sets

COMMUNICATING

Verbally
By Gesture
By Showing
By Drawing
By Diagraming
Listening
Questioning

MEASURING

Size
Weight
Quantity (volume)
Number

INFERRING

Using observations and past experiences to construct tentative explanations, conclusions, predictions, etc.

PREDICTING

(Extrapolating)
Inferring a behavior by imagining an extension of a pattern which has been identified (by graph, table, list, etc.)

EXPERIMENTING

Identification and control of variables

These process skills are useful in curriculum areas other than science. Many teachers report that their first and second graders gradually transfer these skills to use in subjects other than science. The process skills are important in one's role as a consumer, as a citizen, in interacting with people.

Example: Discriminating between inferences and observations.

Elementary teachers realize that children's ideas often exceed their ability to express them verbally. Because of this limitation, young children should be encouraged to use gestures, to demonstrate (with the actual materials) what they did, and to use other appropriate methods to convey their thoughts and their questions to classmates and to the teacher.

To help children grow intellectually and to grow in self-image, teachers are challenged to use all their ingenuity to:

- a. convey to the child that both teacher and classmates are sincerely eager to understand what the child means;
- b. avoid inferring, prematurely, the idea the child is trying to convey.

Sample teacher statements that support communication skills growth:

1. Tell us a little more about it.
2. Show us what you mean.
3. Would it help us to understand if you make a drawing on the chalkboard?
4. Try to say it another way.
5. Jimmy, you look confused. Can you ask a question to help us explain this better for you?
6. Jane, tell us in your own words what you think Anne means. That will help Anne find out if she has gotten her idea across.
7. I'm going to say it in another way and you can see if I understand what you mean.

6. Teacher questions and statements encourage wider student thought and suggestions for additional investigative behavior.

OBSERVATIONS AND CHILD-CENTERED DISCUSSIONS INVARIABLY LEAD TO QUESTIONS.

Investigation type science learning is often divergent since it focuses on what children find meaningful and what children ask about their observations. Some of the questions which arise can be directly answered by further investigation.

However, we should not let children feel that they can find or understand answers to all their questions. Let's face it, they can't. Some questions may need to be modified to divert the child's interest into something which can profitably be investigated by doing something.

When children report conflicting (or seemingly conflicting) outcomes to investigations, the conflict can usually be resolved best by going back to the materials to identify the source of disagreement, e.g.: inaccurate observation, variations in procedure, legitimate differences in interpretation, etc.

Often a common class investigation leads to suggestions from the children or teacher for further investigation. These can provide opportunity for individuals or small groups to do further work at home or at school.

Open ended elementary science provides for:

- a. closure on child's terms
- b. creativity and divergence
- c. individual differences

Examples of teacher reactions which support strategy #6:

1. Try it and see what happens.
2. Can you think of anything you can do to find out?
3. Child: "Why does it do that?"
Teacher: "What did you have to do to make it happen?"
4. Can you think of anything else we can try to find out more about it?
5. Is there anything you might investigate at home that is related to what we have been doing?
6. Jimmie, you thought of another questions while you were working on this investigation. You might want to do some investigating on your own and let us know what you find out.

SCIENCE UNLIMITED

The philosophy of SCIENCE UNLIMITED is quite compatible with that of open education. The televised programs are developed for large group instruction, but the follow-up activities accommodate groups of many sizes.

Children are directly involved with the materials of their environment at the same time that they are involved socially with each other and adults, both professionals and paraprofessionals.

The openness of many investigations provides the child with choice as to questions tested and materials used. Thus, investigations are designed to be self motivating.

Cooperative teaching required in such innovations as the non-graded plan and continuous progress, supports the intent of SCIENCE UNLIMITED. The large blocks of a daily timetable required in cooperative teaching and the correlation of various subjects is the sort of plan that enhances the aims of SCIENCE UNLIMITED.

An on-going science program in the elementary classroom requires its own spot in the daily timetable and at the same time must be able to correlate with other subjects. SCIENCE UNLIMITED was developed with this thought in mind. For example, Investigating Thermometers and Investigating Measurement are math-centered. Investigating Dripping Faucets, an ecologically oriented lesson, would correlate well with social studies, along with language when the children write a story. Investigating Eyes is a health lesson.

Other lessons are especially appropriate for learning centers and still others encourage open-ended investigative activities that children can do independently - some out-of-class, at home activities.

INTERMEDIATE LESSON

INVESTIGATING ICE AND WATER

COMPETENCIES

A. Processes

1. Observing
3. Inferring
4. Predicting
5. Measuring
6. Communicating
10. Experimenting
11. Formulating Models

C. Physical Science

1. A. Form/State of Matter
1. B. Water
2. A. Basic Characteristics of Energy
2. F. Heat

E. Attitudes

1. Towards Classwork
3. Towards Personal Use of Science
4. Towards Oneself

Lesson 1 - ITV Video Module in Investigating Ice and Water. Forty-five minute ITV presentation. See attachment.

Lesson 2 - Activity 1, Readiness Activity, Investigating Ice and Water. Children set up the investigation as seen in the ITV lesson, construct and label diagrams, and predict the results.

Lesson 3 - Activity 2, Children make observations and collect results from investigation set up in Activity 1 (Lesson 3).

Lesson 4 - Activity 3, Children will prepare a water sample to be frozen, then discuss collected results in terms of earlier investigations.

Lesson 5 - Activity 4, Competency Measure, Using a set of icicle drawings, the children will interpret the information from the sequence and predict the outcome by completing the final drawing.

ICE AND WATER

INTERMEDIATE

"Investigating Ice and Water," ISEE Video Tape, I, 20 minutes: The major purpose of this television program is to demonstrate key techniques involved in conducting an investigation with ice and water. The presentation is designed in such a way as to leave the viewers with an intriguing question that can be investigated in the classroom.

"Winter Ice - A First Film," BFA, P, I, 10½ minutes, color, 1970" Ice is frozen water. It may appear as frost, as snow flakes, or as solid coverings on streams and lakes. Icicles are made of melting snow and ice. In the winter, ice forms at the edges of lakes and ponds. Air might be caught in the water, changing ice to a milky whiteness. In the spring, the ice melts and the water flows off in rivers and streams.

"Water and What It Does," Encyclopedia Britannica, P, 11 minutes, color, 1962: Water is composed of tiny, constantly moving particles, existing in three states, solid, liquid, or gas. Demonstrates the mechanisms of dissolving, evaporation, condensation, freezing, and expansion.

OTHER

"Ice," McGraw Hill Films, I, J, 11 minutes, black and white: Explains how ice is produced, why an ice cube bulges at the top, and how to lift an ice cube out of a glass without touching it. Other experiments deal with expansion and temperature change.

INVESTIGATING ICE AND WATER (20 min. - color)

Discussion Period and Time	TV Image	Final Broadcast Statement	Suggested Statements or Questions	Teaching Strategy
1 30 sec.	Several ice cubes in glass of water	What do you observe when the ice is placed in the water?	What things do you notice about the ice? About the water level?	Process Observation
2 40 sec.	Ice cubes in glass of water	How do you explain this change?	How do you explain the change in water level?	Process Inferring
3 30 sec.	Glass	Why do you think it is a good idea to keep a record of your observations during your investigation?	How might observations recorded now help us later in our investigation?	Process Inferring
4 30 sec.	Two diagrams 1-without ice 2-with ice	What information does your diagram record?	What information is contained in the diagram or what do the diagrams tell us? How many bits of information does the diagram preserve?	Process Communicating
5 30 sec.	Ice pushed down with fork	What do you notice happening when the ice is pushed under the water?	Look closely as the ice is pushed down. Tell us what what you see happening to the water.	Ans Evidence

6 30 sec.	Diagram of fork holding top ice cube down to water level	What information does your diagram record this time?	What information is contained in the diagram now? What does the girl's diagram tell you about changes in water level?	5 Process Communicating
7 60 sec.	The three diagrams	Take a moment to look over the the diagrams and see if you can predict how much space will be taken up.	Where do you think the water level will be when the ice	5 Process Predicting

Title: Investigating Ice and Water

Level: Intermediate

Aims: Toward Which This Lesson Contributes

1. The students will solve problems by gathering information, working independently (individually or in small groups), using equipment and materials, observing purposefully and drawing appropriate conclusions based on these findings.
2. The students will demonstrate competency in the use of the processes in science by (a) observing, (b) communicating, (c) measuring, (d) inferring, (e) formulating hypotheses, (f) interpreting data, (g) controlling variables, and (h) experimenting.
3. The students will construct quantitative and qualitative records that can be used for reaching tentative conclusions.
4. The students will accept and modify ideas, and defend a point of view by making use of supporting evidence.
5. The students will explain basic conceptual schemes of the material world using personal experiences acquired through various activities as the basis for explanations.



Instructional Objectives: At the conclusion of this lesson the students will:

1. Interpret information provided by a simple diagram.
2. Communicate an idea by use of a simple diagram.
3. State a relationship between the volume of a piece of ice and the volume of water it changes to and/or is formed from.

Background Information:

A main focus of this lesson is communication by diagrams. Both interpreting and drawing diagrams are skills which are assumed but rarely taught.

Several aspects of diagrammatic representation are developed through this lesson:

1. Diagrams are simple representations rather than realistic drawings, i.e.: a glass can be represented . We often cannot tell any more information by trying  to develop a three dimensional representation such as . In fact, we make our message more confusing.

2. We transmit information through diagrams, therefore, we must be careful to show clearly the ideas we want to communicate. In this lesson, our diagrams must show changes in water level.

3. Diagrams can save us many words. Time during the lesson can profitably be spent helping children appreciate how many words or statements the diagram replaces.

The other component of this lesson is the volume relationship between ice and water it forms and vice versa. This is not an easy concept for intermediate grade children to comprehend. Experience suggests that they develop some interesting inferences or explanations for their observations. Do not force the children to accept verbalizations. Allow the children to evolve their own ideas using your discussion leadership to help them achieve a fit between observations and inferences. This experience with volume changes associated with water ice is a good readiness experience for study of density in later grades.

Ice to water - volume decreases
Water to ice - volume increases

The water level after the ice melts should be the same as the water level the ice is floating freely in it. However, intermediate level children should only be expected to grasp the idea that when ice changes to water it takes up less space than it did as ice. Some intermediate level children are not ready to formulate even this relationship and should not be forced to do so.

This lesson offers an excellent opportunity to help children grow in their concept of the term volume. The teacher is encouraged to interchange the word "volume" with the phrase "amount of space it takes up" during class discussion.

Total Equipment List for a Class of 30:

Diagram Record Sheets (30 and spares) (a sample is included in this lesson)
30 Icicle Problem Sheets (a sample is included in this lesson)
Food coloring

For each group of four or five children:

A tall, straight-sided glass or jar with a rubber band near the top
Water (cold)
2 plastic forks or other devices to submerge the ice cube
A lid for the glass or jar (does not have to fit snugly)
Colored pencils or crayons (if desired for diagrams)
About 9 ice cubes

Activity 1 - Readiness Activity

Materials needed:

Diagram Record Sheets (30 and spares)
Food coloring

For each group of four or five students:

A tall, straight-sided jar with rubber band near top
Cold water
2 plastic forks
Lid for jar
About 9 ice cubes
Colored pencil or crayon

Distribute a glass and fork to each group and a diagram record sheet to each child.

Through discussion, help the class to recognize that the drawings are diagrammatic representations of a side view of the glass. Explain that they will be using these pages to make a record of their investigation by adding more information to the diagrams.

Place the ice cubes in the container. Add as many as will freely float in the water without touching the bottom. Instruct them to hold the ice cubes below the surface of the water with the help of the fork and use the rubber band to mark the level of the water plus the submerged ice cubes. Stress the importance of accuracy and make it clear that once the rubber band marks the level of water plus ice, it must not be moved. Circulate to help and to encourage the children to discuss their ideas about the difference in water level while the ice is submerged and when the ice is freely floating.

Have the children use parts 2 and 3 of their diagram record page to show how the jar, rubber band, and contents look when ice cubes are submerged and when they are floating. Help the children to use simple diagrams. Ask questions to lead the children to explain or change any representation which seems inappropriate. Stress the importance of an eye level view in determining water level.

When the children have completed their diagram records through part 3 on the diagram record sheet, ask them to think about how the jars might look when all the ice has melted. Focus their thinking on the water level. Tell them to write their prediction about the water level in the space provided, stating their choice of "even with the rubber band," "higher than the rubber band," or "below the rubber band." After all have written their predictions, discuss their ideas which led to their predictions. Do not show favor for any choice.

Label the glasses from group identification. Distribute a lid for each glass and discuss the reason for using a lid (to prevent evaporation if the glasses are left for a period of time). Place the glasses where they will not be disturbed.

Activity 2:

Materials needed:

Those from Activity 1

Later in the day or on the following day, when all the ice has melted, group the children as in Activity 1 with their own glasses. Have them observe

and record their observations concerning the height of the water in the container on the record diagram sheet in the space below their prediction and on part 4 of the diagram.

Encourage discussion of their observation.

1. If all results are not consistent, lead the children to identify a need to repeat the activity. Discuss possible differences in procedure among the groups that might have contributed to differences in outcome. Help the children to avoid such variables.
2. When consistent results have been obtained, ask the children, "Which takes up more space, ice or the water from which it is formed?" Discuss this question only to the extent that the interest and ability of the class seems to indicate. The concept involved in this question is not a basic lesson objective.

Activity 3:

Materials needed:

Paper cups

Water

Freezer or an outside location if the outdoor temperature is below freezing (access to below freezing temperature)

This can be done in school or at home

Have the children put water in a paper cup (about 3/4 full), marking the level in any way they choose. Then place the cups in a freezer, or outdoors if the temperature is below freezing, until the water has frozen solid.

Discuss the results, relating the discussion to question number 2 of Activity 2 and to the observations in Activities 1 and 2.

Activity 4 - Competency

Materials needed:

Icicle Problem Sheets (1 per pupil)

Distribute the drawings of the icicle problem. Through class discussion, have the children in the class interpret the information provided by the first four diagrams.

Have them complete the last diagram to show their prediction of how it will look when all the icicle has melted. When all the children have done this, discuss their ideas, encouraging them to relate their reasoning to evidence obtained in Activities 1, 2, and 3.

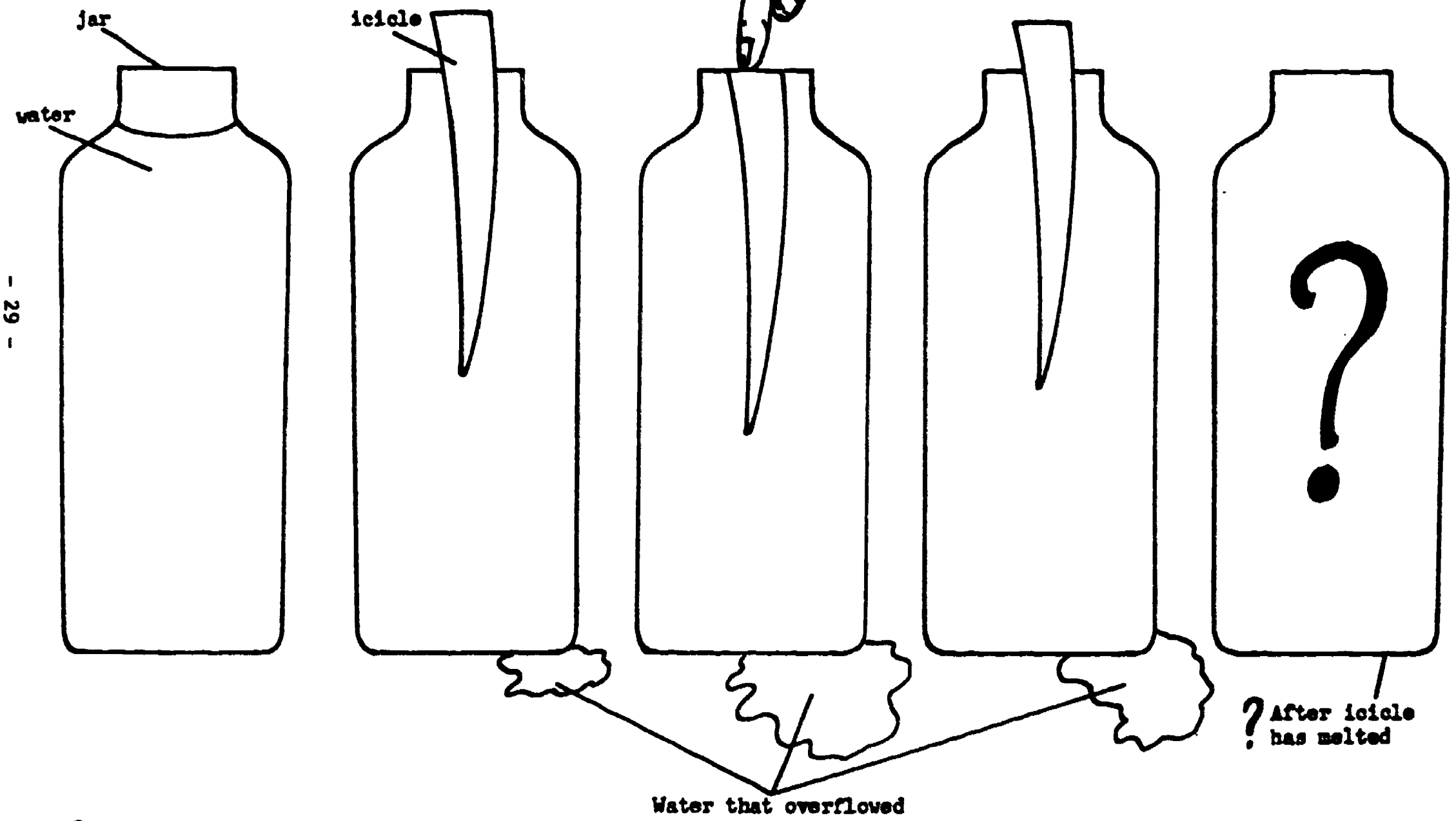

- 29 -

Water that overflowed

? After icicle has melted

INVESTIGATING ICE AND WATER

DIAGRAM RECORD SHEET

Rubber Band --

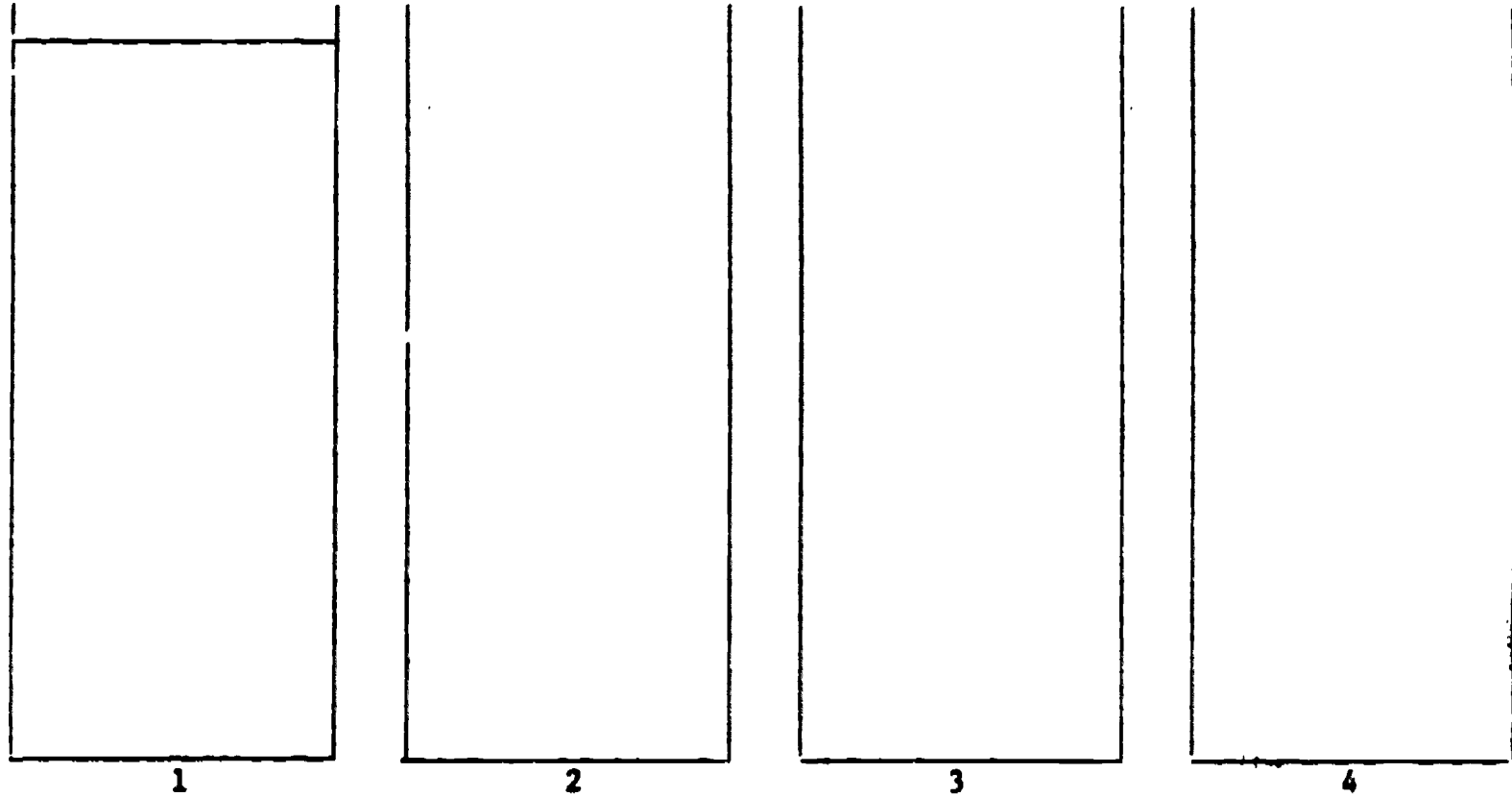

1

2

3

4

Prediction _____

Observation _____

Name _____

INTERMEDIATE LESSON

INVESTIGATING CHEMISTRY

COMPETENCIES

A. Processes

1. Observing
2. Classifying
3. Inferring
4. Predicting
5. Measuring
6. Communicating
8. Defining Operationally
10. Experimenting

C. Physical Science

1. A. Form/State

E. Attitudes

1. Toward Classwork
2. Toward Personal Use of Science

LESSONS

Lesson 1 - Activity 1, Roy Allison lesson, "Investigating Mixtures," Children work in groups with a mixture (nuts, buttons, bottle caps, etc.), making observations of the mixture. The students, then, try and separate their mixtures. Children name other mixtures.

Lesson 2 - Activity II, Roy Allison lesson, "Investigating Mixtures," Children mix water and sugar and observe. The students are challenged to determine if this solution is a mixture. (In this lesson, the concepts of "solution" and "evaporation" are introduced.

Lesson 3 - Video module on Investigating Chemistry. Forty-five minute presentation. See attachment.

Lesson 4 - Activity IV, Roy Allison Lesson. "Investigating Mixtures," Children are given mystery mixtures. Children observe the mixture and decide how they can determine how many substances make up the mixture. The children then carry out their plans and compare the results with their predictions.

Lesson 5 - Activity V, "How Does Litmus Paper Work"," Children are introduced to the effects acids, bases and neutral solutions will have on litmus paper. Students make predictions about 6 solutions effect on the litmus paper. They then test a variety of solutions, recording their findings and grouping the solutions based on their findings.

Lesson 6 - Activity VI, "What Happens When We Mix an Acid with a Base,"

Children test what happens when acids and bases are mixed, by testing an acid with litmus paper before and after adding a base. Children record their observations.

CHEMISTRY

INTERMEDIATE

"Molecules and Matter," (Discovering series), AIT, I, 15 minutes, color, 1978.

"Physical and Chemical Changes," AIT, I, 15 minutes, color, 1978.

"Elements and Compounds," AIT, I, 15 minutes, color, 1978.

OTHER

"The Chemist As a Detective," AIT, I, 15 minutes, color, 1978.

"The States of Matter," AIT, I, 15 minutes, color, 1973: Introduces the states of matter - solids, liquids, and gases and the concept of a plasma state.

Title: "Investigating Mixtures" (Brenda Manley & Roy W. Allison)

Level: Intermediate

Aims: Toward Which This Lesson Contributes

1. Students will demonstrate competency in the use of the processes by (a) observing, (b) classifying, (c) communicating, (d) inferring, (e) measuring, (f) experimenting, and (g) predicting.
2. Students will solve problems by gathering data, using equipment and materials, observing purposefully, and drawing conclusions based on their findings.
3. Students will develop and ask questions of their environment. They will also use answers to questions to describe, clarify, and analyze problems.
4. Students will observe and record data in a form that is convenient for interpretation.
5. Students will defend points of view by making use of supporting scientific evidence.

Instructional Objectives: At the conclusion of this lesson, the students will be able to:

1. operationally define a mixture.
2. give examples of a mixture.
3. describe the properties of a mixture.
4. differentiate between solutions and suspensions.
5. operationally define solutions and suspensions.

6. predict the number of different substances in a mixture.
7. design and carry out a plan to separate a mixture.

Background Information

Most children in your class can identify mixtures, such as nuts or buttons. They can also separate a mixture into its component parts.

This lesson is designed to take the concept of a mixture and develop it through a series of activities which follow. Ultimately, when presented with a "mystery" mixture, the students, by using the concepts developed in this lesson, will be able to determine the properties of the components of the unknown mixture. This lesson will also develop observational techniques useful in science as well as in other academic areas. The lesson should take about five days to complete.

Mixtures are made of different substances put together, but not chemically combined. Soil is a mixture of rock and sand particles with decayed plant and animal matter.

A solution is one type of mixture in which the parts of the mixture are evenly mixed. Tap water, air, vinegar, tea, and sugar dissolved in water are all solutions.

A suspension is a mixture in which the solids are not dissolved in the liquid, so that the parts are not evenly mixed. Salad dressings, hot chocolate, and soil mixed with water are suspensions.

There are three ways to separate a mixture. Evaporation is one way to separate a mixture; such as sugar water. Suspensions can be separated by filtering or straining; such as tea made with tea leaves. Some mixtures can be separated by dissolving one component; such as a mixture of white sand and sugar.

Be sure to demonstrate the proper use of a filter to the class. Use a funnel and a round piece of filter paper or coffee-maker filter. Fold the paper in half twice and open it into a cone shape. Place the paper cone in a funnel and place a container underneath to catch the liquid coming through.

A home-made funnel can be made from a 1 or 2 liter plastic soda bottle by cutting off the top. A coffee filter just fits the top of a 2 liter plastic soda bottle.

If you use iron filings, demonstrate a possible way to remove the filings. Simply place a sheet of paper between the magnet and iron filings, above the mixture. The filings will collect on the paper instead of sticking to the magnet.

Total Equipment List for a Class of 30 Pupils

2 jars of mixed nuts
2 assortments of buttons
1 assortment of hard wrapped candy
1 assortment of bottle caps
30 plastic sandwich bags
30 hand lenses
60 baby food jars with lids
30 sugar cubes (or granulated sugar)
30 paper filters or coffee-maker filters
2 cups granulated sugar
15 bar magnets
5 funnels
30 pieces of construction paper
tap water
newspapers
iron filings
sand
gravel
cork or styrofoam "peanuts"
soil with organic material, sand, or gravel
masking tape

Activity I

Readiness Survey

Material

plastic sandwich bags filled with soil
30 hand lenses
2 jars of mixed nuts
2 assortments of buttons
1 assortment of hard candy
1 assortment of bottle caps
newspapers

Procedure

1. Divide the class into groups giving each group one of the assortments or mixtures.
2. Direct them to observe their assortments.
3. Discuss their observations, leading them to suggest a way to separate their assortment into smaller groups or parts. Allow each child to try his/her suggestion. Have them give their justification for their groupings.
4. Now that they have the smaller groupings have the students make a single assortment or mixture with their objects.
5. For further discussion ask: How did you make your single mixture? Can you separate your mixture as you did the first time? Can you name other mixtures?

6. Make a list of mixtures on the board as children think of them. Discuss different ways to group each mixture. Have children bring mixtures in from home.
7. Hopefully someone will suggest soil, however if no one does you should suggest it. Give each group newspapers to cover the work area. Each person in the group needs a hand lens and a piece of construction paper. Give one plastic bag filled with soil to each group.
8. Each student should place a small amount of the soil on their paper. Using the hand lens students should observe the different parts in soil. Each group should make a list of what they think makes up soil.
9. As they're observing the soil you may want to ask: How many parts do you see? What are the properties of each part? How many different parts could you identify by name? How might you separate the parts of this mixture?

Try their suggestions and encourage further discussion.

Activity II

Solutions

Material

- 30 baby food jars with lids
- 30 sugar cubes or granulated sugar
- masking tape
- warm water

Procedure

1. Have each child put his/her name on a baby food jar using masking tape. They next should fill their jar 2/3 full with warm tap water.
2. Students should observe the water and write their observations on a piece of paper. To help them make this observation ask: How does the water appear? How does water taste? Does water have an odor? How does water feel?
3. Set the water aside and give each child a sugar cube or a teaspoon of granulated sugar. Again each child should observe the sugar. Use the questions as suggested in number 2.
4. Have students drop the sugar in the water, put the lid on the jar, and shake. While shaking the jar, students should observe any changes in the sugar or water. Discuss what they observed.
5. Students should remove the lids and observe the mixture. Again you might use questions similar to those in number 2.

6. The students have just made a solution. Ask them to describe a solution using what they've just observed. If they have problems, demonstrate steps 1-4 again.
7. If a solution is a mixture, you should be able to separate the sugar water into the parts that make it up, sugar and water. Students should suggest possible ways to do just that. Try all suggested ways.
8. After you have tried the various ways to separate the solution of sugar and water, make sure they realize that this solution can be separated into its' parts through EVAPORATION. Place the jars aside to permit evaporation to take place.
9. Something to think about: How would water temperature affect the time for the solution to form? How could we test these suggestions?

Activity III

Suspensions

Material

30 baby food jars with lids
tap water
soil
masking tape
newspapers

Procedure

1. First, have students cover their work area with newspapers. Second, have them put their name on a baby food jar using masking tape.
2. Have each child fill their jar 1/4 full of soil, then add water until the jar is almost full. They should cap their jar tightly.
3. When the jars are tightly capped, shake the jar vigorously. Students should set the jars on their desk and observe them carefully for several minutes. As they are watching their jars, they should record what they see happening.
4. As a group discuss their findings. Ask them if putting the water in first, then the soil would affect the suspension. Have each person write their prediction on a piece of paper, then have someone try it.
5. In their own words have each person tell you what a suspension is. If a suspension is a mixture, then you should be able to separate the soil water into soil and water. Ask students to suggest ways to separate a suspension. Try their ideas. Be sure to demonstrate the use of a filter (see the background information).

Activity IV

Culminating Activity

Material

Mystery mixtures

A - sand and sugar
B - sugar and iron filings
C - Sand, sugar, and iron filings
D - gravel, sugar, cork and iron filings
30 hand lenses
newspapers
filter paper
funnels
paper
bar magnets
water

Procedure

1. Prepare the mystery mixtures ahead of time. Place them in plastic bags or baby food jars and label (A,B,C,D). Be sure to prepare enough so that each student could try each unknown. This is also a good small group activity because they can interact with one another.
2. Discourage tasting as a means of identifying parts of a mixture. Students who chose the sand and sugar should set the water and sugar portion aside to evaporate.
3. Before beginning this activity list some properties which can be used in separating a mixture. Be sure to cover evaporating, filtering, straining, dissolving one component, and using a magnet to remove iron filings (see background information).
4. Students should cover their work area with newspapers. Place possible needed materials on a table at the front of the room so students can get what they need.
5. Have students pour a small amount of the mixture of their choosing, on a piece of paper. First they should observe the mixture with a magnifier.
6. Before they do anything they should predict how many different substances are in their mixture and record these predictions.
7. Students should list any special properties they believe each part will have. Also they should list those properties which will best help to separate the mixture.
8. Now students should write a short plan showing the steps necessary to separate their mixture.
9. Students should carry out their plans.

10. After students have carried out their plans, they should compare their results with their predictions.
11. Each group should present their findings with the entire class.
12. Challenge the students to bring in "mystery" substances for the class to investigate.

Activity V - How Does Litmus Paper Work?

Materials Needed for Each Group:

Red litmus paper	Epsom salts
Blue litmus paper	(mixed with water)
Tea	Salt water
Orange juice	Window cleaner
Water	Jello
48 cups	Shampoo

As an introduction explain to the class that acids will change blue litmus paper red and that bases will change red litmus paper blue. A neutral solution will not change either colored litmus paper.

Prepare the above listed liquids before class as outlined in Activity 1.

Before allowing the students to test the solutions, have them carefully observe and record their findings. After this is completed test with the litmus paper and record results. Group the solutions according to whether they are neutral solutions, acids, or bases.

Activity VI - What Happens When We Mix an Acid with a Base?

Materials Needed for Each Group:

Vinegar
Baking soda
Clear glass or jar
Plastic spoon

Pour vinegar into glass about $\frac{1}{2}$ inch deep. Add about same of water. Test the solution with blue litmus paper. Record results. Leave the blue litmus paper in the solution. With a spoon gradually add baking soda a little at a time. Record observations. Keep adding baking soda until the litmus paper turns color.

After the students have completed their experiments discuss what they observed happening.

Activity 5 - Competency

Materials Needed for Each Group:

Litmus paper

Divide children into groups. Instruct them to choose six materials they would like to test. Have them bring these materials and their own cups or jars for testing.

Step I:

Direct the children to group the solutions according to common characteristics. Record the groupings.

Step II:

Have the children predict which materials are acids, bases, or neutral solutions. Record predictions.

Step III:

Test each material with litmus paper. Record results.

Discuss with each set of students the three groupings they made. Have them compare and contrast the three groups.

INTERMEDIATE LESSON

INVESTIGATING COLOR

A. Processes

1. Observing
2. Classifying
3. Inferring
4. Predicting
5. Measuring
6. Communicating
9. Formulating Hypothesis
10. Experimenting
11. Recognizing Variables
12. Interpreting Data

C. Physical Science

2. D. Light/Color
2. F. Heat

E. Attitudes

1. Toward Classwork
3. Toward Personal Use of Science
4. Toward Oneself
5. Toward Science and Society

LESSONS

Lesson 1 - Activity I, Readiness Survey and Activity II, INVESTIGATING COLOR II (Complimentary colors): Using crayons and construction paper, children experience eye fatigue and after image.

Lesson 2 - Activity III, Competency, INVESTIGATING COLOR II (complimentary colors): Children boil green leaves to extract chlorophyll and use light to discover its color.

Lesson 3 - Optional Activity, INVESTIGATING COLOR II (complimentary colors): A similar activity to Lesson II is done but using food coloring instead of leaves.

Lesson 4 - ITV Video Module on Investigating Color. See attachment.

Lesson 5 - Readiness Survey and Optional Activity, INVESTIGATING COLOR III (heat and light absorption): Using coffee cans painted white and black, water, and thermometers, children can measure and record changes in water temperature when the cans are exposed to sunshine.

Lesson 6 - Activity II and Activity III INVESTIGATING COLOR III (heat and light absorption): The children experiment to discover what effect different colored plastic filters have on construction paper and fabric when exposed to light.

COLOR

INTERMEDIATE

"Color: A First Film," BFA, P, 14 minutes, color, 1979: An illustration of the importance of color in our lives followed by experiments that allow students to analyze white light and to see what happens when the primary colors are combined as light from colored light sources and as pigments. (Repeat from Light, Primary).

"Color and Light: An Introduction," revised edition, Cort, I, J, 11 minutes, color, 1977" Dramatizes the importance of color in our world. Develops the concept that color comes from light. Demonstrates the spectrum of white light, and effect of filters.

"Light and Its Relation to Color," ACAY, I, J, 19 minutes, color, 1977: Demonstrates the concepts of reflection, refraction, and dispersion. Defines transparent, translucent, and opaque objects. Explains how natural rainbows form and then shows how to produce artificial ones.

Title: "Investigating Color II (complementary colors)" (Kathey Llford and Roy W. Allison)

Level: Intermediate

Aims: Towards which this lesson contributes.

1. The student will demonstrate competency in the use of the processes by (a) observing, (b) communicating, (c) inferring, (d) formulating hypotheses, (e) experimenting, and (f) predicting.
2. The student will develop and ask questions of his environment. He will also use answers to questions to describe, clarify, and analyze problems.
3. The student will identify examples of scientific hypotheses and theories as evidence that our interpretation of truth changes as our knowledge increases.

Instructional Objectives: At the conclusion of this lesson, the student will be able to:

1. Infer that the color of an object and the color of its afterimage have some relationship to each other.
2. Demonstrate that certain colored liquids transmit one color and reflect a different color.

Background Information:

Complementary colors are two colors of light, which when combined produce white light (i.e. red and green light).

In Activities I and II, after staring at a colored object for a minute or so and then looking against a white background, an afterimage appears on the white background (the complementary color of the originally viewed color). Eye fatigue explains this phenomenon. For example, when staring at red for a minute, the receptors for "red" become fatigued. When shifting one's gaze to a white surface, the eyes record the rest of the colors from the white, but the tired red receptors do not respond.

For Activity III, chlorophyll absorbs red light photons. All the other colors bounce off it; the result in ordinary light--white minus red--is green to us. But something quite different happens when a light is shined through the liquid in a dark room. You can't see any photons that are bouncing back--they are all on the other side of the bottle, where the light is (check to see this is so--the liquid looks green over there.) The only light you can see is that which has come through the chlorophyll-dyed alcohol to your side of the bottle. But chlorophyll can only absorb red light. What a molecule can absorb, it can also send out. The chlorophyll-dyed alcohol absorbs only red light from the flashlight and sends out the same: you see red. The odd question is, what color is chlorophyll--green or red?

For the Optional Activity, it may take some practice to get just the right shade of color to produce the desired effect. Sometimes, the effect can be achieved better by using Mercurochrome instead of food coloring. When the light shines through the liquid, only a reddish color is transmitted. Surprisingly, often the complementary color is scattered and reflected, in this case green.

Total Equipment List for a class of 30 students:

30 boxes of crayons

at least 60 pieces of white paper

6 flashlights

6 funnels

6 hot plates

green leaves (about 10 for each group of 4)

4 bottles of rubbing alcohol

6 double boilers

6 glass bottles

Optional:

15 flashlights

15 bottles of water

15 containers of red food coloring

Activity I - Readiness Survey

Materials (for each student)

red crayon

2 pieces of white paper

Have each student draw and color a red circle on a piece of white paper. They will stare intently for about 40 to 60 seconds at the circle. (It should be brightly illuminated by a strong light). Next, the student will stare at a white screen, wall, or sheet of paper. Discuss observations.

Activity II

Materials (for each pupil):

black, orange, and green crayons

2 pieces of white paper

Repeat Activity I, except this time, instead of a red circle, draw a flag with black and green stripes, black stars, on an orange field.

Activity III - competency

Materials (for each group of 4 or 5):

green leaves
alcohol
water
double boiler
hot plate
glass bottle
funnel
flashlight

Each group of students should do the following set of directions:

Put several green tree leaves (spinach works too) in the top of a double boiler. Fill the bottom with water, the top with just enough rubbing alcohol to cover the leaves. Set the double boiler on a low heat on the hot plate. As it heats, lower the flame (or turn it off altogether) so the alcohol gets hot, but doesn't boil (it boils at a lower temperature than water). Within 10 minutes, you will notice that the alcohol has turned a rich green from the chlorophyll in the leaves. Remove the pot from the hot plate and let the alcohol cool. When it is cool, use a funnel to pour the green liquid into a small clear glass bottle. Throw the leaves away. Go to a dark area. Hold the flashlight in back of the bottle, then in front. Compare the results.

Optional Activity

Materials (for each pair of students):

flashlight
red food coloring
bottle of water

Have each pair of students mix a few drops of red food coloring into a bottle of water. Then they will view the bottle, first, with light coming from behind it and, then, with the light from the front. Discuss observations. This activity is similar to Activity III; however, the colors are reversed.

* Extreme caution should be exercised when heating alcohol, since the vapors are highly flammable. Use rubbing alcohol (isopropyl) only. Methanol or denatured alcohol fumes are toxic. Avoid breathing the fumes, and ventilate the area. Allow for adequate ventilation.

Title: "Investigating Color III (heat & light absorption)" (Kathy Alford and Roy W. Allison)

Level: Intermediate

Aims: Towards which this lesson contributes.

1. The student will demonstrate competency in the use of the processes by (a) observing, (b) classifying, (c) communicating, (d) measuring, (e) inferring, (f) formulating hypotheses, (g) interpreting data, (h) controlling variables, (i) experimenting and (j) predicting.
2. The student will solve problems by gathering data, using equipment and materials, observing purposefully and drawing appropriate conclusions based on their findings.
3. The student will develop and ask questions of his environment. He will also use answers to questions to describe, clarify, and analyze problems.
4. The student will measure (with English or metric units), gather data and use this data to solve problems.
5. The student will observe and record data in a form that is convenient for interpretation.
6. The student will identify examples of scientific hypotheses and theories as evidence that our interpretation of truth changes as our knowledge increases.

Instructional Objectives: At the conclusion of this lesson, the student will be able to:

1. infer that color is related to the absorption and reflection of radiant energy.
2. record water temperatures taken at periodic intervals on a graph.
3. predict which colors will fade most quickly.
4. predict which colored light filters are the most effective.

Background Information:

For Activity I, the temperature of the black can should rise more than the temperature of the white can. Black is a good absorber of heat, but white is not. White reflects much of the energy that strikes it. Flat black paint works more effectively than high gloss black paint because the gloss increases reflection.

For Activity II, pigments that absorb the most light usually fade most. So darker colors are likely to fade faster than lighter colors. Filters that screen out the most light provide the most protection, so darker filters are usually more effective than lighter ones.

For Activity III, the children may be puzzled to find that the results differ somewhat from those gotten with the colored papers. Some fabrics are made more "color-fast" than others through a chemical-bonding process. In general, however, their order of fading according to color is similar.

Total Equipment List for a class of 30 pupils:

12 coffee cans (6 painted black, 6 painted white)

12 thermometers

30 pieces of graph paper

pack of construction paper of several colors

at least 20 pieces of clear cellophane

at least 20 pieces of colored cellophane

15 pairs of scissors

15 rolls of cellophane tape

at least 20 different samples of colored fabrics

Optional:

coffee cans painted different colors (See below for colors)

Activity I - Readiness Survey

Materials (for each group of 4 or 5):

2 coffee cans (1 painted black, 1 painted white)

thermometers (2)

4 pieces of graph paper

Each group should fill 2 coffee cans with water of the same temperature. A small slit is placed in each plastic lid for a thermometer to fit in. Each group makes sure that the bottom of the thermometer is in the water and not touching the side of the can. The two cans are placed in the sun. The groups observe and record the temperatures of the water in each can over a period of time. Each class member then makes a graph of the water temperatures taken at periodic intervals.

Activity II

Materials (for each group of 4 or 5)

construction paper of several colors, such as white, blue, yellow, red, and black

several pieces of clear and different-colored cellophane or plastic
scissors

cellophane tape

Each group follows this list of questions and activities:

1. Cut squares of different-colored paper.
2. Cut one smaller square of white paper for each color to be tested.
3. Tape one white square in the center of each larger, colored square. (Use only two pieces of tape.) Tape clear cellophane or plastic over each larger square.
4. Do steps 1 through 3 again, cutting the same colors. But now tape a piece of colored cellophane or plastic over each larger square. Use the same color of filter for all.
5. Fasten both sets of matched squares to an inside window, but facing outdoors.
6. Wait two days before removing the white squares and filters to check what happens.

Before taping the experiments on the windows, have each group predict-from least to most-the order the unfiltered colors and the filtered colors will fade. The groups then compare their predictions with the actual results and discuss their findings.

Activity III - competence

Materials (for a group of 4 or 5):

Same as for Activity II except different colored fabrics instead of construction paper

Conduct this activity the same as Activity II.

Optional Activity

Encourage children to repeat Activity I using differently colored coffee cans.

INTERMEDIATE LESSON

INVESTIGATING STRIPS AND LIQUIDS

COMPETENCIES

A. Processes

1. Observing
2. Classifying
3. Inferring
5. Measuring
6. Communicating
8. Defining Operationally
10. Experimenting
11. Recognizing Variables
12. Interpreting Data

C. Physical Science

1. A. Form/State of Matter
1. B. Water

E. Attitudes

1. Toward Classwork
2. Toward Personal Use of Science
4. Towards Oneself

LESSONS

Lesson 1 - ITV Video Module on Strips and Liquids. Forty-five minute presentation. See attachment.

Lesson 2 - Activity 1, Investigating Strips and Liquids: After placing a piece of paper towel in a glass of water, students make observations, list inferences, and state questions about the investigation. The teacher then guides students in understanding the difference between operational and non-operational questions.

Lesson 3 - Activity 2, Children choose an operational question from Lesson 2 to investigate. They plan their procedure, collect materials, and decide how to record their results.

Lesson 4 - Activity 3, Investigations planned in Lesson 3 are completed. Students with guidance from the teacher discuss the various results.

Lesson 5 - Activity 4, Competency Measure, Students presented with a list of questions related to strips and liquids, identify and explain which questions are operational and which are non-operational.

Lesson 6 - Activity 5, This is an optional homework activity for children. An operational question may be investigated at home and results reported during class.

STRIPS AND LIQUIDS

INTERMEDIATE

"Investigating Strips and Liquids," ISEE Video Tape, I, 20 minutes: The program provides the audience with a basic insight into operational and non-operational questions. This foundation will be broadened and strengthened as the children work with the new phenomenon of the interaction between strips and liquids after the program.

"Questioning in Science?" AIT, What About Series, I, J, 15 minutes, color, 1983: A research horticulturist is making progress toward a more salt-tolerant crops because he learned to ask the right question.

"Hypothesizing in Science," AIT, What About Series, I, J, 15 minutes, color, 1983: An agricultural scientist tests the hypothesis that force of a spinning drum will have the same effect as gravity on growing plants in outer space.

INVESTIGATING STRIPS AND LIQUIDS

Television Introduction

Teacher Orientation

This lesson deals with the basic skill of "operational questions" which is the thrust of the SCIENCE UNLIMITED lesson which you will conduct following the program.

A youngster, home from school, shares with his mother some of the ideas which evolved from his science lesson on "operational questions." His class had investigated soap bubbles as a way of generating questions and sorting out those which could be pursued by further observation and experimentation.

In this program, the only reference to "Strips and Liquids" occurs when the youngster places a strip of paper towel in a glass of water as he starts on his science homework assignment.

Thus, the program provides the audience with a basic insight into operational and non-operational questions. This foundation will be broadened and strengthened as the children work with the new phenomenon of the interactions between strips and liquids.

On four occasions during the televised introductory lesson, questions are posed and time provided for discussion in the classroom. The chart of the next page indicated the discussion topic breaks and suggested teaching strategy for each.

INVESTIGATING ICE AND WATER (20 min. - color)

Discussion Period and Time	TV Image	Final Broadcast Statement	Suggested Statements or Questions	Teaching Strategy
1 3 min. 45 sec.	Bubbles being made in different ways	What questions about soap bubbles come to your mind as you watch?	What kinds of things do you wonder about as you observe these bubbles? How about as you watch them being made? What questions occur to you as you watch them after they're made?	4 Wait Time
2 50 sec.	Blackboard with questions	Why are bubbles flat where two join together? How would you try to go about getting an answer to this question?	What might <u>you</u> do to try to find out why that part is flat?	3 Approval
3 50 sec.	"What makes some bubbles last longer than others?"	See how many ideas you have for trying to answer this question.	Each of you try to think of at least two ideas to help you get an answer.	4 Wait Time
4 24 min.	"Why are bubbles round?" Do bigger loops make bigger bubbles?"	First, "Why are bubbles round?" (pause 60 seconds) "Now, go bigger loops make bigger bubbles?"	What is different about how one might find answers to these two questions?	4 Wait Time

Title: Investigating Strips and Liquids

Level: Intermediate

Aims: Toward Which This Lesson Contributes

1. The student will formulate and ask questions of his environment. He will use questions to describe, clarify, analyze problems, and to provide direction for problem solving.
2. The student will solve problems by gathering information, working independently, using equipment and materials, observing purposefully, and drawing appropriate conclusions based on these findings.
3. The student will demonstrate a desire to learn and a curiosity for the unknown by formulating and performing self-motivated investigations.
4. The student will defend a point of view by making use of supporting evidence.

Instructional Objectives: At the conclusion of this lesson, the student will be able to:

1. Discriminate between questions which can be answered by investigating with materials (operational questions) and those which cannot be answered by investigation (non-operational).
2. State at least two conclusions about the strips and liquids which were obtained as a result of investigations performed by students in the class.

Background Information:

One focus of this lesson is concerned with improving the investigation oriented skill of asking questions. Teachers may or may not wish to introduce the terms "operational" and "non-operational" to their children as they help them to appreciate and use the skill of using operational questions.

A second focus of this lesson is open ended investigation. Some of the things students have investigated include:

The effect of varying the depth of the liquid
The effect of using different liquids
The effect of using strips of different kinds of materials
The effect of using strips of different width
The effect of using like strips folded, rolled, pleated, etc.
Careful measurement of change with time
One strip in water enclosed in plastic bag to control evaporation compared with one not enclosed
The effect of temperature on rise of liquid in strip

Children should be encouraged to investigate any workable question they construct. Such investigations not only help children grow in investigative skills but also provide readiness experiences in any of several science content

areas such as capillary action, cohesion and adhesion, paper chromatography - topics they may study in later years and find more meaningful because of such early experiences.

Teachers will find opportunities in this set of activities to help children identify and control variables, to record observations, to identify likenesses and differences, to limit conclusion statements to the evidence obtained, and to repeat experiments to decide whether results are consistent or to reconcile conflicting results.

Total Equipment for a Class of 30 Students:

For each group of 4 students
paper towel strip approximately 1 inch by 7 inches
transparent cup, glass, or jar
1 sheet of lined tablet paper
a notebook or tablet in which to record
other materials as student investigation ideas require. These can be brought from home, found in school, or "scrounged" as needed.

Activity I:

Materials: for each group of 4 students
paper towel strip approximately 1 inch by 7 inches
transparent cup, glass, or jar
1 sheet of lined tablet paper
a notebook or tablet in which to record
other materials as student investigation ideas require. These can be brought from home, found in school, or "scrounged" as needed.

Provide each group with a clear container with about an inch of water, a strip of paper towel, and a piece of tablet paper.

Have a child in each group fold the strip of paper towel lengthwise and then open the fold to form a V-shaped trough.

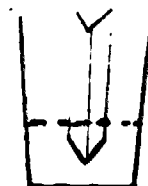

Unfolded strip

Explain that the children are to stand their paper strip in the water and find out what happens. They are to keep a record of all that they observe in one list and any questions resulting from their observations on another list.

After about two minutes, instruct the children to remove their strips, lay them on the tablet paper, and continue observing and stating questions.

While the children are doing this, circulate among groups to help where needed and to stimulate productive activity. After 10-20 minutes, according to your judgment, guide a class discussion. First have individuals, in turn, read an observation from their lists.

For each observation, be certain that the following are considered - as appropriate:

1. Discriminate between observations and inferences.
2. Have children challenge observations if they have any which seem to conflict and guide a reconciliation of difference. Resort to materials if appropriate.
3. If a child's statement is not clear, help the child to communicate, encouraging him to use the materials to clarify meaning.

Then have children read aloud their questions, writing each on the chalkboard as stated. When you have about 8 questions on the board, ask the children which questions might be answered by doing something with materials they have or might be able to obtain. Allow time for them to make a decision about each question on the board. Then have them discuss each question until a fair agreement is reached.

During this discussion, children often develop an operational form for a non-operational question. This new statement might be written next to the original. As discussion proceeds, help children to recognize that most questions starting with "why" are not the kind they can "do something" (an investigation) to try to answer.

Have each group make a new list of questions which they think are ones which they could try to answer by investigating with materials. Circulate to help children as they do this.

Activity II:

Materials: None

Have each group choose a different question which they would like to investigate. Have them plan their procedure, decide what they need, and work out a place to collect the materials and have them ready to use in class by a date agreed upon.

Activity III:

Materials: as determined by the investigative procedure designed by group

When all needed materials have been collected, schedule a time when the children can do their experiments. Then have each group report its findings to the class. Encourage discussion as appropriate, trying to guide any challenges or disagreement so that they can be settled by resorting to the materials. When appropriate, help children to appreciate such important realities as:

An experiment may tell us that something we thought would happen, doesn't. This is just as important as one that turns out as we predicted. This is the way it often happens in science.

Often one experiment, instead of answering a question, leads us to more questions. Such experiments are very helpful in building knowledge. This is the way it often happens in science.

Often, our first experiment needs to be done over, with some improvements before we feel satisfied with our results. This often happens in the science laboratories.

Activity IV: Competency

Review, through class discussion, what the children learned about strips and liquids. Encourage tentativeness in conclusions for which the experiments produced limited evidence or inconclusive evidence. Guide the class to appreciate that such tentativeness is more in keeping with the real nature of science than are sweeping dogmatic conclusions based on limited or carelessly interpreted data.

Present the following list of questions to the class. Have the children decide which are stated so that they might be answered by investigation and which are not

1. How high would water rise in a strip of towel placed in water?
2. What kinds of liquids rise fastest in strips of paper?
3. How much water does the strip soak up?
4. Why doesn't water soak up in aluminum foil?
5. What makes the water keep going up the paper after we take it out of the jar of water?

NOTE: Questions 1, 2, and 3 are stated as operational questions. Questions 4 and 5 are not. However, encourage children to discuss their reasons for each decision. They may, through discussion, reveal thinking which justifies a decision which does not conform of the idea of "persuasive questions" accept any interpretation they can justify.

Activity V: (Optional)

Give class a homework assignment to choose one of the "operational" questions which they have not previously investigated and do an experiment at home to try to answer it. They are to write a report telling what they did, what happened, what they found out about an answer to their question, (conclusion).

INTERMEDIATE LESSON

INVESTIGATING GEOLOGY

COMPETENCIES

A. Processes

1. Observing
2. Classifying
3. Inferring
4. Predicting
5. Measuring
6. Communicating
10. Experimenting
11. Interpreting Data

D. Earth Space Science

1. Geology
2. Earth Changes

E. Attitudes

1. Toward Classwork
2. Toward Personal Use of Science
3. Toward Oneself

LESSONS

Lesson 1 - Activity I - Readiness Activity, Investigating Rocks and Minerals, (Roy Allison Lessons, see attachment): In this activity, students make a collection of rocks and minerals.

Lesson 2 - ITV Film Module on Investigating Geology. Forty-five minute presentation. See attachment.

Lesson 3 - Activity II, Investigating Rocks and Minerals, (Roy Allison Lessons, see attachment): In this activity, students group rock and mineral samples according to the size of the grains, and the shininess of the surface.

Lesson 4 - Activity III, Investigating Rocks and Minerals, (Roy Allison Lesson, see attachment): In this activity, students group rock and mineral samples by the way they break and by their color.

Lesson 5 - Activity IV, Investigating Rocks and Minerals (Roy Allison Lesson, see attachment). In this activity, students classify rock and mineral samples according to streak and chemical tests.

Lesson 6 - Activity V, Investigating Rocks and Minerals, (Roy Allison Lesson, see attachment): In this activity, students classify rock and mineral samples according to Hardness using Moh's Scale of Hardness.

Lesson 7 - Activity VI, Investigating Rocks and Minerals, (Roy Allison Lesson, see attachment): Students compare rocks and minerals according to their specific gravity by measuring the weights of the samples in the air and in the water.

Lesson 8 - Activity VII, Investigating Rocks and Minerals, (Roy Allison Lesson, see attachment): In this activity, students use reference books to determine the identity of their samples of rocks and minerals.

Lesson 9 - Competency Measure, Investigating Rocks and Minerals, p. 13, (Roy Allison Lesson, see attachment): Students use techniques learned in this unit to identify unknown samples of rocks and minerals.

e ;

GEOLOGY

PRIMARY

"Geology," AEBC, Natural Science, 1st Films, P, 10 minutes, color, 19: Everywhere we look, the earth is changing in some way. Animals carry soil from one place to another, water, wind, and changing temperatures wear away mountain and carry the broken rocks to distant places. Plants send their roots into crevices in the rocks, helping to break the rocks and create new soil. In other places, volcanoes, and pressures beneath the earth's surface that cause buckling and folding, result in the formation of new mountains. The changing earth leaves its record of change in the form of fossils and mineral deposits.

"Geology: A First Film," BFA, P. I, 11 minutes, color, 1975: In the tradition of the first film series, here is an introduction to the forms and forces that can be seen shaping the earth's surface. The film is a skillful blend of ideas of science and awareness of the wonders of the earth's changing shape. While viewing very beautiful scenery, young students learn about the forces that change the earth: water, wind, animals, plants, temperature, and the forces beneath the surface. They see how a mountain might be formed and molded, and they learn that fossil and mineral evidence helps us describe the changes that have taken place.

"My World: Earth," CHUH, P, 11 minutes, color, 1974, (If not available, contact University of Illinois)

"Our Round Earth: How it Changes," Cort, P, I, 10 minutes, color, 1971: Shows how water, wind gravity and temperature changes can level tall mountains and carve deep canyons. Views of molten lava, earthquakes and giant cracks in the earth's surface are compared with demonstrations using clay models to see other ways the earth changes.

OTHER

"Finding Out About Rocks," BFA for UEVA, P, I, 14 minutes, color, 1961: Provides a simple introduction of the study of earth materials. Shows in graphic, step-by-step, live-action sequences how the land today evolved from the great mass of rock and water that was the early planet. Illustrates how the pounding action of the surf, freezing temperatures, shifting winds, and simple plants combine with the force of gravity to break up rocks into sand and to form soil. Also rock identification and important uses of minerals.

"Rocks, Where They Come From," Cort, P, 11 minutes, color, 1963: Don sees many interesting rocks at a granite quarry, at a sandstone cliff, and in a museum. He learns that some rocks are made by heat, some are made by water, and others are made over from other rocks by pressure. Simple demonstrations illustrate the effects of these forces in rock formation.

Title - Investigating Rocks and Minerals (Vicki Lutzkanin, Eric Pontius and Roy W. Allison)

Level - Intermediate

Aims - Toward Which This Lesson Contributes

1. Students will demonstrate competency in the use of processes by observing, classifying, communicating, measuring, inferring, interpreting data, experimenting, and predicting.
2. Students will solve problems by gathering data, using equipment and materials, observing purposefully, and drawing appropriate conclusions based on their findings.
3. Students will develop and ask questions of their environment. They will also use answers to questions to describe, clarify, and analyze problems.
4. Students will measure, gather data, and use this data to solve problems.
5. Students will observe and record data in a form that is convenient for interpretation.
6. The students will demonstrate a desire to learn and a curiosity for the unknown by formulating and performing self-motivated science investigations and readings on their own outside the formal confines of science classes.
7. The students will demonstrate a competent use of textbooks, reference books, tables of contents, indexes, and glossaries to obtain information.

Instructional Objectives - At the conclusion of this lesson, the students will be able to:

1. Describe the similarities and differences of rocks and minerals.
2. Classify rocks and minerals according to color, texture, and luster through observation and touch.
3. Classify rocks and minerals through use of the following tests: cleavage and fracture test, streak test, and the test for hardness.
4. Classify rocks and minerals through measurement of specific gravity.
5. Predict the identification of unknown rocks and minerals through observing, classifying, and consulting reference books.

BACKGROUND INFORMATION

Rocks and minerals are similar in appearance. However, there are some differences. Rocks are the materials of which the crust of the earth is made. They form the mountains and underlie the valleys. They include consolidated

matter usually containing minerals. Minerals are the matter which the earth is made. They are specific elements or compounds found naturally in the earth.

The similarities and differences may be understood through observations and discussions of various rock and mineral samples. Allow the students to brainstorm their ideas, recording them on the blackboard. During this discussion it may be appropriate to introduce the three types of rocks and discuss their similarities and differences. A sample of each should be present. The three types of rocks are: igneous rock formed from hot magma (liquid rock), sedimentary rock formed from sediment (bits of weathered rock and other matter carried by water), and metamorphic rock formed by additional heat and pressure exerted on either igneous or sedimentary rock to form new rocks.

In this lesson classifying rocks and minerals will help the students further understand similarities and differences. The teacher should prepare a copy of Worksheet 1 to distribute to each of the students.

The following is an explanation of each column in Worksheet 1:

1. Sample - The rock or mineral to be investigated.
2. Texture - The size of the grains or crystals in the sample.
3. Luster - How the sample reflects light. Is it shiny or dull?
4. Cleavage/Fracture - The way the sample breaks when struck with a hammer.
5. Color - The color of the sample after broken with the hammer.
6. Streak - The color of the mark made by rubbing the rock on unglazed tile.
7. Chemical - Drop vinegar on the sample. Does the vinegar cause the sample to bubble or fizz? If it does, it is a carbonate.
8. Hardness - Testing for hardness using "Moh's Scale of Hardness", See Table 1.
9. Specific Gravity - Find the specific gravity by: (See Diagram 1, page 5).
 - a. Fasten the sample to a spring scale and find the weight in the air. (The metric scale would be more accurate to measure in since grams are smaller units than ounces.) Record the weight.
 - b. Lower the sample into a container of water so that it does not touch the bottom or sides of the container. Record the weight of the sample under water.
 - c. Subtract the difference of the weight in the water from the weight in the air.

- d. Then divide the difference between the air weight and the weight in water by the weight in the air; the answer is the specific gravity.

Example:

a.	Weight of sample in air	25.75 grams
b.	Weight of sample in water	<u>-17.00 grams</u>
c.	Difference between weights	8.75 grams
d.	Difference between weight	<u>Weight of sample in air</u>

		2.94	Round off to the nearest tenth.
8.75	<u>25.75 00</u>		
	17 50		Specific gravity = 2.9
	<u>8 25 0</u>		
	7 87 5		
	<u>37 50</u>		
	<u>35 00</u>		

Reference books such as Herbert S. Zim's Rocks and Minerals: A Guide to Familiar Minerals, Gems, Ores, and Rocks and Richard M. Pearl's How to Know the Minerals and Rocks should be available for the students' use.

It is recommended that each activity be investigated on separate days. The activities could vary in completion time depending on the amount of samples tested. It would be conceivable that they could be completed in one class period of forty-five to sixty minutes if limited number of samples are investigated. This unit should take from two to three weeks to complete.

Total Equipment List for a Class of 30

- | | |
|---|---|
| rock and mineral samples | knife |
| hammer | file |
| unglazed tile | glass pane |
| vinegar | shoebox or container for rocks |
| Moh's Scale of Hardness | notebook |
| Spring Scale | safety glasses |
| rubber bands | medicine dropper |
| large beaker | magnifying glass |
| cotton string (approximately 50 cm. long) | reference books such as Herbert S. Zim's <u>Rocks and Minerals: A Guide to Familiar Minerals, Gems, Ores, and Rocks</u> and Richard M. Pearl's <u>How to Know the Minerals and Rocks.</u> |
| pencil and paper | hand calculator |
| penny | Worksheet 1, "Classifying Chart" |

Activity I - Readiness - Collecting Rocks and Minerals

Description - In this activity the students make a collection of rocks and minerals.

Materials needed for each group

shoebox or container for rocks
notebook
pencil

Directions

Divide the class into groups of two or three students. Take the class on a field trip to collect samples of rocks and minerals. Guide the discussion as to the similarities and differences between rocks and minerals. Begin to direct the students' thinking into classifying rocks and minerals through observation and touch. Have one student in each group record the observations in the notebook for a whole-group discussion after the field trip.

The students may wish to bring samples of rocks and minerals from home in addition to those collected at school. When the collecting period is completed, further discussions should evolve. At this time it may be advantageous for the teacher to introduce the three types of rocks and show examples. The rocks and minerals that the students collected will be used for the following activities.

Activity II - Classifying Rocks and Minerals According to Texture and Luster

Description - In this activity the students will group samples of rocks and minerals according to the size of the grains and to the shininess of its surface.

Materials needed for each group

rock and mineral samples from activity 1
Worksheet 1 "Classifying Chart"
pencil

Directions

Pass out a copy of the worksheet, "Classifying Chart" to each student. Explain that texture is the size of the grains, whether they are large or small grains. Show examples of large and small grains. Allow the students to discuss with their group of two or three students the size of their samples' grains. Have each group choose five different samples and label them A, B, C, D, E. On the worksheet write A, B, C, D, E in the sample column. The students will decide and record the size of the grains of the five samples chosen. (see Table 2)

Discuss that luster is the way light is reflected from the rock or mineral. Is it shiny or dull? Allow time for the students to discuss their samples in their groups and record their answers on the worksheet.

Suggestions for the Gifted

investigate crystal growing (sugar, salt)
make rock candy

Activity III - Classifying Rocks and Minerals According to Cleavage/Fracture

Description - In this activity the students will group samples of rocks and minerals by the way they break and by their color.

Materials needed for each group

the five chosen rock and mineral samples from activity 2
Worksheet 1, "Classifying Chart"
hammer
safety glasses
magnifying glass
pencil

Directions

For this activity it is best to take the class outside to avoid accidents from flying rock and mineral pieces. Before beginning this activity have each student wear safety glasses throughout the activity for safety purposes. Show the students how to strike the samples with the hammer safely.

Discuss the cleavage/fracture and the way the sample broke when struck. Was it a smooth break or a rough one? Point out the color of the rock or mineral on the inside versus the color on the outside. Due to weathering, the color outside may vary a great deal from the color inside. The students may wish to predict the color on the inside before breaking their samples.

Have the students carefully break their five samples and record the cleavage/fracture. (see Table 2) The color of the sample on the inside should be recorded at this time also. A magnifying glass may be used to take a closer look at the samples.

Suggestions for the Gifted

investigate polishing and tumbling rocks and minerals
make homemade jewelry from polished gems

Activity IV - Classifying Rocks and Minerals According to Streak and Chemical Tests

Description - This activity includes two separate tests. First the students will see the difference in color (if any) between the observed color and the color that results when rubbed across an unglazed tile. The chemical test shows students if the sample contains any carbonated materials.

Materials needed for each group

the five chosen rock and mineral samples
unglazed tile
vinegar
medicine dropper
Worksheet 1, "Classifying Chart"

Directions

The streak test requires the use of unglazed tile. The reverse side of a tile that is used in bathrooms makes an excellent unglazed tile surface. Show the students how to rub the sample across the tile noting the color of the streak. The students can compare this streak color with the observed color of activity 3 noting the difference in color. Record the streak color for the five samples on the worksheet.

For the chemical test, a small amount of vinegar is dropped on the sample to observe whether or not the acid causes a bubbling or slight fizzing reaction. If such a reaction is observed, the sample is a carbonate; if no reactions, the sample is a non-carbonates may not produce a fizzing reaction). After this test, record the results on the worksheet.

Suggestions for the Gifted

How do some minerals affect the hardness of water?
What is acid rain?

Activity V - Classifying Rocks and Minerals According to Hardness Using Moh's Scale of Hardness (see Table 1, page 10)

Description - In this activity the students will test the hardness of rocks and minerals according to Moh's Scale of Hardness.

Materials needed for each group

the five rock and mineral samples	file
Moh's Scale of Hardness (Table 1)	glass pane
penny	copper wire
knife	Worksheet 1, "Classifying Chart"

Table 1
Moh's Scale of Hardness

Scale Number	Scale Example	Other Examples	Explanations
1	Talc	Soft lead pencil	Can be rubbed off on the fingers
1½		Ice near freezing	
2	Gypsum	Chalk	Can be scratched with fingernail
2½		Fingernail	Can be scratched by a copper wire
3	Calcite	Marble	Can be scratched with a penny
3½		Copper penny	
4	Fluorite	Yellow brass	Can be scratched easily with a knife blade
4½		Ordinary nail	
5	Apatite	Steel wool; nail file	Can be scratched with difficulty with a knife
5½		Knife blade; glass bottle	
6	Feldspar	Window glass	Can be scratched with a file
6½		Steel file	
7	Quartz	Flint; sandpaper	Scratches glass easily
7½		Garnet paper	
8	Topaz		
8½		Emery paper	
9	Corundum	Silicon	
9½			
10	Diamond		

Directions (see Diagram 2, page 12)

Discuss the idea of the different degrees of hardness of rocks and minerals. Introduce the scale of hardness by providing a copy of Moh's Scale of Hardness (Table 1) to each group. Illustrate an example of testing for hardness by using a sample rock or mineral and testing it for hardness according to their scale. Allow the students to work through their five samples recording their findings on the worksheet. Remind the students to work carefully with the knife and the file.

Suggestions for the Gifted

make fossils from plaster of Paris
experiment by adding other materials (such as salt,
chalk, etc.) to make the fossils harder

Activity VI - Comparing Rocks and Minerals According to Their Specific Gravity

Description - The students will calculate densities of rocks and minerals by measuring the weights of the samples in the air and in the water.

Materials needed for each group

spring scale	large container of
rubber band	water
the five rock and mineral samples	hand calculator
Worksheet 1, "Classifying Chart"	
cotton string	

Directions (see Diagram 1, page 5)

To find the specific gravity of rocks and minerals, it must be calculated. (See background information for step-by-step procedure.) Work through several examples with the students as a large group so that they understand the use of the scale and the calculations. Perhaps the students could be allowed to use hand calculators to figure the specific gravity. Record the specific gravity on the worksheet.

Suggestions for the Gifted

Does the size of the sample affect the specific gravity?
Which of the three types of rocks (igneous, sedimentary,
metamorphic) seems to have a higher specific gravity?

Activity VII - Using Reference Books

Have the students attempt to determine the identity of each of their unknowns based upon the evidence they have recorded on Worksheet 1 - "Classifying Chart." It should be emphasized that the process of determining a possible identification is as important as the identification itself. One key to this identification is the hardness of the sample. The students could list all

materials with specific gravity near the specific gravity of the sample then use the other information such as hardness, color, streak, and texture to further identify the sample. They should feel pleased if they can narrow the possibilities to two or three choices for each sample with the information they have on their charts. Other tests and better means of measuring both hardness and specific gravity would be needed to exactly identify the samples.

Activity VIII - Competency - Identifying Samples

Description - The students will use techniques learned in this unit to identify unknown samples.

Materials needed for each group

rock and mineral samples (unknowns)
Worksheet 1, "Classifying Chart"
pencil
rock and mineral reference books
materials needed to help in identification

Directions

Give each group several unknown rocks and minerals. Have each group try to identify them through classifying, using reference books or other methods learned with the whole class. Discuss answers and predictions.

Suggestions for the Gifted

Research and find out ways to recycle materials such as iron, copper, and aluminum.
What are some jobs that are related to conservation?

TESTING FOR HARDNESS

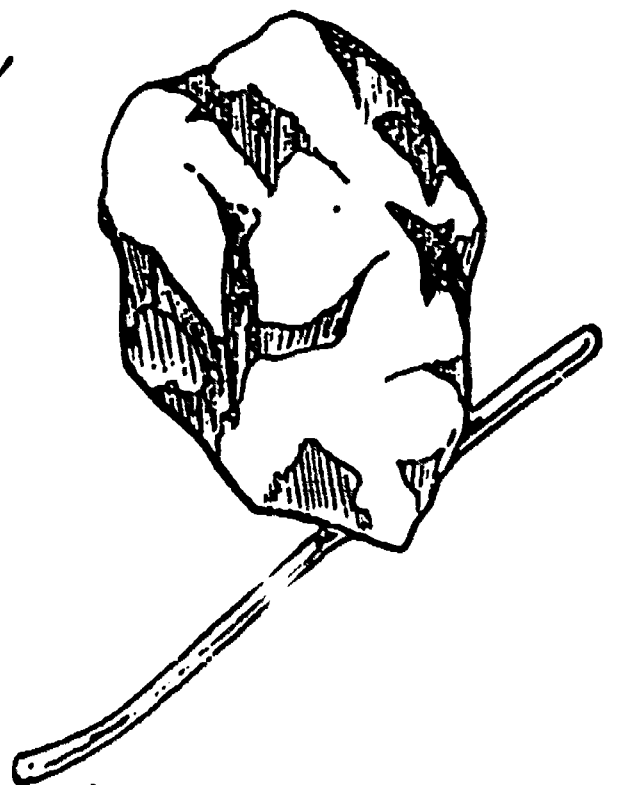
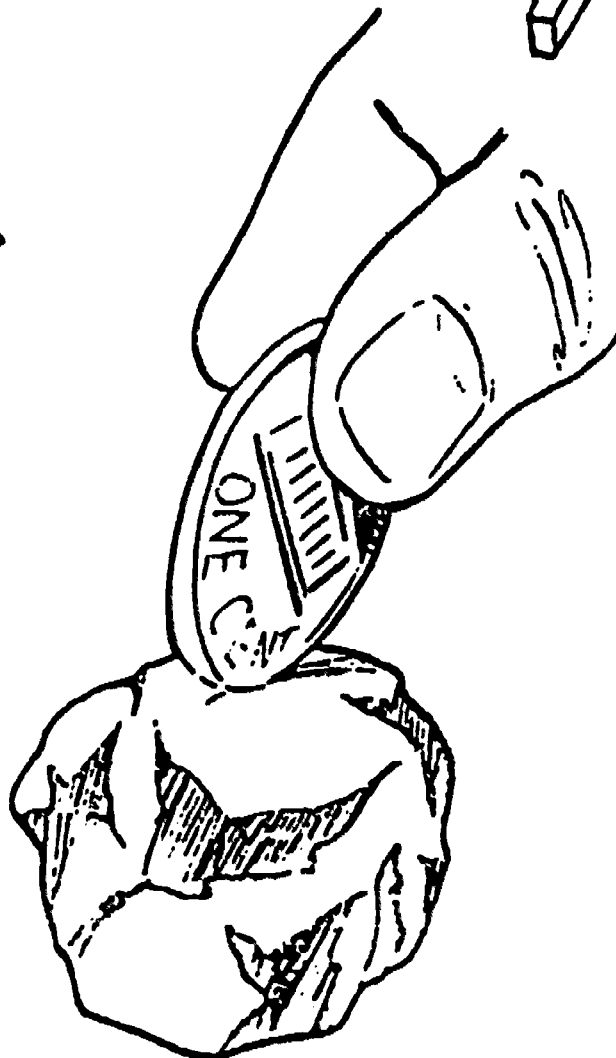
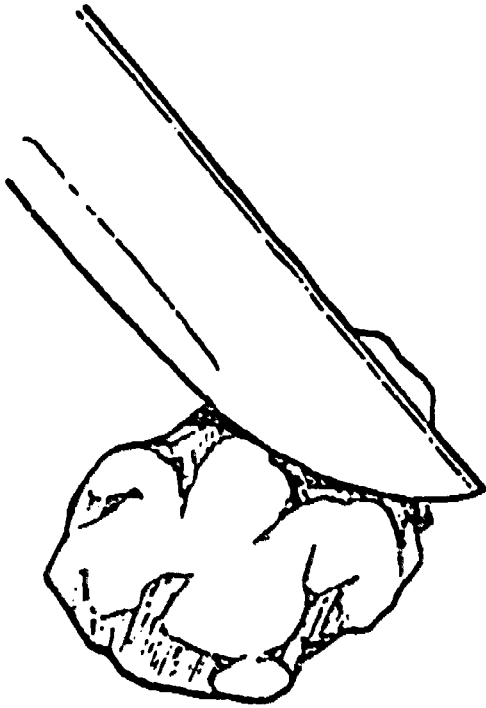
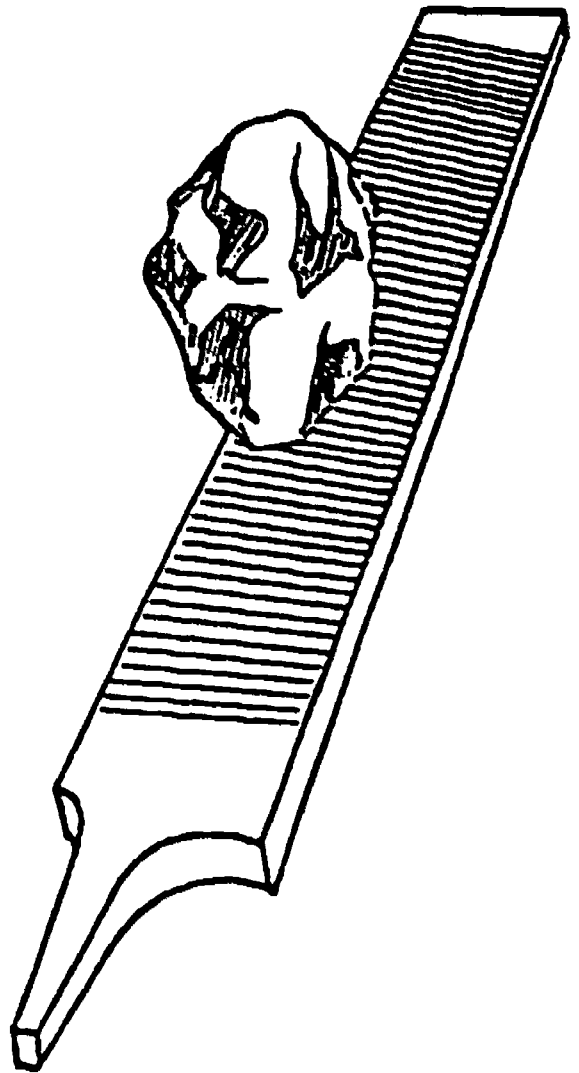
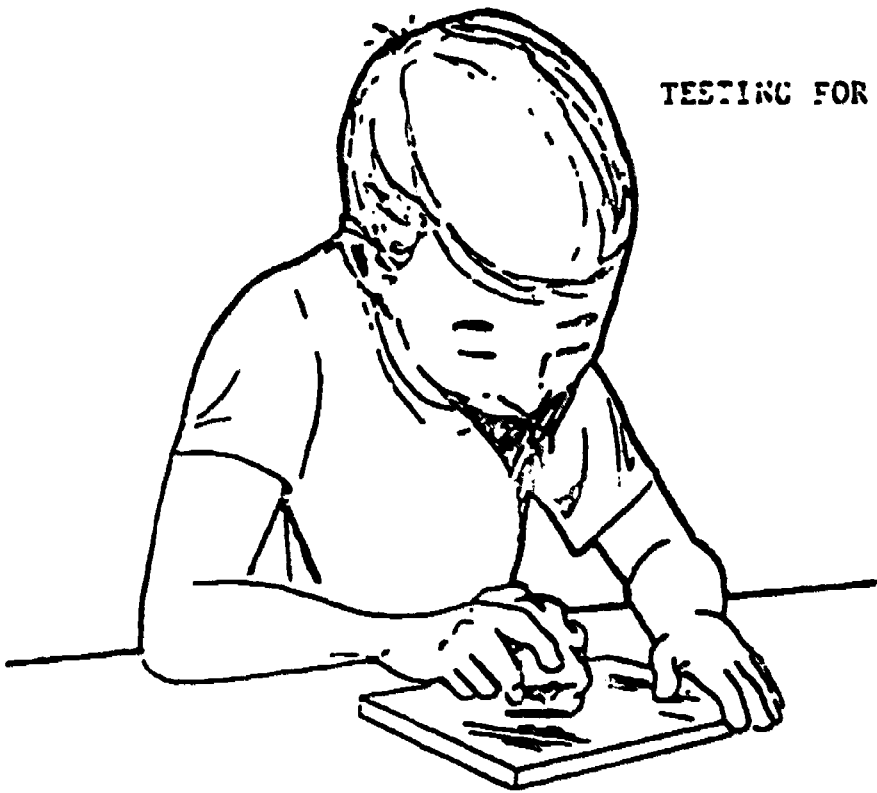

Figure 2

BEST COPY AVAILABLE

SPECIFIC GRAVITY

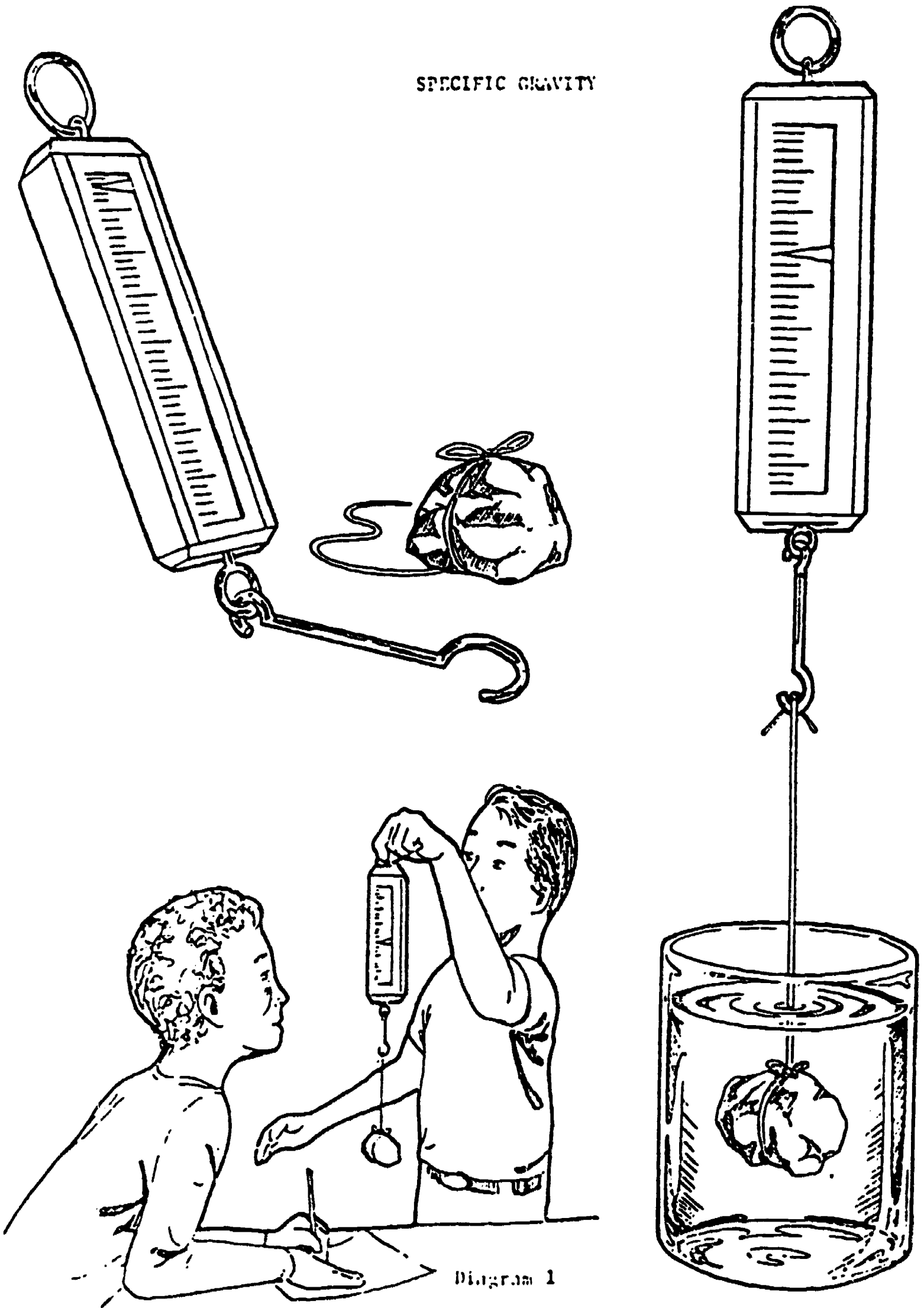

Diagram 1

Classifying Chart

Sample	Texture	Luster	Cleavage/ Fracture	Color	Streak	Chemical	Hardness	Specific Gravity
A	Small grains	Shiny	Smooth, even surfaces	Gray	Black	Non-carbonate	5, Difficult to scratch with knife	3.6
B	Large grains	Dull	Rough	Green	Green	Carbonate, fizzes	3, Can be scratched with penny	2.3

**Annotated Bibliography of Children's
Books for Rocks and Minerals**

Cormack, M. B., The First Book of Stones, Franklin Watts, Inc., NY, 1950.

The author discusses how rocks are formed, where they are found, and different tests to perform on them.

Collins, Henry Hill, The Wonders of Geology, G. P. Putnam's Sons, NY, 1962.

The book shows the effect of wind, water, ice, sun, and gravity on the changing earth.

Del Rey, Lester, Rocks and What They Tell Us, Whitman Publishing Co., Racine, WI, 1961.

The three types of rocks and how they are formed are discussed. The importance of rocks and previous stones and fossils are mentioned.

Evans, Eva Knox, Questions and Answer Adventures: Rocks, Capitol Publishing Co., Inc., NY, 1965.

The author discusses the importance of rocks in the early days. Also the book contains a dictionary of common rocks and minerals.

Fenton, Carroll Lane, Rocks and Their Stones, Doubleday and Co., Inc., 1951.

The author discusses the different rock groups and their importance in telling about the forces that have changed the earth.

Gallob, Edward, City Rocks, City Blocks, and the Moon, Charles Scribner's Sons, NY, 1973

Examples of the three different types of rocks relating them to the city are given in this book.

Gans, Roma, Millions and Millions of Crystals, Harper & Row Publishers, Inc., 1971.

An introduction to the characteristics, formation, and uses of crystals is found in this book.

Hyler, Nelson, The How and Why Wonder Book of Rocks and Minerals, Charles E. Merrill Books, Inc., 1960.

This book is a guide to the definitions of rocks and minerals and to their identification.

Keen, Martin L., Be a Rockhound, Julian Messner, NY, 1979.

The author shows how much fun one can have collecting rocks.

Loomis, Frederic Brewster, Field Book of Common Rocks and Minerals, C.P.
Putnam's Sons, NY, 1948.

The author discusses the ways to identify rocks and minerals by testing. The book contains a list of common rocks and minerals and information about them.

INTERMEDIATE LESSON

INVESTIGATING WEATHER

COMPETENCIES

A. Processes

1. Observing
2. Classifying
3. Inferring
4. Predicting
5. Measuring
6. Communicating
8. Defining Operationally
10. Experimenting
12. Interpreting Data

C. Physical Science

1. A. Form/State of Matter
1. B. Water
2. F. Heat

D. Earth and Space Science

5. Weather and Climate

E. Attitudes

1. Toward Classwork
2. Toward Interest and Careers
3. Toward Personal Use of Science
4. Toward Oneself

LESSONS

Lesson 1 - Activity I, Making Dew, Investigating the Formation of Dew and Frost, Corson, Davis and Allison: The students use soup cans, ice, and water, to observe the formation of "dew."

Lesson 2 - ITV Video Module on Investigating Weather. Thirty-minute presentation. See attachment.

Lesson 3 - Activity II, Determining Dewpoint, Investigating the Formation of Dew and Frost, Corson, Davis, and Allison: The student, lower the temperature of water in a can observing for condensation the measure of the dewpoint.

Lesson 4 - Activity III, Making Frost, Investigating the Formation of Dew and Frost, Corson, David, and Allison: The students lower the temperature of water in a can observing for "frost."

Lesson 5 - Activity IV, Investigating the Formation of Dew and Frost, Corson, avis, and Allison: The students lower the temperature of water in two cans, one with salt, one without, and compare results.

Title - Investigating the Formation of Dew and Frost (Alan Corson, Geri Davis, and Roy W. Allison)

Level - Intermediate

Aims - From ISEE Toward Which This Lesson Contributes

1. The student will solve problems by gathering information, working independently, using equipment and materials, observing purposefully and drawing appropriate conclusions based on these findings.
2. The student will demonstrate competency in the use of the processes of science by: (a) observing, (b) classifying, (c) communicating, (d) experimenting.

Instructional Objectives - At the conclusion of this lesson the student will be able to:

1. Describe how dew and frost are formed.
2. Demonstrate both dew and frost formation.

BACKGROUND INFORMATION

Warm air can hold more water in the vapor stage than can cold air. As air is cooled it loses its ability to hold as much water vapor causing some of this water vapor to condense to form 1. clouds, 2. fog, 3. dew, 4. frost or 5. rain or 6. snow. The conditions and location where this cooling takes place will determine which of these 6 will be formed.

Dew or frost are formed when warm air carrying water vapor hits a cold surface such as your car, lawn or other objects which would cool the air below the ability of the air to hold all of its water vapor. If the cold surface is above 32°F or 0°C the water vapor will form dew. If the cold surface is below 32°F or 0°C the water vapor will form frost. The water vapor changes into feathery ice crystals directly and in no way is frost ever frozen dew.

This lesson is best suited to a time of the year (Spring or Fall) when there is water vapor in the air and some chance of the relative humidity in the classroom being 50% or more.

Total Equipment List for a Class of 30 Students

- 2 thermometers
- 15 soup cans (labels removed)
- 15 teaspoons
- crushed ice
- salt
- water

Activity I - Making Dew

Materials needed - 15 soup cans
15 teaspoons
crushed ice
water

Have each group fill their soup can half-full of cold water. At a signal have each group add some ice to the water in their can.

Tell the students to observe the outside of the can for any change which happens. The teacher could then ask "What do you observe on the outside of your can?" "How did it get there?" "If you went outdoors and found this on your car or grass, what would you call it?"

Activity II - Determining Dewpoint

Materials needed - 1 thermometer
1 can
ice
water

Have one of the students fill the can half full of cold water. Place some ice in the can. Immediately place the thermometer in the can and continue to read and record the temperature every two minutes. Have the students observe the can for the appearance of condensation on the outside of the can. Record the temperature of the water inside the can. This temperature when the first condensation occurs is known as the dewpoint.

This activity could be repeated over several days to show that the dewpoint is constantly changing.

Activity III - Making Frost

Materials needed - 15 soup cans
crushed ice
water
spoons
salt

Have each group of 2 students put about a third of a can of cold water in their can. Then add about 3 teaspoons of salt to each can. Now add crushed ice to nearly fill the can and begin stirring the can with vigor. Continue to stir until something is observed on the outside of the can.

The teacher might ask "What has formed on our cans?" "Can this material be scraped off with your fingernail?" "How does it feel?"

If no frost has formed on the outside of the cans, it may be necessary to make the cans still colder by pouring off some of the water and adding more ice and more salt.

Ask the students to explain "How the frost was formed?" "Where did the water which froze on the outside of the can come from?"

Activity IV

Materials needed - 2 soup cans
2 thermometers
2 teaspoons
ice
salt
water

Have the students fill each can with the same amount of cold water (about 1/3 full). Fill both cans with ice. Place about 6 spoons of salt in one of the cans. Stir the ice and water in both cans for about 5 minutes. As soon as you stop stirring put a thermometer in each can.

1. "Which can is colder?"
2. "What is on the outside of each can?"
3. "What is the temperature of each can?"

INTERMEDIATE LESSON

INVESTIGATING EVAPORATION

COMPETENCIES

A. Processes

1. Observing
3. Inferring
4. Predicting
5. Measuring
6. Communicating
9. Formulating Hypotheses
10. Experimenting
11. Recognizing Variables
12. Interpreting Data

C. Physical Science

1. A. Form/State of Matter
1. B. Water

E. Attitudes

1. Toward Classwork
3. Toward Personal Use of Science
4. Toward Oneself
5. Toward Science and Society

LESSONS

Lesson 1 - ITV Video Module on Evaporation. Forty-five minute ITV presentation.
See attachment.

Lesson 2 - Activity 1, Investigating Evaporation: Children wash their desks and make observations as the water evaporates.

Lesson 3 - Activity 2, Students dampen desks again and then test the effect of wind on evaporation.

Lesson 4 - Activity 3, Students discuss results of previous experiment and develop a list of variables.

Lesson 5 - Activity 4, Students record the time it takes for water to evaporate.

EVAPORATION

INTERMEDIATE

"Investigating Evaporation," ISEE Video Tape I, 20 minutes: The primary purpose of the televised program is to involve the children in careful observation and identification of variables that must be controlled if they are to obtain accurate data when they begin to experiment after the program.

"Rain," AEBC, P, I, 10 minutes, color: Clouds tell us many things. They tell us which way the wind is moving and how fast. If we learn to watch the clouds, we can tell when a storm is coming. Clouds are made of water or ice. When it is cool enough, raindrops fall. We need the rain to help us grow things and to supply fresh water. Rain falls to the ground, collects in streams and rivers, forms lakes, and sometimes causes floods. Much rainwater finds its way back to the ocean to start the cycle of clouds, rain, streams, and oceans all over again.

"Water Cycle," Encyclopedia Britannica, J, 14 minutes, color, 1980: Shows by animation and regular photography, the different phases of the water cycle, evaporation, condensation, saturation, the water table, and the circulation of water on the earth's surface. Closes with discussion of cover crops and dams as controls.

OTHER

"Water and Rain," AIT, Let Me See Series, P, 15 minutes, color, 1982: Viewers see examples of evaporation and Myrtle shows how water cycles. Pocus tells the story of Hilary, a water droplet. Hilary and Myrtle prepare to create a cloud.

INVESTIGATING EVAPORATION

Television Introduction

Teacher Orientation

A major portion of the televised program involves the viewers in the observation of two children as they attempt to set up an experiment testing the effect of the sun's radiation on white and black objects.

The question is: "Is the temperature higher inside a black car than a white car if both are sitting in direct sunlight?"

First the children choose to test the temperature differences of one white and one black car when both are positioned in direct sunlight. They identify variables to control: car model, glass (tinted or clear), where to place thermometer, etc.

When acquiring two identical cars (other than color) becomes a problem, the children design an experiment that is much simpler to manipulate. They choose to insert thermometers into the bottom of two inverted paper cups, one black and one white. Here again, they wrestle with variables that must be controlled in order to test the effect of color on the absorption rate of the sun's radiant energy.

The primary purpose of the televised program is to involve your children in careful observation and identification of variables that must be controlled if they are to obtain accurate data when we experiment.

The television program culminates with the introduction of the viewers to the SCIENCE UNLIMITED lesson, "Investigating Evaporation." At this point, the viewers are challenged to answer another question, "Does wind cause water to evaporate faster?": The television children place a large spot of water on a chalkboard and then fan the water spot until it evaporates.

At this point you should survey your students to see how many believe that the evaporation of one spot of water adequately tests the question.

With some gentle probing and some patience on your part (but without revealing your knowledge that another identical spot of water is needed as a control), you should be able to lead children into the activities of the ISEE evaporation lesson. They can start planning to control such variables as spot size, "wetness," etc.

INVESTIGATING ICE AND WATER (20 min. - color)

Discussion Period and Time	TV Image	Final Broadcast Statement	Suggested Statements or Questions	Teaching Strategy
1 45 sec.	Graphic statement of question	Discuss with your teacher how this question could be tested.	Think about the question on the TV screen for a while. How would you suggest we check out this question?	4 Wait Time
2 38 sec.	Graphic statement of question	Have Allen and Rod thought of everything that might affect the outcome of their experiment?	Are Allen and Rod handling the thermometer correctly? Should they both sit in the same place in the two cars? What other suggestions do you have for Allen and Rod?	5 Process Experimenting
3 45 sec.	Graphic statement of question	What effect could tinted glass and difference in car size have on the outcome of the experiment?	Do you think that the color of affect the temperature in the car? How about car size? What are your reasons for your choice of answers?	5 Process Experimenting
4 1 min.	Graphic statement of question	What ideas do you have about objects that could be used for this experiment?	What two black and white objects might Allen and Rod use to test their experiment? Take a few moments to think about this question.	4 Wait Time

5	Graphic statement of question	What are the reasons for painting the white cup with white paint when it's already white?	In a few seconds I am going to ask you to raise your hands if you believe Allen and Rod should (or should not) paint the white cup which is already white. Will you be prepared to give us a reason?	4
1 min. 30 sec.				Wait Time
6	Graphic statement of question	What else might they have overlooked?		
1 min.				Process Experimenting
7	Graphic statement of question	What might have happened if Allen and Rod did not check the two thermometers to make sure they showed the same temperature.		
52 sec.				Process Experimenting

Title: Investigating Evaporation

Level: Intermediate

Aims: Towards Which This Lesson Contributes

1. The student will demonstrate competency in (a) observing, (b) measuring, (c) communicating, (d) inferring, (e) controlling variables, and (f) experimenting.
2. The student will pursue problems of study and state (and possibly demonstrate) methods for gaining solutions to these problems.
3. The student will measure length and volume in either English or metric units.

Instructional Objectives: At the conclusion of this lesson, the students will be able to:

1. List variables that must be controlled to test the question.
2. Solve, at least tentatively, the control of the wetness variable.
3. Manipulate variables so that the results can be attributed to the wind's effect on evaporation.
4. Cite changes that might be made if the experiment were to be repeated.
5. Discriminate between an investigation that is, or is not, an experiment.

Background Information:

The purpose of this investigation is to help students to develop skills in manipulating and controlling variables. Encourage students to list variables such as: the size of wet spot, the "wetness" of spot, the temperature (nearness to radiator), the material on which the moisture is placed, the location of the spot - in or out of direct sunlight, type of paper or sponge, etc.

"Wetness" will probably be the most difficult variable to control. This could prove to be a problem within itself and there may be no way of measuring precisely the wetness of the paper or sponge by ordinary classroom measurement. Submerge in a deep pan of water two identical paper towels. When they are completely saturated, lift from the water holding only to one corner. Hold over pan and drain excess water for 30 seconds. Two identical sponges, perhaps both brand new, with a half cup of water poured on, and massaged into, each sponge could be an alternative.

The wetness variable is a difficult one to control. This problem might require that groups of children try different ideas and then choose what they feel is the best technique for assuring adequate control of this variable. The use of devices other than sponges or paper towels might be considered. It is possible that, after much thought and testing, you and the students may feel somewhat dissatisfied with your testing technique.

Activity 4 - Competency Measure:

A. No Wind Variable
(Control)

B. Wind Variable

Time _____

After the timer records on the blackboard the results of the experiment, ask the students to discuss their findings. The teacher might compile a list of problems that the students cite that, if better controlled, might make findings more valid, if repeated.

Additional Activities:

1. Students could compare the evaporation rates of different liquids. For example, alcohol could be compared to water.

Now the class is prepared to test the question: "Will wind make the water evaporate faster?" Whether done by several small groups or one large group of students, responsibilities should be assigned to individuals so as to assure reasonable control of variables. One student will need to:

1. Identify two desks with same surface.
2. Identify identical sponges or paper towels.
3. Control the quantity of water on both surfaces.
4. Coach those who apply water to both surfaces in same manner.
5. Time the evaporation rates from both surfaces.

Total Equipment List:

Several sponges of like quality and size
A source of water
A measuring cup
A clock
Paper towels

Activity 1 - Readiness Activity

Discuss with the students several examples of evaporation observable within their environment.

Suggest that the students wash their desks with dampened paper towels. As the water evaporates, discuss with the students their observations.

Activity 2:

Ask the students to dampen their desks again. This time they are to test the question: "Will wind make the water evaporate faster?"

The students are then free to test the effect of wind on their dampened desks. Presumably most of them will fan the desk with a piece of cardboard, tablet, etc. Some may choose to blow their breath on the desk.

Activity 3:

After the students have completed their "experiment," ask each member of the group to choose one of several responses:

1. Yes, I have evidence that wind makes water evaporate faster.
2. No, I do not have such evidence.
3. Undecided.

Enter into a discussion asking individual students to support their responses with evidence. Not only might the teacher probe students' responses, but students should probe each other's responses. Guide the discussion so that a list of variables is developed. A partial list might include:

1. Desks must be the same size, made of same material.
2. Not close to each other.
3. Away from direct sunlight and heat ducts.
4. Sponges or paper towels same size.
5. Sponges or paper towels same "wetness".

INTERMEDIATE LESSON

INVESTIGATING SOUND

COMPETENCIES

A. Processes

1. Observing
2. Classifying
3. Inferring
6. Communicating
10. Experimenting
12. Interpreting Data

B. Biological Science

5. Human Body

C. Physical Science

2. A. Basic Characteristics of Energy
2. E. Sound

E. Attitudes

1. Towards Classwork
2. Towards Personal Use of Science
4. Towards Oneself
5. Towards Science and Society

LESSONS

Lesson 1 - Activity 2, Investigating Sound. Students will experiment with yardsticks and bobby pins to find the relationship between frequency of vibration and pitch.

Lesson 2 - ITV Video Module on Investigating Sound. Forty-five minute presentation. See attachment.

Lesson 3 - Activity 1, Readiness Survey, Students listened to a pre-recorded tape of sounds, predict and identify them, and describe differences in the sounds.

Lesson 4 - Activity 3, Tension-Pitch Relationship, Students manipulate the tension of a stringed apparatus to study the effect of tension on vibration frequency (pitch).

Lesson 5 - Activity 4, Thickness Pitch Relationship, Students manipulate the thickness of strings in the apparatus to study the effect of thickness change on vibration frequency (pitch).

Lesson 6 - Activity 4, Length-Pitch Relationship, Students manipulate the length of the strings in a stringed apparatus to study the effect of length change on vibration frequency (pitch).

Lesson 7 - Activity 5, Competency Measure, Students work with cigar boxes and rubber bands to illustrate the principles of vibration and pitch.

SOUND

INTERMEDIATE

"Investigating Sound," ISEE Video Tape, I, 20 minutes: The television program centers around sounds produced by a rock music group and introduces the viewer to some of the variables that will be explored in the lesson. The lesson which follows the televised introduction gives the children an opportunity to experiment, observe, communicate, and draw inferences.

"Learning About Sound," Encyclopedia Britannica, I, J, 17 minutes, color, 1974: Though sound is unseen, it has a complex physical nature. This film presents the basics of sound, starting with its source - vibrations emanating sound waves. An oscilloscope visualizes the frequency and amplitude of sound waves. An experiment with railroad tracks compares the speed of sound through metal. Scenes explore both electrically synthesized and ultrasonic sounds. Concluding the film, is a discussion of noise pollution and ways to control it.

OTHER

"Vibrations," Encyclopedia Britannica, I, J, 13 minutes, color, 1961: To show that a vibration occurs whenever an action is repeated with a regular rhythm, we see a tuning fork vibrate. Vibrating arms of the fork strike against surrounding air particles which strike our ears and produce sounds.

"Sound for Beginners," Coronet, P, 11 minutes, color: Uses slow-motion photography and visual demonstrations to show that all sounds, even those of different volume and pitch, are caused by vibrations through air. Explains that sound takes time to travel from its source to the ear, and that sound can travel through solids, liquids, and gases.

"Sound About," Aims, P, M, 11 minutes, color, 1967: Provides discovery experiences for children in their science study of concepts in sound. Almost narration free, high visualization is used in a comprehensive approach. Open ended for further inquiry.

"Sound and How it Travels," Encyclopedia Britannica, P, I, 11 minutes, color, 1963: Defines sound and shows that it is caused by vibrations. Explains that vibrations travel from their source through a sound medium, air, liquid, or solid to be heard. Simple demonstrations help to illustrate the difference between one sound and another. Provides an understanding of sound in everyday life, and reveals some of the important uses of sound in specialized work.

"How Sound Helps Us," Coronet, P, 11 minutes, 1964: Listening with Dickie, we become aware of sounds and how they give us various kinds of information as well as pleasure. Combining interesting discovery experiences with beginning science concepts, the film introduces the basic qualities of sound and shows that sounds are made by blowing, rubbing, plucking or hitting one thing against another.

Title: Investigating Sound

Level: Intermediate

Aims: Towards Which This Lesson Contributes

1. The student will solve problems by working independently and in groups, using equipment and materials, observing purposefully, and drawing appropriate conclusions based on these findings.
2. The student will demonstrate competency in the use of the processes of science by: (a) observing, (b) classifying, (c) communicating, (d) inferring, and (e) experimenting.
3. The student will construct quantitative and qualitative records that can be used as evidence for reaching tentative conclusions.
4. The student will defend a point of view by making use of supporting evidence.

Instructional Objectives: At the conclusion of this lesson, the student will be able to:

1. Demonstrate the relationship of the length of a string to the pitch that string produces when plucked.
2. Demonstrate the relationship of the thickness of a string to the pitch that string produces when plucked.
3. Demonstrate the relationship of the tightness of a string to the pitch that string produces when plucked.
4. Predict which of two objects (strings, paper clips, bobby pins, soda straws, rubber bands, etc.) will produce the higher or lower pitch when made to produce sound and give reasons for this prediction.
5. Predict which of two objects will vibrate at the faster rate.

Background Information

The activities in this lesson are concerned with the relationship between the vibrating body producing a sound and the pitch of the sound produced. The greater the number of vibrations per second produced by the vibrating body, the higher the pitch of the sound emitted.

Wave length

Rarefaction

Condensation

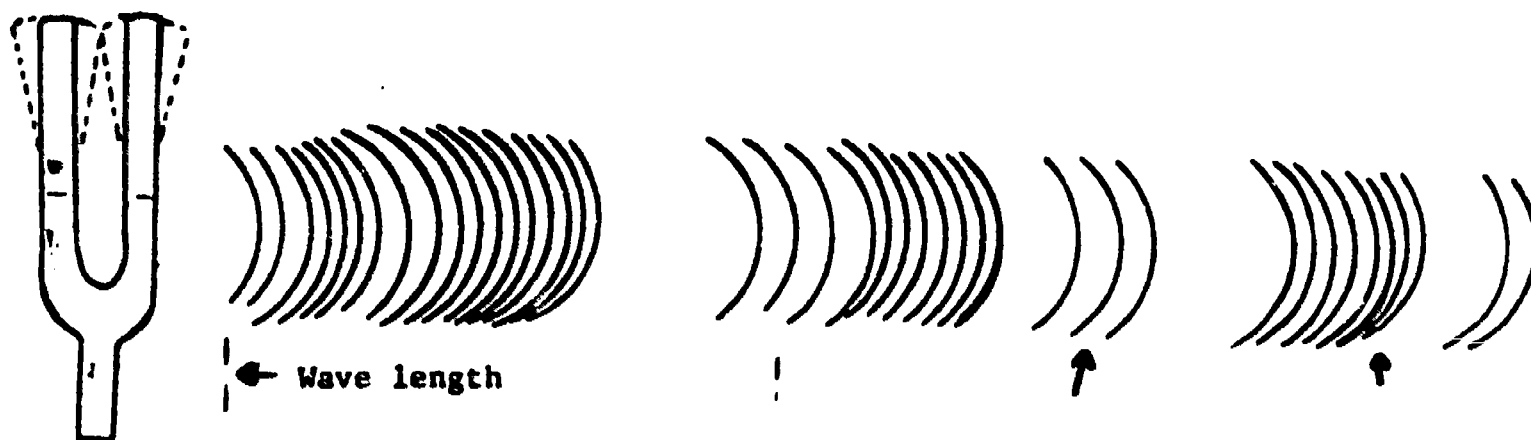

The drawing above is an attempt to represent the production of sound by a vibrating body. The vocabulary introduced above is defined as:

1. Wave length is the distance between the corresponding parts of two consecutive waves. One wave length is produced by one complete vibration of the sounding body.
2. Frequency of a sound wave is determined by the number of complete vibrations of the sounding body per second.
3. Amplitude determines the loudness or intensity of the sound produced by a vibrating body. Small amplitude indicates a soft note. Great amplitude indicates a loud note.
4. Condensations are produced when the vibrating body moves in the direction the sound wave is traveling thus compacting the molecules of air adjacent to the vibrating body more closely together.
5. Rarefactions are produced when the vibrating body moves away from the direction the sound wave is traveling thus permitting the air molecules immediately adjacent to the vibrating body to fill a larger space and thus be farther apart.

No emphasis should be given to the learning of the vocabulary and/or definitions above. These were included to provide the teacher with background information only. The emphasis in this lesson should be placed on the three factors which affect the frequency or vibration rate of a vibrating body. These three factors are responsible for the differences in the pitch of various things (such as a rubber band): length, thickness and tightness. A lower pitch is produced by a long, a thick, or a loose string or band; while a higher pitch is produced by a short, a thin, or a tight string or band if only one factor is changed at a time. In general, a long string or band (or a thick string or band, or a loose string or band) vibrates more rapidly producing a high pitched sound.

If the teacher wishes, many of the activities suggested in this lesson may be adapted to a learning center approach to the teaching of science.

"Investigating Sound" should be conducted by the teacher in such a way that the children are continually making discoveries which will lead to further inquiries about sound.

Total Equipment List for a Class of 30 Students

10 cigar boxes
10 wide rubber bands
10 medium wide rubber bands
30 thin rubber bands
10 meter sticks
30 plastic soda straws
30 pairs of scissors
30 bobby pins
1 tape recorder
1 pre-recorded tape for recorder
1 feel of squidding line (15 lb. test) mono-fillament nylon fishing line
1 reel of squidding line (30 lb. test) mono-fillament nylon fishing line
1 reel of squidding line (45 lb. test) mono-fillament nylon fishing line
1 three-speed record player
1 33 rpm record
1 78 rpm record
assorted boards, nails, screw eyes

Activity 1 - Readiness Survey

Materials: 1 tape recorder
 1 pre-recorded tape of sounds

Have the students listen to the pre-recorded tape of familiar sounds. Ask the class to attempt to identify the sounds they hear. Near the end of the tape, have sounds of slightly different pitch produced by the same type instrument (piano, trumpet, car horns, chimes, tuning forks). Stop the tape recorder or leave sufficient un-recorded tape to permit the students to discuss how the high and low notes were alike and how they were different. Some desirable questions to ask at this time might be:

What caused one sound to be higher (higher pitch) than the other?

What causes sounds to be produced?

How are sounds produced?

If the students are well informed on this topic, it may be well to proceed to something else.

Activity 2:

Materials: 10 meter sticks
 30 bobby pins

Have students work in groups of 3 for this exercise. Give each group a meter stick. Have one student hold one end of the meter stick securely against the edge of a desk or table allowing about 80 cm to extend over or off the edge of the desk or table as shown in drawing A.

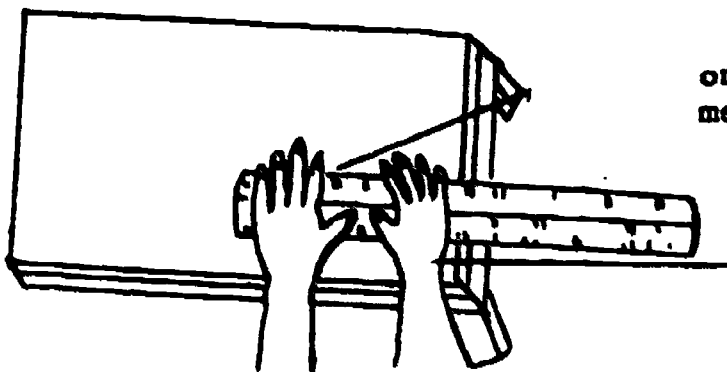

one hand holding down end of
meter stick to table

one hand at edge of table
holding meter stick
tightly to table

Have one member of the group bend the free end of the meter stick slightly upward or downward and release the stick while still bent. As your students watch what they observe when the stick is released. They should reply, "The stick is vibrating" or words meaning this. The teacher should continue the questioning until the students are aware that vibration results from their action in bending the stick.

Now have the students holding the stick move it so that the portion extending off the desk is shorter (about 40 cm). Have them repeat the bending and release of the free end of the meter stick several times while they change the length of the stick extending over the edge of the desk. Ask the students, "How does the length of stick extending over the edge of the desk affect the vibration rate of the stick when it is bent and released?" Do not give them an answer if they do not respond immediately. Instead permit them to go back to their meter stick experiment for an answer. (Do not be concerned with exact vocabulary here.) Accept any wording similar to: (the shorter the stick, the faster it vibrates; the longer the stick, the slower it vibrates.)

Now give each student a straightened (opened) bobby pin. Have him hold one end of the bobby pin at the edge of the desk top with a portion of the bobby pin extending over the edge of the desk. With his free hand, pull the free end of the bobby pin slightly and release. Have the students change the length of the extended portion of the bobby pin several times and repeat the plucking experiment. Ask them to relate the length of the vibrating end of the bobby pin to the highness or lowness (pitch) of the sound it produces to the frequency of vibration. Accept any vocabulary words which relate:

1. The shorter the length of bobby pin extending over the desk edge the faster it vibrates and the higher the pitch of the sound produced.
2. The longer the length of bobby pin extending over the desk edge the slower it vibrates and the lower the pitch of the sound produced.

Activity 3 - Tension - Pitch Relationship
(A possible learning center)

Materials per group:

- 1 piece of pegboard 4' x 4"
- 3 5' lengths of same thickness nylon fishing line
 (thick thread or string could be substituted)
- 1 pencil
- 3 cans (1 lb. coffee cans or equivalent)
- sand or water for weight
- 3 pegboard hooks (alike)

tie a string
 handle to can

punch
 hole
 with
 nail

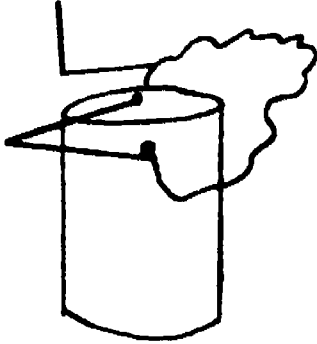

use pegboard hooks of
 this shape to prevent
 pull out



a student may have to
 hold board down here when
 weights are added

fishline

pencil

pegboard

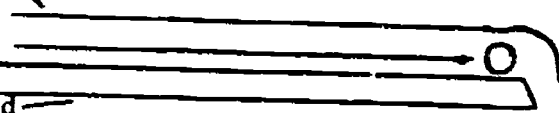

pencil

1 lb. coffee cans

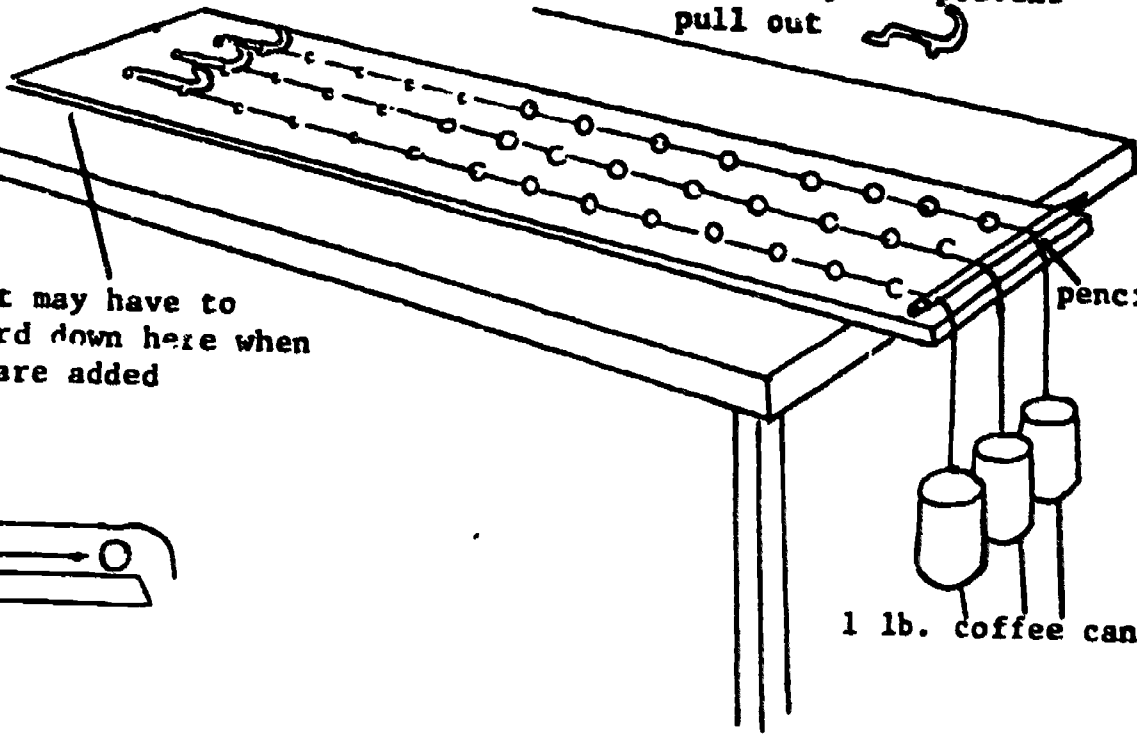

sand or water for weight
3 pegboard hooks (alike)

a student may have to hold
the board down when weights
are added

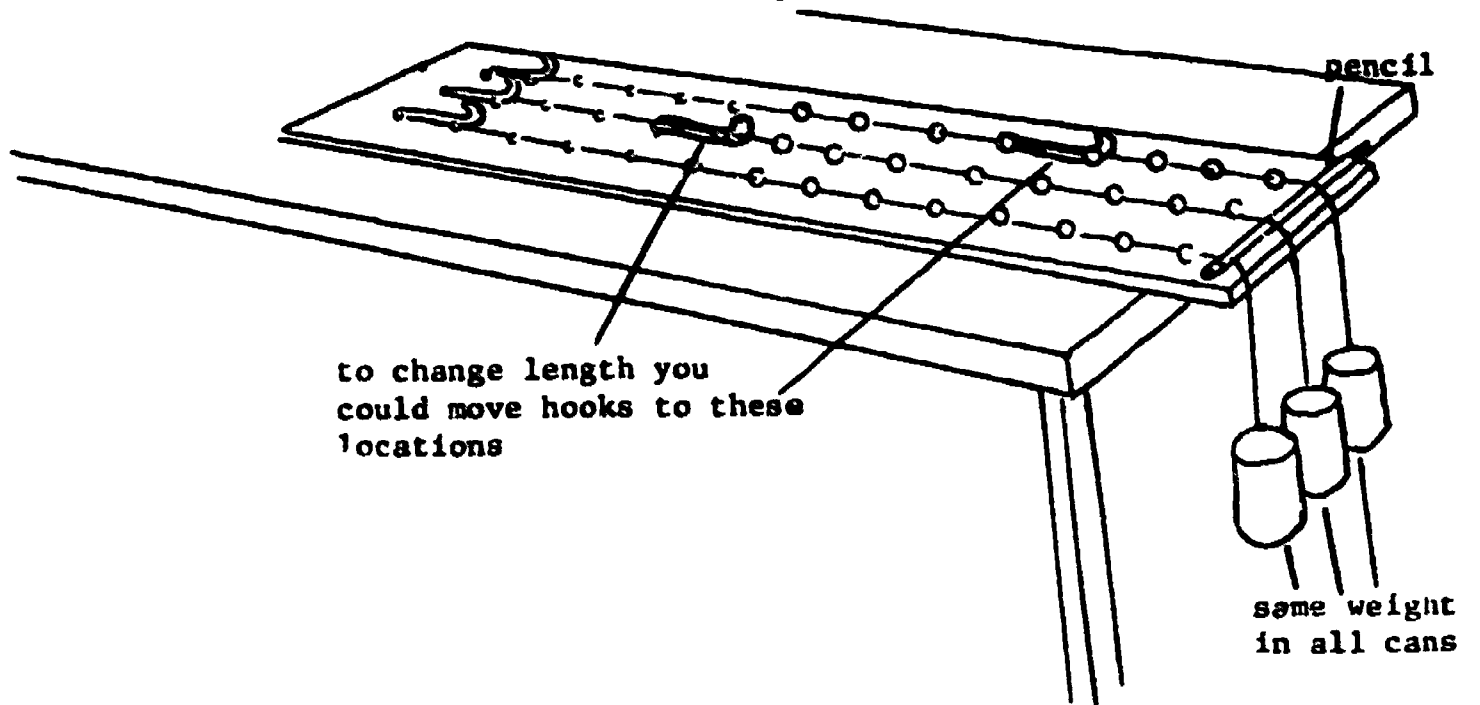

This activity could be a continuation of Activity 3.

Have the students set up the equipment with:

- A. The same tightness or tension
- B. The same length
- C. The same thickness string

Ask the students to suggest ways to keep the thickness constant (the same), the tightness or tension constant, and vary (change) the length. The drawing above suggests a possible arrangement, however others could be just as appropriate. Let the students try their own suggestions. If they do not meet with success, ask them where they think that they could have made the errors. There are times when an experimental failure is a greater learning experience than a successful experiment. The appropriate final observation here should be that the shorter the string, the higher the pitch (all other factors remaining constant).

Activity 5 - Thickness-Pitch Relationship

Materials per group:

- 1 piece of pegboard 4' x 4"
- 3 5' lengths of same thickness nylon fishing line
(thick thread or string could be substituted)

Secure the three hooks into three corresponding holes in the pegboard. Fasten the fishing line to the hooks. Punch holes in the top portion of the coffee cans and attach strings. Fasten the coffee can to the free end of the fishing line. Fill each coffee can with the same small quantity of water or sand (about 1/3 full). Ask the students to observe the three strings at this time and describe how they are alike or different. The discussion which follows should be recorded. The students should report that the strings are:

- A. the same tightness or tension
- B. the same length from hook to pencil
- C. the same thickness string

The responses need not duplicate the vocabulary but should convey the same thought. The teacher could focus the attention of the students on factors not observed by asking appropriate questions such as: How long is each string from the hook to the pencil? or What is the thickness of each string? or Which string is being pulled tighter or more?

Have the students pluck each string at this time and record the results in the table below:

	Length	Thickness	Tension or Tightness	Observation of Pitch
Trial I Every-thing the same	constant or same	constant or same	constant or same	all strings have same pitch
Trial II Change tightness	constant or same	constant or same	constant or same	the tighter the string the higher the pitch the looser the string the lower the pitch

Ask the students to consider the question, "How could we change the tightness on each string and keep the length and thickness the same?" Someone is bound to suggest the addition of more sand or water to the coffee cans. Then have the cans filled to different levels such as 1/3, 2/3, and full. Have the students pluck the strings and discuss and record their findings.

Activity 4 Length-Pitch Relationship

Materials per group:

- 1 piece of pegboard 4' x "
- 3 5' lengths of same thickness nylon fishing line
(thick thread or string could be substituted)
- 1 pencil
- 3 cans (1 lb. coffee cans or equivalent)

- 1 pencil
- 3 cans (1 lb. coffee cans or equivalent)
- sand or water for weight
- 3 pegboard hooks (alike)
- 5' (15 lb. test) mono-filament nylon fishing line
- 5' (30 lb. test) mono-filament nylon fishing line
- 5' (45 lb. test) mono-filament nylon fishing line

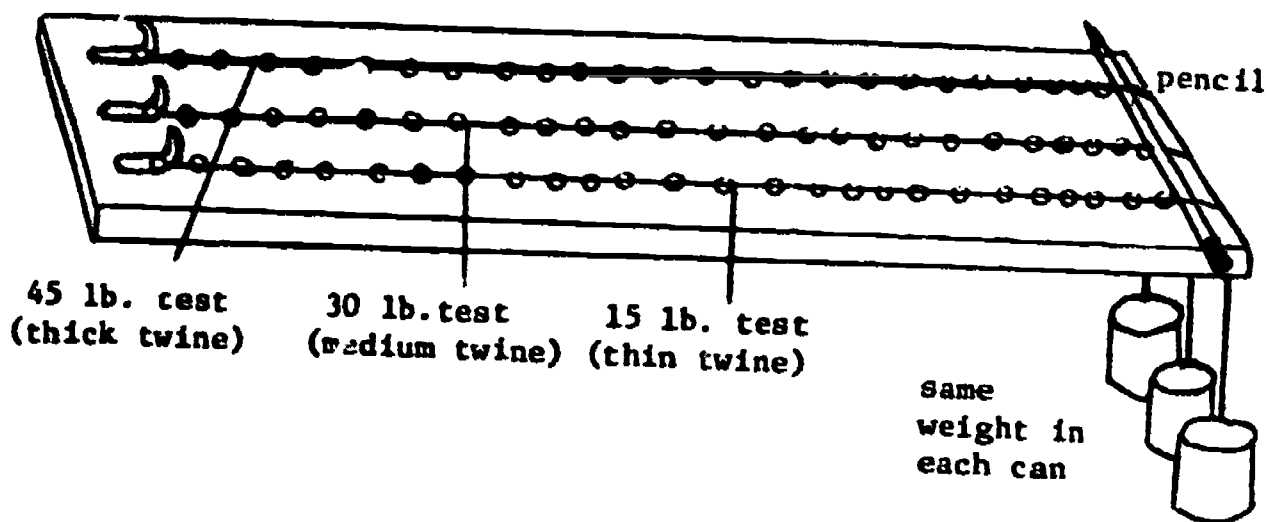

Place the hooks in the pegboard the same distance from the end as was done in Activity 3. Attach one of the three different thicknesses (15 lb. test, 30 lb. test, 45 lb. test) nylon fishing line or three different thicknesses of string or twine on each of the three hooks. The length of the strings should be constant, the tightness of or tension (pull) on the string should be constant, but the thickness of the string should be the variable. The length is controlled by putting the hooks the same distance from the end. The tightness of or tension on the string is controlled by putting the same quantity of sand or water in each can attached to each string being tested. Have the students discuss means of controlling two of the three possible variables while allowing one of these to change. In a true experiment, only one element is allowed to change to determine its effect on all others.

Activity 5 - Competency Measure

Materials for each group:

- 1 cigar box
- 3 thin rubber bands
- 1 thick rubber band

Have the students illustrate the principles dealing with the pitch of strings using rubber bands to illustrate each principle.

Activities for further study:

Teachers and students would find the projects suggested in the books to be listed both interesting and educational. A teacher could make the books and materials available for leisure time projects. Many of the projects suggested in the books would supplement this lesson. The books are:

Musical Instrument Recipe Book, Elementary Science Study, Webster Division, McGraw-Hill Book Company, New York, 1971.

Whistles and Strings, Elementary Science Study, Webster Division, McGraw-Hill Book Company, New York, 1971.

INTERMEDIATE LESSON

INVESTIGATING FLOATING THINGS

COMPETENCIES

A. Processes

1. Observing
2. Classifying
3. Inferring
10. Experimenting
11. Recognizing Variables

C. Physical Science

1. B. Water

E. Attitudes

1. Toward Classwork
2. Toward Personal Use of Science

LESSONS

Lesson 1 - ITV Video Module of Floating Things. Forty-five minute ITV presentation See attachment.

Lesson 2 - Activity 1. Investigating Floating Things. Students observe and record the similarities and differences between a jar of water and one of alcohol. Students then observe what happens when an ice cube is dropped in both jars and add their observations to their list. Finally, students are challenged to differentiate between observations and inferences.

Lesson 3 - Activity 2. Students design experiments to test one of the inferences made during Lesson 1. Students are encouraged to control the variables. Results of their investigations are compared to results from Lesson 1 activity.

Lesson 4 - Activity 3. Students work in small groups to design experiments to test other inferences made during Lesson 1. Students then direct teachers in manipulating the materials to carry out their design.

FLOATING THINGS

INTERMEDIATE

"Investigating Floating Things," ISEE Video Tape, I, 20 minutes: A major portion of the televised program involves the viewers in the observation of the floating behavior of two objects that are quite similar in appearance - a sponge and a piece of light volcanic rock called pumice. Both float in water. One of the major purposes of the lesson is to assist the teacher and the children in differentiating between an observation and an inference.

"Why Things Float," MCGH, I, J, 10 minutes, color, 1970: Deals with the force of buoyance and displacement of objects. Demonstrations are shown with floating objects. Water and mercury are used to show how a marble sinks and floats.

"Sink/Float," AIT, Hand On Series, P, 15 minutes, color, 1975.

OTHER

"What Makes Things Float?" MGHT, I, 11 minutes, black and white, 1951: Two boys learn why, and under what conditions, objects will float in water.

INVESTIGATING FLOATING THINGS

Television Introduction

Teacher Orientation

A major portion of the televised program involves the viewers in the observation of the floating behavior of two objects that are quite similar in appearance - a sponge and a piece of light volcanic rock called pumice. Both float in water.

One of the major purposes of the lesson is to assist the teacher and the children in differentiating between an observation and an inference.

Observations are defined as information acquired through the use of the senses. Careful observation results in what you know as color, texture, weight, size, shape, etc.

Inferences, on the other hand, are interpretations of observations. They are what an observer believes to be justifiable integration of evidence obtained through observations. True observations are never subject to change but inferences are since they are not truths. Inferences are subject to revision as new evidence is acquired.

Inferences are important components in the search for knowledge. However, inferences present problems when pupils treat an inference as an observation. In the televised program, viewers will observe that objects A and B have holes, are similar in shape and size, etc. They could infer that the objects might be sponges, pieces of bread, sandstones, etc.

The televised program culminates with the introduction of the viewer to the ISEE lesson where an ice cube floats in one clear liquid (water) and sinks in another clear liquid (alcohol). With this discrepancy, students should then be highly motivated to seek explanation through observation and inference.

INVESTIGATING ICE AND WATER (20 min. - color)

Discussion Period and Time	TV Image	Final Broadcast Statement	Suggested Statements or Questions	Teaching Strategy
1 30 sec.	Balls, pencil, frisbee, screwdriver	Look at these objects and see if you can decide just by looking at them which will float when you put them in water. What do you think?	Which objects will float? Which to you predict will sink in the water?	5 Process Classification
2 60 sec.	Balls, pencil, frisbee, screwdriver	What did you already know about these objects that helps to decide whether or not they will float?	What have you done with a pencil (screwdriver, ball, (etc.) that helped you decide whether it will float or not?	2 Ans. Evidence
3 60 sec.	Three indi- viduals collecting water samples	See how many different inferences you can come up with.	What do you think the people are doing?	5 Process Inferring
4 40 sec.	Observing objects A and B	List all the ways you observe the objects are alike and all the ways they are different.	How are objects A and B similar? How are they different? Let's list them.	5 Process Observation & Classification

115

115

5 40 sec.	Manipulating two objects, A and B	Look and listen. See what other likenesses and differences you observe.	Now, what differences can we add to our list? How about likenesses/	Process Observation & Classification	5
6 30 sec.	Weighing two objects, A and B	Maybe some of you would like to see if one weighs more than the other. OK, let's see!	Which object, A or B is heavier? Which is lighter?	Process Measuring	5
7 30 sec.	Two objects A and B	Will object A float or sink? Will object B float or sink? What would you infer?	What do <u>you</u> think? Can you explain the reason for your choice?	Process Inferring	5
8 40 sec.	Two objects floating	Based on this additional information, can you make any more inferences about these objects?	What else can you say about the characteristics of A and B?	Process Inferring	5
9 40 sec.	Object B floating	Go back over all your observations and see if you can make any more inferences about object B.	Look at B closely. What else could you say about B?	Process Inferring	5

- 105 -

Title: Investigating Floating Things

Level: Lower Intermediate

Aims: Toward Which This Lesson Contributes

1. The student will demonstrate competency in the use of the processes of science by (a) observing, (b) classifying, (c) inferring, (d) controlling variables, and (e) experimenting.
2. The student will pursue problems of study and state the methods for gaining the solution to these problems.
3. The student will explain basic conceptual schemes of the material world using personal experience acquired through various activities as a basis for the explanation.
4. The student will discriminate between observation and inference.

Instructional Objectives: At the conclusion of this lesson, the student will:

1. Discriminate between observations and inferences.
2. Classify observations concerning buoyancy in one group and inferences in another.
3. Select and test at least one inference.

Background Information:

As water freezes it expands, therefore, becoming less dense; thus, ice floats on or near the surface of water. This is a common, everyday experience in the environment of pupils. Alcohol, on the other hand, is less dense than either water or ice; thus, the ice sinks to the bottom of a container of alcohol. This is not a common experience for children.

Water and alcohol appear to be the same liquid to the observer of this investigation who is advised to use only the sense of sight. Pupils assume both liquids to be water. However, when ice is dropped into each container of clear liquid, the behavior of the cubes differs. At this point, the pupils have experienced an obvious discrepant event.

A discrepant event is a unique teaching strategy where a phenomenon that is presented seems illogical, i.e., ice sinks when the observer expects it to float. This surprise strategy provides children with the motivation to actively seek a solution to the problem.

It is important that the teacher refrain from providing verbal clues that will short-circuit the pupils' investigation. A slip of the tongue revealing that the liquid is alcohol will probably cause the pupils to stop looking for a solution. The objective of inferring that the liquid must have different characteristics is more important than the pupils classifying liquid A as water and liquid B as alcohol.

One of the objectives of this lesson is to help students discriminate between observations and inferences. Observations in this investigation are facts derived from visual examination of the phenomena. Inferences require further investigating, testing, and measuring before they could be established as facts or rejected. The teacher should exert a real effort to help students separate children's observations from inferences. List each separately.

The focus of this investigation is not that students understand the concept of density. This concept is too abstract for most elementary school youngsters to internalize. The investigation of buoyancy should be considered a series of readiness activities that provide students with a number of perceptions that might be recalled later when the student develops more fully his understanding of the density concept.

It is suggested that large enough quantities of liquids be used so that the students can easily view them at some distance. Choosing the teacher demonstration mode of instruction, instead of small group activity was another means of keeping students some distance from the alcohol.

Total Equipment List:

Two gallon glass jars (perhaps mayonnaise jar from school cafeteria or restaurant)

Two quarts of alcohol (ordinary rubbing alcohol (isopropyl) can be used, methanol or methyl alcohol should not be used)

Water

Ice cubes (colored with food coloring if the teacher desires)
[The equipment list for all activities is the same.]

Activity 1:

1. Pour about three (3) quarts of water in a gallon glass jar. Label it "A". Pour about two (2) quarts of alcohol in another gallon glass jar. Label it "B". Place a lid or piece of cardboard on "B" to keep the odor of the alcohol from permeating the air. It is important that there be more water in "A" than alcohol in "B".
2. Ask the students to observe jars "A" and "B" and record observations. List: (1) likenesses and (2) differences.

Here is a partial list:

Observations

(1) <u>Likenesses</u>	(2) <u>Differences</u>
1. Jars same size	1. Levels of liquid
2. Both containers seem to be glass	2. Lid on "B"; no Lid on "A"

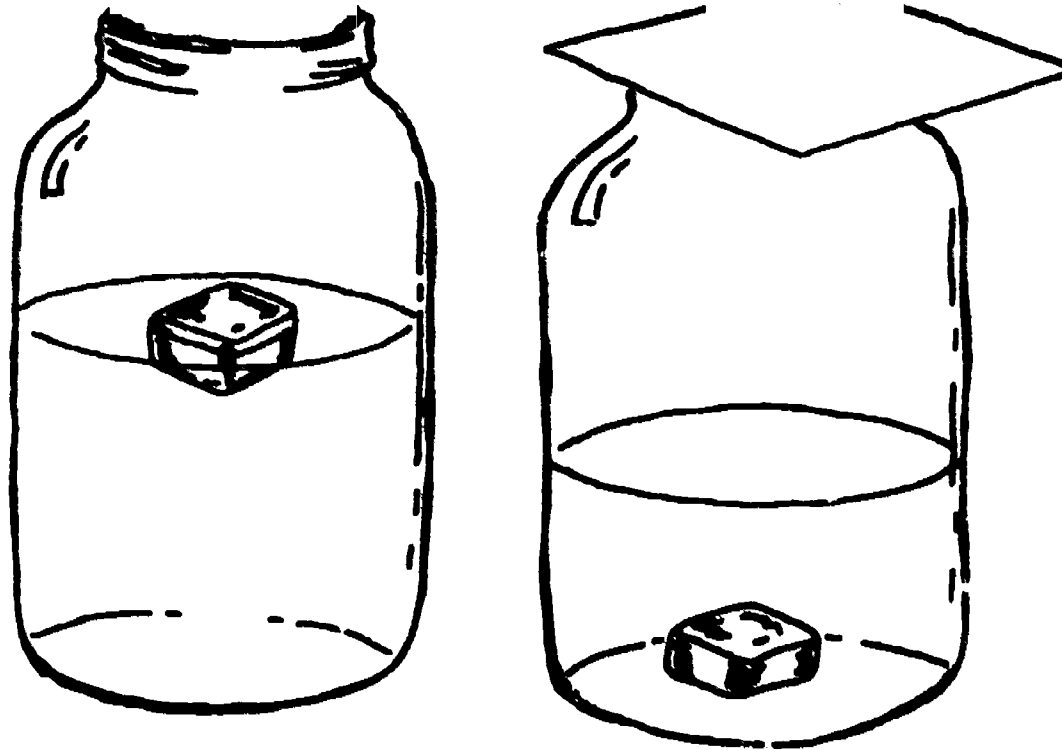

3. As the students observe you, drop part of an ice cube in "A" and a whole ice cube in "B". Ask the students to observe and make additions to their list of likenesses and differences.

Observation

Differences

Ice cube floats in "A",
sinks in "B".

Up to this point, you should have insisted that they list only their observations. Now, encourage them to list some inferences that might explain the behavior of the two ice cubes. When appropriate, ask children to state an observation which suggests the inferences listed.

Inferences

1. Ice cube in "A" floated because it was smaller than ice cube in "B".
2. Ice cube in "A" floated because the liquid is deeper in "A" than in "B".
3. Liquid "S" is made of different chemicals than "B".
4. Liquid "A" is heavier than "B".
5. Ice cube sank in "B" because of the lid.
6. The ice cube sank in "B" because it was not dropped from the same height.
7. The ice cube sank in "B" because it was dropped

8.

9.

Activity 2:

Assist the class as its members design an experiment to test one of the inferences, perhaps Inference 1: "Ice cube 'A' floated because it was smaller than 'B'. Encourage students to control the variables by giving the teacher instructions, for example, select two ice cubes the same size, drop both into liquids at the same time, from the same height, etc. The students should be asked to compare the results of their experiment with Activity 1. (They will probably note that the ice cube still floated in "A" and sank in "B" suggesting that size must not be significant.)

Activity 3 - Competency Measure

Examine the inferences remaining on the list in Activity 1, as well as other inferences your class has added to the list. Each inference could be assigned to a small group of students for the purpose of them suggesting an experiment to test it.

Following the completion of Activity 3, each group should direct the teacher to manipulate the materials according to the experiment designed by that group. To test Inference 2, the liquid levels could be adjusted and ice cubes dropped into each container of liquid. (It would be easier to lower the water level "A" than to raise the alcohol level "B".)

Inference 3 is an example of one that students are unprepared to test. An acceptable alternative in dealing with an inference is to choose not to test it.

Other inferences placed on the list by your class should be tested before Inference 5. If the children choose to remove the lid from container "B" as a means of testing Inference 5, the odor of alcohol will permeate the atmosphere within minutes.

INTERMEDIATE LESSON

INVESTIGATING SIMPLE MACHINES

COMPETENCIES

A. Processes

1. Observing
3. Inferring
4. Predicting
5. Measuring
6. Communicating
7. Using Space/Time Relations
8. Defining Operationally
9. Formulating Hypotheses
10. Experimenting
11. Recognizing Variables
12. Interpreting Data
13. Formulating Models

C. Physical Science

2. A. Basic Characteristics of Energy
2. G. Force and Machines

E. Attitudes

1. Toward Classwork
2. Toward Personal Use of Science
3. Toward Oneself
4. Toward Science and Society

LESSONS

Lesson 1 - Activity I, Readiness Activity, Investigating Pulleys. Students study the principle of opposite motion during pulley use, using diagrams and a flagpole.

Lesson 2 - ITV Video Module on Investigating Simple Machines. A forty-five minute presentation. See attachment.

Lesson 3 - Activity II, Operating a Fixed Pulley. Students work with a fixed pulley and spring scale to predict and measure the effect on force needed.

Lesson 4 - Activity III, Operating a Movable Pulley and spring scale to predict and measure the effect on force needed, and compare to fixed pulley results.

Lesson 5 - Activity IV, Competency. Students are given a known weight and asked to predict the amount of force required to lift it by a fixed pulley apparatus and a movable pulley apparatus. They then test their predictions.

SIMPLE MACHINES

INTERMEDIATE

"Simple Machines (Matter and Motion)," AIT, P, I, 15 minutes, color, 1973.

"Pulley - A Simple Machine," AIT, P, I, 15 minutes, color, 1976.

"The Wheel and Axle: A Simple Machine," AIT, P, I, 15 minutes, color, 1976.

OTHER

"Simple Machines: Using Mechanical Advantages," Barr, I, J, 16 minutes, color, 1978: Levers, inclined planes, pulley, wedges, screws, wheels, and axles are all simple machines that give us extraordinary powers. With them, we can lift, pull, and push things that are many times our own weight. They help us increase a force, change direction of a force or increase speed. Our modern world depends on simple machines.

"Simple Machines: The Lever Family," BFA, P, I, J, 10 minutes, color, 1971: Many tools we use every day are levers. All levers have 3 parts; a fulcrum, an effort arm, and a resistance arm. These three parts can be arranged in any order. Levers help us do work by changing the direction of force or by trading force for distance. Movements in any lever system can be computed by using the formula; $\text{resistance} \times \text{resistance arm} = \text{effort} \times \text{effort arm}$.

"Simple Machines: The Inclined Plane Family," EREC, I, 11 minutes, color, 1960: Introduced Mark, a young boy who discovers, through a series of simple experiments how an inclined plane can make work easier. The experiments include a table-top demonstration that a child can easily reconstruct. The concept of work is explained through the use of animated drawings. Also describes other machines of the inclined-plane family - the wedge and screw.

Title: Investigating Pulleys (Peg Heaney)

Level: Intermediate

Aims: From SFTS Toward Which This Lesson Contributes

1. The students will demonstrate competency in the use of the processes of science by (1) observing, (b) inferring, (c) communicating, (d) predicting, (e) experimenting, (f) measuring, and (g) interpreting data.
2. The students will explain conceptual schemes of the material world using personal experiences acquired through various activities as the basis of their explanation.
3. The students will construct quantitative records that can be used for reaching tentative conclusions.

Instructional Objectives: At the conclusion of this lesson, the students will:

1. Identify a single movable and a fixed pulley.
2. Understand the basic principles involving a movable and a fixed pulley, and the advantages of using each.
3. Predict the amount of effort required to lift an object of a certain weight on both a fixed and movable pulley, using a spring scale as a measure.

Background Information:

The activities in this lesson, which are primarily demonstration lessons, are concerned with the simple machine, the pulley.

The pulley consists of a grooved wheel supported in such a manner as to allow the wheel to turn freely. A rope or cable passes over the groove. One notable advantage of the pulley is its ability to change the direction of force. In the case of the fixed pulley such as one at the top of a flag pole, the obvious advantage is not the force needed to raise a weight, but rather, that pulling in one direction will result in a load moving in the opposite direction. A diagram should be provided to illustrate a single fixed pulley. (See Diagram A)

The single movable pulley, which is illustrated in Diagram B, requires less effort to pull a weight upward. In demonstrating this type of pulley, the students should observe that only about one half the effort is required to lift a weight. Thus, if a load weighs 100 pounds, a little more than 50 pounds of effort would be required to pull the weight upward. However, since both strands of the cord support the weight, lifting a load 10 feet will require that 20 feet of rope be pulled through the pulleys. The activities which follow are a demonstration type. However, the equipment used in this lesson would provide the basis for an excellent learning center in the classroom, where each student would have the opportunity to operate the pulleys individually, predicting and then recording the data.

Remind the children that a brick dropped accidentally from any height can badly bruise fingers or toes -- so a word of caution is wise.

Total Equipment List:

2 pulleys (which can be bought in a hardware store)
1 spring scale (which also can be purchased in a hardware store)
5 feet of clothesline
3 24-inch pieces of clothesline
1 6-inch piece of clothesline
1 4-pound weight (brick)
1 other weight (weighing slightly more than the other weight)
a 2 x 4 or 1 x 3 piece of wood (about 4 feet long)
2 desks
pencil and paper for each student
2 weights of approximately 8 and 20 pounds each

Activity 1 - Readiness Activity

Materials Needed: diagram of a fixed pulley for each student

Distribute the copies of the diagram to each student after which the students will then be taken outdoors to raise the flag to the top of the pole. Teacher responses should be of the type that children can see that by pulling one way on the rope (down) the flag goes the other way (up). This is a very basic and important principle. A brief discussion should follow with the introduction of such terms as "pulley" and "fixed pulley."

Activity II - Operating a Fixed Pulley

Materials Needed:

1 pulley
spring scale
a 4-pound weight (brick)
5 feet of clothesline
3- or 4-foot long piece of wood, perhaps 2" x 4" or 1" x 3"
1 6-inch piece of clothesline (referred to as rope, for attaching pulley to wood)
2 desks

Tie a piece of rope around the brick securely. (If the brick is made with holes in it, thread the rope through the holes.) Attach the spring scale to the brick and lift (without aid of the pulley), recording the weight shown on the scale on the chalkboard.

Put two desks about three feet apart and secure a piece of wood across from one to the other. Attach the pulley to the center of the wood piece and place the clothesline over the pulley. Tie the brick to one end of the clothesline and attach the spring scale to the other end.

Before lifting the brick, ask the students to predict how much force will be required to lift the 4- or 5-pound brick. After some discussion, lift the brick, recording the reading from the scale on the chalkboard. The readings

should be about the same as the reading in Activity I. Be prepared to surprise the students as many will guess that the pulley might cut the force to 2 or 3 pounds. This pulley changes direction of force, it does not reduce the force needed.

Activity III - Operating a Movable Pulley

Materials Needed:

diagram of movable pulley for each student
5 feet of clothesline
a 4-pound weight (brick)
another object (brick) of different weight
spring scale
2 chairs
1 pulley
3 24-inch pieces of rope
1 6-inch piece of rope

Distribute copies of the movable pulley and explain, or have students volunteer, the basic physical differences between it and the fixed pulley.

Tie a piece of rope around the 4-pound brick securely. Attach the spring scale to the brick as shown on Diagram B and lift it, recording the weight shown on the scale on the chalkboard.

Arrange the desks as you did in the previous activity. Thread the clothesline through the pulley so that the wheel rides freely, as if the groove were a track.

Before carrying out the demonstration, ask the students to predict if the force needed to lift the brick with the use of the pulley will be different from the weight of the brick. Record their predictions on the board.

Now pull up on the clothesline and record the reading from the spring scale on the chalkboard. The movable pulley should decrease the effort required to lift the brick by approximately one-half. Take the larger brick and repeat the experiment, to reinforce the fact that the movable pulley reduces the force to about one-half the weight being lifted. Comparing the length of rope pulled through the pulley with the distance the brick moves can be interesting. (Lifting the brick one foot with a movable pulley should require that two feet of rope be pulled through the pulley).

Activity IV - Competency

Materials Needed:

pencil and paper for each student
spring scale
1 brick
2 bricks tied together
2 24-inch pieces of rope

Each student should have a piece of paper and a pencil with which to write their predictions. Display the two bricks tied together and then weigh them with the spring scale. Now ask the children to privately predict how much effort would be required to lift the bricks with a fixed pulley. Test their predictions with the pulley arrangement and compare the results to their predictions.

The same procedure should be followed using the movable pulley. The equipment can now be set up in a corner of the classroom where the students can go individually throughout the day to test their predictions, using the pulleys and the spring scale and objects of different weights. Later, a brief discussion should follow as to the actual outcome using the two different pulleys.

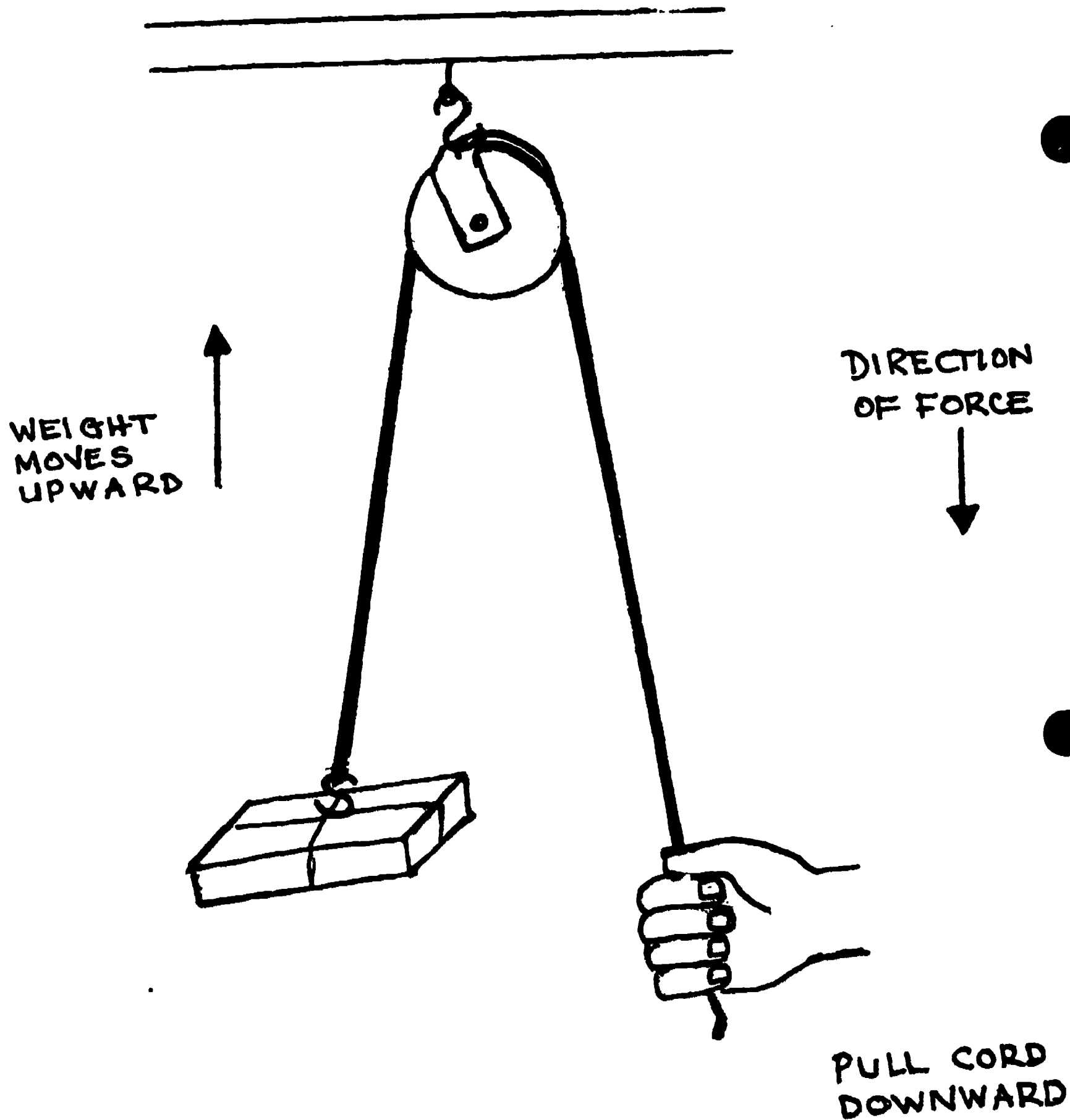

SINGLE FIXED PULLEY

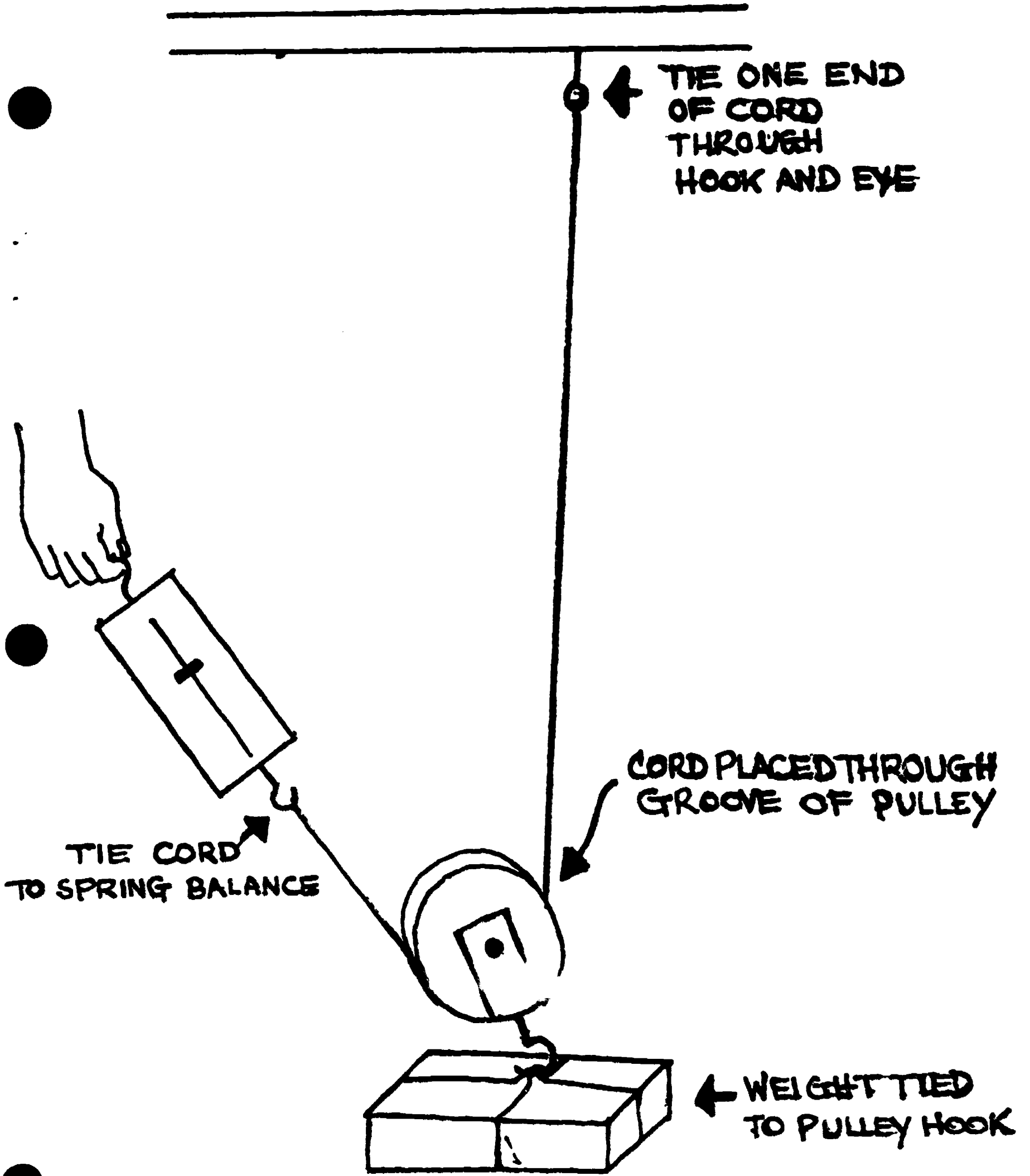

130

SINGLE MOVABLE PULLEY

INTERMEDIATE LESSON

INVESTIGATING BOUNCING OBJECTS

COMPETENCIES

A. Processes

1. Observing
3. Inferring
4. Predicting
5. Measuring
6. Communicating
9. Formulating Hypotheses
10. Experimenting
11. Recognizing Variables
12. Interpreting Data

C. Physical Science

2. A. Basic Characteristics of Energy
2. G. Force and Machines

E. Attitudes

1. Towards Classwork
3. Towards Personal Use of Science
4. Towards Oneself

LESSONS

Lesson 1 - Activity 1, Investigating Bouncing Objects. While various balls are displayed in front of the class, students will predict and record the order of bounce from highest to lowest.

Lesson 2 - ITV Video Module on Bouncing Objects. Forty-five minute presentation. See attachment.

Lesson 3 - Activity 2, Students measure and graph the bounce of a rubber ball when dropping it from various heights.

Lesson 4 - Activity 3, Students predict the bounce of a ping pong ball in relation to the rubber ball in Lesson 3. They then measure and graph the ping pong ball's bounce.

Lesson 5 - Activity 4, Using a super ball or golf ball, students predict, measure, and graph as they did in lessons 3 and 4. Hypotheses are also developed and tested.

Lesson 6 - Activity 5, Competency Measure, Students develop and investigate hypotheses about why some previously tested balls bounced better than others.

BOUNCING OBJECTS

INTERMEDIATE

"Investigating Bouncing Objects," ISEE Video Tape, I, 20 minutes: Viewers are exposed to a variety of kinds of balls and kinds of bouncing surfaces which are part of the world we live in. This program and the lesson which follows can be an important contribution to children's growth in the skills of making inferences, recording data, organizing data, and in using graphs purposefully. It also focuses on the skills of identifying and controlling variables.

"Think: Science and Hitting a Ball," Centron Films, I, J, 19½ minutes, color, 1976: Viewers investigate some of the principles involved in their favorite sports. Their research into tennis, golf, and baseball, leads them to discover about kinetic and potential energy, transfer of energy, center of mass, momentum, and elasticity. Intriguing questions posed at the end of the film challenge students to explore these science principles on their own.

OTHER

"Swish - Science and Curveballs and Gliders," CEC-Centron Educational Films, I, J. 20 minutes, color, 1976: What effect does the fluid called air have on a ball plowing through it? How to air currents flowing around an airplane wing help lift the plane into the air? If a ball spins, won't it change direction? These are some of the questions Professor Higgenbottom asks his viewers. Their investigations carry them into the concept of air pressure, lift, airfoil, design, and Bernoulli's Principle.

INVESTIGATING BOUNCING OBJECTS

Television Introduction

Teacher Orientation

This introduction is designed to provide a rich readiness framework for the lesson which you will conduct following it.

Viewers are exposed to a variety of kinds of balls and kinds of bouncing surfaces which are part of the world they live in. They are asked to make inferences about the differences in how well the different balls they have viewed in action bounce. They then discuss their reasons for their inferences (predictions).

The viewers are then involved in discussion of how one might experiment to seek evidence to support or reject their predictions. They are asked to identify some of the variables which are involved in bouncing.

The children in the program begin to experiment and record their data. The narrator suggests that they use a graph as a way to organize some of their data.

As a line graph is developed, it begins to reveal patterns and trends which suggest further investigations. Thus, the viewers are presented with a purposeful use of the skill of graphing as a way of organizing interpreting data and as a way of stimulating new questions for investigation.

There are seven places during the program where the narration stimulates class response. For one of these, the children are told to write down predictions as they observe. Children should be prepared with paper and pencil before the program starts.

This program and the lesson which follows can be an important contribution to children's growth in skills of recording data, organizing data and in using graphs purposefully. It also focuses on the skills of identifying and controlling variables.

In this program we have provided somewhat longer periods, in response to some of our teacher feedback. We'll be interested in further reactions.

INVESTIGATING BOUNCING OBJECTS

Discussion Period and Time	TV Image	Final Broadcast Statement	Suggested Statements or Questions	Teaching Strategy
1 2½ min.	Assorted shots of balls bouncing	Let's watch them all in action. See if you can decide which one bounces the best.	Think about what you observe and your own experience with balls.	Ideas Materials Ideas
2 2½ min.	Selected shots of bouncing balls seen before	How many variables can you identify?	Since we really don't know, we can only infer. What evidence did each of you use?	Ans. Evidence
3 30 sec.	Set of balls used in earlier action sequences	Write down your predicted order from best bouncer to poorest bouncer.	What differences can you identify. Keep watching. See if you can detect other variables.	Process Variables Observation
4 45 sec.	Tags on board	What suggestions can you make to help find out which ball is the better bouncer?	No discussion.	Process Predict
5 45 sec.	Chart	Have we overlooked any variables?	What might they do to experiment?	Wait Time

6 45 sec.	Chart	Can you figure out which ball was <u>consistently</u> the better councer?	What else might they have done to make this a better experiment?	4 Wait Time
7 45 sec.	Graph of bounce	Can you spot any other patterns or inconsistencies?	What questions about bouncing objects do you have? Can you think of bouncing objects in your own experience that might suggest an investigation?	5 Process Observation

136

137

Title: Investigating Bouncing Objects

Level: Intermediate

Aims: Toward Which This Lesson Contributes

1. The student will formulate and ask questions of his environment. He will use questions to describe, clarify and analyze problems.
2. The student will demonstrate competency in the use of the processes of science by (a) observing, (b) measuring, (c) recording data, (d) formulating hypotheses and (e) solving problems.

Instructional Objectives: At the conclusion of this lesson, the students will be able to:

1. Develop and make quantitative records of ball bounce.
2. Order objects in terms of ball bounce.
3. Design an investigation to test a self-made hypothesis.

Background Information:

This lesson is designed to give children experience in measuring, graphing, and interpreting data. From data they collect, students make inferences and set up investigations to test the inferences.

The bounce of the ball is affected by many factors such as the material of which it is made, its construction, the type of surface on which it is dropped, the weight of a ball versus its size, the height from which it is dropped, air resistance, etc.

Depending on the group, the teacher may provide structure and direction ranging from complete directions to open-ended problem solving.

This lesson can be handled as an open-ended, problem solving one, as a carefully structured investigation, or any degree between these extremes. The teacher can make this decision on the basis of the nature of the group.

Total Equipment List for Each Group of Four:

1. Meter stick.
2. Various balls: sponge rubber ball, ping pong ball, super ball, golf ball, tennis ball, marble, steel ball bearing spherical cork bobber, silly putty, etc.
3. Masking tape and paper (3 ft. lengths).

Activities: Each activity will take from 15 minutes to half an hour.

Activity 1 - Readiness Survey

Materials needed:

Balls which are displayed in front of the class. Students do not touch the balls during this activity.

After the balls have been displayed to the class, ask the students

1. Which ball will bounce the best?
2. How can we tell if our prediction was correct?

Then divide the class into groups of four. Have each group predict and record the order of bounce for the balls displayed, from highest to lowest bounce.

Activity 1 - (Setting the standard for comparison)

Materials needed for each group of four:

Meter stick
Sponge rubber ball
Paper to put on wall
Masking tape
Graph Paper and a marker to write with.

Using the hall or some space where groups can spread out, tape the paper to the wall (to protect the wall and record marks). Let the group drop the ball from increasing heights (up to two meters) and measure the bounce. Groups will need to decide how to measure the bounce, the number of times to drop the ball and each height, how to record the results on a graph and how to develop a standardized procedure to reduce error. It is suggested that the graph be set up to record 10 centimeter intervals, although children may be satisfied to drop the ball from 50 centimeter intervals.

It is important to use the same number of squares for each interval of drop and bounce so that the graph has a one to one scale. Have children mark "X" at the proper point for each measure and then connect the points for a line graph as in the diagram. This will be the basis for comparisons in the following activities.

Children may have difficulties in measuring the bounce from less than a 50 centimeter drop as this requires a low stance to observe and the need to keep one's eyes level with the top of the bounce. A chair may be required for reaching a point for a two-meter drop.

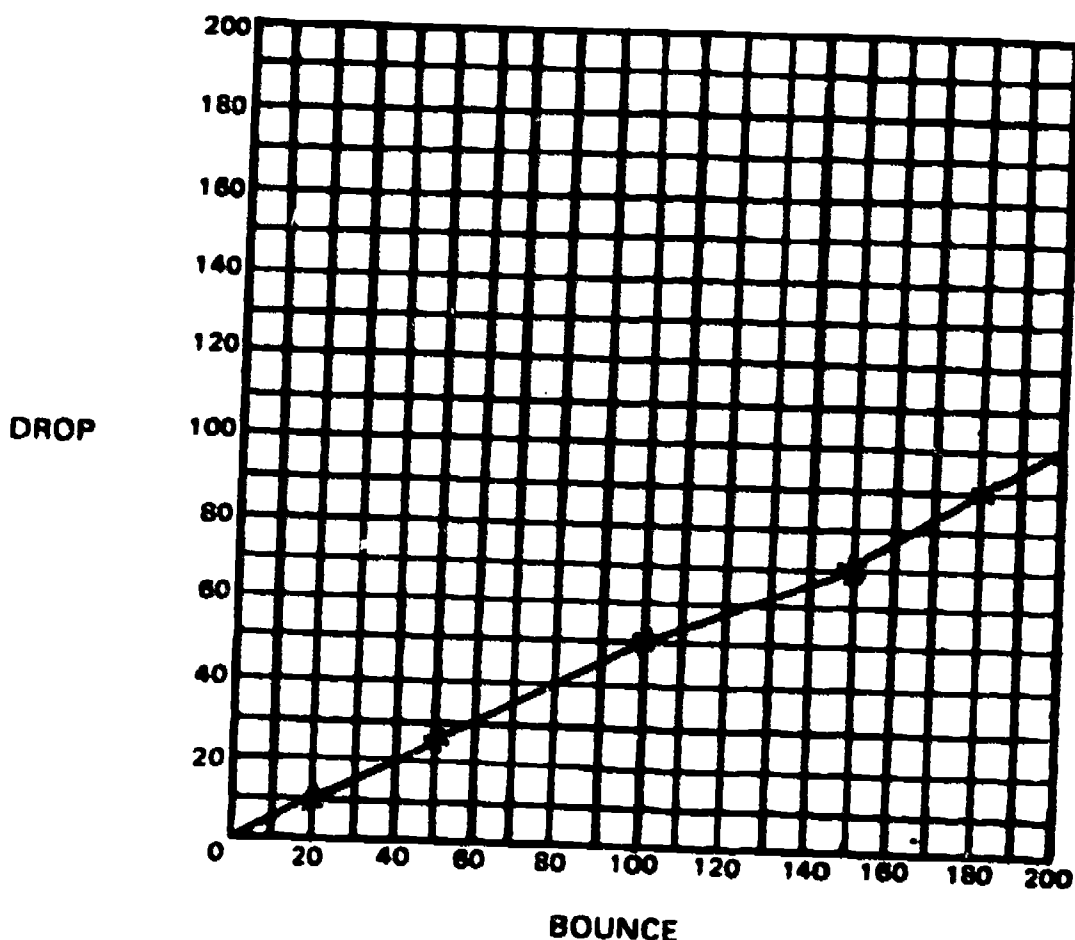

Activity 3:

Materials needed for each group of four:

Same as Activity 1 plus a ping pong ball

Before having groups measure the bounce of a ping pong ball, have them predict its bounce in relation to the sponge rubber ball. Students then measure the bounce of the ping pong ball as they did the sponge ball in Activity 2. Have the students add this data to the first line graph. From a comparison of the two lines on the graph, ask students to explain any difference of behavior. (Note, ping pong balls begin to react to air resistance around 1 meter of drop.)

Activity 4:

Materials needed for each group of four students:

Same as Activity 1 plus a super ball or golf ball.
(Super preferred)

Again, have pupils make predictions before testing one ball. Then measure the bounce of the super ball. Students record the results on the first graph and interpret their findings. Let them set up a hypothesis for the differences in behavior and, if possible, design a way to check the hypothesis.

Activity 5 - (Competency measure)

Materials needed:

Additional bouncing objects such as baseball, volley ball and air pump, marble, steel ball bearing, spherical cork bobber, silly putty, etc.

Have groups summarize their previous investigations and compare their graphs with other groups. Let each group develop some idea to explain why some balls bounce better than others. Encourage students to design and carry out an investigation to test their hypothesis.

Have groups summarize previous investigations and compare their graphs with other groups. There may also be questions about other observations. Let each group develop some idea to explain the difference in ball bounce in which they are interested. Have them design and carry out an investigation to test their hypothesis.

Examples of ideas that have arisen in groups are:

- 1. Effect of floor on bounce - try on wood, linoleum, cement, tile, rug, etc.**
- 2. Effect of material of ball - use steel ball bearing, spherical cork bobber, marble, etc.**
- 3. Effect of size - use balls of same material but different size.**
- 4. Hollow balls versus solid balls.**
- 5. Pressure inside ball - use volley ball and air pump to increase pressure (within safe limits).**

INTERMEDIATE LESSON

INVESTIGATING ELECTRICITY

COMPETENCIES

- A. Processes
 - 1. Observing
 - 2. Classifying
 - 3. Inferring
 - 4. Predicting
 - 6. Communicating
 - 9. Formulating Hypotheses
 - 10. Experimenting

- C. Physical Science
 - 2. B. Electricity

- E. Attitudes
 - 1. Toward Classwork
 - 3. Toward Personal Use of Science
 - 4. Toward Oneself

LESSONS

Lesson 1 - Activity I, Students experiment with static electricity by attracting a suspended plastic spoon to a charged plastic fork.

Lesson 2 - Activity II, Students observe that a stream of water can be bent when attracted to charged objects.

Lesson 3 - ITV Video Module on Electricity. Forty-five minute presentation. See attachment.

Lesson 4 - Activity III, Investigating Static Electricity, Students use charged objects to separate salt and pepper.

Lesson 5 - Activity IV, Students investigate various objects to determine which materials are attracted by a static charge.

ELECTRICITY

INTERMEDIATE

"Electricity All About Us," 2nd edition Cort, P, I, 13 minutes, color, 1975:
How do we make electricity work for us? In simple terms, the film describes the role of circuit breakers and fuses, explains the difference between current and static electricity, and shows how electrons are responsible for electrical activity.

"Electricity Into Light," AIT, (Why? Series), P, I, 14 minutes, color, 1976:
(Video Cassette)

"Electricity Into Heat," AIT (Why? Series), P, I, 15 minutes, color, 1976:
(Video Cassette)

OTHER

"Electricity for Beginners," Cort, I, 10 minutes, color 1963: Demonstrates how electricity is used to produce heat, light, and motion. Uses simple experiments that may be made from inexpensive materials. Points out that a complete circuit is necessary in order to make electricity flow. Explains that only a small amount of electricity is safe to handle and cautions pupils not to use home electricity for experiments.

"Electricity - The Energy of Electrons," Barr, P, I, 16 minutes, color, 1978:
Electricity is one of the most important things in our lives, and we use it in many ways. The potential for electricity is in every atom, for it is caused by the presence or movement of electrons. Whenever the balance of protons and electrons in an atom are upset, the atom will try to re-establish equilibrium and this activity is the source of electricity.

"Electricity Into Motion," AIT (Why? Series), P, I, 15 minutes, color, 1976:
(Video Cassette)

Title: Investigating Static Electricity (Roy W. Allison)

Level: Intermediate

Aims: From SCIENCE UNLIMITED Toward Which This Lesson Contributes

1. The student will formulate and ask questions of the environment. The student will use questions to describe, clarify, analyze problems and to provide direction for problem solving.
2. The student will solve problems by gathering information, working independently, using equipment and materials, observing purposefully and drawing appropriate conclusions based on these findings.
3. The student will explain basic conceptual schemes of the material world using personal experiences acquired through various activities as the basis for his explanation.
4. The student will demonstrate competency in the use of the processes of science by: (a) observing, (b) classifying, (c) communicating, (d) inferring, (e) experimenting.

Instructional Objectives - At the conclusion of this lesson, the students will be able to:

1. Produce a static charge.
2. Demonstrate how static charges are produced.
3. Recognize attraction between two charged objects or between a charged object and an uncharged object.
4. State the different types of static charges possible.
5. Demonstrate that like charges repel.
6. Demonstrate that unlike charges attract.
7. Classify objects by the charge they will take when rubbed.
8. Predict what two objects will attract.
9. Predict what two objects will repel.

BACKGROUND INFORMATION

Friction produces static electricity. All matter is made up of atoms which in turn are made up of electrons, protons, and neutrons. The protons and neutrons are contained in the nucleus of an atom and are tightly held by the substance. The electrons are orbiting about this nucleus and can in some instances be removed from some substances which do not hold electrons securely. Static electricity is produced when two objects being rubbed as electrons are removed from one object (leaving it positively charged) and these electrons flow to the other object (making it negatively charged).

You may begin the lesson by giving the students the following basic information.

1. When you rub a plastic or hard rubber comb with a woolen cloth the comb becomes negatively charged while the woolen cloth becomes positively charged.
2. When you rub a glass rod with a silk cloth the glass becomes positively charged while the silk takes on a negative charge.
3. Like charges repel each other.
4. Unlike charges attract each other.

Of the four enumerated facts above, it would be essential to tell them number 1 and 2. Facts 3 and 4 could be discovered in Activity 1 and Activity 2 of this lesson and it is suggested that the students be permitted to make these discoveries.

The Winter season is the most appropriate time of the year to insure successful experiences. Very low humidity is needed. So on a cold day outside when the snow crunches underfoot, you could be assured that bringing this cold air indoors and heating it will produce the low humidity you need for static electricity experiments to succeed.

It is during conditions just described that we can feel and see the results of a static charge being generated. If we slide our feet across the nap of a new or high fiber rug then reach for a light switch or doorknob you can feel the charge jump from you to the switch. If this is done at night, it would even be possible to see the charge jump. Another opportunity to feel and see a static charge be discharged would be to slide across the plastic seat covers of a car in the wool coat (when the car is warm or dry after a long drive) and then reach for the door handle. You will both see and hear this at night.

Objects which have like static charges repel each other. Objects which have unlike static charges will attract each other. A neutral or unchanged object could be attracted by a charged object. As the testing for attraction or repulsion is carried out, you should bring the two objects being tested together slowly so any action can be seen. If it is possible to safely attach two strings to the ceiling, the objects to be tested could be attached to the strings and thus it would be possible to observe if the strings were closer together near the objects (attraction) or further apart near the objects (repulsion).

The activities in this lesson should be used so that children are given an opportunity to experiment and explore with the materials. Do not give solutions before the students have had a chance to experiment.

Total Equipment List (for class of 30 pupils)

- 30 plastic spoons
- 15 pieces of wool (at least 8" x 8")
- 15 pieces of silk or nylon (at least 8" x 8")
- 15 plastic forks
- 15 plastic bags
- 15 pencils
- 15 sheets unglazed pencil tablet
- 15 rubber combs
- 1 roll masking tape
- 15 thin cotton strings (15 inch lengths)
- 1 spirit duplicator can (1 gallon)
- 1 small nail and hammer to punch hole in can near bottom
- 1 balloon
- salt
- pepper
- styrofoam peanut bits
- unglazed paper bits
- thread bits
- puffed rice

Activity I

Materials needed - 15 plastic spoons
15 pieces of wool
30 masking tape (1" strips)
15 thin cotton strings
15 plastic forks
Break class into groups of two
15 pieces of silk or nylon

Have class members distribute materials.

Have each group attach one end of the string to one of the plastic spoons with the masking tape so that the spoon balances in a horizontal position. Tape the other end of the string to the side of a student's desk so that the spoon hangs down and is free to turn.

Approach the handle of the hanging spoon with the fork handle. Make this approach slowly being careful not to have the handles touch. Ask the students "What did you observe as you approached the spoon that is suspended?" If the response is that nothing happened, this is an appropriate response because we have not as yet created any static electricity.

At this time have the students rub the fork handle with the wool cloth and again approach the suspended spoon without touching it and ask "What do you observe as you approach the spoon that is suspended? The response should be that the fork handle attracts the spoon handle.

Now have the students rub the suspended spoon handle and the fork handle with the woolen cloth and again have them approach the suspended spoon handle with the fork handle and ask "What do you observe as you approach the spoon that is suspended?" The response should be that they repel each other.

You may continue experimenting and recording the results in a chart similar to Chart 1 on page 6. The students will no doubt want to try many things. They should keep in mind that if two things attract they could be either (1) both charged with one positively charged and one negatively charged or (2) one not charged (neutral) and the other charged either positively or negatively. When the two objects repel it means both are charged the same which could be either (1) both charged negatively or (2) both charged positively.

This activity could make a good learning center. Thus students would have an opportunity to continue testing materials after the lesson has moved on to other activities.

Activity II - Bending a stream of water.

Materials needed - same list as used in Activity I

If you can create a small thin stream of water from your faucet at the classroom sink you can do this one easily. Otherwise the students will need to make a small stream of water possible by making a small nail hole at the bottom of a gallon can. Fill the can with water and approach the resulting stream of water from the side with objects charged with static electricity.

Chart 1

SPOON RUBBED WITH

Fork rubbed with:	Nothing	Wool	Silk or Nylon	Plastic
Nothing				
Silk or Nylon				
Plastic				

The stronger the charge the greater the deflection of the stream. Ask the class to determine "Is the stream always bent the same way regardless of the charge or material used?".

Activity III

Materials needed - 15 salt and pepper mixtures
15 woolen cloths
15 plastic spoons

Challenge the students to separate the salt and pepper mixture without touching the mixture with their fingers. The pepper will be attracted to a charged object over a greater distance than the salt. If the salt is picked up it will drop off the spoon handle more easily than the pepper when you tap the spoon.

Activity IV

Materials needed - styrofoam peanut bits
unglazed paper bits
thread bits
puffed rice
15 plastic spoons
15 woolen cloths

Ask the students to determine what materials are attracted by a static charge. Have the students investigate the materials provided. Challenge them to investigate other materials in the classroom or at home and bring in samples of materials they find at home.

INTERMEDIATE LESSON

INVESTIGATING ENERGY

COMPETENCIES

A. Processes

1. Observing
2. Classifying
3. Inferring
4. Predicting
5. Measuring
6. Communicating
8. Defining Operationally
9. Formulating Hypotheses
10. Experimenting
11. Recognizing Variables

C. Physical Science

2. A. Basic Characteristics of Energy
2. G. Force and Machines

E. Attitudes

1. Toward Classwork
2. Toward Personal Use of Science
4. Toward Oneself

LESSONS

Lesson 1 - Activity 1 - Readiness Activity, (Force, Motion, and Rest), Energy Activity, p I-52, (Altoona Lessons, See attached): Students perform simple experiments involving a cup, playing cards, and a penny, to recognize the elements of force, motion, and rest.

Lesson 2 - ITV Video Module on Investigating Energy. Forty-five minute presentation. See attachment.

Lesson 3 - Activity 2, Students examine the relationship between force and inertia of a given object, in this case, whiffle balls.

Lesson 4 - Activity 3, This activity is designed to verify whether a heavier or lighter object will move further (has more energy). Students experiment by weighing marbles, making predictions, then placing them on an inclined plane.

Lesson 5 - Activity 4, This activity is designed to measure the effect of various surfaces on the motion of an object, in this case, whiffle balls. Students place various surface materials on an inclined plane and measure how far the whiffle ball rolls.

Lesson 6 - Competency Measure, Students are given objects and materials that have not been tested. Students write an operational question, predict their results, test their inference, and record their results.

ENERGY

INTERMEDIATE

"The Energy Carol," NFBC, I, J, 11 minutes, color, 1975: This animated parody takes a not-so-subtle poke at the way we live, the way we consume, and what the future might hold. Ebenezer Scrooge, now president of Zues power company, adopts the motto, "To waste is to grow," and in his generous list of Christmas gifts, he includes an electric mirror and a digital toilet paper dispenser. "Bah Humbug" to the energy crisis scorns Ebenezer, until that fateful night when he is visited by the ghost of his former partner and the spirits of energy past, present, and future. The ultimate folly of unbridled energy consumption is revealed; and Ebenezer decides to give practical gifts such as warm coats, blankets, and 9 watt light bulbs.

"Energy," AIT, I, 20 minutes, color, 1980: New Yorkers stories of the great blackout reveal vividly how much we depend on energy. Viewers see its sources, transmission, and economic and environmental costs, as well as some energy options for the future, including conservation.

"Energy - A Family Album," NAVC, All levels, 9 minutes, color, 1977: Presents a history of energy in America. Details the nation's plan to keep ahead of energy demands. Also discusses alternate sources of energy such as geothermal and solar.

OTHER

"Energy," OXF, P, I, 9 minutes, color, 1974: Illustrates the degree to which our modern lifestyle is dependent on energy from natural resources, and explores the spectrum of energy sources from human and animal energy to nuclear power. Practical uses of energy introduce the theme of conservation. Plans for expanded development of nuclear, geothermal, and solar energy are discussed. (IU).

"Energy: A National Issue," AIMS, I, J, 27 minutes, color, 1977: The problem of a decreasing energy supply is presented. Conveys a great deal of information as it follows the Flintstones through history. Includes the history of energy sources, the problem of energy loss in converting heat energy to electricity, and our country's increasing demand for, and dependence on imported oil.

"Energy: Can't Do Without It," MCGH, I, J, 14 minutes, color, 1974: Relates energy to machines and work they do, and our society's utter dependence on machines like the automobile. The film examines our present need for fossil fuels, coal and oil, and the advantages and disadvantages of these fuels. Also how oil is tied into the world political situation, such as the Mideast and Trans-Alaska pipeline. The film points out the need to find new sources of energy, to design more efficient energy-producing and energy-consuming systems.

"About Energy," AIT, 15 minutes, color, 1973: Studies the origins and physical characteristics of energy.

Activity 1 - Readiness Activity (Force, Motion, and Rest) Energy

Materials needed for each group:

Cup
Playing Cards
Penny

This activity is designed to give pupils a chance to recognize the elements of force, motion, and rest. The students will conduct two simple experiments designed for such a purpose.

In the first activity the students will use all three materials and record their results. The students will place a playing card over the cup. After placing the penny on the card, the students will flick the card with their finger.

(Give it a quick snapping blow). What happens to the penny?

The second activity uses the cup and the penny. The students will place the penny in the cup (which will be held in a horizontal position). They will point the open end of the glass forward. With the penny remaining near the bottom of the glass, walk as fast as you can and stop suddenly. What happens to the glass? the penny?

Activity 2 - Force Related to Inertia

Materials needed for each group:

Cardboard (4 ft. x 2 ft.) 4 or 5)
Meter sticks (4 or 5)
Blocks (20)
Wiffle balls (4 or 5)

The objective of this activity is to examine the relationship between force and the inertia of a given object, in this case wiffle balls. The activity requires a small inclined plane.

Ask students to mark off 5 or 10 centimeter spaces on the cardboard inclined plane. Blocks of different sizes may be placed underneath to make various tilts and a table made to record results.

The students will then try various combinations of tilts and starting positions for the ball on the cardboard markings. The student will then measure the distance each ball travels using a meter stick. Record results.

Possible Operational Questions:

1. Would longer cardboard make the ball roll farther?
2. Would different balls affect the distance?
3. Would different surfaces affect the distance?

Activity 3 - Mass (Weight) Related to Energy (Motion)

Materials needed for each group:

Cardboard (4 ft. x 2 ft.) for inclined plane
Balance (grams) for weighing
Various size marbles
Blocks

This activity is designed to verify whether a heavier or lighter object will move farther (has more energy). The students will weigh various sizes of marbles and then test the roll of each marble. Before the roll they should predict the order of the marbles and what they think their roll will be. The marbles should be placed on the inclined plane with no push from the child.

Activity 4 - Friction Related to Energy (Motion)

Materials needed for each group:

Various surfaces (construction paper, styrofoam, wood floor, linoleum floor, rug)
Cardboard (4 ft. x 2 ft.) for inclined plane
Blocks (for tilt)
Wiffle balls

This activity is designed to measure the effect of various surfaces on the motion of an object, in this case wiffle balls. Set incline tilt, place one surface on the cardboard and measure the distance the wiffle ball rolls. Continue same procedure with other surfaces.

Competency Measure

Materials needed:

Inclined plane (ramp)
Meter sticks
Blocks
Various surfaces
Various objects that can roll

In this activity the teacher should give each group of students various surface materials and objects that have not been tested. Students should then write an operational question, predict their expected results, test their inference, and record the results on their own table.

Children's Supplementary Books

1. Hellman, Hal. Energy and Inertia. New York, N.Y., M. Evans and Company, Inc., 1970.
2. Lefkowitz, R.J. Push! Pull! Stop! Go! A book about forces and motion. Parents Magazine Press, 1942.

3. Simon, Seymour. Motion. New York, N.Y. Coward - McCann Inc., 1968.

Title: Investigating Insulators (William C. Killian)

Level: Intermediate

Aims: From ISEE Toward Which This Lesson Contributes

1. The students will work in small groups, observing and drawing conclusions from the findings they arrived at by using the appropriate equipment and materials.
2. The students will demonstrate competency in the use of the process in science by: (a) observing, (b) communicating, (c) inferring, (d) formulating hypotheses, (e) interpreting data, (f) controlling variables, and (g) experimenting.
3. The students will defend their points of view by using any supportive evidence that they may have.

Instructional Objectives: At the conclusion of this lesson, the students will:

1. State at least one characteristic that seems to be common to most conductors.
2. State at least five different materials that can be used as insulators.
3. State at least five different conductors of electricity.
4. State the purpose of insulating material around electrical wiring.
5. State at least two different situations where insulation can be employed other than around electrical wiring.

Background Information:

This lesson is designed to encourage students to see that the concept of insulation not only relates to electricity, but also to other fields.

By utilizing the concept of insulation in this lesson, the students will be able to associate its effect on conductors in the following ways:

1. The concept of insulation applied to thermos bottles.
2. The necessity of insulating homes in the face of the current energy crisis.
3. The importance of insulation as it relates to different metals which conduct electricity.

It is suggested that prior to this lesson, the students might be involved in Investigating Heat Loss. After experiencing this lesson, the students will have a previous experience with which they can associate the concept of insulation.

INTERMEDIATE LESSON

INVESTIGATING HEAT LOSS

COMPETENCIES

A. Processes

1. Observing
2. Classifying
4. Predicting
5. Measuring
6. Communicating
8. Defining Operationally
10. Experimenting
11. Recognizing Variables
12. Interpreting Data
13. Formulating Models

B. Biological Science

4. Animals
5. Human Biology
6. Ecology

C. Physical Science

1. A. Form State of Matter
1. B. Water
1. D. Atoms and Molecules
2. A. Basic Characteristics of Energy
2. F. Heat

E. Attitudes

1. Towards Classwork
3. Towards Personal Use of Science
4. Towards Oneself
5. Towards Science and Society

LESSONS

Lesson 1 - Activity I, Readiness, Investigating Heat Loss. Children will practice reading thermometers and plotting data on a line graph in preparation for investigation.

Lesson 2 - ITV Video Lesson Module on Investigating Heat Loss. Forty-five minute presentation. See attachment.

Lesson 3 - Activity 2, Students measure heat loss over time of a sample of hot water, then graph and interpret the results.

Lesson 4 - Activity 3, Students design and conduct an experiment to test different materials of their choice for their insulative quality.

Lesson 5 - Activity 4, Students compare and interpret the data collected in lesson 4 by the class for different insulators.

Lesson 6 - Activity 5, Each student will be challenged to select one material not tested to be more insulative than air, and one less insulative than air, then test their choices.

HEAT LOSS

INTERMEDIATE

"Investigating Heat Loss," ISEE Tape, p. 127, ITV Handbook for Teachers, 20 minutes: Following a view and discussion of a number of ways in which energy is used, a diagram of a house and a home heating system are shown to illustrate heat loss in a home and ways in which insulation can cut down on this loss of heat. The students work with charts and graphs during the last 10 minutes of the television program.

"Learning About Heat," E.B., color, 15 minutes: Through laboratory demonstrations interwoven with animated episodes, this film discusses the molecular basis of heat, friction, change of state in gases, solids, and liquids, the movement of heat through radiation, convection, and conduction. The film discusses the energy dilemma, focusing on the decreasing amount of fossil fuels.

"Heat and How We Use It," E.B., color, 11 minutes: Provides basic understanding about heat, ways in which it travels and its many uses in every day living. Explains how heat is reflected or absorbed by various materials, how heat expands things such as metals, liquids, and air.

INVESTIGATING HEAT LOSS

Television Introduction

Teacher Orientation

This introduction is designed to provide a transition into the "science activities" which you will conduct following it. You will probably want to spread the ISEE lesson activities over several days. Emphasis in this television presentation will be placed upon introducing basic concepts and techniques leading to student instructional objectives as well as techniques that you may use to promote these desired objectives.

Following a view and discussion of a number of ways in which energy is used, a diagram of a house and a home heating system are shown to illustrate heat loss in a home and ways in which insulation can cut down on this loss of heat. Several opportunities are provided for observation and discussion of what is shown on the television screen.

The following page contains charts and graphs which students fill out during the last 10 minutes of the television program. It is important that copies of the following page be made and distributed to members of the class before viewing the television program. If thermal duplication facilities are available, copies can be made inexpensively in that way. It is suggested that you may also wish to put these charts and graphs on a chalkboard, large chart, or overhead transparency for the entire class to see as you fill them out and work with them.

You will notice that the page following the empty chart and graphs provides approximate entries from the television program for your reference. It should be emphasized that if your students get slightly different readings from the thermometers shown on the screen, their judgments should be accepted and respected. In fact, they may be more accurate!

As always, the activities of the television program will provide useful background experiences for the lesson that follows.

INVESTIGATING HEAT LOSS

Charts and Graphs for Recording Data

Time	Temp.	Temp. Change	Time	Temp.	Temp. Change.
0			0		
2			2		
4			4		
6			6		

10°
8°
6°
4°
2°
0

2 4 6
Time
Can A

10°
8°
6°
4°
2°
0

2 4 6
Time
Can B

Thermal duplicate for classroom use during television program.

INVESTIGATING HEAT LOSS

Approximate Data from Televised Experiment
(Teacher Information)

Time	Temp.	Temp. Change	Time	Temp.	Temp. Change.
0	120°	0	0	120°	0
2	118°	2°	2	117°	3°
4	117°	3°	4	115°	5°
6	115°	5°	6	112°	8°

Can A

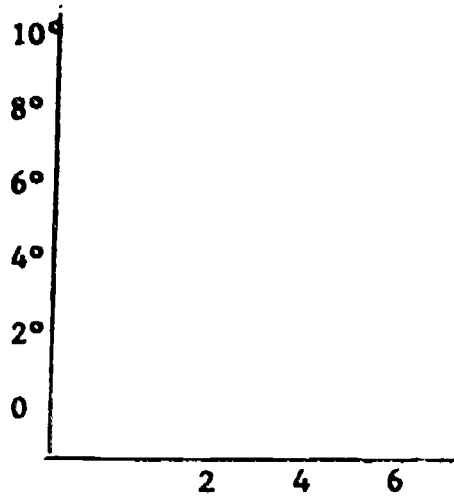

Time
Can A

Can B

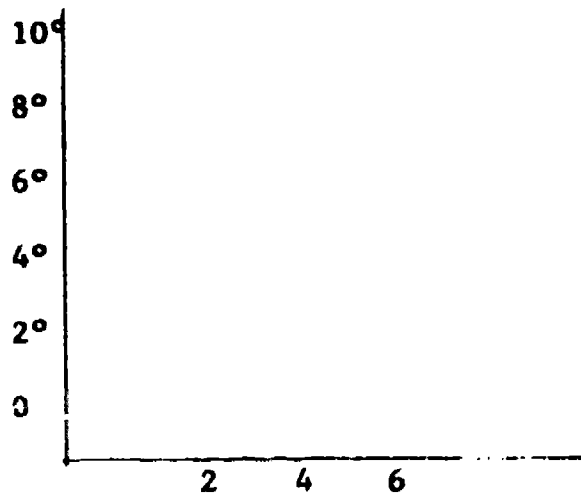

Time
Can B

161

INVESTIGATING HEAT LOSS (20 min. - color)

Discussion Period and Time	TV Image	Final Broadcast Statement	Suggested Statements or Questions	Teaching Strategy
1 1 min.	Scenes of examples of energy use	Watch closely and discuss the ways you see energy being used.	How is energy being used in each one of these examples?	2 Ans Evidence
2 1 min.	Diagram of home and heating system	This diagram will help us to see how this home heating system works. What do you see happening?	Describe everything that you see happening.	3 Approval
3 30 sec.	Diagram of a home and heating system	Let's take another look at the home heating system now and discuss what you see happening.	What do you see happening?	5 Process Observing Communicating
4 15 sec.	Diagram of a home and heating system	Where else could we insulate to reduce heat loss?	Where would you put insulation in the house to cut down on heat loss?	5 Process Predicting
5 10½ min.	Experiment being conducted	Watch every step of the experiment carefully. You won't want to miss any of the clues you need to understand the results of the experiment.	Watch carefully and record the data on your charts	5 Process Measuring

Title: Investigating Heat Loss

Level: Intermediate

Aims: From SCIENCE UNLIMITED Toward Which This Lesson Contributes

1. The student will solve problems by gathering information, using equipment and materials, observing purposefully and drawing appropriate conclusions based on these findings.
2. The student will demonstrate competency in the use of processes of science by (a) observing, (b) measuring, (c) inferring, (d) interpreting data, (e) controlling variables, and (f) experimenting.
3. The student will construct quantitative records that can be used as evidence for reaching tentative conclusions.
4. The student will explain conceptual schemes of the material world using personal experiences acquired through various activities as the basis of their explanation.

Instructional Objectives: At the conclusion of this lesson, the student will be able to:

1. Read thermometers.
2. Plot temperatures on a line graph.
3. Suggest at least one material that might change the rate of heat loss when surrounding a small can of heated water.
4. Identify and list variables that must be controlled to test inferences concerning heat loss.
5. Design at least one experiment to test the effectiveness of an insulating material.
6. Predict at least one material not tested that might be more insulating, and one that might be less insulating than dead, non-moving air, and conduct to test the prediction.

Background Information:

This lesson serves as a readiness activity for students embarking on a series of investigations concerning heat loss. In this case, the loss of heat is from warm water. Water heated to 50°C. (about 120°F.) is safe to handle and provides temperature changes which can be measured by an inexpensive thermometer. A thermometer with a metal or plastic base is preferred over a cardboard base thermometer.

Acquiring water at this temperature can best be done by placing the thermometer under the faucet as one slowly mixes hot and cold water until the temperature of approximately 50°C. is reached (a temperature high enough for noticeable heat loss in a short time). If you carry the warm water from home

or the school lavatory, an insulative container for liquids (such as a thermos) is suggested to retard heat loss before the students use the water for their investigation.

Some students will need to practice their skills of reading a thermometer and graphing. A large cardboard thermometer with a moveable red ribbon simulating alcohol (See ISEE primary grade lesson, "Investigating Thermometers") would be an aid in this activity. A model thermometer outlined on a transparency and shown on the overhead projector would be a helpful aid. If (Celsius) thermometers are available, students should use metric measurements in this investigation.

Below is a simple apparatus that could serve as an insulation box useable by small groups to compare the insulative qualities of many materials. The material to be tested, e.g., pencil shavings, are placed loosely in the space between the small soup can and the larger coffee can.

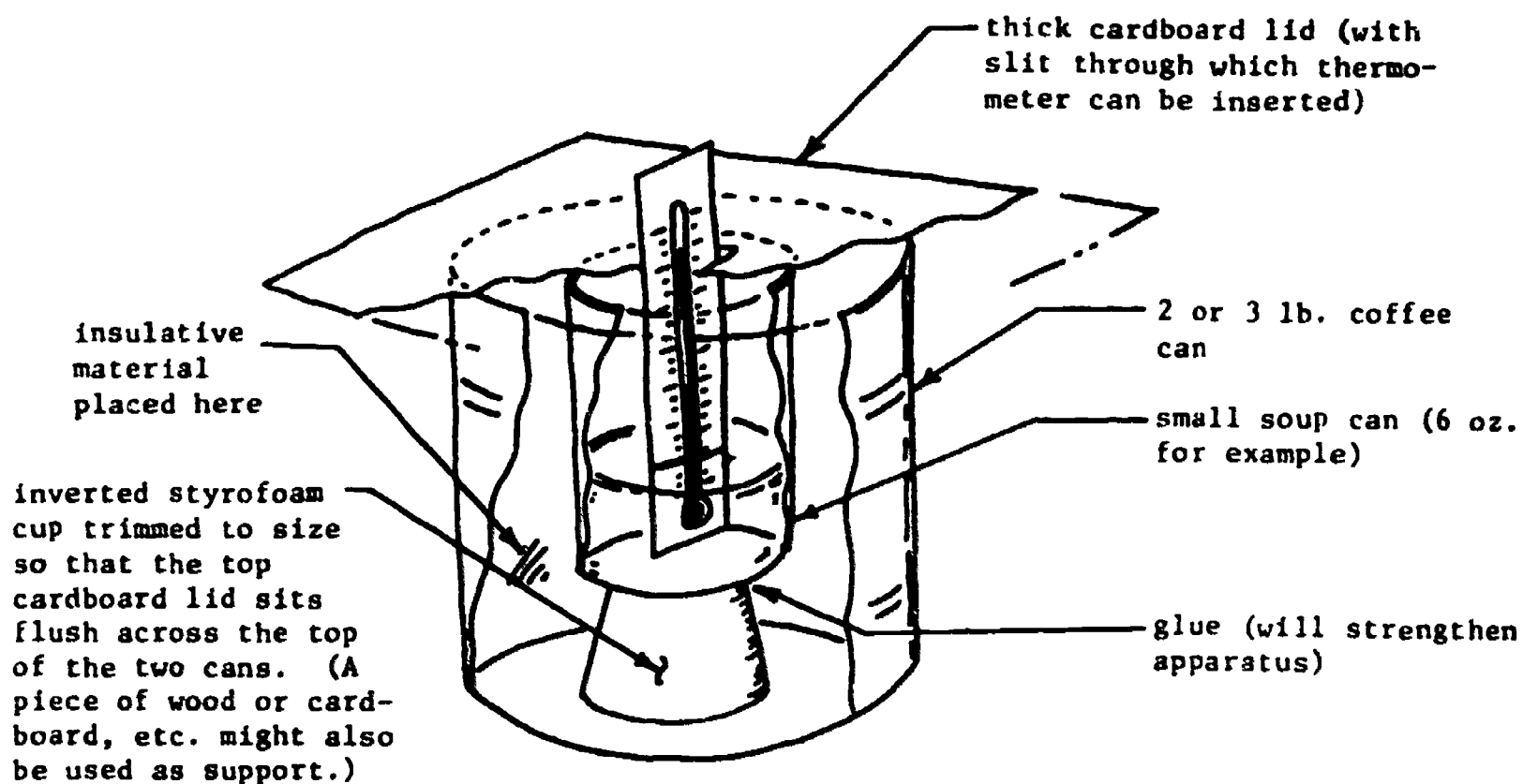

FIGURE 1

Equipment: Total equipment for class of 30

1. Six-two or three pound coffee cans, or cans of similar proportions for insulating containers.
2. Six small soup cans (6 oz. for example)
3. Six cardboard lids about 12 x 12 inches or plastic lids from coffee can
4. Six thermometers
5. One clock that everyone can view
6. Six graphing materials
7. Six straightedges
8. One thermos or other insulative liquid container
9. One measuring cup (metric-where possible)
10. Drawings of thermometers
11. Glue
12. Insulating materials: pencil shavings, styrofoam, gravel, steel wool, sawdust, and other materials suggested by the children.

Activity 1 - Readiness

- Equipment:**
1. Drawings of thermometers
 2. Graph paper

Reading the thermometer with a degree of accuracy is very important in this investigation, so some students should spend some time practicing this skill. The lesson also requires that students plot data on a line graph. A learning center where students work independently at plotting temperature readings on a graph from illustrated thermometers would be one means of accomplishing this goal. A large model thermometer could be used.

Activity 2:

- Equipment:**
1. One insulating box
 2. Water
 3. Graphing materials

Place 75 millilitres (about three ounces) of water at 50°C. (about 120°F.) in the soup can that is placed in the insulating apparatus (Figure 1). The water must be at a level high enough to cover the bulb of the thermometer.

When the thermometer readers are satisfied that the liquid in the thermometer has reached its highest point, the timekeeper begins to time the temperature drop, the student at the blackboard begins to tabulate data (as shown on the following page) and class members record the temperature at the proper intervals on their individual sheets of graph paper. Read the thermometer at two-minute intervals for 10 or 12 minutes and continue to record the information on the graph.

Hypothetical Chart

Time	Temperature	Temperature Difference
0	49°C. (119°F.)	0 (0)
2 minutes	47°C. (115°F.)	2 (4°)
4	46°C. (112°F.)	1 (7°)
6		
8		
10		
12		

Hypothetical Graph

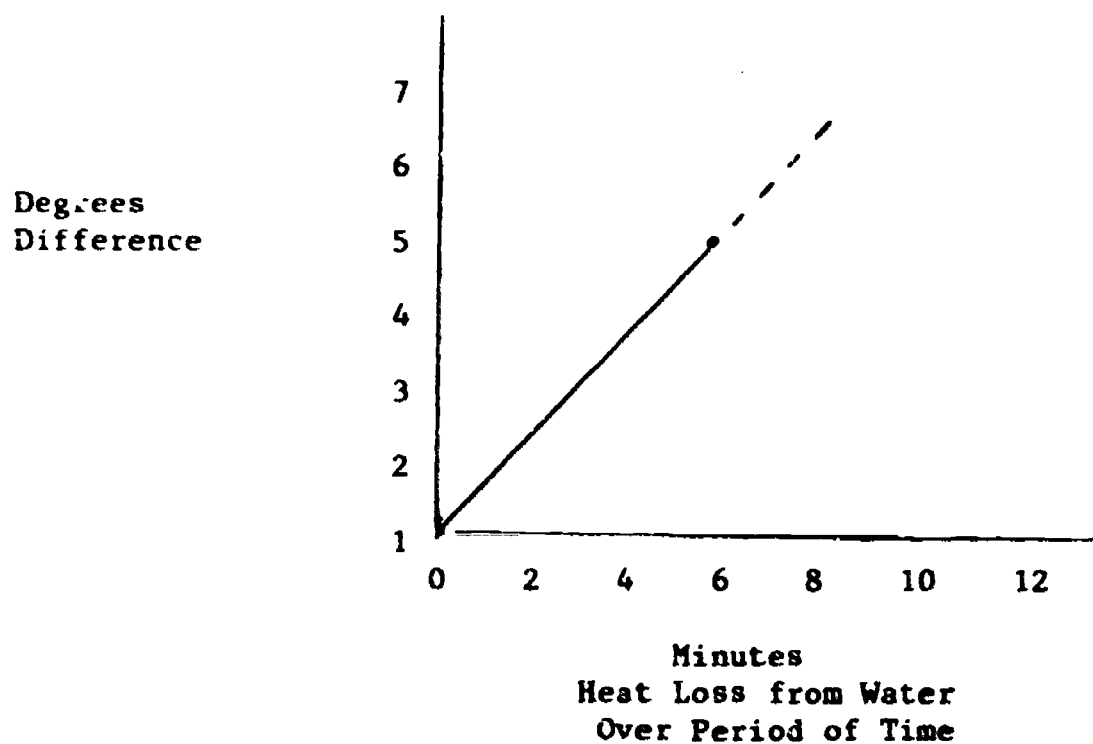

FIGURE 2

Using the information recorded on the graphs, assist students to interpret their data. There will probably be a rather constant slope of the line on the graph indicating that heat loss was rather constant during the time graphed. However, a one-degree drop during some two-minute intervals and a two-degree drop at others may be expected. Such deviations in data provide opportunities for students to offer a tentative explanation for the fluctuations, i.e., the rounding of numbers, reading errors and other factors contribute to such fluctuations.

After two or three readings have been plotted on the graph, ask the students to predict what the temperature is after ten minutes. It is important to remember that the prediction is just that: an estimate. A student's prediction could be somewhat in error, but his rationale for arriving at the predicted figure could be sound.

Activity 3:

Equipment: All materials in the total equipment list

Now that your class has some information on heat loss, assist them in designing an experiment where they test the effect various materials have on the loss of heat energy from the warm water.

If the question, "How might we slow down the loss of heat energy from the can?" brings little response, try, "How does your winter clothing compare to the clothing you wear in summer?"

Using such materials as air, pencil shavings, or gravel, as well as other materials suggested by the children, test their insulating quality in the insulative apparatus (See Fig. 1). The testing could be done as follows:

First, test the insulative quality of the air around the small soup can in the insulative apparatus. (1) Measure 75 millilitres (about 3 ounces) of 50°C. (120 F.) water in the soup can. (2) Place the lid on the insulation apparatus. (3) Push the thermometer through the slit in the lid and deep into the water. (4) At this point proceed as you did in Activity 2, read and record the temperature reading every two minutes once the temperature reading has reached its highest point. Record on chart as shown on the following page (Figure 3).

Next, test several more insulative materials, one at a time, following the same procedure as cited above, with one change. In the air space between the two cans in the insulation apparatus, place another insulative material, e.g., pencil shavings, and test the heat loss at each two-minute interval by reading the temperature.

	A	B	C	D	E
	air	gravel	cold water	shavings	
Minutes	0				
	2	1°C.(2°F.)	2°C.(4°F.)	3°C.(6°F.)	1°C.(2°F.)
	4				
	6				
	8				
	10				
	12				

FIGURE 3

Degrees Difference

During each test, children should be challenged to control the experiments by keeping the water temperature, water quantity, can size, thermometers, etc. the same. The only change from test to test should be the material placed around the inner soup can in the insulating apparatus.

Chairman	Sharon
Timekeeper	Jeff
Thermometer Readers	Sue and Mark
Recorder	John
Grapher	Jebbie

When each group has prepared its experiment with the insulation apparatus, the teacher should pour 75 millilitres (about 3 ounces) of water (preferably from a thermos where 50°C. (100°F.) water has been stored) into the small can. Each group should proceed to gather data as in Activity 2 and record it in a chart.

Activity 4:

Equipment: Chart from Activity 3

Some time will be needed to place the data from the five or six groups on the blackboard (or on a plastic sheet and shown on an overhead projector). The information on Figure 3 should be placed on a line graph so children can compare their findings.

Examining the data for younger children will probably not be as motivating as reading the thermometers and graphing. Older students might wish to spend much time arriving at some conclusions. Conclusions would include such observations as: "They must have read the thermometer incorrectly." or "We may need to test some materials again."

Activity 5:

Equipment: Insulation apparatus

Each student could be challenged to select one material in his environment (not tested in the experiments) which he believes to be more insulative than air and one that is less, test it, then support or reject his prediction.

INTERMEDIATE LESSON

INVESTIGATING ANIMALS

COMPETENCIES

A. Processes

1. Observing
3. Inferring
6. Communicating
8. Defining Operationally
10. Experimenting
12. Interpreting Data

B. Biological Science

1. Characteristics of Living Things
4. Animals

C. Attitudes

1. Toward Classwork
3. Toward Personal Use of Science

LESSONS

Lesson 1 - Activity 1, "Investigating Earthworms." As a group, children discuss what they know about earthworms. Questions they have may be recorded for later reference.

Lesson 2 - Video Module on "Investigating Earthworms." Forty-five minute presentation. See attachment.

Lesson 3 - Activity II, "Investigating Earthworms." Children prepare a box as a habitat for earthworms.

Lesson 4 - Activity III, "Investigating Earthworms." Children collect earthworms for their classroom. Emphasis is placed on the care of the earthworms.

Lesson 5 - Activity IV. Children investigate the effect of shining a flashlight on an earthworm. They keep a record of their observations and any questions they may have. These are then shared at the conclusion of the lesson, with students identifying which questions may be answered through further investigation.

Lesson 6 - Activity V and VI. Students choose a question about earthworms (from previous lesson) to investigate. The students are then to design their investigation, recording and reporting investigations. (Examples of questions might include "Are all parts of the earthworm sensitive to light?" "Is a worm more sensitive to brighter light?")

ANIMALS

INTERMEDIATE

"Arthropods," AIT, Discovering Series, I, 15 minutes, color, 1978

"Ants and Worms," AIT, Let Me See Series, P, 15 minutes, color, 1982: Pocus asks viewers whether earthworms are useful for animals or pets. Myrtle digs them for fishing, and Hocus learns that both ants and worms mix plant and soil material and help the soil hold air and water.

"Where Animals Live," AIT, P, I, 15 minutes, color, 1981: You can tell where many animals live simply by looking at them. Viewers see special adaptations of waders, swimmers, climbers, and plant eaters. Animals from cold places are contrasted with desert animals.

"How Animals Help Each Other," AIT, P, I, 15 minutes, color, 1981: Remora fish feed on shark parasites, and the sharks protect the remora. Prairie dog tunnels provide homes for other animals. Lions hunt in prides, bees share warmth, and ants carry the aphids that give them nectar.

"The Importance of Predators," AIT, P, I, 15 minutes, color, 1981: Predators are part of the natural cycle. The vulture is "nature's garbageman." Insect-eaters prey as efficiently as leopards and sharks. Starfish wait for their prey, but piranha fish attack in schools. Spiders keep the fly and mosquito population down.

OTHER

"Protective Coloration," AEBC, I, 12 minutes, color, 1983: This film explores the different ways animals use coloration in their endeavor to survive.

"Adaptation," AEBC, Many Worlds of Nature, I, 12 minutes, color, 1983: This film depicts the many methods which species use to adapt to their environments, especially the changing environment created by man, and the many worlds of nature.

"Animal Camouflage," CBS, BFA, I, J, 11 minutes, color, 1977: Illustrates how camouflage helps to insure the survival of many animal species. Discusses three forms of camouflage, protective coloring, protective resemblance and mimicry.

"Animal Behavior: A First Film," BFA, P, I, 11 minutes, color, 1973: Observes many kinds of behavior in animals. Explains that most animals behavior has to do with getting food, getting along with other animals, or finding a mate and raising young. Defines stimulus and response.

"What Animals Eat," AIT, I, 15 minutes, color, 1972

Title - Investigating Earthworms (Vicki Lutzkanin, Eric Pontius, and Roy W. Allison)

Level - Intermediate

Aims - From ISEE Toward Which This Lesson Contributes

1. The students will demonstrate competency in the use of the process by observing, communicating, inferring, experimenting, and predicting.
2. The students will solve problems by gathering data, using equipment and materials, observing purposefully and drawing appropriate conclusions based on their findings.
3. The students will develop and ask questions of their environment. They will also use questions to describe, clarify, and analyze problems.
4. The students will demonstrate a desire to learn and a curiosity for the unknown by formulating and performing self-motivated science investigations and readings on their own outside the formal confines of science.

Instructional Objectives - At the conclusion of this lesson, the students will be able to:

1. Describe characteristics of earthworms.
2. Design a suitable home for earthworms.
3. Describe the conditions under which earthworms are more readily available to collect.
4. Identify at least one way earthworms are helpful to man.
5. Identify the parts of the earthworm.

BACKGROUND INFORMATION

Earthworms are very helpful to man. They live in the soil and are important in fertilizing and aerating the soil.

Most children are aware that earthworms come out of the ground after a rain. This lesson will show the students many different kinds of environments earthworms live in.

An oddity of the earthworm is its ability to regenerate new parts. The earthworm has two parts, the head and the tail. The broad band that separates the two sections is known as the clitellum or the egg band. The head is usually darker in color than the tail which ends in a flat section having a tiny hole in the center. If the earthworm is divided in half behind the egg band, the head will regenerate a new posterior end.

To care for earthworms in the classroom, keep the worms in a cool moist, covered tub of at least six inches of soil. Food should include lettuce, vegetation, leaves, or coffee grounds.

The time span of this lesson could range from two to three weeks. The best time for this investigation would be in the spring or the early fall while the weather is warm enough to collect worms outside.

Total Equipment List for a Class of 30:

covered container, such as a styrofoam chest	grass seed
glass or plastic aquarium and cover	sprinkling can
earthworms	water
variety of soil types (sand, loam, clay)	wire screening (3" x 8"), or cloth
pails	newspapers
shovels	spoons
towels	magnifying glass
food for the earthworms such as lettuce, coffee grounds, leaves, cornmeal	black construction paper
pencils and paper	
knives or razor blades	

Activity I - Readiness - Discussion of Earthworms

Description - In this activity the teacher will discover what the children know about earthworms.

Materials needed - none

Directions

Lead a whole group discussion on earthworms to discover what the children know about them. Some students may be aware of the ways in which earthworms are helpful to man. Other students may ask questions that will be answered as they work through the lesson. The children could record their questions to see if they discover their answers at a later time.

Suggestions for the Gifted

Research to find out facts about earthworms not mentioned in the group discussion.

Discuss with a farmer or other resource person the ways in which earthworms are helpful to man.

Activity II - Preparing the Worm Box

Description - In this activity the students prepare a box for the earthworms to live in for the duration of this unit.

Materials needed

styrofoam ice chest and cover
soil
sprinkling can
water
grass seed
wire screening or cloth (3" x 8")

Directions

Do as a whole group or have a small group of children complete. (See Diagram 1, page 4.)

1. Fill the box about three-quarters full of soil, fluffing up the bedding as you put it in.
2. Add some water, and mix it in thoroughly.
3. Repeat step two several times until the bedding is moist and crumbly throughout.
4. Plant the grass seed in the box according to the directions on the package. This will help keep the soil moist.
5. To prepare the cover, cut a hole about two by six inches in the cover to let air and light into the box.
6. Cover the hole with wire screening or cloth to keep the earthworms in and the insects out.
7. Allow the box to stand without cover and earthworms for a few days to allow the grass seed to grow.
8. After the grass begins to grow, keep the worm box out of direct sunlight and in a cool part of the room.

Suggestions for the Gifted

1. How do people who raise earthworms for a living keep them?
2. Build and maintain a vivarium.

Activity III - Worm Collecting

Description - In this activity the students find earthworms to use for experiments in this unit.

Materials needed for each group

pails
shovels
trowels
food for the earthworms

Directions

Working with partners or in small groups arrange for the students to go on a collecting trip. Although it may not always be possible, after a rain is usually a good time to collect worms. They may be found on parking lots where they will crawl to get away from the water. Be sure the worms have not dehydrated on the parking lot.

Instruct the children to look for and dig for worms and to refill any holes or chunks of grass when they finish. Caution the children not to bruise the worms by pulling on them. Collect the worms in the pails to take back to the classroom. The teacher should check to see that no dead worms are put into the worm box. They will contaminate the others.

The earthworms the children collect can be put directly into the worm box. Allow the worms a few days in the box before experimenting with them. Remember to cover the box so that the worms stay inside.

Each week the worms should be fed, and the bedding should be checked to see that it has not dried out. The soil should look moist and crumbly, not muddy and wet.

To feed the worms, scrape a shallow trough about one-half inch deep and six inches wide in the bedding in the center of the worm box. Sprinkle about one-fourth cup of food (coffee grounds, shredded lettuce or leaves, cornmeal) lightly over this area, and mix it gently with the bedding beneath. Sprinkle the whole box lightly with water.

Suggestions for the Gifted

1. Discuss with a resource person how earthworms are fed and maintained.
2. Experiment with feeding earthworms different food.

Activity IV - Worm Experiments

Description - In this activity the students will make up and investigate their own experiments on earthworms.

Materials needed for each group

worms
pails
pails
magnifying glass
anything a student needs to carry out his or her experiment

Directions

Working with partners or in small groups, allow the students to experiment with the worms. They may wish to try and answer some of the questions they raised in activity 1. Some suggestions for experiments are:

1. Observe how the worm crawls. Place obstacles in its way and see what happens.
2. Find out how two earthworms react with each other.
3. Observe the movement of the worm under a magnifying glass.
4. Test different soil environments to see which the worm seems to prefer (wet soil, dry soil, sand, clay).

Allow the students to set up their own experiments. Encourage them to predict the outcomes. After the children have experimented with the earthworms, place the worms back into the worm box. Discuss the results of the experiments with the students.

Suggestions for the Gifted

1. Conduct experiments on the animals from the vivarium.
2. Conduct experiments on other animals such as millipeds or ants.

Activity V - Layering the Earth

Description - In this activity the students will observe how earthworms affect the layers of the earth.

Materials needed

glass or plastic aquarium and cover
black construction paper
variety of soils (sand, loam, clay)
earthworms

Directions - (See Diagram 2)

Prepare an aquarium with layers of soil. Make each new layer very different so that the layers are distinct. Use layers of sand, loam, clay, and repeat the soils until the aquarium is filled.

Make sure the students see the different layers. Cover the four sides with black construction paper.

Take the worms from the worm box and place them in the layered-soil aquarium. Be sure to cover it. Have the students predict what will happen.

After a few days, remove the black paper from one side of the aquarium. The layers should have disappeared.

Discuss with the students what has happened. As the earthworm moves through the soil, it mixes the earth. This is helpful in aerating the soil. Also as the earthworm eats, it deposits wastes which will help enrich the soil.

Suggestions for the Gifted

1. Research other types of worms (flatworms, roundworms, other segmented worms) and discover how they are helpful or harmful to man.
2. Make diagrams of the different kinds of worms.

Activity VI - Regeneration of Earthworms

Description - In this activity the children will discover that earthworms can grow new tails from their heads.

Materials needed for each group

earthworms
knives
worm box
aquarium from activity 5

Directions (See Diagram 3, page 11)

1. Divide the class into groups of five or six students.
2. Give each group two earthworms.
3. Point out the egg band.
4. Discuss that the egg band separates the head and the tail.
5. The head is darker in color and contains around thirty-two rings.
6. The tail end is lighter in color and ends in a flat section having a tiny hole in the center.
7. Cut each of the worms in half just behind the egg band letting the egg band attached to the head.
8. Place the head ends back into the worm box, and the tail ends into the aquarium.
9. Place the worm box and the aquarium in a damp, dark place and allow to remain there for about nine days. Predict what will happen.

10. After nine days, examine the two containers.

Results

The tail will die, but the heads should begin to grow new tails. All the vital organs of the earthworm lie within the first eighteen rings. The length of the worm behind the egg band consists only of intestines.

Suggestions for the Gifted

1. Research the different parts of the earthworm and report on the function of each part.
2. Create a diagram of the earthworm and label the parts.

WORD BOX

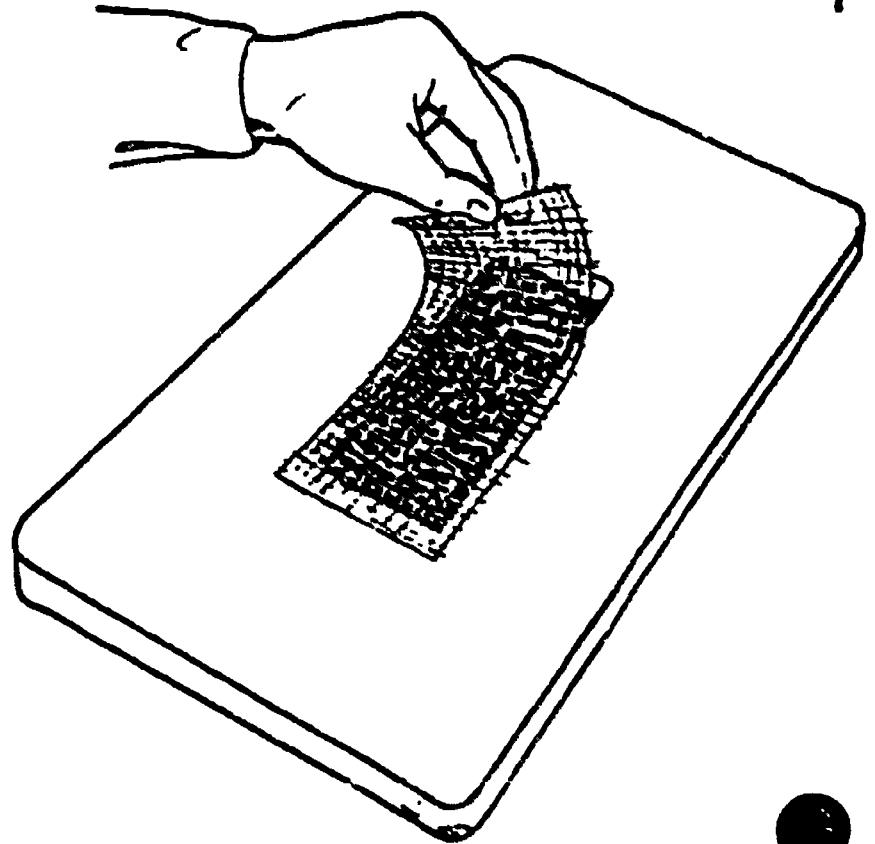
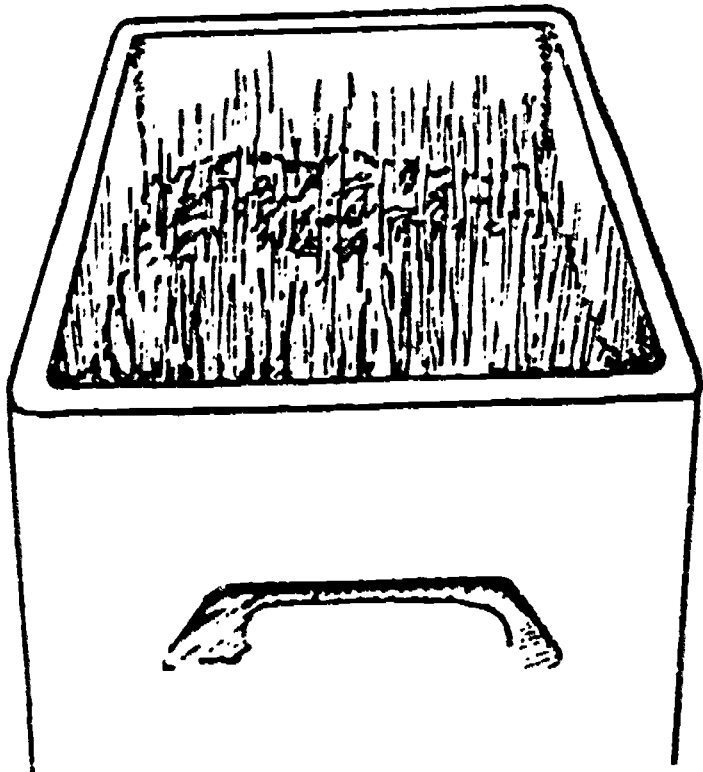
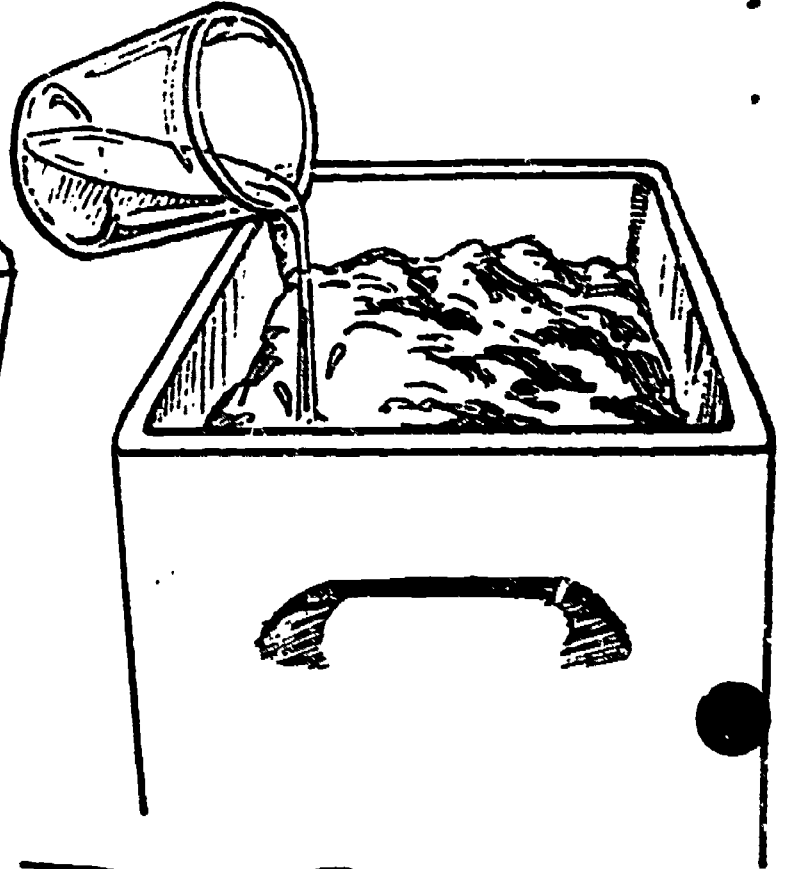
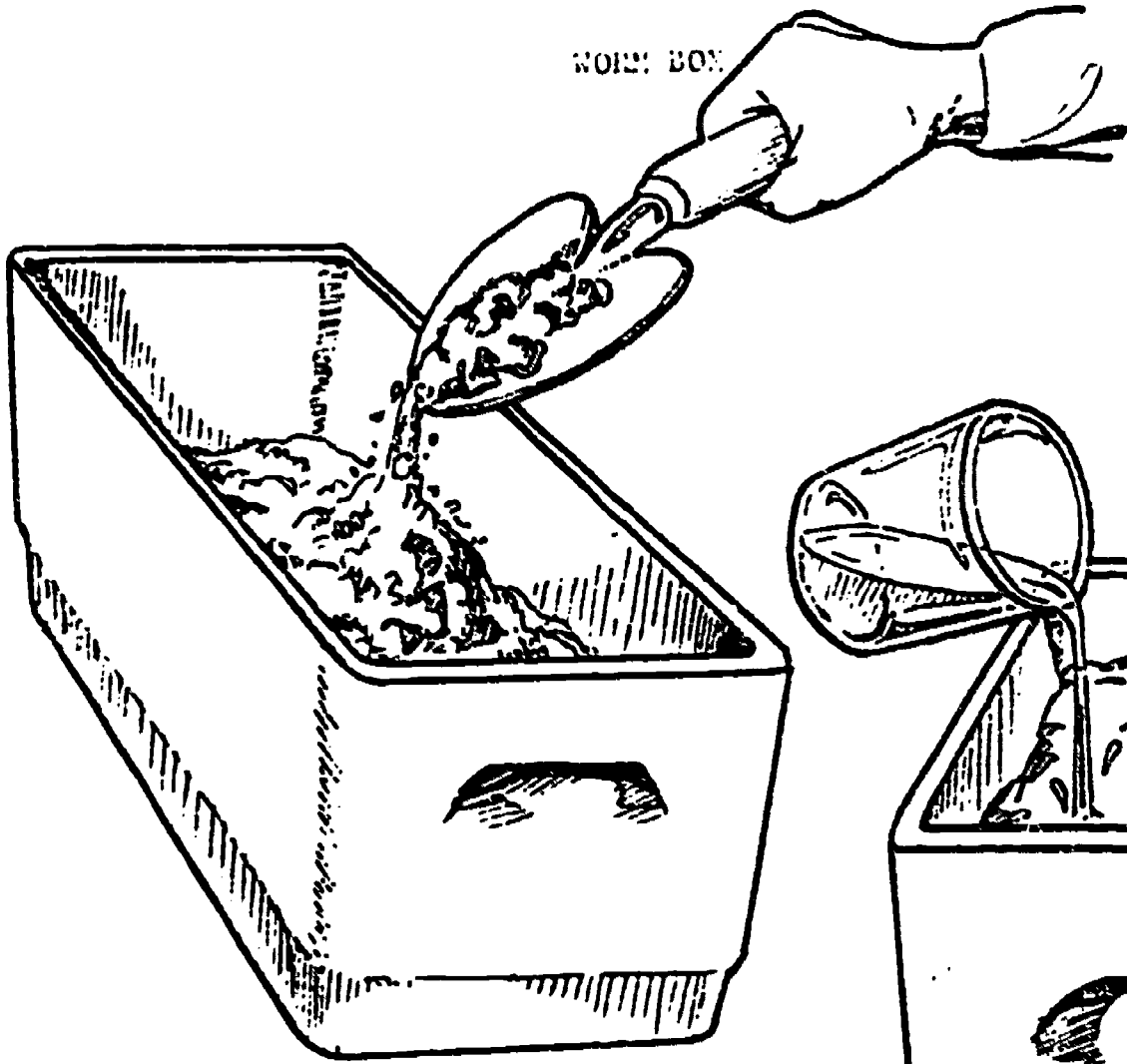

150

LAYERING THE EARTH

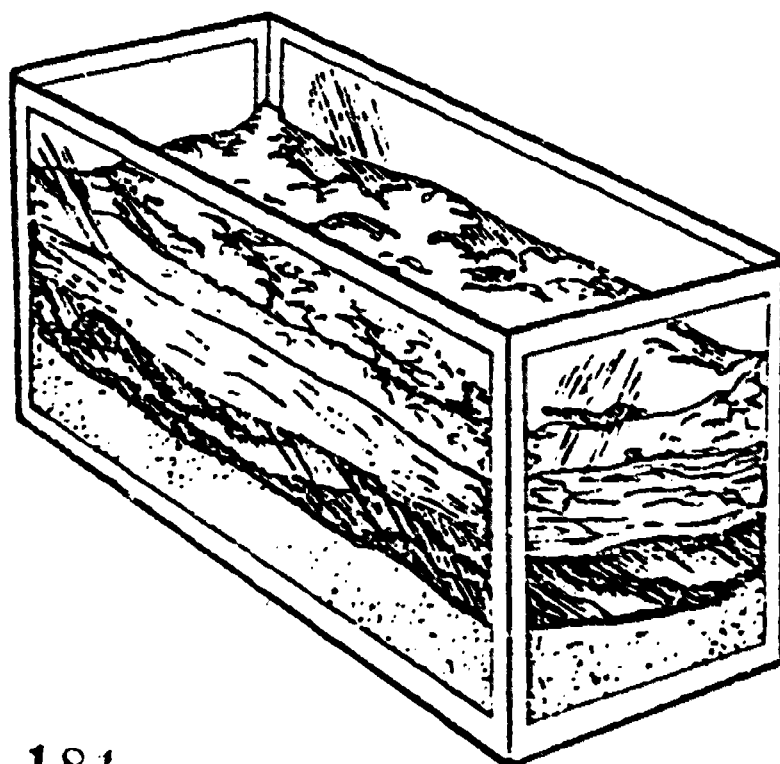
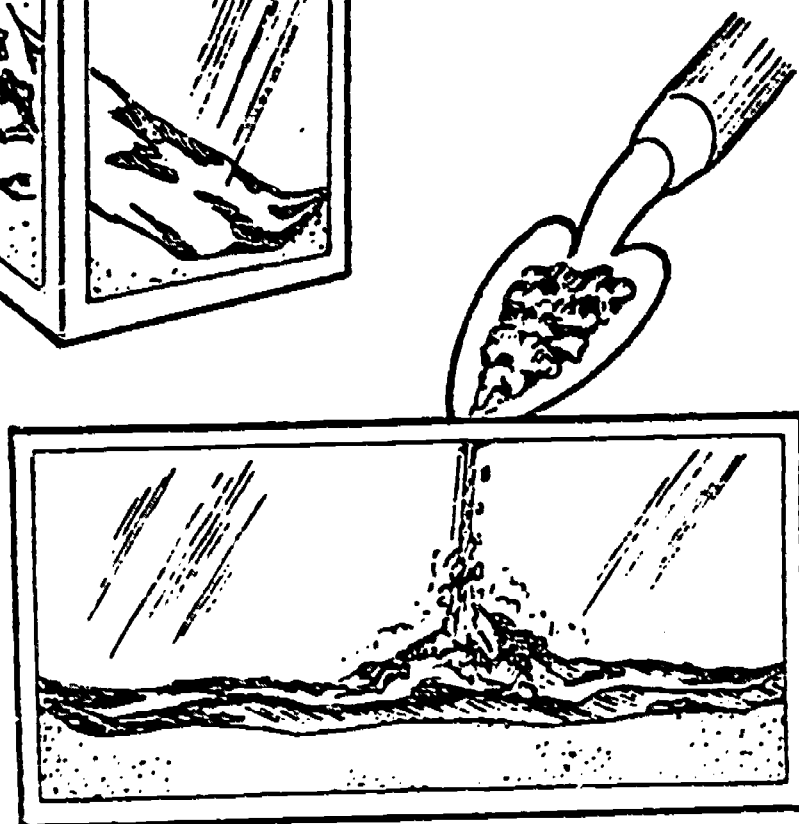
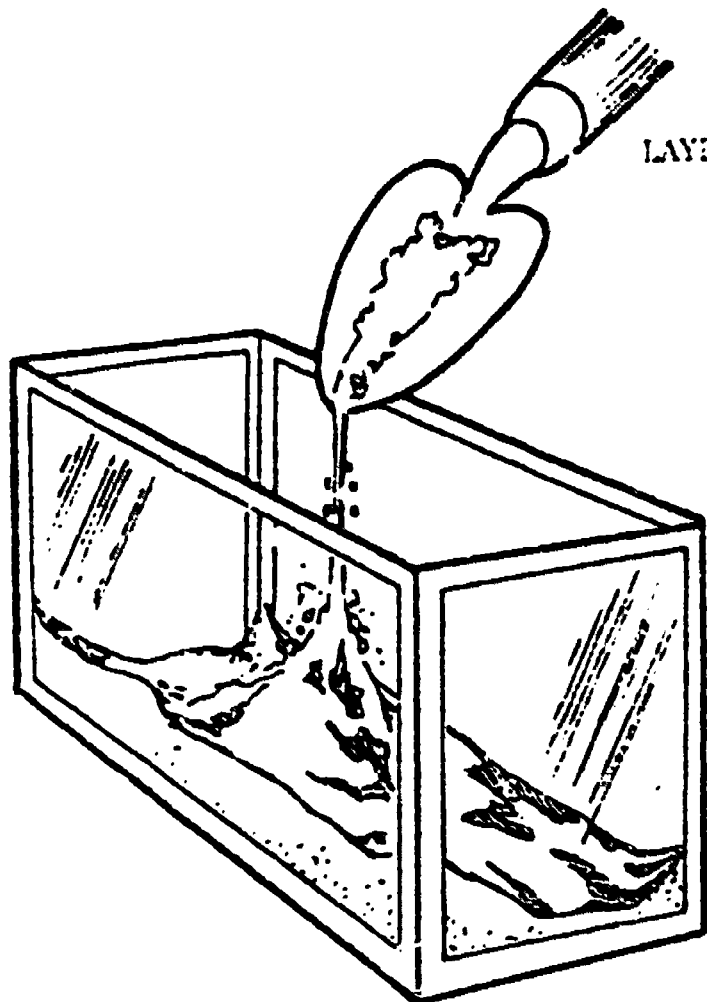

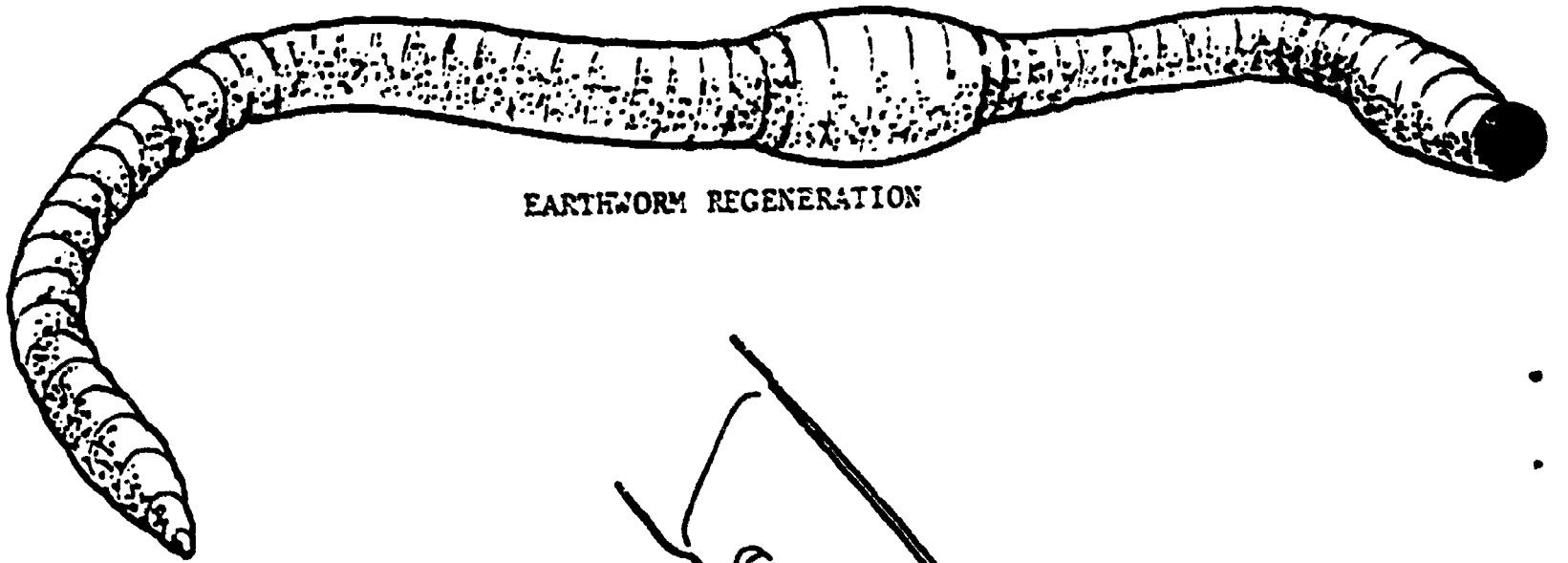

EARTHWORM REGENERATION

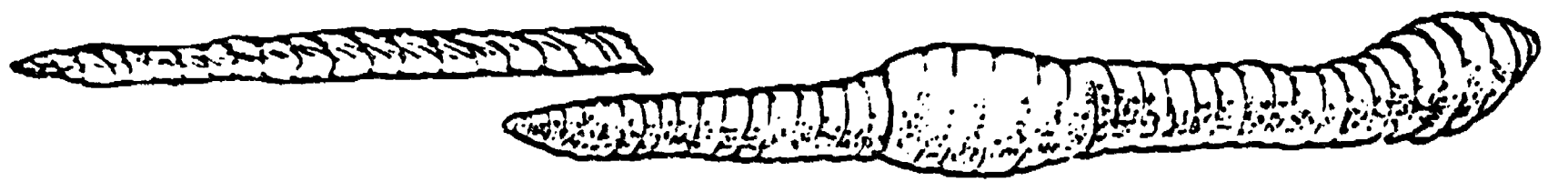
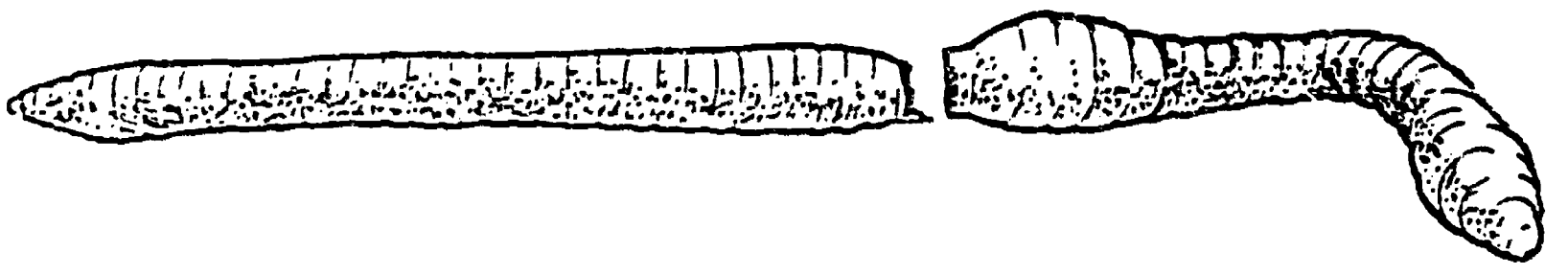
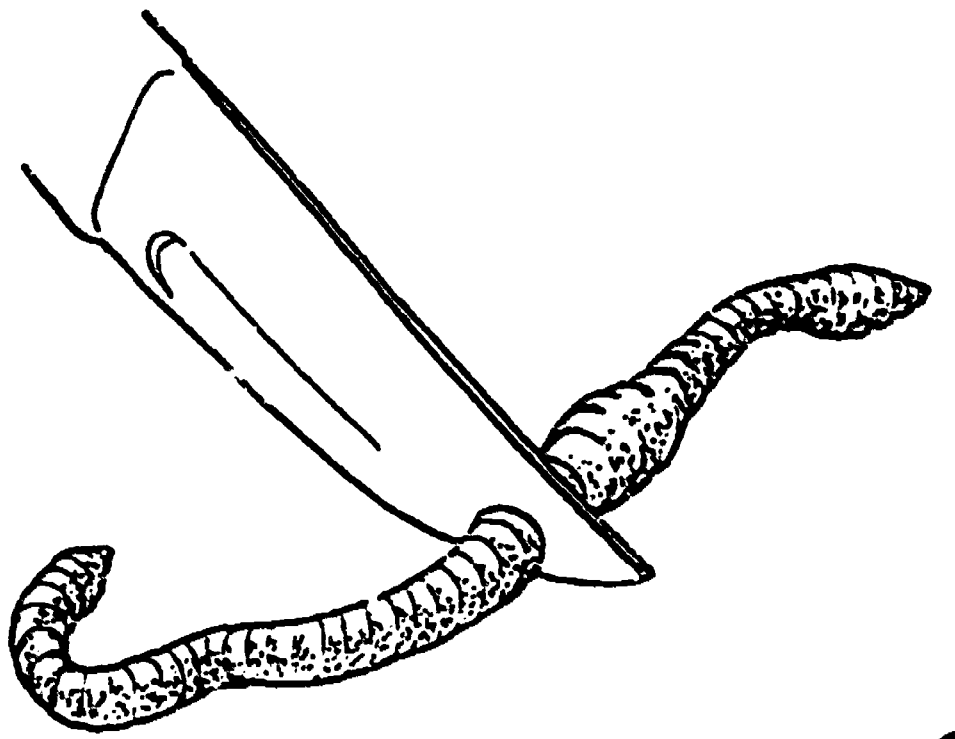

**Annotated Bibliography of Children's
Books for Earthworms**

Darling, Lois. Worms, William Morrow & Co., NY, 1972.

This book explains the structure of the earthworm, describes its behavior and provides instructions on how to keep earthworms alive in a container.

Hess, Lilo, The Amazing Earthworm, Charles Scribner's Sons, NY, 1979.

The author gives a complete account of how to raise earthworms.

Lauber, Patricia, Earthworms, Garrard Publishing Co., Champaign, IL.

This text examines the anatomy, physiology, and life history of earthworms.

Pringle, Lawrence, Twist, Wiggle, and Squirm: A Book About Earthworms, Harper & Row, Inc., 1973.

The author relates facts about earthworms such as their movements, regenerative powers, skin breathing apparatus, mating habits, enemies, and values to plants and soils.

Simon, Seymour, Discovering What Earthworms Do, McGraw-Hill, Inc., 1969.

This book encourages children to find the answers to questions about earthworms through observations and experiments.

Activity V

Materials for each group of 4-6 students:

- earthworm
- darkened room
- flashlight
- wet paper towel
- sheet lined notebook paper
- other materials suggested and gathered by students

* Since worms are sensitive to noise and vibrations, students should be relatively quiet and careful not to cause vibrations on the surface where the worm has been placed. Also, all investigations are to be conducted in a darkened room. These items might be discussed during this initial activity.

Discuss students' personal experiences with earthworms focusing primarily on such experiences as what time of day they might collect earthworms for fishing, what type of light might be used if looking for earthworms at night, etc. Students might then offer inferences as to various effects of light on earthworms based on their observations. List both observations and inferences on chalk board.

Have students begin by working with an earthworm and flashlight to add to their list of observations. Each group should place an earthworm on a wet paper towel and allow the worm to become quiet. Explain that the children are to shine the flashlight on the worm in any manner they choose. They are to keep a record of all their observations in one list and any questions resulting from their observations in another list. (AIM 1)

After approximately 10-15 minutes, have the children turn the flashlight off and continue to observe the worm and state questions. (AIM 1) While the children are thus involved, circulate among groups questioning and responding to stimulate productive activity. At the conclusion of this initial investigation, guide class discussion. First, have individuals read observations from their group lists. Children from other groups should distinguish any inferences offered. They are likewise to challenge any observations for which they can state a conflicting observation. Differences may stimulate further investigation. (AIM 3)

Then, have children read aloud their questions. Write them on the chalk board. After 8-10 questions have been recorded, ask children to identify questions which can be answered through investigation using materials. Also, guide students to rewrite non-operational questions in operational form if interest is evident. (AIM 1)

Proper conditions for keeping the worms may also be discussed during this activity.

Activity V

Materials: None

Have students volunteer for various interest groups to investigate a question of their choice. Have them plan and write their procedure, identify the materials they will need, and collect the materials by a time agreed upon by the teacher and group. (AIM 2)

Activity VI:

Materials: As determined by student groups to perform their investigations

After all necessary materials have been collected, have students begin their investigations, recording their observations and additional questions which may be stimulated by the activity. (AIM 2) Following investigations, have each group report its findings to the class. Stimulate discussion of findings. If desired, students might perform investigations again for entire group to support a tentative conclusion or provide proof of a stated observation. Encourage discussion of conflicting observations and focus on using materials to resolve disagreements. (AIM 3)

Following are investigations conducted by groups of approximately 6 students as a result of questions on the effects of light on earthworms. They are included here as suggestions for use or adaptation. (AIM 4)

- A. Are all parts (head, tail, and sides) of an earthworm sensitive to light?

Materials: flashlight, earthworm, wet paper towel, small cardboard square (with a small hole punched in the middle), small pieces of masking tape, sheet of notebook paper, darkened room

Student Directions: Tape the cardboard over the flashlight. This allows for a narrow beam of light to come from the flashlight. Place a worm on a sheet of wet paper towel, and keep it in a darkened room for a few minutes allowing it to get quiet. Shine the narrow beam of light along the sides of the worm, then at the back end, then at the front end. (Head end may be noted by children as the pointed end, the end that goes forward, or the end closest to a wide band around the body of an adult worm.) Record worm's reaction at each part where light is shined.

Findings: Front end is more sensitive to light. An earthworm has clusters of light-sensitive cells at its front end. (Discussion question: How might this help in guiding an earthworm to the surface of the ground?)

- B. Is a worm more sensitive to brighter light?

Materials: flashlight, earthworm, wet paper towel, yardstick, sheet of notebook paper, darkened room

Student Directions: Place a worm on a sheet of wet towel and keep it in a dark room allowing it to get quiet. Place the 0 end of the yardstick carefully (to limit vibrations) on the towel near the worm. Hold the flashlight at the 36" end of the yardstick. Shine it on the worm and note the worm's reaction. Gradually bring the flashlight closer to the worm noting observed reaction at each marked interval (e.g. every inch, or 2 inches, or 3 inches, etc.)

18.)