

DOCUMENT RESUME

ED 254 727

CE 041 003

TITLE Millwright Apprenticeship. Related Training Modules.
13.1-13.2 Air Compressors.

INSTITUTION Lane Community Coll., Eugene, Oreg.

SPONS AGENCY Oregon State Dept. of Education, Salem.

PUB DATE [82]

NOTE 104p.; For related documents, see CE 040 991-041 007.
Many of the modules are duplicated in CE 040 989.

PUB TYPE Guides - Classroom Use - Materials (For Learner)
(051)

EDRS PRICE MF01/PC05 Plus Postage.

DESCRIPTORS *Apprenticeships; Behavioral Objectives; Energy
Occupations; *Equipment Maintenance; *Equipment
Utilization; Individualized Instruction; Industrial
Personnel; Job Skills; Learning Modules; *Machine
Tools; Postsecondary Education; Power Technology;
*Trade and Industrial Education

IDENTIFIERS *Air Compressors; *Millwrights; Power Plant
Operators; Power Tools

ABSTRACT

This packet of two learning modules on air compressors is one of six such packets developed for apprenticeship training for millwrights. Introductory materials are a complete listing of all available modules and a supplementary reference list. Each module contains some or all of these components: goal, performance indicators, study guide (a check list of steps the student should complete), a vocabulary list, an introduction, information sheets, assignment sheet, job sheet, self-assessment, self-assessment answers, post-assessment, instructor post-assessment answers, and a list of supplementary references. Supplementary reference material may be provided. The two training modules cover types of air compressors and their operation and maintenance.
(YLB)

* Reproductions supplied by EDRS are the best that can be made *
* from the original document. *

ED254727

Metalwright

APPRENTICESHIP

RELATED TRAINING MODULES

13.1-13.2 AIR COMPRESSORS

U.S. DEPARTMENT OF EDUCATION
NATIONAL INSTITUTE OF EDUCATION
EDUCATIONAL RESOURCES INFORMATION
CENTER (ERIC)

✓ The document has been reproduced as received from the person or organization originating it.

() Minor changes have been made to improve reproduction quality.

• Points of view or opinions stated in this document do not necessarily represent official NIE position of policy.

"PERMISSION TO REPRODUCE THIS MATERIAL HAS BEEN GRANTED BY

S. J. Oise

TO THE EDUCATIONAL RESOURCES INFORMATION CENTER (ERIC)."

041003

STATEMENT OF ASSURANCE

IT IS THE POLICY OF THE OREGON DEPARTMENT OF EDUCATION THAT NO PERSON BE SUBJECTED TO DISCRIMINATION ON THE BASIS OF RACE, NATIONAL ORIGIN, SEX, AGE, HANDICAP OR MARITAL STATUS IN ANY PROGRAM, SERVICE OR ACTIVITY FOR WHICH THE OREGON DEPARTMENT OF EDUCATION IS RESPONSIBLE. THE DEPARTMENT WILL COMPLY WITH THE REQUIREMENTS OF STATE AND FEDERAL LAW CONCERNING NON-DISCRIMINATION AND WILL STRIVE BY ITS ACTIONS TO ENHANCE THE DIGNITY AND WORTH OF ALL PERSONS.

STATEMENT OF DEVELOPMENT

THIS PROJECT WAS DEVELOPED AND PRODUCED UNDER A SUB-CONTRACT FOR THE OREGON DEPARTMENT OF EDUCATION BY LANE COMMUNITY COLLEGE, APPRENTICESHIP DIVISION, EUGENE, OREGON, 1984. LANE COMMUNITY COLLEGE IS AN AFFIRMATIVE ACTION/EQUAL OPPORTUNITY INSTITUTION.

APPRENTICESHIP

MILLWRIGHT
RELATED TRAINING MODULESSAFETY

- 1.1 General Safety
- 1.2 Hand Tool Safety
- 1.3 Power Tool Safety
- 1.4 Fire Safety
- 1.5 Hygiene Safety
- 1.6 Safety and Electricity
- 1.7 Fire Types and Prevention
- 1.8 Machine Safeguarding (includes OSHA Handbook)

ELECTRICITY/ELECTRONICS

- 2.1 Basics of Energy
- 2.2 Atomic Theory
- 2.3 Electrical Conduction
- 2.4 Basics of Direct Current
- 2.5 Introduction to Circuits
- 2.6 Reading Scales
- 2.7 Using a V.O.M.
- 2.8 OHM'S Law
- 2.9 Power and Watt's Law
- 2.10 Kirchoff's Current Law
- 2.11 Kirchoff's Voltage Law
- 2.12 Series Resistive Circuits
- 2.13 Parallel Resistive Circuits
- 2.14 Series - Parallel Resistive Circuits
- 2.15 Switches and Relays
- 2.16 Basics of Alternating Currents
- 2.17 Magnetism

COMPUTERS

- 3.1 Digital Language
- 3.2 Digital Logic
- 3.3 Computer Overview
- 3.4 Computer Software

TOOLS

- 4.1 Boring and Drilling Tools
- 4.2 Cutting Tools, Files and Abrasives
- 4.3 Holding and Fastening Tools
- 4.4 Fastening Devices
- 4.5 Basic Science - Simple Mechanics
- 4.6 Fasteners

DRAFTING

- 5.1 Types of Drawing and Views
- 5.2 Sketching
- 5.3 Blueprint Reading/Working Drawings
- 5.4 Working Drawings for Machines and Welding
- 5.5 Machine and Welding Symbols
- 5.6 Blueprint Reading, Drafting: Basic Print Reading
- 5.7 Blueprint Reading, Drafting: Basic Print Reading
- 5.8 Blueprint Reading, Drafting: Basic Print Reading
- 5.9 Blueprint Reading, Drafting: Basic Print Reading
- 5.10 Blueprint Reading, Drafting: Basic Print Reading
- 5.11 Blueprint Reading, Drafting: Basic Print Reading
- 5.12 Blueprint Reading, Drafting: Basic Print Reading
- 5.13 Blueprint Reading, Drafting: Basic Print Reading
- 5.14 Drafting, Machine Features
- 5.15 Drafting, Measurement
- 5.16 Drafting, Visualization

HUMAN RELATIONS

- 6.1 Communications Skills
- 6.2 Feedback
- 6.3 Individual Strengths
- 6.4 Interpersonal Conflicts
- 6.5 Group Problem Solving
- 6.6 Goal-setting and Decision-making
- 6.7 Worksite Visits
- 6.8 Resumes
- 6.9 Interviews
- 6.10 Expectation
- 6.11 Wider Influences and Responsibilities
- 6.12 Personal Finance

BOILERS

- 7.1 Boilers - Fire Tube Types
- 7.2 Boilers - Watertube Types
- 7.3 Boilers - Construction
- 7.4 Boilers - Fittings
- 7.5 Boilers - Operation
- 7.6 Boilers - Cleaning
- 7.7 Boilers - Heat Recovery Systems
- 7.8 Boilers - Instruments and Controls
- 7.9 Boilers - Piping and Steam Traps

TURBINES

- 8.1 Steam Turbines - Types
- 8.2 Steam Turbines - Components
- 8.3 Steam Turbines - Auxillaries
- 8.4 Steam Turbines - Operation and Maintenance
- 8.5 Gas Turbines

PUMPS

- 9.1 Pumps - Types and Classification
- 9.2 Pumps - Applications
- 9.3 Pumps - Construction
- 9.4 Pumps - Calculating Heat and Flow
- 9.5 Pumps - Operation
- 9.6 Pumps - Monitoring and Troubleshooting
- 9.7 Pumps - Maintenance

COMBUSTION

- 10.1 Combustion - Process
- 10.2 Combustion - Types of Fuel
- 10.3 Combustion - Air and Fuel Gases
- 10.4 Combustion - Heat Transfer
- 10.5 Combustion - Wood

GENERATORS

- 11.1 Generators - Types and Construction
- 11.2 Generators - Operation

FEEDWATER

- 12.1 Feedwater - Types and Equipment
- 12.2 Feedwater - Water Treatments
- 12.3 Feedwater - Testing

AIR COMPRESSORS

- 13.1 Air Compressors - Types
- 13.2 Air Compressors - Operation and Maintenance

STEAM

- 14.1 Steam - Formation and Evaporation
- 14.2 Steam - Types
- 14.3 Steam - Transport
- 14.4 Steam - Purification

MISCELLANEOUS

- 15.1 Installation - Foundations
- 15.2 Installation - Alignment
- 15.3 Circuit Protection
- 15.4 Transformers
- 15.5 Trade Terms

TRADE MATH

- 16.1 Linear - Measure
- 16.2 Whole Numbers
- 16.3 Addition and Subtraction of Common Fraction and Mixed Numbers
- 16.4 Multiplication and Division of Common Fractions and Whole and Mixed Numbers

- 16.5 Compound Numbers
- 16.6 Percent
- 16.7 Ratio and Proportion
- 16.8 Perimeters, Areas and Volumes
- 16.9 Circumference and Wide Area of Circles
- 16.10 Area of Plane, Figures and Volumes of Solid Figures
- 16.11 Metrics

HYDRAULICS

- 17.1 Hydraulics - Lever
- 17.2 Hydraulics - Transmission of Force
- 17.3 Hydraulics - Symbols
- 17.4 Hydraulics - Basic Systems
- 17.5 Hydraulics - Pumps
- 17.6 Hydraulics - Pressure Relief Valve
- 17.7 Hydraulics - Reservoirs
- 17.8 Hydraulics - Directional Control Valve
- 17.9 Hydraulics - Cylinders
- 17.10 Hydraulics - Forces, Area, Pressure
- 17.11 Hydraulics - Conductors and Connectors
- 17.12 Hydraulics - Troubleshooting
- 17.13 Hydraulics - Maintenance

METALLURGY

- 18.1 Included are IIS packets:
 - W 3010
 - W 3011-1
 - W 3011-2
 - MS 9001 (1-3-4-8-9-6-7-5-2-9)
 - MS 9200, 9201

POWER DRIVES

- 19.1
 - 101. A-B-C-D-E
 - 102. C-D-E
 - 103. B-C-D-E
 - 104. A-C-E-F-G-H-I-J
 - 107. A
 - 108. A

WELDING

- 20.1
 - 602. A-B-C-D-G-I-L-M
 - 603. A-B-F-G-I
 - W. 3011-1 refer to Metallurgy 18.1
 - WE. MA-18

MILLWRIGHT
SUPPLEMENTARY REFERENCE DIRECTORY

Note: All reference packets are numbered on the upper right-hand corner of the respective cover page.

<u>Supplementary Packet #</u>	<u>Description</u>	<u>Related Training Module</u>
1.8	Concepts & Techniques of Machine Safeguarding, U.S.D.L., O.S.H.A.	1.8 Machine Safeguarding
12.1	Correspondence Course, Lecture 11, Sec. 2, Steam Generators, Types of Boilers I, S.A.I.T., Calgary, Alberta, Canada	7.1 Boilers, Fire Tube Type
12.2	Correspondence Course, Lecture 2, Sec. 2, Steam Generators, Types of Boilers II, S.A.I.T., Calgary, Alberta, Canada	7.2 Boilers, Water Tube Type
12.3	Correspondence Course, Lecture 2, Sec. 2, Steam Generators, Boiler Construction & Erection, S.A.I.T., Calgary, Alberta, Canada	7.3 Boilers, Construction
12.4	Correspondence Course, Lecture 4, Sec. 2, Steam Generators, Boiler Fittings II, S.A.I.T., Calgary, Alberta, Canada	7.4 Boilers, Fittings
12.4	Correspondence Course, Lecture 4, Sec. 2, Steam Generators, Boiler Fitting I, S.A.I.T., Calgary, Alberta, Canada	7.4 Boilers, Fittings
12.5	Correspondence Course, Lecture 10, Sec. 2, Steam Generation, Boiler Operation, Maintenance, Inspection, S.A.I.T., Calgary, Alberta, Canada	7.5 Boilers, Operation
12.7	Correspondence Course, Lecture 3, Sec. 2, Steam Generation, Boiler Details, S.A.I.T., Calgary, Alberta, Canada	7.7 Boilers Heat Recovery Systems
		<u>PUMPS</u>
13.1	Correspondence Course, Lecture 9, Sec. 2, Steam Generator, Power Plant Pumps, S.A.I.T., Calgary, Alberta, Canada	9.1 Types & Classifications
13.2		9.2 Applications
13.4		9.4 Calculating Heat & Flow
13.6		9.6 Monitoring & Troubleshooting
13.7		9.7 Maintenance
13.3	Correspondence Course, Lecture 6, Sec. 3, Steam Generators, Pumps, S.A.I.T., Calgary, Alberta, Canada	9.3 Construction
13.5		9.5 Operation

BEST COPY AVAILABLE

Supplementary Packet #	Description	Related Training Module
14.3 12.8	Correspondence Course, Lecture 6, Sec. 3, Steam Generators, Steam Generator Controls, S.A.I.T., Calgary, Alberta, Canada	14.3 Steam Transport 7.8 Boilers, Instruments & Controls
14.4	Correspondence Course, Lecture 11, Sec. 2, Steam Generators, Piping II, S.A.I.T., Calgary, Alberta, Canada	14.4 Steam Purification
15.1	Correspondence Course, Lecture 1, Sec. 4, Prime Movers, & Auxiliaries, Steam Turbines, S.A.I.T., Calgary, Alberta, Canada	8.1 Steam Turbines, Types
15.2	Correspondence Course, Lecture 4, Sec. 3, Prime Movers, Steam Turbines I, S.A.I.T., Calgary, Alberta, Canada	8.2 Steam Turbines, Components
15.3	Correspondence Course, Lecture 2, Sec. 4, Prime Movers & Auxiliaries, Steam Turbine Auxiliaries, S.A.I.T., Calgary, Alberta, Canada	8.3 Steam Turbines, Auxiliaries
15.4	Correspondence Course, Lecture 6, Sec. 3, Prime Movers, Steam Turbine Operation & Maintenance, S.A.I.T., Calgary, Alberta, Canada	8.4 Steam Turbines, Operation & Maintenance
15.5	Correspondence Course, Lecture 8, Sec. 3, Prime Movers, Gas Turbines, S.A.I.T., Calgary, Alberta, Canada	8.5 Gas Turbines
16.2	Boilers Fired with Wood & Bark Residues, D.D. Junge, F.R.L., O.S.U., 1975	10.2 Combustion Types of Fuel
16.2	Correspondence Course, Lecture 5, Sec. 2, Steam Generators, Fuel Combustion, S.A.I.T., Calgary, Alberta, Canada	10.2 Combustion Types of Fuel
16.3	Correspondence Course, Lecture 5, Sec. 2, Plant Services, Fuel & Combustion, S.A.I.T., Calgary, Alberta, Canada	10.3 Combustion Air & Fuel Gases
17.1	Correspondence Course, Lecture 12, Sec. 3, Steam Generation, Water Treatment, S.A.I.T., Calgary, Alberta, Canada	12.1 Feedwater, Types & Operation
17.2	Correspondence Course, Lecture 12, Sec. 2, Steam Generation, Water Treatment, S.A.I.T., Calgary, Alberta, Canada	12.2 Feedwater, Water Treatments

<u>Supplementary Packet #</u>	<u>Description</u>	<u>Related Training Module</u>
17.3	Correspondence Course, Lecture 7, Sec. 2, Steam Generators, Boiler Feedwater Treatment, S.A.I.T., Calgary, Alberta, Canada	12.3 Feedwater, Testing
18.1	Correspondence Course, Lecture 2, Sec. 5, Electricity, Direct Current Machines, S.A.I.T., Calgary, Alberta, Canada	11.1 Generators, Types & Construction
18.1	Correspondence Course, Lecture 4, Sec. 5, Electricity, Alternating Current Generators, S.A.I.T., Calgary, Alberta, Canada	11.1 Generators, Types & Construction
18.2		18.2 Generators, Operation
19.1	Correspondence Course, Lecture 5, Sec. 4, Prime Movers & Auxiliaries, Air Compressor I, S.A.I.T., Calgary, Alberta, Canada	13.1 Air Compressors, Types
19.1	Correspondence Course, Lecture 6, Sec. 4, Prime Movers & Auxiliaries, Air Compressors II, S.A.I.T., Calgary, Alberta, Canada	13.1 Air Compressors, Types
		13.2 Air Compressors, Operation & Maintenance
20.1	Basic Electronics, Power Transformers, EL-BE-51	15.4 Transformers
21.1	Correspondence Course, Lecture 6, Sec. 5, Electricity, Switchgear & Circuit, Protective Equipment, S.A.I.T., Calgary, Alberta, Canada	15.3 Circuit Protection
22.1	Correspondence Course, Lecture 10, Sec. 3, Prime Movers, Power Plant Erection & Installation, S.A.I.T., Calgary, Alberta, Canada	15.1 Installation Foundations

RECOMMENDATIONS FOR USING TRAINING MODULES

The following pages list modules and their corresponding numbers for this particular apprenticeship trade. As related training classroom hours vary for different reasons throughout the state, we recommend that the individual apprenticeship committees divide the total packets to fit their individual class schedules.

There are over 130 modules available. Apprentices can complete the whole set by the end of their indentured apprenticeships. Some apprentices may already have knowledge and skills that are covered in particular modules. In those cases, perhaps credit could be granted for those subjects, allowing apprentices to advance to the remaining modules.

We suggest the the apprenticeship instructors assign the modules in numerical order to make this learning tool most effective.

SUPPLEMENTARY INFORMATION

ON CASSETTE TAPES

Tape 1: Fire Tube Boilers - Water Tube Boilers
and Boiler Manholes and Safety Precautions

Tape 2: Boiler Fittings, Valves, Injectors,
Pumps and Steam Traps

Tape 3: Combustion, Boiler Care and Heat Transfer
and Feed Water Types

Tape 4: Boiler Safety and Steam Turbines

NOTE: The above cassette tapes are intended as additional
reference material for the respective modules, as
indicated, and not designated as a required assignment.

Modules 18.1, 19.1, and 20.1 have been omitted because they contain dated materials.

2



13.1

AIR COMPRESSORS -- TYPES

Goal:

The apprentice will be able to describe air compressors and their construction.

Performance Indicators:

1. Describe positive displacement compressors.
2. Describe dynamic type compressors.
3. Describe construction of compressor parts.



Study Guide

- * Read the goal and performance indicators to find what is to be learned from package.
- * Read the vocabulary list to find new words that will be used in package.
- * Read the introduction and information sheets.
- * Complete the job sheet.
- * Complete self-assessment.
- * Complete post-assessment.

Vocabulary

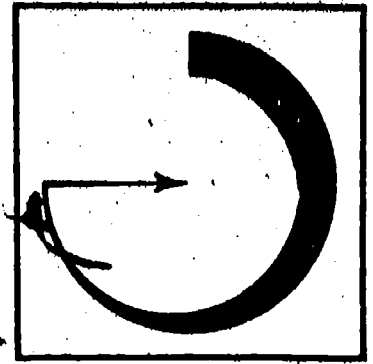

- * Axial thrust
- * Centrifugal
- * Double acting
- * Dynamic type
- * Lobe type
- * Positive displacement type
- * Reciprocating
- * Rotary type
- * Screw type
- * Single acting
- * Sliding vane type

Introduction



Compressed air has many uses around industrial sites. It is used for painting, cleaning, pneumatic tool operation, soot blowing and many other purposes. Air compressors are an integral part of most power plants. Often they are driven by steam from the plant or a steam driven turbine.

Compressors come in many designs and sizes. A size and design is selected according to the work to be performed by the use of compressed air. A plant operator must be able to select the appropriate compressor for their location. A basic understanding of the various types of compressors available will help the operator to make better choices.

Information



Air compressors are of two basic types:

- * Positive displacement
- * Dynamic

Positive Displacement Compressors

A positive displacement compressor is one that compresses a definite amount of air for each stroke or turn that it makes. The positive displacement compressor may be a reciprocating type which uses a cylinder and piston arrangement or a rotary type that uses vanes or lobes to compress the air. Reciprocating compressors may be a single acting in which the compression occurs at one end of the cylinder. A double acting type compresses at both ends of the cylinder. A single acting reciprocating compressor is shown below.

1. plate type valve
2. cylinder
3. cylinder water jacket
4. automotive type piston
5. connecting rod.
6. crankcase
7. crankcase door
8. crankshaft counterweight
9. oil screen
10. low oil pressure alarm

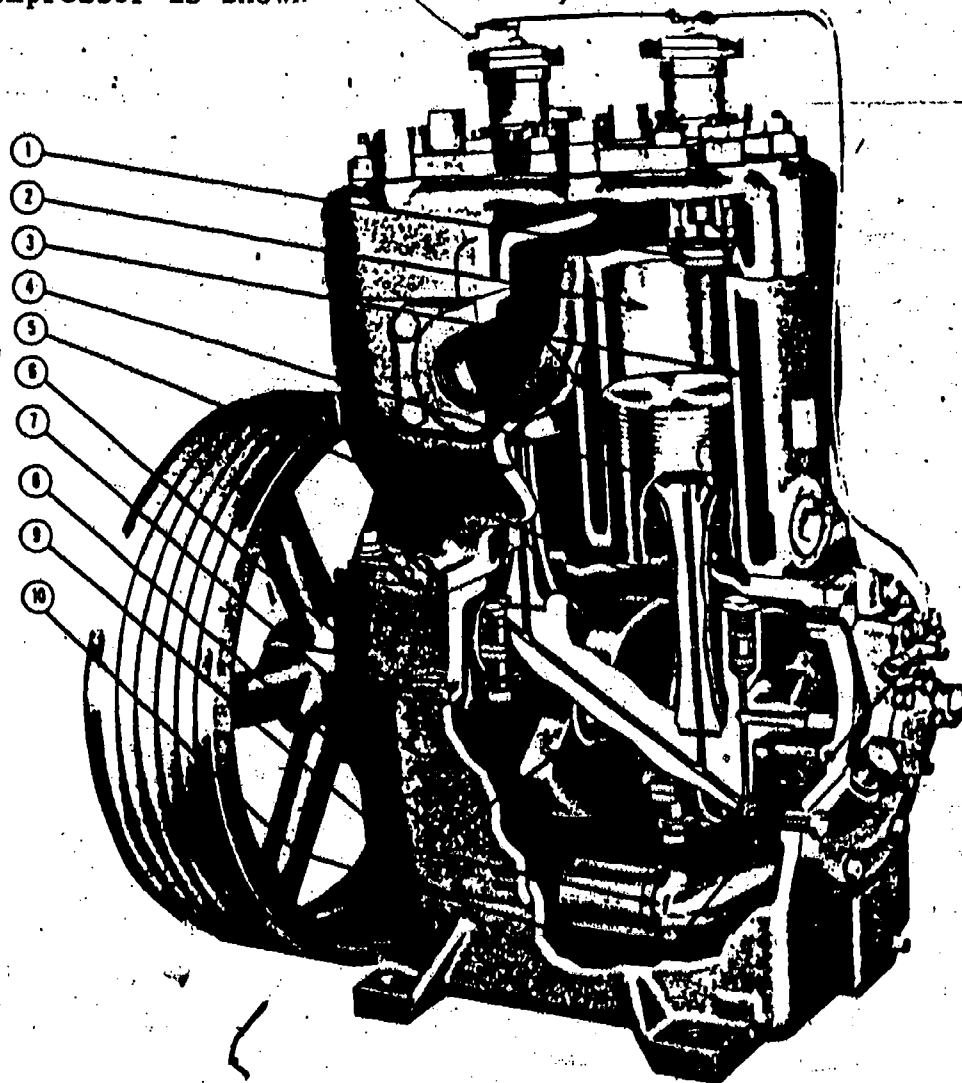

Information

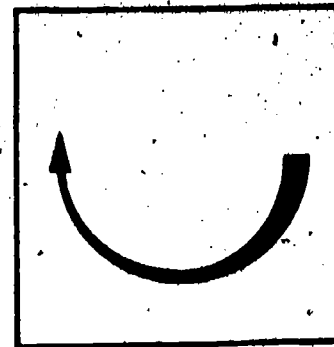

A double acting reciprocating compressor is shown.

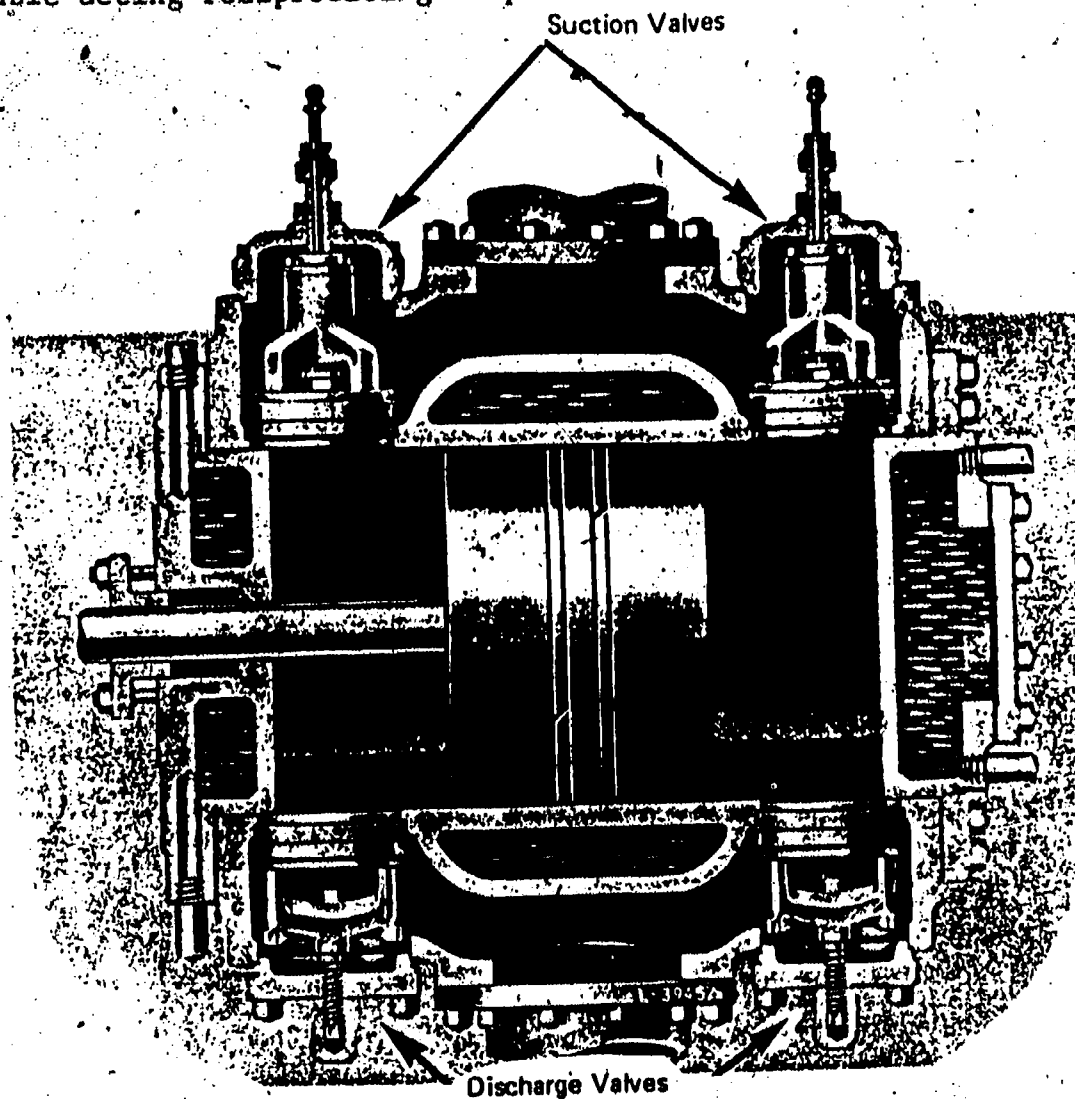

Rotary compressors are positive displacement types. They can be further classified as:

- * Sliding vane type
- * Lobe type
- * Screw type

The sliding vane type has vanes that fit into radial slots on the rotor. As the rotor turns, the vanes are tossed outward by centrifugal force. Air is trapped and squeezed as the vanes move toward the outlet.

Information

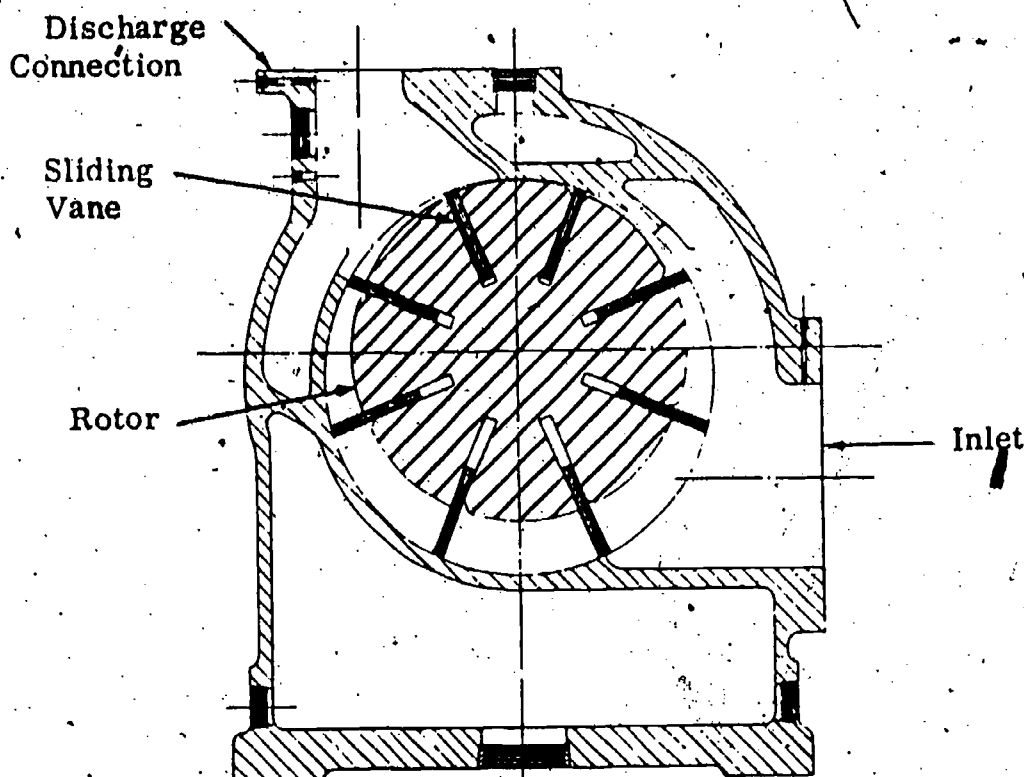
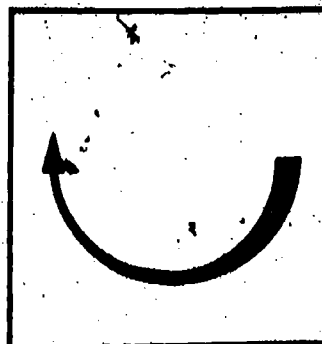

The rotary lobe compressor has lobe shaped impellers that turn in opposite directions. The interface between the lobes squeezes the air as it moves from inlet to outlet.

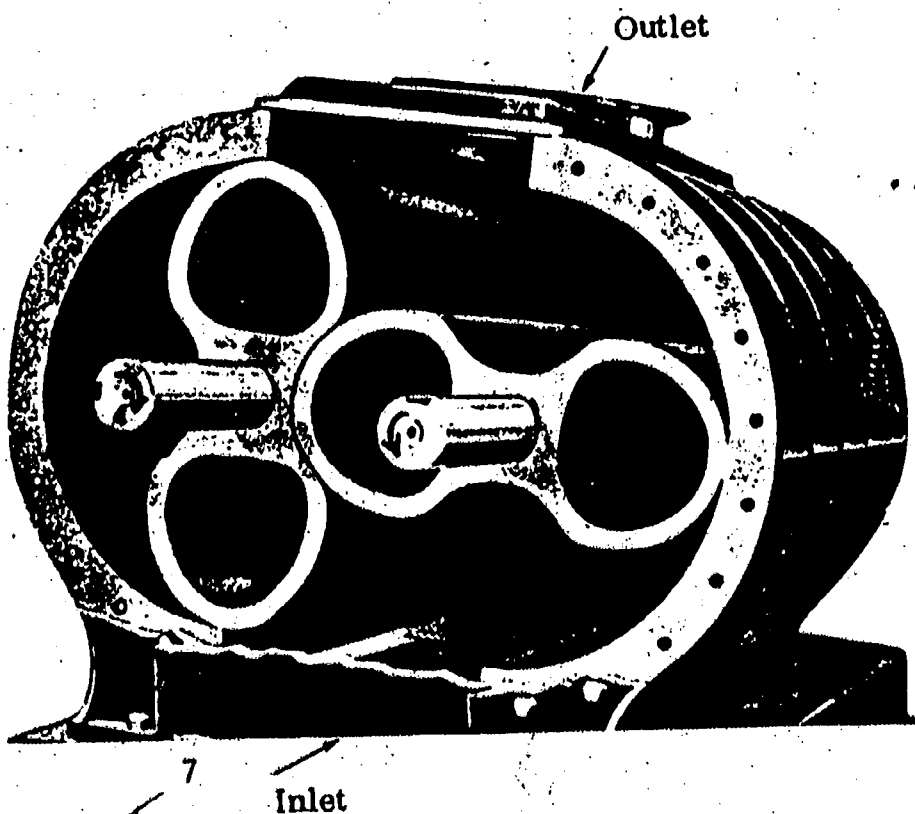

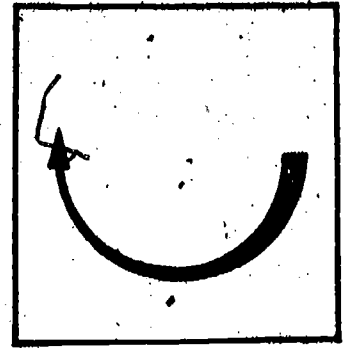

Information

A rotary screw compressor uses two screw shaped rotors that mesh as they turn. One rotor has convex lobes and the other has concave flutes that allow them to mesh.

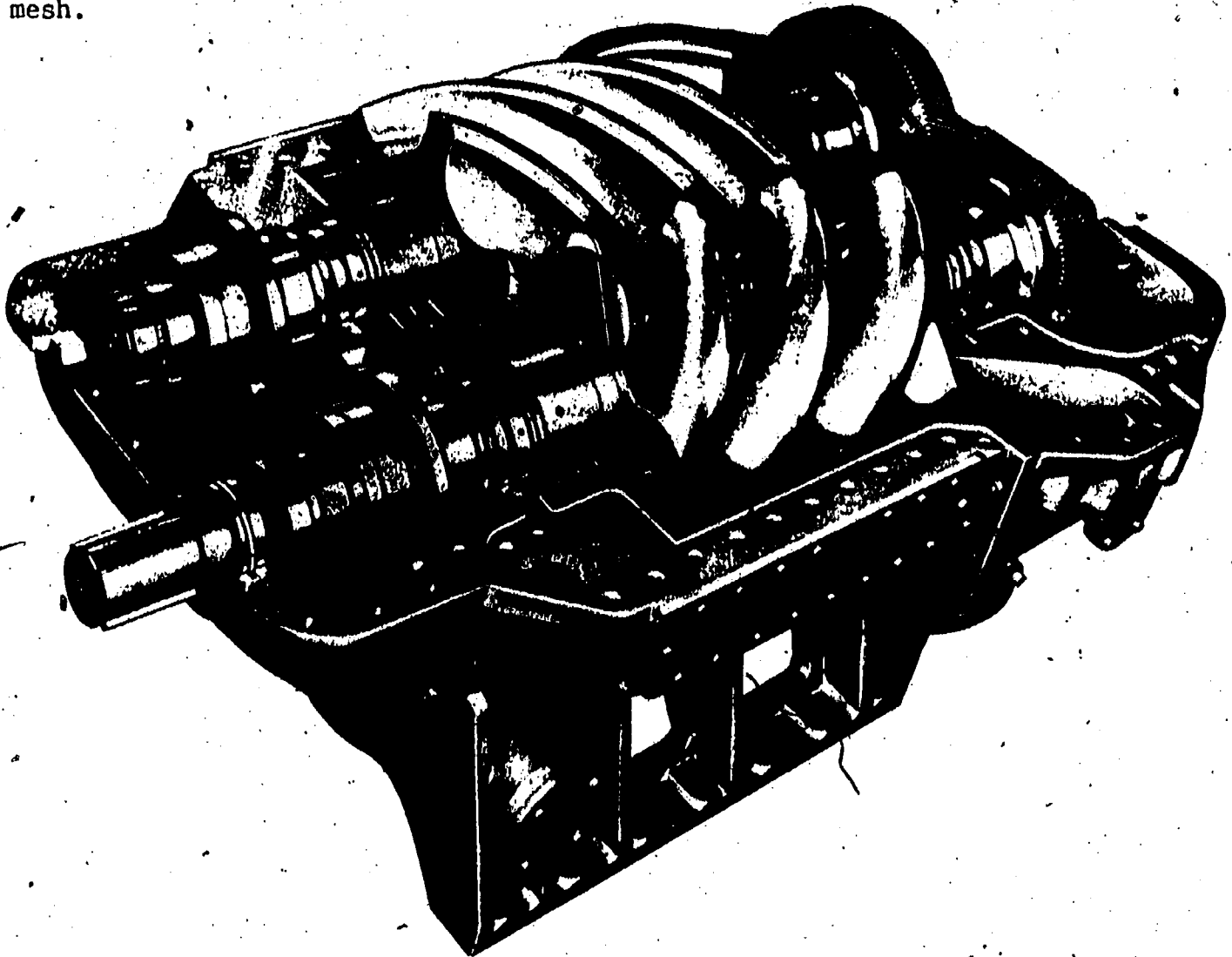

Dynamic Compressors

A dynamic compressor increases the velocity of the air and then converts that velocity into pressure. The dynamic compressor is subdivided into two types.

- * Centrifugal
- * Axial flow

The centrifugal compressor draws air into the eye of the impeller and discharges

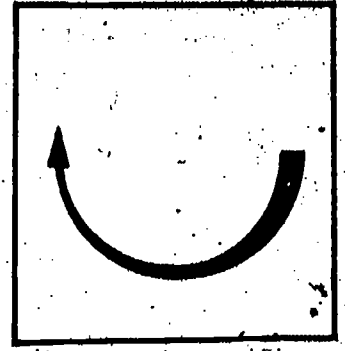

Information

it from the outer rim of the impeller. The casing has attached vanes that diffuse the air and convert it to pressure. The air is then forced through a volute shaped casing to further compress it. This compressor operates on centrifugal action of the impeller.

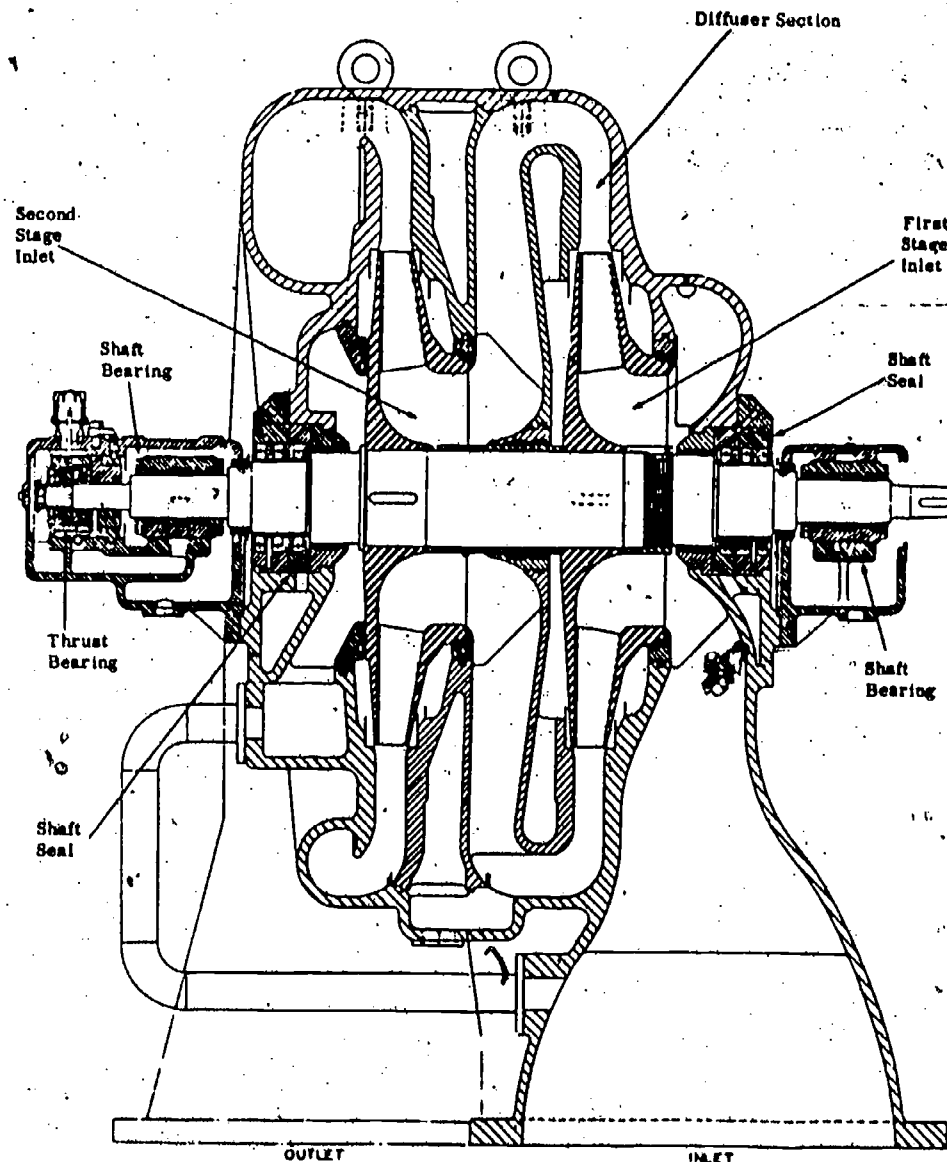

The axial flow compressor has a rotor that rotates within a casing. The rotor has moving blades that move between fixed blades attached to the casing. Air is moved between the two sets of blades. Its velocity is converted to pressure. It is constructed much like a turbine.

Information

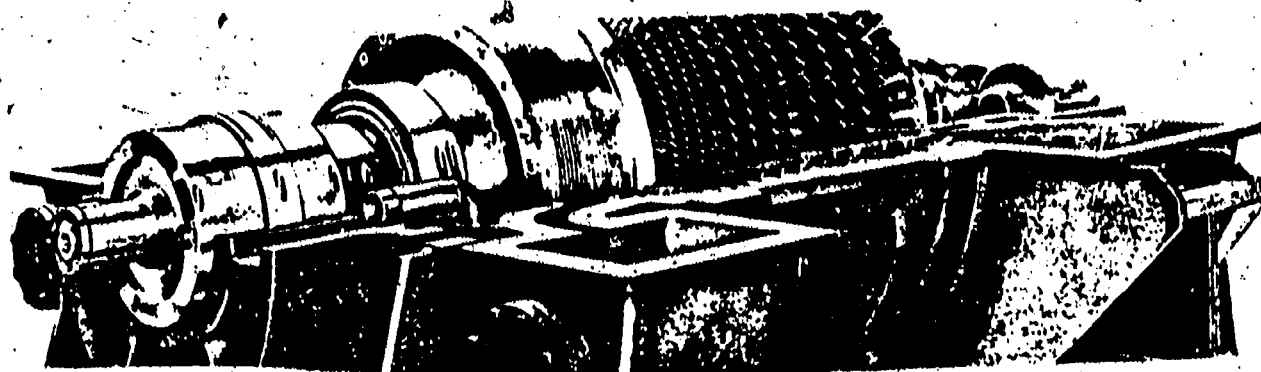
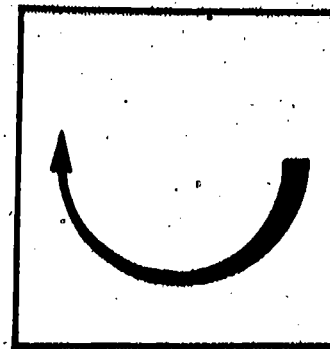

Construction

Compressors are often driven by exhaust steam from steam generation plants. In that case, a reciprocating steam engine is used to drive the compressor. It is usually mounted on a common base with the steam engine. In other cases, a steam turbine may be used to drive the compressor. The compressor parts are made of materials that will withstand the pressures of each situation. The parts of a reciprocating compressor and the materials used in construction are:

- * Cylinders -- cast iron for pressures up to 1000 kPA. Cast steel for pressures up to 6900 kPA and forged steel for pressures beyond 6900 kPA.
- * Pistons -- aluminum, cast iron or steel
- * Crossheads -- steel
- * Crankshafts -- forged steel
- * Valves -- alloy steel

Dynamic compressors of the centrifugal type are driven by gasoline engines, electric motors, steam turbines and gas turbines. The impellers of a centrifugal compressor are steel castings, forging or welded construction. Shafts are forged steel and casings are made of forged steel.

Axial flow compressors are driven by steam or gas turbines. The casings are made of cast steel or cast iron. Their rotor shafts are made of forged steel. The axial flow compressor must be constructed to withstand the axial thrust of the rotating blades. Axial flow compressors are very much like a reaction turbine in the way they are constructed. The problems of axial thrust are the same as that encountered with the turbine.

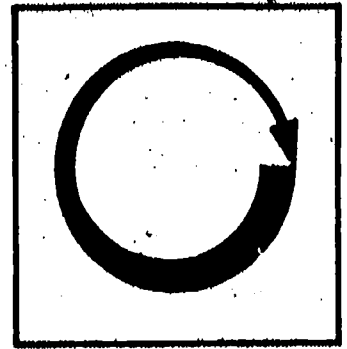

Assignment

- * Read the supplementary reference material and study the photographs and illustrations carefully.
- * Complete the job sheet.
- * Complete the self-assessment and check answers.
- * Complete the post-assessment and have instructor check answers.

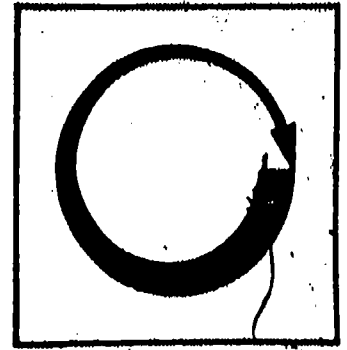

Job Sheet

OBSERVE AIR COMPRESSORS AT YOUR PLANT SITE

- * What kind of air compressors do you see? Classify them.

- * How are they driven?

- * How much capacity (pressure) can they deliver?

- * How is air used at this plant?

Self Assessment

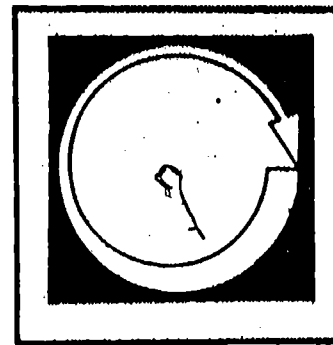

1. What is a positive displacement compressor?
2. List two types of positive displacement compressors.
3. What does double acting mean?
4. List three types of rotary compressors.
5. List two types of dynamic compressors.
6. What is a dynamic compressor?
7. For pressures beyond 6900 kPA, what material should be used for cylinders?
8. What is usually used to drive axial flow compressors?
9. Which compressor is constructed like a turbine?
10. Which type of compressor has an impeller that draws air in through its eye and discharges it from its rim?

Self Assessment Answers

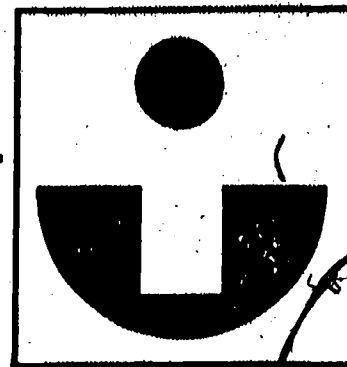

1. One that compresses a definite amount of air at each stroke or turn.
2. Reciprocating, rotary
3. Compresses air at each end of the cylinder.
4. Sliding vane, lobe, screw
5. Centrifugal, axial flow
6. One that increases velocity of air and then converts velocity to pressure.
7. Forged steel
8. Steam turbines, gas turbines
9. Axial flow
10. Centrifugal

Post Assessment

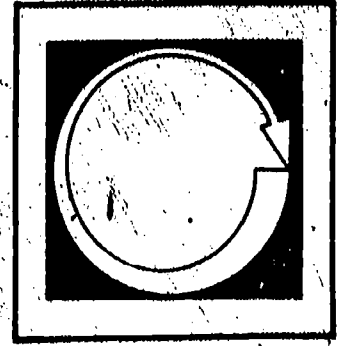

Match the following terms and phrases.

- | | | |
|-------|--------------------------|--|
| _____ | 1. Positive displacement | A. A type of rotary compressor. |
| _____ | 2. Dynamic | B. A type of dynamic compressor with an impeller. |
| _____ | 3. Double acting | C. Used for cylinders of pressures of 1000 - 6900 kPA. |
| _____ | 4. Sliding vane | D. A compressor that compresses a definite amount of air at each stroke or turn. |
| _____ | 5. Axial flow | E. Usually made of forged steel. |
| _____ | 6. Cast steel | F. A problem in axial flow compression. |
| _____ | 7. Canary | G. Constructed much like a reaction turbine. |
| _____ | 8. Axial thrust | H. A compressor that converts velocity of air to pressure. |
| _____ | 9. Shafts | I. A small yellow bird. |
| _____ | 10. Centrifugal | J. Compresses at each end of the cylinder. |

Instructor Post Assessment Answers

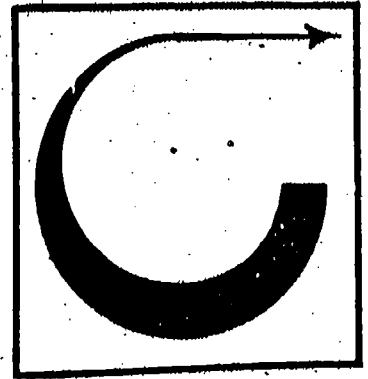

D 1.

H 2.

J 3.

A 4.

G 5.

C 6.

I 7.

F 8.

E 9.

B 10.

● Supplementary References

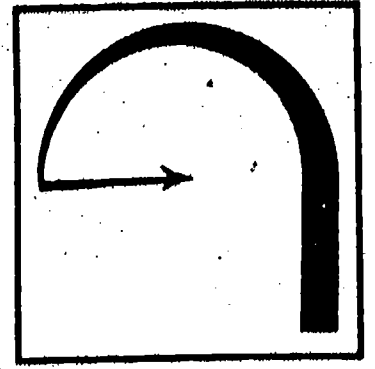

- * Correspondence Courses. Lectures 5 and 6. Section 4, Third Class.
Southern Alberta Institute of Technology. Calgary, Alberta, Canada.



13.2

AIR COMPRESSORS -- OPERATION AND MAINTENANCE

Goal:

The apprentice will be able to describe the operation and maintenance of air compressors.

Performance Indicators:

1. Describe cooling.
2. Describe air receivers.
3. Describe air filtering.
4. Describe regulating.
5. Describe surging.
6. Describe lubrication.
7. Describe maintenance.

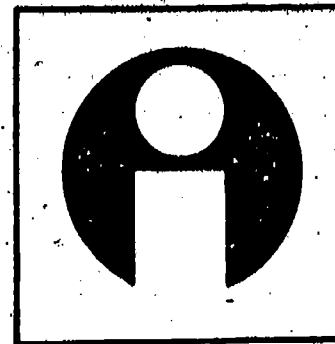

Study Guide

- * Read the goal and performance indicators to find what is to be learned from package.
- * Read the vocabulary list to find new words that will be used in package.
- * Read the introduction and information sheets.
- * Complete the job sheet.
- * Complete self-assessment.
- * Complete post-assessment.

Vocabulary

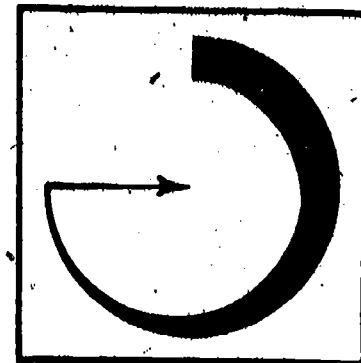

- * Aftercooler
- * Air filter
- * Air receiver
- * Cooling
- * Intercooler
- * Regulation
- * Surging
- * Throttling governor
- * Unloading device

Introduction

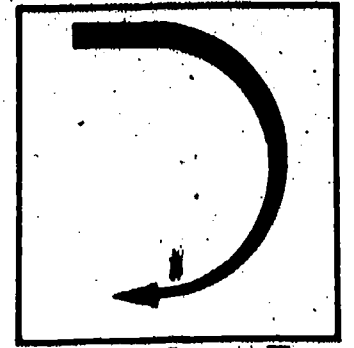

Air compressors must be operated in a manner that is safe and efficient in the production of air. As air is compressed to its maximum pressure, a lot of heat is developed. The heat must be removed from the working parts of the compressor. Cooling becomes a critical factor in air compression.

The heat can cause oils to be converted into carbon deposits. Carbon deposits and their oil vapors combine with air mixtures to make explosions. So oiling of compressors must be done with a great deal of understanding and common sense. Most maintenance efforts are directed toward keeping the compressor cooled down.

Information

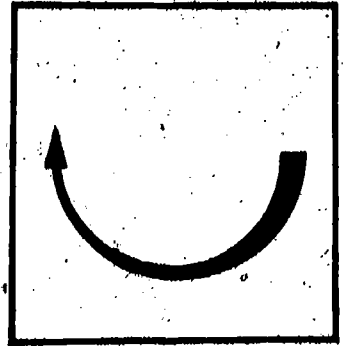

Cooling

Many small compressors are cooled by air pulled in from the atmosphere. Most large compressors are water cooled. Water is routed through the cylinder head in much the same way as an internal combustion engine is cooled. The water travels through water chambers that have been cast into the cylinder block and head. Circulating pumps move the water so that the heat of the cylinder is moved out and cool water is available to absorb heat as it develops. As the water collects heat, it should be cooled by circulating it through a cooling pond or tower before it is returned to the cylinder.

After compression of the air, it is cooled further before being used. The cooling of air after compression is done in two steps. The first step is called intercooling. Intercoolers are waterfilled tubes over which the compressed air passes. When compression is done by stages to get highly compressed air, intercooling is practiced between stages. The intercooler shell must have a drain to remove water that condenses during the cooling of the warm air.

A second step in air cooling is done in the aftercooler. After the compression is completed, air is cooled some more before being delivered to the user site. The aftercooler is a shell and tube structure that contains the water. The air flows over and near the waterfilled tubes and is cooled. The aftercooler must also be provided with a drain.

Air Receivers

An air receiver is necessary for maintaining a reserve air supply. The receiver should be fitted with a pressure gauge, safety valve and a drain cock. The line to the receiver should also have a safety valve to prevent damage from operating the compressor when the line shut off valve is closed.

Air Filters

All atmospheric air that enters the compressor should be filtered. Filtering removes foreign matter that can be abrasive to the compressor cylinder and other parts. A suction air filter should be used on openings that intake air.

Regulation

An automatic system should be installed for controlling the output of the compressor. A variable speed control system helps maintain a constant supply of air in the receiver. The system is controlled by a throttling governor which

Information

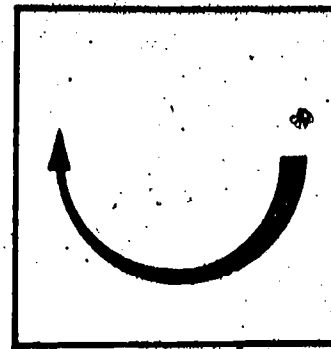

speeds up the compressor when air pressure drops in the receiver. As the air pressure reaches its maximum point, the governor slows down the air compressor. Another system of constant speed control uses an unloading device to regulate air flow to the receiver.

Surging

Dynamic type compressors have problems with surging. Due to changes in volume and pressure, the air sets up a reverse flow that causes shock waves. This surging of air can damage seals, blading and other parts of the compressor. Surging can be prevented by keeping the compressor capacity above surge limits. An automatic blow-off valve can be used to discharge the flow to avoid surging.

Lubrication

Most reciprocating compressors have built in lubrication systems of the pressure or splash types. Dynamic type compressors may have a pressure lubrication system or be oiled by ring and chain oilers.

Maintenance

Each manufacturer provides specific instructions for the maintenance of their compressors. These instructions should be carefully followed. A few maintenance points should be emphasized.

- * Do not over-oil or spill oil. This causes carbon formation when heated. Carbon deposits can cause explosions.
- * Use only recommended oil for the cooling system.
- * Always turn on cooling water before starting the compression.
- * Clean scale deposits from water jackets and intercooler pipe.
- * Repair leaky discharge valves.
- * Clean air filters regularly.

Compressors must be maintained to minimize the heat of compression. Routine maintenance that will prevent the development of carbon deposits will add equipment life and be much safer to the operator.

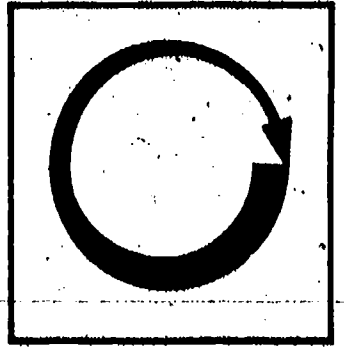

Assignment

- * Read pages 8 - 19 in supplementary reference.
- * Complete the job sheet.
- * Complete the self-assessment and check answers.
- * Complete the post-assessment and have the instructor check your answers.

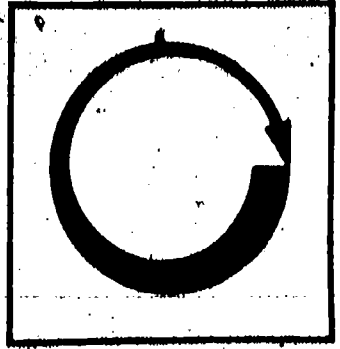

Job Sheet

COMPLETE A MAINTENANCE CHECK ON AN AIR COMPRESSOR

- * Obtain the manufacturers manual on the air compressor.
- * Conduct routine maintenance check following the manufacturers directions.
- * Observe
 - Is there evidence of over-oiling or oil spills?
 - Location of safety valves and shut-off valves.
 - Location of intercooler, after cooler and receiver.
 - Type of compressor, size, rating.

Self Assessment

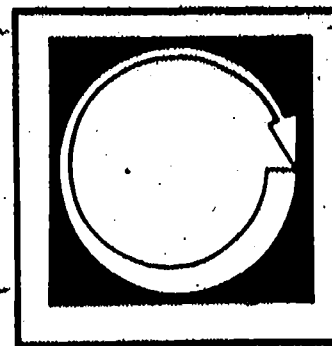

1. How are large compressors usually cooled?
2. How is water moved through the cylinder heads?
3. The first step in the cooling of compressed air is called _____.
4. The second step in cooling of compressed air is called _____.
5. Where does the air go after being cooled?
6. Why should air be filtered before it enters a compressor?
7. A variable speed control system is controlled by a _____.
8. A reverse flow of air that causes shock waves in the air compression system is called _____.
9. What are the results of over-oiling or spilling oil in the air compression?
10. Why should the line from compressor to receiver have a safety valve?

● Self Assessment Answers

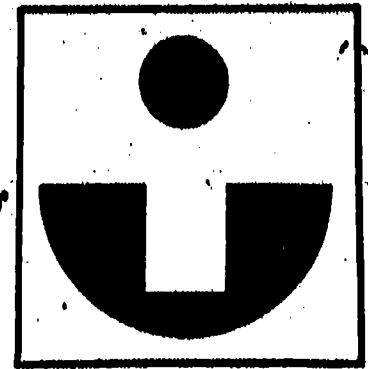

1. Water cooled
2. Circulating pumps
3. Intercooling
4. Aftercooling
5. Air receiver
6. Dirty air is abrasive to the internal parts of the compressor. It causes excess wear on cylinders, valves, etc.
7. Throttling and governor
8. Surging
9. Oil and heat create carbon deposits. Carbon deposits and air can cause explosions.
10. If it has a shut-off valve, it should also have a safety valve. The safety valve protects the pump from overpressure when the shut-off valve has not been opened.

Post Assessment

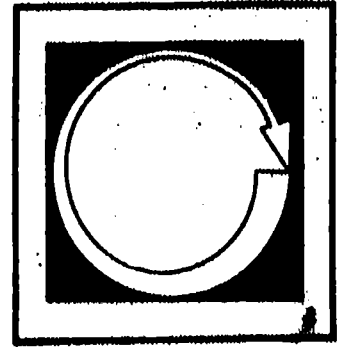

1. Air receiver
 2. Aftercooler
 3. Circulating pumps
 4. Filtering
 5. Throttling governor
 6. Intercooling
 7. Surging
 8. Dynamic type
 9. Reciprocating type
 10. Carbon deposits
- A. Controls a variable speed control system.
 - B. Oiled by pressure system or oil and ring system.
 - C. Shock waves caused by reverse flow of air in compressor.
 - D. Oiled by pressure or splash systems.
 - E. The second step in cooling air after its compression.
 - F. Caused by oil that has been overheated.
 - G. Prevents wear due to abrasive action.
 - H. Should be fitted with a safety valve, pressure gauge and drain cock.
 - I. Moves water through cooling system.
 - J. The first step in cooling of air and often used between stages of compression.

Instructor Post Assessment Answers

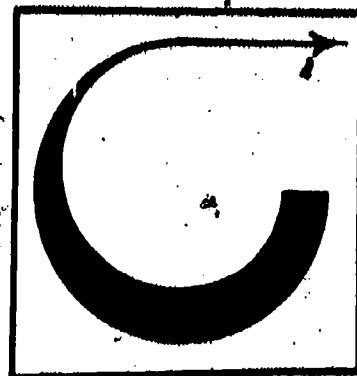

H 1.

E 2.

I 3.

G 4.

A 5.

J 6.

C 7.

B 8.

D 9.

F 10.

● Supplementary References

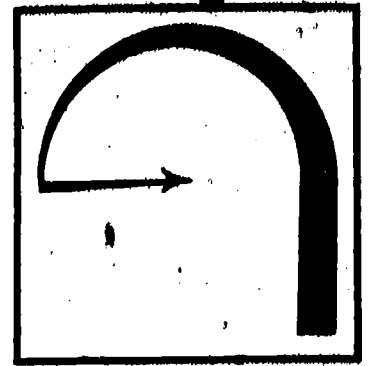

* Correspondence Course. Lecture 6, Section 4, Third Class. Air Compressors.
Southern Alberta Institute of Technology. Calgary, Alberta, Canada.

SOUTHERN ALBERTA INSTITUTE OF TECHNOLOGY
CALGARY ALBERTA

Correspondence Courses

Power Engineering

SECTION 4

Third Class
Lecture 5

PRIME MOVERS AND AUXILIARIES.

AIR COMPRESSORS I

Almost without exception, every industry, whether manufacturing, process, or power producing, finds many uses for compressed air.

Some of these uses are listed as follows:

1. Motive power for grinding and sanding tools, drills, wrenches, riveting hammers and chipping hammers.
2. Motive power for air motors which drive hoists and winches.
3. Blast cleaning or sandblasting of surfaces.
4. Spray painting.
5. Engine starting as with diesel engines.
6. Conveyor systems which move powdered and granular materials by means of compressed air.
7. Control systems where compressed air is used both as a signalling medium and also to power actuating-devices such as air cylinders.
8. Atomizing of liquids such as oil for use as a fuel and water for use in humidifying.
9. Soot blowing for boiler furnaces.
10. Mixing or agitating materials for a process.

Using compressed air to drive tools and other machinery has certain advantages over the use of electricity or steam for these purposes.

1. Compressed air machines can not be damaged by overloading as can electric motors. When the load is too great, the compressed air machine simply slows down or stops.
2. Air driven hand tools are lighter in weight than the electric type.
3. Air driven hand tools do not become hot after extensive use as do the electric type.
4. No danger to the operator of electric shock.
5. Compressed air machinery may be used in explosive atmospheres without hazard because they are free from sparking contacts.
6. Transmission losses are less with air than with steam, since none of the air will condense in the pipelines as is the case with steam.
7. Less danger of personnel being burned from contact with air piping compared to steam piping.

On the other hand, compressed air tools are usually more expensive than are electrically driven tools and air transmission piping is more expensive and more difficult to install than electrical wiring.

Air Compressor Classification

There are two main classifications of compressors, namely; the positive displacement types and the dynamic types.

With the positive displacement types, the air is compressed by the pushing action of pistons or vanes or lobes.

With the dynamic types, the air is first accelerated by impellers or blades and then the velocity of the air is converted to pressure in a diffusing section.

This lecture will deal with the positive displacement compressors and the following lecture will deal with the dynamic types and with compressor auxiliaries.

POSITIVE DISPLACEMENT COMPRESSORS

Positive displacement compressors are so called because a definite amount of air is compressed for every stroke or revolution of the compressor. They may be divided into two general types: reciprocating compressors which employ pistons and rotary compressors which employ vanes or lobes.

Reciprocating Compressors

A reciprocating compressor is one in which the air is compressed by a piston moving in a reciprocating manner within a cylinder. The cylinder must be equipped with intake and discharge valves to control the flow of air entering and leaving. This type of compressor is used in a wide variety of applications including power plant service and commercial, industrial, and mining installations. It is suitable for all ranges of pressure.

Reciprocating compressors are made in a variety of designs or arrangements and may be divided into types according to: whether they are single- or double-acting, cylinder arrangement, method of compression, and method of drive.

Single- or Double-acting.

With the single-acting type, compression takes place at one end of the cylinder only, therefore there is only one compression stroke for every crankshaft or flywheel revolution.

With the double-acting type, compression takes place at both ends of the cylinder and therefore there are two compression strokes per revolution.

A single-acting compressor is illustrated in Fig. 1, while Fig. 2 shows the arrangement of a double-acting compressor cylinder.

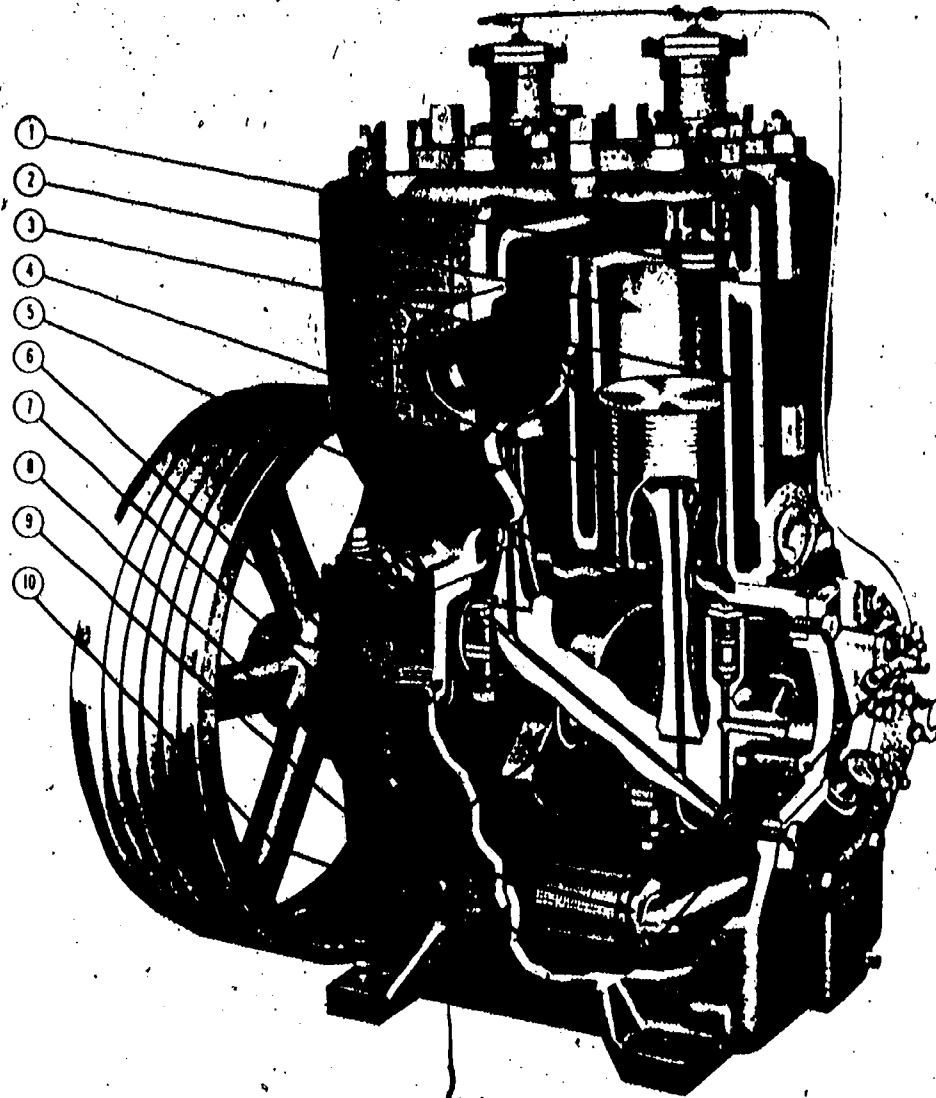

Single-acting Compressor (Colt Industries).

Fig. 1

Referring to Fig. 1, the numbered parts are as follows:

- | | |
|---------------------------|-----------------------------|
| 1. plate type valve | 6. crankcase |
| 2. cylinder | 7. crankcase door |
| 3. cylinder water jacket | 8. crankshaft counterweight |
| 4. automotive type piston | 9. oil screen |
| 5. connecting rod. | 10. low oil pressure alarm |

In this single-acting compressor, the air is compressed during the upward-stroke of the piston. During the downward stroke, more air is drawn into the cylinder.

PE3-4-5-4

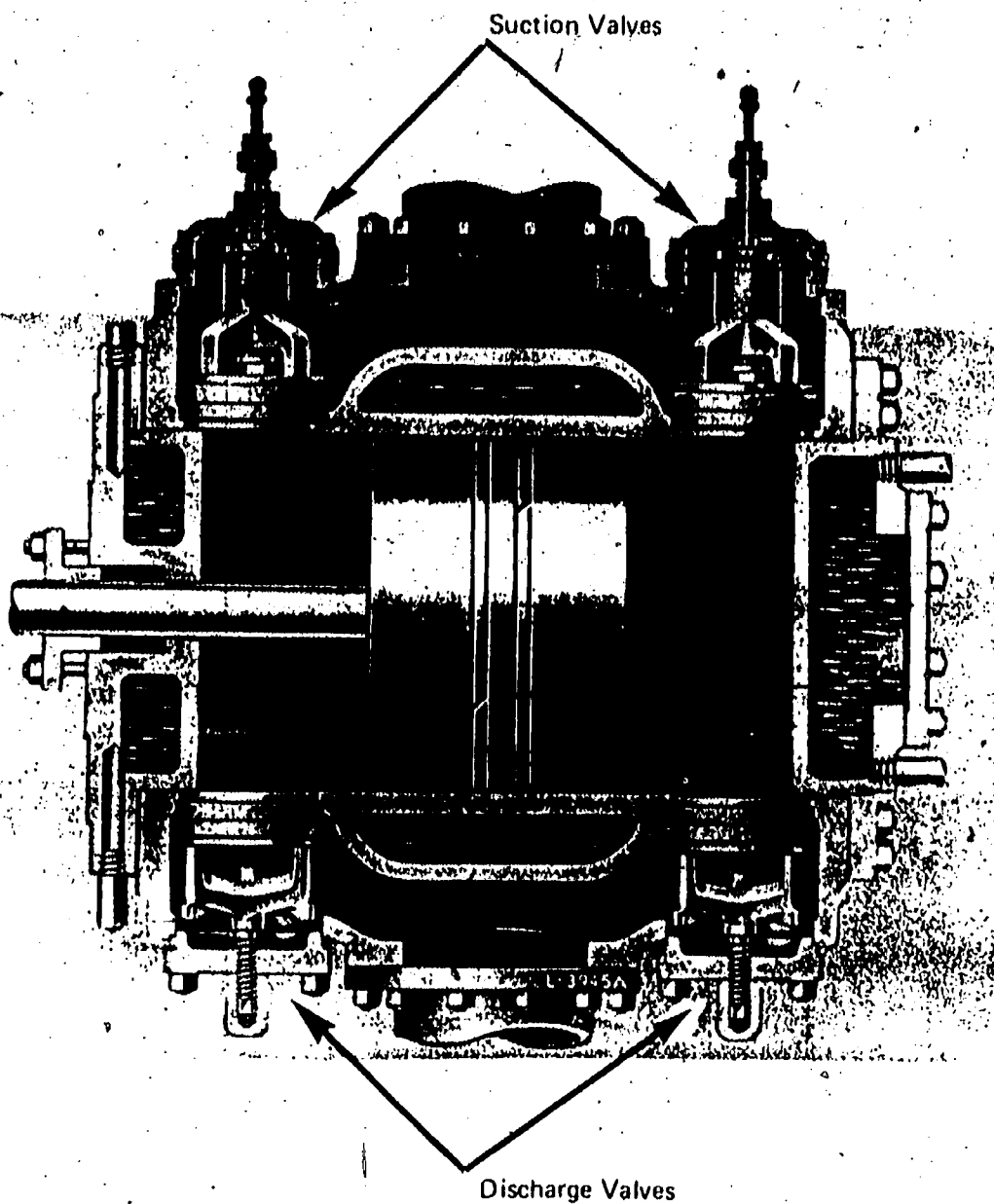

Double-acting Compressor Cylinder (Worthington Corporation)

Fig. 2

Referring to Fig. 2, when the piston moves to the left, a partial vacuum is formed in the right end of the cylinder and air is drawn in through the right hand suction valve. At the same time air is being compressed by the piston and forced out through the left hand discharge valve. When the piston reverses and moves to the right it will compress the air to the right of it and force the air through the right hand discharge valve. At the same time air will be drawn into the cylinder through the left hand suction valve.

PE3-4-5-5

Cylinder Arrangement

Various cylinder arrangements are used in reciprocating compressor design. The compressor cylinder may be arranged with its axis vertical or horizontal, or in some cases, where two cylinders are used, one cylinder may be vertical and the other horizontal. The latter arrangement is known as an angle compressor. Still another arrangement is the V or Y type, which has two cylinders with their axis at an angle of 45° .

The compressor in Fig. 1 is a vertical type, while Fig. 2 is a horizontal type. Fig. 3 shows an angle compressor and the Y type appears in Fig. 4.

Method of Compression

For compressed air pressure up to 850 kPa or possibly 1000 kPa, the air is compressed to the desired pressure in one cylinder which may be either single-acting or double-acting. This arrangement is referred to as single-stage compression.

For pressures from 1000 kPa to about 6900 kPa the air is compressed first in a low pressure cylinder and then further compressed to the final pressure in a high pressure cylinder. This arrangement is known as two-stage compression. The cylinders may be either single-acting or double-acting for sizes below 150 kW. Above this size the cylinders are usually double-acting type.

For special applications where pressures above 6900 kPa are required, the compressors used may have up to six cylinders in series. A compressor having six cylinders in series would be referred to as a six-stage compressor, and in this case, the highest pressure cylinders would be single-acting.

The compressors illustrated in Fig. 3 and Fig. 4 are both two-stage compressors each having a low pressure and a high pressure cylinder.

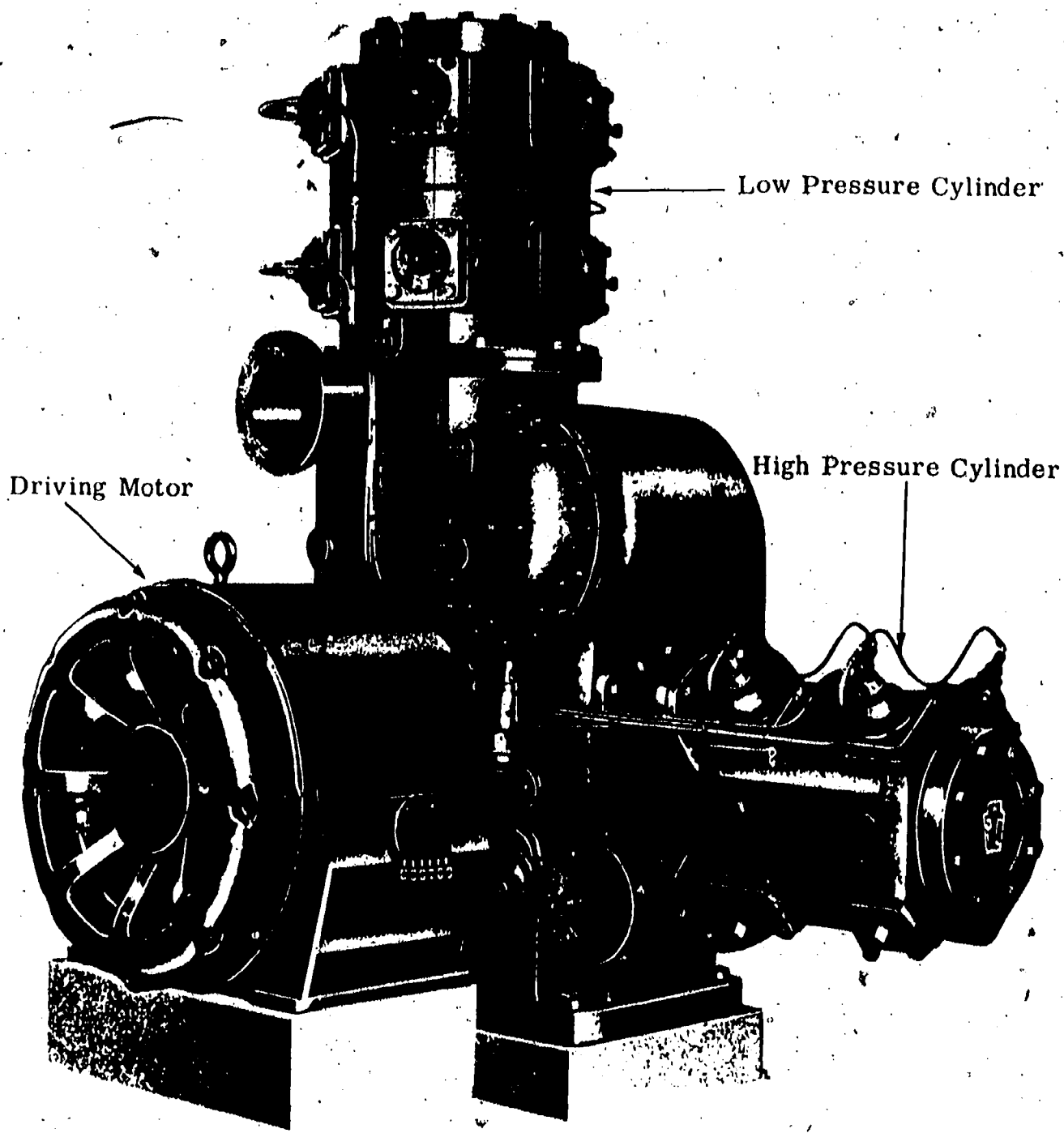

Angle Type Compressor (Rennsylvania Pump and Compressor Co.)

Fig. 3

PE3-4-5-7

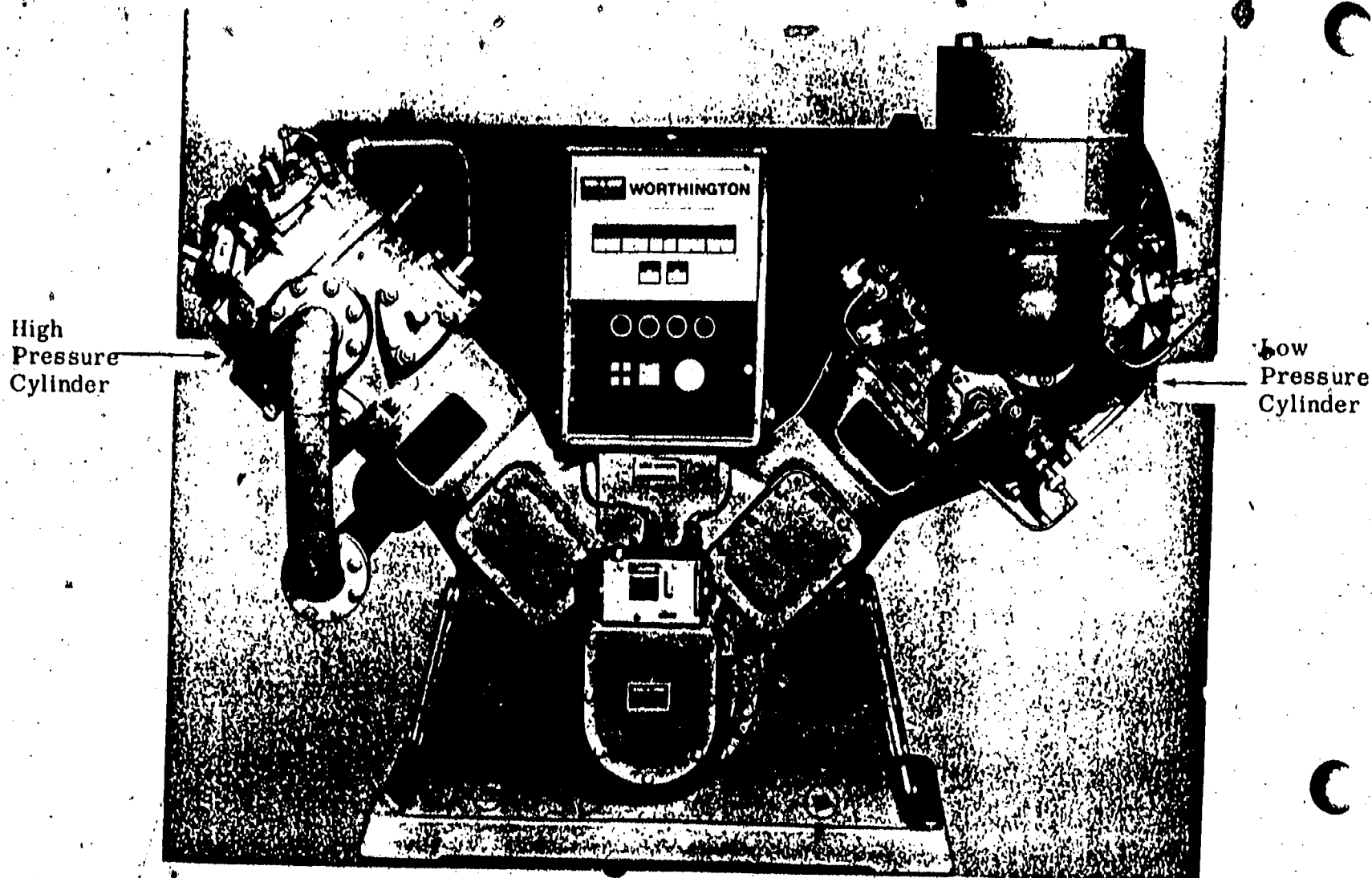

Y Type Compressor (Worthington Corporation)

Fig. 4

Method of Drive

The four principal driving methods for reciprocating compressors are: by electric motor, by internal combustion engine, by steam engine, and by steam turbine.

1. Electric Motor Drive

Electric motors are commonly used to drive all sizes of reciprocating compressors. They may be connected directly to the compressor shaft or they may use belts or speed reduction gears.

PE3-4-5-8

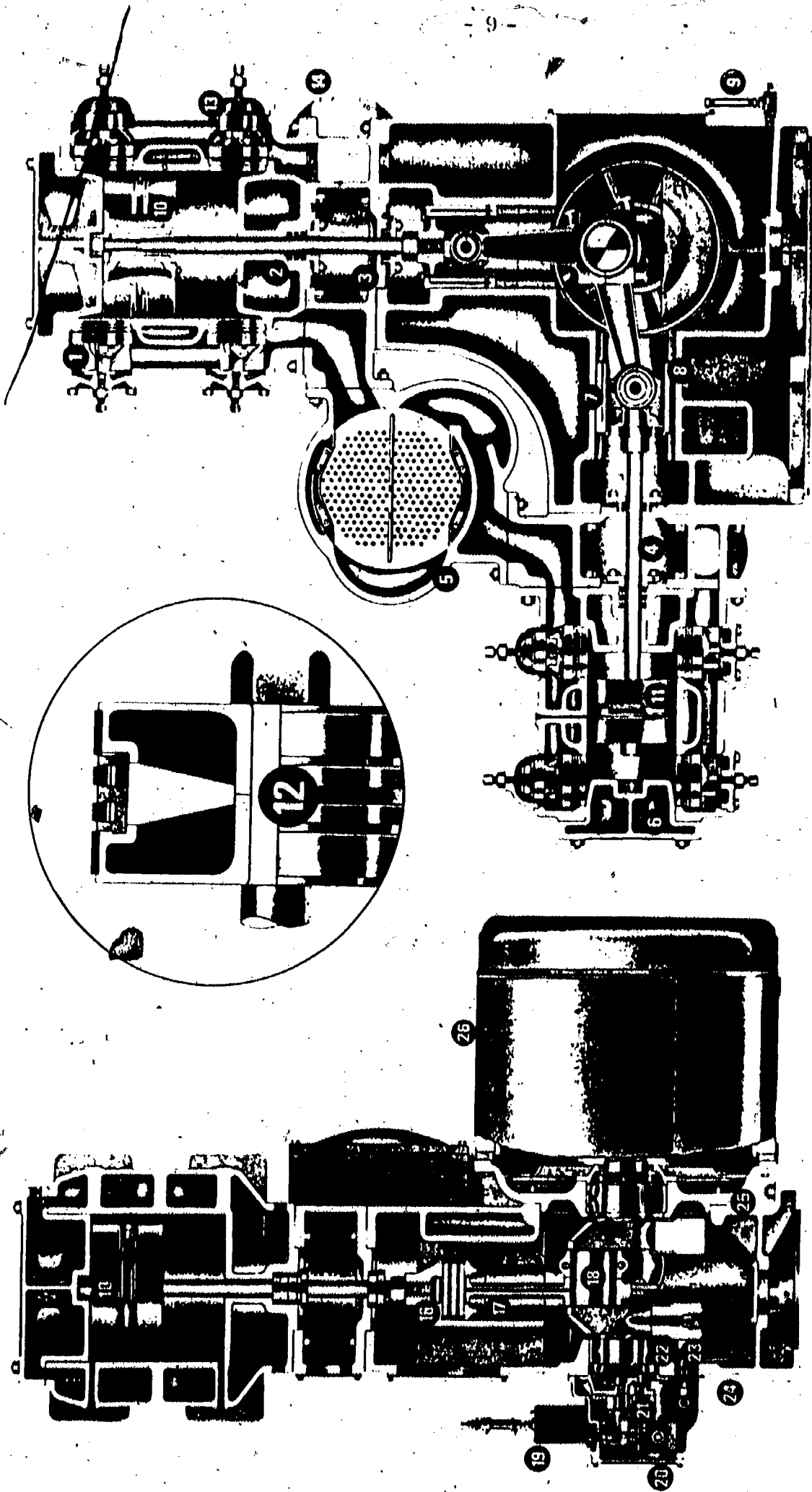

Two-stage Angle Compressor With Flange Mounted Motor
 (Pennsylvania Pump and Compressor Co.)

Fig. 5

PE3-4-5-9

Fig. 5 shows both a side view and an end view of a horizontal, two-stage, double-acting angle compressor, which is directly driven by an electric motor. The motor is bolted by means of a flange to the compressor casing (flange mounted) and the motor rotor is keyed to the compressor crankshaft.

The numbered parts in the illustration are as follows:

- | | |
|-----------------------------------|----------------------------------|
| 1. discharge valve | 14. suction connection |
| 2. piston rod packing | 15. clearance pocket - not shown |
| 3. piston rod oil scraper | 16. crosshead pin |
| 4. piston rod | 17. connecting rod |
| 5. intercooler | 18. crankpin bearing |
| 6. cylinder water jacket | 19. cylinder lubricator |
| 7. crosshead | 20. oil filter |
| 8. crosshead guides | 21. oil pump |
| 9. oil level gage | 22. roller type main bearings |
| 10. low pressure piston | 23. crankshaft counterweight |
| 11. high pressure piston | 24. crankcase |
| 12. detail of teflon piston rings | 25. bearing support |
| 13. inlet valve | 26. frame mounted motor |

If oil-free air is desired then the compressor pistons would be fitted with teflon piston rings which require no lubrication. If oil-free air is not required then ordinary piston rings are installed and a cylinder lubricator (19 in Fig. 5) is used.

The compressor in Fig. 6 is a horizontal, single-stage, double-acting type, which is motor driven by means of V-belts. The V-belt drive is used as a speed reduction device to bring the motor speed, which may be 1800 rev/min, down to a speed suitable for a reciprocating compressor, say 300 rev/min.

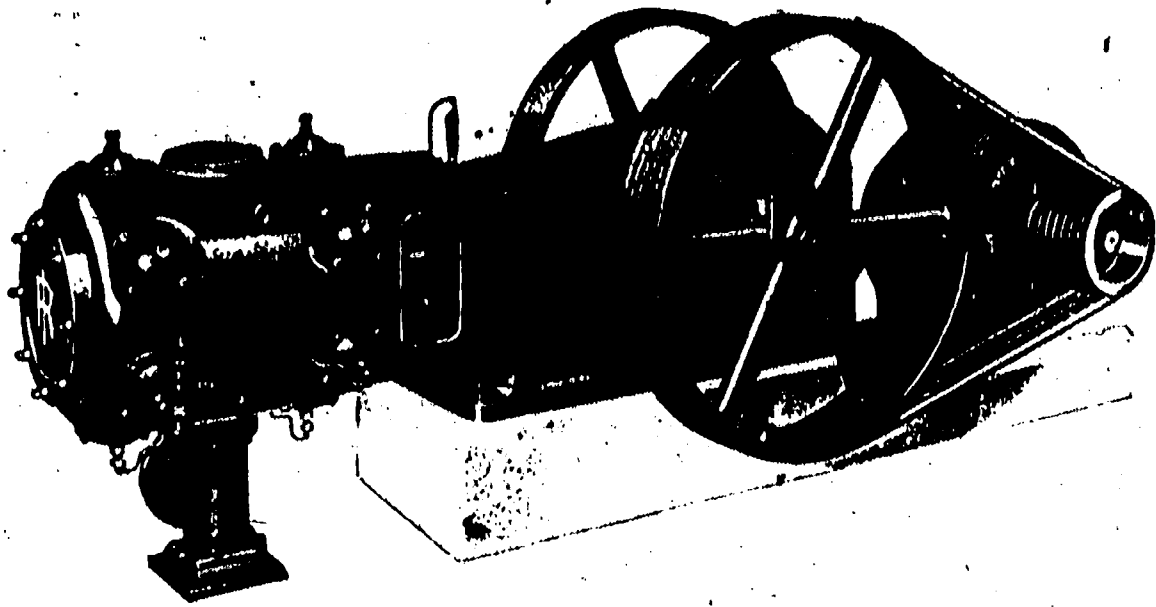

Single-stage, Double-acting Compressor (Ingersoll Rand)

Fig. 6

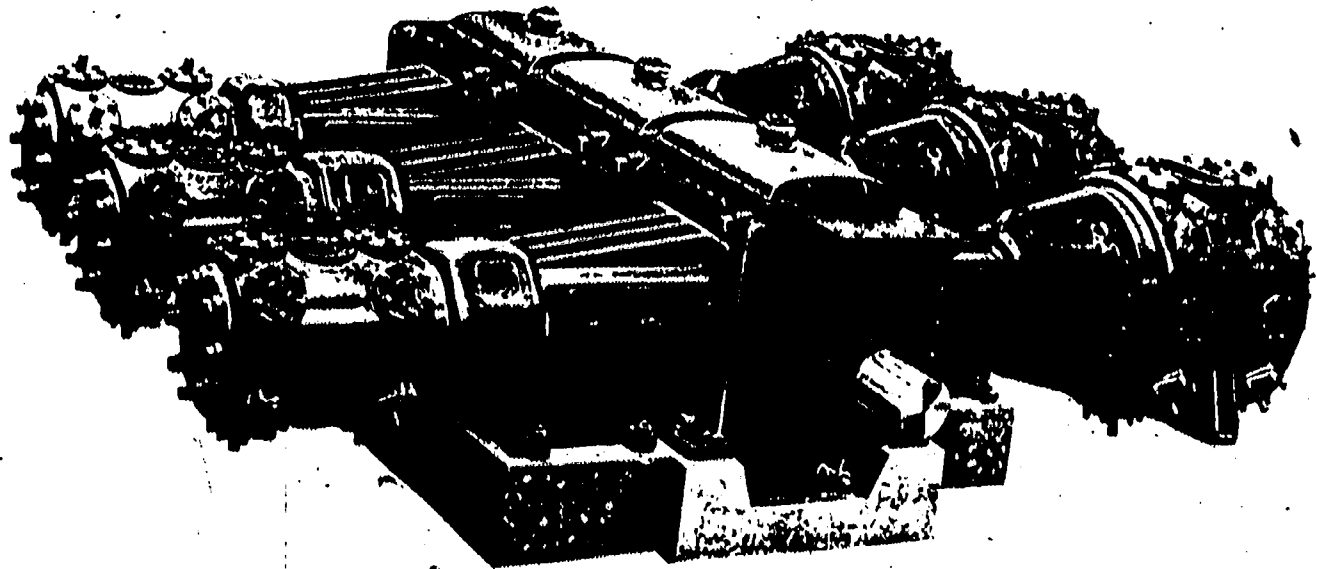

Balanced Opposed Compressor (Clark Bros. Co.)

Fig. 7

PE3-4-5-11

The compressor shown in Fig. 7 makes use of a cylinder arrangement featuring the balanced/opposed principle. Equal numbers of compressor cylinders are mounted on each side of a single crankcase with connecting rods from the cylinders attached to the crankshaft. The cranks are arranged so that opposite pistons are always moving in opposite directions, in this way cancelling any unbalanced forces. The electric motor used to drive this compressor is attached directly to an extension of the crankshaft.

2. Internal Combustion Engine Drive

Internal combustion engines used to drive compressors are usually of the gas fuel or diesel fuel type. The most common design has vertical engine cylinders that drive horizontal compressor cylinders through a common crankshaft.

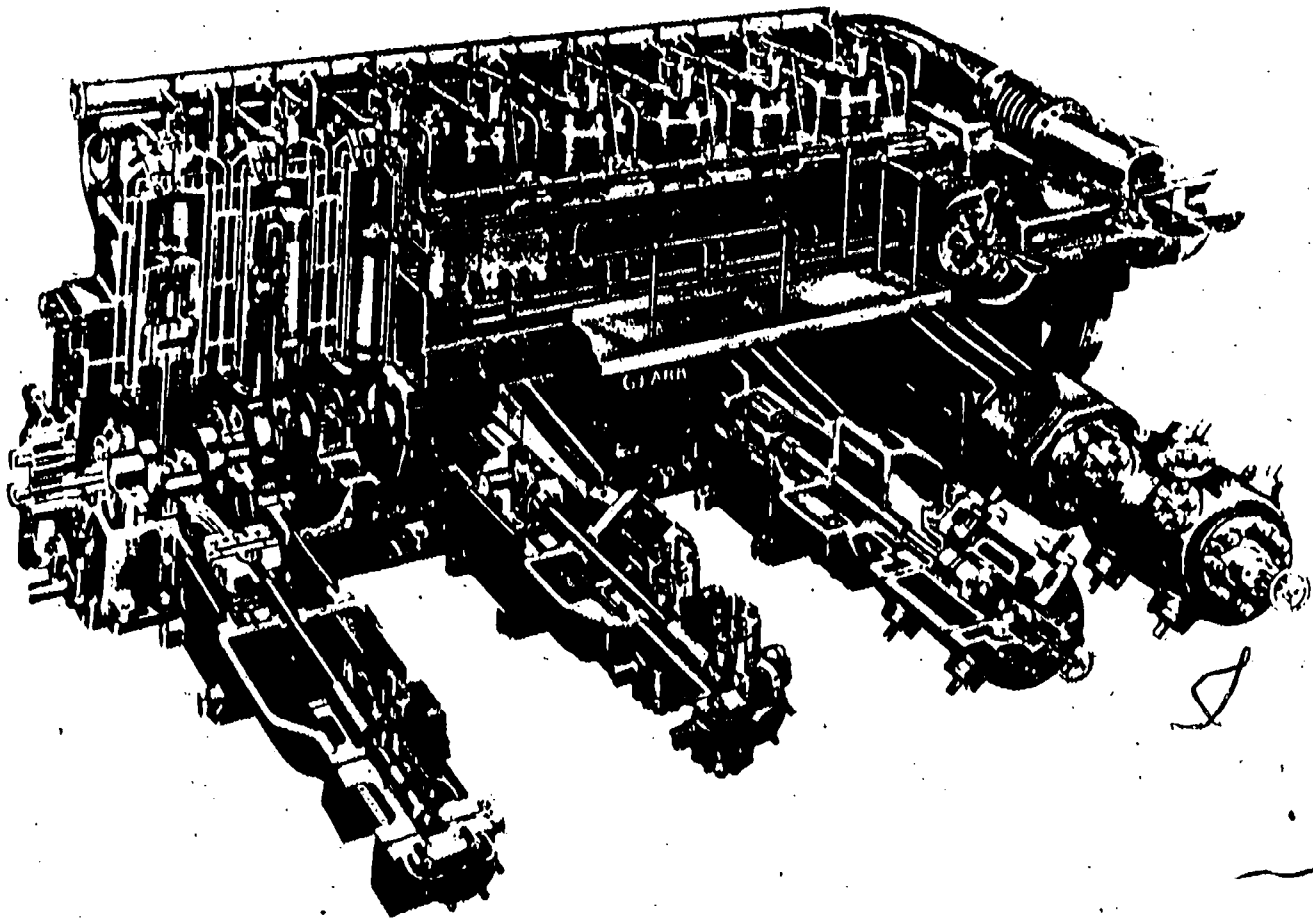

Gas Engine Driven Compressor (Clark Bros. Co.)

Fig. 8

The compressor unit in Fig. 8 consists of four horizontal compressor cylinders. These compressor cylinders are driven by a two-stroke cycle gas engine having eight vertical cylinders. As can be seen in the illustration, both the compressor connecting rods and the engine connecting rods are attached to a common crankshaft. The gas engine is rated at 1100 kW at shaft or shaft output

PE3-4-5-12

3. Steam Engine Drive

The reciprocating steam engine is the oldest method of driving reciprocating air compressors. It is still used extensively where its exhaust steam can be used for process, in which case it has the advantage of economy. A further advantage is that steam engines can be operated efficiently at variable speeds in order to control compressor output.

It is usual to have the engine as an integral part of the compressor on a common base. In most cases the engine cylinder and the compressor cylinder are in line horizontally in a tandem arrangement. Some larger machines have the steam engine vertical with the compressor cylinders horizontal. Two stage compressors are often driven by cross-compound engines.

Other machines, instead of using the integral design, have a separate steam engine which is coupled to a separate air compressor.

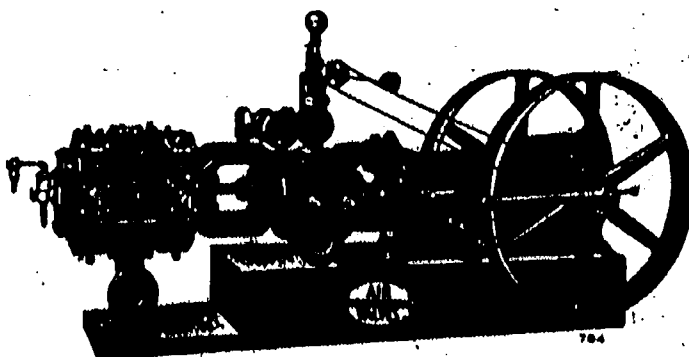

Steam Engine Driven Compressor, Tandem
(Pennsylvania Pump and Compressor Co.)

Fig. 9

The horizontal, double-acting, single-stage compressor shown in Fig. 9, is driven by a steam engine. The two are arranged in tandem with the engine located between the compressor and the flywheels.

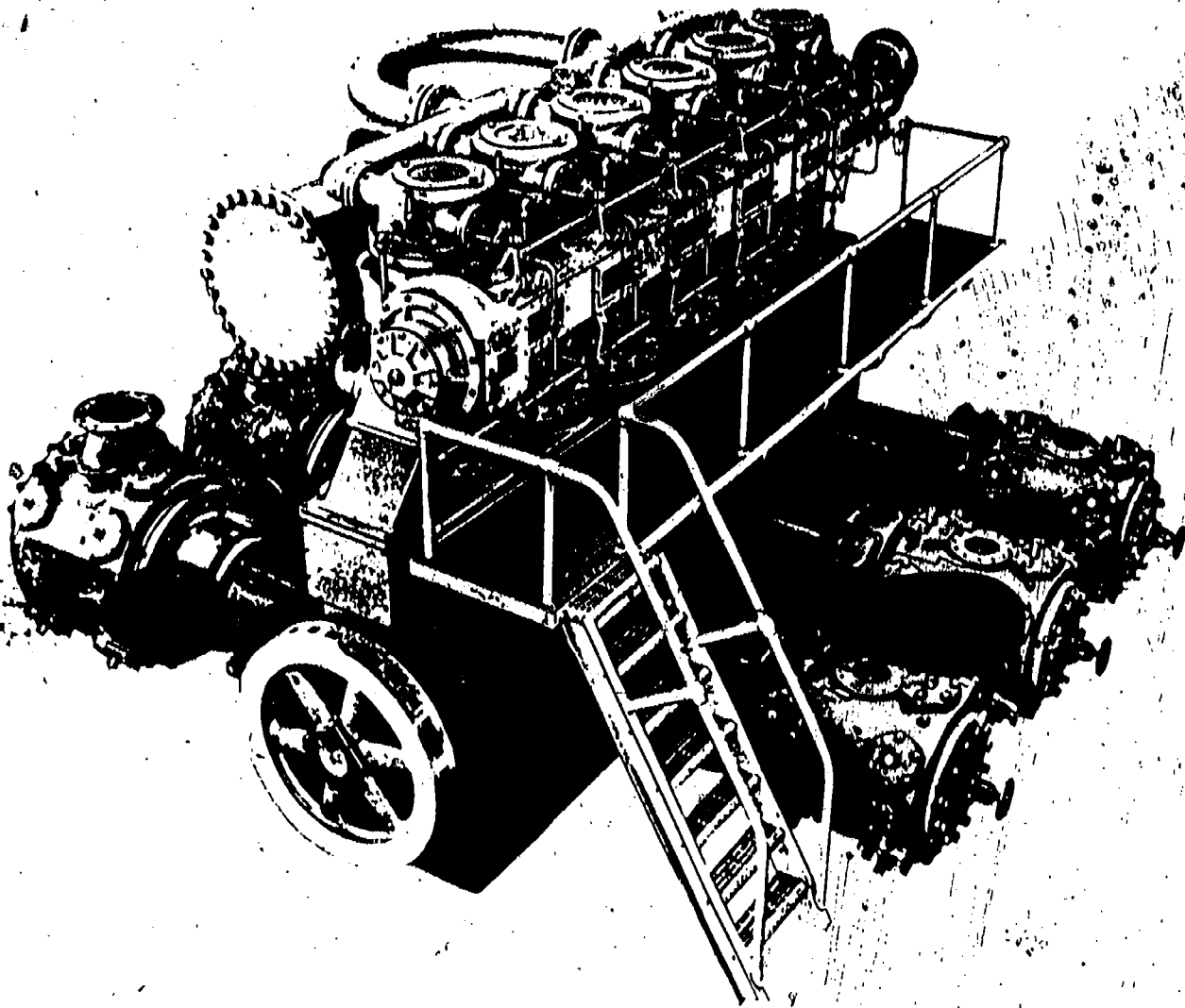

Uniflow Engine Driven Compressor
(Clark Bros. Co.)

Fig. 10

The compressor in Fig. 10 features six horizontal compressor cylinders which are driven by six vertical steam engine cylinders by means of a common crankshaft. Both the compressor cylinders and the engine cylinders are double-acting and the engine cylinders employ the uniflow principle.

The vertical compressor in Fig. 11 is driven by a cross-compound vertical steam engine.

PE3-4-5-14

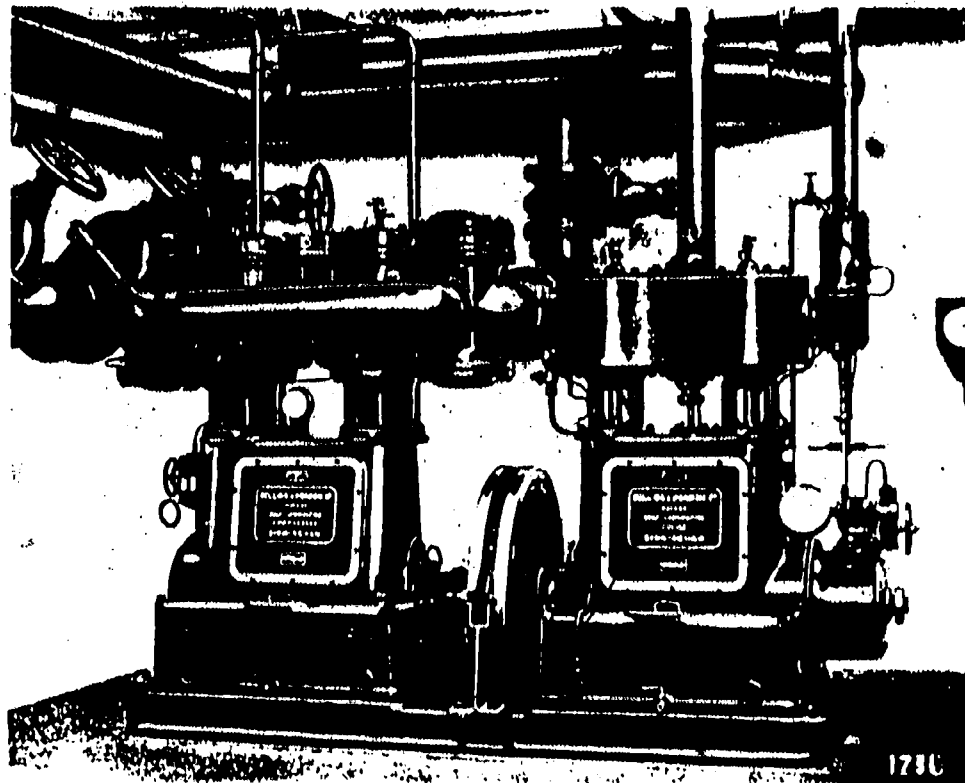

Independent Steam Engine Driven Compressor
(Belliss and Morcom)

Fig. 11

4. Steam Turbine Drive

Where oil-free exhaust steam is required for process, a steam turbine may be preferred for compressor drive rather than a steam engine, although the steam engine is more economical. As the steam turbine operates at relatively high speed, a speed reducing gear arrangement must be used.

Reciprocating Compressor Parts

1. Cylinders

Compressor cylinders are made from cast iron for pressures up to 1000 kPa or cast steel for pressures up to 6900 kPa. Above this pressure the material used is usually forged steel.

When the compressor is in operation, the cylinder is heated due to the heat of compression and the friction of the piston rings. It is necessary, therefore, to remove this heat and to maintain the cylinder at a reasonable operating temperature. This is done by means of water-cooling or by air-cooling.

If water-cooling is used then the cylinder is constructed with a chamber or water jacket surrounding the cylinder barrel through which cooling water is circulated.

PE3-4-5-15

If air-cooling is used then the cylinder is constructed with integral cast fins which provide increased radiating area.

More efficient cooling is obtained with water-cooling than with air-cooling. The air-cooled machine, however, has the advantages of simple construction, less piping needed, and no freezing hazard.

A cross-section of a water jacketed cylinder is shown in Fig. 12, while a small motor driven air-cooled compressor is shown in Fig. 13.

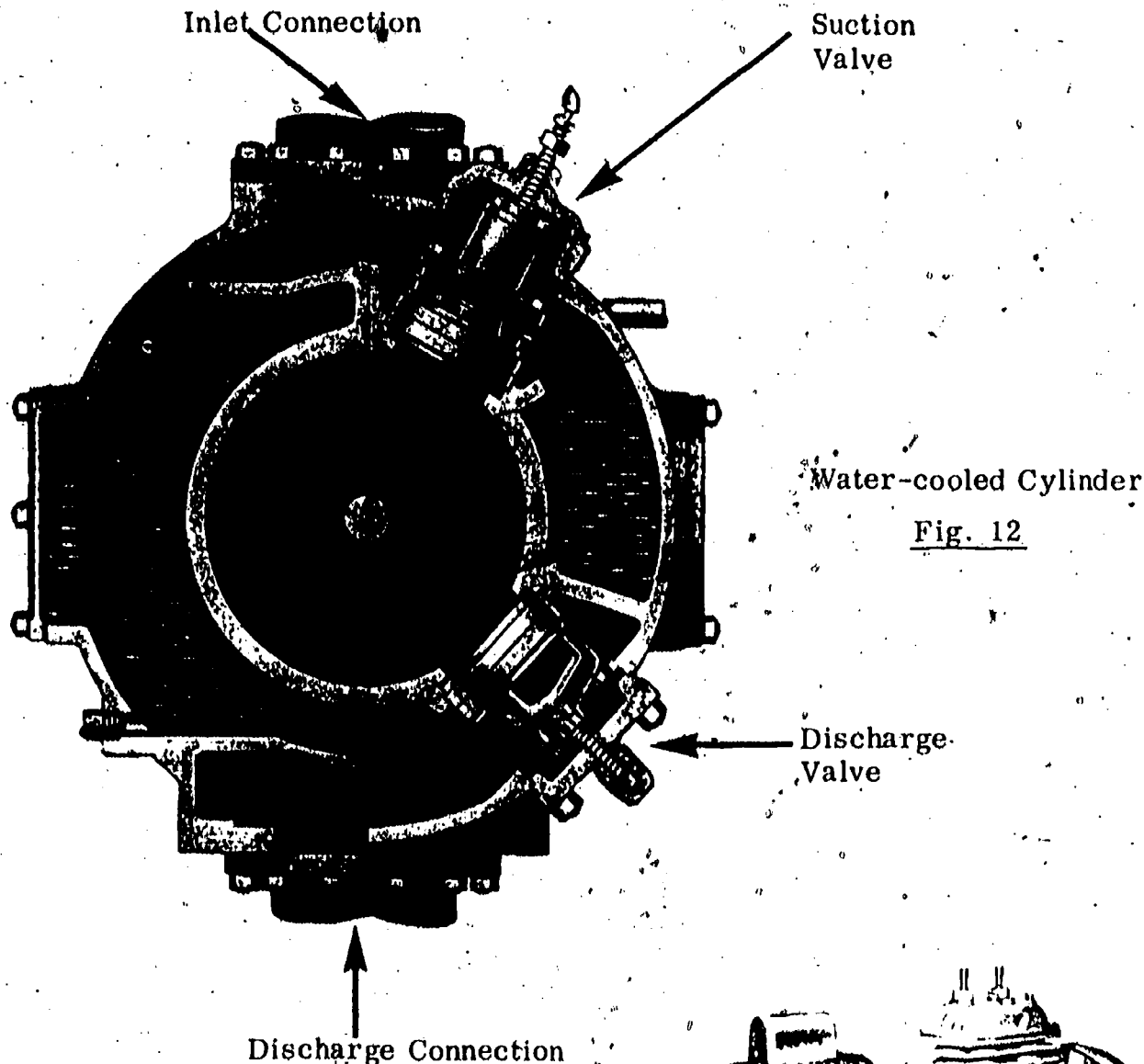

Water-cooled Cylinder
Fig. 12

Air-cooled Compressor
(Colt Industries)

Fig. 13

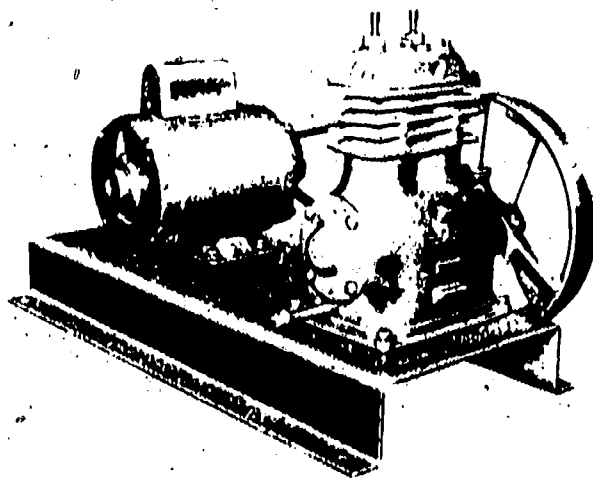

PE3-4-5-16

2. Running Gear Parts

The running gear of a reciprocating compressor consists of piston, piston rod, crosshead, connecting rod, and crankshaft. These parts are illustrated and briefly described as follows.

Pistons may be constructed of steel, cast iron, or aluminum. Trunk type (automotive type) pistons are used for single-acting compressors while double-acting pistons may be solid or hollow and are normally fitted on the piston rod with a taper fit against a machined shoulder on the rod and are locked in place by means of a nut. If cylinder lubrication is used, then piston rings are of cast iron. If oil-free operation is desired, then teflon or carbon rings are employed.

Fig. 14 illustrates two types of compressor pistons, the single-acting trunk type and the double-acting type.



Single-acting Piston

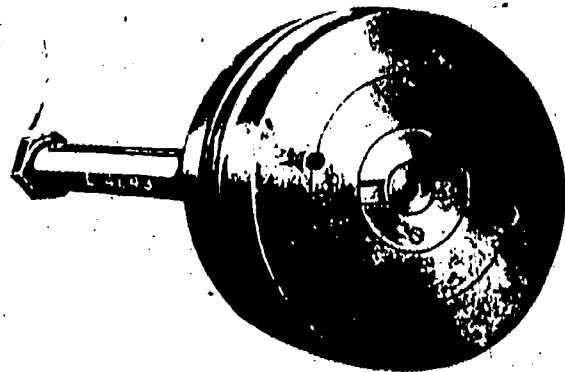

Double-acting Piston

Fig. 14

With the single-acting piston, the connecting rod serves as a piston rod as well, as shown in Fig. 14, while the double-acting piston is attached to a crosshead by means of a steel piston rod.

The crosshead is of steel with upper and lower bearing surfaces which contact the crosshead guides. A threaded hole is provided in one end of the crosshead into which the piston rod fits.

The crosshead pin to which the connecting rod is attached is usually held rigid in the connecting rod and moves within bearings or bushings in each side of the crosshead. In some designs, however, the crosshead pin is securely fastened in the crosshead and the bearing or bushing is in the connecting rod end.

Fig. 15 illustrates the construction of a compressor crosshead.

PE3-4-5-17

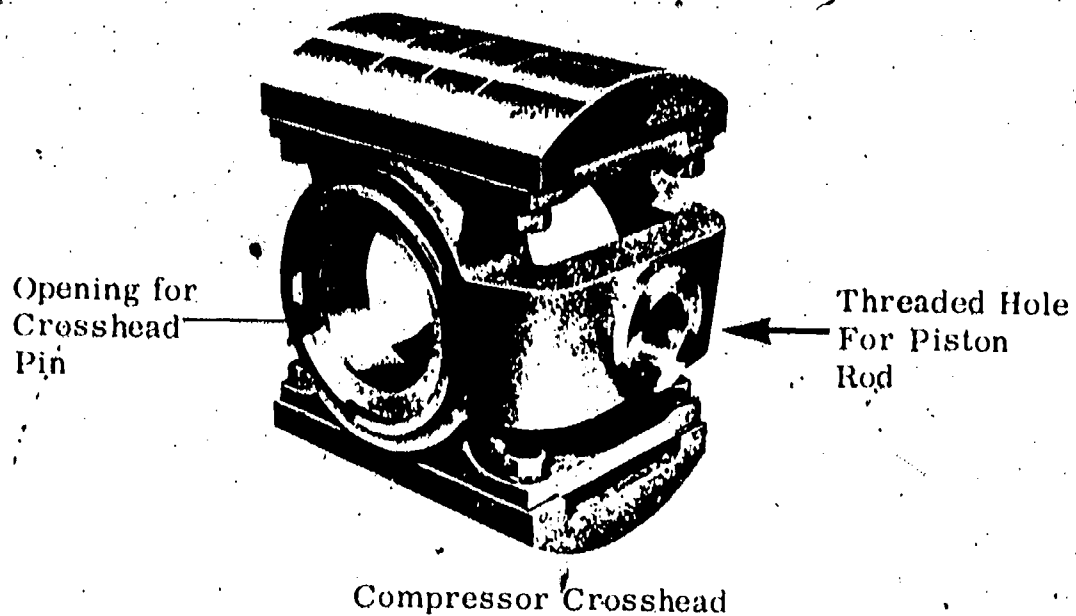

Fig. 15

Compressor connecting rods are constructed of forged steel and have a crankpin bearing at one end and an opening for the crosshead pin (or for the piston pin of a trunk type piston) in the other end.

Fig. 16 shows two designs of connecting rod and Fig. 17 illustrates a connecting rod attached to the crosshead pin within the crosshead.

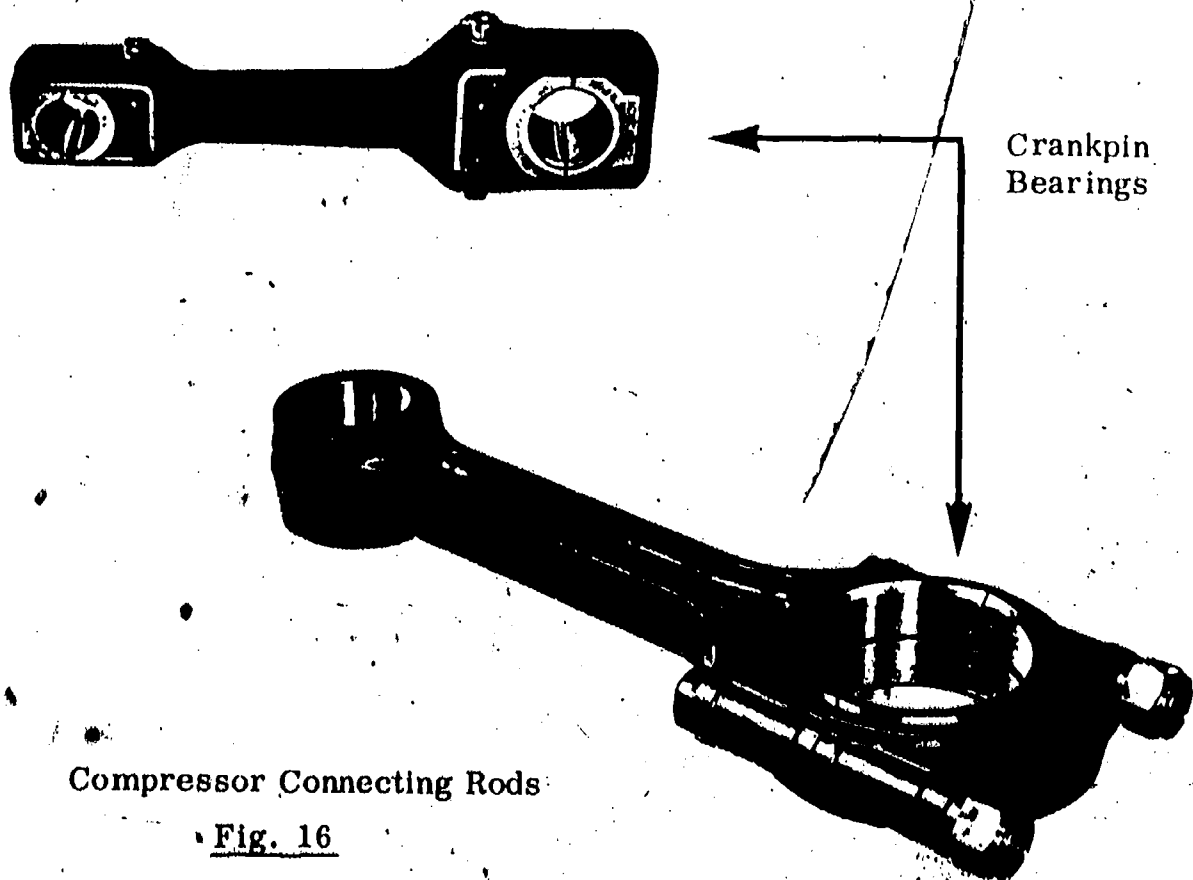
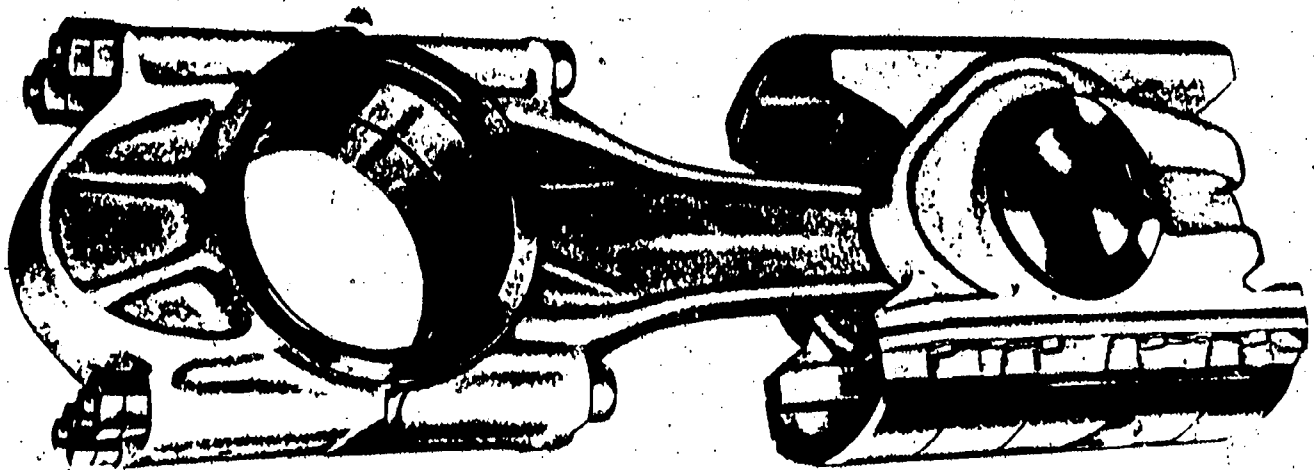

Fig. 16

PE3-4-5-18



Crosshead and Connecting Rod

Fig. 17

Compressor crankshafts are of forged steel and are usually made from a single forging which has been machined and ground to precision limits and drilled to provide oil passages for positive pressure lubrication. In order to balance reciprocating and rotating forces, the crankshaft may be made with counterweights as shown in Fig. 18, or else it may be the type shown in Fig. 19, which has opposing crank throws to provide balance.

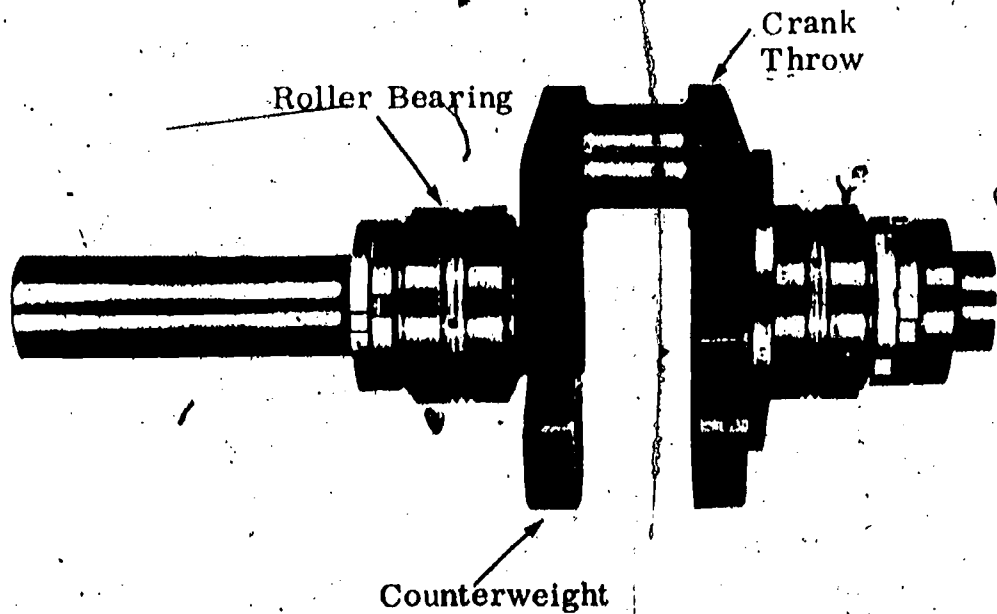

Counterweighted Crankshaft (Worthington Corporation)

Fig. 18

PE3-4-5-19

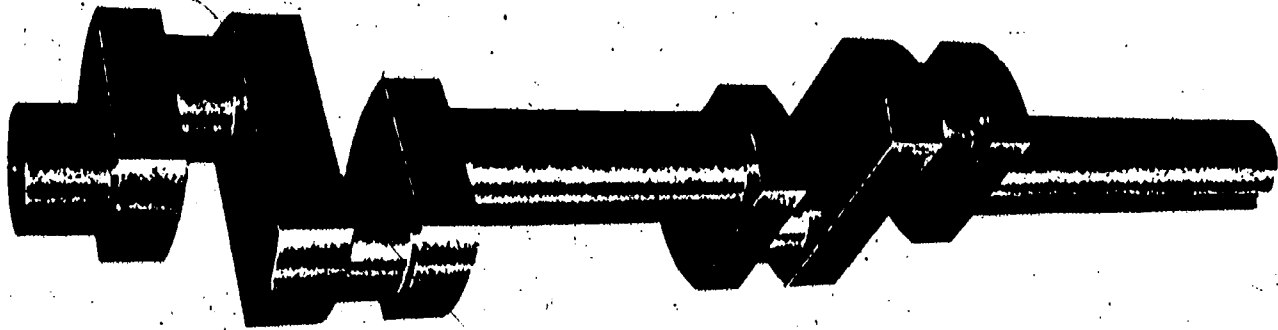

Crankshaft With Opposed Crank Throws

Fig. 19

3. Compressor Valves

Compressor valves are usually the automatic type which open and close on a pressure difference. Two commonly used designs are the plate or disc type and the channel type.

A disc type valve is shown in Fig. 20.

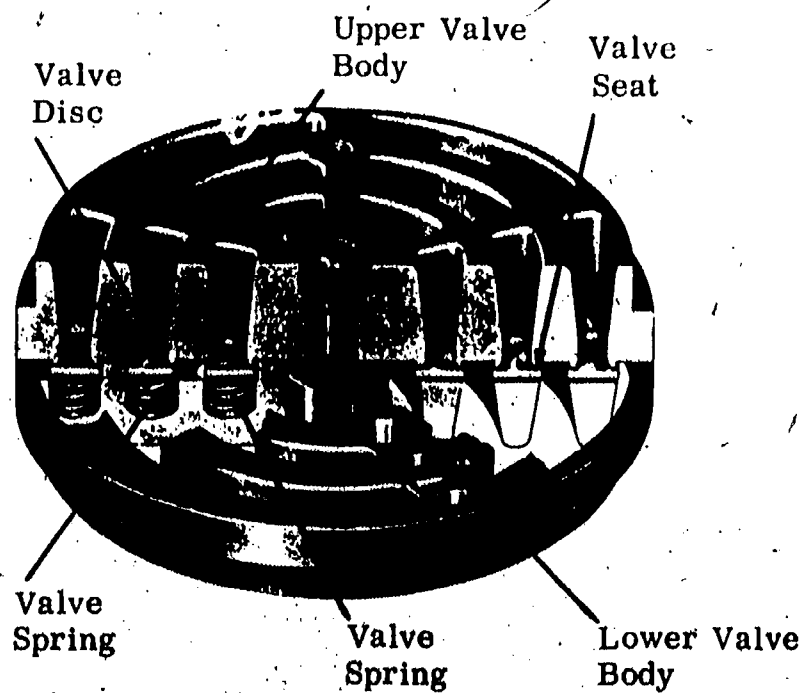

Disc Type Valve

Fig. 20

PE3-4-5-20

In the disc type valve in Fig. 20, the air entering through the ribbed upper body, forces the valve discs down against the cushioning action of the spring. The air then passes through between the valve discs and the valve seats and out through the ribbed lower valve body.

Fig. 21 shows the parts of a channel type valve.

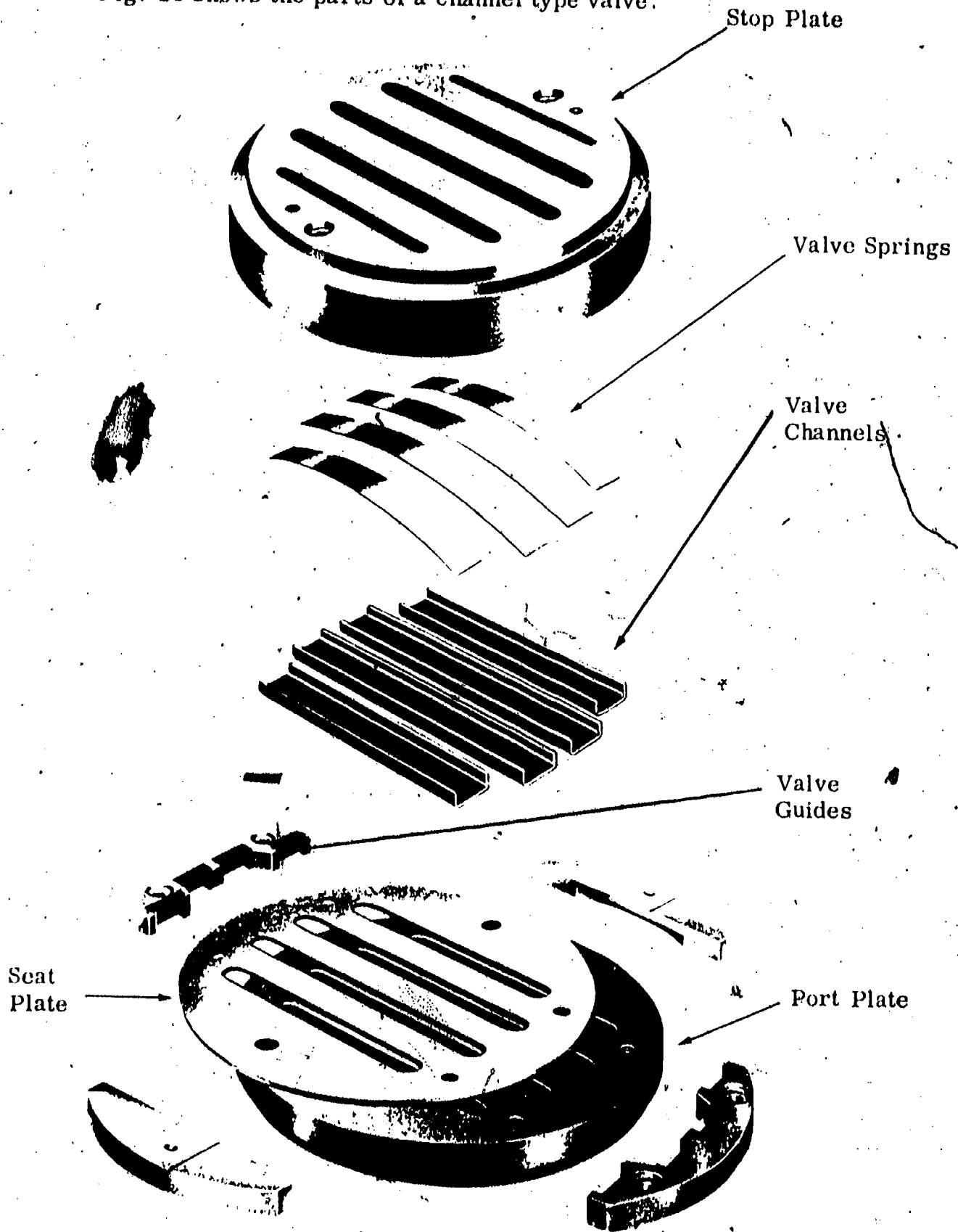

Channel Type Valve

Fig. 21

In the channel type valve the port plate and the seat plate fit together with their passages or openings corresponding. The valve channels fit over these openings and are held down against the seat plate by the valve springs which fit inside the channels and are held in place by the stop plate. The air, entering through the port plate, pushes the channels up off the seat plate against the springs and the air then passes through the openings in the stop plate. Strips of self-lubricating material are placed within the channels to prevent metal to metal contact between the channels and the valve springs.

The Free Piston Compressor

This is a special type of reciprocating compressor featuring a central combustion chamber of the diesel type containing opposed pistons each of which drives another piston within an air cylinder. One of these air cylinders acts as an air cushioning section while the other air cylinder acts as a compressed air producing section.

Fig. 22 illustrates the principle of operation of the free piston machine.

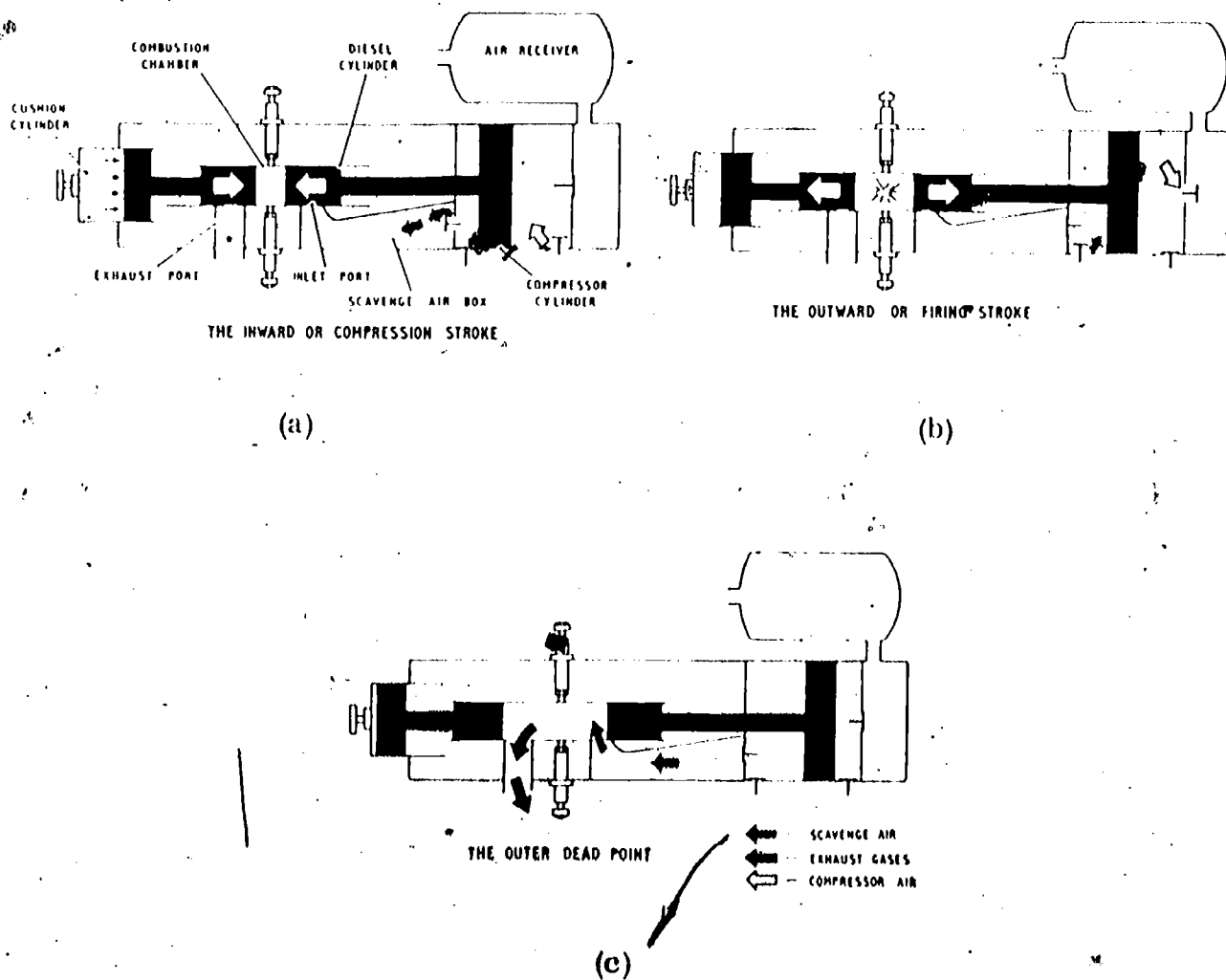

Free Piston Engine Principle of Operation
(Mackay Industrial Equipment Ltd.)

PE3-4-5-22

Fig. 22

BEST COPY AVAILABLE

In (a) in Fig. 22, the two opposed diesel pistons move inwardly, compressing the charge of air trapped between them. At the same time the inner side of the large compressor piston is forcing air into the scavenge air box below the piston rod while air is being drawn into the compressor cylinder on the outer side of the compressor piston. Near the end of the compression stroke, fuel is injected and the power stroke begins.

In Fig. 22 (b), the power stroke is taking place, in which the diesel pistons are forced apart. This causes the large compressor piston to compress the air in the compressor cylinder and deliver it to the air receiver, while at the same time scavenge air is being drawn into the cylinder on the inner side of the compressor piston. At the other end of the machine, the cushion piston is compressing the air in the cushion cylinder and this compressed air will act as a flywheel to force the pistons together again.

Fig. 22 (c) shows the end of the power stroke with the inlet port and the exhaust port for the diesel cylinder both uncovered. Scavenge air then flows from the scavenge air box into the diesel cylinder and the exhaust gases are expelled through the exhaust port. The compressed air in the cushion cylinder, as mentioned, now forces the pistons together again as shown in (a) and the cycle is repeated.

Fig. 23 depicts the general arrangement of the free piston compressor parts. Note that two fuel injectors are used, one at the top and one at the bottom sides of the diesel cylinders.

Rotary Compressors

Like the reciprocating compressor, the rotary compressor is classed as a positive displacement type. Several different designs are in use, the most common being: the sliding vane type, the lobe type, and the screw type.

1. The Sliding Vane Compressor

The sliding vane compressor consists essentially of a cylindrical rotor having radial slots into which sliding vanes fit. The rotor is contained within a water jacketed cylinder or casing and is supported by bearings so that it is eccentric to the casing. As the rotor turns, the sliding vanes move out against the casing wall due to centrifugal force. Pockets of air are trapped between the vanes and the wall. These pockets decrease in volume, due to the eccentricity, as the vanes move around the casing from the intake to the discharge and in this way the air is compressed.

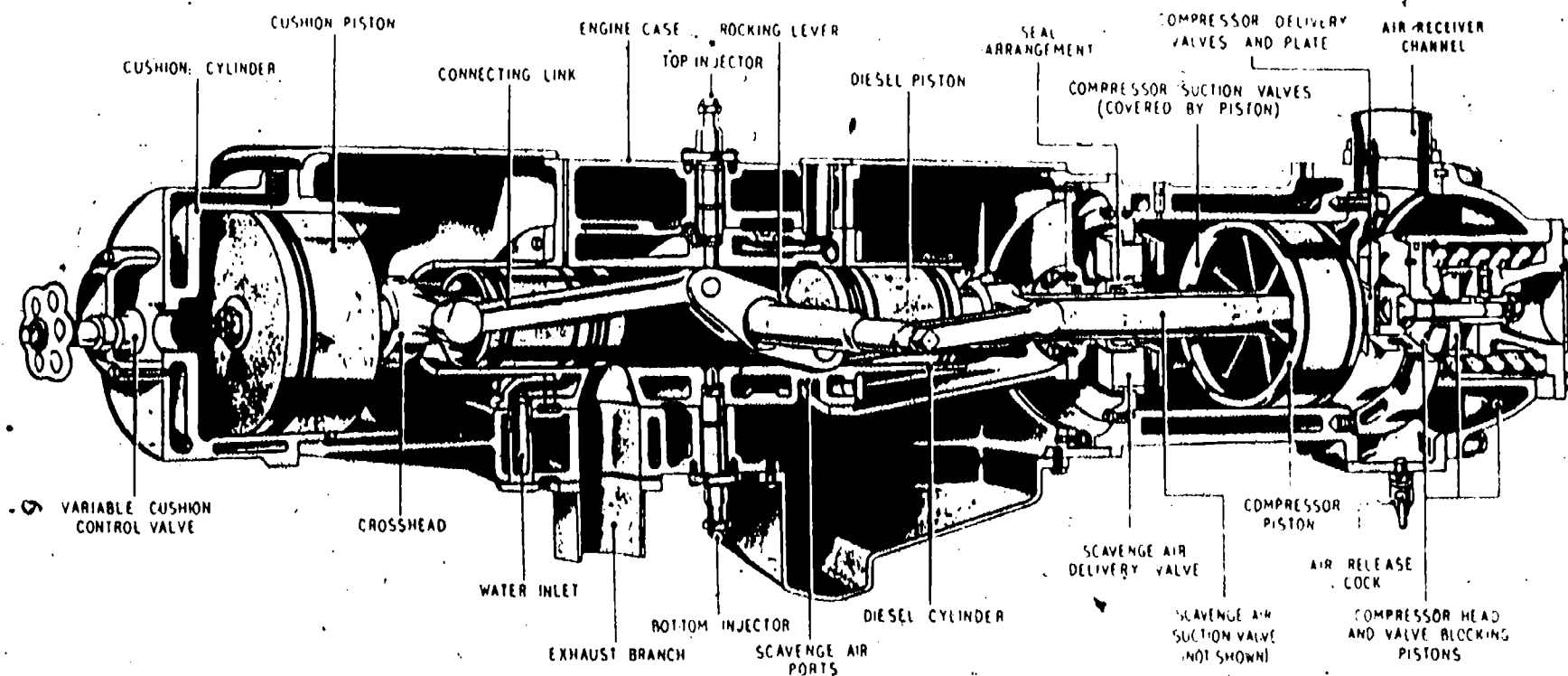

Free Piston Compressor

Fig. 23

- 24 -

Fig. 24 shows a sectional view of the casing and rotor of a sliding vane compressor.

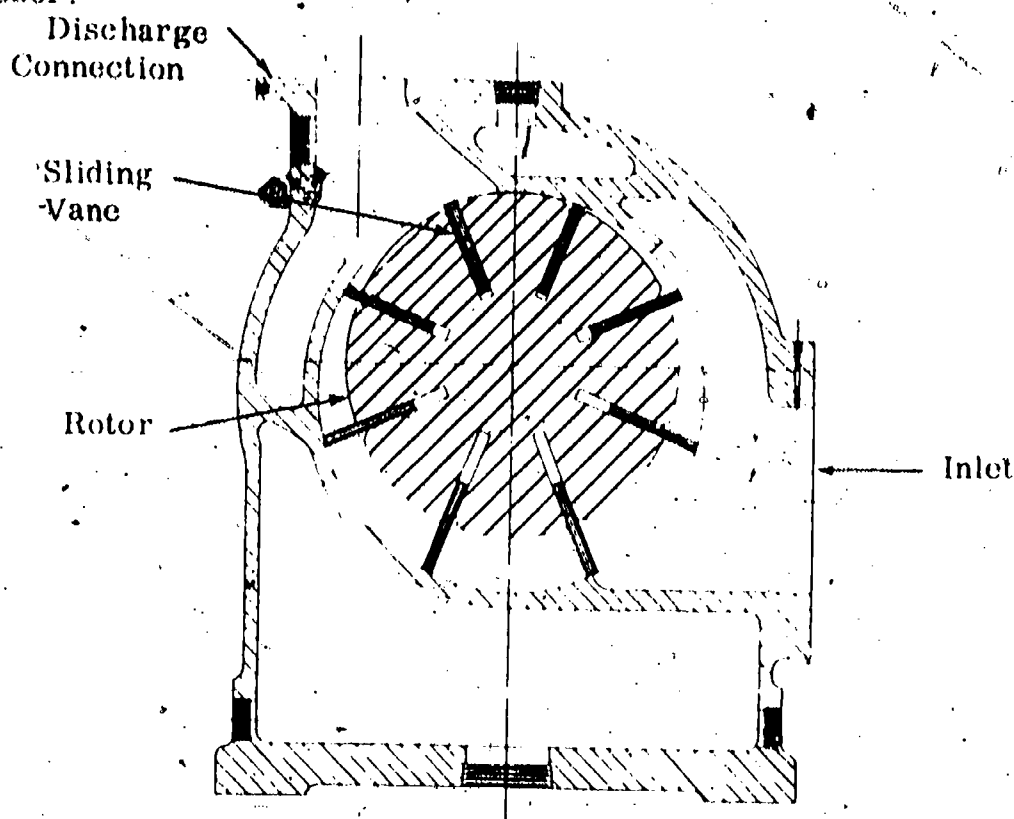

Sliding Vane Compressor, Sectional View
(Allis Chalmers)

Fig. 24

A two-stage sliding vane compressor is illustrated in Fig. 25. The air is first compressed in a low pressure compressor and then flows through a shell and tube intercooler to a high pressure compressor. The two compressor shafts are connected by a flexible coupling and the drive for the unit may be applied at either the high or low pressure side.

The operating speed of this type ranges up to 3,000 rev/min and the most common drive is a direct connected induction motor. Steam turbines and internal combustion engines are also used with speed reducing or increasing gears where necessary. Discharge pressure may be as high as 1000 kPa.

Lubrication is provided under pressure by a belt driven lubricator to bearings and to cylinders.

The sliding vane compressor is less efficient than the reciprocating compressor but it has a lower first cost and produces a steadier flow of air. In addition it has low starting torque requirements because on starting, compression does not begin until sufficient speed has been reached to cause the vanes to move out against the cylinder wall due to centrifugal force.

Another important advantage of the sliding vane compressor is that it does not require inlet or discharge valves. This advantage is common to all rotating compressors.

PE3-4-5-26

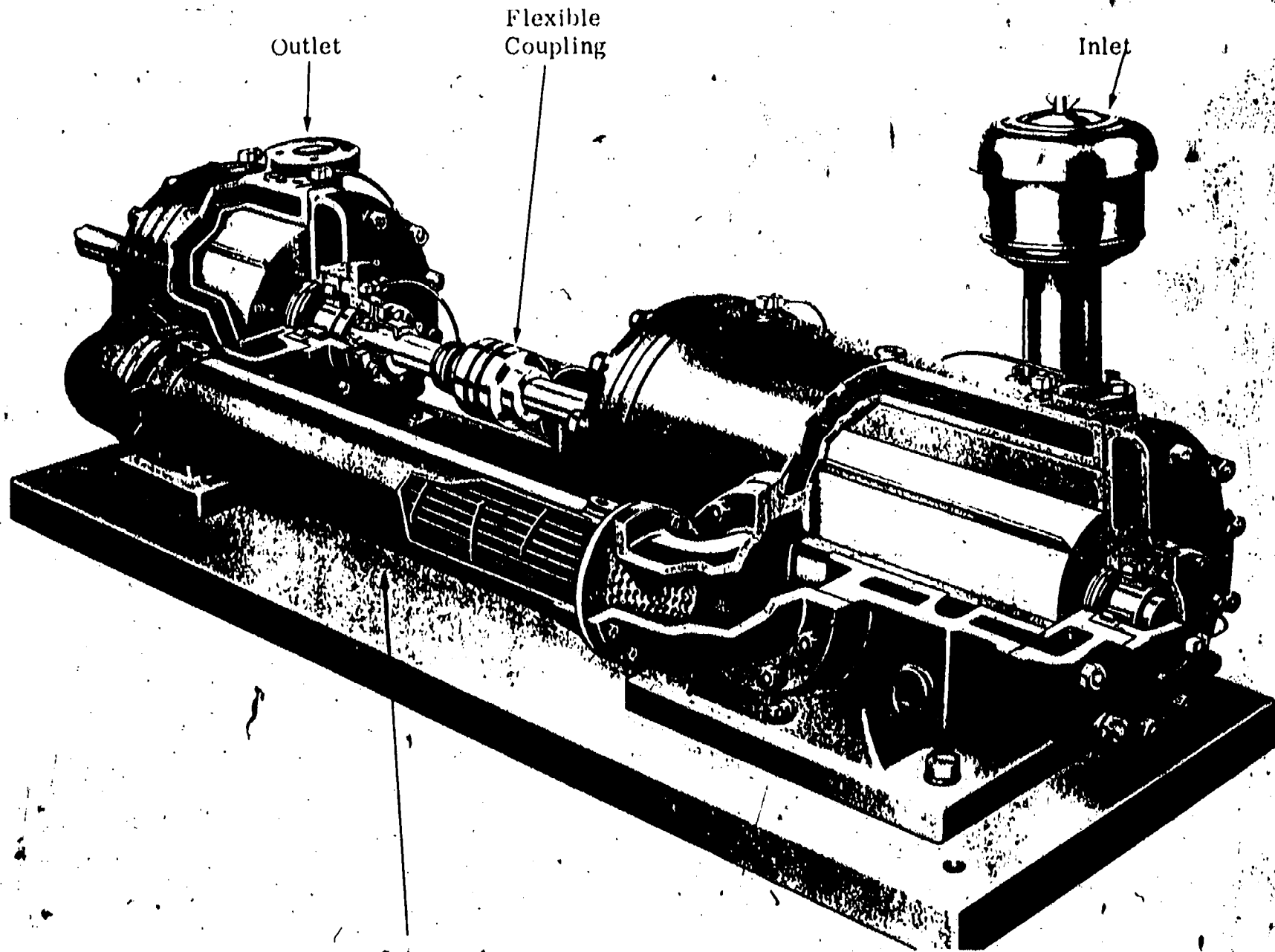

Intercooler
Two-stage Sliding Vane Compressor (Allis-Chalmers)

Fig. 25

73

74

2. The Rotary Lobe Compressor

The general construction of a rotary lobe compressor is shown in Fig.

26.

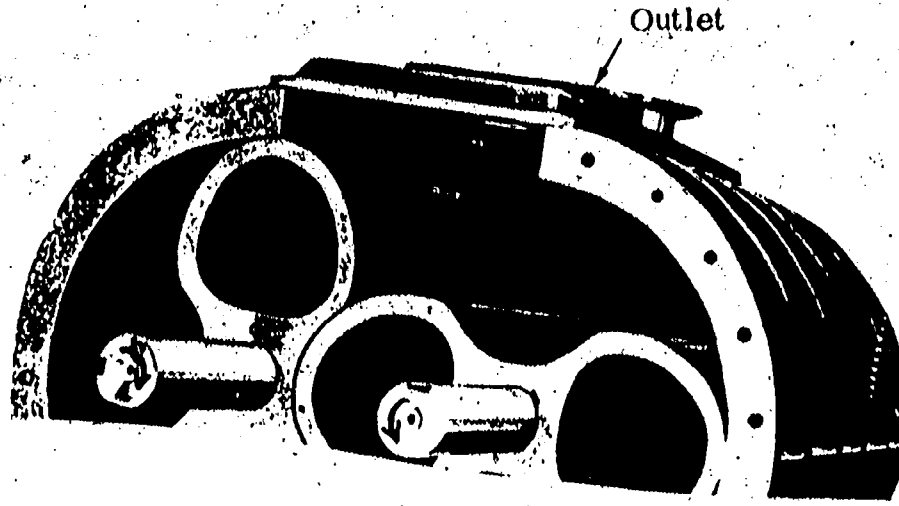

BEST COPY AVAILABLE

The lobe compressor has the advantages of being compact and requiring no inlet or discharge valves. In addition it produces an even flow of oil free air.

3. The Rotary Screw Compressor

The rotary screw compressor features two intermeshing rotors contained within a close fitting casing. The male rotor has four convex lobes and the female rotor has six concave flutes. As the rotors turn and intermesh, the air is compressed and forced out the discharge. The rotors do not come in contact with each other or with the casing thus internal lubrication is not required. The male rotor is usually the driven one and it in turn drives the female rotor by means of timing gears.

Fig. 27 shows a single-stage rotary screw compressor with the top half of the casing removed.

2

The rotary screw compressor is suitable for high speeds and may operate from 3 000 rev/min to 12 000 rev/min. Due to this high speed they may be driven directly by steam or gas turbines. If an induction motor is used then a speed increasing gear is normally required.

The single-stage type will develop discharge pressures to about 700 kPa gage and for pressures above this, multi-stage designs are used.

The advantages of the rotary screw compressor are similar to those of the straight lobe type. They include compactness, vibration free operation, smooth flow, oil-free air, and no suction or discharge valves required. However, like other rotating types, its efficiency is less than that of a reciprocating type.

QUESTION SHEET

POWER ENGINEERING

Third Class
Sect. 4, Lect. 5

1. Discuss the advantages and disadvantages involved in the use of compressed air over the use of steam and electricity.
2. Explain what is meant by the terms: single-stage compression, two-stage compression, single-acting, double-acting.
3. Make a simple single line sketch of a double-acting reciprocating compressor cylinder and describe its operation.
4. Describe two methods of reducing unbalanced forces set up in a reciprocating compressor.
5. Describe two methods of cylinder cooling used for air compressors and give the advantages and disadvantages of each method.
6. Describe the construction and operation of an automatic type of valve for a compressor.
7. Sketch a sectional view of a sliding vane compressor and explain its operation.
8. Describe the construction and operation of:
 - (a) A rotary lobe compressor,
 - (b) A rotary screw compressor.
9. Discuss the advantages and disadvantages of rotary compressors as compared to reciprocating compressors.
10. Describe briefly the operation of the free piston compressor.

PE3-4-5-Q

Correspondence Courses

Power Engineering

SECTION 4

Third Class
Lecture 6

PRIME MOVERS AND AUXILIARIES

AIR COMPRESSORS II

DYNAMIC COMPRESSORS

The term "dynamic" is used to describe those compressors which use blades or vanes to give velocity and then pressure to the air. There are two general types or designs; the centrifugal and the axial flow.

The Centrifugal Compressor

This compressor is similar in operation and construction to a centrifugal pump. It consists essentially of an impeller which rotates at high speed. The impeller is surrounded by a volute shaped casing and, in many cases, by a ring of diffuser vanes in addition to the casing. Air is drawn in at the centre or eye of the impeller and is discharged at the impeller periphery with high velocity due to centrifugal force. On leaving the impeller, the high velocity air passes through the diffuser vanes attached to the casing where some of the air velocity is converted to pressure. The air then passes through the volute shaped casing where a further conversion of velocity into pressure takes place.

A single-stage centrifugal compressor, that is one with a single impeller, may be able to compress atmospheric air to a pressure of about 350 kPa. For higher pressures, a multistage compressor is used having several impellers placed on a common shaft.

The sketches in Fig. 1 show the arrangement of a compressor having a volute casing only and a compressor having both a volute casing and diffuser vanes.

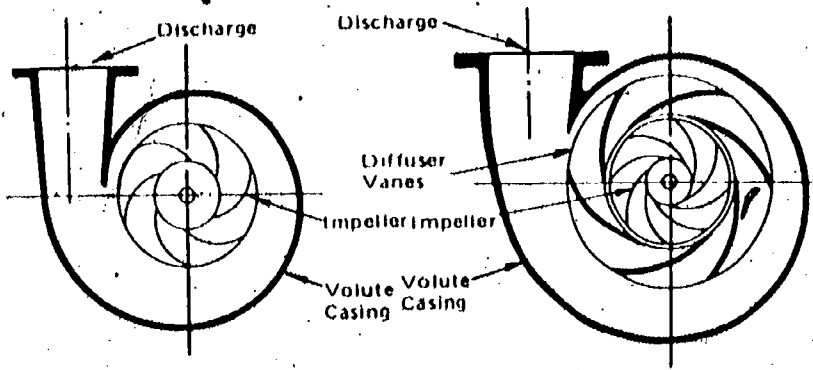

Volute and Diffuser Arrangements

Fig. 1

A single-stage centrifugal compressor having a volute casing but no diffuser vanes is illustrated in Fig. 2.

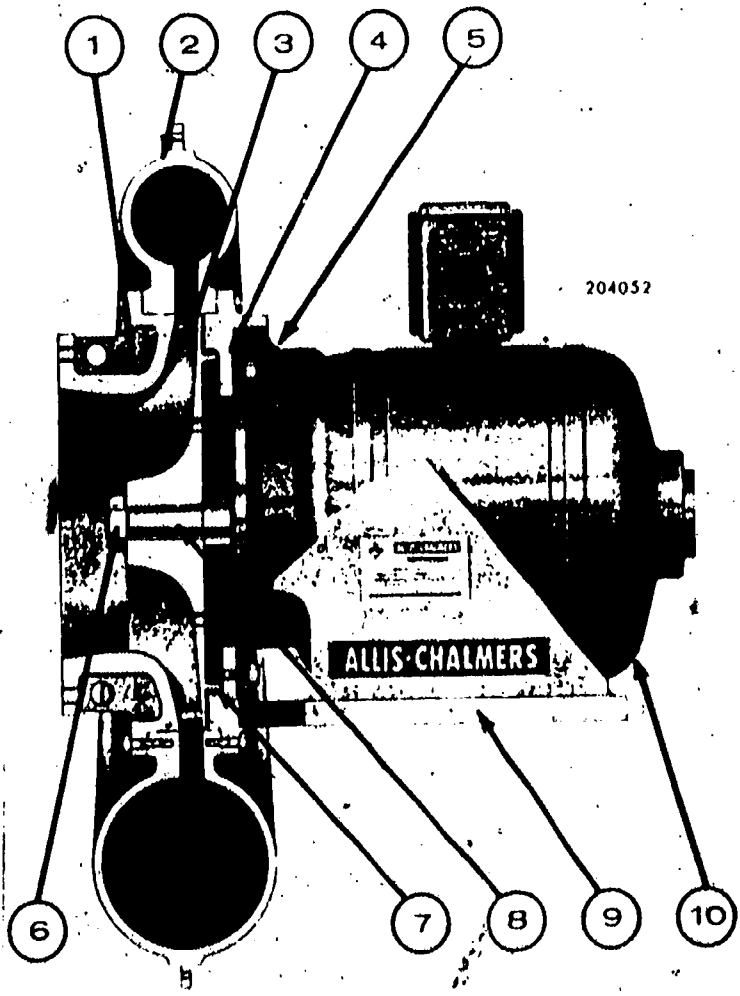

Single-stage Volute Compressor (Allis Chalmers)

Fig. 2

The numbered parts in Fig. 2 are as follows:

- | | |
|-----------------|-------------------------|
| 1. Inlet nozzle | 6. Locknut and washer |
| 2. Casing | 7. Lead sealing strips |
| 3. Impeller | 8. Extended motor shaft |
| 4. Back plate | 9. Base plate |
| 5. Shroud | 10. Motor |

Fig. 3 shows a single-stage compressor having both diffuser vanes and a volute casing.

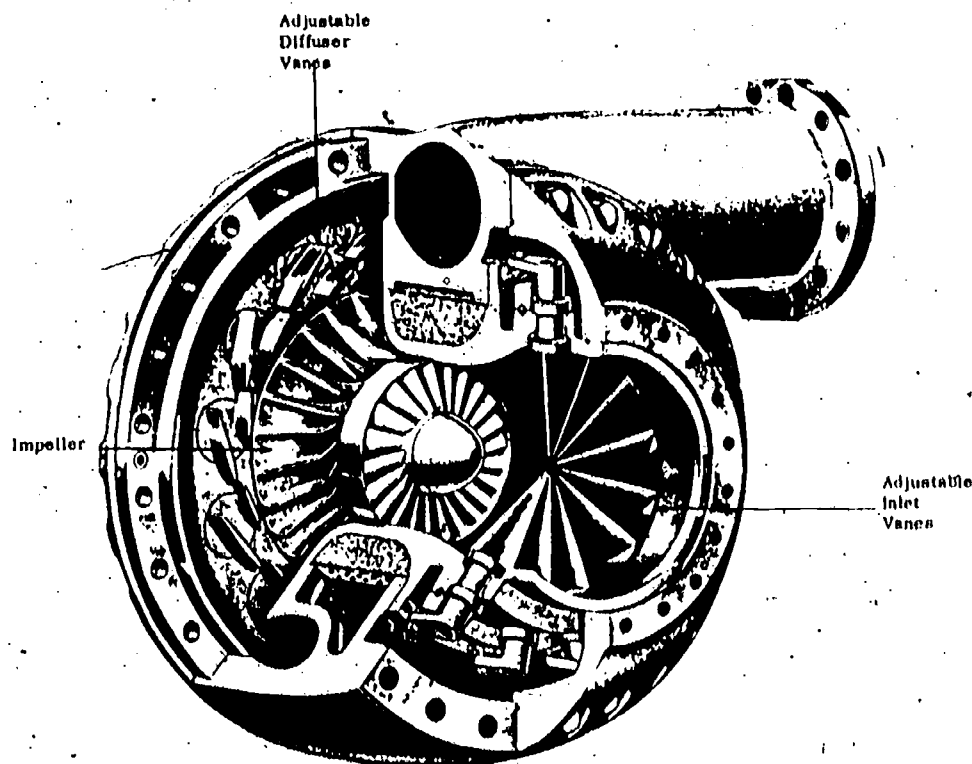

Centrifugal Compressor with Diffuser Vanes
(Worthington Corporation)

Fig. 3

This compressor (Fig. 3) has several features. The impeller is the over-hung type which is mounted on the shaft end and which results in only one shaft seal being required. The diffuser vanes are adjustable in order to change the operating characteristics of the compressor when required. In addition, adjustable inlet vanes are provided in order to control the amount of air flowing to the impeller and thus the capacity of the unit. The impeller itself is equipped with vanes at the eye and these are shaped in such a way to provide shockless entry to the impeller.

PE3-4-6-3

BEST COPY AVAILABLE

Reduce

Fig. 4 shows a sectional view of a two-stage centrifugal compressor.

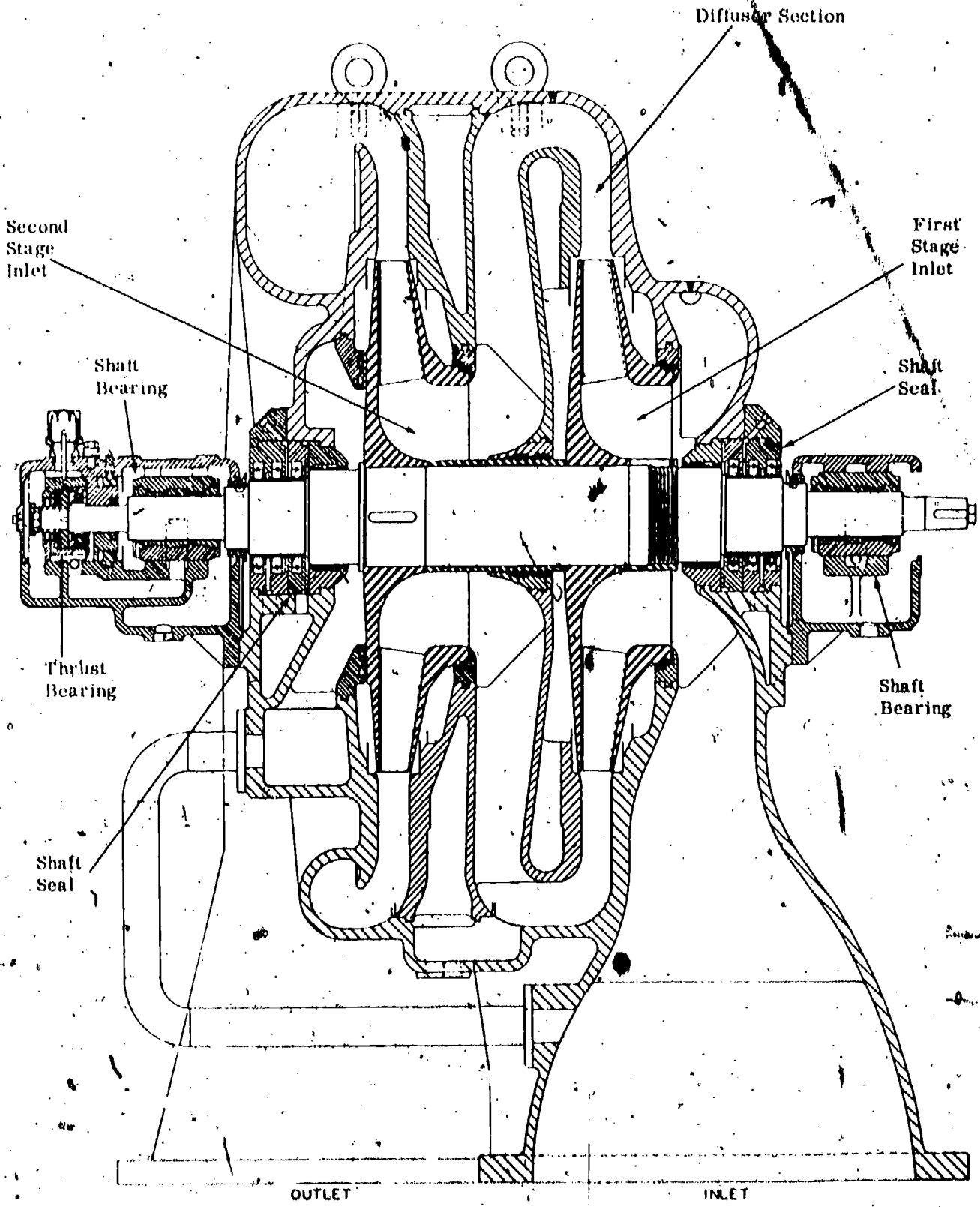

Two-stage Centrifugal Compressor

Fig. 4

PH3-4-6-4

Centrifugal compressors are commonly used for large volume, low pressure applications and have the advantages of simple and rugged construction and low maintenance requirements. Also, as they do not require internal lubrication, they supply oil-free air. Their efficiency, however, is lower than the positive displacement type and they are not suited for low capacity work.

Drivers which are commonly used with centrifugal compressors are steam turbines, gas turbines, electric motors, and internal combustion engines. As centrifugal compressors require to be driven at high speeds they are driven directly in the case of steam and gas turbines but speed increasing gears are required when electric motors or internal combustion engines are used.

Centrifugal compressor impellers are usually made from steel and are cast, forged, or fabricated by welding. The rotor shafts are of forged steel and the casings of cast steel. For pressures below 6900 kPa the horizontal split type of casing is used, while above this pressure the barrel type casing is favored.

The Axial Flow Compressor

In basic design the axial flow compressor is similar to a reaction turbine having moving blades attached to the rotor, alternating with fixed blades attached to the casing. As the rotor turns, the velocity and pressure of the air is increased in the moving blades. When the air passes through the fixed blades its pressure is further increased by conversion of velocity.

Each pair of moving and fixed blades constitutes a stage. The pressure rise per stage is small, so for high pressures a large number of stages are required.

The sketch in Fig. 5 shows a sectional view of an axial flow compressor.

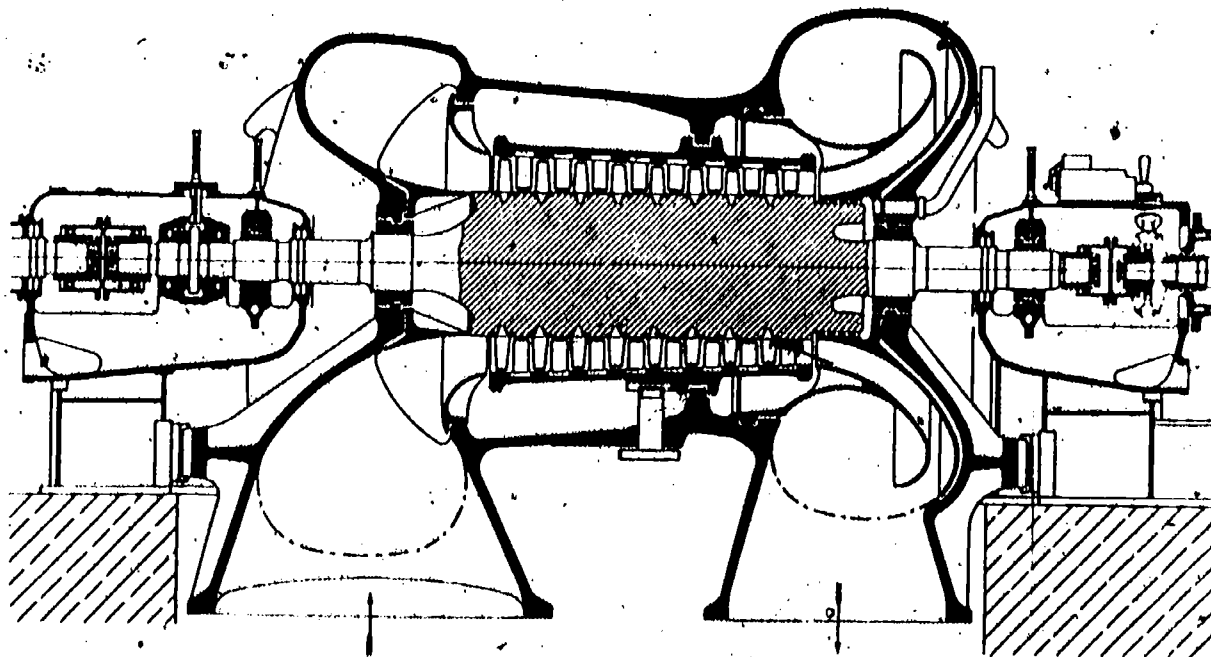

Axial Flow Compressor

Fig. 5

PE3-4-6-5

Referring to Fig. 5, it can be seen that the air enters at one end and flows in an axial direction to the discharge at the other end; hence the name "axial flow".

A large axial flow compressor with the upper casing half removed appears in Fig. 6.

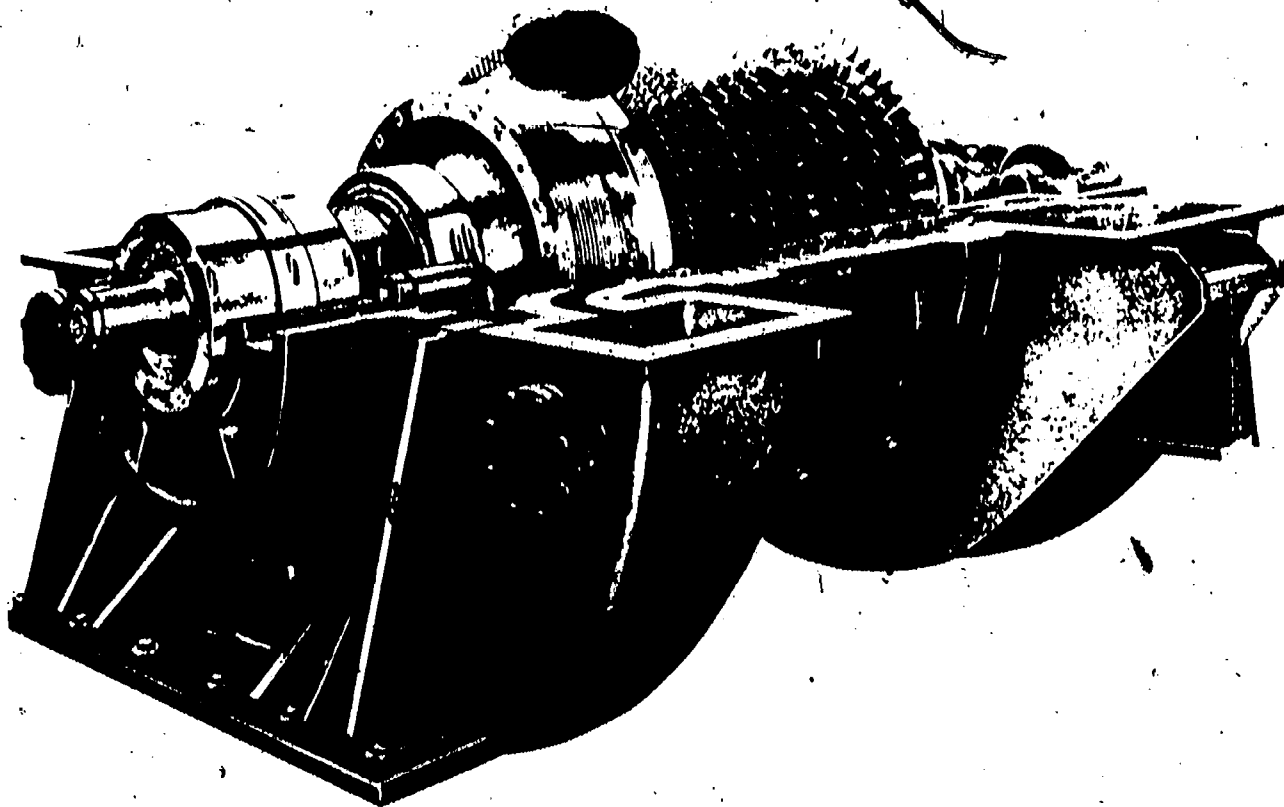

Axial Flow Compressor (Clark)

Fig. 6

Axial flow compressors have similar advantages to those of the centrifugal type with the added advantage of higher efficiency (10% greater). However, the axial flow compressor blades are subject to corrosion and erosion to a greater extent than are the impellers of the centrifugal type.

Steam turbines and gas turbines are usually used to drive axial flow compressors. Electric motors and internal combustion engines are sometimes used and in these cases, speed increasing gears are required.

Drum type rotors with forged steel shafts bolted to the drum ends are normally used for this type of compressor. As with the reaction turbine, there is considerable axial thrust produced and a dummy piston is an integral part of the rotor.

Compressor casings are of cast iron or steel.

Surging

Both the centrifugal compressor and the axial flow compressor are subject to a condition known as surging or pumping.

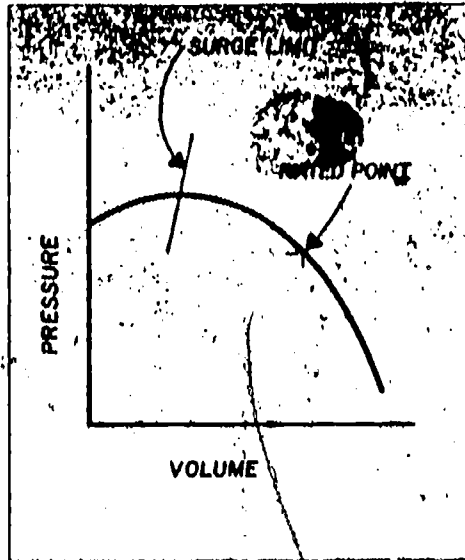

Pressure-volume Curve for Centrifugal Compressor

Fig. 6-A

In the case of the centrifugal compressor, it can be seen from the pressure-volume curve in Fig. 6-A, that at low volumes (low flows or capacities) the pressure drops off. This means that if the volume or demand is to the left of the point marked "surge limit" on the curve then the compressor will not produce a pressure equal to that in the system. A reversal of flow will occur and air will flow from the system back to the compressor. As soon as this occurs the system pressure will drop and the compressor will begin discharging again to the system. These events will occur rapidly as a cycle and this is known as surging.

Surging produces severe shock to the system and may be violent enough to damage compressor blading, shaft seals and even the shaft itself.

To prevent surging, the capacity of the compressor must not be allowed to fall below the surge limit. One method used is to open a discharge line blow-off valve to the atmosphere when the flow through the compressor decreases to near the surge point. The blow-off valve can be operated automatically by means of a flow meter.

The axial flow compressor is even more unstable than the centrifugal type, as its surge limit occurs at higher flows than does the centrifugal.

AIR COMPRESSOR AUXILIARIES

The following paragraphs describe various auxiliaries necessary for the efficient and safe operation of both the dynamic and the positive displacement compressors.

Intercoolers and Aftercoolers

These are usually shell and tube type heat exchangers and may be arranged to have water flowing through the tubes and air passing over the tubes or they may be arranged with air flowing through water surrounded tubes. Their function is to cool the air, either between stages of compression in the case of the intercooler, or after the compression is completed in the case of the aftercooler.

The reasons for cooling the air are as follows:

1. To remove water vapor and oil vapor from the air between compression stages and after the last stage. When the air is cooled, the water and oil vapors will condense and may then be drained from the bottom of the coolers.

If the oil vapor is not condensed and removed it will have a detrimental effect on air operated instruments and also may build up deposits in pipes and reservoirs which may ignite and explode.

If water vapor is not removed from the air then it may collect in pipelines and cause water hammer or damage from freezing. Also in the case of air driven tools and machinery, the water will wash away lubricating oil from the machine surfaces.

2. In the case of an intercooler, another purpose is to decrease the amount of power required to compress the air. Cooling the air during compression will cause the compression to follow more closely to the isothermal process rather than the adiabatic (See Lecture 7, Section 1 for isothermal and adiabatic definitions). The work required for an isothermal compression is less than that required for an adiabatic compression. In fact, the use of an intercooler to cool the air between stages of compression will reduce the power required for compression by 15%. For this same reason, in addition to using intercoolers, compressors are usually water jacketed in order to aid in removing the heat of compression and so approach isothermal compression.
3. Other purposes in reducing the air temperature by means of coolers are to make cylinder lubrication more effective, to reduce weakening of parts due to high temperatures, and to reduce the possibility of explosions of oil vapor mixed with air.

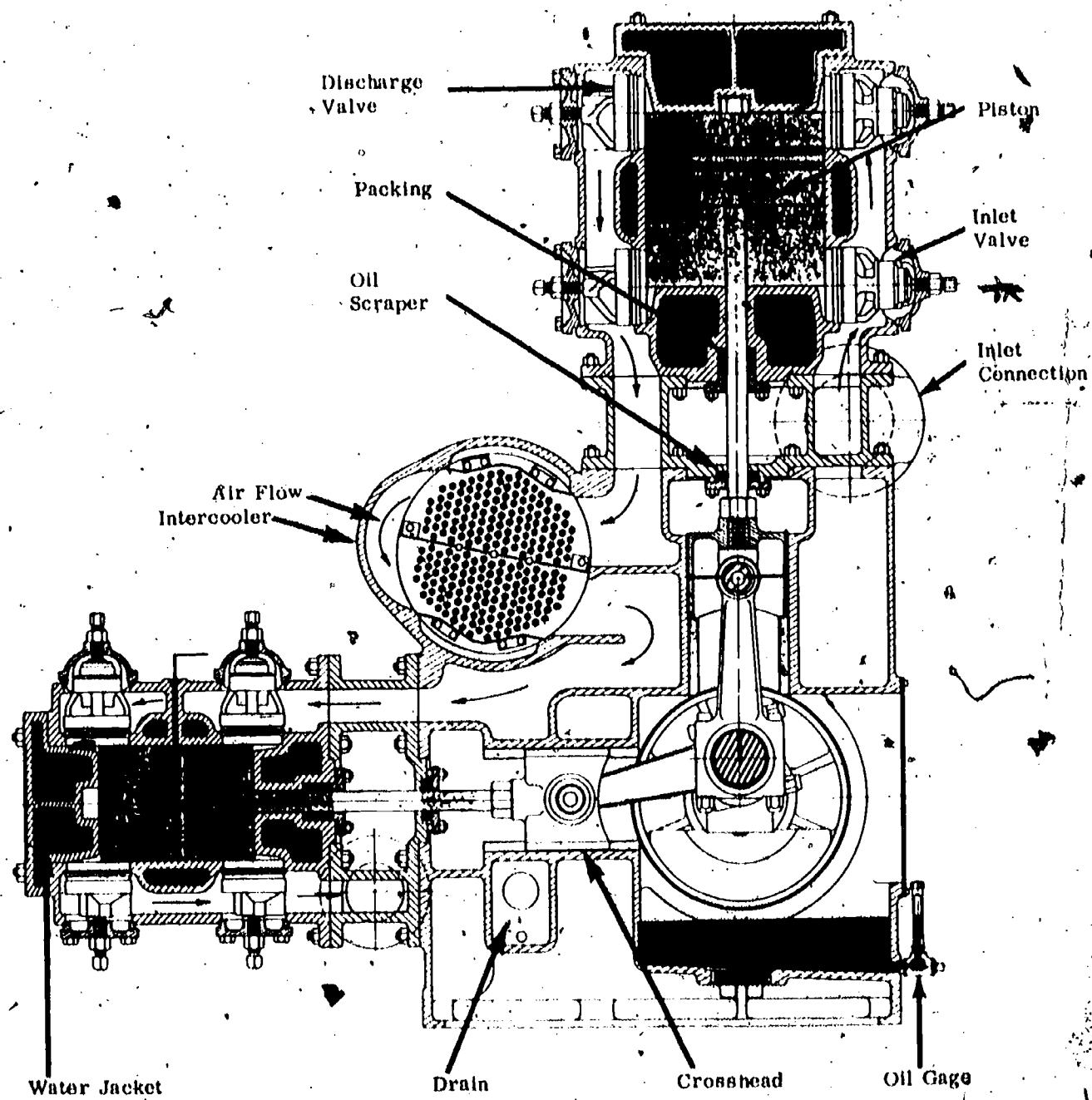

Two-stage Compressor With Intercooler

Fig. 7

PE3-4-6-9

Intercoolers and aftercoolers may be either air-cooled or water-cooled.

The air-cooled type is normally used when the compressor itself is air-cooled and it consists of a finned pipe through which the compressed air passes.

The water-cooled type, as mentioned previously, is of shell and tube construction with either the cooling water passing through tubes or the compressed air passing through water-surrounded tubes.

Fig. 7 shows a two-stage compressor with an intercooler having cooling water flow through the tubes and air flow around the tubes.

Intercoolers should be provided with a safety valve, pressure gages and thermometers on the compressed air side and also thermometers on the cooling water side.

Fig. 8 shows an aftercooler in which the compressed air flows through the tubes and the cooling water flows around the tubes. As the air discharges from the aftercooler, it passes through a cyclone separator where moisture and other particles are removed from the air stream.



Aftercooler with Cyclone Separator

Fig. 8

Aftercoolers, like intercoolers, are fitted with pressure gages and thermometers and, if there is a shut-off valve between the aftercooler and the receiver, the aftercooler must also be fitted with a safety valve.

Aftercoolers should always be equipped with separators and these should be installed as close to the aftercooler as possible.

Air Compressor Receivers

An air receiver is a pressure vessel which is used as a reservoir in a compressed air system. In addition to acting as a reservoir, it acts to dampen pulsations in the discharge pressure of a reciprocating compressor. Another function of the receiver is to allow moisture and oil particles to settle out from the air. The particles collect at the bottom of the receiver and are drained periodically.

Air receivers may be either horizontal or vertical and are usually of welded construction. Their specifications must conform to the A.S.M.E. code, Section VIII, Pressure Vessels. They are fitted with a safety valve, pressure gage, drain valve, openings for inspection and cleaning, and a regulator connection.

A vertical air receiver is shown in Fig. 9.



Vertical Air Receiver

Fig. 9

There have been cases of air receiver failure and these are due to either defective safety valves or weakening of the vessel material due to corrosion.

In view of this, safety valves should be regularly and frequently tested by means of the hand lever. To minimize the possibility of corrosion, the receiver should be kept drained and should be regularly inspected and hydrostatically tested by the proper authorities.

After opening an air receiver for inspection, the interior should be thoroughly ventilated as there is a possibility of the presence of carbon monoxide gas formed from deposits within the vessel. Naked lights should be kept away from the vicinity, as carbon monoxide is a combustible gas.

Air Compressor Control

The discharge flow of air from the compressor must be varied to suit load requirements and to maintain a constant pressure in the system. The methods used to control the compressor output may be grouped under three headings:

1. Start and Stop Control,
2. Variable Speed Control,
3. Constant Speed Control.

1. Start and Stop Control

With this method, the compressor is shut down when little or no air is required by the system. Then when the demand increases, the compressor is started. This starting and stopping can be done by means of a pressure switch which senses the pressure in the receiver.

For example, in order to supply a system with air at 700 kPa, the control could be arranged to start the compressor when the pressure drops to 650 kPa and to stop the compressor when the pressure rises to 750 kPa.

The start and stop method is only used on motor driven units and a large enough receiver should be supplied so that the compressor is not continuously starting and stopping. Also the compressor should be automatically unloaded during the start-up period.

2. Variable Speed Control

The variable speed control method can be used when the compressor is driven by a steam engine, a turbine, or an internal combustion engine.

In order to maintain the system pressure at a constant value, the compressor is speeded up or slowed down according to the system demand. This is done by regulating the steam supply to the steam engine or turbine or the fuel supply to the internal combustion engine. If, for example, the demand for air decreases, then the receiver pressure will increase and this will cause a pressure actuated control to slow down the driving engine or turbine. On an increased demand for air, the receiver pressure will drop and the control will speed up the engine or turbine.

3. Constant Speed Control

With this method, the compressor driver, usually an electric motor, runs at constant speed at all times, but the output from the compressor is varied in accordance to the air demand by some type of unloading device.

A method of unloading which is frequently used with reciprocating compressors is to hold the compressor inlet valves in the open position. As a result of this, the air passes freely in and out of the compressor cylinder without being compressed.

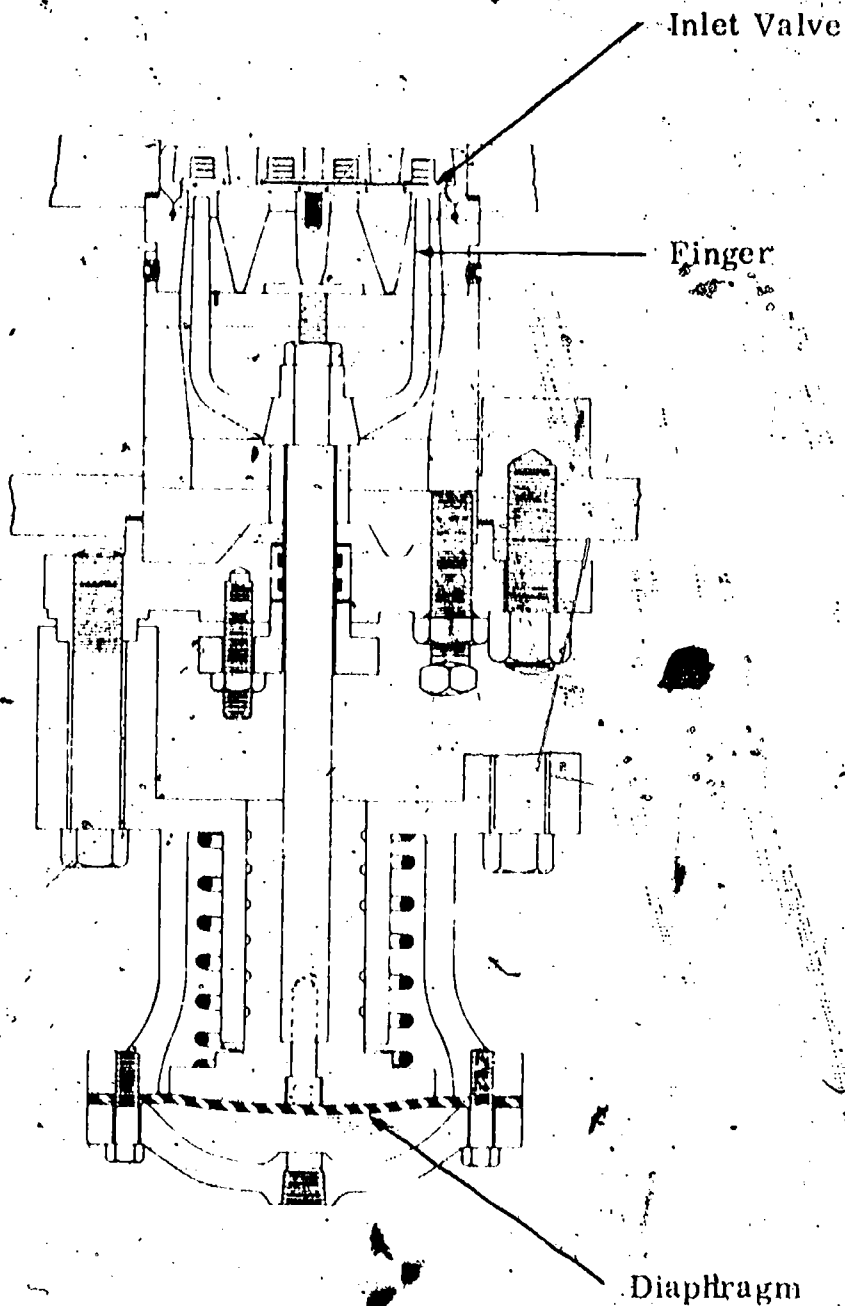

Inlet Air Unloader

Fig. 10

Fig. 10 shows an inlet valve unloader. This unloader consists of a set of fingers which can be moved by means of a diaphragm. When the system air demand decreases, the receiver pressure will rise and when it reaches the cut-out pressure, a spring loaded pilot valve (not shown in the sketch) will open and admit air to the underside of the diaphragm. As a result, the diaphragm moves upwardly causing the fingers to hold open the inlet valve.

PE3-4-6-13

Another method of unloading a compressor is to close a valve in the suction line thus shutting off the flow of air to the compressor. The valve in the suction line is closed by air pressure when the receiver pressure reaches a set value. This method is often used in the case of dynamic and rotary type compressors.

Still another method of unloading, used with reciprocating compressors, is by means of clearance pockets. The greater the clearance volume at the end of the stroke the less air will be compressed during the following stroke. The reason for this is that when the piston begins its next stroke, the volume of air left in the clearance pocket will expand behind the piston and partly fill the cylinder, thus limiting the amount of new air drawn into the cylinder.

A method which combines the use of a clearance pocket and inlet valve unloaders is shown in Fig. 11.

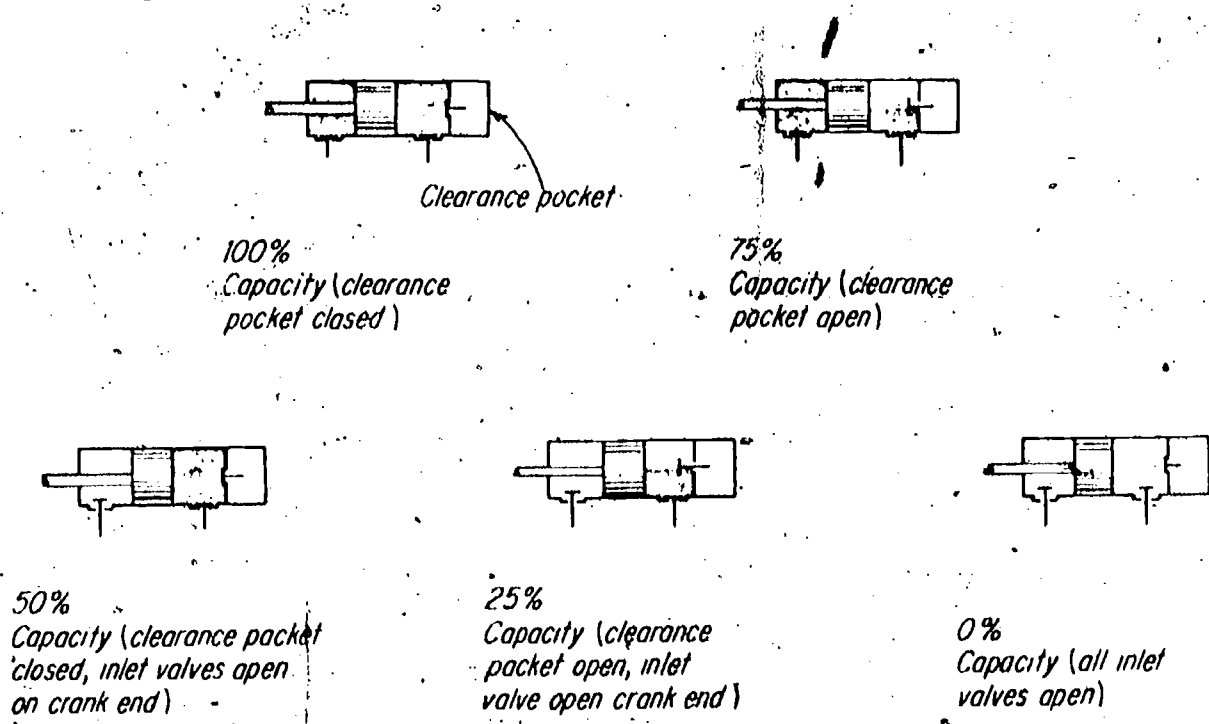

Five Step Control

Fig. 11

Referring to Fig. 11, at 100% capacity the clearance pocket is closed and the inlet valves at each end of the cylinder are not unloaded. At 75% capacity the clearance pocket is open and the inlet valves at both ends are still not unloaded. At 50% capacity the clearance pocket is closed again but the inlet valves at one end are held open by the unloader. At 25% capacity the clearance pocket is open again and the inlet valves at one end are still held open by the unloader. Then at 0% capacity both sets of inlet valves are held open by the unloader.

In addition to controlling the output of a compressor, some system of protective controls should be used. A typical two-stage compressor might have an automatic shutdown device which would operate due to any of the following:

1. High lubricating oil temperature,
2. High intercooler temperature,
3. High discharge air temperature,
4. High discharge air pressure,
5. Low lubricating oil pressure,
6. Low lubricating oil level,
7. Excessive vibration,
8. Cylinder lubricator stopped.

Air Compressor Lubrication

Lubricating oil is necessary in an air compressor in order to perform the following functions:

1. To prevent wear by providing a film between surfaces.
2. To reduce friction and resulting power loss by providing a film between surfaces.
3. To remove the heat produced by friction.
4. To reduce corrosion by providing a coating for metal surfaces.
5. To provide sealing around piston rings, vanes, valves, etc.

Compressor lubrication may be divided into two main sections: external lubrication and internal lubrication.

External lubrication refers to the lubricating of moving parts which are external to the compressor cylinder or casing. These parts would include crankshaft bearings, connecting rod bearings and crosshead on reciprocating compressors, and would include rotor shaft bearings on rotary and dynamic compressors.

Internal lubrication refers to the providing of lubricating oil to the cylinder walls and pistons of reciprocating compressors, and to the vanes and casing walls in some types of rotary compressors.

The dynamic type of compressor such as the centrifugal and the axial flow does not require internal lubrication and this is considered to be an important advantage of this type.

PE3-4-6-15

External Lubrication

In the case of reciprocating compressors, a pressure system is usually used wherein a pump driven from the compressor shaft delivers oil to the crankshaft and connecting rod bearings. The oil is pumped from the crankcase to the bearings and then drains back to the crankcase again.

For small single-acting reciprocating compressors the splash system of lubrication is frequently used. With this method the oil is splashed, due to the movement of the crankshaft, to the various bearings. This method provides internal lubrication at the same time as some oil is splashed to the cylinder walls.

With rotary and dynamic type compressors, the rotor shaft bearings may be ring or chain oiled but often a pressure system is used with a pump forcing the oil to the bearings. Frequently this pump also supplies oil to the bearings of the steam turbine, gas turbine or electric motor which is driving the compressor.

Internal Lubrication

Lubricating oil is generally fed directly to the cylinder walls of reciprocating compressors by a mechanical lubricator, driven from the crankshaft or crosshead. Each cylinder may have one or more points to which the oil is pumped and each of these points should be fed by a separate pump unit of the lubricator. After the oil enters the cylinder through these feed points, the compressor piston spreads the oil over the cylinder walls.

In the case of a single-acting compressor having the bottom of the cylinder open to the crankcase, cylinder lubrication is provided by the oil being splashed from the crankcase to the cylinder walls.

In addition to reciprocating compressors, sliding vane rotary compressors require internal lubrication. This is necessary to prevent metal to metal contact between vanes and casing and also to provide sealing between vanes and casing. A pressure lubricator is used to supply the oil and may discharge the oil into the air intake. The air then carries the oil along to the rotating vanes. The lubricator may also discharge the oil directly to points on the casing and in some designs the oil is pumped through a longitudinal hole in the rotor shaft and then through radial holes to the rotor periphery.

Fig. 12 displays a pressure lubricator, which is belt driven from the rotor shaft of a sliding vane compressor.

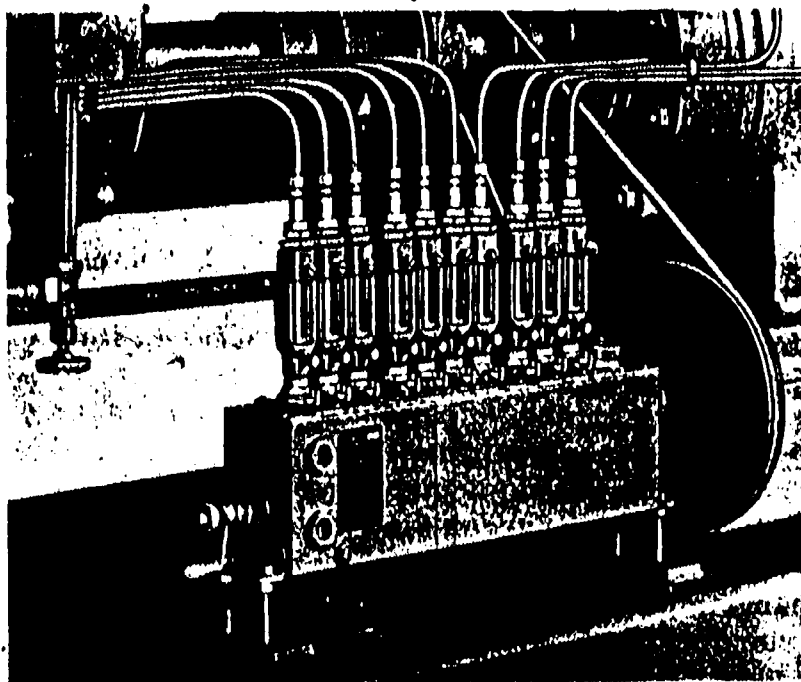

Pressure Lubricator

Fig. 12

A similar design of lubricator to that in Fig. 12, would be used to provide cylinder lubrication for reciprocating compressors.

In regard to the cylinder oil itself, it is important that a suitable oil be used and in addition great care must be taken not to introduce too much oil into the cylinder.

If lubrication is excessive, particularly with unsuitable oils, carbon deposits may be formed upon the discharge valves of reciprocating compressors. These deposits tend to hold the valves open and, as a result, hot high pressure air leaks back into the cylinder during the suction stroke. This will cause higher discharge temperatures and eventually the deposit may become incandescent. If a flammable mixture of air and oil mist, due to excessive oil being scraped from the cylinder walls by the piston, is present, then an explosion may occur.

To avoid the above happening, it is advisable to use an oil having the least tendency to form carbon deposits and in addition to supply the minimum amount of this oil necessary for adequate lubrication. For additional protection, a temperature controlled shutdown device should be used to stop the compressor at abnormally high temperatures. Also, when cleaning compressor cylinders and valves, combustible products such as kerosene or gasoline must not be used. The best cleaning solution is a mixture of one part of soft soap to fifteen parts of water.

PE3-4-6-17

For some types of applications, it is necessary to supply oil-free compressed air. In these cases, if reciprocating compressors are used, they are of the self-lubricating type. In this design, the piston rings are made of carbon or teflon material and the cylinder walls are specially polished to provide an extra smooth surface for the rings to bear against. As the rings are not lubricated they will wear considerably and some leakage from one side of the piston to the other will result. Another disadvantage of this type is that the piping in the system will be liable to corrode due to the absence of an oil coating or film over the inner surface of the piping.

Compressor Installation

An air filter should always be installed in the inlet line to prevent dust and other particles from being carried into the compressor. Where possible, the air supplied to the inlet should be outside air and the intake should be located away from engine or process exhaust outlets. The inlet piping should be at least as large as the compressor intake connection and if the pipe is extremely long then it should be a larger size than the intake connection.

The discharge pipe should be at least as large as the compressor outlet and it should run directly to the aftercooler or directly to the receiver if no aftercooler is used. The line should be run with as few bends as possible and drain valves should be provided at any low spots or pockets.

Fig. 13 depicts the general arrangement of piping from the compressor to the aftercooler and receiver.

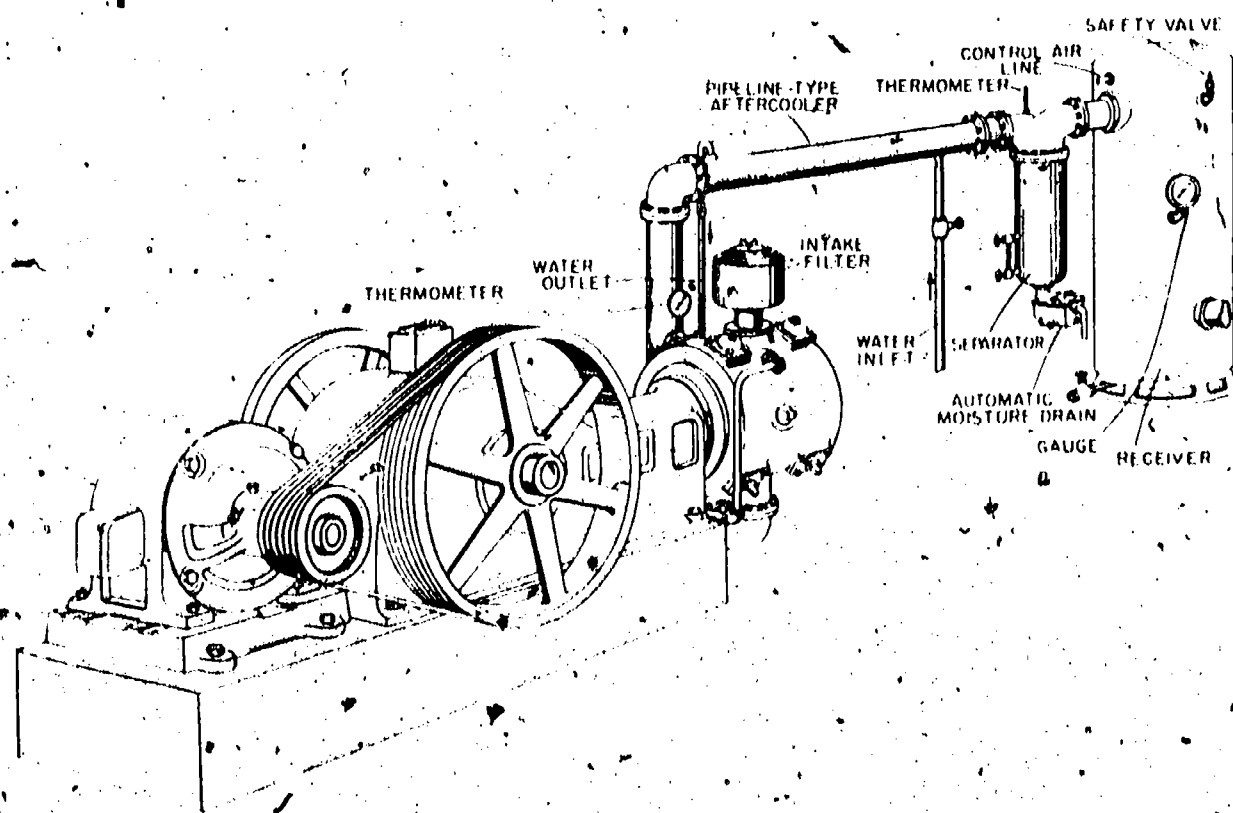

Compressor Discharge Piping

Fig. 13

PE3-4-6-18

Starting a Compressor

The following is a list of the general steps involved in the start-up of an air compressor. However, each individual machine will have more detailed instructions outlined in the manufacturer's instruction book and these should be adhered to.

1. Check crankcase oil level and cylinder lubricator oil level.
2. Operate the cylinder lubricator by hand to supply some oil to the cylinder for starting.
3. Bar the compressor a few turns manually to distribute the cylinder oil and to see that all parts move freely.
4. Check that all valves external to the machine are in the proper position.
5. Check the unloading device to ensure that the machine will start in an unloaded condition.
6. Turn on the cooling water supply to intercooler, aftercooler, and cylinder water jackets. Make sure that these systems are full and that water is flowing from the discharge outlets. Make sure that compressor cylinders and air lines are free of water. There have been cases where water leaking from a ruptured tube in an intercooler has filled the compressor cylinder during shutdown and this has resulted in the destruction of the compressor on start-up.
7. Start the motor or other driver and bring the unit up to full speed. Check for unusual noise or vibration.
8. Check the lubricator sight feed glasses to see that sufficient oil is flowing to the machine.
9. Set the unloading control to automatic and see that it operates correctly when the air pressure reaches the set value.
10. Adjust the cooling water supply to maintain correct temperature. If the cooling water supply is interrupted or is not sufficient then the intercooler air pressure will rise rapidly.

Stopping Procedure

1. Stop the driving unit.
2. Shut off cooling water supply.
3. If there is any likelihood of freezing, then coolers and water jackets must be thoroughly drained.

PE3-4-6-19

A log book should be used to record the operating details of the compressor. Hourly readings should be taken of such items as inlet air temperature, intercooler and discharge air pressures, cooling water inlet and outlet temperatures, etc. In addition, the log book should contain details on maintenance work carried out on the machine such as oil changes and repairs. Also any unusual conditions should be noted in the log book.

Theory of Air Compression

When air is compressed, its volume is reduced and its pressure is increased. Also, due to the heat of compression, the temperature of the air will increase. If the heat of compression, causing the rise in temperature could be removed as quickly as it is generated, then the temperature of the air would remain constant and the power required to drive the compressor would be substantially reduced. This would be the ideal condition known as isothermal compression (compression without a change in temperature). See Lecture 7, Section 1.

If, on the other hand, no heat was removed from the air during compression, then the temperature of the air would rise to a maximum and the maximum amount of power would be required to drive the compressor. This type of compression is known as adiabatic compression (compression without transfer of heat). See Lecture 7, Section 1.

Therefore it can be realized that isothermal compression is preferable because of the lesser amount of power required to carry out the compression.

In actual practice, isothermal compression cannot be attained but it may be approached to some extent by the use of water jackets and intercoolers to remove heat from the air during compression.

The pressure-volume diagram in Fig. 1A shows the curves for isothermal and adiabatic compression.

The area to the left of the curve in each case represents the work required during the compression. It can be seen that the area to the left of the adiabatic curve is greater than the area to the left of the isothermal curve and the difference between the two areas is shown as a dotted section. This dotted section represents the extra work required for the adiabatic compression compared to the isothermal compression.

By following the adiabatic curve, the discharge pressure is reached earlier during the stroke and therefore the piston acts against this discharge pressure for a longer time thus requiring more work.

An actual air compression curve is neither adiabatic or isothermal but lies somewhere between the two.

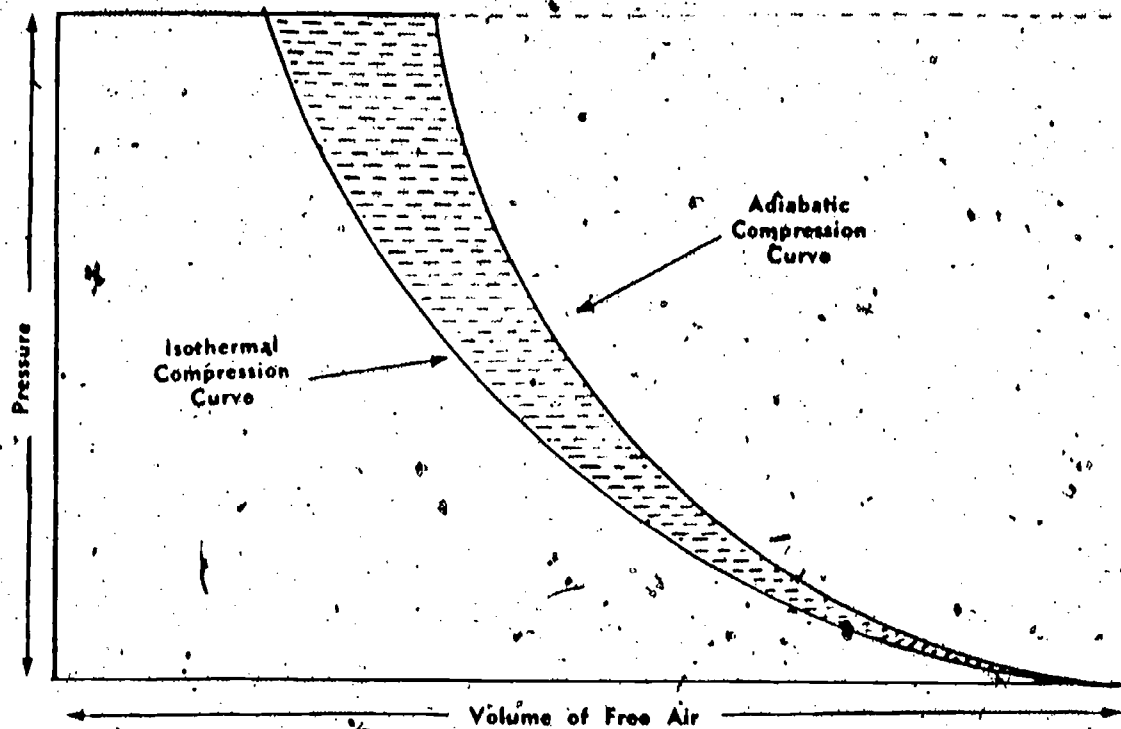

Isothermal and Adiabatic Curves

Fig. 14

Terminology and Definitions

1. Absolute Pressure is the gage pressure plus atmospheric pressure. At sea level, atmospheric pressure is 101.3 kPa so absolute pressure at sea level is gage pressure plus 101.3 kPa.
2. Compressor Displacement is the volume swept out by the piston and is expressed in cubic metres per minute. If the compressor has more than one stage the displacement is the volume swept out by the first stage piston only as the same air passes through all stages in series.
3. Free Air is air at normal atmospheric conditions existing at the compressor inlet.
4. Capacity is the quantity of air compressed and delivered by the compressor and this is expressed in terms of m³/min of free air. It is also known as free air delivered (F.A.D.) or free air capacity.
5. Volumetric Efficiency is the ratio of the capacity to the displacement expressed in percent.

$$\text{Volumetric Efficiency} = \frac{\text{Capacity}}{\text{Displacement}}$$

The capacity is always less than the displacement because of clearance between the piston and the cylinder heads, leakage through valves and other losses.

6. Compressor Pressure Ratio is the ratio of the absolute discharge pressure to the absolute intake pressure.

Effect of Altitude

As the height above sea level or altitude increases, the atmospheric pressure decreases. This means that a compressor installed at a high altitude will require a higher compression ratio to produce the same discharge pressure as would a machine installed at sea level. Furthermore, due to the fact that one lb of air occupies a greater volume at higher altitudes than at sea level, a compressor will deliver a lesser mass of air when operated in locations above sea level.

Effect of Moisture

Free or atmospheric air always carries moisture as water vapor, the amount depending upon the temperature of the air. Air carrying the maximum amount of water at a certain temperature is said to be saturated. Saturated air at normal temperature and atmospheric pressure will contain about 0.5 kg of moisture for every 28 m³ of air and this moisture will be carried into the compressor with the air. When the volume of the air is reduced by compression some of the moisture will be deposited.

It is desirable to remove the water from the air otherwise it will have a detrimental effect on air operated instruments and tools and may also freeze in the air lines.

The steps necessary to get as dry air as possible are to use efficient inter-coolers and an after-cooler, draining off as much water from these as possible; then a large air receiver from which the water is drained off. Air receivers should also be used on the lines where necessary and small ones close to where the air is to be used. All these must have drain cocks to get rid of the water collected.

An additional method used to obtain dry air is to install a dryer immediately after the air receiver. Several different designs of dryers are in existence and a typical type consists of a pressure vessel containing a chemical known as a dessicant. As the compressed air passes through the dessicant, the moisture is absorbed and the dried air then passes into the system. The chemical dessicant must be replaced periodically.

Compressor Calculations

1. Displacement

To calculate the compressor displacement or piston displacement as it is also called, it is necessary to know the inside diameter or bore of the cylinder, the length of the piston stroke and the number of compressing strokes per minute. These all refer to the first stage cylinder, if the compressor has more than one stage.

The displacement per minute is equal to the cross sectional area of the bore times the length of stroke times the number of compressing strokes per minute. The displacement is normally given in cubic metres per minute.

$$\text{Displacement} = \frac{d^2 \times \pi \times L \times N}{4}$$

- Where: d = cylinder bore in metres
- L = length of stroke in metres
- N = number of compressing strokes per minute

For a single-acting compressor, the number of compressing strokes per minute is equal to the rev/min.

For a double-acting compressor, the number of compressing strokes per minute is equal to twice the rev/min.

Example 1

Calculate the displacement of a single-acting compressor having a first stage cylinder bore of 12 cm, a stroke of 10 cm and a speed of 900 rev/min.

Solution

Displacement in m³/min

$$\frac{d^2 \times \pi \times L \times N}{4}$$

$$\frac{0.0144 \times 3.14 \times 0.1 \times 900}{4}$$

$$\underline{\underline{1.017 \text{ m}^3 \text{ per min. (Ans.)}}}$$

PE3-4-6-23

2. Volumetric Efficiency

As mentioned previously, the actual free air delivered by a compressor is less than the displacement of the compressor because of clearance and leakage losses. The ratio of actual free air to the displacement is the volumetric efficiency of the compressor.

$$\text{Volumetric Efficiency} = \frac{\text{Free Air Delivered}}{\text{Displacement}}$$

The free air delivered, or capacity, is determined by actual testing of the compressor and measurement of its output.

Example 2

If the compressor in Example 1 actually delivers 0.8 cubic metres of free air per minute, calculate the volumetric efficiency of the compressor.

Solution

$$\frac{0.8}{1.017} = 0.786 \quad \text{or} \quad \underline{\underline{78.6\%}} \quad (\text{Ans.})$$

QUESTION SHEET

POWER ENGINEERING

Third Class
Sect. 4, Lect. 6

1. Discuss the advantages and disadvantages of the dynamic type of compressor as compared to the positive displacement type.
2. Describe the principle of operation of:
 - (a) A centrifugal compressor having a volute casing with diffuser vanes.
 - (b) A centrifugal compressor having a volute casing without diffuser vanes.
3. (a) List the desirable effects of cooling the air during and after compression.
(b) Describe three methods whereby the cooling of the air is achieved.
4. Explain, with the aid of a diagram, how the work required for isothermal compression compares to that required for adiabatic compression.
5. (a) Why is a safety valve necessary on an aftercooler when there is a shut-off valve installed between the aftercooler and the receiver?
(b) Explain the reason for fitting a safety valve on the intercooler as well as on the receiver.
6. What regular care and attention should intercoolers, aftercoolers, and receivers be given?
7. (a) Describe the method of control used for the air compressor in the plant where you are employed.
(b) Describe this compressor in regard to method of drive, cylinder arrangement, method of compression, etc.
8. (a) Explain the terms external lubrication and internal lubrication and describe how they are accomplished in an air compressor.
(b) What special precautions should be taken in connection with internal lubrication?
9. What precautions should be taken before starting an air compressor?

(see over)

PE3-4-6-Q

(Question Sheet, Cont'd)

10. A single-stage, single-acting, reciprocating compressor has a 300 mm bore, a 46 mm stroke and runs at 200 rev/min. It compresses air from an inlet pressure of 96 kPa to a discharge pressure of 580 kPa and has a volumetric efficiency of 82%. Calculate: (Pressures are absolute)

- (a) the compressor capacity in m^3/min ,
- (b) the compressor pressure ratio.

PE3-4-6-Q-2