

DOCUMENT RESUME

ED 254 725

CE 041 001

TITLE Millwright Apprenticeship. Related Training Modules. 11.1-11.2 Generators.

INSTITUTION Lane Community Coll., Eugene, Oreg.

SPONS AGENCY Oregon State Dept. of Education, Salem.

PUB DATE [82]

NOTE 97p.; For related documents, see CE 040 991-041 007. Many of the modules are duplicated in CE 040 988.

PUB TYPE Guides - Classroom Use - Materials (For Learner) (051)

EDRS PRICE MF01/PC04 Plus Postage:

DESCRIPTORS *Apprenticeships; Behavioral Objectives; *Electrical Systems; Job Skills; Job Training; Learning Modules; Machine Tools; Mechanics (Physics); Postsecondary Education; *Power Technology; *Trade and Industrial Education

IDENTIFIERS *Electric Generators; *Millwrights

ABSTRACT

This packet, part of the instructional materials for the Oregon apprenticeship program for millwright training, contains two modules covering generators. The modules provide information on the following topics: types and construction of generators and generator operation. Each module consists of a goal, performance indicators, student study guide, vocabulary, introduction, information sheets illustrated with line drawings and photographs, an assignment sheet, a job sheet, a self-assessment test with answers, a post-assessment test with answers for the instructor, and a list of supplementary references. (Copies of supplementary references, which are sections of lectures from a correspondence course published by the Southern Alberta Institute of Technology, are included in the packets.) (KC)

 * Reproductions supplied by EDRS are the best that can be made *
 * from the original document. *

ED254725

APPRENTICESHIP

MILLWRIGHT

**RELATED
TRAINING MODULES**

11.1 - 11.2 GENERATORS

U.S. DEPARTMENT OF EDUCATION
NATIONAL INSTITUTE OF EDUCATION
EDUCATIONAL RESOURCES INFORMATION
CENTER (ERIC)

- (*) This document has been reproduced as received from the person or organization originating it.
- () Minor changes have been made to improve reproduction quality.
- Points of view or opinions stated in this document do not necessarily represent official NIE position or policy.

"PERMISSION TO REPRODUCE THIS
MATERIAL HAS BEEN GRANTED BY

S. J. Case

TO THE EDUCATIONAL RESOURCES
INFORMATION CENTER (ERIC)."

CE 041 001

STATEMENT OF ASSURANCE

IT IS THE POLICY OF THE OREGON DEPARTMENT OF EDUCATION THAT NO PERSON BE SUBJECTED TO DISCRIMINATION ON THE BASIS OF RACE, NATIONAL ORIGIN, SEX, AGE, HANDICAP OR MARITAL STATUS IN ANY PROGRAM, SERVICE OR ACTIVITY FOR WHICH THE OREGON DEPARTMENT OF EDUCATION IS RESPONSIBLE. THE DEPARTMENT WILL COMPLY WITH THE REQUIREMENTS OF STATE AND FEDERAL LAW CONCERNING NON-DISCRIMINATION AND WILL STRIVE BY ITS ACTIONS TO ENHANCE THE DIGNITY AND WORTH OF ALL PERSONS.

STATEMENT OF DEVELOPMENT

THIS PROJECT WAS DEVELOPED AND PRODUCED UNDER A SUB-CONTRACT FOR THE OREGON DEPARTMENT OF EDUCATION BY LANE COMMUNITY COLLEGE, APPRENTICESHIP DIVISION, EUGENE, OREGON, 1984. LANE COMMUNITY COLLEGE IS AN AFFIRMATIVE ACTION/EQUAL OPPORTUNITY INSTITUTION.

APPRENTICESHIP
MILLWRIGHT
RELATED TRAINING MODULES

SAFETY

- 1.1 General Safety
- 1.2 Hand Tool Safety
- 1.3 Power Tool Safety
- 1.4 Fire Safety
- 1.5 Hygiene Safety
- 1.6 Safety and Electricity
- 1.7 Fire Types and Prevention
- 1.8 Machine Safeguarding (includes OSHA Handbook)

ELECTRICITY/ELECTRONICS

- 2.1 Basics of Energy
- 2.2 Atomic Theory
- 2.3 Electrical Conduction
- 2.4 Basics of Direct Current
- 2.5 Introduction to Circuits
- 2.6 Reading Scales
- 2.7 Using a V.O.M.
- 2.8 OHM'S Law
- 2.9 Power and Watt's Law
- 2.10 Kirchoff's Current Law
- 2.11 Kirchoff's Voltage Law
- 2.12 Series Resistive Circuits
- 2.13 Parallel Resistive Circuits
- 2.14 Series - Parallel Resistive Circuits
- 2.15 Switches and Relays
- 2.16 Basics of Alternating Currents
- 2.17 Magnetism

COMPUTERS

- 3.1 Digital Language
- 3.2 Digital Logic
- 3.3 Computer Overview
- 3.4 Computer Software

TOOLS

- 4.1 Boring and Drilling Tools
- 4.2 Cutting Tools, Files and Abrasives
- 4.3 Holding and Fastening Tools
- 4.4 Fastening Devices
- 4.5 Basic Science - Simple Mechanics
- 4.6 Fasteners

DRAFTING

- 5.1 Types of Drawing and Views
- 5.2 Sketching
- 5.3 Blueprint Reading/Working Drawings
- 5.4 Working Drawings for Machines and Welding
- 5.5 Machine and Welding Symbols
- 5.6 Blueprint Reading, Drafting: Basic Print Reading
- 5.7 Blueprint Reading, Drafting: Basic Print Reading
- 5.8 Blueprint Reading, Drafting: Basic Print Reading
- 5.9 Blueprint Reading, Drafting: Basic Print Reading
- 5.10 Blueprint Reading, Drafting: Basic Print Reading
- 5.11 Blueprint Reading, Drafting: Basic Print Reading
- 5.12 Blueprint Reading, Drafting: Basic Print Reading
- 5.13 Blueprint Reading, Drafting: Basic Print Reading
- 5.14 Drafting, Machine Features
- 5.15 Drafting, Measurement
- 5.16 Drafting, Visualization

HUMAN RELATIONS

- 6.1 Communications Skills
- 6.2 Feedback
- 6.3 Individual Strengths
- 6.4 Interpersonal Conflicts
- 6.5 Group Problem Solving
- 6.6 Goal-setting and Decision-making
- 6.7 Worksite Visits
- 6.8 Resumes
- 6.9 Interviews
- 6.10 Expectation
- 6.11 Wider Influences and Responsibilities
- 6.12 Personal Finance

BOILERS

- 7.1 Boilers - Fire Tube Types
- 7.2 Boilers - Watertube Types
- 7.3 Boilers - Construction
- 7.4 Boilers - Fittings
- 7.5 Boilers - Operation
- 7.6 Boilers - Cleaning
- 7.7 Boilers - Heat Recovery Systems
- 7.8 Boilers - Instruments and Controls
- 7.9 Boilers - Piping and Steam Traps

TURBINES

- 8.1 Steam Turbines - Types
- 8.2 Steam Turbines - Components
- 8.3 Steam Turbines - Auxillaries
- 8.4 Steam Turbines - Operation and Maintenance
- 8.5 Gas Turbines

PUMPS

- 9.1 Pumps - Types and Classification
- 9.2 Pumps - Applications
- 9.3 Pumps - Construction
- 9.4 Pumps - Calculating Heat and Flow
- 9.5 Pumps - Operation
- 9.6 Pumps - Monitoring and Troubleshooting
- 9.7 Pumps - Maintenance

COMBUSTION

- 10.1 Combustion - Process
- 10.2 Combustion - Types of Fuel
- 10.3 Combustion - Air and Fuel Gases
- 10.4 Combustion - Heat Transfer
- 10.5 Combustion - Wood

GENERATORS

- 11.1 Generators - Types and Construction
- 11.2 Generators - Operation

FEEDWATER

- 12.1 Feedwater - Types and Equipment
- 12.2 Feedwater - Water Treatments
- 12.3 Feedwater - Testing

AIR COMPRESSORS

- 13.1 Air Compressors - Types
- 13.2 Air Compressors - Operation and Maintenance

STEAM

- 14.1 Steam - Formation and Evaporation
- 14.2 Steam - Types
- 14.3 Steam - Transport
- 14.4 Steam - Purification

MISCELLANEOUS

- 15.1 Installation - Foundations
- 15.2 Installation - Alignment
- 15.3 Circuit Protection
- 15.4 Transformers
- 15.5 Trade Terms

TRADE MATH

- 16.1 Linear - Measure
- 16.2 Whole Numbers
- 16.3 Additional and Subtraction of Common Fraction and Mixed Numbers
- 16.4 Multiplication and Division of Common Fractions and Whole and Mixed Numbers

- 16.5 Compound Numbers
- 16.6 Percent
- 16.7 Ratio and Proportion
- 16.8 Perimeters, Areas and Volumes
- 16.9 Circumference and Wide Area of Circles
- 16.10 Area of Plane, Figures and Volumes of Solid Figures
- 16.11 Metrics

HYDRAULICS

- 17.1 Hydraulics - Lever
- 17.2 Hydraulics - Transmission of Force
- 17.3 Hydraulics - Symbols
- 17.4 Hydraulics - Basic Systems
- 17.5 Hydraulics - Pumps
- 17.6 Hydraulics - Pressure Relief Valve
- 17.7 Hydraulics - Reservoirs
- 17.8 Hydraulics - Directional Control Valve
- 17.9 Hydraulics - Cylinders
- 17.10 Hydraulics - Forces, Area, Pressure
- 17.11 Hydraulics - Conductors and Connectors
- 17.12 Hydraulics - Troubleshooting
- 17.13 Hydraulics - Maintenance

METALLURGY

- 18.1 Included are ILS packets:
 - W 3010
 - W 3011-1
 - W 3011-2
 - MS 9001 (1-3-4-8-9-6-7-5-2-9)
 - MS 9200, 9201

POWER DRIVES

- 19.1
 - 101. A-B-C-D-E
 - 102. C-D-E
 - 103. B-C-D-E
 - 104. A-C-E-F-G-H-I-J
 - 107. A
 - 108. A

WELDING

- 20.1
 - 602. A-B-C-D-G-I-L-M
 - 603. A-B-F-G-I
 - W. 3011-1 refer to Metallurgy 18.1
 - WE. MA-18

MILLWRIGHT
SUPPLEMENTARY REFERENCE DIRECTORY

Note: All reference packets are numbered on the upper right-hand corner of the respective cover page.

<u>Supplementary Packet #</u>	<u>Description</u>	<u>Related Training Module</u>
1.8	Concepts & Techniques of Machine Safeguarding, U.S.D.L., O.S.H.A.	1.8 Machine Safeguarding
12.1	Correspondence Course, Lecture 1, Sec. 2, Steam Generators, Types of Boilers I, S.A.I.T., Calgary, Alberta, Canada	7.1 Boilers, Fire Tube Type
12.2	Correspondence Course, Lecture 2, Sec. 2, Steam Generators, Types of Boilers II, S.A.I.T., Calgary, Alberta, Canada	7.2 Boilers, Water Tube Type
12.3	Correspondence Course, Lecture 2, Sec. 2, Steam Generators, Boiler Construction & Erection, S.A.I.T., Calgary, Alberta, Canada	7.3 Boilers, Construction
12.4	Correspondence Course, Lecture 4, Sec. 2, Steam Generators, Boiler Fittings II, S.A.I.T., Calgary, Alberta, Canada	7.4 Boilers, Fittings
12.4	Correspondence Course, Lecture 4, Sec. 2, Steam Generators, Boiler Fitting I, S.A.I.T., Calgary, Alberta, Canada	7.4 Boilers, Fittings
12.5	Correspondence Course, Lecture 10, Sec. 2, Steam Generation, Boiler Operation, Maintenance, Inspection, S.A.I.T., Calgary, Alberta, Canada	7.5 Boilers, Operation
12.7	Correspondence Course, Lecture 3, Sec. 2, Steam Generation, Boiler Details, S.A.I.T., Calgary, Alberta, Canada	7.7 Boilers Heat Recovery Systems
		PUMPS
13.1	Correspondence Course, Lecture 9, Sec. 2, Steam Generator, Power Plant Pumps, S.A.I.T., Calgary, Alberta, Canada	9.1 Types & Classifications
13.2		9.2 Applications
13.4		9.4 Calculating Heat & Flow
13.6		9.6 Monitoring & Troubleshooting
13.7		9.7 Maintenance
13.3	Correspondence Course, Lecture 6, Sec. 3, Steam Generators, Pumps, S.A.I.T., Calgary, Alberta, Canada	9.3 Construction
13.5		9.5 Operation

Supplementary Packet #	Description	Related Training Module
14.3 12.8	Correspondence Course, Lecture 6, Sec. 3, Steam Generators, Steam Generator Controls, S.A.I.T., Calgary, Alberta, Canada	14.3 Steam Transport 7.8 Boilers, Instruments & Controls
14.4	Correspondence Course, Lecture 11, Sec. 2, Steam Generators, Piping II, S.A.I.T., Calgary, Alberta, Canada	14.4 Steam Purification
15.1	Correspondence Course, Lecture 1, Sec. 4, Prime Movers, & Auxiliaries, Steam Turbines, S.A.I.T., Calgary, Alberta, Canada	8.1 Steam Turbines, Types
15.2	Correspondence Course, Lecture 4, Sec. 3, Prime Movers, Steam Turbines I, S.A.I.T., Calgary, Alberta, Canada	8.2 Steam Turbines, Components
15.3	Correspondence Course, Lecture 2, Sec. 4, Prime Movers & Auxiliaries, Steam Turbine Auxiliaries, S.A.I.T., Calgary, Alberta, Canada	8.3 Steam Turbines, Auxiliaries
15.4	Correspondence Course, Lecture 6, Sec. 3, Prime Movers, Steam Turbine Operation & Maintenance, S.A.I.T., Calgary, Alberta, Canada	8.4 Steam Turbines, Operation & Maintenance
15.5	Correspondence Course, Lecture 8, Sec. 3, Prime Movers, Gas Turbines, S.A.I.T., Calgary, Alberta, Canada	8.5 Gas Turbines
16.2	Boilers Fired with Wood & Bark Residues, D.B. Junge, F.R.L., O.S.U., 1975	10.2 Combustion Types of Fuel
16.2	Correspondence Course, Lecture 5, Sec. 2, Steam Generators, Fuel Combustion, S.A.I.T., Calgary, Alberta, Canada	10.2 Combustion Types of Fuel
16.3	Correspondence Course, Lecture 5, Sec. 2, Plant Services, Fuel & Combustion, S.A.I.T., Calgary, Alberta, Canada	10.3 Combustion Air & Fuel Gases
17.1	Correspondence Course, Lecture 12, Sec. 3, Steam Generation, Water Treatment, S.A.I.T., Calgary, Alberta, Canada	12.1 Feedwater, Types & Operation
17.2	Correspondence Course, Lecture 12, Sec. 2, Steam Generation, Water Treatment, S.A.I.T., Calgary, Alberta, Canada	12.2 Feedwater, Water Treatments

Supplementary Packet #	Description	Related Training Module
17.3	Correspondence Course, Lecture 7, Sec. 2, Steam Generators, Boiler Feedwater Treatment, S.A.I.T., Calgary, Alberta, Canada	12.3 Feedwater, Testing
18.1	Correspondence Course, Lecture 2, Sec. 5, Electricity, Direct Current Machines, S.A.I.T., Calgary, Alberta, Canada	11.1 Generators, Types & Construction
18.1	Correspondence Course, Lecture 4, Sec. 5, Electricity, Alternating Current Generators, S.A.I.T., Calgary, Alberta, Canada	11.1 Generators, Types & Construction
18.2		18.2 Generators, Operation
19.1	Correspondence Course, Lecture 5, Sec. 4, Prime Movers & Auxiliaries, Air Compressor I, S.A.I.T., Calgary, Alberta, Canada	13.1 Air Compressors, Types
19.1	Correspondence Course, Lecture 6, Sec. 4, Prime Movers & Auxiliaries, Air Compressors II, S.A.I.T., Calgary, Alberta, Canada	13.1 Air Compressors, Types
		13.2 Air Compressors, Operation & Maintenance
20.1	Basic Electronics, Power Transformers, EL-BE-51	15.4 Transformers
21.1	Correspondence Course, Lecture 6, Sec. 5, Electricity, Switchgear & Circuit, Protective Equipment, S.A.I.T., Calgary, Alberta, Canada	15.3 Circuit Protection
22.1	Correspondence Course, Lecture 10, Sec. 3, Prime Movers, Power Plant Erection & Installation, S.A.I.T., Calgary, Alberta, Canada	15.1 Installation Foundations

RECOMMENDATIONS FOR USING TRAINING MODULES

The following pages list modules and their corresponding numbers for this particular apprenticeship trade. As related training classroom hours vary for different reasons throughout the state, we recommend that the individual apprenticeship committees divide the total packets to fit their individual class schedules.

There are over 130 modules available. Apprentices can complete the whole set by the end of their indentured apprenticeships. Some apprentices may already have knowledge and skills that are covered in particular modules. In those cases, perhaps credit could be granted for those subjects, allowing apprentices to advance to the remaining modules.

We suggest the the apprenticeship instructors assign the modules in numerical order to make this learning tool most effective.

SUPPLEMENTARY INFORMATION

ON CASSETTE TAPES

Tape 1: Fire Tube Boilers - Water Tube Boilers
and Boiler Manholes and Safety Precautions

Tape 2: Boiler Fittings, Valves, Injectors,
Pumps and Steam Traps

Tape 3: Combustion, Boiler Care and Heat Transfer
and Feed Water Types

Tape 4: Boiler Safety and Steam Turbines

NOTE: The above cassette tapes are intended as additional
reference material for the respective modules, as
indicated, and not designated as a required assignment.

Modules 18.1, 19.1, and 20.1 have been omitted because they contain dated materials.

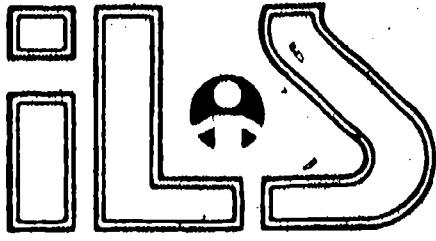

INSTRUCTIONAL LEARNING SYSTEMS

11.1

GENERATORS — TYPES AND CONSTRUCTION

Goal:

The apprentice will be able to describe types of generators and their construction.

Performance Indicators:

1. Describe AC generators.
2. Describe DC generators.
3. Describe field exciters.
4. Describe construction of generators.

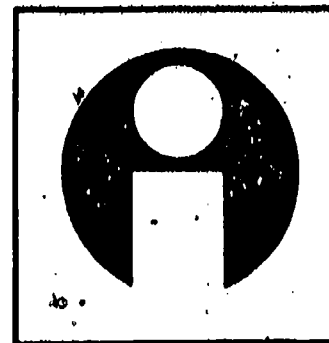

Study Guide

- * Read the goal and performance indicators to find what is to be learned from package.
- * Read the vocabulary list to find new words that will be used in package.
- * Read the introduction and information sheets.
- * Complete the job sheet.
- * Complete self-assessment.
- * Complete post-assessment.

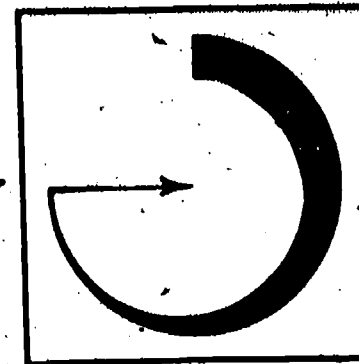

Vocabulary

- * Air cooling
- * Air gap
- * Alternator
- * Armature core
- * Brushes
- * Commutator
- * Compound generator (DC)
- * Core
- * Cylindrical type
- * Direct acting rheostatic regulator
- * End caps
- * Field coils
- * Field poles
- * Flat compounded
- * Frame or yoke
- * Hydrogen cooling
- * Indirect acting rheostatic regulator
- * Interpoles
- * Liquid cooling
- * Magnetic amplifier
- * Motor exciter
- * Over-compounded
- * Pole cores
- * Rotor
- * Salient field pole type
- * Self-excited
- * Separately excited
- * Series
- * Shaft exciter
- * Shunt
- * Static regulator
- * Stator
- * Stator frame
- * Synchronous speed
- * Three-phase
- * Under-compounded
- * Ventilation slots
- * Windings

Introduction

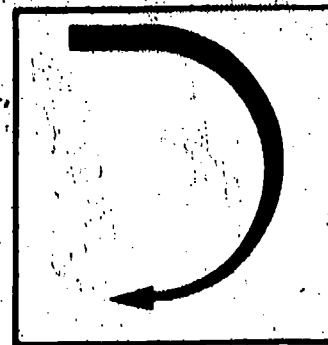

Generators transform mechanical energy into electrical energy. They are basic components of power generation plants. Most generators in industry are of the alternating current type. AC generators are commonly known as alternators. Steam and gas turbines are used to power most large alternators. Some small alternators are engine driven.

A direct current generator is actually an AC generator that has been equipped with a commutator. The commutator is a rectifier. DC generators are not widely used except as field exciters for large AC generators.

Turbine generators are composed of a magnetic field that rotates (rotor) inside a stationary conductor component (stator). This package will describe the types and construction of generators used in power production.

Information



AC Generators

AC generators must be driven at a constant speed. This is to assure the frequency of supply of electricity entering a circuit load. If more than one generator is hooked in parallel, each must be operated at the same speed. That speed is called synchronous speed. The alternator is composed of two components—the stator and the rotor.

Stator Design

The stator is the stationary portion of the alternator. It has three parts:

- * Core -- built of segmented steel sheets that are slotted so that they can be keyed to the stator frame.
- * Windings -- formed from copper conductor materials and wound to fit in the slots of the core. The windings are insulated by a bonding material such as micanite.
- * Stator frame -- supports the core and windings and serves to enclose coolants.

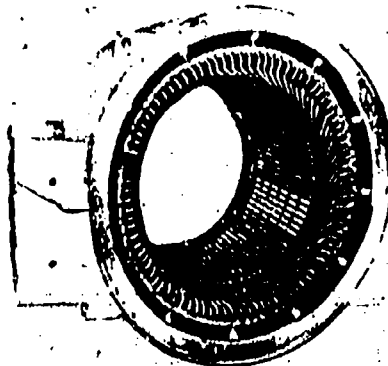

Rotor Design

The rotor is a steel forged shaft that is slotted to receive the rotor windings. Rotor windings are strips of copper that have been insulated with micanite. The windings are held into the rotor body with steel wedges. This protects the windings against the centrifugal force of the turning rotor. Once the steel wedges are driven into place, end caps are used to lock the wedges into position. The rotor shaft is made with ultrasonic test grooves to allow examination of forging soundness. Also, the shaft has machined ventilation slots to assist in the cooling of the rotor.

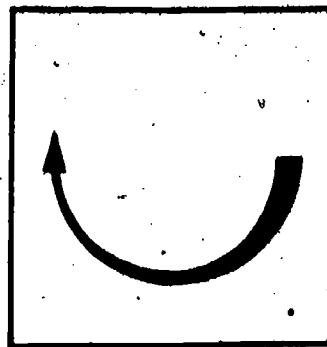

Information

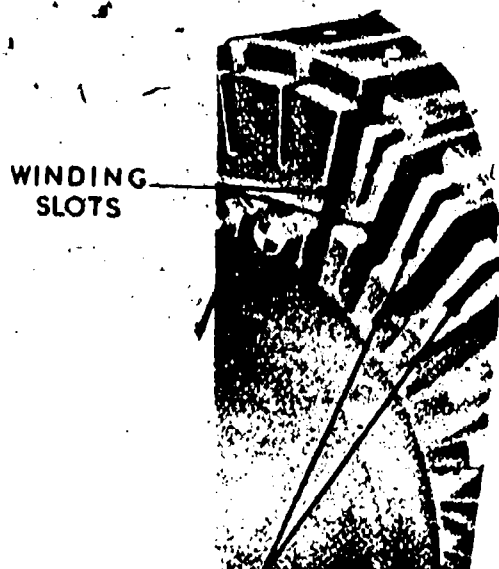

WINDING
SLOTS

VENTILATION SLOTS

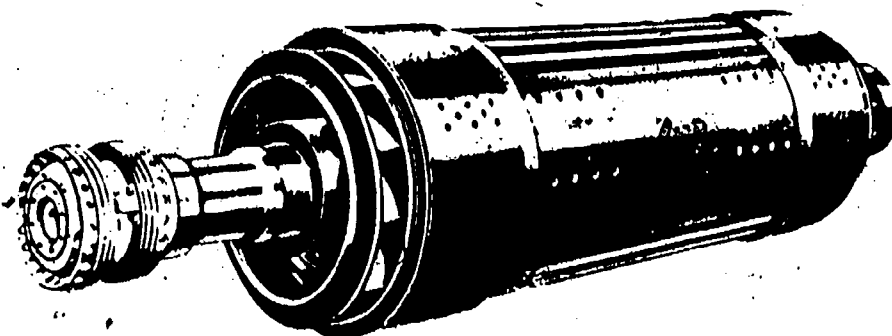

ROTOR COMPLETE WITH WINDING, END BELLS, FANS
AND COUPLINGS

Types of AC Generators

Alternating current generators are of two types. The salient field pole generator is used on water turbines and diesel engine driven plants. It is a slow speed generator. A cylindrical type rotor is used on steam and gas turbine driven alternators. Salient-pole rotors have projecting field poles. The laminated pole pieces with their field coils are mounted on the rim of the steel spider and keyed to the shaft.

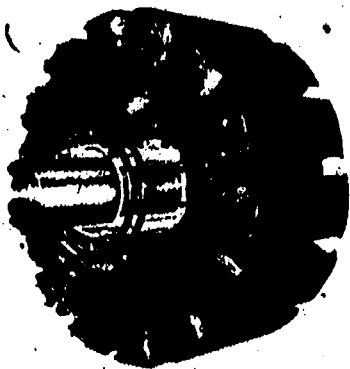

The cylindrical type rotor was shown in rotor design. It is a high speed rotor that can withstand the vibrations much better than the salient-pole type. For that reason, it will be the generator most often found in a power plant.

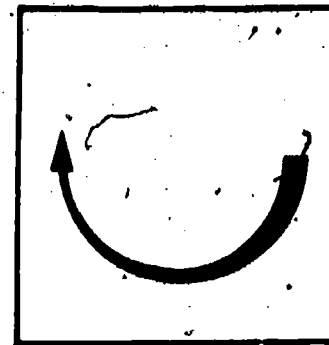

Information

Phase

Both single phase and three-phase alternators are manufactured. The three-phase is the most common type in steam generation plants. The windings are set in three groups. These groups are set apart by 120° . This causes three different, overlapping voltages which tends to even out the power. A single phase electrical wave will produce both positive and negative voltage with each pulsation.

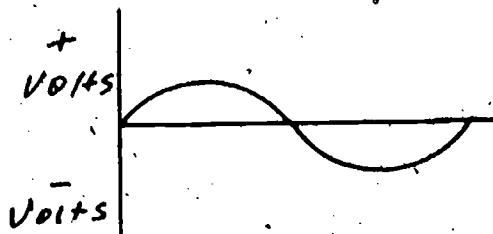

A three phase smooths out the momentary drop by overlapping the electrical waves. This produces a more consistent power.

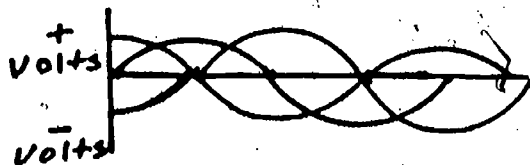

Cooling Design

Alternators are cooled by air, liquid or hydrogen. In an air cooled system, air is recirculated through the windings by use of an air cooler. This enclosed air system uses water as a cooling medium for the air cooler. Hydrogen cooling is also a closed circuit system. Hydrogen has many advantages over air as a cooling medium and transfers heat much more rapidly than air. Hydrogen is more explosive and must be encased in an explosion proof casing. When the stator is opened for repair, the hydrogen should be purged with CO_2 to avoid explosive mixtures of air and hydrogen. Liquid cooling of alternators is a recent design feature. Water is moved through hollow conductors in the stator. The conductors are made of copper. Water is carried to the conductors through stainless steel manifolds and plastic insulating hose.

Information

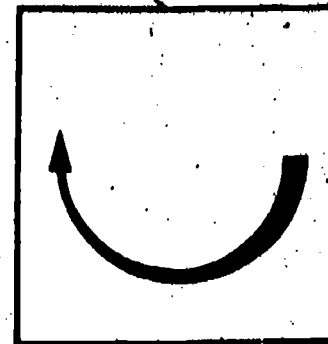

DC Generators

A direct current generator is very much like an AC generator. The big difference is the commutator. A commutator is a rectifier which changes alternating current into a one directional flow. Both AC and DC generators produce alternating current. The commutator changes alternating current to direct current.

DC Design

A DC generator consists of:

- * A frame or yoke that supports the field poles and is also part of the magnetic circuit.
- * Field poles that are bolted to the yoke. These field poles or pole cores are made of sheet steel laminations that are insulated from each other and riveted together.
- * Armature core consists of sheet steel laminations that are keyed to a shaft. The outer surface of the core is slotted to handle armature coils.
- * Air gap is the space between the armature surface and the pole face, Usually 1/16" to 1/4" in length.
- * Commutator — is secured to but insulated from the shaft. It consists of a number of copper segments that are assembled into a cylinder with each segment insulated from the others with mica. The armature coil ends are soldered to the commutator.
- * Brushes — provide the electrical connection between the armature and the outside circuit. These sliding electrical connections are made of carbon and held in place by spring tension.
- * Field coils are placed around the pole cores and connected in series to form a field circuit. The field coils may be connected as shunt field coils or series field coils.
- * Interpoles or commutator poles are small poles placed halfway between the main poles. The interpoles are designed to improve commutation by establishing a magnetic flux when current flows through the armature circuit.

Information



The following diagram shows the parts of a DC generator.

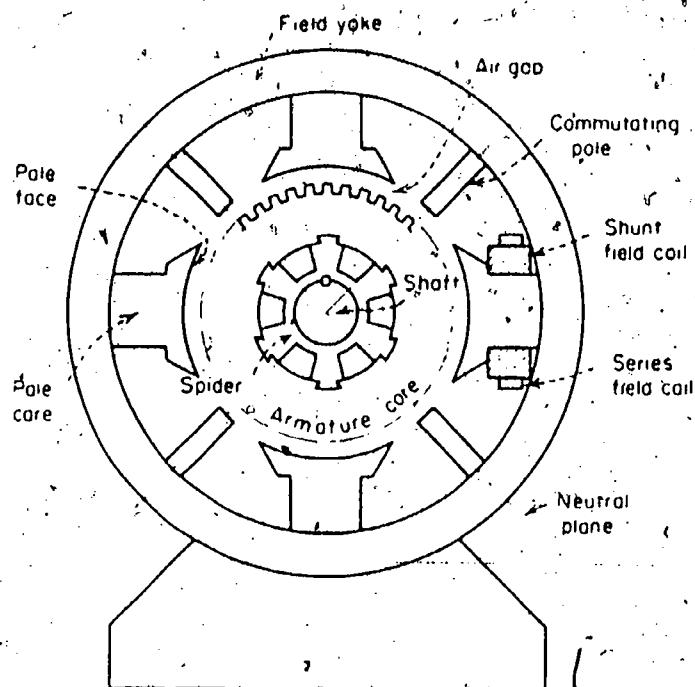

A dismantled generator with parts is shown in the following picture.

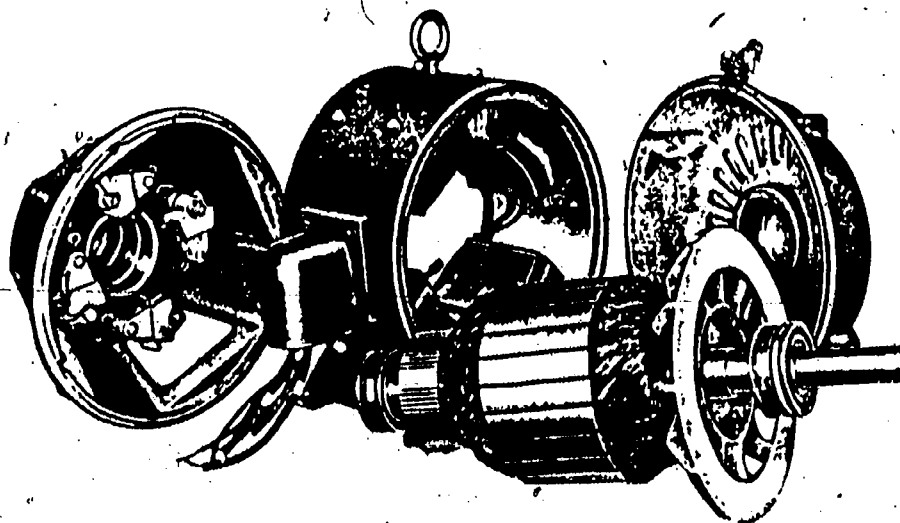

Types of DC Generators

Direct current generators may be classified into three major types.

1. Series
2. Shunt
3. Compound

BEST COPY AVAILABLE

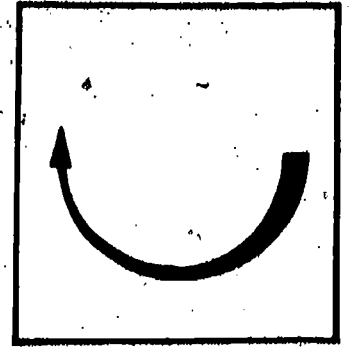

Information

Generators may be classified by the way they receive their current.

- * Self-excited generators receive current directly from the generator terminals.
- * Separately excited generators use a separate source of current to feed the shunt winding.

A series type generator uses heavy copper windings about the field coils that are connected in series with the armature. Increases in armature current shows an increase in the voltage of the electrical current generated.

The shunt type generator shows a decrease in voltage as the load is increased. This is opposite to that of the series type generator.

In compounding a generator, both series and shunt principles are used to obtain a constant voltage under load. If the terminal voltage remains constant under all load conditions, it is called a flat-compounded generator. If more than the needed turns are made in the series field, it is called over-compounded. Less than the needed turns results in under-compounded generators.

Field Excitation

A field excitation system is all of the equipment needed to control, supply and regulate the field current. This section will deal with field excitation for alternating current generators. Field excitation is usually provided by direct current from a DC generator.

Exciters

Exciters are self-excited or separately excited through a shunt field winding. The exciters may be connected directly to the shaft (shaft exciter) or separately driven (motor exciter). An exciter may be connected with the shaft by mounting it directly on the shaft extension (direct connected type), through a direct connection to the shaft with a flexible coupling; or through a gear connection to the turbine generator. All of the above are shaft exciters.

Motor driven exciters often use large flywheels to take advantage of low commutator speeds. These units are made in large sizes.

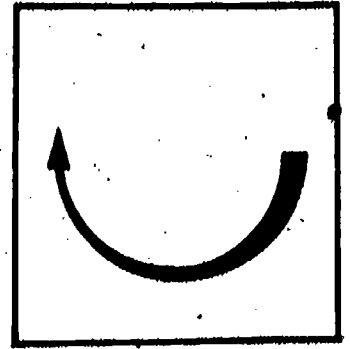

Information

Field Circuit Breakers

When dealing with large field currents, there is a hazard when the magnetic field collapses and high voltage surges into the field windings. To avoid damage from such voltage surges, an additional set of contacts are placed into the field circuit. The contacts use a resistor to absorb the voltage and prevent it from damaging the windings.

Voltage Regulators

Voltage regulators automatically raise or lower the excitation level of generators. When the regulator detects a change in voltage, it responds by changing the field excitation. This permits the generator to deliver output of a constant voltage. Voltage regulators are classified as:

- * Direct acting rheostatic regulators that respond directly to the generator.
- * Indirect acting rheostatic regulators use an auxiliary apparatus to control a rheostat in the generator.
- * Static regulators that use a magnetic amplifier and an amplidyne to regulate the voltage.

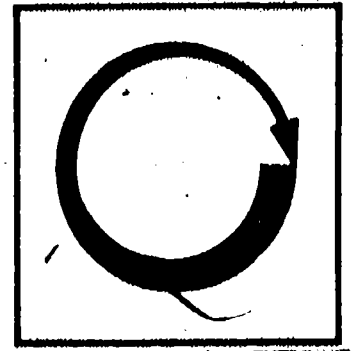

Assignment

- * Read pages 1 - 10 in "Direct Current Machines" of supplementary reference.
Read pages 1 - 22 in "Alternating Current Generators" of supplementary reference.
- * Complete job sheet.
- * Complete self-assessment and check answers.
- * Complete post-assessment and have instructor check your answers.

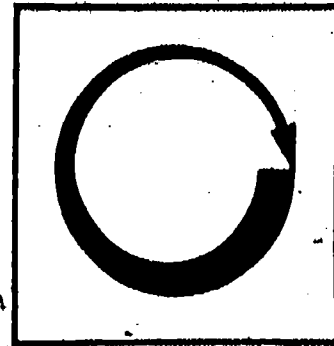

Job Sheet

COMPLETE VISUAL INSPECTION OF AN AC GENERATOR.

- * Locate an AC generator. (Preferably one that is opened up for repair purposes.)
- * Identify the parts of the stator, their design and construction features.
- * Identify the parts of the rotor, their design and construction features.
- * Identify the field exciter and how the voltage is regulated.

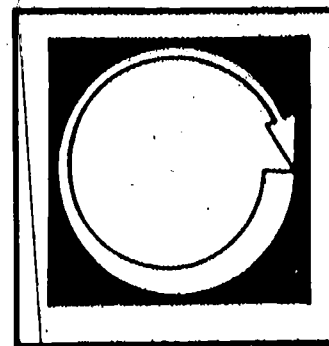

Self Assessment

Match the following terms and phrases.

- | | |
|---------------------------------|--|
| _____ 1. Rotor | A. Used in generator cooling system. |
| _____ 2. Commutator | B. Shows increase in voltage as armature current increases. |
| _____ 3. Static type | C. Built of segmented steel sheets that are slotted. |
| _____ 4. Windings | D. The part of a generator that is stationary. |
| _____ 5. Hydrogen | E. Type of AC generator. |
| _____ 6. Core | F. Fit into slots in the stator core. |
| _____ 7. Salient field pole | G. A type of rectifier that changes alternating current to a one-direction flow. |
| _____ 8. Stator | H. Voltage regulator that uses a magnetic amplifier. |
| _____ 9. Shunt type generator | I. The part of a generator that rotates. |
| _____ 10. Series type generator | J. Shows decrease in voltage as load is increased. |

● Self Assessment Answers

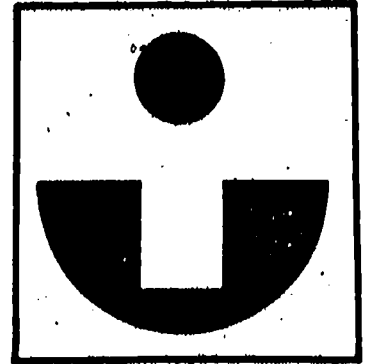

I 1.

G 2.

H 3.

F 4.

A 5.

● C 6.

E 7.

D 8.

J 9.

B 10.

Post Assessment

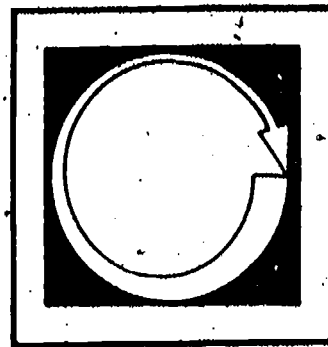

1. When two generators are hooked together in parallel, they must be operated at the same speed. What is that speed called?
2. What are the two major components of a generator?
3. What is the purpose of ventilation slots in a rotor?
4. List two types of AC generators?
5. Which type of AC generator is most commonly used in steam driven power plants?
6. In a three-phase alternator, the windings are set apart by _____ degrees.
7. What is the advantage of three-phase electricity?
8. List three cooling methods for AC generators.
9. List three type of DC generators.
10. List two types of field exciters.

Instructor Post Assessment Answers

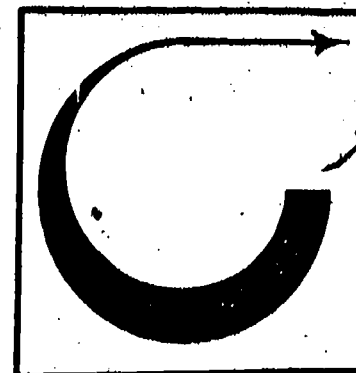

1. Synchronous speed
2. Rotor, stator
3. Cooling of the rotor
4. Salient field pole, cylindrical type
5. Cylindrical type
6. 120
7. Smooths out pulsations to give even power flow
8. Air, liquid, hydrogen
9. Series, shunt, compound
10. Self-excited, separately excited

Supplementary References

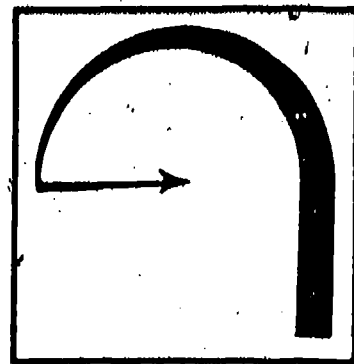

- * Correspondence Course. Lectures 2 and 4, Section 5. Second Class.
Southern Alberta Institute of Technology. Calgary, Alberta, Canada.

SOUTHERN ALBERTA INSTITUTE OF TECHNOLOGY
CALGARY, ALBERTA

Correspondence Courses
Power Engineering

SECTION 5

Second Class
Lecture 2

ELECTRICITY

DIRECT-CURRENT MACHINES

This lecture will outline direct-current motors and generators with regard to construction, type, performance and application. It will include some remarks on Motor-Generator sets, Rotary Convertors, and methods of control of direct-current machinery.

DIRECT-CURRENT GENERATORS

A generator is a device for changing mechanical energy into electrical energy. The mechanical energy is supplied to the generator-drive and the movement of electrical conductors in a magnetic field produces electricity, as was shown in the foregoing lecture.

Direct current finds limited application at the present day, but d-c generators are used for excitation of large alternators, for supplying power station auxiliaries with emergency power, and for such uses as lighting service, stationary-motor service, traction-motor service, electric welding, battery charging, electrochemical processes and communication systems.

Fig. 1 shows the basic d-c generator. Here two electromagnets are mounted in a circular frame called the yoke; the magnetic-field circuit is shown in broken lines. The armature is rotated in this field and the generated current collected through brushes on the commutator.

Fig. 2 gives an illustration of an actual machine.

Construction

(a) The frame or field yoke is steel or cast iron; it serves as support for the field poles and also forms part of the magnetic circuit. The pole pieces are made up of laminated steel plates riveted together and bolted to the yoke. The pole face is made larger than the main body of the pole in order to support the field coil and also reduce the reluctance of the air-gap between field pole and armature.

(b) The armature is made up of laminations of soft iron sheeting insulated from each other by varnish in order to reduce eddy current, keyed to a spider on the shaft, and bolted up between clamping rings.

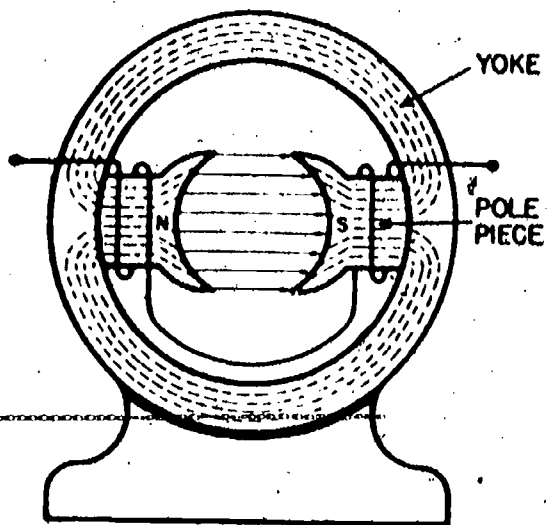

Field

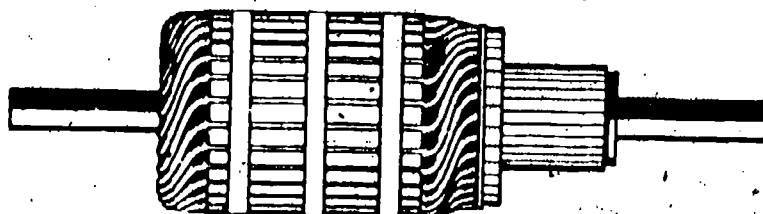

Armature

BASIC D-C GENERATOR

Fig.1



(a) Field, showing yoke, main poles and interpoles

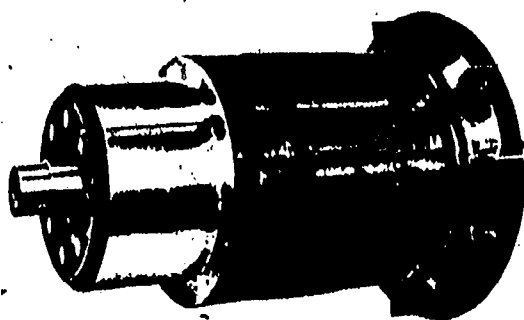

(b) Armature

D-C GENERATOR

Fig.2

(PE2-5-2-2)

The armature coils are laid into slots in the armature core, the ends brought out and connected to the commutator bars.

Fig. 3 shows a section of the arrangement. The commutator bars are insulated from each other and from the shaft.

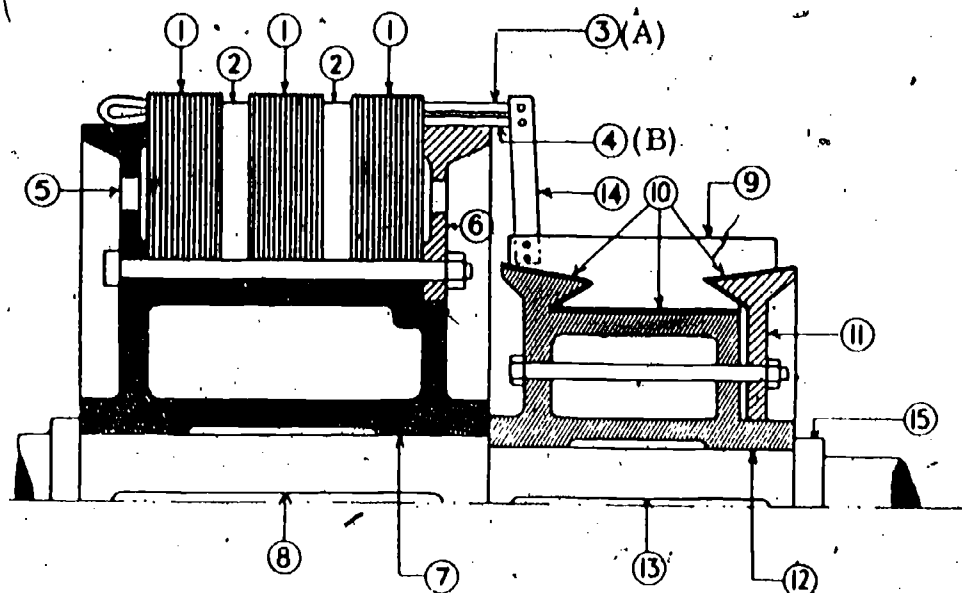

SECTION THROUGH ARMATURE AND COMMUTATOR
FOR D-C GENERATOR

Fig.3

- | | |
|---|---|
| 1. Soft iron stampings insulated from each other. | 9. Copper bar of commutator. |
| 2. Ventilation space. | 10. Mica insulation. |
| 3. Armature conductor (A) | 11. Clamping ring. |
| 4. Armature conductor (B) | 12. Spider keyed to driving shaft. |
| 5. Ventilation space. | 13. Key or feather. |
| 6. Clamping ring. | 14. "Riser" riveted and soldered to copper bar of commutator and to ends of conductors A and B. |
| 7. Spider keyed to driving shaft. | 15. Screwed locking ring. |
| 8. Key or feather, | |

(PE2-5-2-3)

Commutation

The action of a commutator is to reverse the armature coil connections to the external circuit at the same instant that the current reverses in the coils. (See preceding lecture and earlier courses.) The result is uni-directional current (direct current) in the external circuit.

In order to accomplish this without breaking the continuity of current flow to the external circuit the generator brushes are arranged to bridge over two or more segments. This in turn means that while the brush is bridging two segments it forms a short-circuited coil in the armature. If this short-circuited coil is cutting magnetic flux at that time, it will, besides carrying the load current, have an E generated in it and will have a circulating current.

Further this coil will form an induced circuit and will draw an arc if open-circuited. In order to achieve sparkless commutation then, it is necessary to ensure that the short-circuited coil does not have an E generated at the time of leaving the brush.

This will only be the case if the brushes are correctly located at the neutral point where the coil is cutting no flux.

Armature Reaction

Fig. 4 (a), (b) and (c) shows the effect known as "Armature Reaction".

Fig. 4(a) shows the magnetic field in a two-pole generator with no current flowing in the armature conductors. The only effect the armature has upon the field is to cause the flux to take the easy path through a highly permeable soft iron core.

Fig. 4(b) shows the magnetic field produced by the armature conductors, with load current flowing through them. (The field from the poles is entirely omitted).

Fig. 4(c) shows the interaction of these two fields and represents the conditions obtaining when the generator is running on load.

Note, in the first instance (sketch (a)), that the points at which the revolving conductors would be cutting no flux would be at Y and Y' . A line through $Y-Y'$ is termed the neutral axis. In the (c) sketch however, this neutral axis has now been displaced by armature reaction to the position $Y''Y'''$.

The brush position necessary for sparkless commutation in the first instance is at $Y-Y'$ but in the last instance has changed to $Y''Y'''$ which means that as load is increased upon the generator the brushes must be shifted around in the direction of rotation.

(PE2-5-2-4)

Interpoles

The improvement obtained in commutation by brush shifting with changing load can be achieved by the use of interpoles. These are small poles spaced between the main poles and set to oppose the field caused by the armature conductors. Fig. 4(b) shows that interpoles fitted to this machine would have to be S polarity (top) and N polarity (bottom) in order to achieve this object. Or differently stated, the same polarity as the following main pole in the direction of armature rotation.

These interpoles cannot neutralize the armature reaction entirely but they can provide an opposing flux which will keep sparking at the brushes to a minimum. They will do their duty most effectively if the field they produce is directly proportional to the armature current. For this reason the interpole winding is always a few turns of heavy copper, carrying the full armature current, in series with the armature.

The machine pictured in Fig. 2 is fitted with interpoles. Note that interpoles will only be found on d-c machines, an a-c machine has no commutator and hence no need for interpoles.

Compensating Windings

Compensating windings carrying full armature current (as do the interpoles) are sometimes fitted into slots in the pole faces. Their purpose is to neutralize the effect of armature reaction in the zones outside the influence of the interpoles.

Neutral Position

Brush position on the commutator of a d-c machine without interpoles required adjustment with load changes, as stated earlier. With interpoles of proper design, the armature neutral, and consequently the brush positions are fixed. This position will be located and marked on the machine during manufacture. Usually the brush carrier ring has slotted bolt holes and can rotate in its machined spigot landing in the frame when the securing bolts are slackened. The following remarks will give suggested methods of checking the neutral position if this should become necessary.

Before beginning such a check it would be wise to see that the brush gear is correctly fitted and in good order. The brushes should be equally spaced around the commutator, lined up with the segments, and properly bedded to the surface. They should be all of the same grade. The field poles should be checked for tightness in the frame and the air-gaps between pole faces and armature measured to ensure that they are uniform. These will vary with the size of the machine but will be about 1.5 to 6 mm.

(PE2-5-2-5)

DIRECTION OF ROTATION

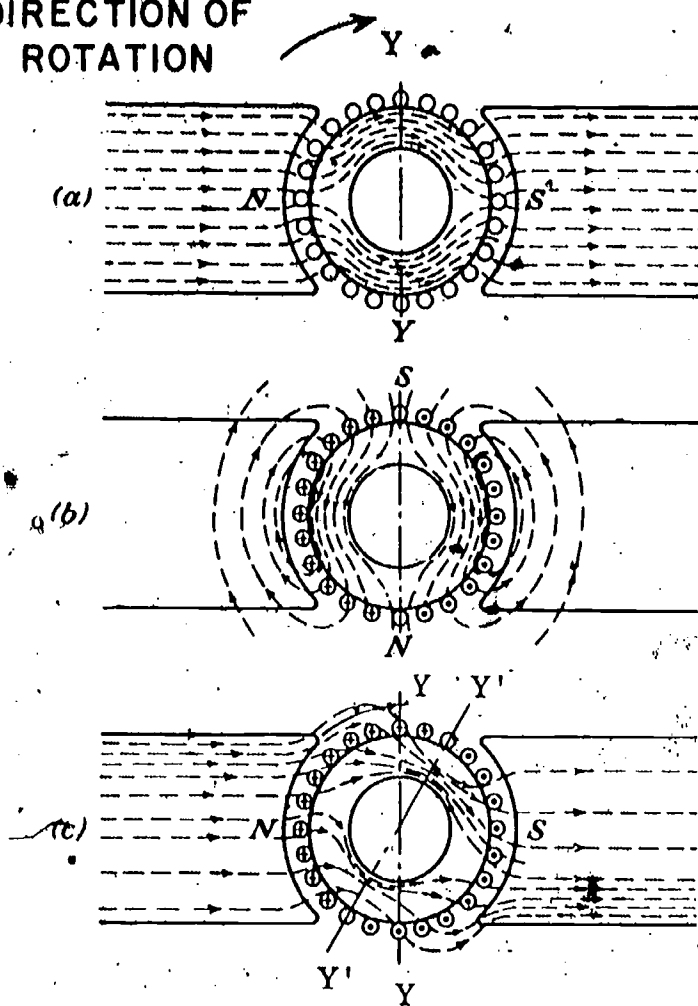

ARMATURE REACTION IN A TWO-POLE GENERATOR

Fig 4

Standing Neutral - The position of the neutral, with the machine standing, can be most accurately found by use of a voltmeter or millivoltmeter. Briefly stated the method is as follows: Connect a voltmeter between +ve and -ve brushes; with the machine standing excite the shunt field to about 25% of rated voltage. Open and close field switch and observe the voltmeter. Shift the brushes until the meter shows no deflection on making or breaking the circuit and they will then be in the correct neutral position.

Running Neutral - A good check can be carried out with the machine being driven as a generator. A pair of test probes is connected to a millivoltmeter and the probes set so that the distance between them is equal to the width of one commutator segment. When these probes are placed on the commutator surface with the machine running, the millivoltmeter will show the voltage drop between segments. Then by exploring near the neutral zone a position will be found where zero reading is obtained on the millivoltmeter and this will be the neutral point.

(PE2-5-2-6)

TYPES OF D-C GENERATORS

There are three main types of d-c generators: Shunt, Series, and Compound. Fig. 5 shows in sequence a Shunt-wound, Series-wound and two types of Compound-wound generators.

Note that all of these machines are self-excited, that is their field current is supplied by their own armatures.

Fig. 6 shows a machine operating with excitation supplied from a separate source.

When a generator is in operation, whether on load or running light, the shunt field is always excited; the series field on the other hand is only excited when the machine is delivering a load current. From this we can see that a series-generator will have very low voltage when the machine is at no-load, whereas a shunt-generator will have fairly constant voltage at all loads.

These facts influence the generator-operating characteristics.

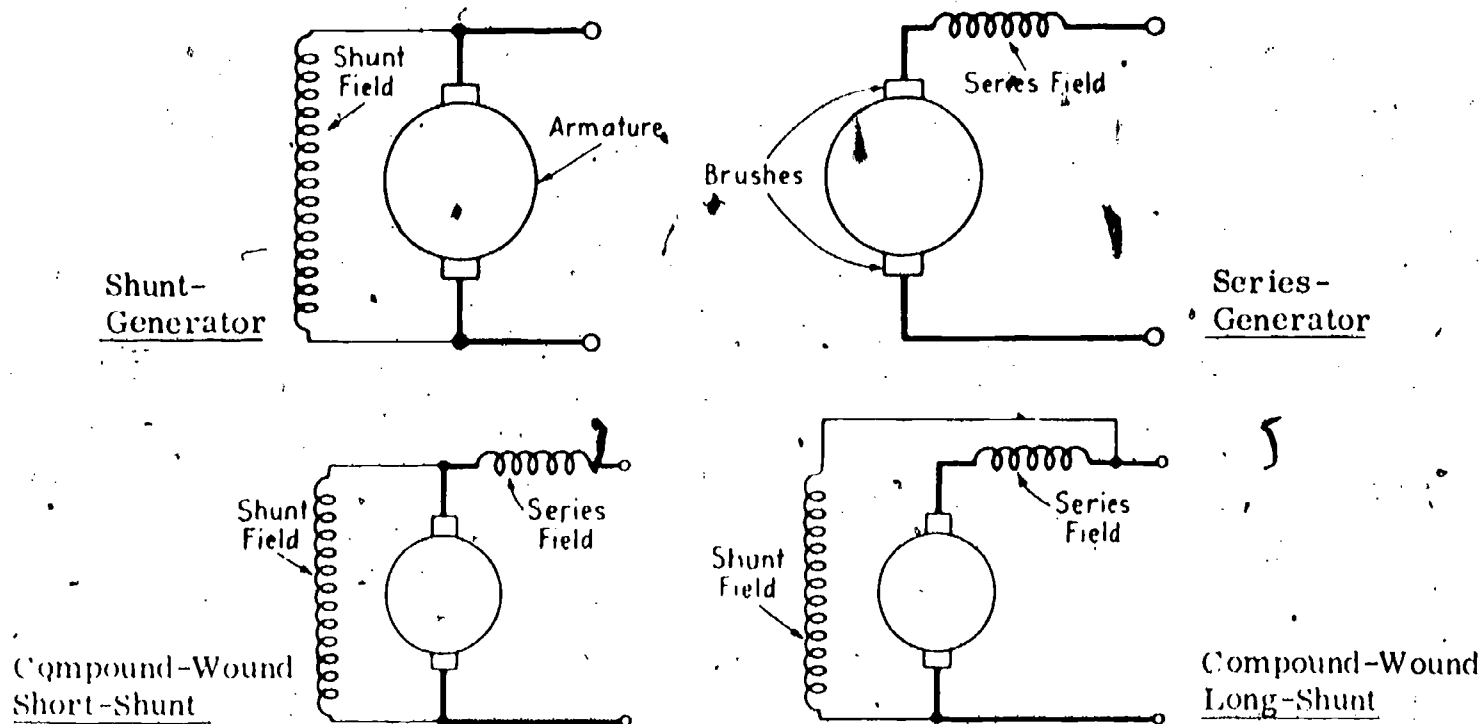

SELF-EXCITED D-C GENERATORS

Fig. 5

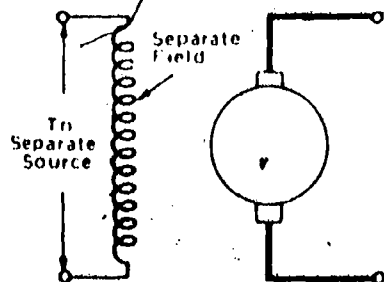

SEPARATELY EXCITED D-C GENERATOR

Fig. 6

(PE2-5-2-7)

Generator Characteristics

One of the most important characteristics of any generator is the variation in its terminal voltage with changing load. This voltage change measured between no-load and full-load is called the voltage regulation, or simply regulation, and would be discovered by experiment, for any particular machine.

This characteristic is important when choosing a generator for a particular duty; it is expressed as a curve of voltage plotted against load (voltage regulation curve) which is derived from readings taken during a test in which the machine is run at constant speed, with field excitation set to give the rated terminal voltage at full-load. No adjustments are carried out during the test.

Expressed as a percentage this is:

$$\% \text{ Regulation} = \frac{\text{No-load volts} - \text{Full-load volts}}{\text{Full-load volts}}$$

The following regulation curves show the voltage characteristic for each of the generator types in turn. (For convenience, Fig. 16 (a) to (e) of the previous lecture, showing the machine connections, has been repeated.)

Separately Excited Generator

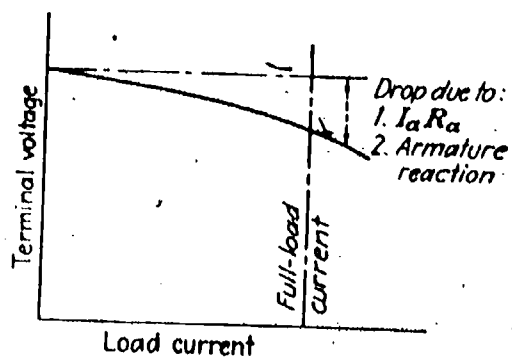

Voltage Regulation Curve

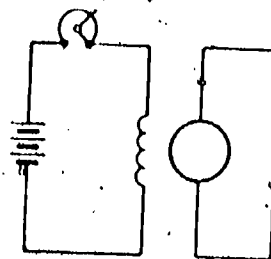

Machine Connections

Fig. 7

The voltage decreases with increase of load current because:

- (a) The armature circuit resistance increases, and
- (b) The armature reaction reduced the effective flux and consequently the emf.

Note again that these curves are drawn for a fixed position of the field rheostat.

The separately excited generator has a decided advantage over the self-excited machine in that it will operate in a stable condition at any level of field excitation. This characteristic makes it particularly suitable as an exciter for a central station alternator. In this plant-arrangement the exciter (the separately excited generator) is driven off the main turbine shaft together with a second or pony exciter which supplies the field of the first.

(PE2-5-2-8)

Shunt-wound Generator

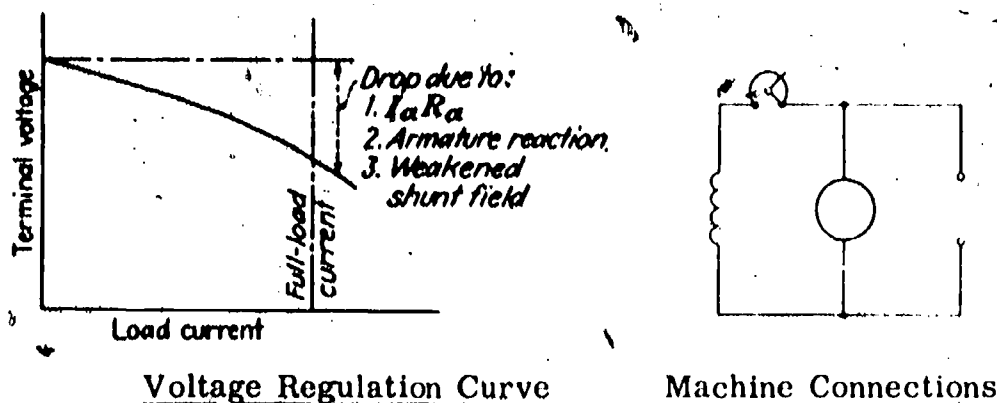

Fig. 8

The terminal voltage decreases with increase of load current for the same reasons as the separately excited machine but the effect is more marked. This is because in this case the shunt field is weakened by the reduction in generated E .

A self-excited generator depends in the first place upon the residual magnetism in the field circuit to build up terminal voltage as the machine is run up. Failure to build up voltage may be due to the loss or the reversal of this residual magnetism. It can be restored by passing current through the field coils; a 6-volt storage battery will usually be sufficient for the purpose.

Before deciding to "flash" the field coils to restore the residual magnetism, care should be taken to see that the whole of the field circuit is in good working order since a fault here could also prevent voltage build-up. The commutator must be clean, the brushes clean and the brush-connections good. The field coils should be checked for open-circuit and for short-circuit.

Series-wound Generator

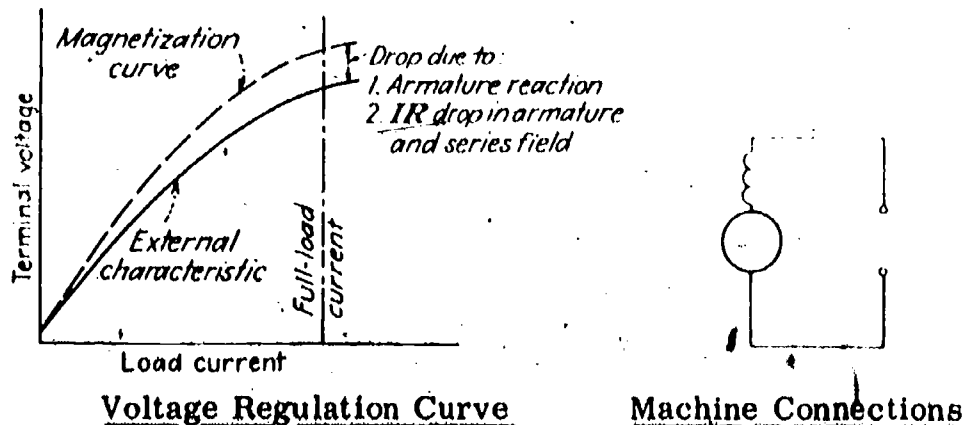

Fig. 9

The series-wound generator is a self-excited generator which has armature and field connected in series. The initial E generated depends upon residual magnetism, the field current is also the load current so that full flux and therefore full voltage cannot be achieved until full-load current is flowing.

(PE2-5-2-9)

Compound-wound Generator

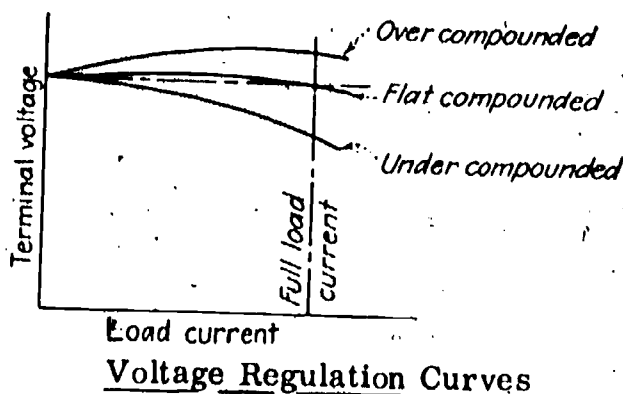
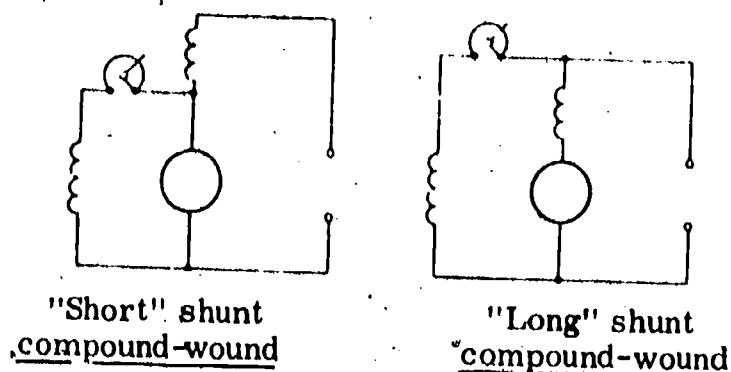

Fig. 10

The compound-wound generator combines the principles of both shunt and series machines and is the design which finds most application.

The relative strength of shunt and series fields can be chosen so that the regulation curves show rising voltage with load (over-compounded machine) or falling voltage with load (under-compounded machine) or a constant voltage from no-load to full-load (flat-compounded machine).

The winding may be connected so that the shunt field is in parallel with the armature only; this is called a "short" shunt. Alternatively the shunt field may be in parallel with armature and series field; this is called "long" shunt. The operating characteristics of both connections are very similar.

Generator Voltage Control

It is possible to prevent the terminal voltage of a generator from varying with the load by controlling the field rheostat so that the field current and hence the magnetic flux is adjusted for each change in load.

For example, an increase of load would cause a drop in terminal voltage, to counteract this the field resistance must be reduced. This will allow greater field current flow and increase the flux density. From the discussions in the preceding lecture it will be recalled that the generated voltage is directly proportional to the rate of cutting lines of force.

The required movements of the field rheostat may be carried out by hand or may be automatically controlled. There are several automatic voltage regulators available: Tirrell, Diactor, and others. All work on the fundamental principle that a terminal voltage change calls for an inverse change in flux.

(PE2-5-2-10)

Parallel Operation of D-C Generators

When more than one generator is required to supply a load and the machines must be run in parallel, precautions must be taken to see that they are stable in their operation. In other words they must each be able to maintain their required portion of the load despite any small temporary fluctuations in speed or voltage."

This stability will only occur when the generators used have "drooping characteristics" (decrease of terminal voltage with increasing load). Shunt-wound generators show this characteristic (see Fig. 8) and are thus always suitable for parallel operating; series-wound generators are not. Compound-wound generators may have a "rising characteristic", that is, the terminal voltage increases with increasing load if they are over-compounded machines.

In a case where two over-compounded generators are run in parallel consider the sequence of events which would follow a momentary increase of speed of one of them. The terminal voltage of this machine will increase; it will then supply more load current. The increase in load current will flow through the series field and cause a further increase in p.d. This sequence will continue progressively until that machine has taken all of the load and is driving the other as a motor. The arrangement would be inherently unstable.

Two machines in similar circumstances but having drooping characteristics would react as follows: The machine which speeded up would supply more load current because of the increased terminal p.d. but this increased load would bring decrease in voltage instead of increase and consequently no tendency to pick up any more load. As soon as the temporary speed increase had gone the two machines would resume their load sharing as before.

Equalizing Connection - The flow of load current through the series-field windings can be equalized by the connection shown in Fig. 11. In this case the corresponding ends of the series fields are connected together so that the two series-field windings are operating in parallel. Any variation in either machine terminal voltage now will cause a change in current flow in both series-field windings and will not cause unbalance. The load which each machine carries will be determined by the shunt field and can be set by the position of the field rheostat.

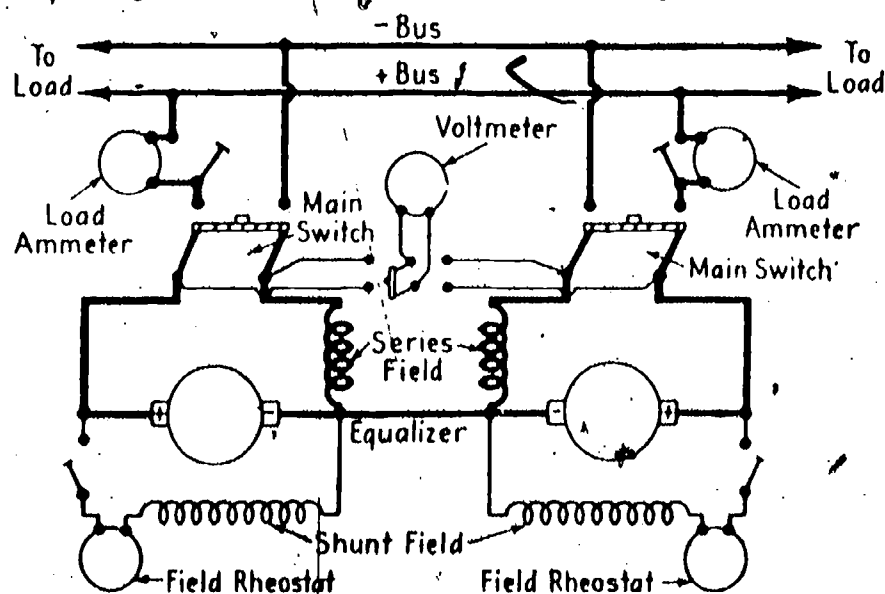

PARALLEL CONNECTION OF COMPOUND GENERATORS
SHOWING USE OF EQUALIZER BAR

Fig 11

(PE2-5-2-11)

DIRECT-CURRENT MOTORS

There are three general types of d-c motors, classified (like the d-c generators) according to the method of field excitation used. The three types are Shunt, Series and Compound-wound motors. They possess certain individual characteristics which depend upon the winding.

There is one characteristic however which is common to all d-c motors and this is the ease with which speed control can be achieved. There is no doubt that this advantage is responsible for the choice of d-c motor-drive in preference to alternating current for many applications.

D-c motors will show characteristics regarding starting torque, overload capacity and speed variation with load changes. In order to measure these the motor must be run from a supply with the voltage remaining constant. It must be borne in mind that these characteristics, determined by experiment, are the inherent characteristics and do not include any manual adjustments.

The selection of the correct motor for a particular application will be carried out largely by matching the load requirements with the known motor operating characteristics.

Operating Characteristics

Dealing with each of the three d-c motor types in turn:

Shunt Motor - This motor is classed as a constant-speed motor. Very little change will take place in its speed over the whole range of load. Speed control can be carried out by adjustment of the field rheostat. Note that weakening the field increases the motor speed. At no time must the field circuit be opened if the motor is running unloaded. The increase in motor speed would be excessive and dangerous.

The shunt motor is useful where a constant speed is required.

Series Motor - Since the armature current of a series motor passes through the field, a change in load causes a change in both armature current and field strength. Increased load will increase both armature current and field strength and consequently slow the motor down; conversely light load will allow the motor to speed up. At no time should the load be removed completely from a series motor. The motor speed will increase to dangerous proportions.

Note that the torque increases very rapidly at low speeds and this makes the series motor particularly useful for starting against heavy loads such as is required for crane work or traction purposes.

Compound Motor - The compound motor combines the characteristics of the shunt and series motors. The speed reduction with load (the regulation) is greater than the shunt motor.

The torque increases more than that of the shunt motor with increased load.

The compound motor finds use where a fairly constant speed is required together with the ability to handle sudden heavy loads.

(PE2-5-2-12)

Starting

All d-c motors, with the exception of very small motors (fractional power up to about 0.5 kW) require starting resistances in series with the armature.

It was shown in the previous lecture that the armature current of a d-c motor when running, will depend upon the difference between the applied and back E's. At the instant of starting the back E is zero because the armature is not revolving; the resistance of the armature winding is very small and therefore excessive, and damaging amounts of current will flow in the armature winding unless some resistance is added.

As the motor speed increases, the back E will increase and the starting resistance can be reduced. See Example 1 for illustration of this point.

Example 1

A 7.5 kW motor has an armature resistance of 0.5 ohms, supply voltage is 230 volts. What resistance is necessary in the armature circuit to restrict the starting current to 1½ times the full-load value of 40 amps? To what can this resistance be reduced, when the back E has increased to 170 volts? What would be the armature current flow if no resistance were inserted?

Solution

$$\begin{aligned}
 \text{Armature current} &= \frac{\text{Applied voltage} - \text{back E}}{\text{Armature resistance}} \\
 \text{Armature current is to be } 1\frac{1}{2} \times 40 &= 60 \text{ amperes} \\
 \text{Applied volts} &= 230 \\
 \text{Back E (at start)} &= \text{zero} \\
 \text{Total armature resistance} &= 0.5 + R \text{ ohms} \\
 \therefore \text{Starting resistance } R &= \frac{(230 - 0)}{60} - 0.5 \\
 &= \underline{\underline{3.33 \text{ ohms}}} \text{ (Ans.)} \\
 \\
 \text{When back E is 170 volts,} & \\
 \text{reduced resistance } R_2 &= \frac{(230 - 170)}{60} - 0.5 \\
 &= \underline{\underline{0.5 \text{ ohms}}} \text{ (Ans.)} \\
 \\
 \text{Armature current without starting resistance} & \\
 &= \frac{230 - 0}{0.5} \\
 &= 460 \text{ A (Ans.) (which is } 11\frac{1}{2} \text{ times} \\
 &\quad \text{normal full-load current)}
 \end{aligned}$$

Fig. 12 (a), (b) and (c) shows the three types of d-c motors: Shunt, Series and Compound, with starting resistances. Note that in each case this is connected in series with the armature winding.

Small d-c motors (below 1 kW) are started direct on line volts because the resistance and inductance of the armature winding is sufficient to restrict the starting current to a safe figure.

Further, this starting current is reduced very rapidly because the motor will accelerate up to speed in a very short time.

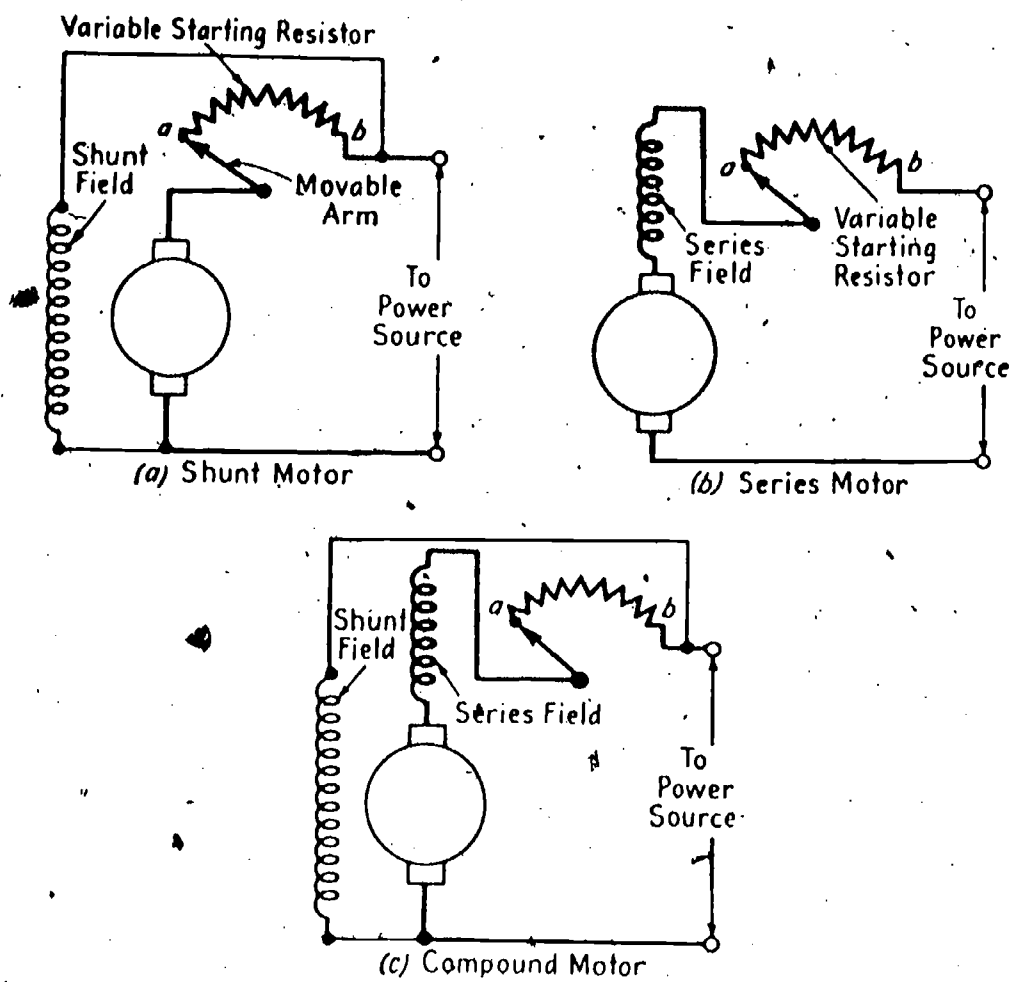

D-C MOTOR STARTING RESISTORS

Fig 12

(PE2-5-2-14)

Automatic Starters

Automatic starting of motors has several advantages over hand control. The settings on the starter can be arranged to give uniform acceleration throughout the motor run-up, and chances of improper operation which occur under hand control are eliminated.

Basically, there are three types of automatic starters, namely: counter-E current limit and time limit. The first are sensitive to voltage and will act to cut out the armature resistance in steps as the motor back E builds up. The second measure the armature current flow and reduce the resistance in the circuit as the starting current decreases. The third operate strictly on a time basis and will cut out armature resistance steps at definite time intervals.

Fig. 13 shows a wiring diagram for an automatic starter of the counter-E type with voltage-sensitive relays. Relays A, B and C are connected across the motor terminals where they measure the armature voltage; this will increase as the back E builds up.

The motor is started by pressing the start button; this energizes the main contactor M which instantly closes the main contacts MX to start the motor, and the auxiliary contacts M1, to seal the start button. The motor therefore starts with resistances R1, R2 and R3 in series with the armature. As the speed increases the rising terminal p. d. energizes the relays A, B and C in sequence.

Relay A will be energized at about 40% voltage, relay B at 60% and relay C at 80%. Each relay operates to cut out armature resistance. Relay A closes the contacts AX, energizes the main relay A1 which in turn closes A1X and shorts out the R1 section of the resistance. When all resistance has been cut out the motor will run until either the stop button is pressed or the contacts OL opened by operation of the overload relay OL. In either case the motor will stop and will not re-start until the whole starting procedure is begun again.

Fig. 14 shows a current limit type of motor starter. This type employs series relays SR1, 2 and 3 which are sensitive to the armature current flowing; these operate the contactors 1A, 2A, 3A which in turn control the contacts 1AX, 2AX and 3AX.

The motor is started by pressing the start button as before; relay M is energized and closes contacts MX and M1. Current then flows through the armature, the three resistances R1, R2 and R3 and the series relay SR1. Heavy starting current through this relay causes it to open the (normally closed) contact SR1X. Contacts M2 next close under the action of the main relay M. This operation has been arranged to have a time lag which is sufficient to allow SR1X contacts to have been opened first.

Decreasing armature current, as the motor speeds up and generates counter-emf, is measured by the relay SR1 and used to re-close contacts SR1X at the required figure. Contactor 1A is now energized and closes main contacts 1AX and auxiliary contacts 1A. The section of armature resistance R1 is thus shorted out and the armature current flows through R3, R2 and series relay SR2.

(PE2-5-2-15)

The sequence is repeated until all armature resistance is cut out, the motor then runs at normal speed until either stopped by hand or tripped on overload.

This current limiting type of starter has the advantage that the motor will start quickly on light load and more slowly on heavy load.

Fig. 15 shows a compound-motor starter which operates through definite time-lag relays. The contactors 1A, 2A, and 3A have time-closing contacts which are energized in sequence beginning with the main contactor M (operating auxiliary contacts M2).

When all have closed and have cut out the armature resistances R1, R2 and R3 (normally closed) contacts 3AX are opened and the final motor speed adjustment and control is carried out by variation of the field rheostat resistance in the shunt field. The motor is stopped in the same way as in the counter-emf and current-limit starters.

Legend (Common to Figs. 13, 14 and 15)

Relays: Voltage Sensitive (A, B and C - Fig. 13)
 Current Sensitive (SR1, 2, 3 - Fig. 14)
 Control Relay (CR - Fig. 15)
 Overload Relay (OL - Figs. 13, 14, 15)

Contactors: Fig. 13 - M, A1, B1, C1
 Figs. 14 and 15 - M, 1A, 2A, 3A

Contacts: Normally Open ||; Normally Closed //

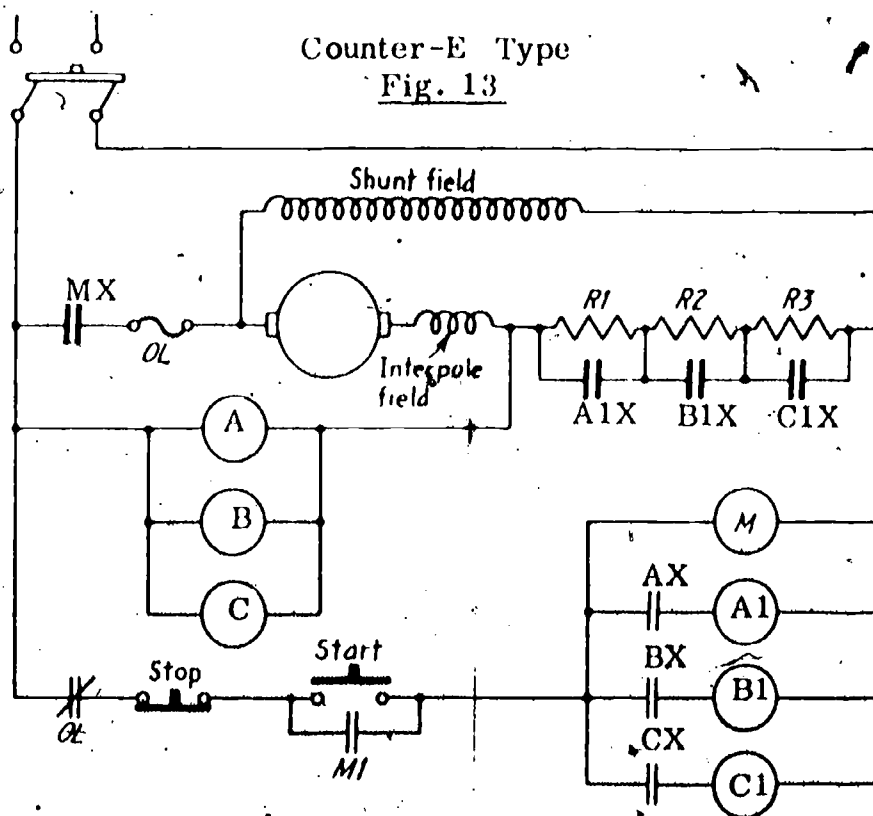

AUTOMATIC STARTER FOR D-C SHUNT MOTOR

(PE2-5-2-16)

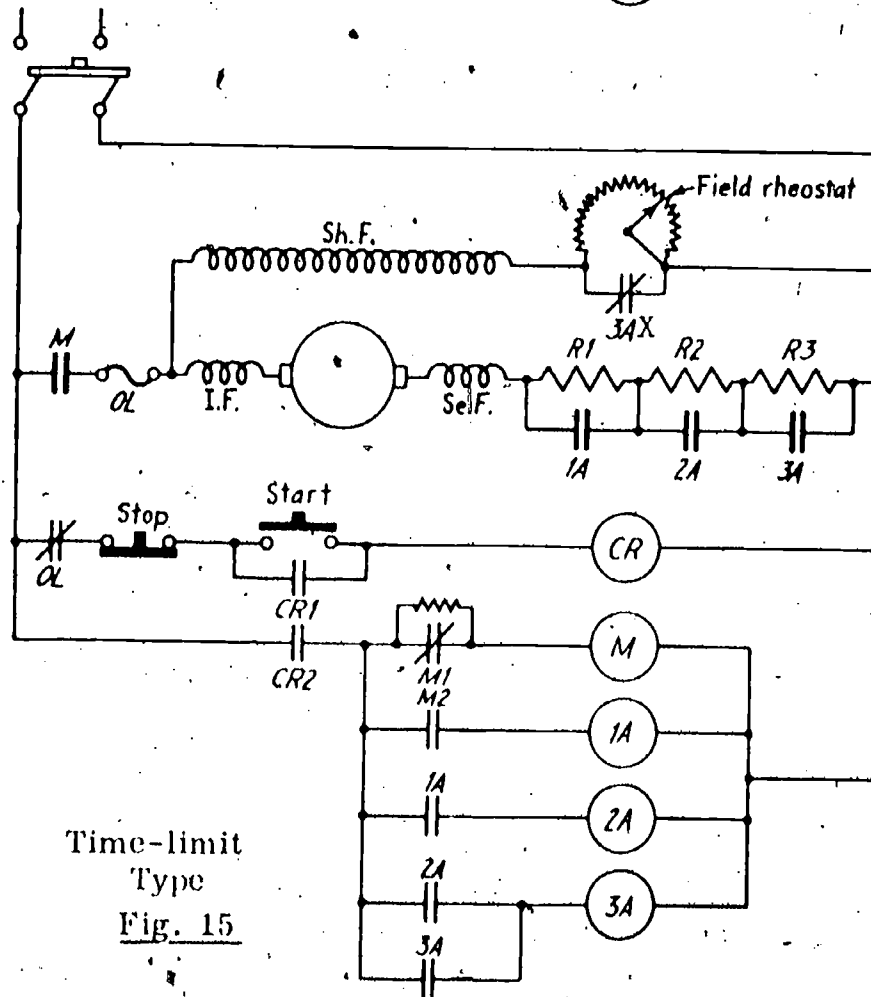
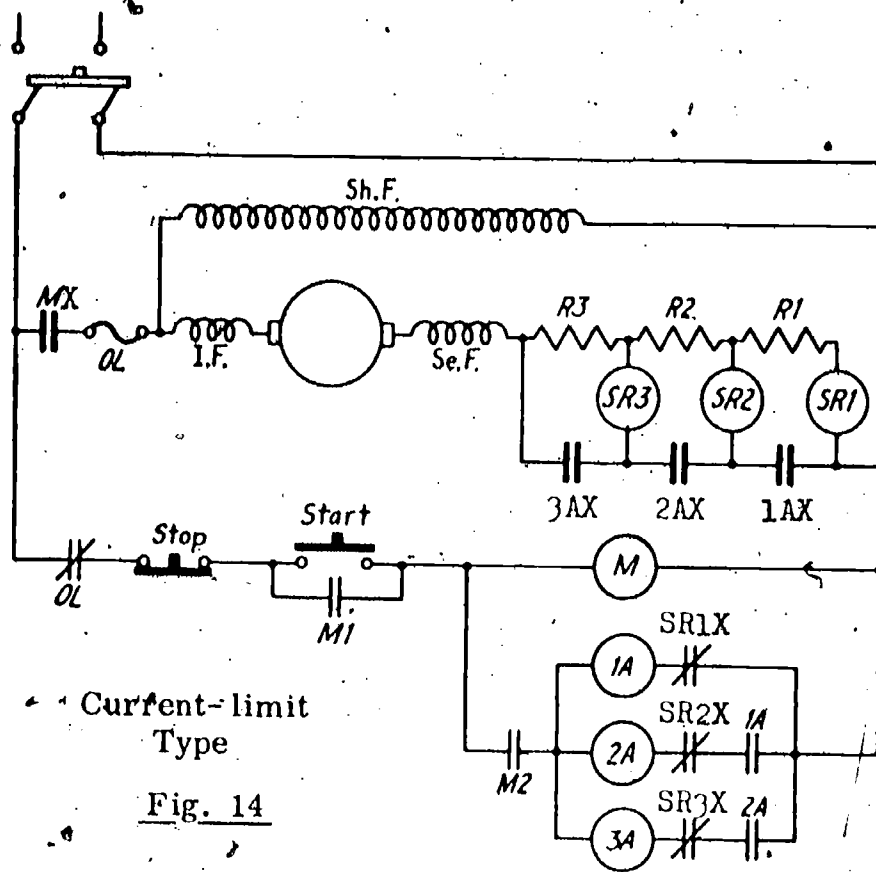

AUTOMATIC STARTER FOR COMPOUND D-C MOTOR

(PE2-5-2-17)

Motor Speed

It was shown in the previous lecture that the force developed by a d-c motor was given by the expression:

$$F = B \times I \times L \quad \text{newtons}$$

where $B =$ flux density (teslas)

$I =$ current in the armature conductors, amperes

$L =$ the conductor length (m)

Also that armature current was given by:

$$I = \frac{\text{Applied voltage} - \text{Back } E}{\text{Armature resistance}}$$

Consider the effect of a reduction in the field strength of a d-c motor as it is running. The back E is immediately reduced and consequently the armature current increases. This increase in armature current I will be proportionately greater than the reduction in field strength B and will result in a greater motor force F and an increase in motor speed.

Example 2

The field strength of a d-c motor is reduced by 5% while running. Determine what effect this has upon the motor speed, given that the motor operates on 220 volts, its armature resistance is 0.3 ohms and it has an armature current of 25 A flowing:

Solution

$$\begin{aligned} \text{Force at first} &= B \times I \times L \quad \text{newtons} \\ \text{Torque or } T &= B \times I \times K \quad \text{Nm} \\ \text{or } T &= B \times 25 \times K \quad \text{Nm} \end{aligned}$$

K is a constant that includes the radius at which the force is acting

$$\text{and Back } E, E_b = E_t - I_a R_a \quad (\text{see Page 24 of the previous lecture})$$

$$\begin{aligned} E_b &= 220 - 25 \times 0.3 \\ &= 212.5 \text{ V} \end{aligned}$$

When the field strength is reduced by 5% the back E is also reduced by 5%.

$$\begin{aligned} \text{Back } E, E_b \text{ now} &= 212.5 \times 0.95 \\ &= 202 \text{ V} \\ \text{Armature current now} &= \frac{E_t - E_b}{R_a} \\ &= \frac{220 - 202}{0.3} \\ &= 60 \text{ amperes} \end{aligned}$$

(PE2-5-2-18)

$$\begin{aligned}\text{Motor Torque now} &= B' \times I' \times K \\ &= 0.95 \times B \times 60 \times K\end{aligned}$$

$$\begin{aligned}\text{Torque increase} &= \frac{0.95 \times 60 \times K}{B \times 25 \times K} \\ &= \underline{\underline{2.28 \text{ times (Ans.)}}}\end{aligned}$$

The result is that the motor speed will increase until rising back-emf limits the armature current to some value which is just enough to carry the motor load at the higher speed.

Weakening the field of a d-c motor is seen to increase its speed and conversely, strengthening the field will slow the motor down. Control of a d-c motor speed then, can be carried out very simply, and over an infinite number of steps, by control of the field current.

Speed Control of D-C Motors

D-c motors lend themselves readily to speed control by variation of either the armature current or field strength. This can be done in the three types of motor by the following methods:

Shunt Motors

- by inserting a field rheostat in the field circuit, by inserting resistance in the armature circuit, or by varying the armature circuit voltage.

Series Motors

- by inserting resistance in the armature circuit.

Compound Motors

- by inserting a field rheostat in the shunt field, by inserting resistance in the armature circuit, or by varying the armature circuit voltage.

The addition of resistances to the armature circuit was made use of in the starters shown in Fig. 12.

Whenever a starter is equipped with some means for varying the speed of the motor to which it is connected, it can then be truly called a controller.

(PE2-5-2-19)

If the armature resistances in Fig. 12 are arranged to be varied when the motor is on load then these become controllers using the armature resistance principle.

An example is shown in Fig. 15 (page 17) of a motor controller using a field rheostat for speed control of a compound-wound motor.

Controllers which use the principle of variation of armature circuit voltage require two separate d-c supplies for the controlled motor: one of fixed voltage for the shunt field and one for varying voltage for the armature. This method can of course only be applied to shunt or compound-wound motors.

The arrangement is shown in Fig. 16 and is known as the Ward Leonard system.

A constant-speed a-c motor is used to drive a d-c generator and an exciter. The exciter supplies constant voltage d-c to the shunt fields of the generator and the controlled motor. Variation of the shunt field current to the generator by means of a field rheostat will result in variation of the generator output armature current and hence the speed of the controlled motor.

The advantage of this system is that it gives speed control over a very wide range with a virtually infinite number of steps. This gives the control required for such motor applications as passenger elevators, cranes, paper mills, etc.

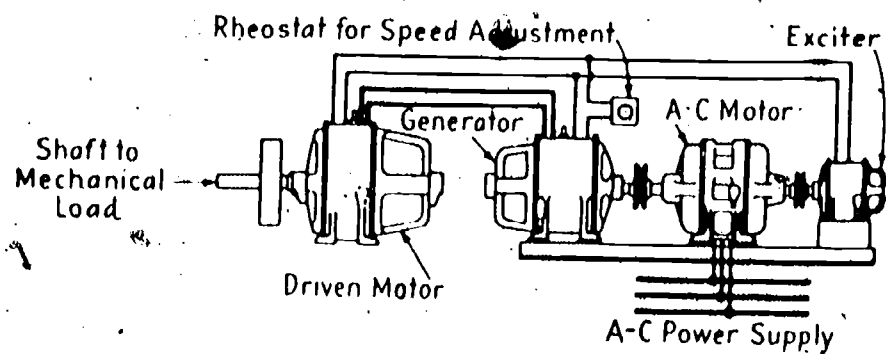

**WARD LEONARD
METHOD OF CONTROL**

2 **Fig. 16**

(DE 2-5-2-20)

POWER LOSSES IN D-C MACHINES

The losses occurring in d-c machines are classified as rotational losses and electrical losses, and can be listed as:

1. Friction losses -
due to bearing friction, brush friction and windage (wind friction).
2. Iron losses -
these occur in the magnetic circuit due to eddy-currents and to hysteresis.
3. Copper losses -
due to the resistance of armature and field windings. They represent electrical power (I^2R) turned into heat.

The efficiency of any machine is given by,

$$\text{Efficiency} = \frac{\text{Output}}{\text{Input}}$$

In the case of a generator the output will be the electrical power sent but while the input will be the mechanical power used in driving the machine. In the case of a motor the reverse is true, output is mechanical power, input is electrical supply.

In either case the output will be the input less the losses, or

$$\text{Efficiency} = \frac{\text{Input} - \text{Losses}}{\text{Input}}$$

This indicates that there are two possible ways in which the efficiency of a machine may be found. By measurement of the total input and the total output, or by calculation of losses.

When finding the efficiency of a motor, the first method would require a dynamometer to measure the output mechanical power or in the case of a generator, a calibrated motor to measure the mechanical input. These tests are difficult to carry out, particularly on large machines, so the second or loss method is generally used. Furthermore the loss method is more likely to be accurate. The total losses will only amount to 5 or 10% of the output hence an error here will have proportionately less effect than if made in the measurement of total power.

These losses can be calculated after resistance measurement has been made and the friction and iron losses determined by test.

The following example shows the application to a generator efficiency calculation.

(PE2-5-2-21)

Example 3

A shunt generator has the following particulars at full-load rating: output 10 kilowatts, volts 230, armature circuit resistance 0.4 ohms, field circuit resistance 192 ohms, friction and iron losses combined 750 watts. Calculate the generator efficiency at this load.

Solution

$$\text{Generator Efficiency} = \frac{\text{Output}}{\text{Input}}$$

$$\text{Output} = \text{Input} - \text{Losses}$$

The losses will consist of Copper loss + Iron loss + Friction loss

$$\text{and the Copper loss} = \text{Armature } I^2R + \text{Field Circuit } I^2R$$

$$\begin{aligned} \text{Generator Output Current} &= \frac{10,000 \text{ watts}}{230 \text{ volts}} \\ &= 43.5 \text{ amperes} \end{aligned}$$

$$\begin{aligned} \text{Field Circuit Current} &= \frac{230 \text{ volts}}{192 \text{ ohms}} \\ &= 1.2 \text{ amperes} \end{aligned}$$

$$\begin{aligned} \text{Armature Current} &= 43.5 + 1.2 \\ &= 44.7 \text{ amperes} \end{aligned}$$

$$\begin{aligned} \text{Armature } I^2R &= 44.7^2 \times 0.4 \\ &= 798 \text{ watts} \end{aligned}$$

$$\begin{aligned} \text{Field Circuit } I^2R &= 1.2^2 \times 192 \\ &= 276.5 \end{aligned}$$

$$\begin{aligned} \text{Total Copper loss} &= 798 + 276.5 \\ &= 1074.5 \text{ watts} \end{aligned}$$

$$\begin{aligned} \text{Total losses at full load} &= 1074.5 + 750 \\ &= 1824.5 \text{ watts} \end{aligned}$$

$$\text{Generator Efficiency} = \frac{10,000 \text{ watts}}{10,000 + 1824.5}$$

$$= 0.846$$

$$= \underline{84.6\%} \text{ (Ans.)}$$

The efficiency of a d-c motor may be calculated in exactly the same way from measurement of the circuit resistances together with a test to find the rotational losses. (The motor is run at rated speed but no load and the measured input will give the no-load rotational loss.)

(PE2-5-2-22)

It is important that the efficiency of d-c machines should be high since the losses in the machine will be transformed into heat, and if large, would result in excessive temperature rise. The specified allowable temperature rises in accordance with N. E. M. A. standard are:

40° C rise for a machine with Class A insulation, maximum allowable total temperature of 105° C.

70° C rise allowed for a machine with Class B insulation, maximum allowable total temperature of 130° C.

Class A insulation consists of cotton, silk, paper or other organic materials impregnated with insulating varnish. Class A is considered standard insulation and will withstand the conditions found in the majority of applications.

Ratings of Generators and Motors

Generator ratings are quoted in kW-output at a given speed and voltage; motors are quoted on power-output at certain speeds and supply voltages. The machines are designed so that the temperature rise will not exceed the allowable maximum when run at these rated loads.

Machine ratings are sometimes given on an intermittent basis (instead of a continuous rating) and in this case the machine design will be smaller. Reliance is placed upon the cooling which will take place during the off-load periods to keep the temperature rise within the allowable limits.

Conversion Machines

It is frequently necessary to change the available electricity supply either from alternating current to direct current or vice versa to suit one particular piece of machinery. Or it may be required to change a d-c supply voltage or to change an a-c frequency or even the number of phases in the supply.

Machines which are used for this purpose are either convertors or rectifiers.

Rotary convertors (also called synchronous convertors), and M. G. (motor-generators) sets change alternating current to direct current. Frequency convertors change a-c supply at one frequency to a-c supply at another frequency. Phase convertors change a single-phase system supply into polyphase (two or three phase).

Rectifiers are used to change alternating current to direct current. For small amounts of power, copper oxide or selenium is used; for large amounts of power, mercury arc or silicon rectifiers are used. The commutator and brushes on the armature of a d-c machine are in themselves a form of mechanical rectifier since the current generated in the armature winding is alternating.

When the supply voltage of a d-c system must be changed to a lower or higher value, a dynamotor is often used. This is a rotating machine, essentially a d-c motor but carrying on its armature separate windings, led to a separate commutator which form a generator. These windings are arranged to give the required new output voltage. The one machine acts as a motor, taking power at the voltage of the supply system and as a generator, supplying the same amount of power (less the losses) at the required new voltage.

The remainder of these machines will be described in subsequent lectures on electrical equipment.

(PE2-5-2-23)

QUESTION SHEET

Second Class
Sect. 5, Lect 2

POWER ENGINEERING

1. (a) Explain why it is desirable to have d-c generator brushes located at neutral points.
(b) What is the purpose, on a generator without interpoles, in shifting the brushes as the load changes?
2. (a) Sketch the arrangement of the following d-c generators: series wound, shunt wound, compound wound.
(b) Give the operating characteristics of the above generator types.
(c) Discuss the advantages of the separately-excited generator over the self-excited type.
3. (a) When d-c generators are to operate in parallel, why is it desirable that they have drooping characteristics?
(b) Explain the purpose of an equalizing connection used with two compound generators operating in parallel.
4. Discuss the operating characteristics of the series, shunt and compound motors.
5. Describe briefly the principle of operation of three different types of automatic starters for d-c motors.
6. (a) Describe the general methods used for controlling the speed of shunt, series and compound motors.
(b) Sketch and describe the arrangement of the Ward-Leonard speed control system.
7. (a) Describe the most accurate method of determining the efficiency of a d-c generator.
(b) A shunt generator, when supplying full load, requires 130 kW to drive it. Voltage developed is 110 volts. Friction and iron losses 4476 watts, armature copper loss equals 3500 watts. Field circuit resistance equals 10 ohms. Calculate the output and the percent efficiency of this machine.
8. What are the purposes of the following machines: motor generator sets, dynamotors, rectifiers, phase convertors, frequency convertors?
9. Describe the general construction of a d-c generator.
10. The efficiency of 7.5 kW shunt-wound d-c motor is 90% and supply voltage is 220 volts. Resistance of shunt is 50 ohms and armature resistance is 0.2 ohms. Calculate the supply current and the value of the starter resistance if starting current through the armature must not exceed $1\frac{1}{2}$ times the running current through the armature.

(PE2-5-2-Q)

Correspondence Courses
Power Engineering

SECTION 5

ELECTRICITY

Second Class
Lecture 4

ALTERNATING-CURRENT GENERATORS

The basic theory of generation as outlined in the first lecture of this section, showed that all generators, whether alternating or direct current, produced alternating current in the first place; the d-c machine must then use a commutator in order to rectify to direct current.

It was further pointed out that E would be generated if a conductor was cut by magnetic lines of force regardless of whether the conductor or the field was the one in motion.

With this in mind it can be seen that a-c generators can be constructed either to have the field stationary or rotating.

In the great majority of cases the field will rotate, the reason being that the rotating member must be supplied through slip-rings and brushes. It is much more practical to supply a small quantity of low-voltage d-c power to the field coils than to collect large quantities of high-voltage alternating current.

There are two distinct types of a-c generator field structures: the salient-pole type and the cylindrical type. Slow-speed generators such as those driven by diesel engines or water turbines have rotors with projecting, or salient, field poles. Steam and gas turbine-driven alternators will have cylindrical-type rotors.

Fig. 1 shows a multi-pole, 240 rev/min, 2140 kW, 60-hertz Allis-Chalmers generator.

Fig. 2 shows a two-pole, 100 MW, 3000 rev/min, 50-hertz machine.

The relation between machine speed, number of poles, and frequency, as given previously is

$$\text{Frequency (hertz)} = \frac{\text{poles} \times \text{rev/min}}{120}$$

Fig. 12 shows the gas paths in a G.E.C. direct-cooled alternator.

This method of cooling has only become feasible with the advent of hydrogen-cooling because of its extreme cleanliness in comparison with air.

Liquid-cooled Alternators

Direct cooling of the conductors in the stator windings of alternators in recent designs has been carried out by circulation of liquid through hollow conductors. The advantages to be gained through more effective cooling of the stator windings are increased current densities in the stator copper, and consequent reduction in overall mass of the machine for any given output.

The liquid chosen as most suitable for this method of cooling was water. The generators being installed in Lakeview Power Station employ water cooling in the stator windings. Stainless steel manifolds carry the cooling-water supply to and from the ends of the hollow copper conductors. Plastic insulating hoses are used for the connections.

Water of high purity is used to ensure low electrical conductivity and so minimize the losses due to leakage current flow; however, it has been estimated that it would be quite possible to use most ordinary tap waters (aside from the problem of scale).

Fig. 13 shows a sectional sketch of a hydrogen-cooled generator with water-cooled stator.

Alternator Windings

The type of winding most generally used in alternator stators is very similar to the d-c "lap winding". The coils upon the d-c armature were joined at the commutator; in the case of the alternator stator the coil ends are simply connected externally in the correct sequence.

Three separate windings are formed, spaced 120 electrical degrees apart and the ends of these windings connected in star (or wye) arrangement. This allows the neutral point to be brought out for grounding.

The rotor is supplied with direct current at a low voltage (110 to 220 volts) through two slip-rings and brushes. In a salient-pole type each pole has an exciting winding. In the cylindrical-rotor type the winding is made concentric around the two (or four) poles. D-c supply is taken from a small d-c generator, the exciter of which may be driven from the main machine shaft or separately.

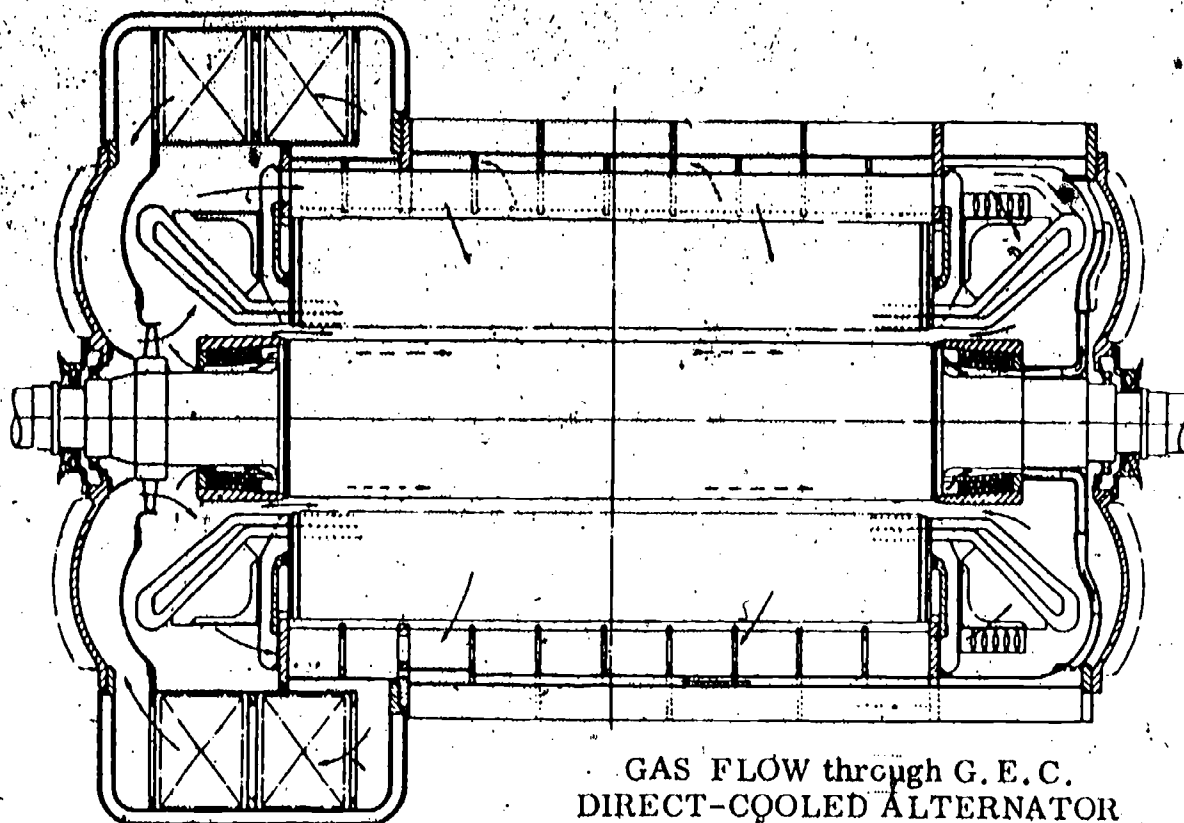

GAS FLOW through G. E. C.
DIRECT-COOLED ALTERNATOR
Fig. 12

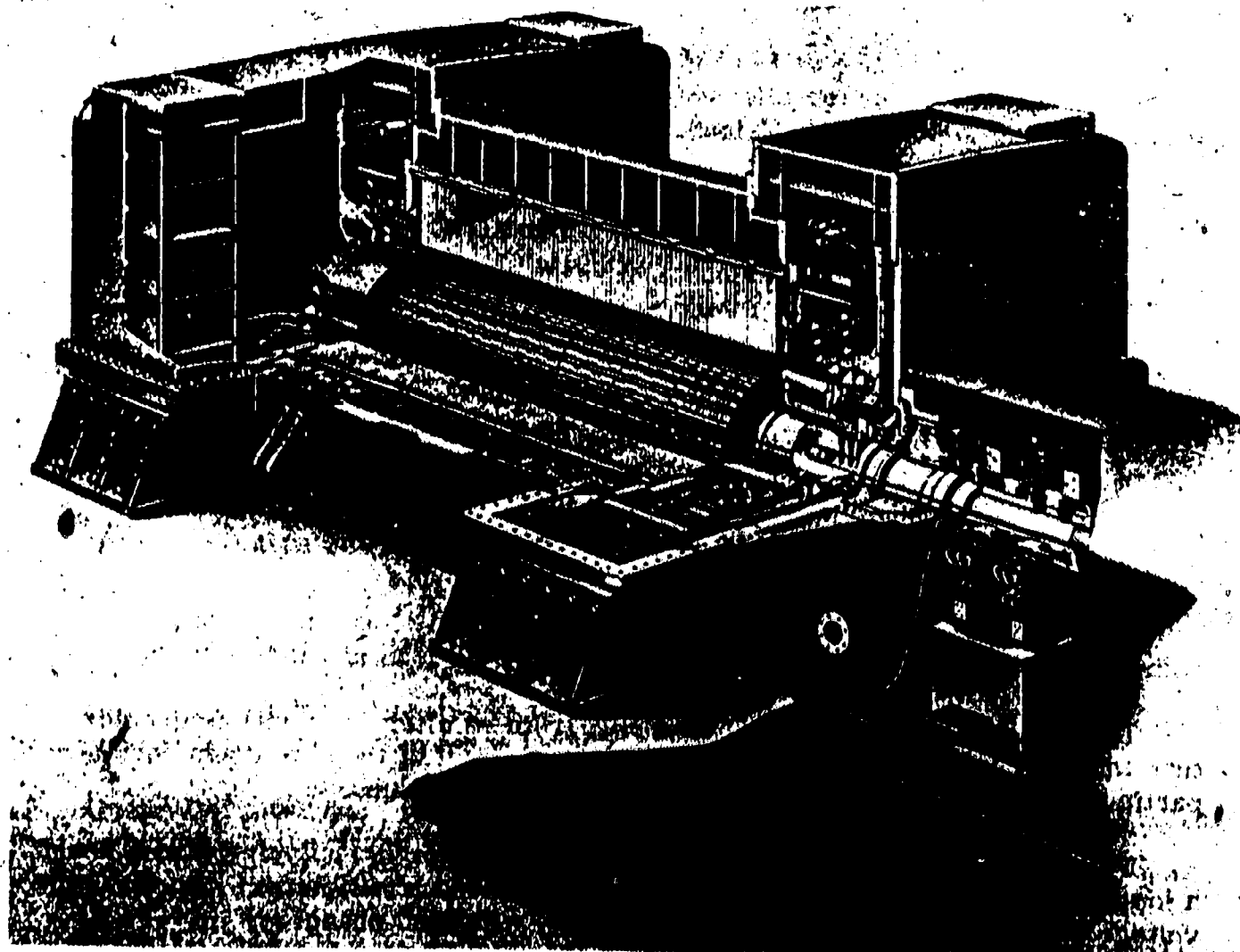

SECTIONAL VIEW of HYDROGEN-COOLED GENERATOR

Fig. 13

(PE2-5-4-15)

Alternator Voltage

The amount of any generated E depends upon the rate at which lines of force are cut.

10^8 lines cut per second or 1 weber/second produces 1 volt, see the first lecture of this section.

For any given generator then, its terminal voltage will depend upon the number of conductors, generator speed, and the field strength. The machine speed and the number of conductors will be fixed so that the emf becomes dependent upon the field excitation and this can be controlled at the exciter by variation of the field rheostat.

Alternator Regulation

Loading an alternator will affect its terminal voltage, as was the case with the d-c generator, but now the amount of voltage variation will depend upon the type of load applied.

If the load consists of pure resistance items such as lighting and heating units, then the pf will be unity and the terminal voltage drop will be about 1% to 10% between no-load and full-load.

A lagging pf load such as induction motors, fluorescent lighting, electric welders, etc. will cause the alternator terminal voltage to drop as much as 25% to 50% between no-load and full-load.

Loading pf loads however, will tend to raise the alternator voltage.

The amount that the terminal voltage will change between no-load and full-load will depend, as previously stated, upon the character and the amount of load applied.

The percentage regulation formula used in the study of d-c generators, applied equally well to a-c generators, that is,

$$\text{Per cent regulation} = \frac{(\text{No-Load Voltage} - \text{Full-Load Voltage})}{\text{Full-Load Voltage}} \times 100$$

Where full-load voltage is the rated voltage at full-load and the no-load voltage is the voltage obtained after rejection of full-load at rated voltage.

The regulation which is to be expected from an alternator will be greater than that of a d-c machine due to the reactance effect of the stator windings and particularly so in the case of low lagging power factor loads.

This condition is made worse where the alternator is supplying load through a long transmission line, complete with reactors and transformers, so that voltage at the load terminals will vary greatly with load changes.

(PE 2-5-4-16)

Large voltage variations are not acceptable to consumers of electricity, and particularly not to industrial consumers and so a quick acting and positive control of alternator terminal voltage is essential. This need is filled by the Automatic Voltage Regulator.

Voltage Regulators

A generator voltage regulator is a device that causes the excitation of the generator to be automatically raised or lowered in order that the output voltage can be maintained within predetermined limits. It must be able to detect a change in voltage, respond to make the necessary correction in field excitation, and stabilize against hunting.

Generator voltage regulators are classified by their means of operation.

Direct acting rheostatic regulators adjust the field strength of a generator directly, without any intermediary apparatus. They give quick response and close regulation. One well known example of this type is the Westinghouse "Silverstat".

Indirect acting rheostatic regulators use auxiliary apparatus to control the movements of a motor-operated rheostat in the generator field-circuit. This type is used in large installations.

Static regulators have no moving parts, and utilize a magnetic amplifier in conjunction with an amplidyne to provide the necessary regulation.

Alternator Power Factor

The power factor of the system supplied by the generators will be determined by the characteristics of the load connected. In the case of one alternator only supplying the load, its power factor will also be that of the load.

Where two or more alternators supply a system (by far the more common case) the pf of each can be controlled individually by alteration of its excitation.

If the excitation of a generator operating in parallel with others is increased beyond the amount required to give normal terminal voltage for the load condition, its pf will change in the lagging direction. Its current output increases also without appreciable change in kW load output.

Conversely if the generator is under-excited its pf becomes leading and the current output again increases without change in kW output.

Control of alternator pf is usually carried out by hand operation of a trimming resistance in the voltage regulator circuit.

(PE2-5-4-17)

Parallel Operation of Alternators

Synchronizing

Alternating-current power systems generally consist of several generating machines connected in parallel to common bus bars which supply the system load. Moreover it is common to have interconnection between local systems through transmission lines. This demands that any generator which is to be switched in to the system must fulfill the synchronizing conditions.

These are as follows:

1. The alternator terminal voltage must equal that of the system.
2. The alternator frequency must approach that of the system within close limits.
3. Phase rotations of alternator and system must be the same. That is, if the system bus bars are designated Red, White and Blue and the maximum of the voltage waves of these three phases occur in the sequence Red, White, Blue, then the incoming machine (which is to be connected Red to Red, Blue to Blue, etc!) must also have voltage maximums occurring in the phase sequence Red, White, Blue.
4. The alternator voltage must be in correct phase relationship with the system, that is, both will reach maximum at the same instant.

The process of synchronizing may be illustrated by the following diagrams of the incoming machine and the system voltage waves, shown on Fig. 14.

The series of operations required to bring about the above conditions and to close the switch are known as Synchronizing.

Taking each in turn:

Condition 1 is fulfilled by adjusting the alternator-field rheostat, after running the machine up to approximately full speed, until the terminal voltage matches the system voltage. Implicit in this condition is also a demand that the shape of the incoming machine voltage wave will correspond closely with that of the system.

For Condition 2, the alternator frequency is controlled by adjusting the speed of the prime mover. In most cases this means control of steam supply to the turbine.

Condition 3 can be checked by lamps or a phase rotation meter. This condition can only be altered by disconnection so that once the phase rotation of a generator is proved correct with relation to the system it will not be necessary to repeat the test. Normal switching on and off load is carried out without changing the generator phase rotation.

(PE2-5-4-18)

STEPS TAKEN TO SYNCHRONIZE AN INCOMING A-C GENERATOR
TO THE SUPPLY SYSTEM

Fig. 14

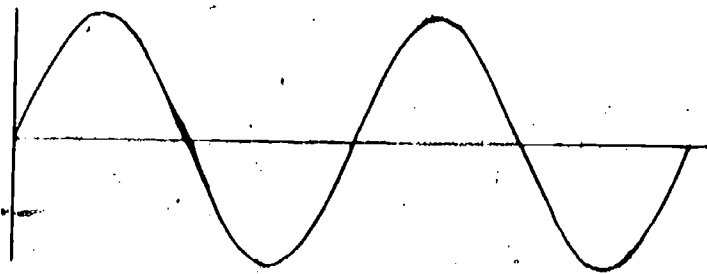

(a) Existing system voltage wave. (One phase only shown.)

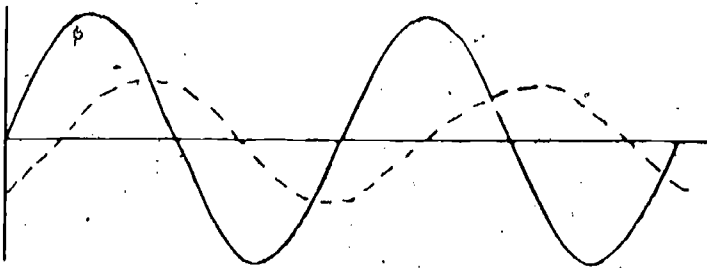

(b) Machine voltage wave shown dotted. Out of phase and frequency. Being built up to equal the system max. volts by adjustment of field rheostat.

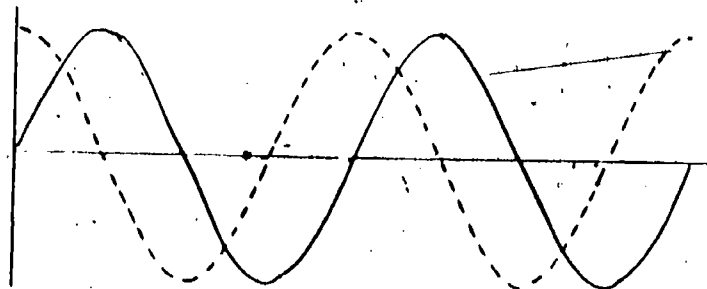

(c) Machine voltage now equal to system. Voltage waves out of phase but frequency being increased by increasing speed of prime mover.

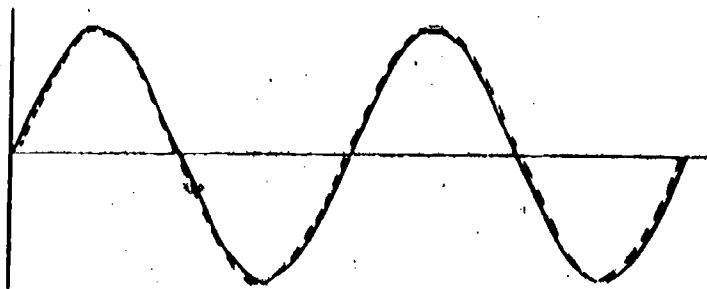

(d) Machine voltage now equal to system, in phase and with equal frequency. Synchronoscope shows 12 o'clock. Switch can now be closed.

(PE 2-5-4-19)

Fig. 15 shows one method of phasing out polyphase alternators. If the phase rotation is correct on the incoming alternator the lights will all be dark or light simultaneously. If the phase rotation is wrong the lights will never all be light or dark at the same time.

The phase rotation may also be checked with a small polyphase induction motor, connected alternately to the system and the incoming machine, as shown in Fig. 16. If the direction of rotation of the motor is the same for both incoming alternator and system, then the phase rotation is the same.

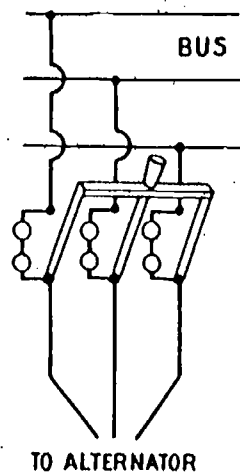

Fig. 15

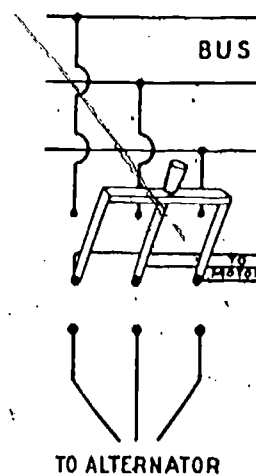

Fig. 16

Finally, Condition 4. The phase relationship of incoming machine and system requires the use of a synchronizing device such as an indicator; this may be in the form of a bank of lamps or a synchroscope. Modern large machines will always use the latter because indication by lamps is not accurate enough.

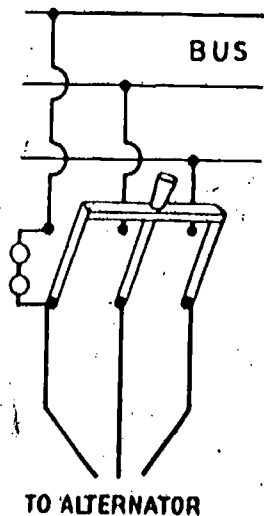

Fig. 17

If lamps are used for synchronizing they will be connected as in Fig. 17.

Assuming that phase rotation has been checked and is correct and that the machine is at full-volts and close to synchronizing speed, the remaining small difference in frequency between incoming machine and system will cause varying displacement between the two sets of voltages.

If lamp indication is being used on all three phases, all lamps will become bright and dark together.

(PE2-5-4-20)

As the voltages of alternator and system become more nearly in step, the flickering becomes slower. The main switch may be closed when all lamps are dark. It is always good practice to close the switch at a time when the incoming machine speed is increasing, the result being that this machine will tend to pick up a little load and will be more stable in operation.

The synchroscope gives a much clearer picture of the phase relationship between the two voltages of incoming machine and system. Rotation of the indicating pointer in the direction marked FAST shows the incoming machine frequency to be faster than the system and vice versa. If the frequency of the incoming machine is equal to the system frequency the pointer will not revolve.

Its position relative to 12 o'clock will indicate the angle of phase displacement between incoming machine and system in electrical degrees. The incoming machine should be paralleled at the instant the synchroscope pointer passes the zero (12 o'clock) position while revolving slowly in the "fast" direction.

Once paralleled the pointer will no longer revolve; to prevent overheating of its coils, the synchroscope should be switched off when not in use.

The synchroscope operates by the interaction of magnetic fields from two circuits, one connected to the alternator and one to the system, upon a soft iron vane or disc with the pointer attached.

Many modern alternators are fitted with automatic synchronizing equipment, the basic operating principle being that agreement between coils supplied from alternator and system produces sufficient field strength to operate a switch-closing relay.

Load Sharing

Control of the load on an alternator is carried out through the prime mover. Increased power supply to the prime mover will result in an increase in the load carried by the alternator and vice versa.

In the case of a turbo-alternator, this load control is carried out by governor adjustment. Section 3 included illustrations and descriptions of various types of governors, and the function of a speed changer (or speeder gear) was described. This is the means by which the electrical load is set. On small machines the setting will be done locally by hand and on larger machines by a small motor operated remotely, possibly from some central control point.

The reason for increased prime-mover power resulting in increased loading is the fact that all alternators operating in parallel on a system are tied absolutely to the electrical speed of the system. They are locked in rotational synchronism as if they were all mechanically geared to a common load, but the engine with the greatest fuel input will do the most work.

Generators which have a drooping speed-load characteristic will operate in parallel with good stability for the same reasons as d-c generators with drooping voltage-load characteristics of pumps with drooping pressure-output characteristics.

(PE2-5-4-21)

Power Factor Control

When two alternators are running in parallel a transfer of load between them will result in a voltage differential. The alternator with the reduced kilowatt loading has its internal voltage increased because of the lessened voltage drops within its stator windings. Hence the machine is said to be over-excited for the new value of load. The alternator with the increased kW loading has its internal voltage decreased because of the increased voltage drops in the stator. Hence this machine is said to be under-excited for the new value of load.

If the pf of the system is unity, this voltage differential will cause reactive cross-current between the machines. If the system pf is lagging however, the effect is to cause a disproportionate division of reactive power between the alternators. The over-excited machine will supply more "Vars" (reactive volt-amps) than the under-excited machine. A pf meter would show lagging on the over-excited machine and leading on the under-excited machine.

The balancing of "Vars" between the machines must be accomplished by adjusting the field excitation of each machine.

The field rheostat of the under-excited machine should be turned in the "raise voltage" direction and that of the over-excited machine in the "lower voltage" direction until the kVA meter indication or the pf meter indication is the same on each machine.

Alternator Rating and Efficiency

The voltage at the terminals of an alternator is affected considerably by the pf of the load it is supplying. For this reason the rated voltage, stated on the nameplate is always given for rated kVA at a specific pf and field current.

The average-system load includes induction, resistance and some capacitance and will commonly be between unity and 0.8 lagging. Alternators for general service will therefore usually have the terminal voltage for rated kVA at 0.8 pf lagging stamped upon the nameplate.

The short-circuit ratio is often included in the nameplate data; this gives an indication of the design of the machine with regard to the quantity of copper and iron in the electrical and magnetic parts. The machine with high short-circuit ratio will contain more materials.

Short-circuit ratio is defined as the ratio of the field current required to produce rated voltage at rated speed and no-load to the field current required to circulate rated stator current when operating at rated speed under sustained short-circuit conditions. The normal figure quoted for a turbo-alternator is between 0.8 and 1.0.

The effect of high short-circuit ratio in the design of an alternator gives it improved stability at times of load changes.

Alternator efficiency is dependent upon the losses in the machine. Not all of the power input to a generator does useful work. Some of the energy input is lost as friction, windage, I^2R losses in the stator and field windings, and hysteresis and eddy current losses in the iron of the stator and rotor field circuits. The efficiency of an alternator operating at 0.8 lagging pf could be expected to reach 98%.

(PE2-5-4-22)

BEST COPY AVAILABLE

QUESTION SHEET

Second Class
Sect. 5, Lect. 4

POWER ENGINEERING

1. (a) Why is it usual to have an alternator field rotating?
(b) Name two types of field construction and explain where each type would be used.
2. (a) How many hertz are generated in one revolution of a 24-pole alternator?
(b) How many rev/min must this alternator make to generate a frequency of 60 hertz?
(c) What must be the speed of a four-pole 25 hertz alternator?
3. Describe the rotor and the stator construction of a large modern alternator.
4. (a) Describe the enclosed air system of alternator cooling.
(b) List the advantages of this system.
(c) What is the purpose of the emergency air inlet and outlet doors?
5. (a) Sketch and describe a hydrogen system of alternator cooling. Include in the sketch gas coolers, pumps, water coolers, etc.
(b) List the advantages of this system.
(c) Describe the method of charging and the method of purging the hydrogen to and from the alternator. Why are these methods necessary?
(d) Describe some other method of alternator cooling.
6. (a) The terminal voltage of an alternator will depend upon what items?
(b) In the normal operation of the alternator, which of these items will be variable?
7. (a) Find the regulation of an alternator which has a full-load voltage of 2400 volts and a no-load voltage of 3240 volts.
(b) Will power factor have any effect upon the alternator regulation? Explain.
(c) What is the purpose of a voltage regulator and how does it fulfill this function?
8. (a) List the conditions which must be satisfied before connecting an alternator in parallel with other alternators.
(b) Explain the various means by which these conditions are satisfied.
(c) How often must the phase rotation of an alternator be checked?
9. (a) How are load adjustments carried out in the case of alternators operating in parallel?
(b) How does this differ from the method of load adjustment used with d-c generators in parallel?
(c) How may the pf of an alternator; operating in parallel with other alternators, be changed? Explain.
10. (a) Define "short circuit ratio" in regard to alternators.
(b) List the losses that may occur within an alternator.
(c) Will these losses be the same at all power factors? Explain.

(PE2-5-4)

(PE2-5-4-2)

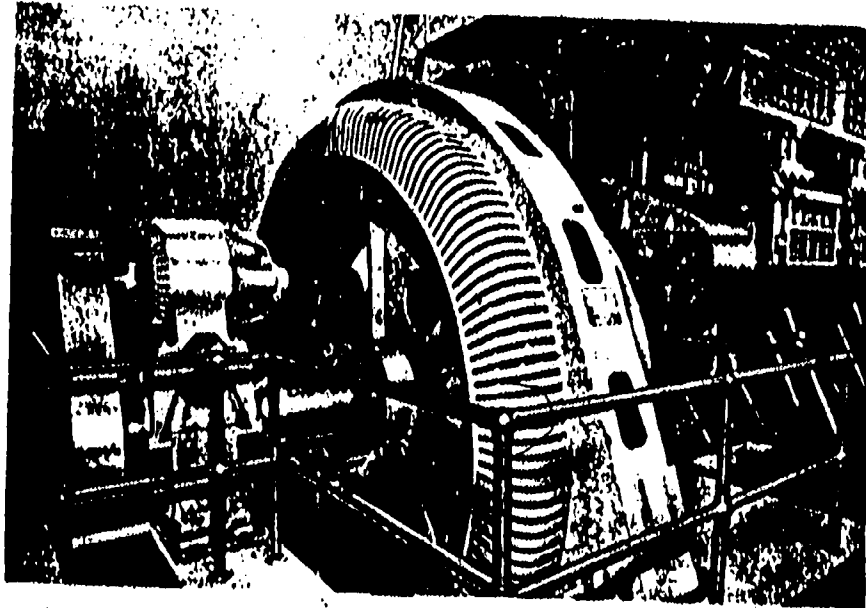

GENERATOR
Fig. 1

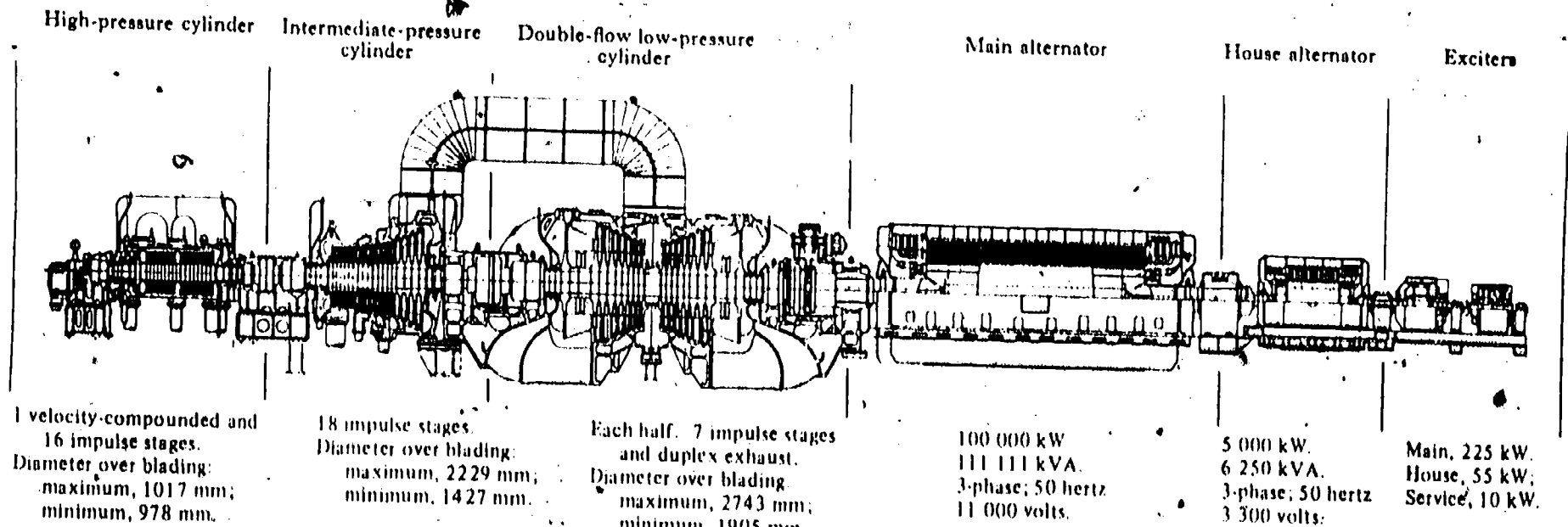

Steam conditions: 4100 kPa, 450°C Back pressure 3 kPa.
Five stages of feed heating to 170°C. Speed of rotation 3000 rev/min.

TURBO-ALTERNATOR

A-c generators are usually referred to as alternators. Unlike d-c generators they must be driven at very definite constant speed, the reason being (as shown above) that only at this speed will the frequency of the supply generated be exactly right.

Where one alternator only is supplying a circuit load, the frequency of that circuit or system will depend entirely upon that alternator speed. If however, there are a number of alternators running in parallel to supply the system, the speed of each machine will be locked into the system frequency and will not be able to vary unless all machines vary together.

Again, if an additional alternator is to be switched into the system supply it must be run up to an exact speed first to correspond with the others. This is termed the Synchronous speed.

For a 60-hertz frequency system a two-pole machine has a synchronous speed of 3600 rev/min; a four-pole machine, 1800 rev/min; twelve-pole, 600 rev/min, etc.

The common types of prime movers used to drive alternators are steam turbines, gas turbines, steam and diesel engines. The types of alternator employed will be chosen to match the prime mover, and both will be influenced by the required output, voltage, etc.

The alternator illustrated in Fig. 3 is a multi-pole engine-type generator typical for use at speeds below 500 rev/min. The machine shown has 28 field poles on the revolving rotor and will run at 257 rev/min to generate 60 hertz. Typical output will be up to 5000 kVA.

The stator consists of a magnetic steel core, built up in laminated sheets. The winding is placed in slots in the core in the same manner as the armature winding of the d-c generator. The rotor carries the field windings, supplied through brush gear and slip-rings.

Fig. 4 shows a half-sectional elevation of a two-pole, 3600 rev/min alternator, turbine driven.

Alternators for hydro-electric or diesel engine generating stations are of the slow-speed multi-pole type; in most cases the hydro-station type will have the alternator shaft disposed vertically. Those for steam or gas turbine drive are always of the horizontal, cylindrical rotor-type shown in Fig. 2.

Standard frequency on the North American continent is 60 hertz (Europe 50 hertz) and alternators normally run at 3600 rev/min when two-pole, and 1800 rev/min when four-pole. The modern turbo-alternator is almost without exception of two-pole design. The lower operating speed with the four-pole machine is not generally favourable to a high-pressure turbine design and the unit as a whole is bulkier and more expensive than a two-pole machine of similar rating.

Modern development has therefore been concentrated on the two-pole generator design.

(PE2-5-4-3)

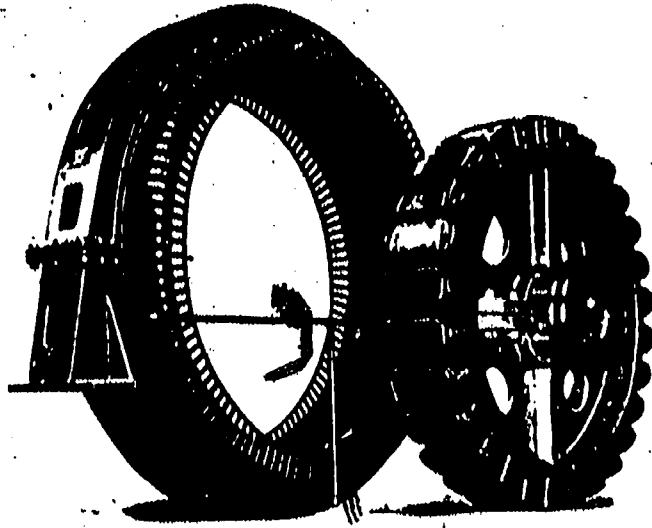

STATOR and ROTOR ASSEMBLIES for a
LARGE ENGINE-TYPE SYNCHRONOUS GENERATOR

Fig. 3

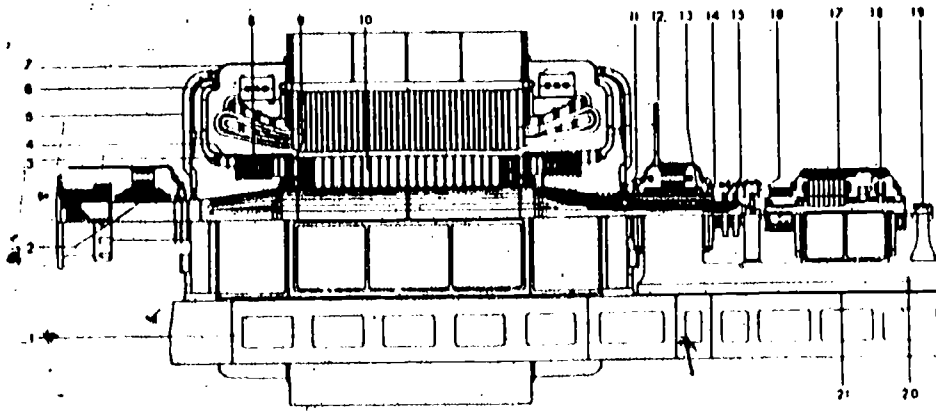

- | | |
|--------------------------------|---------------------------------|
| (1) Alternator Baseplate. | (12) Oil Vent Pipe. |
| (2) Alternator Centre Bearing. | (13) Outboard Flexible Bearing. |
| (3) Rotor End-flange. | (14) Oil Thrower and Oil Guard. |
| (4) Fan. | (15) Slip Rings. |
| (5) Air Shield. | (16) Exciter Flexible Coupling. |
| (6) End Shield. | (17) Main Exciter. |
| (7) Winding Cover. | (18) Service Exciter. |
| (8) Rotor Retaining Ring. | (19) Exciter Outboard Bearing. |
| (9) Rotor Support Plate. | (20) Alternator Pedestal Base. |
| (10) Rotor Cone Plate. | (21) Insulating Shim. |
| (11) Air Baffle (Spring Type). | |

TURBO-ALTERNATOR and EXCITER
 - HALF-SECTIONAL ELEVATION -

Fig. 4

(PF:2-5-4-4)

BEST COPY AVAILABLE

It is, in fact, quite common for a customer to call for a machine on the test to be subjected to a sudden three-phase short circuit at its terminals while running on open circuit at normal voltage and frequency.

Stator winding insulation is generally mica-ite although a number of different winding materials are in use.

The general trend in modern design is to ever-increasing output from an individual machine. In all cases a single machine will cost less than two smaller machines giving the same total output, both in construction and in running costs, despite the more expensive raw materials required and the increasing complexity of design, strenuous efforts are being made to increase the size of alternators. The main limitation on the output which can be obtained from any given alternator frame is the amount of heat which can be dissipated from the stator without the temperature rise of the windings exceeding the permissible limits.

Effective cooling must be carried out in the stator windings too, of course, since these are stationary the problem is not so acute.

The output from the generator is directly dependent upon the excitation power, the increase in output demands increased excitation and therefore either greater excitation or more efficient cooling methods.

AIR COOLING

These systems are the stray field system, the steel body and lamination system.

The first alternator designs used a straight through air cooling system, fans on the rotor shaft drew in atmospheric air and discharged it after once through the core and windings. The disadvantages were that the ventilating

became choked, and also that the fire hazard was increased.

The second design enclosed the alternator air system so that the same air re-circulated through the windings after passing through an air cooler. Most of these designs have a separate ventilating air fan; Fig. 6 shows a typical arrangement.

The advantages are that the windings are kept very much cleaner, the fire hazard is reduced since the quantity of oxygen in the system is limited, and the alternator can be kept quieter and cooler. The alternator design is made more compact because the fan and air cooler can be located in the alternator foundation.

When the air-cooler cooling medium is circulating water, care has to be taken that no scale or rust occurs at the tubes. Means are provided for emergency access to the air in the event of loss of cooling water supply.

The air-cooler cooling medium is circulating water; care has to be taken that no scale or rust occurs at the tubes. Means are provided for emergency access to the air in the event of loss of cooling water supply.

(PE2-5-4-7)

(PE2-5-4-8)

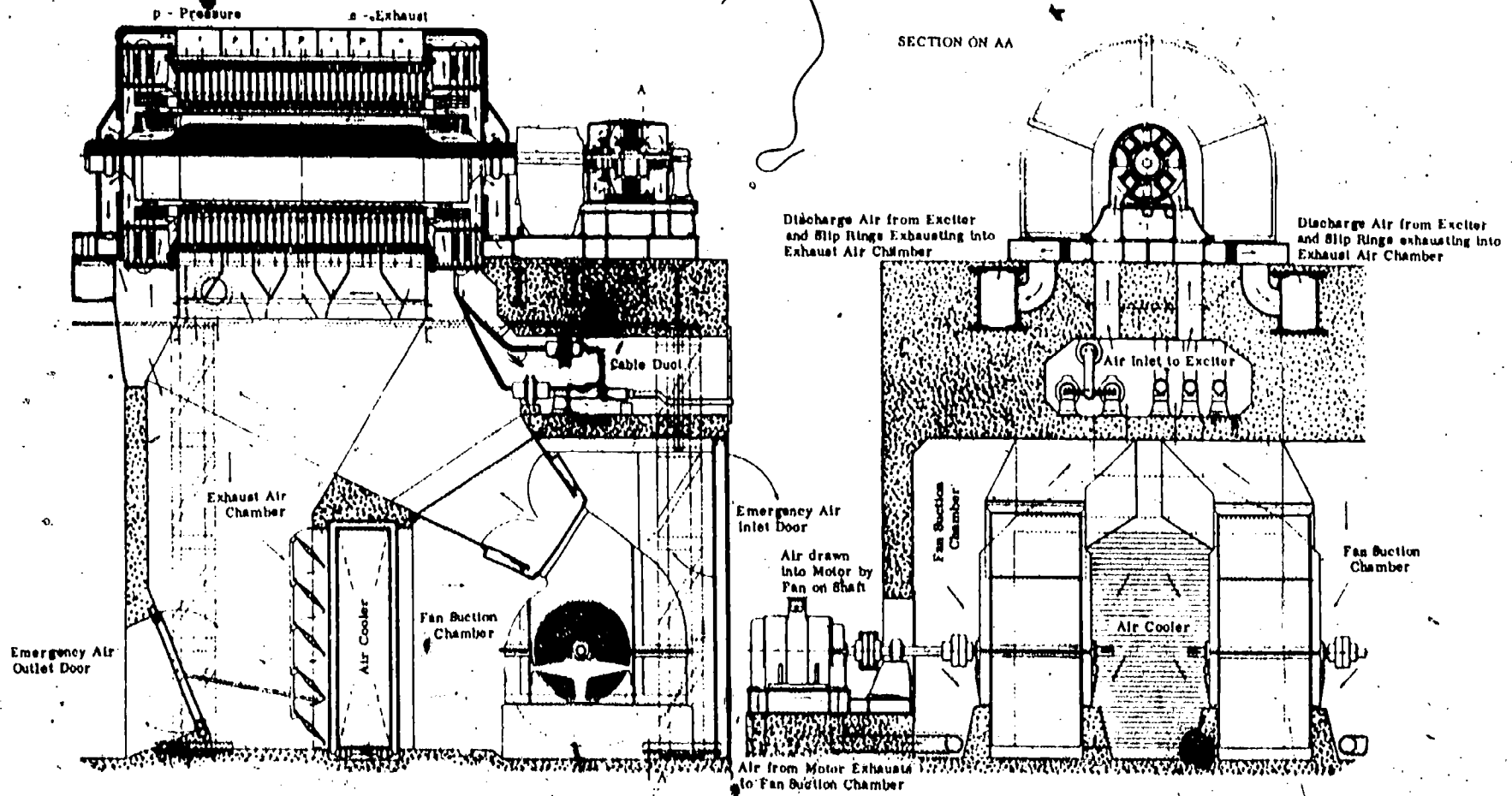

ALTERNATOR VENTILATING ARRANGEMENTS

Fig. 6

75

76

BEST COPY AVAILABLE

Hydrogen Cooling

The use of a closed circuit system of alternator ventilation and cooling suggested the possibility of some other gas in place of air being used as the cooling medium. Air has the disadvantages of a poor thermal capacity, high density and the fact that it will support combustion. The gas which was universally chosen in place of air for alternator cooling was hydrogen.

Hydrogen has outstanding advantages as a cooling medium: it has a high heat transfer coefficient and will therefore absorb and reject heat rapidly; it has a high thermal conductivity and will transmit the heat rapidly. It has a low density and this requires little power to force it through a fan and offers very little braking effect (windage) to the rotating parts of the alternator. The specific heat of hydrogen is high enough to compensate for the low density so that it will carry off about the same amount of heat as air for a given quantity of gas.

Compared directly with air, its specific heat is fourteen times as great, its density is about one-fourteenth part. Its heat transfer coefficient is about one and one-half times that of air and its thermal conductivity six times.

The low density gives reduced windage loss and this results in a direct increase in the alternator efficiency of approximately 1%.

The higher thermal conductivity and greater heat transfer coefficient of hydrogen both reduce the temperature gradient in an alternator, or conversely permit a greater output to be obtained from the same frame.

The increase in output obtained with hydrogen cooling in place of air cooling on any particular machine has been shown to be 20 to 30%, based on a hydrogen pressure of 3.5 kPa. A further increase in output may be obtained by raising the pressure of hydrogen in the alternator, each 7 kPa increase above atmosphere giving about 1% gain in output. Experiments have been carried out with pressures up to 170 kPa and alternators are regularly operated up to 100 kPa.

In addition to the above, the use of hydrogen for cooling brings the following advantages: reduced maintenance because of the gas-tight and hence dirt and moisture-proof casing; quieter operation due to the virtual elimination of windage losses; simplified foundations since external fans and coolers are not required.

The disadvantages are the added complications of a gas control system and shaft sealing devices, and the necessity for a gas-tight and explosion-safe casing.

With regard to the risk of explosion which is attendant upon the use of hydrogen, experience has shown that if ordinary precautions are taken there is no danger. Nevertheless, hydrogen-cooled alternators are enclosed in a casing which is designed to withstand the highest pressure which could occur in the event of an explosion.



HYDROGEN-COOLED ALTERNATOR STATOR CASING
DURING FABRICATION Fig. 7

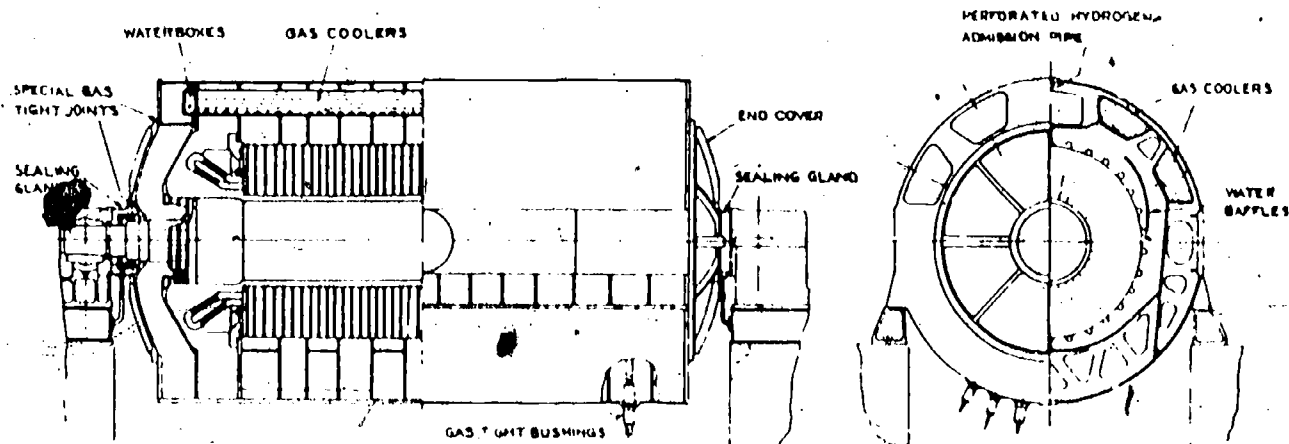

ARRANGEMENT OF HYDROGEN-COOLED ALTERNATOR
Fig. 8

(PE2-5-4-10)

BEST COPY AVAILABLE

In order to avoid having an explosive mixture of air and hydrogen in the stator at times of charging or purging, carbon dioxide is used as a buffer gas, that is, when replacing the air in the stator with hydrogen, carbon dioxide is used to expel the air and then hydrogen in turn displaces the carbon dioxide. In the case of purging the hydrogen from the stator prior to opening up for overhaul, repair, etc., CO₂ is used to expel the hydrogen and then air to displace the CO₂.

Hydrogen and air form an explosive mixture between the limits of 4% and 74% hydrogen in air by volume. During normal running it is not difficult to maintain the purity of the hydrogen in the stator at 95% or above.

The shafts must be sealed at the point where they pass through the stator casing. Various types of shaft seals have been designed and are in use.

Fig. 9 (a) and (b) illustrates a radial clearance and an axial clearance type.

Fig. 10 gives a detail of an axial clearance or thrust-ring type of seal.

In each case the basic idea is to prevent the hydrogen from escaping outwards by forcing seal oil inwards. The present-day seals are extremely effective and the quantity of oil required to maintain tightness is relatively small. The oil is supplied from the main machine lubricating oil system and is returned after passing through a hydrogen detraining tank where the oil is delayed long enough to allow any entrained hydrogen to be given off.

The complete system of pipework and auxiliaries for a hydrogen-cooled alternator of Messrs. C.A. Parsons design is given in Fig. 11.

The layout shows lubricating (seal) oil lines, carbon dioxide, hydrogen, distilled water (for hydrogen coolers) and river water (for distilled water coolers) pipework.

The effectiveness of hydrogen cooling of alternators can be increased by increasing the hydrogen gas pressure in the stator as mentioned earlier. It can also be increased by allowing the gas direct access to the copper conductors on the rotor winding. This method is known as Direct Rotor Cooling and together with increased gas pressure has been responsible for a major advance in the design of turbo-alternators. The rotor winding design is arranged to allow cooling gas to flow in contact with the copper by the use of slotted, grooved or hollow conductors.

The gas flow paths vary with manufacturer's designs. In some cases the gas enters at each end of the rotor and leaves at the centre; in others it flows from end to end. Still other designs allow the gas to enter special rotor ventilation slots and then escape radially through slotted conductors.

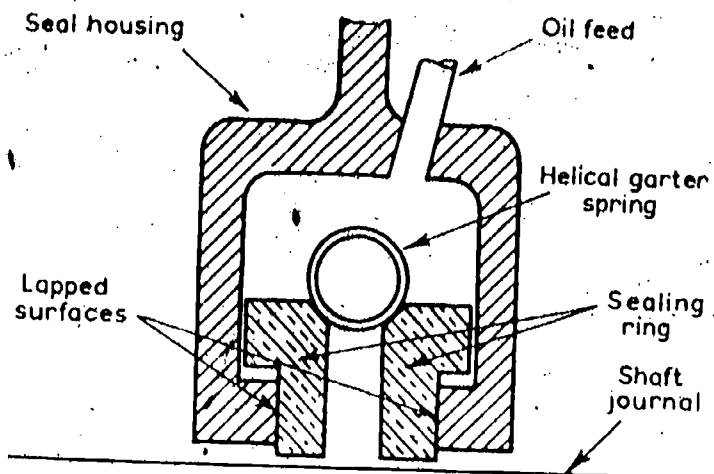

(a) Radial Clearance Type

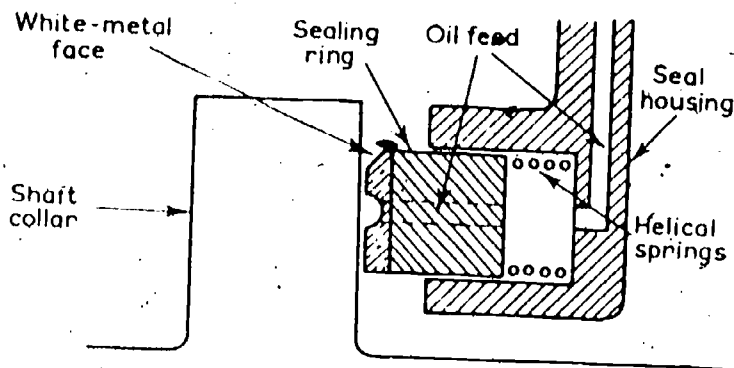

(b) Axial Clearance Type

SHAFT SEAL USED IN HYDROGEN-COOLED ALTERNATORS

Fig. 9

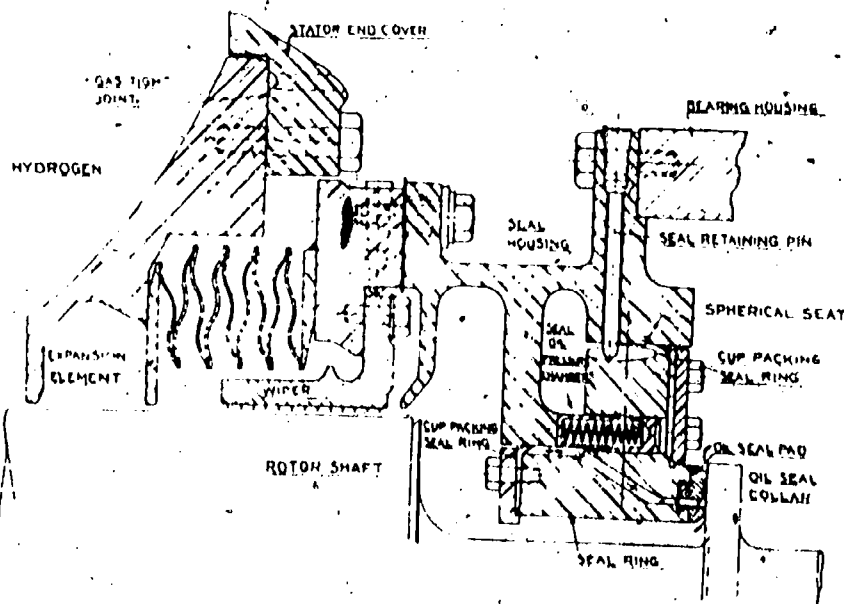

THRUST RING TYPE OF SEAL

Fig. 10

(PE2-5-4-12)

BEST COPY AVAILABLE

SYMBOL	KEY TO SYMBOLS
	SHUT OFF VALVE
	NON RETURN VALVE
	ELECTRICAL CONNECTIONS.

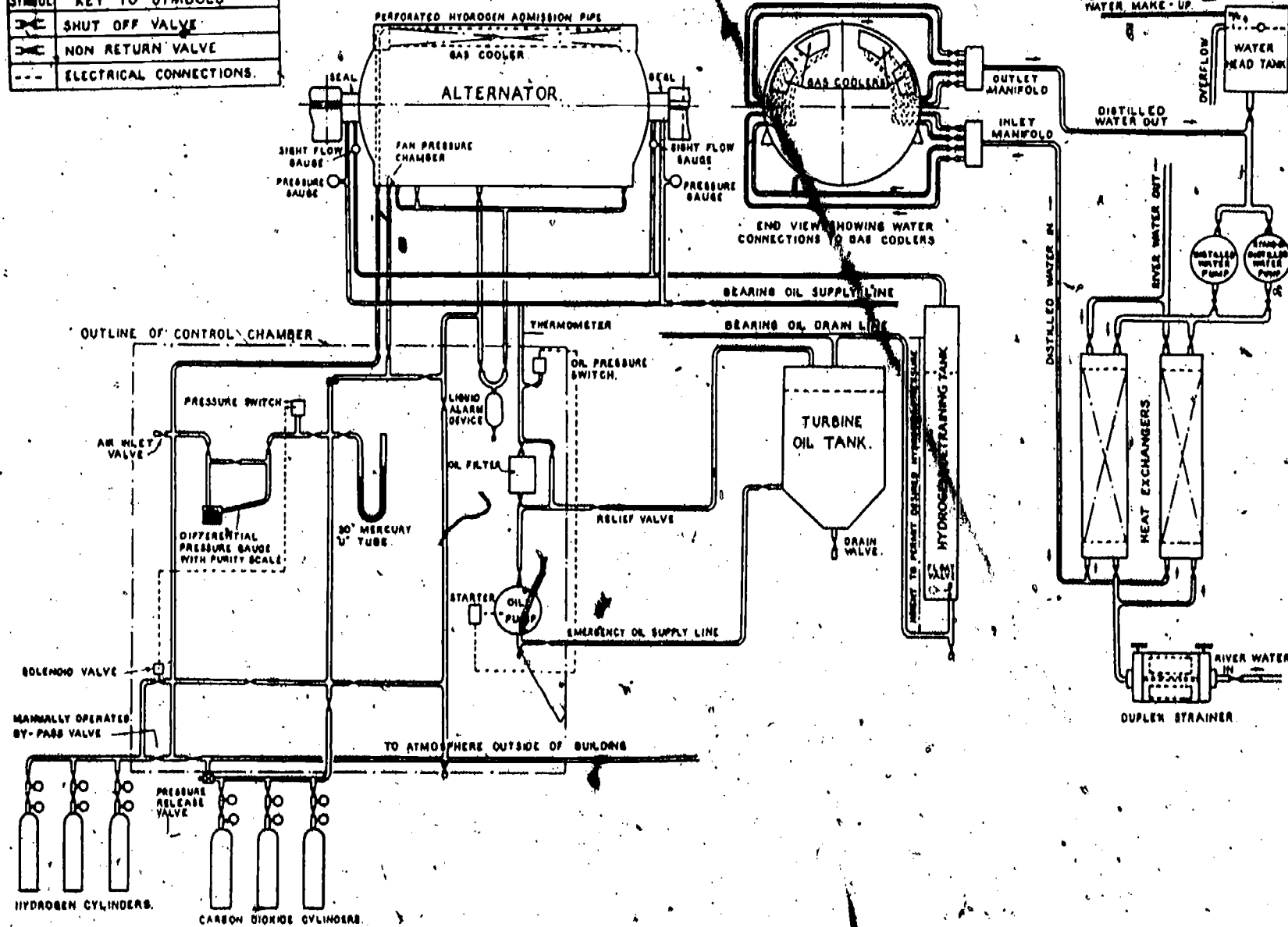

COMPLETE SYSTEM OF PIPEWORK AND AUXILIARIES FOR
HYDROGEN-COOLED ALTERNATOR

Fig. 11

82

(PE2-5-4-13)

BEST COPY AVAILABLE

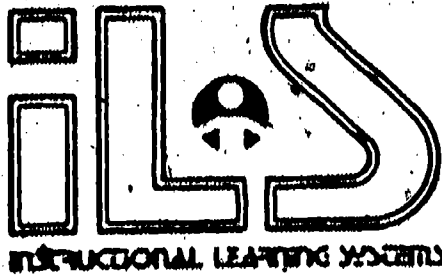

11.2

GENERATORS -- OPERATION

Goal:

The apprentice will be able to describe the operation of generators.

Performance Indicators:

1. Describe control of power factor.
2. Describe synchronizing.
3. Describe paralleling.
4. Describe loading.
5. Describe cooling.
6. Describe safety.
7. Describe protection.
8. Describe maintenance.

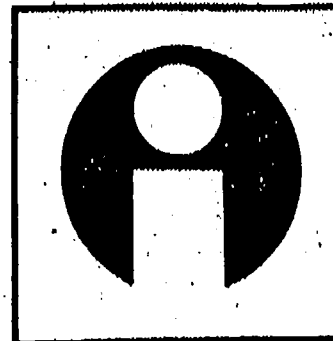

Study Guide

- * Read the goal and performance indicators to find what is to be learned from package.
- * Read the vocabulary list to find new words that will be used in package.
- * Read the introduction and information sheets.
- * Complete the job sheet.
- * Complete self-assessment.
- * Complete post-assessment.

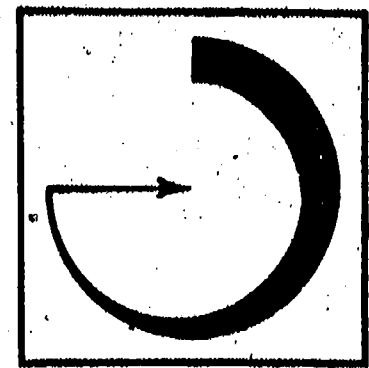

Vocabulary

- * Cooling
- * Enclosed air cooling
- * Hydrogen cooling
- * Liquid cooling
- * Paralleling
- * Power factor
- * Synchronizing



Introduction

The operation of generators is a major responsibility of a steam plant operator. The mechanical energy produced by steam must be converted into electrical energy. Although operators are not electricians, they must understand the operational processes of generators.

Operators must know how to synchronize generators that are operating in parallel. They must understand loading, cooling protection, maintenance, and safety factors of electrical generators. This package introduces the apprentice to these concepts of operation. Further reading and practical experience will build upon this foundation knowledge.

Information



Controlling the Power Factor

When two or more alternators are hooked in parallel, the power factor must be controlled. This can be accomplished by trimming the resistance in the voltage regulator circuit. The excitation must be adjusted for each alternator in the parallel hookup.

Synchronizing

Operation of several alternators in parallel requires that the units be synchronized with each other. Synchronization requires that a generator being switched into a parallel system must have:

- * a terminal voltage equal to that of the system
- * a frequency close to that of the system
- * the same phase rotation as that of the system
- * the same phase relationship as the system

The voltage can be synchronized with the system by running the machine up to the voltage of the system and setting the field rheostat. Alternator frequency can be changed by adjusting the steam supply to the turbine. A phase rotation meter will show if the alternator is out of phase. Many of the modern alternators have automatic phasing equipment.

Paralleling

Paralleling is the practice of hooking several generators in parallel using common bus bars. This process is also called synchronizing as discussed in the previous paragraph. The alternators are connected as a parallel circuit which requires that each motor in the circuit be synchronized.

Loading

Alternator loading is controlled by the prime mover. When the prime mover power is increased, the alternator loading will increase. Control of the loading is handled by adjustments in the governor of the prime mover. Some machines have other types of mechanisms for controlling speeds. Whatever the method for controlling the prime mover speed, it is the only means for adjusting the load on an alternator.



Information

Cooling

Cooling of alternators is accomplished by three major methods.

- * Enclosed air cooling
- * Hydrogen cooling
- * Liquid cooling

The enclosed air system utilizes air to cool water that flows through enclosed tubes. Air recirculates through the windings after it passes through an air cooler. The air is kept cool by circulating water that moves up and down the cooling tubes. The same air is used over and over.

Hydrogen cooling is also a closed system that circulates hydrogen instead of air. The hydrogen is a better coolant than air due to its ability to transfer heat. There is a risk of explosion when hydrogen is mixed with air. For that reason, the hydrogen system must be tightly sealed and gas tight. All hydrogen must be purged from the stator before opening up the system for repair. Purging can be accomplished with carbon dioxide. The use of clean water for cooling the hydrogen is very important. Distilled water is recommended.

Liquid cooled alternators circulate liquid coolants through hollow conductors. Water is the liquid used in this type of cooling system. High purity water is recommended because pure water has much less electrical conductivity than murky water.

Safety

The hazard of hydrogen has been discussed. The operator should always purge out the hydrogen with carbon dioxide before opening up the generator to atmospheric air.

The hazards of electrical shock should be considered when working with generators. Some safety rules that should be closely observed are:

1. Observe the safe minimum distances for electricity. High voltage electricity will arc from 1 to 3 feet.
2. Do not carry metal objects that will tend to cause arcing while working around the generators.
3. Treat all electrical conductors as though they are live wires.

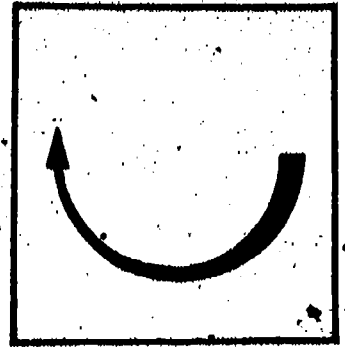

Information

4. When working on equipment, trip the main breaker, lock it and tag it so that others will not turn on the juice accidentally.
5. Check all three phases of a three phase circuit before starting to work on it. One phase may give a misleading reading because of its grounding while the others remain hot.
6. Check the grounding on all equipment whether portable hand tools or major equipment.

Protection

Generators should be protected by circuit breaker equipment. Circuit breakers may be:

- * Air break type that protect up to 575 volts.
- * Oil immersed type for voltages beyond 575 volts.
- * Air blast type — for high voltages.

Generator protection must consider both external and internal faults. A circuit breaker is needed to protect the generator from problems in the transmission system. This allows the generator to revert to a house unit load until the problem is corrected. Another external fault occurs back of the generator. A unit trip relay is used to give protection from this type of fault.

Internal faults can occur in any of the following ways:

- * Phase to ground
- * Phase to phase
- * Double phase to ground
- * Three phase to ground

Protection against internal faults is afforded through a relay protection scheme and grounding through a distribution transformer. These relay schemes are somewhat complex and should be completed by a qualified electrician.

Maintenance

The operator is responsible for routine checks on the condition of generator equipment. Some things that should be checked regularly are:



Information

- * Check for hydrogen leaks with an approved hydrogen tester.
- * Check for liquid leakage by use of liquid detectors underneath the generator.
- * Remove and check hydrogen coolers for water leaks.
- * Inspect collector rings and brushes on field exciters for wear.
- * Preheating of field windings is required on some generators.
- * Follow plant procedures and/or manufacturers instructions for maintenance of generators.

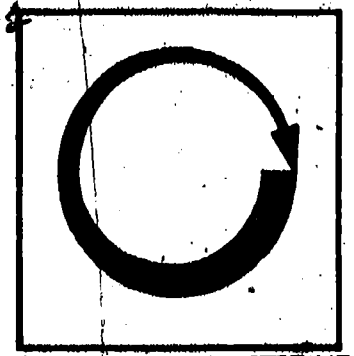

Assignment

- * Read pages 7 - 22 in supplementary reference.
- * Complete job sheet.
- * Complete self-assessment and check answers.
- * Complete post-assessment and have instructor check answers.

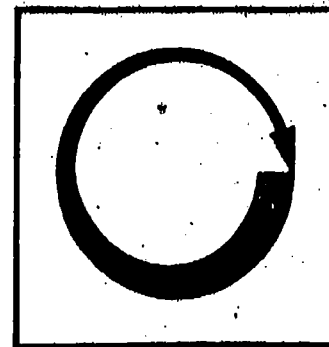

Job Sheet

OBSERVE GENERATION OPERATION

* Observe a trained operator in the operation of a generator.

- Synchronizing
- Loading
- Checking cooling system
- Maintenance

* Observe equipment used for

- Protection
- Cooling

Self Assessment

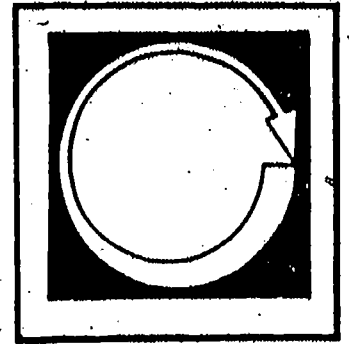

Match the following terms and phrases.

- | | | | |
|-------|-------------------------|----|--|
| _____ | 1. Synchronization | A. | Shows if alternator is out of phase with system. |
| _____ | 2. Alternator frequency | B. | Uses water as a coolant medium. |
| _____ | 3. Alternator voltage | C. | Controlled by the prime mover. |
| _____ | 4. Phase rotation meter | D. | Changed by adjusting the steam supply to the turbine. |
| _____ | 5. Paralleling | E. | Requires that each generator have terminal voltage equal to the voltage of the system. |
| _____ | 6. Loading | F. | Types of circuit protection device. |
| _____ | 7. Enclosed air system | G. | Protects against internal faults in system. |
| _____ | 8. Carbon dioxide | H. | Can be changed by running machine to required voltage and setting rheostat. |
| _____ | 9. Air break | I. | Used to purge hydrogen from a cooling system. |
| _____ | 10. Relay scheme | J. | Hooking several generators to a common bus bar. |

Self Assessment Answers

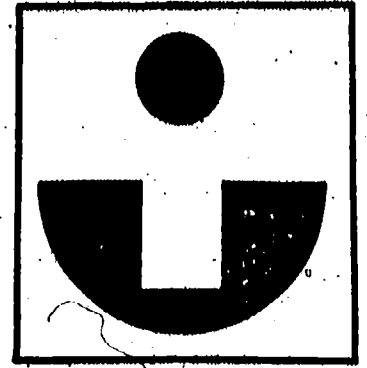

E 1.

D 2.

H 3.

A 4.

J 5.

C 6.

B 7.

I 8.

F 9.

G 10.

Post Assessment

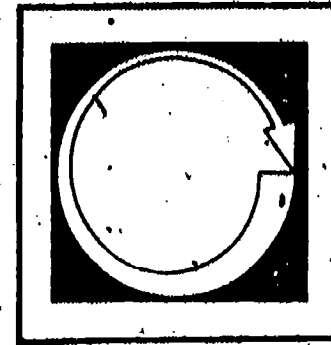

1. List 3 types of internal electrical faults that can occur in a generator system?
2. What kind of device is used to protect the system faulting back of the generator?
3. What kind of device is used to protect the system from faulting that occurs in front of the generator (transmission system)?
4. List 3 types of circuit breakers used in protection of generators?
5. What precaution is important in a hydrogen cooling of generators?
6. Why is distilled water recommended for liquid cooling of generators?
7. List 3 types of cooling systems.
8. When the prime mover power is increased, does the alternator load increase or decrease?
9. How can we determine if an alternator is out of phase with a system?
10. How is the power factor controlled in paralleling?

Instructor Post Assessment Answers



1. Phase to ground, phase to phase, double phase to ground, three phase to ground
2. Trip relay
3. Circuit breakers
4. Air break, oil immersed, air blast
5. Purge hydrogen with carbon dioxide to avoid explosion
6. Has less electrical conductivity
7. Enclosed air, hydrogen, liquid
8. Increase
9. By use of a phase rotation meter
10. By trimming resistance in the voltage regulator

Supplementary References

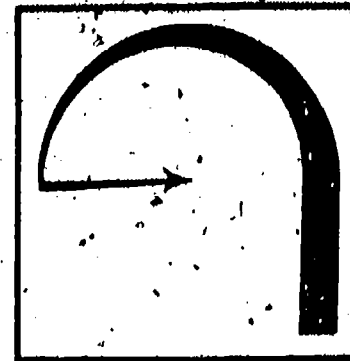

- * Correspondence Course. Lecture 4, Section 5, Second Class. Alternating Current Generators. Southern Alberta Institute of Technology. Calgary, Alberta, Canada.