

DOCUMENT RESUME

ED 254 724

CE 041 000

TITLE Millwright Apprenticeship. Related Training Modules. 10,1-10.5 Combustion.

INSTITUTION Lane Community Coll., Eugene, Oreg.

SPONS AGENCY Oregon State Dept. of Education, Salem.

PUB DATE [82]

NOTE 195p.; For related documents, see CE 040 991-041 007. Many of the modules are duplicated in CE 040 986.

PUB TYPE Guides - Classroom Use - Materials (For Learner) (051)

EDRS PRICE MF01/PC08 Plus Postage.

DESCRIPTORS \*Apprenticeships; Behavioral Objectives; Job Skills; Job Training; Learning Modules; Machine Tools; Mechanics (Physics); Postsecondary Education; \*Power Technology; \*Pressure (Physics); \*Trade and Industrial Education

IDENTIFIERS \*Combustion; \*Millwrights

ABSTRACT

This packet, part of the instructional materials for the Oregon apprenticeship program for millwright training, contains five modules covering combustion. The modules provide information on the following topics: the combustion process, types of fuel, air and fuel gases, heat transfer, and combustion in wood. Each module consists of a goal, performance indicators, student study guide, vocabulary, introduction, information sheets illustrated with line drawings and photographs, an assignment sheet, a job sheet, a self-assessment test with answers, a post-assessment test with answers for the instructor, and a list of supplementary references. (Copies of supplementary references, which are sections of lectures from a correspondence course published by the Southern Alberta Institute of Technology, are included in the packets.) (KC)

\*\*\*\*\*  
 \* Reproductions supplied by EDRS are the best that can be made \*  
 \* from the original document. \*  
 \*\*\*\*\*

ED254724

# METALWORKING

## APPRENTICESHIP

### RELATED TRAINING MODULES

10.1 - 10.5 COMBUSTION

U.S. DEPARTMENT OF EDUCATION  
NATIONAL INSTITUTE OF EDUCATION  
EDUCATIONAL RESOURCES INFORMATION  
CENTER (ERIC)

- This document has been reproduced as received from the person or organization originating it
- Minor changes have been made to improve reproduction quality
- Points of view or opinions stated in this document do not necessarily represent official NIE position or policy.

"PERMISSION TO REPRODUCE THIS MATERIAL HAS BEEN GRANTED BY

S. J. Case

TO THE EDUCATIONAL RESOURCES INFORMATION CENTER (ERIC)."

CE 041000

## STATEMENT OF ASSURANCE

IT IS THE POLICY OF THE OREGON DEPARTMENT OF EDUCATION THAT NO PERSON BE SUBJECTED TO DISCRIMINATION ON THE BASIS OF RACE, NATIONAL ORIGIN, SEX, AGE, HANDICAP OR MARITAL STATUS IN ANY PROGRAM, SERVICE OR ACTIVITY FOR WHICH THE OREGON DEPARTMENT OF EDUCATION IS RESPONSIBLE, THE DEPARTMENT WILL COMPLY WITH THE REQUIREMENTS OF STATE AND FEDERAL LAW CONCERNING NON-DISCRIMINATION AND WILL STRIVE BY ITS ACTIONS TO ENHANCE THE DIGNITY AND WORTH OF ALL PERSONS.

## STATEMENT OF DEVELOPMENT

THIS PROJECT WAS DEVELOPED AND PRODUCED UNDER A SUB-CONTRACT FOR THE OREGON DEPARTMENT OF EDUCATION BY LANE COMMUNITY COLLEGE, APPRENTICESHIP DIVISION, EUGENE, OREGON, 1984. LANE COMMUNITY COLLEGE IS AN AFFIRMATIVE ACTION/EQUAL OPPORTUNITY INSTITUTION. . .

APPRENTICESHIP  
MILLWRIGHT  
RELATED TRAINING MODULES

SAFETY

- 1.1 General Safety
- 1.2 Hand Tool Safety
- 1.3 Power Tool Safety
- 1.4 Fire Safety
- 1.5 Hygiene Safety
- 1.6 Safety and Electricity
- 1.7 Fire Types and Prevention
- 1.8 Machine Safeguarding (includes OSHA Handbook)

ELECTRICITY/ELECTRONICS

- 2.1 Basics of Energy
- 2.2 Atomic Theory
- 2.3 Electrical Conduction
- 2.4 Basics of Direct Current
- 2.5 Introduction to Circuits
- 2.6 Reading Scales
- 2.7 Using a V.O.M.
- 2.8 OHM'S Law
- 2.9 Power and Watt's Law
- 2.10 Kirchoff's Current Law
- 2.11 Kirchoff's Voltage Law
- 2.12 Series Resistive Circuits
- 2.13 Parallel Resistive Circuits
- 2.14 Series - Parallel Resistive Circuits
- 2.15 Switches and Relays
- 2.16 Basics of Alternating Currents
- 2.17 Magnetism

COMPUTERS

- 3.1 Digital Language
- 3.2 Digital Logic
- 3.3 Computer Overview
- 3.4 Computer Software

TOOLS

- 4.1 Boring and Drilling Tools
- 4.2 Cutting Tools, Files and Abrasives
- 4.3 Holding and Fastening Tools
- 4.4 Fastening Devices
- 4.5 Basic Science - Simple Mechanics
- 4.6 Fasteners

DRAFTING

- 5.1 Types of Drawing and Views
- 5.2 Sketching
- 5.3 Blueprint Reading/Working Drawings
- 5.4 Working Drawings for Machines and Welding
- 5.5 Machine and Welding Symbols
- 5.6 Blueprint Reading, Drafting: Basic Print Reading
- 5.7 Blueprint Reading, Drafting: Basic Print Reading
- 5.8 Blueprint Reading, Drafting: Basic Print Reading
- 5.9 Blueprint Reading, Drafting: Basic Print Reading
- 5.10 Blueprint Reading, Drafting: Basic Print Reading
- 5.11 Blueprint Reading, Drafting: Basic Print Reading
- 5.12 Blueprint Reading, Drafting: Basic Print Reading
- 5.13 Blueprint Reading, Drafting: Basic Print Reading
- 5.14 Drafting, Machine Features
- 5.15 Drafting, Measurement
- 5.16 Drafting, Visualization

HUMAN RELATIONS

- 6.1 Communications Skills
- 6.2 Feedback
- 6.3 Individual Strengths
- 6.4 Interpersonal Conflicts
- 6.5 Group Problem Solving
- 6.6 Goal-setting and Decision-making
- 6.7 Worksite Visits
- 6.8 Resumes
- 6.9 Interviews
- 6.10 Expectation
- 6.11 Wider Influences and Responsibilities
- 6.12 Personal Finance

BOILERS

- 7.1 Boilers - Fire Tube Types
- 7.2 Boilers - Watertube Types
- 7.3 Boilers - Construction
- 7.4 Boilers - Fittings
- 7.5 Boilers - Operation
- 7.6 Boilers - Cleaning
- 7.7 Boilers - Heat Recovery Systems
- 7.8 Boilers - Instruments and Controls
- 7.9 Boilers - Piping and Steam Traps

TURBINES

- 8.1 Steam Turbines - Types
- 8.2 Steam Turbines - Components
- 8.3 Steam Turbines - Auxillaries
- 8.4 Steam Turbines - Operation and Maintenance
- 8.5 Gas Turbines.

PUMPS

- 9.1 Pumps - Types and Classification
- 9.2 Pumps - Applications
- 9.3 Pumps - Construction
- 9.4 Pumps - Calculating Heat and Flow
- 9.5 Pumps - Operation
- 9.6 Pumps - Monitoring and Troubleshooting
- 9.7 Pumps - Maintenance

COMBUSTION

- 10.1 Combustion - Process
- 10.2 Combustion - Types of Fuel
- 10.3 Combustion - Air and Fuel Gases
- 10.4 Combustion - Heat Transfer
- 10.5 Combustion - Wood

GENERATORS

- 11.1 Generators - Types and Construction
- 11.2 Generators - Operation

FEEDWATER

- 12.1 Feedwater - Types and Equipment
- 12.2 Feedwater - Water Treatments
- 12.3 Feedwater - Testing

AIR COMPRESSORS

- 13.1 Air Compressors - Types
- 13.2 Air Compressors - Operation and Maintenance

STEAM

- 14.1 Steam - Formation and Evaporation
- 14.2 Steam - Types
- 14.3 Steam - Transport
- 14.4 Steam - Purification

MISCELLANEOUS

- 15.1 Installation - Foundations
- 15.2 Installation - Alignment
- 15.3 Circuit Protection
- 15.4 Transformers
- 15.5 Trade Terms

TRADE MATH

- 16.1 Linear - Measure
- 16.2 Whole Numbers
- 16.3 Addition and Subtraction of Common Fraction and Mixed Numbers
- 16.4 Multiplication and Division of Common Fractions and Whole and Mixed Numbers

- 16.5 Compound Numbers
- 16.6 Percent
- 16.7 Ratio and Proportion
- 16.8 Perimeters, Areas and Volumes
- 16.9 Circumference and Wide Area of Circles
- 16.10 Area of Plane, Figures and Volumes of Solid Figures
- 16.11 Metrics

#### HYDRAULICS

- 17.1 Hydraulics - Lever
- 17.2 Hydraulics - Transmission of Force
- 17.3 Hydraulics - Symbols
- 17.4 Hydraulics - Basic Systems
- 17.5 Hydraulics - Pumps
- 17.6 Hydraulics - Pressure Relief Valve
- 17.7 Hydraulics - Reservoirs
- 17.8 Hydraulics - Directional Control Valve
- 17.9 Hydraulics - Cylinders
- 17.10 Hydraulics - Forces, Area, Pressure
- 17.11 Hydraulics - Conductors and Connectors
- 17.12 Hydraulics - Troubleshooting
- 17.13 Hydraulics - Maintenance

#### METALLURGY

- 18.1 Included are ILS packets:
  - W 3010
  - W 3011-1
  - W 3011-2
  - MS 9001 (1-3-4-8-9-6-7-5-2-9)
  - MS 9200, 9201

#### POWER DRIVES

- 19.1
  - 101. A-B-C-D-E
  - 102. C-D-E
  - 103. B-C-D-E
  - 104. A-C-E-F-G-H-I-J
  - 107. A
  - 108. A

#### WELDING

- 20.1
  - 602. A-B-C-D-G-I-L-M
  - 603. A-B-F-G-I
  - W. 3011-1 refer to Metallurgy 18.1
  - WE. MA-18

MILLWRIGHT  
SUPPLEMENTARY REFERENCE DIRECTORY

Note: All reference packets are numbered on the upper right-hand corner of the respective cover page.

Supplementary Packet #	Description	Related Training Module
1.8	Concepts & Techniques of Machine Safeguarding, U.S.D.L., O.S.H.A.	1.8 Machine Safeguarding
12.1	Correspondence Course, Lecture 1, Sec. 2, Steam Generators, Types of Boilers I, S.A.I.T., Calgary, Alberta, Canada	7.1 Boilers, Fire Tube Type
12.2	Correspondence Course, Lecture 2, Sec. 2, Steam Generators, Types of Boilers II, S.A.I.T., Calgary, Alberta, Canada	7.2 Boilers, Water Tube Type
12.3	Correspondence Course, Lecture 2, Sec. 2, Steam Generators, Boiler Construction & Erection, S.A.I.T., Calgary, Alberta, Canada	7.3 Boilers, Construction
12.4	Correspondence Course, Lecture 4, Sec. 2, Steam Generators, Boiler Fittings II, S.A.I.T., Calgary, Alberta, Canada	7.4 Boilers, Fittings
12.4	Correspondence Course, Lecture 4, Sec. 2, Steam Generators, Boiler Fitting I, S.A.I.T., Calgary, Alberta, Canada	7.4 Boilers, Fittings
12.5	Correspondence Course, Lecture 10, Sec. 2, Steam Generation, Boiler Operation, Maintenance, Inspection, S.A.I.T., Calgary, Alberta, Canada	7.5 Boilers, Operation
12.7	Correspondence Course, Lecture 3, Sec. 2, Steam Generation, Boiler Details, S.A.I.T., Calgary, Alberta, Canada	7.7 Boilers Heat Recovery Systems
		<u>PUMPS</u>
13.1	Correspondence Course, Lecture 9, Sec. 2, Steam Generator, Power	9.1 Types & Classifications
13.2	Plant Pumps, S.A.I.T., Calgary, Alberta, Canada	9.2 Applications
13.4		9.4 Calculating Heat & Flow
13.6		9.6 Monitoring & Troubleshooting
13.7		9.7 Maintenance
13.3	Correspondence Course, Lecture 6, Sec. 3, Steam Generators, Pumps, S.A.I.T., Calgary, Alberta, Canada	9.3 Construction
13.5		9.5 Operation



BEST COPY AVAILABLE

Supplementary Packet #	Description	Related Training Module
14.3 12.8	Correspondence Course, Lecture 6, Sec. 3, Steam Generators, Steam Generator Controls, S.A.I.T., Calgary, Alberta, Canada	14.3 Steam Transport 7.8 Boilers, Instruments & Controls
14.4	Correspondence Course, Lecture 11, Sec. 2, Steam Generators, Piping II, S.A.I.T., Calgary, Alberta, Canada	14.4 Steam Purification
15.1	Correspondence Course, Lecture 1, Sec. 4, Prime Movers, & Auxiliaries, Steam Turbines, S.A.I.T., Calgary, Alberta, Canada	8.1 Steam Turbines, Types
15.2	Correspondence Course, Lecture 4, Sec. 3, Prime Movers, Steam Turbines I, S.A.I.T., Calgary, Alberta, Canada	8.2 Steam Turbines, Components
15.3	Correspondence Course, Lecture 2, Sec. 4, Prime Movers & Auxiliaries, Steam Turbine Auxiliaries, S.A.I.T., Calgary, Alberta, Canada	8.3 Steam Turbines, Auxiliaries
15.4	Correspondence Course, Lecture 6, Sec. 3, Prime Movers, Steam Turbine Operation & Maintenance, S.A.I.T., Calgary, Alberta, Canada	8.4 Steam Turbines, Operation & Maintenance
15.5	Correspondence Course, Lecture 8, Sec. 3, Prime Movers, Gas Turbines, S.A.I.T., Calgary, Alberta, Canada	8.5 Gas Turbines
16.2	Boilers Fired with Wood & Bark Residues, D.D. Junge, F.R.L., O.S.U., 1975	10.2 Combustion Types of Fuel
16.2	Correspondence Course, Lecture 5, Sec. 2, Steam Generators, Fuel Combustion, S.A.I.T., Calgary, Alberta, Canada	10.2 Combustion Types of Fuel
16.3	Correspondence Course, Lecture 5, Sec. 2, Plant Services, Fuel & Combustion, S.A.I.T., Calgary, Alberta, Canada	10.3 Combustion Air & Fuel Gases
17.1	Correspondence Course, Lecture 12, Sec. 3, Steam Generation, Water Treatment, S.A.I.T., Calgary, Alberta, Canada	12.1 Feedwater, Types & Operation
17.2	Correspondence Course, Lecture 12, Sec. 2, Steam Generation, Water Treatment, S.A.I.T., Calgary, Alberta, Canada	12.2 Feedwater, Water Treatments

<u>Supplementary Packet #</u>	<u>Description</u>	<u>Related Training Module</u>
17.3	Correspondence Course, Lecture 7, Sec. 2, Steam Generators, Boiler Feedwater Treatment, S.A.I.T., Calgary, Alberta, Canada	12.3 Feedwater, Testing
18.1	Correspondence Course, Lecture 2, Sec. 5, Electricity, Direct Current Machines, S.A.I.T., Calgary, Alberta, Canada	11.1 Generators, Types & Construction
18.1	Correspondence Course, Lecture 4, Sec. 5, Electricity, Alternating Current Generators, S.A.I.T., Calgary, Alberta, Canada	11.1 Generators, Types & Construction
18.2		18.2 Generators, Operation
19.1	Correspondence Course, Lecture 5, Sec. 4, Prime Movers & Auxiliaries, Air Compressor I, S.A.I.T., Calgary, Alberta, Canada	13.1 Air Compressors, Types
19.1	Correspondence Course, Lecture 6, Sec. 4, Prime Movers & Auxiliaries, Air Compressors II, S.A.I.T., Calgary, Alberta, Canada	13.1 Air Compressors, Types
		13.2 Air Compressors, Operation & Maintenance
20.1	Basic Electronics, Power Transformers, EL-BE-51	15.4 Transformers
21.1	Correspondence Course, Lecture 6, Sec. 5, Electricity, Switchgear & Circuit, Protective Equipment, S.A.I.T., Calgary, Alberta, Canada	15.3 Circuit Protection
22.1	Correspondence Course, Lecture 10, Sec. 3, Prime Movers, Power Plant Erection & Installation, S.A.I.T., Calgary, Alberta, Canada	15.1 Installation Foundations

## RECOMMENDATIONS FOR USING TRAINING MODULES

The following pages list modules and their corresponding numbers for this particular apprenticeship trade. As related training classroom hours vary for different reasons throughout the state, we recommend that the individual apprenticeship committees divide the total packets to fit their individual class schedules.

There are over 130 modules available. Apprentices can complete the whole set by the end of their indentured apprenticeships. Some apprentices may already have knowledge and skills that are covered in particular modules. In those cases, perhaps credit could be granted for those subjects, allowing apprentices to advance to the remaining modules.

We suggest the the apprenticeship instructors assign the modules in numerical order to make this learning tool most effective.

SUPPLEMENTARY INFORMATION

ON CASSETTE TAPES

Tape 1: Fire Tube Boilers - Water Tube Boilers  
and Boiler Manholes and Safety Precautions

Tape 2: Boiler Fittings, Valves, Injectors,  
Pumps and Steam Traps

Tape 3: Combustion, Boiler Care and Heat Transfer  
and Feed Water Types

Tape 4: Boiler Safety and Steam Turbines

NOTE: The above cassette tapes are intended as additional  
reference material for the respective modules, as  
indicated, and not designated as a required assignment.

Modules 18.1, 19.1, and 20.1 have been omitted because they contain dated materials.



## 10.1

### COMBUSTION -- PROCESS

#### Goal:

The apprentice will be able to describe the basic process of combustion.

#### Performance Indicators:

1. Describe basic combustibles-- carbon, gaseous hydrocarbons and carbon monoxide and hydrogen.
2. Describe perfect combustion.
3. Describe complete combustion.
4. Describe incomplete combustion.

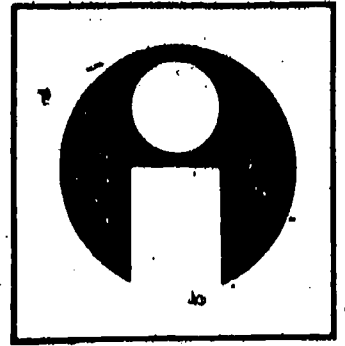

# Study Guide

- \* Read the goal and performance indicators to find what is to be learned from package.
- \* Read the vocabulary list to find new words that will be used in package.
- \* Read the introduction and information sheets.
- \* Complete the job sheet.
- \* Complete self-assessment.
- \* Complete post-assessment.

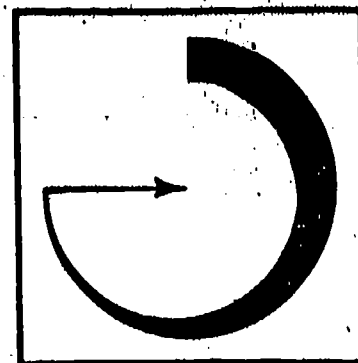

# Vocabulary

- \* Carbon
- \* Carbon dioxide
- \* Carbon monoxide
- \* Combustible
- \* Combustion
- \* Complete combustion
- \* Decomposition
- \* Gaseous hydrocarbons
- \* Incomplete combustion
- \* Perfect combustion
- \* Soot
- \* Sulfur dioxide



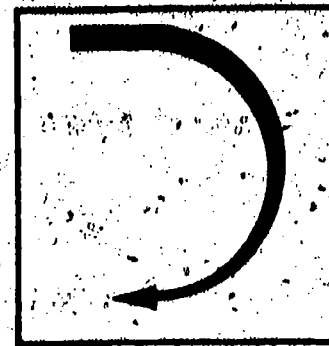

# Introduction

Fuels are burned for the energy that they contain. The burning of fuels is referred to as combustion. As combustion takes place, the heat energy is collected and used for producing steam and other purposes.

The basic combustion process involves combining combustibles with oxygen. Combustion cannot take place in the absence of air (oxygen). The control of air to the combustion chamber is critical for efficient capture of heat energy. Combustion is a chemical process that recombines carbon, hydrogen, oxygen and sulfur molecules.

A plant operator must understand the basic combustion process and how to recognize the characteristics of flames. They must be able to control the oxygen supply in a way that complete combustion can take place. If this is not done properly, the heat energy is lost up the smoke stack.



# Information

The process of combustion must be understood by the operator. Different fuels react in different manners during the combustion process. The portions of a fuel that burns during combustion is called combustibles. The basic combustibles in a fuel are:

- \* Solid carbon
- \* Gaseous hydrocarbons
- \* Carbon monoxide and hydrogen

## Carbon

Carbon fuels such as coke, coal and charcoal burns with a white, luminous flame. The carbon is represented by the symbol C. When carbon mixes with oxygen ( $O_2$ ) from the air, the following products result:

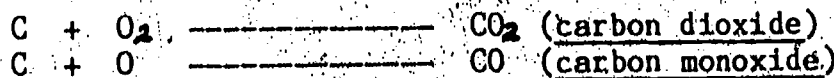

A dioxide means that two oxygen atoms are combined with each carbon atom. Monoxide means that only one oxygen atom combines with each carbon atom. A prefix of di means two. A prefix of mono means one in all chemical formulas. Carbon dioxide is a product of complete combustion. Carbon monoxide is a product of incomplete combustion. Complete combustion is dependent on the amount of oxygen or air that is available to the combustion process. The control of air to a furnace is critical to efficient combustion.

## Gaseous Hydrocarbons

Gaseous hydrocarbons are the basic combustible of fuel oil, natural gas and the heavy tars found in bituminous coal. These hydrocarbons are vaporized before combustion takes place. Hydrocarbons must be mixed with large quantities of air if complete combustion is to take place. The oxygen combines with the carbon atoms to form lighter compounds which are combustible. Another method for combustion of hydrocarbons is to reduce them to soot through decomposition. Decomposition breaks the hydrocarbons into carbon (soot) and hydrogen molecules. The soot (C) is then combined with oxygen ( $O_2$ ) and burned.

## Carbon Monoxide and Hydrogen

Carbon monoxide results from the combustion of hydrocarbon fuels. It is part of most gas fuels. Hydrogen is also liberated in the form of H during the burning of hydrocarbons. Both of these products can be burned at temperatures of  $760^\circ C$ .

# Information

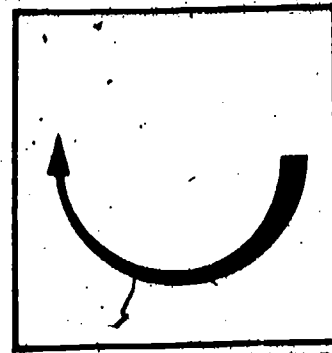

to 1540 C with excess supply of oxygen. Carbon monoxide burns with a light blue flame. Hydrogen shows a colorless flame. The burning of carbon monoxide and hydrogen converts the combustible to carbon dioxide (CO<sub>2</sub>) and water (H<sub>2</sub>O). The chemical formula for the combustion of carbon monoxide is:

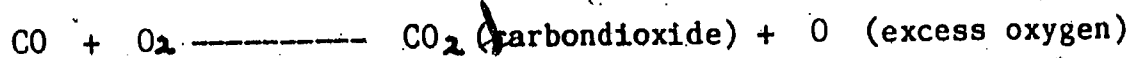

Hydrogen burning is shown as:

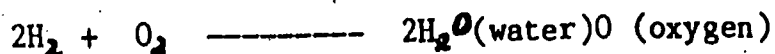

## Sulfur Combustion

Most fuels contain sulfur. The sulfur (S) combines with oxygen (O) sulfur dioxide (SO<sub>2</sub>).

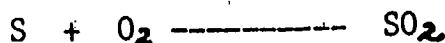

Sulfur is an impurity in the fuel and should be avoided as much as possible. It changes into acid forms that damage metal.

## Perfect Combustion

If all combustibles were completely burned it would be perfect combustion. In perfect combustion, the products would be carbon dioxide, sulfur dioxide, water, nitrogen and ash. Perfect combustion is nearly impossible because of the problems in getting the combustible molecules linked up with oxygen molecules. Large quantities of diluting gases must be present to allow all combustible molecules to find oxygen partners.

## Complete Combustion

Complete combustion occurs when an excess of air is provided beyond that provided for perfect combustion. In addition to CO<sub>2</sub>, SO<sub>2</sub>, H<sub>2</sub>O, N<sub>2</sub> and ash, the flue gases will have O<sub>2</sub> because of the excess air used in the process.

## Incomplete Combustion

In incomplete combustion some of the combustibles pass out the stack without yielding up their heat. The products of incomplete combustion are CO<sub>2</sub>, SO<sub>2</sub>, H<sub>2</sub>O, O, and N<sub>2</sub> as found in complete combustion. In addition, carbon monoxide (CO), hydrogen (H<sub>2</sub>), soot (C) and methane (CH<sub>4</sub>) will be passing out the stack. These

F

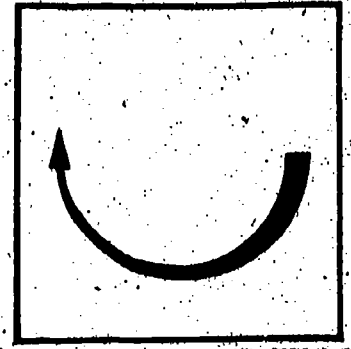

# Information

products are lost to the heat production process by incomplete combustion. Usually, a lack of oxygen is the cause of incomplete combustion. Care must be used in supplying excess air to the combustion process. Too much air can move flue gases out before they give up their heat. On the other hand, too little air always results in heat losses due to incomplete combustion. The air must be well mixed with combustible gases to make the chemical changes needed for complete combustion. Sometimes the flow patterns of gases and air become stratified in layers which prevents mixing. A short bright fire is one that has plenty of or an excess of air. Gas flames with too much air may appear blue at the tips while oil fires emit sparklers. On oil fired boilers a blue haze from the stack indicates excessive air. New air pollution standards require that less excess air be used. This may result in less efficiency because of incomplete combustion.

The operator must learn to recognize the characteristics of flames and stack emissions. Visual inspections are the basis for monitoring the combustion process. Efficient harvesting of the heat is dependent on the completeness of combustion.

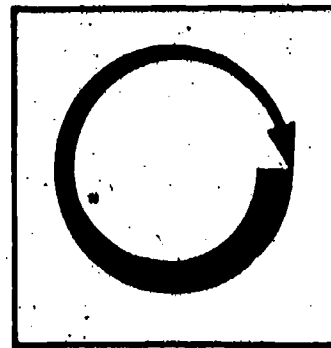

# Assignment

- \* Complete the job sheet.
- \* Complete the self-assessment and check answers.
- \* Complete the post-assessment and have instructor check the answers.

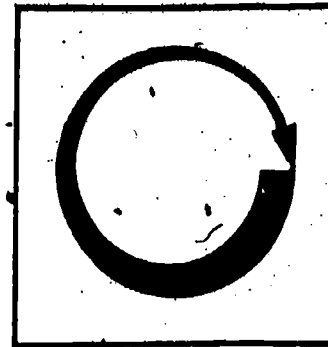

# Job Sheet

## COMPLETE VISUAL INSPECTION OF COMBUSTION PROCESS

- \* Inspect flame and note characteristics.
- \* Inspect stack emissions and note characteristics.
- \* Describe the combustion process as to its completeness or incompleteness based on visual inspection.
- \* If there is a problem with the combustion process, recommend action for its improvement.
- \* Check your observations and recommendations with the operator to determine if your inspection was a valid one.

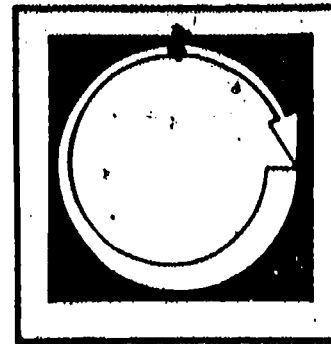

# Self Assessment

Match the following terms and phrases.

\_\_\_ 1. Carbon monoxide

\_\_\_ 2. Carbon dioxide

\_\_\_ 3. Gaseous hydrocarbons

\_\_\_ 4. Decomposition

\_\_\_ 5. Complete combustion

\_\_\_ 6. Incomplete combustion

\_\_\_ 7. Carbon

\_\_\_ 8. Mono

\_\_\_ 9. Excess air indicator

\_\_\_ 10. Di

A. One

B. Products are CO, SO, H<sub>2</sub>O, N and ash.

C. Product of complete combustion.

D. Blue haze at the stack.

E. Basic combustibles of fuel oil and natural gas.

F. Product of incomplete combustion.

G. Two

H. Products are CO, SO, H<sub>2</sub>O, N and CO, H, C, CH.

I. Reduction of hydrocarbons to soot.

J. Burns with a white, luminous flame.

# ● Self Assessment Answers

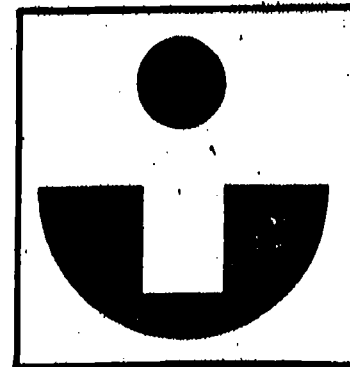

F. 1.

C 2.

E 3.

I 4.

B 5.

● H 6.

J 7.

A 8.

D 9.

G 10.



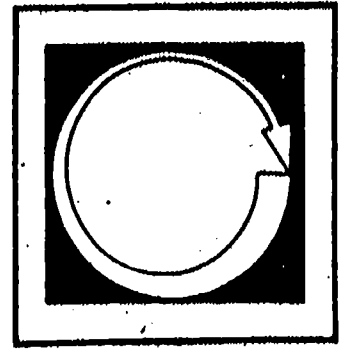

# Post Assessment

1. What is the most common product of incomplete combustion?
2. What is the most common product of complete combustion?
3. What one product is found in complete combustion that is not found in perfect combustion?
4. What harm is done when gases and air become stratified in layers in their flow patterns?
5. Do air pollution requirements always increase the efficiency of combustion?
6. In an oil fired boiler, what would sparklers at the flame tips indicate to the operator?
7. What is the process called in which hydrocarbons are reduced to soot so that combustion can take place?
8. What is the color of a carbon monoxide flame?
9. What two products result from combining carbon and oxygen in the combustion process?
10. What is the product of this chemical reaction?  $S + O \longrightarrow SO$

# Instructor Post Assessment Answers

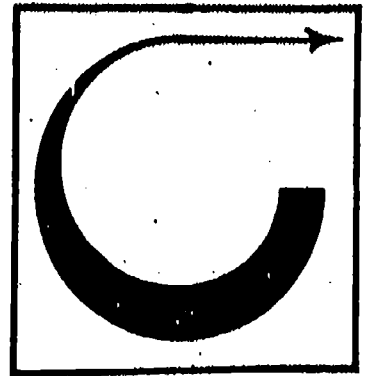

1. Carbon monoxide
2. Carbon dioxide
3. 0
4. They fail to mix causing incomplete combustion.
5. No
6. Too much air
7. Decomposition
8. Light blue
9. Carbon monoxide, carbon dioxide
10. Sulfur dioxide.

# Supplementary References

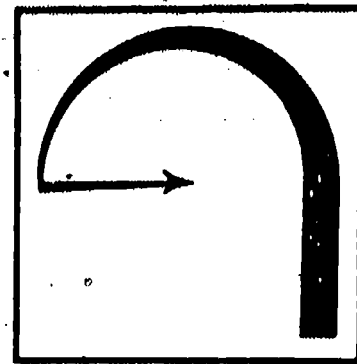

- \* Free choice reading of texts, pamphlets or manufacturer information on the combustion process.

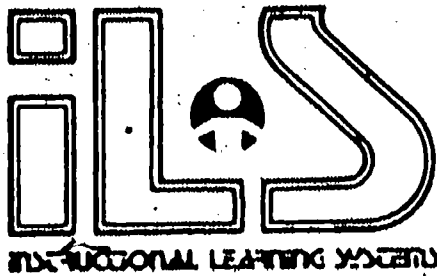

## 10.2

### COMBUSTION — TYPES OF FUEL

#### Goal:

The apprentice can describe types of fuels.

#### Performance Indicators:

1. Describe coal fuels.
2. Describe oil fuels.
3. Describe natural gas fuels.
4. Describe wood fuel.
5. Describe proximate and ultimate analyses.

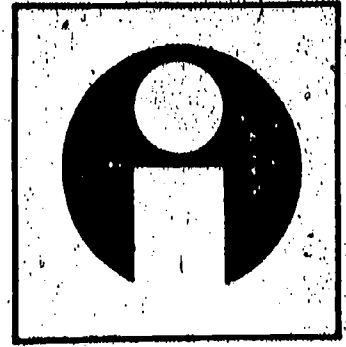

# Study Guide

- \* Read the goal and performance indicators to find what is to be learned from package.
- \* Read the vocabulary list to find new words that will be used in package.
- \* Read the introduction and information sheets.
- \* Complete the job sheet.
- \* Complete self-assessment.
- \* Complete post-assessment.

# Vocabulary

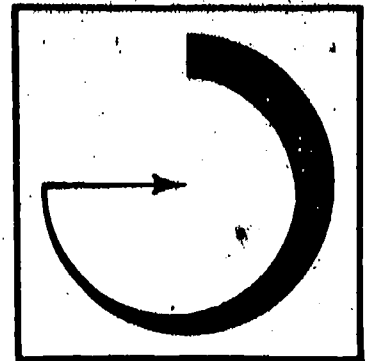

- \* Anthracite
- \* Bituminous
- \* Crude petroleum
- \* Fixed carbon
- \* Heavy oil (Residual oil)
- \* Hogged fuel
- \* Light fuel oil
- \* Proximate analyses
- \* Pulverized coal
- \* Semi-anthracite
- \* Sub-bituminous
- \* Ultimate analyses
- \* Volatile matter

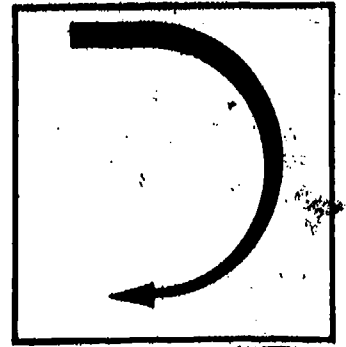

# Introduction

Fuels contain carbon and hydrogen which can be easily combined with oxygen in the combustion process. A fuel can be either a solid such as coal or wood; a liquid such as fuel oil; or a gas such as natural gas.

An operator should understand the fuels and their characteristics, advantages and disadvantages. Each fuel has unique qualities that should be fully understood if efficient heat yields are to be obtained from the combustion of the fuel.

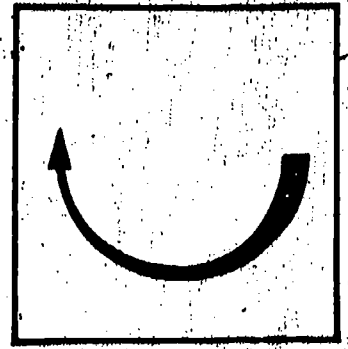

# Information

Fuels are substances that will produce combustion when mixed with oxygen. Many types of fuel are used to operate power plants. The common fuels are:

1. Coal
2. Fuel oil
3. Natural gas
4. Wood

## Coal

Coal is made up of fixed carbon and volatile matter. The volatile matter portion of coal is made up of hydrocarbons that convert to gas form when heated. The portion of coal that is left after the volatile matter is passed off is called fixed carbon. Coals are divided into classes according to their content of fixed carbon and volatile matter.

1. Anthracite — a shiny, hard coal with a high percentage of fixed carbon (92%) and a low percentage of volatile matter (8%).
2. Semianthracite — a dark grey colored coal with 86 to 92% fixed carbon and 8 - 14% volatile matter.
3. Bituminous — a black to dark brown coal that are best suited for power plant fuel. The supply is plentiful and cost is reasonable. The volatile matter content ranges from 14 % to more than 31 %.
4. Sub-bituminous — High moisture content coal which reduces their shipping for power plant fuel.
5. Lignite — Brown colored coal with high moisture and ash content and low heating value. It is not economical to ship lignite long distances.
6. Pulverized Coal — Coal that has been finely ground and can be fed into the furnace with a stream of air. Pulverized coal is utilized by large plants that are located near the coal deposit.

## Fuel Oil

Fuel oil is made from petroleum. It may be of three types.

1. Crude petroleum — as it comes out of the well without processing.



# Information



2. Heavy Oil or Residual Oil -- The residue of crude petroleum after partial refining. Gasoline and other volatile materials have been removed to make it a safer fuel.
3. Light fuel oil -- Residue of petroleum after complete refining.

Fuel oils are designated by grades that range from No. 1, the lightest grade, to No. 6, the heaviest grade. No. 6 fuel oil is the most common to steam generation plants. Fuel oil has many advantages over coal as a fuel. The combustion efficiency is higher; less storage is required; and it requires less labor and equipment.

## Natural Gas

Natural gas is largely methane which is a hydrocarbon with the formula of  $CH_4$ . This means that each molecule of methane is composed of one carbon and four hydrogen atoms that are hooked together like this:

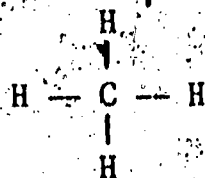

Methane makes up about 77% of natural gas. There is some 6% ethane which is bonded together like this:

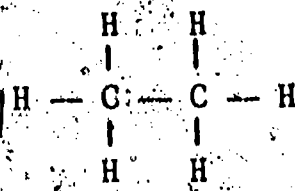

The chemical formula for ethane is  $C_2H_6$  or two carbon atoms and six hydrogen atoms to each molecule.

In addition to methane and ethane, natural gas contains 4% of other hydrocarbons, 7% hydrogen sulfide and 5% carbon dioxide. The sulfur is usually removed from natural gas before it is burned.

Natural gas is the ideal boiler fuel. It does not leave an ash or residue, can be easily mixed with air; and is easy to control. It is more expensive than

# Information

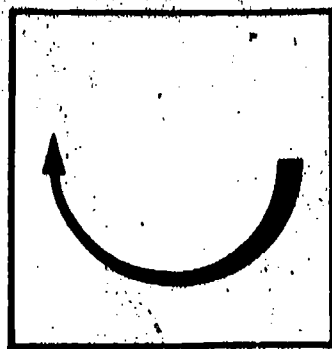

solid fuels and may require long lines to bring it to the plant site.

## Wood

Wood and bark residues can be utilized to fuel boilers. Hogged fuel is wood that has been reduced to small pieces in a machine called a "hog". A typical unit of hogged fuel (200 cubic feet) would contain the following:

- \* Total weight -- 3650 pounds
- \* Dry weight -- 2190 pounds
- \* Water by weight -- 40 percent
- \* Heating value per dry pound -- 9840 BTU
- \* Heating value per unit -- 21, 200, 220 BTU
- \* Ash content -- 1.88 percent

Hogged fuel is classified by species of wood, size, moisture content, ultimate analysis proximate analysis and heating value. The fuel has a high oxygen content which reduces the demands on outside air supply. The sulfur content of hogged fuel is so low that the problems of air pollution are not a risk. The volatile matter content of wood and bark is high (70-90%) and varies between species. Woods with high resin content produce much more heat than low resin woods.

## Ultimate Analyses

Ultimate analyses are used to determine the chemical content of fuels. The amounts (percentages) of hydrogen, carbon, nitrogen and ash in the wood are determined by ultimate analysis. The ultimate analyses for Douglas Fir and Western Hemlock hogged fuel is shown in the following table.

Table 2. Typical Ultimate Analyses Data for Moisture-Free Samples of Hogged Fuel Bark.

Component	Douglas fir (14)	Western hemlock (14)	Avg of 22 samples <sup>1</sup>
	%	%	%
Hydrogen	6.2	5.8	6.1
Carbon	53.0	51.2	51.6
Oxygen	39.3	39.2	41.6
Nitrogen	0.0	0.1	0.1
Ash (inorganics)	1.5	3.7	0.6

<sup>1</sup>These samples were collected and analyzed by Weyerhaeuser Company. They were random samples of hogged fuel taken from various mill sites.

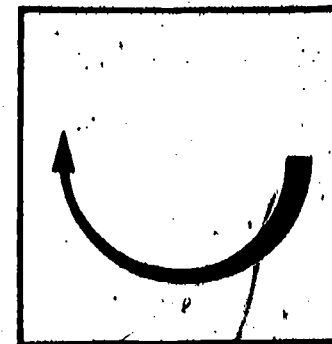

# Information

## Proximate Analyses

Proximate analyses are used to determine the percentages of volatile matter, fixed carbon and ash in a fuel. A proximate analyses of several types of bark and sawdust fuels are shown in the following table.

Table 3. Typical Proximate Analyses of Moisture-Free Wood Fuels (8).

Species	Volatile matter %	Charcoal %	Ash %
<b>BARK</b>			
Hemlock	74.3	24.0	1.7
Douglas fir, old growth	70.6	27.2	2.2
Douglas fir, young growth	73.0	25.8	1.2
Grand fir	74.9	22.6	2.5
White fir	73.4	24.0	2.6
Ponderosa pine	73.4	25.9	0.7
Alder	74.3	23.3	2.4
Redwood	71.3	27.9	0.8
Cedar bark	86.7	13.1	0.2
<b>SAWDUST</b>			
Hemlock	84.8	15.0	0.2
Douglas fir	86.2	13.7	0.1
White fir	84.4	15.1	0.5
Ponderosa pine	87.0	12.8	0.2
Redwood	83.5	16.1	0.4
Cedar	77.0	21.0	2.0

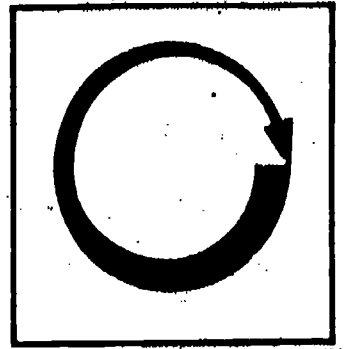

# Assignment

- \* Complete self-assessment and check answers with the answer sheet.
- \* Complete post-assessment and have instructor check your answers.

# Self Assessment

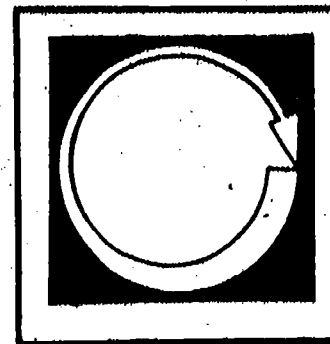

Match the words and phrases.

\_\_\_ 1. Volatile matter

\_\_\_ 2. Fixed carbon

\_\_\_ 3. Anthracite

\_\_\_ 4. Pulverized coal

\_\_\_ 5. Bituminous

\_\_\_ 6. Crude petroleum

\_\_\_ 7. Heavy oil

\_\_\_ 8. Light fuel oil

\_\_\_ 9. Methane

\_\_\_ 10. Wood fuel

A. Shiny, hard coal with high level of fixed carbon.

B. Oil as it comes out of the ground.

C. Oil that has had complete distillation.

D. Makes up 77% of natural gas.

E. Fed into furnace by air stream.

F. Low in sulfur content.

G. Portion of fuel left after volatile matter is passed off.

H. Type of coal that is best suited as power plant fuel.

I. Oil that has had partial distillation.

J. Converts to gas when heated.

# Self Assessment Answers



J 1.

G 2.

A 3.

E 4.

H 5.

B 6.

I 7.

C 8.

D 9.

F 10.

# Post Assessment

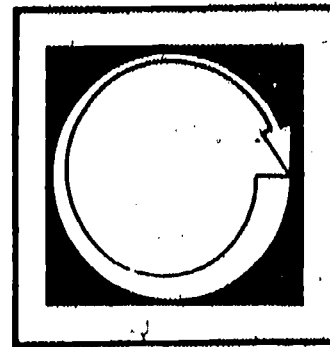

1. Coal is made up of fixed carbon and \_\_\_\_\_.
2. Anthracite has 92% fixed carbon and 8% \_\_\_\_\_.
3. List three types of fuel oil that can be used as furnace fuel.
4. The grades of fuel oil range from No. 1 to No. \_\_\_\_\_.
5. What does the following chemical formula represent?

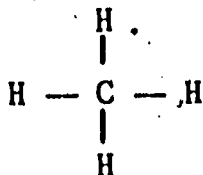

6. Natural gas is made up of 77% \_\_\_\_\_ 6% \_\_\_\_\_  
4% of other hydrocarbons, 7% hydrogen sulfide and 5% carbon dioxide.
7. Describe the ash problem with natural gas fuel.
8. A \_\_\_\_\_ analysis determines the chemical composition of a fuel.
9. A \_\_\_\_\_ analysis determines the percentage of volatile matter, fixed carbon and ash in a fuel.
10. Is sulphur a big problem in wood fuels?

# Instructor Post Assessment Answers

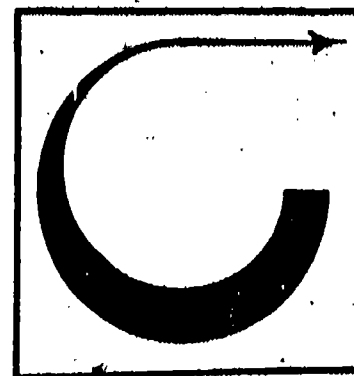

1. Volatile matter
2. Volatile matter
3. Crude petroleum, heavy oil, light fuel oil
4. No. 6
5. Methane
6. Methane, Ethane
7. There is no ash problem.
8. Ultimate analysis
9. Proximate analysis
10. No



# Supplementary References

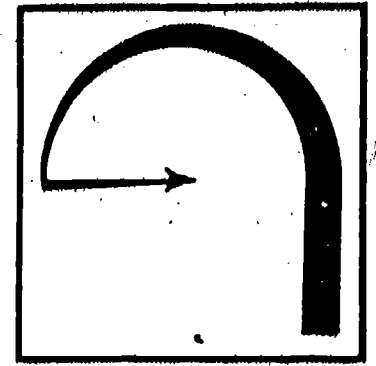

- \* Research Bulletin 17. Boilers fired with Wood and Bark Residues. David C. Junge. Forest Research Laboratory. Oregon State University. 1975.
- \* Correspondence Course. Fuels and Combustion. Second Class, Lecture 5, Section 2. Southern Alberta Institute of Technology. Calgary, Alberta, Canada.

# Boilers Fired with Wood and Biomass Residues

David C. Junge

Research Bulletin 17

November 1975

**BOILERS FIRED WITH WOOD AND BARK RESIDUES**

**David C. Junge, Ph.D.**  
*Research Associate*  
*Department of Mechanical Engineering*  
*and Research Coordinator*  
*Office of Energy Research and Development*  
*Oregon State University*

Research Bulletin 17  
November 1975

Forest Research Laboratory  
- School of Forestry  
Oregon State University  
Corvallis, Oregon 97331

*in cooperation with*

Plywood Research Foundation  
1119 A Street  
Tacoma, Washington 98401

## FOREWORD

This book is not written as a "how-to" book. Rather, it is written to increase the understanding of systems and processes in operating boilers with wood and bark fuels. Emphasis is on the importance of completing the combustion reaction to minimize pollutant emissions.

The material presented grew out of a series of lecture notes. It encompasses the author's personal experience in the field, information found in a variety of publications, and considerable information from on-the-job operators, powerhouse superintendents, and engineers. Although the primary objective was to write a book that would be useful to operators, experience has shown that the information contained also may be of value to managers and engineers concerned with powerhouse operations.

The operation of boilers fired with wood and bark residues can have several goals. Included are the need to generate low-cost steam on a reliable basis that meets stringent emission standards, the desire to obtain high thermal efficiency, and the goal of burning large volumes of waste materials to minimize difficulties in solid-waste disposal.

To meet these objectives, both the system and the operator must function properly. Sufficient equipment must be available to prepare and transport fuel, complete the combustion reaction, generate high-quality steam in response to demand, and clean the exhaust gas stream to meet emission standards. Not only does this require sufficient equipment, it requires that the equipment be well maintained. Plugged, broken, dirty, uncalibrated, or unlubricated equipment prevents the system from doing its job.

Operator skills are equally important. Even the best equipped and maintained systems will not function optimally if the operators are uninformed or misinformed. The purpose of this book is to upgrade the skills of operators of hogged fuel boilers. Subject matter was selected in combustion systems, characteristics of wood- and bark-residue fuels, principles of combustion, factors affecting combustion of hogged fuel, monitoring equipment, combustion control equipment, pollution control devices, measurement of pollutant emissions, and regulations pertaining to emissions from boilers fired with hogged fuel. Emphasis is placed on the importance of completing the combustion reaction as a means of minimizing pollutant emissions.

## ACKNOWLEDGEMENT

This publication was made possible by support from the Plywood Research Foundation, for whose help we are grateful.

## CONTENTS

	Page
FOREWORD	ii
ACKNOWLEDGMENTS	ii
1. COMBUSTION SYSTEMS FOR WOOD- AND BARK-FIRED BOILERS	1
Furnace Designs	2
Fire-Tube and Water-Tube Heat Exchangers	4
Size of Boiler	4
2. CHARACTERISTICS OF FUELS FROM WOOD AND BARK RESIDUES	7
Species	7
Size	7
Moisture Content	7
Ultimate Analyses	8
Proximate Analyses	8
Heating Value	9
3. PRINCIPLES OF COMBUSTION	11
Characteristics of Combustion	11
Chemistry of the Combustion Process	12
Atoms and Molecules	12
Combustion of Wood	13
Excess Air	14
Primary Products of Combustion	14
Other Products of Combustion	17
Summary of Reactants and Products of Combustion	17
4. FACTORS AFFECTING THE COMBUSTION OF HOGGED FUEL	19
Fuel-Related Factors	19
Air-Related Factors	26
Other Factors	29
3. MONITORING EQUIPMENT	31
Fuel Monitors	31
Air Monitors	31
Exhaust Gas Monitoring	32
6. COMBUSTION CONTROL SYSTEMS	35
Fuel-Related Combustion Controls	35
Air-Related Combustion Controls	40
7. POLLUTION CONTROL DEVICES	45
Particle Characteristics	45
Cyclone Separators	46
Multiple Cyclones	48
Scrubbers	49
Baghouse Filters	51
Electrostatic Precipitators	51

8. MEASUREMENT OF AIR POLLUTANT EMISSIONS	53
Opacity Measurement	53
Concentration of Particulate Matter and Mass-Emission Rate	53
Particle Size Measurement	54
9. REGULATIONS PERTAINING TO EMISSIONS FROM BOILERS FIRED WITH HOGGED FUEL	55
Opacity Standards	55
Concentration of Particulate Matter	55
Mass-Emission Rates	56
Size of Particulate Matter	56
Nuisance Regulations	56
Emission of Sulfur Dioxide	57
LITERATURE CITED	59

## 1. COMBUSTION SYSTEMS FOR WOOD AND BARK-FIRED BOILERS

Wood and bark residues can be burned with ease and little or no equipment. This is demonstrated by the classic campfire. You need only start a small fire with dry scraps or twigs and pile the wood properly to enjoy a cheery blaze.

Utilizing wood fuel in this manner is enjoyable, but has drawbacks. First, most of the heat escapes with the exhaust gases. Second, campfires smoke.

To take full advantage of the heating value of wood and bark fuel and yet control the smoke, a complex system for combustion and heat exchange is necessary. These systems, referred to as "boilers," have many components, which include systems to prepare, store, transport, and feed the fuel; systems to heat, transport, and control the flow of air for combustion; a furnace for combustion; a heat exchanger system to transfer available heat from the combustion process to heat energy in steam; control devices to limit emissions of air pollutants; a feed-water treatment system to control foaming, minimize scale formation and sedimentation, and provide a continuous flow of deaerated water to the steam generating system; and systems to monitor and control interrelated processes.

There are many variations in equipment used on boilers. One typical arrangement is shown schematically in Figure 1. Important variations are discussed.

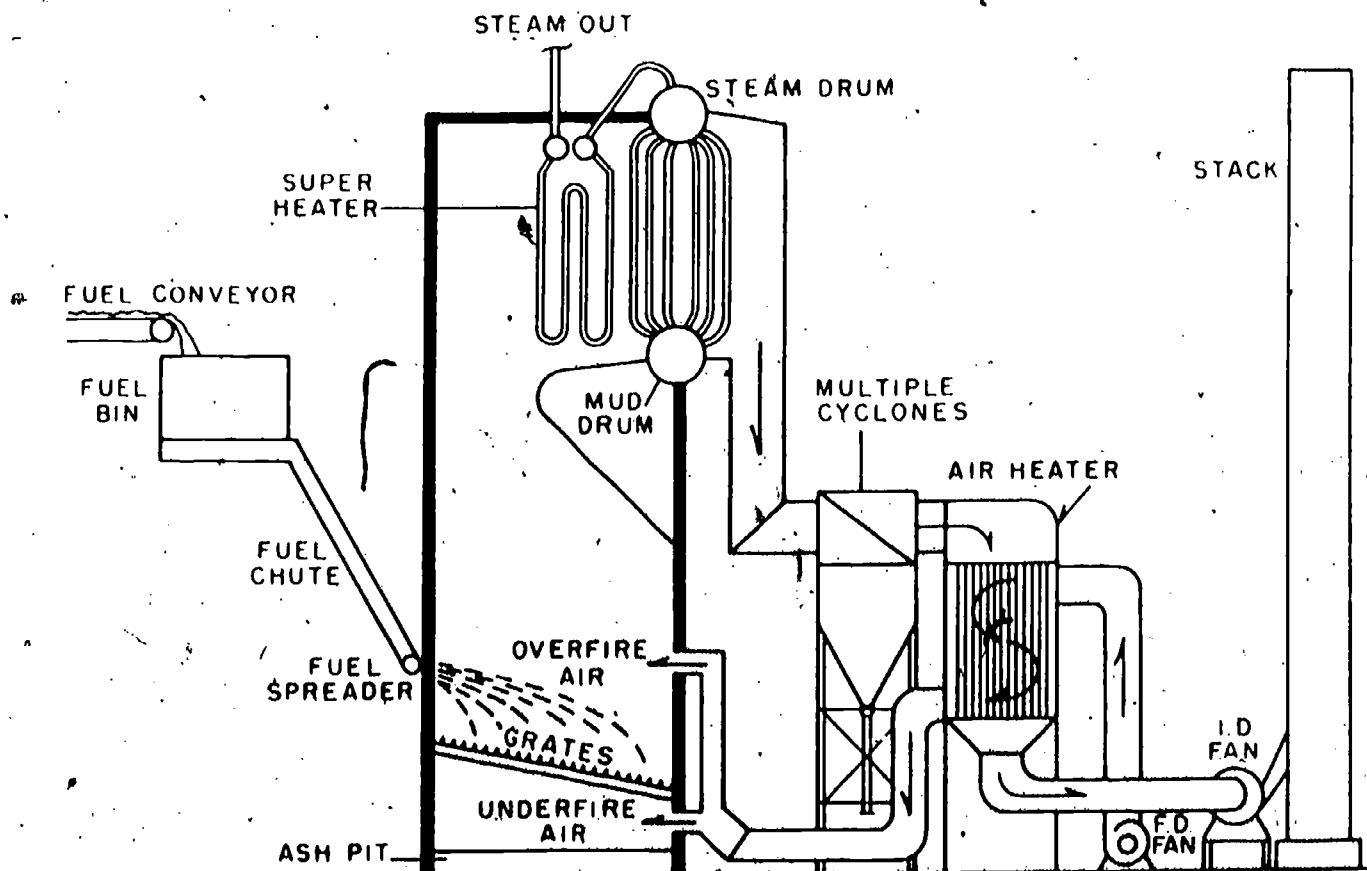

**BASIC COMPONENTS OF A BOILER**

Figure 1. Typical basic components of a boiler.

## Furnace Designs

Three basic classes of furnace design are commonly used for wood firing: Dutch ovens, spreader stokers, and suspension burners.

### Dutch Ovens

The Dutch oven design was the standard up until the late 1940's and early 1950's (Figure 2). It is primarily a large, rectangular box, lined on the sides and top with firebrick (refractory). Heat is stored in the refractory and radiated to the conical fuel pile in the center of the furnace. This aids in driving moisture from the fuel and evaporating the organic materials. The refractory may be water cooled to minimize the damage to the furnace from high temperatures.

The fuel pile rests on a grate. Underfire air is fed through the grates. Overfire air is fed in around the sides of the fuel pile. By design, incomplete combustion is intended to occur in the Dutch oven or primary furnace. Combustion products pass between bridge wall and drop-nose arch into the secondary furnace chamber, where combustion is completed before gases enter the heat exchange section.

This furnace design has a large mass of refractory, which helps to maintain uniform temperatures in the furnace region. This aids in stabilizing combustion rates, but results in slow response to fluctuating demands for steam. The system works well, if it is not fired at high combustion rates and if the steam load is fairly constant. With this design, however, the underfire airflow rate is dependent upon height and density of the fuel pile on the grates. When the fuel pile is wet and deep, the underfire airflow is low. Thus, the fire may be deficient in oxygen. As the fuel dries and the pile burns down, the flow rate increases as the pressure drop through the fuel pile decreases. This brings about an excess of air in the furnace. For fluctuating steam loads, the result is continuous change from insufficient air to excess air. This feature, coupled with slow response, high cost of construction, and high costs of refractory maintenance, resulted in phasing out Dutch oven designs.

A variation of the Dutch oven design is the fuel cell. Fuel cells usually incorporate a primary and a secondary combustion chamber (Figure 3). The primary combustion chamber is a vertical, refractory-lined cylinder with a grate at the bot-

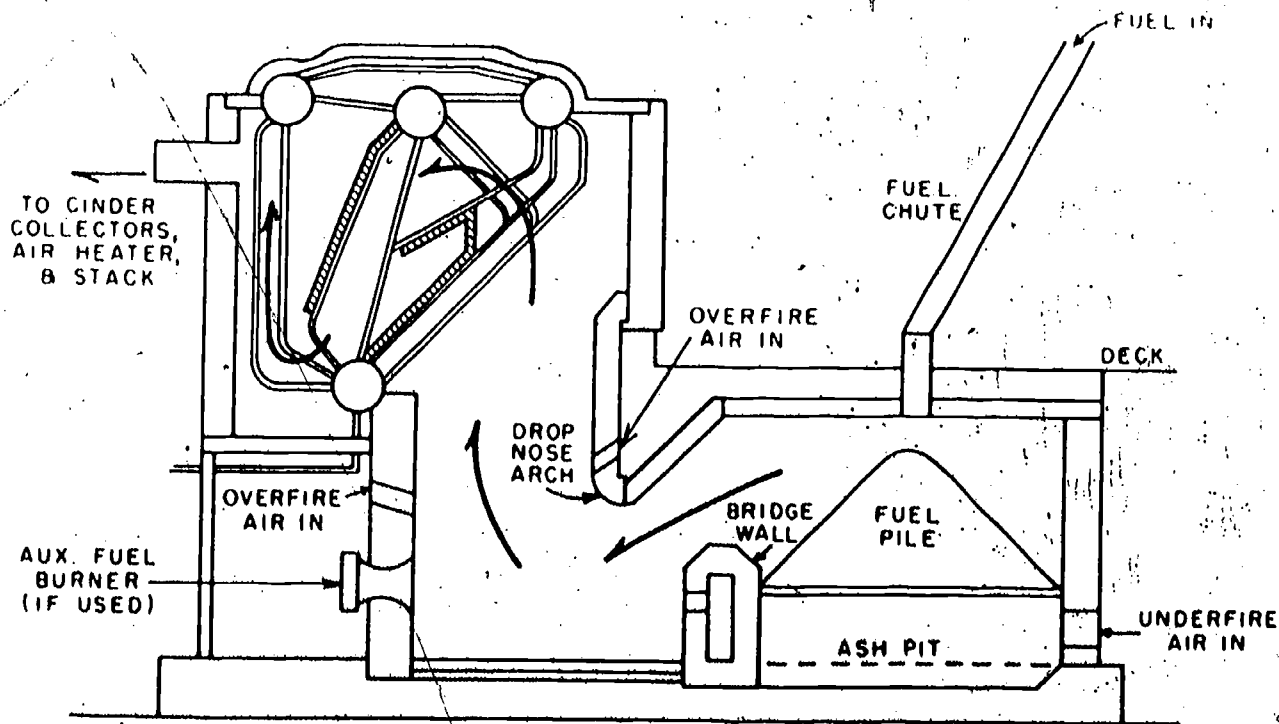

Figure 2. Dutch oven furnace and boiler.



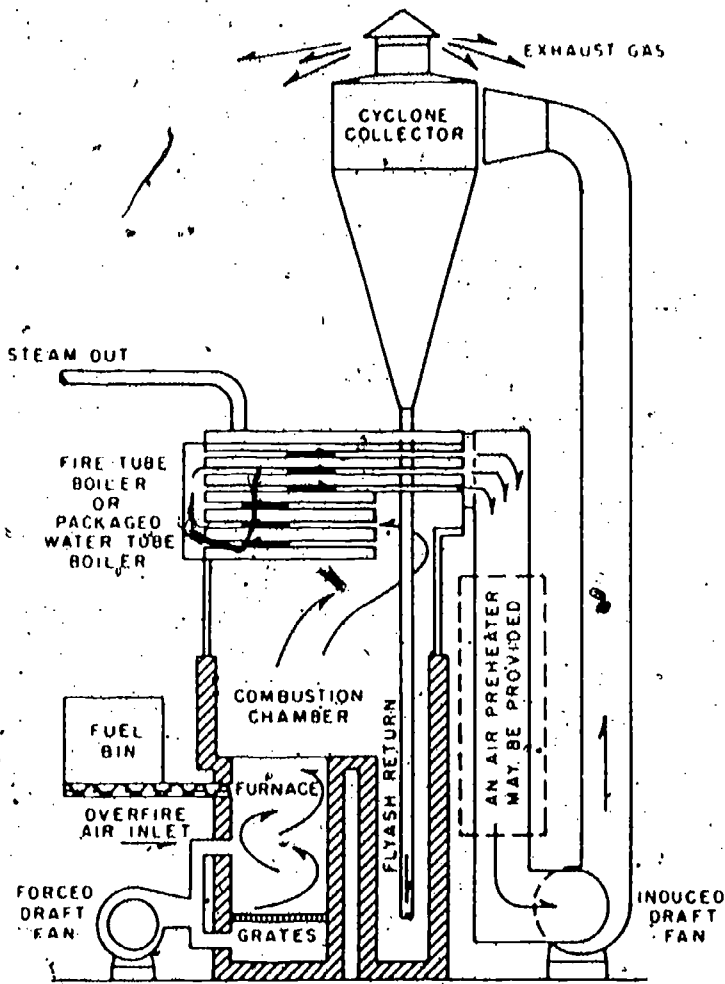

Figure 3. Fuel cell furnace system.

tom. Fuel is fed into the cell and drops to the grate or is fed from an undergrate stoker. Air is fed through the grate, and the combustion is partially completed in the cell. Heat is radiated to the fuel pile from the hot refractory. Combustion is completed in the secondary combustion chamber.

**Spreader Stokers**

In spreader-stoker furnaces (Figure 4), fuel is spread pneumatically or mechanically across the furnace. Part of it burns in suspension, but large pieces fall on a grate. The feed system is designed to spread an even, thin bed of fuel on the grates. The flame over the grates radiates heat back to the fuel to aid combustion. Underfire air can be controlled, because the pressure drop through the fuel mat is fairly constant.

Spreader-stoker furnace walls normally are lined with heat exchange tubes (water walls). As there is little refractory, construction and maintenance costs are low. For a given steam-generation capacity, spreader stokers are substantially smaller than Dutch ovens. Also, they can respond to load variations quickly and with less upset in the combustion process. With little or no refractory to reflect heat back to the fuel, heated combustion air is normally used.

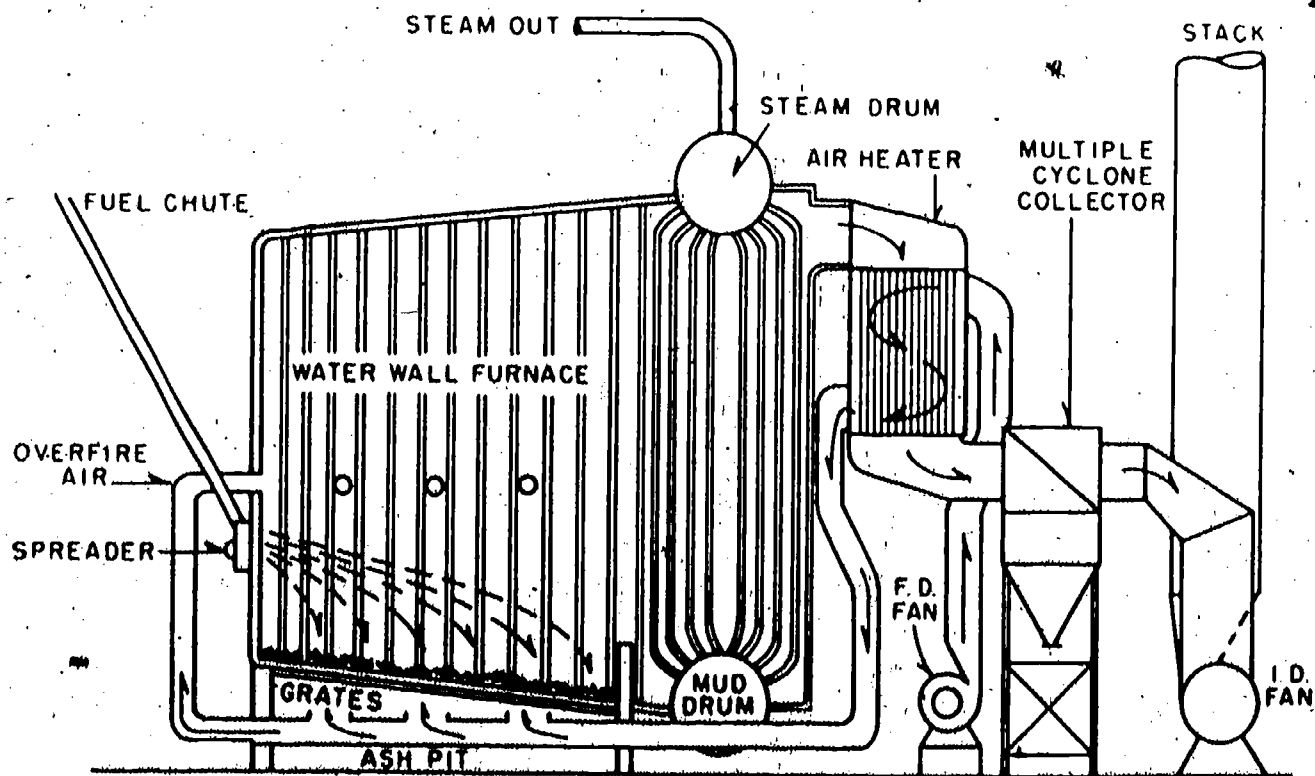

Figure 4. Small spreader-stoker furnace.

### Suspension Burning Systems

Fuel in small sizes can be burned in suspension, that is, supported by air rather than by fixed metal grates. Sanderdust usually is burned in this manner. With adequate reduction in size, wood and bark residues also can be burned in suspension. The advantages of suspension burning include low capital costs for combustion equipment because grates are not required, and ease of operation, as grate cleaning is not necessary. The ash goes into suspension as particulate matter in the exhaust stream or falls to the furnace bottom for removal, and rapid changes in rate of combustion are possible.

Suspension burning has disadvantages, however. Because most of the ash escapes with the exhaust gases, control of fly ash may be difficult.<sup>1</sup> Temperature control in the combustion chamber is critical. If the ash-fusion temperature is exceeded, the ash may form large pieces, which can plug or damage the system. Fuel preparation must be extensive to assure fuel size small enough for suspension burning. Moisture content also must be controlled within reasonable limits. This can be costly for systems burning wood and bark fuels. For sanderdust fuel, the processing already is done. Residence time is critical (as in any combustion system). The nature of suspension burning incorporates short residence. At high combustion rates, it may be insufficient for the process to go to completion.

Suspension burning systems range from simple sanderdust burners mounted in an existing furnace to especially designed furnaces, coupled to extensive systems for fuel preparation. Some systems incorporate cyclones in the suspension process. Recent developments in combustion systems use fluidized beds as suspension systems. These offer great potential for control of the combustion process as well as control of emissions. Only a few fluidized beds are used currently, but they are expected to become more common during the next decade, especially for low-capacity units.

<sup>1</sup>Some suspension units are designed to "slag" or melt the ash in the combustion chamber, thus reducing the amount of ash entrained in the exhaust-gas stream.

### Variations in Grate Designs

Within the categories of Dutch ovens and spreader stokers, the grate systems may vary substantially. They may be categorized as fixed or dumping grates; air-cooled or water-cooled grates; flat or inclined grates; stationary grates, continuously moving chain grates, reciprocating grates; or grates with large area for gas passage, such as "herringbone" rather than pinhole designs. Design of a particular grate system takes into account such factors as fuel size, moisture content, available heat, maximum rate of steam generation of the boiler, and acceptable level of maintenance. Many of the differences, however, reflect the product line of particular manufacturers.

### Fire-Tube and Water-Tube Heat Exchangers

In boilers, the purpose of a heat exchanger is to transfer heat energy released by the combustion process to heat energy delivered in steam. This is done two ways. In the water tube boiler, the most commonly used, water is put into tubes and hot combustion gases pass around the outside of the tubes (Figure 2). In the fire tube boiler, hot gases pass through the tubes and water circulates around the outside (Figure 3). With this design, hot gases can travel through the tubes in turbulent flow patterns, which increases the rate of heat exchange to the water and makes the design very efficient. The design is pressure limited because of high mechanical stresses placed on the drum by its inherent features. Fire tube boilers are seldom larger than 15,000 pounds per hour (pph) in capacity.

In 1973 in Oregon, there were 56 fire tube and 185 water tube boilers fired with residue wood and bark fuels. Together, they consumed 5 million units (one unit equals 200 cubic feet) of fuel in that year (11).

### Size of Boilers

Boilers are measured by their capacity to generate steam. Several measurement systems are used, of which two are particularly important in referring to wood- and bark-fired boilers. The first is boiler horsepower (bhp), which is the rate at

which the boiler can evaporate water at 212 F to saturated steam at 212 F. For example, 1 bhp = 34.5 pounds of water evaporated per hour. A typical boiler might be rated at 700 bhp. It was designed to generate steam at a rate of  $34.5 \times 700 = 24,150$  pph at atmospheric pressure. The system rating above atmospheric pressure would be less than 24,150 pph.

A more exact rating system refers to the design steam generation rate at a particular temperature and pressure. For example, a typical boiler might have a capacity of 50,000 pph at 165 pounds per square inch absolute (psia) at 366 F.

The advantage of specifying temperature and pressure is that it tells you how much energy is available in the steam. Reference to a steam table provides information on the energy in terms of British thermal units (Btu).

Wood- and bark-fired boilers have a wide range in capacity. The smallest units are hand fired and produce less than 1,000 pph of low-pressure steam. At the other end of the scale, boilers are operating with capacities of 450,000 pph. New boilers are designed as large as 800,000 pph. Most commonly, industrial wood- and bark-fired boilers range from 20,000 to 150,000 pph.

## 2. CHARACTERISTICS OF FUELS FROM WOOD AND BARK RESIDUES

Wood and bark prepared for firing a boiler are commonly referred to as hogged fuel. The term stems from the machine used to reduce the size of residues. The machine is called a hog.

Hogged fuel is measured commonly in quantities of 200 cubic feet, called "units." In any given unit, characteristics of the fuel may vary substantially. A typical unit of fuel, however, may have the following characteristics (3): total weight = 3,650 pounds, dry weight = 2,190 pounds, water by weight = 40 percent, heating value per dry pound = 9,840 Btu, heating value per unit = 21,200,220 Btu, and ash content = 1.88 percent.

Hogged fuel can be classified or characterized by species, size, moisture content, ultimate analyses, proximate analyses, and heating value. The influence of these parameters is discussed in Chapter 4, and their control is examined in Chapter 6.

Table 1. Approximate Range in Size and Moisture Content of Typical Components of Hogged Fuel (14).

Component	Size range	Moisture content
	In.	%
Bark	1/32-4	25-75
Coarse wood residues	1/32-4	30-60
Planer shavings	1/32-1/2	16-40 <sup>2</sup>
Sawdust	1/32-3/8	25-40
Sanderdust	2 $\mu$ <sup>1</sup> -1/32	2-8
Reject "Mat Furnish"	10 $\mu$ <sup>1</sup> -1/4	4-8

<sup>1</sup>Small end of the range is measured in microns (One micron = 1/1,000,000 meter).

<sup>2</sup>From kiln dried to green.

### Species

Many species of wood are available for hogged fuel. Some commonly used species in the Pacific Northwest include Douglas fir, true firs, alder, ponderosa pine, western hemlock, spruces, larch, cedars, and redwood. The differences between species that affect their efficiency as hogged fuel are found in heating values and in material handling.

Cedar bark is infamous as fuel because of problems with hogging and transporting. The bark is long and "stringy" and difficult to reduce in size in a hog. It tends to plug feeder systems, wrap up in conveyors, and present difficult handling problems. By comparison, most other commonly used species are less difficult to handle.

### Size

The size of hogged fuel depends on the material that makes up the fuel. A typical sample of hogged fuel might include a combination of bark, coarse wood residues (slabs, trimmings, and endpieces), planer shavings, sawdust, sanderdust, and reject "mat furnish." Each of these component parts has recognizable size characteristics (Table 1).

### Moisture Content

There are two ways to describe the moisture content of fuel; the wet or "as is" basis, and the dry basis. The wet basis is more commonly used. For wet-basis determinations, the weight of moisture in fuel is divided by the total weight of fuel plus moisture, and the answer is expressed as a

percentage. Therefore, moisture content (wet basis) = (weight of moisture x 100)/(weight of dry fuel + weight of moisture).

The relation between moisture contents (MC) expressed on a wet and a dry basis is found easily from the following equations:

$$MC \text{ (wet)} = 100 \times MC \text{ (dry)} / [100 + MC \text{ (dry)}], \text{ and}$$

$$MC \text{ (dry)} = 100 \times MC \text{ (wet)} / [100 - MC \text{ (wet)}],$$

where moisture content is expressed as a percentage on either a wet or dry basis. The wet basis will be used in this work.

Moisture content is significant for two reasons. First, it varies over a wide range of values and, therefore, makes control of the combustion process difficult. For example, consider MC of the different components of hogged fuel. Bark, coarse wood residue, and sawdust normally have a moisture range from 30 to 65 percent. The average value is around 45 percent. This is dependent, however, upon the time of year, the type of wood (species), and the process used at a particular mill. On the other hand, kiln-dried planer shavings, sanderdust, and some rejected mat-furnish materials usually have low MC from 4 to 16 percent. Table 1 summarizes typical MC for the normal components of hogged fuel.

The second significant feature of moisture content is that it has negative heating value; that is, heat is needed to evaporate it.

### Ultimate Analyses

Ultimate analyses are used to determine the chemical composition of fuels. The primary components of hogged fuel include those shown in Table 2. Ultimate analyses point out three significant features of hogged fuel. First, there is only a small variation from sample to sample. This is important in calculating and controlling excess air for combustion.

Second, hogged fuel has a high oxygen content. This is significant because less oxygen has to be supplied from air to complete the combustion process.

Third, the sulfur content of hogged fuel is so low that sulfur dioxide from combustion of hogged fuel does not present a risk of air pollution. Combustion of sulfur-bearing coals or oil results in significant emissions of sulfur dioxide.

### Proximate Analyses

Proximate analyses of fuels are used to determine the percentage of volatile material, fixed carbon, and ash.

Some typical proximate analyses of wood fuels are shown in Table 3. Note the consistent difference in volatile content of bark compared to that of sawdust, regardless of species except for cedar. In general, volatile content of wood is 10 percent higher than that of bark.

The ash content of wood residues is generally low, but still significant where large quantities are

Table 2. Typical Ultimate Analyses Data for Moisture-Free Samples of Hogged Fuel Bark.

Component	Douglas fir (14)	Western hemlock (14)	Avg of 22 samples <sup>1</sup>
	%	%	%
Hydrogen	6.2	5.8	6.1
Carbon	53.0	51.2	51.6
Oxygen	39.3	39.2	41.6
Nitrogen	0.0	0.1	0.1
Ash (inorganics)	1.5	3.7	0.6

<sup>1</sup>These samples were collected and analyzed by Weyerhaeuser Company. They were random samples of hogged fuel taken from various mill sites.

Table 3. Typical Proximate Analyses of Moisture-Free Wood Fuels (8).

Species	Volatile matter	Charcoal	Ash
	%	%	%
<b>BARK</b>			
Hemlock	74.3	24.0	1.7
Douglas fir, old growth	70.6	27.2	2.2
Douglas fir, young growth	73.0	25.8	1.2
Grand fir	74.9	22.6	2.5
White fir	73.4	24.0	2.6
Ponderosa pine	73.4	25.9	0.7
Alder	74.3	23.3	2.4
Redwood	71.3	27.9	0.8
Cedar bark	86.7	13.1	0.2
<b>SANDUST</b>			
Hemlock	84.8	15.0	0.2
Douglas fir	86.2	13.7	0.1
White fir	84.4	15.1	0.5
Ponderosa pine	87.0	12.8	0.2
Redwood	83.5	16.1	0.4
Cedar	77.0	21.0	2.0

burned. The ash content of bark usually is greater than that of wood. Handling and harvesting of logs frequently causes dirt and sand to cling to the bark. Saltwater storage and transport of logs also can add to the ash content of fuel by depositing sea salt in the wood or bark.

#### Heating Value

The heating value of hogged fuel is dependent upon two components of fuel, fiber and resin (4). Wood fiber has a heat value of about 8,300 Btu per pound. Resin has a heating value of 16,900 Btu per pound. Woods with more resin, therefore, have higher heating values than those with low resin contents.

Bark generally has more resin than is in wood. Softwood bark generally has more resin than

hardwood bark. Some typical heating values are shown in Table 4.

Table 4. Typical Heating Values in Btu's Per Pound for Moisture-Free Bark and Wood (8).

Species	Heating value	
	Wood	Bark
Douglas fir	9,200	10,100
Douglas fir	8,800	10,100
Western hemlock	8,500	9,800
Ponderosa pine	9,100	---
Western redcedar	9,700	8,700
Red alder	8,000	8,410

### 3. PRINCIPLES OF COMBUSTION

When wood burns, it undergoes a complex process called combustion that includes both physical and chemical reactions. These will be examined as we define the characteristics of combustion.

#### Characteristics of Combustion

Combustion is both an oxidation and a reduction process in which the fuel is oxidized by oxygen from the air and the oxygen in the air is reduced by the constituents of the fuel. We recognize that to burn hogged fuel, oxygen from the air is necessary.

The concentration of oxygen available for combustion is important in controlling the rate of burning. If pure oxygen is fed into a furnace, the material will be consumed much more rapidly than with normal air. This seldom concerns the operation of hogged-fuel boilers, except in those few installations where primary or secondary air is recirculated from a combustion-exhaust system. Then oxygen concentration is reduced, which slows the rate of combustion or the rate at which the wood burns.

Combustion is an exothermic process that emits or releases heat. The amount of heat emitted as a fuel is burned can be determined precisely. For example, heat released from combustion of Douglas-fir bark (Table 4) is about 10,100 Btu per pound of dry material.

Combustion is a rapid process. Oxidation of materials can occur over a wide range of rates. At one extreme is the oxidation of paint on your automobile. Normally, this is a slow process that occurs over many months. Comparatively speaking, oxidation in the combustion of hogged fuel is rapid. Depending upon the size of the furnace, many tons of fuel can be consumed in an hour.

Combustion occurs in the gaseous phase. Matter can exist as a solid, a liquid, or a gas. For most fuels, combustion can occur only when they are in the gaseous form. The important exception to this is carbon, which can burn in the solid phase.

In combustion, fuels are heated to a temperature high enough to drive off the water in the fuel as water vapor, to decompose the fuel, and to evaporate the volatile component of the fuel. As a gas, fuel can mix thoroughly with gaseous molecules of oxygen in the air. As each molecule of fuel

contacts the appropriate number of molecules of oxygen, a chemical reaction can occur between fuel and oxygen. But in the burning of charcoal briquets, oxygen can reach the surface of the fuel and cause it to glow as combustion occurs.

Combustion is a complex of both physical and chemical reactions. Steps in the burning of hogged fuel are:

**Dehydration**, a physical process, in which fuel is heated to the point where the water evaporates; **evaporation**, a physical process, in which volatile components of the wood are heated, usually between 200 F and 1,100 F, until they change from the solid into the gaseous phase; **pyrolysis**, a chemical decomposition of the original molecules into other molecular species because of high temperature; **mixing** of fuel molecules with oxygen molecules, a physical process that occurs as soon as the fuel is evaporated and comes into contact with the combustion air; and **oxidation and reduction**, a process of chemical reaction in which original reactants disappear to form new chemical substances and heat and light are emitted.

**Light**, which usually is emitted in the combustion process, is dependent upon the type of fuel that is used. Most fuels will burn with visible flame. A hydrogen flame is not easily visible, however. A flame from wood fuels is always apparent during combustion.

Combustion is a free radical reaction. In the two processes, pyrolysis and oxidation-reduction, the molecules of fuel are thought to break apart to form independent, charged ions, referred to as "free radicals." Although this characteristic is significant in the control of some combustion processes, it is not important to combustion of wood and bark residues.

A summary statement might be that combustion is a complex physical-chemical reaction that occurs primarily in the gaseous phase.

## Chemistry of the Combustion Process

Although combustion is a complex physical and chemical process, it can be viewed as two simple reactions for the purpose of combustion calculations. First, carbon (C) combines with oxygen (O<sub>2</sub>) to form carbon dioxide (CO<sub>2</sub>):

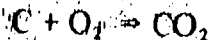

Second, hydrogen (H) combines with O<sub>2</sub> to form water (H<sub>2</sub>O):

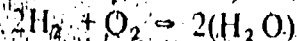

In this chapter, we will consider these basic chemical reactions and demonstrate how much oxygen is required to bring the reactions to completion. In doing this, we will introduce the concept of excess air and discuss its measurement.

### Atoms and Molecules

All things in the world are made up of atoms and molecules. Atoms are basic forms of all substances. If we reduce elements such as carbon, hydrogen, lead, gold, or sodium down to their smallest units, we find atoms.

Molecules consist of one or more atoms. Some molecules consist of the same kind of atoms, some of different kinds of atoms. Oxygen, as we know it in air, is in a molecular form of two atoms of oxygen, expressed symbolically as O<sub>2</sub>. Carbon dioxide molecules, CO<sub>2</sub>, have one atom of carbon and two atoms of oxygen.

An important characteristic of atoms is that they have weight, referred to as atomic weight. Carbon atoms always have the same relative weight, which equals 12. The atomic weights of molecules and other atoms that are important in the combustion of hogged fuel are listed in Table 5. Materials such as hydrogen, oxygen, and nitro-

gen normally are found in nature as two atoms that form a molecule of the substance.

The concept of a "pound mole" is helpful in quantifying chemical reactions. A pound mole of a substance is the same as the molecular weight of that substance, expressed in pounds. For example, a pound mole of carbon is 12 pounds of carbon. A pound mole of oxygen is 32 pounds of oxygen. A pound mole of hydrogen is 2 pounds of hydrogen.

Pound moles have two important features. First, when chemicals undergo chemical reactions, the proportions of materials in the reaction usually are expressed simply in terms of pound moles. For example, when carbon combines with oxygen to form carbon dioxide,

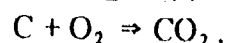
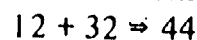

12 pounds of carbon combine with 32 pounds of oxygen to form 44 pounds of carbon dioxide. In terms of pound moles, 1 pound mole of carbon combines with 1 pound mole of oxygen to give 1 pound mole of carbon dioxide.

As a second example, when hydrogen combines with oxygen to form water (H<sub>2</sub>O),

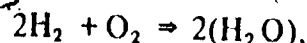
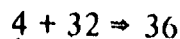
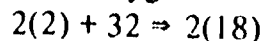

4 pounds of hydrogen combine with 32 pounds of oxygen to form 36 pounds of water. As pound moles, two pound moles of hydrogen plus 1 pound mole of oxygen give 2 pound moles of water. To express the amounts of materials in a reaction by the simple numbers of pound moles is helpful.

A second important feature of pound moles is that for gases, a pound mole always takes up the same volume under standard conditions of temper-

Table 5. Atomic and Molecular Weights of Typical Elements in the Combustion of Hogged Fuel.

Element	Atom symbol	Atomic weight	Molecule symbol	Molecular weight
Carbon	C	12	C	12
Hydrogen	H	1	H <sub>2</sub>	2
Oxygen	O	16	O <sub>2</sub>	32
Nitrogen	N	14	N <sub>2</sub>	28



ature and pressure. One pound mole of oxygen occupies a volume of 359 standard cubic feet (SCF). One pound mole of hydrogen also occupies 359 cubic feet. Similarly, one pound mole of nitrogen (N) (28 actual pounds) takes up 359 cubic feet under standard conditions of temperature and pressure, defined as 32 F and 29.92 inches of mercury (or 14.7 pounds per square inch absolute) in this instance. This information helps to determine the volume of oxygen required to burn a given weight of hogged fuel. It also helps in determining the volume of air required to obtain oxygen for combustion.

### Combustion of Wood

Let us look at the combustion of hogged fuel from a chemical-analysis viewpoint. Under the section in Chapter 2 on ultimate analyses of hogged fuel, we found little variation in the chemical composition of samples of hogged fuel. Table 2 lists data from typical analyses by weight as hydrogen, 6.1; carbon, 51.6; oxygen, 41.6; nitrogen, 0.1; and ash, 0.6 percent.

To relate this information to a practical example, consider that you have 100 pounds of dry hogged fuel with these chemical proportions. Water in hogged fuel does not undergo any chemical change in the combustion process. It simply becomes water vapor. Now, we can look at the fuel in terms of the pounds of different chemical substances in it. For example, 100 pounds of dry hogged fuel equals 51.6 pounds of carbon, 6.1 pounds of hydrogen, 41.6 pounds of oxygen, 0.1 pound of nitrogen, and 0.6 pound of ash.

Next, we convert these pound measurements of the chemical constituents into pound moles of the different parts of the hogged fuel. For example, 1 pound mole of carbon weighs 12 pounds. The 100-pound sample of hogged fuel contains 51.6 pounds of carbon which, at 12 pounds per pound mole, equal 4.3 pound moles. The 6.1 pounds of hydrogen, at 2 pounds per pound mole, equal 3.05 pound moles. And the 41.6 pounds of oxygen, at 32 pounds per pound mole, equal 1.3 pound moles.

As nitrogen and ash do not participate in the combustion process to any great extent, they will

not be considered here. A summary of the pound moles of material found in 100 pounds of dry hogged fuel is shown in Table 6.

Table 6. Partial Summary of the Amount of Elements Found in 100 Pounds of Dry Hogged Fuel.

Element	Amount	
	Pounds	Pound moles
Carbon	51.6	4.3
Hydrogen	6.1	3.0
Oxygen	41.6	1.3

Two basic reactions occur in the combustion of hogged fuel.

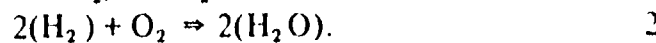

In the first reaction, 1 pound mole of carbon combines with 1 pound mole of oxygen to form 1 pound mole of carbon dioxide. In our example of 100 pounds of hogged fuel, there are 4.3 pound moles of carbon. Therefore, to burn this to completion would require 4.3 pound moles of oxygen.

In the second reaction, 1 pound mole of oxygen is required to burn the 2 pound moles of hydrogen, as seen in equation 2. Therefore, to burn the 3 pound moles of hydrogen in 100 pounds of hogged fuel will require 1.5 pound moles of oxygen.

To burn 4.3 pound moles of carbon, requires 4.3 pound moles of oxygen.

To burn 3.0 pound moles of hydrogen requires 1.5 pound moles of oxygen.

Total oxygen required is 5.8 pound moles.

A 100-pound sample of hogged fuel contains 1.3 pound moles of oxygen as part of the molecular structure of the fuel (Table 6). This oxygen is available for participation in the combustion process.

Total oxygen required to burn fuel is 5.8 pound moles.

Oxygen available from the fuel itself is 1.3 pound moles.

Oxygen that must be supplied from air is 4.5 pound moles.

We can readily convert this amount back into terms that are easier to visualize. Recall that 1 pound mole of any gas takes up exactly 359 cubic feet under standard conditions of temperature and pressure. Thus, 4.5 pound moles of oxygen would occupy 1,616 standard cubic feet ( $359 \times 4.5 = 1,616$ ). As oxygen is roughly 21 percent of the volume of air, the total volume of air required for combustion of 100 pounds of hogged fuel is

$$1,616 \times 100/21 = 7,695 \text{ SCF of air.}$$

This is equal to 617 pounds of air required per 100 pounds of fuel.

#### Excess Air

We have seen the exact amount of air that is required to burn 100 pounds of hogged fuel. In an actual situation, however, some excess air is required for two reasons. First, for combustion to occur, each molecule of gaseous fuel must come into physical contact with one or more molecules of oxygen. To insure this, a few extra molecules of oxygen must be supplied, thus increasing the probability of contact of the molecules. Second, in some furnace designs, excess air is necessary to assist in drying the wet fuel enough for combustion to occur and to properly disperse the fuel on the grates.

Excess air normally is expressed as a percentage of the amount that must be supplied to meet exactly the requirements for combustion. In the example of burning 100 pounds of hogged fuel, we found that 7,695 SCF of air were required. This can be a basis for determining excess air. For example, to calculate the air requirement at 25

percent excess air, we add on 25 percent of 7,695 SCF, or

$$(1 + 0.25) \times 7,695 = 9,619 \text{ SCF.}$$

In the same manner, we can determine the air requirement under conditions of 50, 100, and 150 percent excess air (Table 7).

The effects of excess air on combustion will be discussed later. For the present, we must be aware of the magnitude of the airflow for different percentages of excess air. Each 100 pounds of dry hogged fuel burned requires more than 1,200 pounds of air at 100 percent excess air. Currently, many hogged fuel boilers operate in the range of 150 percent excess air and are using over 1,500 pounds of air per 100 pounds of hogged fuel burned.

#### Primary Products of Combustion

Referring back to Equation 1, we found that carbon in fuel combines with oxygen to form carbon dioxide.

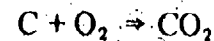

One pound mole of carbon dioxide is formed for each pound mole of carbon and oxygen, and one hundred pounds of hogged fuel contain 4.3 pound-moles of carbon. Therefore, the combustion products will include 4.3 pound moles of carbon dioxide.

Now, consider the components of the combustion products caused by excess air. If the process included no excess air, no oxygen would be in the flue gases. If, however, excess air is provided, the flue gases will contain the excess oxygen that was not used in the combustion process. For

Table 7. Summary of the Combustion Air Requirements to Burn 100 Pounds of Dry Hogged Fuel with Various Percentages of Excess Air.

Excess air	Multiplying factor	Volume of air	Weight of air
		SCF <sup>1</sup>	Pounds
0	1	7,695	617
25	1.25	9,619	771
50	1.50	11,543	926
100	2.00	15,390	1,234
150	2.50	19,238	1,543

<sup>1</sup>SCF: standard cubic feet.

example, if 25 percent excess air is added to the basic air requirement of 7,695 SCF, it is increased by 1,924 SCF of air. This makes a total of 9,619 SCF (Table 7). When the additional 1,924 SCF are added, 21 percent of it is oxygen. Therefore,  $0.21 \times 1,924 = 404$  SCF of oxygen added, but not used in combustion. In terms of pound moles, this is equivalent to

$$404/359 = 1.13 \text{ pound moles.}$$

Therefore, the flue gases for the condition of 25 percent excess air will contain 1.13 pound moles of oxygen per 100 pounds of fuel burned.

The same approach can be used to determine the oxygen content of flue gases for other percentages of excess air (Table 8).

The last component of the flue gases that will be considered is the nitrogen content. Recall that roughly 79 percent of air is nitrogen. This does not undergo any significant chemical reactions in the combustion of hogged fuel. Therefore, nitrogen that enters the process will leave the process as nitrogen.

As with oxygen, the amount of nitrogen entering the process is partially dependent upon the amount of excess air introduced. For the conditions of no excess air, 7,695 SCF of air were required to burn 100 pounds of hogged fuel. Seventy-nine percent of this amount is nitrogen, or  $0.79 \times 7,695 = 6,079$  SCF.

In pound moles, this represents.

$6,079 \text{ SCF} / 359 \text{ SCF per pound mole} = 16.9$  pound moles of nitrogen.

With 25 percent excess air, 9,619 SCF of air was required (Table 7). Seventy-nine percent of this, or

$$0.79 \times 9,619 = 7,599 \text{ SCF,}$$

is nitrogen. In pound moles, this represents

$$7,599 \text{ SCF} / 359 \text{ SCF per pound mole} = 21.2 \text{ pound moles of nitrogen.}$$

Table 9 summarizes the pound moles of nitrogen for various amounts of excess air used to burn 100 pounds of hogged fuel.

With the information in Tables 8 and 9, we now can analyze the major constituents of dry flue gases in the combustion of hogged fuel. With no excess air, we find the following combustion products:

Carbon dioxide = 4.3 pound moles,  
Oxygen = 0 pound moles (Table 7),  
Nitrogen = 16.9 pound moles (Table 8), and  
Total products = 21.2 pound moles.

In percentages:

Carbon dioxide =  $4.3/21.2 \times 100$   
= 20.3 percent of total dry flue gas,  
Oxygen =  $0/21.2 \times 100$   
= 0 percent of total dry flue gas,  
Nitrogen =  $16.9/21.2 \times 100$   
= 79.7 percent of total dry flue gas.

With no excess air, the combustion gases would have 20.3 percent carbon dioxide. This can be measured directly with an Orsat Flue Gas Analyzer.

Table 8. Summary of Oxygen Contents of Flue Gases for Various Percentages of Excess Air to Burn 100 Pounds of Dry Hogged Fuel.

Excess air	Volume of air	Air in excess of base	Oxygen in excess of base	Oxygen in flue gas
%	SCF <sup>1</sup>	SCF <sup>2</sup>	SCF <sup>2</sup>	Pound moles
0	7,695	0	0	0
25	9,619	1,924	404	1.13
50	11,543	3,848	808	2.25
100	15,390	7,695	1,616	4.50
150	19,238	11,543	2,424	6.75

<sup>1</sup>SCF: standard cubic feet.

<sup>2</sup>Surplus over base requirement.

Table 9. Summary of the Nitrogen Content of Flue Gases for Various Percentages of Excess Air to Burn 100 Pounds of Dry Hogg Fuel.

Excess air	Total air	Nitrogen	Nitrogen
%	SCF <sup>1</sup>	SCF <sup>1</sup>	Pound moles
0	7,695	6,079	16.9
25	9,619	7,599	21.2
50	11,543	9,119	25.4
100	15,390	12,158	33.9
150	19,238	15,198	42.3

<sup>1</sup>Standard cubic feet.

With 25 percent of excess air, we find that

Carbon dioxide = 4.3 pound moles,  
 Oxygen = 1.13 pound moles (Table 7),  
 Nitrogen = 21.2 pound moles (Table 8), and the  
 Total = 26.63 pound moles.

In percentages,

Carbon dioxide =  $4.3/26.63 \times 100$   
 = 16.1 percent of total flue gas,  
 Oxygen =  $1.13/26.63 \times 100$   
 = 4.2 percent of total flue gas, and  
 Nitrogen =  $21.2/26.63 \times 100$   
 = 79.6 percent of total flue gas.

In this example, the combustion gases would indicate 16.1 percent carbon dioxide. By going through these calculations for each percentage of excess air, we can develop the values in Table 10.

The values of carbon dioxide and oxygen shown in Table 10 can be plotted against the percentage of excess air (Figure 5). This plot and data from a flue gas analysis for either carbon dioxide or oxygen allow you to read the percentage of excess air immediately. Data on both gases are not necessary, but may help as a check on accuracy of the flue gas analysis.

The water-vapor content of the flue gases is not considered in the analysis because, in most flue gas analyzers, the gas sample is cooled before actual analysis for constituents, which condenses the water vapor and removes it from the sample.

Thus, the analysis is made on only the nonwater constituents of the gas. Data in Table 10 and Figure 6 are calculated on a dry basis.

The actual water-vapor content, measured in flue gases from hogg fuel boilers, ranges from about 6 to 24 percent by volume. For hogg fuel whose average moisture content is from 45 to 50 percent by weight, the water-vapor content of the flue gas will be about 16 percent by volume under stack conditions. This value varies with moisture content in the fuel, relative humidity of the air, and percentage excess air. If a wet scrubber is installed to control particulate emissions from the

Table 10. Composition of Dry Combustion Gases<sup>1</sup> for Various Percentages of Excess Air.

Excess air	Carbon dioxide	Oxygen	Nitrogen
%	%	%	%
0	20.3	0	79.7
25	16.1	4.2	79.6
50	13.5	7.0	79.5
100	10.1	10.5	79.4
150	8.1	12.7	79.3

<sup>1</sup>For combustion of wood and bark, the theoretical sum of carbon dioxide and oxygen should be 20-21% of the dry combustion gases.

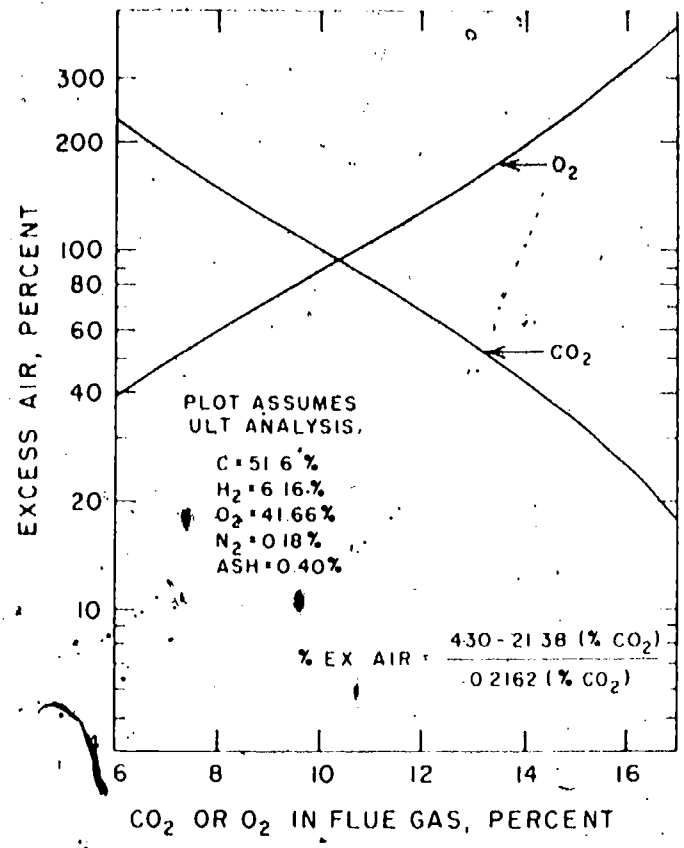

Figure 5. Relation of excess air to percentage of oxygen and carbon dioxide in flue gases.

boiler, water-vapor content in the gas, downstream from the scrubber, will increase.

**Other Products of Combustion**

The foregoing discussion deals only with the primary constituents of flue gases (carbon dioxide, oxygen, nitrogen, and water vapor). These usually make up 98-99 percent of the total material emitted from the combustion process. Other materials are emitted, however (Table 11), which can be categorized as gaseous or particulate. The term "gaseous" is self explanatory. The term "particulate" is somewhat misleading. The Federal Government and most state regulatory agencies define particulate as any material that exists either in the liquid or solid state under conditions of 29.92 inches of mercury (standard atmospheric pressure) and 70 F. With this definition, some materials that exist as gases at the higher stack temperatures (from 400 to 750 F) may condense to form liquids

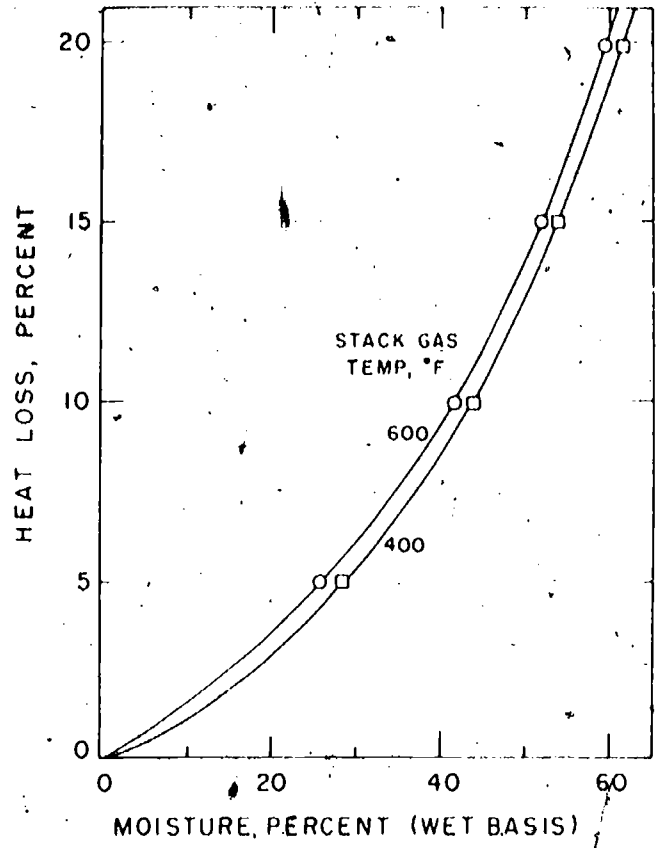

Figure 6. Relation of heat loss to moisture content of Douglas-fir bark.

or solids at lower temperatures. This becomes important with regard to air-pollution emissions, because most boilers have limitations on the concentrations or amounts of particulate material that can be emitted to the atmosphere. Measurement and control methods for particulate emissions are discussed in chapters 5 through 8.

**Summary of Reactants and Products of Combustion**

Table 12 summarizes the data concerning the amount of air used in the combustion of 100 pounds of dry hogged fuel. It also lists the volumes of the gaseous products of combustion for various amounts of excess air. Note that under standard conditions of temperature and pressure, there is little difference in the volumes of gases that enter and leave the process. At higher stack temperatures, however, the exhaust gases expand and become substantially greater in volume.

Table 11. Summary of Materials Normally Found in Flue Gases from Combustion of Hogged Fuel.

Gases	Particulate material
Nitrogen	Inorganic flyash
Carbon dioxide	
Oxygen	Fixed carbon
Water vapor	Traces of metals and salts
Carbon monoxide	
Unburned hydrocarbons <sup>1</sup>	
Sulfur dioxide	
Oxides of nitrogen (NO, NO <sub>2</sub> )	
Inert gases	

<sup>1</sup>High-molecular-weight hydrocarbons may be considered as particulate matter if they can exist as liquids or solids at ambient pressures and temperatures.

Table 12. Air Requirements and Products of Combustion Formed in Burning 100 Pounds of Dry Hogged Fuel with Various Amounts of Excess Air.

Excess air	Total air input	Weight air input	Volume of combustion products	
			Dry basis	Actual basis <sup>2</sup>
%	SCF <sup>1</sup>	Pounds	SCF <sup>1</sup>	SCF <sup>1</sup>
0	7,695	617	7,611	19,521
25	9,619	711	9,560	24,520
50	11,543	926	11,470	29,419
100	15,390	1,234	15,329	39,317
150	19,238	1,543	19,153	49,125

<sup>1</sup>Standard cubic feet.

<sup>2</sup>At stack conditions assumed to be 600 F and 16% moisture content.

The information in Table 12 was developed from the average ultimate analysis of 22 samples of hogged fuel. It may differ slightly for fuels whose ultimate analysis is not the same as that indicated in Table 2. It differs substantially for the combus-

tion of coal, oil, gas, or other fossil fuels.

An important feature of Table 12 is that it indicates the influence of excess air on gas volumes. A detailed discussion of the effects of excess air is provided in Chapter 4.

#### 4. FACTORS AFFECTING THE COMBUSTION OF HOGGED FUEL

We can categorize the factors affecting complete combustion into three groups: Fuel related, air related, and others. Many of these factors are interrelated.

##### Fuel-Related Factors

Some of the characteristics of hogged fuel, such as size, moisture content, ultimate analysis, proximate analysis, and heating value, were discussed in Chapter 2. Each of these factors influences the combustion process.

##### Size

The combustion process is a gaseous-phase reaction (Chapter 3). About 75-85 percent of wood fuels is volatile and must burn in the gaseous state. This requires proper conditions for evaporation of the fuel. The size of fuel particles directly affects their ability to evaporate. The smaller the pieces, the more rapidly their volatile components will vaporize and burn. Large pieces have reduced surface area available for evaporation to occur. Furthermore, large pieces of wood tend to insulate their interior parts, so more time is required for the volatile material to become sufficiently hot to vaporize.

The amount of surface area available for evaporation is represented by the ratio of the surface area to volume. Table 13 shows the

approximate ratio of surface area to volume for each major component of hogged fuel.

##### Moisture Content

Moisture content of fuel directly affects the rate at which fuel can evaporate to the gaseous state. Recall the first step in the combustion process—evaporation of water from the fuel. If the moisture content is high, this process takes a long time and requires a significant amount of energy. For dry wood fuels, evaporation of volatile material takes place immediately, so the combustion process is rapid.

Table 13 lists typical moisture contents for the major components of hogged fuel and the combined relative effect of fuel size and moisture content on the rate of combustion. The last column of Table 13 is a relative scale only. It should not be interpreted to mean that dry sanderdust will burn exactly 100 times faster than wet bark. It does indicate, however, that the actual rate at which sanderdust burns is considerably greater than the rate for wet bark.

Time variations in moisture content may make control of the combustion process difficult.

Table 13. Typical Moisture Contents, Relative Ratios of Surface Area to Volume, and Their Combined Relative Effect on the Rate of Combustion of Wood and Bark Residues.

Residue	Typical moisture content	Relative ratio, surface to volume	Relative effect on rate of combustion
<i>Percent</i>			
Bark	45	1	2
Coarsewood	45	1	2
Planer shavings, kiln-dry	16	5	30
Planer shavings, green	40	5	12
Sawdust	35	6	17
Sanderdust	5	10	200
Reject mat furnish	6	8	130

For example, if the forced- and induced-draft systems are adjusted for good combustion of moderately wet fuel (that is, 45 percent MC) and suddenly a load of dry fuel is sent to the combustion chamber, the rate of combustion increases rapidly. In most boilers, the result is an immediate deficiency of oxygen and generation of unburned carbon particles that cause a black exhaust plume. The reverse situation also can occur. If dry fuel is burned with proper amounts of excess air, and the moisture content suddenly increases to a high level, the rate of combustion will decrease rapidly. Under these circumstances, the excess air may exceed reasonable limits until adjustments in the fuel-air ratio can be made.

As noted earlier, moisture content of fuel is significant because it has a negative heating value; that is, heat is needed to evaporate it. Figure 6 shows the heat loss from a range of moisture contents for Douglas-fir bark. About 13 percent of the total heat in the fuel is required for moisture evaporation at 50 percent moisture content; about 26 percent of the fuel heat is needed at a fuel moisture content of 67 percent.

Not only does increasing the moisture content of fuel increase heat losses and, thereby, reduce overall efficiency, but it also retards combustion, lowers flame temperatures, and reduces the rates of steam generation. When the fuel moisture content reaches a range of 64-70 percent, a stable fire cannot be maintained unless auxiliary fuel is added to help drive off the water. In addition, water in the fuel evaporates to roughly 5,700 times its liquid volume in the furnace. The effect is to increase the gas velocity through the combustion zone, which reduces residence time for combustion, increases particle carryover into the heat exchanger section, and increases the size requirements of gas-cleaning equipment on the boiler. Clearly, an advantage can be gained by limiting the moisture content of hogged fuel. In recognition of this, several plants in the Northwest are installing fuel-drying systems as part of their emission control packages.

These variations in moisture content and size bring up an important feature of feeder systems for hogged fuel. Most fuel-feed systems are controlled on a bulk-volume basis. That is, they are designed to vary only the volumetric flow rate of the fuel.

The relation between the volume of the fuel and its heat content is less constant for hogged fuel than for other fuels. Therefore, attempting to control the combustion process through controlling airflow rate and bulk-feed rate is difficult. A more ideal system would be to measure and control heat flow into the furnace along with airflow into the furnace. Then, when a slug load of planer shavings comes to the furnace, the system could detect its proportionately high heat content and control the rate of fuel feed accordingly. At the same time, corrections could be made to the airflow to maintain a reasonable range of excess air for combustion. Unfortunately, instantaneous, continuous Btu analyzers are not now available for hogged fuel analyses. Therefore, the next best solution is to mix the fuel thoroughly so as to stabilize, as much as possible, the size and moisture content of the fuel.

#### Ultimate Analysis

The data obtained from an ultimate analysis of a fuel sample determine the amount of air required to burn the fuel completely. In Chapter 2, the ultimate analysis data were used to calculate that stoichiometric combustion of 100 pounds of hogged fuel requires 617 pounds of air. Also, the ultimate analysis data made it possible to determine the composition of the products of combustion for different amounts of excess air. Thus, by measuring the percentage of carbon dioxide or oxygen in the dry flue gas, it is possible to determine the percentage of excess air directly.

There is substantial difference in the composition of various fuels, such as natural gas, coal, oil, and wood. Therefore, for each of these fuels the stoichiometric ratios of air to fuel will vary substantially. With knowledge of the ultimate analysis of a fuel, we can make combustion calculations for that fuel and, thereby, determine the relations between flue-gas composition and percentage of excess air. This is one of several critical parameters in controlling the combustion process.

#### Proximate Analysis

Proximate analysis provides information on percentages of volatile material, fixed carbon, and ash in the fuel sample. The percentage of volatile



material (the part of the fuel that vaporizes to form a gas when it is heated to a high temperature) has an important bearing on combustion of the fuel. Except for carbon, all fuels commonly used in boilers must evaporate before they can burn. When they are in the gaseous state, they can mix with oxygen from the air and go through the process of combustion. Carbon can burn in the solid state, as is seen in the combustion of charcoal briquets.

By knowing the percentage of volatile material in a fuel sample, we can estimate the rate of combustion for the fuel. Fuels high in fixed carbon will burn at a slow rate. Therefore, they will require longer residence time in the furnace for complete combustion than fuels with a high percentage of volatile material. Roughly, from 75 to 85 percent of hogged fuel is considered to be volatile (Table 3).

The ash content of fuels, as determined by proximate analysis is significant for several reasons. First, ash does not burn. It plugs the air passages on grates and in the heat exchange sections. The ash that does not stay in the boiler is carried out by the exhaust gases and acts as an air pollutant. As an example of the quantities, consider a boiler that burns 9 units of hogged fuel per hour to make 100,000 pounds per hour of steam. The ash going into the boiler amounts to roughly 9,000 pounds per day if the ash content is 2 percent.

Second, ash can damage the boiler physically. Large quantities of sand and other abrasive material will erode boiler tubes and mechanical collectors. High content of sea salt may cause corrosion in a boiler if condensation occurs in the heat exchangers or breachings.

Knowledge of the ash content of hogged fuel is important in designing mechanical collection equipment. From an operational standpoint, the ash content directly affects the frequency with which grates must be cleaned and soot blown off tubes, and the amount of ash and dirt buildup in the boiler.

### Heating Value

The heating value of fuel directly affects the rate at which fuel is fed into a furnace. For example, a boiler generating 100,000 pounds per hour of steam may have the following equivalent fuel feed rates per minute:

570 pounds of hogged fuel at 40 percent moisture content and 5,000 Btu per pound,

.310 pounds of dry hogged fuel with 9,000 Btu per pound, or

150 pounds of No. 6 fuel oil with 18,000 Btu per pound.

Obviously, the rate of fuel feed affects the operating cost of a boiler. Knowledge of the heating value of fuels, however, is generally not an important factor in operating a hogged fuel boiler. First, measuring Btu content on a continuous basis is difficult. Second, if it could be measured, the values obtained would not influence the settings of the combustion controls on the boiler. Third, the moisture content of the fuel is not taken into account in the values shown in Table 4. Thus, the values do not reflect the available Btu content for generating steam in the boiler. The primary benefit of knowing heating value of the fuel is in making engineering calculations for boiler design and efficiency.

In addition to fuel related factors, such as size, moisture content, ultimate analysis, proximate analysis, and heating value, six other factors affect the combustion of hogged fuel. These include the method of feeding the fuel, the distribution of fuel in the furnace, variations in rates of fuel feed, the depth of fuel pile in the furnace, auxiliary fuel usage, and separate firing practices. Each is discussed in detail.

### Method of Feeding Fuel

The method of feeding fuel to a boiler furnace is dependent upon the furnace design. For Dutch ovens, the fuel is dropped through a chute on top of a pile. Several piles may be used for one boiler. For spreader-stoker furnace designs, the fuel is spread across a grate with a mechanical or pneumatic spreader. The desired result is to lay a thin, uniform mat of hogged fuel across the entire area of the grates (Figures 2 and 4).

These two systems differ substantially. With the Dutch oven, the fuel reaches the top of the pile in a "stream" and cascades down the sides. Little combustion of the fuel occurs until it has settled on the sides of the pile. There, it receives radiant heat from the refractory lining of the oven. This heat input, coupled with convectional heat transfer from the hot gases around the pile, provides energy

to evaporate the water in the fuel and raise the temperature for combustion to occur. Gases evolved from the pile are rich in carbon monoxide. As these pass between the drop-nose arch and the bridge wall, the overfire air supplies sufficient oxygen to complete the combustion of carbon monoxide to carbon dioxide.

In a spreader-stoker design, the fuel is spread across the grate of the furnace so that it must fall through the flames of the burning material on the grates. Small, dry particles of fuel, such as sand, dust and planer shavings, will heat quickly and burn in suspension before they arrive at the grate. Larger, moist fuel parts, such as bark and coarse white wood, will fall to the grate and burn at that location until they become small enough and light enough that the air from under the grates can carry them into suspension. The combustion will be completed for these articles in suspension (provided that the necessary time, temperature, and turbulence are maintained). The spreader-stoker design does not use large amounts of refractory to radiate heat back to the burning fuel pile. Heat is radiated from the flame zone above the grates back to the fuel on the grates. This aids in the initial combustion. Heat also is transmitted to the fuel through turbulent flow of hot combustion gases within the furnace, and from heated underfire air. Combustion must be completed in the furnace chamber.

The method of fuel feed is tied closely to the particular design of furnace, and feeding methods are not easily interchangeable. The furnace design and the methods of fuel feed associated with a particular design do influence the process of combustion.

#### Distribution of Fuel in the Furnace

Furnaces are designed for uniform combustion of fuel across the furnace. Fuel on the left-hand side of the furnace should be subject to the same conditions of available air, temperature, turbulence and gas velocity as fuel on the right-hand side. If the fuel feeding system allows for uneven distribution of the fuel, the combustion system will be unbalanced. The right-hand side may have too much air, too low gas velocity, too high temperature, or too much or too little of

another parameter of combustion. The need for uniformity applies to fore and aft distribution of fuel, as well as side to side. The primary concern is that fuel be placed evenly in the combustion zone in all types of furnaces.

#### Variations in Fuel Feed Rates

In almost all boilers, swings occur in the steam demand under normal operation. In some instances, these range from 40 to 125 percent of the boiler rating over periods as short as a few minutes, although most units do not undergo such violent changes in load. In responding to load variations, the fuel feed rate is increased or decreased. Decreasing feed rate usually has no adverse effect on the combustion reaction. The fire burns to a lower level, and steam production drops off.

With increased steam demand, substantial problems may occur. Consider a furnace that is operating at 75 percent of full load. Suddenly, the load increases to 100 percent. As the steam demand increases, the fuel feed rate increases. The furnace receives hogged fuel with moisture from 45 to 50 percent. This increase in the rate of wet fuel going to the furnace may tend to lower the temperature in the combustion zone. As the temperature drops off, the combustion rate drops off. To compensate for this, more air is added, usually as underfire air, to help dry the fuel and increase the rate of combustion, which increases the percentage of excess air. This tends to reduce combustion efficiency and frequently results in sending substantial amounts of unburned material out of the furnace. Gradually, the wet fuel dries, the temperature in the combustion zone increases, the rate of combustion increases, and the steam output from the boiler increases.

The degree to which the upset in combustion occurs is dependent upon several factors:

- Rate of combustion initially,
- change in fuel feed to meet the new load,
- design and size of the furnace,
- moisture content of the fuel,
- size of the fuel,
- temperature of underfire and overfire air,
- amount of excess air, and
- other related combustion parameters.

The factor that triggered the upset was the increase in fuel feed rate. If feed rate is increased drastically over a short time, substantial upsets can be expected with normal hogged fuel. If the feed rate is increased gradually, less disturbance will occur to the combustion process. The most dramatic example of this upset condition can be seen in furnaces that are batch fed from a hopper. To maintain stable combustion conditions is virtually impossible when a ton or more of wet, cold, hogged fuel is dropped into a furnace.

#### Depth of Fuel Pile in the Furnace

The depth of fuel pile has two major effects on the combustion process. First, the amount of underfire airflow depends on the depth of the fuel pile. As most hogged fuel boilers are not equipped to vary air pressure, when the pile height increases, the airflow rate decreases. A decrease in underfire airflow may raise the overfire airflow if the air duct system is not equipped with individual damper controls.

The reverse situation also occurs. When height of the fuel pile decreases, the underfire air has less resistance to flow as it passes through the pile. Flow rate, therefore, increases in the underfire air and may decrease on overfire air. This applies to Dutch oven and spreader-stoker designs, although the responses to pile depth would not be equal.

The second effect of varied fuel pile height is changes in radiated heat transfer to the fuel and is applicable to Dutch ovens only. In Dutch ovens, the closer the fuel is to the hot refractory lining, the faster the volatile portion of the fuel receives radiated heat and evaporates to the gaseous phase. Thus, raising the pile height can increase the rate of combustion in a Dutch oven. There is an upper limit, however. As the surface of the fuel pile approaches the top of the Dutch oven, the volume of gas in the oven decreases. This reduces residence time and increases gas velocities. The resulting incomplete combustion of fuel will lower the temperature in the furnace and slow the rate of combustion.

#### Separate Firing Practices

In hogged fuel boilers, the various fuel components, such as bark, planer shavings, and sander-

dust, can be mixed together and fed to the furnace as a mixture, or they can be fed separately. Two fuel components that usually are put into the furnace through separate systems are sanderdust and cinders.

*Sanderdust firing.* Sanderdust particles are small and low in moisture content. These characteristics result in extremely rapid combustion if the fuel is properly suspended and other conditions are favorable. Rapid combustion means that the available oxygen will be consumed at a high rate. If the oxygen supply is limited, the sanderdust as well as the other fuel may be "starved" for oxygen. In this instance, unburned particles will leave the furnace as dense, black smoke. To avoid this circumstance, sanderdust can be injected separately with its own controlled air supply.

Separate firing of sanderdust offers several advantages over mixing it with other components of hogged fuel. A well-designed system can limit dust problems in handling and storage, provide a proper balance of air and fuel, provide air at the correct place and, in general, improve combustion conditions. Further, sanderdust firing systems can be responsive to changes in boiler load. They can be used to release heat energy quickly to compensate for rapid swings in load. If sanderdust is mixed with other hogged fuel, the response to load swings is less rapid. Furthermore, sanderdust fired in a mixture with hogged fuel frequently is not well mixed. The result is spasmodically high rates of combustion when the sanderdust is a high percentage of a mixture and high rates of excess air when sanderdust flow rates are reduced. Design criteria for sanderdust firing systems are discussed in Chapter 6.

*Cinder reinjection.* Cinders collected in control devices, such as cyclones or multiple cyclones, also exhibit properties that make them difficult to transport, store, and burn. Discussions of these properties may provide insight regarding their effect on the combustion reaction.

Cinders are a combination of fixed carbon, inorganic fly ash, and larger particles of inorganic, incombustible material such as sand and clay. The percentage of this material that is capable of burning, that is, the fixed carbon, is dependent upon combustion conditions in the furnace. If

conditions are good, perhaps only from 10 to 15 percent of the cinders will be combustible. If combustion conditions are poor, then as much as 90 percent of the cinders may be fixed carbon.

The rate of combustion of fixed carbon is substantially lower than the rate of combustion for the volatile materials in wood fuels. As wood undergoes combustion, the volatile materials evaporate to the gaseous phase and burn. In the gaseous phase, they burn more rapidly than carbon in the solid phase. For example, consider how long charcoal briquets burn compared to blocks of wood cut to the same size. This difference is important for hogged fuel furnaces because, when cinders are reinjected, they require longer residence time to reach complete end products of combustion. If residence time at high temperature is not sufficient, unburned cinders will leave the furnace again as potential air pollutants.

The carbon portion of cinders is not mechanically strong. It crushes easily to a fine powder with low density. This usually occurs in rotary screen systems that remove sand and heavier particles. The resultant form of the carbon makes it difficult to handle because of the dust. It also presents problems when reinjected into the furnace. The small, light particles of carbon can be suspended in the turbulent airflow of the furnace and carried out of the combustion zone quickly—frequently before the combustion reaction has had time to go to completion.

Consider two extreme situations where cinder-reinjection might be employed. First, consider a furnace in which combustion of the fuel is good and only 15 percent of the cinders is carbon (Figure 7). Separation of this material in a screening system probably will meet with only limited success because the carbon particles are expected to be small. Much of the inorganic fly ash will be of about the same size and density. Thus, the screened material that is to be reinjected probably will be only 50 percent combustible at most. Because of its combustion characteristics and size, when it is reinjected, only 50 percent of the combustible portion likely will burn. The rest will be carried out of the furnace as "new cinders."

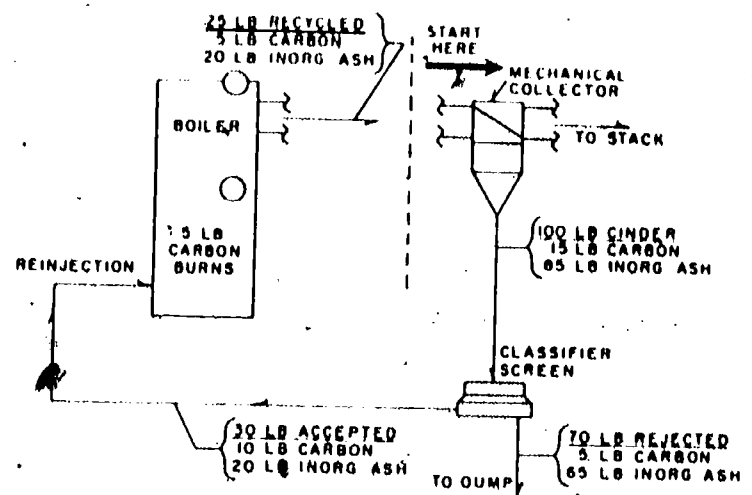

Figure 7. Flow path of 100 pounds of cinders high in inorganic ash, screened and reinjected, with good combustion. Note the small amount of carbon burned and the recirculation of inorganic ash.

Thus, for every 100 pounds of cinders that are initially collected:

- Only 15 pounds will burn,
- the reinjected portion after screening likely will consist of 10 pounds of carbon and 20 pounds of incombustible material, and
- after reinjection, only 5 pounds of the carbon will burn, but the remainder, plus the 20 pounds of incombustible material, will be recycled through the system.

Operating a system like this is difficult to justify when you consider the increased rate of particulate emission from the stack and the erosion of the boiler tubes and the cinder collection system from continually recycled inorganic material.

Now consider the opposite extreme. Assume that you are operating a furnace in which combustion conditions are poor. Cinders collected in the multiple cyclones are 90-percent carbon and large (Figure 8). After screening, the reinjected material is 95-percent carbon and reduced in size. When reinjected into a poor combustion situation, perhaps from 20 to 30 percent of the carbon burns. The remainder is recycled through the system. Being reduced in size, a substantial portion will not be caught in the collectors, but will go out of the stack as air pollutants.

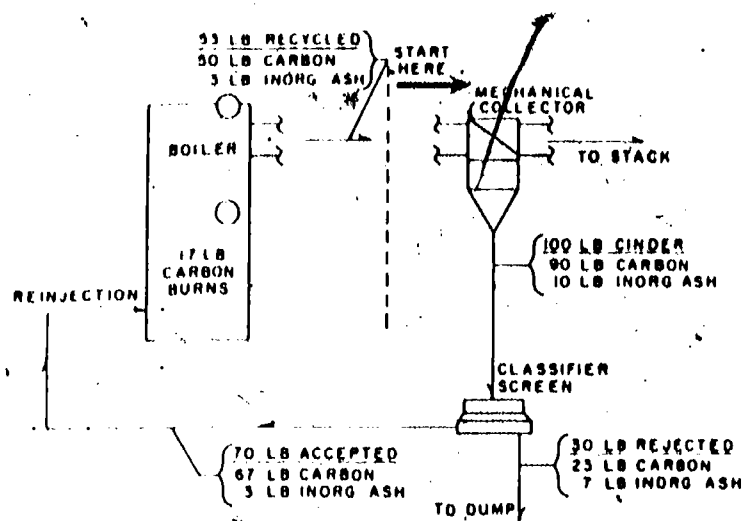

Figure 8. Flow path of 100 pounds of cinders high in carbon, screened and reinjected, with poor conditions for combustion. Note that, although some recycled carbon is burned, much escapes out of the stack.

Two basic things are wrong with this system. First is the attempt to burn, in an already poor combustion situation, a material that does not burn well. Second is the amount of inorganic, incombustible material, which is the same as in the first example of good combustion. As in the first example, this material is recycled through the system, which results in erosion and increased loading to the atmosphere. Again, operating under these conditions is difficult to justify.

This raises an important question: Why reinject cinders at all? The answer is that reinjection helps to solve a serious problem of solid waste. For example, a boiler that is designed for a capacity of 100,000 pounds per hour on hogged fuel probably will emit from 800 to 900 pounds of cinders per hour. Of these, maybe from 300 to 400 pounds per hour are combustible. Reinjection reduces the solid-waste problem in two ways. First, it results in some reduction in the volume of the combustible portion of the ash. Second, it gets rid of the remainder of the ash by emitting it to the atmosphere as particulate matter. Thus, it solves a solid-waste problem by creating an air-emission problem.

If cinders are not reinjected, what can be done with them? Alternatives include use as

landfill, raw material for charcoal briquets, filler material for concrete blocks and roadways, and as a soil conditioner.

### Auxiliary Fuel Usage

Auxiliary fuels frequently are used in hogged fuel boilers. When the hogged fuel is very wet and will not support combustion, other fuel sources can provide the heat required to evaporate moisture from the wood. In some installations, available hogged fuel is not sufficient to generate the steam required. A third reason for using auxiliary fuel is that higher rates of steam generation can be achieved for a given size boiler through the use of fuels with higher Btu content. Fourth, auxiliary fuels can be used effectively to handle rapid swings in load.

Auxiliary fuels such as coal and oil have two major effects on the combustion reaction in a hogged fuel boiler. The first deals with the sulfur content of these fuels. Both coal and oil contain small percentages of sulfur. This material oxidizes in the combustion process to form sulfur dioxide—an air pollutant. Regulatory agencies have established limits on the percentage of sulfur allowable in these fuels. For most areas, the limit after July 1974, is 1.75 percent for bunker-grade oils and 1 percent for coal (5).

In addition to being an air pollutant, sulfur dioxide can cause significant damage to the boiler components if it is allowed to condense. Air preheaters are particularly susceptible to this condensation-corrosion problem.

The second major effect of auxiliary fuels in hogged fuel boilers relates to ash content. This is not serious in the use of natural gas because its ash content is negligible. On the other hand, the ash content of coal can range from 6 to 30 percent (1). Ash content of residual oil should be less than 0.5 percent (1), but has been measured in excess of 10 percent.<sup>2</sup> If coal with an ash content of 6 percent is used, its ash content per ton is three times that of hogged fuel. Thus, loading to the collectors may

<sup>2</sup>Personal communication with Prof. A. Hughes, Dept. of Mechanical Engineering, Oregon State University, Corvallis.

well exceed the design capacity of the collectors, if it is used extensively. Furthermore, size, density, and other characteristics of coal flyash may differ from that of wood.

Use of auxiliary fuel of any type requires that both fuel flow and airflow be controlled within reasonable limits for proper combustion throughout the full range of operation.

Thus, there are many fuel-related factors that exert a significant effect on the combustion reaction in hogged fuel boilers. Included in these are considerations of species, size, moisture content, ultimate analyses, proximate analyses, heating value, method of feeding fuel, distribution of fuel in the furnace, variations in fuel feed rates, depth of fuel pile, separate firing practices, and auxiliary fuel usage.

#### Air-Related Factors

We now will consider air-related factors that affect the combustion reaction. Included will be percentage of excess air, air temperature, ratio of overfire to underfire air, turbulence of air, amount of air compared to size of furnace, and flow relations between induced-draft systems and forced-draft systems.

#### Percentage of Excess Air

As noted previously, excess air is required for complete combustion of hogged fuel. Each molecule of fuel in the gaseous state must come into contact with one or more molecules of oxygen. Only then can the chemical reactions occur to complete the combustion process. By supplying excess air, the probability of this occurring increases.

There is a limit to how much excess air can be added and still help the combustion reaction. Several factors are influential.

When air is brought into the combustion chamber, it is well below flame temperatures. During combustion, it must be heated from its input temperature to combustion temperatures, an increase of up to 1,800 F. This requires heat energy that comes from the combustion. As the amount of air is increased, more energy is taken from the combustion process to heat incoming air.

This lowers the temperature in the combustion zone, which slows the rate of the reaction. If the fuel fails to burn completely because of slow reaction rate, air pollutants will be generated.

As the energy requirement to heat incoming air increases with the amount of excess air, thermal efficiency of the combustion system goes down. The result is that more fuel is required to produce a given amount of steam (Figure 9).

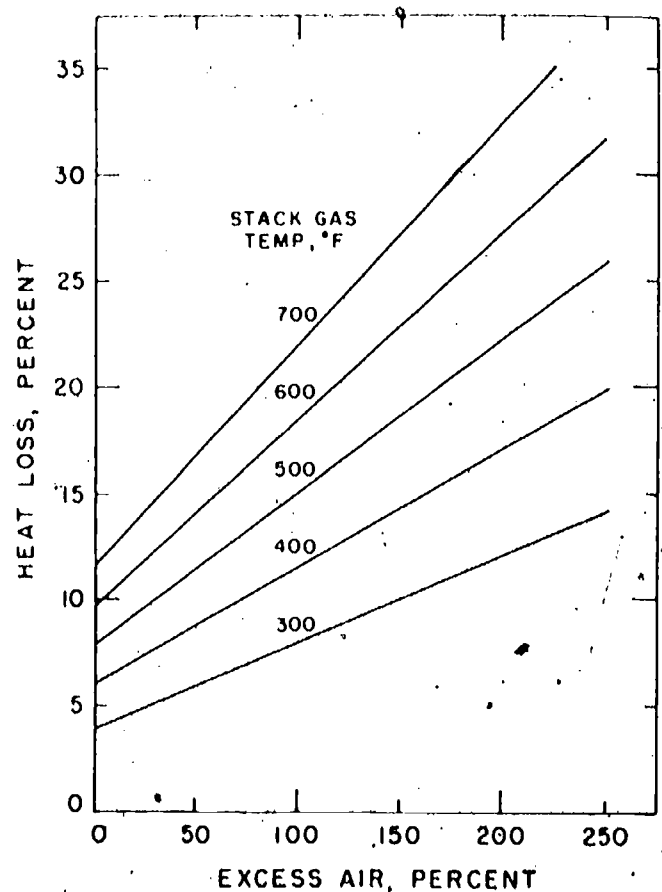

Figure 9. Relation of excess air to heat loss at five temperatures of stack gases.

Furnaces are fixed in volume, that is, they have a certain height, width, and depth, which do not change. As airflow into a furnace increases, the velocity of gases passing through the furnace increases. Furnaces are designed for a reasonable range of gas velocities based on an assumed upper limit of excess air, usually 50 percent. If more than 50 percent excess air is used, gas velocities in the

furnaces may be so high (particularly at high rates of steam generation) that they will carry fuel out of the combustion zone. If this occurs and the unburned fuel enters the heat exchange tubes of the boiler, gas temperatures will drop quickly below those necessary for the combustion reaction to go to completion. Thus, air pollutants will be formed.

An interrelated effect of high gas velocities because of excess air is to reduce the residence time of fuel in the combustion zone. The combustion reaction takes time to go to completion. If large amounts of excess air result in high gas velocities, they also result in short residence time of volatile gases and fly carbon in the combustion zone. Again, this means that the process may be stopped before combustion is completed (by low temperatures in the heat exchange zone) and unburned organic materials will go out the stack as air pollutants.

The gas flow rate into and out of a furnace has a linear increase proportional to increased excess air (Table 12). At 100 percent excess air, roughly twice as much gas passes through the furnace as at 0 percent excess air. Pressure drop through the system increases as well as mass flow. Movement of this gas requires forced-draft and induced-draft fans, which in turn require power. The cost of energy to run these fans is significant. For example, a 100,000-pounds-per-hour hogged fuel boiler using 100 percent excess air requires 50 horsepower more than for the same boiler using 50 percent excess air. Over a year's time, this will cost \$3,125 for power at 10 mills per kwh.

The size of forced-draft and induced-draft systems, which include motors, fans, ducts, and dampers, is based on the steam generation rate of the boiler and some reasonable, maximum value of excess air; for example, 50 percent. If more than 50 percent excess air is used, then one or more of the system components will be an improper size. This can result in loss of control of the systems because of being outside their design ranges; improper balance between forced-draft and induced-draft systems, which can cause pressurizing of the furnace or excessive furnace draft; and inability of the air systems to respond to load changes or variations in the fuel.

The size of the particulate collection systems also is based on the maximum steam generation rate and some reasonable value of excess air. As in the instance of forced-draft and induced-draft systems, pollution control equipment will not function at its best if gas flow rates deviate from design conditions. Too much excess air will result in lower collection efficiency for most pollution control systems.

In summary, some excess air is necessary to bring about proper combustion. Too much excess air can be detrimental to a combustion system because it:

- Cools the combustion reaction and slows down the rate of reaction.

- Reduces thermal efficiency.

- Increases gas velocities in the furnace and transports the fuel out of the furnace before it burns completely.

- Reduces residence time in the furnace so that fuels cannot burn completely.

- Requires extra power in the fan system, which can be a significant cost factor.

- Can unbalance an air system, which results in loss of combustion control, improper pressure conditions in the boiler furnace, and inability of the system to respond to load variation.

- Causes improper operation of collection equipment if the gas flow exceeds design conditions, which can occur with large percentages of excess air.

How much excess air should be used? According to most designers and manufacturers of hogged fuel boilers, from 25 to 50 percent is the optimum range. In actual practice, most hogged fuel boilers are operated at from 100 percent to 150 percent excess air and are not operating at the best conditions. Most of these units would operate better for combustion efficiency at lower levels of excess air.

As a matter of practicality, the best level of excess air will vary from boiler to boiler. Generally, if the level is from 40 to 75 percent, the unit probably is functioning reasonably well. This corresponds to carbon dioxide levels in the exhaust gases of 14.3 to 11.0 percent. We should recognize that, because of the variations in furnace design,

28  
fuel moisture content, steam generation rate, and other factors that affect the combustion process, optimum conditions for excess air cannot always be maintained. Equally, we should be aware of the negative effects of too much excess air.

#### Air Temperature

The temperature of air entering the combustion zone has a significant effect on combustion. Preheating this air has the following advantages: It increases ability of the air to remove moisture from wet fuel; it increases the furnace temperature, which increases the rate of combustion and reduces formation of air pollutants; it increases overall efficiency of the system by utilizing heat energy that otherwise would be lost up the exhaust stack; and it increases the steam generation capacity.

#### Ratio of Overfire to Underfire Air

In most hogged fuel boilers, the incoming air for combustion is split into two ducts. One brings the air in under the fuel pile or grates. The other brings air in over the fuel pile. In many spreader-stoker designs, part of the overfire air is used to pneumatically spread the fuel across the grates.

The percentage of total combustion air going to the underfire and overfire air ducts influences the combustion process. The ratio of the two flows is, therefore, one of the parameters of concern. The best ratio for good combustion varies from boiler to boiler. It is also dependent upon the characteristics of the fuel, such as moisture content and size.

In theory, boilers should function best with 75 percent overfire air and 25 percent underfire air. This idea is based on proximate analyses of hogged fuel. Roughly 75 percent of the fuel is volatile organic material (Table 3). As it goes through the steps of combustion, it will pyrolyze to the gaseous state. The combustible gases will rise above the solid hogged fuel, mix with air, and burn. Thus, 75 percent of the air, in theory, should be supplied above the pile. The remaining 25 percent of the fuel, the fixed carbon, will remain on the fuel pile or grate system. Combustion air to meet its needs (25 percent of the total) should be supplied from underfire air.

Unfortunately, this theoretical approach does not account for many design parameters that affect the combustion process. Perhaps the main variable to be considered is the furnace design, such as (Dutch oven or spreader stoker). Another important variable is fuel moisture content, as more moist fuel requires more underfire air. Taken together, the result is that many systems operate best with 75-percent underfire air and 25 overfire air.

#### Turbulence of Air

For complete combustion, one or more molecules of oxygen must come into direct physical contact with each molecule of gaseous fuel at a temperature adequate to insure ignition and with sufficient residence time to complete the reaction. Adequate mixing of the gaseous fuel and oxygen is brought about by turbulent gas flow in the furnace. The primary purpose of overfire air jets or nozzles is to accomplish this. Generally, the more turbulence in the furnace, the higher the probability of completing the combustion reaction. If the gas flow pattern is smooth or laminar, little mixing occurs.

For safety, mixing is important to avoid dead spaces or quiescent zones where fuel vapors can accumulate and reach high concentrations. This can result in puffing or small explosions in the combustion zone.

#### Flow Relations Between Forced-Draft and Induced-Draft Systems

Forced-draft air systems bring combustion air to the furnace. Complete systems include facilities to deliver preheated air under automatically controlled flow conditions throughout the full range of boiler operations. Induced-draft air systems draw the combustion products out of the boiler under controlled flow rates, and remove entrained air pollutants. Such equipment as multiple cyclones and scrubbers generally are considered part of the induced-draft system because of their physical location and effect on pressure drops and flow rates in that system.

Forced-draft and induced-draft systems play important roles that affect the combustion reaction. Their operation directly affects most of the



related combustion parameters, such as percentage of excess air, turbulence, and air temperature. Furthermore, the balance between flows in these two systems determines the pressure in the furnace. In most hogged fuel boilers, particularly older installations, a slight negative pressure is maintained in the furnace and heat exchange sections to minimize puffing and to keep fuel and combustion products in the furnace.

Not all hogged fuel boiler installations operating today are equipped with balanced, automated, forced-draft and induced-draft systems. Many have no forced-draft system at all. Others use natural draft from smoke stacks rather than a controlled induced-draft fan system. Such installations do not have good control of the combustion process throughout the full range of operation. Incomplete combustion may occur at regular intervals with resultant emissions of smoke, cinders, underburned hydrocarbons, and other air pollutants.

### Other Factors

To maintain good combustion conditions and good heat transfer, soot and ash deposits from the furnace and heat exchanger tubes must be removed. Failure to remove such materials results in partial blocking of the gas passages. If the grates are plugged, insufficient air for combustion will occur in localized parts of the furnaces. This brings about loss of steam generating capacity, loss of efficiency, and increased pollutant emissions. Similarly, if the tube passages are plugged, capacity and efficiency are reduced.

Most plants have regular schedules for soot blowing and grate cleaning. The frequency depends on content of fuel ash, combustion efficiency,

furnace design, average rate of steam generation, plant steam demand schedule, local regulations on air pollution, and operator's initiative.

How well the job is done depends both on the operator and the equipment he controls. The important point is, a clean boiler is more efficient and pollutes less than one fouled with ash and soot.

The operator has some control over the cleanliness of a boiler, but he has less control over other factors that significantly affect the combustion reaction. These include basic design, maintenance, steam generation rate, and water level.

Dutch ovens and spreader stokers use different approaches to fuel combustion. As such, their differences in basic design influence the combustion reaction.

As with all production equipment, boiler components require maintenance to function well. Poor maintenance results in lower boiler efficiency and higher emission rates for air pollutants. It may result also in safety hazards, unwanted downtime, and significant equipment damage.

Boilers are designed to produce steam within a range of rates. If actual loads are either too low or too high, combustion conditions will be upset by equipment limitations. In many installations, the maximum steaming rate is not determined by the boiler capacity, but by emission levels from the system.

Many operators have reported that variations in water level in the steam drum affect the combustion rate. Field experience indicates that a responsive, automatic, liquid-level control system on the feed-water system at the steam drum is helpful in controlling furnace temperatures. This is particularly true for water walled, spreader-stoker systems.



## 5. MONITORING EQUIPMENT

Monitoring equipment is used to measure and indicate the important parameters in boiler operation. It is distinguished from control equipment, which controls the combustion variables. Examples of monitoring equipment include meters to read temperature, pressure, and flow rates of steam produced. Some monitoring systems are limited to providing data for the operator's information. Others use the information as a signal to operate a control system. For example, steam flow meters simply record the flow rate of steam produced. Steam pressure, however, is indicated on a gauge for the operator's information, and also used as a control signal to increase or decrease fuel flow.

For common monitoring systems to monitor pressure, temperature, and flow, many good references are available (1, 3).

### Fuel Monitors

Most hogged fuel boilers do not have equipment to measure variables of hogged fuel such as moisture content and size. There are systems, however, that can provide useful information for operators.

Metal detectors have the obvious advantage of limiting damage to equipment because of tramp metal in the fuel system. They can be used to shut off conveyors, sound alarms, or perform similar functions.

Fuel weighing systems provide data concerning fuel flow rates that have two uses. It is helpful in accounting for total fuel usage, and can be used to signal the operator when no fuel is being carried by the conveyor system. Weight data are limited in value because weight of fuel varies directly with moisture content, and moisture content can vary over a wide range in hogged fuel.

Television scanners can monitor most fuel handling systems, including conveyors, hogs, storage bins or piles, feed systems, and screens. Each component of the system can plug or fail to function, with the result that the fuel supply to the boiler stops. By locating closed-circuit television scanners at critical points in the system, any disruption can be spotted quickly by the operator, and corrective action can be undertaken to minimize changes in fuel flow to the boiler. Scanners can be installed with several cameras and only one video screen. Using the selector switch, the operator can check the system at any one of several points.

Fuel feed monitors are helpful in the common situation where hogged fuel boilers are equipped with more than one feed point. The operator can have an easily visible means of determining whether or not fuel is flowing freely through each feeder. Feed monitors are found in a wide variety of types, from plexiglass panels in the system, to mechanical linkages that move as long as fuel is being fed. The rate of feed seldom is measured.

Fuel moisture meters could be helpful. Spot checks occasionally are made on fuel moisture content. Few plants do it regularly, however, and the data are not used to control the combustion process. Efforts are under way to develop reliable systems for continuously measuring fuel moisture. This type of information is useful in determining when to use auxiliary fuel, but it is not necessary to the operation. Where fuel drying and sizing are part of the operation, moisture measurement can be a valuable control monitor for the fuel preparation system.

### Air Monitors

The comments on air monitoring equipment are limited to combustion air input systems and air measurements in the induced-draft system. Exhaust gas monitoring equipment is discussed separately.

Even though temperatures and flow rates of combustion air are critical parameters in the combustion process, few boilers are equipped with monitors to measure and indicate gas temperatures or flow rates, for several reasons.

First, seldom does a need exist to know what the air temperatures are. If the boiler has an air preheater, it is used to maximum capacity. If it has no air heater, knowing the air temperature does not provide information to assist the operator in his duties.

Second, total airflows have a direct bearing on the percentage of excess air. This parameter can be determined accurately from analyses of the exhaust gases. Therefore, measurements of input airflows are redundant.

Third, the cost of installing equipment for continuous monitoring of airflow has prohibited its use. Continuous measurements of gas flows to underfire and overfire air systems would be helpful to the operator. It would tell him to correct the flows for optimum combustion conditions. The economic returns of such equipment, however, are difficult to identify. Therefore, few boilers are equipped with monitors for input airflow.

Air pressure monitors are common on boilers. Draft gauges on control panels indicate positive and negative pressure conditions at various points in the combustion and heat exchange systems. Data from these instruments are used by the operator to determine when plugging occurs because of ash building up in the system. They also are useful in setting airflows to maintain proper pressure conditions in the furnace.

### Exhaust Gas Monitoring

Flue gases can be monitored continuously to determine parameters such as temperature, percent carbon dioxide or oxygen, and opacity or optical density.

#### Temperature

Measurement of flue gas temperature can provide helpful information to an operator, but its use is limited. This parameter is dependent upon so many variables that fluctuations are difficult to relate to specific variables. For example, changes in air heater performance, steam generation rate, fuel moisture content, fuel heating value, and percent excess air all affect exhaust gas temperatures.

Because of installation costs and limitations on value of the data, many boilers are not equipped for continuous monitoring of stack temperature.

#### Percent Carbon Dioxide or Oxygen

Of all continuous monitors available to the boiler operator, those used to analyze flue gas for carbon dioxide or oxygen are the most valuable indicators of combustion conditions. As noted in discussion of the effects of excess air, the balance between fuel and air supply is critical to proper combustion. Continuous measurement of combustion products can inform the operator of any upsets in the balance of these variables. The operator then can adjust conditions to maximize boiler efficiency and minimize air pollutant emissions. Without data from flue gas analyses, the operator can only guess at the percentage of excess air being used in the system.

Continuous gas analyzers are costly to install (for example, \$2,000-\$5,000 per installation). They also require reasonable maintenance and calibration to function properly. They are easily justified, however, because of fuel savings and reduction of air pollutant emissions.

One difficulty should be noted regarding continuous flue gas monitors. Most commercial units are fairly delicate instruments. The output signal is based upon a small voltage generated by the instrument in response to the concentration of the gas being analyzed. If the instrument is not grounded properly, a false reading may occur because of an electro-chemical reaction within the instrument. This is a common problem, but one that is easy to correct.

The best alternative to continuous flue gas analyzers is use of grab-sample analyzers. Two types are commonly employed: the Orsat analyzer and Fyrite gas analyzers. Each is adequate for measurements to within about 0.2 percent. The cost is moderate, and the instruments are well designed for field use. Orsat analyzers require more skill to operate than do the Fyrite units, but they may have a slight advantage in increased accuracy. Both units require regular replacement of chemicals. Either one is adequate for taking spot checks.

on flue gas constituents. Sample time from start to finish may be 10-15 minutes. Therefore, if combustion conditions vary substantially over short intervals, this type of analysis may not be suitable.

The importance of flue gas analyses cannot be overstressed. Every operator should have these data at his disposal at all times. Without them, he cannot properly control the combustion process.

### Opacity

Most regulatory agencies have implemented standards regarding opacity limitations. The standards specify that emissions may not exceed an opacity limit (usually 20 or 40 percent) (5) for more than 3 minutes out of any hour. Commercial opacity monitors are available and commonly are used. Their use, however, is limited to providing information to the operators. In most states, charts from opacity monitors are not acceptable to regulatory agencies as proof that the emissions are in compliance. Opacity monitors are useful as warning devices to signal an operator of a combustion upset that results in particle emissions. They do not respond to gaseous pollutants.

Opacity monitors are installed in the exit-gas duct system, usually downstream from devices for emission control (for example, multiple cyclones). This location may be in the breeching or in an exhaust stack. The systems commonly have a light source, a photoelectric cell, an amplifier, and a recorder (Figure 10) (6). Light from the source travels through the exhaust gas stream. Particles in the gas stream will absorb or scatter the light and reduce the signal at the photoelectric cell. This approach to monitoring has several inherent difficulties.

First, the amount of light absorption and scattering depends on the distance that the light beam travels in the gas stream. Opacity regulations refer specifically to opacity at the discharge point from the stack. If the distance across the top of the stack is exactly the same as the distance from the monitor light source to the photocell, the monitor can record accurately the opacity at the top of the stack. But if the distances are not equal, the monitor is not measuring the opacity at the top of

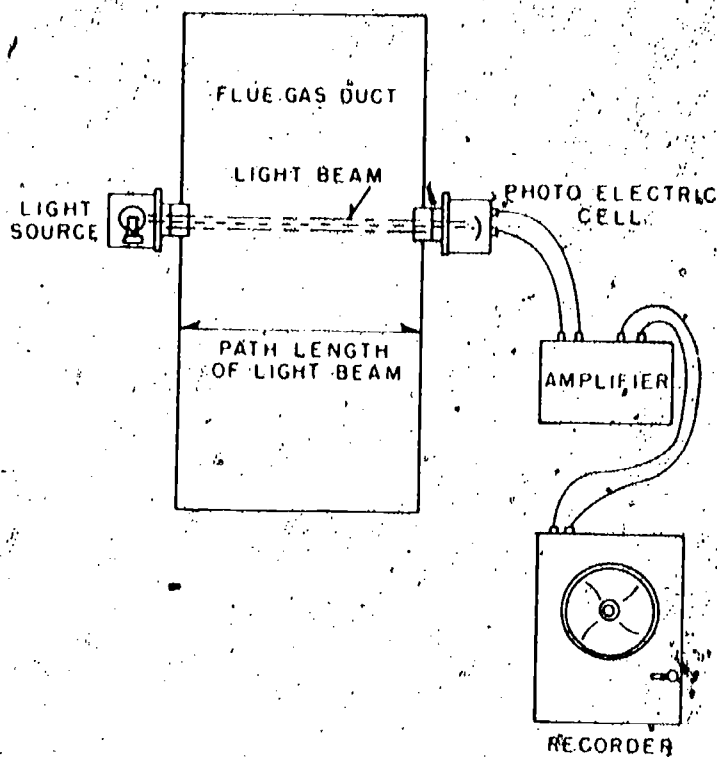

Figure 10. A common arrangement of instruments to monitor opacity of exit flue gases.

the stack. Substantial errors can occur because of differences in geometry.

Second, being mounted in the boiler breeching, the monitors may be subject to high temperature and vibration. These factors may result in limited bulb life and need for frequent maintenance and recalibration of the monitors.

Third, particulate emissions from the furnace tend to coat the protective lenses on the optical system. This coating results in false readings of opacity. Lenses must be cleaned frequently to keep the instruments functional. The more expensive commercial models are equipped with continuous purge systems to avoid this problem.

Fourth, opacity is dependent upon many factors, such as gas temperature (density), size of particulate matter, concentration of particulate matter, relative humidity, and length of light path. Should any of these parameters vary between the monitoring location and the discharge point of the stack, the opacity monitor would not reflect opacity at the stack discharge point.

Note that opacity is strongly dependent upon size of the particles in the gas stream. Large particles do not scatter or absorb light to the same degree as small particles. For example, in a heavy rain you may be able to see clearly for ½ mile. But if rain droplets are reduced in size to fog, visibility can drop to only a few feet. Because opacity is dependent upon particle size, measurements of opacity cannot be used as measurements of particle concentration. Attempts to show relations between concentrations of flue gas particles and opacity have not been highly successful.

The cost of opacity monitors ranges widely. The least expensive units can be installed for less than \$500. At the other end of the scale, the investment can exceed \$6,500. For \$6,500, however, the operator benefits from automatic recalibration at regular intervals, continuous purge systems to keep the lenses clean, automatic correction for geometric differences between the actual monitoring location and the stack outlet, low maintenance, and high reliability in the system.

#### Opacity and Optical Density

Some commercial monitors measure optical density rather than opacity. To avoid confusion over terms, understanding the relation between these terms may be helpful.

Opacity is measured on a scale from 0 to 100 percent. At 0-percent opacity, the light beam is not scattered or absorbed. It passes through the gas stream and reaches the photoelectric cell at full intensity. As the concentration of particles in the gas stream increases, scattering and absorption of the light beam increase. At 100-percent opacity, no light is received at the photoelectric cell from the light source.

Optical density has a scale from 0 to infinity. It is defined as:

$$\text{Optical density} = \log_{10} [(1/100 - \text{percent opacity})] \quad (\text{Figure 11})$$

Zero percent opacity corresponds to zero optical density. One hundred percent opacity

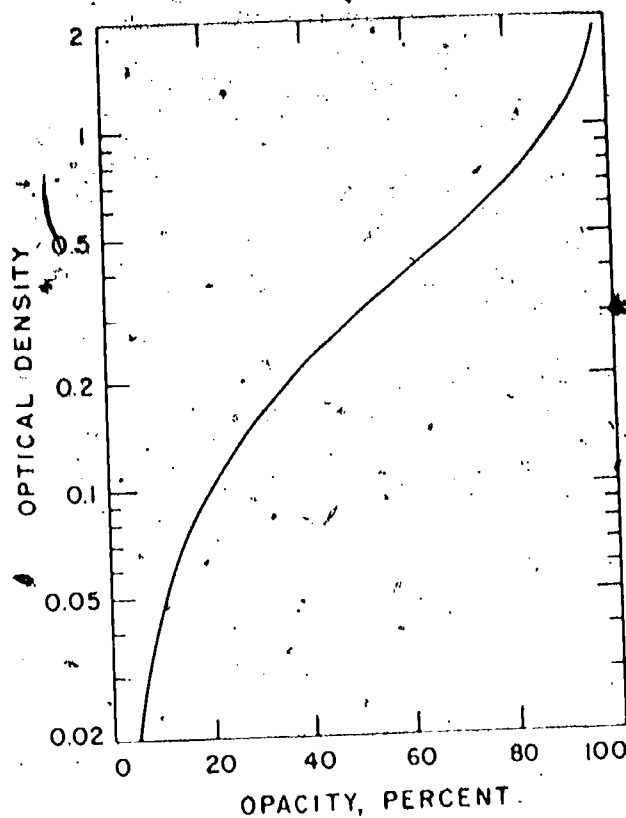

Figure 11. Relation of opacity to optical density.

corresponds to infinite optical density. The term "absorbance" is used interchangeably with optical density.

#### TV Stack Monitors

Closed-circuit television systems have been installed in many plants to visually monitor stack emissions. They aid the operators by providing a continuous display of stack visibility. Although this is useful during daylight, it is of little value at night unless the plume from the stack is well lighted. The advantage of this system is that it allows the operator to see stack emissions without leaving the boiler control panel. The main disadvantage is that the operator must constantly observe the monitor to detect upsets. This disadvantage can be overcome by use of an opacity monitor with appropriate time delay and visual or audible alarm.

## 6. COMBUSTION CONTROL SYSTEMS

Control of the combustion process requires control of variables that affect the process (Table 14). Not all of the variables can be controlled. For example, in most plants, tree species of the fuel cannot be controlled. Some important variables, however, can be controlled.

Generally, control systems have two goals: control of the variables within specific range limits (for example, control of excess air in a range from 40 to 75 percent); and maintenance of uniform levels of each variable (for example, keeping the fuel well mixed so that the average fuel size and moisture level stay constant).

Table 14. Factors Affecting the Combustion Reaction in Boiler Installations Fired by Hugged Fuel.

Identification	Reference page
<b>FUEL-RELATED FACTORS</b>	
Species	9
Size	10
Moisture content	11
Ultimate analyses	14
Proximate analyses	15
Heating value	16
Method of feeding fuel	36
Distribution of fuel in furnace	37
Variations in fuel feed rates	38
Depth of fuel pile in furnace	39
Separate firing practices	40
Auxiliary fuel usage	44
<b>AIR-RELATED FACTORS</b>	
Percent excess air	47
Air temperature	51
Ratio of overfire air to underfire air	51
Turbulence of air	53
Flow relation between forced-draft and induced-draft systems	53
<b>OTHER FACTORS</b>	
Cleanliness of the combustion system	54
Basic furnace design	55
Maintenance of components	55
Steam generation rate	55
Steam drum water level	56

### Fuel-Related Combustion Controls

#### Fuel Size Control

Four systems can be used to control fuel size: screening fuel to separate the oversize pieces;

hogging the large pieces to reduce their size; mixing the fuel in the storage and transport systems to maintain uniform size; and maintaining separate facilities for storage, transport, and feeding of sand and dust.

BEST COPY AVAILABLE

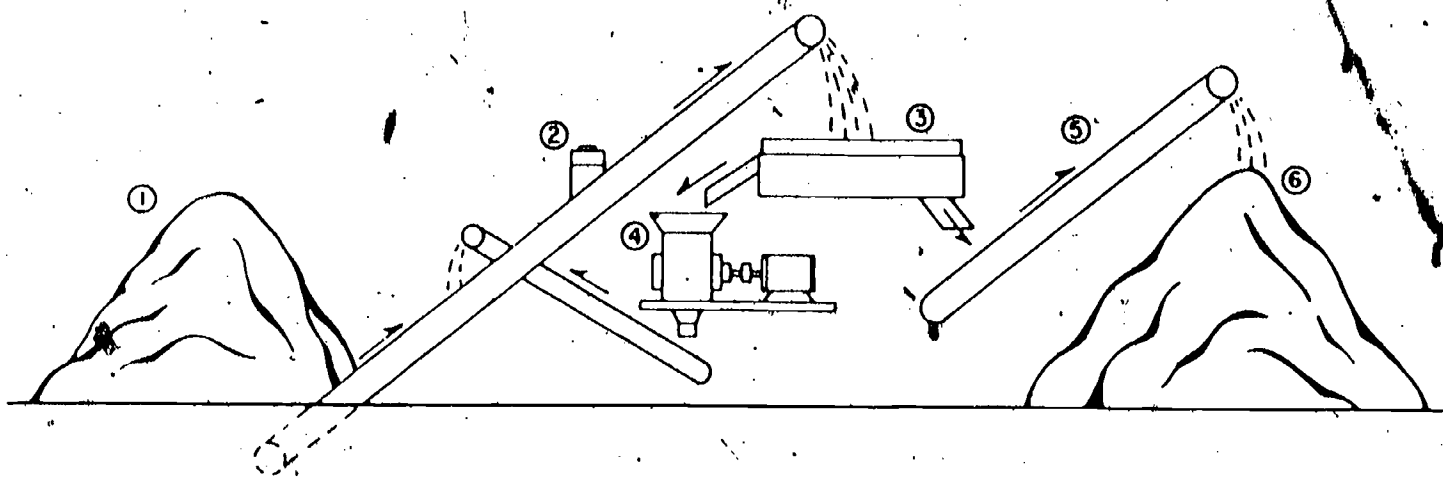

Figure 12. System for preparing hogged fuel.

1. Pile of rough fuel.
2. Metal detector.
3. Separating screen.
4. Hog for pieces too large to pass through the separating screen, with conveyor to recirculate hogged pieces.
5. Conveyor for material that passes through the separator screen.
6. Storage for hogged fuel.

Screening and hogging operations generally are combined (Figure 12). In Figure 12, note the metal detector ahead of the screen. This protects the hog and the rest of the combustion system from tramp metal.

Hogs are usually hammer type, as they have fewer maintenance problems than knife hogs. Power requirements range from 25 to 1,500 horsepower. Power requirements increase with the rate of material flow and with size reduction requirements.

Separation of sanderdust and other fine material that is produced by specific process operations serves two purposes. Small, dry particles create severe dust problems, unless storage and transport facilities are designed for dust control. By separating this material and handling it in a controlled system, the dust problem and explosion potential can be substantially limited. Also, small dry particles burn rapidly and, therefore, consume oxygen rapidly. If sanderdust is fired in a separate burner, the proper air-to-fuel ratio can be maintained for good combustion. If sanderdust is mixed with hogged fuel, proper air-to-fuel ratios are difficult to maintain.

#### Fuel Moisture Content Control

As with size, fuel moisture can be controlled with several methods:

Vibrate "loose" water off the fuel on a shaker screen.

Press water out mechanically.

Drive off moisture by heating the fuel in fuel dryers.

Cover the fuel storage pile to keep rain water out.

Control the processes that generate the fuel to limit water addition to the fuel.

Mix the fuel so that moisture content is uniform over time.

Each of these control methods is self explanatory, and each has limitations. Vibrating off water may be effective when the moisture content exceeds 55 percent. If the process that generates the wood adds large quantities of moisture (for example, hydraulic barking), this can be an inexpensive and low-maintenance approach to control of surface moisture.

Presses also are limited in the amount of moisture they can remove. For most hogged fuel, pressing can lower moisture levels to 50-55 per-

cent. Heating the fuel can reduce moisture content. Moisture level maintained in a range from 25 to 35 percent is usually adequate for good combustion. At levels below 20 percent, significant dust problems can occur with "fines."

Heating-type dryers have the potential for generating pollutants of three types: if the wood fuel is overheated (above 300 F) the volatile organic material will evaporate and go out of the dryer with the exhaust gas stream, which may condense in the atmosphere to form a visible plume; dry "fines" may create a dust pollutant problem; and, if the dryer is fired by a separate combustion system, products from the combustion process may become pollutant emissions.

Covered fuel storage will keep rain out of the fuel, and this can be a significant benefit in wet climates. The disadvantages lie in cost of the structure and access to the fuel in event of a fire in the pile. If fuel is put through a drying system, particularly one that reduces moisture levels to less than 45 percent, covered storage of the dried fuel may be desirable.

Control of water additions to fuel in production processes is usually difficult. For example, hydraulic barking cannot be replaced by mechanical barkers at most plants. There is a trend, however, toward dry-deck log storage and sorting rather than ponding. This reduces moisture levels in wood residues. By careful inspection of the processes that generate wood residues, it may be possible to locate other sources of water addition and to reduce these sources.

Adequate fuel mixing can be accomplished by spreading fuel across the face of a pile and removing the fuel from a central pickup point. As noted previously, mixing brings about uniformity in both size and moisture content. This adds to the stability of the combustion process.

#### Maintaining Fuel Heating Value

Experience has shown that Btu content of hogged fuel can be reduced substantially by storing it for long periods at high moisture levels. According to one study, Douglas-fir hogged fuel lost 7 percent of its initial heating value over 10 months (7). As a rule of thumb, hogged fuel should not remain in a pile in excess of 3-4 months.

A first-in first-out system for fuel storage is effective in limiting storage time. For most plant sites, this requires addition of, or changes to, conveyor systems. Figure 13 illustrates one such scheme for fuel storage.

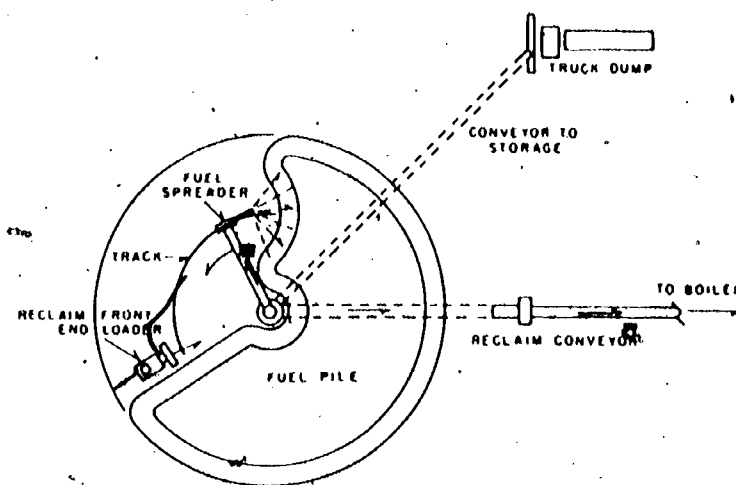

Figure 13. System to limit fuel-storage time by insuring that fuel first into storage will be first out to be burned. (Radar Pneumatics Company, Portland, Oregon.)

#### Control of Fuel Distribution in the Furnace.

The methods applied to control fuel distribution in the furnace are, of course, dependent upon the basic furnace design. In Dutch ovens with center feed chutes, little can be done to alter the placement of fuel over the grates. Ideally, the pile should be set squarely in the center of the refractory and symmetrically about the underfire air feed system. If the fuel chute is off center and piles fuel in a corner or to one side of the oven, combustion will not proceed uniformly in the pile. Corrections for better distribution of fuel in Dutch ovens are usually expensive and must be made with a cold furnace.

For spreader stokers, most systems have manual adjustments for fuel distribution. Mechanical spreaders can be slowed or increased in speed. Baffle plates often are provided to control the angle at which fuel is injected into the furnace. Other adjustments are sometimes available to set the width of the fuel path. These same variables are often available on pneumatic spreader systems. The most important control, however, is the operator. By inspecting the fuel pile through inspection and cleanout ports, he can determine the uniformity of



fuel distribution in the furnace and can make any required adjustments to correct difficulties. This should be done regularly. No automatic systems are available to replace operator skills in this area.

### Controlling Variations in Fuel Feed Rates

For combustion control, the ideal situation is to have steam generation rate and fuel feed rate always constant. The worst condition is to have fuel fed on a batch basis to a furnace with a highly fluctuating demand for steam.

Fortunately, few furnaces are batch fed today. The fuel flow usually is controlled by a hopper fed screw or similar device. Direct current drives are common where the control signal comes indirectly through a transducer for steam header pressure. Great ingenuity has been shown in boiler plants to provide uniform fuel feed to the furnaces.

Process operations in the plant control steam demand and, therefore, fuel flow rate. Better control of process operations often can help to eliminate wide fluctuations in steam demand. This requires understanding of the problems and cooperation on the part of plant supervisors and production personnel.

### Fuel Pile Height Controls

Over the past 60-70 years, there has been little or no fixed control of the depth of fuel piles, either in Dutch ovens or in spreader stokers. Each operator runs the furnace the way he thinks is best. Only recently was any effort exerted to control the depth of the fuel piles by automatic means. This technology has been applied to Dutch ovens with moderate success.

The approach is simple. A temperature sensing probe is inserted from the top into the pile. As the pile burns down, the probe is exposed to higher rate of heat input. When more fuel is added, it covers the probe and thereby insulates it from the flame temperatures. By measuring the probe temperature, a direct measure of the pile height is obtained. The temperature can be used as a control signal to the feed system. Thus, the height of the pile can be controlled automatically.

Several commercial models are available. These are divided into two classes: those that sense the temperature with a thermocouple and those that use continuous water flow through the probe

and then measure the temperature of the water. Each system appears to work well with little or no maintenance difficulties. The water system has a disadvantage in that, even though the flow rate is low, the total volume of water that is used can be large over a year. This is extremely important in light of the strict standards for water discharge that are facing industry.

The alternative to automatic control of fuel pile height is manual control by the boiler operator. This requires continued surveillance of the furnace condition, particularly during load swings, and constant adjustment to maintain optimum conditions. For most installations, this is not optimal. The operator attempts to maintain the fuel pile at a reasonable working height with limited instrumentation and considerable guesswork.

### Sanderdust Firing

Most difficulties experienced with sanderdust firing are related to the small size of the particles and their low moisture content. Taking these into consideration, one can develop design criteria for systems to fire this material that allow advantageous use of sanderdust. A well-designed system would reasonably control dust, avoid plugging, provide variable control of feed rate, ensure good particle suspension, locate the particles in the flame, and maintain a pilot light.

*Dust control.* Any system for transporting, storing, and feeding must be designed to minimize dust emissions. This is important to meet regulations for air pollution control as well as for control of fire or explosions.

*Nonplugging.* As with any system for feeding, storing, or transporting fuel, efforts must be made to avoid plugging the system. This generally does not present special problems with sanderdust, unless the material is wetted to limit dust. Dry sanderdust will flow easily and seems to respond well to the use of vibrators where necessary. Bridging can be a problem, but it is easily avoided through proper design of the system.

*Controlled variable feed rate.* Control of the feed rate of sanderdust is as important as with any other fuel. Special attention is needed to insure constant, nonplugging feed to maintain steady combustion. Control of combustion air for the fuel

is equally important. The small size and dry nature of sanderdust result in very rapid combustion. Sufficient air must be supplied at the right place to completely burn this material. Large quantities of excess air must be avoided, however, as they, too, can upset the combustion process. A well-designed system incorporates variable airflows that correspond to requirements for the full range of sanderdust feed rates.

*Good particle suspension.* The firing system should separate individual particles of sanderdust as they are injected into the furnace. This is necessary to mix particles with combustion air. Separation usually is accomplished with swirling vanes or a cyclonic type of feeding system.

*Location in the flame zone.* To complete the combustion reaction, sanderdust particles must be exposed to high temperature long enough to burn completely. This occurs if they are injected directly into the flame in the furnace. If, however, they enter the furnace at a point where they are not exposed to flame temperatures long enough, combustion will not be completed.

*Pilot light requirements.* Many boiler installations incorporate a pilot light system for sanderdust burning. For safety, this is desirable. For combustion, pilot lights probably do not add significantly to the process. Their prime function is to avoid an explosive situation in the furnace under fluctuating conditions.

Difficulties experienced with sanderdust firing usually can be traced to failure to recognize the unique properties of this fuel and to provide adequately for them.

### Cinder Reinjection

Attempts to improve combustion conditions through cinder reinjection may have negative results. As noted previously, carbon particles do not burn rapidly. They are generated in an atmosphere of incomplete combustion. To send a low-grade fuel back into a furnace with poor combustion does not improve combustion conditions. Some procedures, however, are helpful in limiting the negative effects of cinder reinjection.

Classifying the cinders is probably the most beneficial. This process separates the combustible material from the noncombustible, inorganic constituents. Typical classifier installations have rotat-

ing or vibrating screens that separate particles by size. Small particles are considered to be high in noncombustible material. Large particles are high in carbon and are returned to the furnace.

A particular advantage of classifying cinders is that the process removes abrasive material from the fuel. If the noncombustible silicates and metallic oxides are cycled around the system, from the furnace through the heat exchangers and multiple cyclones, severe erosion can occur. This causes high maintenance, particularly to collectors and heat exchanger tubes. Classifying limits this problem.

Although not commonly done for boilers fired with hogged fuel, crushing carbon particles before reinjecting them has an advantage. The purpose is to gain the maximum possible ratio of surface area to volume so that the material will burn rapidly. Note that this procedure is commonly used in large, coal-fired power plants where the coal is pulverized to fine powder before injection. Large carbon particles have low density and will be suspended in the exhaust gases. As they burn slowly, they may not be in the flame long enough to burn completely in the furnace. Small particles, however, may be in the flame long enough to burn completely.

Providing a proper cinder injector is as important to combustion as designing a proper oil or sanderdust burner. If the carbon particles are pulverized, they must be properly suspended and provided with an appropriate fuel-to-air ratio at the place where combustion occurs. A well-designed system should include storage bins and feeders that can assure a continuous and controlled flow of this fuel. Proper turbulence should be available for good mixing during combustion.

### Control of the Combustion Process With Auxiliary Fuels

When auxiliary fuels are used in conjunction with hogged fuel, the combustion process becomes more complicated. Two areas are of particular concern: ash buildup and availability and control of combustion air.

Auxiliary fuels used are predominately residual fuel oils. Natural gas and coal, however, are used also. The recent shortage of fossil fuels in general has resulted in plants receiving residual fuels with high ash contents, up to 10 percent. This

can contribute about 2½ times the amount of ash per Btu of heat input as normal hogged fuel. Plants that fire a combination of hogged fuel, residual oil, and sanderdust may experience heavy deposits of slag on heat exchange tubes. These deposits contain high concentrations of calcium sulfide (calcium from ash in the fuel and sulfur from the auxiliary fuel oil). The high furnace temperatures associated with use of auxiliary fuel oil may contribute to formation of this slag on superheater tubes. Lowering the maximum steam generation rates may help to alleviate this problem, as it would result in lowered furnace temperatures. Use of fuels with lower ash content also would help, if such fuels were available and economically attractive.

When auxiliary fuels are used, they are fed through especially designed burners that should provide adequate primary and secondary air for the particular fuel being fired. Combustion air required for hogged fuel should not be used to burn auxiliary fuel. Conversely, auxiliary fuel burners should not be used to supply air for burning hogged fuel. Air should be provided at the point where combustion is occurring and with sufficient turbulence for good mixing.

In Chapter 3, combustion calculations were made for hogged fuel with a particular ultimate analysis. Residual fuels will have completely different ultimate analyses, with generally higher carbon contents and lower oxygen contents. Combustion products as measured in the flue gas will be, therefore, substantially different for oil than those for hogged fuel. As the carbon dioxide or oxygen content of the flue gas is used normally to determine the percentage of excess air in the combustion process, care must be exercised to avoid misinterpretation of the data when auxiliary fuels are used. For example, 12 percent carbon dioxide is equivalent to 50 percent excess air for oil-fired plants. For hogged fuel, 12 percent carbon dioxide is equivalent to 70 percent excess air. Furthermore, as flue gases from combustion of hogged fuel will mix rapidly with gases from auxiliary fuel, it is difficult to determine through flue gas analysis which fuel has an excess or a deficiency of air.

## Air-Related Combustion Controls

Air-related combustion controls are concerned with percentage of excess air, air temperature, ratio of overfire to underfire air, air turbulence, flow relations between forced-draft and induced-draft fan systems, and maintenance of boiler components.

### Percentage of Excess Air

The first step in controlling excess air is to monitor the products of combustion (carbon dioxide and/or oxygen). The data can be used to adjust excess air levels to provide optimum conditions for combustion. Without instruments to monitor the flue gas constituents, excess air can be controlled only by guesswork. Note that it is necessary to measure either carbon dioxide or oxygen, but measuring both is unnecessary.

The signal from a flue gas analyzer can be used as a control signal fed directly to controls for the forced-draft and induced-draft dampers (Figure 14). As an alternative, the signal may be read by the operator, who then makes manual adjustments to the airflow controls. The type of airflow adjustment depends upon the design of the boiler (that is, Dutch oven, spreader stoker, or other) and the equipment available to regulate the combustion process. Obviously, the process cannot be controlled without adequate fans, dampers, and positioners, and sufficient instrumentation to provide status data to the operator.

Regulating the percentage of excess air is simple. As the level of carbon dioxide drops, the rates of overfire and underfire airflow are reduced. (Note that this is dependent on the design of the furnace and the firing equipment available). For many hogged-fuel furnaces, the desired set point for carbon dioxide is about 13.5 percent (or 50 percent, excess air). When levels of carbon dioxide go above the set point, the airflow rates should be increased.

The concept of controlling percentage of excess air is simple to grasp. Accomplishing this task continuously for a given boiler installation is generally not so simple. Typically, a boiler has continued variations in steam generation rate, fuel

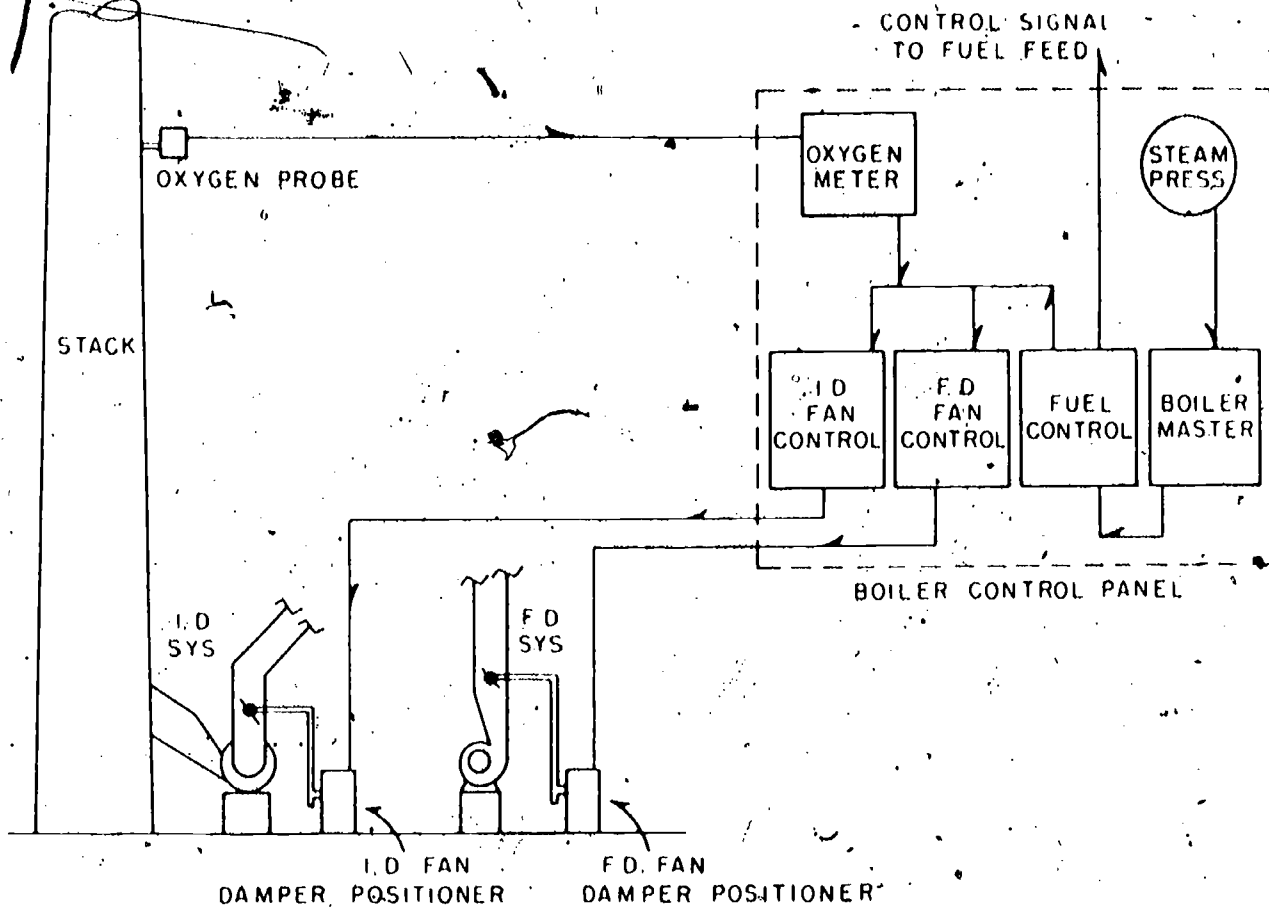

Figure 14. A flue-gas analyzer used to control dampers for induced-draft (I.D.) and forced-draft (F.D.) fan systems (13):

moisture content, fuel size, fuel heating value, amount of ash buildup on grates and in heat exchangers, and other variables that affect combustion.

These variables complicate the control of excess air on an automatic, continuous basis. A skilled operator, however, using information provided by continuous flue-gas analysis, can make appropriate corrections to the system and maintain reasonable combustion conditions. Two things are necessary, data on flue-gas constituents, and sufficient boiler controls to allow the operator to make the required corrections.

#### Air Temperature Control

In most plants, the boiler operator has no means of regulating air temperature directly. If a preheater is part of the system, it normally is used to its full capacity. If there is no preheater, the furnace must function on colder air.

Although the boiler operator usually does not have control over temperature of the forced-draft air system, he does have control over other air inputs to the furnace. With few exceptions, hogged-fuel boiler furnaces are operated at a slightly negative pressure. Therefore, if any openings are in the furnace, cold ambient air will be pulled in. Such openings usually are found as:

- inspection ports,
- cleanout doors,
- cracks in the casing,
- cracks in the refractory,
- fuel chutes,
- and poor seals around sources of cold air, such as doors, drums, pipes, and sootblowers.

By closing sources of cold air to the furnace, the operator can gain additional control of the combustion process. Not only does he increase combustion-zone temperatures, he can avoid local

"cold spots" that add to maintenance problems, and he is better able to control excess air. Note that infiltration (leakage) has all of the detrimental characteristics of cold, excess air, but provides none of the benefits of excess air.

#### Controlling the Ratio of Overfire to Underfire Air

Control of this variable must be accomplished with properly installed fans, air ducts, and dampers. The design is dependent upon the type of furnace. Spreader-stoker furnaces and suspension systems require different ratios of airflow distribution than do Dutch ovens.

The operator is concerned with several operational problems regarding the distribution of air in the forced draft system. For wet fuel, adequate underfire air must be provided to help drive off the moisture from the wood. For pneumatic spreader systems, sufficient overfire air must be provided to distribute the fuel. As ash or fuel builds up on the grates, underfire airflow will be reduced. This is caused by lessened pressure across the grates and ash. Reduction of underfire airflow also may mean a proportionate increase in overfire airflow, depending on the fan system used. Overfire air must create maximum turbulence without disturbing ash or fuel on the grates. Furthermore, the overfire air must be arranged to avoid impingement directly on hot refractory or metal surfaces to limit damage resulting from condensation, thermal stresses, and thermal shock.

Few hogged fuel boilers are equipped with a forced-draft air system that has capability to continuously balance the flows between overfire and underfire air. For most plants, primary control is in keeping the grates sufficiently clear of heavy ash buildup. The goal is to limit the pressure drop across the grates to reasonable levels. This will assure the flow of underfire air. Sealing leaks in the furnace and air systems also will assist in obtaining a proper balance. Deliberate design of high-pressure drop (from 2 inches to 3 inches of water) across spreader-stoker grates can aid in insuring good distribution of undergrate air even when fuel distribution on the grate is not ideal.

#### Control of Air Turbulence

Turbulent patterns of gas flow are brought about by position, direction, velocity, and mass-

flow rates of gases entering the furnace. High turbulence is obtained when the gases are sent into the furnace in swirling patterns from high-velocity nozzles. The position and the direction of the nozzles have strong influence on the flow pattern. These inlet nozzles usually are fixed, so operators have little or no control on the degree of turbulence in the furnace. Minor changes can be made to the turbulent-flow patterns by varying the ratio of overfire to underfire air. For most hogged fuel boilers, however, control of this variable in the combustion reaction is left to engineers and designers of boilers. Turbulence in existing boilers frequently can be improved by addition of properly located, high-velocity air nozzles.

#### Control of Flow Relations Between Forced-Draft and Induced-Draft Fan Systems

Forced- and induced-draft fan systems should be operated so as to provide a proper amount of excess air for good combustion. For most boilers fired with hogged fuel, an appropriate range would be from 40 percent to 75 percent excess air. Second, a slightly negative pressure in the furnace is desirable to keep the products of combustion in the furnace. This is particularly true of old furnaces that have many leakage points. Under such circumstances, excessive negative furnace draft adds undesirable infiltration air. On new furnaces with completely sealed exterior casings, to maintain negative furnace draft is not necessary. Third, these fan systems should maintain an adequate amount of turbulence in the combustion zone. Last, they should provide sufficient air to distribute fuel properly in spreader-stoker furnaces with pneumatic spreaders. Each of the criteria should be met throughout the full range of steam generating rates for the boiler. Further, the forced-draft and induced-draft systems must be able to respond to load variations rapidly.

If the criteria for these systems are to be met, the fan systems must be equipped with calibrated, automatic controls. An operator cannot make manual adjustments to control airflow dampers with the speed or accuracy that is required to maintain proper air balances throughout the full range of operating loads. The controls should be properly maintained. Regularly scheduled cleaning, lubricating, and calibration should be done by a

competent instrument technician. Operators should be intimately familiar with the capabilities of the control systems at their disposal and make full use of them.

**Maintenance of Boiler Components**

The foregoing discussion should make the reader aware that controlling the combustion process requires a substantial amount of complicated equipment. To gain high efficiency and low levels of air pollution requires:

Fuel sizing, drying, mixing, storage, and feeding equipment with special provisions for firing sand, dust, clinders, and auxiliary fuel.

A grate system with provisions for ash removal.

An air system with forced draft and induced draft fans, dampers, damper positioners, and controls.

An air preheater system.

Devices to reduce air pollution by removing particles in the flue gas.

Monitoring equipment to provide information for control of excess air.

A heat exchanger system, equipped with soot blowers, to avoid ash buildup in the gas passage.

Maintenance of these components is an important factor in achieving high efficiency and low emission levels. Without proper maintenance, the various parts of the system soon will fail to perform their intended functions.

Most maintenance needs are obvious. For example, sliding surfaces need regular lubrication. Without it, they eventually will stop sliding or be severely damaged. Other maintenance needs are not so obvious. For boilers fired with hogged fuels, two are of particular concern: boiler control systems and leakage of air into the system.

*Boiler control systems.* Most boiler control systems have pneumatic controls that are operated with compressed air and have low airflow rates. Maintenance problems arise because of contamination of the compressed air. Lubricating oil and condensed water collect in the air lines and are extremely effective in plugging lines and coating controls with a gummy, sticky surface. As an indication of the magnitude of the problem, a control panel, with air flowing at 1 cubic foot per minute through control lines, uses over 500,000 cubic feet of air a year. If an aftercooler is used on the compressor to remove 90 percent of the entrained water, the control panel may still have 5 gallons of water condensing in the lines each year. Mixed with cylinder lubricating oil, this forms a coating that can make a control system inoperative in from 4 to 2 years.

Two corrective measures are recommended. First, install a refrigerating and filtering system to remove the impurities. Second, provide cleaning and recalibration of the boiler controls regularly by a competent instrument technician. Major cleaning and recalibrating should be done at least every 2 years. This service is available from reputable contractors, if not readily available "in house."

*Leakage of air into the system.* Control of airflows throughout the boiler system is critical in maintaining good combustion. Any uncontrolled airflow into the process results in some loss of control of the process. As most furnaces and emission control devices are operated under slightly negative pressures, any opening in the system results in airflows into the system. Typical openings are open inspection ports, cracks in the furnace casing or setting, open cleanout doors, openings around soot blowers, cracks in the breaching and fan casings, and fuel chutes that allow passage of large airflows. These varied, uncontrolled sources of air should be sealed tightly.

## 7. POLLUTION CONTROL DEVICES

Air pollutants are classed either as gaseous pollutants or particulate pollutants. The combustion process generates both. Gaseous pollutants include carbon monoxide (CO), sulfur dioxide (SO<sub>2</sub>), oxides of nitrogen (NO<sub>x</sub>), and unburned hydrocarbon gases (HC).

Particulate pollutants are defined as any material that exists in the liquid or solid state under standard conditions of temperature and pressure and is emitted to the atmosphere by the process. Uncombined water is excluded from the definition because it is not generally considered an air contaminant. The definition, however, does include flyash, unburned carbon, condensed droplets of liquid hydrocarbons, and metallic salts. All of these materials are products of the combustion of hogged fuel.

Emissions of gaseous pollutants from boilers fired with hogged fuel are minimal and not of great concern, especially from well operated units. Regulations pertaining to these are discussed in Chapter 8. Pollution control devices generally are not installed on hogged fuel boilers to control gaseous combustion products.

Emissions of particulate pollutants can be substantial. Any major upset in stable combustion can generate large amounts of carbon and unburned hydrocarbons. Devices are installed on most boilers to capture these pollutants. The control devices generally fall into one of four categories: cyclone separators, scrubbers, baghouse filters, and electrostatic precipitators. Each of these will be discussed in detail.

Of the four categories, the cyclone and multiple cyclone devices are the most popular. They are the least expensive, require the smallest amount of physical room, have few moving parts to wear out, and, if properly designed and maintained, can be reasonably efficient. But, unless the combustion process is well controlled throughout the full firing range of a particular boiler so that resulting emissions are low, these control devices cannot guarantee to bring boilers into compliance with stringent emission regulations.

The recent trend in emission control devices is toward use of scrubbers in combination with cyclonic-type collectors. Many plants have somewhat antiquated boiler equipment, uncontrolled fuel moisture and size, and inadequate combustion controls. Faced with stringent emission regulations, this system seems to be least expensive in guaranteeing compliance. Baghouses and electrostatic precipitators generally are not considered practicable at this time and are used only rarely.

Meeting stringent air-pollution standards generally requires the use of one or more types of control devices. These varied devices do have limitations, however. If the combustion process is poorly controlled and generates excessive amounts of particulate material, the pollution control devices may be inadequate to keep the boiler within compliance. Combustion control is as important in meeting emission standards as are pollution control devices.

### Particle Characteristics

The effectiveness of pollution control devices depends to a large extent on characteristics of the particles they are trying to capture. Therefore, we should understand some of these characteristics when discussing control devices.

#### Size

Size seems to be a simple concept. When we want to know the size of something we generally measure it with a scale. In measuring small particles, the scale is in microns, which are units of length equal to 1/1,000,000 meter. A period from

a typewriter is about 850 microns in diameter. A typical particle of flyash might be 15 microns.

Flyash particles from a boiler may range from less than 1 micron to more than 100 microns. To determine particle size, many particles are measured and the results are averaged. Particle size may be stated as an average or mean size, or size may be expressed in terms of weight fractions with assumed shape and density.

#### Density

Density refers to how much a substance weighs per unit of volume. Water has a density of 62.4 pounds per cubic foot, but the density of air

is roughly 0.08 pound per cubic foot. Density of particles is important, because it affects the collection efficiency of pollution control devices. Low-density particles are more difficult to collect than high-density ones.

### Settling Velocity

The maximum speed that a particle can attain when it is falling through quiet air is its settling velocity. Large, dense particles, such as bricks, can achieve a high velocity. Cigarette smoke, on the other hand, contains very small particles and is not dense. This combination gives the appearance that smoke particles do not settle at all. Actually, they do settle, but very slowly. Particles that settle at less than 1 centimeter per second are considered to be aerosols.

### Resistivity

Resistivity of particles is related to their ability to carry electron charges. It is only of concern in the use of electrostatic precipitators as pollution control devices. Some particles can accept electron charges, others cannot. Hogged fuel flyash has only limited capability to accept electron charges because of its resistivity character.

### Adhesive Character

Some particles are naturally sticky. Under proper conditions of temperature and moisture, they will adhere to themselves and to other surfaces. Such particles may be easy to separate from an airstream, but difficult to remove from the control device. Most emissions from hogged fuel boilers present no such problems. Only high levels of unburned hydrocarbons present problems that are apt to be severe.

### Particle Strength

A major difficulty with fixed carbon particles is that they break easily into smaller particles. Mechanical processes where rubbing, abrasion, vibration, or crushing occurs can have a major effect on the size of carbon particles. This is of concern in control devices of systems for collecting and handling carbon.

Particle characteristics of size, density, settling velocity, resistivity, adhesive character, and

strength all have a bearing on the selection of appropriate particle-collection equipment. This will become apparent in discussion of the various control devices.

## Cyclone Separators

The most common particle-control device in use is the cyclone separator, which cyclonically separates particles from exhaust gases. As shown in Figure 15, the particle laden gas enters the top of the cyclone. The tangential inlet (or inlet guide vanes) spins the gas stream in a helical path down the inside. The particles in the gas stream are forced to deviate from a straight pathway as they rotate about the cyclone axis. Their resistance to

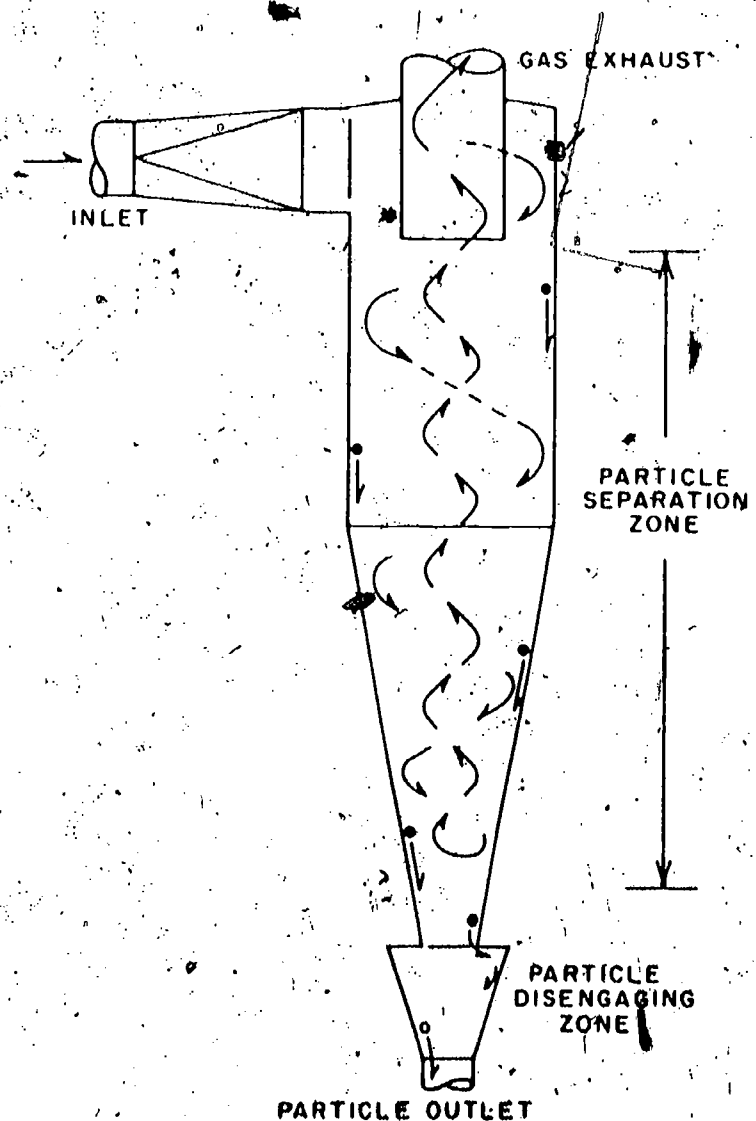

Figure 15. Cyclone collector for particles in flue gases (9).



change in direction causes the particles to migrate toward the cyclone walls. As they reach the walls, gravity and the downward motion of the gas stream carry them to the bottom. The gas stream changes direction as it approaches the bottom and goes toward the discharge in a return vortex.

Many factors affect cyclone efficiency. Six important ones are discussed here.

*Diameter of cyclone.* As cyclone diameter increases, particles must travel further through the air stream to reach the wall. Therefore, increasing diameter reduces collection efficiency.

*Length of cyclone.* As cyclone length increases, the gas has a longer residence time. Longer residence time means more time for the particles to move through the gas to the wall. Thus, increasing the length of the cyclone increases efficiency.

*Particle disengaging zone.* When particles reach the bottom of the cyclone, they drop out under the force of gravity. If a bin or collection chamber is at the bottom, the return vortex may dip into the bin and reentrain particles in the exit gas stream. To prevent this occurrence, some cyclones are equipped with disengaging zones at the outlet. As particles reach the bottom of the first cone, they drop into a second one. Their helical path sends them to the periphery of the second cone, away from the return vortex. This reduces the chance of reentrainment and increases cyclone efficiency.

*Flow rates of the gas stream.* Cyclones are designed to operate within a range of gas flow rates. If the gas flow rate is too low, the particles will not experience sufficient centrifugal force to separate them from the carrier gas. If, on the other hand, flow rates are too high, then energy is wasted in a drop in pressure across the unit, and the high flow rates may disrupt the return vortex configuration. This will reduce efficiency also. Manufacturers' design criteria should be followed to see that the cyclones are used within the specified range of gaseous flow rates.

*Push- or pull-through systems.* Cyclones can be operated either as push-through systems or, under vacuum conditions, as pull-through systems. Theoretically, there is little difference in efficiency. In practice, however, push-through systems are usually more efficient, because pull-through

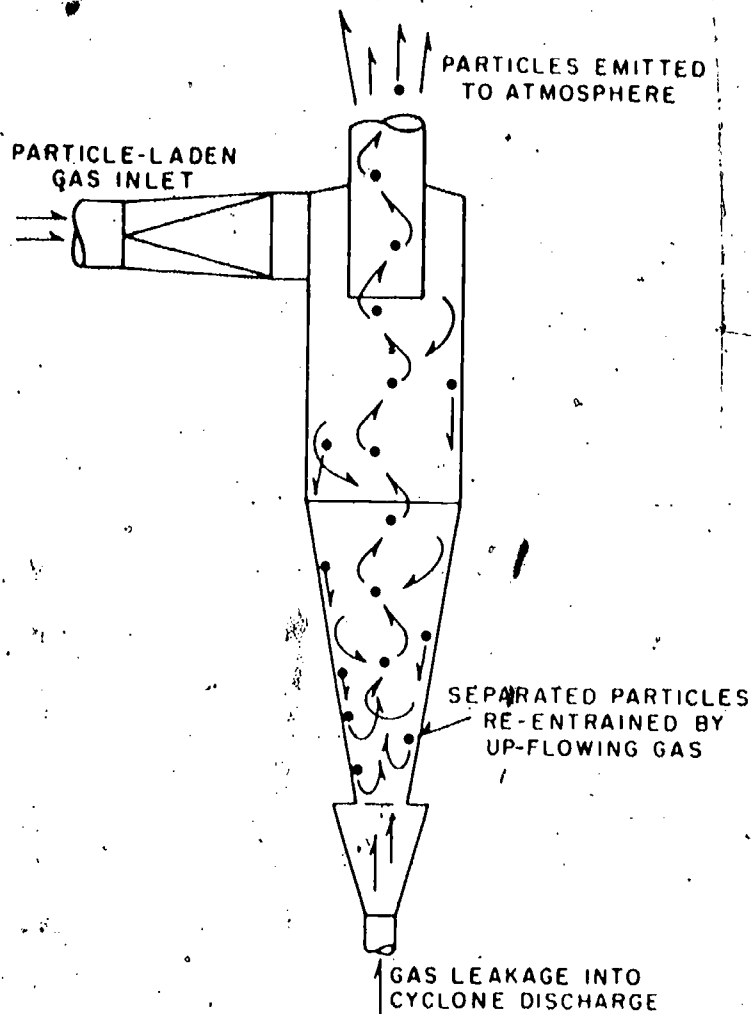

Figure 16. In pull-through cyclones, leakage through vacuum seals at the discharge point for particles will lead to their re-entrainment (9).

systems must have vacuum seals on the bottom of the cyclone where the particles are discharged. If leakage occurs on these seals, air will leak into the cyclone at this point and reentrain particles (Figure 16). Because leakage is likely to occur at some point on a pull-through system, such systems tend to be generally less efficient than push-through systems. On hogged fuel boilers, push-through systems subject the induced-draft fan to extensive abrasion from particles in the flue gas. Therefore, pull-through systems normally are used.

*Particle characteristics.* As noted previously, size and density of particles control their settling velocity. Particles that can settle rapidly out of an air stream are easily captured in a cyclone separator. They can cross airstream lines and reach the cyclone walls during the residence time of gas in

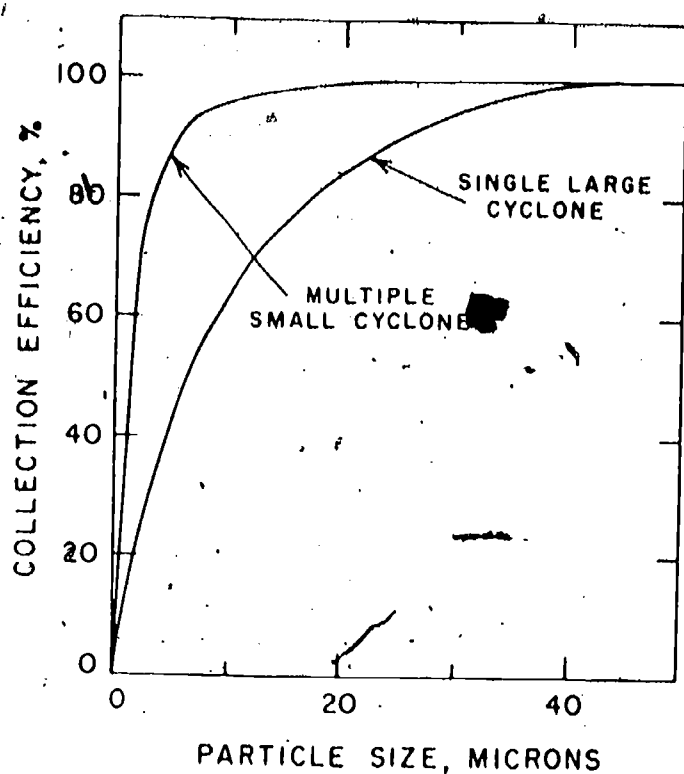

Figure 17. Relation of particle size to collection efficiency of cyclones (9).

the cyclone. On the other hand, small particles with low settling velocities may not be able to reach the cyclone walls in the brief time that the gas is in the cyclone. Figure 17 illustrates a typical curve of cyclone efficiency for various particle sizes. Note that for a typical cyclone, particles whose diameters exceed 40 microns have a 99 percent probability of being captured. Particles whose diameters are less than 10 microns have only a 64 percent probability of being captured. If this particular cyclone were used to separate sanderdust from an airstream and the mean size of the sanderdust was 7 microns, the cyclone efficiency would be about 53 percent.

**Plugging.** Pneumatic transport systems are designed to handle a continuous flow of material without plugging. Because of mechanical difficulties, however, most cyclones will plug on occasion. Whenever this occurs, the full concentration of incoming particulate matter is exhausted from the cyclone, usually to the atmosphere.

Although other factors can affect the collection efficiency of cyclones, these seven factors are the most significant and deserving of attention.

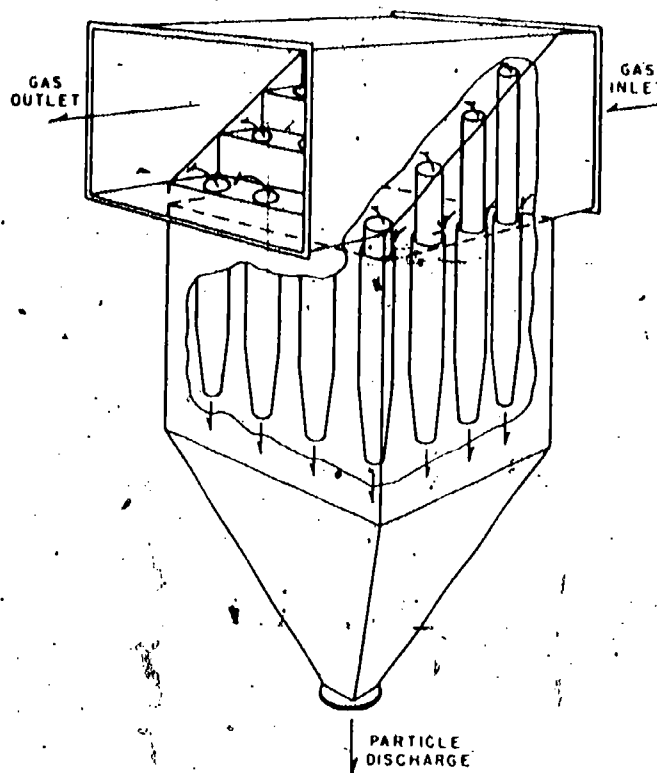

Figure 18. Simplified diagram of a multiple cyclone.

### Multiple Cyclones

Multiple cyclones are particle collection systems that have more than one cyclone, ducted in a parallel-flow arrangement. Usually, the term is applied to systems that contain from 50 to 250 small-diameter cyclones, enclosed in a single box. A typical multiple-cyclone installation is pictured in Figure 18. The inlet gas stream is ducted to a manifold cyclone inlet. The gas stream entering any individual cyclone is directed into a helical path through inlet guide vanes at the top of the cyclone. This path provides the centrifugal force to separate the particles from the gas stream. As with conventional large cyclones, the gas stream moves downward and then reverses its direction and exits the cyclone in a return vortex. Particles that are removed from the gas stream drop out of the bottom into a hopper or bin.

The purpose of using a multiple-cyclone system rather than one or two large cyclones is that multiple cyclones have much smaller diameters on each individual cyclone. This increases the efficiency of particle collection, particularly with

small particles. Many small cyclones are required to handle a large gas flow because of the flow limitations of each small unit. Figure 17 illustrates a typical collection-efficiency curve for multiple cyclones compared to standard large cyclones.

The factors that affect efficiency of a multiple-cyclone installation are much the same as those that affect efficiency on large single units. There are other considerations, however.

Most multiple-cyclone installations on hogged fuel boilers are installed upstream from the induced-draft fan. This is done so that air entering the fan will be clean, thereby limiting erosion on the fan. This means, however, that most of the multiple-cyclone installations are operated under vacuum conditions. Therefore, any leakage in the bin or collection hopper at the bottom of the cyclones will result in reentrainment of the particles and lower collection efficiency. Particular attention should be paid to sealing inspection ports.

Leakage into a collection hopper not only reduces efficiency, it also increases the danger from fires in the hopper. The gas stream in multiple cyclones is usually oxygen deficient, because it has just come from a furnace and combustion process. The hot bits of unburned carbon usually will burn rapidly, if subjected to a stream of fresh air from a leak in the hopper.

Removal of material from the hopper must be able to keep up with the rate of input. If not, the hopper will plug and eventually the individual cyclones also. Most hoppers have inspection ports or other means of noting when the system plugs. Individual cyclones also can plug, especially if they are of small diameter.

A great disadvantage in the design of multiple cyclones is that they are encased in a metal box that prevents regular, visual inspection of each of the cyclones inside. Because the material that they remove from the exhaust gases contains small amounts of ash and sand, abrasive damage to individual cyclones is a common problem. Multiple cyclones can be eroded completely without operators being aware of their condition. To keep them in good working condition, a regular, visual inspection of each cyclone is recommended. This is, of course, difficult to do when the boiler must be

kept in service continuously with minimum shut-down time.

Uneven gas distribution to multiple cyclones can decrease their efficiency. Substantial variations in inlet pressures from one point in the multiple-cyclone box to another will result in improper flow patterns of the flue gases. Flue gases will flow out of the bottom of a few individual cyclones, into the hopper, and back up through the bottom outlets of other cyclones, with substantial reentrainment resulting.

### Scrubbers

As noted previously, small particles with low settling velocities are difficult to capture in cyclone separators. Large particles can be captured with relative ease. One approach to particle control is to trap small particles on the surface of large particles, such as liquid droplets, and then collect the large particles. This is done in devices referred to as scrubbers, or "wet scrubbers," as most scrubbers use a liquid to capture the particles.

The design of scrubbers seeks to optimize three parameters: surface area of the liquid, contact between particles and liquid, and collection of the liquid.

Surface area of the liquid exposed to the particles can be maximized by spray showers (Figure 19), venturi scrubbers (Figure 20), and other systems that convert the liquid into small droplets. (Note: a gallon of water sprayed into droplets the size of a period has a surface area of about 300 square feet.) Alternative means of increasing the liquid surface area include water-curtain scrubbers and foam scrubbers.

The particles may be brought into contact with the exposed surface of the liquid as an integral feature of the scrubber. For example, in venturi scrubbers, the area just downstream from the throat of the nozzle is extremely turbulent. The turbulence increases the probability of contact of individual particles with liquid droplets. As another example, in spray-nozzle systems, increasing the pressure drop across the nozzles increases the velocity of droplets formed by the nozzles. The high-velocity droplets will impact upon particles carried in the gas stream. Some scrubbers use

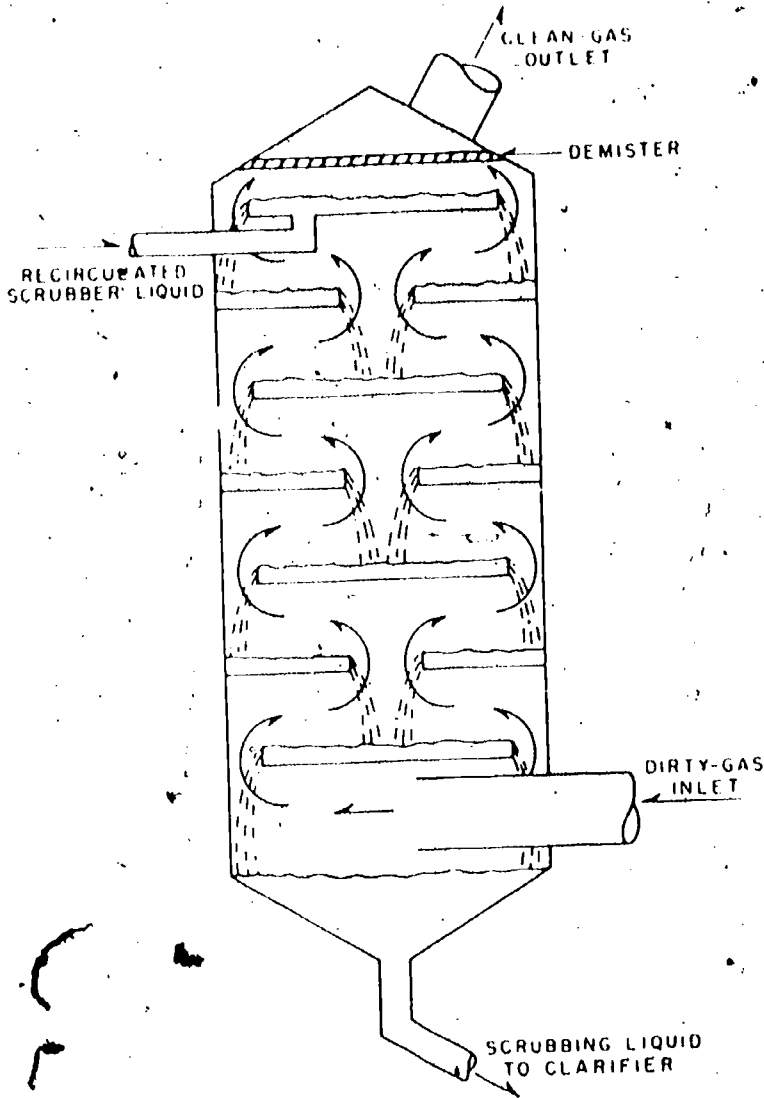

Figure 19. A cascading shower scrubber for increasing the efficiency of removing small particles from gases.

mechanical fans to aid in bringing the liquid into contact with particles in the gas stream.

Collecting the liquid in the most efficient manner is not difficult to accomplish because of the size of the liquid droplets. A properly designed cyclone system works well in conjunction with venturi scrubbers and spray-shower systems. Enclosed liquid-curtain scrubbers keep all of the liquid in the system, except for the portion that may go off as a vapor in the exit gas stream.

The liquid used in wet scrubbers is usually water. When the systems are applied to hogged fuel boilers, the resulting liquid will become basic, with a pH in the range 7.5-10. Evaporation of the scrubbing liquid will take place because of the heat

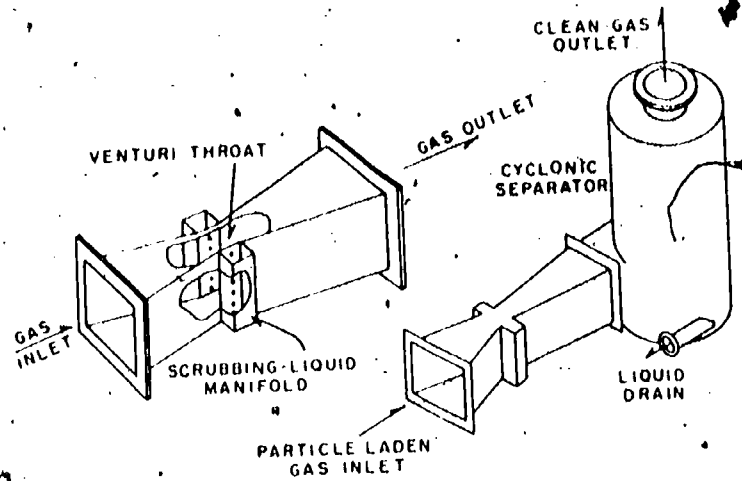

Figure 20. A venturi scrubber system in which turbulence downstream from throat increases the contact of particles and liquid droplets (10).

input of the incoming flue gas. The plume leaving a particular scrubber may be, but is not necessarily, saturated with water vapor. Water vapor in the exit gas will condense when it comes into contact with cool, ambient air. It forms tiny droplets that make the plume visible to the public. The visible plume from wet scrubber systems is a serious detriment because of the adverse public reaction regarding visible emissions.

Wet scrubber systems generally are divided into three classes, based upon the energy input to the system (Table 15). As expected, the collection efficiency of small particles generally increases with higher energy input to the system. The energy input, may be in the form of a drop in pressure across liquid spray nozzles, venturi sections, collection cyclones, or other devices.

Collection efficiencies for wet scrubbers extend over a wide range. For use on boilers fired

Table 15. Three Classes of Wet Scrubbers, Based on Energy Requirements.

Description	Pressure drop across the system
	In. water
Low	0-10
Medium	10-30
High	30-100

with hogged fuel, systems usually are designed to operate with overall collection efficiency ranging from 95 to 98 percent, expressed as a percentage by weight. Collection efficiencies will be higher for large particles and lower for small particles.

An advantage of wet scrubber installations for boilers is that they are not subject to fire damage. If hot sparks carry over to a wet scrubber, the liquid will quench the fire quickly. The obvious disadvantage of such systems is that they generate problems of water pollution. Once the particles are trapped in the scrubbing liquid, they must be removed and the liquid recirculated. Field experience indicates that the solid particles will settle out of the water in a reasonably brief time (for example, 30 minutes). Thus, clarifiers work well to settle the particulate, but they are expensive to construct. Solids disposal from the clarifiers is an associated problem. For example, a boiler with a capacity of 100,000 pounds per hour, using hogged fuel, may generate from 8 to 10 tons per day of solids in the exhaust gas stream. If this is collected in a wet scrubber, the solids from the clarifier will be in the form of a slurry, that is messy to handle and difficult to dispose of. It is extremely important in designing a wet scrubbing system to make adequate provisions for collection and disposal of the solids.

#### Baghouse Filters

Baghouse filters are not used extensively on boilers fired with hogged fuel, largely because of fire hazard.

Baghouse filters are containers filled with cylindrical bags made of cloth. The particle laden airstream enters the bags from the bottom. As the gas passes through the bags, the particles are trapped on the inside surface. Various systems have been designed to remove trapped particles. These include shaking, reversing the gas flow, impinging a high-velocity jet of air on the outside of the bag at regular intervals, and other techniques. In each system, the goal is to make the trapped particles fall out of the bag into a collection hopper.

Baghouse filters have the advantages of being extremely efficient, even for fine (sub-micron) particles. Their collection efficiencies commonly

are greater than 99 percent. They do not require a great deal of energy to operate. Pressure drops are normally less than 10 inches of water. They do not add liquid, so there is no visible plume and no water cleanup problem.

The disadvantages may outweigh the advantages. The bags are temperature limited. The upper limit of temperature is considered to be 600 F for most commercially available material. A small fire in the ash collection hopper, or a glowing ember in the flue gas, would cause extensive damage to a baghouse. If used downstream from an efficient multiple-cyclone collector, however, the combustible content of the material captured in a baghouse generally will be too low to support combustion in the baghouse. This potential for fire damage is the most critical disadvantage.

Baghouse life is limited by wear on the bags. The constant flexing or shaking action to remove collected particles shortens normal bag life to 18-24 months. This results in high maintenance costs.

Baghouses are generally large structures. Many plants do not have adequate room to locate this type of pollution control device.

Baghouses have high initial capital cost compared to alternative devices.

Baghouses must be fully insulated to avoid condensation inside the bags or on cool surfaces. This is particularly important where sulfur-bearing auxiliary fuels are used.

#### Electrostatic Precipitators

Electrostatic precipitators have been used widely to control particle emissions from combustion sources. They are rarely used on boilers fired with hogged fuel, however.

In operation, a negatively charged electrode runs parallel to a positively charged (grounded) plate (Figure 21). A large, direct-current voltage (that is, from 30,000 to 90,000 volts) is applied between the wire electrode and the plate. This brings about a flow of electrons through the gas from the wire to the plate. Particles entrained in the gas stream are bombarded by electrons traveling toward the positive plate. As electrons gather

BEST COPY AVAILABLE

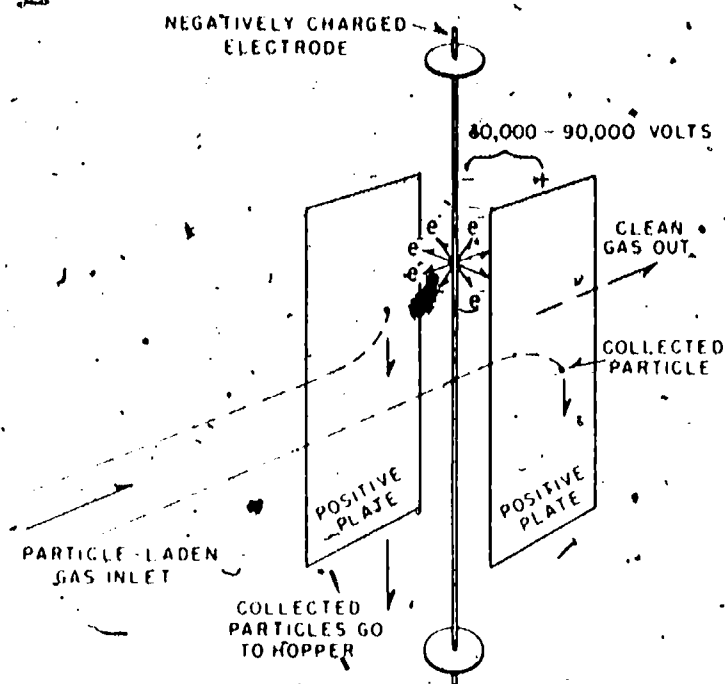

Figure 21. In an electrostatic precipitator, particles gain electrons from a negatively charged electrode, are attracted to positively charged plates, then shaken into a hopper.

on the individual particles, the particles take on a net negative charge. This net charge pulls the particles toward the plate, where they are collected.

Shaking or rapping devices are installed on the plates to dislodge the collected particles. They fall into a collection hopper below the plates.

Many factors affect collection efficiency in these units. One of the important factors is resistivity of the particles. If they have low electrical resistivity, such as that of carbon, they give up the negative charge to the positive plate and assume a positive charge. As like charges are repelled, carbon particles are pushed away from the plate and are reentrained in the gas stream. This substantially lowers collection efficiency.

On the other hand, if particles have high electrical resistivity, they will be unable to give up their negative electric charge. As the particles build up on the collecting plate, they can form an insulating barrier and even set up a net negative charge. Again, this reduces precipitator efficiency.

The emissions of flyash and unburned carbon from boilers fired with hogged fuel have low electrical resistivity. Electrostatic precipitators therefore have low collection efficiency. The efficiency can be increased by conditioning the particles with injection of a material that will alter resistivity to a more appropriate operating range. Sulfuric acid mist is used in some instances to accomplish this. Such solutions, however, present problems of corrosion to the equipment and increased potential for environmental pollution.

Electrostatic precipitators are large pieces of equipment and are costly to install. The combined factors of high capital cost and potential for low efficiency have resulted in limited use of these devices to control emissions from boilers fired with hogged fuel.

## 8. MEASUREMENT OF AIR-POLLUTANT EMISSIONS

Several different measurements can be made of air pollutant emissions from boilers fired with hogged fuel. For example, standard procedures have been developed to determine opacity, concentration of particular matter in grains per standard cubic foot (gr/SCF), mass-emission rate in pounds of particulate per hour, particle size distribution, and concentration of various pollutant gases such as carbon monoxide, nitrogen compounds, and sulfur dioxide.

These measurements are discussed individually in the next several sections, except for gaseous pollutants, which are not of primary concern when burning hogged fuel, as noted in Chapter 7.

### Opacity Measurement

The discussion in Chapter 5 deals with instruments that can monitor opacity. This can be done automatically and continuously with commercially available equipment. Most regulatory agencies, however, will not accept the chart records from such equipment as proof of compliance with opacity regulations. They require that the opacity be determined visually by a trained and certified person.

Two scales of measurement are commonly used. The Ringelmann Smoke Scale for use on black smoke emissions and the Opacity Scale for use on emissions of other colors. The relation of these two scales is as follows:

Ringelmann scale	Opacity scale
No.	%
0	0
1/2	10
1	20
1 1/2	30
2	40
2 1/2	50
3	60
3 1/2	70
4	80
4 1/2	90
5	100

Certification schools for smoke and opacity readings have been set up across the country. Classes are held throughout the year to meet the demand. In general, the classes consist of two separate sessions. The first is to learn the theory and limitations of the technique. The second is to gain field experience in actually reading plumes. Examinations are held at the end of each session to determine degree of competence. Recertification

of ability in smoke and opacity reading is required at intervals ranging from 6 months to 1 year. For information on such schools, contact the state regulatory agency.

### Concentration of Particulate Matter and Mass-Emission Rate

Measurement of the concentration of particulate matter is complex. There are no commercially available instruments that can do this continuously. It must be done on a "grab sample," in which a representative sample of the boiler emission is collected from the flue gas. The sample is analyzed by a procedure established by the U.S. Environmental Protection Agency (E.P.A.).

The specific procedure requires a minimum of \$4,000 in equipment to gather the sample. In addition, a substantial amount of laboratory equipment is required for the analyses. The process of sampling and analysis for a single complete E.P.A. test on a boiler at one operating level costs about \$2,000. A complete series of tests may cost as much as \$25,000. This complex process requires skilled technicians and engineers. It is much more than simply sticking a probe into an exhaust stack and reading a number.

Of particular concern in the procedure is the sampling location. The E.P.A. has recommended that sources be sampled at a location at least eight diameters downstream and two diameters upstream from the nearest source of disturbance to the airstream (5). This includes such parts as valves, bends, elbows, expansion joints, and tees. For many boiler installations, the recommended sampling location may be 100 feet up the smokestack. The cost of installing a sampling platform large enough to accommodate technicians and sampling

equipment on a smokestack may run into thousands of dollars. Such platforms should include adequate safety railings, toe railings, wind screens, and electric service outlets. They also should be equipped with some means of supporting a block-and-tackle hoist for raising and lowering the equipment.

There is a tendency to construct such platforms as temporary arrangements. Due consideration should be given to the fact that for each boiler test, several technicians will have to work about 2 days on the platform. The effects of exposure to heat, cold, wind, high elevation, and exhaustion demand that every safety precaution be provided.

The specified procedure is published in the Federal Register of December 23, 1971 (5). The same procedure is used to determine the mass-emission rate.

#### Particle Size Measurement

The procedure used to determine particle size has two steps. The first is to collect a representative sample of the particles and the second is to

analyze the sample. Like measurements of particle concentration, particle size measurement requires sophisticated equipment for collection and analysis, as well as skilled technical approaches.

Representative sampling for particulate matter can be achieved only if the particulate matter enters the sampling system at the same velocity as the airstream in which it is entrained. This is called isokinetic sampling.

Analysis of the collected samples usually is done with a microscope under laboratory conditions. A minimum of 100 particles should be measured to determine the size distribution of particles in each sample. Size is reported in terms of the percentage of particles smaller than a given size.

For particles collected in impaction systems, analyses for size and weight distribution may be carried out by weighing the samples of particles collected in each section of the impactor. This also allows a determination of mean size and size distribution of the particles, based on the weight distribution of the sample.



## 9. REGULATIONS PERTAINING TO EMISSIONS FROM BOILERS FIRED WITH HOGGED FUEL

Emission regulations are enforced by three levels of governmental agencies: the U.S. Environmental Protection Agency, state regulatory agencies, and local or regional agencies. Their enforcement programs are based on a permit system, which requires that any piece of equipment or process that generates or emits pollutant materials to the atmosphere must have a permit to operate. To obtain such a permit, one must demonstrate that the pollutant emissions will be lower than the maximum values established by the agencies. Further, before new equipment can be installed, the agencies must be satisfied that emissions from the equipment or process will not exceed the established standards. Some agencies' regulations include requirements that "best available technology" or "best available practical technology" be employed to control emissions. Some agencies also require that new installations include "advances in the art" of control of emissions. Interpretation of these requirements is frequently a controversial matter.

Actual emission standards vary somewhat from agency to agency. Most agencies have set standards regarding opacity, concentration of particulate matter, size of particulate matter, nuisance resulting from emissions of particulate matter, and emissions of sulfur dioxide. Some agencies have set standards on the mass of particulate that can be emitted, based on either an hourly rate or the rate of heat input to the boiler.

### Opacity Standards

Opacity standards generally are based on location of the installation and its age. For example, if a boiler is located in an area of high population density, the regulation may specify that opacity of the plume from the stack may not exceed 20 percent for more than 3 minutes of any hour. A boiler located in a more remote area may be subject to a limitation of 40 percent opacity.

In general, boilers that were installed and operating before 1970 and are located in areas of low population density are subject to the limitation of 40-percent opacity. New installations are subject to the 20-percent-opacity limitation for most agencies. Standards for Oregon and Washington are indicated in Table 16. Readers should obtain copies of current regulations that apply to their specific jurisdiction.

### Concentration of Particulate Matter

Regulations affecting allowable concentrations of particulate matter often are stated in terms of maximum grains per standard dry cubic foot of exhaust gas corrected to 12 percent carbon dioxide. This needs some explanation.

A grain is 1/7,000 pound. Most emission regulations have set either 0.10 or 0.20 grain per standard dry cubic foot (SDCF) as the maximum limit.

The term "standard dry cubic foot" is often confusing, because no agreement exists as to how standard conditions are defined. Most agencies agree that standard pressure equals 1 atmosphere, or 29.92 inches of mercury. Standard temperature is not agreed upon, however. It is variously stated as 32 F, 60 F, 68 F, 70 F, 0 C, or 20 C. The majority of the agencies accept 68 F or 20 C, which are equivalent.

The correction to 12 percent carbon dioxide is a linear correction to the measured concentration of particulate matter. It is made so that individual plants will not attempt to meet standards by diluting the emissions with clean air. For example, suppose boiler emissions were subject to a limitation of 0.10 gr per SDCF, and test showed a concentration of 0.15 gr per SDCF. One means of lowering the measured value is to add clean air at the base of the exhaust stack. By blowing in air at a rate equal to the rate of exhaust gas flow from the boiler, the concentration of particulate matter would drop to 0.075 gr per SDCF. At the same time, levels of carbon dioxide from the boiler would be diluted. By enforcing a correction to 12 percent carbon dioxide, the agencies assure that exhaust air is not diluted to meet emission standards.

The standards themselves are generally set at either 0.10 or 0.20 gr per SDCF. As with opacity

Table 16. Summary of Opacity Regulations in Oregon and Washington<sup>1</sup>.

Agency	Existing sources :		New sources
	Before 7-75	After 7-75	
	%	%	%
OREGON			
Oregon D.E.Q. <sup>2</sup>	40	40	20
Lane Regional A.P.A.	40	40	20
Mid-Willamette Valley A.P.A.	40	40	20
WASHINGTON			
Washington D.O.E. <sup>3</sup>	40	20	20
N.W. Washington A.P.A.	40	40	20
Olympic A.P.A.	40	20	20
Puget Sound A.P.A.	40	20	20
S.W. Washington A.P.A.	40	20	20
Spokane County A.P.A.	40	40	40
Tri-County A.P.A.	40	40	20
Yakima County A.P.A.	40	20	20

<sup>1</sup> Personal communication from M. Cory, Boise Cascade Corporation, Boise, Idaho. Mr. Cory contacted each agency listed and compiled their regulations.

<sup>2</sup> Special control areas restrict existing sources to 20%.

<sup>3</sup> May require a restriction to 20% opacity and 0.10 gr per standard cubic foot in sensitive areas.

standards, the level is based on location of the facility and on its age. Grain loading standards for Oregon and Washington are shown in Table 17.

#### Mass-Emission Rates

As an alternative to establishing limits on concentrations of particles in flue gases, some agencies have set limits on the pounds of material that may be emitted per hour or per million Btu's of heat input to the boiler. In general, the maximum values allowable vary with the size of the boiler. Larger boilers have the more stringent standards. For specific values applied to local plants, contact the regulatory agency that has jurisdiction over the particular plant in question.

#### Size of Particulate Matter

Some, but not all, agencies have established limits on the maximum size of particles that may be emitted by boilers. The limitation usually is set

at 250 microns. Its purpose is to avoid spreading large pieces of unburned carbon, which act as a soiling nuisance. Consideration now is being given to establishing regulations on the maximum concentration of smaller particles (that is, less than 10 microns). This is a result of studies indicating that smaller particles present the greatest hazard to human health.

#### Nuisance Regulations

Most agencies have a general regulation that pertains to nuisance emissions. The usual statement is to the effect that no process or operation shall emit materials that are a nuisance to the surrounding property or community. Such regulations are not directed specifically toward boilers fired with hogged fuel. They are referred to occasionally, however, if flyash or unburned carbon from a stack becomes a public nuisance.

BEST COPY AVAILABLE

Table 17. Summary of Particulate Concentration Standards in Oregon and Washington.

Agency	Existing sources		New sources
	Before 7-75	After 7-75	
	Gr <sup>2</sup>	Gr <sup>2</sup>	Gr <sup>2</sup>
OREGON			
Oregon D.E.Q.	0.2	0.2	0.1
Lane Regional A.P.A.	0.2	0.2	0.1
Mid-Willamette Valley A.P.A.	0.2	0.2	0.1
WASHINGTON			
Washington D.O.E.	0.2	0.2	0.2
N.W. Washington A.P.A.	0.2	0.2	0.1
Olympic A.P.A.	0.2	0.1	0.1
Puget Sound A.P.A.	0.2	0.2	0.1
S.W. Washington A.P.A. <sup>3</sup>	0.2	0.2	0.2
Spokane County A.P.A.	0.1	0.1	0.1
Tri-County A.P.A.	0.2	0.2	0.1
Yakima County A.P.A.	0.2	0.1	0.1

<sup>1</sup>Personal communication with M. Cory, Boise Cascade Corporation, Boise, Idaho. Mr. Cory contacted each agency listed and compiled their regulations.

<sup>2</sup>Grains per standard cubic foot.

<sup>3</sup>After 1975, best available control technology is required on all boilers. The regulation is only a guide to allowable emission levels.

#### Emission of Sulfur Dioxide

Hogged fuel contains low levels of sulfur. A typical analysis may show 0.080 percent by weight (2). Auxiliary fuel may be sulfur bearing, however,

and most agencies have placed limits on the allowable sulfur content of boiler fuels. Typical values are shown in Table 18.

Table 18. Regulations of the State of Oregon Pertaining to Allowable Sulfur Content in Auxiliary Fuels (12).

Fuel type	Maximum allowable sulfur
	%
Residual oil	2.5 before 7-74
Residual oil	1.75 after 7-74
No. 1 Dist. oil	0.3
No. 2 Dist. oil	0.5
Coal	1.0

## LITERATURE CITED

1. Babcock and Wilcox Co. New York. Steam, Its Generation and Use. 38th Ed. Chapter 15. 1972.
2. Brown, O. Energy Generation from Wood Waste. Technical paper presented at meeting of International District Heating Assoc., French Lick, Indiana. (Eugene Water & Electric Board, Eugene, Oregon.) June 20, 1973.
3. Combustion Engineering Corporation. Combustion Engineering. Otto DeLorenzi, ed. 1947.
4. Corder, S. E. Wood and Bark as Fuel. Res. Bull. 14. Forest Research Laboratory, Oregon State University, Corvallis. 28 p. 1973.
5. Federal Register. Vol. 36, No. 247, Part II. December 23, 1971.
6. Fick, O. Compliance vs. Control Monitoring Using Optical, In-Stack Opacity Monitors. Tech. Paper presented at meeting of Pacific N.W. International Section, Air Pollution Control Assoc., Seattle, Washington. November 1973.
7. Friedman, E., E. Tower, and R. B. Boals. The Effect of Storage on Douglas Fir Hugged Wood and Sawdust. Research Leaflet No. 3. Oregon Forest Products Laboratory. School of Forestry, Oregon State College, Corvallis. 15 p. May 1945.
8. Mingle, J. G. and R. W. Boubel. Proximate Fuel Analysis of Some Western Wood and Bark. Wood Science 1(1):29. July 1968.
9. Public Health Service. Air Pollution Engineering Manual. U.S. Public Health Service Publication No. 999-AP-40.
10. Sargent, G. D. Dust Collection Equipment. Chemical Engineering. P. 130-150. January 27, 1969.
11. State Of Oregon, Dept. of Environmental Quality, Emission Inventory Records-Computer Data Bank. January 1974.
12. State of Oregon, Dept. of Environmental Quality. Air Pollution Control Regulations. OAR 22-005 through OAR 22-015.
13. Van Berkum, R. A. Boiler Instrumentation, in the Environment of the '70's. Tech. Paper presented to the Instrument Society of America, Portland, Oregon. April 24, 1974.
14. Weyerhaeuser Company. Waste Wood Utilization for Energy. An in-house document of the Fuels and Combustion Section of Weyerhaeuser Company, Tacoma, Washington. October 1973.

Correspondence Courses  
Power Engineering

SECTION 2

STEAM GENERATORS

Second Class  
Lecture 5

FUELS and COMBUSTION

Heat Value of Fuels

The heating value of a fuel is most satisfactorily determined experimentally, using a calorimeter, since only by this method can the exact effect of all the constituents in the fuel be measured.

However, a reasonably accurate calculation can be made from the analysis of the fuel and the known heat release per kg of each of the combustible elements.

Heat Value by Calculation

Fuel analyses take two forms: the "Proximate" and the "Ultimate" analysis.

Proximate Analysis gives the percentages by mass of Volatile matter, Carbon, Ash and Moisture, and is of principal interest to those engaged in the practical operation of the boiler plant; more consideration will be given to this aspect in later lectures.

Ultimate Analysis gives the composition of the fuel in percentages of Nitrogen, Oxygen, Carbon, Ash, Sulphur and Hydrogen (as an aid to memory the initial letters of these constituents form the words "no cash").

NOTE: The Ultimate Analysis takes no account of the free moisture in the fuel as does the Proximate. In this case the sample is dried before commencing the analysis.

Usually a statement of heating value will accompany the chemist's report on the fuel analysis and will have been determined experimentally using a calorimeter.

A calculation of the heating value of the fuel can be made, if necessary from the Ultimate Analysis using the known heating values of each of the combustible materials as follows:

Carbon - When 1 kg of carbon is completely burned it liberates 33 890 kJ of heat.

Hydrogen - The complete combustion of 1 kg of hydrogen liberates 143 900 kJ of heat.

Sulphur - The complete combustion of 1 kg of sulphur liberates 9290 kJ of heat.

Any given fuel will liberate heat in proportion to the mass of each of these elements which it contains and the heat value can be calculated if the Ultimate analysis is known.

Example 1

Calculate the heat value of a coal having the following ultimate composition:

Carbon	..	65%
Hydrogen	..	4.7%
Ash	..	9.8%
Sulphur	..	0.5%
Nitrogen	..	1.8%
Oxygen	..	18.2%
		<u>100.0%</u>

Solution

Analysis are always expressed in percentages. This means that 100 kg of coal contains 65 kg of Carbon, 4.7 kg of Hydrogen, etc.

Heat from Carbon

One kg of carbon will liberate 33 890 kJ, hence 65 kg of carbon will liberate 33 890 x 65 kJ, or

$$\begin{aligned}
 H &= 33\ 890 \\
 C &= 33\ 890 \times 65 \\
 &= 22\ 028.50 \text{ kJ/100 kg} \\
 &= 22\ 028.5 \text{ kJ/kg of coal}
 \end{aligned}$$

Heat from Hydrogen

Some of the hydrogen in the coal is in the form of moisture or water, and therefore is not available for combustion and does not liberate any heat. Moisture (water or steam) is composed of 1 kg of hydrogen in chemical combination with 8 kg of oxygen, or 9 kg altogether. It is usual to consider that ALL the oxygen present is in the form of moisture with one-eighth of its own mass of hydrogen.

$$\begin{aligned}
 \text{Then, Hydrogen as moisture} &= 18.2 \div 8 \\
 &= 2.275 \text{ kg}
 \end{aligned}$$

(PE2-2-5-2)



Hydrogen, available for combustion = 4.7 - 2.275  
 = 2.425 kg  
 $H_h$  = 143 900 (H - 0/8)  
 = 143 900 x 2.275  
 = 327 372.5 kJ/100 kg  
 = 3 273.725 kJ/kg of coal

Heater from Sulphur

One kg of sulphur would liberate 9290 kJ, hence 0.5 kg will liberate

0.5 x 9290 = 4645 kJ, or  
 $H_s$  = 9290 x 0.5  
 = 4645 kJ/100 kg of coal  
 = 46.45 kJ/kg of coal

∴ Heat value of coal = 22 028.5 + 3 273.7 + 46.45  
 = 25 348.7 kJ/kg (Ans.)

It will be noted that the heat contributed by the sulphur in the majority of coals is negligible and as a rule is not considered. The heat from the hydrogen is small, while the carbon provides the greater part of the heat.

The heat value of the coal may also be obtained by using the Combined or DULONG'S FORMULA, as follows:

Heat Value  
 = 33 890C + 143 900 (H - 0/8) + 9290.S kJ/100 kg of coal  
 = 339C + 1439 (H - 0/8) + 93S  
 = 22 029 + 3274 + 46 = 25 349 kJ/kg of coal

Fuel Oil

The fuel oil used for steam generation is a refined crude from which a proportion of the lighter oils - gasoline, kerosene, etc - have been evaporated. Fuel oil is usually measured in terms of barrels, and weighs from 310 to 350 kg per barrel. In comparison with coal, oil occupies about 50% less space and is approximately 35% less in mass for equal heating value.

Constituents

Fuel oil consists of hydrocarbons similar to the volatiles in coal but which are liquids at atmospheric temperatures and pressures. The analysis of mineral fuel from different fields varies considerably:

Carbon	82 to 86%
Hydrogen	11 to 15%
Oxygen	0 to 3%
Sulphur	0 to 2%
Heat Value	43 000 to 45 000 kJ/kg

(PE2-2-5-3)



Calorific Value

The heat value of any oil may be calculated by the same methods as used for coal using DuLong's formula, though it is open to greater errors because of the wide range of hydrocarbons which may be in these fuels.

Advantages of Fuel Oil.

1. Higher heating value, approximately 35%.
2. Less storage space for equal heat values.
3. No dirt or dust; no fires to clean.
4. No loss in heat value due to storage deterioration.
5. Excess air is kept to a minimum.
6. Greater adaptability to load variations.
7. Less boiler room labor - no ash handling required.
8. High combustion efficiency.

Gas

Natural gas is being used increasingly for steam generation in power plants.

Constituents

Gas consists of a mixture of the lighter (or gaseous) hydrocarbons. A typical analysis may be:

By volume, Methane (CH <sub>4</sub> )	89.0%
Ethane (C <sub>2</sub> H <sub>6</sub> )	5.5%
Lighter hydrocarbons	4.5%
	100.0%

That is, 89 m<sup>3</sup> of CH<sub>4</sub> per 100 m<sup>3</sup> of gas, etc.

Heat Value

The heat value varies from 46 420 to 55 700 kJ/kg. It is more convenient to state the heat value in kJ/m<sup>3</sup>. The heat value per kg is constant but the heat value per m<sup>3</sup> varies as the mass per m<sup>3</sup> varies, depending upon its temperature and pressure. At the temperature and pressure existing in most districts, the heat value of natural gas is approximately 37 250 kJ/m<sup>3</sup> (at 16°C and 101.3 kPa.)

(PE2-2-5-4)



### Chemistry of Combustion

Combustion calculations depend upon four fundamental laws:

1. Conservation of Matter - Matter cannot be destroyed and cannot be created.
2. Conservation of Energy - Energy cannot be destroyed and cannot be created.
3. The Gas Law - The volume of a gas is directly proportional to its absolute temperature and inversely proportional to its absolute pressure.
4. The Law of Combining Masses - All substances combine only in accordance with a definite, simple relationship as to relative masses.

All matter, whether solid, liquid, or gaseous is composed of molecules and all molecules are composed of atoms.

THE MOLECULE IS THE SMALLEST PORTION OF MATTER THAT CAN EXIST ALONE.

THE ATOM IS THE SMALLEST PORTION OF MATTER CONSIDERED, but an atom cannot exist alone. Substances whose molecules consist of single atoms are termed monatomic; those whose molecules contain two atoms are diatomic.

Elementary molecules generally are composed of two atoms represented by symbols thus: Hydrogen  $H_2$ , Oxygen  $O_2$ , Nitrogen  $N_2$ , etc, which are all ELEMENTS or elementary substances.

Compounds are composed of atoms of two or more different elements such as: Carbon Monoxide  $CO$ , Carbon Dioxide  $CO_2$ , Oxide of Hydrogen  $H_2O$  (steam or water), etc.

The atoms of any element all have the same mass but the atoms of different elements have different masses:

		<u>Atomic Mass</u>
Hydrogen	..	1
Carbon	..	12
Oxygen	...	16
Nitrogen	..	14
Sulphur	..	32

NOTE: The above are relative or proportional masses and will be treated as kg-mass in this lecture.

(PE2-2-5-5)

Combinations of atoms always occur in simple and definite proportions of their atomic masses and are expressed by simple symbols, thus:

H<sub>2</sub>O means that two atoms of hydrogen (2 kg) have combined with one atom of oxygen (16 kg) to form one molecule (18 kg) of steam or water.

CO<sub>2</sub> means that one atom (12 kg) of carbon have combined with two atoms (32 kg) of oxygen to form one molecule (44 kg) of carbon dioxide.

The mass of the products resulting from a combustion reaction is always equal to the sum of the masses of the substances which enter the reaction.

The student should refer frequently to the foregoing definitions, especially for explanations of formulas which may present difficulties.

The source of supply of the oxygen necessary for combustion is the air. The proportions by mass of oxygen and nitrogen are

$$O_2 = 23.2\% \text{ and } N_2 = 76.8\%.$$

Therefore to supply 1 kg of oxygen requires  $\frac{1}{0.232} = 4.31$  kg of air. This 4.31 kg of air is composed of 1 kg of O<sub>2</sub> and 3.31 kg of N<sub>2</sub>. The nitrogen, of course, serves no useful purpose in combustion.

Combustion of Carbon

An atom of carbon may combine with:

- (1) two atoms of oxygen to form carbon dioxide (CO<sub>2</sub>), or
- (2) with one atom of oxygen to form carbon monoxide (CO).

Expressing these as formulas:

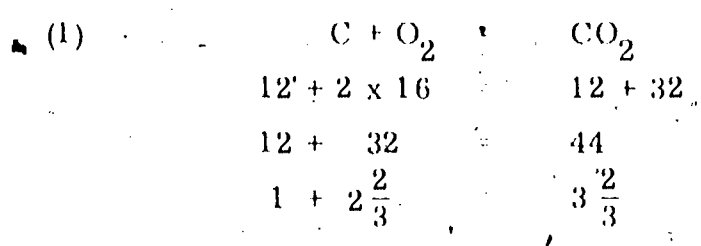

When 1 kg of carbon is completely burned with 2  $\frac{2}{3}$  kg of oxygen it produces 3  $\frac{2}{3}$  kg of CO<sub>2</sub> and liberates 33 890 kJ of heat. It will be obvious that any mass of CO<sub>2</sub> must be composed of  $\frac{12}{44} \times 100 = 27$ ; 27% by mass of carbon and 72.73% by mass of oxygen, or

$$1 \text{ kg CO}_2 = 0.2727 \text{ kg C} + 0.7273 \text{ kg O}_2$$

that is, a ratio of carbon to O<sub>2</sub> of 1 : 2.667

(PE2-2-5-6)



- 7 -

If 1 kg of O<sub>2</sub> is contained in 4.31 kg air it will be necessary to supply for complete combustion of 1 kg of carbon:

$$2.667 \times 4.31 = 11.493 \text{ kg of air.}$$

This amount will contain N<sub>2</sub>

$$2.667 \times 3.31 = 8.827 \text{ kg N}_2$$

Thus in the complete combustion of 1 kg of carbon the resulting products of combustion will be:

$$1 \text{ kg C} + 2.667 \text{ kg O}_2 = 3.667 \text{ kg CO}_2$$

$$\text{and } 2.667 \times 3.31 \text{ kg N}_2 = 8.827 \text{ kg N}_2$$

$$\text{Total mass of flue gas} = 12.494 \text{ kg}$$

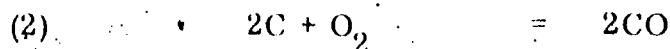

$$12 + 16 = 28$$

$$1 + 1\frac{1}{3} = 2\frac{1}{3}$$

When 1 kg of carbon burns incompletely with only  $1\frac{1}{3}$  kg (too little) of O<sub>2</sub> it produces  $2\frac{1}{3}$  kg of CO and liberates 10 305 kJ of heat.

If the CO formed goes up the stack it carries away with it 33 890 - 10 305 = 173 585 kJ of heat which is all wasted.

Any mass of CO must be composed of  $\frac{12}{28} \times 100 = 42.86\%$  by mass of carbon and  $57.14\%$  by mass of oxygen, or

$$1 \text{ kg CO} = 0.4286 \text{ kg C} + 0.5714 \text{ kg O}_2$$

that is, a ratio of carbon to O<sub>2</sub> of 1 : 1.333

Air required to burn 1 kg of C to CO

$$1.333 \times 4.31 = 5.745 \text{ kg of-air}$$

Thus, in the incomplete combustion of 1 kg of carbon to CO, the resulting products of combustion will be:

$$1 \text{ kg C} + 1.333 \text{ kg O}_2 = 2.333 \text{ kg CO}$$

$$\text{and } 1.333 \times 3.31 \text{ kg N}_2 = 4.412 \text{ kg N}_2$$

$$\text{Total mass of flue gas} = 6.745 \text{ kg}$$

(PE2-2-5-7)

Combustion of Hydrogen

Two molecules of hydrogen (four atoms) combine with one molecule of oxygen (two atoms) to form two molecules of water.

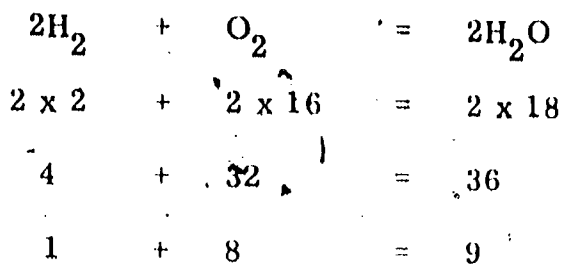

When 1 kg. of  $\text{H}_2$  is burned with 8 kg of  $\text{O}_2$  it produces 9 kg of  $\text{H}_2\text{O}$  and liberates 143 900 kJ of heat.

Any mass of  $\text{H}_2\text{O}$  must be composed of  $\frac{4}{36} \times 100 = 11.1\%$  by mass of  $\text{H}_2$  and 88.9% by mass of  $\text{O}_2$

$$\text{or } 1 \text{ kg } \text{H}_2\text{O} = 0.111 \text{ kg } \text{H}_2 + 0.889 \text{ kg } \text{O}_2$$

that is a ratio of  $\text{H}_2$  to  $\text{O}_2$  of 1 : 8.

Air required to burn 1 kg of  $\text{H}_2$  to  $\text{H}_2\text{O}$

$$8 \times 4.31 = 34.48 \text{ kg of air}$$

Thus in the combustion of 1 kg of  $\text{H}_2$  to  $\text{H}_2\text{O}$ , the resulting products of combustion will be:

$$\begin{array}{rcl}
 1 \text{ kg } \text{H}_2 + 8 \text{ kg } \text{O}_2 & = & 9 \text{ kg } \text{H}_2\text{O} \\
 \text{and } 8 \times 3.31 \text{ kg } \text{N}_2 & = & 26.48 \text{ kg } \text{N}_2 \\
 \text{Total mass of flue gas} & = & 35.48 \text{ kg}
 \end{array}$$

Combustion of Sulphur

In a similar manner to the above:

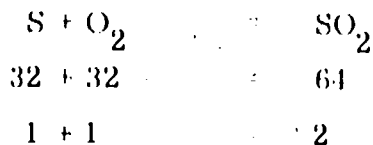

When 1 kg of S is burned with 1 kg of  $\text{O}_2$  it produces 2 kg of  $\text{SO}_2$  and liberates 9290 kJ of heat.

Any mass of  $\text{SO}_2$  must be composed of  $\frac{32}{64} \times 100 = 50\%$  by mass of S and 50% by mass of  $\text{O}_2$ , or

$$1 \text{ kg } \text{SO}_2 = 0.5 \text{ kg } \text{S} + 0.5 \text{ kg } \text{O}_2$$

that is a ratio of S to  $\text{O}_2$  of 1 : 1

Air required to burn 1 kg of S to  $\text{SO}_2$ :

$$1 \times 4.31 = 4.31 \text{ kg of air.}$$

(PE2-2-5-8)

Thus in the complete combustion of 1 kg of S to SO<sub>2</sub>, the resulting products of combustion will be:

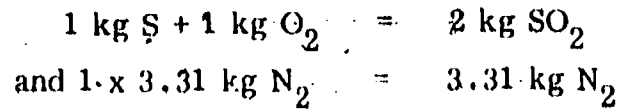

Total mass of flue gas = 5.31 kg

In a similar manner by applying the Law of Combining Masses, the proportions required for the combustion of any hydrocarbon can be quickly calculated, since the ratio of C to H<sub>2</sub> is known and each can be calculated separately as a fraction of the whole (assumed as 1 kg).

From the foregoing calculations Table 1 has been computed. In the case of methane and ethane the student will find it of great value to calculate the data for himself, checking his results against those given in the table.

Table 1

Combustion Data tabulated in kg/kg of Fuel

	Molecular Symbol	Theoretically required kg		Products of Combustion kg				
		O <sub>2</sub>	Air	CO <sub>2</sub>	H <sub>2</sub> O	N <sub>2</sub>	CO	SO <sub>2</sub>
Carbon (to CO <sub>2</sub> )	C	2.67	11.49	3.67	--	8.82	--	--
Carbon (to CO)	C	1.33	5.75	--	--	4.42	2.33	--
Carbon Monoxide	CO	0.57 <sup>b</sup>	2.46	1.57	--	1.89	--	--
Hydrogen	H <sub>2</sub>	8.00	34.48	--	9.00	26.48	--	--
Sulphur	S	1.00	4.31	--	--	3.31	--	2.00
Methane	CH <sub>4</sub>	4.00	17.24	2.75	2.25	13.24	--	--
Ethane	C <sub>2</sub> H <sub>6</sub>	3.73	16.09	2.93	1.80	12.36	--	--

Table 2

Combustion Data tabulated in m<sup>3</sup>/m<sup>3</sup> of Fuel

	Molecular Symbol	Theoretically required m <sup>3</sup>		Products of Combustion m <sup>3</sup>				
		O <sub>2</sub>	Air	CO <sub>2</sub>	H <sub>2</sub> O	N <sub>2</sub>	CO	SO <sub>2</sub>
Carbon Monoxide	CO	0.5	2.38	1	--	1.88	--	--
Hydrogen	H <sub>2</sub>	0.5	2.38	--	1	1.88	--	--
Methane	CH <sub>4</sub>	2.0	9.52	1	2	7.52	--	--
Ethane	C <sub>2</sub> H <sub>6</sub>	3.5	16.67	2	3	13.17	--	--

(PE2-2-5-9)

The derivation of Table 2 requires the application of "Avogadro's Hypothesis" which states

**EQUAL VOLUMES OF DIFFERENT GASES AT THE SAME TEMPERATURE AND PRESSURE WILL CONTAIN EQUAL NUMBERS OF MOLECULES.**

If this is so, then one molecule of any gas must occupy the same volume. Further, some standard volume could be chosen which would just contain the molecular mass of each gas.

For example, hydrogen has a molecular mass 2.016 at standard temperature and pressure (101.3 kPa and 0°C). 2.016 kg of H<sub>2</sub> will occupy V m<sup>3</sup>.

$$\begin{aligned} \text{where } V &= \frac{wRT}{P} \text{ m}^3 \\ \text{and } w &= 2.016 \text{ kg} \\ R &= 4124 \text{ J/kg K (The Characteristic Constant for Hydrogen)} \\ T &= 0 + 273 \text{ K} \\ P &= 101.3 \times 1000 \text{ Pa} \\ V &= \frac{2.016 \times 4124 \times 273}{101.3 \times 1000} = 22.4 \text{ m}^3 \end{aligned}$$

Similar calculations if carried out for different gases will always give this figure of 22.4 m<sup>3</sup> if the mass of gas considered is the molecular mass of that gas expressed in kg.

This standard volume of gas is termed 1 kg Mole.

In the case of hydrogen, Table 1 states that 1 kg of H<sub>2</sub> requires 8 kg of O<sub>2</sub> for complete combustion.

Now since 1 kg of any gas occupies

$$W \times \frac{22.4}{\text{mol wt}} \text{ m}^3 \quad \text{where } W = \text{mass of gas in kg}$$

$$1 \text{ kg of H}_2 \text{ will occupy } \frac{1 \times 22.4}{2} = 11.2 \text{ m}^3$$

$$8 \text{ kg of O}_2 \text{ will occupy } \frac{8 \times 22.4}{32} = 5.6 \text{ m}^3$$

$$\text{Checking with Table 2, } 1 \text{ m}^3 \text{ of H}_2 \text{ will require } \frac{5.6}{11.2} = 0.5 \text{ m}^3 \text{ of O}_2$$

If it is desired to find the volume of a gas at a different temperature or pressure, application of the Gas Law will give the desired results.

From Table 1 a simple formula may be constructed for the air theoretically required for the perfect combustion of any fuel. This is expressed in terms of kg of air per kg of fuel as follows:

$$\text{Air required} = \frac{1}{100} \left[ 11.49C + 34.48 \left( \text{H}_2 - \frac{\text{O}_2}{8} \right) + 4.31S \right]$$

Example 2

Calculate the air theoretically required for a coal of the following analysis

(dry):	Carbon	..	69.3%
	Hydrogen	..	4.2%
	Oxygen	..	7.5%
	Nitrogen	..	1.1%
	Sulphur	..	0.6%
	Ash	..	17.3%
			<u>100.0%</u>

(PE2-2-5-10)

Moisture (not included in the analysis) was found to be 2.1%.

Solution

$$\begin{aligned}
 \text{Air required} &= \frac{1}{100} \left[ 11.49C + 34.48 \left( H_2 - \frac{O_2}{8} \right) + 4.31S \right] \\
 &= \frac{1}{100} \left[ 11.49 \times 69.3 + 34.48 \left( 4.2 - \frac{7.5}{8} \right) + 4.31 \times 0.6 \right] \\
 &= \frac{1}{100} [796 + 112.5 + 2.6] \\
 &= 7.96 + 1.125 + 0.026 \\
 &= \underline{9.111 \text{ kg of air/kg of coal (Ans.)}}
 \end{aligned}$$

While this formula is accurate enough for most purposes, calculations involving each of the component parts of any fuel set out in tabulated form below, gives a more accurate and clear picture of the processes involved in the combustion process.

Method of Working

C	-	0.693	O <sub>2</sub>	=	2.667	x	0.693	=	1.848
			Air	=	11.493	x	0.693	=	7.964
			CO <sub>2</sub>	=	3.66	x	0.693	=	2.536
			N <sub>2</sub>	=	8.827	x	0.693	=	6.117
H <sub>2</sub>	-	0.042	O <sub>2</sub>	=	8	x	0.042	=	0.336
			Air	=	34.48	x	0.042	=	1.448
			N <sub>2</sub>	=	26.48	x	0.042	=	1.112
			H <sub>2</sub> O	=	9	x	0.042	=	0.378
S	-	0.006	O <sub>2</sub>	=	1	x	0.006	=	0.006
			Air	=	4.31	x	0.006	=	0.026
			N <sub>2</sub>	=	3.31	x	0.006	=	0.020
			SO <sub>2</sub>	=	2	x	0.006	=	0.012

Tabulation

	Mass/kg of Cpal kg	Required-kg		Products of Combustion - kg/kg Coal				
		O <sub>2</sub>	Air	CO <sub>2</sub>	O <sub>2</sub>	N <sub>2</sub>	H <sub>2</sub> O	SO <sub>2</sub>
C	0.693	1.848	7.964	2.536	--	6.117	--	--
H <sub>2</sub>	0.042	0.336	1.448	--	--	1.112	0.378	--
O <sub>2</sub>	0.075	--	--	--	0.075	--	--	--
N <sub>2</sub>	0.011	--	--	--	--	0.011	--	--
S	0.006	0.006	0.026	--	--	0.020	--	0.012
Ash	0.183	--	--	--	--	--	--	--
Totals		2.190	9.438	2.536	0.075	7.260	0.378	0.012
O <sub>2</sub> in coal		0.075	0.323	--	0.075	0.248	--	--
Totals		2.115	9.115	2.536	0.000	7.012	0.378	0.012
SO <sub>2</sub> as CO <sub>2</sub>		--	--	0.012	--	--	--	0.012
Total		2.115	9.115	2.548	0.000	7.012	0.378	0.000

(PE2-2-5-11)

From the totals it is now necessary to subtract the O<sub>2</sub> originally in the coal as well as the air and the N<sub>2</sub> equivalent of this oxygen.

The SO<sub>2</sub> in the flue gas appears as CO<sub>2</sub> in the analysis (as will be explained in the following material) so therefore is next added to the CO<sub>2</sub>.

The last line gives the final totals. Note that the total air required is now 9.115 kg/kg of fuel compared to 9.111 kg as given by the formula, an error which is negligible.

Excess Air Calculations

Since in the operation of a boiler, theoretical conditions are never attained, it is important that the foregoing calculations be tied in with practical conditions.

The mass of air theoretically required for the combustion of one kg of dry coal is (from the above tabulation) 9.115 kg. For each 20% in excess of this amount (that is, each 1.823 kg above 9.115) there will appear in the products of combustion:

$$1.823 \times 0.232 = 0.423 \text{ kg O}_2$$

$$1.823 \times 0.768 = 1.4 \text{ kg N}_2$$

Table 3 has been tabulated for varying amounts of excess air:

Table 3

	Mass of Products of Combustion kg	Mass of Products varying amounts of Excess Air - kg				
		20%	40%	60%	80%	100%
CO <sub>2</sub>	2.548	2.548	2.548	2.548	2.548	2.548
O <sub>2</sub>	0.000	0.423	0.846	1.269	1.692	2.115
N <sub>2</sub>	7.012	8.414	9.816	11.218	12.620	14.022
H <sub>2</sub> O	0.378	0.378	0.378	0.378	0.378	0.378
Total	9.938	11.763	13.588	15.413	17.238	19.063

In order to be of practical value it is necessary to calculate for percentage volume of dry products of combustion, since in furnace efficiency tests the content of the flue gases is given in percentage volume. Also the water content cannot be measured because the analyses is made at room temperature, thus the water will have condensed.

While the further calculations necessary to establish excess air charts, theoretical furnace temperatures, etc. are beyond the scope of this course, nevertheless the foregoing material covers the basic theory necessary to enable the engineer to understand their derivation.

(PE2-2-5-12)



## THE COMBUSTION PROCESS

Much research has been carried out and many theories have been advanced to fit the facts observed in experiments in the chemical lab and the plant. The following facts may be utilized to give indication of what is occurring during the combustion of a fuel.

Hydrogen burns with a colorless flame  
Carbon Monoxide burns with a light-blue flame  
Carbon burns with a white luminous flame  
Sulphur tends to color the flame yellow.

### The Elementary Combustibles

All fuels are complex substances containing many different combustible and some incombustible compounds. These combustibles may be divided into three groups of elementary combustibles which have similar combustion characteristics:

- (1) Solid Carbon
- (2) Gaseous Hydrocarbons
- (3) Carbon Monoxide and Hydrogen.

#### (1) Solid Carbon

Approximated by coke, charcoal, and anthracite containing a minimum of volatile, moisture and ash.

Pure carbon unites with  $O_2$  from the air forming  $CO_2$ , CO and a complex oxide of carbon ( $C_xO_y$ ) which breaks down readily on contact with more  $O_2$  into  $CO_2$  or CO.

More of the product of incomplete combustion (CO) is formed at low temperatures and more of the product of complete combustion ( $CO_2$ ) at high temperatures. The  $CO_2$  formed may be reduced to CO by contact with hot carbon. The amount of reduction depends on the quantity of  $O_2$  (air) present, the time of contact and the temperature of the air and carbon.

#### (2) Gaseous Hydrocarbons

These form the chief constituents of Natural Gas, Fuel Oil, and the volatiles in coal. They vary considerably in quality from the very heavy volatiles (tars) given off from bituminous coals to the very light gases which constitute natural gas. The heavier hydrocarbons of fuel oils and coals are vaporized by heat (or gasified) before combustion. They may be completely burned in one or both of two ways:

- (a) By decomposition into carbon (soot) and hydrogen when heated. The  $H_2$  burns readily and the soot also will burn if the furnace temperature is high and there is an ample supply of oxygen present. The soot formed is a complex molecule of carbon of not less than 12 atoms, or  $C_{12}$ , which must contact with 12 molecules of  $O_2$  in order to be burned. Experiment shows that if this carbon is not burned within one foot of the surface of the firebed it is very unlikely that it will be burned at all but will deposit on the heating surfaces as soot.

- (b) The heavy hydrocarbon may pick up successive atoms of oxygen which change it into a lighter compound after each such addition. This process is very rapid at high temperatures if sufficient  $O_2$  is present and causes neither soot nor smoke. There is a race between these two processes in the burning of all hydrocarbons. A combination of high temperature, oxygen in excess, thorough mixing and time of contact favors the second (b) which is the one desired, as neither smoke nor soot results.

Decomposition, with formation of soot and smoke will take place if any one of these factors, especially oxygen, is absent.

(3) Carbon Monoxide and Hydrogen (CO and  $H_2$ )

These are the constituents of most artificial gases. Also during the combustion of carbon, CO may be formed while CO and  $H_2$  may be liberated when hydrocarbons are burned.

If burned at atmospheric pressure at any temperature between  $760^{\circ}C$  and  $1540^{\circ}C$ , with an excess of  $O_2$ , they burn directly to  $CO_2$  and  $H_2O$  in accordance with formulas given earlier in this lecture.

Hydrogen burns about three times as rapidly as CO.

Combustion of Natural Gas

Natural gas is an easy fuel to burn because the hydrocarbons of which it is composed are in such a finely divided state (as gas) that the air necessary for combustion can mix freely and intimately with them.

Its hydrocarbons may:

- (a) Burn directly into  $CO_2$  and  $H_2O$ .
- (b) Decompose into C and  $H_2$ , or
- (c) Decompose into CO and  $H_2$ , as explained above.

Lack of air in premixing, or only a small proportion of the total air required with the gas, results in a long white flame, indicating that solid carbon particles are being heated to incandescence in the flame and that the gas or some part of it has been decomposed into C and other constituents as already shown.

As a larger proportion of the necessary air is premixed the flame shortens and becomes blue in color with a hard intense-blue centre cone surrounded by a softer envelope of a lighter blue, indicating that the hydrocarbons have been broken down into CO and  $H_2$  by combination with the larger proportion of  $O_2$  present and that the CO and  $H_2$  are burning simultaneously into  $H_2O$  and  $CO_2$ .

There is a limit to the quantity of air that may be premixed for any given burner, at which the flame either blows away from the tip or flashes back into the mixing pipe or chamber. With a white flame, soot is being formed which will burn to  $CO_2$  if the temperature is high enough and sufficient air is present around the flame. If insufficient air is present this soot will cool and deposit when it reaches the heating surfaces of the boiler.

(PE2-2-5-14)

It is important to appreciate that soot is formed in the flame or at the burner and not at the heating surfaces on which it deposits and that it can be prevented only by changing combustion conditions so that it will be consumed either within or quite close to the flame.

The only direct evidence of the relative efficiencies of the two types of gas burners - those which premix a large part and those which premix none or only little of the total air required - is by the boiler efficiency obtained. About equal efficiencies appear to be obtained by both methods provided the furnace is designed for the burner being used.

Combustion of Oil

Oil can be vaporized into the gases of its component hydrocarbons if the temperature is sufficiently high. This is seldom the case in the short time available in the combustion chamber.

In practice the oil is atomized into extremely small portions so as to present more surface for collecting heat and so promoting vaporization.

The majority of oil burners produce a white flame which indicates that some solid carbon is burning separately.

Combustion of Coal

This is a much more complex process than the combustion of either gas or oil, and generally requires a much higher draft pressure to force the air through the firebed and a larger supply of air because of the impossibility of any premixing of the fuel and air.

There are two distinct stages necessary for complete combustion of solid fuels on grates:

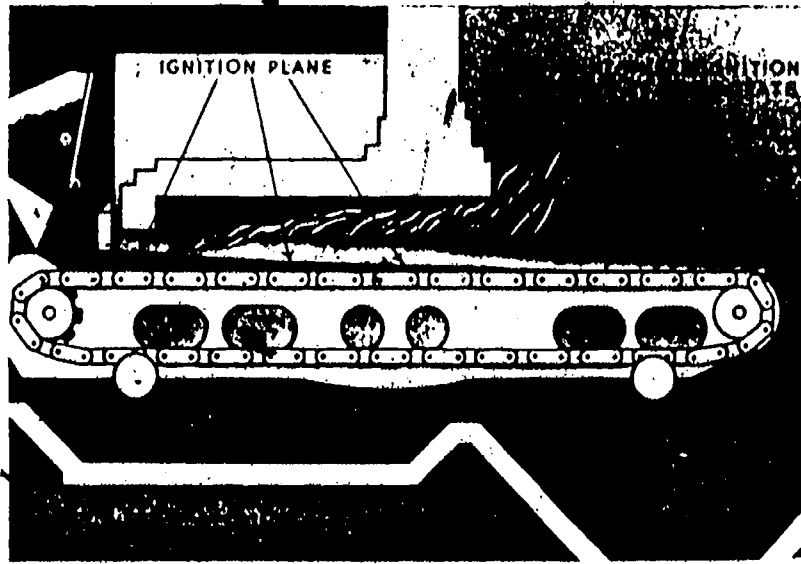

Combustion on a Chain Grate Stoker  
Fig. 1

- (1) Combustion within the fuel bed,
- (2) Combustion over the surface of the fuel bed.

Fig. 1 above shows combustion on a chain grate stoker.

(PE2-2-5-15)

### (1) Combustion within the Fuel Bed

Air (oxygen) passes into the incandescent firebed and immediately combines with the carbon to form  $\text{CO}_2$ . The  $\text{CO}_2$  comes into contact with more carbon and may be converted to  $\text{CO}$  ( $\text{CO}_2 + \text{C} \rightarrow 2\text{CO}$ ). The  $\text{CO}$  may come in contact with more  $\text{O}_2$  and be completely burned to  $\text{CO}_2$  ( $2\text{CO} + \text{O}_2 \rightarrow 2\text{CO}_2$ ). These reactions occur and reverse repeatedly as the air and gases flow through the firebed, but as  $\text{CO}_2$  is unstable in the presence of incandescent carbon there is always some  $\text{CO}$  escaping from the surface no matter how much oxygen (air) is forced through the firebed.

Some of the  $\text{O}_2$  passing through the firebed combines with the hydrogen in the fuel to form  $\text{H}_2\text{O}$ . Some of this  $\text{H}_2\text{O}$ , coming into contact with incandescent carbon, is decomposed into hydrogen and carbon monoxide ( $\text{H}_2\text{O} + \text{C} = \text{H}_2 + \text{CO}$ ). This process also occurs and reverses repeatedly within the firebed but as  $\text{H}_2\text{O}$  also is unstable under firebed conditions there is always some  $\text{H}_2$  and  $\text{CO}$  present at the surface of the fire.

It is evident that air is required over the surface of the fire in order to burn these combustibles no matter how much air is admitted through the grates, and that more is required for Bituminous than for Anthracite coal or Coke in order to burn the larger proportion of volatiles present.

### (2) Combustion over the Surface of the Fuel Bed

When green coal is fired it must be heated to the temperature of the furnace in order to ignite. This heating evaporates the moisture at about  $93^\circ\text{C}$  (one kg of water absorbs about 2260 kJ during evaporation under furnace conditions) and drives off the volatiles between  $150^\circ$  and  $480^\circ\text{C}$ . As each of these processes absorbs heat the temperature of the furnace is lowered.

If the temperature over the fire is sufficiently high and sufficient  $\text{O}_2$  is present, the volatiles ignite and burn to  $\text{CO}_2$  and  $\text{H}_2\text{O}$  as explained previously, but if not, they pass to the stack unconsumed and their heat values are lost. The volatiles may be decomposed into carbon and hydrogen and this condition is evidenced by clouds of dense black smoke consisting largely of the moisture in the coal colored by the unconsumed carbon or soot.

While this loss is greatest immediately after firing, it will be present in greater or less degree at all times if air is not admitted at or near the surface of the fire because of the unconsumed  $\text{H}_2$  and  $\text{CO}$ , also  $\text{CH}_4$  and other hydrocarbons always present, as shown by Table 4.

The speed of combustion decreases rapidly with distance from the surface of the firebed because the proportion of  $\text{N}_2$ ,  $\text{CO}_2$  and  $\text{H}_2\text{O}$  is continually increasing and hindering contact between the combustible gas and the available oxygen present.

Table 4

Coal	N <sub>2</sub>	CO <sub>2</sub>	O <sub>2</sub>	CO	H <sub>2</sub>	CH <sub>4</sub>	Total Combustibles
Bituminous	64.0	8.3	0.5	16.3	7.8	3.1	27.2
Anthracite	66.7	6.7	0.4	21.8	4.1	0.3	26.2
Coke	72.3	10.7	0.1	16.3	0.6	0.0	16.9

(U. S. Bureau of Mines Bulletin No. 137)

Optimum Furnace Conditions

From the foregoing discussion it is possible to list the conditions necessary in order to obtain a maximum of heat liberation from the fuel burned:

- (1) Sufficient AIR must be admitted and some portion of this air be admitted over and close to the surface of the fire.
- (2) The TEMPERATURE must be high enough to ignite the combustible gases given off.
- (3) The air must have a TURBULENT flow within the furnace to ensure its O<sub>2</sub> contacting with all the combustibles present.
- (4) The gases must be in the hot zone for sufficient TIME for combustion to proceed to completion.

Assuming that sufficient air is being admitted, then the requirements are: TIME, TEMPERATURE and TURBULENCE.

Temperature Required

There is a definite temperature below which any given combustible will refuse to ignite; it is necessary to raise the temperature of a match by friction, placing it in contact with a hot surface, or focussing the sun's rays on it through a lens. Once the low-temperature ignition tip is lighted however, the temperature of the flame is high enough to ignite the stick which has a very much higher ignition temperature.

Combustion is continuous over the fire for the same reason; the elementary gases H<sub>2</sub> and CO ignite first and heat the remainder to their ignition temperatures. A coal fire requires a minimum temperature of about 980°C in order to continue burning. A good hot furnace has a temperature of about 1300°C. The temperature is limited by the quality of the firebrick, 1650°C being about the maximum.

The higher the temperature of the burning gases the more rapid and more efficient will be the combustion provided sufficient O<sub>2</sub> is present. Hence pre-heating the furnace air raises the efficiency of combustion and the heat used in preheating it is returned to the furnace in the higher temperature of the gases in addition.

PE2-2-5-17)

Completeness of Combustion

The dependence of the efficiency of combustion on the quantity of air used may be expressed in three ways:

• (1) PERFECT COMBUSTION in which exactly the theoretically correct amount of air necessary is supplied and the combustibles are all completely burned.

This is impossible in any commercial furnace because of the difficulty of contacting between the  $O_2$  and the combustibles in the presence of large quantities of diluting gases.

The products of perfect combustion would be  $CO_2$ ,  $SO_2$ ,  $H_2O$ ,  $N_2$  and ash.

(2) COMPLETE COMBUSTION in which all the combustibles are completely burned but more air than the minimum theoretically required is used.

This is attainable in any boiler furnace that is properly designed for the fuel being used and the load being carried. The resulting stack gases will contain  $CO_2$ ,  $SO_2$ ,  $H_2O$ ,  $O_2$ ,  $N_2$  and Ash.

There will be more  $N_2$  because of the excess  $O_2$ .

(3) INCOMPLETE COMBUSTION in which some of the C, CO and  $H_2$  passes to the stack without liberating their full quotas of heat.

The stack gas will consist of  $CO_2$ ,  $SO_2$ ,  $H_2O$ ,  $N_2$  together with C (soot), CO,  $H_2$ , probably  $CH_4$  or other hydrocarbons and may not contain free  $O_2$ .

The most efficient combustion of any fuel is produced when sufficient excess air is used to convert all of its carbon content into  $CO_2$  and none into CO.

It may be said that excess air is the key to the location of by far the greater part of the boiler losses caused by inefficient combustion of the fuel. The two largest are:

- (1) Sensible heat carried away by the flue gas;
- (2) Undeveloped heat in C, CO,  $H_2$  and hydrocarbons.

Effect of Incorrect Excess Air

Too much air reduces the furnace temperature and so reduces combustion efficiency; may cause solid carbon to be cooled and deposited as soot; causes increased flue gas temperature because the gases flow over the heating surfaces at a higher velocity and have less time in which to give up their heat.

• Too little air always results in incomplete combustion; depositing of unburned solid carbon as soot; production of CO, and when CO is present in the flue gas there is generally also some  $H_2$  and  $CH_4$ . Furnace temperature is not necessarily increased because less heat is liberated from the fuel.



Effect of Poor Mixing

There may be stratification, which means that the air and combustible gases flow in separate stream lines from the furnace to the stack, resulting in incomplete combustion; all the bad effects of too little and too much air may follow. This is the most common boiler ailment and is often due to thin places or holes in the fire, indicating inefficient operation.

Purchasing a Fuel

It is not possible, generally, to exercise very much choice when purchasing natural gas or fuel oil as there is generally one field near the place of use which can deliver the fuel at a much lower price than any other field.

The conditions are quite different however, in purchasing a coal. So many fields are worked that considerable choice can be exercised. The heat value alone is not by any means a true index because two coals of similar heat values may have such widely differing combustion characteristics as to render one entirely unsuitable for a given furnace while the other may be quite satisfactory.

Moisture and ash have no heating value but are charged for in the price of the coal and also contribute to freight and handling costs; the moisture also carries about 2260 kJ/kg away to the stack while the ash has to bear the expense of removal.

Sulphur contributes a very small amount to the heat value of the fuel and is harmful because SO<sub>2</sub> forms an acid, when moist, which corrodes the metal flues and stack. Phosphorus also forms a corrosive acid.

A satisfactory coal therefore should have a high heating value, with a minimum of moisture, ash, phosphorus and sulphur.

The nature of the ash is of importance. The ash in some coals fuses into a semi-liquid, pasty mass which sinks through the firebed, forms a clinker at the cool lower surface of the grate, stops or retards the flow of air and causes a large ashpit loss by excessive poking and more frequent cleaning of fires.

Excess Air Required

The quantity of air in excess of the quantity required for perfect combustion that is necessary in any given case depends upon the nature of the fuel - solid, liquid or gaseous; the load being carried, the design of the furnace and the method of firing. Average practice indicates the quantities to vary about as follows:

Natural Gas	10 to 15%
Fuel Oil	15 to 20%
Coal - Hand Fired	40 to 100%
Chain Grate Stokers	40 to 80%
Overfeed Stokers	40 to 80%
Underfeed Stokers	30 to 75%
Powdered Fuel	15 to 20%

(PE2-2-5-19)

In any case, the excess air should be kept down to the minimum that will carry the load without CO being present in the stack gases.

### Excess Air Measurement

Whenever a definite quantity of given fuel is completely burned an equally definite quantity of CO<sub>2</sub> and H<sub>2</sub>O is produced. The use of more air than is required by the actual combustion process does not and can not produce more CO<sub>2</sub> but the excess oxygen appears in the flue gas as O<sub>2</sub>, having undergone no change while passing through the furnace, as was noted in Table 3.

### Effect of Hydrogen in the Fuel

All fuels contain hydrogen in addition to carbon; the higher grade coals contain small quantities, the quantity being greatest for coals of the Bituminous class because of their high volatile content. Fuel oil and natural gas contain still larger quantities.

The flue gas analysis is made at boiler room temperature and the steam formed from the combustion of the hydrogen is condensed to water either before reaching or within the analyser and so escapes analysis. The nitrogen taken in along with the O<sub>2</sub> which has been used to burn the hydrogen appears in the analysis, increases the total volume of flue gas flowing and thus further reduces the proportion that the CO<sub>2</sub> is of that total.

### Practical Working Formulas

Excess air quantities calculated on the basis of pure carbon content obviously will not be true for coals containing any appreciable proportion of free hydrogen and still less true for fuel oil or natural gas which contain large proportions of hydrogen.

Formulas which do allow for the hydrogen have been calculated for several coals and for typical gas samples and it has been found that the following formulas give results sufficiently accurate for practical purposes:

$$\begin{array}{l} \text{Natural Gas: Excess Air} \quad \frac{12 - \text{CO}_2}{\text{CO}_2} \\ \text{Average Coals: Excess Air} \quad \frac{18.5 - \text{CO}_2}{\text{CO}_2} \end{array}$$

These formulas have been derived from charts such as shown in Fig. 2, the details of which were calculated from the Ultimate Analysis of the coal.

By means of the chart:

- (a) The excess air being used can be found if the CO<sub>2</sub> being obtained is known;
- (b) The O<sub>2</sub> that should be present with any given CO<sub>2</sub> can be found;
- (c) The total heat loss to the stack can be found if the flue gas (stack) temperature is known;
- (d) The stack loss with any given air flow compared with the actual loss found from the actual evaporation indicates if large unaccounted-for losses are occurring.

(PE2-2-5(20))



### Combustion Graph of a Typical Sub-bituminous Coal Fig. 2

CO<sub>2</sub>, O<sub>2</sub> and Heat Loss percent for various percentages of Excess Air and at various flue gas temperatures.

Analysis of Coal: Carbon - 59.8% Sulphur - 0.4%  
Oxygen - 26.5% Nitrogen - 1.3%  
Hydrogen - 5.2% Ash - 6.8%

Heat value by calorimeter - 23 260 kJ/kg

Shown dotted: 10.4% CO<sub>2</sub> and 290 stack temperature  
Excess Air = 84.0% (nearly)  
O<sub>2</sub> (should be) 9.7%  
Dry Flue-gas Loss = 16.4%  
Total Stack Loss = 22.2%

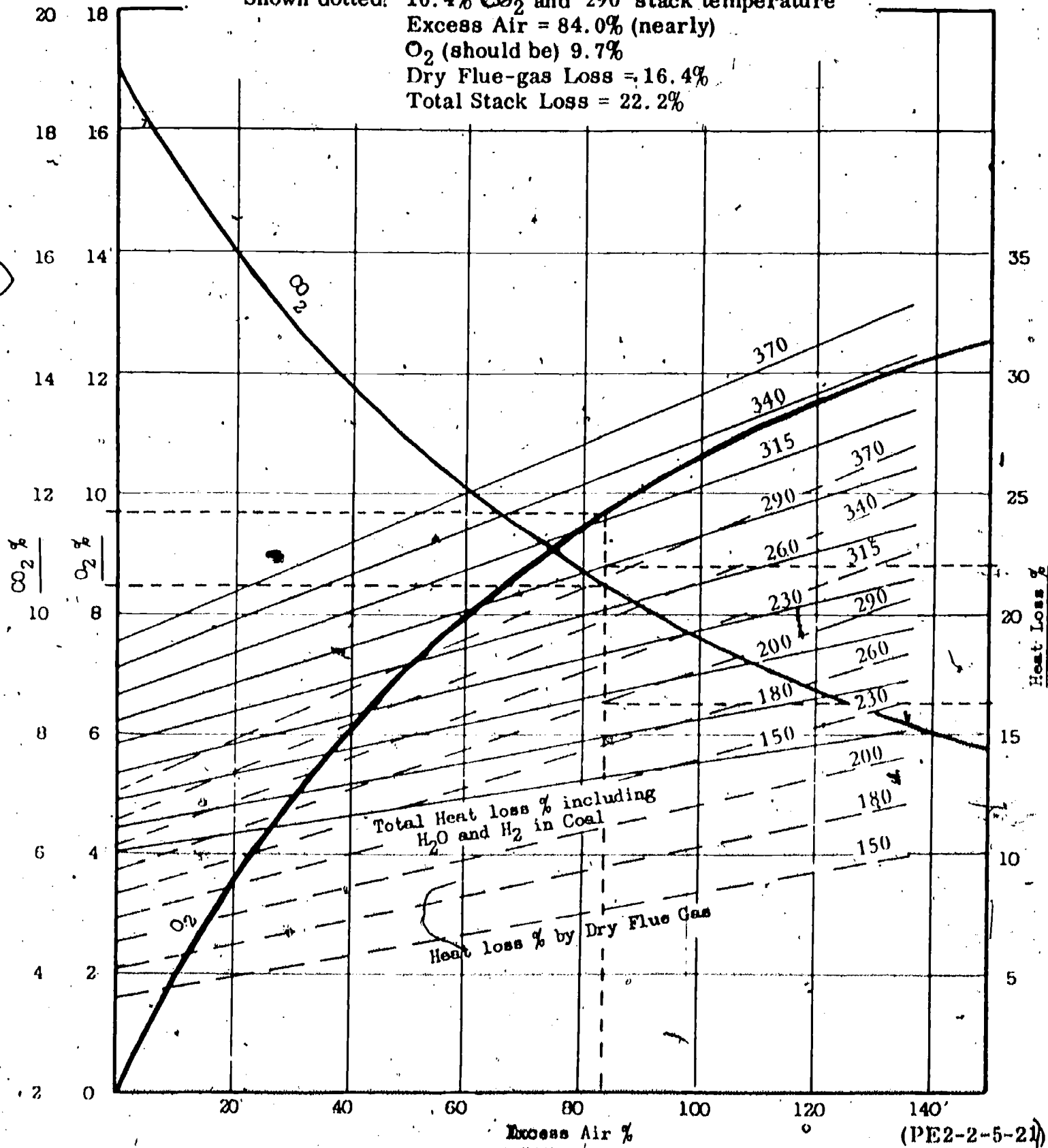

(PE2-2-5-21)

## Flue Gas Analysis

### What to expect in the Flue Gas

It will be clear from the foregoing that the flue gas should be analyzed for:

- (1)  $\text{CO}_2$ , the product of complete combustion corresponding to a maximum liberation of heat;
- (2)  $\text{CO}$ , the product of incomplete combustion as an indicator of the quantity of undeveloped heat escaping to the stack;
- (3)  $\text{O}_2$ , as an indicator of the excess air being used.

The best operation is that which produces a maximum  $\text{CO}_2$  with a minimum of  $\text{O}_2$  and no  $\text{CO}$ .

### Collecting a Sample

It has been authoritatively stated that obtaining the sample is far more difficult than analyzing it. The sample must be a true average of all the gas flowing and it is never easy to obtain a sample that is truly representative. The composition of the gas may vary considerably between the outer edge and the centre of the gas passage.

The sampling pipe should be located as near as possible to the boiler exit and in a straight passage if possible. The holes should face towards the direction of flow. As it is in the direct path of gas (and soot) flow it must be cleaned frequently, especially if connected to a  $\text{CO}_2$  Recorder.

The sampling pipe may be introduced through the brickwork, the side of the casing or any convenient connection and the hole be luted with fire-clay or stemmed with soft asbestos rope to prevent leakage of air inwards which will dilute the sample and cause inaccurate analyses.

A filter of slag wool or other substance that will not absorb moisture should be interposed in the line between the connection to the flue and the analyzer. Pipe threads should be clean and well-fitted or air will be drawn into the analyzer with the flue gas.

### The Analyzer

Fig. 3 illustrates an Orsat type flue gas analyzer of which there are several well-known makes on the market; the best known is probably the Hays. Full instructions are furnished with this instrument.

It consists of a measuring bottle or burette A and three containers, B, C and D.

The burette has a scale divided into 21 parts which would indicate 21% of  $\text{CO}_2$  obtained from the perfect combustion of pure carbon. It is water-jacketed so as to maintain the gas at the temperature of the boiler room during the analysis and keep the volume the same for all analyses made.

The three containers, B, C and D contain chemical solutions which remove the  $\text{CO}_2$ ,  $\text{O}_2$  and  $\text{CO}$  respectively.

(PE2-2-5-22)

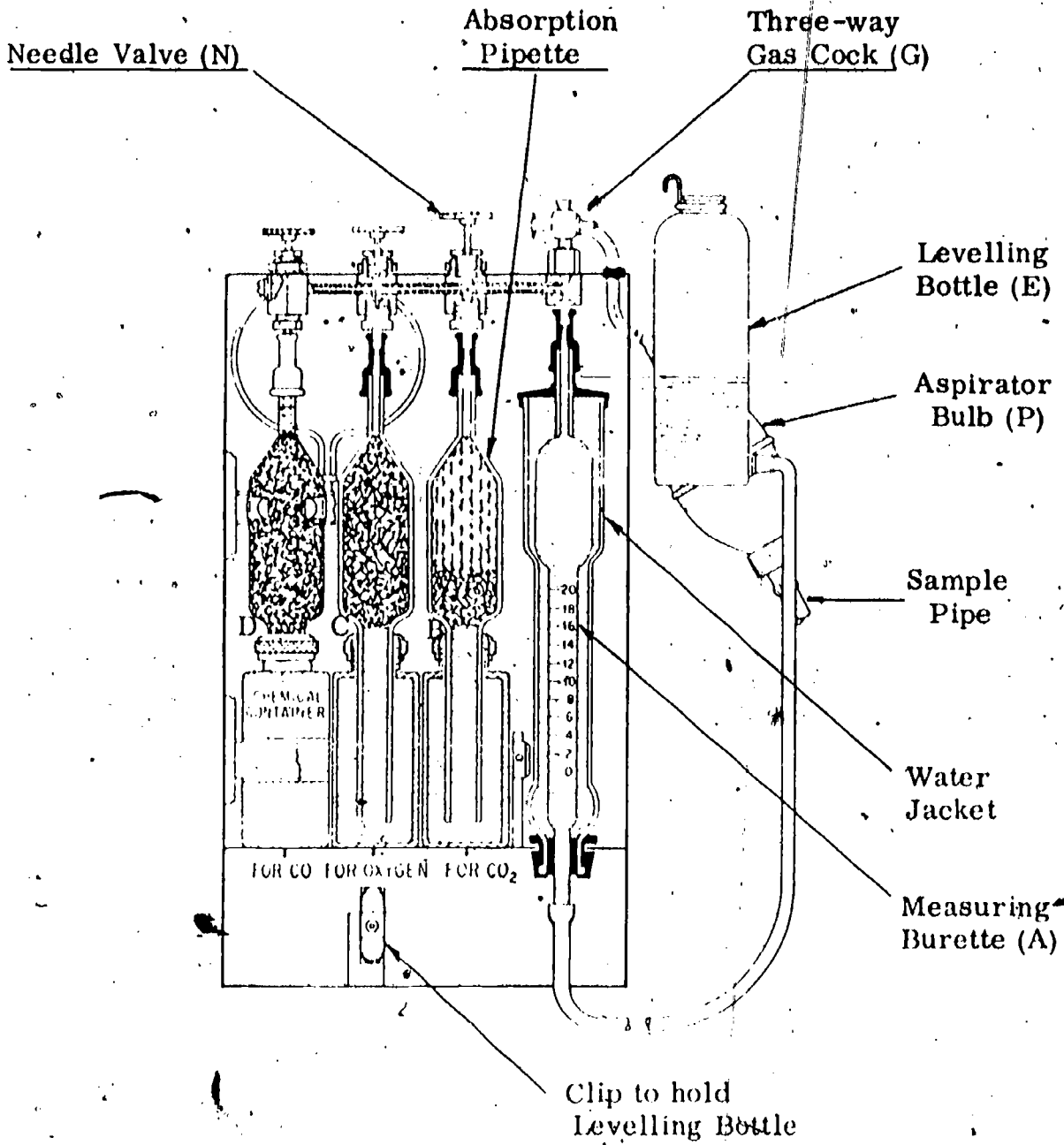
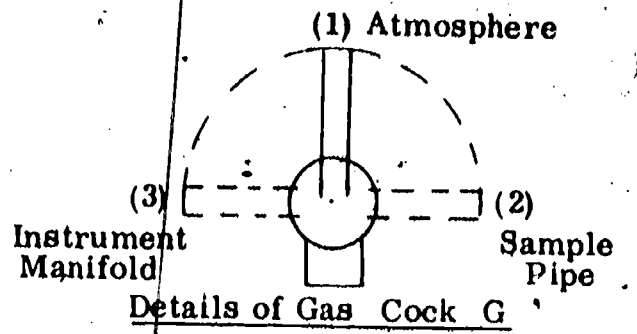

Orsat Flue Gas Analyzer  
Fig. 3

(PE2-2-5-23)

Container B is partly filled with a solution of caustic potash (potassium hydroxide KOH) which absorbs  $\text{CO}_2$  but does not absorb either  $\text{O}_2$  or  $\text{CO}$ . It may be made up as follows:

For  $\text{CO}_2$ : Dissolve 500 g of potassium hydroxide (KOH) in 1 L of water in rubber-stoppered bottle. Absorption pipette packed with rolls of iron-wire gauze,  $\text{CO}_2$  absorbed quickly. Iron does not oxidize in KOH. One charge will do for about 500 analyses.

Container C is partly filled with a mixture of caustic potash and pyrogallic acid which will absorb both  $\text{CO}_2$  and  $\text{O}_2$ . It may be made up as follows:

For  $\text{O}_2$ : Dissolve separately 7 g of pyrogallic acid in  $25 \text{ cm}^3$  of water and 50 g of potassium hydroxide in  $110 \text{ cm}^3$  of water. Mix the solutions forming alkaline pyrogallate and pour at once into a double pipette. KOH purified by alcohol must not be used. Absorption of  $\text{O}_2$  is slow at or below  $10^\circ\text{C}$ . One charge is good for about  $200 \text{ cm}^3$  of  $\text{O}_2$ .

Container D is partly filled with an ammoniated solution of cuprous chloride which will absorb  $\text{CO}_2$ ,  $\text{O}_2$  and  $\text{CO}$ . It may be made up as follows:

For  $\text{CO}$ : Dissolve 15 g of cuprous chloride ( $\text{CuCl}$ ) and 10 g of ammonium chloride ( $\text{NH}_4\text{Cl}$ ) in the minimum quantity of concentrated ammonium solution and dilute to  $200 \text{ cm}^3$ . Transfer at once to double pipette packed with rolls of copper gauze.

The gas cock G has three positions (as shown in the inset) in all of which it is open to the burette:

Position (1) opens the burette to the atmosphere.

Position (2) opens the burette to the aspirator bulb which is connected to the sampling pipe.

Position (3) opens the burette to the manifold connecting with the containers, B, C and D.

The levelling bottle E is used to move the gas from the burette to the containers during the analysis:

#### Measuring the Sample

With the gas cock G open to the atmosphere raise the levelling bottle E; the air in the burette will be forced out of G to atmosphere. Turn G over to position (2) connecting it with the aspirator or air pump P. Lower the bottle E and hang it on the bottom of the case so as to draw in a charge from the sampling tube. Pump a charge through G, the burette and the water in the bottle for not less than half a minute using the aspirator bulb so as to clear the pipes of all old gas or air.

Raise the levelling bottle E with G open to the atmosphere until the water in the burette is at the same level as the water in the bottle, and both are at zero. Be careful not to lower the bottle again and so draw in air through the open cock G.

### Analyzing for CO<sub>2</sub>

Turn cock G over to position (3) and put the burette into communication with the manifold. Open needle valve N fairly wide and raise levelling bottle. As the water flows into the burette the gas is forced into the container B and at the same time the caustic potash solution is forced down into the lower part of the container. The upper container is filled with steel wire which is thoroughly wetted with the solution. The gases, in passing over this wire, give up their CO<sub>2</sub> content. Do not lift the levelling bottle high enough to send water into the manifold.

Lower the levelling bottle again slowly and as the water runs back from the burette into the bottle the gas will follow it back from the container B into the burette and the solution will again flow upwards into the upper part of the container B. Be careful not to lift any of the solution into the manifold.

Close needle valve N and lower the levelling bottle until the level of the water is the same in the burette and the bottle. Read the level in the burette; the reading on the scale is the percentage CO<sub>2</sub> content of the flue gas and the excess air can be calculated by the formula on Page 20 or from a chart similar to the one in Fig. 2, if available.

As a check on the tightness of the pipe connections and the strength of the solution, the gas may be passed several times into the solution. If the readings reach a maximum value which does not increase, the solution is good. If the reading does not reach a maximum value but rises with each successive passage, the pipe line, stop cock or manifold joints are leaking.

The above may read as though the process is complex, but, after an operator has made a few analyses, he should have no difficulty at all in making one in two minutes or even less.

### Analyzing for O<sub>2</sub>

Exactly the same process is carried out in analyzing for O<sub>2</sub>. After the reading for CO<sub>2</sub> has reached a stable maximum the gas is passed into container C and its volume measured afterwards. This reaction is slower and should be given three or four passes in order to reach a constant reading.

The difference between the reading after analyzing for O<sub>2</sub> and that obtained after removing the CO<sub>2</sub> will give the percentage of O<sub>2</sub> in the flue gas.

### Analyzing for CO

Exactly the same process is followed in analyzing the remainder of the gas for CO. This reaction is slower than either of the two preceding ones and generally requires several passages of the gas in order to reach a stable reading.

As the cuprous chloride in D will absorb O<sub>2</sub> and CO<sub>2</sub> as well as CO it is essential that all the O<sub>2</sub> and CO<sub>2</sub> be removed before analyzing for CO. Similarly all the CO<sub>2</sub> must be removed before analyzing for O<sub>2</sub>. As the solutions in C and D will both absorb O<sub>2</sub> from the air, care should be taken to prevent air getting into the lower containers by using the rubber bags and stoppers provided with the instrument.

(PE2-2-5-25)

A sample analysis might be:

First reading:	12.2		CO <sub>2</sub> = 12.2%
Second reading:	17.3	17.3 - 12.2 =	O <sub>2</sub> = 5.1%
Third reading:	17.3	17.7 - 17.3	CO = 0.4%

Interpreting the Analysis

There is little use in knowing that operation is poor unless means are taken to improve it.

The excess air being used can be found by calculation, and by comparison with the excess air considered good for the method of firing, an opinion can be formed of the efficiency of operation.

Tables showing good, bad and indifferent CO<sub>2</sub> analyses are given in various books but these have little value unless complete details are known regarding:

- (1) Kind of coal and its analysis.
- (2) Method of stoking: hand, stoker or powdered fuel.
- (3) Method of causing draft: chimney, forced or induced.
- (4) Furnace volume compared with the grate area.
- (5) Rating at which the boiler is being operated which controls the rate at which fuel is being burned.

Each of these factors will change the excess air required, therefore no CO<sub>2</sub> will be best for any two plants which differ in any of them. There is a BEST CO<sub>2</sub>% for any given plant at any given load when burning any given fuel, which will not be the same for any other load or fuel.

The BEST CO<sub>2</sub>% is the one that gives the highest boiler efficiency. This can be found by running a six or eight hour test under steady load taking CO<sub>2</sub> analyses every 10 or 15 minutes, at the same time reducing the air supply until smoke or CO just appears in the flue gas. This gives the maximum CO<sub>2</sub> and excess air that can be used economically.

If such tests are run at different loads or ratings, a valuable set of data is obtained giving the best CO<sub>2</sub>% for different loads. Such data will indicate:

- (1) The relative efficiency of the shift men.
- (2) The cleanliness of the boiler surfaces (soot and scale).
- (3) The condition of the baffles.
- (4) The tightness of the boiler settings.

The Orsat analyzer gives percentage by volume of the flue gases, whereas analysis of fuels generally and efficiency calculations are based on percentage by weight. The following formula correlates the two values. The symbols represent volumetric percentages of the constituents of the gas analyzed while the result is the dry gas per kg of carbon:

$$\text{Dry gas per kg carbon} = \frac{11 \text{ CO}_2 + 8 \text{ O}_2 + 7 (\text{CO} + \text{N}_2)}{3 (\text{CO}_2 + \text{CO})}$$

The assumption is made here that the combustion of any fuel is due to the oxidization of carbon, either free or combined. The only gases which can exist, then, are carbon dioxide, carbon monoxide, oxygen and nitrogen, all the carbon coming from the fuel while the oxygen and nitrogen are from the air introduced for combustion.

The principal assumption of this formula is that the analysis as used is of dry gas, but in practice there will be a negligible amount of moisture from the air, and a varying amount due to the hydrogen content of the fuel.

One further error and one which can be rectified to a large extent by modifying the formula is that resulting from the presence of sulphur in varying amounts in most fuels. This sulphur burns to SO<sub>2</sub> which is absorbed in the analyzer as CO<sub>2</sub>.

From Table 1, one kg of carbon resulted in 3.67 kg CO<sub>2</sub> while the mass of SO<sub>2</sub> from 1 kg of sulphur is 2.00 kg. A correction factor is then added to the previous formula (which, incidentally, is based upon the relative density of the gases present) giving us the following:

$$\text{Dry gas per kg as fixed fuel burned} = \frac{11 \text{ CO}_2 + 8 \text{ O}_2 + 7 (\text{N}_2 + \text{CO})}{3 (\text{CO}_2 + \text{CO})} \times \left( \text{C} + \frac{3}{8} \text{S} \right) + \frac{5}{8} \text{S}$$

Example 3

Calculate the mass of dry flue gas from the following analysis:

CO <sub>2</sub>	..	13.1%
O <sub>2</sub>	...	6.1%
N <sub>2</sub>	...	80.8%

Composition of coal showed 80% C and 1.2% S.

Solution

Dry gas per kg as fired fuel burned

$$\begin{aligned} &= \frac{11 \times 13.1 + 8 \times 6.1 + 7 (80.8 + 0)}{3 (13.1 + 0)} \times \left( .80 + \frac{3}{8} \times .012 \right) + \frac{5}{8} \times .012 \\ &= \frac{144.4 + 48.8 + 565.6}{39.3} \times .8045 + .0075 \\ &= \frac{758.5}{39.3} \times .8045 + .0075 \\ &= 15.55 + .0075 \\ &= \underline{\underline{15.5575 \text{ kg (Ans.)}}} \end{aligned}$$

The above formula is necessary in the calculation of boiler efficiency tests as will be shown in a later lecture.

Flue Gas Analysis, burning Oil or Natural Gas

The maximum CO<sub>2</sub> percentages attainable when burning oil or gas are considerably lower than those that can be attained from the combustion of coal because of the different ratios between the carbon and hydrogen constituents. The perfect combustion of crude oil with no excess air will give about 16% CO<sub>2</sub> in the flue gas and the combustion of natural gas under the same conditions, will give about 12% CO<sub>2</sub>.

In practice, the excess air cannot be reduced below about 20%, which gives approximately 13% CO<sub>2</sub> for crude oil and 10% CO<sub>2</sub> for natural gas, as the maximum percentages obtainable under working conditions.

Table 5 gives a comparison between the proportions of CO<sub>2</sub> and O<sub>2</sub> in the flue gas for coal, crude oil and natural gas, with varying percentages of excess air:

Table 5

Fuel	Products	Percentages of Excess Air						
		0	10	20	40	60	80	100
Coal	CO <sub>2</sub>	18.6	16.9	15.5	13.2	11.3	10.2	9.2
	O <sub>2</sub>	0.0	2.0	3.5	6.1	8.0	9.4	10.6
Crude Oil	CO <sub>2</sub>	15.8	14.2	13.0	11.1	9.6	8.5	7.6
	O <sub>2</sub>	0.0	2.0	3.7	6.2	8.2	9.6	10.8
Natural Gas	CO <sub>2</sub>	12.0	10.8	9.8	8.3	7.2	6.3	5.7
	O <sub>2</sub>	0.0	2.1	3.8	6.4	8.3	9.8	11.0



QUESTION SHEET

POWER ENGINEERING

Second Class  
Sect. 2, Lect. 5

1. What information is obtained from :  
(a) Proximate Analysis of a coal ;  
(b) Ultimate Analysis of a coal.  
(c) Of what practical value is each of these analyses to the Engineer ?

2. (a) A coal has the following ultimate analysis by mass per cent:

Carbon	..	82.15
Hydrogen	..	5.09
Nitrogen	..	1.48
Oxygen	..	7.32
Sulphur	...	0.82
Ash.	..	3.14
		<hr/>
		100.00

Moisture by proximate analysis is 4.95 per cent.

Calculate the free hydrogen, combined hydrogen, total mass of water vapor per kg of fuel in the flue gas, and the heating value per kg of dry fuel.

- (b) Find the mass of air theoretically required to burn one kg of this coal.
- (c) How much air would you suggest be supplied per kg of this coal if the method of firing is 'Pulverized Fuel' ?
3. (a) Sketch and describe the Orsat Apparatus, naming all the chemicals used and their purposes.
- (b) Describe the procedure of analyzing a flue gas with this apparatus.
4. What is the effect upon the flue gas analysis of air leaking into a boiler setting?
5. (a) What optimum furnace conditions are necessary to obtain a maximum of heat liberation from the fuel burned?
- (b) Discuss the differences between:  
(1) Perfect Combustion,  
(2) Complete Combustion, and  
(3) Incomplete Combustion.

(PE2-2-5-Q)



## 10.3

### COMBUSTION -- AIR AND FLUE GASES

#### Goal:

The apprentice will be able to describe air and flue gas relationships in combustion.

#### Performance Indicators:

1. Describe air requirements for combustion.
2. Describe flue gases.
3. Describe flue gas analysis

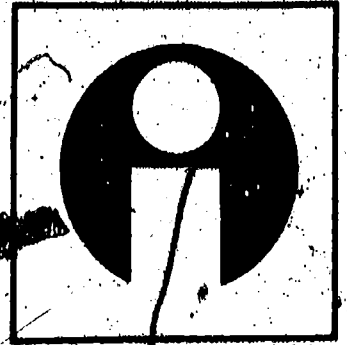

# Study Guide

- \* Read the goal and performance indicators to find what is to be learned from package.
- \* Read the vocabulary list to find new words that will be used in package.
- \* Read the introduction and information sheets.
- \* Complete the job sheet.
- \* Complete self-assessment.
- \* Complete post-assessment.

# Vocabulary

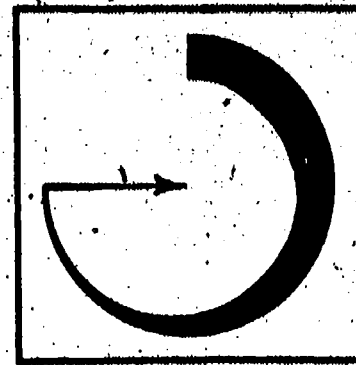

- \* Analyzing cells
- \* Automatic gas analyzer
- \* Carbon dioxide ( $\text{CO}_2$ )
- \* Carbon monoxide ( $\text{CO}$ )
- \* Combustible analyzing cell
- \* Compensating filaments
- \* Excess air
- \* Measuring filaments
- \* Oxygen analyzing cell
- \* Sulfur dioxide ( $\text{SO}_2$ )
- \* Theoretical air

# Introduction

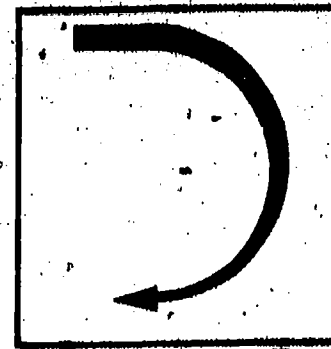

The combustion process must be carefully monitored if efficiency in combustion is desired. Flue gases hold the clues that tell us whether the combustion was complete or incomplete.

Since flue gases cannot be physically measured, they must be analyzed by chemical procedures. This can be accomplished by a laboratory approach or through the use of automatic analyzers.

Once the analyses have been completed, the operator must make adjustments to improve the combustion process. If too much CO is found in the flue gas, combustion is incomplete and more air should be supplied.

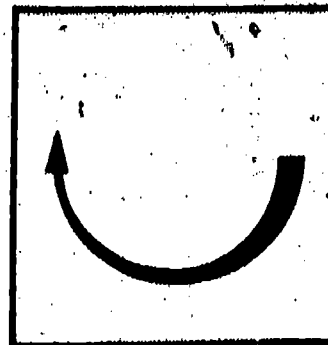

# Information

Complete combustion requires air for oxygen. Air contains 21% oxygen and 79% nitrogen. The amount of air required for complete combustion is called theoretical air. In practice, more air must be added beyond the theoretical air to assure that all fuel comes in contact with oxygen molecules. Excess air is that amount of air added beyond the theoretical air requirement. Excess air is shown as a percentage of theoretical air.

Combustion in the presence of excess air produces substances that will appear in the flue gas. These are called the products of combustion. Complete combustion gives products of carbon dioxide, sulfur dioxide, water and excess O<sub>2</sub>. Carbon monoxide in the flue gas is a product of incomplete combustion. The efficiency of combustion can be determined by analyzing the flue gas.

## Flue Gas Analysis

A flue gas analysis determines the volume percentages of carbon dioxide (CO<sub>2</sub>), carbon monoxide (CO) and oxygen (O<sub>2</sub>). Water and sulfur content are not normally measured in a flue gas analysis.

The maximum content for CO<sub>2</sub> of various fuels is as follows:

- \* Coal 19%
- \* Oil 15.5%
- \* Natural Gas 12%

These maximums are based on absence of excess air. If excess air is supplied, the percentages of CO<sub>2</sub> will be reduced.

The analysis procedure can be completed by use of:

- \* Orsat Apparatus — a device composed of burettes, bottles, bulbs and valves.
- \* Automatic gas analyzer which collects the sample, tests and records results.

The steps in analyzing for CO<sub>2</sub> with the Orsat apparatus are laboratory procedures that require detailed and painstaking effort. This process will not be detailed in this package. The apprentice that wishes to master the process should consult a manual. The same apparatus is used to analyze for O<sub>2</sub> and CO content.

# Information

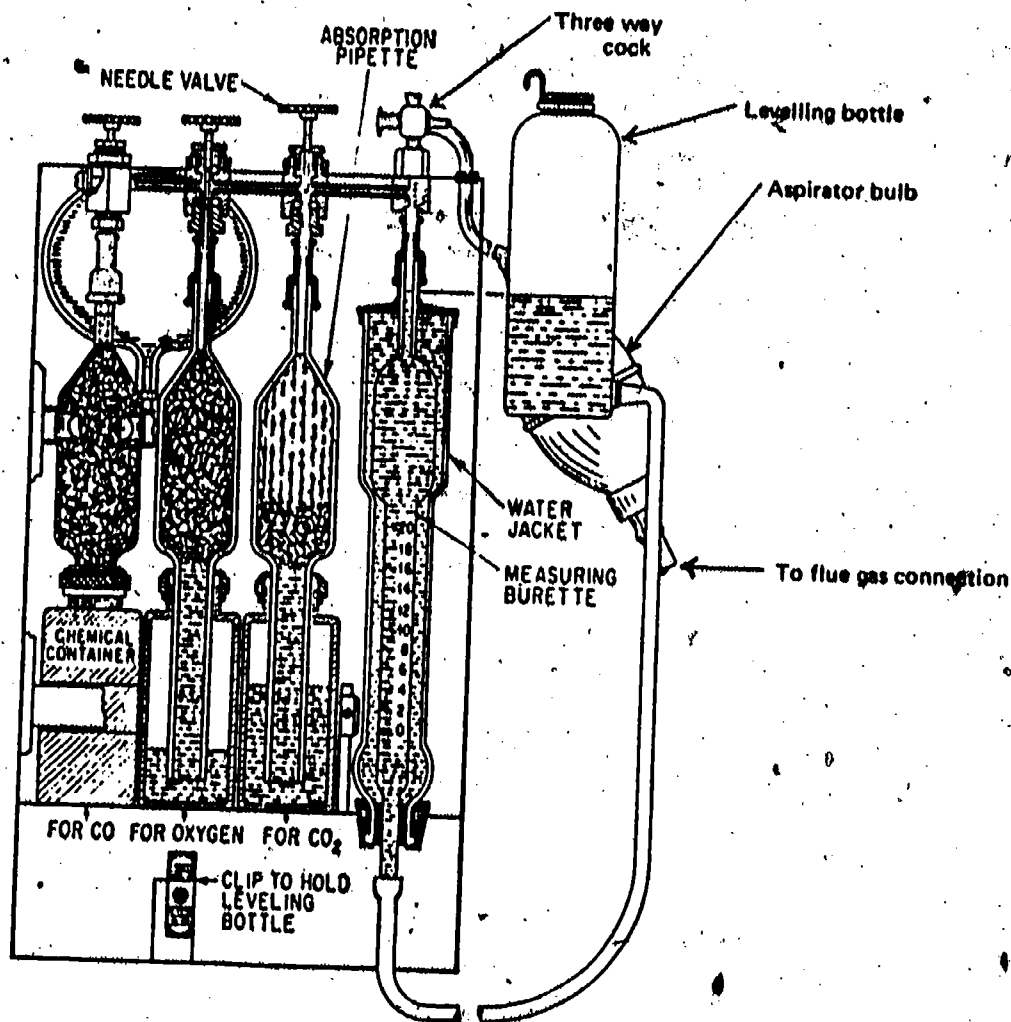
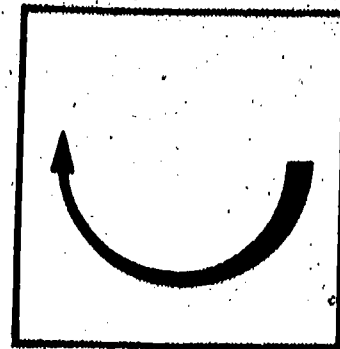

Orsat Apparatus

## Automatic Gas Analyzers

Modern power plants have instruments that automatically measure the levels of  $\text{CO}_2$ ,  $\text{O}_2$  and  $\text{CO}$  in the flue gases. Automatic analyzers use measuring filaments and compensating filaments of platinum. Hydrogen is supplied to the filaments from a tank. When the sample gas meets the hydrogen at the filament, combustion occurs. The two filaments will heat up to different levels which changes the electrical resistance of the filaments. This electrical resistance is measured and recorded automatically. The measuring devices are called analyzing cells.

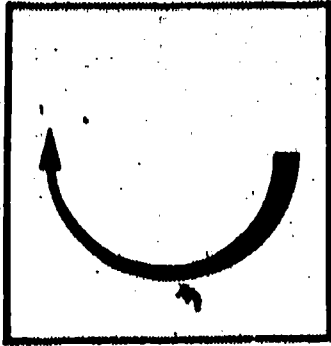

# Information

Each analyzing cell contains the two platinum filaments. There is an oxygen analyzing cell and a Combustible analyzing cell in an analyzer. A diagram of an automatic gas analyzer is shown below.

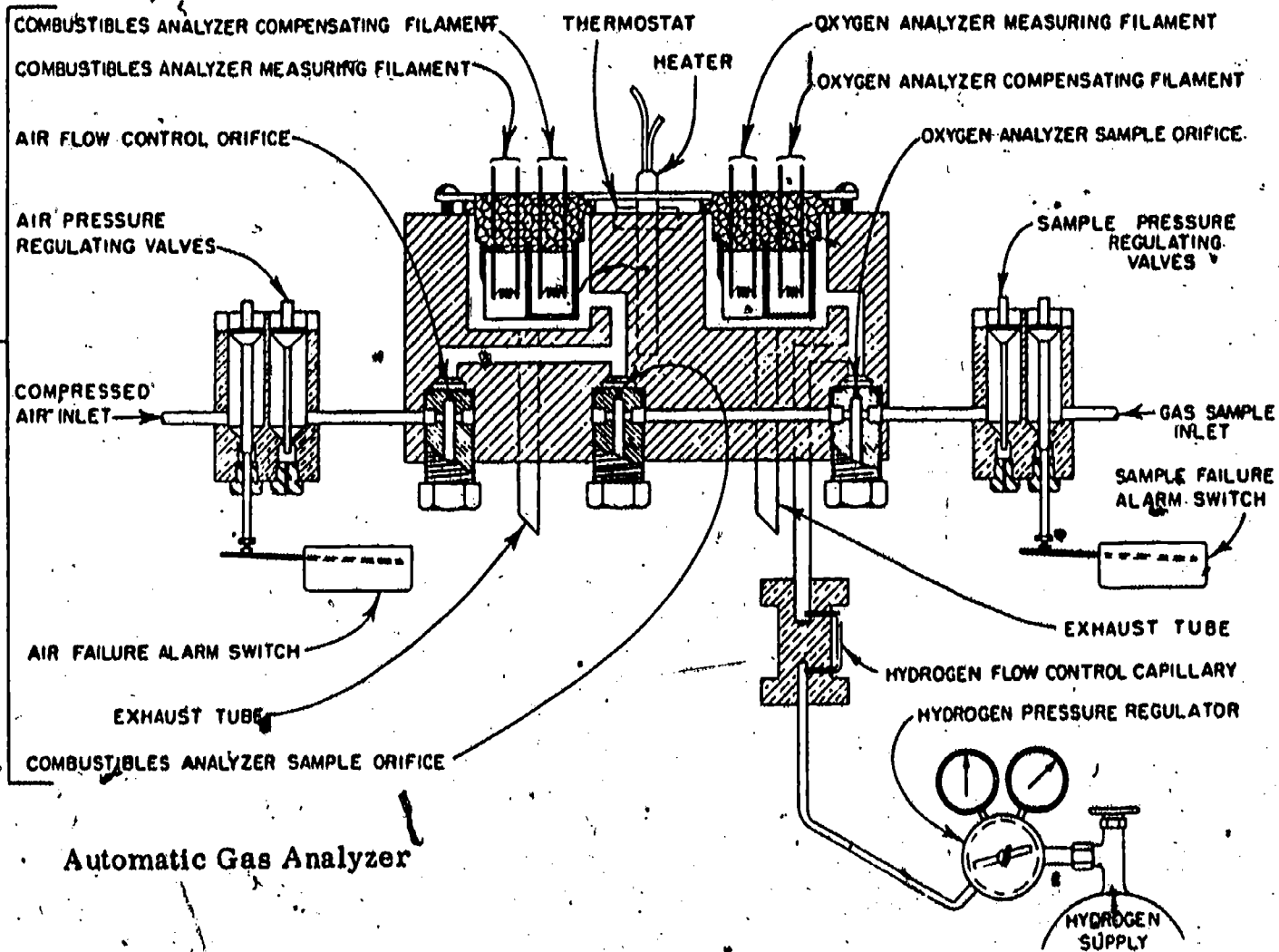



# Assignment

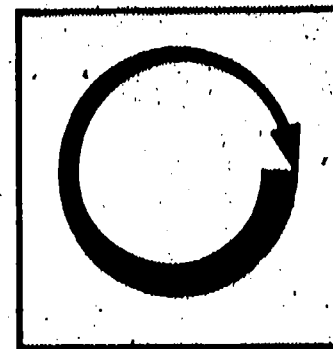

- ✓ Read pages 13 - 20 in the supplementary reference.
- \* Complete job sheet.
- \* Complete self-assessment and check answers.
- \* Complete post-assessment and ask instructor to check answers.

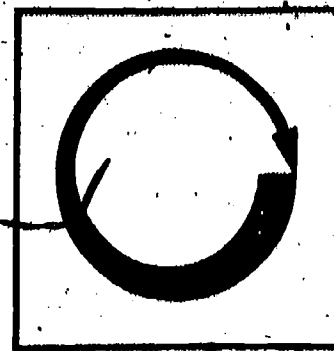

# Job Sheet

## ASSIST JOURNEYMAN IN ANALYZING FLUE GAS

- \* Ask experienced operator to assist in making flue gas analysis.
- \* Observe their techniques in:
  - Pulling the gas sample
  - Testing for  $\text{CO}_2$
  - Testing for  $\text{O}_2$
  - Testing for  $\text{CO}$
- \* Observe the computations of percentages.
- \* Ask operator to explain findings.
- \* Ask operator to explain actions to be taken as a result of the test.
- \* If automatic gas analyzers are used, ask operator to explain the recorded analysis.

# Self Assessment

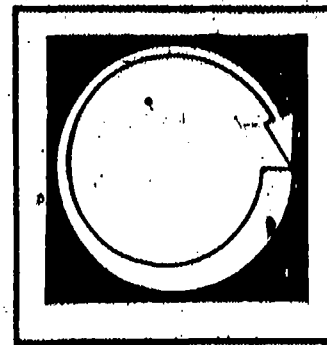

1. The exact amount of air needed to achieve complete combustion is called \_\_\_\_\_ air.
2. Additional air beyond that needed for complete combustion is added so that all fuel will be exposed to oxygen. The additional air is called \_\_\_\_\_ air.
3. The products of complete combustion are \_\_\_\_\_ sulfur dioxide,  $H_2O$  and  $O_2$ .
4. A product of incomplete combustion is \_\_\_\_\_.
5. What three substances are analyzed in a flue gas analysis.
6. Are sulfur and water content of flue gases analyzed?
7. The maximum  $CO_2$  level is lowest for \_\_\_\_\_ fuel.
8. The \_\_\_\_\_ apparatus is used for analyzing flue gases.
9. What are the measuring devices in an automatic gas analyzer?
10. Automatic analyzers use compensating filaments and \_\_\_\_\_ filaments in the analyzing cells.

# ● Self Assessment Answers

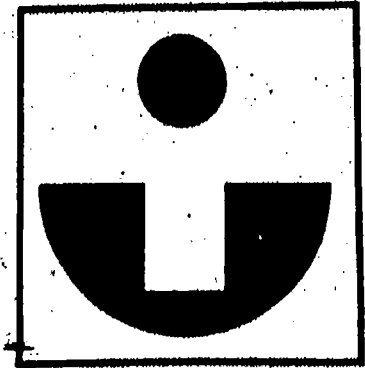

1. Theoretical air
2. Excess air
3. Carbon dioxide
4. Carbon monoxide
5.  $\text{CO}_2$ ,  $\text{O}_2$ ,  $\text{CO}$
6. No
7. Natural gas
8. Orsat
9. Analyzing cells
10. Compensating

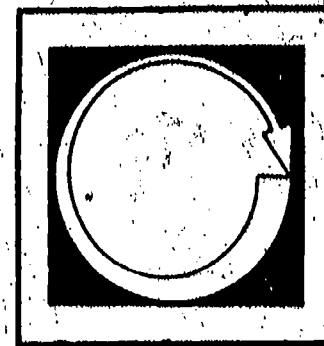

# Post Assessment

1. Flue gas can be analyzed by two methods. List those methods.
2. List two types of filaments in the analyzing cells of an automatic gas analyzer.
3. List two types of analyzing cells in an automatic gas analyzer.
4. Air contains \_\_\_\_\_% nitrogen and \_\_\_\_\_% oxygen.
5. List the products of complete combustion.
6. What is the major product of incomplete combustion?
7. How is the sulfur content of flue gas measured?
8. What is an Orstat apparatus used for?
9. Is the percentage levels of  $\text{CO}_2$  increased or decreased with the addition of excess air?
10. What substances are analyzed in a flue gas analysis?

# Instructor Post Assessment Answers



1. Orsat apparatus, automatic gas analyzer
2. Measuring and compensating
3. Oxygen analyzing cells and combustible analyzing cells
4. 79% nitrogen and 21% oxygen
5. Carbon dioxide ( $\text{CO}_2$ ), sulfur dioxide ( $\text{SO}_2$ ), water, oxygen ( $\text{O}_2$ )
6. Carbon monoxide ( $\text{CO}$ )
7. Sulfur is not measured
8. Analyze flue gases
9. Decreased
10.  $\text{CO}$ ,  $\text{O}$ ,  $\text{CO}$

# Supplementary References

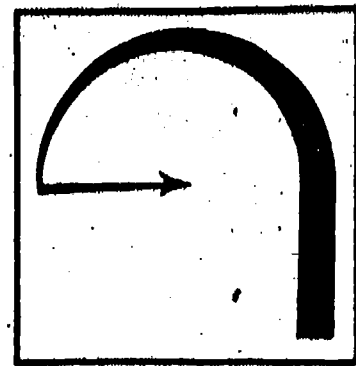

- \* Correspondence Course, Lecture 5, Section 2, Third Class.  
Southern Alberta Institute of Technology. Calgary, Alberta, Canada.

SOUTHERN ALBERTA INSTITUTE OF TECHNOLOGY  
CALGARY ALBERTA

Correspondence Courses

Power Engineering

SECTION 2

Third Class  
Lecture 5

PLANT SERVICES

FUELS & COMBUSTION

The term combustion refers to the burning of the fuel in the boiler furnace in order to produce large quantities of heat which must then be transferred to the water in the boiler. The Power Engineer should be familiar with the methods used to transfer this heat from the furnace to the water and he must also understand the process involved in the combustion of the fuel in the furnace.

Boiler Heat Transfer

As discussed in Lecture 7, Section 1 of this course the three methods by which heat may be transferred are: radiation, convection and conduction. All three methods are involved in the flow of heat from the boiler furnace to the water and steam contained within the boiler.

In the modern steam generator, the greatest part of the heat produced by the combustion of the fuel within the furnace is transferred by radiation to the water wall tubes which form the furnace enclosure. Some heat also radiates to any superheater tubes which are located in the furnace proper.

Any boiler and superheater tubes which are not within the radiant zone and all economizer and air heater tubes receive heat by convection currents of hot flue gas travelling from the furnace.

The ratio of heat transferred by radiation to the heat transferred by convection will depend upon the design of the steam generator. As stated previously, the usual arrangement is to have the greatest part of the heat transferred to the heating surface by radiation. This is because the rate of heat absorption per square foot of heating surface is much greater with radiant transfer than with convection transfer. The rate of heat transfer by radiation will depend largely upon the temperature within the furnace. The rate of heat transfer by convection will depend upon the amount of gas flow as well as the temperature of these gases.



When the heat reaches the surfaces of the tubes it is transferred through the tube walls to the water or steam within the tubes by conduction. The water in contact with the tube walls becomes heated and will expand and rise due to its decreased density. Colder and more dense water will take its place and will in turn be heated and will rise. In this way convection currents are set up which produce circulation of the boiler water. The tubes which are exposed to the heat will produce bubbles of steam mixed with the water rising in them. These tubes are referred to as risers because the steam-water mixture flows upwardly in them. Other tubes which are unheated or exposed to less heat are called downcomers and in these tubes the cooler and more dense water will flow downwardly.

Figure 1 illustrates how this circulation is produced in a simple water tube boiler circuit.

Simple Water Tube Circuit

Figure 1.

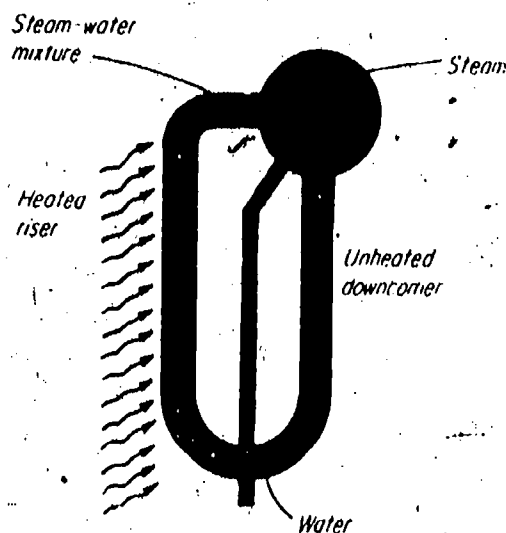

### Efficient Boiler Operation

In order to operate a boiler with the maximum of efficiency the following conditions must be fulfilled:

1. The heating surface through which the heat is transferred to the boiler water must be large, must be covered with water at all times and must be kept clean. If possible, the surfaces receiving heat by convection should be arranged at right angles to the hot gas flow in order to absorb all possible heat.
2. There must be a constant and positive circulation of water throughout the boiler;
3. All parts of the boiler must be readily accessible for cleaning, repair and inspection.
4. There must be complete separation of the steam from the water before the steam leaves the steam drum.
5. Any impurities deposited by the boiler water should be able to collect in mud drums or headers located away from the action of the fire.
6. The combustion chamber or furnace must be designed to ensure the complete combustion of the boiler fuel.

PE3-2-5-2

These conditions all depend to a large extent on the design of the boiler. However, the cleanliness of the heating surfaces and the completeness of the combustion of the fuel will both be affected by the method of operation. The methods for maintaining clean heating surfaces will be covered in a later lecture. The problems regarding combustion will be discussed in the following sections of this lecture.

### Heat Losses

When a given amount of fuel is burned completely, a definite amount of heat is produced. If the fuel is not burned completely then the amount of heat produced will be reduced accordingly and the cost of operating the boiler will rise. In other words a portion of the fuel will be wasted.

However, even when a fuel is burned completely not all of the heat produced will be transferred to the boiler water. Some will be lost due to the heat left in the flue gases leaving through the chimney and some will be lost to the atmosphere by radiation from external boiler surfaces.

These losses may be reduced to some extent. In the case of the heat in the flue gases, a portion of this may be recovered by the use of air heaters and economizers. Heat lost through radiation from boiler external surfaces may be reduced by the use of insulated boiler casings. Air heaters, economizers and boiler casings were all discussed in Lecture 3, Section 3.

Assuming these losses have been reduced to the minimum, it remains therefore, for the power engineer to maintain boiler efficiency by ensuring that the process of combustion within the boiler furnace is as complete as possible. In order to accomplish this it is necessary that the basic laws of combustion and their application in practice are thoroughly understood.

### Definition of Combustion

Combustion in the boiler furnace may be defined as the chemical combination of certain elements in the fuel with oxygen obtained from the air. The result of this combination is the release of energy in the form of heat.

### Requirements For Complete Combustion

In order for the fuel to burn completely in the furnace the following conditions must be fulfilled:

1. Enough air must be supplied to the furnace in order to provide sufficient oxygen to combine with all the combustible elements of the fuel.
2. The air and the fuel must be thoroughly mixed together so that each particle of fuel can come in contact with the necessary air. This thorough mixing of fuel and air is known as turbulence.

PE3-2-5-3

3. The temperature in the furnace must be above the ignition temperature of the fuel to ensure that the combination of fuel and oxygen takes place rapidly.
4. The furnace must be designed to allow enough time for the combustion to be completed before the fuel strikes the relatively cool surfaces of the tubes.

The above requirements may be summed up as enough air plus time, temperature, and turbulence. The latter three requirements are often referred to as the three T's of combustion.

### Classification of Fuels

To be classed as a fuel a material must contain elements which will combine rapidly with oxygen to produce combustion. Two of the most common elements with this property are hydrogen and carbon and all commercial fuels contain a large proportion of these elements.

Fuels are classed according to whether they are in a solid, a liquid, or a gaseous state. The most common solid fuel used for steam generation is coal. Occasionally wood is used in some special applications. The liquid fuels used in boilers are usually petroleum crude oils with the lighter more refined fuel oils used in some cases. The most common gaseous fuel is natural gas with by-product gases, such as those produced when crude oil is processed into gasoline or those produced as a by-product from blast furnaces, being used occasionally.

#### Coal

The constituents of coal are carbon, hydrogen, oxygen, sulphur, nitrogen, moisture and ash. Coal originally existed as vegetable matter and this vegetable matter then underwent geological changes which transformed it to its present state. Generally speaking, the greater the geological changes the greater will be the percentage of carbon within the coal. Some of the carbon is combined with hydrogen to form hydrocarbons. These hydrocarbons along with other compounds are known as volatile matter as they pass off as a gas when the coal is heated. The part of the carbon remaining after the volatile matter is driven off is known as fixed carbon.

Coals are divided into classes or groups according to various characteristics such as their percentage of fixed carbon and volatile matter and their heating value. The classes which concern the Power Engineer are as follows:

#### 1. Anthracite

This coal is harder than any other type and has a shiny lustrous appearance. It has a high percentage of fixed carbon, over 92 percent, and less than 8 percent of volatile matter. It is slow to ignite but burns at a high temperature with a short clear flame and no smoke. It is used to a limited extent in power plants due to its high cost.

2. Semianthracite

This coal is dark gray in color and burns with a short clear flame. It contains between 86 and 92 percent of fixed carbon and between 8 and 14 percent of volatile material. Like anthracite, it has limited use in power plants because of high cost and scarce supply.

3. Bituminous

This class of coal has several sub-divisions according to the volatile content. Low volatile bituminous has between 14 and 22 percent volatile material. Medium volatile bituminous has from 22 to 31 percent volatile material. High volatile bituminous has several grades one of which features over 31 percent volatiles. The other grades of high volatile bituminous are ranked according to their heating values.

In general, bituminous coals range in color from black to dark brown. They may be either caking or non-caking. That is to say they either tend to fuse into a mass in the furnace (caking) or they burn freely without fusing (non-caking or free-burning).

Bituminous coals are generally considered to be the best suited for power plants as their cost is reasonable and the supply is plentiful.

4. Sub-bituminous

These coals are black in color and have a high moisture content. They disintegrate when exposed to air and are difficult to store. When burning they do not cake but burn freely. Due to their high moisture content they are not usually shipped for power plant use.

5. Lignite

These coals are brown in color and have a laminated fibrous structure. They have high ash and high moisture content and their heating value is low. Due to this high moisture content and low heating value it is not economical to ship lignite coal long distances. However, it is commonly used by power plants which are located in or adjacent to lignite coal fields.

### Typical Coals

Table I shows the constituent percentages of some typical coals.

District	Fixed Carbon	Volatile	Moisture	Ash	Heat Value kJ/kg
Camrose	37.9	26.6	28.5	7.0	18700
Crowsnest	57.8	24.9	2.5	14.8	29000
Drumheller	44.2	30.7	18.2	6.9	22700
Wabamun	39.5	26.5	21.8	12.2	18580
Bienfait	33.0	26.0	35.0	6.0	17130
Estevan	30.8	24.4	35.2	9.6	15580
Pennsylvania	66.5	20.6	3.4	9.5	31610

Table 1

These values should be taken as being broadly representative only, as samples taken from the same district and even the same mine will often vary considerably in composition and heating value.

### Pulverized Coal

Pulverized coal is coal which has been ground or crushed by mechanical means to a fine dust-like powder. When it is in this form it may be fed to the boiler furnace by means of a stream of air which not only carries the pulverized fuel but also provides some of the oxygen necessary for combustion.

With the coal in this powdered form it can be easily and thoroughly mixed with the combustion air and therefore burned efficiently. This means that coals of lower grades and lower costs may be used.

Another advantage is the ease of control. Coal in the pulverized form can be regulated as easily as can oil or gas.

This method of burning coal is used usually in the large capacity plants particularly those located in or adjacent to large low grade coal deposits.

### Fuel Oil

Fuel oil as used for steam generation is a petroleum product and may be one of three main types according to the method of production.

1. Crude petroleum is occasionally used as a boiler fuel and it is petroleum as it comes from the well without undergoing any processing. As it still contains volatile products such as gasoline it presents a fire hazard during storage and must be used with care.

PE3-2-5-6

2. If the crude petroleum is submitted to a partial refining process such as limited distillation, then the gasoline and other highly volatile products can be removed and the residue left will be a safe fuel oil known as heavy or residual fuel oil.
3. If the crude petroleum is submitted to extended distillation processes then among the products produced will be light fuel oils.

The main constituents of fuel oils are carbon and hydrogen combined into hydro-carbon compounds, small amounts of oxygen, sulphur, nitrogen, and some traces of ash.

A typical analysis of a heavy fuel oil would give the following percentages by weight.

Carbon . . . . .	85.7
Hydrogen . . . . .	10.5
Sulphur . . . . .	2.8
Oxygen and Nitrogen . . . . .	0.92
Ash . . . . .	0.08

The heating value of such an oil would be in the area of 45260 kJ/kg.

Fuel oils are divided into five classes numbered 1, 2, 4, 5, and 6, with No. 1 designating the lightest grade and No. 6 the heaviest. A former grade, No. 3, was eliminated some years ago. No. 6 oil is also referred to as bunker C and it is the cheapest and most commonly used fuel oil for steam generation.

Among the advantages of oil over coal as a boiler fuel are: reduced storage problems, cleanliness, ease of control, less handling equipment and less labor required, and higher combustion efficiency.

Natural Gas

Natural gas is found within porous rock or within cavities found in rock formations. It is obtained by drilling wells into the gas bearing formations and it usually occurs in conjunction with crude petroleum.

The main constituent of natural gas is methane, a compound of carbon and hydrogen. Smaller quantities of other hydro-carbons such as ethane and some nitrogen, oxygen and carbon dioxide make up the other constituents. In some cases the natural gas may also contain an appreciable amount of hydrogen sulphide which is removed and converted to sulphur before the gas is used as a fuel. The sulphur thus obtained provides a valuable product which is in high demand on world markets.

A typical analysis of natural gas is listed below with the values as volume percentages.

Methane . . . . .	77.73
Ethane . . . . .	5.56
Other hydro-carbons . . . . .	4.21
Hydrogen sulphide . . . . .	7.00
Carbon dioxide . . . . .	5.50



The heating value of natural gas will vary according to its constituents and expressed in terms of mass will generally run from 46420 to 55700 kJ/kg. It is more usual, however, to rate the heating value for a gas in terms of volume and natural gas usually has a value of about 37250 kJ/m<sup>3</sup> at standard temperature and pressure of 16°C and 101.3 kPa.

Natural gas makes an ideal boiler fuel as it yields no ash or residue. It can be easily mixed with air, requires no extensive handling equipment in the plant, and is easy to control. However it is usually more expensive than the solid and liquid fuels and its use usually involves long large diameter pipe lines for transmission to the plant.

### Fuel Analyses

In order to determine various aspects of a fuel, such as its burning characteristics, heating value and amount of air required for combustion, it is necessary to analyze the fuel. In this way the components of the fuel and their amounts are found.

Two types of analyses may be carried out and they are called the proximate analysis and the ultimate analysis.

### Proximate Analysis

This analysis is carried out on a solid fuel such as coal and determines the percentage of moisture, volatile material, fixed carbon and ash. This will indicate to a certain extent the behavior of the fuel in the furnace and the best method of firing such a fuel.

The method used to obtain the analysis is to heat the coal and thus drive off the moisture and volatiles. Then the carbon is burned and the residue left is considered to be the ash content.

To drive off the moisture a coal sample is heated in an oven at 104°C for one hour. The percentage of moisture will be the loss of mass of the sample divided by the mass of the sample before heating times 100.

To determine the percentage of volatile material, a second coal sample is heated in a covered container in a 954°C oven for seven minutes. The loss of mass will represent both moisture and volatile material and the percentage of volatile material is found by subtracting the previously obtained moisture percentage.

The next step is to heat another sample at 760°C for 2 hours until it is completely burned. The remaining residue will be the ash content of the fuel.

The percentage of fixed carbon is then taken to be the difference between 100 and the sum of the ash, volatiles and moisture percentages.

Table 1 on page 6 of this lecture shows the proximate analyses of the coals listed.

PE3-2-5-8

Ultimate Analysis

While the proximate analysis is sufficient to determine the burning qualities of a fuel, a more detailed analysis is required in order to carry out combustion calculations. This more detailed analysis, called the ultimate analysis, breaks down the fuel chemically into all its elements such as carbon, nitrogen, oxygen, hydrogen and sulphur. This analysis must be carried out in a chemical laboratory by a qualified chemist.

An ultimate analysis of a typical coal might give the following percentages by weight.

Ash . . . . .	9.47
Carbon . . . . .	77.29
Hydrogen . . . . .	4.59
Oxygen . . . . .	5.61
Nitrogen . . . . .	1.73
Sulphur . . . . .	1.31

Fuel Heat Value

When a unit amount of a fuel is burned completely the heat produced by this combustion is called the heat value or calorific value of the fuel. It is expressed as kJ/kg for solid and liquid fuels and as kJ/m<sup>3</sup> for gaseous fuels. In the case of the gaseous fuel the cubic foot is measured at standard conditions of 16°C and 101.3 kPa.

Two methods are used to determine the heat value of a fuel: (1) by calculation based on the ultimate analysis of the fuel, and (2) by burning a sample of the fuel and measuring the heat produced in an instrument called a calorimeter.

The first method is based upon the knowledge that when burned, 1 kg of carbon will produce 33890 kJ, 1 kg of hydrogen will produce 143900 kJ and 1 kg of sulphur will produce 9290 kJ, the values having been obtained by experimentation. Therefore if the amount of carbon, hydrogen and sulphur contained in the fuel is known from the ultimate analysis then the heat value of the fuel can be calculated.

In the second method where a calorimeter is used, a measured mass of a solid or liquid fuel or a measured volume of a gaseous fuel is burned in the presence of sufficient air to ensure complete combustion. The heat produced is absorbed by a measured amount of water contained in a jacket around the fuel container. The temperature rise of the water is measured and in this way the amount of heat produced is determined. The outside of the calorimeter is insulated to prevent the escape of heat to the surrounding atmosphere.

PE3-2-5-9



Combustion Chemistry

As stated previously, combustion may be defined as the combining of oxygen with the combustible elements of a fuel.

An element may be defined as a substance that cannot be broken down into any other substance. If, for example, a piece of the element carbon was divided up into microscopic particles then each particle would still be a particle of carbon.

Each element is made up of atoms which combine together to form molecules of the element. A molecule of oxygen, for example, is made up of two oxygen atoms while a molecule of carbon is made up of one carbon atom. The molecule is considered to be the smallest particle of a substance that can exist independently. Thus if a molecule of oxygen was broken down into its two atoms then these oxygen atoms would not exist independently but would rapidly combine with some other substance or with each other again.

The atoms of one element may combine with atoms of another element to form a compound. The compound carbon dioxide is formed when an atom of carbon combines with two atoms of oxygen thus forming a carbon dioxide molecule.

Elements and compounds are denoted by symbols and listed below are the symbols for the more common elements and compounds used in combustion calculations.

Carbon . . . . .	C
Hydrogen . . . . .	H <sub>2</sub>
Sulphur . . . . .	S
Carbon monoxide . . . . .	CO
Oxygen . . . . .	O <sub>2</sub>
Nitrogen . . . . .	N <sub>2</sub>
Carbon dioxide . . . . .	CO <sub>2</sub>
Sulphur dioxide . . . . .	SO <sub>2</sub>
Water Vapor . . . . .	H <sub>2</sub> O

The symbols also indicate the number of atoms that make up a molecule of the substance. Thus a molecule of the element sulphur has one sulphur atom, a molecule of the element nitrogen has two nitrogen atoms and a molecule of the compound water is made up of two hydrogen atoms combined with one oxygen atom.

Equations For Complete Combustion

The requirements for complete combustion are: enough oxygen, good mixing of the fuel and oxygen, high enough temperature, and sufficient time for the complete combining of the fuel and oxygen to be carried out.

PE3-2-5-10



If all these conditions are fulfilled then all the combustible elements of the fuel will be burned and the non-combustible elements will pass through the furnace unchanged except for being heated.

A typical fuel may contain the following elements: carbon, hydrogen, sulphur and nitrogen. The first three are combustible elements and the last is non-combustible. The following equations represent the combining of these combustible elements with oxygen during complete combustion.

1. Carbon + Oxygen → Carbon dioxide

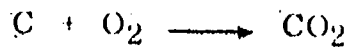

2. Hydrogen + Oxygen → Water Vapor

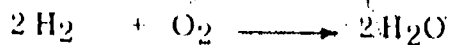

3. Sulphur + Oxygen → Sulphur dioxide



The nitrogen being a non-combustible element does not combine with oxygen but passes through the furnace unchanged except for an increase in its temperature.

#### Equations For Incomplete Combustion

If any of the requirements for complete combustion are missing then the combustible elements will not combine completely with oxygen. The following equations represent the incomplete combining of the oxygen and the combustibles.

1. Carbon + Insufficient Oxygen → Carbon Monoxide

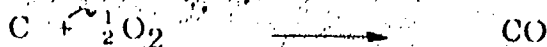

The formation of carbon monoxide instead of carbon dioxide is undesirable because carbon monoxide is a combustible compound and in passing out of the furnace without burning will represent a loss of fuel. However, if the carbon monoxide combines with more oxygen before leaving the furnace then its combustion will be complete and carbon dioxide will be formed.

Carbon monoxide + oxygen → Carbon dioxide

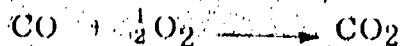

2. Hydrogen + Insufficient oxygen → Water vapor + free hydrogen

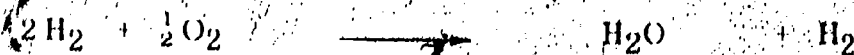

The formation of free hydrogen is undesirable because it is a combustible element which if not burned will represent a waste of fuel.

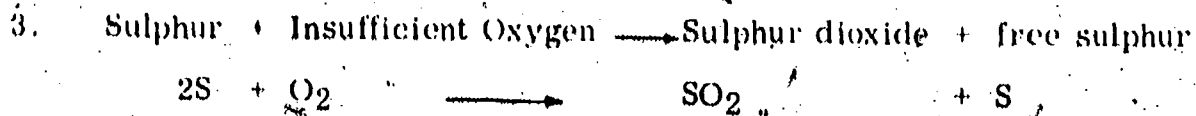

Similarly the formation of free sulphur is undesirable as being combustible it represents a waste of fuel. In actual practice the sulphur in a fuel is considered as an impurity for although it is a combustible element it tends to produce corrosive acids in the presence of water.

### Combustion Air and Excess Air

Air is basically composed of a mixture of oxygen and nitrogen in the proportion of 21 parts of oxygen to 79 parts of nitrogen by volume.

The oxygen required for complete combustion must be obtained from the air supplied to the furnace. The amount of air required to supply just enough oxygen for complete combustion is called the theoretical air. In actual practice however, it is necessary to supply more than this theoretical amount of air in order to make sure that all particles of fuel come in contact with oxygen. The amount of air in excess of the theoretical air is called excess air and is usually expressed as a percentage of the theoretical air.

For example, if the theoretical amount of air required for the complete combustion of 1 kg of a coal is 12 kg and the actual amount of air used in the furnace is 18 kg per kg of coal then the excess air =  $18 - 12 = 6$  kg. Expressed as a percentage this would be  $6/12 \times 100 = 50\%$ .

The percentage of excess air required for proper combustion of a fuel may vary from 10% to 60% or even higher. The amount required will depend upon: the time available for the fuel to mix with the air before it comes in contact with the relatively cool heating surfaces and is cooled below ignition temperature; how well the fuel and air can be mixed together; and the temperature existing within the furnace. These factors were summarized as time, turbulence, and temperature under the heading "Requirements For Complete Combustion" on page 3 of this lecture.

It can be seen therefore that a gaseous fuel such as natural gas which can easily be mixed with the combustion air will require less excess air than a solid fuel such as coal.

It is desirable to reduce the amount of excess air supplied to the furnace as much as possible as the air is heated to a high temperature in the furnace and therefore carries a large amount of heat out through the stack. In addition, the power required for forced draft and induced draft fans will decrease with decreased air supplied.

On the other hand, if the excess air is reduced too much then there will be the possibility of incomplete combustion occurring with formation of carbon monoxide and free hydrogen as explained under the heading "Equations For Incomplete Combustion" on page 11.

### Combustion Products

When a fuel is burned in the presence of excess air and the combustion is complete certain substances will be produced and will appear in the flue gas. The carbon in the fuel will burn to produce  $\text{CO}_2$ , the hydrogen will burn to produce  $\text{H}_2\text{O}$  and the sulphur will burn to produce  $\text{SO}_2$ . In addition to these products there will be excess  $\text{O}_2$  that has not been required in the burning of the fuel, the nitrogen from the air, and a certain amount of ash. The excess  $\text{O}_2$  will result from the fact that excess air has been supplied to the furnace.

If despite the presence of excess air the combustion was not complete, due to low furnace temperature or poor mixing of the fuel and air, then in addition to the above substances there would be some  $\text{CO}$  produced which would appear in the flue gases.

From the above paragraphs it can be seen that the relative amounts of  $\text{CO}_2$ ,  $\text{O}_2$ , and  $\text{CO}$  in the flue gases will give an indication of the efficiency of the combustion and the amount of excess air used. For this reason it is common practice to make an analysis of the flue gas either periodically or continuously to provide a guide for the boiler operators.

### Flue Gas Analysis

When an analysis of the flue gas is made the volume percentages of the  $\text{CO}_2$ ,  $\text{O}_2$  and  $\text{CO}$  are determined. While the flue gas may also contain some  $\text{SO}_2$  and water vapor the percentages of these are not normally obtained. The  $\text{SO}_2$  content is so small that it may be neglected and the water vapor does not provide a guide for combustion efficiency.

If a fuel composed entirely of pure carbon was burned completely with no excess air then the part of the air that combined with the carbon would be the oxygen which makes up 21% of the air volume. The volume of  $\text{CO}_2$  formed by the combining of the oxygen with the carbon will be equal to the volume of the oxygen which it has replaced and will therefore be 21% of the flue gas. The other 79% of the flue gas will be nitrogen.

If excess air is used in the burning of the carbon then the nitrogen percentage in the flue gas will increase and in addition there will be a percentage of  $\text{O}_2$  present because of the excess air providing more  $\text{O}_2$  than is needed to combine with the carbon. As a result the  $\text{CO}_2$  percentage will decrease.

If, instead of pure carbon, a fuel consisting of hydrogen and carbon is burned completely without excess air then as well as  $\text{CO}_2$  in the flue gas there will be  $\text{H}_2\text{O}$  from the combustion of the hydrogen. As a result the  $\text{CO}_2$  percentage will be reduced. The higher the percentage of hydrogen in the fuel the lower will be the percentage of  $\text{CO}_2$  in the flue gas.

The maximum  $\text{CO}_2$  content of flue gas for various fuels is as follows: for coal, approximately 19%; for oil, approximately 15.5%; and for natural gas, approximately 12%. These figures are for combustion with no excess air. If excess air is used, as it would be in actual practice then the above percentages will be reduced in accordance with the amount of excess air. For example, coal burned with 50% excess air will give a percentage of  $\text{CO}_2$  in the flue gas of approximately 12.

163-2-5-13

### Making the Analysis

The most common method of making periodic analyses of the flue gas is by means of the Orsat apparatus. This instrument is illustrated in Figure 2 and consists of three absorption pipettes for the absorption of  $\text{CO}_2$ ,  $\text{O}_2$ , and  $\text{CO}$  respectively; a water jacketed measuring burette; a levelling bottle; an aspirator bulb; connecting glass and rubber tubing; needle valves; and a three way cock.

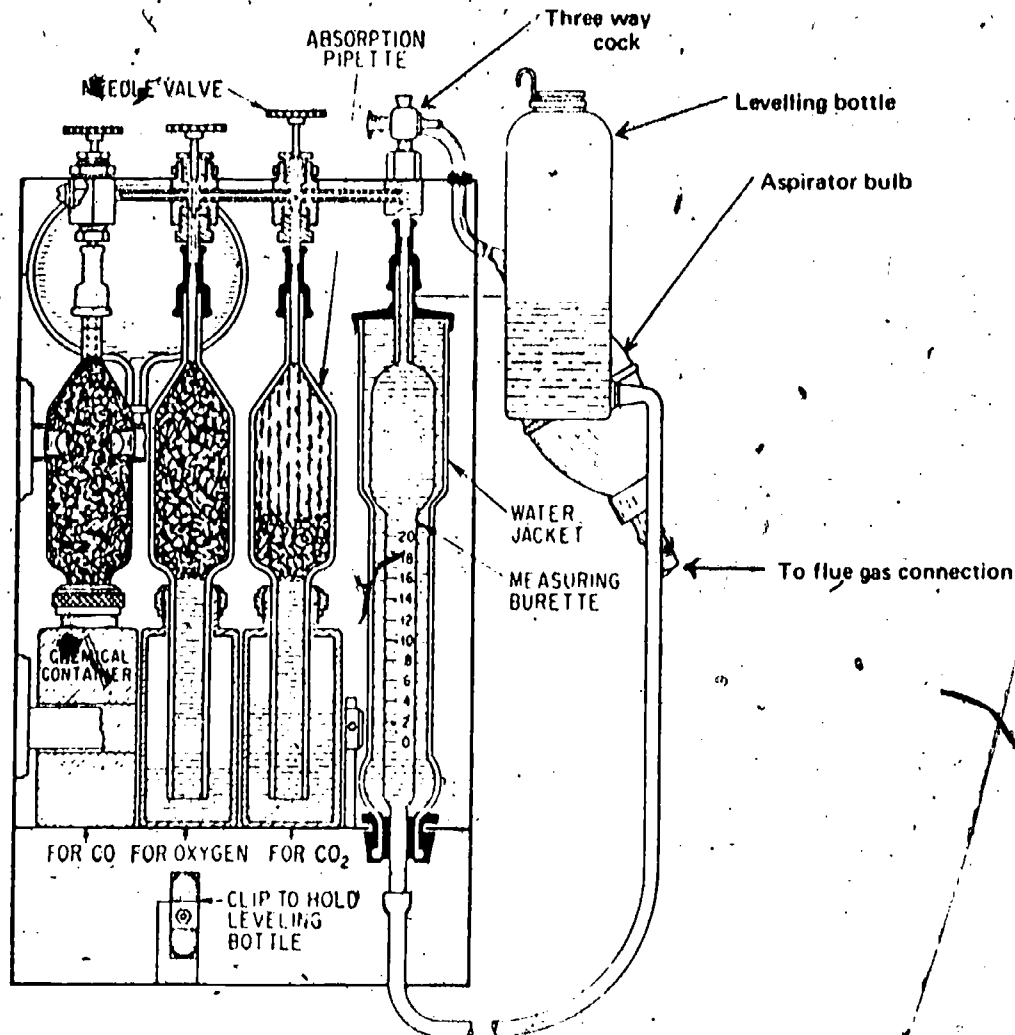

Orsat Apparatus

Figure 2

By means of the three way cock the top of the measuring burette may be connected through the aspirator bulb to the boiler flue gas passage, or it may be connected to the atmosphere, or it may be shut off from both the flue gas and the atmosphere. The burette is also connected to a manifold serving the three absorption pipettes and each pipette has a needle valve between it and the manifold.

The burette holds exactly 100 cubic centimetres of gas and has a graduated scale engraved upon the glass. The levelling bottle is connected by means of a rubber tube to the bottom of the measuring burette.

PE3-2-5-14

To obtain a sample of flue gas the levelling bottle is first filled with water, the three way cock is opened to the atmosphere and the levelling bottle is raised thus filling the measuring burette with water and driving the air out into the atmosphere. The three way cock is then opened to the aspirator bulb and boiler flue gas passage and the levelling bottle is lowered. The aspirator pump is then used to pump flue gas into the measuring burette. Any excess gas simply bubbles out through the levelling bottle. The three way cock is again opened to the atmosphere and by raising the levelling bottle slowly, the water level in the burette is brought to the zero mark. This means that now there is exactly 100 cm<sup>3</sup> of gas in the burette and the three way cock is now turned to shut off the burette from the atmosphere and from the aspirator. The 100 cm<sup>3</sup> sample of flue gas is now trapped inside the burette.

To analyze this sample for CO<sub>2</sub>, the needle valve on the first pipette is opened and the levelling bottle raised to force the gas from the burette to this pipette. This pipette contains a solution of caustic potash which will absorb the CO<sub>2</sub> in the gas. The caustic potash solution also absorbs any SO<sub>2</sub> which might be present in the gas but as mentioned previously this will be a negligible amount. The levelling bottle is now lowered to draw the remaining gas back into the burette and the pipette needle valve is closed again. A reading of the scale is now taken at the water level. This reading will give the percentage of CO<sub>2</sub> in the sample.

Figure 3 illustrates the foregoing steps in analyzing for CO<sub>2</sub>.

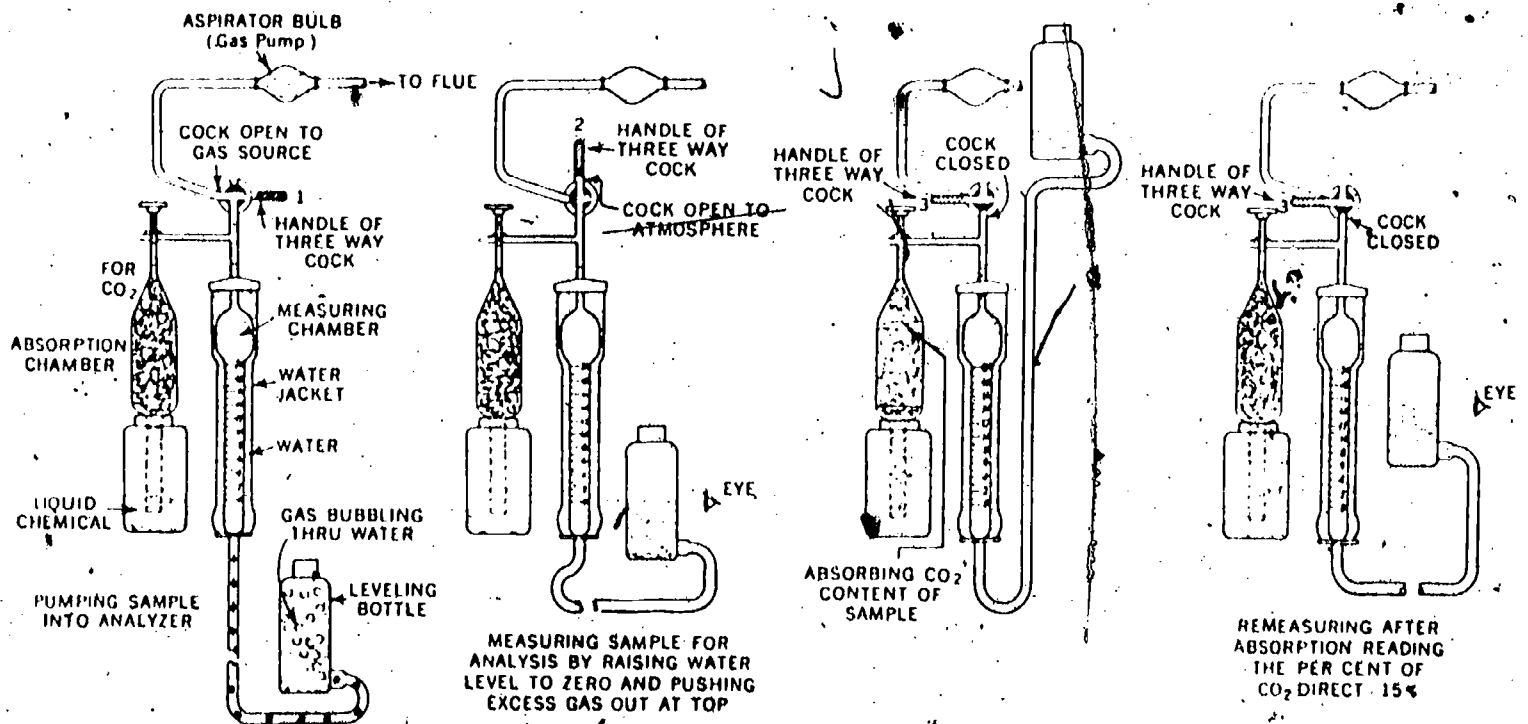

Analyzing for CO<sub>2</sub>

Figure 3

PE3-2-5-15

COPY AVAILABLE

These steps should be repeated several times to ensure complete absorption of the CO<sub>2</sub>.

The sample may now be analyzed for the oxygen content. The needle valve on the oxygen absorption pipette is opened and the sample is forced from the burette into this pipette by raising the levelling bottle. The pipette contains a mixture of caustic potash and pyrogallic acid which absorbs the oxygen in the sample. The sample is then drawn back into the measuring burette by lowering the levelling bottle and the pipette needle valve is then closed. The reading is taken on the graduated scale at the water level in the burette. The above steps must be repeated several times until a constant reading is obtained.

To determine the CO content of the sample the needle valve on the third absorption pipette is opened and the sample is forced from the measuring burette to the pipette and back into the burette again by manipulation of the levelling bottle. This procedure is also repeated several times until a constant reading is obtained. The chemical contained in the third pipette is an ammoniacal solution of cuprous chloride which has the ability to absorb CO.

The volumes of the gases absorbed in a typical analysis might read as follows:

After absorption of CO<sub>2</sub> . . . . . 16 cm<sup>3</sup>

After absorption of O<sub>2</sub> . . . . . 20 cm<sup>3</sup>

This 20 cm<sup>3</sup> represents the volume of CO<sub>2</sub> absorbed plus the additional absorption of the O<sub>2</sub>.

After absorption of CO . . . . . 20.6 cm<sup>3</sup>

This 20.6 cm<sup>3</sup> represents the CO<sub>2</sub> absorbed, plus the O<sub>2</sub> absorbed plus the CO absorbed.

The percentage readings are therefore:

CO <sub>2</sub> . . . . .	16%
O <sub>2</sub> (20 - 16) . . . . .	4%
CO (20.6 - 20) . . . . .	0.6%

### Application of Results

#### 1. Flue Gas Content

In the typical analysis listed, in the previous section only 20.6% of the sample of flue gas consisted of products of combustion (CO<sub>2</sub>, O<sub>2</sub> and CO). The remaining 79.4% consisted of inert gases, mostly nitrogen, with which we are not concerned.

2. Indications of Incomplete Combustion

Sufficient air must be provided for combustion. If insufficient air is being supplied or if the air is not thoroughly mixed with the fuel then some of the carbon will not combine completely with oxygen and so CO will appear in the analysis. In the example given, 0.6%.

3. Indications of Excess Air

If air is being supplied in excess of the theoretical amount necessary then it will be shown by O<sub>2</sub> in the analysis. In the example given, 4%.

4. Applying the Analysis

The results of the analysis should be used as a guide in regulating the air supply and the firing methods so as to produce the highest percentage of CO<sub>2</sub> without any CO. In conjunction with this, the lowest percentage of O<sub>2</sub> should be maintained by reducing the amount of excess air as much as possible.

Table 2 gives a comparison between the proportions of CO<sub>2</sub> and O<sub>2</sub> in the flue gas when burning coal, crude oil, and natural gas with varying percentages of excess

Fuel	Products	Percentage of Excess Air						
		0	10	20	40	60	80	100
Coal	CO <sub>2</sub>	18.6	16.9	15.5	13.2	11.3	10.2	9.2
	O <sub>2</sub>	0.0	2.0	3.5	6.1	8.0	9.4	10.6
Crude Oil	CO <sub>2</sub>	15.8	14.2	13.0	11.1	9.6	8.5	7.6
	O <sub>2</sub>	0.0	2.0	3.7	6.2	8.2	9.6	10.8
Natural Gas	CO <sub>2</sub>	12.0	10.8	9.8	8.3	7.2	6.3	5.7
	O <sub>2</sub>	0.0	2.1	3.8	6.4	8.3	9.8	11.0

Table 2

Automatic Gas Analyzers

There are numerous devices for analyzing the flue gases leaving a boiler furnace. These devices are usually arranged to continuously draw a sample of flue gas from the boiler, analyze it and record the results of the analysis on a chart. Some types determine the CO<sub>2</sub> content of the sample only while other types are designed to determine the O<sub>2</sub> content only. Still another type analyzes the flue gas sample for both O<sub>2</sub> and for combustibles such as CO and H<sub>2</sub>.



Figure 4 illustrates the arrangement of an automatic gas analyzer which determines both the O<sub>2</sub> and combustible content of the flue gas.

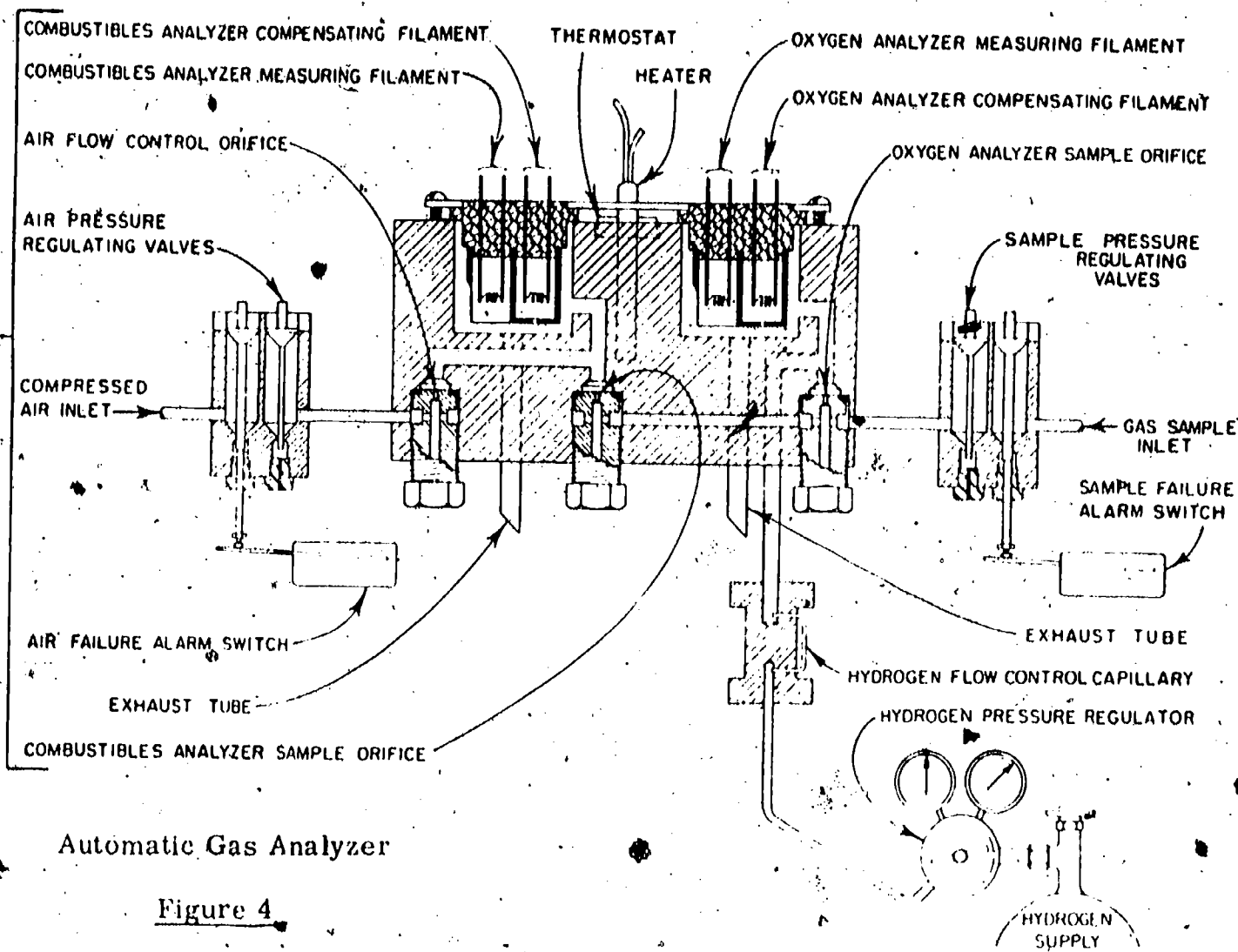

Automatic Gas Analyzer

Figure 4

Referring to Figure 4, the sample of the flue gas is withdrawn from the boiler and supplied to the analyzer under pressure by a water operated aspirator or injector. The pressure of the sample is controlled by two pressure regulating valves placed in series. These regulating devices consist of free floating valves which float on the gas stream and if the gas sample pressure increases then these valves will rise and allow some of the gas to escape to atmosphere. Conversely, if the gas sample pressure drops, then the valves will lower and reduce the escape of the gas to the atmosphere. In this way the gas sample pressure is maintained at a constant value which is determined by the weight of the valves.

After passing through the pressure regulating valves a portion of the gas sample is bled off through the oxygen analyzer sample orifice to the oxygen analyzer cell. Another portion of the sample is bled off through the combustibles analyzer sample orifice to the combustibles analyzer cell.

PEB-2-5-18

After passing through the oxygen sample orifice, that portion of the gas sample is mixed with hydrogen supplied from a storage cylinder. This mixture of sample gas and hydrogen now passes into the oxygen analyzing cell which contains two platinum filaments. Enough electrical current is passing through these filaments to cause them to glow. One of these filaments is called the measuring filament and the gas mixture has free access to it. The other filament is called the compensating filament and only a small amount of the gas mixture can contact it.

When the mixture of sample gas and hydrogen comes in contact with the hot filaments the hydrogen in the mixture will begin to burn. The amount of combustion and therefore the amount of heat produced from this combustion will depend upon the amount of oxygen contained in the flue gas sample as this is the only oxygen available for combining with the hydrogen.

The measuring filament will be heated up by this combustion to a greater extent than the compensating filament as the measuring filament is exposed to a greater amount of the burning gas. The electrical resistance of the measuring filament will be increased to a greater extent than that of the compensating filament due to this heating up. The change in electrical resistance is measured automatically and is proportional to the oxygen percentage in the gas sample. This percentage is then indicated on a recorder.

The portion of the gas sample which passes through the combustibles orifice mixes with compressed air which is supplied at a regulated pressure from a compressed air source. The mixture of sample gas and air then enters the combustibles analyzing cell which, like the oxygen analyzing cell, contains two platinum filaments, one a measuring filament and the other a compensating filament. The mixture has free access to the measuring filament while the compensating filament comes in contact with only a small amount of the mixture.

If any combustibles are present in the gas sample then they will combine with the oxygen from the compressed air and will burn. The heat produced will increase the resistance of the measuring filament to a greater extent than that of the compensating filament and this change will be proportional to the combustibles percentage in the sample. This percentage can then be indicated on a recorder.

The block containing the analyzing cells is maintained at a constant temperature by means of a thermostatically controlled heater element.

Pressure sensitive alarms are used on the sample gas inlet line and on the compressed air inlet line to indicate failure of supply of either one.

#### Smoke Prevention

With the burning of some fuels, particularly coal, there is the possibility that smoke may be formed in the furnace and discharged as part of the flue gas through the chimney to the atmosphere.

PE3-2-5-19

Smoke consists of volatile material from the fuel mixed with very fine particles of carbon and is the result of incomplete combustion. It has already been stated that to obtain complete combustion there must be high enough furnace temperature, sufficient air supplied, thorough mixing of the air with the fuel and sufficient time for the combustion to be completed. From this it follows that by burning the fuel under these conditions in the furnace, smokeless combustion will be obtained. This result however cannot be attained unless the furnace is both properly designed and correctly operated.

Smoke is detrimental to health and destructive to property for which reasons cities have smoke prevention by-laws. However, to the engineer there is also the consideration that the smoke is direct evidence of waste and uneconomical use of fuel. Therefore efforts to secure and maintain good combustion will result in fuel bill saving.

The absence of smoke however should not be accepted as conclusive evidence that combustion is complete. Excess air in large amounts may so dilute the smoke as to render it almost invisible, while at the same time lowering the furnace temperature and carrying away heat while passing through the furnace thus reducing the efficiency of the boiler.

QUESTION SHEET

Power Engineering

Third Class  
Sect. 2, Lect. 5

1. Explain why all of the heat theoretically obtainable from a fuel cannot be transferred to the water and steam in a boiler.
2. (a) Define the term "combustion" as applied to a boiler furnace.  
(b) List the conditions necessary for complete combustion.
3. (a) List five main classes of coal and name and describe briefly those classes commonly used for steam generation.  
(b) Explain why the other classes are not usually used for steam generation.
4. (a) List the advantages of oil over coal as a boiler fuel.  
(b) What are the three types of oil used as boiler fuels?  
(c) What are the advantages and disadvantages of natural gas as a boiler fuel?
5. (a) Explain what is meant by a "proximate" and an "ultimate" analysis of a fuel.  
(b) Describe briefly the procedure involved in making a proximate analysis of a coal.
6. Explain how a calorimeter is used to determine the heat value of a fuel.
7. (a) List the combustible and the non-combustible elements of a coal.  
(b) Give the equations for the complete combustion of the combustible elements.  
(c) Give the equations for the incomplete combustion of these elements.
8. (a) What is meant by the term "excess air"?  
(b) Explain why too much excess air is undesirable.
9. (a) Make a simple sketch of an Orsat flue gas analyzer.  
(b) Describe briefly how a flue gas analysis is made with the Orsat apparatus.  
(c) Explain how a flue gas analysis will indicate combustion efficiency and amount of excess air.  
(d) Give the readings for a typical analysis of the flue gas for your plant.
10. Briefly describe the principle of operation of an automatic gas analyzer.

PE3-2-5-Q

**BEST COPY AVAILABLE**



## 10.4

### COMBUSTION -- HEAT TRANSFER

#### Goal:

The apprentice will be able to describe heat transfer methods.

#### Performance Indicators:

1. Describe heat transfer by conduction.
2. Describe heat transfer by convection.
3. Describe heat transfer by radiation.



# Study Guide

- \* Read the goal and performance indicators to find what is to be learned from package.
- \* Read the vocabulary list to find new words that will be used in package.
- \* Read the introduction and information sheets.
- \* Complete the job sheet.
- \* Complete self-assessment.
- \* Complete post-assessment.

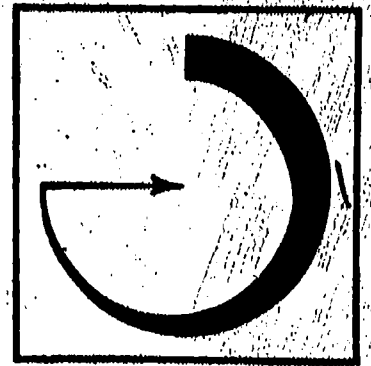

# Vocabulary

- \* Conduction
- \* Convection
- \* Convection currents
- \* Forced convection
- \* Heat transfer
- \* Insulation
- \* Joules
- \* Natural convection
- \* Radiation
- \* Thermal conductivity

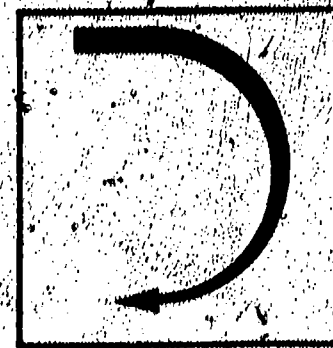

# Introduction

---

Heat is generated in a furnace and must be transferred to other locations. Water, steam and air must receive heat from the boiler furnace.

Much of the heat can be efficiently utilized if the methods of heat transfer are understood and followed. The operator must understand the basic methods of heat transfer in order to understand the procedures in boiler operation.

This package explains the three methods of heat transfer.



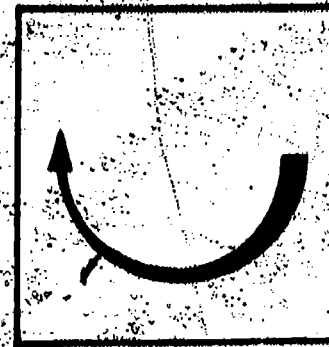

# Information

Heat flows from one body to another. The flow is always from the body of high temperature to the one of lower temperature. The rate of flow is dependent on the temperature differences and type of material that the heat is flowing through. The movements of heat from one place to another is called heat transfer.

Heat transfer can be accomplished by three methods.

1. Conduction
2. Convection
3. Radiation

## Conduction

In conduction, heat moves through a body from one molecule to the next molecule. If a high temperature is applied to one molecule, the heat will move to surrounding molecules of lower temperature. An example of conduction occurs when a metal object is heated on one end. The heat will travel from molecule to molecule until the opposite end will eventually become hot. Some materials conduct heat very well. The ability to conduct heat is called thermal conductivity which is expressed in joules of heat transferred. Copper has a high thermal conductivity. Air, wool, cork and asbestos have low thermal conductivity and are used as insulation to reduce the transfer of heat.

## Convection

Heat transfer by convection involves liquids or gases. As a liquid or gas is heated, it expands and rises toward the top. When it moves upward, it is replaced by cool liquid that will be heated. The water in a boiler drum is heated by convection currents. Flue gases move up the smokestack by convection currents. This is known as natural convection because it rises on its own as the temperature increases. In cases where hot water is moved through a system by a pump, it is called forced convection. Many residential water systems in Alaska use forced convection to transfer heat. On -50° nights, one can hear the gurgle of forced convection as it moves hot water throughout the house.

## Radiation

Radiation refers to the emission of waves. In the case of heat transfer, the waves are emitted from a high temperature bodies. The receiving body will either absorb the thermal waves; allow them to pass on through; or reflect them away. Some materials absorb heat and others reflect it. Smooth surfaces tend

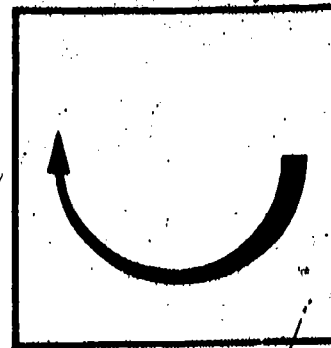

# Information

to reflect it. Smooth surfaces tend to reflect heat while rough surfaces absorb it. Air tends to pass the energy through absorbing only a small part of the heat. In boiler operation, heat is transferred from the furnace to the tubes by radiation.

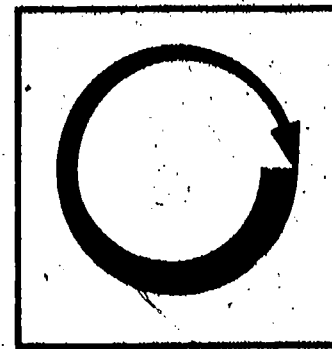

# Assignment

- \* Read pages 8 - 9 in reference.
- \* Complete job sheet.
- \* Complete self-assessment and check answers.
- \* Complete post-assessment and have instructor check answers.

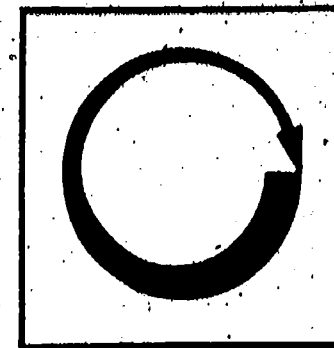

# Job Sheet

## CONDUCT EXPERIMENTS IN HEAT TRANSFER

1. Take a piece of copper wire. Hold on to one end and stick the other end in the fire. Continue holding until heat reaches your hand. (CONDUCTION)
2. Hold your hand over a fireplace fire or campfire at some distance above the flames. Feel the warm currents from hot air and gases. (CONVECTION)
3. Find a spot that will allow the sun to beam directly on to your body. Feel the warming by the thermal waves of the sun. (RADIATION)

# Self Assessment

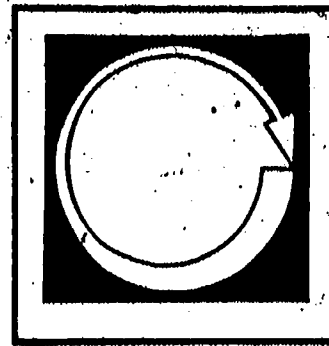

1. The movement of heat from one body to another is called \_\_\_\_\_.
2. The movement of heat from molecule to molecule is called \_\_\_\_\_.
3. Thermal waves move from one body to another by \_\_\_\_\_.
4. Fluids and gases move heat by rising upward as the temperature rises. This method of heat movement is called \_\_\_\_\_.
5. The ability to conduct heat is called \_\_\_\_\_.



# ● Self Assessment Answers

1. Heat transfer
2. Conduction
3. Radiation
4. Convection
5. Thermal conductivity

# Post Assessment

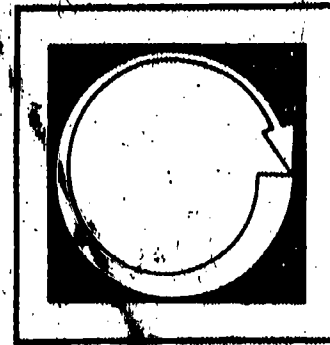

1. List three methods of heat transfer.
2. Which method of heat transfer is used to move heat from the furnace to boiler tube walls?
3. Which method of heat transfer is involved in moving flue gases up the smokestack?
4. The thermal conductivity of materials is expressed in \_\_\_\_\_.
5. List two types of convection.

# Instructor Post Assessment Answers

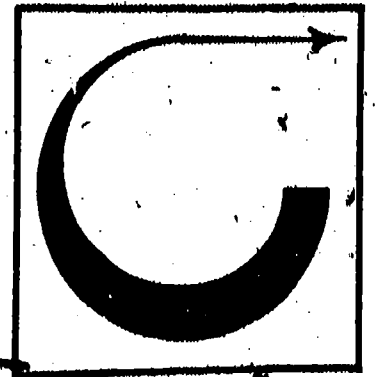

1. Conduction, convection and radiation.

2. ~~Radiation~~

3. Convection

4. Joules

5. Natural and forced



# ● Supplementary References

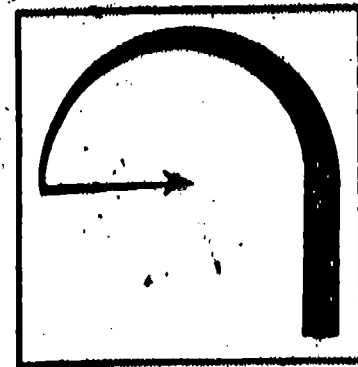

- \* Basic Training Manual for Steam Power Plant Operators. Pacific Gas and Electric Company. 1964.

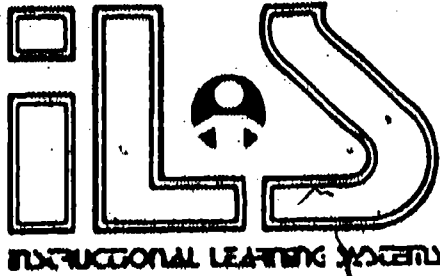

10.5

COMBUSTION — WOOD

**Goal:**

The apprentice will be able to describe factors affecting combustion of wood fuel.

**Performance Indicators:**

1. Describe fuel related factors affecting combustion.
2. Describe air related factors affecting combustion.
3. Describe other factors affecting combustion.



# Study Guide

- \* Read the goal and performance indicators to find what is to be learned from package.
- \* Read the vocabulary list to find new words that will be used in package.
- \* Read the introduction and information sheets.
- \* Complete the job sheet.
- \* Complete self-assessment.
- \* Complete post-assessment.

# Vocabulary

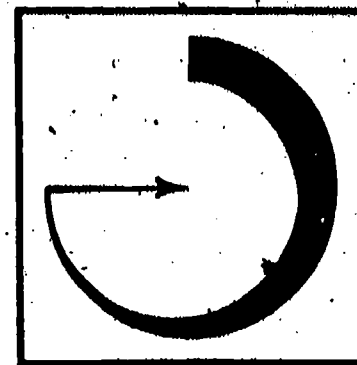

- \* Evaporation
- \* Gaseous-phase reaction
- \* Moisture content
- \* Proximate analysis
- \* Size of particle
- \* Turbulence
- \* Ultimate analysis

$\rho$ :

# Introduction

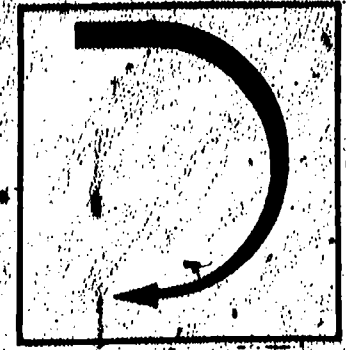

Waste wood products are becoming more important as a fuel for steam generation equipment. As forest products firms seek better utilization of their by-products, the generation of power offers a practical use for hogged fuels.

The Oregon landscape was recently dotted with wigwam burners and waste sawdust piles. Those scenes have vanished. Hogged fuels, sawdust and barkdust have become valuable by-products of a forest economy. Power generation is one option in full utilization of Oregon trees.

The combustion of wood differs from other fuels. This package discusses some of the factors to be considered in the combustion of wood fuel.

# Information



In Oregon, hogged fuel is used to generate steam in many plants because of its availability. The combustion process in wood differs from that of other fuels. Basically, it is a gaseous-phase reaction. About 75-85% of wood fuel is volatile matter and must burn in the gaseous state. Several factors affect the burning of wood fuels and their heat yield.

## Size of Wood Particles

Since most of the wood must be converted into a gaseous state for burning, evaporation becomes important. The size of the wood particles determine how fast the evaporation takes place. The smaller pieces, the faster the wood will vaporize and burn. A surface area to volume ratio is used to designate the effect on combustion rates by different size wood particles.

## Moisture Content

Moisture content directly affects the evaporation rate of wood fuel. Evaporation takes place immediately with dry wood fuel. In woods with high moisture content, much of the heat is needed to evaporate the moisture. The following table shows the moisture content and relative ratio of surface to volume and its effect on the rate of combustion for several types of wood fuel.

Wood and Bark Residues	Moisture Content (%)	Ratio Surface to Volume	Effect On Rate of Combustion
Bark	45	1	2
Planer Shavings (Kiln dry)	16	5	30
Planer Shavings (Green)	40	5	12
Sawdust	35	6	17

Note the effect of particle size by comparing bark and sawdust. The sawdust has a value of 17 as compared to 2 for bark. The rate of combustion is much faster for sawdust. Likewise, compare kiln dry and green planer shavings. Moisture content affects the rate of combustion considerably.



# Information

## Ultimate Analysis

The ultimate analysis shows that 617 pounds of air is required to burn 100 pounds of hopped fuel. The excess air can be determined directly from measuring  $CO_2$  and  $O_2$  and comparing it with this ultimate analysis of wood fuel.

## Proximate Analysis

The proximate analysis provides percentages of volatile materials, fixed carbon and ash in a fuel. From 75-85% of wood is volatile matter. A 2% ash content is of concern to an operator. Ash does not burn but it can cause problems by plugging up airways and grates. Mechanical collection equipment must be designed to withstand this high ash content.

## Method of Feeding Fuel

The method for feeding fuel is dependent on the furnace design. In a Dutch oven furnace, the fuel is poured onto the top of a pile and allowed to tumble down the pile to the furnace grates. Combustion is slow in taking place. A spreader-stoker furnace is fed by spreading the fuel across the grate and fall through the flames. Combustion takes place immediately. The method of feeding will have an effect on the efficiency of combustion.

## Distribution of Fuel in Furnace

Fuel must be spread evenly over the furnace floor. Even distribution of fuel should be practiced in all types of furnaces.

## Variations in Fuel Feed Rates

Increases in fuel feed rates to meet load demands may affect combustion. Loading high moisture fuel into a furnace may cause an upset in the combustion process. The feed rate should be increased gradually—not all at once. Gradual increases help maintain stability of the combustion process.

## Depth of Fuel Pile in Furnace

Deep piles of fuel cause a decrease in airflow under the fire. Most wood furnaces are not equipped to vary the air pressure. In Dutch oven furnaces, changes in fuel pile depth causes changes in the transfer of radiation heat. Care should be given to maintaining a fuel pile depth that is constant.

# Information



## Separate Firing Practices

Sometimes, several types of hogged fuel are used at the same time. Some operators mix the fuels together and others feed them into the furnace separately. Quite often sanderdust and bark are fed separately. Problems in combustion can arise when different fuels are fed into the furnace. Sanderdust is highly combustible while bark is less combustible. The uneven combustion rates may lead to problems in stabilizing the combustion process.

## Auxiliary Fuel Usage

Other fuels are often used to support combustion of high moisture wood. Coal and oil contain sulfur which creates air pollution. This may not be desirable when air pollution standards are to be met. Natural gas is a good choice of auxiliary fuels because it is relatively free of ash.

## Percentage of Excess Air

Some excess air is necessary for the combustion process. Too much excess air creates problems. Manufacturers recommend 20-50 percent range as being optimum for excess air in hogged fuel boilers.

## Air Temperature

When air enters the combustion zone, it should be preheated. Preheated air is important to drying of the fuel and speeding up the combustion rate.

## Ratio of Overfire to Underfire Air

The ratio will vary with the design of the furnace. A theoretical ratio shows that 75% of the air should be supplied above the fuel pile and 25% below it. Fuel moisture content and furnace design influence the ratio. With some high moisture woods, the underfire air should make up 75% of the total air.

## Turbulence of Air

Complete combustion requires that oxygen molecules must come into contact with each fuel molecule. In order to make this contact, the air and fuel must be tossed around by a gas flow in the furnace. The more turbulence of air, the better the combustion process. Well mixed fuel and air is safer because fuel vapors are not allowed to collect in pockets. Explosions can be the result of such vapor pockets.



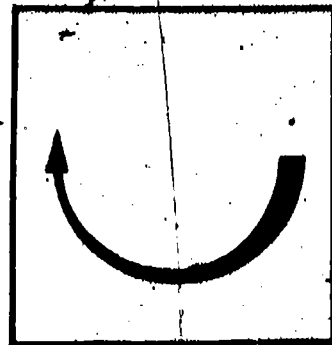

# Information

## Flow Relations Between Forced-Draft And Induced-Draft Systems

Some hogged fuel furnaces do not have balanced, automated draft systems. Such installations do not have good control of the combustion process. Incomplete combustion in the form of emissions of smoke cinders and other pollutants can be observed coming out of the stack.

### Other Factors

Soot and ash deposits must be regularly removed if good combustion conditions are to be maintained.

Boiler cleaning and maintenance is important to good combustion.

The water level in the steam drum should be maintained for optimum combustion.

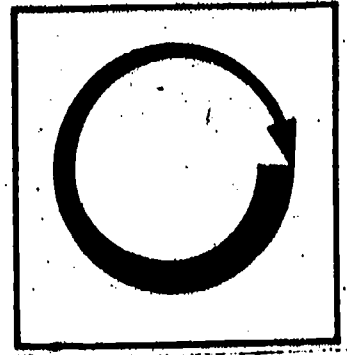

# Assignment

- \* Read pages 19-29 in supplementary reference.
- \* Complete the job sheet.
- \* Complete the self-assessment and check answers.
- \* Complete the post-assessment and ask instructor to check answers.

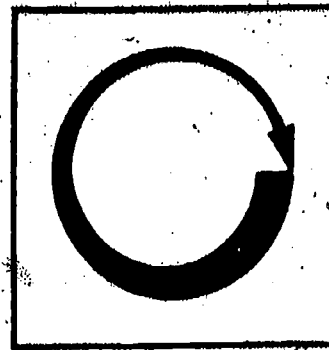

# Job Sheet

## VISIT WOOD BURNING BOILER SITE

- \* Locate a nearby plant that uses wood as a fuel.
- \* Ask permission to visit and observe wood fueled equipment.
- \* Determine
  - What type of hogged fuel is used?
  - How is the fuel processed before entering furnace?
  - What kind of furnace is used?
  - What type of draft control is used?
  - Does the plant use an auxiliary fuel? What kind?
  - Does the plant use separate firing practices for more than one kind of hogged fuels?
  - What types of equipment are used to monitor fuel, air, exhaust gases?
  - What special equipment is used to control the combustion process?
  - How is air pollution monitored?

# Self Assessment

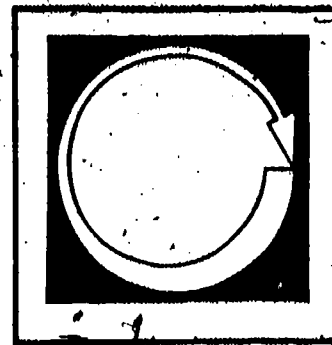

1. What percentage of hogged fuel is volatile matter?
2. The rate of evaporation is largely determine by \_\_\_\_\_ of the wood particles.
3. Which has the higher moisture content--sawdust or bark?
4. Which will burn faster--sawdust or bark?
5. What is shown in a proximate analysis?
6. What is shown in an ultimate analysis?
7. Should wood fuel be fed as a pile of fuel or spread evenly over the furnace?
8. What is caused by making the fuel pile too deep?
9. What is the major disadvantage of coal and oil as auxiliary fuels?
10. Why is air turbulence important to combustion?

# Self Assessment Answers

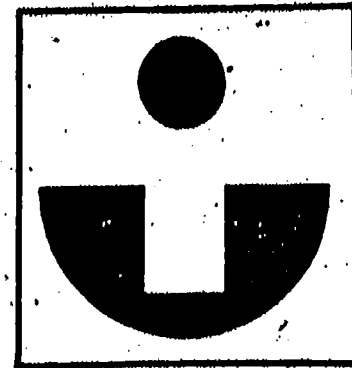

1. 75 - 85 %
2. Size
3. Bark
4. Sawdust
5. Percentages of volatile matter, fixed carbon and ash in fuel
6. Percentages of carbon, hydrogen, oxygen, nitrogen and ash in fuel
7. Spread evenly over floor
8. Decreases in airflow under the fuel pile
9. Adds air pollution problem
10. Aid combustion and prevent gas vapor pockets

# Post Assessment

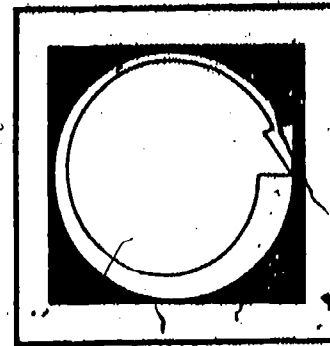

1. In systems without good draft equipment, what are some observable signs of incomplete combustion?
2. Which furnace would offer the fastest rate of combustion due to its method of feeding--the Dutch oven or a spreader-stoker type?
3. When there is a sudden demand for steam load, should the operator increase the feed rate gradually or all at once?
4. Why do small wood particles give better combustion rates than large particles?
5. The effect of particle size on combustion rates is described as a surface area to \_\_\_\_\_ ratio.
6. The percentages of oxygen, hydrogen, carbon, nitrogen and ash in a fuel is determined by \_\_\_\_\_ analysis.
7. The percentages of volatile matter, fixed carbon and ash is determined by a \_\_\_\_\_ analysis of wood fuels.
8. The theoretical ratio of air needed for combustion is \_\_\_\_\_ % supplied as overair and \_\_\_\_\_ % as underair. Due to design differences this ratio does not apply in many furnaces.
9. List two reasons why air turbulence is important to combustion?
10. Does the airflow increase or decrease under the fire when fuel is piled too deep?

# Instructor Post Assessment Answers



1. Smoke cinders and pollutants passing out the stack
2. Spreader--stoker.
3. Gradually
4. Allows evaporation to take place faster
5. Volume
6. Ultimate analysis
7. Proximate analysis
8. 75 % overair and 25% underair
9. Mixes fuel and air molecules and prevents fuel vapor pockets which may cause explosions.
10. Decrease

# Supplementary References

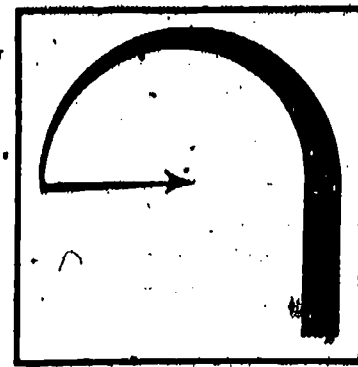

- \* Boilers Fired With Wood and Bark Residues. David C. Junge. Research Bulletin 17. Forest Research Laboratory. Oregon State University. 1975.