

DOCUMENT RESUME

ED 254 706

CE 040 982

TITLE Stationary Engineers Apprenticeship. Related Training Modules. 12.1-12.9. Boilers.

INSTITUTION Lane Community Coll., Eugene, Oreg.

SPONS AGENCY Oregon State Dept. of Education, Salem.

PUB DATE [82]

NOTE 176p.; For related documents, see CE 040 971-990. Many of the modules are duplicated in CE 040 997.

PUB TYPE Guides - Classroom Use - Materials (For Learner) (051)

EDRS PRICE MF01/PC08 Plus Postage.

DESCRIPTORS *Apprenticeships; Behavioral Objectives; Energy; Energy Occupations; Equipment Maintenance; *Equipment Utilization; Job Skills; Job Training; Learning Modules; Postsecondary Education; *Power Technology; *Trade and Industrial Education

IDENTIFIERS *Boilers; *Stationary Engineering

ABSTRACT This learning module, one in a series of 20 related training modules for apprentice stationary engineers, deals with boilers. Addressed in the individual instructional packages included in the module are the following topics: firetube and watertube boilers; boiler construction; procedures for operating and cleaning boilers; and boiler fittings, heat recovery systems, instruments and controls, piping, and steam traps. Each instructional package in the module contains some or all of the following: a lesson goal, performance indicators, a study guide, a vocabulary list, an introduction, instructional text, an assignment, a job sheet, a self-assessment activity, a post-assessment instrument, answers to the post-assessment instrument, and a list of recommended supplementary references. (MN)

 * Reproductions supplied by EDRS are the best that can be made *
 * from the original document. *

ED254706

APPRENTICESHIP

STATIONARY
ENGINEERS

RELATED
TRAINING MODULES

12.1-12.9 BOILERS

U.S. DEPARTMENT OF EDUCATION
NATIONAL INSTITUTE OF EDUCATION
EDUCATIONAL RESOURCES INFORMATION
CENTER (ERIC)

This document has been reproduced as
received from the person or organization
originating it.
Minor changes have been made to improve
reproduction quality.

Points of view or opinions stated in this docu-
ment do not necessarily represent official NIE
position or policy.

"PERMISSION TO REPRODUCE THIS
MATERIAL HAS BEEN GRANTED BY

J. J. Case

TO THE EDUCATIONAL RESOURCES
INFORMATION CENTER (ERIC)."

FE 040982

STATEMENT OF ASSURANCE

IT IS THE POLICY OF THE OREGON DEPARTMENT OF EDUCATION THAT NO PERSON BE SUBJECTED TO DISCRIMINATION ON THE BASIS OF RACE, NATIONAL ORIGIN, SEX, AGE, HANDICAP OR MARITAL STATUS IN ANY PROGRAM, SERVICE OR ACTIVITY FOR WHICH THE OREGON DEPARTMENT OF EDUCATION IS RESPONSIBLE. THE DEPARTMENT WILL COMPLY WITH THE REQUIREMENTS OF STATE AND FEDERAL LAW CONCERNING NON-DISCRIMINATION AND WILL STRIVE BY ITS ACTIONS TO ENHANCE THE DIGNITY AND WORTH OF ALL PERSONS.

STATEMENT OF DEVELOPMENT

THIS PROJECT WAS DEVELOPED AND PRODUCED UNDER A SUB-CONTRACT FOR THE OREGON DEPARTMENT OF EDUCATION BY LANE COMMUNITY COLLEGE, APPRENTICESHIP DIVISION, EUGENE, OREGON, 1984. LANE COMMUNITY COLLEGE IS AN AFFIRMATIVE ACTION/EQUAL OPPORTUNITY INSTITUTION.

APPRENTICESHIP

STATIONARY ENGINEERS
RELATED TRAINING MODULESCOMPUTERS

- 1.1 Digital Language
- 1.2 Digital Logic
- 1.3 Computer Overview
- 1.4 Computer Software

SAFETY

- 2.1 General Safety
- 2.2 Hand Tool Safety
- 2.3 Power Tool Safety
- 2.4 Fire Safety
- 2.5 Hygiene Safety
- 2.6 Safety and Electricity

DRAWING

- 3.1 Types of Drawings and Views
- 3.2 Blueprint Reading/Working Drawings
- 3.3 Scaling and Dimensioning
- 3.4 Machine and Welding Symbols

TOOLS

- 4.1 Measuring, Layout and Leveling Tools
- 4.2 Boring and Drilling Tools
- 4.3 Cutting Tools, Files and Abrasive
- 4.4 Holding and Fastening Tools
- 4.5 Fastening Devices

ELECTRICITY/ELECTRONICS

- 5.1 Basics of Energy
- 5.2 Atomic Theory
- 5.3 Electrical Conduction
- 5.4 Basics of Direct Current
- 5.5 Introduction to Circuits
- 5.6 Reading Scales
- 5.7 Using a V.O.M.
- 5.8 OHM'S Law
- 5.9 Power and Watt's Law
- 5.10 Kirchoff's Current Law
- 5.11 Kirchoff's Voltage Law
- 5.12 Series Resistive Circuits
- 5.13 Parallel Resistive Circuits
- 5.14 Series - Parallel Resistive Circuits

- 5.15 Switches and Relays
- 5.16 Basics of Alternating Currents
- 5.17 Magnetism

HUMAN RELATIONS

- 6.1 Communications Skills
- 6.2 Feedback
- 6.3 Individual Strengths
- 6.4 Interpersonal Conflicts
- 6.5 Group Problem Solving, Goal-setting and Decision-making
- 6.6 Worksite Visits
- 6.7 Resumes
- 6.8 Interviews
- 6.9 Work Habits and Attitudes
- 6.10 Wider Influences and Responsibilities
- 6.11 Personal Finance
- 6.12 Expectations

TRADE MATH

- 7.1 Linear - Measure
- 7.2 Whole Numbers
- 7.3 Addition and Subtraction of Common Fraction and Mixed Numbers
- 7.4 Multiplication and Division of Common Fractions and Whole and Mixed Numbers
- 7.5 Compound Numbers
- 7.6 Percent
- 7.7 Mathematical Formulas
- 7.8 Ratio and Proportion
- 7.9 Perimeters, Areas and Volumes
- 7.10 Circumference and Wide Area of Circles
- 7.11 Area of Planes, Figures, and Volumes of Solid Figures
- 7.12 Graphs
- 7.13 Basic Trigonometry
- 7.14 Metrics

HYDRAULICS

- 8.1 Hydraulics - Lever
- 8.2 Hydraulics - Transmission of Force
- 8.3 Hydraulics - Symbols
- 8.4 Hydraulics - Basic Systems
- 8.5 Hydraulics - Pumps
- 8.6 Hydraulics - Pressure Relief Valve
- 8.7 Hydraulics - Reservoirs
- 8.8 Hydraulics - Directional Control Valve
- 8.9 Hydraulics - Cylinders
- 8.10 Hydraulics - Forces, Area, Pressure
- 8.11 Hydraulics - Conductors and Connectors
- 8.12 Hydraulics - Troubleshooting
- 8.13 Hydraulics - Maintenance

REFRIGERATION

- 9.1 Refrigeration - Introduction
- 9.2 Refrigeration - Compressors
- 9.3 Refrigeration - Temperature Controls
- 9.4 Refrigeration - Condensers and Evaporation
- 9.5 Refrigeration - Purge, Evacuate, Recharge
- 9.6 Refrigeration - Troubleshooting

MACHINE COMPONENTS

- 10.1 Machine Components - Shafts
- 10.2 Machine Components - Bearings
- 10.3 Machine Components - Seals and Gaskets
- 10.4 Machine Components - Chain Shafts
- 10.5 Machine Components - Belts and Pulleys

LUBRICATION

- 11.1 Lubrication - Introduction
- 11.2 Lubrication - Standards and Selection of Lubricants

BOILERS

- 12.1 Boilers - Fire Tube Types
- 12.2 Boilers - Watertube Types
- 12.3 Boilers - Construction
- 12.4 Boilers - Fittings
- 12.5 Boilers - Operation
- 12.6 Boilers - Cleaning
- 12.7 Boilers - Heat Recovery Systems
- 12.8 Boilers - Instruments and Controls
- 12.9 Boilers - Piping and Steam Traps

PUMPS

- 13.1 Pumps - Types and Classification
- 13.2 Pumps - Applications
- 13.3 Pumps - Construction
- 13.4 Pumps - Calculating Heat and Flow
- 13.5 Pumps - Operation
- 13.6 Pumps - Monitoring and Troubleshooting
- 13.7 Pumps - Maintenance

STEAM

- 14.1 Steam - Formation and Evaporation
- 14.2 Steam - Types
- 14.3 Steam - Transport
- 14.4 Steam - Purification

TURBINES

- 15.1 Steam Turbines - Types
- 15.2 Steam Turbines - Components

- 15.3 Steam Turbines - Auxillaries
- 15.4 Steam Turbines - Operation and Maintenance
- 15.5 Gas Turbines

COMBUSTION

- 16.1 Combustion - Process
- 16.2 Combustion - Types of Fuel
- 16.3 Combustion - Air and Fuel Gases
- 16.4 Combustion - Heat Transfer
- 16.5 Combustion - Wood

FEEDWATER

- 17.1 Feedwater - Types and Equipment
- 17.2 Feedwater - Water Treatments
- 17.3 Feedwater - Testing

GENERATORS

- 18.1 Generators - Types and Construction
- 18.2 Generators - Operation

AIR COMPRESSORS

- 19.1 Air Compressors - Types
- 19.2 Air Compressors - Operation and Maintenance

MISCELLANEOUS

- 20.1 Transformers
- 21.1 Circuit Protection
- 22.1 Installation - Foundations 770
- 22.2 Installation - Alignment
- 23.1 Trade Terms

STATIONARY ENGINEER
SUPPLEMENTARY REFERENCE DIRECTORY

Note: All reference packets are numbered on the upper right-hand corner of the respective cover page.

Supplementary Packet #	Description	Related Training Module
12.1	Correspondence Course, Lecture 1, Sec. 2, Steam Generators, Types of Boilers I, S.A.I.T.; Calgary, Alberta, Canada	12.1 Boilers, Fire Tube Type
12.2	Correspondence Course, Lecture 2, Sec. 2, Steam Generators, Types of Boilers II, S.A.I.T., Calgary, Alberta, Canada	12.2. Boilers, Water Tube Type
12.3	Correspondence Course, Lecture 2, Sec. 2, Steam Generators, Boiler Construction & Erection, S.A.I.T., Calgary, Alberta, Canada	12.3 Boilers, Construction
12.4	Correspondence Course, Lecture 4, Sec. 2, Steam Generators, Boiler Fittings II, S.A.I.T., Calgary, Alberta, Canada	12.4 Boilers, Fittings
12.4	Correspondence Course, Lecture 4, Sec. 2, Steam Generators, Boiler Fitting I, S.A.I.T., Calgary, Alberta, Canada	12.4 Boilers, Fittings
12.5	Correspondence Course, Lecture 10, Sec. 2, Steam Generation, Boiler Operation, Maintenance, Inspection, S.A.I.T., Calgary, Alberta, Canada	12.5 Boilers, Operation
12.7	Correspondence Course, Lecture 3, Sec. 2, Steam Generation, Boiler Details, S.A.I.T., Calgary, Alberta, Canada	12.7 Boilers Heat Recovery Systems
12.8	Refer to reference packet 14.3/12.8	
13.1	Correspondence Course, Lecture 9, Sec. 2, Steam Generator, Power Plant Pumps, S.A.I.T., Calgary, Alberta, Canada	PUMPS 13.1 Types & Classification
13.2		13.2 Applications
13.4		13.4 Calculating Heat & Flow
13.6		13.6 Monitoring & Troubleshooting
13.7		13.7 Maintenance
13.3	Correspondence Course, Lecture 6, Sec. 3, Steam Generators, Pumps, S.A.I.T., Calgary, Alberta, Canada	13.3 Construction
13.5		13.5 Operation

Supplementary Packet #	Description	Related Training Module
14.3 12.8	Correspondence Course, Lecture 6, Section 3, Steam Generators, Steam Generator Controls, S.A.I.T., Calgary, Alberta, Canada	14.3 Steam, Transport 12.8 Boilers, Instruments & Controls
14.4	Correspondence Course, Lecture 11, Section 2, Steam Generators, Piping II, S.A.I.T., Calgary, Alberta, Canada	14.4 Steam, Purification
15.1	Correspondence Course, Lecture 1, Sec. 4, Prime Movers & Auxiliaries, Steam Turbines, S.A.I.T., Calgary, Alberta, Canada	15.1 Steam Turbines, Types
15.2	Correspondence Course, Lecture 4, Sec. 3, Prime Movers, Steam Turbines I, S.A.I.T., Calgary, Alberta, Canada	15.2 Steam Turbines, Components
15.3	Correspondence Course, Lecture 2, Sec. 4, Prime Movers & Auxiliaries, Steam Turbine Auxiliaries, S.A.I.T., Calgary, Alberta, Canada	15.3 Steam Turbines, Auxiliaries
15.4	Correspondence Course, Lecture 6, Sec. 3, Prime Movers, Steam Turbine Operation & Maintenance, S.A.I.T., Calgary, Alberta, Canada	15.4 Steam Turbines, Operation & Maintenance
15.5	Correspondence Course, Lecture 8, Sec. 3, Prime Movers, Gas Turbines, S.A.I.T., Calgary, Alberta, Canada	15.5 Gas Turbines
16.2	Boilers Fired with Wood and Bark Residues, D.D. Junge, F.R.I., O.S.U. 1975	16.2 Combustion Types of Fuel
16.2	Correspondence Course, Lecture 5, Sec. 2, Steam Generators, Fuel Combustion, S.A.I.T., Calgary, Alberta, Canada	16.2 Combustion Types of Fuel
16.3	Correspondence Course, Lecture 5, Sec. 2, Plant Services, Fuel & Combustion, S.A.I.T., Calgary, Alberta, Canada	16.3 Combustion, Air & Fuel Gases
17.1	Correspondence Course, Lecture 12, Sec. 3, Steam Generation, Water Treatment, S.A.I.T., Calgary, Alberta, Canada	17.1 Feed Water, Types & Operation
17.2	Correspondence Course, Lecture 12, Sec. 2, Steam Generation, Water Treatment, S.A.I.T., Calgary, Alberta, Canada	17.2 Feed Water, Water Treatments

Supplementary
 Packet

Description

Related Training Module

17.3	Correspondence Course, Lecture 7, Sec. 2, Steam Generators, Boiler Feed Water Treatment, S.A.I.T., Calgary, Alberta, Canada	17.3 Feed Water, Testing
18.1	Correspondence Course, Lecture 2, Sec. 5, Electricity, Direct Current Machines, S.A.I.T., Calgary, Alberta, Canada	18.1 Generators, Types & Construction
18.1 18.2	Correspondence Course, Lecture 4, Sec. 5, Electricity, Alternating Current Generators, S.A.I.T., Calgary, Alberta, Canada	18.1 Generators, Types & Construction 18.2 Generators, Operation
19.1	Correspondence Course, Lecture 5, Sec. 4, Prime Movers & Auxiliaries, Air Compressor I, S.A.I.T., Calgary, Alberta, Canada	19.1 Air Compressors, Types
19.1 19.2	Correspondence Course, Lecture 6, Sec. 4, Prime Movers & Auxiliaries, Air Compressors II, S.A.I.T., Calgary, Alberta, Canada	19.1 Air Compressors, Types 19.2 Air Compressors, Operation & Maintenance
20.1	Basic Electronics, Power Transformers, EL-BE-51	20.1 Transformers
21.1	Correspondence Course, Lecture 7, Sec. 5, Electricity, Switchgear & Circuit, Protective Equipment, S.A.I.T., Calgary, Alberta, Canada	21.1 Circuit Protection
22.1	Correspondence Course, Lecture 10, Sec. 3, Prime Movers, Power Plant Erection & Installation, S.A.I.T., Calgary, Alberta, Canada	22.1 Installation Foundations

RECOMMENDATIONS FOR USING TRAINING MODULES

The following pages list modules and their corresponding numbers for this particular apprenticeship trade. As related training classroom hours vary for different reasons throughout the state, we recommend that the individual apprenticeship committees divide the total packets to fit their individual class schedules.

There are over 130 modules available. Apprentices can complete the whole set by the end of their indentured apprenticeships. Some apprentices may already have knowledge and skills that are covered in particular modules. In those cases, perhaps credit could be granted for those subjects, allowing apprentices to advance to the remaining modules.

We suggest the the apprenticeship instructors assign the modules in numerical order to make this learning tool most effective.

SUPPLEMENTARY INFORMATION

ON CASSETTE TAPES

Tape 1: Fire Tube Boilers - Water Tube Boilers
and Boiler Manholes and Safety Precautions

Tape 2: Boiler Fittings, Valves, Injectors,
Pumps and Steam Traps

Tape 3: Combustion, Boiler Care and Heat Transfer
and Feed Water Types

Tape 4: Boiler Safety and Steam Turbines

NOTE: The above cassette tapes are intended as additional
reference material for the respective modules, as
indicated, and not designated as a required assignment.



12.1

BOILERS -- FIRE TUBE TYPES

Goal:

The apprentice will be able to describe types of fire tube boilers.

Performance Indicators:

1. Distinguish between fire tube and water tube boilers.
2. Describe horizontal return boilers.
3. Describe scotch boilers.
4. Describe one and two-pass boilers.
5. Describe dryback and wetback types of boiler.
6. Describe packaged boilers.
7. Describe firebox boilers.
8. Describe externally fired boilers.
9. Describe internally fired boilers.
10. Describe shell internals of a boiler.
11. Describe safety devices and practices with fire tube boilers.

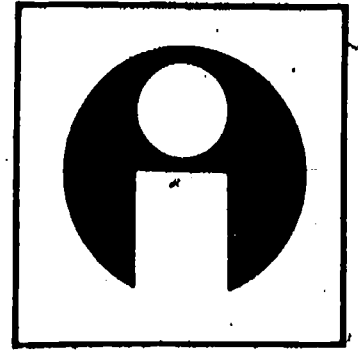

Study Guide

- * Read the goal and performance indicators to determine what is to be learned from package.
- * Read the vocabulary list to find new words that will be used in package.
- * Read the introduction and information sheets.
- * Complete the job sheet.
- * Complete self-assessment.
- * Complete post-assessment.

Vocabulary

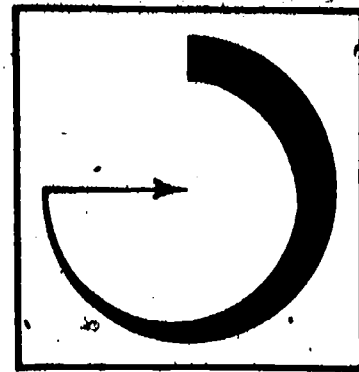

- * Blow-off connection
- * Dryback boiler
- * Externally fired boiler
- * Firetube boiler
- * Horizontal return tube boiler
- * Internally fired boilers
- * Internal furnace boilers
- * One pass boiler
- * Packaged firetube boiler
- * Safety valves
- * Scotch boilers
- * Steam dome
- * Steam outlet
- * Smoke box
- * Smoke stack
- * Tube plates
- * Two-pass boiler
- * Water-leg
- * Watertube boiler
- * Wetback boiler

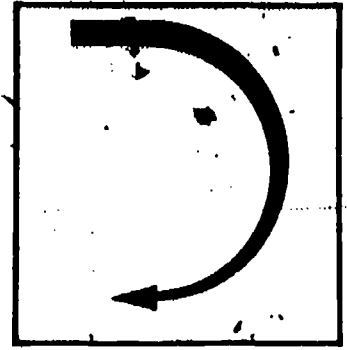

Introduction

High pressure boilers can be divided into major classifications--firetube and watertube. A firetube boiler has tubes that carry flue gases from the fluebox. The tubes are surrounded with water. As the gases travel through the firetubes, the surrounding water is heated to produce steam.

A watertube boiler circulates water through tubes instead of flue gasses. Hot flue gasses, outside the tubes, heat the water in the tubes and produce steam.

This package will describe the firetube boiler. Another package will describe watertube boilers.

Information

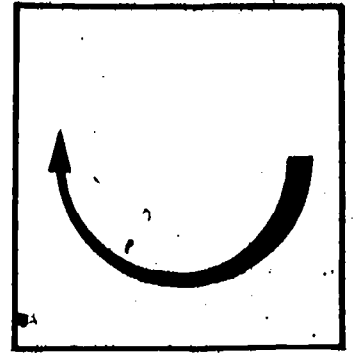

A steam boiler is merely a steel container in which water can be heated to produce steam. The water is heated and evaporated into steam that drives a prime mover such as the steam turbine.

The firetube boiler uses tubes to carry the heat throughout the water. Close contact between water and heated tubes makes steam production more efficient. The principle of the firetube boiler is shown in the following diagram.

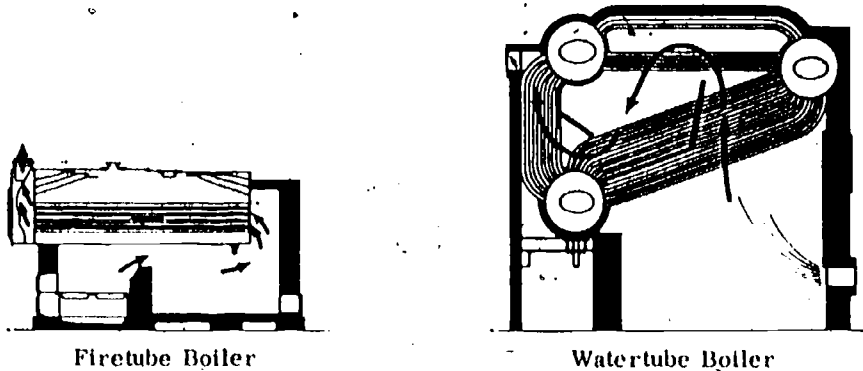

Firetube Boiler

Watertube Boiler

Firetube boilers are simple in construction and low first costs make them suitable for many applications in steam generation. Many variations in design help to improve the efficiency and adaptability of the firetube boiler.

Horizontal Return Tube Boiler

A horizontal return tube boiler has firetubes running the length of the boiler shell. The top portion of the boiler is above water level and allows steam to collect. Horizontal return tube boilers can use a variety of fuels. A diagram of the horizontal return tube boiler follows.

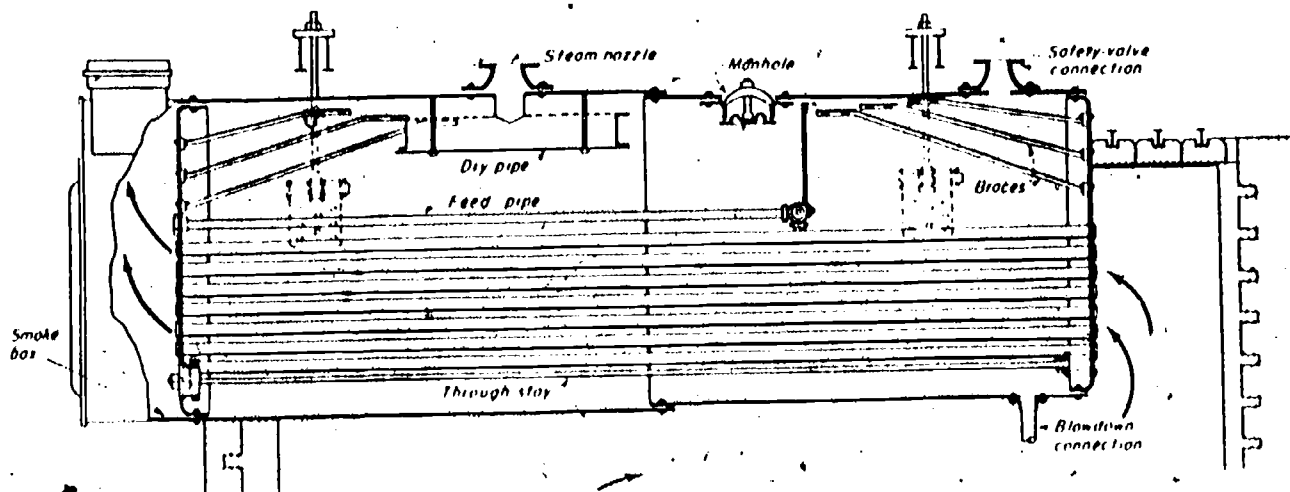

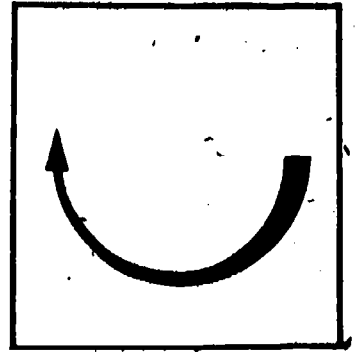

Information

Scotch Boilers

Scotch boilers are self-contained units with the firebox inside the boiler shell. The furnace is located below the firetubes. As gases are produced, they flow into a chamber at the end of the boiler and then pass through the firetubes to the smokebox. Such boilers are sometimes called internal furnace boilers. Scotch boilers are of welded construction with a refractory type rear chamber to send the gases back through the firetubes to the smokebox.

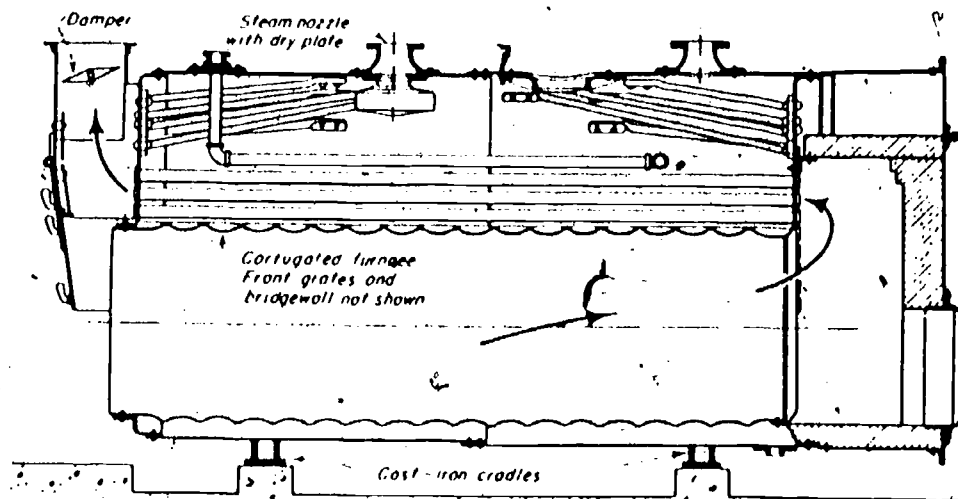

One Pass boilers

One pass boilers have one set of firetubes that extend much of the length of the boiler shell. Gases pass through the tubes in one direction as was shown in the horizontal return tube boiler.

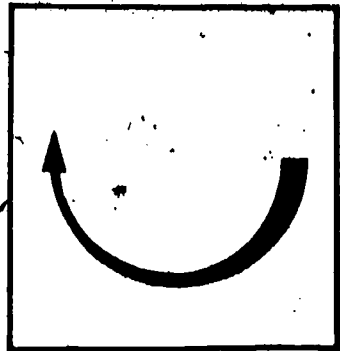

Information

Two Pass Boilers

Two pass boilers have two sets of firetubes. The gasses pass through a short set of tubes and return back through a long set of tubes. The long tubes are smaller than the short tubes.

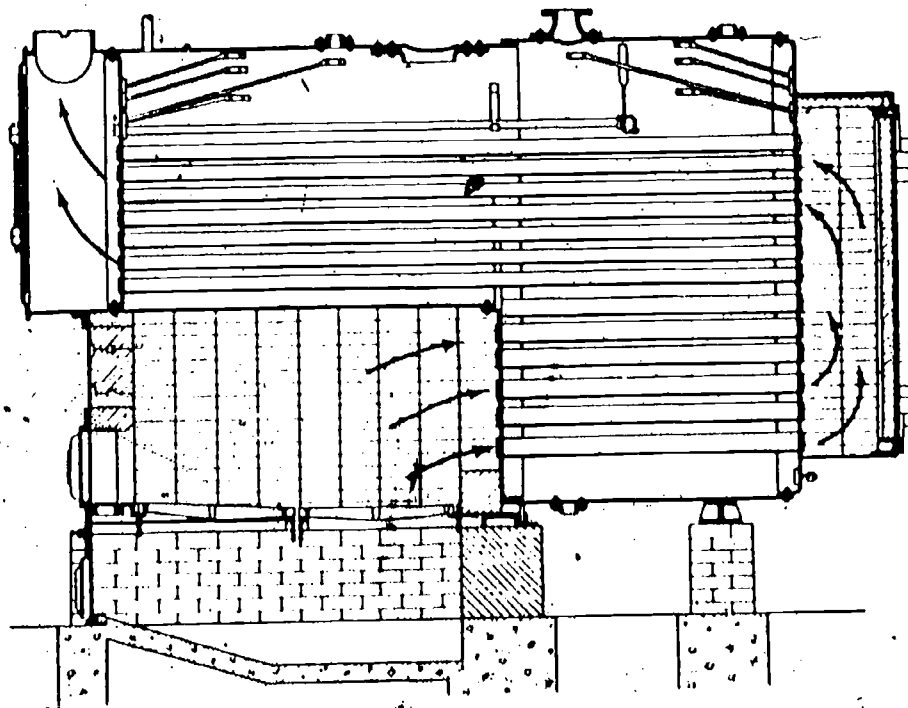

Dryback Boilers

In dryback type boilers, the furnace opens into a refractory lined chamber which causes the gasses to flow back through the firetubes. The chamber is dry which gives it the name "dryback". A brick lining is used for the chamber.

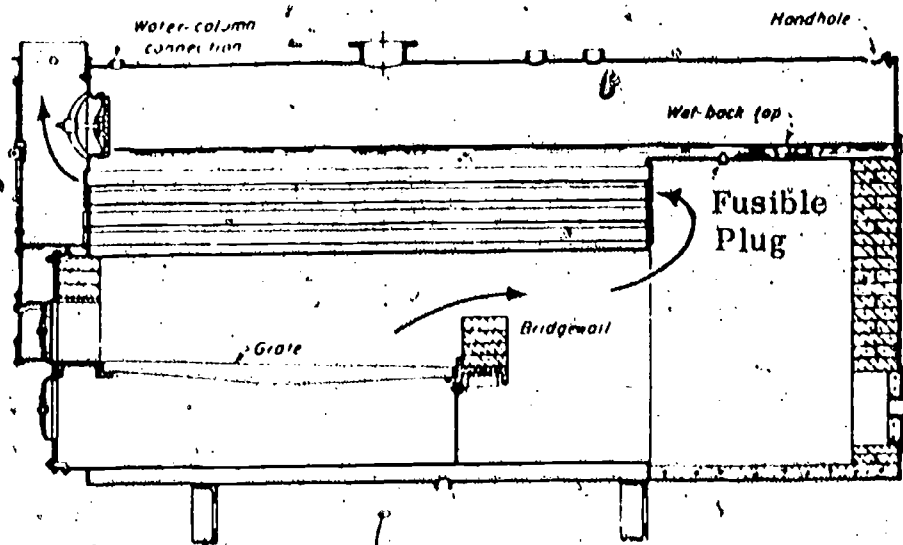

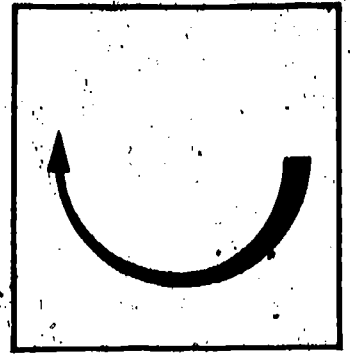

Information

Firebox Boiler

This boiler is a low cost, efficient and compact type that is usually used as a heating boiler. The shell has two sections with two sets of firetubes. Gasses travel through tubes in the lower shell section and reverse through the upper tubes. Fireboxes are encased in brick in most firebox boilers although some designs use water to surround the firebox.

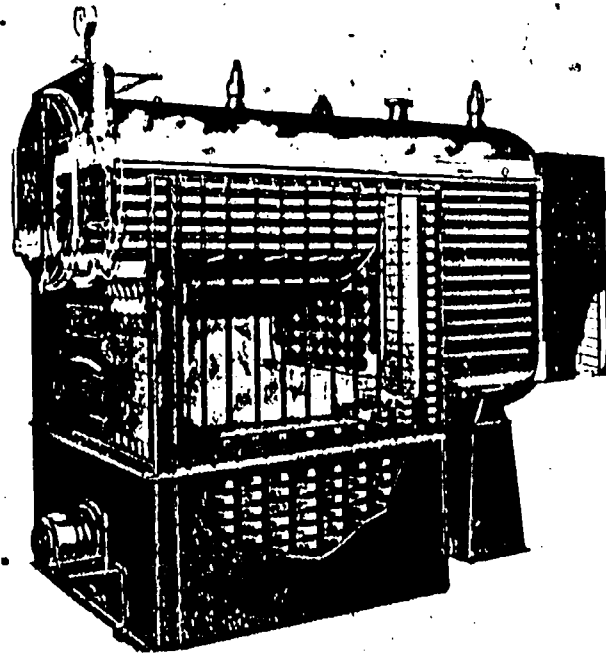

Internally Fired Boilers

Designers found that the heating surface could be increased by enclosing the furnace, as well as the firetubes, inside the boiler shell. The furnace of an internally fired boiler is almost totally surrounded by water.

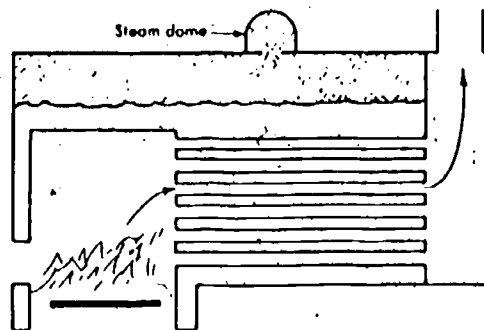

Information

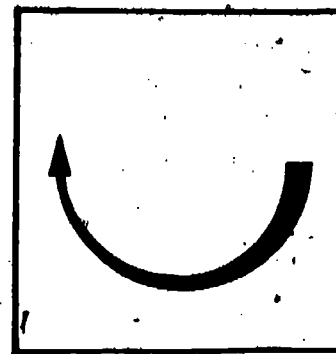

Wetback Boilers

Wetback type boilers have a rear chamber that is surrounded by water. This wetback design is also called a scotch marine boiler. The water that surrounds the rear chamber is called a water-leg.

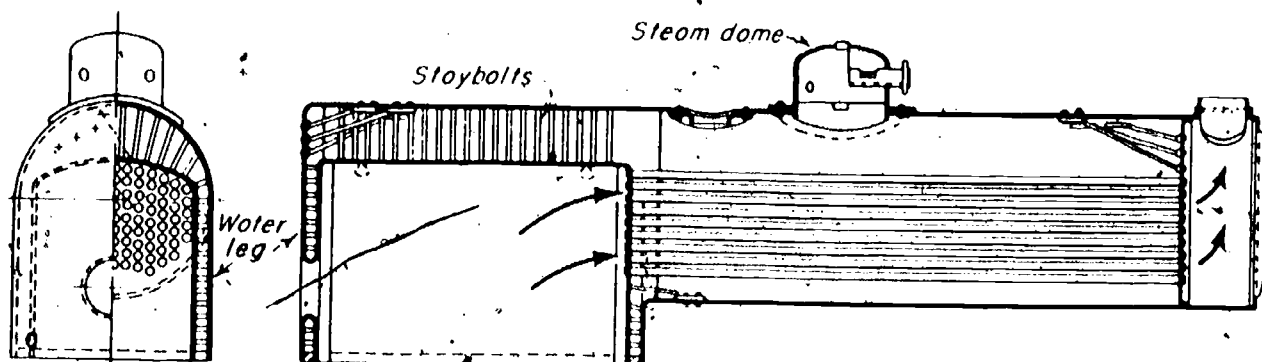

Packaged Firetube Boilers

A boiler unit that is purchased with the auxiliaries and control units intact are called "packaged" boilers. Packaged boilers can be purchased in two, three and four pass designs.

Information

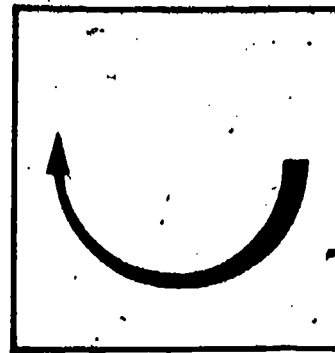

Externally Fired Boilers

In externally fired boilers, the furnace is located outside of the boiler shell. The horizontal return-tube boiler is an example of the externally fired boiler. A brick refractory houses the firing equipment.

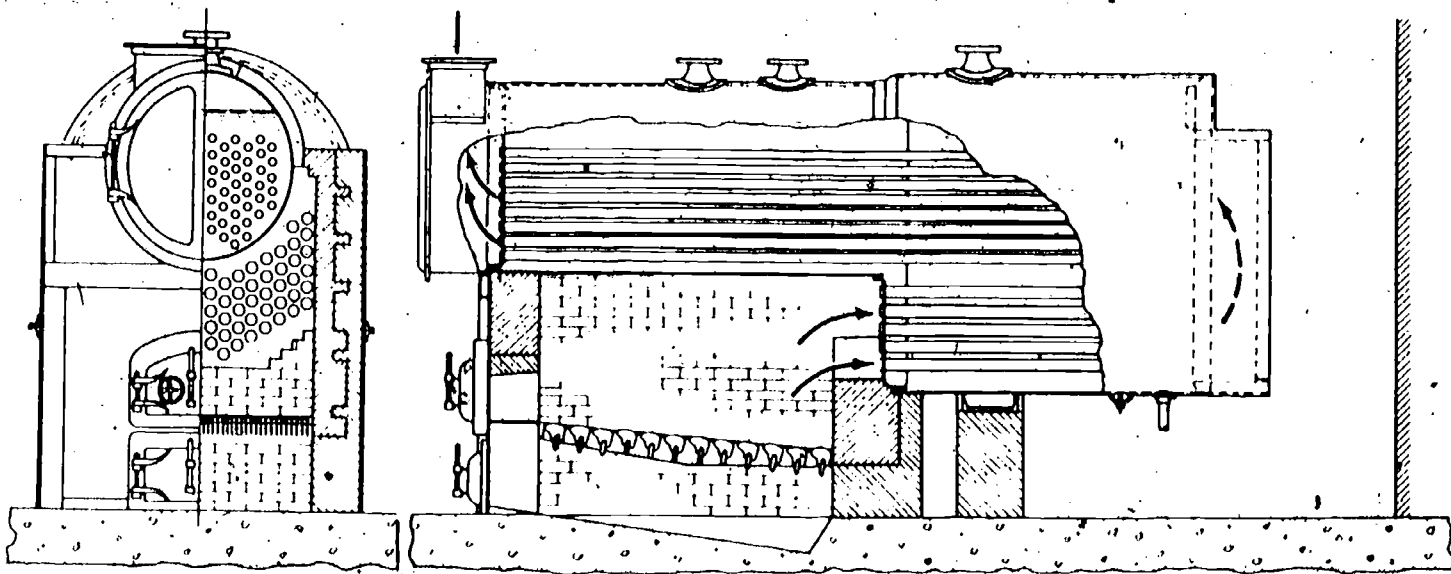

Information

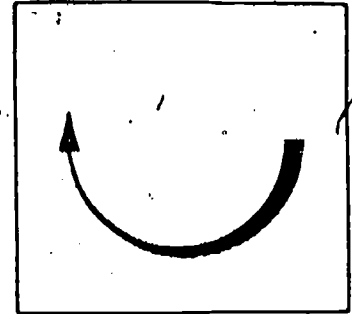

Shell Internals

Most boilers have cylindrical shells to resist the internal pressure of the steam. The internal shell is strengthened by the use of the diagonal stays, through bolts or tubes designed as stays. The major internal force is directed more along the length of the boiler than along its girth. A basic component of the firetube boiler is the firetubes which carry the heated gases that heat the water. The firetubes are 76 mm to 102 mm in diameter and expand at each end into tube plates. The tube plates are supported by diagonal stays or braces that attach to the boiler shell. A blow-off connection permits cleaning and draining of the boiler. Internally fired boilers have a firebox inside the shell that is surrounded by a water-leg or brick. A steam dome contains a steam outlet and safety valves. A smokebox receives the gases that emerge from the firetubes and directs them into the smoke stack for discharge from the system.

Safety Devices and Practices

The firetube boiler is much more dangerous when it explodes. Where a watertube boiler explosion is usually limited to a ruptured tube, the firetube boiler explodes completely. For safe operation of firetube boilers the operator should:

1. Make sure that the boiler conforms to ASME code in regard to materials, fabrication methods and installation of fittings.
2. Make sure that controls are responsive to changing conditions.
3. Maintain boiler in a clean condition.
4. Make periodic inspections of boiler parts.
5. Read manufacturers instructions for operation and safety of specific boiler that is being operated.

Boilers are fitted with safety valves to prevent explosions. The operator must be sure that these safety devices are functioning and that the controls are properly registering the pressures within the boilers. Damaged parts should be replaced before the boiler becomes hazardous to operate.

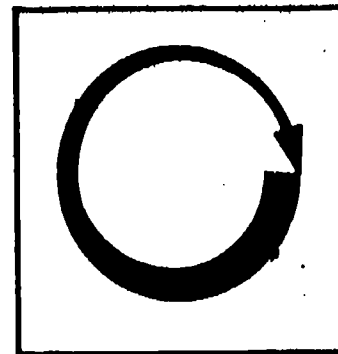

Assignment

- * Read pages 1-21 in supplementary reference and study diagrams.
- * Complete job sheet.
- * Complete self-assessment and check answers.
- * Complete post-assessment and ask the instructor to check your answers.

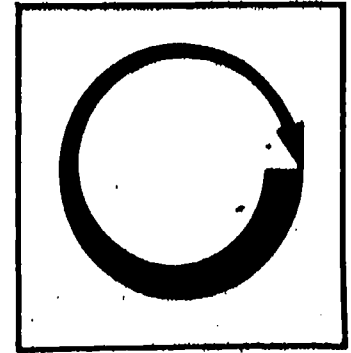

Job Sheet

INSPECT A FIRETUBE BOILER

- * Carefully inspect a firetube boiler at your plant site or neighboring site.
- * Is it a horizontal return tube or scotch type?
- * Is it a one pass or two pass boiler?
- * Is it a wetback or dryback type?
- * What safety features does it have?
- * Locate
 - Blow-off connections
 - Safety valves
 - Steam outlet
 - Smoke box
 - Smoke stack

Self Assessment

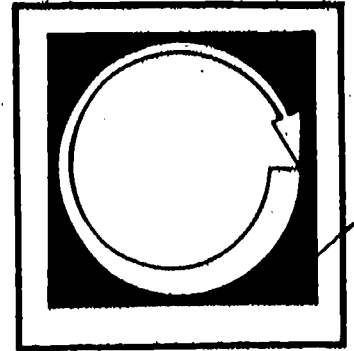

1. A boiler that carries heated gases through its tubes is a _____ boiler.
2. Boilers with an internal firebox and a refractory type rear chamber are called _____ boilers or internal furnace boilers.
3. A boiler that produces steam on one trip of gases through the firetubes is a _____ boiler.
4. Boilers that pass gases through a short set of tubes and then reverses the flow back through a longer set of tubes is a _____ boiler.
5. A boiler that has a brick lined rear chamber is a _____ type.
6. One that has a rear chamber surrounded by a water-leg is a _____ type.
7. A scotch marine boiler is a _____ type.
8. Boilers that are purchased complete with auxiliaries and controls are called _____ boilers.
9. A boiler that uses a two-section shell with short tubes in the lower section is a _____ boiler.
10. The _____ connection permits the boiler to be cleaned and drained.

● Self Assessment Answers

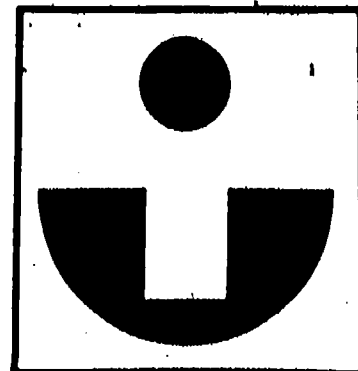

1. Firetube
2. Scotch
3. One-pass
4. Two-pass
5. Dryback
6. Wet back
7. Wet back
- 8. Packaged
9. Firebox
10. Blow-off

Post Assessment

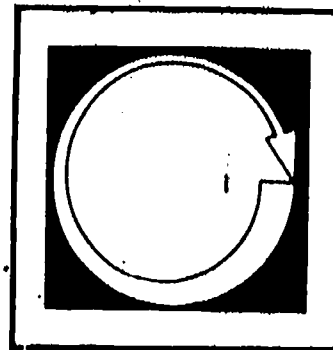

Match the following boilers and boiler part descriptions with their names:

- | | | |
|-------|---|----------------------------|
| _____ | 1. Dry rear chamber lined with brick. | A. Blow-off connection |
| _____ | 2. Boiler unit purchased complete with controls and auxillaries. | B. Internally fired boiler |
| _____ | 3. Rear chamber surrounded by water-leg. | C. Wetback |
| _____ | 4. Receives gases from firetubes and directs them to smokestack. | D. Packaged |
| _____ | 5. Allows boiler to be cleaned and drained. | E. Steam dome |
| _____ | 6. Contains a steam outlet and safety valves. | F. Dryback |
| _____ | 7. Boiler with both firetube and furnace enclosed in shell. | G. Tube plate |
| _____ | 8. Boiler has a two-section shell that contains short tubes in one section and long tubes in the other section. | H. Smokebox |
| _____ | 9. Expanded ends of a firetube. | I. Steam boiler |
| _____ | 10. A container in which water is heated to produce steam. | J. Firebox boiler |

Instructor Post Assessment Answers



F 1.

D 2.

C 3.

H 4.

A 5.

E 6.

B 7.

J 8.

G 9.

I 10.

● Supplementary References

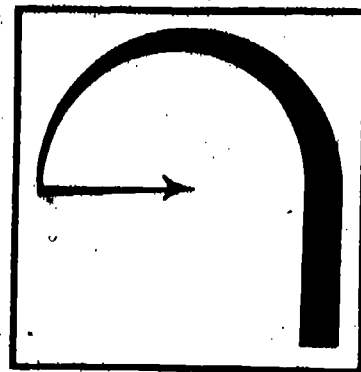

Correspondence Course. Lecture 1, Section 2, Second Class Steam Generators.
Southern Alberta Institute of Technology. Calgary, Alberta, Canada.

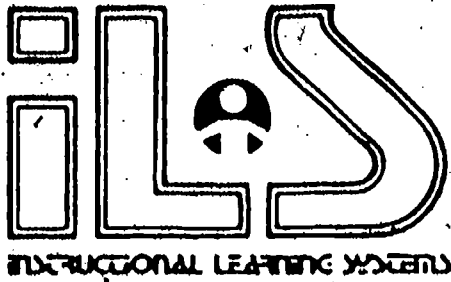

12.2

BOILERS -- WATERTUBE TYPE

Goal:

The apprentice will be able to describe types of watertube boilers.

Performance Indicators:

1. Describe straight and bent tube type boilers.
2. Describe horizontal and cross drum boilers.
3. Describe vertical, box and inclined headers.
4. Describe furnace baffles and refractory furnaces.
5. Describe waterwalls.
6. Describe stirling type boilers.
7. Describe lower drum/headers.
8. Describe drum internals.
9. Describe safety devices and practices.

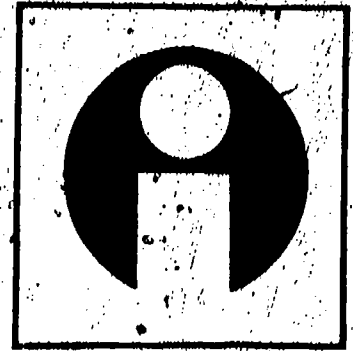

Study Guide

- * Read the goal and performance indicators to find what is to be learned from package.
- * Read the vocabulary list to find new words that will be used in package.
- * Read the introduction and information sheets.
- * Complete the job sheet.
- * Complete self-assessment.
- * Complete post-assessment.

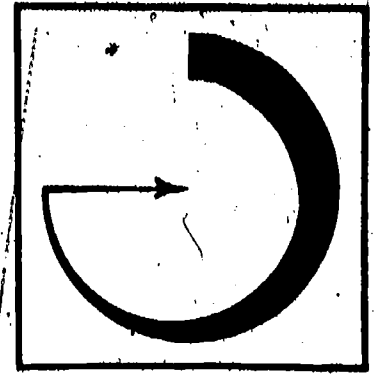

Vocabulary

- * Dent tube
- * Blow-off connection
- * Box headers
- * Cross baffles
- * Cross drum
- * Curved baffles
- * Downcomers
- * Drums
- * Feedwater inlet
- * Furnace baffles
- * Horizontal drum
- * Inclined headers
- * Longitudinal baffles
- * Lower drums/headers
- * Packaged boilers
- * Refractory furnace
- * Risers
- * Steam inlet
- * Stirling type
- * Straight tube
- * Tube nipple
- * Vertical headers
- * Waterwalk

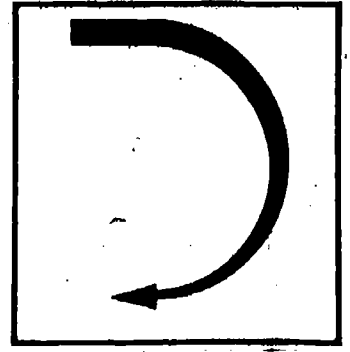

Introduction

Watertube boilers use their system of tubing to carry water instead of gases. The hot gases flow over the tubes and heat the water that is inside the tubes. Designers have improved watertube boilers during the past few years until they are very competitive with the firetube type. The need for high pressures have given the watertube boiler an advantage. A second advantage is the safety factor. Watertube boilers are not as dangerous when exploding. Normally they rupture a watertube internally rather than blowing out the entire boiler shell. The watertube boiler has greater flexibility and requires less space than firetube boilers of the same capacity.

Information

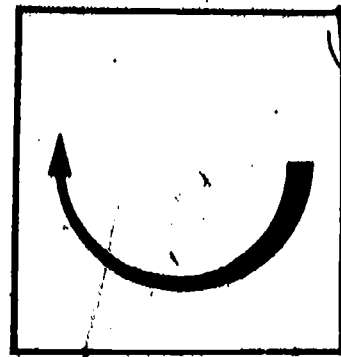

Watertube Boilers

Watertube boilers can be divided into two types:

1. Straight tube
2. Bent tube

Straight tube boilers are not widely used in today's steam plants. Some old boilers of straight tube design are still in operation today but very few new ones are being made. The bent tube design has advantages that make it the popular choice. Drums are used to collect and separate water and steam. The bent tubes connect to the drums.

Packaged Watertube Boilers

A boiler that is shipped complete with fuel burning and draft equipment and automatic controls and accessories is a "packaged" boiler.

Horizontal Drum

A horizontal drum boiler is one that has a drum that is located in a horizontal plane and lies in the same direction as the straight tubes. The tubes and mud drum are connected by a tube nipple. The drum is located overhead and collects steam from the tubes.

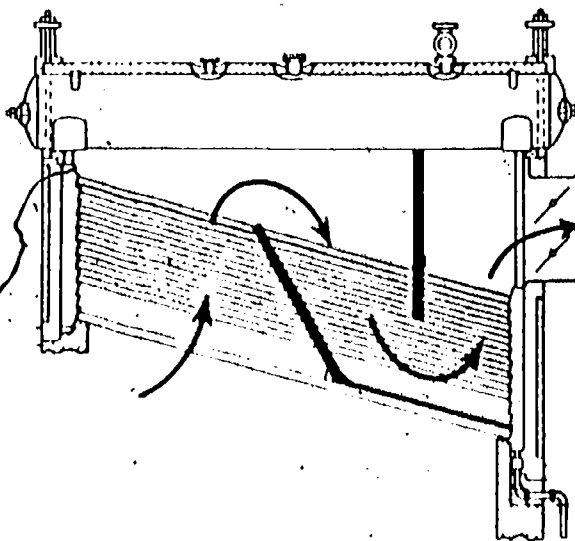

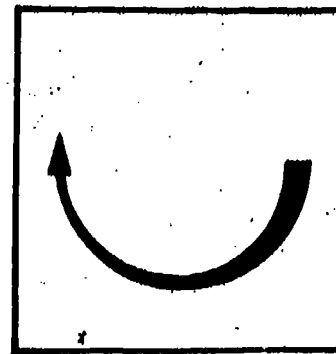

Information

Cross Drum

The cross drum is another configuration for straight tube boilers. The drum lies at right angles to the tubes.

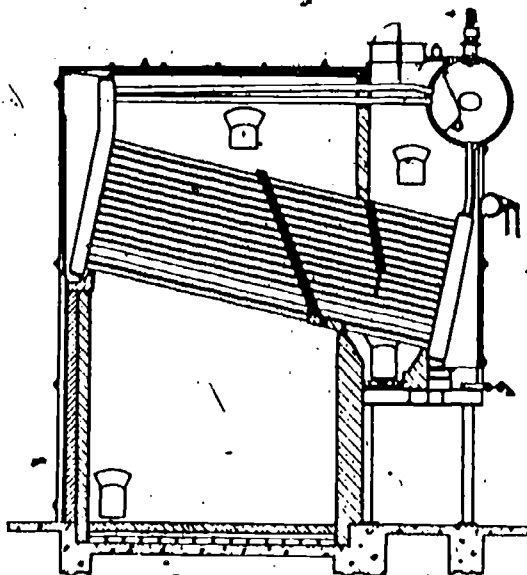

Bent Tube Boilers

Bent tubes allow more surface exposure to the heat. They can be built in configurations that give a more desirable size and can usually be built cheaper than a straight tube boiler. Older boilers may have four or five drums but new models use only one or two drums. Improvements in design and fluid handling have reduced the number of drums needed in a unit. A bent type of structure shows the tubes and drums arrangement.

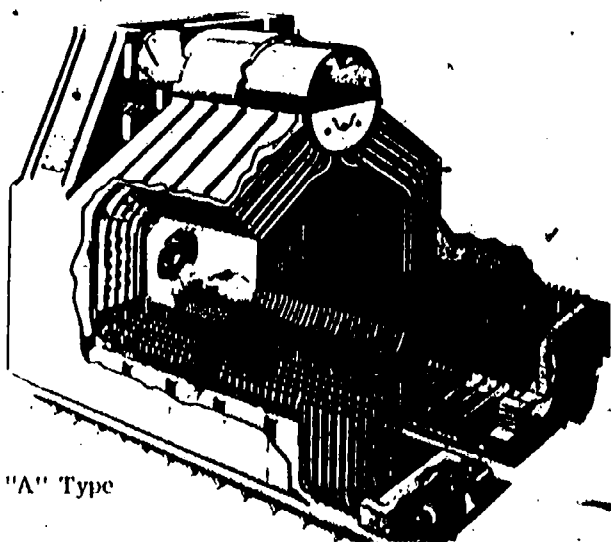

"A" Type

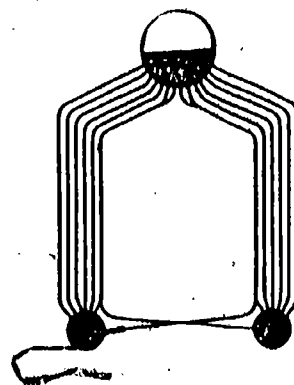

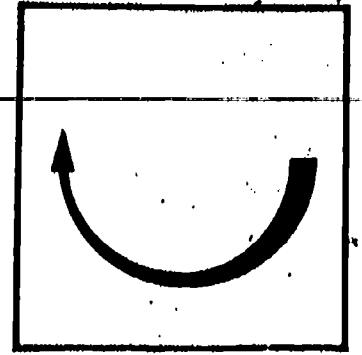

Information

Inclined Headers

Headers are found at each end of the watertubes. These headers carry the water back to the drum. The headers can be aligned in either a vertical or inclined position in relation to the tubes and drum. Inclined headers are usually associated with a cross drum arrangement of a straight tube boiler. A header is a manifold that collects water from the tubes and carries it back to the drums.

Vertical Headers

Vertical headers are used on both cross drum and horizontal drum designs. The tubes run between vertical headers which are connected to the drum.

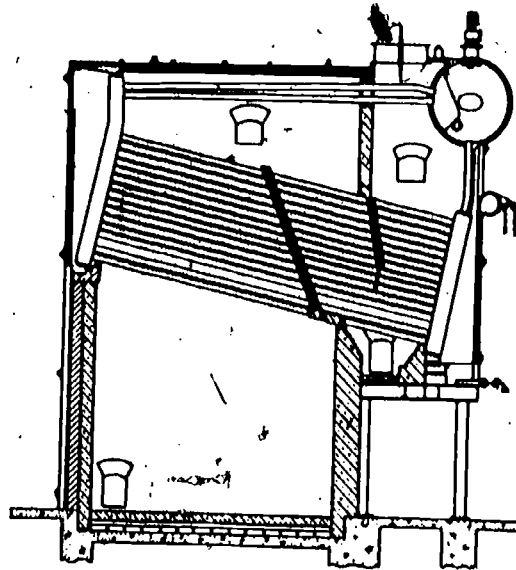

Box Headers

Box headers are used in some of the older straight tube boilers. A box at the bottom of a header forms the mud drum of the boiler. Each header connects to the mud drum with a tube nipple. Box headers are formed in the shape of a box.

Furnace Baffles

Baffles are used to create a flow of gases back and forth over the tubes while the water makes the needed number of passes. Baffles are made of brick, tile or other refractory material. If placed so that gases flow at right angles to the tubes, they are called cross baffles. Longitudinal baffles cause gases to flow in parallel with the tubes. Curved baffles reduce the friction which cause eddy currents.

Information

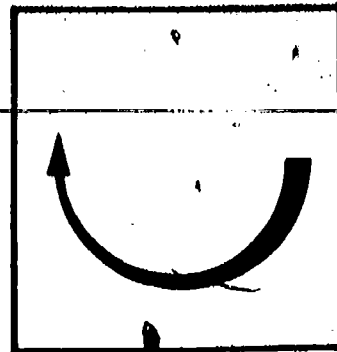

Refractory Furnace

A refractory furnace is one that is lined with brick or other refractory material.

Waterwalls

Waterwalls or water legs are often used to provide a heat absorbing surface about the furnace. It serves the same purpose as brick in a refractory furnace. Almost 50% of the total furnace heat is absorbed by the waterwall. Waterwalls are also used to surround the tubes and carry steam to the top drum. As water and steam rise from the mud drum upward to the drum, convection tubes serve either as risers or downcomers. The risers carry steam upward to the drum. Downcomers carry water and steam downward to the mud drum and it is recirculated. A waterwall captures much of the furnace heat and uses it in the formation of steam.

Stirling Type Boiler

The Stirling type is a two or more drum bent tube boiler. The boiler has two or more upper drums and a mud drum. The upper drums are connected to the mud drum by bent watertubes. The upper drums are partially filled with water. The drum space above the water level is used to capture steam. A steam outlet and safety valves are part of the upper drum arrangement. Also a feedwater inlet is part of the upper drum. The Stirling type boiler has a refractory type furnace or water walls. The mud drum contains water.

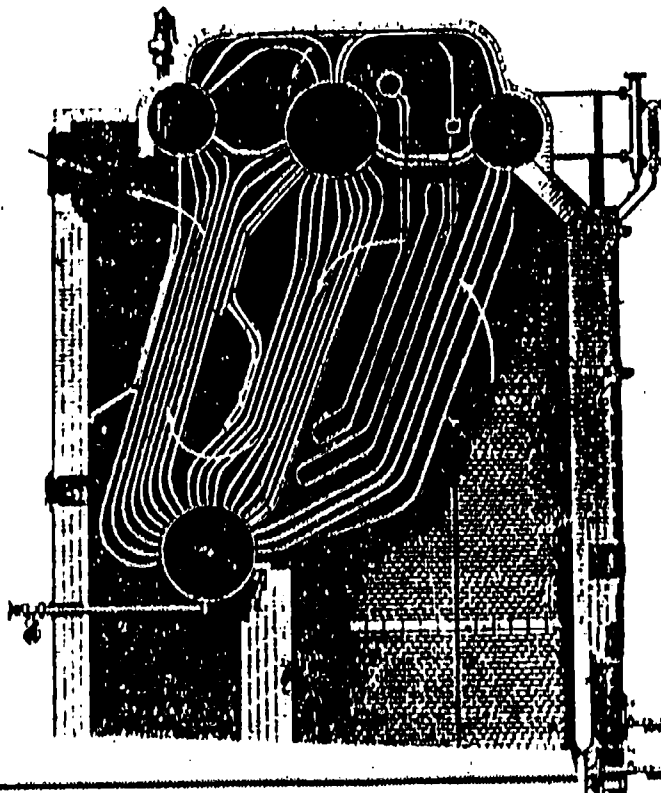

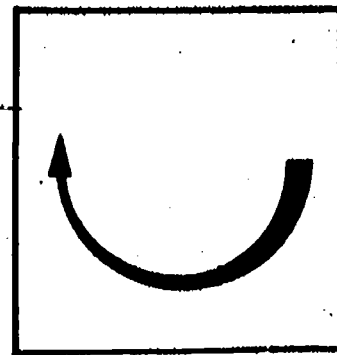

Information

Lower Drums Headers

On many new models of watertube boilers, the lower drums are completely filled with water. Actually they serve as headers to direct water into the risers and collect water from the downcomers.

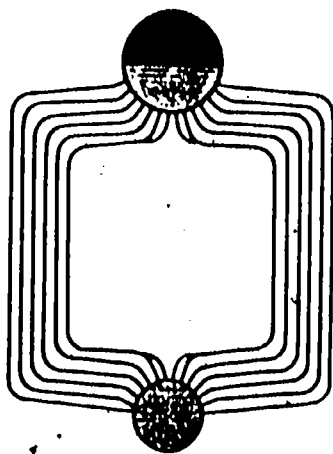

"O" Type

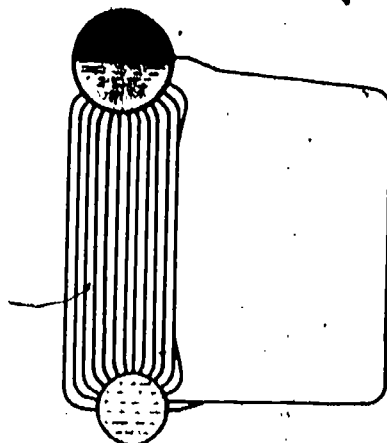

"D" Type

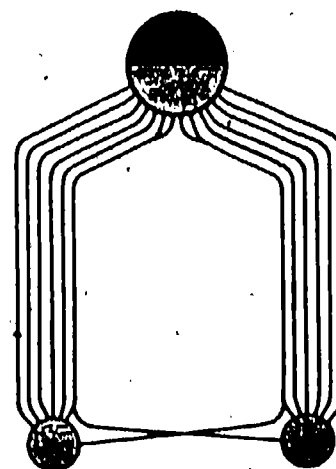

"A" Type

Drum Internals

Several devices are installed inside the steam drum of the boiler. Among those devices are steam separators, steam washers, chemical feed lines, boiler feedwater lines and blow-off lines. Steam separators separate the water and steam that enters the drum through the risers. Some separators use centrifugal force to separate the water from steam. Others use plates and baffles to separate the moisture. Primary separators are often of the cyclone type with a corrugated scrubber for a secondary separator. Steam washers rinse the steam between primary and secondary separations. Washing gets rid of vaporized silica which will foul turbine blades. An internal feedline distributes feedwater within the drum. A perforated pipe that distributes chemicals to prevent scale and corrosion is part of the drum internals. Blow-Off lines are of two types. A continuous blow-off line is located well below the water line and draws off sludge. A surface blow-off line is used to extract impurities at the water surface.

Information

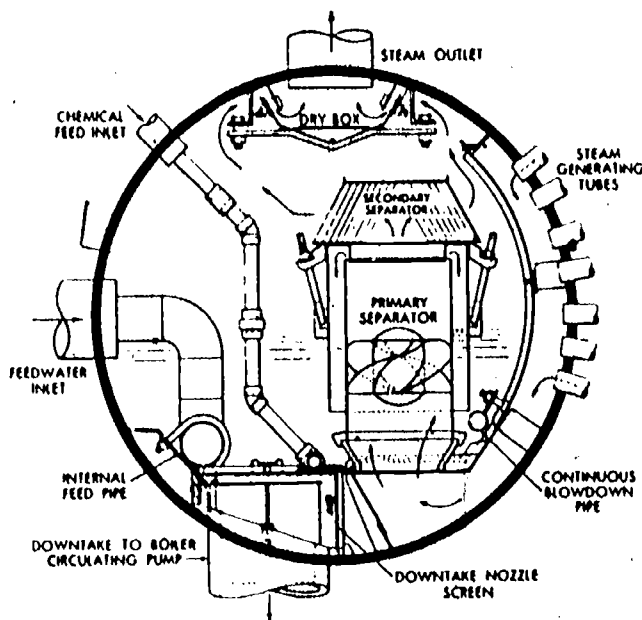
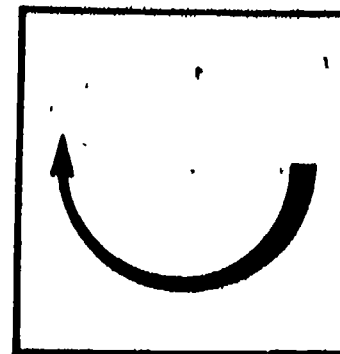

Safety Devices and Practices

A boiler explosion creates danger from flying parts from the steam force. When the drum ruptures, some of its water is converted to steam. The volume of water in the drum determines the force of the explosion--not pressure of the boiler. The watertube boiler is much safer than the firetube boiler in regard to explosions.

Safety valves prevent the boiler from exceeding pressures for which it was designed. Code requires that each boiler have at least one safety valve and more if the heating surface exceeds 47 square meters.

Pressure relief valves are another type of safety device. It is triggered when pressures exceed a preset level.

Each superheater is required to have at least one safety valve.

The operator can maintain a safe operation by:

1. Assuring that the boiler design conforms to ASME code for construction.
2. Following specific safety instructions of the boiler manufacturer.
3. Assuring that safety equipment and controls are responsive to changing conditions.

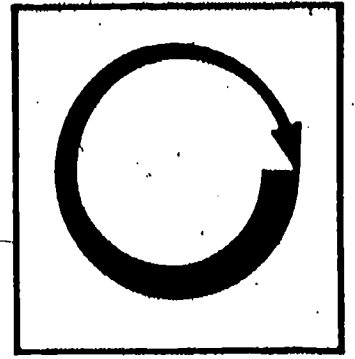

Assignment

- * Read pages 1 - 27 in supplementary reference. Pay close attention to illustrations.
- * Complete job sheet.
- * Complete self-assessment and check answers.
- * Complete post-assessment and have instructor check answers.

Job Sheet

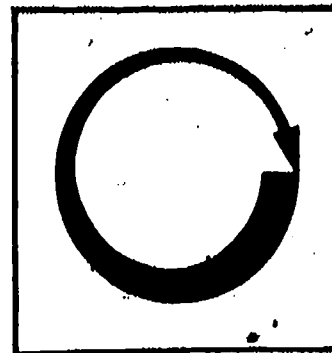

INSPECT A WATERTUBE BOILER

- * Locate and secure permission to inspect a watertube boiler.
- * Examine the boiler and its components.
 - What is the drum arrangement?
 - Is it straight or bent tube type?
 - Does it have headers? What type?
 - Does it have waterwalls?
 - Is the furnace lined with refractory material?
 - Can you locate the feedwater inlet?
 - Can you locate the steam outlet?
 - Can you locate the blow-off connection for boiler cleaning?
- * Write a short description of the boiler: Manufacturer, type, descriptive features.
- * Check description with instructor to make sure that your observations were on target.

Self Assessment

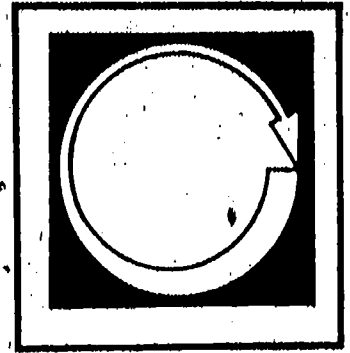

1. Water and steam are collected and separated in the _____.
2. A boiler that comes complete with automatic controls, fuel burning and draft equipment is called a _____ boiler.
3. A boiler that has a drum lying at right angles to the watertubes is called a _____ type.
4. A _____ boiler allows the watertubes more surface exposure to the heated gasses.
5. A _____ is a manifold that collects water from the tubes and carries it back to the drum.
6. _____ are used to divert the flow of gases back toward the watertubes.
7. A _____ uses water to absorb the heat of the furnace.
8. _____ tubes carry steam upward to the drum.
9. _____ tubes carry water and steam downward to the mud drum.
10. The Stirling type boiler has a _____ type furnace.

● Self Assessment Answers

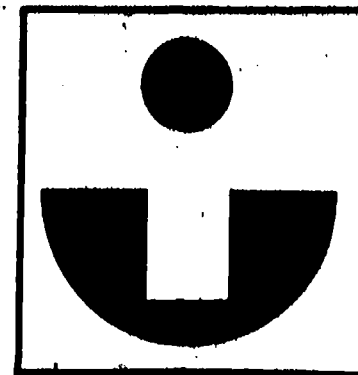

1. Drum
2. Packaged
3. Cross drum
4. Bent tube
5. Header
6. Baffles
7. Waterwall
8. Risers
- 9. Downcomers
10. Refractory

Post Assessment

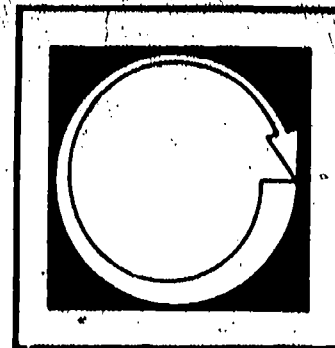

Match the following terms and phrases

- | | |
|------------------------------|---|
| _____ 1. Header | A. Collects and separates water and steam. |
| _____ 2. Waterwall | B. Lies at right angle to watertubes. |
| _____ 3. Cross drum | C. Allows more surface exposure of tubes to heat. |
| _____ 4. Bent tube | D. Acts as a manifold that collects water from tubes and returns it to drums. |
| _____ 5. Drum | E. A waterfilled tube or column that surrounds the furnace area. |
| _____ 6. Stirling type | F. Fitting in mud drum. |
| _____ 7. Riser | G. Fitting in upper drum. |
| _____ 8. Downcomer | H. Carries water and steam downward. |
| _____ 9. Blow-off connection | I. A four drum bent-tube boiler with three upper drums and a mud drum. |
| _____ 10. Steam outlet | J. Carries steam upward. |

Instructor Post Assessment Answers

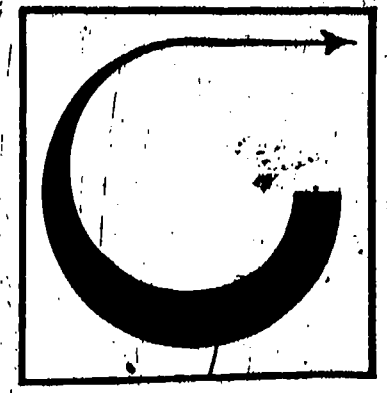

- D 1.
- E 2.
- B 3.
- C 4.
- A 5.
- I 6.
- J 7.
- H 8.
- F 9.
- G 10.

● Supplementary References

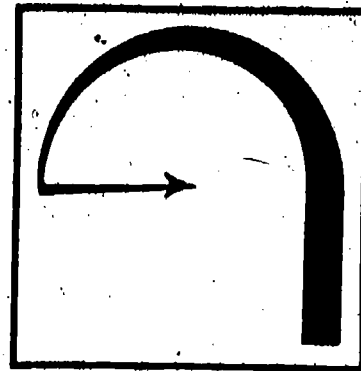

- * Correspondence Course, Lecture 2, Section 2, Second Class. Steam Generators. Southern Alberta Institute of Technology. Calgary, Alberta, Canada.



12.3

BOILERS -- CONSTRUCTION

Goal:

The apprentice will be able to describe boiler construction.

Performance Indicators:

1. Describe materials used in boiler construction.
2. Describe processes used in boiler construction.

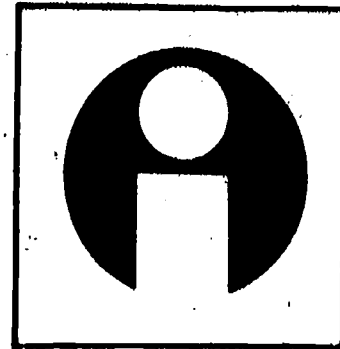

Study Guide

- * Read the goal and performance indicators to find what is to be learned from package.
- * Read the vocabulary list to find new words that will be used in package.
- * Read the introduction and information sheets.
- * Complete the job sheet.
- * Complete self-assessment.
- * Complete post-assessment.

Vocabulary

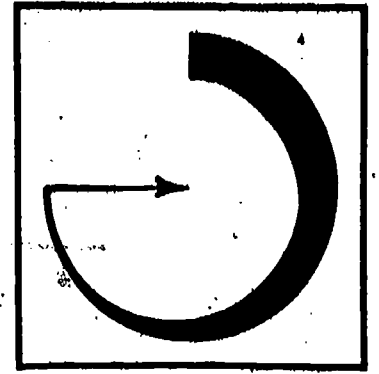

- * Capped
- * Carbon steel
- * Casings
- * Extrusion process
- * Ductwork
- * Fin tubes
- * Flat stud tube
- * High alloy steel
- * Hydrastatic testing
- * Killed
- * Low alloy steel
- * Mandrel
- * Piercing and rolling
- * Rimmed
- * Sectionally supported settings
- * Semi-killed
- * Solid wall settings
- * Stays and braces
- * Tangent tube
- * Tube and brick
- * Watercooled settings
- * Welded tube

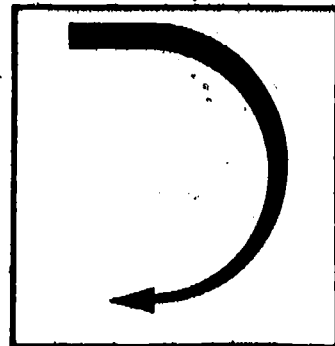

Introduction

Modern boilers are expected to operate at high pressures with a life expectancy of 20 years. Good materials must be used in construction of the steam plant and the fabrication methods must be of high quality.

Since most parts will be subjected to high pressure, ferrous materials are rather standard in boiler construction.

This package will discuss the materials used and fabrication methods for boiler construction.

Information

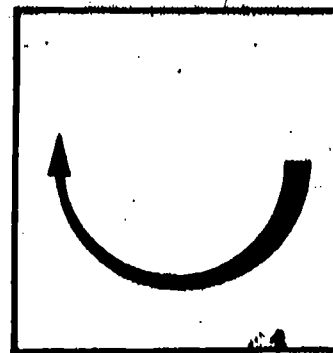

Types of Steel

Steel is the most common metal used in the manufacture of boilers. Many grades and types of steel are available:

- Carbon steel (.2 to .3% carbon)
- Low alloy steel (up to 5% alloy)
- High alloy steel (over 10% alloy)

Steel is often classified according to its manufacturing process and the amounts of carbon monoxide produced as the steel solidified. These classes are:

1. Rimmed--has a rim of pure iron and a core of carbon steel.
2. Capped--has a thinner rim and less carbon in the core than rimmed.
3. Semi-killed--has silicon and aluminum added to prevent excess gas bubbles.
4. Killed--has all oxygen removed by adding oxygen and aluminum as deoxidizing agent. Process used in making both carbon steel and alloy steel.

Materials for Boiler Construction

The following chart shows the materials used in boiler construction.

Boiler Parts	Type of Material
Drum and Shell	Carbon steel or low alloy steel. Rolled while hot and welded seams. May also be extruded.
Tubes	Carbon steel or alloy steel.
Pipe fittings, valves, water columns for pressures under 2400 kPa and temperatures less than 232 C. - Up to 1700 kPa*	Malleable iron and cast nodular iron. Cast iron

* kPa (kilo Pascal) is a metric measure of pressure equal to 6.895 psi or pounds per square inch.

Information

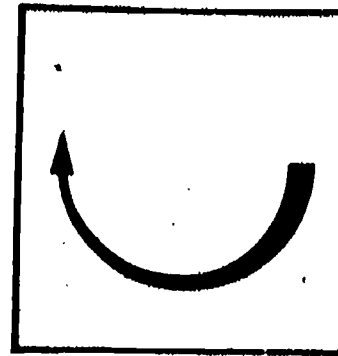

Boiler Parts

Type of Material

Blow-off connections and other connections that fit directly into the boiler.

Carbon steel or alloy steel.

Processes of Boiler Construction

Foundations

Foundations must be constructed to eliminate movement from settling or other shifting. The foundation size depends upon the weight of the boiler to be supported. Boiler manufacturers will supply the specifications for each boiler sold. Large boilers require overhead support from structural steel hangers. Small boilers may be grouted into the cement floor of the power plant.

Settings

A setting is a wall that encloses the furnace and pressure parts of a boiler. Usually a setting is made with firebrick or plastic fireclay. Solid wall settings are independent of the boiler. Sectionally supported settings are anchored and supported in sections by external steelwork. Watercooled settings are used in internally fired firetube boilers and water tube boilers. A tube and brick setting offers both refractory and water cooled furnace walls. A common type of tube and brick wall is constructed with fin tubes. Metal fin bars are welded to tubes to give a continuous wall surface and bricks are laid against the fin tubes.

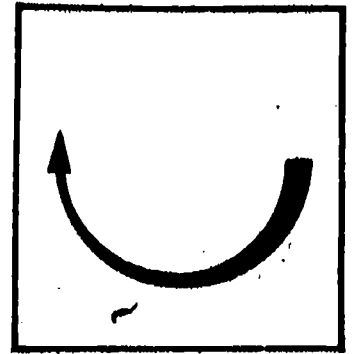

Information

Other types of wall settings include:

- Tangent tube
- Flat stud tube

Baffles

Brick or other refractory material is used to construct baffles. Individual bricks are fitted around the tubes in a way that the flow of gases is directed to the tubes. Gases must be redirected so that a continuous pattern of heat is directed to the tubes. Some baffles are manufactured as one piece. Others are formed as curves to reduce friction.

Casings

Air tight casings are used to protect wall insulation and to keep air away from the furnace. Casings are made of welded steel. Often a layer of insulation is placed between the casings and wall tubes.

Tubes

Tubes are formed by the extrusion process or by piercing and rolling. The extrusion process squeezes hot steel through a die that has a mandrel to punch out the opening in the tube.

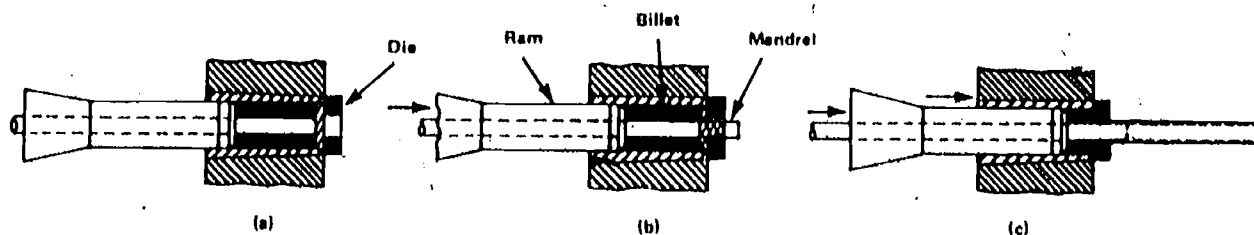

Information

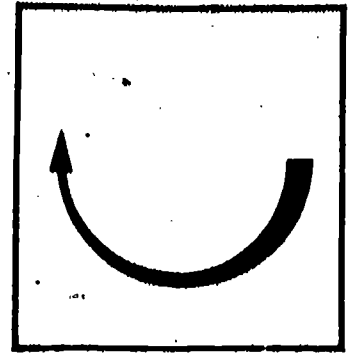

In piercing and rolling, hot carbon or alloy steel bar is forced through a piercing point with rollers. The bar is then reheated and rolled to reduce its wall thickness. Then it is burnished and rolled to finished size. Welded tubes are made from flat strips of steel by rolling and then butt welding the seams.

Tube Installation

The tubes are joined to drums and headers by expanding or welding to tube stubs. An expander tool presses the tube wall into the tube hole and expands it. In welded installations, the tube is connected to the tube stub of the drum and welded in place. Alignment jigs are used to align the parts for welding.

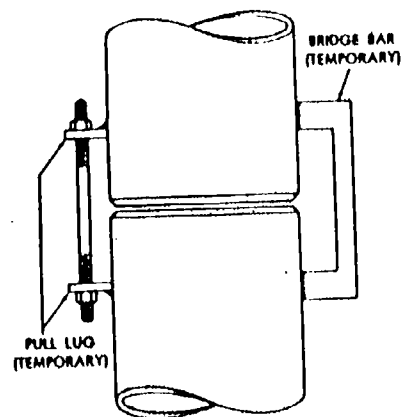
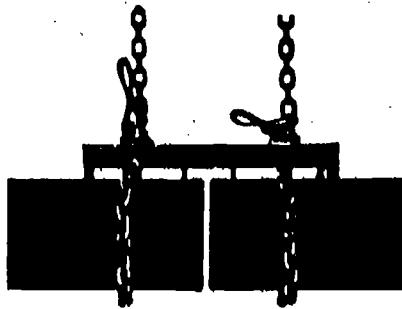

Stays and Braces

Firetube boilers require stays and braces to hold their shape under pressure. All flat surfaces must be braced. Tube sheets must be stayed to the shell. In firebox type boilers, the water-legs must be supported by stays.

Hydrastatic Testing

Manufacturers test boilers by filling them with water and applying 1.5 times the pressure for which they were designed. Leakage from welds allow the tester to spot defects in the weld or other metal parts.

Information

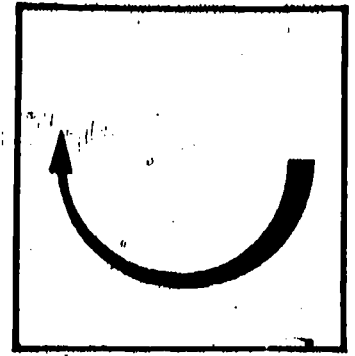

Ductwork

Metal ducts are required to move combustion air and gases to and from the furnace. The common ducts required are:

- Main air duct from fan to heater to burner.
- Main gas duct from the economizer outlet to heater to fan to stack.
- Air circulating duct from heater outlet to fan inlet.

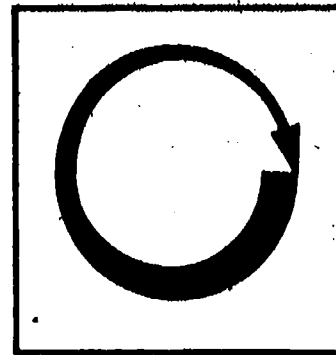

Assignment

- * Read pages 1 - 29 of supplementary reference.
- * Complete job sheet.
- * Complete self-assessment and check answers.
- * Complete post-assessment and have instructor check answers.

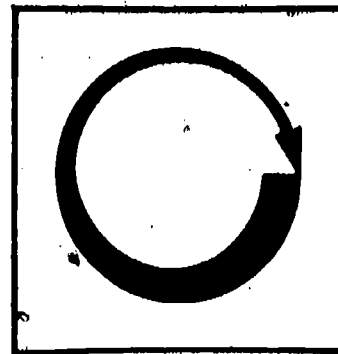

Job Sheet

INSPECT CONSTRUCTION OF A BOILER

- * Obtain permission to inspect a boiler.
- * Observe materials used in construction of 
 - Shell or drum
 - Casing
 - Blow-off valves
 - Other valves and fittings
 - Tubes
 - Wall setting
 - Ductwork
- * Observe construction features
 - Which parts are riveted or bolted?
 - Which parts are welded?
- * Ask questions needed to understand the materials used in boiler construction and processes for construction.

Self Assessment

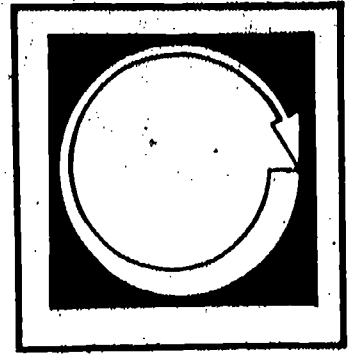

1. Low alloy steel has _____ percent or less of alloy.
2. _____ steel has all of the oxygen removed by adding deoxidizing agent.
3. Drums are made from _____ steel and low alloy steel.
4. _____ wall settings are independent of the boiler.
5. A setting is a wall that encloses the _____ and pressure parts of a boiler.
6. Metal bars welded to tubes for construction of a setting are called _____.
7. A setting that uses both brick and tubes is called a _____ and _____.
8. _____ or other refractory material is used to construct baffles.
9. Casings are made of _____ steel.
10. An _____ tool is used to press tubes into the tube holes of a drum and lock them in place.

Self Assessment Answers

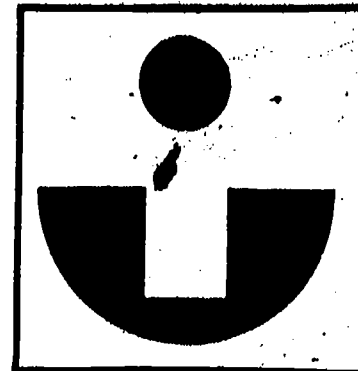

1. 5%
2. Killed
3. Carbon
4. Solid
5. Furnace
6. Fin tube
7. Tube and brick
8. Brick
9. Welded
10. Expander

Post Assessment

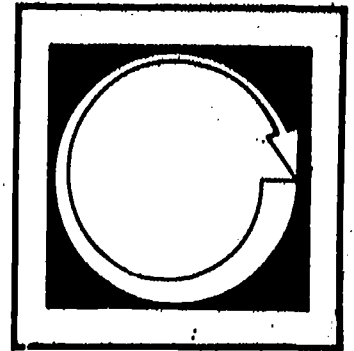

Match the following terms with their descriptive phrase.

- | | |
|---------------------------|---|
| ___ 1 Hydrastatic testing | A. Used to align tubes for welding. |
| ___ 2 Stays and braces | B. Made of carbon steel or alloy steel. |
| ___ 3 Ductwork | C. Pressure applied at 1.5 times designed levels. |
| ___ 4 Alignment Jigs | D. Has less than .2 to .3 percent carbon. |
| ___ 5 Baffles | E. Helps firetube boilers hold their shape under pressure. |
| ___ 6 Foundation | F. Required to move combustion air and gases to and from furnace. |
| ___ 7 Setting | G. Squeezes hot steel through die to make tube. |
| ___ 8 Tubes | H. Constructed from a refractory material. |
| ___ 9 Carbon steel | I. Wall that encloses furnace and pressure parts. |
| ___ 10 Extrusion process. | J. Must be free of settling and shifting. |

Instructor Post Assessment Answers

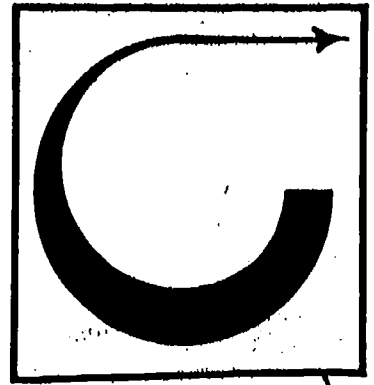

C 1.

E 2.

F 3.

A 4.

H 5.

J 6.

I 7.

B 8.

D 9.

G 10.

● Supplementary References

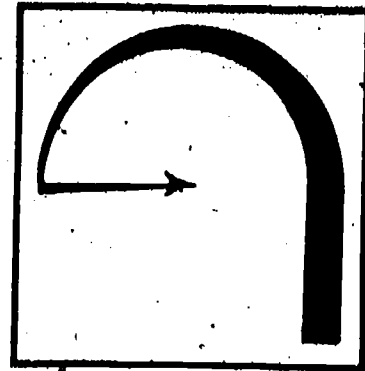

- * Correspondence Course. Lecture 2, Section 2, First Class. Steam Generation. Southern Alberta Institute of Technology. Calgary, Alberta, Canada.

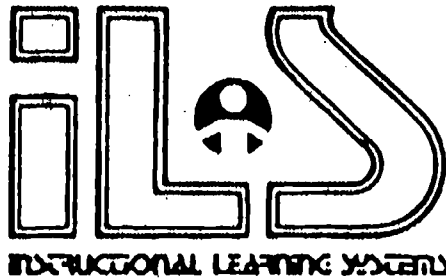

12.4

BOILERS -- FITTINGS

Goal:

The apprentice will be able to describe boiler fittings.

Performance Indicators:

1. Describe safety valves.
2. Describe water columns and gage glasses.
3. Describe pressure gages.
4. Describe feedwater connections.
5. Describe blow-off valves and connections.
6. Describe stop and check valves.
7. Describe drum internals.
8. Describe soot blowers.
9. Describe fusible plugs.



Study Guide

- * Read the goal and performance indicators to find what is to be learned from package.
- * Read the vocabulary list to find new words that will be used in package.
- * Read the introduction and information sheets.
- * Complete the job sheet.
- * Complete self-assessment.
- * Complete post-assessment.

Vocabulary

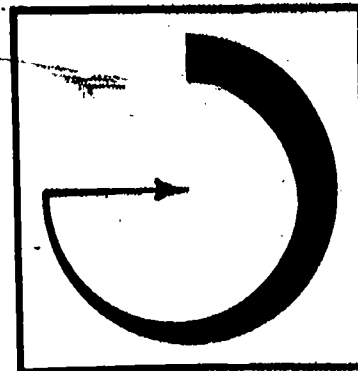

- * Angle type valve
- * Bellows gauge
- * Bi-color gauge glasses
- * Bottom blow-off
- * Bourdon, spring gauge
- * Combination blow-off valve
- * Continuous blow-off
- * Fireside fusible plug
- * Flat gauge glasses
- * Gauge glasses
- * Gate type valve
- * Globe type valve
- * Helix Bourdon gauge
- * High pressure gauge glass
- * Huddling chamber type valves
- * Jet flow type valves
- * Long retractable nozzle soot blower
- * Main dial gauge
- * Metallic diaphragm gauge
- * Non-return stop valve
- * Nozzle reaction type valve
- * Outside screw-and-yoke type valve
- * Pointer mechanism
- * Power operated relief valves
- * Pressure gauge siphons
- * Pressure gauges
- * Remote gauge glass indicators
- * Safety valves
- * Seat and disc blow-off valves
- * Seatless sliding plunger and blow-off valve
- * Single nozzle retractable soot blower
- * Sliding disc blow-off valve
- * Solenoid
- * Spiral Bourdon gauge
- * Surface blow-off
- * Torsion bar safety valve
- * Tubular gauge glasses
- * Water column
- * Waterside fusible plug

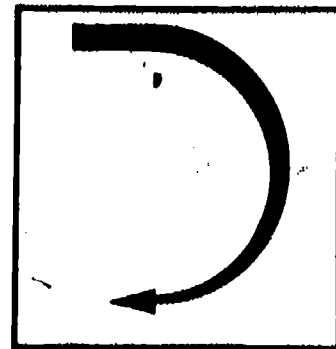

Introduction

Boiler fittings are those items that are directly attached to the boiler. The fittings are necessary for safe and efficient operation of the boiler.

The apprentices should be concerned with this unit of instruction. Future safety may depend on the ability to identify each fitting, its function and how it operates. Steam plant operators must know about fittings and gain experience in their operation.

Beyond the safety aspects, fittings are part of efficiency. The goal of all good operators is to run safe and efficient plants.

Information

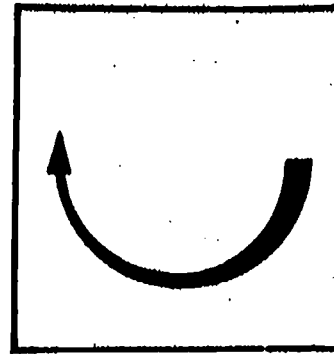

Safety Valves

Safety valves prevent excess pressures in the boiler. When the pressure exceeds safe levels, the safety valve will trip. There are several types of safety valves. Some are held shut by steel springs or torsion bars and open by steam when the pressure exceeds the setting of the valve. The valve may be opened by nozzle reaction, jet flow or huddling chamber.

Nozzle Reaction Valve

When the valve opens, a baffle and disc are raised upward by the steam. This closes off the baffle ports and reverses the direction of the steam. Pressure drops allow the baffle to move downward and steam can flow through the baffle ports.

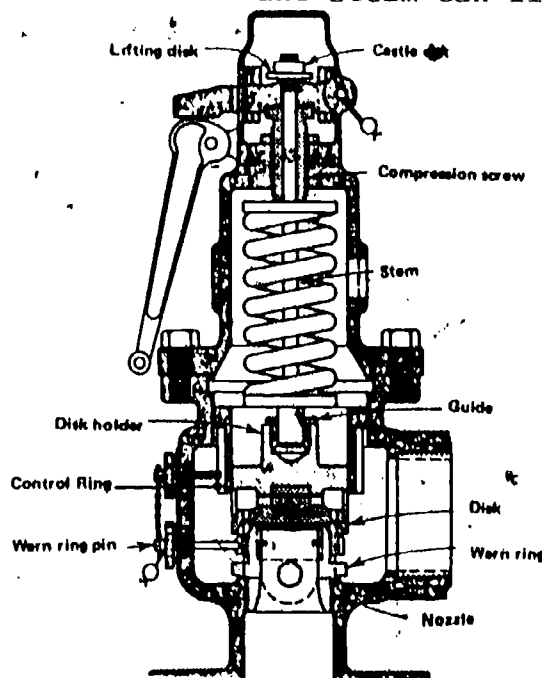

Jet-Flow Safety Valves

Steam flows from this valve and strikes the piston. The jet stream is deflected downward to the nozzle ring. This gives more thrust and the valve opens further.

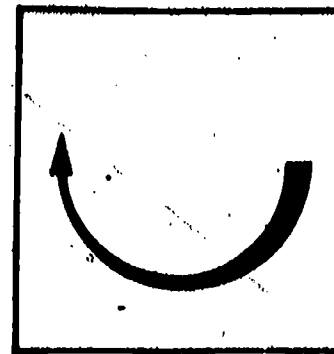

Information

Huddling Chamber Safety Valves

The valve is opened by pressure upon the disc. As it opens the huddling chamber fills with steam and causes a further lift to the disc.

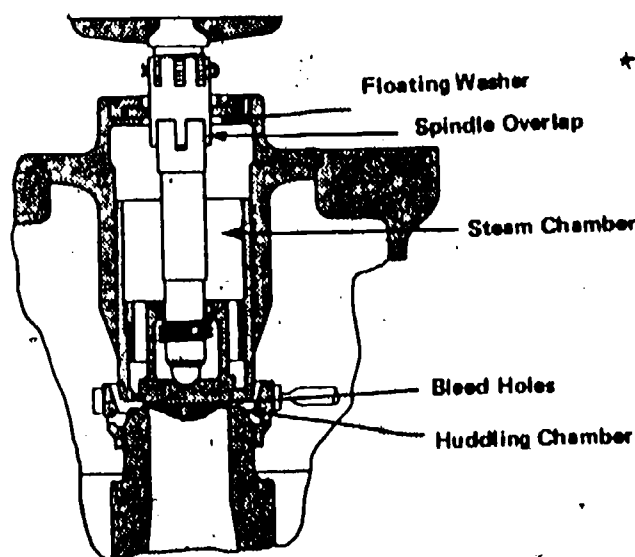

Power Operated Relief Valves

Relief valves can be operated by steam, hydraulics, electricity or remote control. An element is connected with the pressure vessel or header. When pressures exceed the limit, this element activates a solenoid which opens the pilot valve. The excess pressure is relieved from the boiler.

Torsion Bar Safety Valve

On high pressure dry steam such as superheaters or reheaters, torsion bars are used instead of coil springs. Torsion bars are preferred in extreme conditions of high pressure and high temperature.

Water Columns And Gauge Glasses

Gauge glasses are used to read the water levels in a boiler. A water column makes the glass gauge easier to read. The water column allows low and high level alarms to be installed. Gauge cocks are also installed on water columns. Tubular gauge glasses are used with pressures up to 2800 kPa. Higher pressures require a flat glass gauge.

Bi-Color Gauge Glass

One type of gauge glass uses colored glass (green and red) to make easier

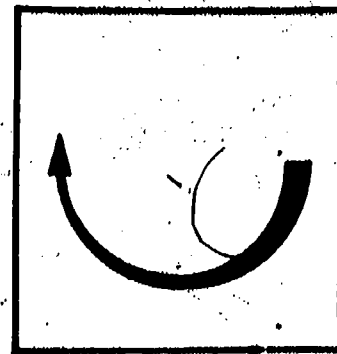

Information

reading of the gauge. A light is directed through the colored glass strips. Green light will only shine through when water is in the gauge. Red light shines through when water is absent.

High Pressure Gauge Glass

High pressure gauge glasses are usually built with ports rather than flat glass. Individual port assemblies consist of a flat glass, gaskets, washers, and a cover and screws.

Remote Gauge Glass Indicators

On large boilers it may be difficult to read the gauge glass from floor level. A system of mirrors can be used to transmit the indicator to floor level. Another method of remote indication is achieved by use of a diaphragm. One side of the diaphragm is connected to the water side and the other to the steam side of the boiler. The varying levels of water cause the diaphragm to move. Red and blue light indicators show the water levels.

Pressure Gauges

Each boiler has a pressure gauge that shows the pressure within the boiler. The gauge shows a range of 1 1/2 times (or more) the allowable working pressure. Pressure gauges are classified into three basic types.

1. Bourdon spring gauge
2. Bellows gauge
3. Metallic diaphragm gauge

Bourdon Spring Gauge

The Bourdon spring is a C-shaped tube that is closed at one end and attached to a pointer mechanism. When pressure is exerted in the tube, the Bourdon spring tends to straighten out. This process operates the pointer that shows the pressure on the dial. Variations of the Bourdon spring gauge are the spiral Bourdon tube and the Helix Bourdon tube. The C-type Bourdon spring gauge is used to measure boiler pressure at the main dial gauge. The Helix and spiral tube gauges are used for recoiling indicators. A spiral Bourdon tube gauge is shown as an example of the Bourdon principle.

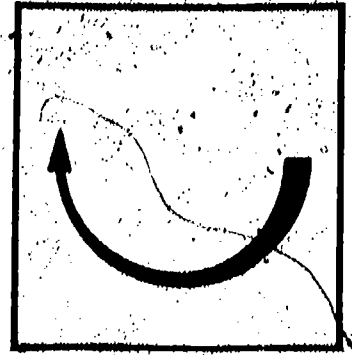

Information

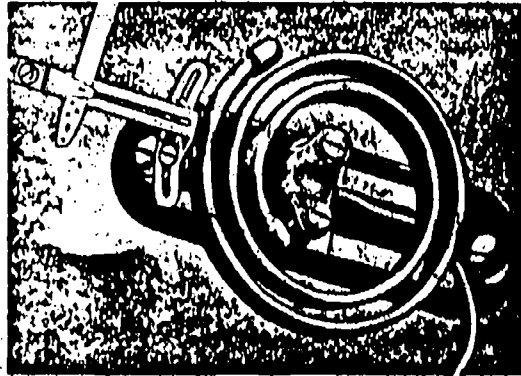

Bellows Gauge

The bellows gauge uses a bellows of elastic metal. When pressure is applied to the bellows, a push-rod moves the dial indicator according to the level of pressure. The bellows is used in pneumatic controls and draft measurement indicators. A bellows type gauge is shown below.

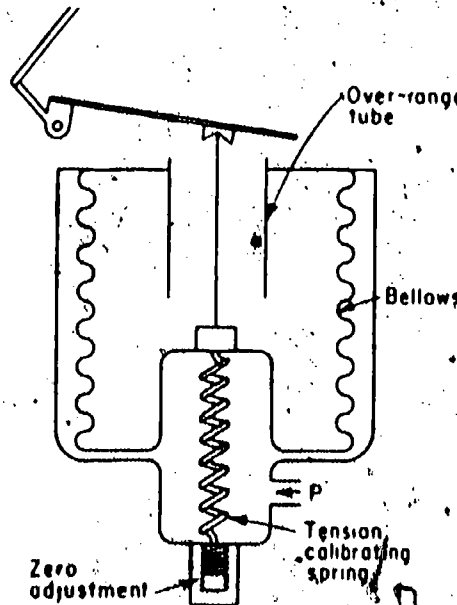

Metallic Diaphragm Gauge

This type of pressure gauge operates with metallic capsules. The metallic capsules are connected together. When pressure is exerted inside the capsules, the capsules expand and move the linkage that operates the indicator. This type is also used in low pressure applications.

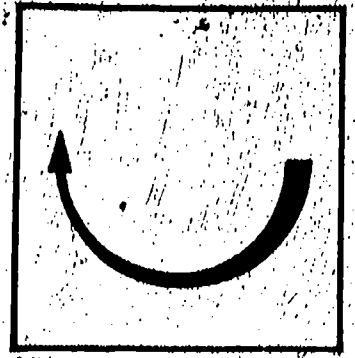

Information

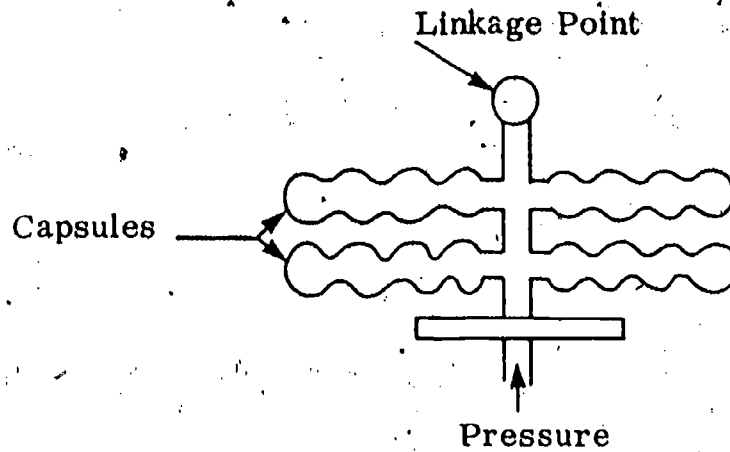

Pressure Gauge Siphons

Steam pressure measurement must prevent the hot steam from entering the elements. If steam is allowed to enter the elements, the result will be inaccurate indications of pressure. A siphon is used to trap condensed steam and maintain a seal between the element and the hot steam.

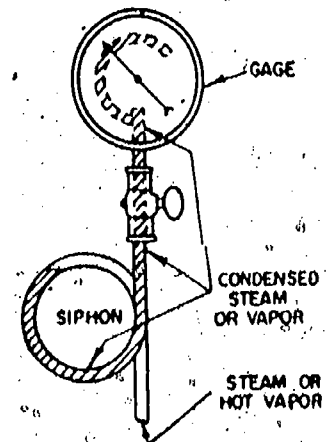

Boiler Stop Valves

A stop valve is used at steam outlets in a boiler. The valve should be an outside screw-and-yoke type. Usually the outside screw-and-yoke valve is set next to a non-return valve. The two valves should be located close to the boiler with the non-return valve being closest to the boiler. Stop valves are of the following types.

1. Gate type
2. Angle type
3. Globe type

Information

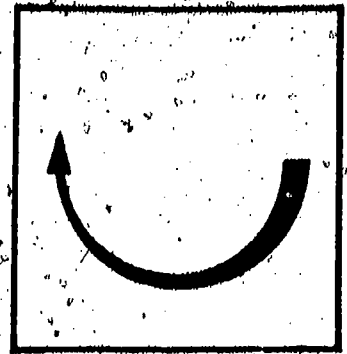

All of these valves are of the outside screw-and-yoke type. One type of screw-and-yoke valve (Gate type) is shown.

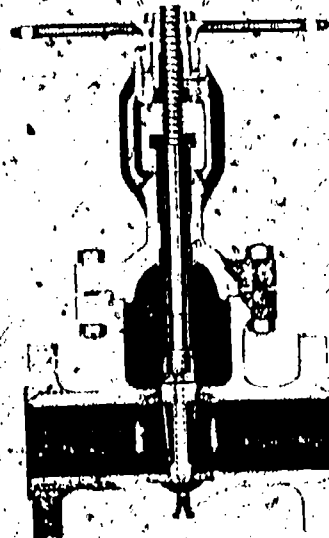

Non-Return Stop Valves

This stop-and check valve prevents a reverse flow of steam back into the boiler. Normally this valve is used when several boilers are pumping into a one common main. It is operated with a piston and disc to open and close the valve. It opens when inlet pressure is greater than outlet pressure. The valve closes when inlet pressure is greater than outlet pressure. Several types of non-return valves are used.

1. Globe non-return valve
2. Y-type non-return valve
3. Angle type non-return valve

All of these valves are operated with a piston and disc arrangement.

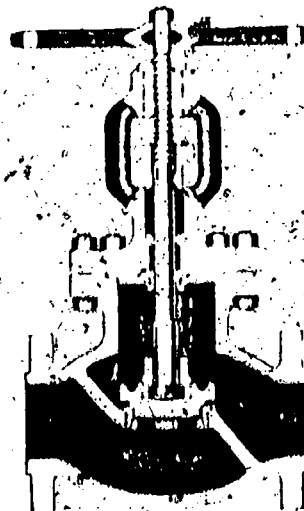



Information

Blow-off Connections

Blow-off connections are used for the following purposes:

1. Removal of sludge from boiler.
2. Inject acid cleaning solutions into boiler.
3. Lower excess water level in the boiler.

Types of Blow-off

Three major types of blow-off connections are found on boilers.

1. Bottom blow-off are at the bottom of the boiler and used to remove sludge from the boiler. On firetube boilers, the blow-off connection is to the rear of the boiler. Watertube boilers may have several blow-off connections to clean sludge out of the mud drums and headers.
2. Continuous blow-off connections are located below the water surface. Their purpose is to remove water that is heavy with dirt or sludge. A collecting pipe is located in the heavy water concentrate. A regulating valve controls the amounts of water removed by the continuous blow-off. Most continuous blow-off is part of a heat recovery system that salvages heat from the blow-off.
3. Surface blow-off connections are used to skim off surface sediment from the boiler water. The blow-off line is located at water level. A skimming pan moves up and down with variations in the water level. It scoops off sediment at the water surface.

Blow-off Valve Types

Four types of blow-off valves are used:

1. Sliding disc
2. Seatless sliding plunger type
3. Seat and disc type
4. Combination



Information

The sliding disc valve is a quick opening valve that operates by lever action.

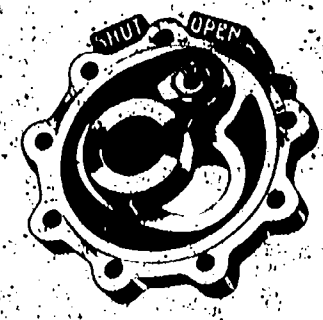
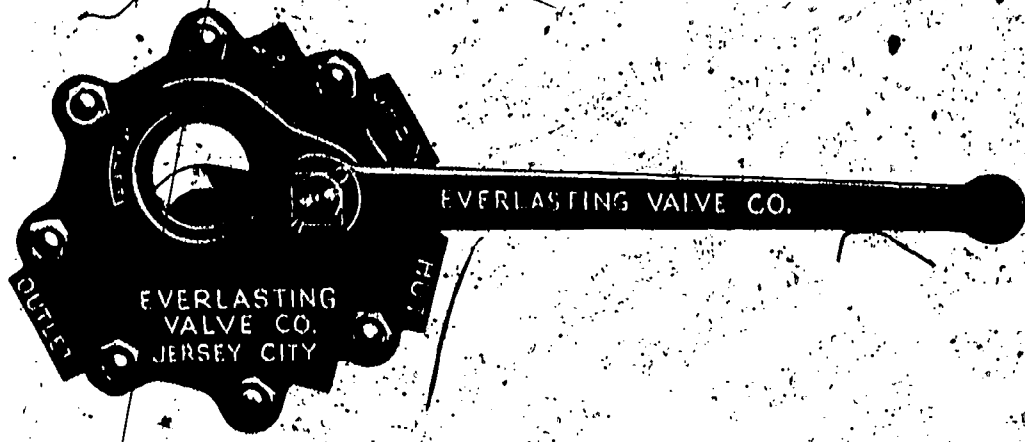

The sliding plunger type is a slow opening valve operated by a handwheel.

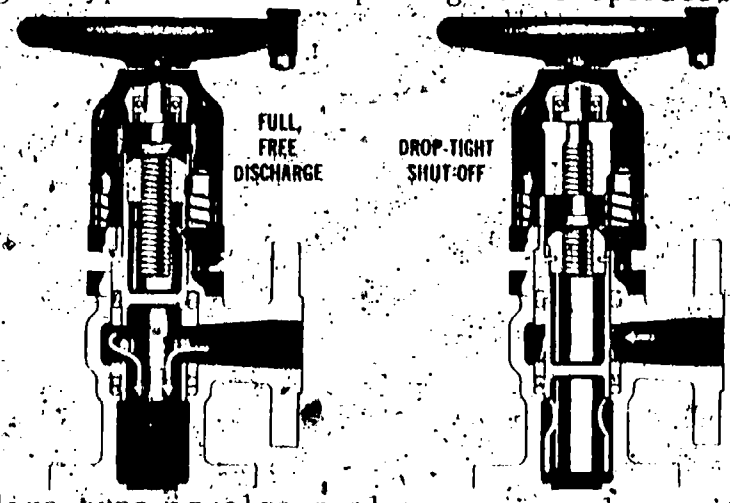

The seat and disc type is also a slow opening valve with a bottom disc that closes the valve. It is a handwheel operated valve.

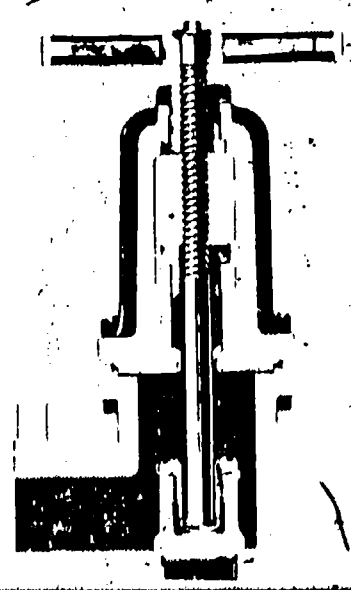

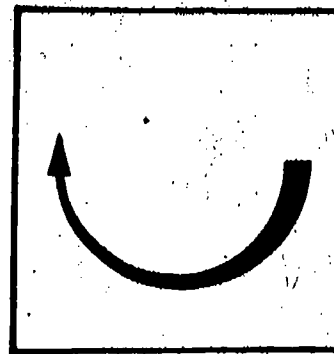

Information

Combinations of two types may be housed in one unit. The inlet valve may be of one type and the discharge valve of another type.

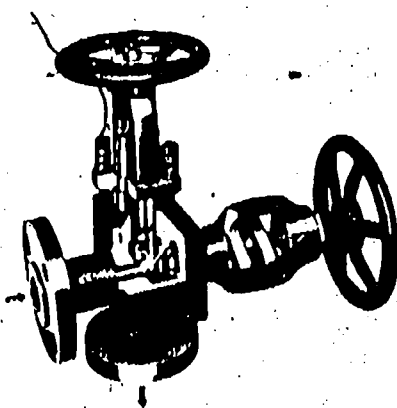

Blow-off Connections

Requirements for blow-off connections are summarized below.

1. Flanges shall not be of bronze, brass, flanged or screwed fitting types for use in blow-off lines.
2. Non-ferrous pipe or tubes shall not be used for blow-off piping.
3. All fittings between boiler and blow-off valves shall be of steel for pressures over 900 kPa.
4. Blow-off valves may be of cast iron if pressures do not exceed 1400 kPa. For pressures in excess of 1400 kPa, steel must be used for valves.
5. Minimum size for blow-off pipe is 25mm and the maximum is 64mm for boilers with over 64 square meters of heating surface. For those with less than 64 square meters, the minimum size is 16 mm.

There are many other requirements that are part of boiler safety codes. These requirements should be studied in relation to specific boilers that the apprentice is working with at the time.

Drum Internals

Several types of fittings are attached inside the steam drum. These fittings are devices for separating and washing steam; handling feedwater; handling chemicals and blow-off lines. These devices are given specific treatment in another package. The internals of a steam drum contain the following:

1. Steam separator
 - a. Combustion Engineering type
 - b. Babcock and Wilcox type

Information

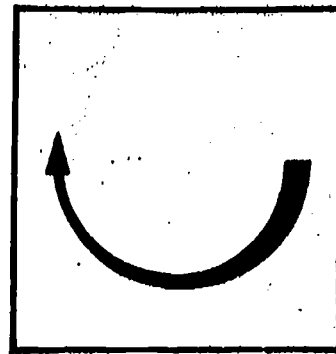

2. Steam washer
3. Feedwater lines
4. Chemical lines
5. Blow-off lines

The arrangement of these fittings within a drum are shown below.

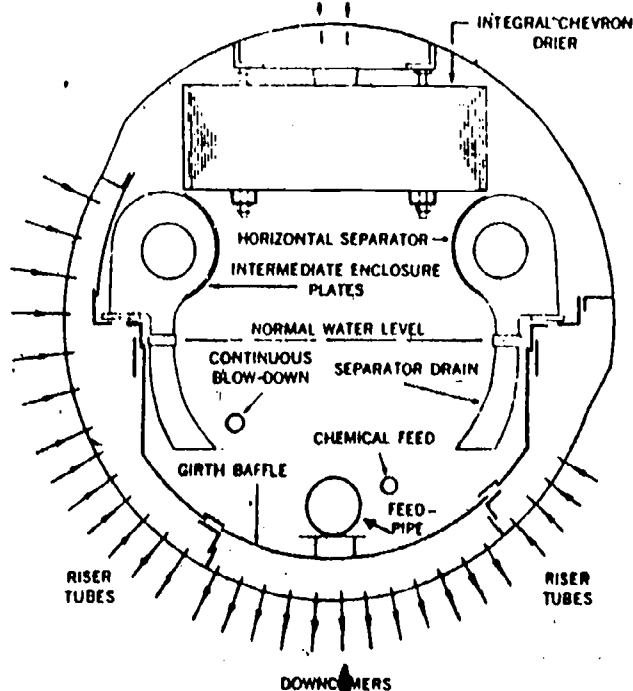

Soot Blowers

Soot blowers are used to remove ash from the furnace walls. An accumulation of ash and slag cuts down the efficiency of steam generation. The type of fuel used in combination determines how much soot removal equipment is needed. Natural gas burns clean and does not require soot blowers. Fuel oil burners do not require soot blowers. On those units that are fired with coal, soot blowers become very important. Soot blowers are of two types:

1. Single nozzle retractable type
2. Long retractable double nozzle type

In the single nozzle type, one motor operates the retractable nozzle. The nozzle extends and retracts. Another motor rotates the nozzle a full 360°. Steam, air or water is directed against the sides to dislodge the ash and slag from the heating surfaces. A single nozzle retractable blower is pictured.

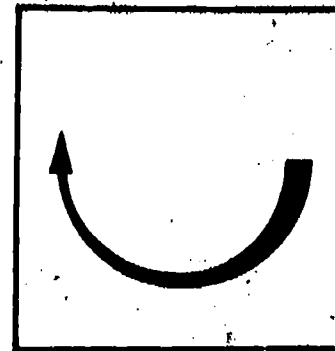

Information

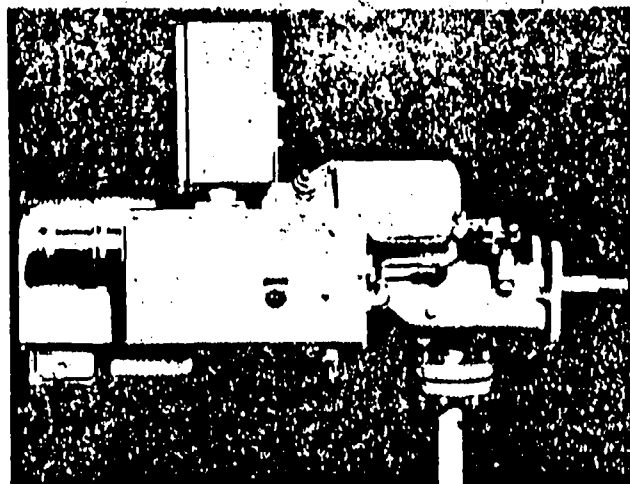

Single Nozzle Retractable Wall Blower

A long retractable nozzle blower is used to clean soot from high temperature areas such as superheaters. A long retractable model is shown.

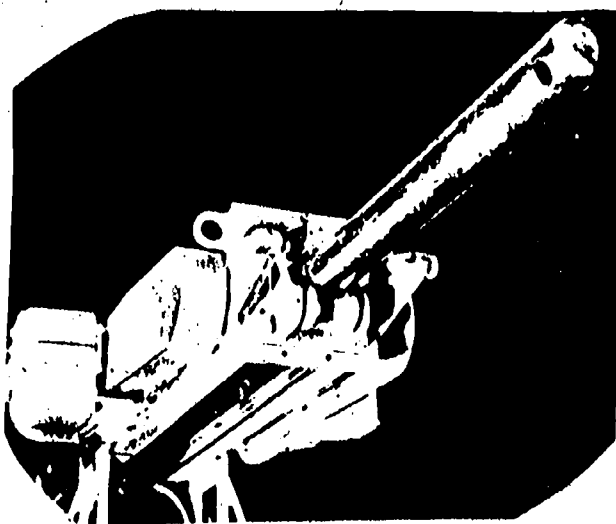

Feedwater Connections

Feedwater connections include valves, fittings and piping for moving feedwater to the boiler. All boilers must have one or more means of feeding water into the system.

Feedwater Valves

Feedwater lines must be fitted with stop valves between the check valve and the boiler. When more than one boiler is supplied by a common feedwater source, a

Information

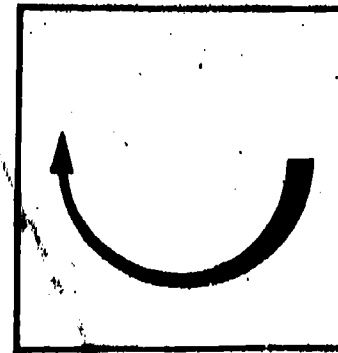

Regulating valve must be installed on branch lines to the individual boilers.

Feedwater Piping

Piping must meet the requirements of the working pressure of the boiler. The pipe thickness is computed by the following formula:

$$t = \frac{PD}{2SE + 2yP} + C$$

where: t = thickness of pipe

P = maximum allowable working pressure

S = maximum allowable stress value at operating temperature (from table)

E = efficiency of longitudinal welded joints (From code)

C = minimum allowance for threading and structural stability in m.m. (From code)

y = a temperature coefficient (From code)

A list of code tables are needed to compute thicknesses needed for feedwater piping on specific boilers.

Fusible Plugs

Fusible plugs give warning of low water levels in the boiler. It is a brass plug with a tin-filled tapered hole drilled through it. It is installed at the lowest permissible water level in the boiler. When water levels drop below the plug, the tin will melt and steam will blow out the plug. The operator is warned so that the boiler can be shut down before damage occurs. Plugs are classified as:

1. Fireside plugs which are tapped into holes from the fire side.
2. Waterside plugs which are tapped from the water side of the boiler.

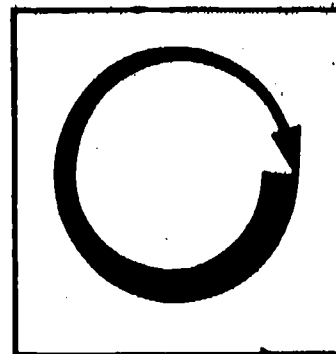

Assignment

- * Read and study illustrations in supplementary references. Read as much of the references as time will allow.
- * Complete the job sheet.
- * Complete the self-assessment and check answers.
- * Complete the post-assessment and ask the instructor to check your answers.

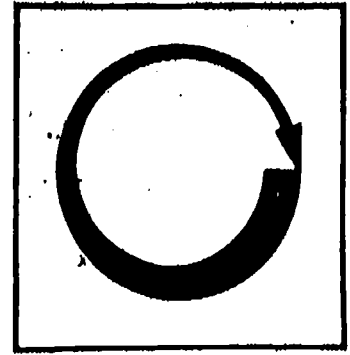

Job Sheet

ANALYZE THE FITTINGS ON A BOILER

- * Observe a boiler and closely inspect for the following items. Identify types of each item.
 - Safety valves
 - Water columns and gauge glasses
 - Pressure gauges
 - Feedwater connections
 - Blow-off connections
 - Stop and check valves
 - Drum internals (if possible)
 - Soot blowers (if possible)
 - Fusible plugs (if possible)
- * For those items that cannot be readily identified, consult a manufacturer's diagram or ask the operator to help.
- * Learn the identity of every gauge, valve and fitting that is attached to the boiler and its purpose.

Self Assessment

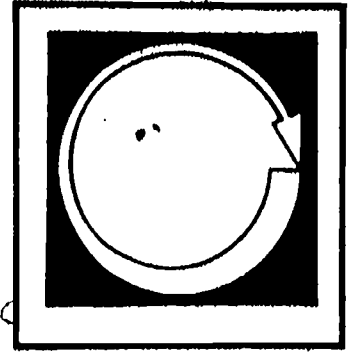

Indicate what type of fitting is listed below by inserting the proper letter in the blank beside the number.

- | | |
|---|-----------------------------------|
| <input type="checkbox"/> 1. Single nozzle retractable type | A. Safety valve |
| <input type="checkbox"/> 2. Globe type | B. Water column or gauge glass |
| <input type="checkbox"/> 3. Seatless sliding plunger type valve | C. Pressure gauge |
| <input type="checkbox"/> 4. Bourdon spring gauge | D. Feedwater connection or valve. |
| <input type="checkbox"/> 5. Screw and yoke type gauge | E. Blow-off connection or valve. |
| <input type="checkbox"/> 6. Nozzle reaction type | F. Stop or check valve |
| <input type="checkbox"/> 7. Steam washer | G. Drum internal |
| <input type="checkbox"/> 8. Flat glass gauge | H. Soot blower |
| <input type="checkbox"/> 9. Fireside type | I. Fusible plug |
| <input type="checkbox"/> 10. Regulating valve | J. Non-return stop valve |

Self Assessment Answers

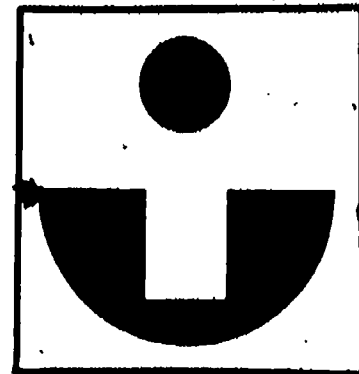

H 1.

J 2.

E 3.

C 4.

F 5.

A 6.

G 7.

B 8.

I 9.

D 10.

Post Assessment



TRUE or FALSE

1. A power operated relief valve is a type of safety valve.
2. Gauge glasses are used to determine the color of boiler water.
3. Tubular gauge glasses are needed on boilers with operating pressures above 2800 kPa.
4. Pressure gauges must show a range of 1 1/2 times the allowable working pressure to meet code.
5. A bellows gauge is a type of pressure gauge.
6. The Bourdon spring gauge operates from pressure on a C-shaped tube that causes it to straighten out and open the valve.
7. The outside screw-and-yoke valve is the most common type of safety valve used on boilers.
8. There are two major kinds of blow-off connections on boilers.
9. A steam separator is one of the drum internals.
10. Natural gas burners require several soot blowers to free the heating surface of ash.

Instructor Post Assessment Answers

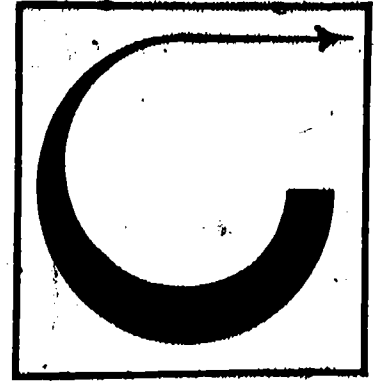

1. True

2. False

3. False

4. True

5. True

6. True

7. False

8. False

9. True

10. False

● Supplementary References

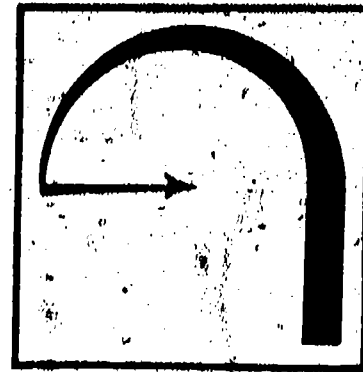

- * Correspondence Courses. Lectures 4 and 5, Section 2, First Class. Steam Generation. Southern Alberta Institute of Technology. Calgary, Alberta, Canada.

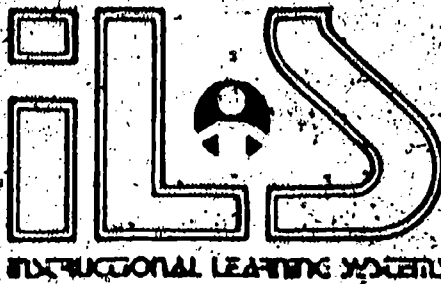

12.5

BOILERS — OPERATION

Goal:

The apprentice will be able to describe steps in boiler operation.

Performance Indicators:

1. Describe hydrostatic testing.
2. Describe drying out the refractory.
3. Describe "boilout".
4. Describe setting of safety valves.
5. Describe procedures for start-up of boiler.
6. Describe procedures for operating a boiler under normal conditions.
7. Describe procedures for operating boiler under emergency conditions.
8. Describe types and causes of boiler explosions.
9. Describe procedure for shut-down of boiler.

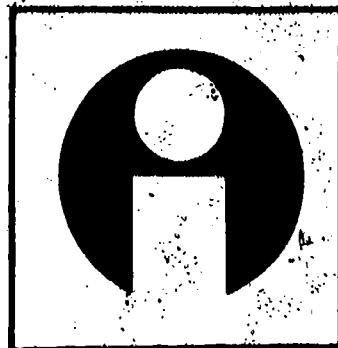

Study Guide

- * Read the goal and performance indicators to find what is to be learned from package.
- * Read the vocabulary list to find new words that will be used in package.
- * Read the introduction and information sheets.
- * Complete the job sheet.
- * Complete self-assessment.
- * Complete post-assessment.

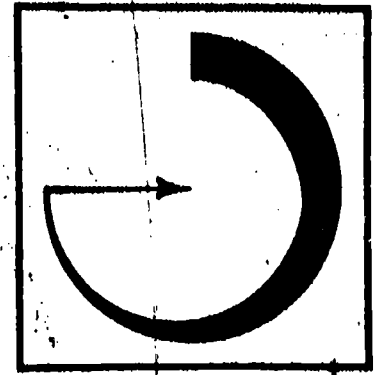

Vocabulary

- * Boiling out
- * Flame-out
- * Foaming
- * Forced draft fan
- * Furnace explosion
- * Hydroset
- * Hydrostatic testing
- * Induced draft fan
- * Pressure explosion
- * Priming
- * Purging
- * Safety valve compression screw
- * Thermocouple
- * Turnbuckle

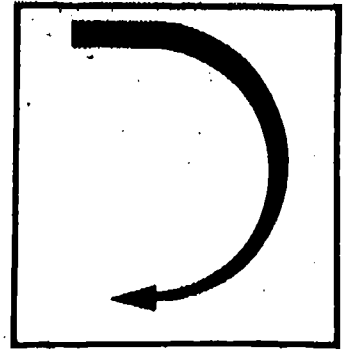

Introduction

A boiler operator must follow a set of prescribed procedures for starting, operating and shutting down a steam generation plant. These procedures are necessary for safe and successful operation of a boiler.

This package discusses the basic practices for operation of boilers. The material is targeted at those that will be operating and maintaining boilers-- not boiler mechanics.

Information

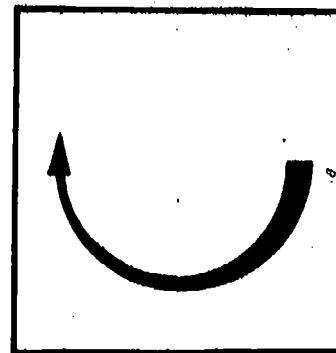

Pre-operation Activities

Hydrostatic Testing

Boilers that are new or recently overhauled should be tested under pressure for leaks. A hydrostatic test places the boiler under 1.5 times its working pressure plus 10% additional pressure. Pinhole leaks and cracks can be detected in the boiler. High quality water of atmospheric temperature should be used for the test. Water must not be more than 100° F cooler than the boiler tube metal temperature.

Drying Out The Refractory

The refractory of a new boiler must be dried out before placing it into full steam production. A low firing rate that will maintain 95° C water temperatures is needed for drying the refractory.

Boiling Out The Waterside

The waterside of new boilers should be boiled out to get rid of grease and dirt that has accumulated during its construction. The boiling out can take place at the same time the refractory is being dried out. The boiler is filled with clean water and 25 % of the required "boiling out" chemicals are added. The boiler manufacturer's recommendations must be followed on amounts of chemicals. After the fireside drying is complete, the other 75% of the chemicals are added and the firing rate is increased. The boiler pressures are raised to one-half of their working pressures. Blow-off valves are operated every 2-4 hours to remove the sludge. When the flow-off water becomes clear, the boil out is complete.

Safety Valve Setting

At the end of boil out, the main steam lines, superheater and reheater should be blown out. Once these have been blown out, the safety valves should be set. A hydroset unit is attached to the safety valve spindle by means of a turnbuckle. Pressure is put on the safety valve by a hydroset pump until it reaches its setting. If the valve does not act when its setting is exceeded the valve setting must be adjusted with the safety valve compression screw. A hydroset unit and safety valve are shown in the following diagram.

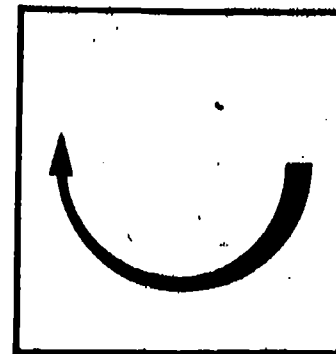

Information

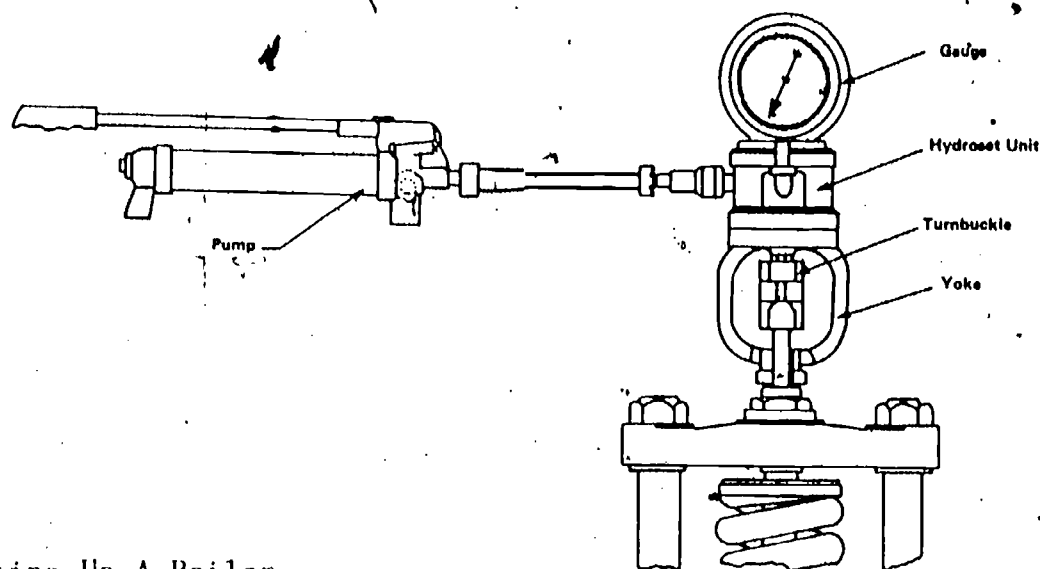

Starting Up A Boiler

1. Fill with high quality water.
2. Keep vents open during filling to allow air to escape.
3. Purge the furnace before lighting. Use 25% of full load of air flow and make at least five volume changes in multiple burner units and eight volume changes in single burner units.
4. Light the burners.
5. Control temperature of flue gas that flow to superheater or reheater by regulating firing rate.
6. Protect drums and headers from rapid temperature change during time that pressures are being raised. If boiler serves one turbine unit, the turbine should be started when one-half the working pressure is reached. This starts a flow of steam through the superheater and reheater. The turbine should not be placed under load.
7. Measure temperature of flue gas in the furnace sections by means of thermocouples. Temperature change rate must not be over 40 C per hour for rolled tube joints or 200 C per hour with welded joints.
8. If system has headers, open drain valve on non-return valve and crack open the header valve. After pressure has equalized, open the header valve wide. Open non-return valve and close drain valve once the boiler is feeding into the system.

Operating Boiler Under Normal Conditions

Maintain Water Levels

Boilers are equipped with gauge glasses and water columns to indicate water

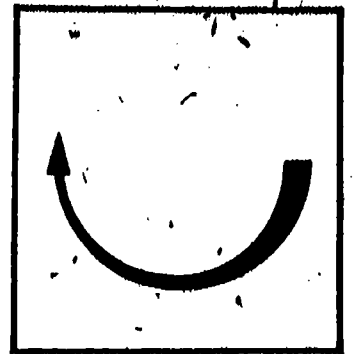

Information

levels in the boiler. Some boilers have alarms for high and low water levels. Water columns should be blown down according to the manufacturer's recommendations. Blow-down shows the operator whether the water column is accurately measuring the water level. Boiler feed pumps must be checked for bearing temperatures and lubricated when needed. Stand-by feed pumps should be started and allow them equal operation time with the regular feed pump. The water level control system must be checked regularly.

Water Supply

Feedwater supply must be properly treated. Water testing tells the operator how many chemicals need to be added to the feedwater. Blow-down requirements can also be determined by testing. Testing should be done at 24 hour intervals or more often in some cases.

Combustion

Flue gas should be analyzed by recording analyzer or by visual examination of flame color. Fuel burning and draft equipment must be checked and burners cleaned. Fuel temperature becomes important in oil fired furnaces. Air temperature must be watched in coal fired furnaces. An operator must maintain the proper ratio of fuel and air that is fed to the furnace.

Soot Blowing

Soot and ashes clog up the heating surfaces and result in inefficiency of steam production. When soot and ashes build up, they must be blown out with the soot blowers. Soot blowers use either steam or air to remove soot and ashes from the heating surfaces. When the temperature of the flue gas becomes high, the soot blower should be turned on. Blowers should only be turned on when the boiler is loaded beyond 50% of its rated output. Furnace draft must be increased during soot blowing to prevent blowback of dust through furnace doors.

Dust Collectors

An operator must make sure that dust collector tubes are clear. Dust must be collected from the hoppers regularly to avoid plugging of outlets.

Ash Removal

Ash removal is a chore for operators that fuel with coal. Dumping grates and



Information

grate stokers are used in many coal-fired plants. The operator must check on the type of ash removal equipment to make sure it is working properly.

Boiler Blow-off

Continuous blow-off rates and times are established by manufacturers. Within a plant, the frequency of blow-off is usually determined by the person in charge of feedwater treatment. Waterwall blow-off should only be done at times when the boiler is banked or operating at low levels.

Inspections

Operators should make a general inspection of the boiler plant each shift or more often if possible. Leaks and problems should be detected as early as possible. All fittings and gauges should be carefully checked and a written record made on the findings of that inspection.

Keeping Logs

Routine duties and the time of their performance should be recorded on a log sheet, i.e. soot blowing, blow-off. Problems should also be recorded along with notes or comments on the problem. All entries should show date and time of the inspection, action or problem.

Operating A Boiler In Trouble

Emergencies do occur in boiler operation. The operator must know what to do in case of an emergency.

Low Water Level

There are many conditions that cause a low water level to occur. Actions will depend somewhat on the nature of the condition that caused the problem. In most cases, the fire should be cut off as quickly as possible. The gauge glass or water column should be blown-down to determine if the condition is being accurately measured. The air supply should be cut off and the boiler steam outlet closed to avoid rapid pressure changes that might stress and damage the metal. Where combustion can be stopped immediately, the feedwater should be shut off. If fueled with coal or wood, it is difficult to stop combustion immediately and the feedwater should be left on.

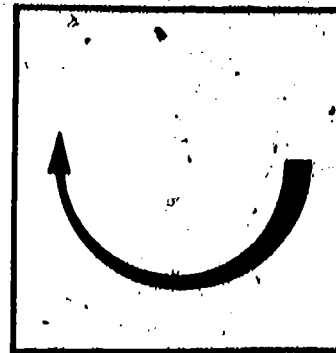

Information

High Water Levels

High water levels can result in damage to turbine blades and piping failures. Water is passed on with the steam instead of separating in the drum. In emergencies created by high water level the operator should:

1. Shut off feedwater
2. Shut off fuel
3. Shut off air
4. Close turbine stop valves or header valves to prevent water from entering the turbine
5. Use blow-off valves to bring water level down to normal

Priming and Foaming

Water is sometimes carried over with steam into the turbine. This condition is known as priming. It may be due to a high water level or it may result from foaming. When large amounts of bubbles form in the drum, it is called foaming. Foaming is controlled by blow-down and addition of feedwater. Sometimes, anti-foam chemicals are used to prevent foaming.

Fan Failure

Failure of the draft fans allow combustible gases to fill the furnace. The fuel should be cut off at once. If the induced fan fails, the fuel and forced draft fan should be shut off.

Flame or Ignition Failure

A flame failure occurs when the flame is extinguished for some reason. It is often referred to as a flame-out. If fuel continues to flow into the furnace during a flame-out, combustible gases collect and might cause an explosion. When a flame-out occurs, the fuel should be shut off immediately. Some boilers have automatic flame-out devices which shut down the fuel supply. Alarms may be attached to gas analyzer devices for signalling flame-out conditions. The furnace should always be purged with a flow of air after a flame failure.

Loss of Load

Sudden loss of load causes a rapid rise in boiler pressure. The safety valves will open as a result of that pressure. Combustion controls will react to cut down the firing rate. The operator must decide whether to shut the boiler down

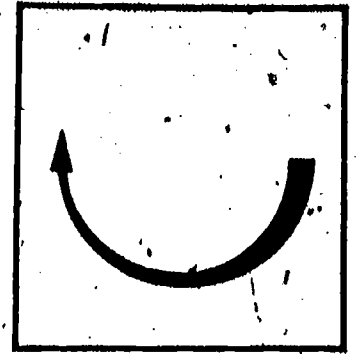

Information

or continue operating at a low firing rate.

Boiler Explosions

Boiler explosions may be due to the ignition of combustible gases in the furnace--a furnace explosion or too much pressure breaking a boiler part--a pressure explosion. Explosions cause property damage and loss of life to those in the vicinity. The most common causes of furnace explosions are:

1. Failure to purge the furnace before start-up.
2. Fuel added to main burner without pilot flame.
3. Pilot flame is too weak to ignite main burner.
4. Loss of main burner flame in a flame-out.
5. Lighting a burner from other burners which cause an accumulation of gases in an area before it is ignited.
6. Incomplete combustion due to improper air supply.
7. Insufficient air flow through a banked stoker-fired furnace.
8. Improper soot blowing procedures.

Pressure explosions are caused by:

1. Operating boiler at pressures beyond that for which it was designed.
2. Weak materials that fail at normal working pressures due to stress, overheating and erosion.

Shutting Down a Boiler

Boilers are shut down for cleaning, inspection and repair. The basic steps for shut down are:

1. Switch combustion controls from automatic to manual when load is reduced to 25%.
2. Run stoker hoppers and pulverized coal mills empty.
3. Cut burners out sequentially.
4. Leave burner air registers in firing position.
5. Trip main fuel supply valve.
6. Purge for 5 minutes.
7. Shut down fans and close burner registers.
8. Cool slowly and regulate cooling by thermocouples.

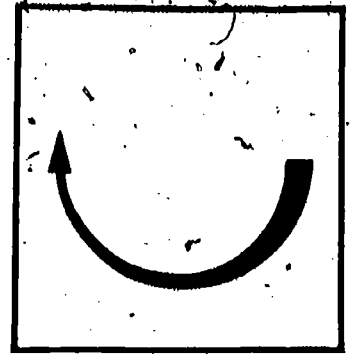

Information

9. Close feedwater valves and header stop valves.
10. Close down non-return valve.
11. Open drain between header stop valve and non-return stop valve.
12. Open economizer recirculating valve.
13. Open drum vents after pressure drops to 175 kPa or 25 psi.
14. Drain boiler.
15. Close, lock and tag valves.
16. Isolate the fuel supply.



Assignment

- * Read pages 1 - 21 in supplementary reference.
- * Complete job sheet.
- * Complete self-assessment and check answers with answer sheet.
- * Complete post-assessment and ask the instructor to check your answers.

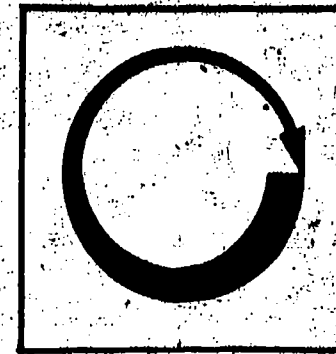

Job Sheet

OBSERVE START-UP, OPERATION AND SHUT-DOWN PROCEDURES

- * Ask an operator to let you observe operational procedures.
- * Observe the steps in starting up a boiler.
- * Observe the steps in normal operations.
- * Observe the steps in shut-down.

It may not be possible to observe all of these procedures but the apprentice should take the initiative in learning good operational procedures. Close observation of an experienced operator is a good way to learn procedures.

Self Assessment

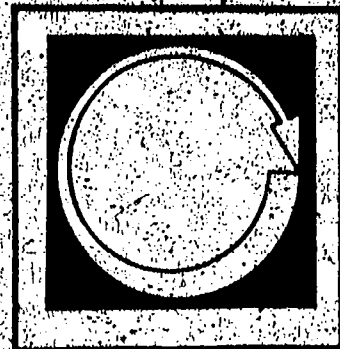

Match the following terms with their appropriate description.

- | | |
|--|---|
| ___ 1. Boiling out | A. Passing air through boiler to remove combustible gases. |
| ___ 2. Drying out refractory | B. Record of actions and problems in boiler operation. |
| ___ 3. Gauge glasses and water columns | C. Unit used to set safety valves. |
| ___ 4. Hydrostatic testing | D. Causes water to pass to the turbine along with steam. |
| ___ 5. Thermocouples | E. Removal of grease and sludge from boiler by blow-off until water is clean. |
| ___ 6. Hydroset | F. Removes ash from burner surfaces of boiler. |
| ___ 7. Purging | G. Tests boiler pressures to 1.5 times rated pressure. |
| ___ 8. Soot blower | H. Devices used in measuring temperature of flue gas. |
| ___ 9. Log | I. A low firing rate and 95 C water temperature needed. |
| ___ 10. High water level | J. Show water level of boiler. |

Self Assessment Answers

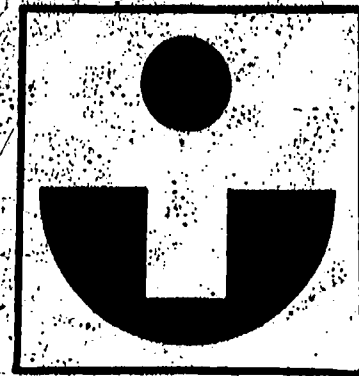

E 1.

I 2.

J 3.

G 4.

H 5.

C 6.

A 7.

F 8.

B 9.

D 10.

Post Assessment

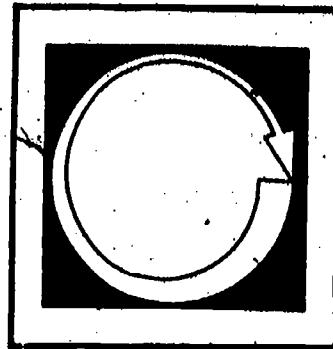

1. Operators should make a general inspection of all fittings and gauges at least once a _____.
2. Water carried over to the turbine with steam is called _____.
3. Large amounts of bubbles in the drum is called _____.
4. Two types of fans are used to move air through the boiler--the forced draft and _____ draft fan.
5. A _____ results when there is a momentary lapse in fuel supply to the burners and they lose their flame.
6. The two major types of boiler explosions are _____ and _____ explosions.
7. An operator should switch combustion control equipment from automatic to manual when the load is reduced to _____%.
8. Forcing air through a boiler to remove combustible gases is called _____.
9. A _____ test places the boiler under 1.5 times as much pressure as its design rating.
10. The accuracy of gauge glasses and water columns can be tested by _____.

Instructor Post Assessment Answers

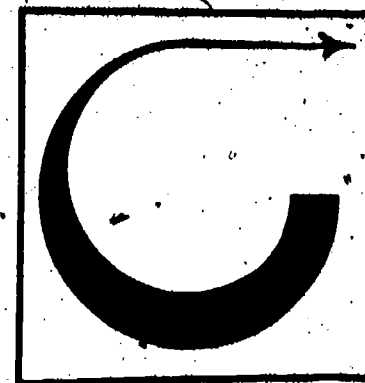

1. Shift
2. Priming
3. Foaming
4. Induced
5. Flame-out
6. Furnace and pressure
7. 25
8. Purging
9. Hydrostatic
10. Blow-down

Supplementary References

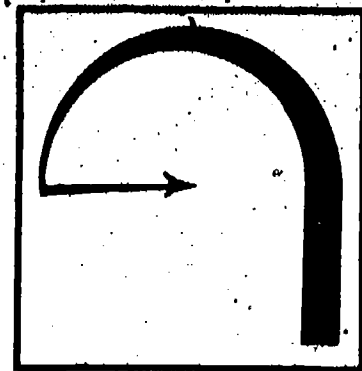

* Correspondence Course. Lecture 10, Section 2, First Class. Steam Generation.
Southern Alberta Institute of Technology. Calgary, Alberta, Canada.

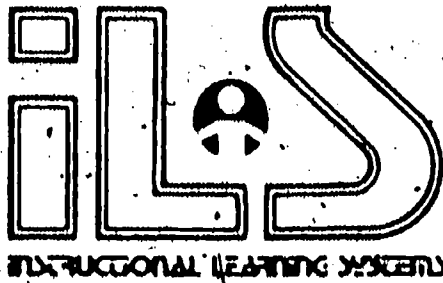

12.6

BOILERS -- CLEANING

Goal:

The apprentice will be able to describe methods for cleaning a boiler.

Performance Indicators:

1. Describe cleaning of air.
2. Describe cleaning of feedwater.
3. Describe cleaning of steam.
4. Describe cleaning of soot, ash and scale.
5. Describe cleaning in routine operations.

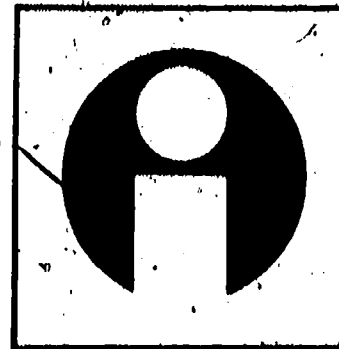

Study Guide

- * Read the goal and performance indicators to find what is to be learned from package.
- * Read the vocabulary list to find new words that will be used in package.
- * Read the introduction and information sheets.
- * Complete the job sheet.
- * Complete self-assessment.
- * Complete post-assessment.

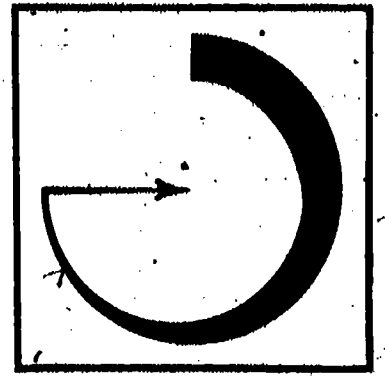

Vocabulary

- * Air washers
- * Alkaline boil out
- * Ash hoppers
- * Ash separators
- * Continuous blow-off
- * Dust collectors
- * Flyash blowers
- * Inhibited acid cleaning
- * Precipitators
- * Purging
- * Retractable nozzles
- * Sootblowers
- * Steam separators
- * Steam washers
- * Surface blow-off



Introduction

Efficiency and safety of boiler operation is highly dependent on keeping the boiler parts clean and free of grease, combustible gases, ashes and soot. Purging the boiler with fresh air to rid it of combustible gases is one type of cleaning operation. Ash and soot removal is a cleaning problem in boiler systems. Feedwater must be kept clean of impurities. This requires another cleaning process that involves surface and continuous blow-down systems:

Several packages have dealt with the various cleaning processes. This package will briefly discuss cleaning and cleaning systems. Each of the systems will be discussed in greater detail in other packages that relate to draft control, feedwater and boiler construction and operation.



Information

Cleaning the Air

Draft equipment provides a flow of air through the boiler. At the same time waste gases are moved away from the combustion chamber. An accumulation of combustion gases can be a safety hazard that causes explosion. Purging is a strict requirement for all boiler startups. Clean air flows through the boiler and removes all combustible gases before firing the boiler. The purging operation must become a habit with boiler operators. Draft equipment must function properly during operation. The furnace needs air for combustion. Waste gases must be removed continuously to eliminate hazards of explosion. Forced draft and induced draft fans are used to move new air into the boiler and combustion gases out.

Cleaning the Feedwater

Feedwater is cleaned by mechanical and chemical methods. Controlling the quality of feedwater that enters the boiler is most important. The water may be treated with chemicals such as softeners and anti-foam materials. Blow-down connections are designed to help keep the feedwater clean. Surface blow-off removes impurities of the water line. Continuous blow-off removes water from well below the surface. The continuous blow-off is located at a point where heavy accumulations of solids occur. This continuous removal of feedwater that is heavy with solids is a cleaning method. Blow-off is used to remove sludge and scale from the boiler.

Cleaning the Steam

A number of devices are used to clean steam before it enters the turbine. If the steam contains water, it causes fouling of the turbine blades. The water is actually cleaned from the steam by such devices as steam separators and steam washers. These devices are part of the drum internals.

Cleaning Out Soot, Ash and Scale

Soot and ash tend to cover the heating surfaces of the boiler. Excess soot and ash reduce the transfer of heat and efficiency of steam production. Soot blowers are used to remove soot and ash from the furnace, superheater and reheater walls. These soot blowers operate on steam, water or air pressure that is delivered through retractable nozzles. The operator determines the need for soot blowing and follows prescribed safety procedures in operation of the blowers. With some fuels, especially coal burning plants, ash handling equipment becomes very important in boiler operation. Ash handling equipment

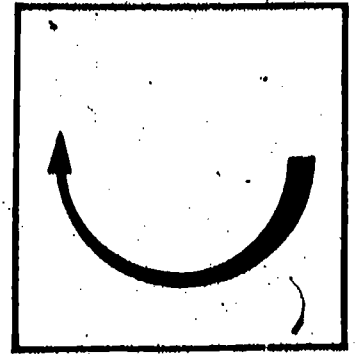

Information

includes waterfilled ash hoppers, blowers for handling flyash, ash separators, air washers, dust collectors and precipitators.

Scale deposits are a major problem in boilers. The control of feedwater quality determines the amount of scale deposit in the boiler. Scale deposits are removed by mechanical or chemical cleaning methods. Mechanical cleaning involves cleaning tools with cutter heads of hard surfaced material. These tools are powered by steam or air and rotate at high speeds. The tools actually cut the scale deposits from tubing and drum surfaces. Chemical cleaning is used to reach surfaces that cannot be cleaned by mechanical methods.

Two methods of chemical cleaning are used. The alkaline boil-out is used to remove grease and oil. Inhibited acid cleaning uses acid to dissolve scale. A test should be made of the scale deposit and a chemical strength selected for each type of deposit. Chemical cleaning is usually accomplished with a low strength acid (inhibited hydrochloric) that will remove the deposit without damage to the metal. Experts are usually contracted to do chemical cleaning.

Cleaning in Routine Operations

Most cleaning operations require that the boiler be shut-down and cooled for internal inspection. The following steps are basic to the cleaning operation.

1. Reduce load on boiler.
2. At about 50% load, operate all sootblowers to clean fireside surfaces.
3. Open drum vents after boiler pressure reduces to 30 kPa.
4. Isolate boiler by closing and tagging valves and opening circuit breakers.
5. Open blowdown valves and drain boiler when it has cooled down to 90 C.
6. Remove steam drum manhole cover.
7. Remove lower drum manhole cover. This step must be done after step 6 to avoid steam burns.
8. Open blowdown valves and flush boiler with high pressure hose.
9. After draining, close and tag blowdown valve.
10. Open fireside access door.
11. Inspect drums, drum internals, burners, dampers, sootblowers, tubes and connections.
12. Record condition of parts in the inspection log.
13. Make recommendations on cleaning methods to be used. Outside help may be needed in analyzing scale deposits and recommending chemical cleaning method to be used.
14. Perform additional cleaning as determined by inspection.

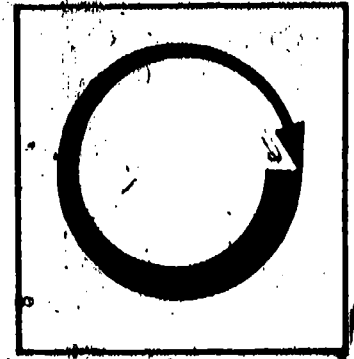

Assignment

- * Read manufacturer instructions on methods for cleaning a specific boiler.
- * Complete the job sheet.
- * Complete the self-assessment and check your own answers with the answer sheet.
- * Complete the post-assessment and ask the instructor to check your answers.

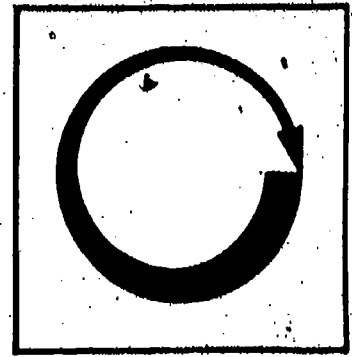

Job Sheet

CONDUCT INTERNAL INSPECTION OF BOILER

- * Review safety rules for entering a boiler that is shut down.
- * Obtain permission from operator to inspect interior or assist operator in making routine inspection.
- * Keep log on condition of all parts inspected.
- * Inspect drum, tubes, drum internals, dampers, sootblowers, burners, connections and other parts for deposits, erosion, wear, etc.
- * Complete inspection log and show it to instructor for comments.
- * Make recommendations for cleaning of the boiler. If possible have instructor to verify your recommendations.

Self Assessment

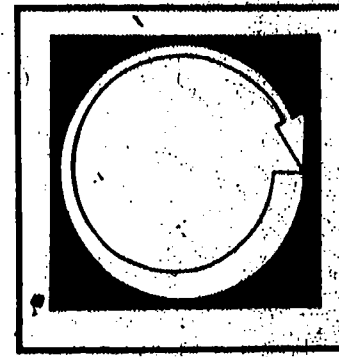

Mark each of the following pieces of equipment or process according to the following code.

- (A) -- used in cleaning air
- (F) -- used in cleaning feedwater
- (S) -- used in cleaning steam
- (Q) -- used in cleaning ash, soot and scale

1. Mechanical cleaning _____
2. Steam separator _____
3. Induced draft fans _____
4. Inhibited acid cleaning _____
5. Surface blow-off _____
6. Retractable nozzles _____
7. Dust collector _____
8. Ash hoppers _____
9. Purging _____
10. Alkaline bofl-out _____

● Self Assessment Answers

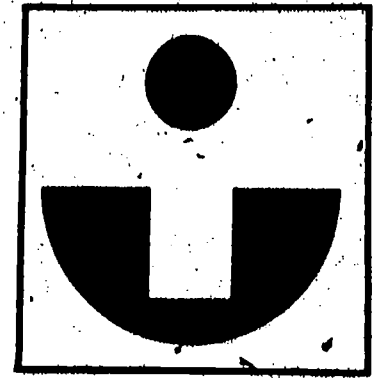

1. Q
2. S
3. A
4. Q
5. F
6. Q
7. Q
8. Q
9. A
10. Q

Post Assessment

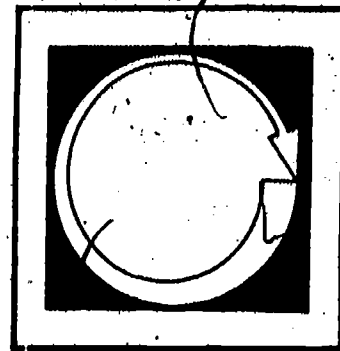

1. List two main methods for cleaning a boiler.
2. List two devices used in cleaning steam.
3. How does soot deposits on heating surfaces reduce the efficiency of steam production?
4. Which method of chemical cleaning is used for removal of grease and oil from boiler.
5. What are two types of blow-off?
6. What device uses retractable nozzles?
7. How is sludge normally removed from the boiler?
8. What is the purpose of purging?
9. List two types of fans used in draft control systems.
10. Which type of chemical cleaning is used to dissolve scale deposits?

Instructor

Post Assessment

Answers

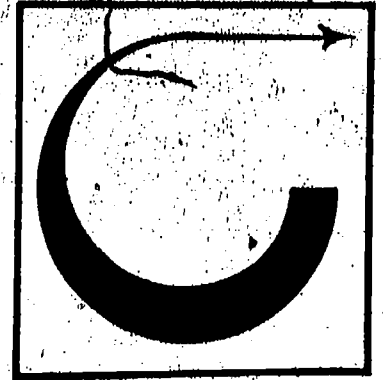

1. Mechanical and chemical
2. Steam separator and steam washer
3. Reduces heat transfer
4. Alkaline boil-out
5. Surface and continuous
6. Sootblowers
7. By blow-off procedures
8. Removes combustible gases from boiler prior to ignition. Purging prevents explosions from these gases.
9. Forced draft and induced draft
10. Inhibited acid cleaning

Supplementary References

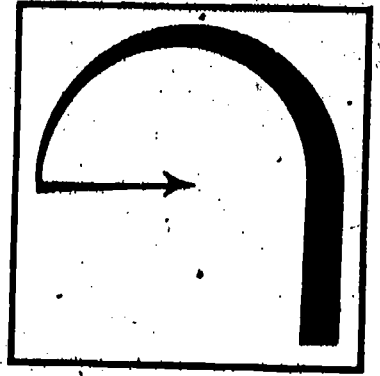

* Manufacturer's Instruction Manual on boiler cleaning procedures.



12.7

BOILERS -- HEAT RECOVERY SYSTEMS

Goal:

The apprentice will be able to describe heat recovery systems.

Performance Indicators:

1. Describe types of superheaters and reheaters.
2. Describe methods of steam temperature control.
3. Describe types of economizers.
4. Describe types of air heaters.

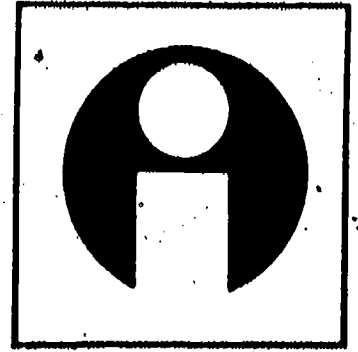

Study Guide

- * Read the goal and performance indicators to find what is to be learned from package.
- * Read the vocabulary list to find new words that will be used in package.
- * Read the introduction and information sheets.
- * Complete the job sheet.
- * Complete self-assessment.
- * Complete post-assessment.

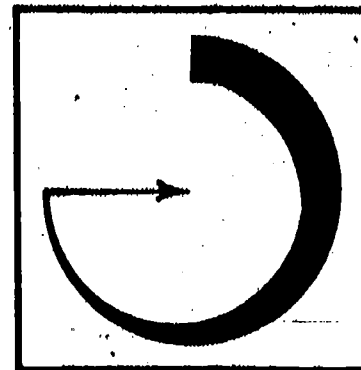

Vocabulary

- * Attemperation
- * Combination superheaters
- * Combustion gas by-pass
- * Combustion gas recirculation
- * Continuous tube
- * Convection superheaters
- * Desuperheating
- * Dry steam
- * Economizer
- * Extended surface tubes
- * Integral economizer
- * Integral type
- * Plate air heaters
- * Radiant superheaters
- * Recuperative air heaters
- * Regenerative air heaters
- * Reheaters
- * Rotary regenerative air heater
- * Saturated steam
- * Separate economizer
- * Separately fired type
- * Superheaters
- * Tilting burners
- * Tubular air heaters
- * Twin furnace
- * U-bend tubes

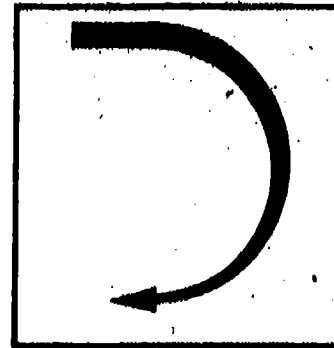

Introduction

Heat recovery systems improve the efficiency of steam generation. The heat that is normally lost as combustion gases pass up the smokestack are conserved as heat for making steam.

This package describes the various types of heat recovery systems. With this basic understanding, the apprentice can learn more about heat recovery through on-the-job experience.

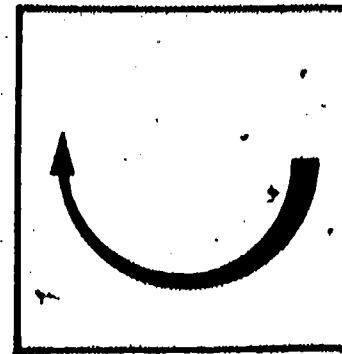

Information

The boiler has several components that are designed for recovery of heat from combustion gases. The more heat that can be recovered, the more efficient the steam generation process becomes.

Heat recovery includes superheaters that remove water from steam to make it more efficient. Reheaters serve as superheaters for steam that is returned from the turbine. Economizers absorb heat from the combustion gases into tubes filled with feedwater. Air heaters absorb the combustion gas heat into the air that will be returned to the furnace. All of these components are designed to improve the efficiency of modern boilers.

Superheaters and Reheaters

The superheater and reheater are designed to increase the temperature of steam. Both are made of tubes over which the furnace gases can pass. Saturated steam is dry steam at the same temperature of the water from which it was boiled. If it contains water, it is wet steam. If this steam has the moisture removed by passing it over a superheater, it becomes dry steam with increased temperature. Dry steam produces more energy than saturated steam. After steam enters the turbine and expands, it cools and the temperature drops. The steam is returned to the boiler for reheating. A reheater is actually a type of superheater.

Superheaters are of two types:

1. Integral type
2. Separately fired type

Integral Type Superheaters

Integral type superheaters may be further classified into:

1. Convection superheater that is shielded from the radiant heat of the furnace.
2. Radiant superheater that is exposed to the radiant heat of the furnace.
3. Combination superheater that is partly exposed and partly shielded.

Information

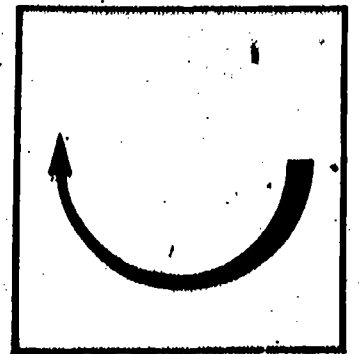

A convection type superheater is shown below.

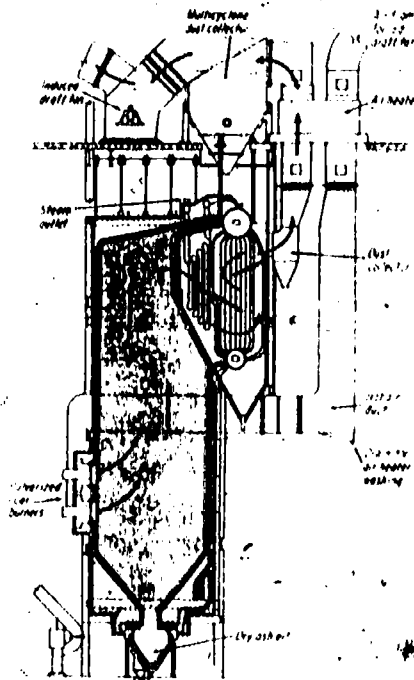

A combination superheater is shown in the following illustration.

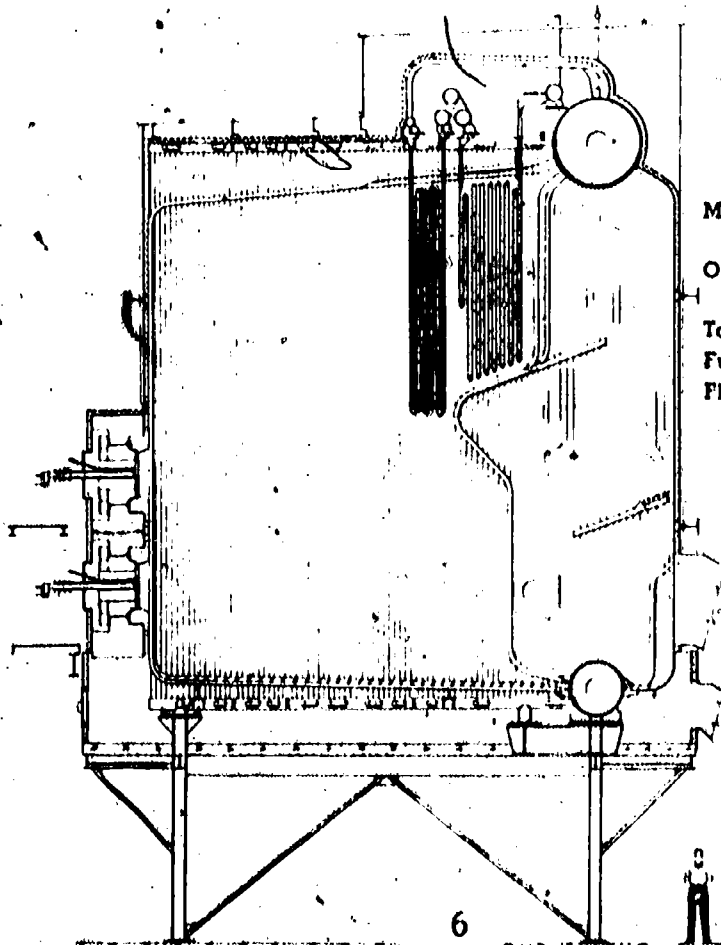

Superheaters in Series
(Combustion Engineering Inc.)

Maximum Continuous Steam Output—
163 290 kg/hr

Operating Pressure—
6480 kPa psi at superheater outlet

Total Steam Temperature— 485° C

Fuel—Natural Gas and Fuel Oil

Firing Equipment—6 C-E Type R Burners

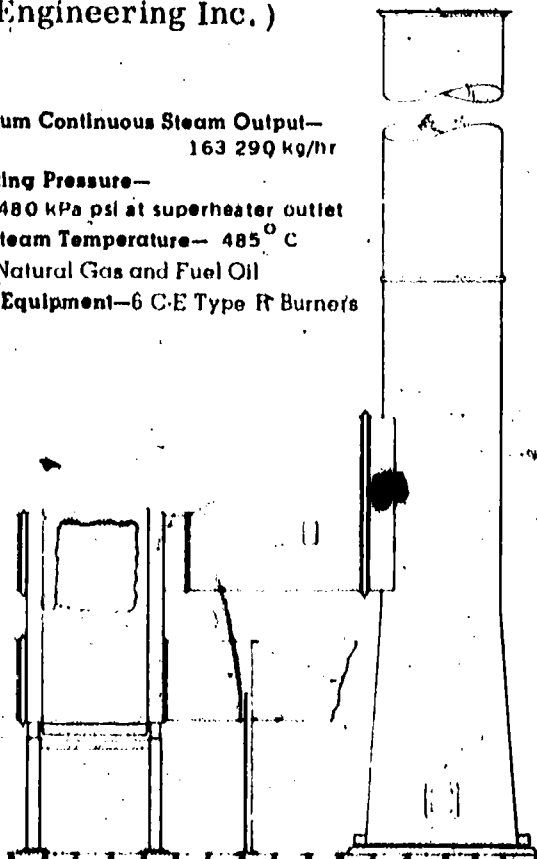

BEST COPY AVAILABLE

Information

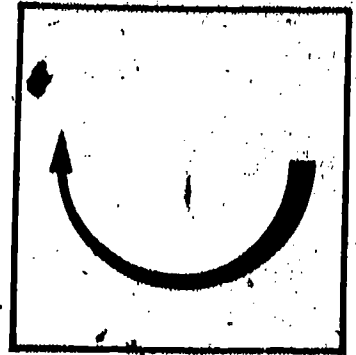

Separately Fired Superheaters

A separately fired superheater has its own furnace. It is housed separately from the steam furnace. It may be supplied with steam from several units. The greatest disadvantage to this type of superheater is the cost. The principle of a separately fired superheater is shown in this diagram.

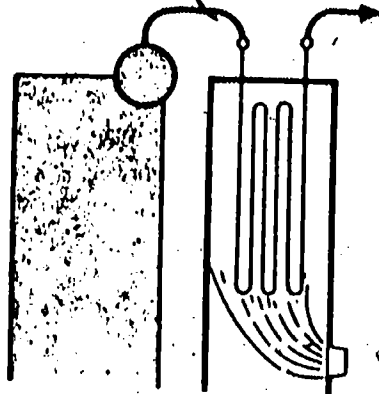

One adaptation of the separately fired superheater is the twin furnace. It consists of two furnaces in one unit. Superheater tubes are placed in one furnace and the steam from both pass through it.

Steam Temperature Control

Several methods are used to control the temperature of steam leaving the superheater. For efficient turbine operation, the temperature of its steam supply must remain constant.

- Tilting Burners have burners that can be tilted up or down. If temperature is too high, the burners are tilted downward. If too low, they are tilted upward.

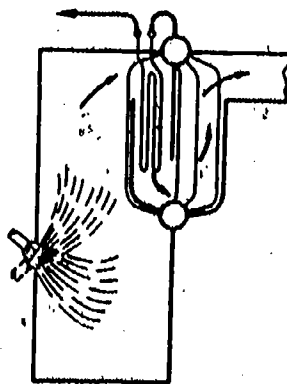

BODY AVAILABLE

Information

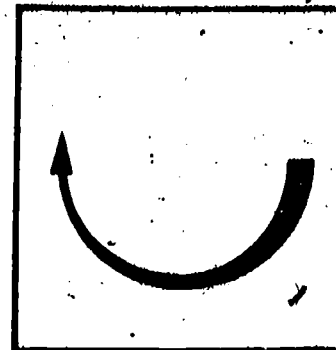

- Twin Furnace used on separately fired superheaters.
- Combustion Gas Bypass routes some of the combustion gases around the superheater to avoid overly high temperatures.

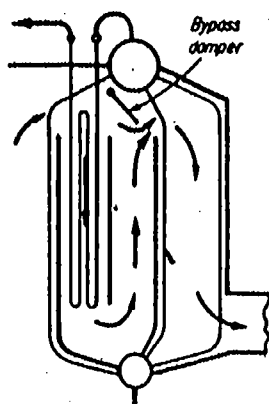

- Combustion Gas Recirculation recirculates combustion gas over the superheater tubes to raise temperature.

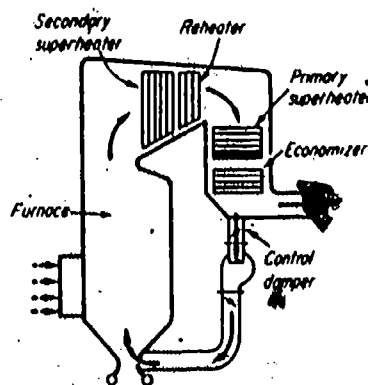

- Desuperheating lowers temperature by spraying feedwater into the superheated steam.

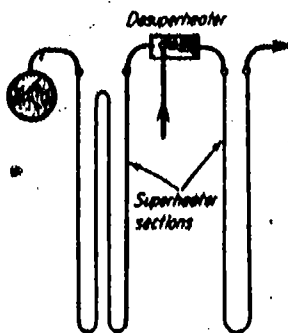

BEST COPY AVAILABLE

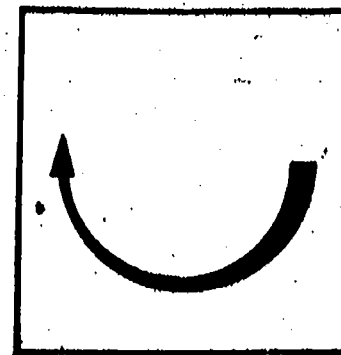

Information

- Attemperation lowers the steam temperature by condensing it as it passes over the attemperator tubes which are filled with feedwater.

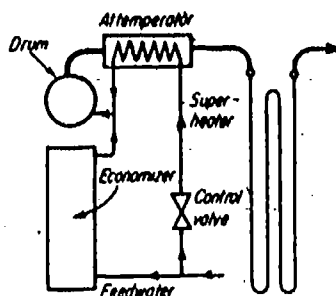

Economizers

Economizers are also a series of tubes. They are designed to absorb heat from combustion gases. This savings of heat will improve the economics of steam generation. Economizers are of two basic types:

1. Integral economizer is one that forms an integral part of the boiler.
2. Separate economizer is located outside of the boiler. This type is the most commonly used economizer.

Integral Economizer

The integral economizer is a tube and drum arrangement. The tubes may attach to the drum of the boiler or may have two drums of its own. Some typical integral economizer arrangements are shown.

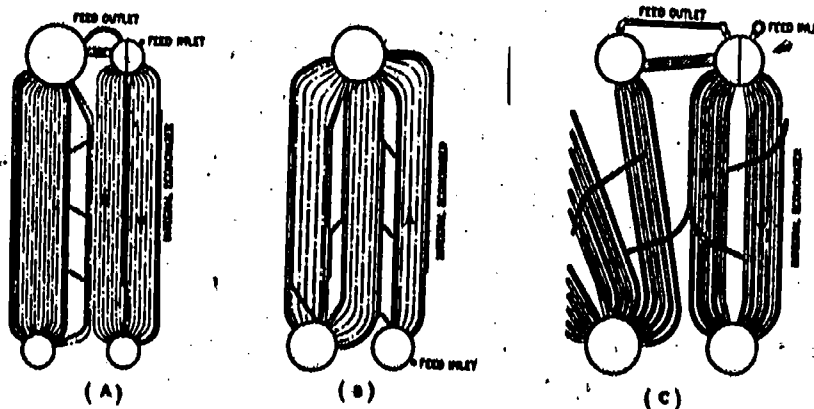

Information



Separate Economizer

Separate economizers are located outside the boiler. They consist of rows of tubes placed horizontally. The tubes are filled with feedwater. As combustion gases flow over the tubes, the feedwater collects heat from the gases. Economizers are available in different configurations.

- Extended surface tubes have straight tubes with cast iron fins that provides more surface for heat collection.

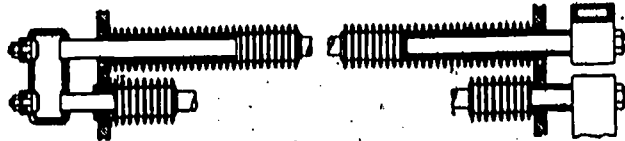

- U-bend tubes has extended surface u-bend tubes.

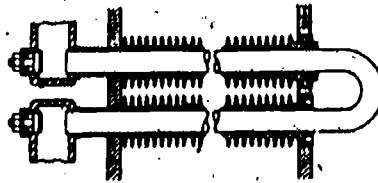

- Continuous tube has a continuous tube that loops between headers.

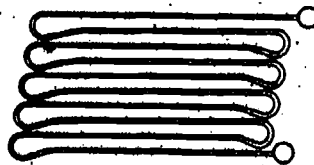

Air Heaters

Air heaters are used to collect heat from the flue gases. It can be used in addition to the economizer. The air heater is a heat exchange surface that is

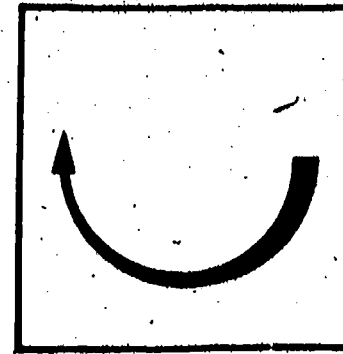

Information

located in the flow of combustion gases. The air absorbs the heat where in an economizer the heat was absorbed by feedwater in the tubes. Heated air is then used in the combustion process. Combustion efficiency is improved with increases in the temperature of the air that enters the furnace. Air heaters are of two basic types:

1. Recuperative heaters
2. Regenerative heaters

Recuperative Air Heaters

The heat from the gases is transferred through the wall of a tube or plate to the air on the other side. Recuperative air heaters may be further classified into two types.

1. Plate air heaters consist of a series of thin plates with passageways between them. Flue gases pass through every other passage and air passes in the alternate spaces. - The gases and air flow in opposite directions. Heat is passed through the plates.
2. Tubular air heaters have a series of tubes that carry air to the combustion chamber. Flue gases pass over the tubes and heat is transferred through the tube wall to the air inside. Tubular heaters may be arranged horizontally or vertically.

Regenerative Air Heaters

In regenerative air heaters, metal sheets are heated by the gases and then moved to heat the air at another location. It becomes a second hand heating process as compared to recuperative type heaters. The most common type is the rotary regenerative air heater. The rotor turns slowly and the metal plates are heated by the gases. As it continues to turn, it passes through the air section and gives up its heat. A rotary regenerative air heater is pictured below.

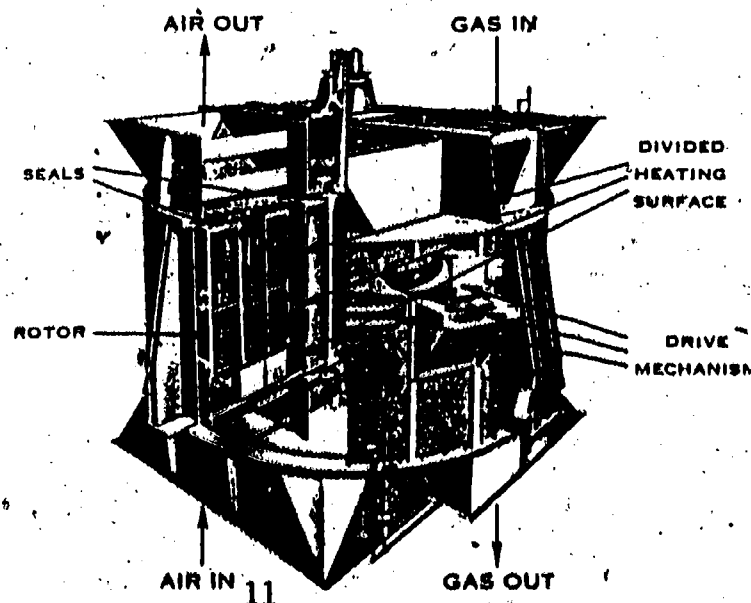

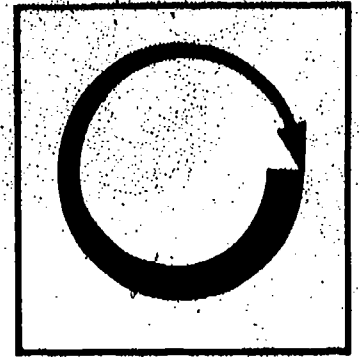

Assignment

- * Read pages 18-38 in the supplementary reference.
- * Complete job sheet.
- * Complete self-assessment and check answers.
- * Complete post-assessment and ask the instructor to check your answers.

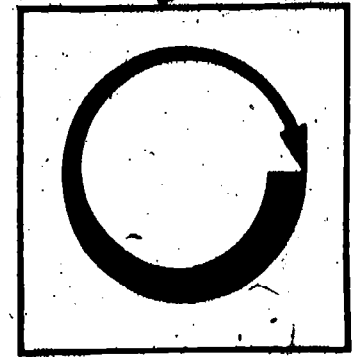

Job Sheet

INSPECT A HEAT RECOVERY SYSTEM

- * Locate a steam generation plant that has a modern heat recovery system.
- * Ask permission to visit the facility.
- * Observe the heat recovery system and ask questions of operator.
 - Does it have a superheater?
 - Is the superheater of the integral type or separately fired?
 - Is it a convection, radiant or combination type superheater?
 - Does it use tilting burners, twin furnaces, combustion gas bypass, combustion gas recirculation, desuperheating, attemperation or other methods of temperature control?
 - Is the economizer of the integral or separate type? How is it made?
 - Are the air heaters recuperative or regenerative types?

Self Assessment

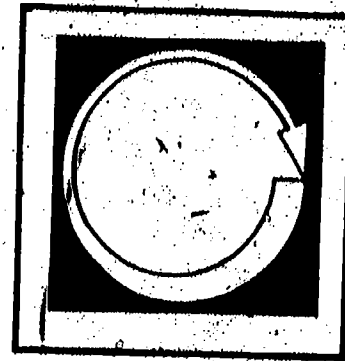

Match the following terms with the phrases by writing the proper letters into the blanks beside the numbers.

- | | |
|-------------------------------------|---|
| ___ 1. Economizers | A. Exposed to the radiant heat of the furnace. |
| ___ 2. Reheaters | B. Steam with moisture removed by superheating. |
| ___ 3. Convection type superheater | C. Partially exposed and partially shielded from the radiant heat of the furnace. |
| ___ 4. Saturated steam | D. Reheats steam that is returned from the turbine. |
| ___ 5. Separately fired superheater | E. Absorbs heat from combustion gases into feedwater filled tubes. |
| ___ 6. Dry steam | F. Shielded from radiant heat of the furnace. |
| ___ 7. Radiant superheater | G. Type of air heater. |
| ___ 8. Tilting burners | H. Steam that contains moisture. |
| ___ 9. Combination superheater | I. Method for controlling temperature of steam that leaves the superheater. |
| ___ 10. Recuperative | J. Superheater has its own furnace separate from the steam generation furnace. |

● Self Assessment Answers

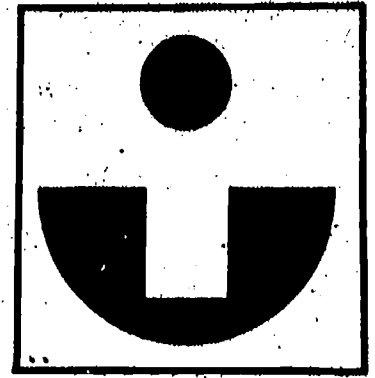

E 1.

D 2.

F 3.

H 4.

J 5.

B 6.

A 7.

I 8.

C 9.

G 10.

Post Assessment

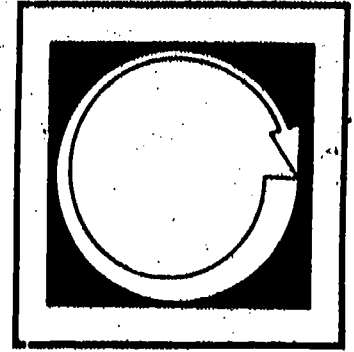

1. U-bend tubes are often found in _____.
2. An _____ economizer is formed as a part of the boiler.
3. _____ air heaters transfer heat through the walls of a plate or tube.
4. _____ air heaters move metal sheets through combustion gases for collecting heat and then rotate to a fresh air stream to deposit heat.
5. A rotary air heater is an example of a _____ air heater.
6. _____ superheaters are shielded from the radiant heat of the furnace.
7. _____ superheaters are exposed to the radiant heat of the furnace.
8. One adaptation of the separately fired superheater is the _____.
9. _____ is the spraying of feedwater into superheated steam to lower its temperature.
10. Extended surface tubes are a type of tube that is found in _____.

Instructor Post Assessment Answers



1. Economizers
2. Integral
3. Recuperative
4. Regenerative
5. Regenerative
6. Convection
7. Radiant
8. Twin furnace
9. Desuperheating
10. Economizers

● Supplementary References

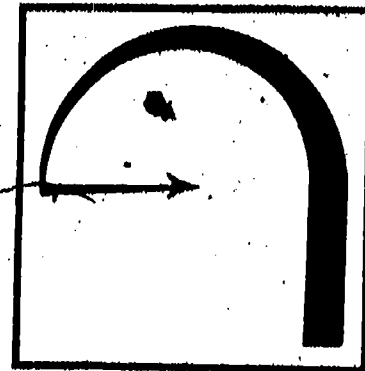

* Correspondence Study. Lecture 3, Section 3, Third Class. Steam Generation.
Southern Alberta Institute of Technology. Calgary, Alberta, Canada.

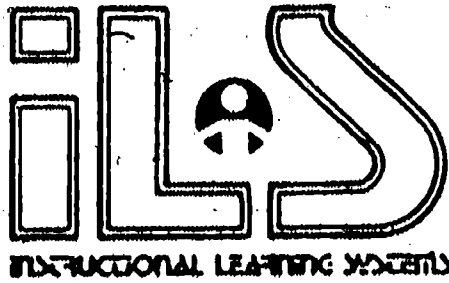

12.8

BOILERS -- INSTRUMENTS AND CONTROLS

Goal:

The student will be able to describe the instruments and controls for boiler operation.

Performance Indicators:

1. Describe measuring devices.
2. Describe controllers, transmitters and actuators.
3. Describe feedwater control systems.
4. Describe combustion control systems.
5. Describe steam temperature control systems.

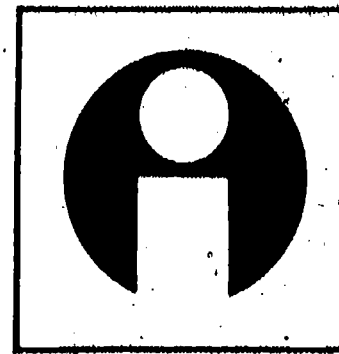

Study Guide

- * Read the goal and performance indicators to find what is to be learned from package.
- * Read the vocabulary list to find new words that will be used in package.
- * Read the introduction and information sheet.
- * Complete the job sheet.
- * Complete self-assessment.
- * Complete post-assessment.

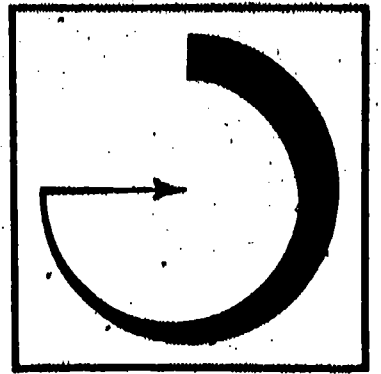

Vocabulary

- * Actuator
- * Bellows gauge
- * Bi-metallic thermometer
- * Bourdon tube
- * Controller
- * Diaphragm pressure gauge
- * Float cage
- * Float manometer
- * Float weight device
- * Flow nozzle
- * Flow transmitter
- * On-off controller
- * Orifice plate
- * Positioner
- * Pressure transmitter
- * Proportional controller
- * Proportional plus integral (reset) controller
- * Proportional plus reset plus derivative controller
- * Remote indicating bulb thermometer
- * Single element control
- * Temperature transmitter
- * Thermocouple
- * Thermo-electric pyrometer
- * Thermo-hydraulic system
- * Thermo-expansion regulator
- * Transmitter
- * Two element control
- * Three element control
- * Venturi tube

Introduction

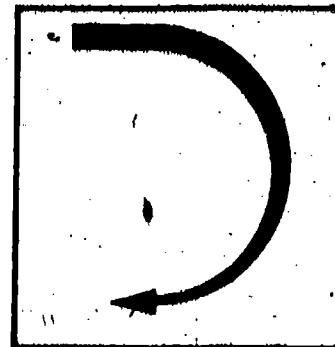

The safe and efficient operation of a steam generation plant is dependent upon the proper control of temperature, pressure, levels and flow of air, fuel, water and steam. This can only be accomplished with the help of control equipment that shows the operator what is happening inside the boiler.

These variables must be measured and that measurement must be shown in a dial or gauge that is visible to the operator. This package is designed to acquaint apprentices with the measuring instruments and how the measurements reach the dials and gauges.

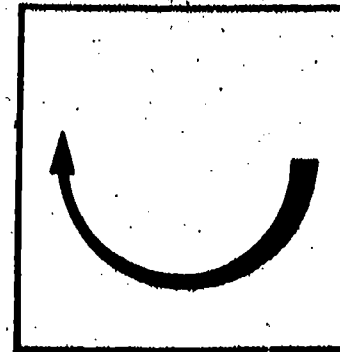

Information

The instrumentation and control devices must measure such things as temperature, pressure, fluid flow and fluid levels. Other control devices monitor feedwater, combustion and steam temperature.

Measurement Devices

Temperature Measurement Devices

Heat transfer involves changes in temperature. The following items must have temperature control and thus must be measured regularly.

1. Steam
2. Feedwater
3. Oil
4. Cooling water
5. Flue gas

There are many types of instruments for measuring temperature. These include:

1. Glass stem thermometers
2. Remote indicating bulb thermometers
3. Bi-Metallic thermometers
4. Thermo-electric pyrometer

The glass stem thermometer operates with a column of mercury or alcohol in a glass tube. Mercury filled thermometers are suitable for high temperatures. Alcohol filled thermometers are best suited to low temperatures.



5
Glass-stem Thermometers

Information

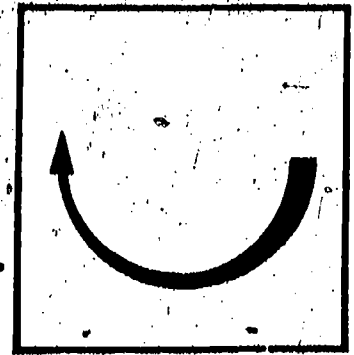

A remote-indicating bulb thermometer is used to record temperatures away from the site of measurement. This thermometer is made of a Bourdon tube, a capillary tube and a bulb. Changes inside the tube cause the Bourdon tube to expand or contract. The Bourdon tube is attached to an indicator arm.

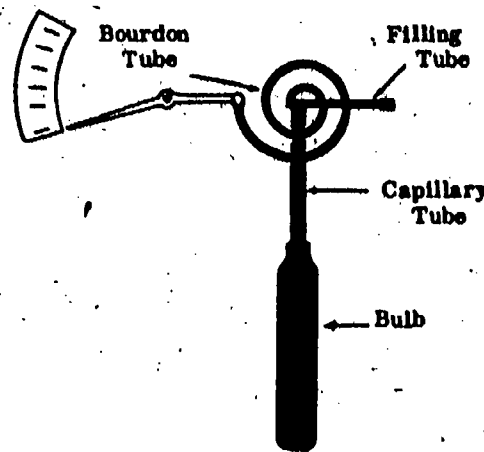

Remote Bulb Thermometer

Bi-metallic thermometers are made of thin metal strips of different metals. The metals expand at different rates because of differences in metallurgical properties of the two metals. As the metals are welded together, expansion causes a bending action which moves the indicator. Brass and an iron nickel alloy are commonly used as metal strips.

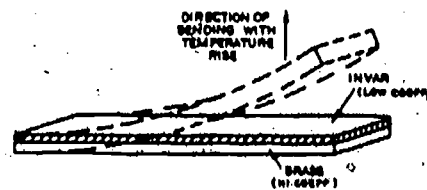

Bimetal Strip

A thermo-electric pyrometer is actuated by a thermo-couple which responds to temperature change by increasing or decreasing its voltage output.

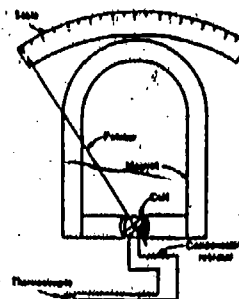

6 Thermoelectric Pyrometer

Information

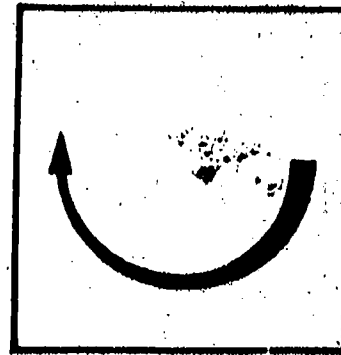

Some of the common pressure measurements are:

1. Steam
2. Feedwater
3. Furnace
4. Condenser
5. Oil

The devices used to measure pressure include:

1. Bourdon tubes
2. Bellows pressure gauge
3. Diaphragm pressure gauge

The Bourdon tube is shaped in the form of a C, spiral or helix. The open end of a Bourdon tube is attached by a linkage mechanism that moves an indicator. Increases in pressure cause the tube to straighten and move the indicator.

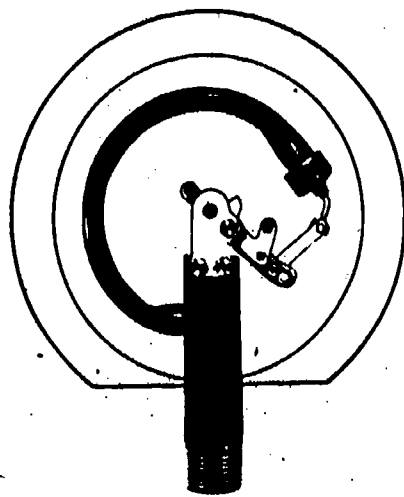

A bellows pressure gauge is a corrugated chamber that expands along its length. Pressure on the bellows causes expansion. This expansion moves a linkage to the indicator which registers change in pressure.

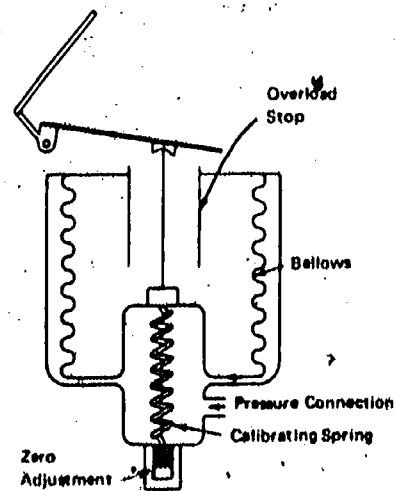

Bellows Pressure Gauge

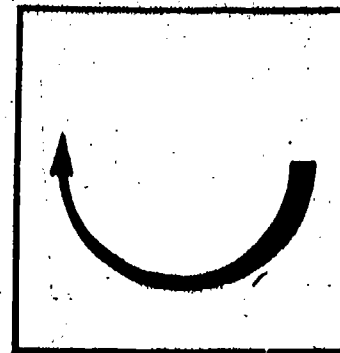

Information

The diaphragm pressure gauge utilizes a liquid filled u-tube that is connected to the pressure sources at one end. The other end of the u-tube is connected to the atmosphere. The difference in pressure at the two ends of the u-tube is measured. Pressure on the diaphragm moves one side of the u-tube which, in turn, moves the indicator arm.

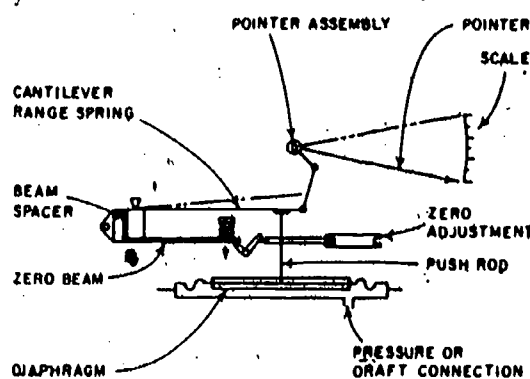

Diaphragm Pressure Gage

Flow Measurement Devices

The rate of flow must be measured for steam, feedwater, fuel and air. Flow is measured by measuring pressure drops across a constriction within the pipe. A constriction increases velocity and decreases pressure of the substance flowing through a pipe. In measuring the flow of steam an orifice plate is used as a means to constrict flow.

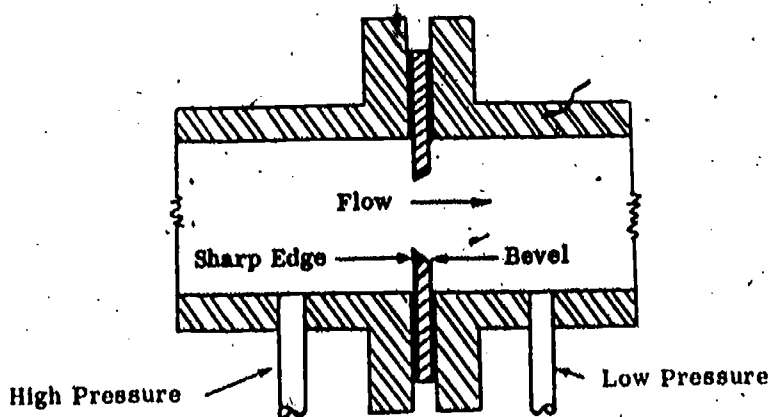

Orifice Plate with Pressure Taps

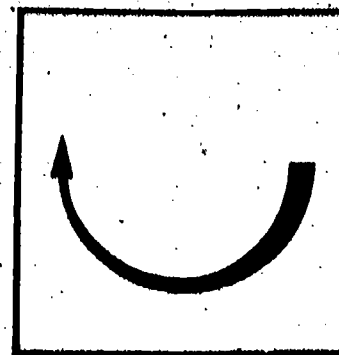

Information

Liquid flow uses a flow nozzle or venturi tube to constrict the flow for measurement.

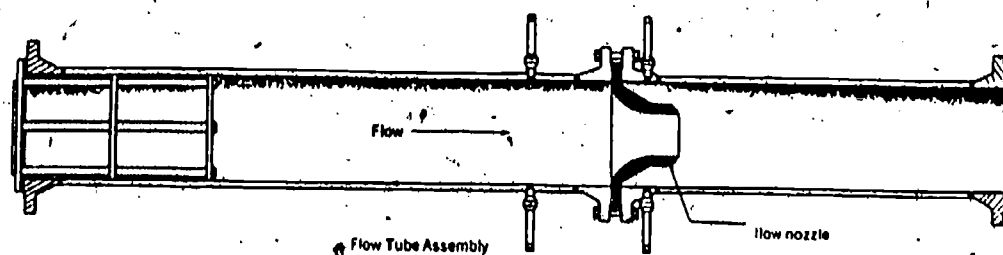

Flow Nozzle

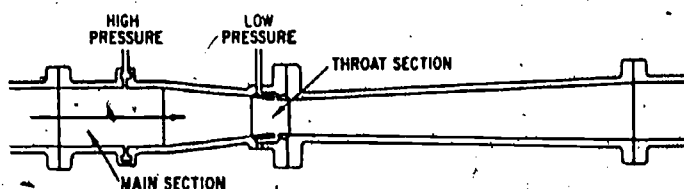

Venturi Tube

The actual measurements are made with pressure measuring devices. The flow is proportional to the square root of the pressure drop at the constriction.

Level Measurement Devices

Devices are needed to measure the levels of liquids such as:

1. Boiler water
2. Storage tanks
3. Fuel tanks
4. Condenser hot well

The devices most commonly used to measure levels include:

1. Gauge glasses
2. Float weight device
3. Float cage
4. Differential pressure gauge

Information

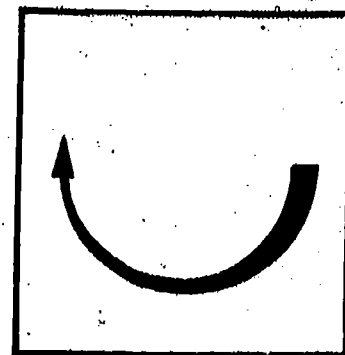

The gauge glass has been discussed in detail in other packages. Float weight devices use floats inside the tank which are attached to a scale device outside. The float moves up and down with the water level and changes the measurements on the scale.

Float cage units are attached to a container on the outside. It is connected to the liquid near the bottom of the tank and to the vapor space above the liquid. As the levels change, the float moves up and down. The level is measured on an indicator scale.

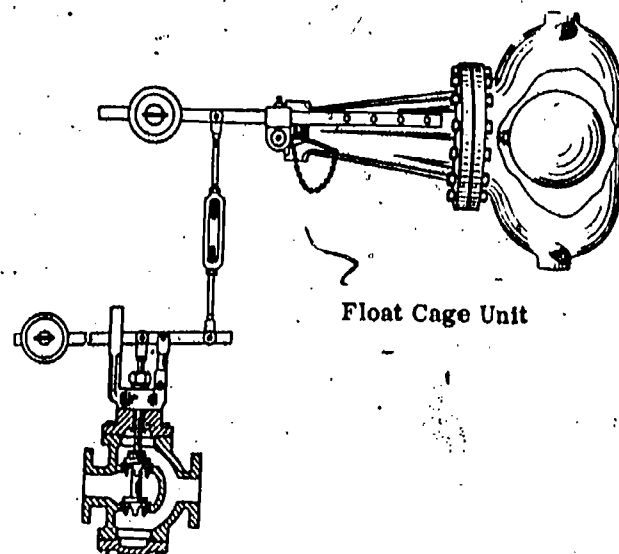

The float manometer is a differential pressure gauge. The manometer is attached to the top of the vessel. A mercury reservoir responds to the rise and fall of liquid in the vessel. The movement of the mercury moves a float which actuates the indicator.

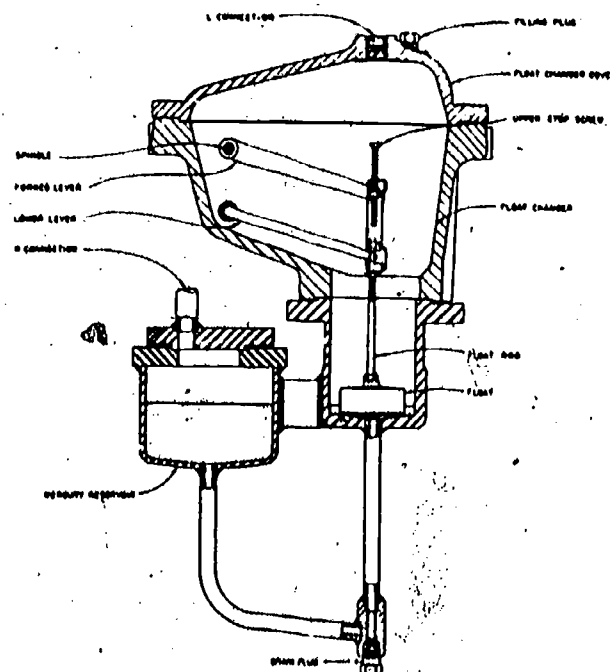

Float Type Manometer

Information

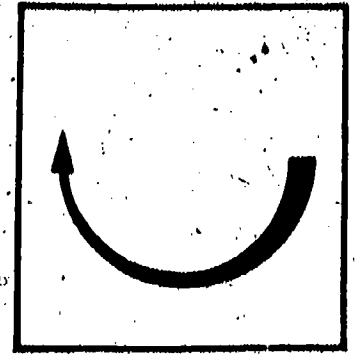

Controllers, Transmitters and Actuators

A control system consists of three main parts:

1. Controller
2. Transmitter
3. Actuator

Controllers

Controllers sense changes in such things as pressure, temperature and levels and send the signal on to an actuator which can change dials and open valves. The controller must have a sensing device and a signalling device. The signal device may be operated by electrical signal or by pneumatics. Some common controllers are:

1. On-off controller are set to measure above or below a set point. A flapper is held against a nozzle for maximum settings and away from the nozzle for minimum settings.
2. Proportional controllers measures how much a measurement is above or below the set points. These controllers have some problems with offset. Offset is the difference between new corrected valves and the set point valves.
3. Proportional plus integral (reset) controller offset problems can be avoided by adding an adjustable restriction and positive feedback bellows to the controller. The feedback bellows serves as a reset that brings measurements back to set point.
4. Proportional plus reset plus derivative controller has, in addition to the reset feature, a controller with a rate action or derivative feature. This feature consists of a restriction in the airline to the feedback bellows. A rate action feature causes a quick return to the set point and the final controls move further in the required direction.

Transmitters

A transmitter measures the signal produced by the controller and converts the signal into transmission signals. The transmission signals are sent to the controller and indicators. Some transmitters contain sensing devices rather than the controller. Transmitters operate on pneumatic or electronic signals.

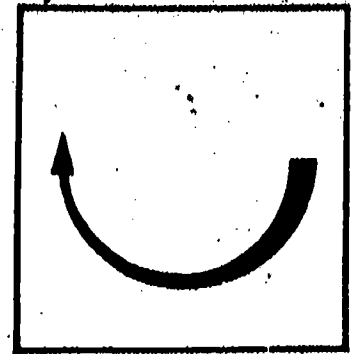

Information

Transmitters may be classified as:

1. Pressure transmitters
2. Flow transmitters
3. Level transmitter
4. Temperature transmitter

The pressure transmitter uses a sensor of the Bourdon, bellows or diaphragm types. The transmitter is arranged in a flapper-nozzle assembly. They operate on pneumatic or electronic signals.

Flow transmitters use the orifice plate to restrict the flow and produce a pressure drop. A bellows type sensor measures the pressure drop.

A level transmitter uses a float device to move the flapper. A feedback bellows is used to keep the signal output proportional.

Temperature transmitters use a Bourdon tube to move the flapper in relation to the nozzle.

Actuators

Actuators receive signals from the controller and change them into mechanical motion. The pneumatic or electronic signals are changed into mechanical energy for opening valves, dampers, etc. Actuators may be classified according to the signals that they receive--pneumatic or electronic. Another way to classify actuators is by the type of motion they produce--rotary or linear. A positioner may be used to amplify the control signal at low pressures and using high pressure air to move the actuator.

Control Systems

Feedwater Controls

Feedwater control systems may be classified as:

1. Thermo-hydraulic
2. Thermo-expansion
3. Single element
4. Two element
5. Three element

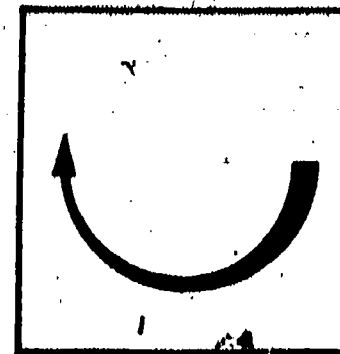

Information

The thermo-hydraulic system has a feedwater regulating valve which is actuated by a generator. An outer tube of the generator is connected to the feedwater regulating valve and the bottom. At the top, both inner and outer tubes are connected to the steam and water. Heat from steam in the inner tube cause the water in the outer tube to flash into steam. This forces water into the bellows which controls the opening and closing of the feedwater valve.

Thermo-expansion regulators are a tube mounted on a beam and attached to the steam and water space. As water level drops in tube, its temperature is raised by the steam on its outside. The increased heat expands the tube and actuates the feedwater regulating valve.

Single element control has a drum level transmitter signal differences between drum levels and the set point. This system is used where slow changes are made in the feedwater load. Single element control only responds to teh drum level variable.

Two element controls use a system that responds to both drum level and steam flow. The drum level measurement balances water input with steam output. Steam flow measurements proportions water according to the steam flow.

Three element controls measure steam flow, feedwater flow and drum level.

Combustion Control Systems

The flow of fuel and air must be regulated to get good combustion. The ratio of fuel to air must be maintained for combustion efficiency. There are three types of combustion controls:

1. On-off controls
2. Positioning controls
3. Metering controls

The on-off control system consists of a bellows operated switch which is activated by boiler pressure. A drop in pressure will start the fans and burner. This system is inefficient because of the variation of boiler pressure between "cut in" and "cut out" points.

Positioning control involves actuators that position the draft dampers and fuel valve according to the boiler load. A positioning control is operated by a master controller that signals the actuators for dampers and full valve.

Information

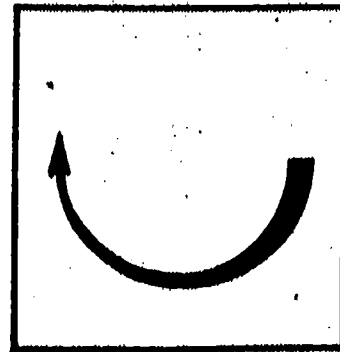

Metering control use a master controller to signal the damper and fuel valve actuators. In this case, the signals are based on measured or metered amounts of fuel and air.

Steam Temperature Control

The temperature of superheated steam must be constant for turbine efficiency. Several methods of steam temperature control are discussed in other packages in more detail. These methods of temperature control are:

1. Combustion gas bypass which routes combustion gases around the superheater to avoid overly high temperatures.
2. Combustion gas recirculation which recirculates combustion gases over the superheater tubes to raise temperatures.
3. Desuperheating by spraying feedwater into the superheated steam to lower temperature.
4. Tilting burners to vary temperature by tilting burners upward or downward.
5. Twin furnaces used on separately fired superheaters that allows temperature control.
6. Attemperation lowers steam temperature by passing it over attemperator tubes and desuperheating it.

A three element control for steam temperature uses an attemperator with signals from three sources. The signals come from the steam or air flow meter, the thermal element in the attemperator nozzle and a thermal element in the second stage superheater. The final steam temperature is determined by the thermal element in the second stage superheater.

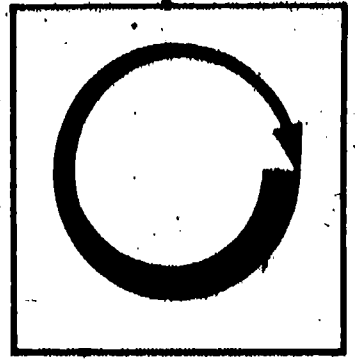

Assignment

- * Read pages 1 - 43 in supplementary reference. Study diagrams and illustrations.
- * Complete the Job Sheet.
- * Complete the self-assessment and check answers.
- * Complete the post-assessment and ask the instructor to check your answers.

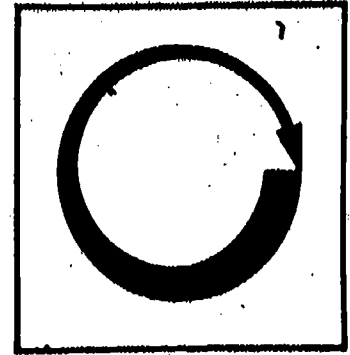

Job Sheet

ANALYZE MEASUREMENT DEVICES

- * Obtain devices for measuring temperature, pressure, levels and flow.
- * Carefully inspect them one at a time.
- * Do the measuring instruments fit the classifications given in this learning package?
- * Do you understand the principle of their operation?
- * Read manufacturers specifications and diagrams to enhance your understanding of these devices.

Self Assessment

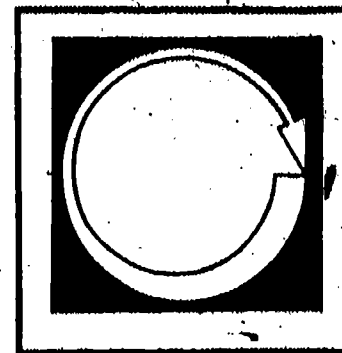

Indicate what the following devices are used to measure. Show by placing a code letter in the space at the front of the device. Pressure (P), Temperature (T), Flow (F), Level (L)

- _____ 1. Venturi tube
- _____ 2. Bourdon tube
- _____ 3. Gauge glass
- _____ 4. Glass stem
- _____ 5. Float cage
- _____ 6. Orifice plate
- _____ 7. Remote indicating bulb
- _____ 8. Bellows gauge
- _____ 9. Thermo-electric pyrometer
- _____ 10. Diaphragm gauge

● Self Assessment Answers

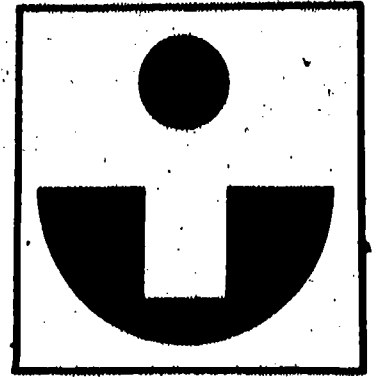

F 1.

P 2.

L 3.

T 4.

L 5.

F 6.

T 7.

P 8.

T 9.

P 10.

Post Assessment

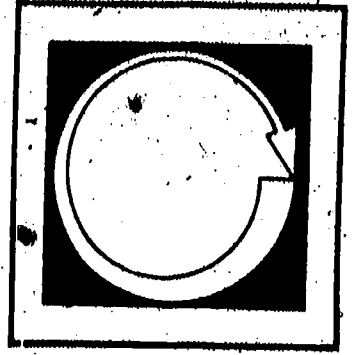

Please show these devices as controllers, transmitters or actuators by placing (C) for controller, (T) for transmitter or (A) for actuator in the blank space.

- 1. On-off type
- 2. Level
- 3. Proportional plus integral reset
- 4. Flow
- 5. Temperature
- 6. Pressure
- 7. Rotary
- 8. Linear
- 9. Pneumatic
- 10. Electronic

Instructor Post Assessment Answers

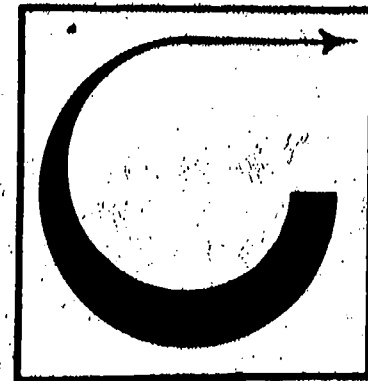

- C 1.
- T 2.
- C 3.
- T 4.
- T 5.
- T 6.
- A 7.
- A 8.
- A 9.
- A 10.

● Supplementary References

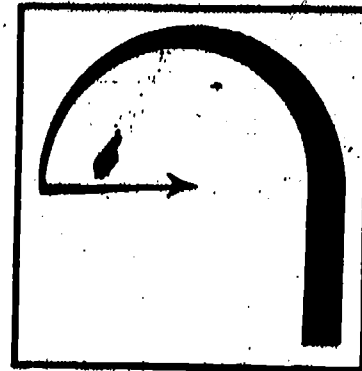

* Correspondence Course. Lecture 11, Section 2, First Class. Steam Generator Controls. Southern Alberta Institute of Technology. Calgary, Alberta, Canada.

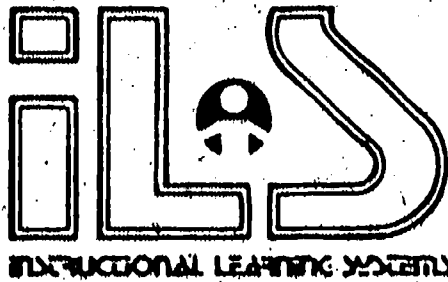

12.9

BOILERS -- PIPING AND STEAM TRAPS

Goal:

The apprentice will be able to describe the parts of a boiler piping system.

Performance Indicators:

1. Describe piping materials and connections.
2. Describe types of valves.
3. Describe steam traps.
4. Describe bypass and drain lines.
5. Describe water hammer.

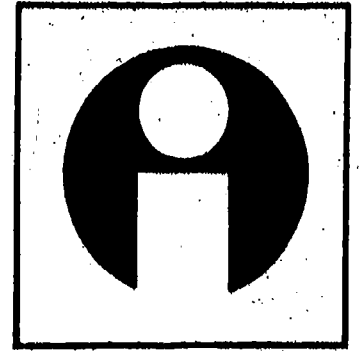

Study Guide

- * Read the goal and performance indicators to find what is to be learned from package.
- * Read the vocabulary list to find new words that will be used in package.
- * Read the introduction and information sheets.
- * Complete the job sheet.
- * Complete self-assessment.
- * Complete post-assessment.

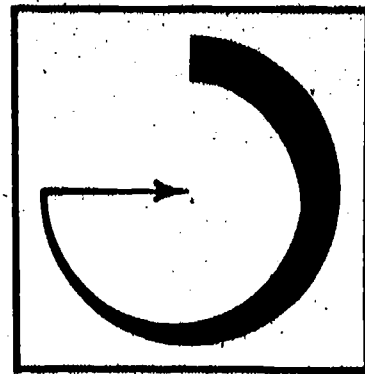

Vocabulary

- * Alloy steel pipe
- * Brass pipe
- * Bypass and drain line
- * Carbon steel pipe
- * Check valve
- * Control chamber
- * Couplings
- * Drag Valve
- * Elbows
- * Flanges
- * Gate valve
- * Globe valve
- * Impulse trap
- * Inverted bucket trap
- * Laterals
- * Outlet orifice
- * Plastic pipe
- * Plug valve
- * Reducers
- * Stainless steel pipe
- * Steam trap
- * Tees
- * Water hammer

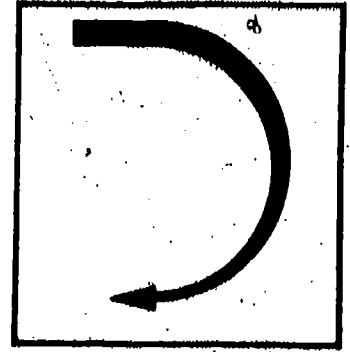

Introduction

The piping for transporting water, steam and condensate through the power plant is a complex system. These materials are handled at a wide range of temperatures and pressures. Each set of conditions require piping with characteristics for handling the material without becoming corroded or eroded.

The piping system must have valves for controlling the movement of the fluids through the plant. Steam traps are necessary for removing condensate from the steam as it travels through the piping.

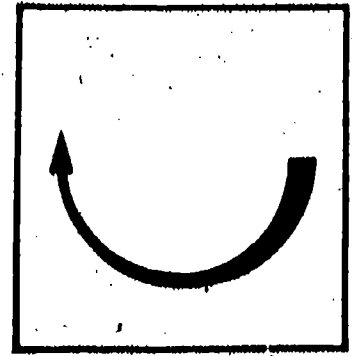

Information

Piping

There is a wide variation of pressures, temperatures and chemical composition of fluids handled through a power plant. Different fluids require different pipes for their transport through the plant. Some of the common piping materials and their applications are listed below.

Alloy steel -- high pressure, high temperature.

Carbon steel -- high pressure, moderate temperature.

Stainless steel -- extreme high pressure and temperature and maximum corrosion and erosion resistance.

Copper -- Low pressure, low temperature where cleanliness is essential.

Brass -- low pressure, low temperature where corrosion resistance is important.

Plastic -- low pressure and temperature where corrosion resistance is important.

Pipes are joined together with couplings, flanges and welded connections.

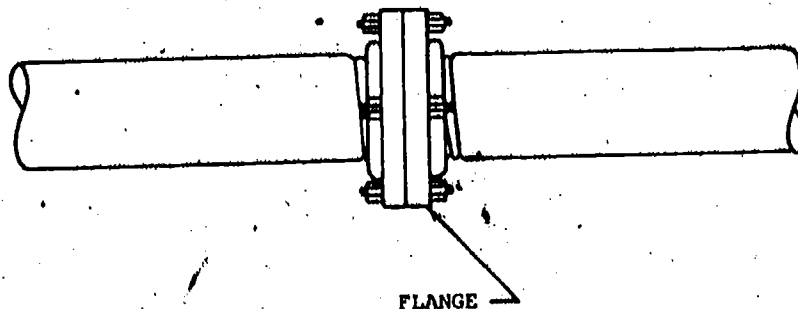
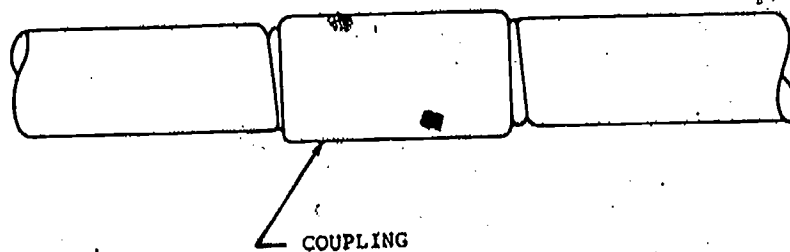

Information

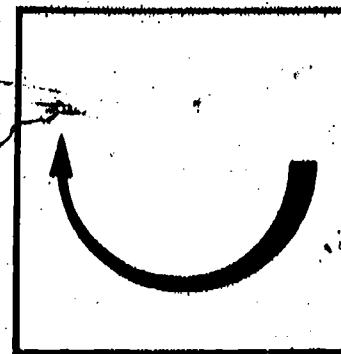

Pipes are also joined by elbows, reducers, tees and lateral fittings.

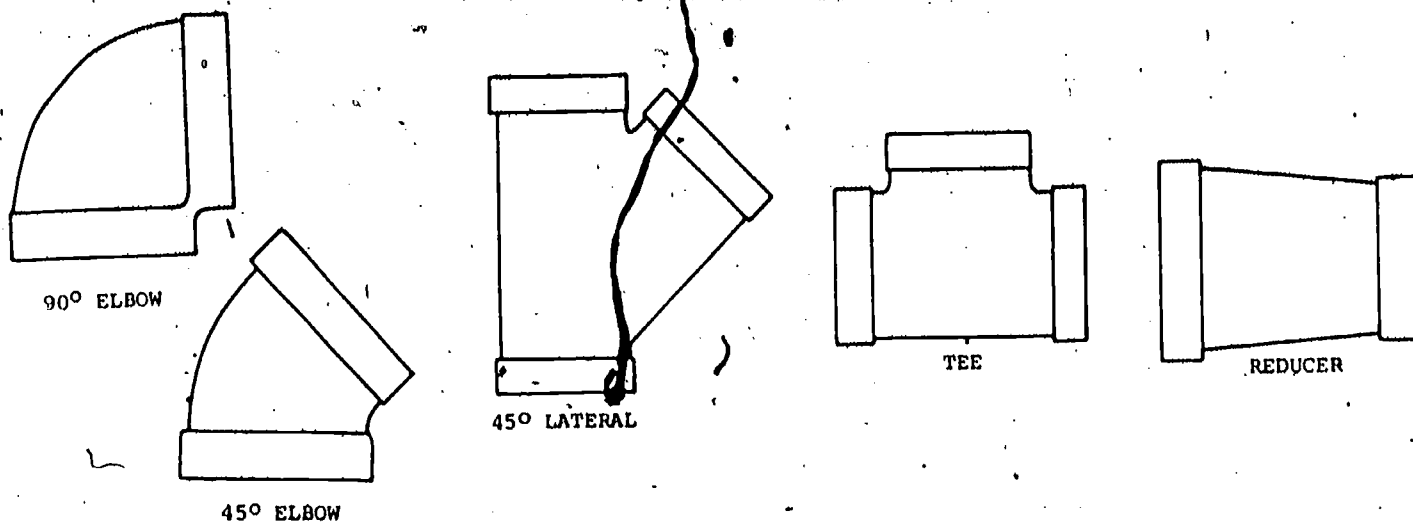

As pipe is subjected to extremes in temperature, it tends to expand and contract. This can cause problems unless allowances have been made for handling expansion and contraction. Expansion can be controlled by use of expansion joints and levels and loops.

Valves

The pipeline contains several valves which control the flow of liquid. One classification of valves is by their function, i.e. stop valve, throttle valve, control valve. Another method of classification is according to the construction of the valve. The gate valve, globe valve, check valve and plug valve are shown below.

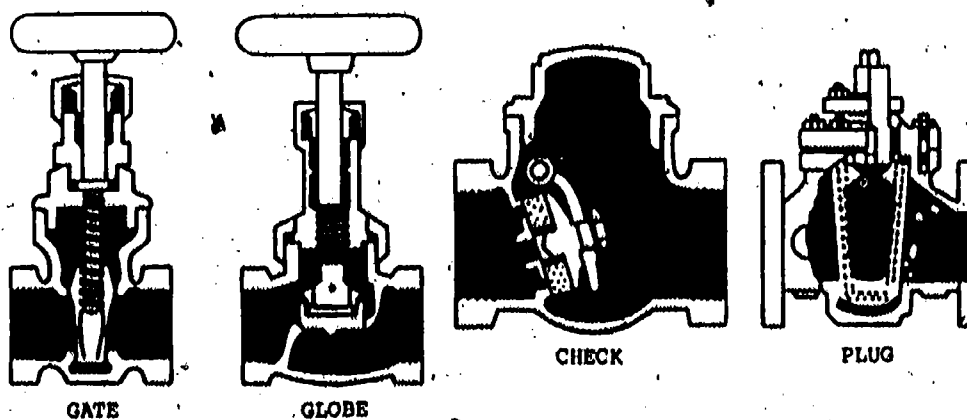

Information

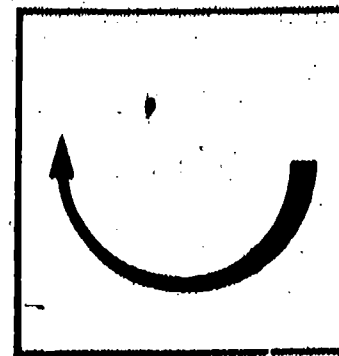

Note that the gate valve is closed by a wedge that moves up and down from a central stem that is perpendicular to the line of flow. The globe valve has a seat ring that lies parallel to the line of flow. Check valves only allow a flow in one direction. A plug valve opens and closes by a 90° rotation of the cylinder.

The individual parts of a globe valve are shown in detail.

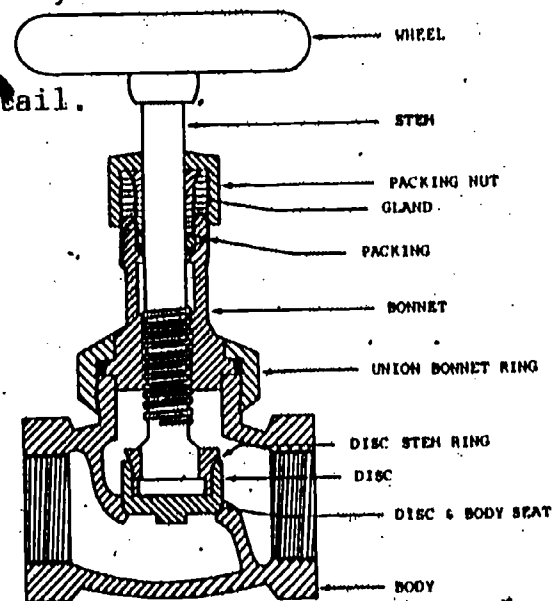

There are a number of special valves used in power plants. One of these is the drag valve. The drag valve is a pressure control valve which consists of a series of stacked discs with flow passages etched into their faces.

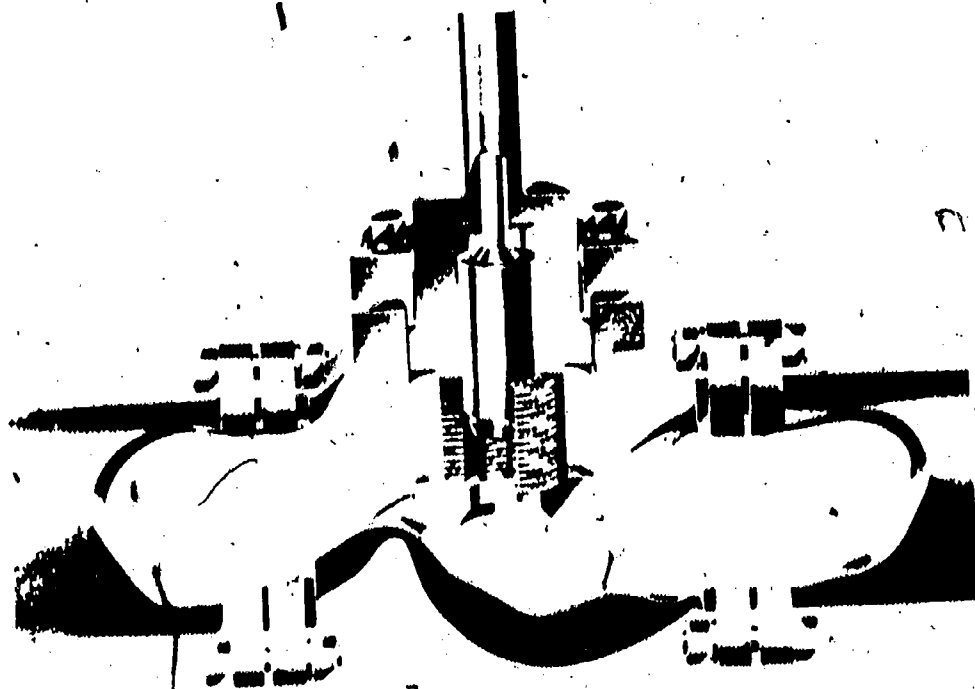

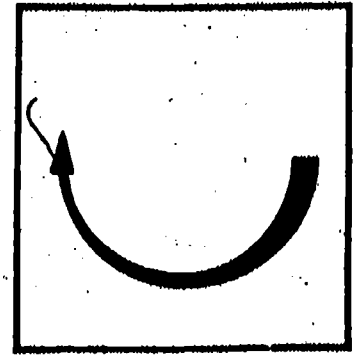

Information

Valves are usually provided with handwheels or other means of leverage that make them easy to open. Care must be exercised to prevent leakage through closed valves. Once a valve starts to leak through, it will continue to erode. No matter how much pressure is applied, it will continue to leak.

Steam Traps

A steam line must be drained of condensate. All steam lines need drains to remove the condensate. The removal of condensate from a steam line is done with steam traps. A steam trap holds the steam while condensate continues to flow. Two types of steam traps are commonly used:

- * Impulse traps
- * Inverted bucket traps

In the impulse trap, the pressure of the condensate acts on the underside of the control disc (Q). This opens the outlet orifice (P) which allows condensate to flow through. As the condensate drains it is replaced by more and hotter condensate. The arriving condensate flashes into steam around the edge of the control disc into control chamber (K). This pressure forces the control disc down and shuts off the trap. When the condensate cools, the trap will open again.

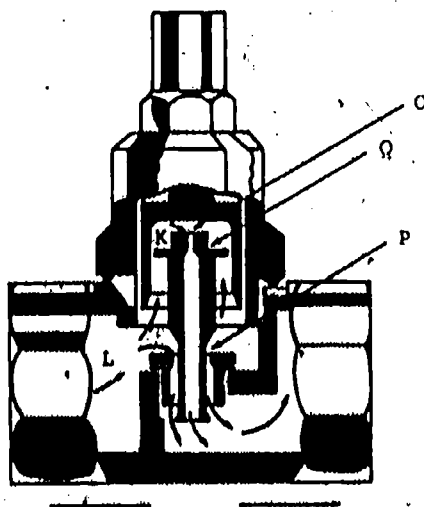

IMPULSE TRAP

- L. INLET CHAMBER
- K. CONTROL CHAMBER
- O. CONTROL ORIFICE
- Q. CONTROL DISC
- P. OUTLET ORIFICE

Information

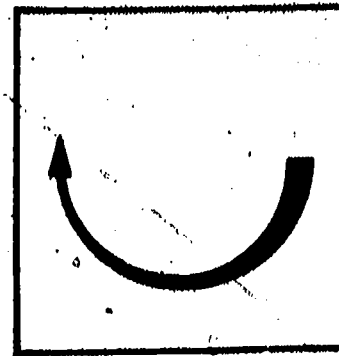

The inverted bucket trap operates somewhat differently than the impulse trap. When the trap is full of water, the bucket rests on the bottom of the reservoir with its open end over the trap inlet. The trap discharge valve is open. When steam acts upon the water, it causes water to be pushed out of the trap. Steam replaces the discharged water, causing it to rise and close the discharge valve. The closed end of the bucket has a vent hole for air and steam to escape. As steam and air escape, more water rises in the bucket. As the water rises in the bucket, it sinks and closes the discharge valve.

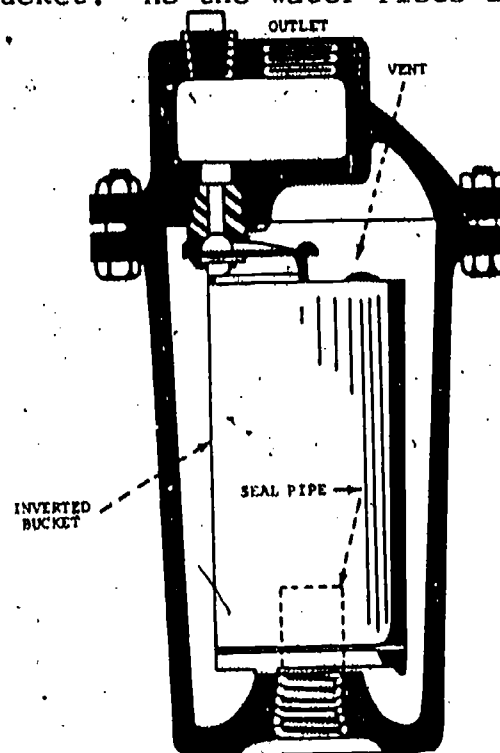

Bypass and Drain Lines

Bypass lines are secondary pipelines through which fluids are routed while the main lines are out of service. Drain lines are used to remove condensate from steam lines. A typical bypass and drain line system is shown in this trap installation.

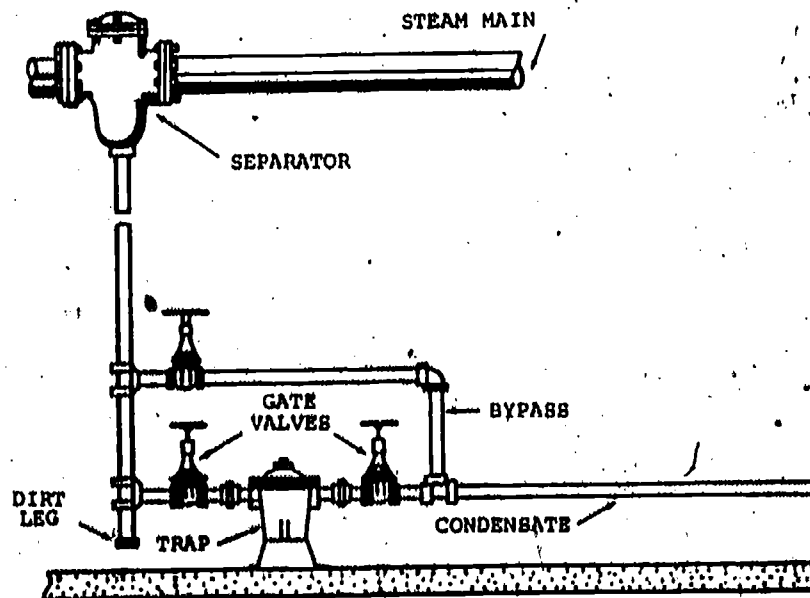

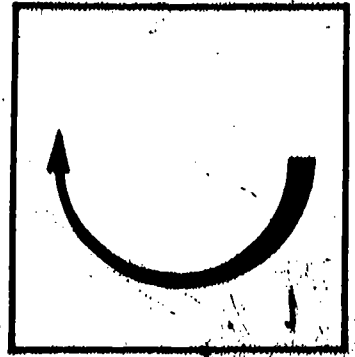

Information

Water Hammer

When water is confined under high pressure, it can be very dangerous. If the flow of water is suddenly stopped, it can lead to a condition known as water hammer. It is a shock force that can cause explosion of the line. Vertical waterlines are more likely to have water hammer than horizontal lines. Valves should be opened slowly to avoid waterhammer in either water or steam lines. Hammers in steam lines can occur when hot water is admitted into a cold line. Within steam lines, this condition is more likely to happen in long, horizontal lines. This differs from waterlines which more often occur in vertical lines.

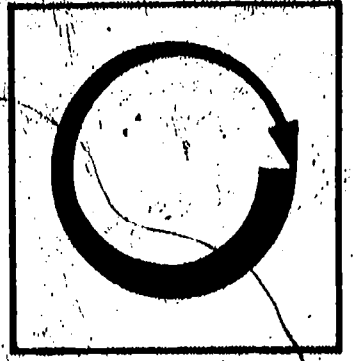

Assignment

- * Complete job sheet.
- * Complete self-assessment.
- * Complete post-assessment.

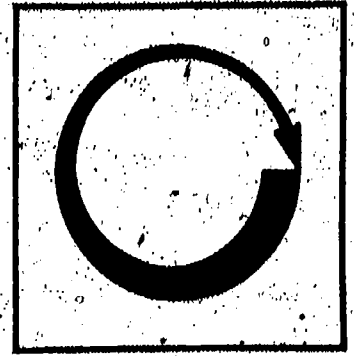

Job Sheet

INSPECT THE PIPING OF A STEAM PLANT

- * Carefully inspect each pipe that enters the boiler.
 - Where does the pipe come from?
 - What does it carry?
 - How are pipes connected? flanges, couplings?
 - What type of material? alloy steel, copper?
 - What kinds of valves do you see? gate, globe, plug, etc.?
 - Can you locate the steam traps?
 - What type of steam trap?
 - Is there bypass and drain lines?
 - Do you find piping, valves and traps that are different from the descriptions in the learning package?
- * Ask the operator to explain those items that were not described in package.

Self Assessment

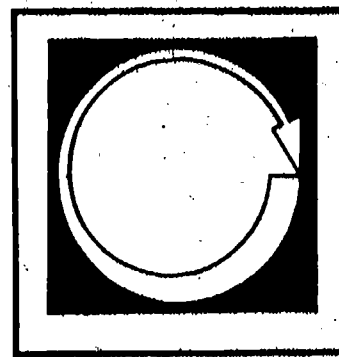

Match the following terms with the most appropriate description.

- | | | |
|-------|-------------------------------|--|
| _____ | 1. Gate valve | A. Materials used for high temperature and high pressure pipe. |
| _____ | 2. Inverted bucket | B. Material used for extreme high pressure and temperature pipe with maximum corrosion resistance. |
| _____ | 3. Water hammer in waterlines | C. Method of joining sections of pipe together. |
| _____ | 4. Alloy steel | D. Valve seat ring lies parallel to the line of flow. |
| _____ | 5. Copper | E. Valve wedge lies perpendicular to the line of flow. |
| _____ | 6. Stainless steel | F. A type of steam trap. |
| _____ | 7. Couplings | G. More likely to occur in vertical lines. |
| _____ | 8. Waterhammer in steam lines | H. More likely to occur in long, horizontal lines. |
| _____ | 9. Globe valve | I. Material used in low pressure, low temperature piping that requires cleanliness. |
| _____ | 10. Plastic | J. Material used in low temperature, low pressure piping where corrosion resistance is important. |

● Self Assessment Answers



- E 1.
- F 2.
- G 3.
- A 4.
- I 5.
- B 6.
- C 7.
- H 8.
- D 9.
- J 10.

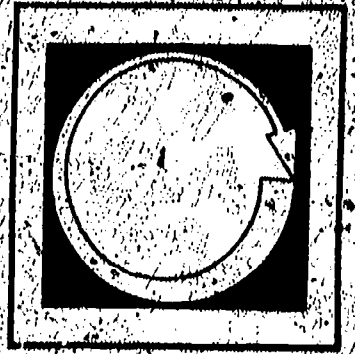

Post Assessment

1. What causes a water hammer in a waterline?
2. What causes a water hammer in a steam line?
3. What piping material would you select for extreme high temperature and pressures and corrosion resistance?
4. What piping material would you select for high pressure and moderate temperatures?
5. Which piping material would you select for low temperatures, low pressures and cleanliness?
6. List two connecting methods for joining pipe.
7. List two fittings used to join pipe together.
8. List two types of steam traps.
9. What kind of valve is a drag valve?
10. Which type of valve allows water to flow in only one direction?

Instructor Post Assessment Answers

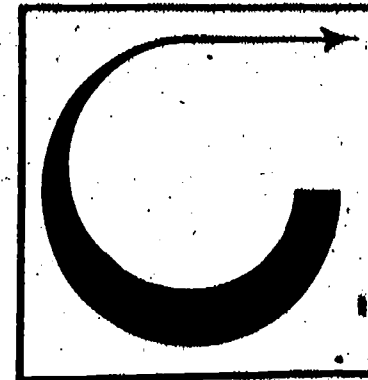

1. Sudden stopping of flow of water under pressure.
2. Admitting hot water into a cold steam line.
3. Stainless steel
4. Carbon steel
5. Copper
6. Couplings, flanges, welding
7. Elbows, tees, reducers, laterals
8. Impulse, inverted bucket
9. Pressure control valve
10. Check

● Supplementary References

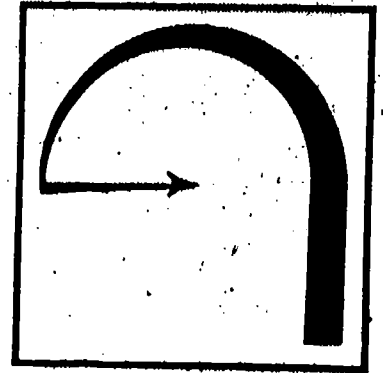

* Instruction Manual. Operator Training Program. Volume I. Pacific Gas and Electric Company. 1974.