

DOCUMENT RESUME

ED 252 743

CE 040 603

AUTHOR Illerbrun, Marley
TITLE Long Term Care Aide/Homemaker. Resource Handbook.
INSTITUTION British Columbia Dept. of Education, Victoria.
REPORT NO ISBN-0-7726-0154-2
PUB DATE 84
NOTE 231p.; For related course outlines, see CE 040 598 and CE 040 604.
AVAILABLE FROM Publication Services Branch, British Columbia Ministry of Education, 878 Viewfield Road, Victoria, BC V9A 4V1 (Catalog No. MN 0070--\$10.00 plus 10% shipping).
PUB TYPE Guides - Classroom Use - Materials (For Learner) (051)
EDRS PRICE MF01 Plus Postage. PC Not Available from EDRS.
DESCRIPTORS Adult Education; Allied Health Occupations Education; Allied Health Personnel; *Attendants; Career Education; Communication Skills; Foreign Countries; Higher Education; Home Health Aides; Individual Development; Inservice Education; Interpersonal Competence; *Job Training; Learning Activities; Nurses Aides; *Nursing Homes; *Occupational Home Economics; Personal Care Homes; *Residential Care; Textbooks; *Visiting Homemakers
IDENTIFIERS British Columbia

ABSTRACT

This handbook provides basic information for preparing individuals to work as long-term care aides and homemakers. It is written both for college students in long-term care aide/homemaker programs and for individuals already employed in these occupations. Health care agencies giving orientation training for new employees and inservice training for experienced staff may use this as a resource book for their employees. Four sections cover communication skills and personal work skills, growth and development of the individual and family, the employment field, and caring for clients. Exercises dealing with the information presented appear throughout the four sections. An appendix offers information on first aid for emergencies. Other contents include a glossary and answer key for the exercises. (YLB)

 * Reproductions supplied by EDRS are the best that can be made *
 * from the original document. *

ED252743

LONG TERM CARE AIDE/ HOMEMAKER

RESOURCE HANDBOOK

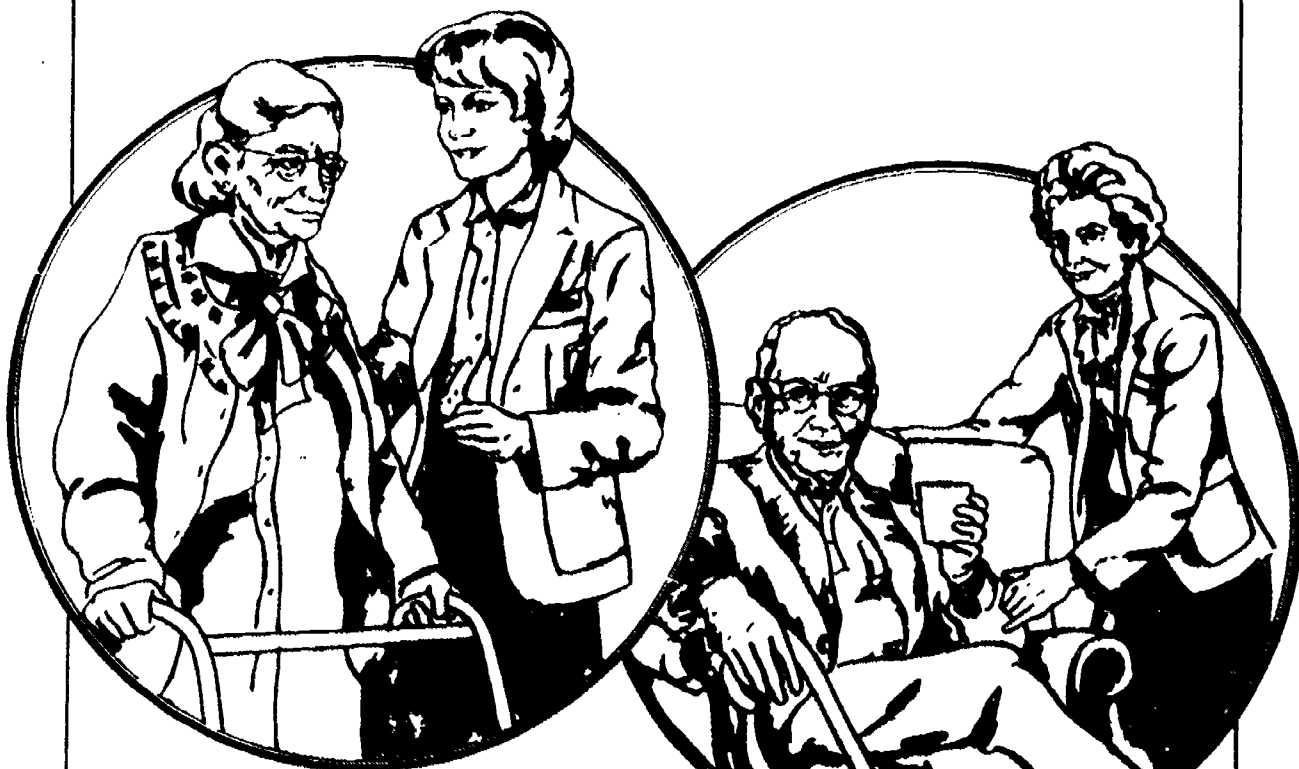

Province of British Columbia
Ministry of Education
POST-SECONDARY DEPARTMENT

U.S. DEPARTMENT OF EDUCATION
NATIONAL INSTITUTE OF EDUCATION
EDUCATIONAL RESOURCES INFORMATION
CENTER (ERIC)

✓ This document has been reproduced as received from the person or organization originating it. Minor changes have been made to improve reproduction quality.

• Points of view or opinions stated in this document do not necessarily represent official NIE position or policy.

"PERMISSION TO REPRODUCE THIS MATERIAL IN MICROFICHE ONLY HAS BEEN GRANTED BY

*British Columbia
Ministry of Education
A. K. Bridge*

TO THE EDUCATIONAL RESOURCES INFORMATION CENTER (ERIC)."

CE 040603

Canadian Cataloguing in Publication Data

Ellerbrun, Marley.

Long-term care: aide/homemaker

Written by Marley Ellerbrun. -- C. Acknowledgments.
LPP 1984-1984 - 1984-1984

I. Long-term care of the sick -- British Columbia --
Handbooks, manuals, etc. -- Visiting housekeepers --
British Columbia -- Handbooks, manuals, etc. -- I.
British Columbia. Ministry of Education. Post-
secondary Dept. -- II. Title.

1984-1984 1984-1984 1984-1984 1984-1984 1984-1984

For further information contact:

Coordinator, Health Programs
Post-Secondary Department
Ministry of Education
Parliament Buildings
Victoria, British Columbia
V8V 2M4
Telephone: (604) 387-4611

Copies of this publication can be ordered from:

Publication Services Branch
Ministry of Education
878 Viewfield Road
Victoria, British Columbia
V9A 4V1
Telephone: (604) 387-5331

© Ministry of Education, Province of British Columbia
No part of this publication may be reproduced in any form without
permission in writing from the publisher.

1984

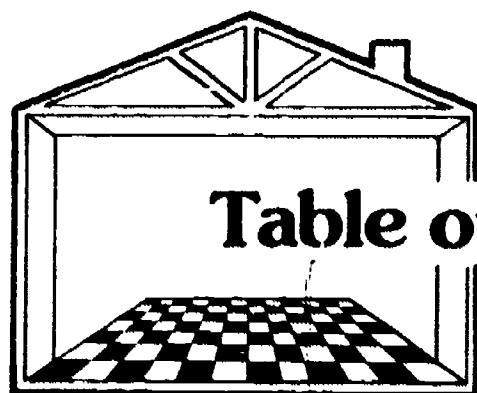

Table of Contents

	Page
Introduction	v
Acknowledgments	vi
Source of Data	vii
SECTION 1 COMMUNICATION SKILLS AND PERSONAL WORK SKILLS	1
Introduction	2
Basic Principles of Communication	3
Improving Communication and Interpersonal Relations	5
Special Areas of Communication	10
Group Communication	12
Observing and Reporting	13
Using Communication Devices	16
Problem Solving Skills	16
Exercise 1-1	18
SECTION 2 GROWTH AND DEVELOPMENT OF THE INDIVIDUAL AND FAMILY	21
Introduction	22
Body Systems	23
Exercise 2-1	32
Human Needs	33
Stress	44
Exercise 2-2	46
Individual Growth and Development	48
Institutional Living	58
The Family in Growth and Development	61
Home Versus Institutional Care	65
Dealing with Dying and Death	68
Exercise 2-3	73

	Page
SECTION 3 THE EMPLOYMENT FIELD	77
Introduction	78
Health and Social Services in British Columbia	79
Employment Practices	83
Legal Implications of Employment	86
Finding a Job	88
Exercise 3-1	95
SECTION 4 CARING FOR CLIENTS	97
Introduction	98
Safety	99
Exercise 4-1	102
Care of the Client's Environment	102
Exercise 4-2	115
Personal Care	117
The Four "Rights" of Care	131
Exercise 4-3	134
Nutrition	136
Look, Listen and Smell for warning of food contamination. When in doubt, throw it out	152
Exercise 4-4	163
Moving Clients	165
Exercise and Activity	173
Comfort and Rest	176
Exercise 4-5	178
Emergency Care	180
Exercise 4-6	187
Measuring and Weighing in Metric	188
Exercise 4-7	190
Appendix	191
Glossary	201
Answer Key	211

INTRODUCTION

The intent of this book is to provide basic information preparing individuals to work as long term care aides and homemakers. The text is based on skills jointly established for these occupations by the Ministry of Education and the colleges.

Long Term Care Aide/Homemaker is written both for college students in long term care aide/homemaker programs and for individuals already employed in these occupations. Health care agencies giving orientation training for new employees and in-service training for experienced staff will find this a useful resource book for their employees.

Questions appear throughout the four sections and answers are at the back of the book. Health care students and workers are encouraged to purchase and use this as a handbook, answering the questions, referring to it for information, and writing their own notes in it.

ACKNOWLEDGMENTS

The Ministry of Education wishes to thank Marley Illerbrun for writing ***Long Term Care Aide/Homemaker Resource Handbook***. The ministry also would like to thank Pat Freund, Audrey Green, June Litster, Linda Ruehlen, and Ethel Turner for assistance given to the author.

SOURCE OF DATA

The four case reports in Section 2 are taken from the text ***Geriatric Nursing for Practical Nurses***. 2d ed. Stevens, Marion Keith. Philadelphia: Saunders, 1975 with the permission of the publisher.

A number of illustrations in Section 4 are taken from the texts ***Being a Nursing Aide***. 2d ed. Schniedman, Rose, and Lambert, Susan. Bowie: Published for Hospital Research and Educational Trust by Robert J. Brady Co., 1978; and ***Being a Home-maker/Home Health Aide***. Zucker, Elana D, ed. Bowie: Published for Hospital Research and Educational Trust by Robert J. Brady Co., 1982 with the permission of the publisher.

Section 1

**Communication Skills
and
Personal Work Skills**

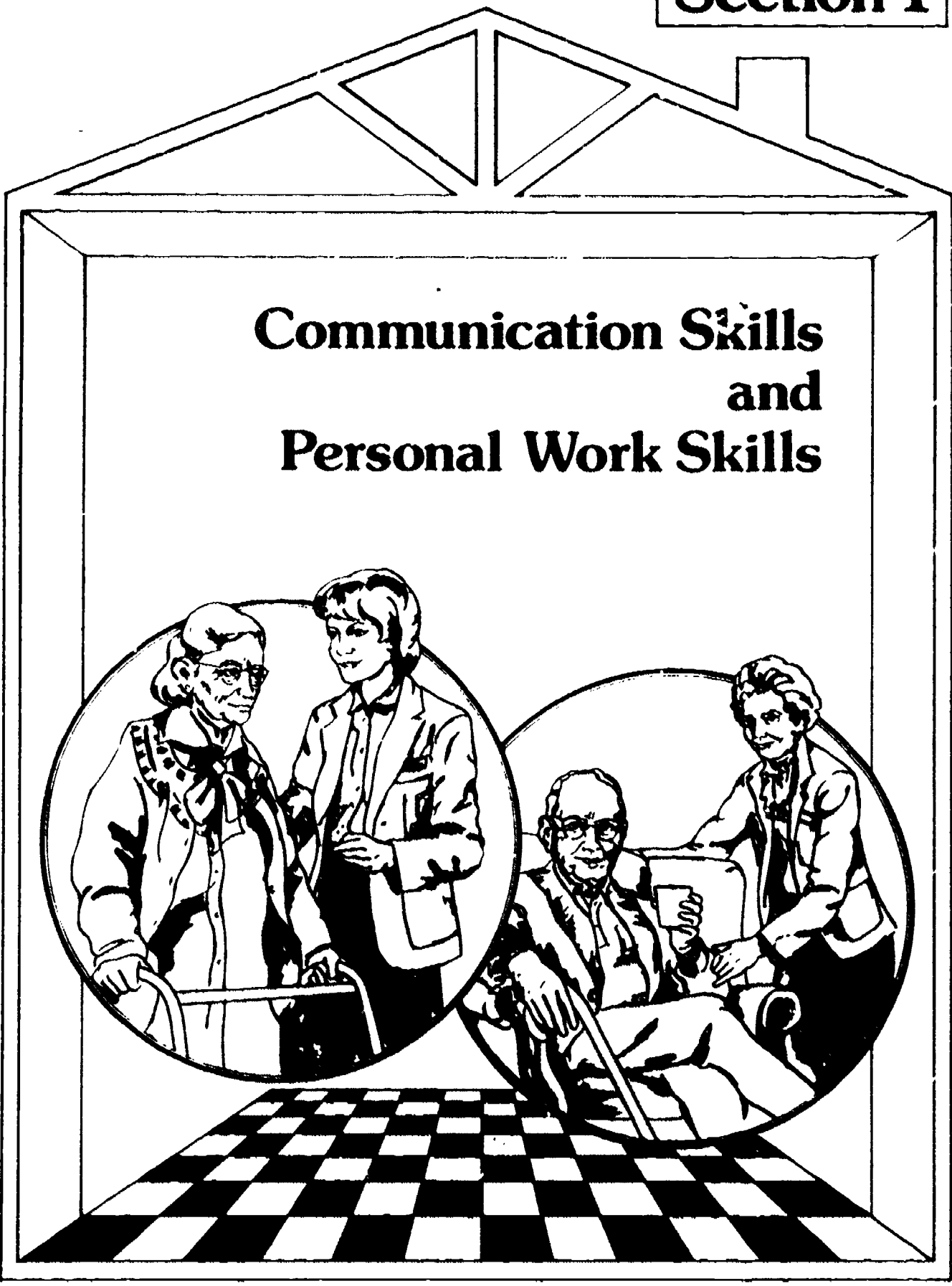

INTRODUCTION

One of the most important abilities that you can have as a care giver is the ability to communicate well with clients and their families, with co-workers, and with other members of the health care team. Section 1 discusses the knowledge and skills that are part of good communication and relations with others; it includes subjects such as body language, self-knowledge and self-acceptance, respecting human differences and rights, social courtesies, and adapting communication to the individual.

Other areas of communication dealt with are: communicating with the emotional, the blind, and the deaf; observing and reporting; and using communication devices.

In addition to communication and interpersonal skills, this section also discusses problem solving skills, giving procedures to help you plan your work and solve problems.

BASIC PRINCIPLES OF COMMUNICATION

Verbal Communication

Verbal communication is using words to state or write a message. Unfortunately, words mean different things to different people and thus a message can be confusing. For example, the statement "Carol's not happy about it" could mean that Carol is mildly displeased, is extremely angry, or is somewhere between the two. (Figure 1-1). Because of the potential for confusion with words, it is important to carefully choose your words.

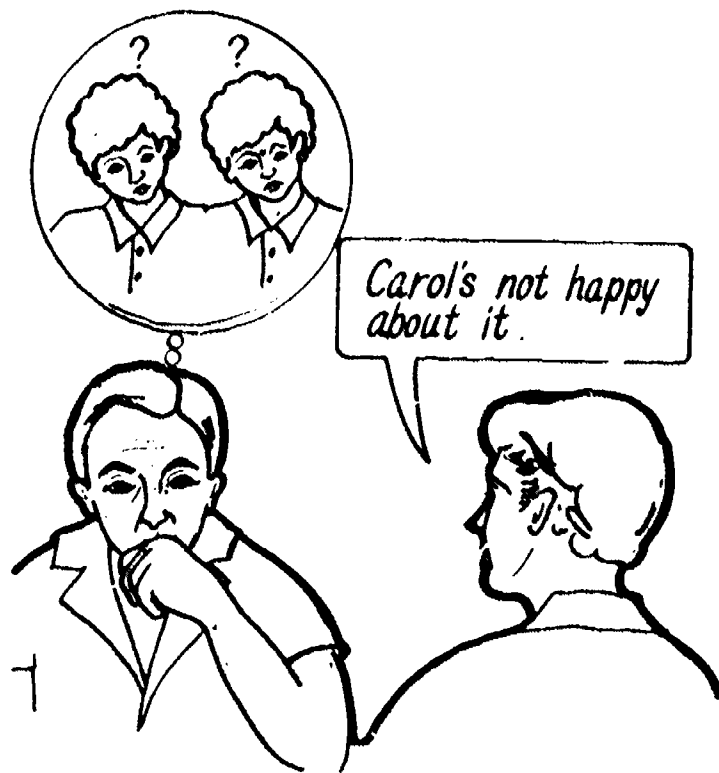

Figure 1-1. Words Can Be Confusing.

Non-Verbal Communication

Non-verbal communication is communicating or conveying a message using no words. Non-verbal communication is also called body language. People are constantly sending mes-

sages without words: for example, a wave of the hand, a smile, a frown, tears, a certain posture or tone of the voice all send very clear messages to others. In fact, about 90% of communication is non-verbal and only 10% verbal.

When people use words that do not match their gestures, actions, facial expression or posture, they send messages leaving others uncertain of what they really mean. "No, I'm not sad," says the man in Figure 1-2, but his facial expression says he is sad. Do you believe his words or his face? Non-verbal messages are often more accurate than verbal ones, but this is not always the case. Thus there is some doubt whether the man is sad or not. Since you cannot stop your body language (even silence sends a message to others), you must be sure that the message is the one you wish to send. If clients get the wrong impression from your body language or words, your effectiveness as a care giver is reduced.



Figure 1-2. Body Language.

Sending and Receiving Messages

Sending messages, whether verbal or non-verbal, is the first half of communication. The other half is the receiving of the message. Both the

sender of a message and the receiver must work hard for good communication to take place. The sender must use the right words and appropriate body language, and the receiver must listen carefully to the words and closely observe the sender's body language (Figure 1-3).

The receiver must also acknowledge receiving the message in some way. This is called giving

feedback. Feedback may be verbal or non-verbal and shows the sender that the message is or is not understood. Feedback may be a nod of the head, a comment, a puzzled look, a question, or the carrying out of an action requested by the sender. If the feedback indicates that the message is not understood, the sender must try again to communicate the message.

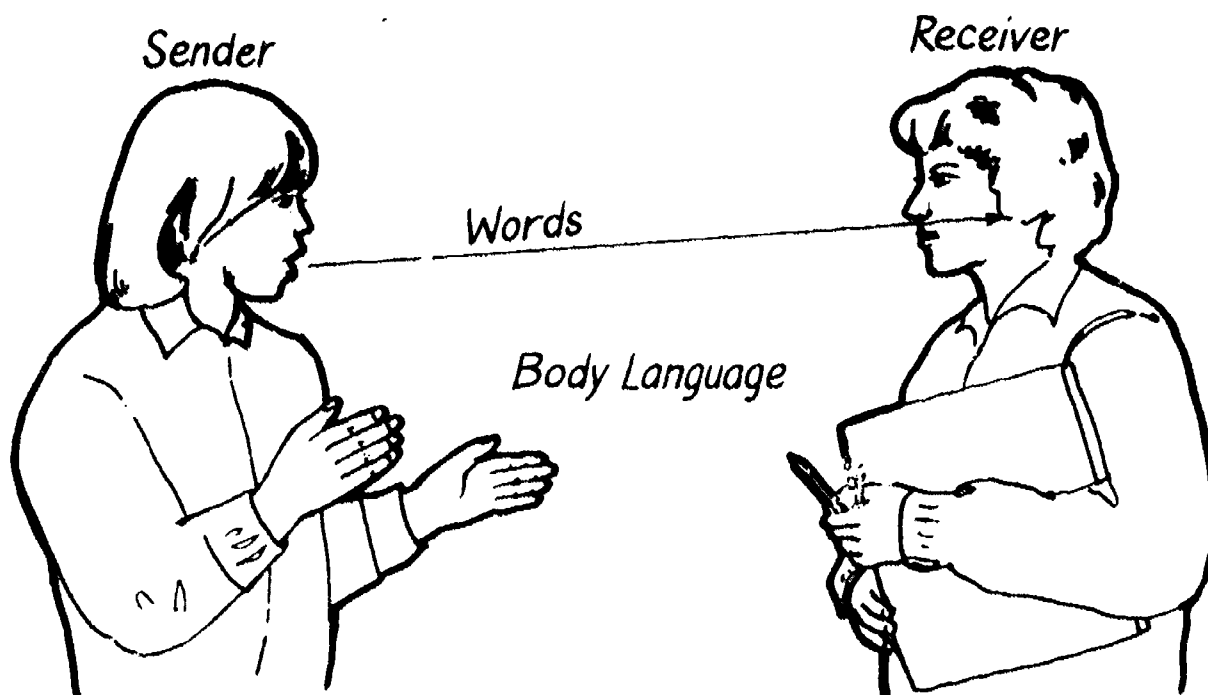

Figure 1-3. Sending and Receiving a Message.

Factors Influencing Communication

Some of the main factors that influence communication are:

Confidence. Both senders and receivers of messages are influenced by self-confidence or **self-esteem.** A confident person, one who has self-esteem, feels comfortable communicating with others. A person lacking confidence on the other hand, is often reluctant to say or do things others may disagree with. A lack of self-confidence can also interfere with hearing and with the ability to accept constructive criticism.

Emotions. Anger, fear, joy, or excitement can cause people to hear poorly, use unclear words, or act in such a way as to hinder communication.

Beliefs, values, myths, biases. The way people feel towards the person with whom they are communicating, or the subject they are communicating on, affects both the sending and receiving of messages.

Time and place. There usually is a right time and place for communication. Choosing the right time and place will help improve communication.

Personal space. People have a preference as to how close they wish others to stand or sit by them. When someone comes too close or stays too far away, communication is hindered.

Interest. If people are interested in a person or subject, they usually pay close attention to what is said. If they are not interested, they probably won't pay attention and will therefore miss the message.

Senses. The ability to hear, see, speak, and understand affects both the sending and receiving of messages.

Attitude, enthusiasm, sincerity, tone of voice, and aggressiveness are other factors influencing communication.

Communication is:

- An exchange of information, ideas, thoughts, or feelings.
- What is said and how it is said.
- Body language as well as words.
- Something people can't stop doing.

IMPROVING COMMUNICATION AND INTERPERSONAL RELATIONS

Self-Knowledge and Self-Acceptance

Interpersonal skills, the skills used in communicating and getting along with others, are improved by having a thorough knowledge of yourself your strengths, weaknesses, values, beliefs, likes, and dislikes. By knowing yourself, you can put your strengths to better use, you can gain a perspective that allows you to better appreciate that each person is an individual, and you can show more self-control in your dealings with others.

As part of the process of gaining self-knowledge, it is useful to think of yourself as having three main selves (Figure 1-4): your ideal self (the self you would like to be), your public self (the self you show to others), and your real self (the person you really are).

Is your real self very different from your public self? Or are they basically the same? Showing

your real self to others means that you are comfortable with yourself and probably relate and communicate well with others. You accept yourself for what you are. On the other hand, hiding your real self behind a very different public self indicates that you have not accepted or come to terms with the person you really are. Not accepting your real self is both stressful and a block to communication.

What about your ideal self? Are your ideals realistic? Can you accomplish them or at least part of them? If not, maybe you should look at changing them.

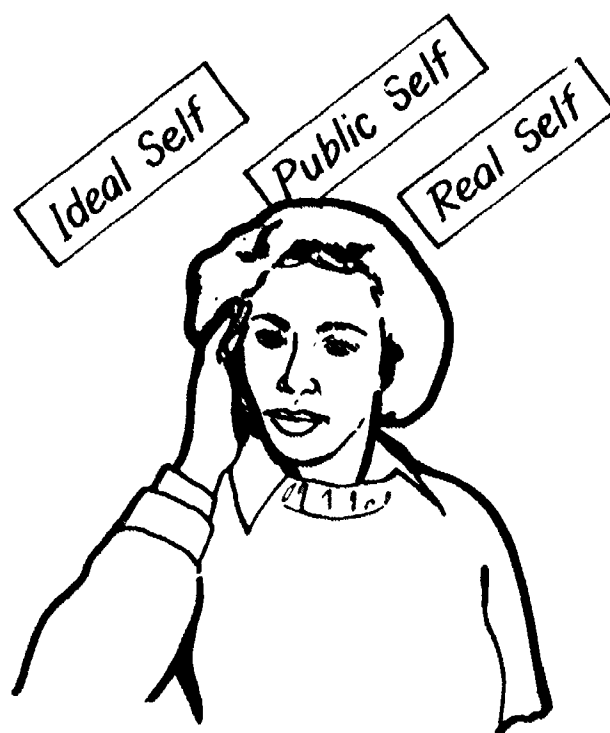

Figure 1-4. Three Selves.

Self-Image

The way you see yourself is referred to as your self-image. This **self-image** or picture of yourself strongly affects the way you see, hear, understand, and evaluate everything around you. Much of a person's self-image is formed in childhood, but it continues to form and change throughout life.

A strong self-image means that you feel good about yourself and are likely to have positive and healthy relations with others. A poor self-image means that you feel unworthy and are

likely to be insecure in your dealings with others. If you have a strong self-image, you can more easily express your feelings, admit you are wrong, accept constructive criticism, admit you don't know something, or voice ideas that are different from those of others. In other words, you can be more honest and open about yourself.

One of the main elements that goes into the making of your self-image is how you are treated by the people important in your life: family, friends, teachers, students, and fellow workers. Their response to you strongly influences the way you view yourself. To have a strong self-image, you need a certain amount of love, acceptance, and respect from these people.

Recognizing and Accepting Feelings

It is an important part of interpersonal relations to recognize and accept how others are feeling. People get frustrated when their feelings are misunderstood, ignored, or rejected.

Some common feelings are: happiness, sadness, anger, frustration, inadequacy, and depression. As a care worker you will find that some feelings are comfortable for you to deal with, whereas others are not. It is these latter feelings, the ones that you are not comfortable with, that you have to learn to recognize and accept. Telling a client, "You shouldn't feel that way," or "You don't really mean that," is not very helpful. It simply means that you don't want to accept the feelings because they make you uneasy. People get angry, they dislike others, they feel unworthy, and get depressed. Telling them that they shouldn't have these feelings is unrealistic and makes them feel misunderstood.

If you allow others to be honest about the way they feel, you encourage good communication. Unpleasant feelings of clients are better out in the open where you can perhaps learn what causes them, and therefore maybe do something about controlling or eliminating them (Figure 1-5).



Figure 1-5. Recognizing Feelings.

Respecting Rights and Requests

Receiving respect gives a person a sense of worth and contributes to the person's self-image. In caring for others, you should respect clients and their rights. These rights include the right to:

- Participate in making decisions relating to their own welfare.
- Have personal requests heard and responded to appropriately.
- Have personal space respected and belongings handled with care.
- Have personal tastes or preferences in food, dress, daily routines, and privacy respected.
- Have maximum independence.
- Refuse care or treatment.

Respecting a person should not be tied to agreeing with the person. You can hold quite different views from other people, but still respect them. People feel much more comfortable with you knowing that you respect them no matter how different their views are from yours.

Involve clients as much as possible in their care and in making decisions for themselves. Doing this shows your respect for them. When

tempted to do something or make a decision for a client, remind yourself that you are robbing the client of independence and hurting his or her self-image. Even though you could do a task much faster yourself, it is often better to stand back and watch a client perform the task or assist the client to perform the task.

Making decisions will be easier for clients if they can stay close to the lifestyle they are used to. Some adjustments may have to be made for disabilities, but a client's preferences in clothing, meals, leisure activities, and daily routines can nearly always be accommodated to some degree.

Personal requests should be responded to quickly and appropriately. Care workers should be aware of how culture, lifestyle, and disabilities may affect clients' requests. Always try to adapt your care, approach, and activity planning to each client's special needs. If a request is beyond your limitations as a care worker or is not possible to fulfill, explain to the client why you cannot respond as asked. Perhaps your supervisor can help with requests you are unable to fulfill.

Respecting Human Differences

Individuals have certain **beliefs** and **values** that they have accumulated over their lifetime. Beliefs can have a narrowing influence, preventing a person from accepting those held by others. For example, a belief in a religion or a political party can cause some people to blindly reject a person from another religion or political party (Figure 1-6).

People should be aware of the tendency of their beliefs and values to make them intolerant to those of others. They should remind themselves that other people's beliefs and values are formed in the same way as their own and are of equal value to their own. If people accept the rights of each other to hold different beliefs and values, then they need not feel threatened by those who think differently from themselves.

This is not to say that you must always agree with others, but rather that you accept the right

of others to their values and beliefs. The important point here is that you can accept a person without having to agree with the person's views. This is not always easy, but it is necessary if people are to get along with one another.

Beliefs and values are only one area where people are different. Other major areas of difference are race, culture, skills, interests, education, occupation. When confronted with differences in others, the following reactions should be avoided: prejudice, stereotyping, discrimination, and scapegoating.



Figure 1-6. Narrowing Influence of Beliefs.

Prejudice is forming an opinion about someone or something before really understanding or knowing the person or thing. The opinion may be a prejudice in favour of or against something, for example, "all conservatives are nice people" or "all conservatives are twits." Prejudice is not based on knowledge and thus prevents real communication from taking place.

Stereotyping is forming a standard, oversimplified view of people based on their being a member of a group. Two examples of stereotyping are "all religious people are narrow-minded" and "all old people are cranky." If you hold stereotyped assumptions about people, it will be very difficult for you to communicate with them.

Look at Figure 1-7. How old is the woman? Is she attractive? What kind of head covering is she wearing? Actually, there are two women in this picture; one is young, one old. This illustration shows how a first impression can stop you from seeing the whole picture.



Figure 1-7. First Impression.

Discrimination is singling out a person or a group for favor or disfavor. Discrimination means treating some people differently than others in the same situation. If a person is refused a job because of being a member of a race that an employer is prejudiced against, that is discrimination. Or if a person gets special treatment because of being a friend of the boss, that is also discrimination.

Scapegoating is blaming someone or some group for a mistake or problem that they are innocent of or at most only partly responsible for. A common scapegoating that is heard in recent times is that immigrants are responsible for our high unemployment.

Everyone is capable of prejudice, stereotyping, discrimination, and scapegoating. Try to work at eliminating these reactions in your relations with people, and learn to accept people on their own merits.

Adapting Communication To The Individual

It is helpful knowing to whom you are talking and the individual's circumstances before communicating. With this information, you can adapt your communication to the individual.

Some of the pieces of information that will help you do this are:

Age. The approach to communication often depends on the age of the person.

Capacity. Intelligence, alertness, interests, and degree of confusion all affect the ability to communicate.

Social relation. People respond differently to family members, strangers, friends, co-workers, bosses, service workers, etc.

Emotions and attitudes. Communication is influenced by the emotions and attitudes of the person.

Time. How busy is the person? How much time has he or she to communicate?

Personal space. Where is the line marking the individual's personal space?

Common Courtesies

Courtesy is a main element in bringing harmony to interpersonal relations (Figure 1-8). Because courtesies are small and don't stand out, they are often overlooked and not given credit for being important. A little courtesy can make a care worker's job a lot easier. Following are a list of common courtesies:

- Call people by the name they prefer. Some elderly people like to be called by their last name: Mr. Jones, Mrs. Wong. Others will request that you use their first names, and still others may say something like, "Call me Gramps." If in doubt of what to call someone, be more formal, not less.
- Use please, thank you, excuse me, good morning, and other courteous phrases in

your relations with clients, family members, and co-workers.

- Knock before entering any private space; for example, a client's room or house, the supervisor's office.
- Pay attention to and show interest in others.
- Don't interrupt conversation or activity.
- Don't talk over an individual's head. Include the individual in the conversation even if you are not sure he or she understands.
- Ask before doing anything to or with another person. Feelings of worthiness and independence depend on people maintaining some control over events affecting them.



Figure 1-8. Small Courtesies.

Guidelines for Good Communication

The Physical Setting

- Choose a suitable place and time for communication.
- Control background noise or interruptions.
- Try to find the right distance from the person, neither too close nor too far away.

- Face the other person, frequently making eye contact.
- Use touch carefully, watching how the person responds.

Sending Messages

- Choose your words carefully.
- Keep messages as simple and brief as possible.
- Speak clearly or write legibly.
- Allow time for replies.
- Repeat information as often as necessary, showing patience by not changing your actions or the tone of your voice.
- Seek feedback that the message is understood.

Receiving Messages

- Listen attentively.
- Carefully observe gestures, posture, facial expression and other body language.
- Give feedback, and if you don't understand a message, ask that it be repeated or explained in different words.

General Suggestions

- Encourage communication and try to make it stimulating. At the same time, keep in mind that some individuals will prefer silence and privacy.
- Know the individual as well as possible. Avoid making mistakes like speaking loudly into the wrong ear of a client who is hard of hearing in one ear.
- If you treat people well and expect the same from them, they will usually live up to your expectations.
- Don't adopt a patronizing manner or an inappropriate familiarity.
- Be honest and open with others. Try not to let prejudice, stereotyping, discrimination, or scapegoating hinder your communications.
- Recognize and accept the feelings of others.
- Respect the rights of others.

- Accept inappropriate behaviour without encouraging it. Habit, nervousness, or health problems may cause rambling, laughing, or crying at the wrong times.
- Practice common courtesies.

SPECIAL AREAS OF COMMUNICATION

Handling Emotional Situations

Situations where clients show strong emotions such as fear, anger, or joy may be difficult to handle. Some general rules for handling emotional situations are:

Prepare the client well for upcoming events. This will eliminate unwanted or upsetting surprises and allow the client to gradually adjust to the event.

Recognize in advance the type of situation that may emotionally affect the client. Prepare for the situation and monitor the client in the situation, if possible, trying not to let the client get over stimulated. Or, if the client is too upset by the situation, avoid it all together.

Remain calm and do not make judgments about the client's emotional state. If you get emotional, there will be two problems to deal with, one more than you need.

Listen, comfort, support, and respond as seems appropriate. Often just listening can help clients solve their own problems (Figure 1-9).

Give thorough and honest explanations of any situation. Be sure to explain in a way the client can easily understand.

Let the client express his or her feelings. Once these feelings are out in the open, they may not seem so threatening.

Get assistance when needed. Sometimes a problem can seem too complicated to handle alone.



Figure 1-9. Listening to Problems.

Types of Emotional Situations

Following are types of emotional situations you are likely to encounter and advice on how to deal with them:

Anxiety, fear. Honest, realistic reassurance helps. Try to build up the client's confidence by remaining calm, reassuring, and non-judgmental.

Anger. Accept the feeling, but not necessarily the behaviour. Merely getting the anger out in the open may help. Remember that anger is often not directed at the real problem.

Overly affectionate behaviour. Try tactfully telling the client that it makes you uncomfortable. People react differently to affection.

Grief and bereavement. Avoid passing judgment. Be considerate and allow for privacy. Someone important to the individual is the best helper at a time of grief.

Depression. Sometimes it helps getting clients to express the feelings that are depressing them. There are many degrees of depression. Seek assistance if you feel the depression is serious.

Dying. Don't put off a client who wants to talk about dying. Listen to the client's thoughts. Seek

assistance: often family members are the most comforting to a dying client.

Seeking your advice. Encourage clients to make their own decisions. Listen to them. Know your limitations in the advice you can give and seek assistance as required.

Aggression, hostility. Remain calm and non-threatening. Try to avoid taking a punishing attitude. Getting clients to express their hostility sometimes helps. Be sure to protect others and yourself. Seek assistance as required.

Communicating with the Blind

Blind clients, obviously, cannot receive information sent through body language, but they can interpret tone of voice and touch accompanying the spoken word. Be observant with blind clients, and try to learn how to best communicate with them. You have to do this with all clients, but with blind (or deaf) clients, you may have to work a little harder at it. Many libraries have braille books for the blind and also tape-recorded books.

When communicating with the blind:

- Always announce your arriving and leaving so that you don't surprise blind clients or leave them talking to the air.
- Speak at normal volume. Remember they're blind, not deaf.
- Describe the location of objects and when appropriate guide the client's hands to touch the objects.
- Don't be reluctant to use common remarks like "I'll be seeing you" with the blind. They will not be offended.
- Be natural.

Communicating with the Deaf

All deaf clients respond to body language and some can lip read to varying degrees. Writing notes is the one sure way of communicating with the deaf, especially if you are giving directions that must be accurate. Keep handy a paper and a pencil or broad-nibbed black felt pen. An erasable slate can also be used.

Following are practices for communicating with the deaf:

- Lower the tone of your voice when speaking to the partially deaf. Deafness affects the higher tones of hearing first. The client may be able to hear the deeper tones. Speak clearly.
- Face partially deaf clients and deaf clients who can lip read when speaking to them. Face all deaf clients when trying to get their attention.
- Encourage clients to wear hearing aids if they have them. Be sure the batteries are fresh and the hearing aids are otherwise in good repair (Figure 1-10).
- Use written communication if needed, especially to be sure that important information is understood. Write legibly.
- Use gestures to communicate or reinforce your words.



Figure 1-10. Checking Hearing Aids.

Communicating with Non-English Speaking Clients

You may require an interpreter to communicate with a client who doesn't speak English. You also may require a sign language interpreter. Be sure that the interpreter fully understands the message you wish sent. Also try as best you can to see that the client understands the translated message. Always be aware of the possibility that the message can get lost in translation.

Blindness and deafness are obvious handicaps that affect communication. Other not so obvious handicaps can also hinder communication; for example, forgetfulness. Try to be aware of all the handicaps that can interfere with communication.

Disorientation (Confusion)

Disorientation means that an individual has lost the ability to recognize time, place, or persons. Disoriented or confused clients may be unaware of the date, the hour of the day, or the year, and they may not know where they are or even who they are. The confusion may be temporary or long term. Some of the causes of temporary confusion are: high fever, anxiety, infection, medication problems, and a change of living environment.

Several types of programs help clients cope with their confusion or assist them in becoming less confused. All of these programs must be carried out in a consistent, knowledgeable way. Members of the health care team must all follow the rules of the program when dealing with the client. In some cases a decision may be made simply to accept a client's confusion and protect the client from injury that could result from the confusion. Such an acceptance requires patient, non-judgmental care from health care workers.

When a program is used, all staff must be made thoroughly aware of their role in it. Following are programs to help confused clients. Do not attempt to use these programs or therapies without professional direction.

Milieu therapy. Encompasses the client's total environment. Organizes all activities to give the client maximum independence and satisfaction.

Life review therapy. Reviews the client's achievements and disappointments in life in order to help the client accept the past and feel comfortable in the present. This is sometimes called reminiscence therapy.

Multi-sensory activity programming. Uses resource materials appealing to all of the five senses to stimulate the client's memory of past events. Also uses group discussions with older adults.

Remotivation therapy. Tries to stimulate the impulses and energy required to fulfill the client's basic emotional needs.

Expressive therapy. Tries to reorient the client through the release of repressed feelings by encouraging participation in the arts: dance, music, drama, poetry, art, and story writing.

Reality therapy. Treats clients as normal non-confused persons and expects them to take responsibility for their actions.

Reality orientation. Uses large-print visual reminders and consistent verbal approaches to assist clients in relating to their life and their daily tasks.

GROUP COMMUNICATION

A group (two or more people) is not just a collection of individuals. To become a real group, the individuals must share common goals and develop stable roles in their communications and relations with one another. The health care team is a good example of a group; the individual members have a common goal, the care of the client, and have standard roles to perform.

Functioning well within a group can be very demanding because of the variety of personalities to deal with. Group members must find appropriate ways of communicating and cooperating with one another. Two points to keep in mind with groups are the majority can be wrong and leaders do not have a monopoly on the truth. An informed, well-thought-out point of view is far more valuable than one simply adopted from the others in the group.

In a group it is necessary to recognize the roles and responsibilities of the various members, yourself included. Some members are responsible for giving instructions and guidance. Other members have to follow directions. By knowing your role and the roles of others in the group, you will be a more effective group member.

Members of health care teams are often called upon to assist each other in client care. You have to learn the right times to ask for and offer assistance. When assistance is given to you, accept it graciously; when you give assistance, give it willingly.

Positive Group Practices

The following behaviors are helpful in strengthening a group as a working unit:

- Readily share information about group concerns.
- Share opinions without being judgmental.
- Maintain a warm, friendly atmosphere, making relations easier.
- Encourage participation of all group members.
- Encourage harmony and cooperation by limiting misunderstandings and mediating disagreements.
- Compromise when reasonable to improve the group's output.
- Be involved with the group and empathize with it.
- Maintain the standards of the group.

OBSERVING AND REPORTING

When caring for a client, it is important to continually be observing for anything that may indicate a change in the client's condition. Since you are in frequent contact with the client, you may be the first to notice a change. Observing is more than just looking. Other senses are used as well — hearing, smelling, touching and sometimes just having a funny feeling that something is wrong. When assessing any change in a client, remember to carefully follow the ABCs of observation: appearance, behavior, and conversation (Figure 1-11). By developing a thorough system of observation, you will make your reports to your supervisor or team leader more accurate and complete.

Your observations are important; they add to the total health care picture of clients and help to ensure that the clients receive exactly the type of care they require. After receiving evidence from you that a client's needs have changed, the supervisor may revise the client's care plan to reflect the changes.

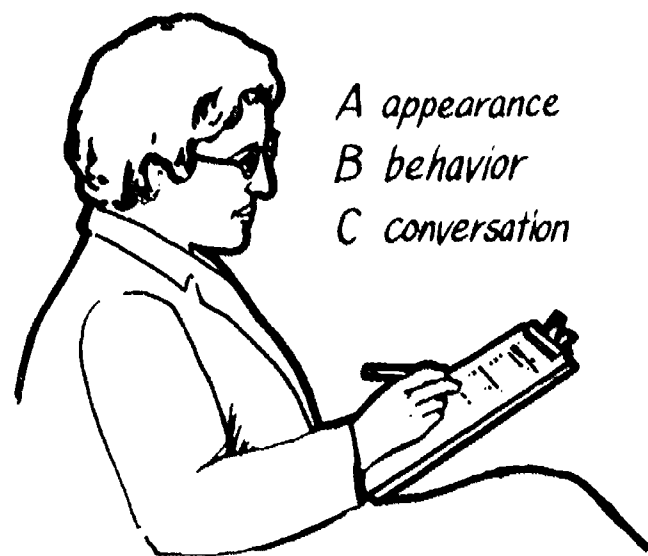

Figure 1-11. ABCs of Observation.

Checklist for Observing Clients

1. Appearance

- As usual or changed?
- Relaxed or tense?
- Hygiene and grooming. Good? Fair?
- Environment. Altered?
- Skin. Hot? Cold? Dry? Moist?
- Colour. Pale? Flushed? Bluish? Yellowish?
- Skin. Broken? Rash? Bruises? Swelling?
- Eyes. Dull? Bright? Yellowish? Red?
- Mouth. Dry? Coated? Unusual odour?
- Urine. Frequent? Painful? Colour? Odour?
- Stool. Frequent? Colour? Consistency?
- Breathing. Rapid? Uneven?
- Position. Frequent changes?

2. Behaviour

- Body. Weaker? Stronger? Shaky? Poor balance?
- Cough. Dry? Moist? Positioned? Frequent?
- Pain. Where? When? Severe?
- Vomiting. When? Amount? Contents?
- Temperament. Agitated? Mood changes? Quiet?
- Activities. As usual? Changes?
- Eating habits. Hungry? Thirsty?

3. Conversation

- Complaints?
- Speech difficulties?
- Confused?

There are two types of reporting: objective reporting and subjective reporting. **Objective reporting** means reporting exactly what you observe. Examples of objective reporting are:

- Mr. Jones' left leg is more swollen today. The swelling is mainly around the foot and ankle.
- Joan Smith has two scrapes the size of a quarter on her chin. They are clean and not bleeding, but she says that they are sore.

Subjective reporting means giving your opinion on what you observe. Examples of subjective reporting are:

- Mr. Jones' left leg is more swollen today. I think it is because he doesn't keep it up on the stool when there's no one watching.
- Joan Smith has two large scrapes on her chin. I'll bet her older brother shoved her into the table.

Subjective reporting often includes hunches. Although hunches can be very inaccurate, sometimes they can be valuable to the supervisor since you probably know the client well. Be sure to tell the supervisor since you probably know the client well. Be sure to tell the supervisor that the information is your opinion and not something you observed.

Objective reporting should be used most often. To be accurate, note the time, the place, and as many details as possible about the observation. Agencies have different policies regarding the procedures for observations. Be sure to learn the policies of your agency.

When recording, write clearly, using correct spelling and grammar. Permanent client records are legal documents that must be as clear as possible. If you are a poor speller, keep a dictionary handy. Try to use words you are sure of; fancy terms are often more confusing than everyday language.

Abbreviations

Abbreviations may make the job of recording easier. It is important however that everyone use the same abbreviations, or major misunderstandings may arise. If B.P. means "blood pressure" to one worker and "bedpan" to another, confusion results. The following abbreviations are commonly used in the health care field. Add to the list any new ones you come across.

a	before
A	axilla temperature
abd.	abdomen
a.c.	before meals
a.m.	morning
ad lib	at pleasure

amt.	amount	P.T.	physical therapy
approx.	approximately	q.d.	daily
.i.d.	twice a day	q.i.d.	four times daily
B.M.	bowel movement	q.o.d.	every other day
B.P.	blood pressure	q.s.	quantity sufficient
B.R.P.	bathroom privileges	q2h	every 2 hours
°C	centigrade or celcius	R.B.C.	red blood cells
c	with	R.O.M.	range of motion
C & A	clinitest and acetest urine test	Rt. or R	right
CO ₂	carbon dioxide	R _x	treatment, prescription
Ca	cancer	s	without
cc	cubic centimeter	s.o.b.	short of breath
CHO	carbohydrate	spec.	specimen
CPR	cardiopulmonary resuscitation	stat.	immediately
C.V.A.	cerebrovascular accident (stroke)	supp.	suppository
D.A.T.	diet as tolerated	S & A	sugar and acetone urine test
d/c	discontinue	t.i.d.	three times daily
drsg.	dressing	T.P.R.	temperature, pulse and respiration
Dx	diagnosis	ung.	ointment
E.C.G. or E.K.G.	electrocardiogram	V.S.	vital signs
e.g.	for example	W/C	wheelchair
F.B.S.	fasting blood sugar	wt.	weight
Fl. or fld.	fluid		up, increase
Fx or #	fracture		down, decrease
GI	gastrointestinal		
g	gram		
gtt.	drop		
hr. or h	hour		
h.s.	at bedtime		
H.W.B.	hot water bottle		
H ₂ O	water		
I & O	intake and output		
irreg.	irregular		
kg	kilogram		
L	litre		
liq.	liquid		
Lt. or L	left		
m	metre		
mL	millilitre		
N/A	not applicable		
N.B.	note carefully		
N.P.O.	nothing by mouth		
O ₂	oxygen		
o.d.	daily		
o.o.b.	out of bed		
p	after		
p.c.	after meals		
p.m.	evening		
P.O.	by mouth		
p.r.n.	as necessary		

Reporting and Recording Rules

- Follow agency policies for reporting and recording.
- Record soon after you make observations so that you don't forget details.
- Collect accurate, complete information, and record it in a logical order. Identify the client and yourself.
- Make objective reports. If you give your opinion, say so.
- If you are not sure of a piece of information, record it anyway, noting your uncertainty. It is better to be on the safe side.
- Report and record any change in a client's condition.

USING COMMUNICATION DEVICES

There are many communication devices available; for example, telephones, intercoms, call bells, and emergency call systems. Different ones will be used by different agencies. Most communication devices are relatively simple to operate once you have had a demonstration. Follow agency policy when using these devices. Some general practices with communication devices are:

Telephone

- Ask before using a client's telephone.
- Answer the telephone pleasantly.
- Don't use the telephone unnecessarily or for personal calls.
- Take written messages or refer calls when appropriate.
- Allow the telephone to ring 8 to 10 times when calling.
- Make calls short and concise.

Intercom

- Follow directions for use.
- Avoid unnecessary use, personal remarks, or commands.
- Keep your voice pleasant and at a comfortable listening level.
- Recognize that the intercom may be confusing for oriented clients or disturbing for others.

Call bells

- Explain the use of the call bells to clients.
- Leave a call bell within the client's reach.
- Answer call bells promptly and pleasantly.
- Learn the meaning of different call signals.

Emergency Call System

- It may be part of the telephone or intercom system.
- Become familiar with its operation.
- Refresh your memory on its use by regularly re-reading the operating directions.

Communication devices are of great assistance if they are used properly and are kept in good repair.

PROBLEM SOLVING SKILLS

Problem Solving Process

In order to use your time and energy effectively on the job and at home, you must be organized. One way of getting organized is to use the problem solving process. Note that the word "problem" is used here in the sense of something distressing you and also in the broader sense of a task or a job that you want to accomplish.

Figure 1-12 shows the four steps in problem solving. The time spent on each of the four steps will depend on the problem. Following is a discussion on the four steps. The sample problem used is a flashlight that won't work.

1. **Define the problem.** What exactly is the problem? You can't search for a solution until you clearly know what the problem is. The problem in the sample is a dead flashlight.
2. **Think up possible solutions for the problem and form a plan of action.** Thinking up solutions will depend on your knowledge, skill, past experience, work capacity, energy, interests. You may seek advice from an information pamphlet, a book, a video-tape, or another person. The solu-

tions will also depend on the resources available to you — money, tools, equipment, services.

Are the solutions realistic? Can you get everything you need to carry out the solutions? Of the several possible solutions, which would be the best to try first? A common method is to start with the simplest or easiest of the solutions, then progress to the more complex ones. Another method is to follow a hunch as to which solution is most likely to succeed.

Once you have decided on a possible solution, set a plan of action.

Possible solutions for the dead flashlight are new batteries or a new bulb. Which of these solutions would you try first? Look at the bulb. If it looks okay, try replacing the batteries. If the bulb looks burnt out, try replacing it first. The solutions, of course, depend on the assumption that you either have the new bulb and batteries or have the money and means to get to a store to buy them.

3. **Put the plan for solution into action.** The amount of effort and organization required will depend on the complexity of the plan. In the simple example of the dead flashlight, change either the bulb or the batteries, whichever you decided to try first.
4. **Evaluating the results of the plan.** Did it solve the problem? If not, return to another of the possible solutions and try it. You might also go back and see if you have correctly defined the problem. A point to remember here is that there are very few problems for which you can't find a solution if you only look hard enough. Did the flashlight go when you changed the batteries? If not, try replacing the bulb. Or, did it go when you changed the bulb? If not, replace the batteries. If neither of the solutions work, the only thing left may be to buy a new flashlight.

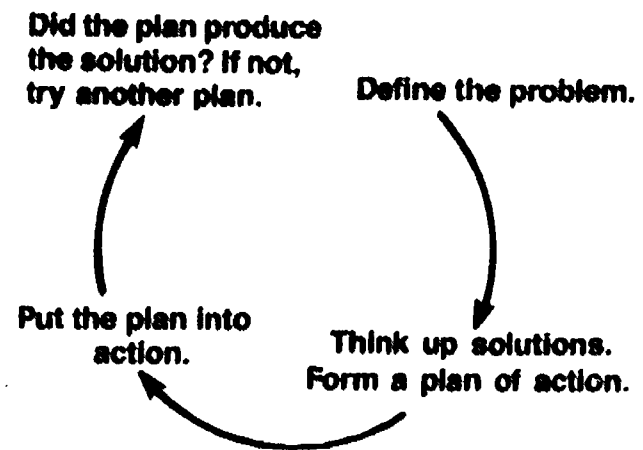

Figure 1-12. Problem Solving.

Care Plans

Make a care plan before starting the work; this is an efficient way to get tasks done with minimal physical and emotional strain on you and your client. First, identify what needs to be done. Knowledge of the client's needs, your own capabilities, and the routine of the agency all point to a number of tasks. Second, set priorities. Consider the relative importance of all the tasks and do the most important first. Be aware how much time each task requires and which tasks can be combined. Third, decide what supplies and equipment are needed to complete the assigned tasks. A logical plan based on these three points saves time and energy.

For complex tasks a written care plan is necessary, whereas for simple tasks a plan kept in your head is probably adequate. However, if you have trouble remembering details, write down all your plans and follow your plan sheet as you work. The efficient completion of the job is the goal of planning and organizing. To carry out a plan:

- Organize the work environment for efficiency. Have the equipment within easy

reach, and try to complete one task before moving on to the next.

- Complete the care within the assigned time period. This requires habits of working quickly and efficiently and not getting distracted.
- Change the plan as the need arises. Often the situation changes, making it necessary to alter the plan. Try to be flexible and don't panic; panic decreases your ability to think clearly.

Organization skills increase with experience. Good work habits improve efficiency and thus the quality of care.

Group Problem Solving

In a group, solving problems and planning action requires cooperation and communication. A group's human resources are much greater than an individual's, and thus more suggestions and ideas are put forward by a group than by an individual. Ideas coming from a group discussion must be drawn together and evaluated in such a way that members feel their ideas are given fair consideration. Once the group has agreed upon a plan to solve the problem, the members must responsibly carry out the plan for it to be effective.

EXERCISE 1-1

Crossword

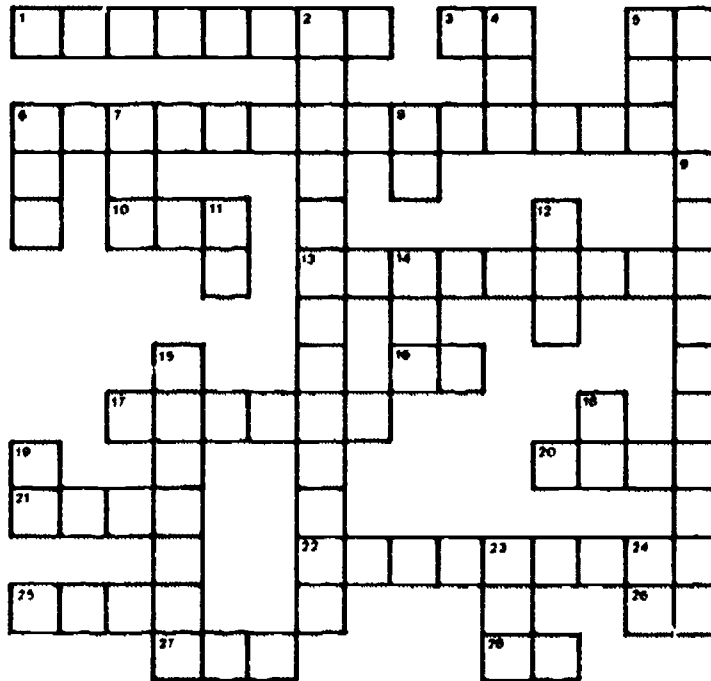

Across:

1. Shows that a message got through.
3. Abbreviation for kilogram.
5. Abbreviation for by mouth.
6. Reaction that singles out some people for different treatment than others.
10. Abbreviation for twice a day.
13. Communication without words.
16. Abbreviation for daily.
17. Communication with words.
20. Abbreviation for immediately.

21. Abbreviation for suppository.
22. Type of reporting that states only the facts.
25. Abbreviation for specimen.
26. Shortened form of small.
27. Abbreviation for three times daily.
28. Abbreviation for before meals.

Down:

2. Sending and receiving messages.
4. Abbreviation for drop.
5. Abbreviation for as necessary.
6. Abbreviation for diet as tolerated.
7. Abbreviation for short of breath.
8. Abbreviation for not applicable.
9. Feels comfortable communicating with others.
11. Abbreviation for discontinue.
12. Abbreviation for bathroom privileges.
14. Abbreviation for nothing by mouth.
15. Gives people a sense of worth.
18. Abbreviation for left.
19. Abbreviation for quantity sufficient.
23. Abbreviation for stroke (cerebrovascular accident).
24. Abbreviation for vital signs.

Questions

1. Why is it important to pay attention to non-verbal communication?
2. In communication, what are the responsibilities of the message sender and the message receiver?
3. Match:

a. Self-acceptance	1. Needs love, acceptance, and respect from others.
b. Self-knowledge	2. Understanding your real self, ideal self, and public self.
c. Self-image	3. Coming to terms with the person you really are.
4. Why is it important to recognize the feelings of others?
5. What is wrong with doing everything you can for clients?
6. Match:

a. Prejudice	1. Blaming one person when many other people were also responsible.
b. Stereotyping	2. Singling out an individual and treating that individual harshly.
c. Discrimination	3. Having an opinion about a person without knowing the person.
d. Scapegoating	4. A standard, oversimplified view of a person.
7. List five phrases that show courtesy to others.
8. Why is it a good idea to prepare clients well for upcoming events?

9. If you have observed that a client gets upset in certain situations, what should you do?
10. When communicating with clients and when dealing with clients who are emotional or stressful, the statement "Be non-judgmental" is frequently heard. What does being non-judgmental mean?
11. If a client is expressing anger at something such as the food for lunch, does it necessarily mean that the food is the source of the anger?
12. What should you do when coming upon and leaving a blind person?
13. If a blind person can't locate an object, how can you be helpful?
14. What should you do when speaking with a partially deaf client?
15. What is the one sure way of communicating with the deaf?
16. List five causes of temporary confusion.
17. What are the ABCs of observation?
18. Why are your observations important?
19. What is the difference between subjective and objective reporting? Which do you use most frequently?

Section 2

**Growth and Development
of the
Individual and Family**

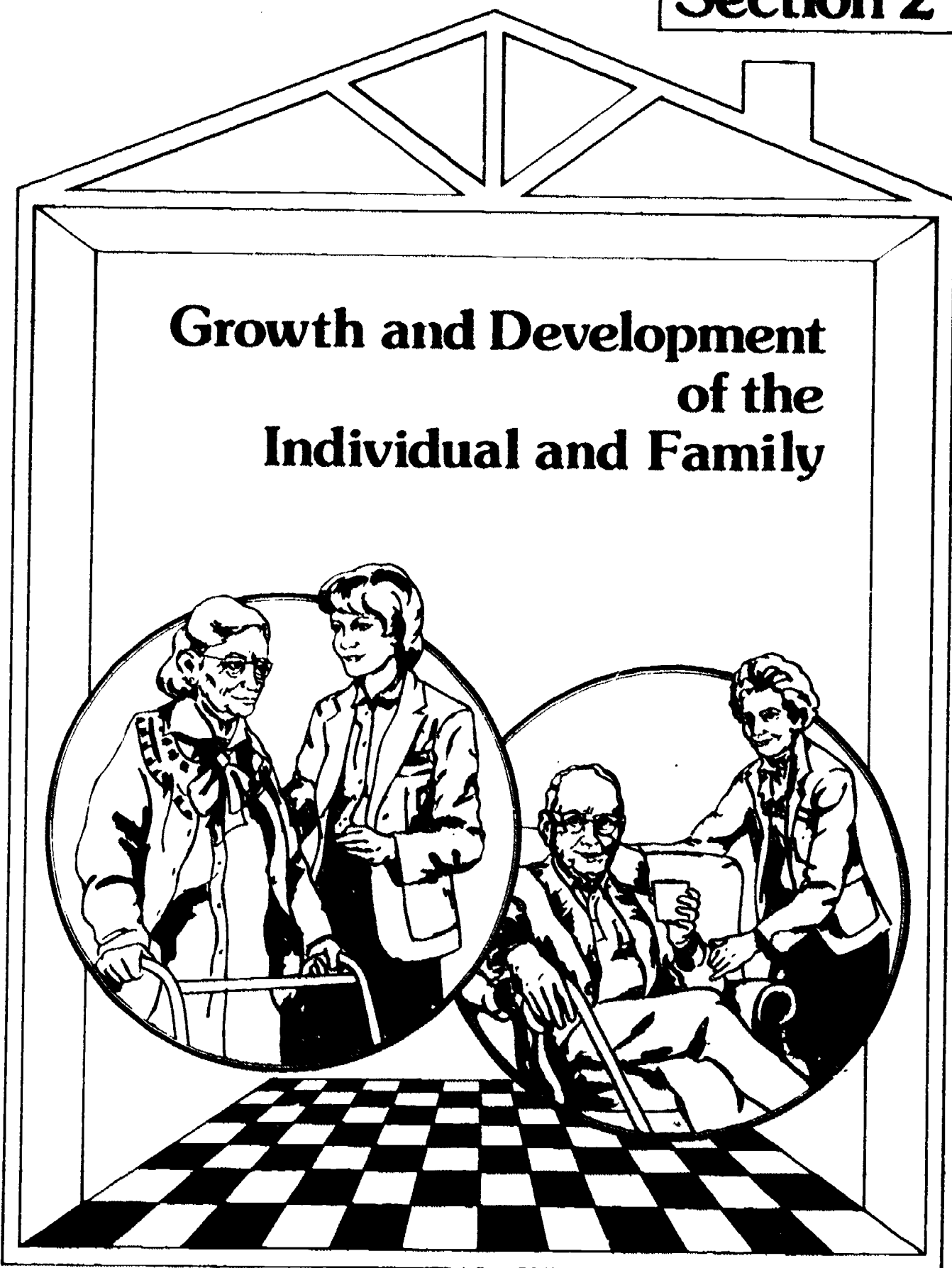

INTRODUCTION

Section 2 gives a basic picture of what you as a care giver work with — people. The ten systems that make up the human body (e.g., circulatory system, nervous system, respiratory system) are discussed. Human needs are also looked at. All people have basic human needs. Some of the needs such as oxygen, food, and sleep are necessary for survival. Others such as the need for love and the need to find stimulating things to do make life more rewarding and fulfilling.

Stress is a physical and mental reaction that people have to situations they find themselves in. You should know some of the basic facts about stress and how it affects yourself and your clients.

Growth and development is the term used to sum up the changes that take place in people throughout the various stages of life. One way of examining the changes is to look at the tasks that most people learn to do at each stage. These tasks are called developmental tasks. Families, like the individuals who grow up within them, also have developmental tasks for the different stages of family life. The tasks and concerns of a family who have a member receiving care are discussed in particular.

The stage of life called old age, 65 years to death, is dealt with in some detail covering topics such as retirement, the limitations of aging, and adjusting to institutional living.

Having gone through the growth and development stages from prenatal to old age. This section ends with a discussion of dying and death. The intention is to give some understanding of what a dying person is going through and how to care for the dying.

BODY SYSTEMS

Body Structure

Cells are the building blocks of all living things. The human body is made up of millions of cells. Although cells have different tasks, some tasks are common to all cells: breathing, digesting food, eliminating wastes, reproducing.

Cells working together doing a task form **tissue**. There are five different types of tissue: skin and body lining tissue, connecting tissue, nerve tissue, muscle tissue, and blood and lymph tissue.

Tissues working together carrying out a function form **organs**. Examples of organs are the heart, bones, and brain. Most organs are found in cavities or spaces within the body. The main body cavities are: the cranial cavity, spinal cavity, thoracic cavity, and the abdominopelvic cavity (Figure 2-1). The thoracic cavity and abdominopelvic cavity are separated by a large muscle called the diaphragm. Organs working together make up the body systems. There are ten body systems:

- Respiratory system
- Circulatory system
- Digestive system
- Urinary system
- Skeletal system
- Muscular system
- Endocrine system
- Nervous system
- Reproductive system
- Skin

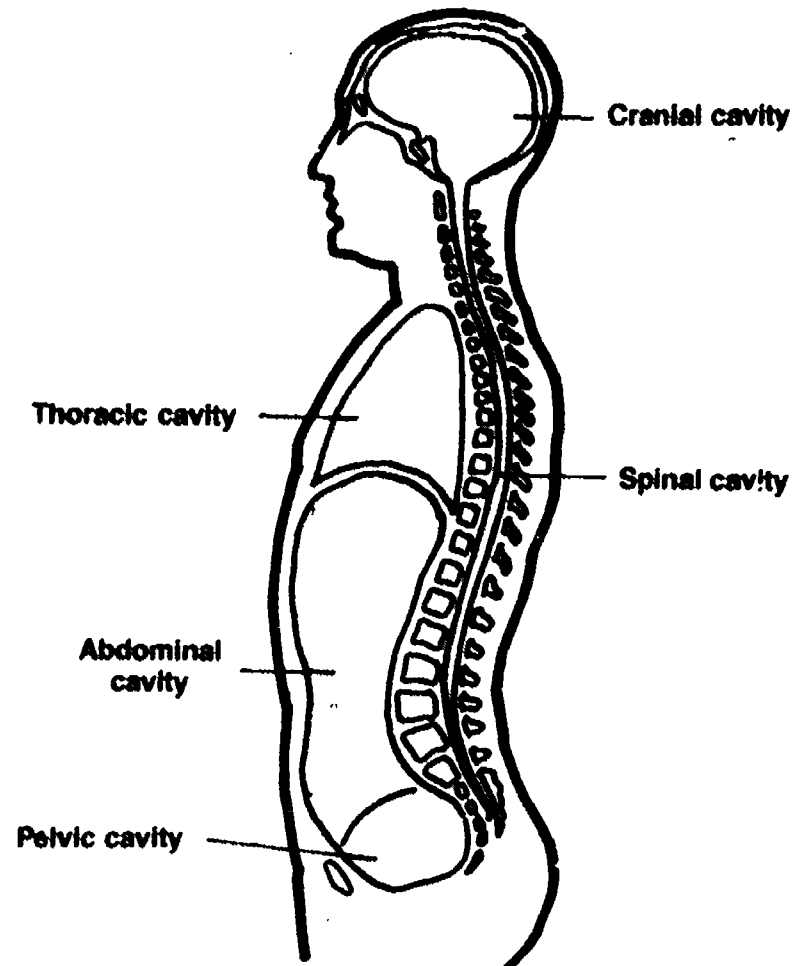

Figure 2-1. BODY CAVITIES.

Respiratory System

Functions

- Takes oxygen into the body.
- Exchanges with the blood oxygen for carbon dioxide.
- Eliminates waste carbon dioxide from the body.

Figure 2-2 shows the parts of the respiratory system. The nostrils, pharynx, larynx (voice box), trachea, and bronchi are pathways for inhaling oxygen and exhaling carbon dioxide. The alveoli are small air sacs in the lungs allowing oxygen to pass into tiny blood vessels and carbon dioxide to pass out of the vessels.

Breathing is brought about by a large muscle called the diaphragm. The diaphragm causes the lungs to inflate and deflate by pulling down and pushing up at regular intervals. As people age, deep breathing (and therefore strenuous

exercise) becomes more difficult because the chest is less able to expand and contract with the inflating and deflating of the lungs.

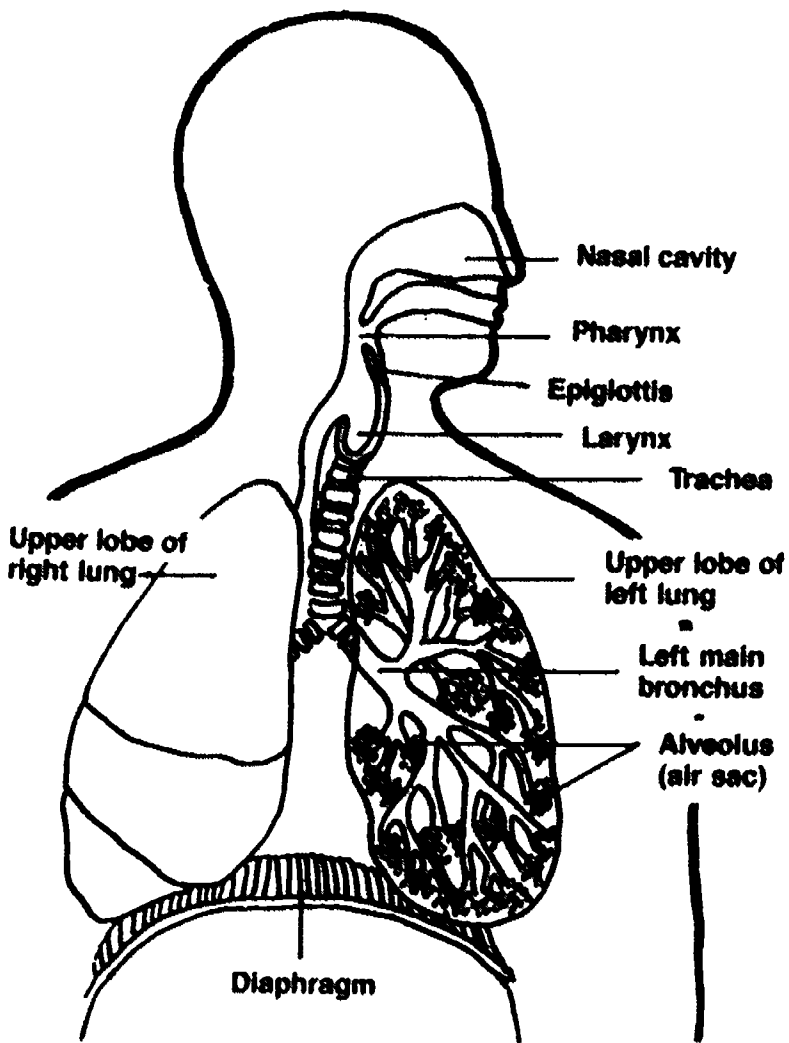

Figure 2-2. RESPIRATORY SYSTEM.

Circulatory System

Functions:

- Carries food and oxygen to all body cells.
- Carries wastes and carbon dioxide away from all body cells.
- Helps protect against infection.

Figure 2-3 shows the parts of the circulatory system. Following is a list of the parts and their functions:

Heart. Pumps blood through the circulatory system.

Blood vessels. There are three types of blood vessels: arteries, veins, and capillaries. Arteries

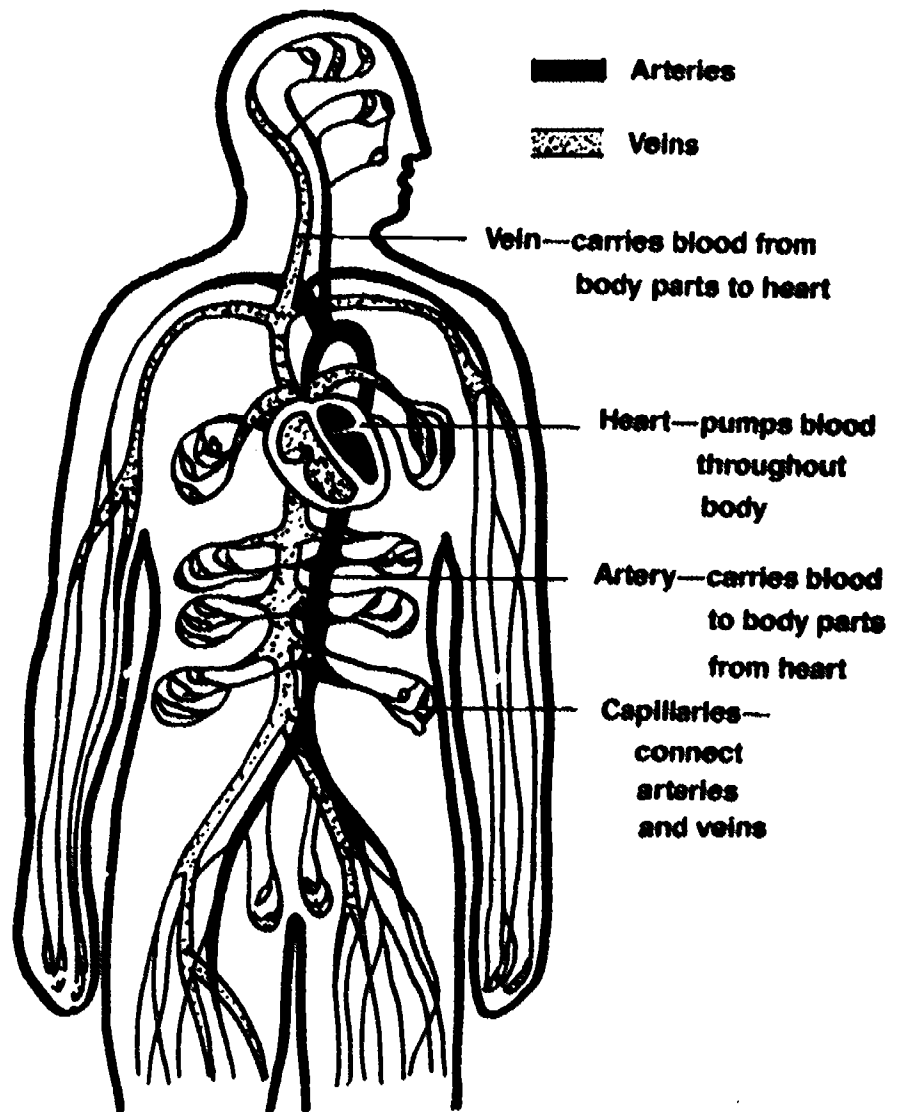

Figure 2-3. CIRCULATORY SYSTEM.

carry blood from the heart to the body cells. Veins carry blood back to the heart from the body cells. Capillaries connect arteries and veins. The capillaries allow oxygen and food to pass through to body cells and carbon dioxide and wastes to pass back into the blood.

Blood. Blood is made up of red blood cells, white blood cells, platelets, and plasma. Red blood cells carry oxygen and carbon dioxide.

White blood cells help fight infections. Platelets help clotting. Plasma is the fluid portion of blood that transports cells, gases, foods, wastes, and hormones.

Lymphatics. Help fight infection and disease.

The heart is a muscular organ about the size of a large fist. It is divided into two sides each with an upper chamber called an atrium and a lower chamber called a ventricle (Figure 2-4).

When the heart beats, its right side collects blood from the body and pumps the blood through the lungs to give off carbon dioxide and pick up fresh oxygen. The blood then goes to the left side of the heart and is pumped through arteries to all parts of the body, delivering food

and oxygen and collecting wastes and carbon dioxide. There are valves between the heart chambers just as there are in any pump. These valves open and close to let blood in and out of the chambers, keeping it flowing in a steady one-way stream.

Aging causes some major changes in the circulatory system. The heart valves may become less efficient, and blood vessel walls may harden, both of which affect blood circulation.

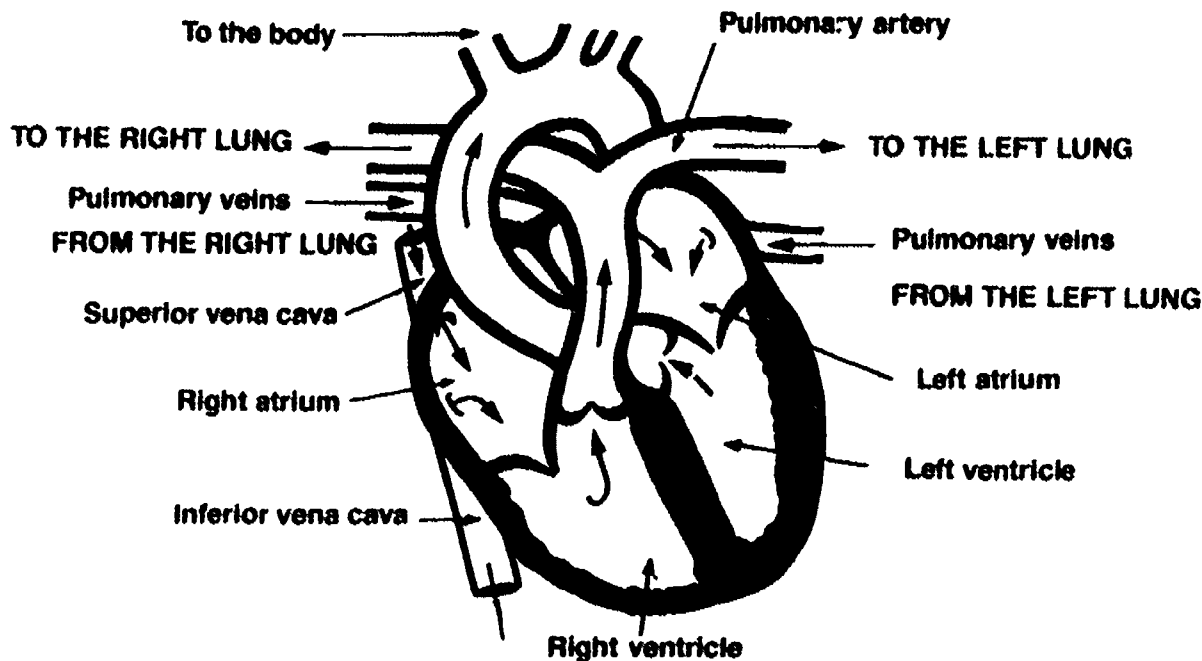

Figure 2-4. HEART.

Digestive System

Functions

- Prepares food (**digestion**) for use by body cells.
- Eliminates solid wastes.

Figure 2-5 shows the many organs that make up the digestive system. Following is a list of the digestive organs and their functions:

Mouth. Inside the mouth, the teeth, tongue, and saliva break food down into smaller particles that can pass further along the digestive system.

Esophagus. A passageway for food.

Stomach. Gastric juices break down food. The churning and mixing help digestion.

Small Intestine. Digestive juices from the liver and pancreas help break down food. Liquified food particles cross over into tiny blood vessels in the wall of the small intestine.

Large Intestine. Water passes through into tiny blood vessels in the wall of the large intestine. Waste products pass out of the large intestine through the rectum.

The digestive system is a continuous, hollow tube that goes from the mouth to the rectum. Each portion of the system plays an important part preparing the food for use by body cells and eliminating the leftover waste.

Three organs assist in digestion but are not part of the tube that the food passes through: the liver, gallbladder, and pancreas. The liver manufactures bile and stores some of the food that is

ready for use by the body. The gallbladder stores the bile from the liver and releases it into the small intestine for use in digestion of fats. The pancreas produces pancreatic juice, releasing the juice into the small intestine for use in digestion of carbohydrate.

After most of the food nutrients are absorbed into the blood stream from the small intestine, the waste products of the food pass out of the body through the large intestine. The large intestine removes much of the water from the food leftovers so that the waste is more solid

when it exits through the rectum and anus. A **sphincter** muscle circles the anus and controls the passage of the waste.

Bowel movement (bm), feces, excrement, and stool are terms used for the elimination of solid waste. An individual who has lost the ability to control the passage of solid waste is said to be **involuntary** or **incontinent** of stool.

Aging and sometimes stress can cause all parts of the digestive system to be less efficient, leading to indigestion and constipation.

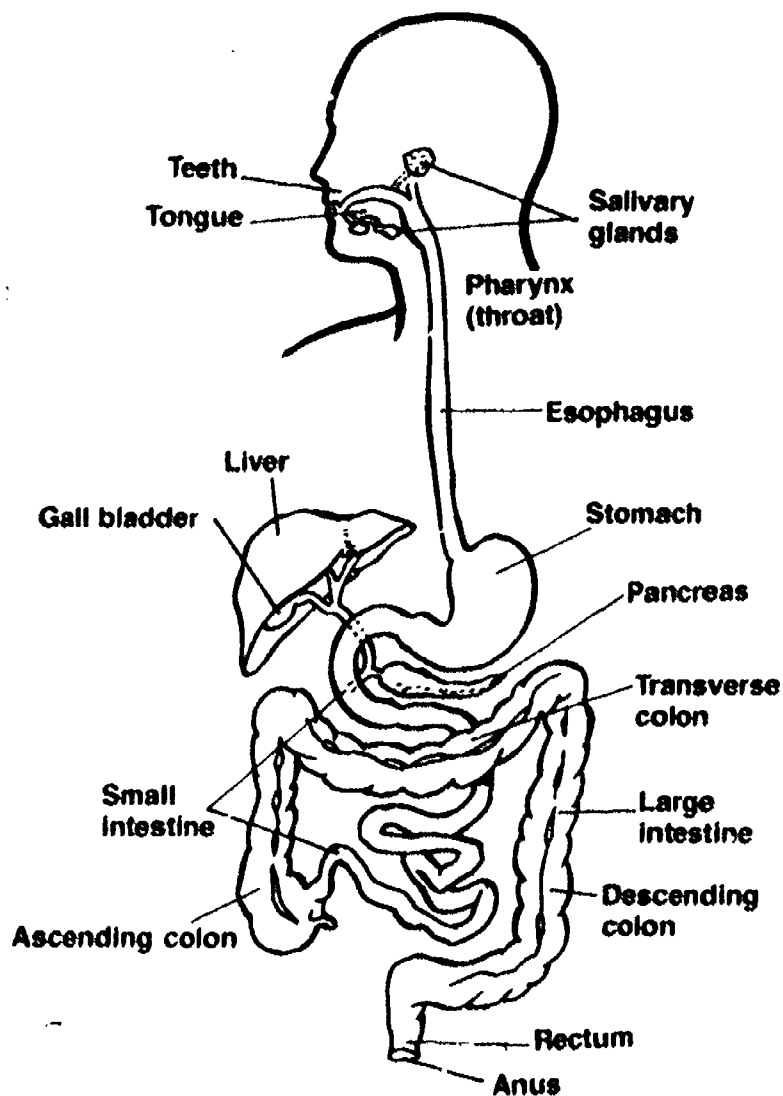

Figure 2-5. DIGESTIVE SYSTEM.

Urinary System

Functions

- Maintains the level of fluid in the body.
- Eliminates liquid waste.

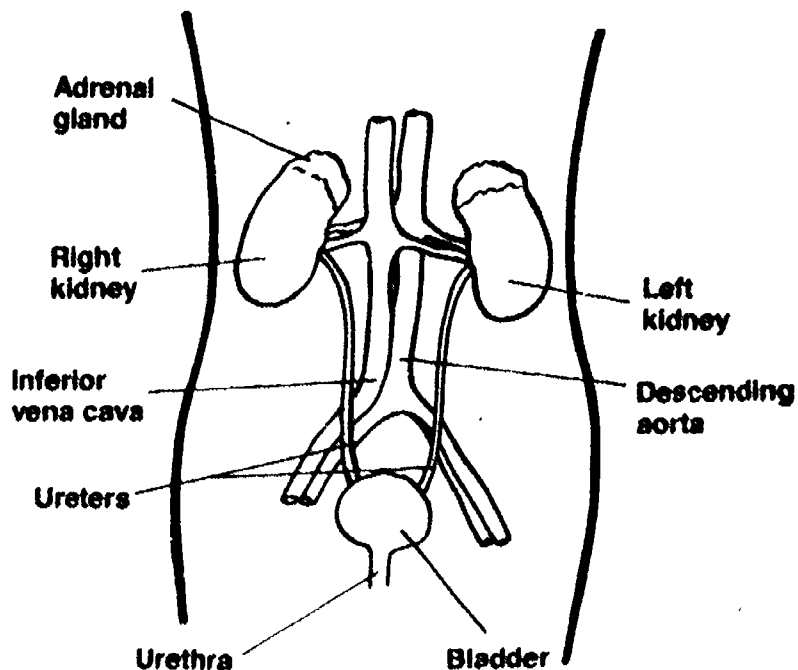

Figure 2-6. URINARY SYSTEM.

Figure 2-6 shows the organs that make up the urinary system. Following is a list of the urinary organs and their functions:

Kidneys (2). Filter waste products from the blood and mix these wastes with water to form urine.

Ureters (2). Carry the urine from the kidneys to the bladder.

Bladder. A reservoir or storage tank for urine. Empties urine into the urethra when necessary.

Urethra. Carries urine out of the body.

A small muscle called the bladder sphincter circles the urethra where it joins the bladder. This muscle controls the passing of urine. When the urinary system is sure that the body has an adequate level of fluid, urine is allowed to pass out of the body. Terms used for the passing of urine are: urinate, void, pass water, and micturate.

An individual who has lost the ability to control the passing of urine is said to be incontinent of urine. Aging sometimes causes changes in the urinary system that can lead to dribbling of urine or leakage after sneezing or coughing. This is called stress incontinence because the dribbling is caused by stress or pressure put on the system by the sneezing or coughing. Be aware of a client's possible embarrassment from urine dribbling or leakage, and treat the problem respectfully.

Skeletal System

Functions

- Supports the body.
- Gives shape to the body.
- Works with the muscular system to allow movement of the parts of the body.
- Protects internal organs.
- Helps produce blood cells in the bone marrow.

The skeletal system is made up of 206 bones of varying sizes and shapes. Figure 2-7 shows the human skeleton and gives the names of the major bones.

The skeleton gives the body a rigid framework. Movement of the parts of the skeletal system occurs at **joints**, the places where two bones meet. Joints vary in the type of movement they

are capable of. Following are types of movement at joints (Figure 2-8):

Flexion. Bending

Extension. Straightening

Abduction. Movement away from the body

Adduction. Movement toward the body

Rotation. Circular movement

Bones tend to become more brittle with age so that **fractures** (broken bones) occur more easily.

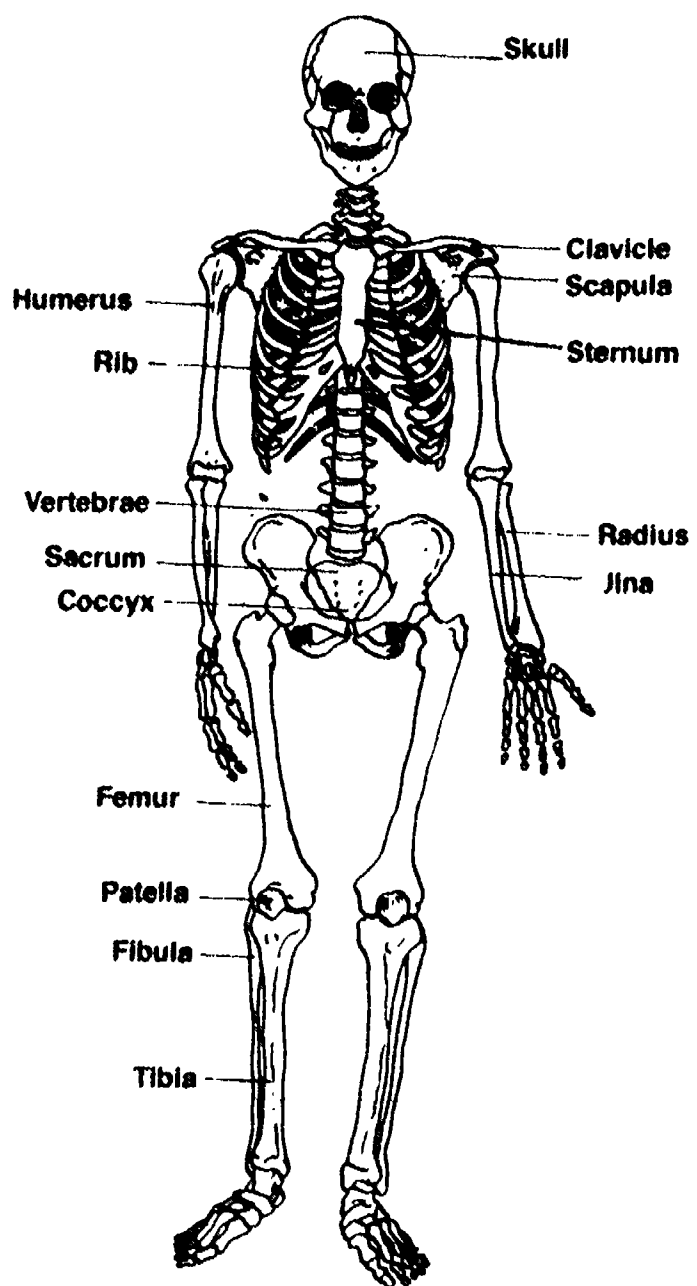

Figure 2-7. HUMAN SKELETON.

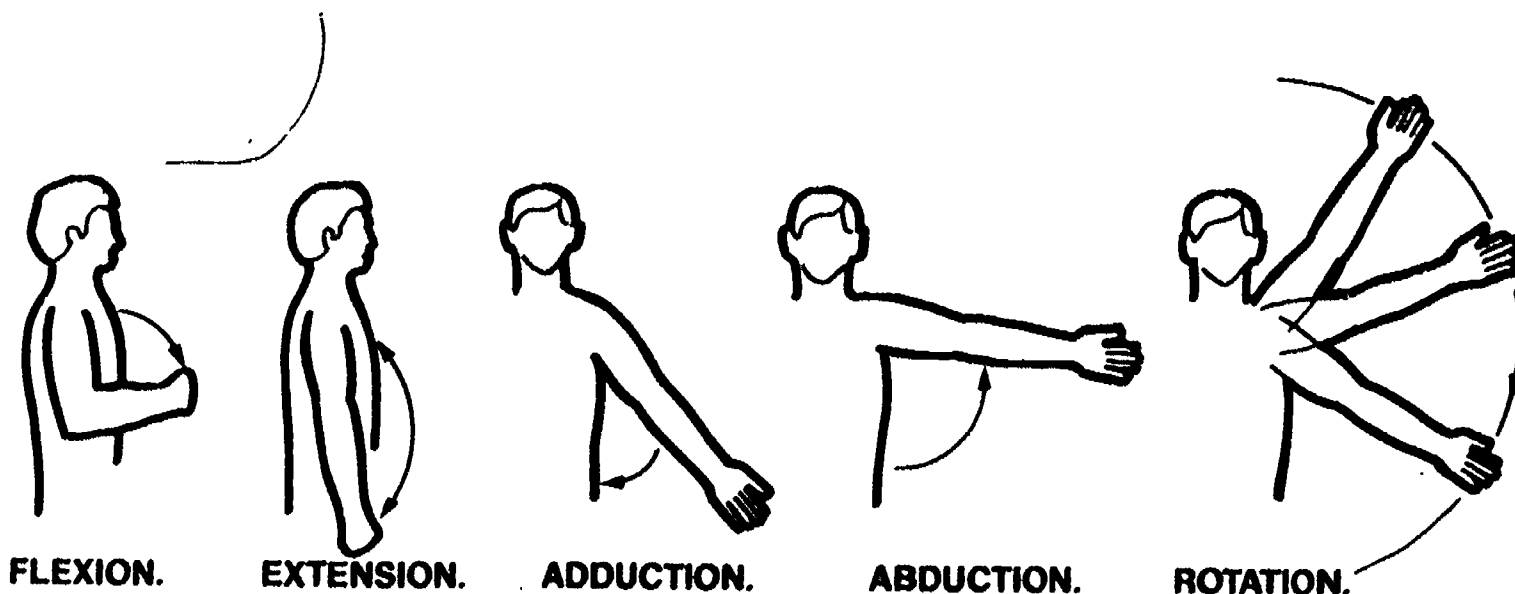

Figure 2-8. MOVEMENT AT JOINTS.

Muscular System

Functions

- Works with skeletal system to allow movement of parts of the body.
- Maintains posture.
- Protects internal organs.
- Produces body heat.

In the body's muscular system there are about 500 muscles divided into 3 types:

Voluntary. Muscles whose actions are controllable.

Involuntary. Muscles whose actions are not directly controllable; that is, they act automatically.

Cardiac. The heart muscle.

All three types of muscles share common characteristics. The muscles are:

Stretchable. They can be pulled longer and thinner.

Elastic. When released after pulling, they return to their previous shape and size.

Cooperative. They always work in pairs or groups, never alone. Muscles must be regularly exercised to remain healthy. A muscle that is not used often enough may **atrophy** (shrink in size and weaken), or it may develop a **contracture** (a permanent tightening of the muscle). A muscle that is overworked may become fatigued and weakened. Aging causes some loss of muscle strength and endurance.

Endocrine System

Function

- Regulates all body functions.

The organs of the endocrine system are called **endocrine glands**. These glands secrete chemicals called **hormones**. Hormones have very important roles in the proper functioning of the body. Figure 2-9 shows the location of endocrine glands. Following is a list of these glands and their functions:

Pituitary gland. Regulates growth and sexual development. Acts as a master gland having some control of all the other glands.

Thyroid gland. Regulates the rate of food and oxygen use (**metabolism**) and body growth.

Parathyroid glands (4). Control body use of calcium and phosphorus.

Pancreas. Produces insulin to regulate carbohydrate use.

Adrenal glands (2). Produce adrenalin to help control metabolism and cope with stress. Also produce cortisone to help regulate carbohydrate use.

Ovaries (2). Regulate menstruation in females. Also regulate female sex characteristics. Produce ova (eggs) for reproduction.

Testes (2). Regulate male sex characteristics. Produce hormones necessary for production of sperm.

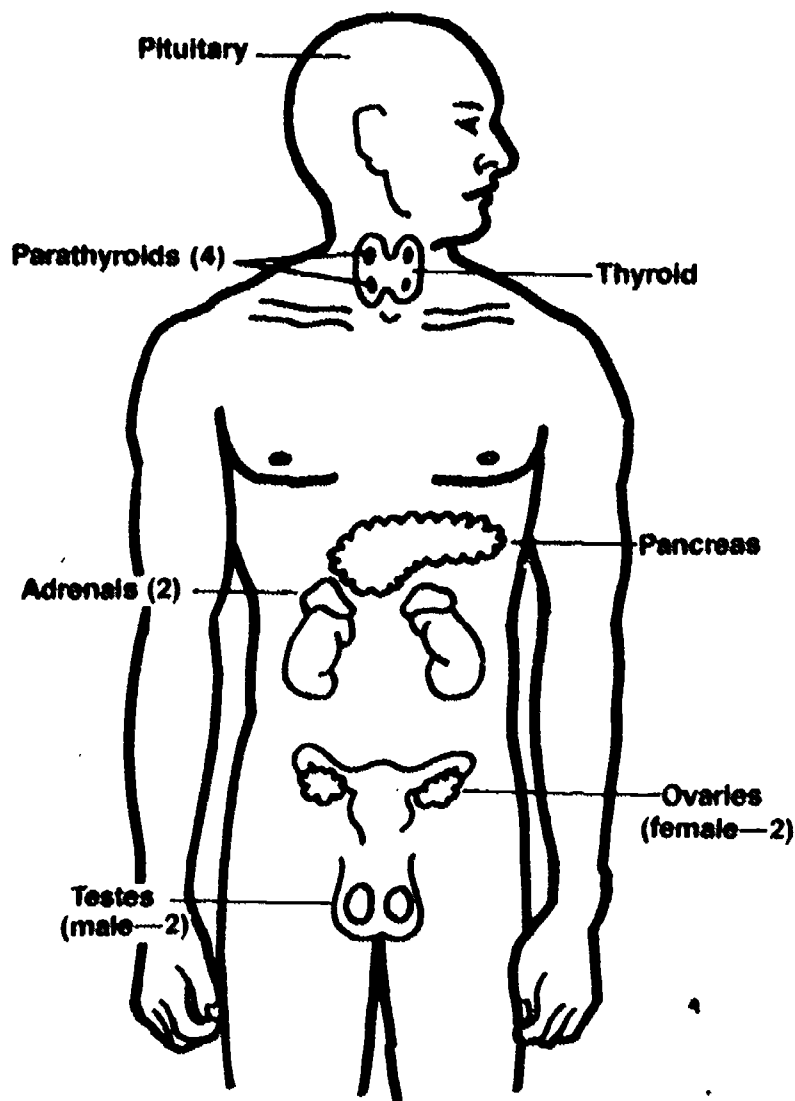

Figure 2-9. ENDOCRINE GLANDS.

Nervous System

Functions:

- Coordinates all body functions.
- Interprets messages from the five senses.

The nervous system is made up of the brain, the spinal cord, and the nerves:

Brain. Acts as the central computer of the body and is responsible for: thinking, emotions, senses, coordination, learning, and memory. The right side of the brain controls activities of the left side of the body and vice-versa.

Spinal cord. Carries messages to and from the brain. The spinal cord controls reflexes like eye-

blinking and knee-jerking and acts as a protective short circuit for the nervous system.

Nerves. Carry messages to and from the spinal cord and brain.

Messages that are carried from the brain to the muscles are called **motor impulses** because they cause movement. Messages travelling to the brain are called **sensory impulses** because they carry information from the senses.

Following is a list of the five senses and their organs:

Sight. Organ: eye

Hearing. Organ: ear

Smell. Organ: nose

Taste. Organ: tongue

Touch. Nerve endings in the skin feel pressure, heat, cold, and pain

The organs of the nervous system cannot be repaired or renewed when they are badly damaged. This means that messages are unable to travel over injured parts of the system, and thus brain communication with distant parts of the body is decreased or cut off. If motor impulses don't get through to a part of the body, the part will be unable to move (**paralysis**). Or, if sensory impulses don't get through to the brain from a part of the body, the part will have no feeling.

Aging causes some changes in the speed and efficiency with which the nervous system functions. Slower reactions, poorer vision or hearing, and a decrease in the ability to taste are changes that may occur. Such changes must be accepted and dealt with as part of the normal aging process. Eyeglasses and hearing aids, different cooking and seasoning methods, and allowances for slower reaction may help compensate for the changes. As a care worker you must respect aging clients undergoing such changes and do what you can to preserve their self-image.

Reproductive System

Functions

- Ensures survival of the human species.
- Produces hormones to control sex characteristics.

Female Reproductive System

Following are the female reproductive system organs (Figure 2-10) and their functions:

Ovaries (2). Produce eggs for reproduction and manufacture female sex hormones.

Fallopian tubes (2). Carry the egg to the uterus.

Uterus. Houses the baby in pregnancy. The lining is shed monthly in menstruation.

Vagina. The passageway for menstruation, the birth canal, and the female organ of sexual intercourse.

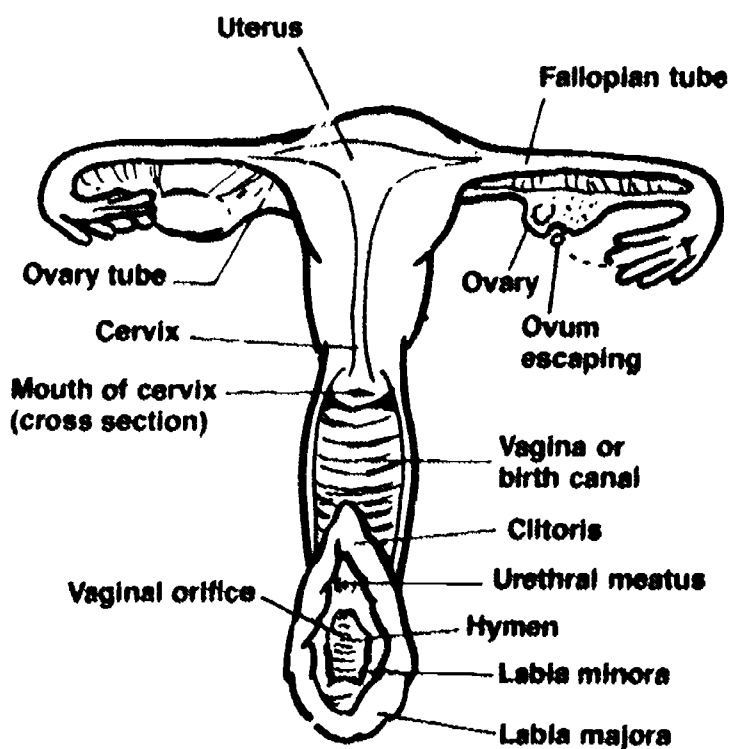

Figure 2-10. FEMALE REPRODUCTIVE SYSTEM.

Every 28 days or so after a girl reaches the age of 11 to 13, one egg is produced by one of the ovaries. This is called **ovulation**. The egg travels through the nearest fallopian tube to the uterus. While the egg is being produced, the uterus builds up a rich and nutritious lining of blood vessels and tissues to receive the egg if it should become fertilized. If the egg is not fertilized during its journey from the ovary to the uterus, it is absorbed by the body and disappears. The rich lining of the uterus, which is no longer needed, breaks down and passes through the vagina as part of the monthly bleeding known as **menstruation**. Menstruation continues until middle age. The time during which it ceases is called **menopause**.

Male Reproductive System

Following are the male reproductive system organs (Figure 2-11) and their functions:

Testes (2). Produce sperm for reproduction and manufacture male sex hormones.

Prostate gland. Produces fluid to help sperm survive.

Vas deferens (2). Passageways for sperm.

Penis. Contains urethra as a passageway for sperm. The male organ for sexual intercourse.

When a boy reaches the age of about 13 or 14, the testes begin to produce sperm. Sperm travel from the testes through the vas deferens where they are stored in a special section along with fluid necessary for their survival.

During sexual excitement, the blood vessels in the penis fill up so that it becomes stiff and enlarged. This is called an erection. At the climax of sexual intercourse strong contractions of the muscles at the base of the penis force the sperm and fluid out through the tip of the penis. This ejaculation can also occur during sleep or as a result of manual stimulation of the penis. At the time of climax, the sperm in the fluid enter the woman's vagina, pass through the cervix of the uterus, and eventually enter the fallopian tubes where fertilization of the egg may occur.

Male and female sexuality is a part of life that does not disappear with age. Sexual need varies with the individual. It is important for you as a

care worker to remember that sexuality is a normal human need.

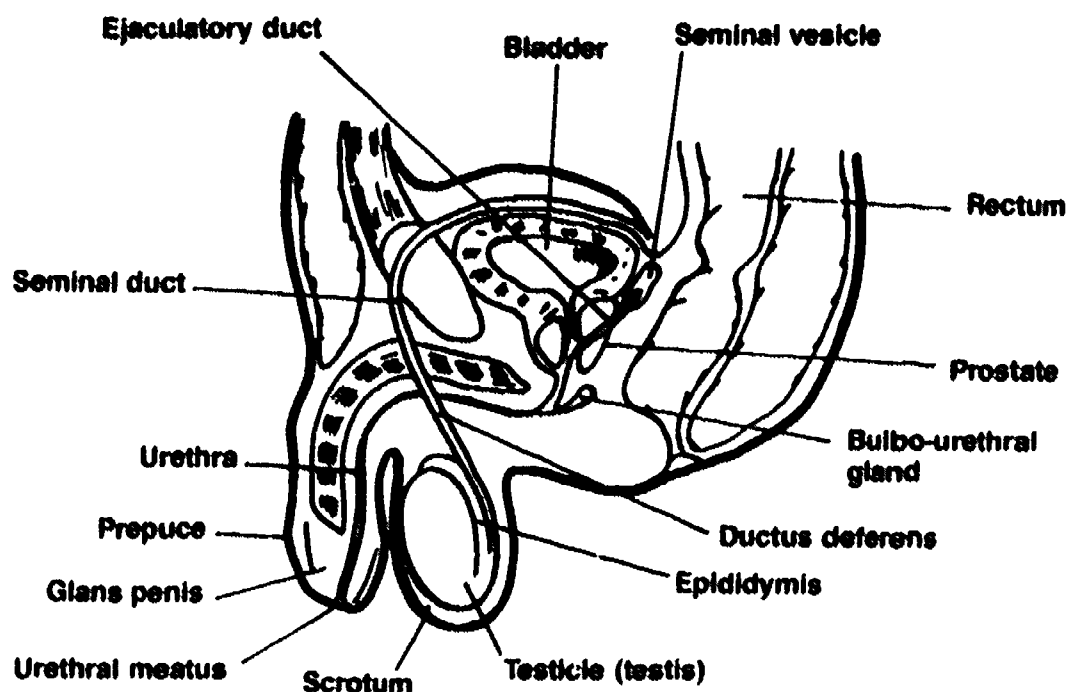

Figure 2-11. MALE REPRODUCTIVE SYSTEM.

Skin

Functions:

- Covers and protects the body.
- Eliminates waste through sweat.
- Helps regulate body temperature (the evaporation of sweat cools the body).
- Nerve endings in the skin sense pressure, heat, cold, and pain.

The skin covers the outer surface of the body. A healthy skin acts as a barrier to harmful substances and thus protects the body. Any break in the surface of the skin will permit bacteria to enter the body.

By means of perspiration (sweating), the skin of an average adult gives off close to one litre of liquid waste every day. As this moisture evaporates, it cools the body. When an individual feels

cold, less sweat is lost through the skin in order to keep the body warmer. Clean skin with unplugged pores is necessary for the body to perspire correctly.

The skin produces oil to keep itself lubricated and healthy, although sometimes the oil can build up in pores causing discomfort. Since an oil buildup is more likely to happen if the pores become clogged, cleanliness is necessary to keep the skin healthy.

As the skin ages, it thins and wrinkles and very often becomes dryer and more easily injured. These changes cannot be stopped, but they can be made less of a problem with good skin care. Basic skin care practices are:

- A nutritious diet
- Adequate fluid intake
- Regular exercise and rest
- Good personal hygiene

EXERCISE 2-1

1. Match:

- | | |
|-----------------|---|
| a. Body cells | 1. Tissue working together to perform a function. |
| b. Body tissue | 2. Group of organs working together. |
| c. Body organs | 3. Building blocks of all living things. |
| d. Body systems | 4. Cells working together to perform a task. |

2. Match:

- | | |
|------------------------|--|
| a. Respiratory system | 1. Protects internal organs. |
| b. Circulatory system | 2. Produces body heat. |
| c. Digestive system | 3. Interprets messages from the five senses. |
| d. Urinary system | 4. Exchanges oxygen for carbon dioxide. |
| e. Skeletal system | 5. Ensures survival of the human species. |
| f. Muscular system | 6. Eliminates liquid wastes. |
| g. Endocrine system | 7. Carries food and oxygen to the body cells and removes wastes and carbon dioxide from the cells. |
| h. Nervous system | 8. Covers and protects the body. |
| i. Reproductive system | 9. Prepares food for use by the body cells. |
| j. Skin | 10. Regulates all body functions. |

3. What is the name of the muscle that causes breathing?

4. Aging can _____ blood circulation.

5. What three organs assist in digestion of foods, but are not part of the digestive tube?

6. What is stress incontinence?

7. What can happen to a muscle that is not used enough?

8. What three organs make up the nervous system?

HUMAN NEEDS

Human needs can be classed as survival needs, security needs, social and stimulation needs, and self-esteem and achievement needs. Some needs such as the survival needs for oxygen and food are necessary in order to live; without them the human organism would die. Other needs such as the social need for love or the need for achievement help to make a person's life more rewarding and fulfilling.

Although people have the same basic needs, individuals vary in the degree to which they have many of the needs. For example, some people need more sleep than others, some people have a stronger need for security than others, and some people have a greater need for achievement than others. The extent to which a person's needs are met strongly influences the person's general well-being and outlook on life.

People are always striving to fulfill their needs and these needs usually have an order of priority. The pyramid in Figure 2-12 shows one theory of the order in which needs are usually filled; the needs at the base of the pyramid must be met before those higher up can be filled. It is true that on occasion a person is able to seek needs at a higher level on the pyramid without having met a lower need. However, usually people function better at striving for higher needs when their basic requirements are met. For example, a woman who has little food and money and is living in an overcrowded apartment will probably have difficulty trying to meet her achievement needs.

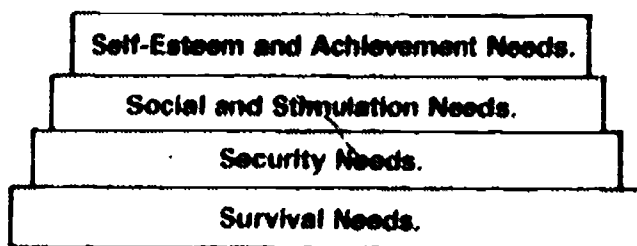

Figure 2-12. Hierarchy of Needs.

Survival Needs

In order to survive, humans need oxygen, food, fluid, rest and sleep, mobility, and elimination (Figure 2-13).

Oxygen

All parts of the body need oxygen to function; oxygen allows the body to turn food into useful energy and heat. The body breathes in air and takes oxygen from the air. Breathing or respiration is automatically controlled by the brain, but emotions and stress can affect the rate and depth of **respiration**. The respiratory and circulatory systems must be fairly healthy for oxygen to get to the parts of the body, and the air must be reasonably unpolluted. Unless ill, an individual meets the need for oxygen unassisted.

Food

The body's fuel is food. Canada's Food Guide gives the required amounts of different types of food needed daily. The necessary types of food are:

Carbohydrates. Source of energy found in fruits, vegetables, sugars, starches.

Proteins. Are used for building and repairing body tissues and are found in meats, poultry, fish, dairy products, legumes.

Fats. Source of heat and energy found in oils, butter, cream, egg yolk.

Vitamins. Are used for growth and repair and are found in many foods in varying quantities.

Minerals. Are used to build tissues, bones, teeth, and are found in many foods in varying quantities.

Roughage. Are used to stimulate bowel elimination.

The digestive and circulatory systems must be in reasonable health for food to get to the cells of

the body. The type and quantity of food that individuals require changes at different stages of life. Due to age or a disability, some individuals are unable to obtain and prepare food for themselves and will require assistance.

Fluid

Water makes up a good portion of body fluids such as blood, saliva, and intestinal juices. In fact, between 50 and 80 percent of total body weight is water. Thus it is easy to see how important fluid is for survival.

Water taken into the body must be reasonably pure. Water transports oxygen and foods to parts of the body and carries away waste products. The digestive, urinary, and circulatory systems must be fairly healthy for fluid needs to be met. The thirst mechanism of the body helps regulate fluid intake. Ill or some disabled persons may require aid in meeting their fluid requirements.

Rest and Sleep

About one-third of our lives is spent in sleep. Sleep allows the body to refresh and renew itself and also allows time for growth and repair. Rest and relaxation permit a recharging of physical and emotional energy. People require different amounts of sleep and usually fulfill this need unassisted. Stress can cause difficulties in sleeping.

Mobility

Movement and activity strengthen and tone the body. Inadequate mobility can affect sleep and can also disturb normal bone growth, resulting in porous, brittle bones. The ability to be mobile is closely related to self-image; if people become immobile, they usually think less of themselves. Thus it is important for clients to remain as mobile as possible. The need for movement is normally met unaided, but persons of certain age groups or persons who are ill or disabled may require assistance.

Elimination

All body systems produce waste products that must be removed or eliminated from the body. These waste products are urine, feces, perspiration, and exhaled air containing mostly carbon dioxide. The type and amount of wastes created depends on the individual's diet, fluid intake, breathing, temperature, and stress level. Elimination needs are sometimes difficult to control for persons of certain age groups or for some disabled people, and they may require assistance with elimination.

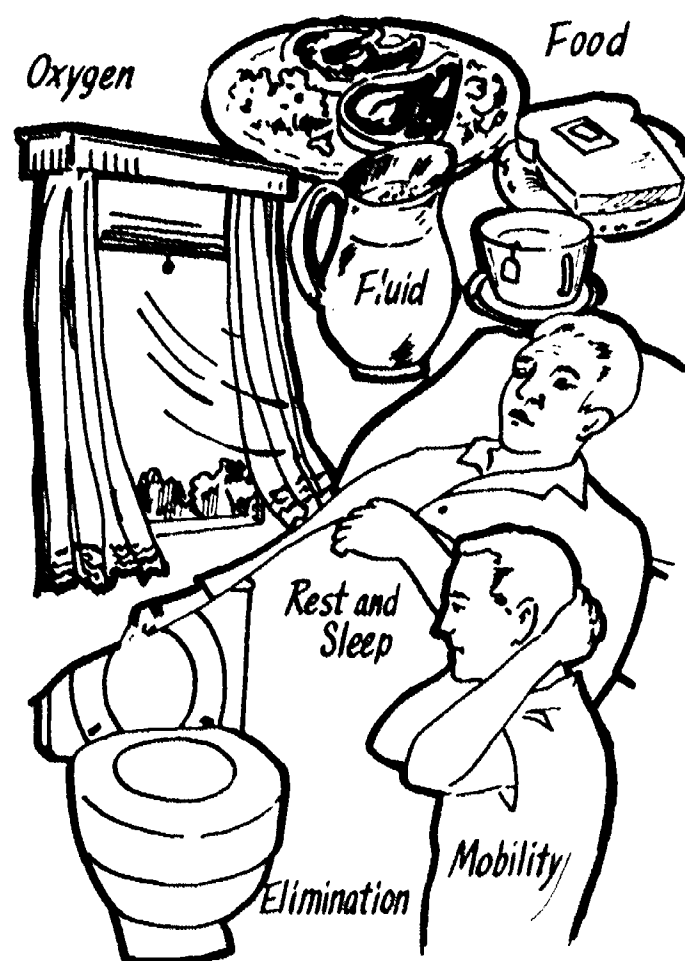

Figure 2-13. Survival Needs.

Meeting Survival Needs

No system of the body works alone; systems work together to fulfill survival needs. An example of body systems working together can be seen in mobility. To be mobile a skeletal system is needed for support and a muscular system for movement. For the muscles to move they re-

quire a message directing them (nervous system), fuel (digestive, endocrine, respiratory, and circulatory systems), and waste removal (circulatory, urinary and digestive systems). This means that eight body systems are actively involved in making a body mobile. Note that **the body systems that fulfill survival needs must be kept active to stay healthy.**

There are several main factors that determine how well individuals meet their survival needs:

- Age
- Health
- Ability
- Economic status
- Available assistance

Infants cannot meet many of their own needs. This dependence gradually lessens from childhood to adulthood as individuals become responsible for themselves. Some adults, however, may be unable to care for themselves because they have a physical disability or are ill. These adults require help to meet their daily needs. Other adults may be financially unable to meet their needs, even food needs, and they will also require assistance.

The amount of assistance available to people varies greatly depending on their culture, country, province, community, and economic level. Certain cultures encourage families to look after the needs of their own family members. Some countries have widespread social services, whereas others offer very little assistance to their citizens. Often services that are easily obtained in a city are impossible to get in a rural area. In some areas, help is available only to those who can pay for it or make the extra effort to seek it out. Luckily, in Canada there is assistance for most people. Homemaker agencies, home care agencies, and residential care facilities assist many people to meet their basic needs.

Meeting the Oxygen Need

To meet the need for oxygen people must have:

A healthy respiratory system. Disease or infection of the respiratory system interferes with

the ability to draw oxygen from the air breathed in.

A healthy circulatory system. Poor functioning of the circulatory system hampers delivery of the oxygen picked up from the lungs and intended for the body cells.

Clean air. The amount of oxygen in polluted air may not be enough for an individual's needs.

If problems exist in any of these areas, measures have to be taken to correct them. Medical treatment of health problems should improve the functioning of the respiratory and circulatory systems. Insufficient oxygen due to air pollution may require moving to another location until the air pollution is decreased. Occasionally, it may be necessary for individuals to receive extra oxygen from a tank in order to meet their need for oxygen.

Meeting Food and Fluid Needs

To meet the needs for food and fluid, people must have:

Healthy digestive, urinary, and circulatory systems. Disease or infection of the digestive system can interfere with the breaking down and absorbing of water and useful food particles. Urinary problems may prevent a good fluid balance. Poor functioning of the circulatory system will hamper delivery of food and water to the body cells.

Adequate food and fluid intake. If people do not eat the correct types and quantities of food and fluid, their nutritional needs cannot be met. Information on nutrition is found in Canada's Food Guide.

Money to buy the required foods and fluids. Poverty is one of the major causes of poor nutrition.

Physical ability to shop for and prepare foods and fluids. Medical treatment of disease or infection will help the functioning of a client's body systems. The client's nutritional intake may be improved by a discussion on dietary

requirements and economical meal preparation with yourself or a dietitian. Note that you may need to repeat and re-explain information about food and fluid needs to clients so that they fully understand these needs. Be sure to check that you are reinforcing the right facts; if in doubt, check with a dietitian or your supervisor.

Financial and physical difficulties require assistance. Your supervisor may contact government agencies for financial aid or for help with meal preparation. If this is a new problem, be sure to accurately report it to your supervisor. The earlier the problem is discovered, the sooner it can be solved.

Meeting Rest and Sleep Needs

Rest does not simply mean not being active; it requires physical comfort and freedom from stress and anxiety. Individuals vary as to the amount of rest and sleep they require.

Rest or sleep may be more difficult for people living alone or in a care facility. It is not uncommon for people living alone to fear that they are incapable of dealing with their problems, and sleeplessness may result from this fear. Persons new to a care facility may find the unfamiliar surroundings, sounds, and activities interfere with their rest or sleep. To meet rest and sleep needs people must have:

- A feeling that things are under control, either their control or a concerned person's control.
- An understanding of problems in their life that might hinder their rest or sleep.
- Freedom from physical discomfort or irritation.
- Adequate exercise and activity.
- Knowledge that help is available if needed.

Remember that individuals do not agree on what is restful. Music that may be soothing to one person may be very irritating to another. Some people are more relaxed in a reclining chair than in bed. Under stress, many people rest more easily if they are not left alone, whereas others must feel they are in very private surroundings before they can rest.

Aging alters the need for sleep and sleeping patterns. A newborn baby may sleep a total of 18 to 20 hours per day. Most adults require from 6 to 8 hours of sleep per night. The elderly often find they sleep shorter periods at night, but require a rest during the day. You should learn your clients' sleeping and resting requirements and patterns so that you can better help them get adequate rest and sleep.

Meeting the Mobility Needs

To meet the mobility need people must have:

Healthy muscular and skeletal systems. The skeleton must be strong enough to support the body, and the muscles must be able to move the body parts. Also, the nervous system must send accurate messages to the muscles.

Regular exercise. Exercise should be part of each individual's day; it can range from vigorous sports to prescribed exercises done in bed.

Age is related to body movement and mobility. Infants are very supple and active, but their movements are not very well controlled. As infants grow, they gradually gain more control and coordination. The aging adult loses some muscle elasticity and strength and may lose bone solidity as well. People of all ages, including the elderly, should keep as mobile as they are able.

Disease or injury to the muscular, skeletal, or nervous systems may cause temporary or permanent impairment of movement. If this occurs, range of motion exercises may be prescribed to keep joints as movable as possible. The client's physician writes orders detailing what exercises are to be done and how often. Exercises are discussed in Section 4 under the heading, "Dangers of Inactivity".

Unhappy clients or clients under stress may stop usual activities and exercise. This can lead to stiffness and loss of strength and mobility. If the inactivity continues for long, even for a period as short as 24 hours, much time and effort may be required to restore the body to its former level of activity. Remember, it is much easier to maintain body mobility than it is to regain it.

Meeting the Elimination Need

To meet the need for elimination, people must have:

Healthy digestive and urinary systems. If waste products are not collected efficiently in these systems and removed from the body, they can build up and cause major health problems.

Adequate food and fluid intake. If adequate quantities of nutritious food and fluids are not taken in, elimination is slowed down.

Privacy. Elimination is a very private matter for most people. People are most comfortable during elimination knowing that others cannot see, hear, or smell them. If they feel they are "performing in public," they may have difficulty eliminating.

A position of comfort. Individuals become used to a fairly comfortable position for eliminating in which gravity can help the process. The usual position is to be seated with the feet supported, or standing for male urination. Elimination habits are established very early in life, usually by age 2 or 3, and thus changes can be hard to make. There is tremendous psychological value for a client to be normally positioned for elimination. Some clients have trouble eliminating in unusual positions on a bed.

With aging, human systems generally slow down. The slowdown of the digestive system may mean that wastes are not moved through the system as efficiently as before. A slowdown in the passage of wastes may in time cause **constipation**. Constipation is a condition of hard, dry stool that is difficult and even painful to pass and is passed less frequently than normal.

Older adults, in particular, are prone to constipation and often show concern about it. Steps taken to prevent constipation are (Figure 2-14):

Exercise. Activity helps the bowels function.

Roughage. Extra roughage in the diet such as is found in bran, raw fruits, and vegetables stimulates the bowels.

Fluid. Two to three litres of fluid per day helps to keep feces moist so that they pass easily.

Routine. Establishing a regular routine for elimination can be helpful.

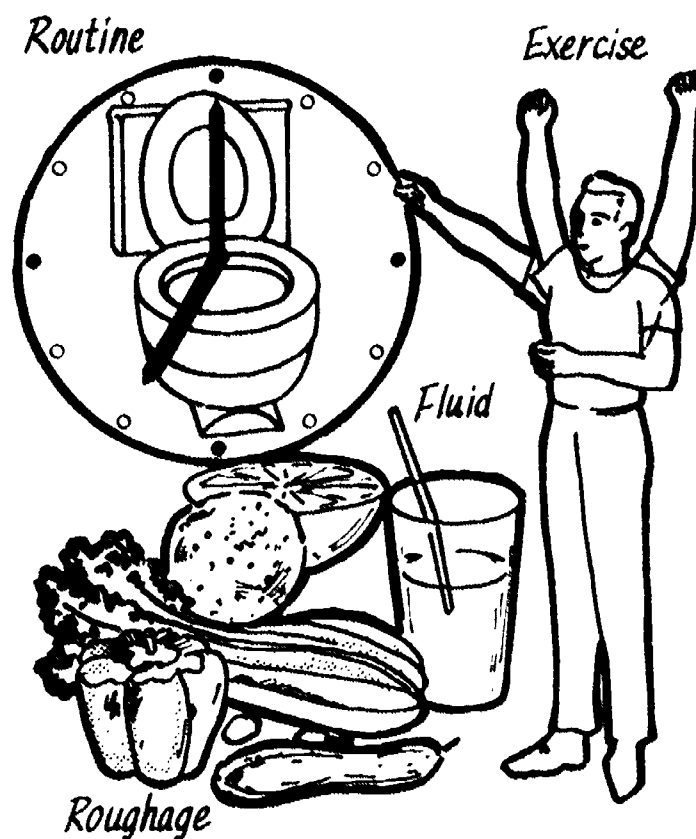

Figure 2-14. Preventing Constipation.

Meeting Security Needs

To meet security needs people must have:

Shelter, clothing, and warmth. People need protection from the weather, and they need a comfortable temperature to live in.

A safe environment in which they are not threatened. Faulty electrical wiring, a dangerous stove, and broken stairs are examples of conditions that can make an environment unsafe and cause insecurity. Feeling threatened by someone or some group, whether the threat is real or imagined, also causes insecurity.

Not more than a normal amount of anxiety. Too much anxiety over real, imagined, or exaggerated problems causes insecurity.

Confidence in their means of support. People need to believe that they themselves have the means, or someone else will supply the

means, so that they can carry on the life they are used to. People vary in what means it takes for them to feel secure.

In addition to these items, people also have physical defenses and psychological defenses to help them meet their security needs.

Physical Defenses

To fight off disease and infection, the body has three lines of defense:

- Skin
- Blood cells and lymph
- Antibodies

Intact skin acts as a barrier to foreign substances capable of harming the body. Good skin care practices keep the skin an effective barrier.

If infection enters the body, the white blood cells and lymph cells gather to neutralize and destroy the infection before it causes harm. It may take a little time to gather enough white blood cells to control the infection. The area of infection is warmer than the rest of the body, because the increased warmth helps to fight the infection.

Except when infection exists, temperature changes in the body are controlled to keep the temperature as close to 37°C as possible. The body produces heat when it is cool by faster use of fuel (food) and by muscle activity. Shivering is a muscle activity that warms the body. To cool itself when overheated, the body relies on perspiration and radiation of heat into the cooler environment.

Antibodies also protect the body; they are produced in response to a certain disease and thereafter remain in the body to help build up immunity or resistance to that disease. Individuals vary in their resistance to diseases. Antibodies are also made in the body in response to an immunization injection. For example, if weakened measles-causing organisms are injected into the body, the body produces antibodies to fight these organisms. Once formed, the antibodies are always there to help prevent the body from getting measles in the future.

Pain is a body defense signal; it is a feeling of discomfort sent to the brain by the sensory nerve cells in an area of distress. Pain alerts a person to the fact that injury, infection, or illness may have occurred, and thus it helps to safeguard the person.

In addition to the physical reaction of pain, there is also a psychological reaction that varies greatly with cultural background, personality, situation, and mood. Some cultures encourage a strong, stoical attitude toward pain, whereas others support a more noisy, dramatic reaction. Some people are more outgoing than others and communicate their pain more readily. Pain can be felt differently depending on the situation. For example, a little girl who stubs her toe while playing with her friends may simply say, "Ouch," and go on playing; but the same child may cry loudly and run for attention if she stubs her toe in front of her anxious mother. Mood also affects pain. For example, a confident, happy person may ignore a pain, whereas a depressed person may really feel it. As a health care worker you must be aware and accepting of different reactions to pain.

Always report clients' pain. Keep in mind the different ways that clients react to pain. Observe children carefully for pain, since they are unable to speak. Watch for the following outward signs of pain:

- Tears in eyes
- Tense facial expression
- Holding a body part
- Quiet, withdrawn behaviour
- Restlessness

Pain Information To Report

- Location of pain
- Time it started
- Type of pain: sharp, dull, constant, intermittent
- Severity of pain: mild, moderate, severe
- Factors affecting pain: e.g., movement, deep breathing, body position

Psychological Defenses

When a person is unable to face a problem, anxiety results. To counteract the anxiety, the person may try to ignore the problem or deny that it is a problem, finding another more acceptable name or explanation for it. These psychological defense mechanisms are used to some degree by everybody; they are an attempt to reduce anxiety or to save face. Such defenses are only considered abnormal when they are overused to the point where a person never admits to problems or tries to solve them. Common psychological defense mechanisms are:

Rationalization. Use of an acceptable excuse for unacceptable behaviour. Example: The statement "I couldn't do my assignment because I didn't have time" may be a rationalization for the assignment being too difficult or for a failure to make the time to do it.

Denial. Disowning or refusing to admit the existence of intolerable facts or feelings. Example: Children frequently feel dislike of their parents but are afraid to admit this for fear they will be rejected. A person who is dying may deny the fact, because he or she can't accept it.

Repression. Forcing an unpleasant thought or memory out of conscious awareness. Such convenient forgetting is quite common. Example: A person undergoes an embarrassing experience but is unable to remember it soon afterwards.

Displacement. Transferring a feeling from one situation to another. Example: A male client who is upset because he can no longer care for himself may be short-tempered with the care worker. The old saying about "kicking the cat" is another example of displacement.

Projection. Placing the blame for one's own shortcomings onto another person or situation. Example: A female student fails an exam. She explains that it wasn't her fault she failed; it was the instructor's fault because the instructor didn't like her and picked on her.

Conversion. Using illness as a means of escape by turning anxiety into a physical symptom. Example: A child develops a stomachache the morning of an important school test. The

stomachache is a means to avoid the test. Such a self-willed illness also is sometimes an unconscious request for love and acceptance, because extra attention is often given for illness.

Fantasy. Daydreaming to escape reality. Example: A client thinks only of a happy past rather than deal with unpleasant realities of the present.

Withdrawal. Removing oneself from a situation physically or emotionally. Example: A male client does not like a person. If the person comes into the company of the client, the client leaves if he can or else withdraws into himself, refusing to recognize the existence of the other person.

Psychological defense mechanisms are used by people to avoid problems, to make the world appear better than it is, and to make their behavior appear more reasonable and acceptable to themselves and others. These defense mechanisms can become mental crutches that prevent people from looking for better ways of dealing with their situations or problems. Like real crutches, however, they cannot be taken away until other support is found.

Meeting Stimulation Needs

A mentally and physically active person is usually happier than an inactive person. In other words, the natural state for people is to be busy doing or thinking something. In order to become active, a person must be stimulated (excited) by the thought of acting and also be motivated (want) to take action.

The three aspects of taking action — stimulation, motivation, performing the act — can be seen to work in a circle. The idea of the act is presented to a person, the person is excited by the idea, gets motivated to do the act, and then performs it. By performing the act, the person is further excited and continues to do it.

People need stimulation to be active and healthy. Too little stimulation can inhibit a person's ability to function and deal with the world. Symptoms of inadequate stimulation are:

- Boredom
- Disorganized thinking
- Increased sleeping
- Anxiety or panic

People who are most likely to suffer from not enough stimulation are those who live in isolated situations. People with sensory loss such as poor sight or hearing can also have inadequate stimulation. In addition, various sedating medications can contribute to a lack of stimulation.

On the other hand, a person can get too much stimulation, although this is far less common an occurrence than too little. In any case, too much stimulation can be as damaging as too little because it can cause a person to withdraw or tune out everything.

Stimulation From Activity

Physical and mental activities stimulate people. The range of activities is very wide. Mental activity can be doing a crossword puzzle or reading a book on Einstein's theory of relativity. Physical activity can be building a model airplane or building a house. The main point about activities with regard to stimulation is that it doesn't matter how important or meaningful an activity is. What matters is that the activity is stimulating, keeping the person's mind and body active and interested in life.

As a care worker you should be careful not to impose your values on clients' activities. Encourage clients in activities that they show an interest in, even though you personally may feel the activity is a waste of time. Activities and motivating clients to do activities are discussed in Section 4 under the heading, "Motivation and Activation Programs."

The need to keep the body active is frequently stressed. Not so frequently mentioned is the need to keep the mind active. The mind is like the body in that if it is not used, its ability to function deteriorates.

Stimulation From Novelty

Generally speaking, people are stimulated by novelty, by the new or different. Examples of novelty are: meeting a new person eating different food, trying a new activity, going to a movie, read a book (Figure 2-15), meeting a new challenge, buying something, visiting a new place, rearranging the furniture in a room, or trying a different way of doing something. Do what you can to encourage novelty in the lives of your clients. It may take an effort to encourage certain clients to try something new, but the benefits for the clients usually make it worthwhile.

One thing to keep in mind, however, is that in some situations novelty can be annoying rather than stimulating. For example, a client may find a change in routine upsetting, especially if the change seems to have been made just for the sake of a change.



Figure 2-15. Reading.

Stimulation From Sexuality

Sexuality is a term that applies to all aspects of being sexual: sexual activity, attitudes, thoughts, feelings, and roles. Sexuality is a main form of stimulation for people. It is an ongoing life force expressing itself in different ways at various stages of life. Factors that influence sexuality are

family, culture, sexual experiences, and social circumstances.

Studies have shown that the elderly are capable of much more sexuality than was previously accepted. Moreover, elderly people think of themselves as sexual beings. This is a fact that society has tended to deny or ignore, probably because many people are uncomfortable with the subject of sexuality and the elderly. As a care worker you should accept that sexual activity amongst at least some of the elderly is a fact of life, and consenting elderly adults have a right to private sexual expression.

Sexual matters tend to shock and entertain, leading to undue attention and gossip. When sexual incidents occur in health care facilities, they often create a degree of tension out of proportion to the actual occurrence. This tension is not just created by staff but by other clients who can be very critical of the behaviour of others, especially sexual behaviour.

With confused persons, it is easy to imply sexual motives where none exist. An example is when a wandering client gets into another's bed, perhaps for warmth, company, or the memory of years spent sleeping with a spouse. Clients who expose themselves or undress publicly may have innocent motives. In dealing with these occurrences, it is important not to exaggerate the intention or manufacture a problem. Keep an open mind, and discuss the incident with other staff.

As a health care worker you must not impose your own sexual standards on clients. This does not mean that you have to accept sexual behaviour or language you find offensive. If you voice your dislike of offensive language or behaviour to a client (who is mentally alert) and the client persists, then leave the area, giving your reason to the client. Contact your supervisor for advice.

Masturbation or fondling of the sexual parts by clients may be a problem for workers or relatives to deal with, often because they link shame and guilt to the practice. If a client masturbates in private, this should not concern others; however, public masturbation may require discussion to work out a satisfactory solution.

Remember that a closed door or drawn curtain indicates a private space. Much embarrassment can be prevented by respecting private spaces and knocking or announcing your presence before entering.

As a care worker you must be careful that your language and behaviour are not seen as sexually provocative by clients. Your style of dress should be conservative and your behaviour respectful. A sexually enticing manner, even when not practiced deliberately, indicates a lack of awareness or sensitivity to something that could be sexually frustrating for the client.

Refer any situation involving sexuality that you are unsure of to your supervisor. Sometimes just talking over the situation can lead to an understanding of a client's behaviour that may enable you to work comfortably with the client. However, remember to respect confidentiality with regard to the sexuality of clients.

Social Needs

People have a need for the society of other people. How many people they need, how frequently they need to see them, and how close they need to feel to them depends on the individual. Some factors that affect a person's need for other people are:

Personality, family life and background, culture, health, past experiences, busyness. Try to learn what are the "people" needs of your clients, and do what you can to see that these needs are fulfilled.

People have a need to give and receive love and affection. They need to feel a closeness to others, usually more than one person. The need for love, affection, and closeness continues throughout life. In old age the need can encounter difficulties since the older person's spouse and many of his or her friends and relatives may have died. The physical separation from friends and relatives that takes place when moving to a care facility and the problems created by a new disability also hamper relationships of the elderly. For these reasons, elderly clients often

tum to their health care workers for love and affection. The care worker is a very important person to them.

Another social need is to belong to and be accepted by a group. People feel good when others value their membership in a circle or organization. This need is lifelong, being especially strong in adolescence and old age. Some clients may need frequent reassurance that they are truly accepted as a member of a group.

Sometimes inhibitions such as shyness and a situation such as living in an isolated area interfere with the need to belong to a group. People living in isolated situations have to make a special effort to feel part of a group.

Many people get a feeling of belonging from their job. However, if this is their only source of belonging, they will probably experience difficulties when they retire.

Death of acquaintances, living a great distance from family, children, retirement, and in many cases a hide-the-elderly-away attitude of society lead many elderly people to feel they no longer belong. Although they are part of a group when living in a care facility, clients may resist belonging to it because they wish to be elsewhere.

Self-Esteem And Achievement Needs

Self-esteem means feeling good about yourself. People with self-esteem are better able to develop their skills and abilities, since people function better when they feel good about themselves. Self-esteem is usually enhanced by achievement and by recognition of the achievement from others (Figure 2-16).

The amount of support needed by adults in maintaining their self-esteem varies. Some adults are considerably independent and are able to feel good about themselves without much confirmation from others. Other adults need a lot of reassurance that they are worthwhile individuals.

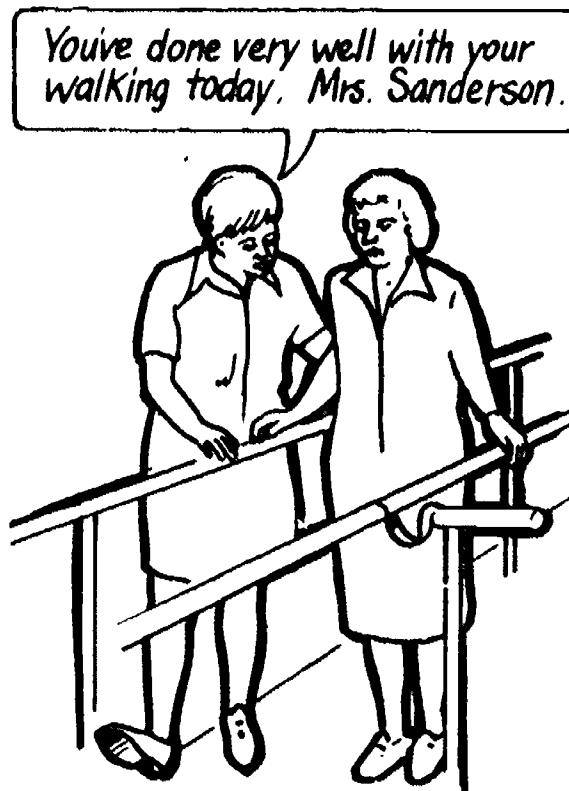

Figure 2-16. Recognition.

Self-esteem is related to the recognition individuals receive from others. One type of recognition is a simple recognition of a person's existence shown in such ways as saying hello, using their name, talking to them, and remembering things that they have previously said or done. For some people, being recognized as having a certain status is important, but for others status is unimportant.

Another type of recognition is recognizing a person for an achievement. It is important to understand that achievement is relative to the individual. Walking up some stairs may not be much of an achievement for a healthy teenager, but it may be quite an achievement for an elderly person who has difficulty walking. The need to achieve and to be recognized for achievements continues throughout life. The need is stronger in some people than in others, and in individuals themselves the need changes at different stages in life and even from day to day.

As a health care worker you should give both types of recognition to your clients. You should recognize your clients as people and as achievers. This may be difficult if you do not particularly like a client or find it hard to see

anything praiseworthy in what a client does. However, the effort will be worthwhile in the benefits to the client's self-esteem. Note that when recognizing a client for an achievement, try to be genuine in your praise. Don't over-praise or praise the client for something both you and the client know not to be true.

Beliefs And Values

Everyone holds certain beliefs and values. Beliefs can range from a belief in a remedy for a cold to a belief in a God, and values can range from a value given to an old pair of shoes to a value given to friendship or families. People hold a multitude of different beliefs and values; it is safe to say that no two people have all the same ones. Throughout a person's life some beliefs and values remain relatively constant, whereas others change in varying degrees.

Many factors influence the beliefs and values that a person holds. Some of these are: culture, religion, family, education, and life experience. Although a belief or value may seem simple in itself, the process by which a person comes by it can be far from simple. A belief that someone has in marriage, for example, could be developed through experience over a period of many years. Understanding that many factors and experiences have gone into the forming of a person's beliefs and values can help you better appreciate the importance they have for the person. From this appreciation can come a greater tolerance for the beliefs and values of others, especially those who think and feel differently from yourself.

As a care worker you should respect the beliefs and values of your clients. Clients are entitled to their beliefs and values just as you are entitled to yours. You should not try to tell clients what they should believe in or value, whether it is about something as ordinary as a brand of tea or something as weighty as the existence of God. Conversely, you don't have to agree with clients' beliefs if you happen to feel otherwise. Instead, let clients know that you think differently, but you respect their right to have and express their

own beliefs and values (Figure 2-17). Remember, people consider their beliefs the best possible.

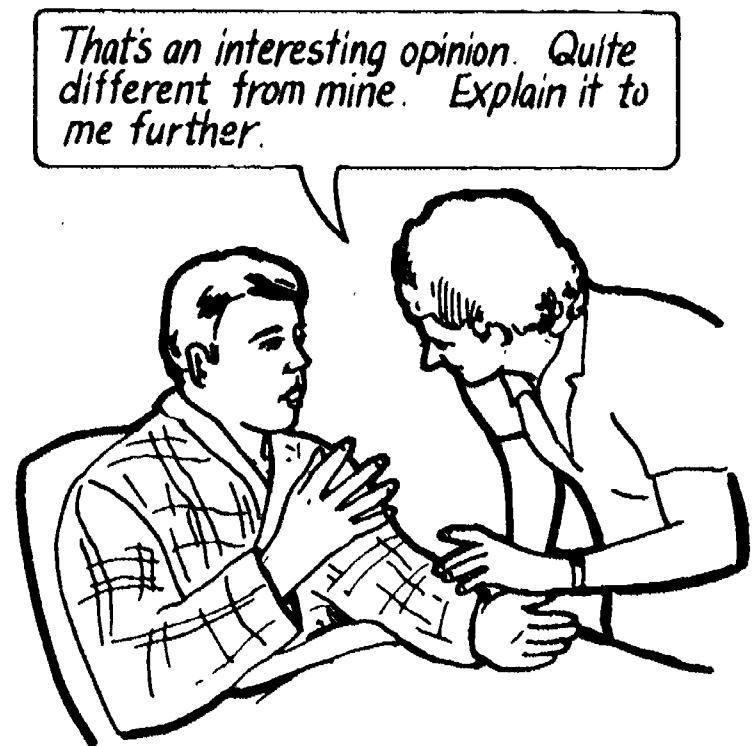

Figure 2-17. Respecting the Opinions of Others.

Philosophy Of Individual Worth

As a health care worker you can better care for clients if you develop a philosophy of individual worth. A philosophy of individual worth is the belief that everyone, regardless of personal circumstances or qualities, has worth and is entitled to respect as a human being. This means that the quality of your care should not go up or down depending on the client; you should give all your clients the same quality of care. The following suggestions will provide a starting point for applying a philosophy of individual worth in your relationships with clients:

- Accept each client as an individual having a unique personality.
- Recognize that clients have their own way of trying to meet their needs. These ways have been developed over a lifetime and cannot be readily changed.

- Try to develop tolerance by making a conscious effort to understand and accept each client's behaviour.
- Expect that many of your clients will not behave as you would want them to.
- Do not expect the client to adapt to you. You should strive to adapt to the client.
- Consider the point that clients with backgrounds different from your own offer you the opportunity to learn about human behaviour, seeing how it is influenced by customs, beliefs, values, religious practices, and economic levels.
- By accepting others as they are, you can greatly contribute to a client's sense of being accepted.

STRESS

Stress may be defined as bodily or mental tension in response to a situation that can be real, imagined, or some of both. Situations such as losing a job, having financial problems, or moving to a care facility are likely to produce stress. In fact, any change in a person's life causes some degree of stress. There is another type of stress that occurs when the body responds to an injury or an infection, but it is not discussed here.

When stress occurs, people must adapt in some way to eliminate or lessen the tension or strain. Well-being depends a lot on a person's ability to deal with stress. Note that people have different levels of tolerance to stress and stressful situations.

Many things happen every day that are stressful or cause anxiety (Figure 2-18). Students may feel anxious about their families, finances, or ability to pass a course. Health care workers may feel stressful from dealing with an uncooperative client whose needs are greater than the time allowed for care. A health care worker can also feel stressful about problems at home such as a sick child. Clients may react stressfully

to their dependence on health care workers, to financial problems, or to family responsibilities.

Not all stress is harmful; in fact, much of human action is based on some degree of stress. In other words, stress is a motivating force. For example, a single mother is under the strain of trying to support herself and her two children on a waitress's salary. She takes a legal secretary course, something she has always wanted to do, so that she can better provide for her children. She completes the course and gets a job as a legal secretary. In this case stress produced a positive result.

Good fortune, besides bad, can also cause stress. Winning a million dollars in a lottery causes stress in that the winner must decide what to do with all the money and must adjust to changes that the money will bring. Mind you, this is a stress that most people would be happy to have.

Stress becomes damaging when there is too much of it for a person to handle or the problem causing the stress appears insolvable. Some of the outward signs of harmful stress are: excessive anxiety, depression, fearfulness, anger, irritability, difficulty in sleeping, increased drinking, and uncharacteristic behaviour.

Coping is the term used for the effective handling of stress. Some of the main factors that affect an individual's ability to cope are:

The stressful situation. This can range from something minor like the loss of a dollar bill to something major like the death of a loved one.

The individual's stress reaction. How does the individual react to the potentially stressful situation? Not at all? Some? A great deal? For example, an elevator ride or a needle injection may be accepted very casually by one individual but cause near hysteria in another.

The amount of stress. Many problems are more difficult to cope with than one. Sometimes a person may seem to get upset over a mere trifle, but the trifle may be the last straw when added to already existing problems.

Personality. Some personalities seem better suited to cope with stress than others. Such

personalities thrive on situations that others find very stressful.

Past experience. Success in dealing with a similar stressful situation in the past can give confidence to cope in the present, whereas past failures in similar situations can increase stress.

The duration of exposure. A person may be able to cope with a stressful situation for a short period of time but may get worn down by the stress if exposed to the situation for a long time.

- Feeling warm all over
- Difficulty sleeping
- Extreme tiredness

These are normal reactions to threatening situations. Other reactions may include the psychological defense mechanisms discussed earlier in this section.

Stress Interference With Needs

Stress can interfere with the ability to meet needs. Prolonged stress has a tendency to weaken self-image, making people doubt themselves and feel ineffective and rejected. In this frame of mind, they are less able to make the effort to fulfill needs such as stimulation needs, social needs, and achievement and self-esteem needs.

Stress can also interfere with the ability to meet basic survival needs such as food and fluid, rest and sleep, and mobility. Under stress, people don't think as clearly as normal, lose the ability to concentrate causing their skills to suffer, and can become preoccupied with their problems to the point of neglecting their health.

Stress or anxiety based on real problems is often easier to deal with than stress based on imaginary ones. Something can usually be done about real problems, and when the problem is under control, the stress decreases or disappears. Imaginary problems, on the other hand, are more difficult to contend with for the simple fact that they are imaginary. Note that it does no good to tell people their problems are imaginary and they should not waste time worrying about something that doesn't exist. Your comment will probably just add to their anxiety.

Health care workers should be supportive of clients who are under stress. In order to help clients, you must have some understanding of the problems that are causing the stress.

Listening attentively to clients, not judging them, stressing positive aspects of the situation, encouraging them, and offering honest praise may

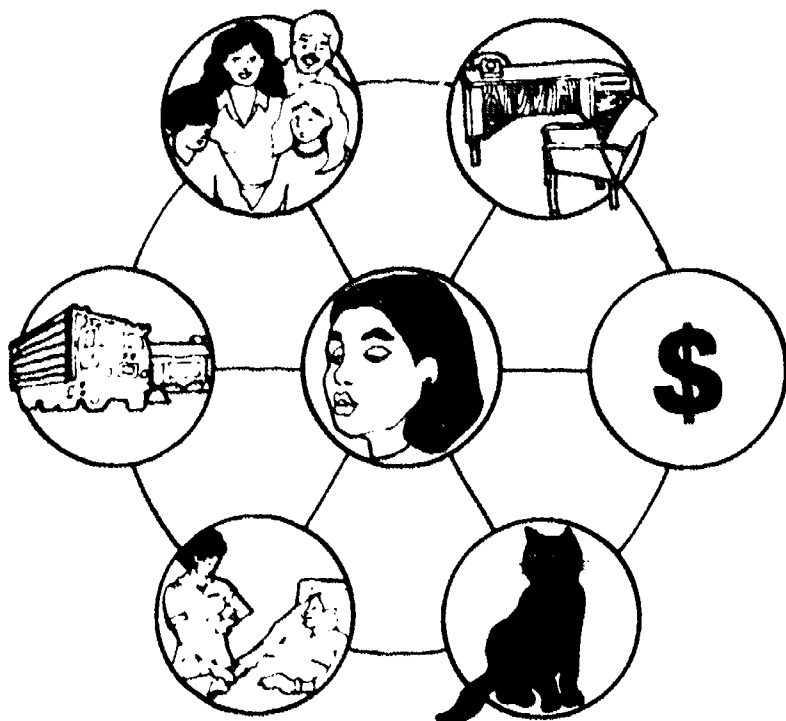

Figure 2-18. Common Stresses.

Physical Effects of Stress

Everyone has felt physical reactions to a stressful occurrence at some time. Some of the physical effects of stress are:

- Increased heart rate
- Dry mouth
- Nausea (sick to the stomach)
- Diarrhea or constipation
- Frequent need to urinate
- Increased perspiration
- Flushed face

all be helpful. A sense of humour and an ability to put things into perspective can also be useful when helping clients with stress. Having understood the problems at the root of the stress, assist

clients in whatever way you can to lessen their worries or solve their problems. Remember too, that your giving good care eliminates at least one worry for a client.

EXERCISE 2-2

Crossword

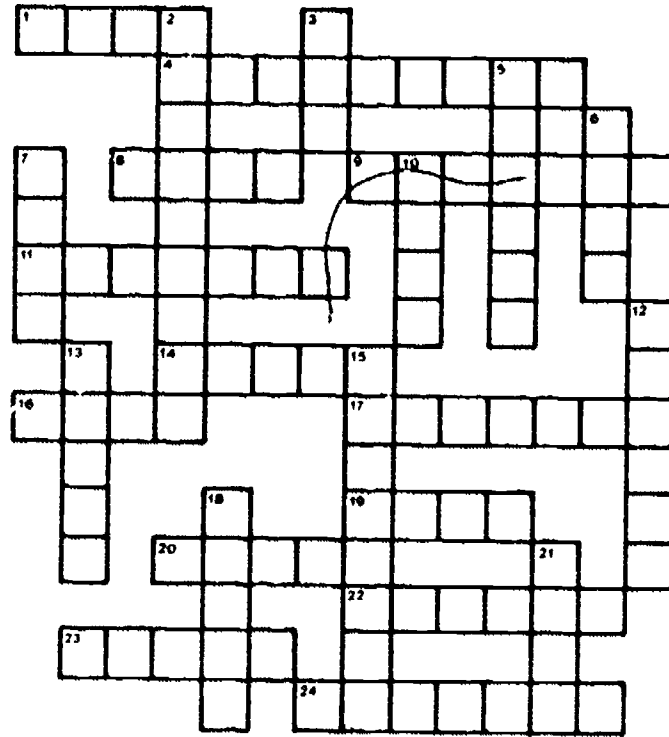

Across:

1. Oxygen is a survival _____.
4. Passageway for digested food.
8. A survival need associated with sleep.
9. Produce eggs and female sex hormones.
11. Passageway for urine to leave the body.
14. Carry blood from parts of the body to the heart.
16. 206 of these make up the body framework.
17. Filter wastes from blood and _____; the wastes with water.
19. One of two organs in which O_2 and CO_2 are exchanged.
20. Name for liquid waste.
22. Produce sperm and make sex hormones.
23. Liquid survival need.
24. Reservoir for urine.

Down:

2. System that prepares food for use by body cells.
3. Hormones control _____ characteristics.
5. The bodies message carrying circuit.
6. Building blocks of all living things.
7. Solid waste exits the body through it.
10. Term for the passing of urine.
12. If not used will atrophy.
13. Impulses carried from the brain to the muscles.
15. System that gives shape to the body.
18. Central computer of the body.
21. Term for solid waste.

Questions

1. List the six survival needs.
2. If a client is eating poorly because of a lack of money, what help is available?
3. On the average, adults need 6-8 hours of sleep per night. What is a common change from this sleeping pattern in the elderly?
4. Define: constipation. What are four steps to take to help prevent constipation?
5. With elderly clients stiffness can result from a period of immobility as short as _____hours.
6. What is the function of the white blood cells and the lymph cells?
7. True or false? The body forms one type of antibody to fight many different diseases.
8. How does pain help to safeguard a person?
9. What information should you report about a client's pain?
10. True or false? An imagined problem can cause a person to feel insecure just as much or more so than a real problem.
11. Why do people use psychological defense mechanisms such as rationalization, repression, and fantasy?
12. If a client is frequently bored, and is sleeping a lot, what need is the client not meeting?
13. The mind is like the body in that if it is not used, its ability to function _____.
14. What statement is made regarding sexuality and consenting adults?
15. How should you treat a client's space that is behind closed doors or curtains?
16. What are two forms of recognition that you should give clients to improve their self-esteem?
17. What is the main point to remember about client's beliefs and values?
18. Define: philosophy of individual worth.
19. List 5 outward signs of harmful stress.
20. What effect can stress have on a person's health?
21. What must you have before you can help someone cope with stress?

INDIVIDUAL GROWTH AND DEVELOPMENT

The changes that take place in a human being between conception and death can be called growth and development. **Growth** refers to the increase in body size from conception to adolescence. After adolescence there is no real growth, but physical changes do occur. **Development** refers to the changes that take place in an individual brought on by learning and the acquiring of new abilities. At various stages of life there are certain tasks that most people learn to do; these are known as **developmental tasks**.

Developmental tasks have a learning order; a task at a lower stage serves as a prerequisite for a task at a higher stage. Unless individuals succeed in learning the appropriate developmental tasks at each stage of growth, they do not have a firm foundation on which to build the tasks for the next stage. For example, if in early childhood children do not begin control over their emotions, they will have difficulty in middle childhood learning to get along with playmates.

As a person grows and develops, developmental tasks that were learned in the past become part of larger, final results. For example, a young boy learns to catch a ball. He enjoys this skill for its own sake. Later on as a member of the school baseball team he will have forgotten learning to catch a ball, but this early learned skill is a part of the many skills that have gone into earning him the position on the team.

There are three basic factors that influence the age at which a developmental task is faced and how well it is accomplished: **Physical readiness**. The body must be developed well enough for the task to be possible. For example, it is impossible for a newborn baby to learn to walk because the child's body is not physically ready.

Environment. Culture and traditions decide when many tasks are learned. Learning to read

and write for example, occurs at different ages in different societies.

Individual makeup. Personality and values influence what tasks a person undertakes and the energy the person brings to the tasks. One child may study piano, whereas another may take up competitive hockey. One adolescent may have long ago decided on a career, but another may have given no thought to a career. Two people take up an activity. One person pursues the activity with interest and energy, but the other loses interest and drops out.

The major periods of growth and development are:

- Prenatal (before birth)
- Infancy (0 to 1 year)
- Early childhood (1 to 6 years)
- Middle childhood (6 to 12 years)
- Adolescence (12 to 19 years)
- Early adulthood (19 to 30 years)
- Middle age (30 to 65 years)
- Old age (65 years to death)

Many developmental tasks take place over several stages of life. Learning to get along with age-mates is a good example of a recurring task (one that occurs over and over again). It begins in earnest for most children about the time they start school, and its first phase is pretty well mastered by the age of nine or ten. The coming of puberty changes the nature of the task and brings it to a new phase: learning to get along with age-mates of the opposite sex. Soon another phase of the task occurs: learning to get along with others of both sexes in a socially mature way in order to accomplish a goal or job. Even then the task of learning to get along with others is not completed. The elderly often face this task in a new way when they have to learn to interact with the other elders of society.

Success with a recurring task in its earliest phase probably prepares one well for success with the task in later stages. Consequently, a crucial period for the learning of a developmental task is when it first appears.

Prenatal (Before Birth)

The developing fetus spends the time in the uterus preparing for life separate from its mother. This period before birth has been the subject of much study in recent years, but there are many unknowns still to be answered. One current theory is that the fetus is aware of its parents' voices and their stress in the outside world and that the fetus has a degree of awareness during birth. This theory maintains that a lot more communication is possible between parents and a fetus than was previously believed. See Table 2-1 for prenatal growth and development.

TABLE 2-1 Prenatal Growth and Development

<i>Physical Growth</i>	<i>Developmental Tasks</i>	<i>Needs of Stage</i>
Grows from 2 cells (egg and sperm) to a 3500 gram (7½ pound) baby in 40 weeks.		Healthy mother.

Infancy (0-1 year)

Infants are very self-centered and concerned only with their own well-being. The early parent-child relationship is extremely important; it is the basis for all of the child's future relationships. Consistent loving and caring helps children to leave infancy better able to trust others and the world around them. On the other hand, lack of love and care at this stage can be the beginning of lifelong mistrust and insecurity. See Table 2-2 for infancy growth and development.

TABLE 2-2 Infancy Growth and Development

Physical Growth	Developmental Tasks	Needs of Stage
Weight doubles in 6 months, triples in 12. Height increases by one-third. Teeth appear. Body becomes straighter and firmer.	Learning trust. Coordination of body parts ● Grasping ● Rolling over ● Crawling ● Sitting ● Standing ● Walking Learning to eat solid food. Learning the meaning of words.	Physical and emotional needs. Stimulation and novelty needs. Play is vital to learning.

Early Childhood (1-6 years)

Children in the early childhood or preschool stage have an enormous number of tasks to master and must have the support and encouragement of their parents to succeed. Children at this stage must be allowed to make some of their own decisions and to have some independence in safe situations. Children who have had adult support and approval and a degree of independence should leave early childhood able to motivate themselves and take some initiative. They are ready to undertake the process of independence that occurs during middle childhood. Inadequate adult encouragement and a lack of independence in early childhood can leave children ashamed, guilty, doubting their own worth, and lacking in self-confidence. See Table 2-3 for early childhood growth and development.

TABLE 2-3 Early Childhood Growth and Development

<i>Physical Growth</i>	<i>Developmental Tasks</i>	<i>Needs of Stage</i>
<p>Growth slows down. Limbs grow faster than the body. Back becomes straighter. Abdomen becomes flatter.</p>	<p>Talking. Gaining some independence and initiative. Learning sex differences and sexual modesty. Increasing coordination. Controlling elimination of body wastes. Distinguishing between right and wrong. Beginning to control emotions. Beginning to develop a conscience. Feeding self. Learning to relate to others. Distinguishing reality from fantasy.</p>	<p>Routine since repetition helps learning. Approval and support. Parents as good role models to follow. Encouragement. Play since learning occurs from it.</p>

Middle Childhood (6-12 years)

Children in middle childhood continue to meet many developmental challenges. Their widening knowledge and experience is a solid background on which to build their life. Successful mastering of challenges during this industrious stage helps children to proceed with a feeling of achievement. If too much or too little is expected of them, resulting in a lack of success, they can feel inferior and inadequate. See Table 2-4 for middle childhood growth and development.

TABLE 2-4 Middle Childhood Growth and Development

<i>Physical Growth</i>	<i>Developmental Tasks</i>	<i>Needs of Stage</i>
<p>Growth varies with the individual.</p> <p>Growth spurt near the end of the stage (girls sooner than boys).</p> <p>Posture is more adult.</p>	<p>Refining motor skills.</p> <p>Building a wholesome attitude toward the self.</p> <p>Learning to get along with age-mates.</p> <p>Learning roles in society.</p> <p>Developing basic skills of reading, writing, and arithmetic.</p> <p>Developing values and morality from many sources.</p> <p>Forming concepts like time, space, numbers.</p> <p>Developing attitudes toward groups.</p> <p>Increasing independence.</p> <p>Controlling emotions and behaviours.</p>	<p>Play remains important.</p> <p>Contact with a variety of age groups and social situations.</p> <p>Good role models to follow.</p>

Adolescence (12-19 years)

Adolescence or the teens is often a very difficult period of development, because the adolescent is not a child anymore but is not yet considered an adult. Adolescents are working to achieve an identity of their own that is independent of their parents and other adults. If they are unable to succeed in establishing their own identity, they will doubt themselves and probably have difficulty forming close relationships. See Table 2-5 for adolescent growth and development.

TABLE 2-5 Adolescent Growth and Development

<i>Physical Growth</i>	<i>Developmental Tasks</i>	<i>Needs of Stage</i>
<p>Growth spurt (girls reach adult height earlier than boys.</p> <p>Secondary sex characteristics develop.</p>	<p>Achieving more mature relationships with age-mates.</p> <p>Identifying with social roles.</p> <p>Accepting own appearance.</p> <p>Using the body effectively.</p> <p>Gaining physical and emotional independence from parents.</p> <p>Preparing for a career.</p> <p>Forming own value system.</p> <p>Achieving socially responsible behaviour.</p> <p>Developing intimate social relationships.</p>	<p>Independence.</p> <p>An understanding of the many stresses and challenges facing them.</p> <p>Taking responsibility for their decisions.</p> <p>Conformity.</p>

Early Adulthood (19-30 years)

Early adulthood marks a person's acceptance into the world of adults with its increased responsibilities. Success at this stage allows people to be productive and contributing members of society, forming life patterns that probably will continue for many years. See Table 2-6 for early adulthood growth and development.

TABLE 2-6 Early Adulthood Growth and Development

<i>Physical Growth</i>	<i>Developmental Tasks</i>	<i>Needs of Stage</i>
Physical maturity reached. Body systems functioning at their peak.	Selecting a partner. Learning to live with a partner. Planning for and having children or planning not to have children. Taking on educational, career, community and social responsibilities. Refining judgment and self-control. Assisting parents.	Intimate relationships. Achievement. Recognition. Group activities. Love and belonging.

Middle Age (30-65 years)

In middle age people continue to contribute to their families and society. Many social and career goals are reached and individuals are often functioning at their peak. Some changes that occur in middle age can be very stressful; for example, career disappointments, marriage breakups, caring for a chronically ill parent, children leaving the "nest," and the death of aged parents. Those who cope well at this stage are able to deal with life as it comes with a certain degree of confidence. Those who fail to cope are often insecure and fearful of the future. See Table 2-7 for middle age growth and development.

TABLE 2-7 Middle Age Growth and Development

<i>Physical Growth</i>	<i>Developmental Tasks</i>	<i>Needs of Stage</i>
Weight gain and redistribution. Menopause in females. Skin wrinkles. Hair changes to grey. Decreased muscular strength. Changes in vision.	Adjusting to idea of aging. Accepting life's changes. Assisting children to become independent. Succeeding in chosen career. Developing leisure time activities. Adjusting to aging parents and their possible need for assistance.	Stimulation. Recognition. Achievement. Love and belonging. Self-esteem.

Old Age (65-death)

Physical Changes

Skin

- Wrinkled and sagging due to loss of elasticity
- Thin and dry due to less active oil glands
- Brittle, thickened nails due to poorer circulation
- Discoloured spots due to pigment changes

Muscular and Skeletal Systems

- Stiffer joints that may limit movement
- Shortened height caused by changes in the spinal column
- Porous, brittle bones because bone growth is slow
- Muscles become smaller, stringier, and less elastic

Circulatory System

- Heart pumps less efficiently and reacts poorly to physical stress.
- Blood vessels are less elastic

Respiratory System

- Chest expands poorly and lungs are less elastic

Digestive System

- Movement of waste through the bowel slows down
- Food needs are less because of decreased activity

Urinary System

- Kidneys become less efficient in filtering wastes
- Males may develop difficulty with urination because of prostate enlargement
- Females may develop difficulty controlling their bladder sphincter, causing dribbling of urine when coughing or sneezing

Nervous System

- Messages to and from the brain travel slower, so reaction times and reflexes are slower
- Vision is less efficient
- Hearing of high-pitched sounds decreases
- Sense of touch is less efficient

Reproductive System

- Male testes become smaller and the prostate gland enlarges
- Vaginal lining is more prone to infection because of menopausal changes

Endocrine System

- All glands function less efficiently leading to a general slowdown of body systems

Developmental Tasks

- Adjusting to changes in health and physical strength
- Adjusting to changing roles and retirement
- Adjusting to death of spouse and friends
- Continuing relationships with age-mates and independent adult children
- Continuing activities and interests
- Maintaining satisfactory living arrangements and accommodation

Needs of Stage

- Love, acceptance, and belonging
- Usefulness and achievement
- Activity and social contacts
- Stimulation
- Security

In a society that focuses on youth, the changes that take place with aging are often regarded as negative. Aging is a natural process bringing about changes in physical appearance and body functioning. Old age should not be seen as

separate from life but rather as another stage in an ever-changing life. Old age may have new limitations, but it also has, like all other stages in life, new challenges.

If old age is looked upon as a kind of death in life, that is what it can become. Old age does not have to mean disability, illness, or uselessness. There is such a thing as healthy and happy old age; some individuals function at seventy years as well as others do at thirty. Too many older people fail to function to their capabilities simply because they have accepted someone else's attitude that they are "too old". Those older persons who master the adjustments required of the elderly can feel a part of society and have integrity and dignity; those who don't can feel left out and useless.

The following poem looks at care from a client's point of view.

*What do you see nurses, what do you see?
Are you thinking when you look at me. . .
A crabbed old woman not very wise
Uncertain of habit with far away eyes.
Who dribbles her food and makes no reply
When you say in a loud voice. . . "I do wish
you'd try."
Who seems not to notice the things that you do
And forever is losing a stocking or shoe.
Who unresisting or not, lets you do as you will
With bathing and feeding, the long day to fill.
Is that what you're thinking, is that what you
see?
Then open your eyes nurse, you're not looking
at me.
I'll tell you who I am as I sit here so still,
As I move at your bidding, as I eat at your will.*

*I'm a small child of ten with a father and mother
Brothers and Sisters who love one another
A young girl of sixteen with wings on her feet
Dreaming that soon a lover she'll meet
A Bride soon at twenty. . . my heart gives a leap
Remembering the vows that I promised to keep.*

*At twenty-five now I have young of my own
Who need me to build a secure, happy home.
A woman of thirty, my young now grow fast
Bound together with ties that should last.
At forty, my young sons have grown and gone
But my man's beside me to see I don't mourn.*

*At fifty, once more babies play round my knee
Again we know children, my loved ones and me*

*Dark days are upon me, my husband is dead
I look at the future, I shudder with dread,
For my young are all rearing young of their own
And I think of the years and the love that I've
known.*

*I'm an old woman now and nature is cruel
'Tis her jest to make old age look like a fool
The body, it crumbles, grace and vigour depart
There is a stone where I once had a heart
But inside this old carcass a young girl still dwells
And now and again my battered heart swells.*

*I remember the joys, I remember the pain
And I'm loving and living life over again
I think of the years, all too few, gone too fast
And accept the stark fact that nothing can last
So open your eyes nurses, open and see
Not a crabbed old woman, look closer . . .
SEE ME!*

This poem is a reminder to care workers that the elderly people you are caring for were not always as you see them now. They were young once, were children, lovers, parents, workers, vitally living many of life's experiences. Moreover, they do not see themselves strictly as the old person they are now, but rather as the person who has lived all of these experiences. They wish they could show you this brighter part of themselves so that you could see how much more there is to them than the old person in front of you.

Aging imposes some limitations. Decreased physical strength may make previously easy jobs more difficult. Vision and hearing loss can be frustrating, and dealing with new situations and information can require more concentration. However, the biggest limitation is the aging person's attitude (Figure 2-19).

Each stage of development has limitations that frustrate: a child limited by immature coordination or understanding is unable to perform an intricate task. An adolescent anxious to be independent is limited by, for example, education, emotional development, and job experience. Perhaps the biggest difference between earlier frustrations and those of old age is the knowledge that the limitations of aging are not going to disappear with further development. In fact, they may well get worse. This knowledge can be

frightening and lead to depression, which is quite common in the elderly.

Besides personal limitations, limitations are placed on the elderly by society. People often look for problems with the elderly and find ones where none exist. For example, behaviour such as occasional slowness in the forming of thoughts is not thought of as unusual in a younger person but is looked on as a sign of senility in the aged. Society often ignores the elderly's wealth of knowledge, skill, and human resources, all of which could be useful to the community. The reason is partly that younger people are busy with their own concerns and partly perhaps that younger people are uneasy in dealing with the aged because it brings to mind their own old age, something they don't want to think about. The elderly feel this neglect and it adds to their frustration and sense of uselessness.



Figure 2-19. Positive Approach to Life.

Retirement

In the western world people are very much identified by their jobs. One of the first questions asked of a new acquaintance is, "What do you do for a living?" On hearing the answer the asker makes some assumptions about the person. It is no wonder then that retirement with its

removal of job identity causes much confusion and a sense of loss in those who have not formed a positive view of themselves as a person separate from their work.

The cultivation of hobbies and interests outside of employment can help a person adapt to retirement, but this must begin many years before retirement takes place. Traditionally, it is the male who is employed outside the home and must make the major adjustment to the increased leisure time of retirement. The housewife in this traditional setting still has her job, but she has to adjust as well. The husband's increased presence in the home can interfere with her routines and housekeeping duties.

Retirement may bring a drop in income that alters the standard of living or lifestyle of the couple and creates arguments over which expenses are of higher priority. Planning in advance for financial security and setting down rules for money management may be helpful.

The social life of some individuals is strongly connected with a job, and retirement may strain or break the old ties with people and activities. Plans for new social activities and meeting new people can be difficult for the elderly, especially if they have not yet accepted the fact of their advancing years and want nothing to do with "those old people."

Retirement, like other stages in life, has its problems; but through thoughtful care, health care workers can do much to help clients adjust to it.

INSTITUTIONAL LIVING

Even though an outsider might consider a new location advantageous in every way, moving from one's own home to an institution is a traumatic experience. For older people who may not tolerate change easily, there are added difficulties:

Loss of Independence. For some clients, the decision of moving into an institution may not have been their own. Family, friends, and health care personnel may have combined to make the decision "for the client's own good." Even for those who decided themselves to come to the institution, there are adjustments to regulations and schedules that may allow little freedom of choice. Personal habits in an institution are often interfered with; for example, the frequency of bathing, and the hours of rising and retiring. Sometimes financial control may be lost, or the client must consult with someone before making financial decisions. All this adds up to a loss of independence and privacy for the client and can lead to feelings of helplessness and a desire to withdraw.

Separation from family and friends. Sometimes the institution is a great distance from the client's home, or the institution may be situated so that transportation to and from it is difficult. Some facilities do not have rooms for couples so that partners must occupy separate rooms. Family members often feel very guilty about their relative being in a facility. To avoid their guilty feelings they may visit infrequently, and this further adds to the client's sense of loss.

Change in environment. The change involved in a move to an institution from a house where one has lived for many years is overwhelming. The loss of old familiar surroundings and belongings can cause confusion, and the decrease in personal space and privacy can be quite threatening. Prized possessions left behind may be strongly missed. The huge lounges, open areas, and functional furnishings found in some facilities do not give a homey feeling. The social environment changes from the client living alone, or with a few people possibly of different ages, to living with many people mainly of the same age. The fact that the staff is often predominantly female also represents a major change for some clients.

Advantages of an institution are in the eyes of the beholder. A family member of an elderly client just admitted to a care facility may see a safe, comfortable room; regular, nutritious and well-prepared meals; courteous, trained assis-

tants; an exciting activity schedule and many new people to share the activities with. On the other hand, the client may see a sterile, unfamiliar, tiny room; meals chosen by others and served in an impersonal dining hall; attendants checking upon you all the time; and a bunch of old people playing useless games while they sit around waiting to die.

Making an Institution Homelike

Many things can be done in helping a client adjust to institutional life and in making an institution more congenial and homelike. Allowing residents to bring as many personal possessions and furnishings as are practical into the available space makes the residents more likely to identify with the new location and gives them things that are their own and nobody else's (Figure 2-20). Having personal belongings in an institution helps residents develop a sense of personal space and uniqueness.

Community involvement of various age groups, especially children, with the institution is helpful in making the social environment more natural. For its part, the institution can try to contribute to the community; for example, by making its facilities available to appropriate community groups, by producing goods useful to others like the knitting of clothing for poor children or charity sales, and by encouraging residents to make their knowledge and skills available to the community. All of these activities make the residents feel more a part of the community and give them a feeling of usefulness and achievement.

Allowing residents to have some say in their own schedule is important. A woman client who for years has gone to bed at 2:00 a.m. and risen at 10:30 a.m. will not easily adjust to a routine of retiring at 9:00 p.m. and rising at 7:00 a.m. Obviously, some scheduling has to be followed, but it should be left as flexible as possible to accommodate the habits and preferences of the individual residents.

Liberal visiting hours and the possibility of leaving the institution to visit family or friends or to stay with them for a period of time help lessen feelings of separation and encourage a sense of independence. Another practice, the involvement of family and friends in the day-to-day life of the facility, works to everyone's benefit. No matter how competent and caring the staff may be, they cannot replace the client's own family and friends. Clients are always particularly sensitive to their visits. Families and friends should be encouraged that their visits are important and enjoyed. A family's guilt at having put a relative in an institution will be decreased by seeing that the relative is receiving good care and is content.

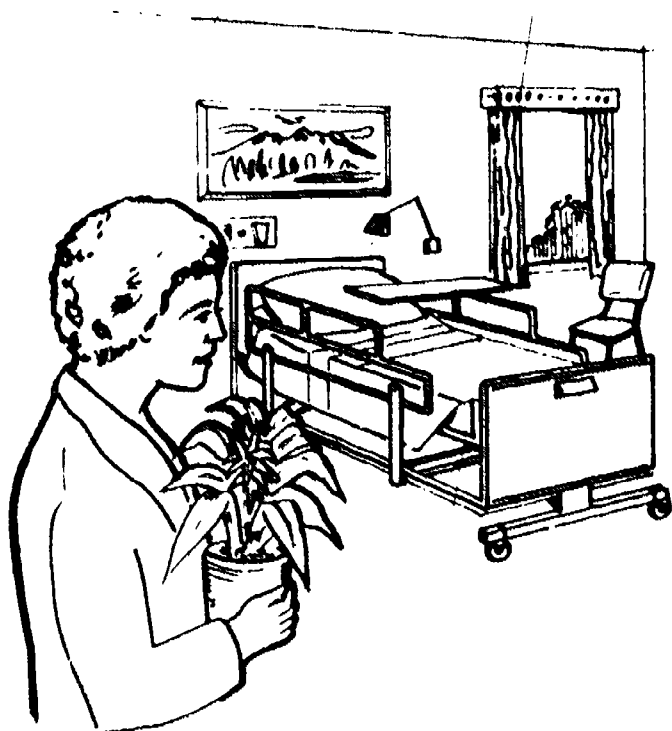

Figure 2-20. Personal Belongings.

Difficulties in Adjusting to an Institution

Temporary confusion is a common problem for elderly individuals having difficulty adjusting to institutional living. The confusion is a stress reaction to the new surroundings, routines, and people. These individuals become preoccupied in coping with the changes. This interferes with their day-to-day functioning, and they temporarily show signs of confusion.

Confusion is a fairly common reaction to a stressful situation in any age group. Forgetting the date, waking up in an unfamiliar bed and feeling lost, feeling isolated in a new situation because you don't know the people, are all examples of confusion experienced by people of all ages. However, such confusion in the elderly is rarely accepted as a normal and temporary reaction; it is usually interpreted wrongly as the beginning of senility, the deterioration of the individual's mental faculties.

Although in most cases confusion is a temporary reaction, occasionally it is an ongoing behaviour of some elderly clients.

Guidelines with Confused Clients

1. Create a calm, relaxed, friendly environment.
2. Be polite, respectful, interested, sincere, and matter-of-fact.
3. Introduce yourself and others.
4. Speak distinctly and directly to the person.
5. Use opportunities in conversation to mention time, place, and person.
6. Divert the confused client from rambling speech and purposeless activity.
7. Explain new procedures before doing or having them done.
8. Allow plenty of time for response.
9. Give clear, specific directions.
10. Show residents you expect them to understand and comply.
11. Show residents you expect them to do as much as possible for themselves.
12. Establish and maintain a routine, e.g., morning care.
13. Talk about generally familiar things.
14. State questions and answers in clear, simple terms.
15. Do all of the above **consistently**.

THE FAMILY IN GROWTH AND DEVELOPMENT

The family is the basic unit of our society and acts as a support system for the individuals within it. Just as family members themselves are constantly changing, so is the family; births, deaths, and the various stages of growth and development of the individuals within the family all change the family structure.

Developmental Tasks of the Family

The roles of individual family members depend on age, sex, personality, culture, and position in the family. Similar to the way that developmental tasks for individuals change over the years, so do the developmental tasks for families change with each stage of the family life cycle (Table 2.8). All families face the following basic tasks:

Physical maintenance. Providing shelter, food, clothing, health care, etc.

Allocation of resources. Meeting family needs and expenses, dividing material goods, facilities, space, authority, respect, affection, etc.

Division of labour. Deciding who does what jobs, assigning responsibility for earning income, managing the household, caring for family members, etc.

Social training of family members. Guiding the learning of acceptable patterns for controlling elimination, eating, sleeping, expressing sexual drives, etc.

Reproduction, recruitment, and release of family members. Raising children and releasing them at maturity, taking in new family

members by marriage, and establishing a place for others such as in-laws, relatives, step-parents, guests, and friends.

Maintenance of order. Establishing conduct and types of interaction between family members.

Placement of members in the larger society. Fitting into the institutions and organizations of the community, and protecting family members from undesirable outside influences.

Maintenance of motivation and morale. Rewarding members for achievement; satisfying individual needs for acceptance, encouragement, and affection; meeting personal and family crises; and refining a philosophy of life and a sense of family loyalty through contact, rituals, festivals, assistance, etc.

Since learning first takes place within the family, the family has a profound effect on all future behaviour of a child. Ways of communicating and relating to others, ways of seeing and doing things, values, beliefs, biases, all begin with the family. Also, the foundations for an individual's self-image are laid during early experiences within the family. Attitudes and patterns of behaviour formed in family living can strongly influence an individual's career, marriage, and general social behaviour.

If the developmental tasks of the family are not carried out successfully, the effects will be seen in the individual family member, in the family, and in society. The individual family member might turn out to lack motivation and responsibility and have a poor self-image and poor communication skills. The family probably won't be a cohesive unit sharing things, encouraging one another, and helping one another out. Society loses too because the family members may not fit into the community as productive citizens; or worse, they may become lawbreakers.

TABLE 2-8 Family Developmental Tasks

Stage of the Family Life Cycle	Positions in the Family	Family Developmental Tasks
1. Newly Married Pair	Wife Husband	Establishing a mutually satisfying marriage. Adjusting to pregnancy and the promise of parenthood. Fitting into the kin network.
2. Expectant Parents and Parenthood	Wife-mother Husband-father Infant daughter or son or both	Having, adjusting to, and encouraging the development of infants. Establishing a satisfying home for both parents and infants.
3. The Crowded Years	Wife-mother Husband-father Daughter-sister Son-brother	Adapting to the critical needs and interests of preschool children in stimulating, growth-promoting ways. Coping with energy depletion and lack of privacy as parents.
4. The Early School Years	Wife-mother Husband-father Daughter-sister Son-brother	Fitting into the community of school-age families in constructive ways. Encouraging children's education achievement.
5. The Adolescent School Years	Wife-mother Husband-father Daughter-sister Son-brother	Balancing freedom with responsibility — teenagers mature and emancipate themselves. Establishing postparental interests and careers as growing parents.
6. The Launching Years	Wife-mother-grandmother Husband-father-grandfather Daughter-sister-aunt Son-brother-uncle	Releasing young adults into work, military service, college, marriage, etc., with appropriate rituals and assistance. Maintaining a supportive home base.

7. *The Empty Nest*

Wife-mother-grandmother
Husband-father-grandfather

Rebuilding the marriage relationship.
Maintaining kin ties with older and younger generations.

8. *The Aging Years*

Widow-widower
Wife-mother-grandmother
Husband-father-grandfather

Coping with bereavement and living alone.
Closing the family home or adapting it to aging.
Adjusting to retirement.

Family Structure

Two terms referring to family structure are the **nuclear family** and the **extended family**. The nuclear family consists only of parents or parent and children living together. The extended family is made up of children, parents, grandparents, and possibly uncles, aunts, and cousins all living together as a family. Other family structures are shared-parenting families, and group families.

In recent times nuclear families in North America have tended to be small and living by themselves. The economy has been good so that they could afford to live on their own. However, this may not always be the case. If the economy deteriorates, there could be a return to living arrangements of the past where extended families lived together to lessen expenses.

Family members have great influence on one another, but sometimes individuals not actually related to the family are equally influential. These individuals, called **significant others**, are good friends who are accepted as family and even assume the role of a family member.

Family Support

New roles may be forced on individuals in the family because one family member becomes a health care client and is not capable of fulfilling his or her assigned function. An example is the illness of a father requiring the mother to finan-

cially support the family and the children to take on more household chores. A strong, cooperative family will make these changes because of the responsibility they feel towards the family. A weaker family unit may have difficulties because each member feels unable or unwilling to accept the added responsibilities.

The father in this example may feel guilty since he is not carrying his share of the family burden. He will require support and reassurance from his family and the health care staff. If the family makes a decision to move the father into an institution, it may be their turn to feel guilty, and they may need support and reassurance from one another and the health care staff.

Family Problems

As a health care worker you should watch for personal problems of family members because they may worry or depress your client. The problems may be obvious, or you may get a feeling that something is wrong. Report your concerns to your supervisor. Some signs of personal problems are:

- Abuse of alcohol or drugs
- Erratic behaviour
- Mood swings
- Deterioration in reasoning ability
- Withdrawal from people
- Worsening of grooming standards
- Lack of interest and activity

- Signs of bruising, burns, scrapes, wounds
- Unusual fear of a family member
- Poor nutrition

The Reactions of Families of Health Care Clients

Families have different ways of coping. Try to learn the methods of coping used by the families of your clients so that you can work within these methods. This is not always easy. Families can use the same psychological defense mechanisms as individuals when faced with the stress of a family member in health care. For example, they can use the mechanism of denial to keep knowledge of the illness from the client. They, in their wisdom, have decided that the client shouldn't know. Difficult though this may be for you to accept, the family and the client have a right to deny the illness if that is their way of coping. Go along with the family, but discuss with your supervisor ways of handling such a situation so that you give the required care.

Another family reaction that can take place is an over dependence on the health care worker. The client's family may be fearful of doing anything without assistance of the health care worker and may refuse to accept responsibility for care. Support of their care, reassurance, and leaving simple-to-follow directions can help the family members gain the confidence to take part in care (Figure 2-21).

Occasionally, family members will be impatient, critical, or even insulting to the care worker. This is probably a case of their transferring anger, frustration, or guilt to an outside source. The family members may feel upset and guilty at bringing their relative to a care facility. Unable to face or express their distress and guilt, they lash out at the care worker.

Understanding that there is always a reason behind such behaviour may help you deal with it. Discussing the problem with your supervisor may also be of help. When conflicts arise, be



Figure 2-21. Family Taking Part in Care.

diplomatic and try to establish an atmosphere of cooperation as soon as possible because this is best for all concerned.

Getting to know family members by name and their relationship to the client adds to your knowledge of the client. In casual conversations that you have with the client, family is a topic of interest. Include family in conversations about the care.

You should be aware of the rights of clients' families according to agency policy. Agency policy regarding care, clothing, outings, and anything else related to families and friends should be clearly defined. The interests and feelings of family members should be acknowledged and attempts made to accommodate them. However, there can be occasions where the client and family members disagree on an important matter. At such times, seek the assistance of the supervisor. Unusual reactions or behaviour of either the client or family members during visits should be reported.

A goal of institutions should be to make visitors feel welcome (Figure 2-22). This can be done by greeting visitors courteously, escorting them as necessary, and providing seating and privacy.

These welcoming courtesies should be extended to all of a client's visitors, not only family members. Often friends are just as important to the client as family and in some cases even more important.



Figure 2-22. Showing Courtesy.

Encouraging Family Involvement

Sometimes clients enjoy having family members and friends participate in their care or attend activities with them. The first step in involving family is to find out if clients want their family to participate, or if they would rather their care be left to the health care workers. The second step is to find out if the family wants or is able to participate. Not all families enjoy the close contact of health care. Also, there may be good reasons why some families prefer not to be involved.

If the client and family are in agreement, the next step is to find out what type of activity or care would best suit the family members. To do this, learn the abilities and interests of individual members and try to match duties with this information. Note that involving the family is an ongoing process. Sometimes in the course of caring for a client you may discover new ways in which family members can take over some of

the care duties. Your supervisor can give guidance in this area.

Getting the family involved in care should be done in such a way as to include them as part of the health care team. Introducing them to other residents and staff and discussing the care with them help to make them feel involved. Encouraging and complimenting their efforts will make them feel appreciated, and they are more likely to continue participating.

Adjusting care to allow family participation may mean extra time for such things as instructing and supervising. Thus time schedules may require alteration.

Health care workers are often critical of families for their seeming neglect. Without knowing all the circumstances, it is unfair and unhelpful to be critical. Furthermore, staff criticism can have the effect of increasing a family's guilty and hostile feelings, causing them to visit even less.

HOME VERSUS INSTITUTIONAL CARE

It is often difficult to know if a client should be cared for at home or in an institution. There is no easy answer to this question; much more is involved than simply the degree of disability or need for care. Other factors that should be considered are: personality, the helpfulness of the family, physical ability, mental clarity, the availability of a bed in an institution, the wishes of the client and the client's family, and the availability of home care assistance.

Following are listed some of the advantages of care in a home and care in an institution:

Home Care Advantages

Familiar surroundings

Institutional Care Advantages

24 hour assistance available

Personal belongings at hand	Registered nurse may be on duty
Closer to friends	Safe 24 hour supervision for the ambulatory confused
Family pets allowed	
Greater privacy	Appropriate equipment for care
Control of personal schedule	No home maintenance or repairs
May be less costly to the client	Recreational facilities
Less costly to the community	Food services
	Cleaning service

Case Reports: Where Will They Live?

People requiring care differ greatly in their needs and desires, so it is impossible to develop hard and fast rules as to whether a client should have home or institutional care. The following four case reports illustrate the adjustment of four different individuals to four unique life situations.

Case Report 1

Mrs. Jones was a small woman with thin gray braids which she wore like a coronet around her head. Her children were married and Mrs. Jones had lived alone since the death of her husband. She was a self-sufficient woman and managed to keep busy with her housework, reading, and knitting.

Then one morning she slipped and broke her hip. She was one of the first patients admitted to the new general hospital. She made an uneventful recovery, remaining a few days longer than necessary while her married children arranged for a practical nurse to stay in the home with her. At this time there were no nursing homes [long term care facilities] in the area.

The day Mrs. Jones was to be dismissed from the hospital, she had a heart attack. The heart

attack was slight, and Mrs. Jones recovered and again planned to go home.

On the day she was to leave the hospital, she had a second attack. When the same thing happened a third time, no one had the courage to suggest that she plan to go home again. Since the hospital was new and had no shortage of beds, and Mrs. Jones had no shortage of money but an obvious need for the security which the hospital offered, the family and doctors agreed that Mrs. Jones would remain as a patient indefinitely.

Mrs. Jones was told that she could stay as long as she liked. At her request she was moved to the four-bed ward — a large, sunny room with space to accommodate six beds. In the morning, Mrs. Jones would have a leisurely breakfast in bed and then wait patiently until the nurse brought bath water. Mrs. Jones took her own bath and again waited quietly for the nurse to return and wash her back and help with a gown and robe. Mrs. Jones kept a wheelchair by the bed and was able to get into it quite well without help. She would then wheel herself to the big ward window and sit in the sun, knitting sweaters for her grandchildren.

Although she had walked very little since the broken hip, she was alert and active. She became an authority on ward routine and ward personnel. Remaining rather quiet most of the time, she overheard all the doctor's directions and the other patients' complaints and sometimes knew more about the ward than some of the nurses on duty. For a very small, quiet woman she exerted a rather large influence on the ward patients. She had little tolerance for the patient whose moans and groans appeared only when an audience of doctors or nurses was present, but she was the first to pull her signal light if a patient needed real help.

On Sundays she put on her best blue quilted robe and wheeled herself to the sun porch, where she received visitors. She soon made it clear that she was "not at home" any other time. "Visitors bother the other patients," she explained. Sometimes she wheeled her chair down to the lobby and sat well back in a corner and watched the parade of people while she

knitted. She would wheel her chair onto the elevator and wait until somebody came along going up or down. Everybody knew Mrs. Jones and everybody loved her. She required little and gave much in the example of happiness and contentment and the remarkable way in which she adjusted to the final years of a happy life. It was a sincere loss to all when she died 3 years later.

Case Report 2

Mr. Deering was a 63 year-old salesman. His job required much travel, but Mr. Deering seemed to be in good health and liked to travel. The first sign of trouble appeared when Mr. Deering was in a city some distance from home. He left the local company office one afternoon and started back to his hotel. When he reached the street, he suddenly realized that he had no idea where he was registered. It was more than forgetting a name. He could not remember anything concerning the morning before he had come to the office — where he was staying, what he had had for breakfast, how he had gotten to the office. He knew who he was and why he was in a strange city, but he could not recall the name of the city.

He walked up and down the street trying to remember. Finally he returned to the office with some embarrassment. "George," he said, "Do you know where I am staying?"

"Of course," said George. "The Greenwood, where you always stay. Here, wait a minute. I'll drive you."

Back at the hotel, Mr. Deering entered as though into a strange place, although he knew that he must have stopped here many times. Nothing was familiar, the lobby, his room number, his room. After a restless night, Mr. Deering called the main office and requested two weeks' leave. He took a cab to the airport and returned home. On the plane, he said over and over to himself, "The Greenwood, The Greenwood." It was a strange word. One he had learned yesterday.

Two days later he went to a doctor for a checkup and was told that he had experienced a "small

stroke". He retired from his job, losing a part of his pension, and for a few weeks all went well.

Then one day his wife missed him from the garden, where a few moments before he had been watering the roses. After a search, she found him several blocks from home, wandering around in a confused state.

From that day on, it was necessary to watch him closely because of the tendency to wander off. He still seemed to know who he was, but his confusion increased and he rebelled at being kept at home. He would slip out, and then put up a fight when found.

He was still strong and two people were often required to get him home again when he wandered off. An attempt was made to have an attendant with him, but he would get away from the attendant. On these wanderings, he would ignore traffic and was in constant danger of being struck down. He was becoming forgetful about his appearance, eating, bathing, and dressing. Finally, a decision was made that for his safety and care a nursing home (long term care facility) was the best answer.

Case Report 3

Mrs. King had been an active career woman. Her husband died when her daughter was a small child, and Mrs. King had supported herself and her daughter. The daughter had married and Mrs. King had continued to lead a busy, independent life. Without warning she suffered a heart attack, which made it necessary for her to stop work and inadvisable for her to continue to live alone.

Mrs. King and her daughter were very close, but the son-in-law was not a person who would enjoy the presence of a mother-in-law in his home. Mrs. King's small pension was inadequate for the upkeep of an apartment. The three talked the matter over and agreed to a solution which has worked very well. Two rooms in the daughter's house were made into a small apartment for the mother. Here Mrs. King continued her way of life with her own friends, coming and going as she liked. When the son-in-law was

away, she and the daughter often ate together. When he was home, Mrs. King remained in her own home like any good neighbour. They visited back and forth as neighbours do, sent special dishes to each other, or had coffee together in the morning. But they retained a degree of privacy which was important to both, and Mrs. King had the security of having someone in the house with her.

Case Report 4

Mr. and Mrs. Brown planned for retirement for many years. They discussed, at length, where they would like to live, settling finally on a small seacoast resort town. They bought a lot and spent many pleasant hours planning a small house.

As retirement time approached, they put their home on the market and sold it, with the condition that they occupy it until a given date. Then they hired a contractor to begin building the retirement home. Furniture was checked over and much of it divided among the children. The essentials and certain loved pieces they moved to the retirement home. Possessions requiring much care or expensive upkeep were parted with.

It was with some misgiving that they gave up friends and familiar surroundings and a familiar pattern of life. They wondered if they should have settled in a town where a daughter lived. (She was transferred the following year.) They arrived at the new home, weary and uncertain. Mr. Brown had been an executive in an ulcer-producing kind of position. He was pale, overweight, and looked much more than his 65 years. Some friends thought that retirement would be the finishing blow.

Mr. Brown put away his tight white collars and stiff business suits and got into old, comfortable clothes. The older the clothes, the better he liked them. In hot weather he combined brevity with age in his choice of wardrobe. The new house was in a wooded, uncleared area. Mr. Brown started clearing by hand. All morning he could be seen swinging a blade, chopping weeds,

sawing up small trees into firewood, probably at the same time chopping away his hostilities accumulated from a cruel, competitive business world. In the afternoon he would fish from the dock in front of his house, not caring very much whether he caught anything or not, but accepting as a pleasant surprise the occasional catch.

Mrs. Brown also turned to a more casual way of life than she had been able to follow as the wife of an executive. She rebelled against the many demands which had been made upon her formerly. She absolutely refused to entertain or serve on committees or answer the telephone. This last was handled by simply refusing to have a telephone.

She spent her time with simplified housekeeping, reading cook books or in long conversations with Mr. Brown after his day out-of-doors. Often the two just sat quietly enjoying each other's company. They wrote long letters to very special friends and cultivated a few choice new ones.

In a year's time these two people had dropped many years from their physical age. Mr. Brown had lost 30 pounds and gained a good tan and firm muscles. He had developed a lively interest in growing camellias and continued his fight with nature for the spot of woods around the house. By using hand tools, Mr. Brown was giving nature a fighting chance in claiming the woods. Sometimes nature got ahead, sometimes Mr. Brown. But Mr. Brown was definitely ahead in the struggle for his own health against time.

DEALING WITH DYING AND DEATH

There is a west coast Indian riddle that asks, "How long is the life of a butterfly?" The answer is, "Just long enough; neither a second too short nor a second too long." People in our society would probably be a lot better off if they could view their own death this philosophically. Death.

however, is not a subject that many individuals are comfortable with. Most people intellectually recognize that death is inevitable, but few are able to emotionally accept it. They are not prepared to think about their own death or to talk about another person's death with the person.

Our society's method of dealing with death is to keep it out of sight as much as possible. The majority of people go through life without ever seeing anyone die or spending time with someone who is dying. Often, they do not see their deceased relative until the relative is "sleeping" at a funeral home. This was not always the case. In earlier and simpler times people died at home, were prepared for burial, and were buried by family and friends. Although this may seem repugnant to some, it is a fact that the reality of death was much clearer under these circumstances. People had to confront death and so had a better chance of coming to terms with it.

Helping clients face death can be part of a health care worker's job. To do this task, you must come to grips with your own feelings and fears about death. By accepting death, particularly your own death, you can act more naturally around a dying client. You will also better understand the dying client and thus be able to show more compassion.

Dr. Elizabeth Kubler-Ross has written a book titled ***Death and Dying*** in which she records the results of many years of research with dying patients. Dr. Kubler-Ross found that there are five main stages an individual will commonly go through when faced with the crisis of dying. These stages are not always obvious, and they may not occur in order.

1. **Denial.** This has been called the "not me" stage. There is no acceptance of the reality of dying because the person refuses to believe it is happening.
2. **Anger.** The "why me" stage. The anger and hostility of the person is directed against, for example, family, the health care system, God, fate. There is a slight admission of the possibility of dying and frustration as to why.

3. **Bargaining.** Sometimes called the "yes me, but" stage. The person admits to the possibility of dying, but tries to bargain for more time. The bargaining may be with the family ("If you treat me better, I may not die"), a physician ("I've got too much left to do, you'll have to cure me"), or God ("I'll never do anything bad again if you let me live").
4. **Depression.** The "yes me" stage. The person realizes death is coming and goes through periods of depression, mourning the past and the mistakes made, and also grieving for all that will be missed in the future. The stress seems overwhelming, since the person realizes that death is the end of everything he or she has known.
5. **Acceptance.** Finally the person comes to terms with dying and is ready to face death. The person may, for example, want to see the family, to patch up old feuds, or write a new will. In this way the person is preparing to separate from loved ones.

Common Fears of the Dying Person

Following are some of the fears that dying people have: fear of pain, being alone, losing control, and facing the unknown. A common worry of some dying people is that they are a burden to others.

If dying clients can be reassured about their fears and worries, a large amount of their stress can be eliminated. With modern pain-killing medication, people do not have to die in pain. Reassurance that someone will always be close by is comforting to a dying person. Often family members will take turns being at the bedside, or staff members will check in frequently and sit with the individual when they can. Family and staff can ease the dying person's stress by reassuring the person that he or she is not a burden. As actions often speak louder than words, frequent, willing visits and carrying out tasks without complaint may convince the person of the love and concern of others. To lessen the dying person's fear of losing control, try to leave some

decisions for the person to make or at least participate in, and treat the person with respect and dignity.

Spiritual or religious beliefs may become especially important to the dying. Sometimes fears about death can be overcome by strong belief. Care workers should be accepting and make no judgments of clients' beliefs. Also, they should respond quickly to requests for clergy.

Care of the Dying

Dying occurs while one is still alive; it is the forerunner of death. The physical capabilities of dying people will range from being able to entirely care for themselves to being unable to do anything for themselves. With a dying client, you should give good physical care, but at the same time give the independence that the client wishes.

In caring for dying clients, be a good listener and allow the clients to express their feelings — all their feelings not just the agreeable, positive ones. Comments like “Oh, you don't mean that!” or “Please stop crying, you hurt me” only tell clients that you are unwilling to hear their real feelings. Try to show that you accept their ideas and understand their fears.

It may also be necessary to listen to and support the fears and frustrations of a dying person's family. Remember, they are going through a very difficult time too as they watch their relative die.

When death is near, the person will be bedridden and extremely dependent. The following care measures apply:

- Comfort is the first consideration (Figure 2-23); unnecessary treatments and procedures are usually discontinued.
- A listening ear may still be required and also the reassurance that someone will stay at the bedside. Touch gives reassurance of presence.
- The environment is important for the client and for relatives. The room should be clean, neat, and well-aired. Avoid chilling or over-

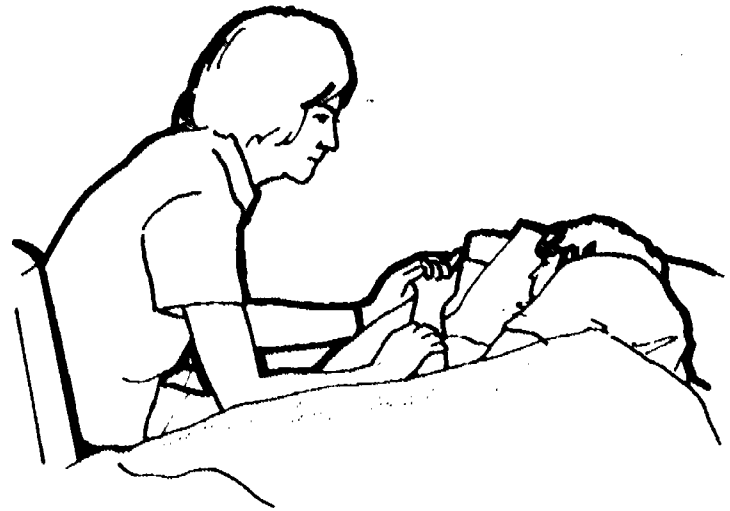

Figure 2-23. Giving Comfort to a Dying Person.

heating the room. Note that the skin of a dying person is colder than normal because body heat is directed inward. Unless requested, the room should not be dark. The dying client's vision is failing and reasonable light is helpful and reassuring. Familiar and significant objects should be in view.

- The special mouth care procedure (see Section 4) is frequently required. If the client's eyes are kept open, drops may be needed.
- Pressure areas are more susceptible than ever due to poor circulation; don't omit turning and rubbing.
- Use whatever measures are necessary to ease respiratory distress: for example, humidifier, positioning.
- Give fluids of the client's choice as long as they are tolerated. Obviously, these fluids are given for the sake of comfort rather than nutrition.
- Maintain safety precautions.
- Accommodate family and visitors who may wish to help with care.
- Remember that hearing is the last sense to go. Avoid indiscreet conversation that the client could overhear. Talk to the client even if the client cannot respond. Do not whisper.
- Refer questions about legal advice, donation of the body or its parts, funeral arrangements, etc., to your supervisor.
- Observe and report changes in the client's condition such as: breathing change, colour change (bluish or mottled), difficulty swallow-

ing, temperature change (skin cold and clammy), incontinence of urine or stool, restlessness, change in facial expression.

The Rights of a Dying Person

Figure 2-24 gives a bill of rights for dying people. This bill was created at a workshop in Lansing, Michigan conducted by Amelia J. Barbus.

- I have the right to be treated as a living human being until I die.*
- I have the right to maintain a sense of hopefulness however changing its focus may be.*
- I have the right to be cared for by those who can maintain a sense of hopefulness, however changing this might be.*
- I have the right to express my feelings and emotions about my approaching death in my own way.*
- I have the right to participate in decisions concerning my care.*
- I have the right to expect continuing medical and nursing attention even though "care" goals must be changed to "comfort" goals.*
- I have the right not to die alone.*
- I have the right to be free from pain.*
- I have the right to have my questions answered honestly.*
- I have the right not to be deceived.*
- I have the right to have help from and for my family in accepting my death.*
- I have the right to die in peace and dignity.*
- I have the right to retain my individuality and not be judged for my decisions which may be contrary to beliefs of others.*
- I have the right to discuss and enlarge my religious and/or spiritual experiences, whatever these may mean to others.*
- I have the right to expect that the sanctity of the human body will be respected after death.*
- I have the right to be cared for by caring, sensitive, knowledgeable people who will attempt to understand my needs and will be able to gain some satisfaction in helping me face my death.*

Figure 2-24. The Dying Person's Bill of Rights.

Care of the Body After Death

When death occurs, it is common for family members to gather and say their goodbyes. Making time available for this gathering and ensuring that the body is clean and comfortably positioned with dentures and other prostheses in place can ease the grief of the family. Showing respect for the body is an indication that the dead person was well cared for. Removal of extra equipment from the room before viewing can help family members accept the death. Remember that privacy is a priority for grieving relatives. Family members may have specific religious, cultural, or personal requests. These requests should be respected and accommodated if possible. Consult your supervisor if you are unsure of the acceptability of a request.

Personal possessions and valuables should be dealt with according to agency policy. Check with your supervisor regarding who should receive clothing and belongings. Often a signature is required to indicate that family members have received personal possessions.

Preparation of the body for removal to a mortuary should not begin until the physician has pronounced death. Legally, death has not occurred until this point. Physical preparation of the body will vary slightly from agency to agency, but cleanliness is universal. Make sure the body is clean and identified according to policy. Check the policy carefully before proceeding with other preparations.

Children and Death of a Parent

Death can be particularly bewildering to children. It is very important that at the time of a parent's death children be treated in a caring, sensitive manner. If they are, they are more likely to be able to cope with the trauma of the death of their mother or father, and gain some strength from the experience. If they are not, they can receive an emotional wound whose scar can last a lifetime.

The following are guidelines for assisting children to cope with a death of a parent:

Be honest. Explain the death and answer the children's questions truthfully. If you do not know the answer to a question such as "Why did God let mommy die?" tell the child you do not know. The problem with telling children "little stories" in order to spare their feelings is that you don't know where the stories will lead to. For example, saying that mommy is "asleep and won't wake up anymore" can leave children afraid to go to sleep for fear that they, too, won't wake up; or saying that mommy "has gone on a long trip and won't ever come back" can leave children feeling abandoned and fearing travel, since if they go away, they may, like their mother, not come back either. Children must be told that death is final, that their mother or father is dead and won't come back to life.

Be gentle. Being honest does not mean being blunt or insensitive. You can be honest but at the same time be thoughtful and gentle.

Recognize that children are children. They are most concerned with their own needs such as who will take them to the baseball game now or make their lunch. This is their nature; they are not being selfish or uncaring. Death is a difficult idea for children to grasp, and they should not be criticized for not fully understanding it.

Be supportive of their grief. Give encouragement when the children are ready to grieve their loss. It takes time for the reality of death to sink in and for children to gain the courage to deal with their great loss. Let the children know that it is okay to cry and reveal their feelings (Figure 2-25). Talking about your own feelings

of their dead parent may help them express their feelings. Note that a child's grief may continue for a long time, and even long after it disappears, it can reappear.

Don't overburden them with responsibilities. Don't tell children that they are now the man or the woman of the house. It is hard enough to lose a parent without losing one's childhood as well.

Carry on routines. Continue the children's daily routine, and keep them in the same environment if at all possible. This is not a time for any more major changes in their life.

Take them to the funeral. The funeral allows children an opportunity to emotionally respond to their parent's death. It also gives them an opportunity to think out their ideas on the finality of death.



Figure 2-25. Children Expressing Their Feelings.

EXERCISE 2-3

Crossword 1

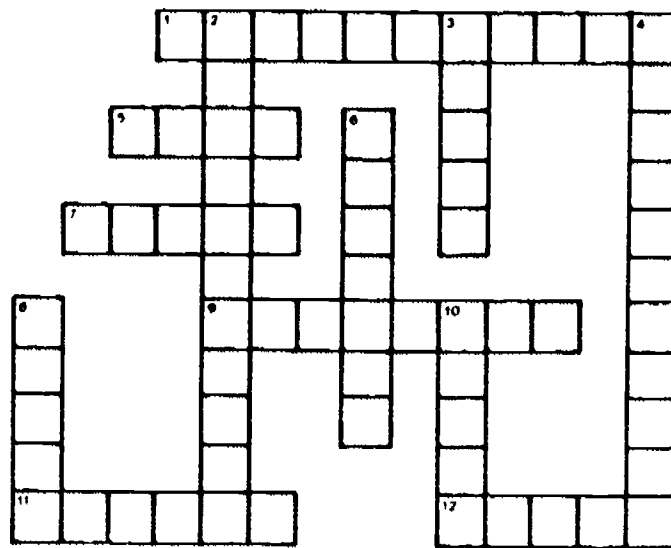

Across:

1. Growth and development stage from age 12 to 19.
5. Social need for all ages.
7. Individual over 19 years of age.
9. Growth and development stage before birth.
11. Increase in physical size.
12. Period of rapid growth.

Down:

2. Changes due to learning.
3. Individual between 1 and 12 years of age.
4. Culture and traditions surrounding an individual.
6. Growth and development stage from birth to 1 year.
8. Process of growing older.
10. Skills to be learned.

Crossword 2

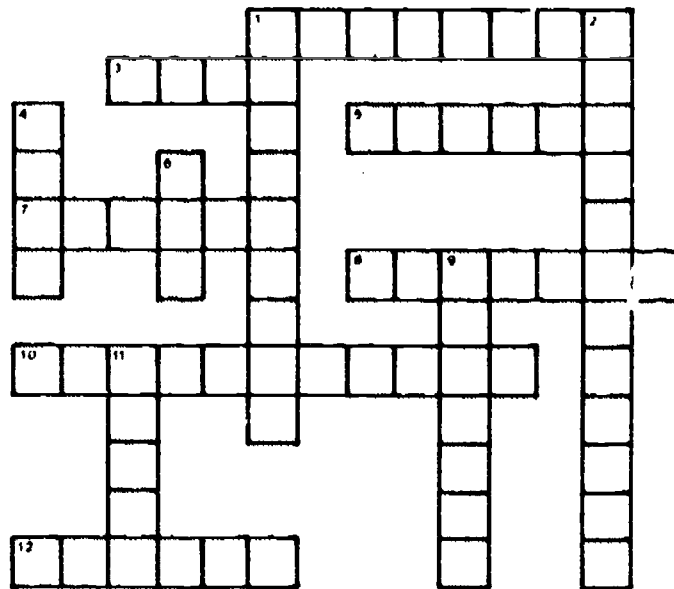

Across:

1. Family made up of parents, children, grandparents, and other relatives living together.
3. Care approach involving health care workers, the client, family, and others.
5. Significant _____.
7. Basic unit of our society.
8. Family made up of parents and children living together.
10. Stage of family life cycle encouraging children's education.
12. The family functions as a support _____ for its members.

Down:

1. Stage of family life cycle when children have left home.
2. Family rudeness to a care giver may be an example of this psychological defense mechanism.
4. Name of the female married partner.
6. Relatives, family.
9. Stage of family life cycle with pre-school children.
11. Age, sex, position in family, and cultural factors decide family members' _____.

Questions

1. Match:

- | | |
|----------------------------------|--|
| a. Prenatal (before birth) | 1. Beginning to control emotions |
| b. Infancy (0-1 year) | 2. Gaining physical and emotional independence from parents |
| c. Early childhood (1-5 years) | 3. Weight redistribution |
| d. Middle childhood (6-12 years) | 4. Lasts about 40 weeks |
| e. Adolescence (12-19 years) | 5. Refining judgement and self-control |
| f. Early adulthood (19-30 years) | 6. First learning to eat solid food |
| g. Middle age (30-65 years) | 7. A general slowdown of body systems occurs |
| h. Old age (65 years to death) | 8. Has a task of building a wholesome attitude toward the self |

2. In general, what is the biggest limitation on aging people's abilities and activities?
3. What type of people are likely to find retirement a blow?
4. What are three major difficulties faced by someone who moves into an institution?
5. What are five practices that can make an institution a more homelike place to live in?
6. What is the important thing to keep in mind with a client who shows confused behaviour after moving into a care institution?
7. The _____ has a profound effect on all future behaviour of a child.
8. If a family does not successfully carry out the developmental tasks of the family, what can be the effect on an individual family member?
9. Why should you be observant for personal problems of family members of a client?
10. Before you involve family in care, what should you find out first?
11. If a client and family have a way of coping that you personally don't agree with, what should you do?
12. If a client's family is overdependent on you, what can you do to encourage them to take more responsibility for the care?
13. What factors other than disability have a bearing on whether or not someone should receive care at home or go into an institution?
14. What are the five stages that Elizabeth Kubler-Ross says dying people commonly go through?
15. Before you can do a good job at caring for dying clients, what do you personally have to do?
16. Following are some common fears and worries of a dying person. Briefly state what you can tell or do for clients in each case.
Pain
Being alone
Losing control
Being a burden

17. When death is near, what is the first consideration of care?
18. What care would you give a dying person in the following areas?
Mouth:
Eyes:
Pressure areas:
Respiratory distress:
Fluids:
19. After a client has just died and time is made for the family to grieve over the body, what should you check about the body?
20. When children ask about the death of a parent, what is the best approach to take in your answer?

Section 3

The Employment Field

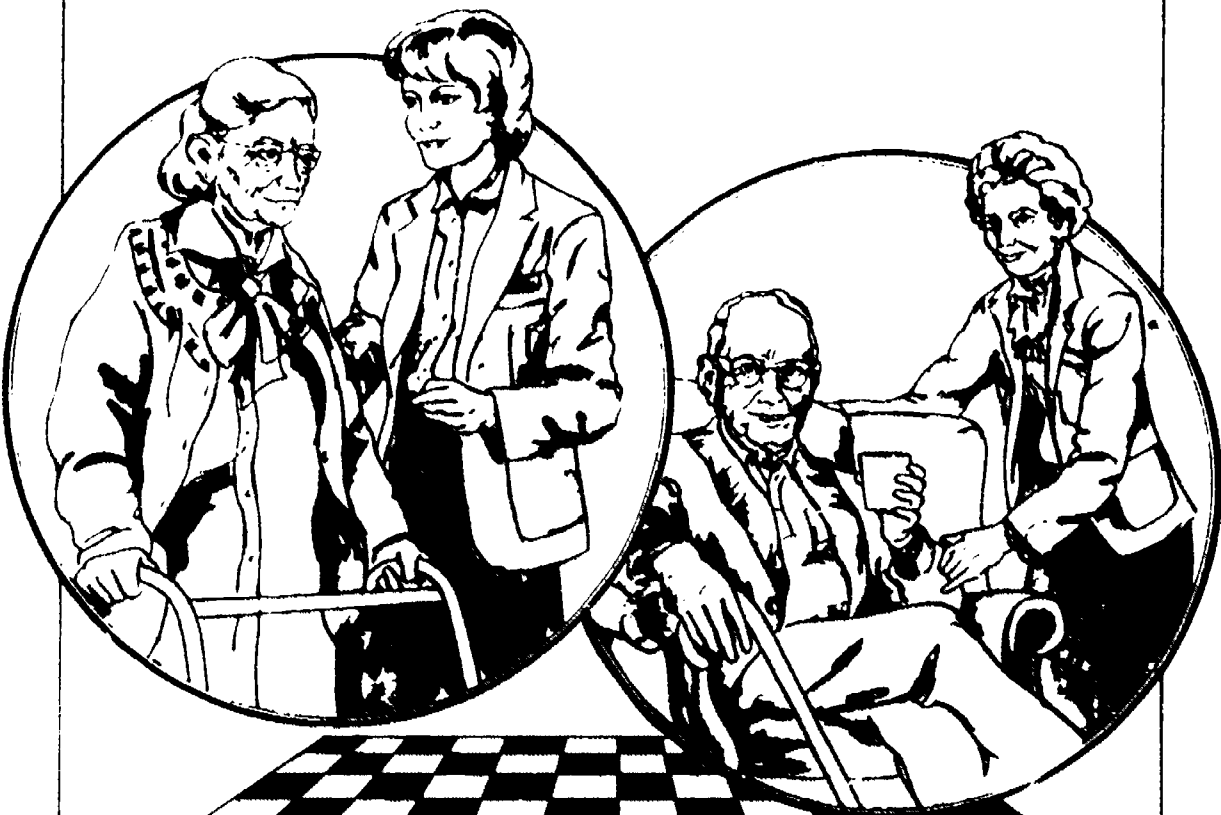

INTRODUCTION

Section 3 introduces you to other members of the health care team and describes the different health and social services available in British Columbia. It also discusses various aspects of employment in the care giving field. Your responsibilities as an employee for a care agency or institution are examined, as are your rights. Similarly, the employer's responsibilities and rights are examined. You are made aware of legal terms that could have a bearing on a care giver's job. Knowing what the law is enables you to protect yourself by avoiding actions or situations that you could, even quite innocently, be liable for. The section ends with some basic information on how to go about getting a job at a care agency or institution.

HEALTH AND SOCIAL SERVICES IN BRITISH COLUMBIA

Figure 3-1 shows the range of health and human services available in British Columbia. The major providers of these services are:

- Ministry of Health
- Ministry of Human Resources
- Health units
- Hospitals
- Long term care facilities
- Homemaker agencies
- Voluntary agencies

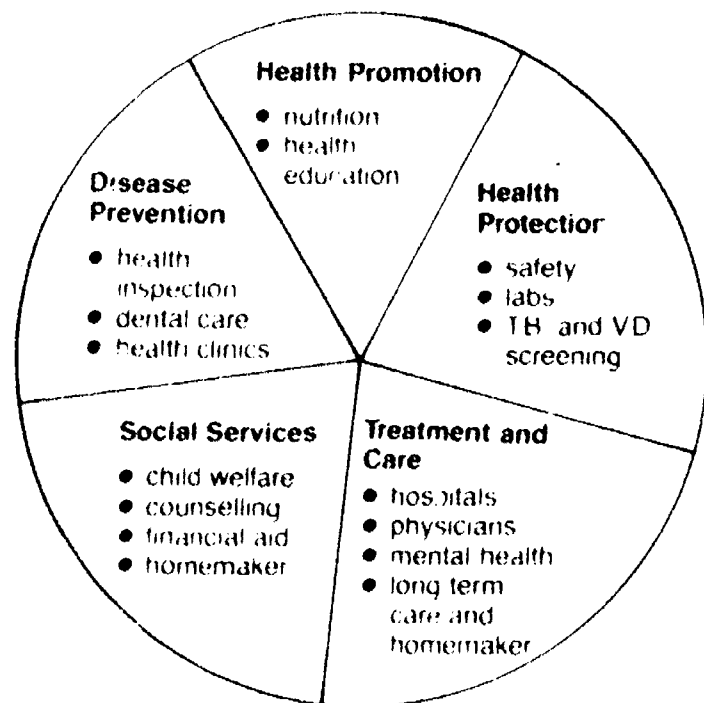

Figure 3-1. Health and Human Services in British Columbia.

The Health Care Team

Health can be defined as a state of physical, emotional, and social well-being. A list of some of the people involved in the health care of clients and their families follows. You may be in contact with many of these members of the health team, depending on your place of employment.

Physician. Diagnoses and prescribes treatment for illness and promotes health.

Pharmacist. Dispenses prescribed medication.

Social worker. Helps families and clients with problems such as financial and family problems. Provides a link between the community and government resources.

Homemaker. Provides personal assistance and environmental care in the home.

Long term care aide. Provides personal assistance and environmental care in long term care facilities.

Licensed practical nurse. Performs nursing duties under the direction of a registered nurse or physician.

Registered nurse. Is responsible for professional nursing care of clients.

Physiotherapist. Directs and assists in exercising clients with poor muscle and nerve function.

Occupational therapist. Plans and assists with activities that help clients adjust to their situations.

Speech therapist. Assists in retraining clients with speech difficulties.

Dietician. Assists clients and families in achieving good nutrition within their budgets.

Public health inspector. Is responsible for checking the healthiness of public places.

Clergy. Offer emotional and spiritual support to clients and families

Technician. Works with diagnostic tests. Two examples are an X-ray technician and laboratory technician.

Communicating and Cooperating with the Health Care Team

Satisfactory relations with others on the job require working cooperatively with members of other health care services. All services have responsibilities towards the client. You should respect the roles of other workers and recognize that each group is responsible to its own supervisor. In other words, do not give orders to people from another service; give information, if it is needed, but not orders. If there is a problem, inform your supervisor who can then take up the matter with the supervisor of the other service. This may appear a roundabout way to solve a problem, but clear-cut lines of authority are necessary to avoid confusion.

Communication channels in an organization are referred to as horizontal or vertical (Figure 3-2).

Horizontal communication occurs between people who are at the same level in an organization, and **vertical communication** between people at different levels. Communicating with a fellow care giver is horizontal communication. Communicating with your supervisor is vertical communication. The example problem just mentioned between yourself and a person from another service should be dealt with as vertical communication with your supervisor rather than as horizontal communication with the person.

When working for an agency in a private home, you communicate with a supervisor. This is usually done by telephone. Since supervisors are busy, you may not always be able to get in touch with them. In this case leave a message so that they know you are trying to contact them.

Figure 3-3 is an organizational chart showing the relationship of services in the health care field.

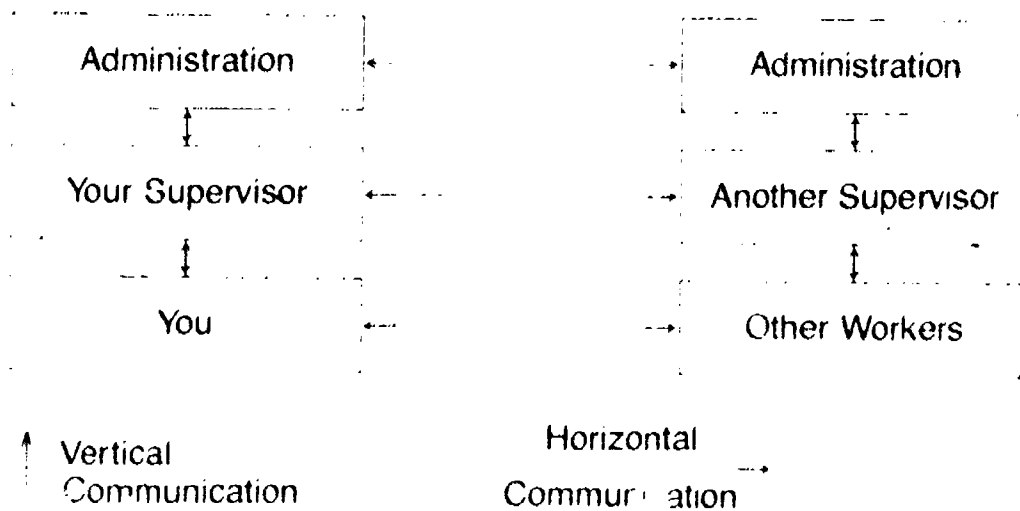

Figure 3-2. Lines of Communication and Authority.

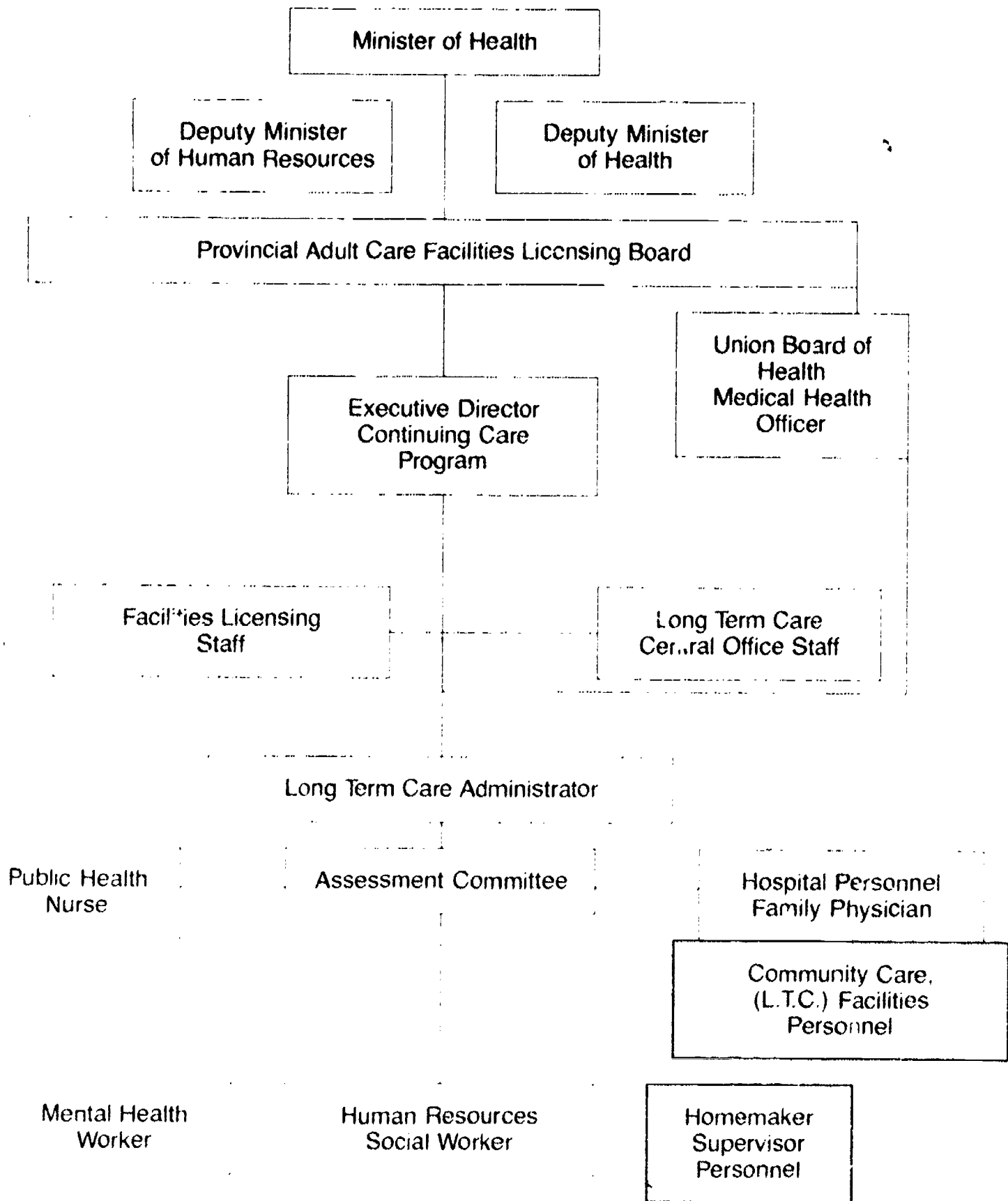

Figure 3-3. Chart of Relationships of Services in the Continuing Care Field.

Long-Term Care

The long term care system was established in British Columbia in 1978 to provide services and care for those who have health-related problems and cannot live independently without help. Supportive services or care is provided to long term care clients in a:

- Home
- Personal or intermediate care facility
- Extended care facility

Potential clients are assessed according to their health, ability to function, needs, and other factors to find out which services are best for them.

Home Care Services

For the client who is able to remain at home with some assistance, three main types of service are available:

Handyman service. Services such as window washing, minor repairs, and garden maintenance.

Homemaker service. Assistance with bathing and grooming, cooking, laundry, house cleaning, shopping, and general hygiene. Provided by qualified homemakers and supervisors.

Home care. Nursing and rehabilitation care provided by qualified nurses, physiotherapists, occupational therapists, and speech therapists.

Personal, Intermediate, and Extended Care Services

Care facilities are considered when it is no longer possible or reasonable to help a client stay at home or in the care of a relative or friend. There are three main types of care facilities:

Personal care. For clients able to look after themselves with minimal help and supervision. No registered nurse is required.

Intermediate care. For clients who require general support and some professional care but

are still able to do much for themselves. Intermediate care has levels 1, 2, and 3 indicating the degree of disability. There is a wide range of disabilities between the three levels. Staff must include a registered nurse, at least part-time, aides, activity staff, and a nutritionist.

Extended care. For clients who need to have professional health services available at all times. Staff must include a registered nurse for 24 hours a day. Other staff may be licensed practical nurses, aides, activity staff, physiotherapists, occupational therapists, social service persons, pharmacists, nutritionists, and chaplains.

Community Services

Many organizations, volunteer agencies, churches, and professional associations offer services helping people live independently or making life more varied and enjoyable for those unable to regain independence. Examples of community services are:

Meals-on-wheels. Regularly delivers nutritious, hot meals.

Red Cross loan service. Provides sickroom equipment, wheelchairs, crutches, and canes for up to three months.

Kinsmen rehabilitation service. Provides rehabilitation equipment on a doctor's approval.

Mobile library service. Delivers books to those unable to get to the library.

Stroke clubs. For clients who have had a stroke.

Day care centres. Provide care for adults once or several times a week.

Seniors' centres. Offer activities and counselling.

Consumer associations. Provide assistance with finances and credit.

Alcohol and drug counselling. Counsels clients with alcohol or drug problems, and also counsels their families.

Information on these and other services can usually be found by contacting the municipal hall, community service centre, or the social services guide either in the yellow pages or in the white pages at the beginning of the telephone book.

EMPLOYMENT PRACTICES

Policies and Procedures of Employment

The rules and methods of conducting the day-to-day business of an agency are known as policies and procedures. Agency policies and procedures include regulations on lines of communication and authority and information on the rights and responsibilities of both the employee and employer.

Most agencies have a policy manual stating the appropriate action to deal with general situations and outlining who reports to whom and who is responsible for what. Agencies also usually have a procedure manual that gives step-by-step instructions on how to perform required tasks, for example, bathing a client.

Employment Rights and Responsibilities

A right is something that one is entitled to such as the right to a fair trial. A responsibility is an obligation that one must fulfill such as a mother's responsibility for her children. Both employers and employees have rights and responsibilities.

Employer Rights

- Receive cooperation from employees in practices related to employment.
- Have employees follow policy.
- Get reasonable performance for pay.
- Be shown a reasonable degree of respect from employees.

Employer Responsibilities

- Provide understandable personnel policies giving job descriptions, conditions of work, benefits, causes for dismissal or disciplinary action, expectations, and terms of employment such as hours of work, salary, vacation, and shift work. See Figure 3-4 for a sample policy outline.
- Provide an up-to-date procedure manual.
- Provide adequate working conditions.
- Evaluate employees and keep them informed of their progress.
- Respect the rights of employees.

Employee Rights

- Have adequate working conditions.
- Receive a fair salary.
- Have access to policy and procedure information.
- Be made aware of the employer's evaluation of their performance.
- Be shown a reasonable degree of respect from their employer.

Employee Responsibilities

- Maintain good personal health standards, and take the appropriate actions when ill.
- Maintain good personal hygiene and grooming in accordance with job requirements and personnel policies. Grooming includes cosmetics, hair, fingernails, clothing and jewelry.

- Take a responsible approach to the job by being punctual, dependable, and accountable for personal actions. Show self-discipline, and recognize the need for ongoing learning and development of skills and interests.
- Show an ethical approach to the job by maintaining confidentiality, following personal and professional standards, respecting the rights of individuals (e.g., their right to privacy and equal access to services), and reporting questionable practices.
- Safeguard clients by maintaining care standards.
- Recognize personal limitations and ask for help when required.
- Recognize employment limitations and perform within them.
- Be familiar with the employer's policies and procedures.

Figure 3-4: Sample Personnel Policies

Personal Conduct:

1. **Confidentiality:** Care must be taken to preserve the client's privacy. Discussion regarding the client must only be with the supervisor, nurses, social workers or other professionals on the care team.
2. **Advice to clients:** Avoid giving advice to clients. Listen with understanding and be prepared to suggest alternative solutions. A knowledge of community agencies and services that the client may contact is important.
3. **Accepting gifts:** Do not accept gifts from clients.
4. **Smoking in client's home or facility:** It is advisable to receive permission to smoke from the client. Limit smoking to a minimum while on duty.
5. **Physical punishment:** Must never be used on children. If the homemaker is unable to cope with a problem, contact the supervisor.

Work Record:

The record of hours worked is submitted on time sheets. The homemaker must be accurate.

Time Sheets:

Must include:

1. Date: day, month, year
2. Time work commenced: time work completed
3. Client's signature for each day
4. Full name and address of client
5. Submit time sheets promptly at the time specified by the agency.

Payroll Deductions:

Income Tax, Canada Pension Plan (CPP), Unemployment Insurance (UIC).

Insurance (Personal):

Protective insurance in relation to the employee's employment is provided through the Workers Compensation Act of B.C. and the employer's liability insurance.

Transportation:

When a homemaker is required to travel as part of the regular work, mileage is usually paid as set by the agency.

Homemakers must not transport clients in their own vehicles without approval of the agency. This can only be done when the employee is satisfied that all car, driver and personal liability insurance are in effect.

Bus fare is covered by many agencies depending on the circumstances. For example, all employees who visit more than one client per day and who use buses to travel to reach the next client will be reimbursed. Transportation to the first client and from the last client to the employee's home is not covered.

Discipline/Dismissal

The agency will discipline any employee for just cause.

Gross misconduct — theft, neglect or mistreatment. Discharge shall be immediate with written notice.

Inappropriate conduct with a client. Will be corrected by the supervisor or coordinator, followed by a written warning. If the homemaker's conduct does not improve, the homemaker will be discharged after two weeks written notice.

Grievance Procedure

- a. Every effort should be made to settle a grievance directly between the supervisor and the homemaker.
- b. If the grievance cannot be resolved, the agency may choose to discuss the situation with a homemaker committee.
- c. If the grievance is not resolved within a time limit (usually two weeks), the homemaker will submit a written grievance. The committee will examine all the facts and give the employee a written decision.

Personal Limitations

As a care worker you soon realize that you cannot solve unaided all the problems that you come across in your job. There is knowledge you don't have, skills you don't possess, and situations that you have never had to deal with before. Some of your limitations will be defined for you by your employer, but others you will have to recognize yourself. When you encounter a job or a problem that you are uncertain of or can't do, face your limitations and seek help. Asking for help is not a sign of weakness or incompetence. On the contrary, it is a sign that you want to give the client the best care possible and don't want to take any chances.

Some sources of help or assistance are:

- Supervisor
- Fellow care workers
- Client's family
- Physician
- Fire department
- Public health nurse
- Telephone company

LEGAL IMPLICATIONS OF EMPLOYMENT

A person working in a care setting is considered to have contracts both with the employing agency and with the clients. These contracts may be written but more frequently are not.

Though it is true that responsibility increases with the level of authority, each individual is still held responsible for his or her own actions. This holds even when following orders. If it can be shown that a person who carried out an order was aware that the order was wrong, then that person is held responsible for the action. Just as

following orders is not accepted as an excuse in law, neither is ignorance of the law an excuse. If you break a law, you are legally responsible, even though you didn't know it was a law.

An employee cannot be held responsible for the actions of an employer. On the other hand, an employer can be held responsible for the actions of an employee. However, the guiding principle of law is that individual employees are held responsible for their own actions.

A special concern in care settings is to perform duties that are within the scope of your training, position, and abilities. In some institutions duties are clearly defined and strictly enforced. However, many other long term care and homemaker agencies operate less clearly. In these agencies employees should get their work duties straight with the supervisor.

An employee has a legal responsibility not to commit a criminal act on the job; for example, petty thievery. It is unwise for care workers to commit a crime, however small, and feel overconfident that they won't get caught or that nothing would happen if they were caught. Legal cases involving members of a care team are usually complicated and unclear in nature; many factors influence the outcome.

Your major responsibility as a health care worker, legally and otherwise, is to do your job with reasonable care and skill, showing respect and concern for others.

Consent

All health care requires the cooperation of the client, and care procedures may only be carried out with the client's consent. The client has the right to refuse any care, and this right must be respected both for ethical and legal reasons. It cannot be assumed that because a client agrees to have homemaker services, the client also agrees to whatever the homemaker thinks is best. Nor can it be assumed that a client who pays a monthly fee to a care facility agrees with every suggestion made by the care staff.

Consent must be obtained for each new situation and re-obtained for each repeat of an old one. Gaining consent begins by honestly explaining what is to be done. Legally, consent of the client can only be obtained by positive means; it cannot be obtained by threats, falsehoods or force. Situations occur in which individuals are unable to give consent for physical or mental reasons. In these situations it is the responsibility of the care giver to be justified in proceeding with the care and to give the care competently and respectfully.

Legal Terms

The following are legal terms related to care work. All of the terms deal with actions that care workers should avoid.

Liability. Taking responsibility for your own actions. Care workers are required to perform duties that are in keeping with their training and experience. They can be legally liable for doing less than they should or for doing something that they shouldn't. For example, your client, Mrs. Q., has had a headache all morning and is very uncomfortable. You decide that one of her arthritis pain-killers will cure the headache and give her one. In this case you could be liable for giving her the pill, because you don't have the training to make such a decision. This is the job of a doctor or a nurse.

Negligence. Doing something a reasonable and prudent person would not do, or not doing something a reasonable and prudent person would do in a similar situation. For example, your client, Mrs. K., asks to be turned on her left side. You do so but leave her too close to the edge of the bed, and she rolls off and falls to the floor, bruising her hip. This is negligence on your part.

Assault. An attempt to harm a person or a threat to harm a person. Note that a threat to harm someone is enough to constitute assault. Physical violence need not take place. For example, Mrs. H. is a restless client who continually knocks equipment and utensils off her bedside table, keeping others awake. You tell her that if she does not settle down, you will have

to tie her hands to the bed. This threat is considered an assault.

Battery. An act of violence against another person. Battery involves assault, and the two terms are commonly used together. For example, Mrs. F. is an elderly client who is upset and yelling at you. To calm her down, you slap her face. You have committed assault and battery.

Libel or slander. Damaging or untrue statements affecting the reputation of another person. Libel is usually written, whereas slander is usually spoken. For example, your client's mother lives out of town and writes frequently to ask about her daughter's condition. In one of your written replies, you tell her not to worry so much about her daughter because she is really not ill. She is just trying to get attention. This can be considered libel. To give another example, Mr. G. an extremely ill and difficult client has tried your patience to the breaking point. You advise the evening homemaker to resign from the case, because the client is mentally ill and does not know what he is doing. This can be considered slander.

Invasion of privacy. Unnecessarily exposing a client's body or revealing personal information about a client obtained during care. For example, Mrs. X., a well-known author that you have been caring for dies on your day off. A newspaper reporter phones you at home to ask for information for the paper, and you tell the reporter everything you know about Mrs. X. You have committed an invasion of your client's privacy.

False imprisonment. The unnecessary restriction of the freedom of another person. For example, Mr. P. insists on getting out of bed, even though his doctor has said he is to be on complete bedrest. To keep him in bed, you apply wrist and ankle restraints. This can be considered false imprisonment.

Witnessing Documents

It is wise to avoid signing or witnessing documents for a client, because you may not have an

understanding of what your responsibility is in the matter. One document you may be asked to witness is a last will and testament. This is a written declaration saying what a person wishes done with his or her possessions after death. By signing as a witness, you are saying that the right person wrote and signed the will and that the person is of sound mind and made the will voluntarily.

To avoid problems, you should refer the client to a qualified person rather than signing yourself. Agencies have policies about who may or may not sign or witness documents. It is never necessary to sign a document against your own wishes or better judgment.

Taking Telephone Orders

A physician will sometimes phone a new treatment or medication order to a care facility. The problem with writing down orders given by telephone is that you are left without backing if the person giving the orders later disputes their accuracy. In most facilities, orders for drugs and the results of lab work must be received by a nurse. For your own protection, find out the policy of your agency regarding medical telephone messages.

When taking an ordinary telephone message, always write it down carefully, and read it back to the caller before hanging up.

Transporting Clients

Staff in long term care facilities are usually not permitted to use their own vehicles for transporting clients. On the other hand, the ability to transport clients by car may be a condition of employment for homemakers.

The first concern in the transporting of clients is the insurance coverage of your vehicle. You must be positive that your insurance covers the chauffeuring of clients. Avoid accepting money from a client for transportation, because this changes your liability should an accident occur.

Most homemaker agencies have adequate mileage reimbursements for transporting clients.

Physical and Verbal Abuse

Obviously, physical or verbal abuse of a client is morally, ethically, and legally unacceptable. The problem, however, arises in knowing just where abuse begins and acceptable behaviour ends. Care givers should not leave themselves open to even a suggestion of abuse; they should be "safe rather than sorry" in all situations concerning abuse. Self-control is a major responsibility of care workers.

Just as abuse is unacceptable from a care worker, so is it from a client. No health care worker has to meekly accept verbal or physical abuse from a client. If a client's behavior is offensive, you should inform the client that such actions are unacceptable and you will not continue unless it stops.

Setting limits to behavior or language that you will accept often causes the client to reassess and alter his or her actions. If the client refuses to change, you may have to withdraw, but check first that it is safe to leave the client. Inform your supervisor of any difficulties with clients, and notify the supervisor immediately if you withdraw from a client.

FINDING A JOB

Knowing how to find a job can be a job in itself. Depending on the economy, jobs may be plentiful or scarce. In either case you should know the procedures and skills that give you the best chance of obtaining employment.

Sources of Job Information

How do you find out where jobs are available? The most common sources of job information are:

- Canada employment centres
- Classified advertisements in newspapers
- Personal contacts
- Visits or telephone calls to appropriate agencies
- Letters to distant agencies

Job-Finding Skills

Knowing where the jobs are is part of a job search. Another major part is selling yourself to potential employers.

Finding a job can require a good degree of salesmanship: the employer is the consumer and you, the applicant, are the product. A product that is well-packaged and fits the needs of the consumer always sells. These principles can be applied directly to the job search. First, do an honest assessment of the product. What are your main strengths and abilities? What type of work do you enjoy most? What salary do you consider adequate? The answers to these questions will direct you to appropriate employers.

If you enjoy working with the elderly, you should approach an agency that cares for older people. Or, if you enjoy working with children in groups and have good working relations with them, seek employment in an agency that cares for children or perhaps a group home for chil-

dren. Working with children usually means you have to be prepared to work full time on any shift. You can also consider caring for foster children in your own home.

An assessment of your strengths, abilities, likes, dislikes, and goals should help you find a job that is right for you. The assessment will help you to more clearly answer questions from interviewers.

Application Forms

For local employers, you may wish to request an application form in person and arrange for a later interview. A personal visit can give you an idea of what the agency is like. Alternatively, you may prefer to telephone employers requesting an interview and application form.

Figure 3-5 shows a sample application form. Since this form is often the first item an employer sees when considering someone for employment, it should be clearly written, concise, accurate, and complete. Always check the form over carefully before submitting it.

Letters of Application

If you are applying for positions in another city or province, you will need letters of application. Figure 3-6 shows a sample letter of application. Note the numbers beside the different parts of the letter. These numbers correspond with the numbered explanations given in the key for the figure.

Figure 3-5 Sample Application Form

NEEPAWA Homemaker Agency:

APPLICATION FORM

Name: _____ **Social Insurance No:** _____

Address: _____ **Telephone Number:** _____

Birthday: _____
DAY MONTH YEAR

Whom to notify in case of an **EMERGENCY?** Name: _____

Address: _____ Telephone Number: _____

Dependents: Number _____ Age(s) _____

Education: Circle year completed in school

1 2 3 4 5 6 7 8 9 10 11 12 13

State any other special training: _____

LIST BELOW OTHER POSITIONS HELD:

From	To	Name and Address of Employer	Salary
1.	_____	_____	_____
2.	_____	_____	_____
3.	_____	_____	_____

Are you presently employed? YES [] NO [] If so, state where:

Name: _____ Address: _____

References (NOT RELATIVES), preferably former employers:

	Name	Address
1.	_____	_____
2.	_____	_____
3.	_____	_____

What hours can you work? _____ **Weekends?** _____

Are you available for 24 hour service (live-in)? YES [] NO []

How early in the morning could you be on the job?

7:00 A.M. _____ 7:30 A.M. _____ 8:00 A.M. _____ 8:30 A.M. _____

Have you a car for transportation? YES [] NO []

Will you depend on buses? YES [] NO []

Would you prefer to care for: Children [] Senior citizens [] Chronically ill []

Please state why you have applied for this position: _____

Date: _____ **Signature:** _____

Figure 3-6 Sample Letter of Application

1 2534 Westwind Drive
New Westminster, B.C. V6B 1E2
April 3, 1984

Mrs. Edith Service
Director of Homemaker Service 2
Neepawa, B.C.

Dear Mrs. Service: 3

Please consider my application for the position of homemaker advertised in Friday's Beacon.
4 I believe that my training and experience have prepared me to handle the job to your
satisfaction, since I graduated from the Nightingale Long Term Care/Homemaker Program on
March 15th, 1984. 5

I feel that my experience growing up as the eldest child in a family of five children has given me
many of the skills I need as a homemaker. I have also had the experience of looking after my aged
father for six years. He fractured his hip in an industrial accident and has been bed-ridden during
this time.

My own children left home and you will note from my resume that I have been employed part-
time for several years. I am now prepared to work full-time.

I am including a resume on which I have indicated two references as to my character and
background. 6

I hope I may hear from you very soon. I am available for an interview at your convenience. 7
My phone number is 531-3226.

Yours very truly, 8

Reta McCormick

encl. 9

Explanation Key for Figure 3-6

Type or clearly write the letter, but always sign your name in your own handwriting.

1. **Return address and date.** Give your full mailing address and the date of your letter.
2. **Inside address.** This is placed at the left margin but lower than the date. It includes the:
 - a. Name of the person to whom you are writing (sometimes the name is not given)
 - b. Title or position of the person
 - c. Name of the organization or business
 - d. Full addressNote the punctuation of the inside address.
3. **Greeting.** If you know the person's name, use it. If no position is given and you only have the name of the organization, direct your letter to "The Supervisor" in the inside address and use "Dear Madam:" in the greeting.
4. **The advertised position applied for.** Give the name, number (if known) or description of the job as it appeared in the

advertisement. Also state where you saw the advertisement.

5. **Qualifications.** Give the important details of your qualifications, particularly as they relate to the position you want. If you can, show that you have the qualifications asked for in the advertisement. This is the most important part of the letter. You want the employer to be interested in your qualifications and thus want to know more about you. Also state whether you wish part-time or full-time work.
6. **Enclosures.** State in a sentence or two what you are enclosing with the letter.
7. **Request for an interview.** State that you wish to have a job interview and are available for one. Give any times that you are not available due to work or other reasons.
8. **Close.** Include a complimentary close such as "Sincerely yours," or "Yours truly," sign with your signature, and type or print your name beneath.
9. **Encl.** Means enclosures and indicates that you are sending something with the letter. In this case a resume is enclosed.

Figure 3-7: Sample Resume

RESUME

McCORMICK, Mrs. Reta 1
2534 Westwind Drive
New Westminster, B.C.
V6B 1E2

1 Telephone: 531-3226

Age: 53 years 2
Marital Status: Widow
Health: Good
Social Insurance Number: 708-342-238

WORK EXPERIENCE: 3

August 1965 — June 1972

Royal Columbian Hospital
Dietary assistant part-time

October 1972 — July 1976

Canada Safeway Limited
Cashier part-time

July 1977 — August 1978

Surrey Volunteer Coordinating Centre
Receptionist and secretary for summer relief.

RELATED EXPERIENCE: 4

I have looked after my father who has been bed-ridden for six years. I have done volunteer work at a crisis centre.

EQUIPMENT I CAN OPERATE: 5

I am familiar with the operation of all household appliances such as washing machines, dryers, dishwashers, vacuum cleaners, and light kitchen appliances.

EDUCATION: 6

Brock High School, Hamilton, Ontario. Completed grade 12 in 1945.

Surpass School of Business Reception. Completed a typing course in 1946.

Nightingale Long Term Care/Homemaker Program, 1984.

HOBBIES AND INTERESTS: 7

Pottery, weaving, music and reading.

REFERENCES: 8

Mrs. S. Singleton
Personnel Manager
Royal Columbian Hospital
330 East Columbia Street
New Westminster, B.C.
Phone Number: 522-2771

Mr. V. Unit
Canada Safeway Limited
12805 — 16th Avenue
Surrey, B.C.
V4A 3K6
Phone Number: 536-8202

Resume

A resume is a summary of information pertinent to your career. An effective resume can be of great assistance in obtaining a job. Start by doing a rough draft, and finish with a final copy that is as neat and comprehensive as possible. A sample resume is given in Figure 3-7. The numbers next to the parts of the resume correspond with numbered explanations given in the key for the figure.

Explanation Key for Figure 3-7

1. **Your name, address, and telephone.** Be sure to give a number where you can be reached during the day.
2. **Personal data.** Age, marital status, health, social insurance number. You might also include height, weight, dependents.
3. **Work experience.** Give the month, year, employer, and job title for each job. You may wish to detail the duties of a job if you feel it is advantageous.
4. **Related experience.** List in short sentences any activities, volunteer work, or hobbies that could be related to the job.
5. **Equipment I can operate.**
6. **Education.** Public school, training courses, on the job training. State where and when you took the course.
7. **Hobbies and interests.** List only a few.
8. **References.** List two or three work or character references with the address and telephone number for each.

List any other information that you feel may be pertinent to the position. Try to get your resume to fit on one page.

Job Interviews

Most employers prefer to interview prospective employees before considering them for employ-

ment. A personal interview allows the interviewer to gain a different impression of an individual than he or she can get from an application form, a letter of application, or a resume. The qualities employers value most are honesty, reliability, willingness to work, and ability. The packaging of the product you are selling is most important in the interview. Studies have shown that opinions are formed in the first few minutes of meeting another person, and it can take a good deal of time and effort to change or correct these opinions. Thus it is important at an interview to try to make a good impression right from the start.

Make arrangements for the interview appointment in a businesslike manner. Be on time for the interview. Pay special attention to dress and grooming; it is best to be moderate in both, neither overdoing it nor being too casual. Blue jeans should never be worn to an interview. Before going to the interview you should learn something about the agency and the job so that you can not only answer the interviewer's questions but also ask some questions yourself. The question of salary should not appear to be your main concern, so save it until later in the interview.

Since your body language sends the interviewer messages, watch your posture, don't chew gum, and try not to fidget. Smoking is best avoided, unless the interviewer invites you to do so. Be as confident as you can, and practice your communication skills in order to make a good impression.

Follow-Up

Follow-up means checking back with employers to determine your success. There are no hard-and-fast rules about this, but many people feel that "the squeaky wheel gets the oil." Your enquiries should be courteously made so as not to provoke aggressive or angry reactions. Ask during your interview when you can check back regarding the job.

Job refusals can be demoralizing but should not make you lose confidence in yourself. Real-

istically you have to expect some refusals as part of looking for a job. Something can be learned from every job interview and improved upon

the next time. If you have been honest with yourself about your strengths and abilities, refusals need not undermine your confidence.

EXERCISE 3-1

Crossword

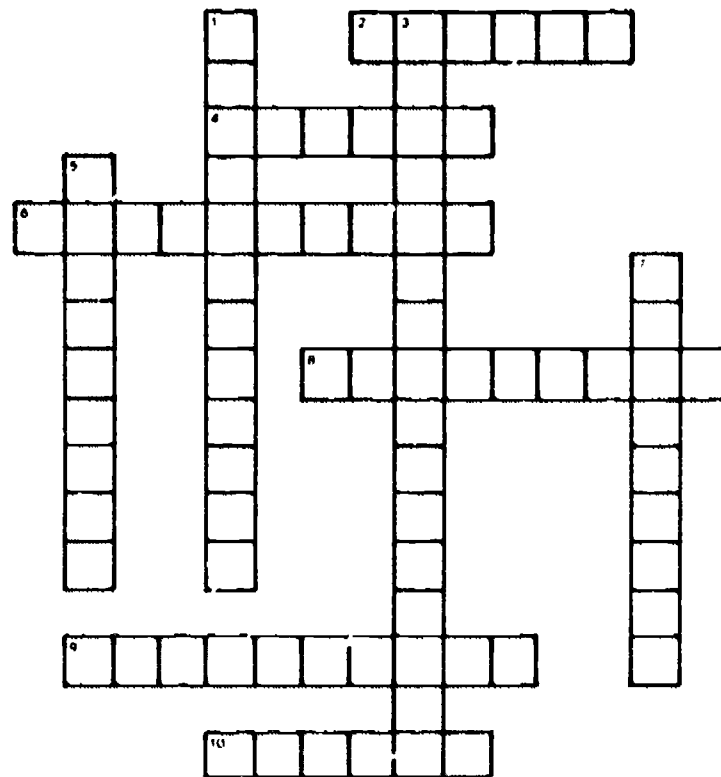

Across:

2. Offer spiritual and emotional support.
4. Receiver of health and social services.
6. Physio, occupational or speech.
8. Provides personal assistance and environmental care in the home.
9. Dispenses prescribed medication.
10. Registered or licensed practical.

Down:

1. Helps clients and families solve problems.
3. Provides personal assistance and environmental care in long term care facilities.
5. Promotes health and diagnoses and prescribes for illness.
7. Assists with achievement of good nutrition.

Questions

1. What is the difference between horizontal and vertical communications?
2. What three services are available to a client at home?
3. At an extended care facility a _____ must be on duty for 24 hours a day.
4. Where would you get information about available community services?
5. Match:
 - a. Employee right
 - b. Employee responsibility
 - c. Employer right
 - d. Employer responsibility
 1. Provide an up-to-date procedure manual.
 2. Have access to policy and procedure information.
 3. Take an ethical approach to the job.
 4. Get reasonable performance for pay.
6. If you do not know that an action is illegal when you perform it, are you considered legally responsible?
7. Match:
 - a. Assault
 - b. Battery
 - c. False imprisonment
 - d. Invasion of privacy
 - e. Liability
 - f. Libel or slander
 - g. Negligence
 1. Responsibility for your own actions.
 2. Doing something that a reasonable person would not do, or vice versa, not doing something that a reasonable person would do.
 3. Threaten or attempt to harm another person.
 4. Act of violence against another person.
 5. Damaging statements that affect a person's reputation.
 6. Revealing personal information about a client.
 7. Unnecessary restriction of another person's freedom.
8. Why is it a good idea not to accept money from clients for transportation in your vehicle?
9. What should you do before submitting an application?
10. If you are writing a letter of application to an agency and do not know the person to whom you should address the letter or their position, you should write _____ in the inside address and _____ in the greeting.
11. What is the most important part of a letter of application?
12. A letter of application is usually accompanied by a _____.
13. List actions that will help make a good impression in a job interview.

Section 4

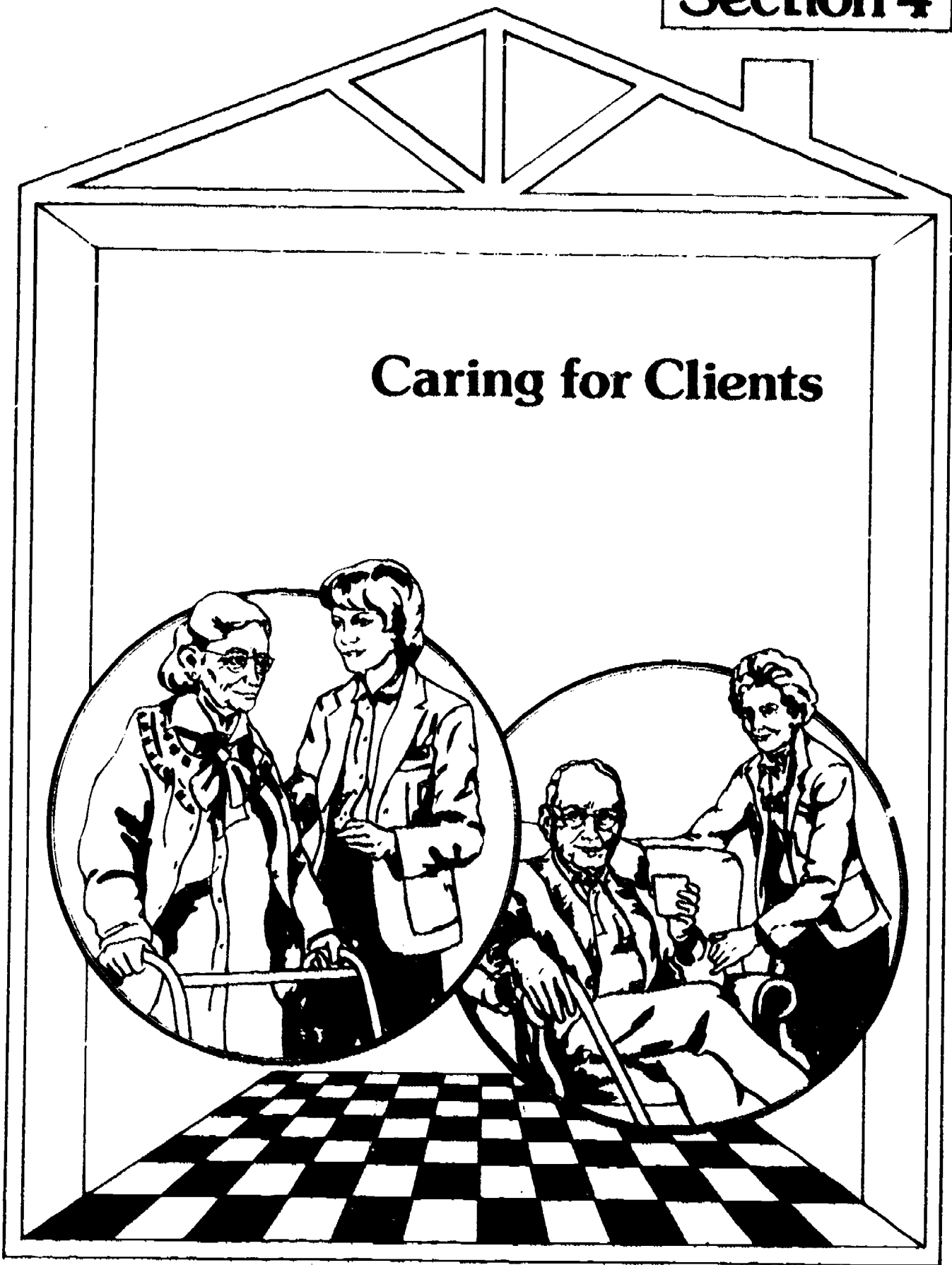

INTRODUCTION

Section 4 is the longest of the four sections, equal in length to the other three sections together. This section deals with all the day-to-day details involved in caring for clients both in homes and institutions. For some tasks such as making a bed and giving a bed bath step by step procedures are given. Throughout the section you will find practical information and procedures that will be very useful to you in a care giving job.

The nine main areas of care discussed are: safety, care of the client's environment, personal care, nutrition, moving clients, exercise and activity, comfort and rest, emergency care, and measuring and weighing in metric.

The discussion on safety gives basic precautions for keeping clients and their surroundings safe. Care of the environment includes cleaning tasks, bedmaking, and clothing care. Personal care deals with all aspects of body hygiene such as bathing, skin care, mouth care, perineal care, and elimination. Nutrition covers such subjects

as Canada's Food Guide, menu planning, eating habits, diets, mealtimes, feeding, and many procedures with foods from shopping to serving.

Moving clients discusses body mechanics — the safe, efficient techniques of using the body to do work such as lifting something or assisting a client to walk. Also discussed are safe procedures for positioning, turning, transferring, and transporting clients. Exercises and activities are described with the intention of keeping clients mobile, active, and interested in life. Steps are given to care for clients' comfort and rest in order to avoid the many negative effects that discomfort and improper rest produce. Emergency care deals with what to do when emergencies occur such as fire, cuts, falls, fever, vomiting, choking, and convulsions.

The section ends with a brief discussion on the metric system of measurement from the point of view of what you would need to know for a care giving job.

SAFETY

Keeping yourself and your clients safe is a major part of care giving. To prevent accidents from happening, you must put into practice the basic rules of accident prevention.

Principles of Accident Prevention

- Be alert to potential accidents and their causes.
- Be aware of the special safety precautions for children, the elderly, the confused, and the handicapped.
- Check equipment regularly.
- Report unsafe situations promptly.
- Learn safety rules and follow them closely.

Accidents do not just happen; they are the result of carelessness or ignorance. Some general causes of accidents are:

- Cluttered surroundings
- Furniture that is broken or poorly balanced
- Poor lighting
- Poor smoking habits
- Electrical appliances with frayed cords
- Open stairways
- Equipment in poor working order
- Poor body mechanics

Safety should go beyond the obvious concerns such as falls, burns, cuts. Such basic measures as always identifying a client in an institution before giving care and washing your hands properly are also important safety concerns.

Make sure that clients can quickly call for assistance should an accident or unsafe situation occur. For example, in institutions call bells should be handy and promptly answered; in

homes the telephone should be close at hand (Figure 4-1). Frequent checks should be made to see that clients who may be unable to call for help are okay.

When making safety rules, always keep in mind that the maximum independence of the client is a main goal of good care: make changes in the environment whenever possible rather than restricting or overprotecting the client.



Figure 4-1. Telephone Close By.

Safety with Children

Children have accidents such as falls, burns, cuts, scrapes, drownings, poisoning and traffic injuries. Following are special safety precautions with children:

- Constantly check children's activities.
- Make sure that cleaning fluids and medicines are safely out of reach of children in a locked cupboard.
- Safely store all sharp objects such as scissors, razors, and knives.
- Insist that children correctly use car seats and seat belts for every trip in the car (Figure 4-2).
- Turn pot handles in over the stove to prevent accidental dumping.
- Safely store plastic bags.
- Place matches or lighters out of reach.
- Put plug covers on electrical outlets to prevent shocks.

- See that toys are washable, durable, too large to swallow, painted with non-toxic paint, in good repair, and smooth-edged.
- Carefully supervise animals around children.
- Remove poisonous plants from the environment.
- Supervise play areas.

Children should be taught safety rules as soon as they can understand the rules.

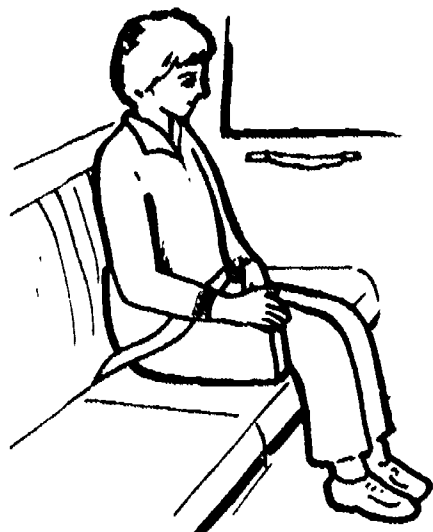

Figure 4-2. Seatbelts.

Safety With the Elderly

The elderly have accidents like burns, falls, cuts, and scrapes. When setting safety precautions for the elderly, you must have their cooperation. Keep in mind the elderly client's need for independence as well as for safety. Following are safety precautions with the elderly:

- Remove scatter rugs or at least make sure that they have non-skid backing.
- See that rubber mats, non-slip tape, and sturdy handholds are in place in the bath area.
- Check that highly polished floors are not slippery.
- Carefully check the temperature of heating pads and hot water bottles.
- Turn off the hot water before the client gets into the bathtub.
- Check that aids such as eyeglasses, hearing aids, or canes are in good repair and are used by the client.

- Assist clients in their daily activities if they are unsteady.
- Check that medications are clearly labelled so that the right medication is taken in the right quantity.

Safety With the Disabled and Confused

Clients with poor sight will have difficulty coping with changes in their environment. For example, furniture should not be moved because the client will be used to its placement. Similarly, cutlery should always be in the same position on the table or tray.

Clients who have poor hearing, a loss of sensation, or suffer from confusion also require special safety measures. Clients with poor hearing may not be able to hear safety instructions that you give them. Be sure to use alternative means of communicating these instructions such as gestures or a written message. People who have lost feeling or sensation in their limbs will need special assistance when having a bath or when close to sources of heat such as water bottles, heating pads, and electric blankets. A confused client may be unaware of possible danger. Supervision of confused clients helps prevent wandering and other unsafe behavior.

Safety Devices

Following are some devices that are used for the safety of clients:

- Wheelchairs for the disabled
- Siderails for the confused and the restless
- Handrails by the bath tub, toilet, and stairs
- Special clothing such as slings and protective shoes
- Restraints

It is necessary to identify which clients require the use of safety aids and to see that the aids are used properly.

Restraints

Restraints are used only when ordered by a client's physician, unless the client requests them or an emergency arises. Restraints may be either mechanical or chemical. **Chemical restraints** are medications that calm clients in order to keep them safe. **Mechanical restraints** are devices designed to safely secure the client; they range from a seatbelt to a safety jacket. Remember that a client's feelings may suffer from the use of restraints; they should only be used as a last resort.

Guidelines for Use of Restraints

- Remember that restraints must be ordered by a physician except in emergencies.
- Check that restraints are not abrasive to the skin.
- Check restrained clients hourly for any needs or requests such as hunger, thirst, cigarettes, and toileting. Also check that the restraints are not interfering with circulation or respiration or causing skin abrasions or tingling of the limbs.
- Periodically loosen or remove restraints. Supervise the client while the restraint is off.
- Report resistance or refusal to wear restraints.
- Inform clients and visitors about the need for the restraints.
- Remember that restraints are not a substitute for care and attention.

Safety in the Home

Stress safety and set an example of practising safety in the home. Your words and actions may impress upon the client the importance of preventing accidents. Some rules that will help improve safety in clients' homes are:

- Ask for assistance or information whenever you are uncertain.
- Report any unsafe conditions to your supervisor.

- Keep emergency telephone numbers beside the telephone; e.g., police, fire department, ambulance, client's physician, poison control centre (Figure 4-3).

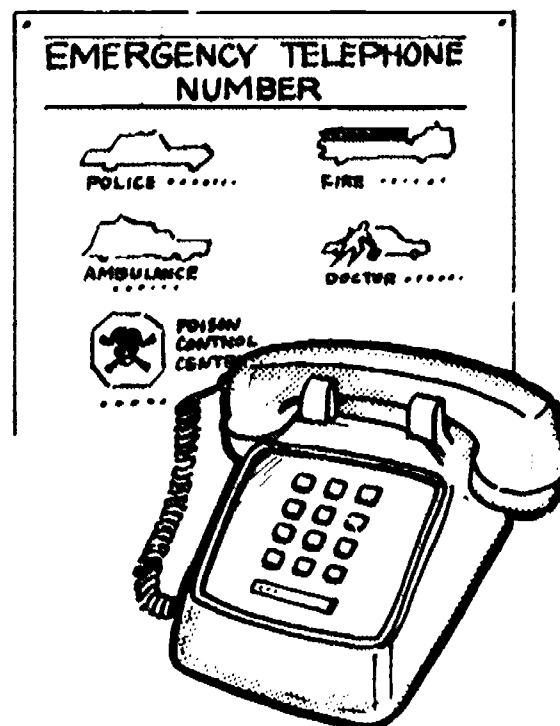

Figure 4-3. Emergency Telephone Numbers.

- Don't use anything from an unlabeled container.
- Don't use equipment or appliances that you are not sure how to operate.
- Make sure the lighting is adequate in work areas.
- Plan a fire exit route, or ask if the family has already developed one.
- Wipe up spilled liquids promptly.
- Pick up clutter.
- Encourage good smoking habits. Set out ashtrays, and see that they are used and safely emptied. Supervise smokers who are confused, shaky, or bed-ridden.
- Don't place electrical cords under rugs.
- Keep flammable objects away from the cooking area.
- Don't leave cooking pots unattended.
- Closely observe your client's need for assistance walking, getting on and off the toilet, and getting into and out of the bathtub.

Medication Safety

Legally, only qualified workers may administer medication, prescribed by a doctor, to a client. A client who is on medication may require some assistance, but the responsibility for taking the medication must be the client's. As a health care worker you may become familiar with the client's medication schedule and remind the client to take the medication or assist the client to select the correct medication, but you must never assume the responsibility for administer-

ing the medication. If the client is physically or mentally incapable of taking medication, contact your supervisor for assistance.

Agencies and institutions have different policies and procedures for the administration of medication. Become familiar with the policies of your agency and assure yourself that they are legally and ethically acceptable. Remember that you are legally liable for all your actions; doing something you have not been trained for is unlawful.

EXERCISE 4-1

1. Review the safety precautions for clients. This review should be a regular, automatic part of your care.
2. List five general causes of accidents.
3. What are four disabilities of clients that require special safety precautions?
4. Describe the difference between chemical and mechanical restraints.
5. Except in an emergency, restraints must be ordered by _____.
6. What precautionary care should be given to clients who are in restraints?
7. Make a safety check of your own home. Post emergency phone numbers by the telephone and plan a fire exit route. Correct or get corrected all unsafe conditions.
8. Who may select and administer medication to a client?

CARE OF THE CLIENT'S ENVIRONMENT

The saying "a man's home is his castle" sums up the feeling that most people have for their private space, whether that space is an apartment, a house, or a room in a care facility or a relative's home. As a care worker you should respect the private spaces of your clients.

When your assignment includes housekeeping tasks such as dusting, vacuuming, washing dishes, and disposing of rubbish, you are operating within the personal space of clients, doing tasks that most likely they have previously done for themselves. For this reason, it is important to courteously seek guidance from the clients on their way of doing the tasks. Also, don't take over tasks unnecessarily; encourage clients to continue doing as many tasks as they can. If a client needs help with a task, assist him or her with it. It is better for a client's self-esteem to be able to do part of a task than none at all.

Cleanliness

What exactly does clean mean? You will find that cleanliness means different things to different clients. Since a main goal of care is to make clients comfortable in their own living space, you should try to follow each client's sense of cleanliness providing, of course, it is reasonable. Basically, clean means being free of:

- Pathogenic microorganisms
- Clutter
- Dust, dirt, or grim

Cleanliness is a safety measure for both the client and yourself.

Pathogenic microorganisms are tiny living things capable of causing disease or infection. They include germs, bacteria, and viruses. Cleanliness helps stop these microorganisms from spreading. **Asepsis** is another term for cleanliness or freedom from pathogenic microorganisms.

Unfortunately, microorganisms are not visible, but it is possible to see them with the mind's eye. Think of all the places in a home that you consider dirty or unclean such as the toilet, garbage containers, floors, diaper pail, pet's beds, and sick room. When you stop a baby from drinking the cat's water or playing with a sailboat in the toilet, you are making a distinction between something considered clean and something dirty. You have seen with your mind's eye the microorganisms in the cat's water and toilet.

When cleaning, you should always work from the clean to the dirty to prevent microorganisms from spreading. For example, in bathrooms clean the toilet last. If you start with the toilet, you will spread microorganisms over everything else in the room that the cloth and your hands touch.

Cleaning work should also progress from far to near or top to bottom (Figure 4-4) so that you don't have to reach over and risk dirtying an area already cleaned. Think of a counter you are wiping: start at the back (farthest from you) and work toward the front (nearest to you). When bathing a client in bed, reach and wash the farthest arm first, then wash the arm nearest to

you. Working from top to bottom is also a logical way to bath a client.

To prevent contamination, always set clean items down in clean areas and dirty items in dirty areas. If you set a dirty toilet brush on a clean kitchen counter, the whole counter is dirty or contaminated. Vice versa, if you set clean clothing on a dirty floor such as is found in a heavy traffic area, the clothing is now dirty, even though there may be no actual dirt visible.

In summary, when cleaning:

- Work from clean to dirty.
- Work from far to near and top to bottom.
- Touch clean to clean and dirty to dirty.

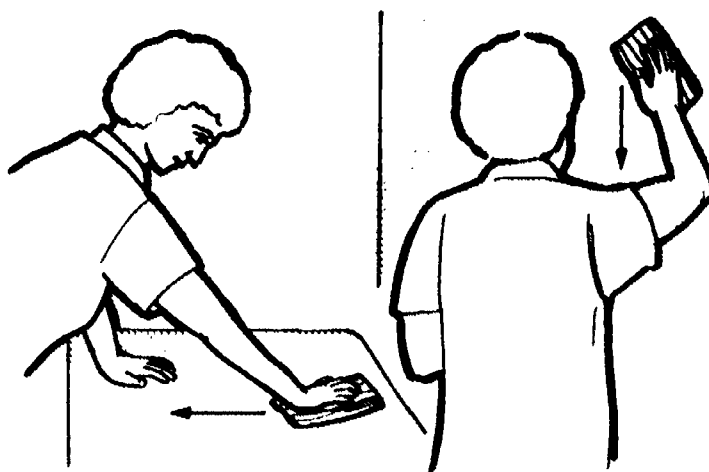

Clean from far to near.
Clean from top to bottom.

Figure 4-4. Cleaning.

Preventing the Spread of Microorganisms

Microorganisms are everywhere: in the air, in the soil, on bodies, and on things seen and touched every day. They do not all produce infections or disease; in fact, many are necessary for the body to function. The microorganisms that are harmful to the body are called pathogens. Microorganisms are circulated by:

Air. Some microorganisms cling to and multiply in dust particles in the air. Sneezing, talking, and coughing are three ways that humans pass microorganisms into the air.

Personal contact. Touching contaminated people, living things, or objects spreads microorganisms.

Food and water. People who eat or drink contaminated food or water, themselves become contaminated.

Insects and animals. Animals and insects are often unaffected by microorganisms that are disease-causing in humans.

Elimination products. Feces, nose and throat secretions, drainage from infected wounds, all contain microorganisms.

Several measures will help stop the spread of microorganisms. The most important is handwashing (Figure 4-5). Wash your hands before and after giving personal assistance to a client, after handling soiled articles, before preparing foods, and after elimination. Be sure your clients understand the importance of handwashing in controlling the spread of microorganisms.

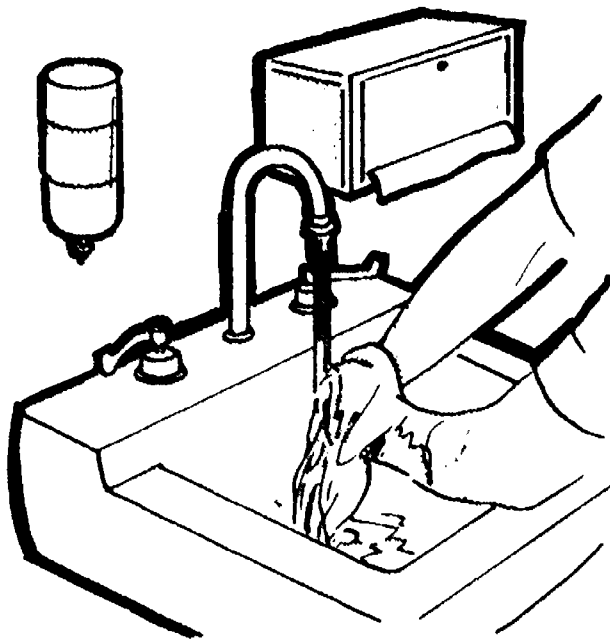

Figure 4-5. Handwashing.

Handwashing Procedure

Equipment and Supplies:

- Water (running water is preferable)
- Soap

- Towel (paper towels are preferable)
- Nailbrush and nailfile (optional)

1. Wet your hands, apply soap, and lather well.
2. Rub your hands to soap all surfaces of your fingers, hand and wrists.
3. Clean your fingernails with a nailbrush and nailfile while washing.
4. Rinse your hands under running water, letting the water flow from your wrists to your fingertips.
5. Dry your hands thoroughly.
6. To prevent recontamination of your hands, turn off the tap with a paper towel, tissue, or piece of toilet paper as is shown in Figure 4-6.
7. Dispose of the paper towel appropriately.

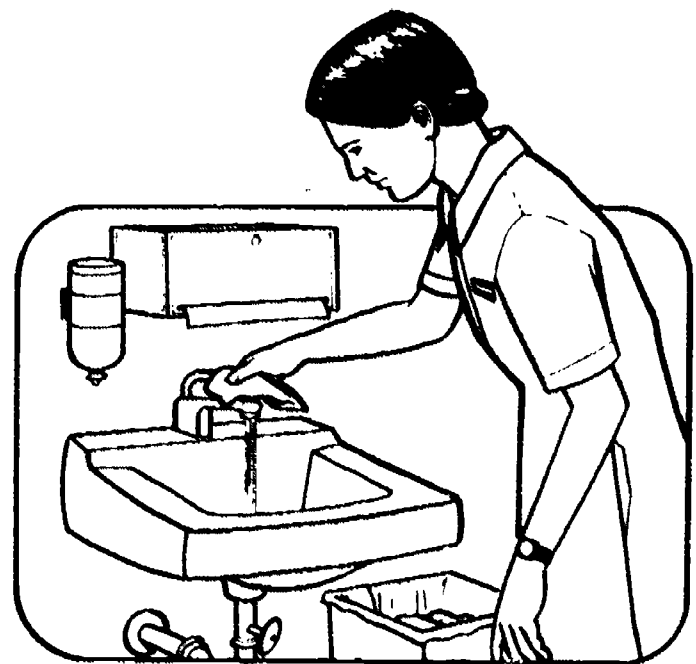

Figure 4-6. Turning Off the Tap.

Minimizing dust in the air is another means of preventing the spread of microorganisms. Vacuums and damp mops limit the spreading of dust. Keeping surfaces clean and handling linen carefully without shaking it also limit the amount of dust in the air.

Separating people with infections from the rest of the household can reduce spreading of the infection. The proper disposal of used tissues

and cleanliness of the bathroom, bedpans, and urinals can also restrict the spreading of infection.

Good housekeeping techniques help to remove insect or animal pests. Sometimes professional exterminators may be necessary if the problem gets out of hand. Your supervisor can give advice in this area.

Improper storage can cause food to spoil or become contaminated. Read and follow instructions for correctly storing food.

Contaminated water is not usually a problem in our country, but you should be aware of it. Drinking water in containers should be changed frequently and the containers cleaned regularly.

Microorganisms flourish in warm, moist, dark areas. One germ can blossom into millions if these conditions exist. Try to keep warm, dark areas clean and dry. Two examples of such areas on the body are under the breasts and between the toes. Damp cleaning equipment is another place where microorganisms can flourish.

Cleaning Procedures

Agencies have different policies as to the cleaning done by their staff. Know the cleaning policies of your agency. Before beginning any cleaning task, it is necessary to ensure that correct, clean equipment and supplies are available. For example, a dirty mop can spread more microorganisms than it removes.

The easiest way to ensure that equipment is clean and ready for use is to thoroughly clean it after each use. Use warm, soapy water on washable items, paying special attention to crevices and hollows. Rinse off the soap well, and dry the article thoroughly. Be sure to use a safe solution and procedure for cleaning the equipment. Read directions or ask for advice if you are unsure about cleaning a piece of equipment.

Other general cleaning techniques are:

- Don't mix cleaning products as this may cause a dangerous chemical reaction that could harm you or the item you are cleaning.

- Be careful with harsh cleaning products because they can remove the protective surface from articles and can irritate skin or damage clothing.
- Be sure that an item can tolerate scrubbing if it is necessary to remove soil.
- Change the cleaning water before it becomes overly dirty, since dirty water spreads germs.
- Most objects that are cleaned with a cleaning product will need to be thoroughly rinsed or wiped off to prevent streaking and residue.
- After cleaning a piece of equipment, place the cleaned equipment in its proper spot. Store all cleaning products in cool areas safely out of reach of children; a lock on the cupboard door is added safety.

Cleaning a Broom

1. Dip the broom up and down in a pail of sudsy water until it looks clean. Then rinse it well and go outside to shake the water from it.
2. Wipe the handle clean with sudsy water, then rinse and dry it well.
3. Hang the broom with the head down to dry.

Cleaning a Mop

1. Remove washable mop heads from the handle and machine or handwash the heads in hot, soapy water. Rinse well and hang to dry.
2. Wipe the mop handle and metal frame with sudsy water, then rinse and dry well.

Cleaning a Sponge or Dust Cloth

1. Shake the sponge or dust cloth into a paper bag to remove lint and dust.
2. Machine or handwash it in hot soapy water. Rinse well and hang to dry.

Wiping up Spills

Major cleaning tasks can be avoided with prompt attention to spills. Wipe the stove after use to prevent the cooking-on of spilled food. Unplug and wipe down all appliances after use, and wash counters and refrigerator shelves with soapy water as necessary.

Spills on floors are a safety hazard and thus should be wiped up as soon as possible (Figure 4-7). Spills on furniture should be identified as to type so that the right cleaning material can be used. In addition to looking unsightly, spills on furniture and carpets can be a health hazard by giving microorganisms a place to multiply.



Figure 4-7. Wipe Up Spills Immediately.

Floor Care

The floors of rooms frequently used, hallways, and heavy traffic areas often need sweeping or vacuuming daily to keep dust and litter from accumulating. Damp mop linoleum or vinyl flooring weekly, using clear water or a diluted all-purpose cleaner to remove surface soil. Be sure to dilute cleaners according to directions on the label and to have the mop damp, not soaking wet, so as not to dull the floor. You can damp mop waxed wood floors as well, or use a combination cleaning-waxing product. The stripping of old wax and the application of new is usually a special task requiring extra time. Check with your supervisor about this.

Carpeted floors may require daily vacuuming in heavily used areas and weekly vacuuming in areas used less frequently. Carpet washing is another procedure that you should ask your supervisor about. Shake small area rugs outside to remove excess dirt.

Washing Dishes

Dirty dishes should not be allowed to sit around too long as the leftover food is ideal for the growth of microorganisms. When washing dishes by hand, start with the cleanest items (glasses and cutlery) and end with the dirtiest ones (pots and pans). Wash the dishes in hot, soapy water, rinse them in hot, clear water, and stand them to drain. Be sure to have the dirty dishes in a different area than the clean ones.

It is more hygienic to let dishes dry in the air than to wipe them; however, the client may not wish the dishes left on the counter. Ask the client where the dishes go and put each in its spot so that it can be easily found when needed.

Cleaning Windows

Some agencies do not consider window washing part of regular cleaning practices, employing heavy-duty cleaners to handle this task. Check whether your employer expects you to clean windows.

A commercial window cleaner or a cleaning solution made by mixing water and white vinegar or water and household ammonia can be used for cleaning windows. If the water is hard or if there are salt deposits on the glass, a white vinegar solution is most effective. Ammonia and water is best for removing a heavy, greasy film. Don't try to accomplish both of these jobs at once by combining vinegar and ammonia in water. The two solutions neutralize one another, making the combined solution useless. When working with ammonia, don't breathe in fumes from the ammonia, and be sure there is good air circulation.

Wipe off the window cleaner and soil with a clean dry cloth, squeegee, paper towel, non-

woven disposable cloth or crumpled newspaper. Use firm strokes down or across the entire length or width of the glass to minimize streaking. As each section of the window is cleaned, wipe any spilled cleaning solution from the woodwork and trim.

While doing the windows, check if the sills, frames, shades, storm windows, screens, and curtains also require attention. Report further tasks to your supervisor.

Cleaning the Fridge

Wipe up spills in the fridge as they occur and clean and dry containers before placing them in the fridge. With these practices, the fridge should require extensive cleaning and defrosting only once a month. The supplies needed for cleaning a fridge are:

- Warm, soapy wash water
- Warm rinse water with a little baking soda (2-3 teaspoons) to cut the odor
- Cloths for washing and drying

Many fridge manufacturers recommend that the fridge be unplugged before being washed. Agency policy does not always require this, but for safety unplug at least older fridges or turn the dial to defrost or off.

Remove food from the fridge, and check for spoiled or uncertain items that should be thrown away. Stack frozen foods together, covering them with newspaper or a cloth to keep them as cool as possible.

Take out the fridge's loose part (racks, shelves, drawers), and set them either out of the way or in hot soapy water in the sink.

To speed defrosting, place a container of piping hot water in the freezer compartment of non-frostfree fridges (frostfree freezers do not require defrosting), and wait for ice to come away from the sides. **Never use force or sharp metal utensils to dislodge ice: you will damage the fridge.**

Wash all parts of the fridge with warm, soapy water, using a plastic scrubber or brush to remove stubborn materials. Rinse each part well,

then dry it thoroughly. Don't forget to wash the rubber strip around the door.

Once the inside of the fridge is done, wash, rinse and dry the loose parts in the sink, then replace them and reset the temperature dial. Plug in the fridge if it was unplugged. Wipe and dry all food articles before placing them in the fridge. Refill and return the ice-cube trays. Wipe down the outside of the fridge. Vacuum behind the fridge when possible as the dust can be a fire hazard. **Check again to be sure the fridge is plugged in and turned on.**

Cleaning the stove

A clean stove looks better, lasts longer, gives better cooking results and is more energy efficient. If spills are cleaned after each use of the stove, extensive cleaning need only be done monthly or after a cooking mishap. It is unwise to line the top elements or the oven with tinfoil to cut down on cleaning because this can cause the appliance to dangerously overheat.

Many manufacturers recommend cutting power to the stove before cleaning. This is done by going to the main electrical panel and turning off the breaker switch or, in the case of older systems, taking out the fuse. Check your agency's policy on this. Be sure the oven and elements are cool. Equipment and supplies for cleaning a stove are:

- Warm, soapy wash water
- Warm rinse water
- Washing cloth or sponge
- Plastic scrubber
- Paper towels
- Newspaper
- Ammonia or commercial oven cleaner

Spread newspapers on the floor in front of the stove to give a good work area and keep the floor dry. Take out the stove's loose parts (burner rings, drip pans, racks), and place them in hot, soapy water in the sink.

Wash the top and exterior of the stove, rinse, and dry well. Remove the oven door if possible because this makes cleaning the oven easier.

Lay it on papers on the floor. Wipe up any loose dirt or grease with paper towels or crushed newspaper. A slightly soiled oven might respond to a solution of 3 tablespoons of ammonia added to the wash water and left on the oven overnight. A really dirty oven will require a commercial oven cleaner. Follow the directions on the cleaner carefully, avoid breathing in the fumes, wear gloves, and immediately wash off any cleaner that gets on your skin.

After the oven is rinsed and dried, clean the loose parts in the sink and replace them carefully. Clean up the area around the stove. Turn the power to the stove back on if it was turned off.

Cleaning the Bathroom

The bathroom can be a source of microorganisms and unpleasant odors if it is not kept clean. The cleaning principles mentioned earlier regarding working from clean to dirty and from top to bottom apply here.

Many newer bathrooms have fixtures made of fiberglass or materials that scratch with the use of abrasive cleaning powders. When in doubt, use liquid cleaner diluted appropriately. Always rinse well, whatever cleaner is used. Wash, rinse, and dry the medicine cabinet, mirror, and sink. Wash and rinse the bathtub or shower stall. If there is a shower curtain, wash it first before washing the bathtub or stall. Wash and rinse the bathroom walls as necessary.

Wash the toilet using a separate cloth, sponge or brush. **Never** use these articles on anything else. A commercial disinfectant cleaner or mild chlorine bleach solution is best for the toilet.

Wash or damp mop the floor using a diluted disinfectant cleaner or a diluted ammonia solution.

Garbage Disposal

Garbage that is allowed to accumulate is both a safety hazard and a health hazard, since it adds to clutter and is an ideal breeding ground for microorganisms. Garbage should be routinely

removed from living quarters. Means of waste disposal will vary with the client and the district. A client may have a compost heap on which to place all organic waste like spoiled or leftover food, peelings, and coffee grounds. Another possibility is that the client may place paper, garbage, wood, and cloth in an incinerator in the yard for burning. Note that empty spray cans should not be incinerated because of the danger of explosion. Also, flammable liquids should not be burned. Some clients may wash and save all glass containers and tin cans for recycling.

City regulations often forbid burning and require that garbage be set out for pick up by collectors once a week. To be sure the garbage is stored in sanitary ways, put wet garbage in plastic bags and garbage in general in animal-proof containers, preferably outside.

The contents of old insecticide bottles should not be emptied down the drain. Discard the bottle in the garbage.

Small wastebaskets in the home should be lined with a paper or plastic bag to prevent soiling of the wastebasket. They should be emptied regularly.

Bedmaking

Bedmaking is very important in client care, since a comfortable, well-made bed can do much to help clients meet their rest and relaxation needs. If a client is confined to bed, the condition of the bed is even more vital. For example, a wrinkled bed can lead to bedsores from body pressure on the wrinkles.

Bedmaking may be done when the bed is unoccupied or occupied. Although the procedures are different for making unoccupied and occupied beds, there are some rules that are common to both procedures.

Bedmaking Rules

- Follow the bedmaking style preferred by the client whenever possible.

- Use good body mechanics when making a bed. If the height of the bed is adjustable, put the bed at a comfortable working height.
- When handling soiled linen, don't hug it to your clothing, don't place it on the floor (a soiled pillow case makes a good laundry bag) and don't shake it.
- Make sure the bottom sheets are tight, smooth, and wrinkle-free.
- Use a draw sheet when appropriate. A draw sheet is a protective half-sheet covering the middle portion of the bed.
- Cover plastic or rubber draw sheets with a cloth sheet.
- Apply the top sheet, blankets, and spreads, making sure to leave toe room.
- Save time and energy by organizing yourself to complete one side of the bed before starting the other.
- Be sure the client's linen supply and laundry facilities can handle the bed-changing schedule.
- Wash your hands before and after bedmaking.
- Keep clean linen and dirty linen separate.
- Gather your clean linen ahead of time and stack it in the order that it will be used.
- Pillowcases must be put on and taken off in a way that limits the spread of microorganisms between you and the pillow and vice versa. Never hold a pillow against your body or under your chin.

Making an Unoccupied Bed

1. Place a chair near the bed. Change the pillow cases, place the pillows on the chair, then place the clean linen on the pillows.
2. Loosen all bed linen and remove the pieces one by one. Place the spread and blankets on the back of the chair.
3. Note that one side of the bed is completely made, then the other side.
4. Standing on one side of the bed, place the clean bottom sheet on the bed folded

lengthwise with the center in the middle of the bed (Figure 4-8). Have the bottom hem even with the foot of the mattress so that there is plenty to tuck in at the head of the bed. Tuck in the sheet at the head.

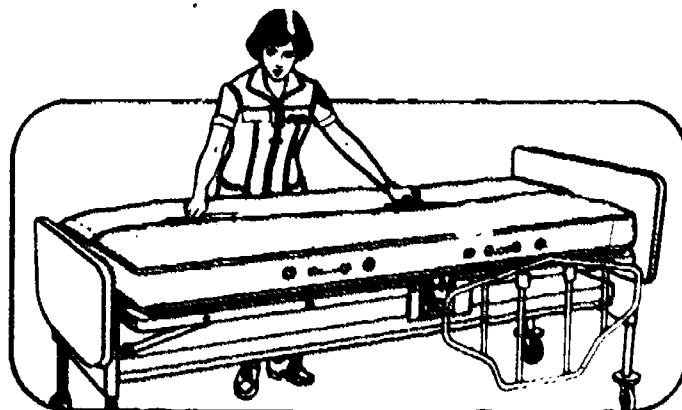

Figure 4-8. Making an Unoccupied Bed.

5. To make a secure corner, pick up the edge of the sheet as is shown in Figure 4-9. Fold a triangular section onto the mattress (Figure 4-10), then tuck the hanging portion under the mattress (Figure 4-11). Pull the triangular section over the edge of the mattress. A small triangle now forms on the side of the mattress at the corner as is seen in Figure 4-12. Tuck in the complete side of the sheet (Figure 4-13) to get the secure corner.
6. If needed, place a rubber draw sheet, folded in half, on the bed about 14 to 18 inches from the head. Cover it with the cloth draw sheet. Tuck both in (Figure 4-14).
7. Place the top sheet on the bed folded lengthwise with the center in the middle of the bed. Have the top hem even with the head of the mattress and the rough edge of the hem facing up. Tuck in the sheet at the foot of the bed and make a secure corner. At the head of the mattress the top sheet loosely hangs over the side of the bed.
8. Place the blanket on the bed folded lengthwise with the centre in the middle of the bed. The top hem should be about 6 inches from the top of the sheet. Tuck in the

blanket at the foot of the bed and make a secure corner. Like the top sheet, the blanket is not tucked in on the side at the head of the mattress.

9. Place the spread on the bed folded lengthwise with the center in the middle of the bed.

10. Move to the other side of the bed and tighten and tuck in all sheets and the blanket one by one in the same order, making the appropriate corners.
11. Fold the top sheet back over the blanket and spread to protect them (Figure 4-15).
12. Finish the spread as appropriate and place the pillows on the bed.

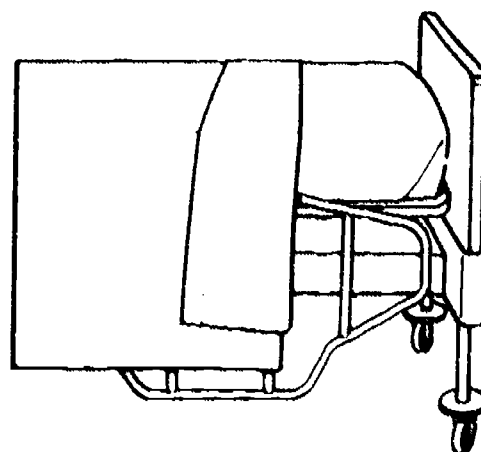
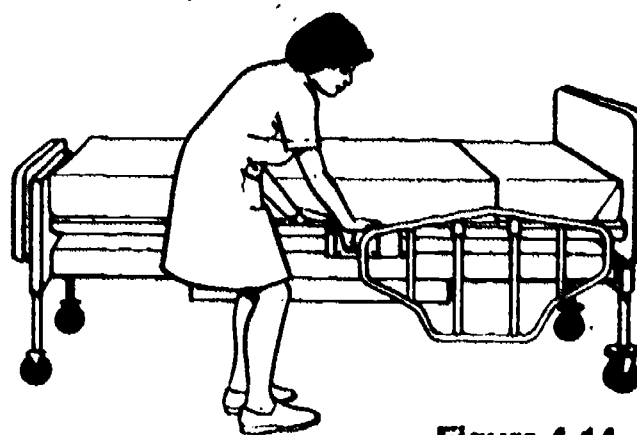
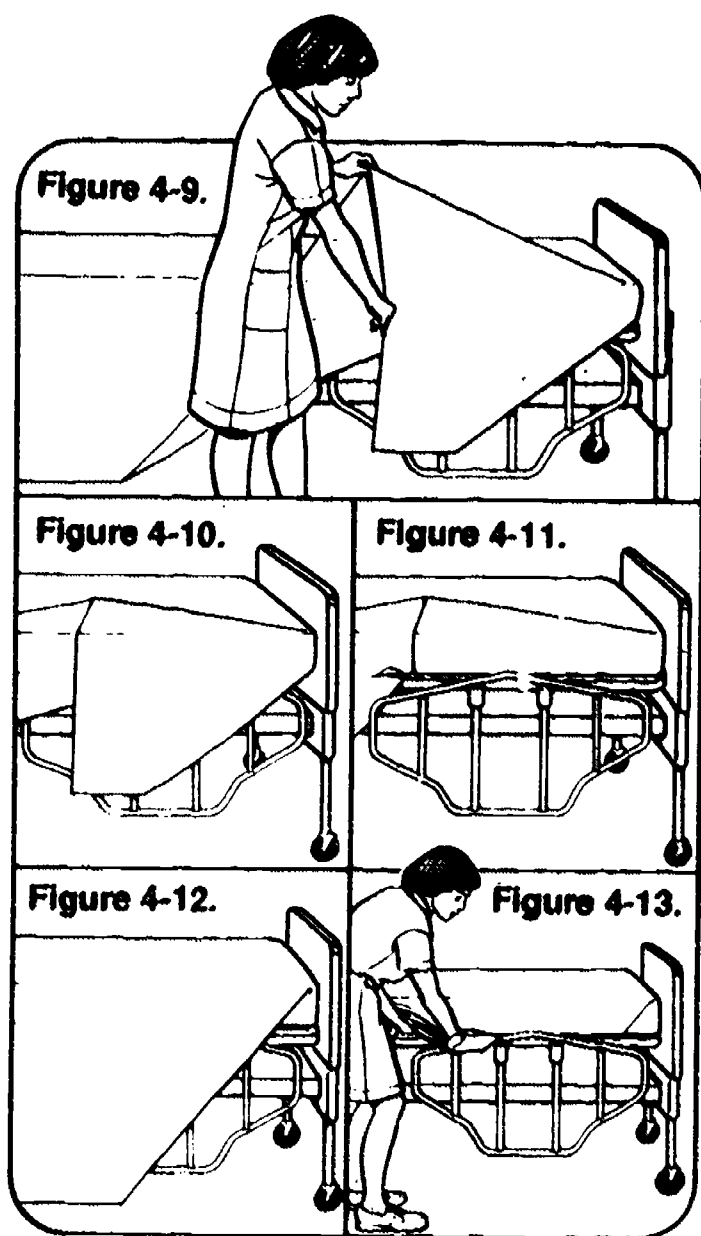

Making an Unoccupied Bed.

Making an Occupied Bed

1. Place a chair near the bed to set the clean linen on.
2. Make sure the bed is flat, if possible, and remove all extra pillows and articles.
3. Loosen all the bed linen and remove the spread and blankets, leaving the top sheet covering the client. Place the folded spread and blankets on the back of the chair.
4. Raise the bedrail on the opposite side of the bed from where you start working. Ask the client to turn on the side looking toward the rail and help the client to get comfortable.
5. Fan-fold the bottom sheet, the rubber draw sheet, and the cloth draw sheet one by one toward the client and tuck them slightly under the client's back (Figure 4-16).
6. Place the clean, bottom sheet on the bed folded lengthwise with the center in the middle of the bed. Have the bottom hem even with the foot of the mattress so that there is plenty to tuck in at the head. Tuck the sheet under at the head, make a secure corner, then tuck in the entire side (Figure 4-17).
7. Place the extra folds of the bottom sheet against the client's back underneath the fan-folded rubber draw sheet already on the bed. Be sure that the new sheet does not touch any soiled or damp areas.
8. Pull the rubber draw sheet over the clean sheet and tuck it in.
9. Cover the rubber draw sheet with a clean cloth draw sheet folded in half. Tuck the extra folds gently under the client's back and tuck in the free edge (Figure 4-18).
10. Assist the client to roll toward you over the ridge of linen in the middle of the bed onto the clean sheets. The client remains covered by the soiled topsheet.
11. Raise the bedrail on your side, go to the opposite side of the bed, and lower the bedrail.

12. Remove the soiled bottom sheet and the cloth draw sheet. Pull the clean bottom sheet tight and tuck it under at the head of the bed, make a secure corner, then tuck in the entire side. Make sure it is smooth and wrinkle free (Figure 4-19).

Figure 4-16.

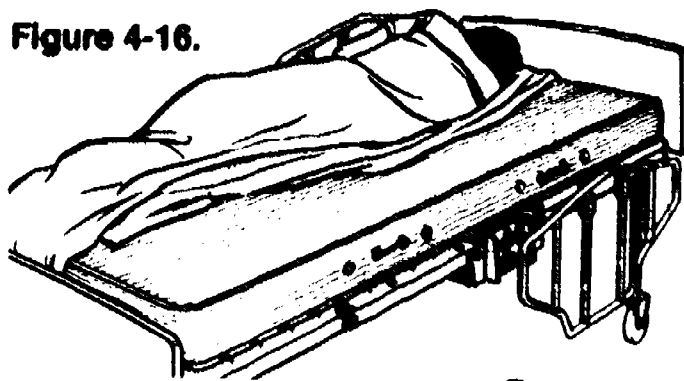

Figure 4-17.

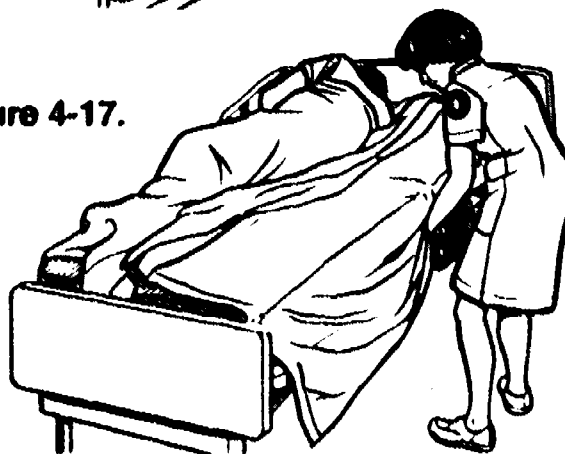

Figure 4-18.

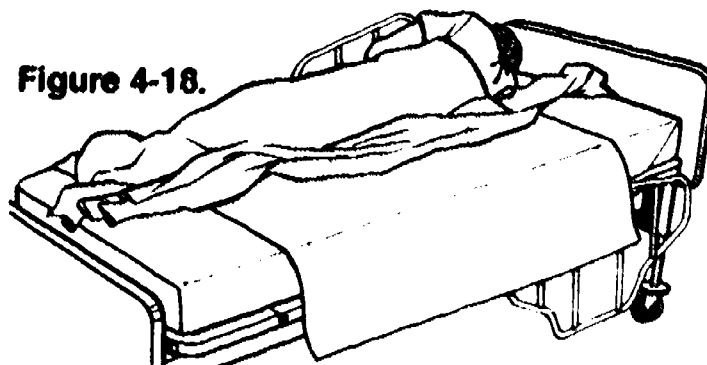
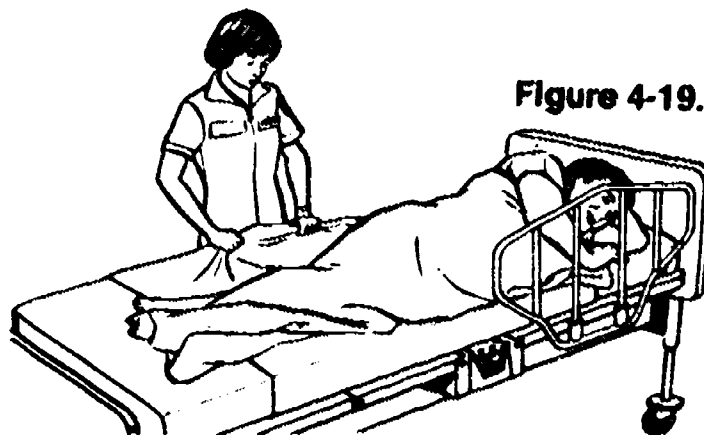

Figure 4-19.



Making an Occupied Bed.

13. Tighten and tuck in the rubber drawsheet, then the cloth drawsheet.
14. Ask the client to roll onto the back and help the client get comfortable.
15. Change the pillow cases and replace the pillows under the client's head.
16. Place the clean top sheet on top of the soiled sheet covering the client. Have the top hem even with the head of the mattress and the rough edge of the hem facing up. Don't cover the client's head. Have the client, if able, hold the hem of the clean sheet while you gently pull the soiled one out from underneath toward the feet. Make sure you do not expose the client. Tuck in the top sheet at the bottom and make secure corners.
17. Place the blanket on the bed with its top hem about 6 inches from the top of the sheet. Tuck in the bottom and make secure corners.
18. Place the spread on the bed and finish it as appropriate.
19. Fold the top sheet back over the blanket and spread to protect them.
20. Reposition the client with the extra pillows and the bed positioned as required. On adjustable beds, adjust the bed to its lowest level before leaving unless the client requires otherwise.

Clothing Care

Clothes are a personal expression of the wearer. For this reason, in addition to the fact that clothes are expensive, clients may be very concerned about you assisting with or doing their laundry. Be aware of these natural concerns about clothes, and be sure to have all information necessary before starting clothing care.

In care facilities there are policies and procedures established for care of clients' clothes; for example, the labelling of clients' clothes to ensure that the right clothes are returned right client.

Minor clothing repairs such as sewing on a button are part of the laundry process, but major repairs should be referred to the client's family members or your supervisor. Do what you can to keep the client's clothes looking good. Lost buttons and loose hems detract from the client's appearance. Always store clothes properly; this keeps them clean and makes them last longer.

Laundry Symbols

On newer clothing you will find laundry symbols (Figure 4-20) that give accurate information for clothing care. The five basic laundry symbols appear in three colours. The colours have the same meaning as traffic lights (Figure 4-21). Figure 4-22 gives the meaning of the coloured symbols.

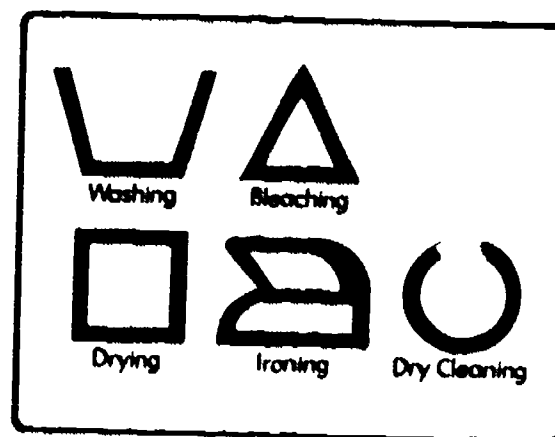
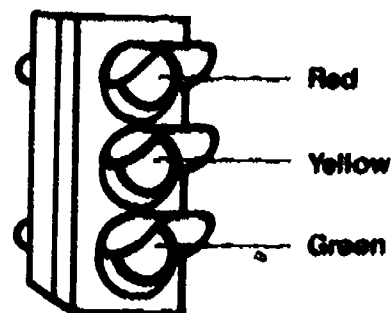

Figure 4-20. Laundry Symbols.



Red — Do not apply this procedure to this garment. An "X" through the symbol is an added warning that the procedure must not be used.

Yellow — Seek further information.

Green — No special precautions needed.

Figure 4-21. Colours of Laundry Symbols.



Washing

Red — Do not wash.

Yellow — Machine wash in warm water.

Green — Machine wash in hot water.



Handwash



Bleaching

Red — Do not bleach.

Yellow — Use chlorine bleach with care.

Green — Use chlorine bleach as directed.



Drying

Red — Do not tumble dry.

Yellow — Tumble dry at a low setting.

Green — Tumble dry at a high setting.



Hang to dry.



Drip-dry and hang soaking wet.



Lay flat to dry.



Ironing

Red — Do not iron or press.

Yellow — Iron at low to medium temperatures.

Green — Iron at high temperatures.



Dry Cleaning

Red — Do not dry clean.

Yellow — Dry clean at low temperatures.

Green — Dry clean.

Figure 4-22. Coloured Laundry Symbols.

Laundry Additives

Detergent

- Suitable for all types and temperatures of water and most fibres and fabrics.
- Follow directions on the container for the right amount to make about one-half inch of suds.
- Cold water detergents can be used at all temperatures.

Soap

- Effective only in warm, soft water.
- Use a small amount to get about two inches of suds.

Enzyme Pre-Soak

- For protein stains (blood, perspiration, urine, feces).
- Follow directions on the container.
- Never use on wool or silk or blends of these fabrics.

Bleach

- Add to the water before adding the clothes, or dilute before adding at mid-cycle.
- Never pour directly on clothes.
- Never use on wool or silk or blends of these fabrics.
- Never mix with ammonia.

Fabric Softener

- Never pour directly on clothes.
- Do not mix with other laundry additives.

Laundry Hints

- Sort clothes according to colour and washing requirements; e.g., white clothing, dark clothing, heavily soiled clothing, fine garments.
- Close zippers and empty pockets before laundering.
- Fill washers loosely, top loaders to the top of the agitator and front loaders half-full.
- Use a water level appropriate to the size of the load.
- Don't overload dryers.
- Machine dry for the shortest time possible and remove clothes immediately.
- Empty the dryer lint filter after each load.
- Do not machine dry articles made of foam rubber, glass fibre, and some plastics.

Environmental Comfort

A comfortable and attractive environment can contribute much to a person's state of mind. The environment can make a big difference to someone who is recovering from illness or undergoing rehabilitation.

An environment must be more than clean to be comfortable. Other factors that affect the comfort of an environment are: ventilation, light, temperature, humidity, odors, and noise. These factors must be controlled to maximize the comfort of the environment.

Inadequate ventilation will lead to problems such as stale air, mustiness, and unpleasant odors. Opening doors and windows to provide blow-through can freshen the environment considerably, but be sure that the client agrees and is protected from drafts. It might be advisable to leave windows open (but secure) to air the house while the client is out. During airing, turn the thermostat down so that heat is not wasted. When the client returns, close the windows and reset the thermostat.

Light affects most people. On dreary winter or rainy days, the low light intensity seems to make some people feel low or down. On the other hand, a bright sunny day seems to brighten many peoples' spirits. Sunlight is a natural, comforting type of light that artificial lighting cannot duplicate. If you can encourage clients to leave drapes open letting in natural light, the environment will be brighter and more cheerful, and electrical costs will be cut. Note that some individuals develop headaches from certain types of fluorescent lighting and that the elderly are slightly more sensitive to glare.

Light should be adequate to perform the tasks being done in a room. Both too little light and too much light can cause eye fatigue.

Sometimes hall lights in care facilities remain on 24 hours a day and can confuse some clients. This situation can be remedied by drawing the curtains to shut out glare or by closing the client's door. On the other hand, some clients may wish to have a night-light on for security or may need one in the hallway and bathroom to prevent falls when getting up in the night.

Temperature is a major concern, especially for the elderly who often feel cold. Most people are comfortable at a temperature between 65 and 72 degrees Fahrenheit or 18 and 22 degrees Celsius. If possible, have a temperature that is most comfortable for the client. If this is not possible, for example, the heating system is not readily adjustable, the client may require extra wool sweaters to keep warm or may need to open a window to cool off. Encourage clients to dress for the temperature. In the summer heat, a fan may help to cool stuffy quarters.

Humidity is the amount of dampness in the air and depends on climate. High humidity or excess dampness can make cold feel colder and hot feel hotter. Low humidity causes a dry throat and nose, dry eyes, and a general dried-out feeling. Humidity can be increased by room humidifiers or by putting open containers of water close to heat sources. The containers should not go dry. Decreasing humidity can only be done with dehumidifiers that usually attach to the heating system. Unfortunately, dehumidifiers are costly.

Noise is any sound a person does not want to hear. It may be the neighbour's television or radio, talking or laughing in the hallway, unnecessary use of the intercom, or noisy equipment.

Whatever its source, noise interferes with activities, rest, and sleep and should be controlled when possible.

Odors also interfere with the client's comfort and may be especially distressing for someone who

is slightly nauseated or sick to the stomach. There are several ways to cut down on odor:

- Dispose of garbage and waste promptly.
- Empty and clean bedpans, urinals, and commodes promptly and thoroughly.
- Change and dispose of soiled linen promptly.
- Use personal and room deodorants appropriately.
- Remove old flowers and stagnant water.
- Discourage inappropriate storage of leftover food.
- Avoid heavy perfumes.

When caring for a client's comfort, remember that the client should maintain as much independence and control over the environment as possible. The assistance given to the client will depend on the client's abilities and inclinations and in agency policy. Encourage clients to tidy and arrange their environment as long as they are able, assisting them when they need help with things such as arranging their furniture or drapes or finding the best spot for call bells. Always respect each client's need for personal space and belongings.

EXERCISE 4-2

Crossword

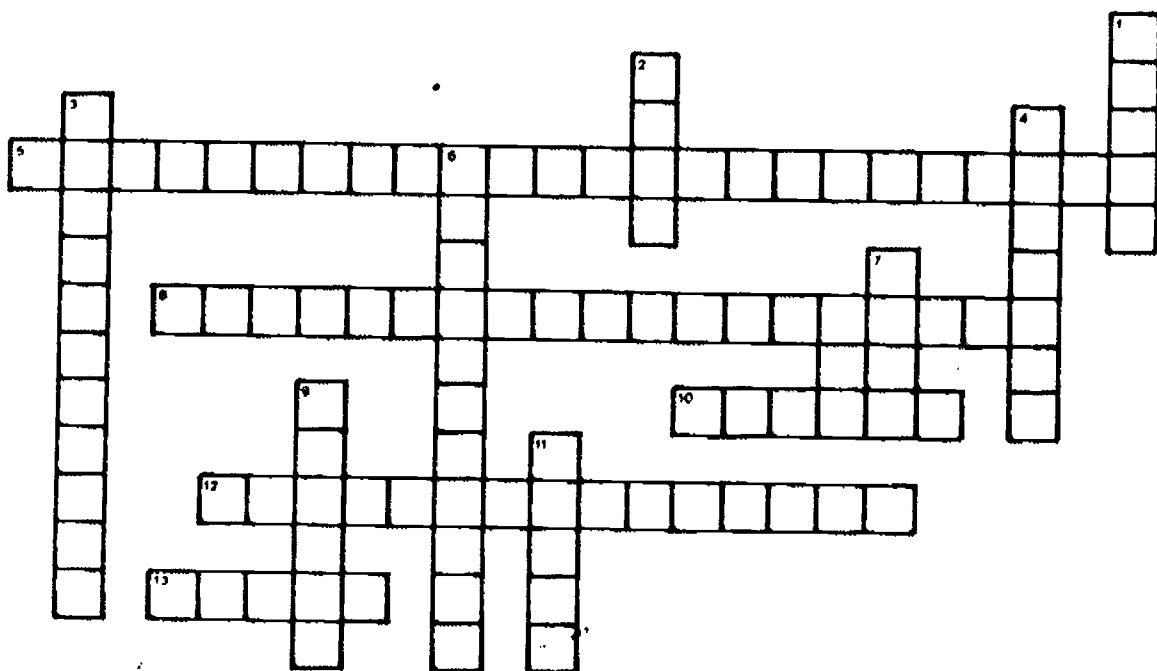

- Across:**
5. Tiny germs, bacteria, and viruses capable of causing disease.
 8. One means of circulating microorganisms.
 10. Cleanliness is a _____ measure for clients and yourself.
 12. One means of circulating microorganisms.
 13. Contaminated; unclean.

- Down:**
1. One of three conditions needed for microorganisms to flourish.
 2. Another condition needed for microorganisms to flourish.
 3. The most important way to stop the spread of microorganisms.
 4. Freedom from pathogenic microorganisms.
 6. Condition that helps stop microorganisms from spreading.
 7. Carries microorganisms in the air.
 9. A third condition needed for microorganisms to flourish.
 11. Not dirty; free of contamination.

Questions

1. List three principles of cleanliness to use for all cleaning duties.
2. Review the cleaning techniques and procedures so they become automatic to you. Use these cleaning practices in your own home to help you become familiar with them.
3. List three "don'ts" of handling soiled linen.
4. Why do you completely make one side of a bed before going to do the other side?
5. After washing your hands, why should you turn off the tap with a paper towel or tissue?
6. When is the best time to clean a piece of cleaning equipment?
7. Why should different cleaning solutions not be mixed together?
8. True or false? A small appliance should be wiped down, then unplugged and put away.
9. What is a good homemade solution for cleaning heavy, greasy film from windows?
10. True or false? To properly clean a fridge you have to take all the food out of the fridge as well as the removable shelves, racks, and drawers.
11. A really dirty oven requires a _____ oven cleaner.
12. What type of cleaner should you use on fiberglass-type sinks, bathtubs, and showers?
13. Garbage should be _____ removed from living quarters.
14. Why is it important to make a wrinkle-free bed?
15. How far should the rubber draw sheet be from the top of the bed?
16. When making a bed, which sheets and covers require secure corners?
17. What do the colours red, yellow, and green mean in relation to the laundry symbols?

18. Match:

- | | |
|----|--------------------|
| a. | 1. Dry clean |
| b. | 2. Hang to dry |
| c. | 3. Hand wash |
| d. | 4. Chlorine bleach |
| e. | 5. Drip dry |

19. List six factors that play a role in the comfort of the environment.

PERSONAL CARE

Hygiene

Physical care of an individual is often called personal **hygiene**. Hygiene aims at establishing and maintaining health habits that preserve good health. Bathing, shaving, skin care, hair care, mouth care, and dressing are all part of personal hygiene.

Ideally, people should look after their own hygiene. However, many clients are unable to do so and require some degree of assistance. Clients' feelings must always be considered when giving hygiene care. They may feel embarrassed or ashamed that they cannot carry out their own hygiene. Be thoughtful and courteous and always respect the client's privacy.

Common Hygiene Products

Many cosmetics and personal care products are used in daily hygiene. Often clients are accustomed to certain hygiene products; they identify with these products and feel good using them. Take notice of clients' preferences in personal care products.

Often cosmetic items are given as gifts. Making hints to relatives and friends of clients regarding preferred cosmetics is practical and usually helpful. Common cosmetics are:

Soaps. Aid in cleaning, but have a drying effect. Use sparingly on dry skin. Heavily perfumed soap may irritate skin.

Lotions and oils. Lubricate or moisten dry skin.

Deodorants and antiperspirants. Reduce the odor and the amount of underarm perspiration. Can irritate sensitive skin.

Bath powders. Scent bath water. Can cake in body creases, so rinse off carefully.

Perfumes, colognes, aftershave lotions. Scent the body. Have a strong drying effect on the skin, so use sparingly.

Makeup. Can improve the client's self-image if the client is accustomed to using it. Remove at night and cleanse the skin.

Nail polish. Can irritate some individuals. Keep nail polish on fingernails and toenails in good repair.

Bathing

The type of bath a client requires depends on several factors: the client's condition and physical capabilities, the type of bath recommended by the client's physician, and the available equipment and facilities.

A client who is physically capable can have a bath in a bathtub or take a shower. The client may only require assistance into and out of the bathtub or shower. Clients in care facilities can use a special bath like the Century Tub or Jacuzzi. Clients confined to bed may require either a complete or partial bedbath (sponge bath). An

infant's bath will usually be in a small portable tub or perhaps a sink. Whatever the type of bath, there are some common rules for bathing:

- Wash your hands before and after bathing a client. As previously stated, the general rule regarding handwashing when performing procedures with clients is to wash your hands before and after the procedure and any time during the procedure that your hands become contaminated.
- Prepare the environment by having the bath area warm and the bathing supplies and equipment handy.
- Take safety precautions; for example, get the client to check the water temperature, leave the bath area door unlocked, wipe up spills, use good body mechanics, and encourage the client to use the handrails and good body mechanics.
- Offer toilet assistance before the bath.
- Ensure the client's privacy and warmth throughout the bathing.
- Follow principles of cleanliness by working from clean to dirty, far to near, top to bottom, and front to back.
- Observe the client's skin condition.
- Carefully assist clients to towel dry as required.
- Report significant observations of the client's body or behaviour.

Bathtub Procedures

1. Place your supplies, equipment, and clean clothing for the client within reach.
2. Fill the bathtub half-full with warm water. Let the client test the temperature and make adjustments before the client gets in. Don't add water while a client is in the bathtub.
3. Help the client undress and get into the tub. Encourage the client to use the handrails and good body mechanics when getting settled into the bath (Figure 4-23).
4. Help wash as needed. Offer to do the client's back. Let the client soak if he or she wishes. Usually 15 minutes is adequate. If the client

can safely be left alone, leave for this period, but stay within calling distance.

5. Empty the tub. Place a towel around the client's shoulders for warmth. Assist the client from the tub and help the client get dried and dressed as needed.
6. Assist the client from the bathroom. After the client is safe and comfortable, return to clean the tub and tidy the bath area.

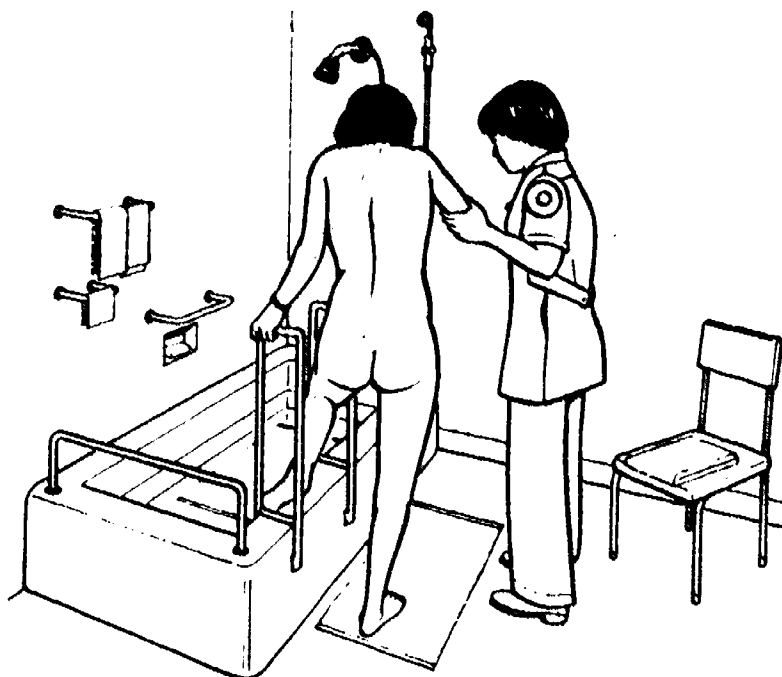

Figure 4-23. Helping a Client into a Bath.

Shower Procedures

1. Place your supplies, equipment, and clean clothing for the client within reach.
2. Prepare the shower area:
 - Place a non-skid mat on the shower floor.
 - Turn the water on and adjust it to warm.
 - Let the client test the water temperature before entering.
 - Don't adjust the temperature while the client is in the shower.
3. Help the client undress and get into the shower. Encourage use of the handrails.
4. If the client can safely wash alone, leave the shower area, but stay within calling distance.

5. Turn off the water and place a towel around the client's shoulders for warmth. Assist the client from the shower stall and help the client get dried and dressed as needed.
6. Assist the client from the shower area. After the client is safely comfortable, return to clean the shower and tidy the shower area.

Special Baths

Because a bath in a bathtub is more refreshing and relaxing than a bedbath, many care facilities have installed special tubs. Wheeled patient carriers can lower disabled clients into the tubs and remove them after their bath. You will have to learn how to operate these tubs and carriers. Most agencies have written procedures stating how to operate the equipment. Also, it is helpful to try the equipment out yourself as this will give you insight into how you can better assist the client to use the equipment.

Following are some rules with special baths:

- Prepare the bath and check for correct operation of the equipment before going for the client.
- Ensure privacy and warmth. This may mean wrapping a flannelette sheet or a warm bathrobe around the client if the client is transported through corridors.
- Transfer the client into and out of the carrying chair using good body mechanics.
- Observe the usual bathing safety precautions mentioned for bathing and showering.
- Assist the client as necessary.
- Leave the equipment and room clean and tidy.

Bedbaths

Bed-ridden clients have a need for cleanliness just the same as other people. Bedbaths are used for these clients. Some clients will be able to complete most of a bedbath themselves, whereas others will require it to totally be done for them. A bedbath can mean washing the entire body (complete bedbath) or washing only those parts of the body that need it (partial

bedbath). The parts of the body that are washed in a partial bedbath will vary from client to client, but usually include the face and hands, armpits (axilla), and perineum (genital area). Whether the bedbath is complete or partial, there are some common rules to follow:

- Keep the client's body in proper alignment.
- Don't leave soap in the wash water.
- Ensure that the water remains warm and clean by changing it as needed.
- Use the bath as an opportunity to observe the state of the client's skin.
- Stop the bath if the client appears distressed or overtired.

Complete Bedbath Procedure

Equipment and Supplies:

- Wash basin
 - Soap
 - Washcloth and towels
 - Flannelette bath sheet
 - Bedlinen as necessary
 - Lotions and cosmetics as desired
 - Clean clothing for the client
1. Place supplies, equipment, and clean linen and clothing within reach.
 2. Remove the spread and blankets, folding them over the back of a chair. Cover the client with a flannelette blanket, large towel, or bathrobe. Remove the top sheet, folding it over the back of the chair.
 3. Position the client close to your side of the bed as flat as is comfortable. Remove the client's clothing and any jewelry.
 4. Fill the wash basin about two thirds full of water at the temperature the client prefers.
 5. A bath mitt made by folding a washcloth (Figure 4-24) is often easier to control than a loose washcloth.
 6. When washing, pay special attention to folds and creases and massage bony prominences. Expose only the part of the body being washed. After washing a body part, rinse and dry it thoroughly.

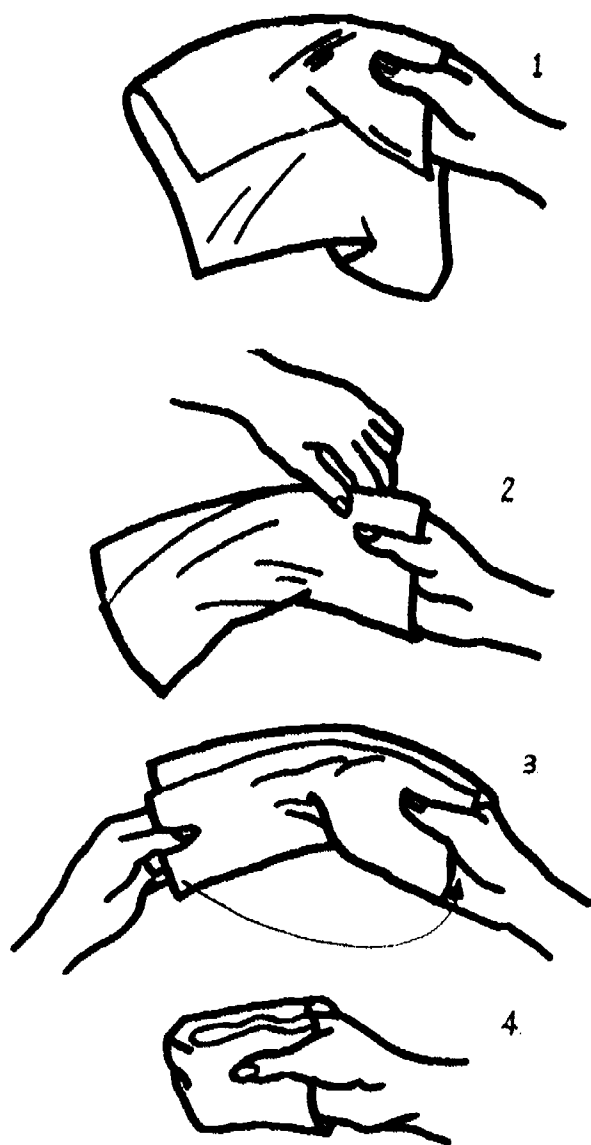

Figure 4-24. Bath Mitt.

7. Bath the client in the following sequence:

- a. **Eyes.** Wash from inner to outer corners. Use no soap.
- b. **Face.** Ask if the client wishes soap. Some clients may be able to wash their own face (Figure 4-25).



Figure 4-25. Washing Face.

- c. **Hands, arms, and armpits.** Start with the farthest arm.
- d. **Chest and breasts.** Dry well under breasts.
- e. **Abdomen.** Cover the chest with a towel while washing the abdomen (Figure 4-26).



Figure 4-26. Washing the Abdomen.

- f. **Feet and legs.** Support the joints and soak the feet in a basin if possible. Check the toenails for needed care.
- g. **Back and buttocks.** Rub the back with lotion (Figure 4-27).

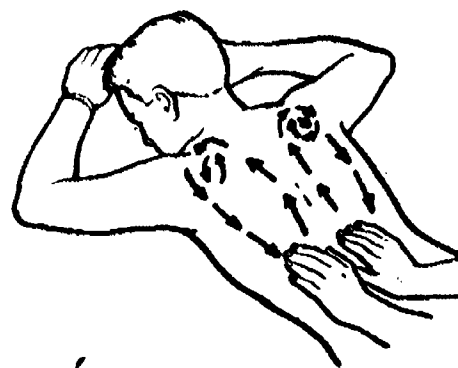

Figure 4-27. Rubbing the Back with Lotion.

- h. **Perineal area.** Get the client, if able, to wash, rinse and dry the genitals. Soap and rinse the washcloth for the client. If the client is unable to do the washing, do it for the client, following the principles of cleanliness.
8. Dress the client in clean clothing, comb the client's hair, and position the client comfortably.

9. You may wish to make the bed at this time.
10. Leave the client comfortable and the room neat.

Infant Baths

An infant is usually bathed in a plastic basin or a clean sink with a flat changing area next to it. The environment must be warm so that the baby does not become chilled. Following are special safety precautions to take when washing a baby:

- Wash your hands before washing the baby.
- Never turn your back on the baby.
- Never leave the baby unattended.
- Don't use Q-tips in the baby's nose or ears.
- Support the baby's head.

Infant Bath Care

Equipment and Supplies:

- Basin or cleaned sink
- Towels, one to lay the baby on and one for drying
- Washcloth
- Baby soap (check with the mother for preference)
- Cream for buttocks
- Cotton balls
- Diaper and clean clothing

1. Place supplies and clothing within easy reach and in order of use.
2. Fill the basin or sink with 2 inches of warm water and test the temperature with your elbow.
3. Lay the baby on a towel close to the basin or sink. Undress the baby and wrap the infant in a towel.
4. Wash the eyes with wet cotton balls, wiping from the inner to the outer corner. Use a fresh ball for each eye.

5. Wash the face without soap and pay attention to creases in the neck and folds in the ears.
6. Place the baby in a football hold (Figure 4-28) with the head held over the sink or basin. Using a small amount of soap, lather the head well and rinse thoroughly. Dry the baby's head.
7. Lay the baby on the towel and unwrap the infant. Using a cradle hold (Figure 4-29), lower the baby into the water.



Figure 4-28.
Football Hold.

Figure 4-29.
Cradle Hold.

8. Continue to cradle the infant while washing and rinsing with the other hand. Wash the perineum (genital area) last. If the baby is a girl, wash the perineum from front to back. If the baby is a boy and is not circumcised, gently wash the head of the penis after pulling back the foreskin. Be sure to pull the skin forward again.
9. Lay the infant on the towel and dry the baby thoroughly with a separate towel. Apply cream to the buttocks or as the mother prefers.
10. Put a diaper on and dress the infant, then place the baby in the crib.
11. With the infant safe, clean and tidy the bath area.

Skin Care

Since skin is so important as a barrier to pathogenic microorganisms, care must be taken to keep it unbroken and healthy. Over dryness and soiling can lead to skin breakdown, as can resting on wet surfaces or lying or sitting in one position too long.

Skin must be observed frequently for changes or signs of problems. Skin must be kept clean and dry. This is especially true for clients who cannot control their elimination (incontinence). Bed linen or chair padding must be wrinkle-free, and clients should be handled gently. Fingernails can accidentally scrape or tear skin and thus should be trimmed regularly.

Lotions, oils, and powders may keep dry skin from cracking, and moisture-proof creams or ointments can help keep skin dry despite incontinence. Be aware, however, that too much of these substances in body creases can hold moisture and contribute to skin breakdown.

Pressure to an area of the body can decrease the blood flow in that area and cause the skin to break down. This type of pressure sore is called a bedsore, pressure sore, or **decubitus ulcer**. Figure 4-30 shows the areas of the body most prone to pressure sores.

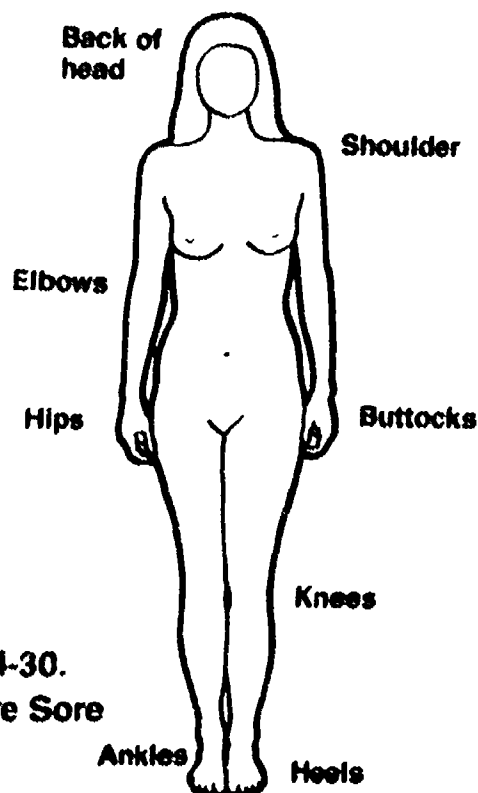

Figure 4-30.
Pressure Sore
Areas.

The best way to prevent pressure sores is to have the client change position at least every two hours. Simply shifting the weight off an area of the body allows the blood flow to nourish it again.

When a reddened pressure area is found, massaging around the area in a circular motion can encourage good circulation. An oil or lotion can aid the massage. With people prone to skin breakdown, bony prominences should be firmly but gently massaged for a short period each day.

There are aids and devices that cushion the skin and relieve pressure somewhat. Some of these are: water mattresses, air mattresses, foam pads, sheepskin pads, and heel boots. When a pressure area is beginning to breakdown, everybody seems to have a favorite remedy to put on the sore. However, the best treatment is a massage and keeping the client off the pressure area as much as possible. A rule to remember with pressure point care is: **you can put anything on a pressure area except the person.**

Any skin change should be promptly reported to your supervisor, e.g., a color change, rash, bruise, break in the skin, or pressure sore. Describe each change carefully giving the location, size, and exact details as to what it looks like.

Mouth Care

Mouth care is the cleansing of the mouth, gums, tongue, and teeth or dentures. It should be done first thing in the morning, after meals, and at bedtime, if possible. All clients should receive mouth care, whether they are able to do it themselves or require someone to do it for them. The following rules apply to all of the several ways of giving mouth care:

- Be sure the client can swallow or spit before filling the mouth with toothpaste or fluids.
- Be sure the client is appropriately positioned.
- Be sure clothing and bedding is protected.
- Be careful if it is necessary to put your fingers into a client's mouth.
- Wash your hands before and after giving mouth care.

Mouth Care Procedure

Purpose:

- Rid the mouth of foreign material
- Keep the mouth moist and in good condition
- Keep breath odor-free and the mouth pleasant tasting
- Help prevent tooth decay or denture problems

Equipment and Supplies:

- Toothbrush and toothpaste or denture cleaner
- Sink or small basin
- Water
- Cup
- Towel
- Mouthwash may be desired

1. Place the equipment and supplies within easy reach.
2. Position the client and assist as necessary in brushing the teeth, tongue, and mouth surfaces.
3. Rinse the mouth with water or mouth wash.
4. Carefully observe the condition of the mouth. Lubricate the lips if necessary.
5. Dry the mouth and face carefully.
6. Tidy up and restock the equipment and supplies.

Denture Care Procedure

Equipment and Supplies:

- Tissues
- Denture cup
- Toothbrush
- Denture cleaner or toothpaste
- Mouthwash may be desired

1. Ask the client to remove the dentures. Accept the dentures with a tissue to prevent them slipping from your hands. If you must

remove dentures, run the flat of your index finger along the gum ridge of the denture and apply pressure to release the suction. Place the dentures in a denture cup or small basin for transporting to the sink (Figure 4-31).

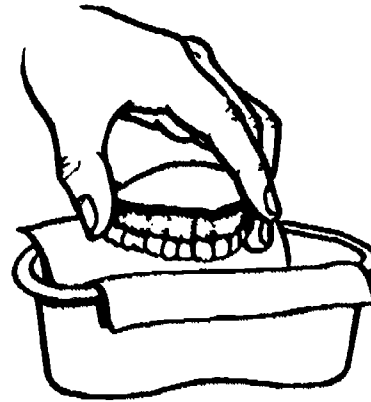

Figure 4-31. Transporting Dentures.

2. Line the sink with paper towels or a washcloth and fill the sink with warm water. These measures will prevent the dentures from breaking should they drop.
3. Hold the dentures securely while cleaning them with a toothbrush and toothpaste (Figure 4-32). Rinse the dentures thoroughly under cool running water.

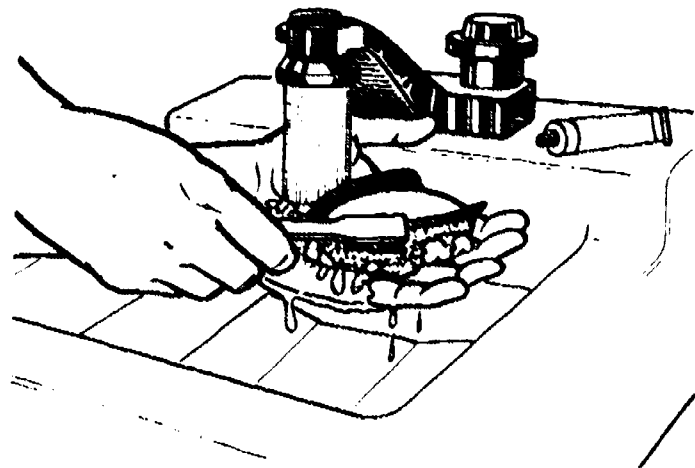

Figure 4-32. Cleaning Dentures.

4. Place the cleaned dentures in a denture cup filled with fresh water or mouthwash and water, and put them in a safe place until the client is ready for them. In a care facility the denture cup should be labelled with the name and room number of the client (Figure 4-33).

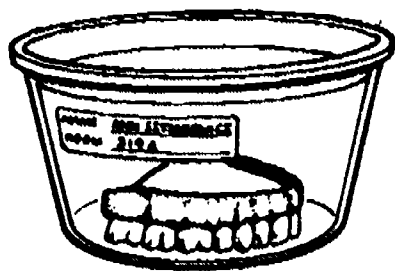

Figure 4-33. Storing Dentures.

5. Before the client replaces the dentures, be sure the client's mouth is clean. Hand the client the dentures with tissue.
6. Tidy up and restock the equipment and supplies.

Special Mouth Care

Special mouth care is given to clients who are unconscious, have dry mouths, or are mouthbreathers. This mouth care procedure must be done for the clients.

Special Mouth Care Procedure

Equipment and Supplies:

- Small basin
 - Gauze square padding, tongue depressor
 - Small towel
 - Mouthwash
 - Lubricant such as glycerine flavoured with lemon juice (commercial lemon and glycerine swabs are available)
1. Turn the client's head gently toward you and place a towel under the head.
 2. Dip a gauze applicator in mouthwash, then cleanse all the surfaces of the mouth, changing gauze as necessary.
 3. Assist the client to rinse the mouth, if the client is able, then wipe the lips and face with a towel.
 4. Apply lubricant to the mouth surfaces and cream to the lips as required.

5. Tidy up and restock the equipment and supplies.

Feet, Toenail, And Fingernail Care

Care of feet and toenails is a routine part of most baths. Many elderly and handicapped clients will require assistance, since it is difficult for them to reach their feet. The nails of the elderly are thick and brittle and can be tough to trim. Be careful when trimming toenails not to injure the feet. Many care facilities regularly use the services of a foot care specialist called a podiatrist or chiropodist. Between visits the staff are responsible for observing feet and nails and for maintaining their hygiene. Poor circulation in the feet may be aided by foot soaks and gentle massage.

Fingernails are most often cared for by the client, but you may be required to give this care to disabled or confused clients. Trim fingernails, shaping and removing roughness with a file.

Some points to remember in caring for feet, toenails, and fingernails are:

- Soak feet and hands before cutting nails to soften them. The most convenient time for cutting is after the bath. Feet may be soaked while the client sits in a chair or lies in bed (Figure 4-34).

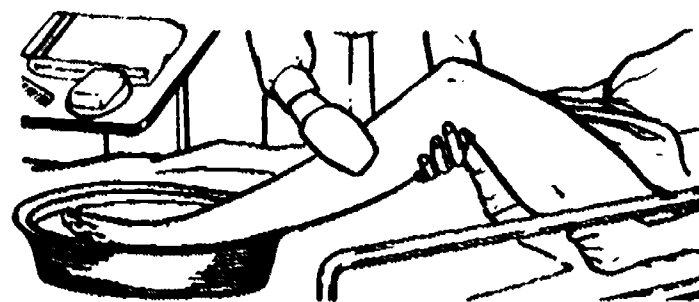

Figure 4-34. Soaking Feet.

- Keep fingernails and toenails clean and reasonably short.
- Use creams and lotions on feet, as required, especially for clients with dry, cracked skin.
- Use powders on feet sparingly to prevent caking.

- Use appropriate nail cutters or clippers and files that are frequently cleaned.
- Observe feet carefully and report suspected problems to the supervisor.
- Work within your limitations; refer for attention feet or nails that you are uncertain how to care for.

Hair Care

The aim of hair care is to have clean, well-groomed hair and a healthy scalp. The frequency of hair washing will vary greatly depending on the condition of the client's hair, but brushing and combing should be part of daily care.

Some points to remember when giving hair care are:

- Encourage clients to do their own hair care when possible.
- Style hair according to the client's wishes.
- Carefully observe the condition of the hair and scalp and report suspected problems.
- Shampoo as necessary. Usually the elderly require shampooing less frequently than younger people.
- According to the client's needs, select the best place for a shampoo; e.g., a bed, sink, tub, or shower.
- Use prescribed shampoos, following directions
- Rinse the hair well.
- Protect the client's eyes and ears with a washcloth.

Bed Shampoo Procedure

Equipment and Supplies:

- Wash cloth
- Towels
- Containers of clean water at an appropriate temperature
- Large container to catch used water

- Drainage trough (roll newspapers into a horseshoe shape and cover the papers with a plastic bag (Figure 4-35))

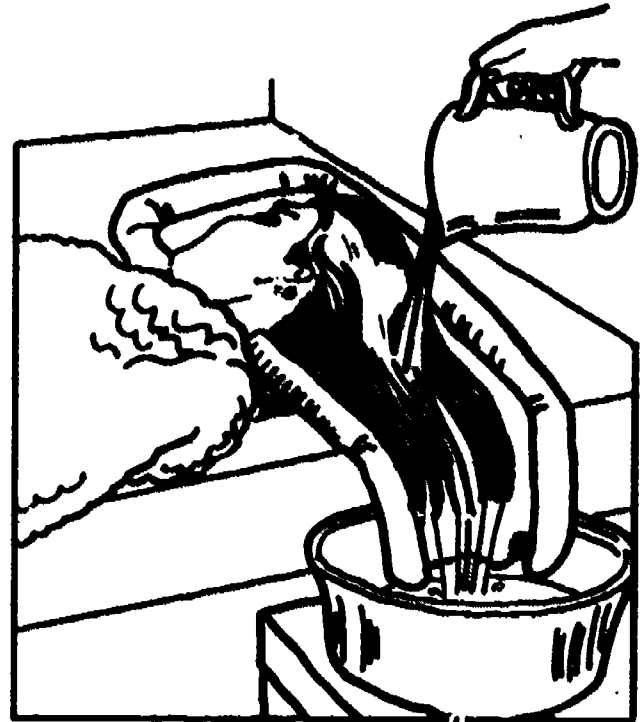

Figure 4-35. Drainage Trough for Washing Hair in Bed.

- Bed protection (rubber sheet or plastic bags)
 - Shampoo, comb, brush
1. Comb the client's hair and gently remove tangles. Remove the pillow from the bed. Protect the head of the bed with waterproof sheets or bags.
 2. Move the client's head and shoulders to the edge of the bed nearest you, and place the drainage trough under the client's head.
 3. Position the container to catch the drainage. Protect the client's eyes with a washcloth.
 4. Wet the client's hair with warm water. Pour shampoo onto your hand, then transfer it evenly onto the hair. Massage using the balls of the fingers in a circular motion. Be sure to shampoo the nape area.
 5. Rinse the hair thoroughly. If the hair is very soiled or oily, repeat the shampoo and rinse.
 6. Raise the client's head and wrap it in a towel. Remove the drainage trough. Dry the client's hair thoroughly.
 7. Style the hair as the client wishes, then tidy the area.

Perineal Care

Care of the *perineum* or genital area and rectum uses the same principles of cleanliness as all other personal care, but because the genitals are considered very private by most people, special attention should be given to the client's feelings. Perineal care is part of a bath.

Respect the client's privacy by closing the door or drawing the curtain and by exposing as little of the body as possible. Complete the task quickly and efficiently using a calm, matter-of-fact approach. Do not show distaste. Follow the principles of cleanliness, remembering that the urinary opening is the cleanest part of the perineum and the rectum (anus) is the dirtiest. Use a fresh part of the washcloth for each part of the genital area.

Perineal Care Procedure

Equipment and Supplies:

- Washcloth
- Towels
- Soap and water

Male

1. Wash the penis, paying attention to the urinary opening and folds of the foreskin. Retract the foreskin if necessary.
2. Rinse and dry well. Draw the foreskin forward again.
3. Wash the testes and the groin. Rinse and dry well.
4. Wash, rinse, and dry the rectal area.
5. Observe carefully for any rash, open areas, or discharge.

Female

1. Wash, rinse, and dry the perineal area working from the centre to the outside and the front to the back. Pay special attention to the folds.

2. Wash, rinse, and dry the groin area.
3. Wash, rinse, and dry the rectal area.
4. Observe carefully for any rash, open area, or discharge.

If the patient has a tube in place to drain urine (urinary catheter), carefully cleanse around the urinary opening to remove drainage and crusting. Be very cautious not to pull on the tubing.

Shaving

Most men shave as part of their routine morning care, and some women find they have dark hair growth that may need occasional bleaching or shaving. You may have to assist the client shaving or shave the client yourself, depending on the client's capabilities.

Shaving may be done with an electric shaver or a safety razor. If you have never used a safety razor, get some practice shaving your own legs with one before tackling a face.

Shaving Procedures

Equipment and Supplies:

Shaving with an electric shaver:

- Electric shaver
- Pre-shave lotion
- After-shave lotion

Shaving with a safety razor:

- Safety razor
- Basin of hot water
- Lather or soap and shaving brush
- Washcloth
- Towel
- After-shave lotion

Electric shaver.

1. Apply pre-shave lotion to the beard area.
2. Shave with slow circular strokes, using light pressure.

3. Apply after-shave lotion, if the client desires it.
4. Clean the shaver as required before storing it.

Safety razor.

1. Apply hot, moist washcloth to the beard for a few minutes to soften the whiskers.
2. Apply lather or soapsuds generously to the beard area.
3. Keep the skin taut with one hand, while you shave the face in downward strokes. Try to get an even, level line at the sideburns. Be careful when shaving around the mouth, nose, and chin cleft. The neck can be shaved with upward strokes, but they are harder on the skin than the downward ones.
4. Wash off the remaining lather and pat the face and neck dry.
5. Apply the after-shave lotion if the client desires it.
6. Clean the razor under running water. Safely discard the blade or disposable razor if necessary.

Dressing

If a client needs assistance getting dressed, there are several points to remember:

- Allow clients to select their own clothing.
- Encourage clients to do as much as possible themselves.
- Follow a client's dressing routine if it works well for the client.
- Place the clothing within reach, piled in the order of use.
- Always dress a weak, paralyzed, or injured limb first and undress it last.
- Button-up or zippered tops are easiest.
- Over-the-head shirts go on a weak arm first, then over the head, and finally over the strong arm.

- Be aware of special requirements like belts, braces, or slings.
- Ensure comfort by avoiding wrinkled or twisted garments.
- Report clothing in need of repair or replacement.

Elimination

Elimination is the discharge of waste products from the body. The urinary system eliminates fluid wastes and the digestive system rids the body of solid wastes. See Section 2 for a discussion on meeting elimination needs.

Some clients have a bowel movement every day, whereas others may have one every second day or twice a week. It is important to know each client's elimination pattern. In any case, stress the need to act quickly when the urge to defecate arises, because the urge can soon pass. This is especially important for bed-ridden clients who often have a decreased urge to pass urine and feces.

Aids to Elimination

People often have habits helpful to elimination; for example, drinking a large glass of hot water first thing in the morning and eating bran cereal for breakfast. Ensuring that a client drinks plenty of fluid helps both fluid and solid waste elimination. Adequate exercise aids elimination and the muscular system; it also gives the client a sense of well-being and accomplishment.

Since most people are accustomed to eliminating in the bathroom, it is ideal if a client can reach the bathroom or be assisted there. If this is not possible, alternatives include using a commode (Figure 4-36), bedpan (Figure 4-37) or urinal (Figure 4-38).

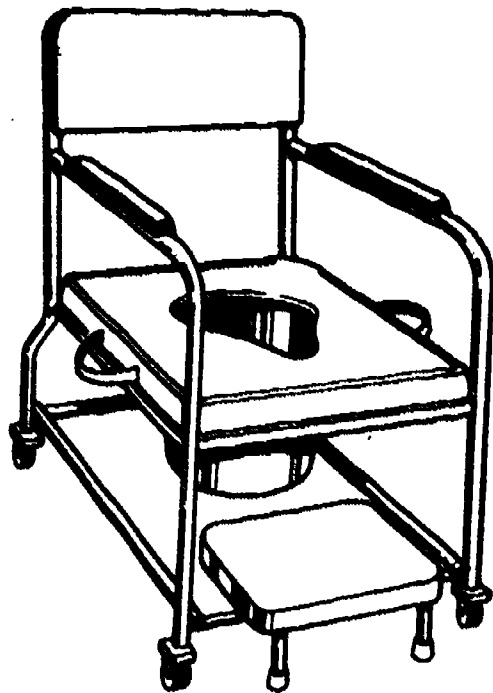

Figure 4-36. Commode.

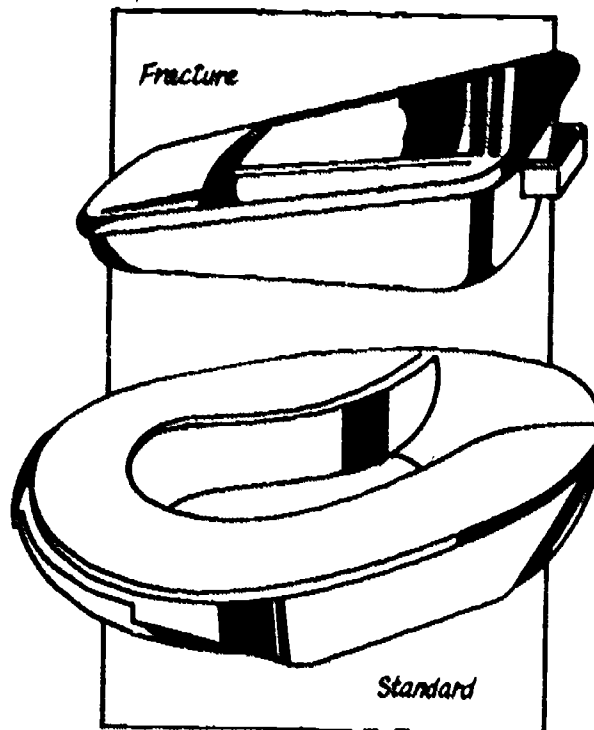

Figure 4-37. Bedpans.



Figure 4-38. Urinal.

Assisting Clients to a Toilet or Commode

Respond promptly to a client's request for toileting, since delay may lead to incontinence or disappearance of the urge to eliminate. Ensure privacy by asking visitors to leave the area and closing doors or curtains as appropriate. Note that a small amount of water in a commode container will make cleaning easier.

Know how much assistance the client needs, and discuss exactly how the move will be made. The cooperation of the client is essential. Assist the client onto the toilet or commode, using the correct transfer techniques and body mechanics.

Once the client is comfortable and safe, you may leave the client in private. Stay within calling distance, and leave the tissue and call bell (if appropriate) within reach. Return promptly when called, and assist as necessary to clean the client. Help the client from the toilet or commode, then help in washing the client's hands at a sink or basin or with a wet cloth. Make the client comfortable, then return to clean the com-

mode or the toilet according to agency policy. Before cleaning, observe the products of elimination (See "Elimination Observations" a few pages forward). Return the commode to storage ready for use.

Assisting Clients With a Bedpan

Clients who are unable to leave their beds or do not have enough time to get to the bathroom may use a bedpan in bed. Women will use the pan for both urine and stool elimination, but men will likely use it only for stool elimination.

There are two main types of bedpans (Figure 4-37). The standard pan is most often used. The narrower slipper pan may be needed for clients who cannot raise their hips high enough for the standard pan.

Getting seated on a cold pan is very distressing; this can be avoided by warming the pan with warm water and drying it before offering it to the client. Ensure the client's privacy. Balancing on a bedpan can be difficult and uncomfortable, so be sure the client is steady and positioned as

comfortable as possible. Also, don't leave the client on the bedpan any longer than necessary.

Bedpan Procedure

Equipment and Supplies:

- Bedpan and bedpan cover
 - Toilet tissue
 - Handwashing essentials
1. Checking that the bed is flat, fold the top sheets out of the way. Be careful not to expose the client.
 2. Have the client bend the legs and push up with the feet to raise the hips. Assist as needed by raising the lower part of the client's back while you slip the bedpan into position. Have the pan centered with the seat under the client's buttocks. Raise the client's head, if permitted, so the client is in a more natural sitting position.
 3. If the client cannot raise the hips, roll the client away from you on the client's side. Place the bedpan in position against the buttocks and hold it there while you assist the client to roll back onto the pan.
 4. Leave the client as comfortable as possible, safe, and able to reach tissue and a call bell. Stay within calling distance and return promptly when called.
 5. Assist as necessary in cleaning the client, and remove the bedpan by raising the hips again. If the client is unable to do the cleaning, turn the client on the side and thoroughly cleanse the rectal area. Cover the bedpan immediately and place it safely out of the way.
 6. Take the bedpan to the bathroom, then assist in washing the client's hands.
 7. Leaving the client comfortable, return to the toilet and raise the seat. Before emptying, observe the contents. Clean and store the pan as required.

Assisting Clients With a Urinal

Male clients will likely be more at ease urinating into a urinal or bottle than into a bedpan. A sitting position is probably best. The urinal can be left handy so the client can use it at will; it should be covered if possible and left in an appropriate spot. Check frequently to see if the urinal needs emptying.

A male client who is experiencing urine dribbling or incontinence may feel comfortable leaving the urinal in place between his legs. The urinal should be correctly positioned on its flat side to prevent spillage, and the penis should be as far into the opening as possible.

Take care when removing a urinal not to spill it. Carry the urinal to the bathroom, then assist in washing the client's hands. Leaving the client comfortable, return to the toilet and raise the seat. Before emptying the urinal, observe the contents. Clean and return the urinal.

Elimination Observations

Elimination should be observed for changes in:

- Behaviour
- Usual pattern of elimination
- Amount and frequency of elimination
- Elimination product

A client who becomes distressed during elimination may be in pain. Certain facial expressions or gestures can also indicate that the client is having discomfort eliminating. Pain should be reported promptly.

Changes can take place in a pattern of elimination. For example, a client who normally has a bowel movement every morning becomes irregular or else has a movement every second day. If this change is not accompanied by distress, it may be a natural change in the client's habits. If there is distress, a problem is indicated.

Increased frequency of urination could be a sign of health problems, especially if the increase is accompanied by burning or stinging, foul odor,

cloudy urine, or blood in the urine. The problem could be an infection. A decreased frequency in urinating could also indicate health problems or could simply be a result of the person not drinking enough fluid. Changes in urination frequency should be reported to the supervisor.

Changes in the amount of elimination passed at any one time can be a sign of problems. Frequent loose stools or diarrhea should be reported, as should constipation or small, hard stools. Large amounts of urine or scant amounts should also be reported.

Normally, urine should be:

- Straw coloured
- Clear
- Not strong smelling

Normally, a stool should be:

- Formed but soft
- Brown
- Not foul smelling

If you observe the following characteristics in stools or urine, report them:

Stool

- Liquid
- Hard, small lumps
- Greenish colour
- Blackish colour
- Coffee grounds appearance
- Fresh blood stained
- Unusual contents
- Foul odor
- Discomfort

Urine

- Cloudy
- Dark amber colour
- Colourless
- Pinkish colour
- Strong or foul odor
- Floating particles
- Burning sensation when urinating

Bowel and Bladder Retraining Programs

Clients who have lost control over their elimination will want very much to regain that control. Bowel and bladder retraining programs are used to help them.

A bowel and bladder retraining program has routines that must be strictly followed. Some of these routines are eliminating at specific times, planning the timing and amount of fluid intake, and sometimes using special treatments like suppositories or enemas. The most important part of any retraining program is the client's cooperation. The client must understand the program and willingly participate, or it will fail.

Despite a strong desire to control elimination, there will be frustrations and disappointments on the way to achieving the goal. The client must be helped to overcome setbacks and to try again. Being positive and supportive while understanding the client's frustrations is the best approach. Concentrating on each small success can help to build the client's determination and pride of achievement.

The retraining program routine must be carried out consistently, or it will not work. A habit is formed by performing a procedure over and over again, exactly the same way every time. Since shortcuts break the pattern, they can confuse the client and weaken the habit. Bowel and bladder retraining doesn't happen overnight; it can take many months of concentrated effort. This effort, however, is worth it considering the benefits to the retrained client.

Special Elimination Needs

Special treatments or procedures may be carried out to help clients eliminate, to obtain specimens for tests, or to make tests on urine or stool. These procedures must be ordered by the client's physician and carried out carefully for accurate and successful results.

THE FOUR "RIGHTS" OF CARE

**The RIGHT PROCEDURE
must be done by the
RIGHT METHOD with the
RIGHT CLIENT at the
RIGHT TIME.**

Suppositories and Enemas

A client who is constipated may require special assistance such as a suppository or enema to bring on a bowel movement. A **suppository** is a bullet shaped preparation of **lubricant** or **laxative** medication usually inserted into the rectum to aid elimination of feces (Figure 4-39).

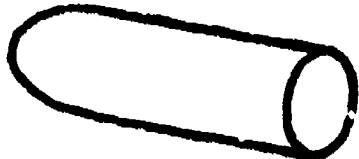

Figure 4-39. Suppository.

Lubricants help soften a hard stool and make the stool's passage from the bowel easier, whereas laxatives actually stimulate the bowel to eliminate. A cleansing **enema** squirts a liquid into the rectum, stimulating the bowel to eliminate.

Enemas and suppositories must be ordered by the client's physician, and the dosage or amount must be exactly as specified. Common points to remember for enemas and suppositories are:

- Check that toilet facilities are available before beginning the procedure.
- Explain the procedure carefully to the client.
- Wash your hands before and after the procedure.
- Ensure privacy and don't overexpose the client.

- Follow the procedures in the right order.
- Position the client, if possible, on the left side with the right knee bent up. This is the easiest position for the client to retain the enema or suppository.

Suppository Procedure

Equipment and Supplies:

- Suppository as ordered
 - Glove or finger protector
 - Lubricant
1. Protect your index finger with a glove or finger protector.
 2. Lubricate the suppository and your index finger.
 3. Insert the suppository gently into the rectum as far as your finger will go. Encourage the client to take a deep breath to help relax the rectum.
 4. Remove your finger and encourage the client to retain the suppository as long as possible.
 5. Assist the client with toileting and hygiene as required.
 6. Tidy up and discard the disposable items. Leave the client comfortable and safe.
 7. Report the procedure and the results.

Cleansing Enema Procedure

Equipment and Supplies:

- Prescribed enema container with the correct solution at the proper temperature (40C). Larger quantities of solution will require a container and rectal tube for insertion (Figure 4-40). A plastic bottle with an administration tip (Figure 4-41) can be used for smaller quantities of solution.
- Glove (if required)
- Lubricant
- Protective padding

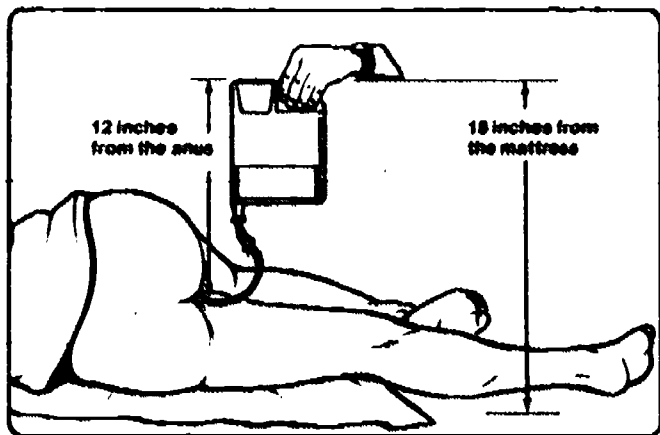

Figure 4-40. Tube-Type Enema.

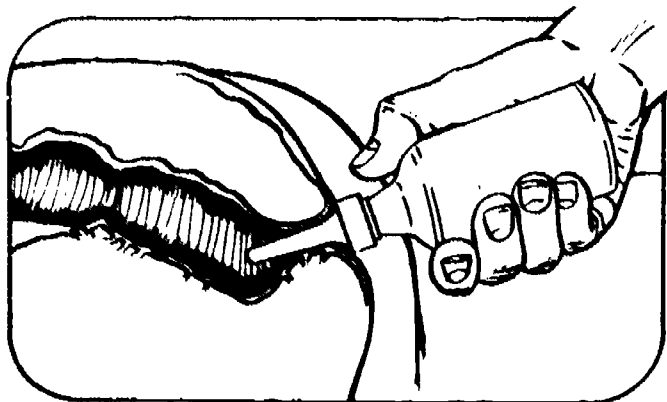

Figure 4-41. Tip-Type Enema.

1. Protect the bed with a protective padding while positioning the client.
2. Expel air from the tubing. Lubricate well the rectal tube or administration tip.
3. Insert the rectal tube slowly and gently to a depth of 10 to 15 cm (4 to 6 inches) or the administration tip to the hub. If you feel an obstruction, do not push further.
4. Raise the tube-type enema container about 45 cm (18 inches) above the bed or about 30 cm (12 inches) above the anus (Figure 4-40). Open the clamp and allow fluid to flow in slowly. Squeeze the tip-type enema firmly to expel the contents (Figure 4-41). Pause if discomfort occurs.
5. Remove the tube or tip slowly and encourage the client to retain the enema as long as possible.

6. Assist the client with toileting and hygiene as required.
7. Tidy up and discard the disposable items. Leave the client comfortable and safe.
8. Report the procedure and results.

Collection Of Specimens

Urine and stool are collected and then examined by a laboratory to give information about body functioning. When collecting a specimen, it is important to:

Select the right container. Some containers contain preservatives, some are sterilized, and some are waterproof. The container must be matched to the specimen. Check with your supervisor.

Collect the right specimen. Be sure to ask when the specimen should be obtained and what amount is needed.

Use the correct method. A special procedure may be required to collect the specimen. Ask your supervisor.

Correctly label the container in legible writing. Make sure that the client's name, address, and doctor's name are easily readable on the label. The date and time the specimen was obtained and the type of specimen should also be written on the label. Place the label on the container immediately after you have collected the specimen.

Use good cleanliness techniques (asepsis). Since you are dealing with waste products, steps must be taken to be sure pathogenic microorganisms are not spread. Wash your hands before and after collecting the specimen. Don't spill down the outside of the specimen container; use a funnel for urine (Figure 4-42) and pour carefully. Wipe up any spills with disinfectant cleaner. Assist the client to wash his or her hands.

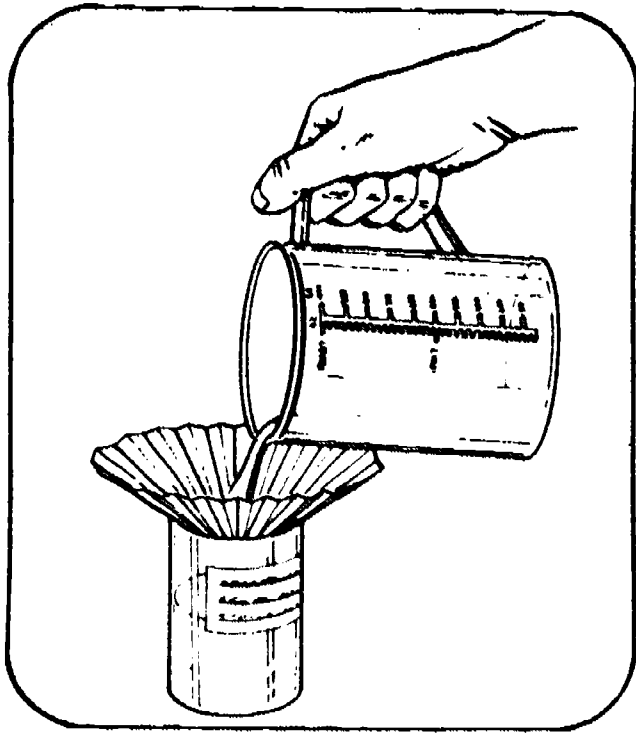

Figure 4-42. Pouring Urine.

Deliver the specimen to the correct location. Agency policy will determine where the specimen goes after collection. Specimens taken in a care facility may be left at the main desk or may need to be taken to the laboratory. Specimens taken at home will have to be delivered to the clinic or laboratory. Check to see if the specimen must be delivered immediately or can wait until your time with the client is finished.

Testing Diabetic Urine

A diabetic is not able to properly use the carbohydrate in food. Waste from a diabetic's inefficient use of carbohydrates is eliminated in the urine. Testing the urine of a diabetic for sugar and acetone gives an idea of how well the diabetes is controlled.

The urine tested must be as fresh as possible. To obtain fresh urine, have the client empty his or her bladder and discard the urine. A half hour later have the client again urinate this time into a clean container. This urine will be fresh, and there will be enough for the test since only a small amount is needed. Specimens are usually collected before meals or at bedtime.

There are several ways diabetic urine can be tested (Figure 4-43). Urine can be dropped onto reactive tablets, reactive tape or sticks can be dipped into urine, or tablets can be dropped into urine. Whatever the method, the procedure must be carried out exactly as instructed on the testing material. To get accurate results, material quantities must be correctly measured and time limits closely followed.

If you are required to test diabetic urine and have never been shown how, ask your supervisor for instruction. Inaccurate test results can lead to serious health problems for a diabetic client.

To interpret the test, compare the colour of the reactive material with the colour graph that comes with the testing material. Record your results and report them immediately if they are unusual.

The testing material containers and equipment must be kept clean and dry to get accurate results. Dirty or wet testing materials should be discarded.

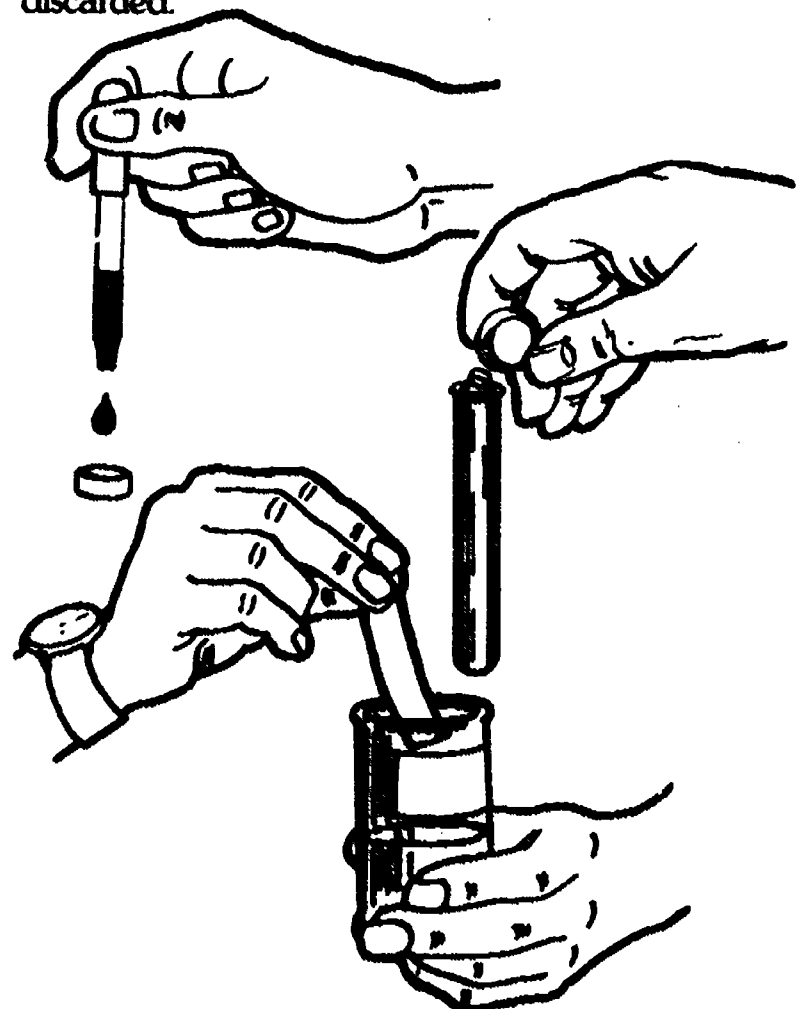

Figure 4-43. Testing Diabetic Urine.

Catheter Care

Some clients will have a catheter or tube inserted into their bladder and left there for continuous urine drainage. This tube can irritate the urinary opening and cause discharge. The presence of a urinary catheter calls for special care:

- Pay special attention to the tube and urinary opening. Carefully wash off any drainage.
- Check that the catheter tubing is secure and is not pulled tight, causing discomfort.
- Check that the connections are sealed and the urine is flowing freely within the system.
- Check that the drainage bag is below the level of the bladder to prevent backflow of the urine.
- Empty the bag at regular intervals, observing cleanliness techniques.

- Position the client carefully so that the tubing is not kinked or blocked.
- Be considerate of the client's feelings by keeping the tubing and drainage bags discreetly out of sight as much as possible.

Emptying Urinary Drainage Bag

The drainage bag for a urinary catheter is attached to a bed, wheelchair, or chair, or is attached to the leg of a client who is more mobile. To empty the bag, open the tube at the bottom of the drainage bag and allow the urine to flow into a container. Be sure the container is large enough to hold the urine. After the bag is drained, securely close the tube and cover the end. Wipe any drips. Measure the urine if necessary, and dispose of it down the toilet.

EXERCISE 4-3

Crossword

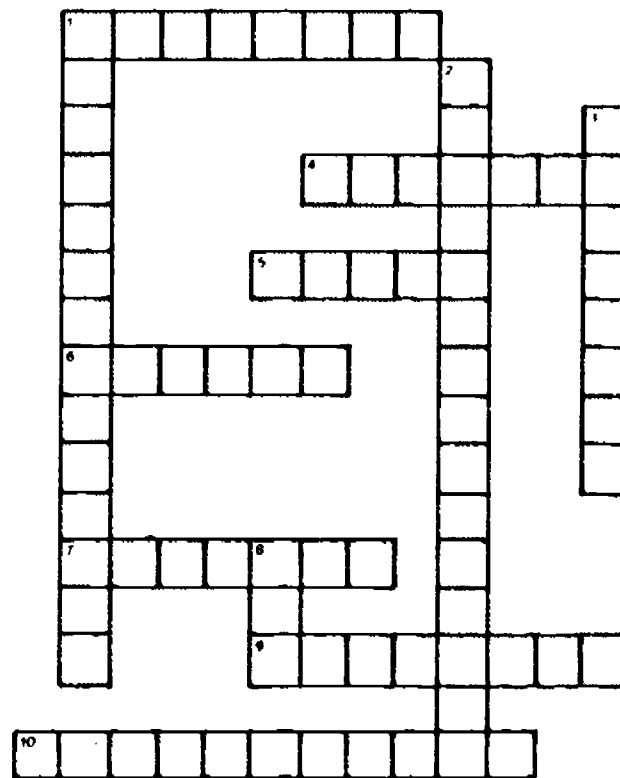

Across:

1. Artificial teeth.
4. Personal care practices for good health habits and good health.
5. Liquid introduced into the rectum to stimulate elimination.
6. Bottle used by men to catch urine.
7. Portable toilet chair.
9. Medication that stimulates the bowel to eliminate.
10. Bullet shaped preparation of medication.

Down:

1. Bedsore, pressure sore.
2. Tube into bladder to drain urine.
3. Genital area, area between thighs.
8. Lubricates dry skin.

Questions

1. Review the personal care procedures until you are familiar with them. Practice the principles and procedures in your own daily care.
2. Why is it necessary to take special care with clients' feelings when performing hygiene care?
3. When performing a procedure, when should you wash your hands?
4. What preparations are made to the bath area prior to a client bathing?
5. What safety measures should be taken when assisting a client take a bath?
6. What parts of the body are usually cleaned during a partial bedbath?
7. True or false? When giving a bed bath, wash all the parts of the body, then rinse and dry them.
8. What are five safety precautions to take when bathing an infant?
9. List four causes of skin breakdown.
10. Describe skin changes that you would report promptly to your supervisor.
11. The best way to prevent pressure sores is to have the client change positions at least every _____ hours.
12. Why is mouth care done?
13. True or false? After cleaning dentures, they should be dried.
14. When is the best time to cut nails? Why?
15. When giving a shampoo, how do you protect the client's eyes?
16. What is a basic point to keep in mind when styling a client's hair?
17. What is a method of softening a beard prior to shaving?
18. How do you get a bedpan under the buttocks of clients who:
 - a. Can raise their hips?
 - b. Cannot raise their hips?
19. What are five things you can do to help a client feel less embarrassed and uncomfortable during perineal care?

20. Identify the "cleanest" part of the perineum and the "dirtiest".
21. When dressing a client with a weak left side, which side would you dress first? Which side would you undress first?
22. List eight factors that may affect normal elimination.
23. What observations would you report about a client's elimination?
24. Describe normal urine.
25. List the four "rights" that apply to all procedures.
26. What is a fifth "right" that applies to enemas and suppositories?
27. List six major concerns when collecting a specimen.
28. The urine of diabetics is tested for _____ and _____ to see if the diabetes is under control.
29. What checks should be regularly made on catheter tubing?

NUTRITION

Nutrition is the study of food and how the body uses it. The aim of nutrition is to properly nourish the body. Nutrition plays an important part in good health. Not only does it affect body functions, but also it affects appearance, personality, behaviour, working potential, and general outlook on life. The right foods can maintain or restore good health; the wrong foods can result in dietary deficiencies and poor health.

The food a person eats should contain all the necessary nutrients needed to keep the body healthy. Besides nutrients, the body also needs water and fibre.

Nutrients are chemical substances in food that nourish the body. There are about 50 nutrients classed under the headings: **proteins, carbohydrates, fats, vitamins and minerals**. A food may contain only one nutrient (sugar contains only carbohydrate) or several nutrients (milk contains protein, fat, calcium, vitamin A, D, and niacin). No one food contains all the nutrients needed by the body.

Nutrients help the body work in many ways. They build and maintain body tissues, regulate body processes, and supply energy. Some nutrients work in more than one way; for example, protein builds and renews tissues, forms antibodies to fight disease, and can supply energy. Some nutrients work together; for example, vitamin D and calcium, and vitamin C and iron. Table 4-1 lists some of the important nutrients, their functions, and sources.

TABLE 4-1 Nutrients, Water, and Fibre

Nutrient	Functions	Sources
Proteins	Build and repair body tissue. Form antibodies to fight disease.	Animal sources — milk, cheese, eggs, meat, fish and poultry. Plant sources — dried legumes (peas, beans, lentils) cereals, nuts, peanut butter.
Carbohydrates	Supply energy.	Starches — breads, cereals, rice, pastas, potatoes. Sugars — fruit, jam, honey, syrup.
Fats	Supply energy. Carry fat soluble vitamins, A, D, E, and K. Protect and insulate body parts.	Meat, cheese, oils, salad dressing, nuts, shortenings, butter, margarine, cream.
Fat-Soluble Vitamins		
Vitamin A	For healthy eyes and skin.	Dark green and yellow vegetables, yellow fruits, egg yolks, liver, butter, milk.
Vitamin D	Helps the body use calcium and phosphorus for strong bones and teeth.	Fish liver oil, egg yolk, milk.
Vitamin E	Maintains healthy membranes.	Vegetable oils, wheat germ, whole grains, eggs, liver, fruit and vegetables.
Vitamin K	For normal blood clotting.	Green and yellow vegetables.
Water-Soluble Vitamins		
Vitamin B	Helps body use carbohydrates. For normal growth and development. Maintains appetite and digestion. For normal nervous system.	Liver, dried legumes, whole grain or enriched cereals, milk, cheese, eggs, leafy green vegetables.
Vitamin B6	For healthy blood.	Meat, liver, vegetables.
Vitamin B12	For healthy blood.	Meat, liver, vegetables.
Folic Acid	For healthy blood.	Meat, liver, vegetables.
Vitamin C	For healthy gums and teeth. Maintains strong blood vessels.	Citrus fruits (orange, lemon, grapefruit), tomato, broccoli, cauliflower, cabbage, potatoes.
Minerals		
Calcium and Phosphorus	For strong bones and teeth. For normal blood clotting. For normal nerve and muscle function.	Milk, cheese, yogurt, ice cream, dried fruit, dried legumes, vegetables.

TABLE 4-1 Nutrients, Water, and Fibre — Continued

Nutrient	Functions	Sources
<i>Iron</i>	For red blood cells.	Liver, red meats, egg yolk, dried legumes, leafy green vegetables, whole grain and enriched cereals.
<i>Iodine</i> <i>Sodium and Potassium</i>	Proper function of thyroid gland. Maintain normal fluid balance.	Iodized salt, seafood. Sodium — salt, pickled and processed foods, most fruit and vegetables. Potassium — most fruit and vegetables, oranges, bananas and tomatoes.
Water	Regulates body processes. Carries nutrients to body cells and water away from the cells.	Milk, juices, soups, sauces, fruits, vegetables, and meats.
Fibre	Provides bulk to maintain intestinal mobility.	Fruits and vegetables, whole grain cereals, bran, nuts, popcorn.

Calories

Energy is necessary to fuel the body's growth and maintenance. The amount of energy supplied by food is measured in **calories**. Fat, carbohydrate, and protein all supply calories, but weight for weight, fat provides more than twice as many calories as protein or carbohydrate. Vitamins and minerals are aids that allow the body to use energy. They do not supply calories.

The human body stores excess calories as fat. Weight is gained by taking in more energy from food than the body can use up through physical activity. Weight is lost by decreasing calorie intake and increasing physical activity so that

more energy is used than taken in. By balancing food intake with physical activity, weight can be kept at a proper level.

The number of calories needed varies with sex, age, size, health, and activities. For example, a lumberjack uses up more energy than an office worker, and a teenage girl uses more calories than her grandmother. Energy requirements are high during the teen years when much growth and development is taking place. If teenagers continued to eat the same amount of food throughout their lives, they would gradually gain weight because the body metabolism slows down and activity level usually drops as people get older. See Table 4-2 for daily calorie requirements of different age and sex groups.

TABLE 4-2: Average Daily Calorie Requirements

Children

1- 2 years:	1100 calories
2- 3 years:	1250 calories
3- 6 years:	1600 calories

Teenage Girls

10-12 years:	2250 calories
12-14 years:	2300 calories
14-15 years:	2400 calories
15-18 years:	2300 calories

Adult Women

18-35 years:	2000 calories
35-55 years:	1850 calories
55-75 years:	1700 calories
Pregnancy:	Add 300 calories

Children

6- 8 years:	2000 calories
8-10 years:	2200 calories

Teenage Boys

10-12 years:	2500 calories
12-14 years:	2700 calories
14-18 years:	3000 calories

Adult Men

18-35 years:	2800 calories
35-55 years:	2600 calories
55-75 years:	2400 calories

Canada's Food Guide

Tables 4-3 and 4-4 show Canada's Food Guide. Canada's Food Guide is a simple food plan that helps in choosing a good variety of nutritious foods every day. The guide recommends the

number of servings you should choose daily from each of the four food groups: **Milk and Milk Products, Bread and Cereals, Fruits and Vegetables, and Meat and Meat Alternates**. Each food group supplies certain kinds and amounts of nutrients; together they provide all the nutrients necessary for good health.

TABLE 4-3: Canada's Food Guide

Milk & Milk Products	+	Bread & Cereals	+	Fruits & Vegetables	+	Meat & Meat Alternates	=	CANADA'S FOOD GUIDE
Vitamin A				Vitamin A		Vitamin A		Vitamin A
Riboflavin		Thiamin Riboflavin Niacin				Thiamin Riboflavin Niacin Folic Acid		Thiamin Riboflavin Niacin Folic Acid
Vitamin D Calcium				Folic Acid Vitamin C				Vitamin C Vitamin D Calcium
Protein Fat		Iron Protein		Iron		Iron Protein Fat		Iron Protein Fat
		Carbohydrate		Carbohydrate				Carbohydrate

Because each food group has its own nutritional strength, a person should eat foods from all four groups each day. All four groups are equally important to good health. Nutrients are not interchangeable, and thus food groups are not interchangeable. This means you cannot omit two servings of milk and milk products with the intention of substituting five servings of bread and cereals.

Canada's Food Guide is flexible. Both the number of servings and the serving size are listed as a range, not as a set amount. Choices can be made from within this range to satisfy individual energy needs and personal preferences and still supply the essential nutrients. For example, the guide recommends 3-5 servings from the bread and cereal group. One serving from the bread and cereal group could be $\frac{1}{2}$ — 1 cup of a cooked cereal. An elderly lady with a small appetite could have $\frac{1}{2}$ cup of cooked cereal for breakfast plus 2 other servings from this group later in the day. On the other hand, an active teenage boy could easily require 1 cup of cooked cereal in the morning, leaving him another 4 servings from this group for later. Both the elderly lady and the teenage boy can meet their nutrient requirements from Canada's Food Guide.

The number of recommended servings of milk and milk products varies because the need for calcium and vitamin D changes throughout life. There are separate recommendations for children, adolescents, adults, and pregnant or nursing mothers.

Canada's Food Guide is versatile. Personal tastes can easily be accommodated. Each food group lists many food choices varying in cost and calorie content. For example, the meat and meat alternates group lists:

- Shrimp (low calorie)
- Pork sausage (high calorie)
- Peanut butter (less expensive)
- Prime rib (more expensive)

Fats, sugars, and alcohol are not listed in Canada's Food Guide, since they contain few nutrients. These foods contribute empty calories to a diet and do nothing for good health.

Factors That Influence Eating Habits

As a health care worker you should realize how important nutrition is to the health of your clients and encourage their eating a wide variety of good foods to get all the important nutrients. When planning meals for your client, consider the following factors influencing the type and quantity of food that people eat:

Appearance of food. If food does not appear appetizing, it will likely remain uneaten. Food should look, smell, and taste good. Add interest to a meal by varying the flavour, colour, texture, temperature, and shape of the food. Arranging adequate portions neatly on the dishes and serving the food attractively will stimulate the appetite. Besides paying attention to the appearance of the food, also consider the table setting. Use simple place settings with colourful table linen, napkins, and decorations.

Atmosphere. Unpleasant sights and odors can lessen the appetite. If the client uses a bedpan before a meal, make sure the room is properly aired and deodorized before serving the meal. Mealtimes should be relaxed and often social. Encourage clients to have friends or family in if they enjoy company at meals. If your employer or your schedule allows it, have a cup of coffee or tea with the client at mealtime.

Emotional state. Eating is closely related to emotions. Loneliness, grief, depression, and anxiety can cause a loss of appetite in some people. Serving favourite foods simply and attractively in small portions may encourage these people to eat.

On the other hand, there are people who eat to forget their problems, and their overeating can lead to obesity. Usually the problems of over-eaters have to be dealt with first before their eating habits will change.

Health problems. People with some diseases (for example, cancer, diabetes, or heart disease) and people with food allergies cannot eat certain foods. Make sure that clients with food restrictions get all the necessary nutrients from other foods. Clients who are in pain or are uncomfor-

table (for example, they are constipated or have a foul tasting mouth) may not feel like eating.

Age. Children's appetites increase during periods of rapid growth such as the first two years of life and adolescence. In between these stages they may be fussy eaters and eat poorly. This is normal, and meals for these children should be nutritious but small. Food should not be forced on children.

People need less food as they get older and their body systems slow down. Serving elderly clients low-calorie, high-nutrient foods is best for their health.

Activity level. The more energy one uses, the more food one needs. An inactive person does not need as many calories to meet the body's needs as does an active person. However, the inactive person still needs the same nutrients. A client who is in bed most of the time may not feel like eating and is best served light, frequent, nutritious snacks.

Income. Wealthy people can buy expensive foods such as steak and seafood. They may choose these foods rather than more economical, nutritious ones because of habit or because they think these are status foods.

People on low incomes are limited in their choice of food. These clients often need help planning their shopping to get the best food value for their money.

Lack of nutrition knowledge. Many people do not know what foods are good for them and may have developed poor eating habits. Some people are easily influenced by advertising and fad diet claims. Others worry about the chemicals in food and don't eat foods with additives even though the foods are safe and nutritious.

Lack of cooking skills. Some people do not know how to cook nutritious foods. They rely on processed, convenience foods that are expensive and high in sodium (salt).

Taste and opinion. People differ in their tastes; one will love a certain food and another will hate it. Also people have strong personal opinions about food, and often these opinions are not based on good nutrition.

Family customs. Family traditions influence me. patterns. Two examples are fish and chips on Friday and bacon for Sunday breakfast. Again, these customs are not always based on good nutrition.

Culture. Ingredients, combinations of dishes, and cooking techniques vary in different cultures. Familiar dishes appeal to people more than dishes they are not used to. For example, cheese, pasta and tomato sauce may appeal to an Italian, whereas a Chinese person may prefer rice and fish.

Religion. Certain religions have rules about foods that can and cannot be eaten by their members. Examples of religious dietary restrictions are:

- Mormons don't drink beverages containing caffeine such as coffee, tea, cocoa, and colas.
- Seventh Day Adventists are vegetarians who take milk and egg products in their diet.
- Orthodox Jews eat kosher foods (allowed foods prepared according to strict laws).
- Moslems do not eat pork.
- Hindus do not eat beef.
- Sikhs are vegetarians.

Menu Planning

When caring for clients in their homes, it is often necessary to prepare meals and assist with the purchasing of food. Before going shopping, it is wise to plan menus and check which ingredients the client already has.

Making a shopping list is an efficient way to shop; it ensures that unnecessary articles are not purchased and necessary articles are not forgotten. When planning menus, think in terms of 24 hour periods, remembering that one client may eat the traditional three meals a day, whereas another client may eat light snacks every few hours. Keep in mind eating habits and any dietary restrictions that the client may have. Be sure to discuss the menus with the client **before** purchasing the food.

Menu Considerations

Canada's Food Guide should form the foundation of the menu, taking into account the client's likes and dislikes. Plan meals in which flavours of different foods go well together. Three strong flavoured foods at the same meal will clash with one another. A better plan is to combine one strong flavoured food with milder ones.

Colour and texture should also be thought of. Three white coloured foods (white fish with egg sauce, mashed potato, steamed cauliflower) can appear very unappetizing. Similarly, three mushy foods (soft meatballs in thick sauce, steamed squash, and mashed potato) can be unappetizing for a client who enjoys a variety of food textures. On the other hand, some clients will require soft foods because of difficulties with their dentures, or for other reasons.

The cost of food is important. Plan nutritious but inexpensive meals especially for clients on a limited budget. Compare different brands for the best bargain. Take advantage of food specials. Careful use of leftovers is economical and can decrease meal preparation time. Today's roast chicken can be tomorrow's chicken sandwich and the next day's chicken broth base for soup.

Diet Restrictions — Special Diets

A client's food intake can be adjusted by a special diet to maintain good health, restore health, or improve health. Often a physician will order the inclusion or elimination of certain foods in the diet. The following changes occur in special diets:

Calorie change. This is usually a diet in which the number of calories a day is reduced so that the client can lose weight. A reducing diet restricts the eating of high carbohydrate foods such as cakes, and eliminates the empty calorie foods like candy and alcohol. Choosing foods that are high in nutrients and low in calories is the key here.

Consistency change. A liquid diet or a soft diet may be given to clients who cannot chew, swallow, or easily digest foods unless the foods have been chopped, strained, or chosen for their soft texture. It is difficult to have a liquid diet that has all the necessary nutrients and yet is interesting to the client. Broths, juices, and milk form the basis for liquid diets. Soft diets consist of foods that are naturally soft or foods that are chopped or pureed.

Fiber change. Fiber or roughage may be adjusted for clients with elimination difficulties or disease of the bowel. A diet high in fiber increases quantities of whole grains and raw fruits or vegetables. A reduced roughage diet omits these foods.

Chemical changes. A very common chemical that is restricted in special diets is sodium chloride or table salt. It is almost impossible to eliminate all sodium from a nutritious diet. Physicians may order varying degrees of salt restriction from simply not adding salt to food to omitting sodium-high foods. Some foods that contain a lot of sodium are: most cheeses, luncheon meats, canned soups, and canned vegetables.

Nutrient changes. Some special diets alter the amount of nutrients; namely protein, carbohydrate, or fat. Each of these nutrients may be increased (a high protein diet) or decreased (a low fat diet), or they may be carefully calculated to the needs of an individual (a diabetic diet). Usually a client on a special diet has a menu plan to assist in meal decisions.

Irritant changes. Many foods are irritating to the digestive system, and may have to be reduced to decrease discomfort or allow healing. Some irritants are: spices, raw fruits or vegetables, fried foods, coffee, and alcohol.

Encouraging a client to maintain dietary restrictions can be a major task. The task is easier if the client understands the reasons for, and importance of, the restrictions.

Table 4-4 lists common types of special diets. Tables 4-5, 4-6, and 4-7 each show a sample menu for a special diet.

TABLE 4.4: Special Diets

Diet	Reason for Diet	Diet Foods	Foods to be Avoided
<i>Full Fluid</i>	After surgery or for a digestive upset. Before an X-ray.	Food in fluid form. e.g., milk, custard, junket, ice cream, sherbet, eggnog, cream soups.	All others.
<i>Mechanical Soft</i>	Difficulty swallowing or chewing, e.g., broken jaw, or a sore mouth from a tooth extraction.	Regular diet foods that are chopped or strained. Foods soft in consistency and easily digested, e.g., minced meat, pureed vegetables.	
<i>Bland</i>	Stomach ulcers or bowel problems.	Regular diet except the foods to be avoided.	Fat foods, e.g., fried foods. Gas-forming foods, e.g., cabbage, onions, chili, curry. Spicy foods. Strong tea or coffee.
<i>Low Residue</i>	Rectal or bowel problems.	Regular diet except the foods to be avoided.	Foods high in fiber, e.g., fresh fruits, vegetables, bran, nuts, popcorn. Foods that are difficult to digest, e.g., cabbage.
<i>Low Cholesterol</i>	Heart and circulation problems. High blood cholesterol.	Regular diet with restrictions in the amounts of foods to be avoided.	Restricted amounts of animal fat and dairy products, e.g., butter, cream, eggs.
<i>Low Fat</i>	Obesity (fat). Liver, gall-bladder or heart disease.	Regular diet except the foods to be avoided. Lean cuts of meat, fish and poultry. Baked, broiled, and boiled foods. Polyunsaturated oils, e.g., corn oil, safflower oil, sunflower oil.	High saturated fat foods, e.g., butter, cream, cream cheese, ice cream. Table and cooking fats, gravies, rich sauces. Fried and deep fried foods.

TABLE 4-4: Special Diets — Continued

Diet	Reason for Diet	Diet Foods	Foods to be Avoided
<i>Low Sodium (Low Salt)</i>	Heart diseases and some liver and kidney diseases.	Regular diet except the foods to be avoided. Increase intake of potassium rich foods, e.g., banana, melon, potato, grapefruit, orange, tomato, and the juices from the latter three fruits.	No salt should be used in cooking or added at the table. Processed cheese and spreads. Pickled, salted and smoked meats. Pretzels, chips, olives, pickles, relishes. Seasoning salts, MSG, soya sauce
<i>High Calorie</i>	Undernourishment. Cancer.	Regular diet with increased intake of high calorie fats and carbohydrates, e.g., ice cream, dates, butter.	None.
<i>High Protein</i>	Undernourishment. Cancer.	Regular diet with increased intake of protein foods, e.g., meat, eggs, cheese, milk. Fortified milk. Add milk powder to ground meat, casseroles, soups, and gravies. Add chunks of meat and cheese to salads, and vegetables.	
<i>Diabetic</i>	Diabetes.	Prescribed balance of fats, proteins, and carbohydrates. Calorie intake should match insulin intake and activity level.	Concentrated sugars, e.g., cakes, chocolate, candy, honey, syrup, jams.

TABLE 4-5: Sample Menu for a Diet for Pregnant Women

Breakfast	Citrus fruit (orange, grapefruit or their juice) Whole grain cereal with 1 cup of milk Egg Bread — 1 slice buttered Beverage of choice
Mid-Morning Snack	Bread — 1 slice buttered Milk
Lunch	Chicken salad sandwich Raw carrots and celery Canned pears Milk
Mid-Afternoon Snack	Apple Milk
Supper	Casserole with hamburger, rice, tomato Side salad Pudding with chopped banana Arrowroot biscuits — 2 Milk Beverage of choice
Evening Snack	Milk

TABLE 4-6: Sample Menu for a Salt-Restricted Diet

Note: All foods to be cooked without salt, and no salt to be put on the food at the table.

Breakfast	Citrus fruit juice Cooked cereal with milk Bread — 1 slice buttered with salt-free butter Egg Beverage of choice
Mid-Morning Snack	Apple Beverage of choice
Lunch	Chicken sandwich with lettuce Raw tomato slices Banana Milk
Mid-Afternoon Snack	Bread — 1 slice buttered with salt-free butter Beverage of choice

Supper	Casserole with hamburger, rice, frozen peas Cantelope with ice milk Beverage of choice
Evening Snack	Whole grain biscuits — 2 Beverage of choice

TABLE 4-7: Sample Menu for a Fat-Restricted Diet

Breakfast	Citrus fruit or juice Cooked cereal with skim milk Boiled egg Bread — 1 slice unbuttered Beverage of choice
Mid-Morning Snack	Apple Skim milk
Lunch	Skim milk cottage cheese with pineapple Raw carrots and celery Rye crisps — 4 Beverage of choice
Mid-Afternoon Snack	Fruit juice Arrowroot biscuits — 2
Supper	Sliced chicken Baked potato Broccoli Corn Sherbet with fresh fruit Skim milk Beverage of choice
Evening Snack	Melba toast — 4 Skim milk cheese Beverage of choice

Diabetic Diet

Most diabetics have a menu outline indicating the foods they must eat, the quantity, and the time to eat. If a diabetic has no menu outline, seek assistance from the supervisor. Diabetic diets are prescribed according to the individual diabetic's needs and must be followed exactly. The following rules apply to all diabetic diets:

- Provide all meals and snacks at the prescribed times.

- Measure the ingredients of all the foods that you prepare. The measuring is usually done before cooking.
- The serving sizes should be exactly as stated in the menu outline.
- The client is permitted to eat only those foods listed on the diet. All the food prescribed for a given meal or snack should be eaten.

If a diabetic client is unable to eat, or the opposite, is very hungry, contact your supervisor for direction.

Vegetarian Diets

An increasing number of people are becoming vegetarians. They choose not to eat meat for many reasons such as religious practice, personal principles, and economics. To work with a vegetarian client, it is important that you understand the principles of vegetarianism. There are three general categories of vegetarian diets:

1. **Lacto-ovo-vegetarian diet.** Uses eggs, milk, and all dairy products (cheese, yogurt, ice cream), but does not use meat, poultry, or fish.
2. **Lacto-vegetarian diet.** Similar to the first diet with the exception of eggs.
3. **Vegan diet.** Strict vegetarian diet that uses only plant foods. It does not use any foods of animal origin; i.e., meat, fish, poultry, eggs and dairy products.

Properly selected vegetarian diets should supply all the necessary nutrients in the required amounts. When planning vegetarian meals, it is important that you choose food sources that supply the necessary protein for body growth and repair. Vegetable proteins are called incomplete proteins, but they can be combined with other foods to make complete proteins. An example of a vegetable-animal protein combination is macaroni and cheese with cereal and milk. The cheese and milk improve the quality of the protein in the macaroni and cereal. An example of a vegetable-vegetable protein combination is oatmeal with legumes. The protein in oatmeal links with that in legumes to improve the protein quality.

The food combinations in Table 4-8, when eaten together, supply complete proteins. Any food from the left square can be combined with any food from the corresponding right square making a complete protein.

TABLE 4-8 Food Combinations for Complete Proteins

Note: To make a complete protein, combine a food on the left with one on the right in the same division.

1. Oatmeal	Legumes, e.g., kidney beans, lentils,
Brown rice	chick peas, soybeans
Whole wheat bread	Wheat germ
Millet	Peas
Barley	
Wheat flour	
Bran	
2. Peanuts	Spinach
Cashews	Wheat germ
Pistachio nuts	Sesame seeds and soybeans
Black walnuts	Legumes (not with peanuts)
Brazil nuts	
3. Cauliflower	Millet
Green peas	Sesame seeds
Lima beans	Par-boiled rice
Brussels sprouts	Brazil nuts
Broccoli (dark green and leafy)	Mushrooms

4. Black beans
 Kidney beans
 Chick peas (or garbanzo beans)
 Navy beans
 Soybeans
 Lentils

Wheat
 Rice
 Millet
 Corn (only with soybeans or black beans)
 Wheat bran
 Barley

Once you are sure that a vegetarian client has met the protein requirements, pay special attention to the intake of calcium and riboflavin (B vitamin). Animal foods (milk, cheese, and yogurt) are the best sources of these nutrients. If your client is a strict vegetarian, include extra large servings (1/2–1 cups) of leafy green vegetables, soybeans, whole grain cereals, and legumes to meet the calcium and riboflavin needs. The iron usually supplied by meat can be obtained from dried fruit, spinach, and whole wheat germ. Strict vegetarian clients may require Vitamin B₁₂ and Vitamin D supplements and possibly calcium and riboflavin supplements, if they don't get these from their diet.

Serve a variety of fruits and vegetables so that elderly clients receive all the essential vitamins and minerals. Fruits and vegetables also contribute necessary fluid and fibre.

To provide good nutrition for elderly clients, health care workers must understand the many factors that affect the appetites and diets of older people (Figure 4-44). Tooth loss and poor fitting dentures can affect the diets of the elderly; for example, they may not be able to eat meats that are hard to chew. Encourage elderly clients to eat nutritious, easy-to-chew foods like fish, peanut butter, eggs, soft fruits, and canned vegetables. Add extra protein to their diets by using milk powder in soups, puddings, and sauces and by putting chopped meat in casseroles and soups.

Nutrition For The Elderly

Understanding the special dietary needs of the elderly is important. Generally, elderly people require the same amounts of nutrients as younger adults but fewer calories. Follow Canada's Food Guide and choose high-nutrient, low-calorie foods. For example, serve cottage cheese rather than cream cheese, or poultry rather than sausage.

Elderly people often lack adequate amounts of certain nutrients. Sufficient calcium is a problem, partly because many elderly dislike milk. To get adequate calcium in their diet, serve cheese, yogurt, leafy green vegetables, dried fruits, and other calcium-rich foods.

Iron deficiency is common in the elderly. Good sources of iron are liver, red meats, whole grain cereals, dark green vegetables, and egg yolk. Serve some of these iron-rich foods each day. Canada's Food Guide recommends four daily servings of fruits and vegetables for all adults.



**Tooth loss, poor-fitting dentures.
 Difficulty swallowing.
 Taste buds decline.
 Difficulty manipulating utensils.**

Figure 4-44. Factors Affecting the Diets of Older People.

Elderly people may have difficulty swallowing due to decreased saliva production. Good food choices to aid swallowing are moist foods such as meat in broth, vegetables in cream sauce, and fruit in custard. Serve beverages with meals.

The number and sensitivity of taste buds decline with age and thus the elderly person cannot taste sourness, bitterness, and saltiness as sharply as younger people. Use distinctive spices and herbs in cooking to make food more interesting. Refrigerated foods served at room temperature are more flavourful than if they are eaten straight from the fridge.

Older people retain their sensitivity to sweet. Serve naturally sweet foods like fruit cocktail or fruit yogurt, and discourage the eating of chocolate, toffee, mints, and other empty-calorie foods.

Manipulating utensils such as a can opener or vegetable peeler may be difficult for many elderly people. This difficulty restricts their food choices. Also, some elderly clients have problems handling cutlery, and they find this embarrassing. Check with your supervisor or community occupational therapist about cooking and eating aids. Another thing you can do is leave clients' food in a state they can cope with. For example, if a client has hand-manipulating problems, buy frozen not canned peas and shell fresh peas for the client.

Elderly people often complain about gas and indigestion. Examine their diets and suggest not eating foods that could be causing the problem; e.g., fried foods, chocolate, or beans. Also encourage the eating of small, frequent meals rather than large meals.

Constipation also troubles the elderly. Dietary causes of constipation are unbalanced diets with low fluid and fibre intake and irregular meal times. Serve good sources of dietary fibre daily; e.g., fruit, vegetables, and whole grain cereal. Expensive commercial laxatives are usually unnecessary. Encourage clients to drink plenty of fluids throughout the day. Two litres a day is recommended. Meals should be eaten at regular times each day.

Older people often move slower, walk shorter distances, and are able to carry less weight. Shopping may be difficult and frustrating for them. Many are limited to nearby convenience stores that are usually expensive. Purchase large, heavy items such as flour and potatoes for them and arrange for delivery of dairy products. In short, find out what shopping elderly clients are able to do for themselves, then fill in the gaps.

Progressive loss of eyesight with age can make reading labels, package directions, and recipes difficult. Assist clients in reading package labels and directions and perhaps in writing down the directions in print large enough for the client to read. Obtain large print cookbooks such as the **Senior Chef** for clients with deficient eyesight.

A low, fixed income restricts food choices and leaves no extra money for quantity purchases of food specials. Advise clients on low incomes how to get the best nutritional value for their money. For example, meat, an expensive food item, can be substituted by inexpensive proteins like peanut butter, beans, lentils and eggs.

Some older people live in quarters with little space for food preparation, refrigeration, or storage. Buying and cooking food in advance is impossible. In such a situation a hotplate is common. The heating up or frying that is usually done on a hotplate can produce boring meals. As an alternative, explore the many possibilities for appealing and nourishing skillet and one pot (slow cooker) dinners.

Elderly people living alone often lack the motivation to cook for themselves. Even if they have some motivation, it can be frustrating trying to find amounts of meat and produce small enough for one. These clients may need encouraging to take an interest in food. Note that there are many good cookbooks with simple, fun recipes for one and two people.

Having company is important when eating. Suggest clients join community groups or adult care day centres that offer inexpensive, well-balanced meals in the company of other seniors. Music, TV, radio, or magazines may help substitute for company when the client is alone.

Food choices made by older people are often based on long held habits or prejudices. Two examples of irrational food prejudices are rejecting powdered milk on the grounds that it is a "wartime food" or corn because it is "pig's food." Learn the eating habits of your clients and try to discourage the bad habits. Remember, though, your role is to encourage and influence, not to impose your will on the client.

Elderly people may be uncertain of modern packaging and processing methods. They will likely choose food in familiar forms, which are not always the most nutritious; e.g., fruit canned

in syrup rather than frozen fruit. New advertising can be confusing to the elderly consumer, as can large, overpowering supermarkets, which the elderly pass up for familiar but more expensive specialty stores.

The elderly are very susceptible to highly promoted food fads and unnecessary nutrient supplements. Many of their precious dollars are wasted attempting to gain relief from chronic aches and pains by purchasing "wonder foods." Supplying accurate nutritional information to clients who are taken in by food fads will hopefully save them money and direct them to a better-balanced, nutritious diet.

Food Storage and Preparation Guidelines

After spending a lot of time and money shopping for good food, it is important to store and prepare the food so that it retains its quality

(Figure 4-45). Food nutrients can be destroyed by improper storage or preparation. For example, exposure in storage to air, water, or light can destroy vitamins B and C, as can cooking in water and adding baking soda. The following guidelines on storage and preparation will help retain the nutrients in food.



Store food correctly.

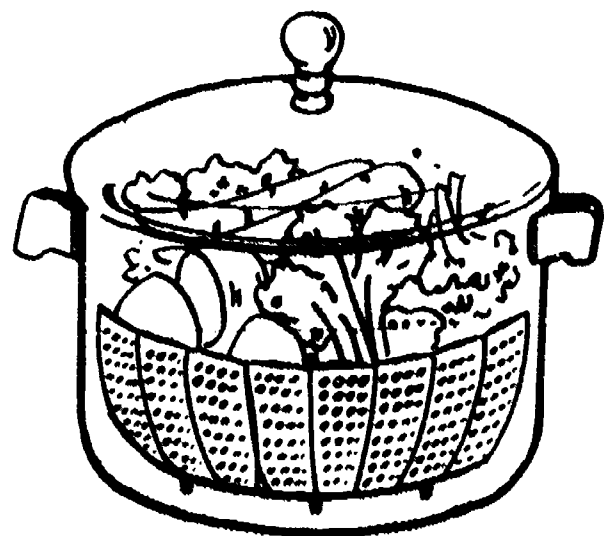

Steam vegetables to retain nutrients.

Figure 4-45. Storing and Preparing Food.

Food Storage

- Wash, dry, and refrigerate fruits and vegetables as soon as possible. Use plastic bags or a food crisper to prevent moisture loss, wilting, and decay.
- Use fresh fruits and vegetables quickly because the quality of their nutrients decreases during storage.
- Make up only as much orange juice as can be used in a few days because it loses its vitamin C in contact with air. Do not shake or whip orange juice unnecessarily. Do not boil orange juice.
- Store meat in moisture proof wrap such as freezer bags or aluminum foil.
- Store canned goods so that the oldest are used first. Make sure the canned goods are not stored near hot water pipes or other heat sources.
- Dried and packaged foods should be stored in airtight containers.
- Milk and milk products must be refrigerated to prevent spoilage.
- Store articles as near as possible to the place where they will be used.
- Store cleaning products out of reach of children.
- Store eggs with the large ends up to preserve their quality.

Food Preparation

- Serve fruits and vegetables raw as often as possible because some of their nutrients are lost in cooking. When cooking is desired, cook them in large pieces to decrease the surface area exposed. Cook vegetables only until tender and crisp; do not overcook them.
- Cook foods with as little water as possible, or better yet use a steamer.
- Do not add baking soda to preserve colour in food as it destroys vitamins. Leaving the lid off pots for the first few minutes of cooking may help retain colour.

- Use vegetable cooking water and meat drippings to make sauces, soups, and gravies. This way you take advantage of the nutrients that have separated out during cooking.
- Avoid frying foods whenever possible because frying adds more fat to the diet than is required.
- Roast meat at a low temperature (150°C to 165°C or 300°F to 325°F) for a longer period of time rather than at a high temperature for a shorter time. The latter method tends to toughen the meat.
- Use all leftovers quickly to minimize nutrient loss and food spoilage.

Food Safety

Food Poisoning

Food poisoning occurs when a person eats food contaminated with a large number of harmful bacteria. Symptoms of food poisoning are nausea, vomiting, diarrhea, and cramps. The very young and the elderly are most susceptible to food poisoning. Harmful bacteria in low numbers are present in the air and soil and on raw meat, vegetables, and dairy products. To grow and multiply, the harmful bacteria need special conditions. Bacteria grow well in warm, moist foods such as sauces and gravies. They also multiply fast in low acid foods such as milk, eggs, meat, poultry, and vegetables. These foods are considered potentially unsafe and require special handling.

Temperature is important in preventing food poisoning. Bacteria are usually killed by high heat, and refrigeration slows down their growth. Keep potentially unsafe foods out of the temperature danger zone: 4°C (40°F) to 60°C (140°F).

Clients depend on you to handle food properly in order to prevent food poisoning. The following tips will help you keep food safe:

Food Safety When Shopping

- Buy from reputable dealers with clean stores.
- Buy hot foods hot (e.g., barbecued chicken, sausage rolls) and cold foods cold (e.g., deli meats and salads).
- Don't buy thawed foods that are supposed to be frozen.
- Don't buy cracked eggs.
- Don't buy swollen, leaky, or badly dented cans.
- Don't buy chilled food packages that are swollen, e.g., meat, fruit juice, made up pastry, yogurt).

Preparing Food Safely

- Wash your hands thoroughly before handling food.
- Don't touch your face or hair. Avoid handling food if you have infected cuts, a bad cough, or are sneezing.
- Prevent cross contamination. Never handle cooked and raw foods together. Do not use the same utensil board for cooked and raw foods without washing the board thoroughly in between.
- Don't taste food with cooking utensils.
- Wash fresh fruit and vegetables before eating them.
- Keep the kitchen clean.

Storing Food Safely

- Cover perishables well and place them in the refrigerator as soon as possible after shopping.
- Immediately refrigerate cooked food that is to be stored without waiting for it to cool. Separate the food in small quantities so it cools faster.
- Keep hot foods hot and cold foods cold. Buffets and second helpings pose problems here.
- Follow storage and cooking instructions on the labels of perishable foods and frozen

foods, especially TV dinners and pre-packaged meats.

- Poultry requires special care. Never stuff poultry until it is ready to be put into the oven. Make sure poultry is thoroughly cooked; i.e., the internal temperature of the poultry meat is 60°C (140°F). Don't use slow cookers for poultry. Separate the stuffing from poultry before storing it in the refrigerator.
- When canning at home, follow professional directions carefully. Use a pressure cooker to can low acid foods; e.g., meats, fish, poultry, soups, most vegetables (beans, peas, corn, asparagus). Use an open kettle only for canning jams and pickles. As a precaution against inadequate canning procedures, home canned fruits and vegetables should be boiled or cooked thoroughly before being eaten.

**LOOK, LISTEN AND SMELL
for warning of food
contamination.
When in doubt, throw it out.**

Safe Handling of Food

Institutions have policies regarding food handling such as requiring kitchen workers to cover their hair and wear garments supplied by the agency. Usually kitchen cleaning procedures are clearly spelled out and routinely done.

In the home, safe food handling is the responsibility of the health care worker. Encourage the client to adopt sanitary practices such as hand-washing before handling and eating food, wiping food preparation surfaces with a sanitizing solution such as diluted bleach, and cleaning up after preparing and eating food.

People are the main source of food contamination. Disease-causing organisms can be passed from one person to another by coughing or sneezing on food or by not washing hands before handling food (Figure 4-46). Skin infections on the hands such as infected cuts or boils

are particularly hazardous because the hands touch the food directly. When preparing food, wash your hands:

- Before handling the food
- After going to the toilet
- After sneezing, coughing, blowing your nose, or touching your hair
- After touching unclean articles such as garbage

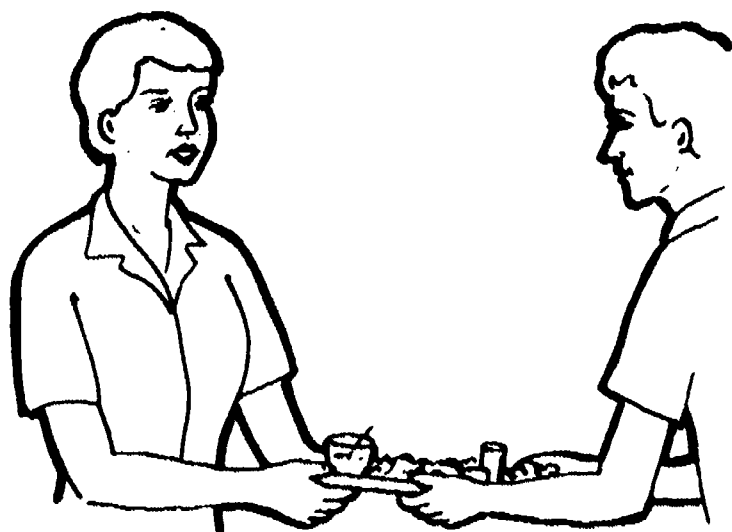

**Don't cough or sneeze on food.
Wash your hands before handling food.**

Figure 4-46. Handling Food.

Shopping For Food

Food takes a large piece of most family budgets. It is very important that you know how to shop wisely since many clients will depend on you to choose nutritious foods at reasonable prices. The following tips will help you cut food costs without reducing nutrition or quality.

Make a Meal Plan

- Use Canada's Food Guide for nutritious meal plans.
- Plan menus for a week, taking into consideration how you will use leftovers. Wasting leftovers is wasting money.

Make a Grocery List

- In addition to the menu plan, keep an ongoing list of supplies needed, jotting down items that you notice are getting low as you use them. Check the list prior to going shopping to add anything you missed.
- Be familiar with regular prices of staples and baking goods. By comparing advertised prices with regular prices, you can tell if they are really specials.
- Check the food ads for weekly specials and comparison shop between stores. But remember, the cost of travelling can eat up the savings on the food.
- Collect coupons for items you normally use.

Avoid Impulse Buying

- Stick to the grocery list.
- Eat before shopping; hungry shoppers spend more.
- Shop alone as much as possible; company can distract and influence you.
- Make as few trips to the store as possible; shoppers buy more with every visit.

Check Displays

- Look for the less expensive brands.
- Check up and down the shelves because the most expensive brands are usually at eye level.
- Use unit pricing to see which brand and size is the best buy. For example, how much per 500 grams is the cheese? How much per kilogram is the meat? How much per litre is the vegetable oil?

Check Labels

Ingredients. Listed in order by amount from the largest to the smallest. Choose foods with

salt and sugar listed near the end of the ingredients list or not at all.

Grade. Tells size, shape, colour, etc. It has no bearing on nutritional content.

Storage Information.

Additives. These must be listed. Choose foods that have been enriched or fortified with vitamins and minerals.

Meat cuts. Indicates the tenderness and the cooking method to use. Note that less tender cuts are just as nutritious as tender cuts.

Pay Attention at the Checkout

- Watch the scales.
- Watch the totals on the cash register. Make sure special prices are rung in.

Shopping Tips

Save on Milk and Milk Products

Butterfat content. Milk and cream prices are influenced more by butterfat content than nutritional value. Whipping cream, for example, has the highest fat content and costs about five times as much as whole milk. Whole milk, in turn, costs more than skim milk, especially powdered skim milk. Serve ice milk and sherbet instead of ice cream; they are cheaper and contain less butterfat.

Flavoured dairy products. Peach yogurt, pineapple cottage cheese, and chocolate milk are examples of flavoured dairy products that usually cost more than the plain products and have the further disadvantage of added sugar. Make your own flavoured yogurt by adding jam, jelly, or fruit to plain yogurt. Make a sour cream dip by adding finely chopped vegetables with seasoning to plain sour cream. Use sweetened condensed milk only in dessert or candy recipes; it is higher priced than evaporated milk and contains a large proportion of sugar.

Cheese. Prices of cheddar and other kinds of hard cheese vary according to age and method of preparation. For example, old (or strong) cheese and hickory-smoked cheese cost more than mild or medium cheddar. Use the less expensive mild or medium cheese instead of old cheese in most recipes, unless you want a sharp cheese flavour. Compare the prices of bulk cheese with the price of packaged cheese or individually wrapped slices of cheese. Also compare the prices of Canadian specialty cheeses with the price of comparable types of imported cheese. Flavour cheese by adding spices, herbs, chopped chives, pimento, bacon bits or pineapple to soft cheese, cottage cheese, or cream cheese. Grate cheese that has become hard and use it in baked goods (biscuits, muffins, pastry), sauces, and casseroles.

Milk powder, evaporated milk. Use reconstituted milk powder instead of fluid milk in cooking. To make a less expensive 2% milk, mix reconstituted milk made from powder with an equal amount of whole milk. Make a whipped topping from skim milk powder or evaporated milk to substitute for whipped cream or ready-made cream topping. Similarly, substitute evaporated milk for light cream in recipes.

Cocoa mix. Make your own instant cocoa mix for cocoa and chocolate milk by combining instant skim milk powder (1 L), cocoa (175 mL) and sugar (250 mL). To make hot cocoa from the mix, combine 100 mL of the mix with 200 mL boiling water. To make chocolate milk, combine 75 mL of mix with 200 mL cold water.

Save on Bread, Cereal, and Pasta

Plain breads, cereals, and pastas are usually better buys than those with fancy flavours and shapes. As a rule, the more processed a product is, the more it costs.

Bread. Compare the prices of loaves of bread by comparing both weight and number of slices of bread in the loaves. Sandwich bread can cost more per loaf than regular bread, but it can cost less per serving as slices are usually thinner. Compare prices of frozen bread dough by the

cost per pound. For best food value, select enriched white bread or whole grain bread such as rye or 100% whole wheat. Stock up on day-old bread at the bakery and freeze it; it will keep for two months in the freezer. Buy frozen bread on special; you can store it up to one month.

Cereal. Select whole grain cereals, because they provide more nutrients and better money value than most processed, ready-to-eat cereals. Note that some refined cereals have added nutrients to replace those lost in processing. Buy unsweetened cereals rather than costlier sweetened ones. If the cereal has to be sweetened, add your own; it's cheaper. Compare cereals by unit price rather than package price. Large packages of cereal are generally a better buy than small ones, but not always.

Pasta. Check pasta labels for added nutrients because enriched pastas provide better nutrition for your food dollar. Buy pasta products (macaroni, spaghetti, and noodles) on special; they keep indefinitely when stored in their original packages in a dry place. Combine pastas with cheese, eggs, or nuts for nutritious, money-saving main dishes. Remember that pasta dishes reheat well, often tasting as good or better the second time. Select brown rice or converted (regular) rice over enriched white rice because the former contain more thiamin, niacin, and iron.

Save on Fruits and Vegetables

The prices of fresh fruits and vegetables vary, but they are usually lowest in season. Canned and frozen fruits and vegetables are available year round and generally are more economical than imported fresh produce in the winter months. When comparing the cost of fresh vegetables with the cost of canned or frozen vegetables, remember that waste from fresh vegetables (outer leaves, peel, roots, etc.) is part of the cost. Buy fresh fruit by the basket or in bulk packages as it usually costs less this way than by the kilogram or pound. However, since fruit spoils, don't buy more than you can use.

Compare costs per serving of various grades and kinds of fruit to get the best value for your money. For example, look for sliced or diced canned peaches and pears because they are often a better buy than the halves. Select small apples and bananas for children rather than large ones because often children only eat half of the large ones. Compare the prices of fresh, canned, and frozen vegetables by cost per serving rather than cost per unit.

Save on Meat and Meat Alternates

Meat and meat alternates consume a large part of the food dollar. To stay within the budget, it is important to know how to shop for the best values in meat, poultry, eggs, and fish.

Meat

Look for the name of the cut on the meat label and learn to recognize the section of the animal from which it comes. As mentioned earlier, this will give you a guide to its relative tenderness and the way it should be cooked. Cuts from the rib and loin such as beef rib or pork loin roast are tender and should be cooked by dry heat: roasting, panfrying, or broiling.

On the other hand, cuts from the beef shoulder or chuck such as blade pot roast are less tender and should be cooked by moist heat: pot roasting, braising, or stewing.

Compare cuts of meat by cost per serving rather than cost per kilogram or pound, because fat bone and gristle reduce the number of servings. When you are entertaining, use lower priced cuts of meat to make delicious dishes like beef bourguignon, beef stroganoff, and curries.

Regular ground beef is often used for meat patties and meatballs. The combination of lean meat and fat in regular ground beef makes the patties and meatballs juicy and not too compact. Lean ground beef is preferable for people on reduced fat diets and for meat loaves and casseroles where fat cannot be drained away.

Use variety meats such as liver, kidney and tongue; they are nutritious and are often cheaper than other meats. Beef and pork liver sell for less than calf's liver and have almost the same nutrients. Buy luncheon meats such as bologna and liverwurst in bulk or sliced at the delicatessen counter. This is usually cheaper than buying luncheon meats in the pre-sliced, prepackaged form.

Take advantage, if possible, of meat specials to buy meat for several meals or to freeze the meat for later use.

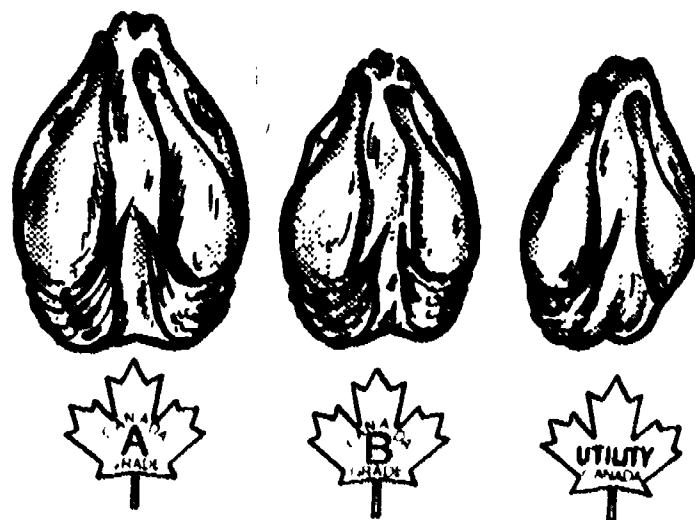

Figure 4-47. Poultry.

Poultry

Although most of the poultry on the market is Canada grade A quality, you can find Canada grade B and Canada utility poultry (Figure 4-47). The lower grades are cheaper but are just as tasty and nutritious. The difference in the grades is that grade B poultry has minor imperfections and is not as well fleshed or fattened as grade A. Utility grade would otherwise be grade B except that the poultry has a part missing, bruised skin, discolouration, or pin feathers. Compare the price per kilogram or pound of whole chicken with that of chicken parts; it is often cheaper to buy a whole bird and cut it up if you can use all the parts at the time or freeze some for later.

When buying a turkey, note that fat injected turkeys (butterballs) are more expensive than regular turkeys. Cook a large turkey and freeze the extra meat immediately after cooking. The frozen turkey can be served for many meals in a variety of ways. For example, braise legs and thighs in a flavourful sauce; slice breast meat, dip it in egg and crumbs, and saute it like veal cutlets; simmer the wings, neck and other boney parts with vegetables for stew (add the leftover gravy if you like); use bits and pieces of meat to make turkey fried rice; serve sliced turkey and gravy on a plate with vegetables; serve hot turkey sandwiches with a salad.

Eggs

Buy the grade and size of eggs best suited to your purpose. Sizes of grades A1 and A eggs are extra large, large, medium, small, and peewee. At certain times of the year, medium or small eggs may be a better buy than large or extra large. Take advantage of peewee eggs, which are sometimes sold at half the price of large. They are an ideal size, hard cooked, for lunch boxes or party appetizers. Buy grade B eggs for baking when they are available. Although they may have imperfectly formed shells and thinner whites and flatter yolks than grade A eggs, they still have the same nutritional value.

Freeze leftover egg whites and yolks; they will keep for up to four months. To freeze yolks, add 5 mL (1 teaspoon) of sugar or 2 mL ($\frac{1}{4}$ teaspoon) of salt to 50 mL ($\frac{1}{4}$ cup) of egg yolks; this reduces gumminess when the yolks are thawed. Freeze egg whites as they are.

Fish

Compare cost per serving of fresh and frozen fish to find the best buy. Compare prices of canned salmon: sockeye, coho, pink, and keta. There is not much difference in flavour, but sockeye is the reddest in colour.

Buy plain frozen fillets and bread them yourself. Use flaked tuna rather than the more expensive

solid tuna in sandwiches, casseroles, and in most dishes requiring tuna except perhaps salads where appearance is more important. Occasionally buy canned mackerel as an inexpensive substitute for tuna in recipes.

Save on Fats and Oils

Fats and oils come in many types. Those of animal origin such as butter and lard remain solid at room temperature. Those of plant origin can be solid or liquid: margarine and vegetable shortenings are solid, whereas the oils from corn, soybeans, peanuts, rapeseed (also known as canbra and colza), safflowers, and sunflowers are liquid at room temperature.

When purchasing fats or oils, the large containers are usually the best buy.

Buy olive oil only when it is called for in a recipe because it is expensive and, unlike the other vegetable oils, has a special flavour of its own that may not be suitable in the recipe. Use liquid oil rather than high priced spray oil to prevent foods from sticking to pans.

Compare prices of margarine and butter. Is the butter worth the extra money? You can make a whipped butter for sandwiches by beating 50 mL ($\frac{1}{4}$ cup) of milk into 250 g ($\frac{1}{2}$ lb) of softened butter until the mixture is light and fluffy. This homemade whipped butter expands the volume of the butter by a third and makes it easier to spread.

Strain, cover, and refrigerate oil after deep frying. It can be used several times for frying the same type of food.

Convenience Foods

Convenience foods are prepared or packaged in such a way as to make serving them quicker and easier. Common types of convenience foods are:

1. Mixes: e.g., cake mixes, pancake mixes, muffin mixes, and instant mashed potatoes.

2. Prepared frozen foods; e.g., TV dinners, pizza, fish and chips, cakes, fruit and meat pies.
3. Individually packaged foods; e.g., little boxes of raisins, small tins or containers of apple juice, small containers of yogurt.
4. Pre-baked and pre-cooked foods from a bakery or deli; e.g., cookies, cakes, fruit and meat pies, salads, pastas, hot meats.

Note that what is considered a convenience food today may not be so in the future. Canned soups were probably called a convenience food when they first appeared on the market but are not considered so today. Many people today no longer think of a cake mix as a convenience food, having never made at least certain types of cakes without one. There is little question that the trend is towards more convenience foods in the supermarkets.

Several factors have a bearing on the decision of whether or not to buy convenience foods:

Cost. Convenience foods are usually more expensive than making them yourself. It's important to get an idea of how much more expensive they are. Using a biscuit or a pancake mix, for example, can be 3 or 4 times as expensive as mixing up your own ingredients, especially if you use skim milk powder. Occasionally you may find a convenience food that is cheaper than the unprocessed form of the food. For example, processed potato products such as frozen french fries and instant mashed potatoes can be cheaper than fresh potatoes, especially in early summer before the new crop comes in.

Time saved. Do you really save much time with a convenience food? Or could you almost make it as fast yourself? If it does save a lot of time, maybe it is worthwhile; your time is valuable and perhaps you could be of better service to your client if you used the time do something else.

Ingredients at hand. Maybe it is not practical to have on hand the ingredients to occasionally make a certain food. In this case, the convenience food could be more economical.

Quality. Does the convenience food taste good? Or is it a poor second to the food you make yourself?

Nutritional value. Does the convenience food contain equivalent nutritional value to the food you make yourself?

Client's preference. Your client may prefer certain convenience foods, and so you buy them for that reason.

Mealtime

For anyone whose activities are restricted, mealtimes can be high points in the day. To help make meals pleasant occasions, consider the eating environment. It should be clean and pleasant, but more importantly, it should be where the individual wants to eat. In a care facility there may be little choice of location since meals are served in the dining area, but clients may be able to choose a table and company for the meals. At home the client may choose to eat at the kitchen table or on a tray in the living room rather than in the dining room.

If the client is physically and emotionally comfortable, mealtime will be more successful. Assist with handwashing and toileting as necessary before the meal. Try to avoid unpleasant events or discussions at mealtime. Some clients may require special serviettes or aprons to protect their clothing. Make sure these are available or are placed on the client if assistance is required. Other needs of clients should be taken care of such as special utensils or positioning. Attention to clients' comforts and needs prior to eating are preparations that make mealtimes more pleasant for all.

Feeding Adults

Some clients may be unable to feed themselves because of weakness, disability, or a need to rest. Whatever the reason, most clients who can't feed themselves are sensitive about it and have difficulty accepting it. Be aware of their feelings and do what you can to protect their

self-image when assisting them to eat. Encourage clients to do as much of the feeding as they are able to or are allowed. Take your time. Don't make the client feel rushed.

The following hints are helpful when feeding clients:

- Check the meal before presenting it to the client to be sure it is complete, nicely served, and the right temperature.
- If possible, sit on a chair beside the client because this is more natural for feeding.
- Make sure all utensils are easily reached.
- Assist the client only as necessary even though this may take more time.
- Season the food to the client's taste, as long as the seasoning is within the diet restrictions.
- If a client's vision is poor, tell the client what you are feeding him or her.
- Combine foods on the fork only if the client wishes.
- Use caution with hot foods, especially liquids. Warn the client.
- Use a straw for liquids and soups.
- Offer the food in the preferred order.
- Feed paralyzed clients on the side of their mouth that is not paralyzed.
- Place food on the tip of the spoon or fork rather than the side, and fill the utensil only half full.
- Avoid spilling and wipe the client's mouth as frequently as is appropriate.
- Allow the client to finish one mouthful before offering another.
- Wash the client's face and hands after the meal as required.
- Tidy the bed of a client who is fed in bed.

Child Nutrition

In the home, health care workers are often asked to prepare meals for families. By following Canada's Food Guide you ensure that school age and adult clients receive all the nutrients necessary for good health. You must also ensure

that infants and pre-school children are well nourished.

Feeding Infants

Infant formula should be prepared according to package instructions. Remember that cleanliness in preparing the bottle of milk is extremely important.

Solid foods are introduced into an infant's diet when the infant is between three and six months old. There are several reasons for waiting until this time:

Tendency to overfeed. By being anxious that a baby eat well, adults have a tendency to overfeed the baby. A baby forced to eat a lot learns to eat a lot. This can lead to obesity.

Immature digestive system. A baby under three months has little saliva and swallows solids

poorly. The digestive system may be unable to handle solid foods.

Increased risk of allergies. A baby runs the risk of allergic reaction to solid foods, especially protein foods.

Solids are not necessary. Breast milk or infant formula supplies all the adequate nutrients required by the young baby.

Note that solid foods complement, but do not replace, milk. Infants continue to drink milk as they learn to eat solids.

When starting solid feeding, introduce only one food at a time so that the baby can get used to the different tastes and textures. Also, by keeping foods separated, you can quickly detect the culprit if allergies develop. Start with a very small amount of food, one teaspoon or less in milk, and gradually work up to a suitable amount. The types of solid food and the amounts to introduce to babies are given in Table 4-9.

TABLE 4-9: Guide to the Introduction of Solids to Infants

<i>Age in Months</i>	<i>Food Introduced (1 tbsp = 15 ml)</i>
0	
1	
2	
3	Cereals (1-4 tbsp)
4	Vegetables (1-4 tbsp): carrots, green beans, squash, potato, spinach
5	Fruits (1-4 tbsp)
6	Meat, poultry, fish (1-4 tbsp)
7	Dairy products (1-4 tbsp), finger foods, rusks
8	Egg yolk (1/4 tsp—1 yolk)
9	Other vegetables: cauliflower, broccoli, tomato
10	Baked beans, lentils, peas
11	Egg white (1 tsp—whole white)
12	Whole egg

Commercial Baby Foods

Commercial baby foods, though more expensive than making your own, can be very nutritious. However, always read the baby food labels carefully. Avoid baby food with added sugar, salt, and fillers. Sugar adds unnecessary calories and encourages a sweet tooth. Salt puts extra stress on the baby's kidneys. High salt intake may also be related to tenseness. The sugar and salt are added only to give the parent a pleasant taste when sampling the food; they are not good for the baby.

Avoid combination foods such as beef and farina, cereal and fruit, or a mixture of creamed vegetables. In mixed dinners it is hard to determine how much of each food the child is getting. Don't purchase baby desserts. Pudding, pies, and fruit supremes contain too many calories. The baby's appetite should be saved for more nutritious foods. Remember these points when serving commercial baby foods:

- Always wash the jar of baby food before opening it.
- Check the seal by listening for a pop. Don't use any jars of food that aren't sealed.
- Refrigerate cooked foods immediately after cooking.
- Foods prepared in small quantities may be kept for 2 days in the refrigerator if they are well covered.

Feeding Pre-School Children

Although every child is different, there are a few common points to remember when feeding children (Figure 4-48). Young children like foods with soft consistencies. They dislike hard dry foods, partly because they have little saliva to moisten the food. Runny puddings, mashed potatoes, minced beef, and fresh bread are all favorites. Children prefer their food lukewarm. They don't like food to be too hot or too cold. Soup must be cooled and ice cream soft. Foods with little spice and seasoning are best. Bright colors and contrasts also get positive reactions. Give children small servings that are not overpowering. The servings must be easy to man-

age; for example, one-half glass of milk and meat in bite-size pieces. A child won't eat well if uncomfortable. Is the chair wobbly? Are the child's feet dangling down? Is the child's nose at table level? Are the utensils and glass the right size? Check all these things to ensure the child can enjoy the meal.

Most important of all, try to make meals happy times for the children to explore new foods. The atmosphere at mealtime should be relaxed. Children lose their appetite when arguments flare up. Don't over react to temporary food dislikes of children; the dislikes may become permanent. For example, a child who is forced to eat a bowl of cold, gluey oatmeal may well refuse to eat oatmeal forever after.



Like foods with soft consistencies, not dry, hard food.
Lukewarm temperature.
Little spice or seasoning.
Small servings.
Bright colors and contrasts.

Figure 4-48. Feeding Children.

Dealing With Children Who Refuse to Eat

It is not uncommon to find a child of pre-school age on a "hunger strike". The child can really be not eating, or can be eating useless foods between meals. Junk foods will give the child sufficient calories but will cause a serious lack of protein, calcium, and vitamins.

If the hunger strike is an ongoing problem, you must try to understand the reasons for it and find

a solution. Generally speaking, a refusal to eat is a behavioural problem that goes beyond the meals themselves; it is a reaction against someone (most likely the parents) or against something that is frustrating the child. Children refusing to eat feel the need to assert themselves, and they also seek attention. By not eating, they get their own way and win attention from their worried parents. When faced with children who refuse to eat:

Don't:

- Force them to remain at the table until their plate is empty.
- Promise a treat dessert if they finish what is on their plate.
- Serve them left overs that they didn't eat from the last meal.
- Make them eat one bite for daddy, and one bite for mommy, and one for grandma, and so on.
- Talk about vitamins and foods that will make them taller, make their hair grow, etc.
- Show any disapproval or anxiety in your voice or manner.

Do:

- Accept a refusal of food calmly.
- Take their full plate away and clear the table as usual.
- If they ask for something to nibble on between meals, refuse firmly but gently, saying that it will soon be time for the next meal. Resist the temptation to say something smug like, "If you would eat your meals, you wouldn't be hungry."
- Between meals give them the extra attention they are looking for.

Fluid Intake

Ideally, an adult should drink between 2 to 3 litres of fluid daily in order to keep a good balance between fluid intake and fluid output. You may have to encourage clients to meet this fluid need, particularly if they feel unwell or if they are unused to drinking adequate quantities. The following hints will help:

- Inform clients of the importance of adequate fluid intake.
- Serve the type of fluids preferred by the client if possible.
- Serve fresh fluids at regular intervals.
- Be aware of the needs of those unable to ask for fluids and offer them fluids regularly.
- Use any opportunity to provide extra fluids; for example, after taking medication or a drink while in the bathroom.
- Set up a chart for the client to record fluid intake. The client may find this interesting.

For health reasons it may occasionally be necessary to restrict the amount of fluid intake of a client. Make sure the client is aware of the fluid intake limit and also family members or others who assist the client. Work out a schedule of fluid intake with the client, if possible helping the client select alternatives to fluids. Observe meals and snacks to see that the schedule is followed.

Measuring Fluid Intake and Output

In order to keep track of the client's fluid balance, you may be asked to measure and record all fluid intake and output. Make sure that clients know a record is being kept and enlist their aid in keeping track. It is very important that the record be accurate. Intake covers any fluids taken by mouth, including ice cream, jelly, and custard. The quantity should be recorded immediately so that it is not forgotten. Fluid output includes urine, emesis (vomit), wound drainage, blood loss, and excessive perspiration. Output should be recorded each time the client uses the bedpan, urinal, or basin. Perspiration can simply be recorded as excessive or a count can be kept of how many times the bed sheets or clothing are soaked and changed. A simple form for a fluid intake and output record is shown in Table 4-10. This record can be posted at a suitable location.

To measure fluid intake, keep a graduated or marked measuring container handy. Keep another measuring container in the bathroom to measure output. These containers should be carefully cleaned at regular intervals.

EXERCISE 4-4

Crossword

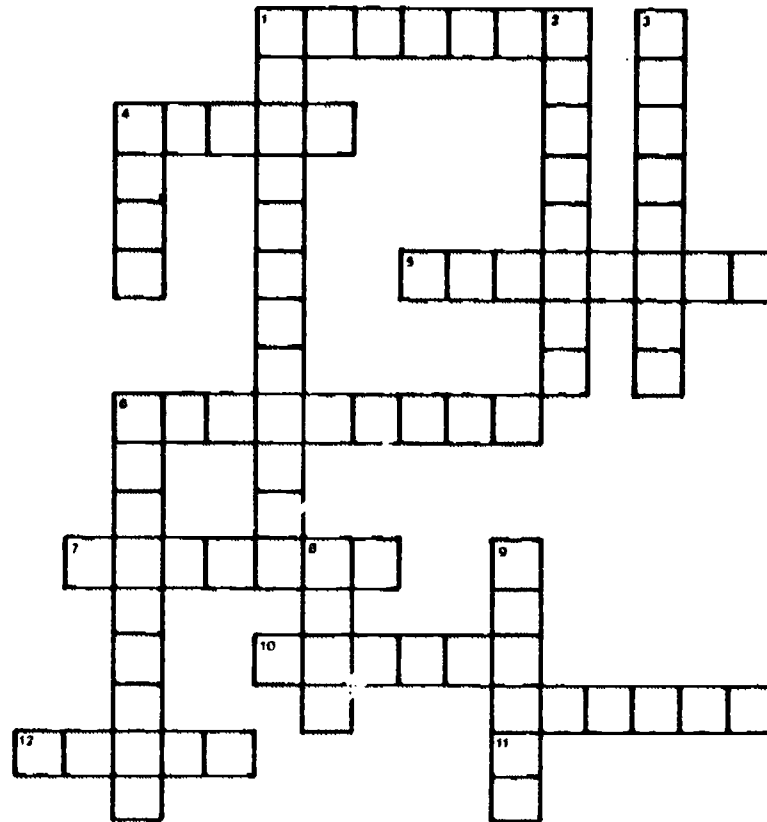

Across:

1. Helps build bones and teeth.
4. Provides bulk or roughage.
5. May be fat soluble or water soluble.
6. The study of food and how the body uses it.
7. Nutrient that builds body tissue.
10. Helps the thyroid gland function.
11. One function of protein.
12. Contains no calories but helps regulate body functions.

Down:

1. Nutrient found in starches and sugars.
2. Aids that help the body function like phosphorus, sodium and potassium.
3. Measurement of food energy.
4. Carry vitamins A, D, E, and K.
6. Nourishing chemical substances in food.
8. Helps red blood cells function.
9. Fuels body growth and maintenance.

Questions

1. What is the average daily calorie requirement for a 70 year old woman?
2. List the four food groups of Canada's Food Guide. Review the daily requirements of each group for different ages and practice using the guide in your own meal planning.
3. What is the basic rule of Canada's Food Guide?
4. Attractively served food _____ the appetite.
Unpleasant sights and odours at mealtime can _____ the appetite
5. What are two "lacks" that can cause poor nutritional habits?
6. What should you do prior to going shopping?
7. Special diets have changes in certain substances. List the five common areas of change. Review the chart of special diets to become familiar with foods allowed and not allowed.
8. List six general rules to follow when planning, cooking and serving meals for a diabetic.
9. What four nutrients will be lacking in the diet of a strict vegetarian who does not eat eggs or dairy products?
10. What foods can be combined with the incomplete protein in rice to give a complete protein?
11. What are two minerals that elderly people can often be deficient in?
12. What are the dietary causes of constipation?
13. Why can some elderly people have trouble in chewing and swallowing food?
14. What is the rule for the amount of orange juice to make up at one time?
15. True or false? Raw vegetables have the same nutrients as cooked vegetables.
16. What is the temperature danger zone for food? Why?
17. In the preparation of food, when should you wash your hands?
18. How can you tell if poultry is thoroughly cooked?
19. How do you make a homemade cocoa mix?
20. How can you increase the amount of butter by one-third?
21. Match:
 - a. Cost per unit
 - b. Meat loaf
 - c. Olive oil
 - d. Nutritious variety meats
 - e. Pasta
 - f. Meatballs
 - g. Bread
 - h. Grade B poultry
 - i. Cost per serving
 - j. Beef shoulder cuts
 1. Too expensive for regular cooking
 2. \$3 for meat for 5 people
 3. Keeps indefinitely
 4. Use regular ground beef
 5. Use lean ground beef
 6. Liver and kidney
 7. Cook by moist heat
 8. Has minor imperfections
 9. Can be stored for 2 months in the freezer
 10. \$2.10 per 500 grams

22. What are three factors that have a bearing on the purchasing of convenience foods?
23. When feeding a client, what is the important thing to remember with regard to the client's feelings?
24. Give three preparations that make mealtimes more pleasant.
25. At what age range are babies started on solid foods?
26. How much egg yolk can be given to an 8 month old baby?
27. In a word, describe the general food preferences of children in the following areas:
 Consistency:
 Temperature:
 Amount of spice:
 Serving size:
28. What is the ideal amount of daily fluid intake for an adult?
29. What fluids are counted when measuring a person's fluid output?

MOVING CLIENTS

Body Mechanics

Body Mechanics is the term used for the safe, correct use of the body to do work. Body mechanics is especially important when lifting, turning, transferring or transporting clients. Good body mechanics protects your back and adds to your client's safety. Poor body mechanics can cause back problems leading to discomfort, absenteeism (back problems are a major cause of absenteeism), long periods of treatment, or an operation. Remember you have only one back, so use it safely.

Body Mechanics Techniques

The following are basic body mechanics techniques:

- Get close to your load. Whether lifting a person or an object, have the weight as close to

your body as possible. Don't lift with outstretched arms.

- When lifting, try to involve as many muscle groups as possible; e.g., lift an object with two hands instead of one.
- Bend your knees when lifting and keep your back straight (Figure 4-49). In this way you are using the large muscles of the legs, buttocks, and arms to lift rather than the smaller and weaker back muscles. This is the basic rule of lifting.

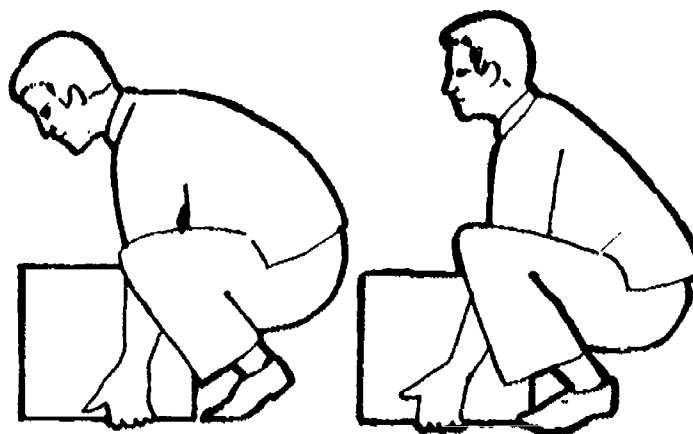

Back bent —
Incorrect.

Back straight —
Correct.

Figure 4-49. Lifting Technique.

- Turn your feet, not your back. If you must change direction, turn your whole body by taking small steps rather than twisting your torso (Figure 4-50).

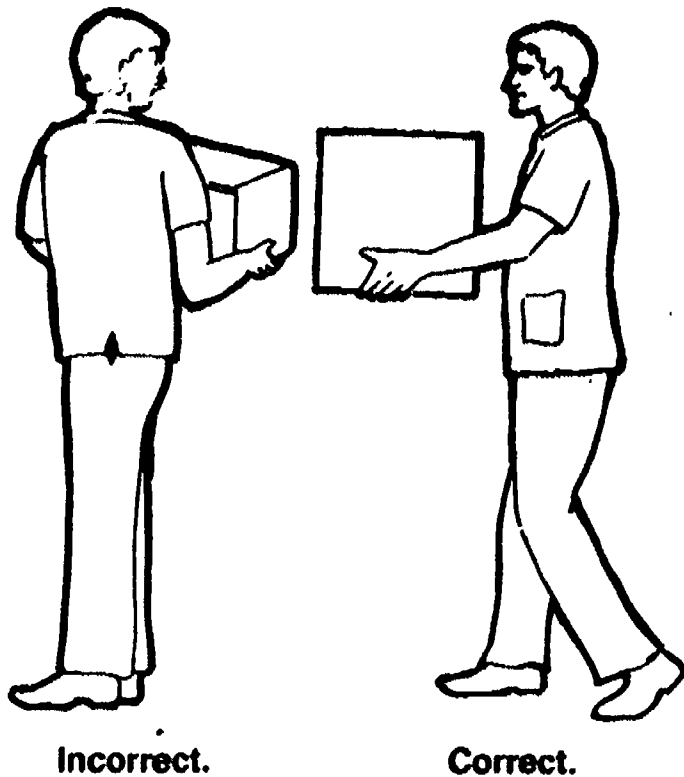

Figure 4-50. Turning Technique.

- Face the load in the direction that you wish to take.
- Work at a comfortable height. To get a comfortable height, either raise the work up or lower yourself down. For example, you might squat to trim a client's toenails or place the seated client's foot on a towel on your lap. With adjustable beds, raise the bed to a comfortable working height.
- Pull rather than push and push rather than lift. If you must move a heavy object, first try pulling it, next try pushing it, and finally lift it. Perform work in a way that puts least stress on the body.
- Never attempt to lift anything that is too heavy for you to safely lift yourself or too large to safely grasp. Get help.
- When lifting with another person or persons, appoint a leader to coordinate the lifting. If your moves are not in unison and smooth, injuries can result to the lifters. One tech-

nique, counting "one, two, three, lift," is useful.

- When helping clients move, encourage the clients to lift themselves as much as possible.
- Use aids whenever possible. A simple example is to use a stool to reach high objects. A more complex example is to use a mechanical lifting device (Figure 4-51) for placing disabled clients into the bath tub and removing them. Be sure you know how to safely operate the equipment.

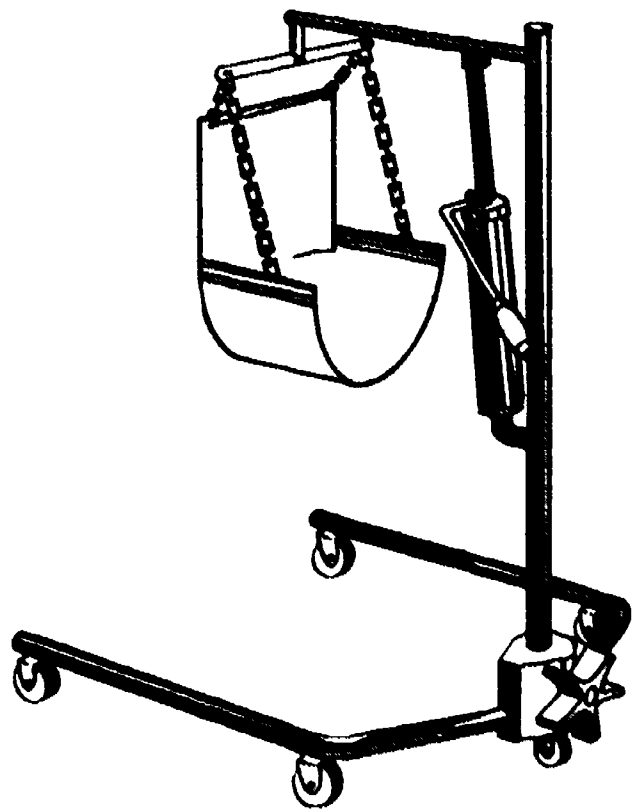

Figure 4-51. Mechanical Patient Lifter.

Posture

The checkpoints of good posture or body alignment are:

- Head up, eyes straight ahead
- Neck and back straight
- Arms relaxed at sides
- Chest up and out
- Abdomen tucked in
- Knees very slightly flexed
- Feet slightly apart, toes pointing forward

To find the ideal standing posture, follow these steps:

1. Stand one foot away from a wall and lean back against the wall, bending your knees slightly (Figure 4-52).
2. Tighten your abdominal and buttock muscles and inch up the wall.
3. Straighten your legs (Figure 4-52). You now have the ideal standing posture.

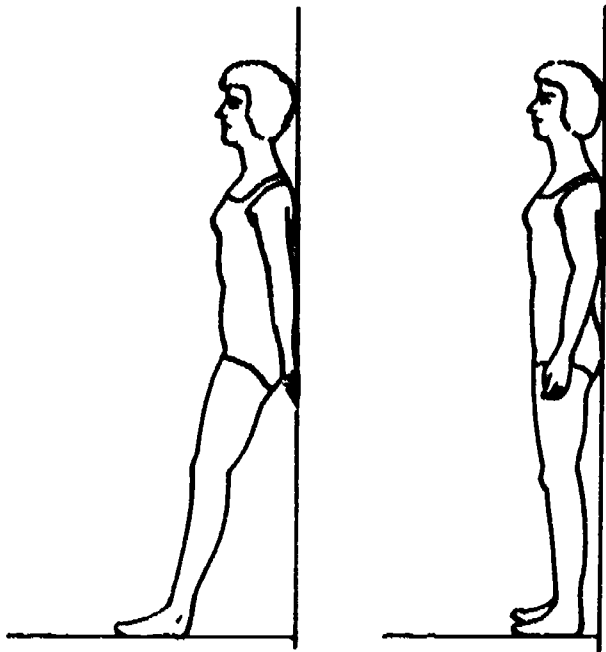

Figure 4-52. Correct Posture.

4. Walk around maintaining the same posture. Occasionally place your back against the wall again to see if you are keeping good posture. Note that for some people this ideal posture is uncomfortable. These people should modify the posture to one that is more comfortable.

Positioning Clients

Positioning is the term used for placing parts of the body into a safe, comfortable, and properly aligned position. Clients who are severely disabled may require you to position their arms, legs, head, and body. To maintain a position, pillows, rolled blankets, foam pads, sandbags,

and other aids may be needed. Remember that helpless clients may be unable to tell you about their discomfort, so be aware of all possible signs of distress.

Whether the client is seated or in bed, try to picture the correct position for the parts of the client's body. Having got this picture, arrange limbs gently without forcing any movement. Observe the client for any signs of discomfort and stop if the signs appear. Basic bed positions are shown in Figure 4-53.

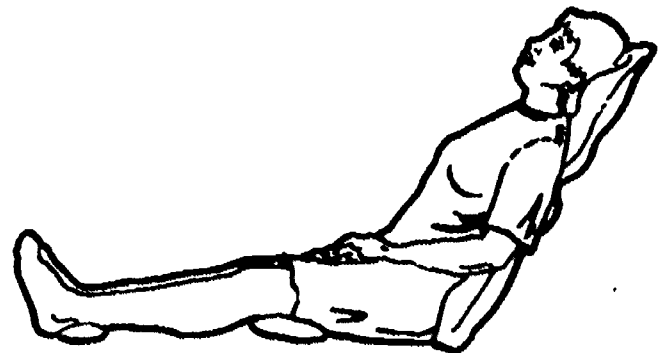

Reclining — sitting in bed.



Supine — lying on the back.



Prone — lying on the stomach.



Lateral — lying on the side.

Figure 4-53. Basic Bed Positions.

To prevent pressure sores, the client's position should be changed at least every two hours, or earlier if reddened skin occurs. This means changing the position of the limbs and the degree of flex in the joints. If a joint was flexed in the last position, it should be extended in the new one, and vice versa. Changing the flex in the joints helps prevent contracture of the muscles. Be sure that limbs and joints are supported to eliminate any strain. Try not to restrict the movement of strong limbs.

Be aware if a client has a weak and a strong side. The client may be able to help somewhat with the strong side, but the weak side may have little strength and require total assistance. Carefully observe the weak side because it may have no sense of feeling to warn the client of discomfort.

A limb that is swollen should be raised to prevent further swelling. Ideally, a swollen limb should be higher than the level of the heart, but this may not be reasonable when the client is in a chair.

Turning Clients

When turning clients onto their side, it is best to turn them in one piece like rolling a log. Log-rolling, as this technique is called, prevents twisting of the client's back.

Encourage the client to assist in being turned. Standing beside the bed, firmly but gently grasp the client's shoulder and hip farthest from you. Coordinate your actions with the client's effort, and roll the client smoothly toward you. When the client is well balanced, hold the position with one hand while you place a pillow behind the client's back and shoulders for support. Arrange the arms and legs in good alignment and support them with pillows, folded towels, or blankets. Be sure that parts of the body are not on top of each other; in other words, skin is not resting on skin and creating unnecessary pressure.

If you are turning a client onto a weak side, pay special attention to the weak arm and leg. Weak limbs should not be awkwardly positioned or cramped under the client's body, because the

client will be unable to move them should they become uncomfortable.

Lifting Sheet

A lifting or turning sheet may also be used as an aid for turning clients. This sheet must be placed under the client and extend from the shoulders to at least mid-thigh (Figure 4-54). To turn a client with a turning sheet, roll up the sheet close to the farthest side of the client's body and grasp the roll firmly beside the hips and shoulder. Pull the sheet smoothly toward you, and the client will turn. With an assistant on the opposite side of the bed, the client can also be moved up or down the bed on the lifting sheet.

The lifting or turning sheet may be left under the client and changed as necessary. Make sure it is not wrinkled or lumpy.

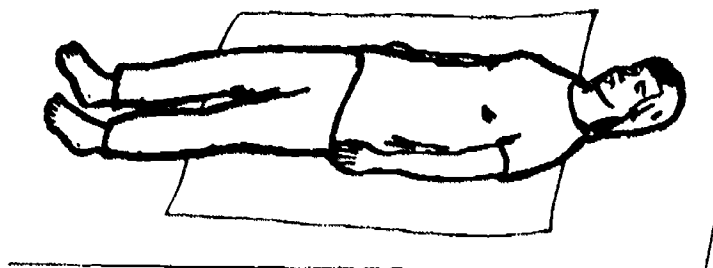

Figure 4-54. Lifting Sheet.

Transferring Clients

A transfer is the movement of clients from one piece of furniture or equipment to another, for example, from a bed to a commode, a wheelchair to a toilet, or a bed to a stretcher. In a transfer, clients are not lifted, rather they move themselves with assistance. A transfer requires the cooperation of the client because the client and the assistant must synchronize their movements. The following are good transferring practices:

Organization. Plan the transfer; organize yourself, the client, and the environment for the move. Discuss each step of the move with the

client beforehand so that the client can help with the transfer. Assess the assistance required and be aware of a client's weak and strong sides. Remove all obstacles and extra linen from the area. Have all the needed equipment at hand ready for use. For example, place the commode in position and lift the cover up to expose the seat.

The strong side. Transfer toward a client's strong side whenever possible. Clients are able to help move toward their strong side; the weaker side can tag along. Knowing which is the strong side will tell you where to place the transferring equipment for getting the client onto or out of the equipment. Figure 4-55 shows transferring equipment positions for a client with a strong left side.

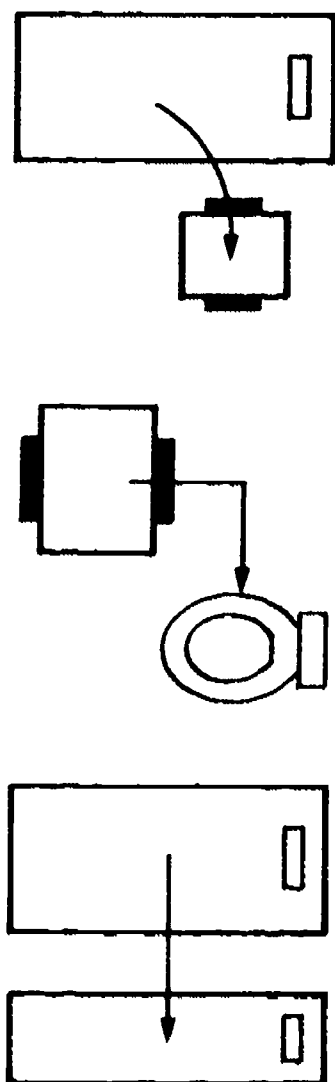

Figure 4-55. Transferring a Client with a Strong Left Side.

The weak side. Protect the weak side. If the client cannot move a weak arm, make sure the arm is securely held when transferring. Tuck the arm into a dressing gown opening, pocket, or belt.

Furniture height. Transfer to furniture of a height equal to that of the surface the client is moving from whenever possible. Low chairs are very difficult to get out of, especially for clients with leg weakness.

Wheelchair preparation. Prepare wheelchairs by setting brakes and raising footrests. If brakes are not set, the wheelchair may roll away as you try to lower the client into it. If footrests are not raised when transferring a client from a wheelchair, the client could stand up on the footrests and tip over with the wheelchair. Note that commode chairs often have brakes that can be set.

Armchairs. Transferring to a chair is easier if the chair has arms, since clients can assist by grasping the chair arm with their strong hand.

Transfer belt. If clients require much assistance, tie a transfer belt around their waist to give a firm holding place. The belt is necessary because you should not pull or hold onto weak arms, shoulders or joints, and yet it is hard to get a grip on a client elsewhere. A good leather belt, towel, or sheet tied snugly around the waist can substitute for a transfer belt.

Assistance. Ask for assistance if you are unsure of the transfer or the client is too heavy or weak to transfer by yourself. If problems develop during a transfer, the client will lack confidence the next time. Making a plan based on a sure knowledge of the transfer requirements will help avoid problems.

The weak leg. Support the client's weak leg when necessary by bracing it with your leg. The client can move the strong leg, and you can move the weak one.

Privacy and modesty. Respect the privacy and modesty of the client during transferring.

Footwear. Make sure the client is wearing non-skid slippers or shoes; your back could be injured catching a sliding client.

Body mechanics. Both you and the client should attempt to follow good body mechanics techniques during transferring.

Helping a Client Sit Up

To transfer clients from a bed, they must first be sitting on the edge of the bed. If clients cannot sit up by themselves, you can assist them to do so in one smooth motion:

1. Explain the move so that the client can help if able.
2. Roll the client toward you onto the side.
3. Bend the client's legs.
4. Place one arm under the shoulders and the other over and behind the knees.
5. In one movement bring the client's legs over the edge of the bed as you lift the shoulders to the sitting position.
6. Support the client in front until the client is safe and steady. If the client feels dizzy, lay him or her down again.

Before sitting up a weak or unsteady client, put the client's shoes or slippers on. You can also put on a transfer belt while the client is still laying down.

Transferring From a Bed to a Chair

To transfer a client from a bed to a wheelchair, commode, or armchair:

1. Organize. Decide what assistance is needed. If the client has a strong side, place the chair on the strong side at a 45° to 90° angle (Figure 4-56). Clear all obstacles. Have clothing and a transfer belt handy if needed. Set the wheelchair brakes and position the footrests. Discuss the move with the client and ask for the client's help.

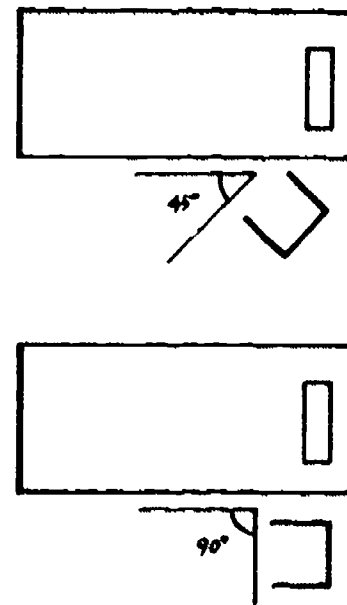

Figure 4-56. Transferring from a Bed to a Chair.

2. Put on a transfer belt if necessary. Put on slippers or shoes. Assist the client to the sitting position with the legs over the side of the bed, and move the client forward so that the client's feet can be flat on the floor. Protect a weak arm.
3. Lean the client toward you, placing your arms under the client's arms and grasping the belt at the back. Ask the client to put his or her arms around your shoulders (not your neck), or to reach with the strong arm for the arm of the chair. Bend your legs.
4. If the client has a weak leg, brace it with yours, and following the prearranged signal stand, pivot, and slowly lower the client into the chair.
5. Check that the client is safe and comfortable. Adjust the chair as needed.

Transferring From a Wheelchair to a Toilet

Transferring a client in a bathroom can present problems, since many bathrooms are not designed to accommodate wheelchairs. You may not be able to position the wheelchair so that the client can transfer toward the strong side. Posi-

tion the chair as best you can. Get the client to use the handrails if they are available.

To transfer a client from a wheelchair to a toilet:

1. Decide what assistance is required, determine if the client has a strong side, place the wheelchair, set the brakes, position the footrests, and discuss the move with the client.
2. Put on a transfer belt if necessary, and protect a weak arm. Assist the client to move to the front edge of the seat so that the client's feet are flat on the floor.
3. Lean the client toward you, placing your arms under the client's arms and grasping the belt at the back. Ask the client to put his or her arms around your shoulders (not your neck), or to reach with the strong arm for the handrail. Bend your legs.
4. If the client has a weak leg, brace it with yours, and following the prearranged signal stand, arrange the client's clothing, pivot, and slowly lower the client onto the toilet. Make sure there is no clothing under the client.
5. Check that the client is safe and comfortable.

These same steps can be used to transfer the client from the toilet back to the wheelchair. For more able clients it may be necessary only to plan and supervise the transfer because they are capable of performing it unassisted. Other clients may only need assistance with clothing and wiping.

Transferring From a Bed to a Stretcher

Occasionally in a care facility it is necessary to transfer a client from a bed to a stretcher. This is a procedure that requires at least two assistants, or more if the client is weak or heavy.

To transfer a client from a bed to a stretcher:

1. Decide what assistance will be needed and get the required help. Explain the move to the client.

2. Place the stretcher next to the bed on the client's strong side. Lock the brakes and ask the assistants to make sure that the stretcher stays tight against the bed.
3. Encourage more able clients to "crabwalk" onto the stretcher with your assistance.
4. If the client is unable to crabwalk onto the stretcher, place a lifting sheet under the client. Following a prearranged signal, have the assistants grasp the sheet and lift and slide the client onto the stretcher.
5. Check that the client is safe and comfortable.

Transferring From a Wheelchair Into a Car

Transferring a client from a wheelchair into a car is almost the same as from a wheelchair to a toilet, except you have a car door to deal with. Some car doors can pose a problem because they do not open widely. There are two common methods for transferring a client into a car:

Method A. Push the car seat back as far as possible. Position the chair alongside the car (Figure 4-57) and perform a stand, pivot, and lower transfer as previously described. Assist the client as necessary to turn and lift his or her feet into the car.

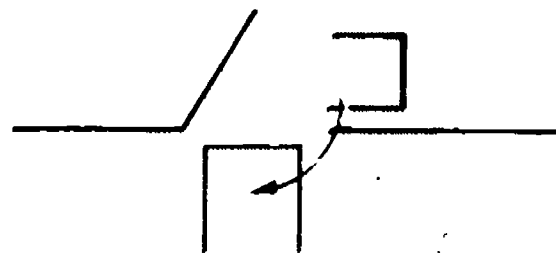

Figure 4-57. Transferring to a Car.

Method B. A sliding board (a smoothly finished, strong board) is used to bridge the gap between the chair and the car seat. The client with assistance as necessary places one end of the board on the car seat and the other end on the wheelchair seat and slides into the car (Figure 4-58).

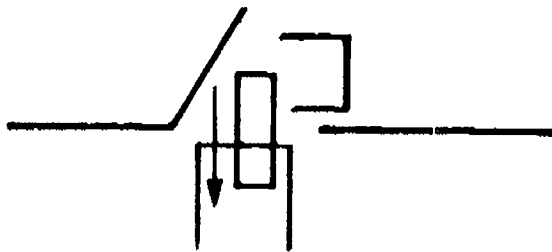

Figure 4-58. Using a Sliding Board to Transfer to a Car.

Transporting Clients

Wheelchairs and wheel stretchers are used for transporting clients from one place to another. They are a tremendous help if used correctly, but improper use can make them quite unsafe.

Safe Use of a Wheelchair

Clients may have their own wheelchair, they may rent one, or they may use one that belongs to the care facility. Besides considering the client's safety and comfort when using a wheelchair, also keep in mind that a wheelchair is an expensive piece of equipment. It should be handled carefully and kept clean and in good working order.

Often a client can transfer without assistance into and out of a wheelchair and also manoeuvre the wheelchair. Agency policy varies on wheelchair procedures. Some require that all clients use a seat belt, whereas others require seat belts only on confused or weak clients. Carry out the wheelchair policy of your agency. Following are rules for wheelchair use:

Wheelchair parts. Be aware of all wheelchair parts and their uses. Some wheelchairs have arms that collapse for easier transferring, special brake levers, and anti-tipping devices. Many special adaptations can be made to wheelchairs.

Brakes. Set the brakes before transferring or at any time the wheelchair is stationary.

Positioning the client. Position the client safely and comfortably. Pressure pads made of foam, artificial sheepskin, or cushions may be placed under the client. If the client is to be in the

wheelchair for a long period, encourage the shifting of body weight at regular intervals to relieve pressure and prevent skin breakdown.

Protecting the client. Make sure that limbs cannot dangle into the spokes of the wheels. Support the arms as required and place the client's hands on the lap when moving the wheelchair. Support feet on the footrests so that they are not injured in motion. Apply a seat belt if needed or if agency policy requires one.

Privacy and modesty. Cover the client appropriately. The client should not be exposed or feel cold. Housecoats, slippers, clothing, shoes, blankets, and lap robes should be used as needed. Make sure that covers don't dangle into the wheels.

Wheelchair control. Maintain full control of the wheelchair by concentrating on the task at hand and using the right techniques. When wheeling the chair up or down an incline, always stay downhill from the client. Figure 4-59 shows the correct position for going up or down an incline. Figure 4-60 shows the correct practice of backing onto an elevator. When exiting the elevator, back the wheelchair off in a similar manner.

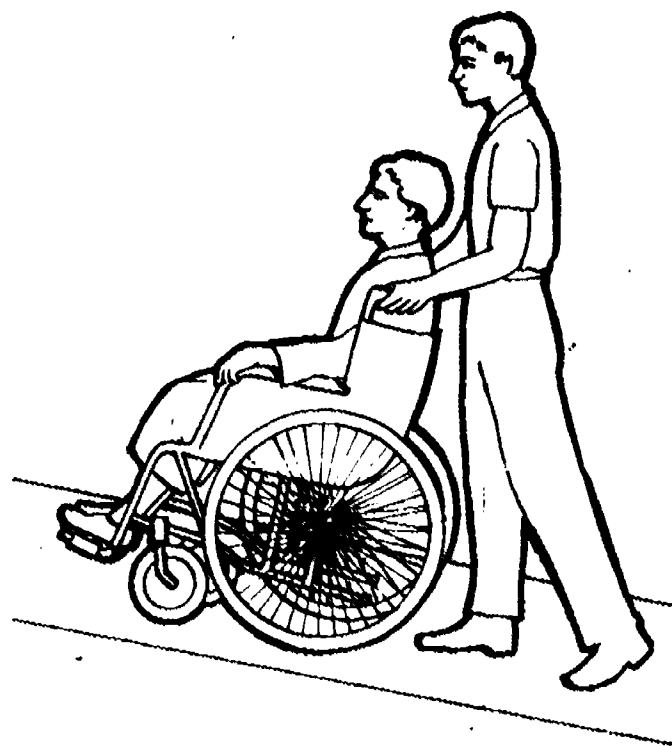

Figure 4-59. Handling a Wheelchair on an Incline.

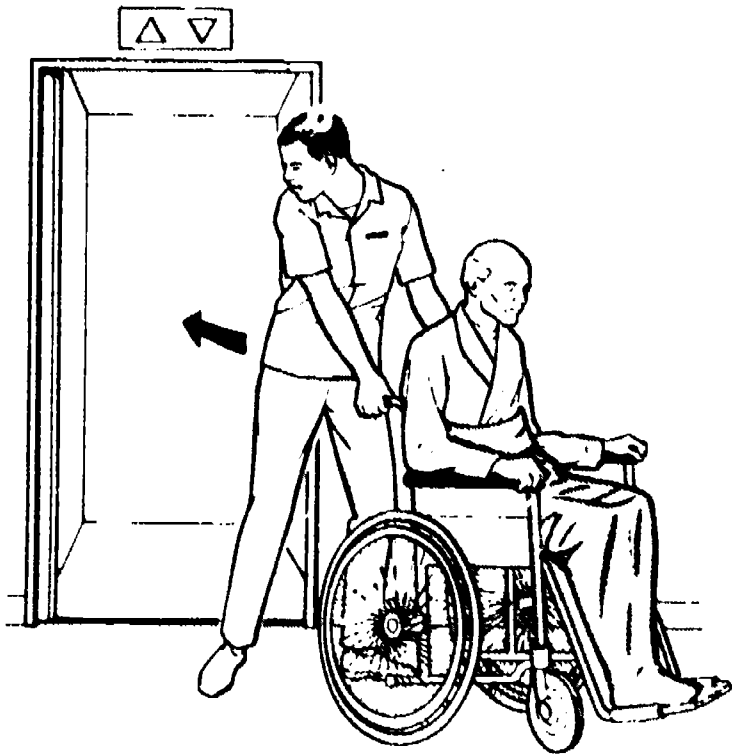

Figure 4-60. Backing a Wheelchair onto an Elevator.

Safe Use of a Stretcher

A client positioned on a stretcher must be both safe and comfortable. Most stretchers are equipped with siderails and at least one safety belt to keep the client secure. Figure 4-61 shows the correct procedure of pushing a stretcher with the client's feet first. In this way you can stay close to the client's head and protect it. Pull stretchers onto elevators with the client's head first and push them off with the client's feet first.

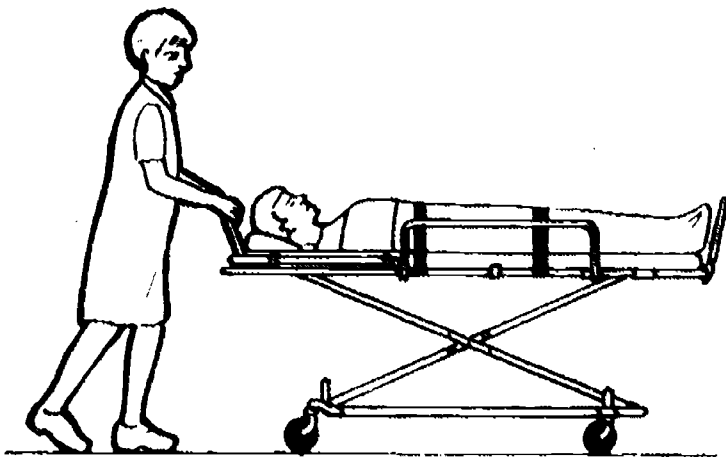

Figure 4-61. Pushing a Stretcher.

As with a wheelchair, always remain downhill from the stretcher for better control. An exception to the rule of standing at the head end of the stretcher occurs when the stretcher is on an incline: in this case stand at the foot end so that the client's head is uphill. Check your route carefully for obstacles or other people.

EXERCISE AND ACTIVITY

Dangers of Inactivity

Inactivity, be it in astronauts strapped in their space chairs, in young bedridden accident victims, or in elderly persons confined to a wheelchair, causes many problems. The body is built for movement; all body systems depend on movement for correct functioning. Body systems suffer from prolonged inactivity, whether it is caused by disease, disability, helplessness, or simply a refusal to be active. Some of the effects of inactivity are:

- Poor circulation increasing the likelihood of pressure sores, cold feet and hands, overworking of the heart, dizziness on rising, and slower mental functioning.
- Shallow breathing that allows secretions to collect in lungs causing a shortness of breath and a possibility of infection.
- Lack of appetite that can lead to poor nutrition.
- Elimination problems such as constipation and an increased chance of urinary infections due to slowing of the elimination systems.
- Weakening of bones that need to be used to remain healthy. As bones become porous and fragile, fractures are more likely.
- Tightening of muscles (contractures) due to lack of use. The body becomes less flexible and may become misshapen. Long term im-

mobility and contractures can lead to joints becoming rigid and immovable.

The saying "If you don't use it, you lose it" is especially relevant to inactivity. If a body system is not used properly, eventually it no longer functions properly.

Exercise

To counteract inactivity, exercise and activity are required. Exercise can be of different types depending on the client's capabilities and need for assistance:

Active exercise. Done entirely by the client.

Active-assisted exercise. Done by the client with some assistance to make the movement easier.

Passive exercise. Done by a physiotherapist because the client is unable to exercise or is required not to actively help in the exercise.

Passive exercises must be ordered by the client's physician and are usually carried out by a physiotherapist. You may be asked to continue with these exercises after receiving direct instruction on how to do them. In addition to the instruction you should also have written directions for the passive exercises to refresh your memory each time you do them. It is important that these exercises be done right, otherwise the client could be injured.

Some care facilities have active group exercises with a leader demonstrating exercises for clients to imitate. Attendance is optional.

Following are rules for supervising a client doing active exercises or assisting a client with active-assisted exercises:

- The client's body should be in good alignment for the exercises.
- Never take an exercise beyond the point where the client feels discomfort or fatigue.
- The exercises should be done slowly and smoothly, avoiding jerking.
- There should be a complete pause at the beginning and end of each motion.

- Each exercise should be repeated 3 to 5 times or as often as directed.
- The exercises should be done in a logical order, for example, starting at the head and working toward the feet. In this way no exercises are left out.
- When assisting a client, use the flat part of your fingers rather than your fingertips because the fingertips may cause feeling of pressure or tickling.
- Promptly report any unusual occurrences or observations.

Functional Movements

Functional movements are movements carried out during the normal activities of daily living. Functional movements can be looked upon as exercises, and clients should be encouraged to perform them. For example, clients must be able to raise their hand above shoulder height to comb their hair, and they must be able to bend forward to put on their trousers, socks and shoes. These and other functional movements can be made part of daily care by incorporating them into bathing and dressing routines.

Assisting With Walking Devices

Clients who are unsteady and need support when walking may be able to use a cane or walker to remain independent. A cane is used in one hand only and can be used by clients with one weak side. The cane is always held in the strong hand. A walker requires use of both hands.

Walking devices must be the correct height to be safe and useful to the client. If they are too short or too long, they do not support or aid balance. The height of the walking device is correct when the hand grip reaches the client's wrist bone as the client's arm hangs straight at the side. This height allows for a slightly bent elbow when the device is in use.

Canes and walkers should be in good repair and should have slip-proof tips on all legs. Since clients place weight on canes and walkers, they would lose their balance if one slipped.

The walking sequence of a client using a cane or walker should be:

1. Cane or walker
2. Weak leg
3. Strong leg

This sequence allows the device to support the weak leg's efforts until the strong leg comes forward. The weak leg must not get ahead of the cane or walker because balance would then be lost. Canes (Figure 4-62) include the traditional model and the more supportive tripod cane and quad cane.

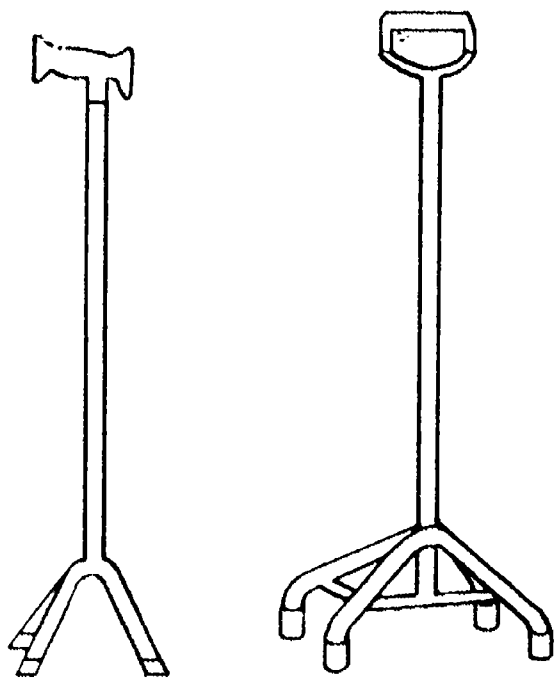

Figure 4-62. Canes.

Walkers vary slightly in style with some having wheels on the back two legs. Figure 4-63 shows a common type of walker. Clients may feel more secure with a walker than a cane because they are surrounded by the support. In walking, the device should be lifted and moved forward rather than dragged or pushed. This lifting may be assisted if required. When turning a walking device, clients should be encouraged not to shuffle or twist but instead to take small turning steps while continuing to use the device.

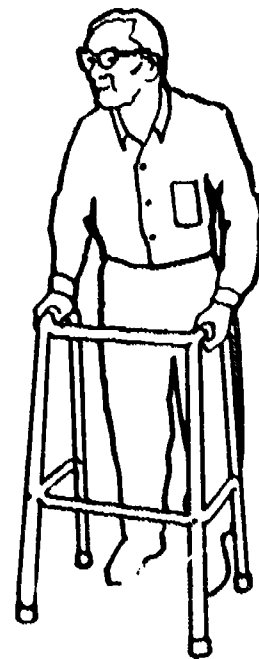

Figure 4-63. Walker.

Motivation and Activation Programs

Motivation programs try to help clients develop the desire to participate in activities. Activation programs try to give clients the physical and social skills required for the activities. These programs set goals for each client, taking into account the individual's needs, interests, and capabilities. The general aim of the programs is to keep clients interested and participating in activities.

Some clients enjoy group activities, whereas others prefer doing things on their own. Similarly, some clients like vigorous activities, whereas others prefer quiet pastimes. Try to find activities that stimulate and interest the individual client and encourage the client to participate in these activities. If clients are interested in an activity, they are much more likely to participate in it.

Finding stimulating activities for clients is not always easy. For example, don't assume that because of personal background a client will like a certain activity; a retired clergyman may hate hymn sings, but an ex-wrestler may love them! You may have to work at finding the right activities for clients, but the benefits are worthwhile.

Try to make participation in activities easier by introducing clients to others who may have similar interests. If clients enjoy the people, they may be motivated to continue the activity.

To be successful many programs require the support and assistance of all staff members. Consistent encouragement and work to keep activities interesting and meaningful are essential. If clients see that the activity is useful and their presence is appreciated, they are more likely to participate.

Recreation and Diversion

Recreation and diversions are activities that pleasantly occupy one's time. They offer an opportunity to do things outside of daily routine and to interact with other people. Recreation and diversions may be part of a motivation or activation program, or they may be simply for the client's enjoyment.

To a client who is usually housebound, going shopping is recreation. Care facilities often have discussion groups, evening classes, and entertainment evenings that clients may attend if they wish. Encourage clients to join in. Keep in mind, however, that some clients prefer the diversion of sitting over a cup of tea with an agreeable companion rather than joining organized activities.

Some clients occupy themselves with religious thoughts and activities and they may wish for privacy and solitude. Care workers should remain nonjudgemental toward religious beliefs and practices and should assist clients to prepare for and attend services.

Keep clients aware of available recreation and diversions and support their choice. Be sure to present activities suited to the client's physical and mental capabilities, otherwise the client may feel frustrated and not participate. The main point about recreation and diversions is that the client must enjoy them and not see them as a chore or duty.

Changes in Activity Patterns

Clients should daily be observed for their capabilities in self care, movement, and activity, and for their attitude toward activity. Clients have their own individual activity pattern. Changes in this pattern are important and should be reported. Note that changes in an activity pattern are often gradual and may not be noticeable on a day to day basis. A periodic review comparing a client's past activities with present ones should point out the changes. Note that it is equally necessary to report a change in the client's attitude toward activity because attitude affects participation.

COMFORT AND REST

As was mentioned in Section 2, rest requires physical comfort and freedom from stress and anxiety. Comfort and rest are important to keep the body functioning properly and to maintain a feeling of well-being. People require different amounts of sleep. If they don't get their personal quota of sleep, their body will not be refreshed and renewed, and thus their activities and dealings with others will be affected.

Any discomfort will interfere with the ability to rest or sleep. Since the signs of discomfort are often non-verbal, careful observation is necessary to spot them. Report unrelieved discomfort promptly. Common signs of discomfort are:

- Restlessness
- Tenseness
- Irritability
- Thought impairment
- Anxious or pained facial expressions
- Distorted posture or position

Discomfort may be physical or emotional. A baby feels discomfort from the fear of being left alone as much as from soiled diapers. A prob-

lem at work interferes with the sleep of an adult, as does a bruised shoulder. An elderly woman finds her rest disturbed as much by the illness of her husband as by her arthritic hands.

Helping a client to rest comfortably involves dealing with the cause of the discomfort in addition to taking measures to increase comfort.

Decreasing Discomfort

Loosening tight clothing, smoothing wrinkles in bedding, adjusting pillows and bed pads, changing soiled or wet clothing and linen can all remove the source of a client's discomfort. Assisting a client with toileting to empty a full bladder or to relieve gas will decrease discomfort, as will care that helps relieve constipation. For the bed-ridden client, a change of position may ease stiffness and discomfort or a backrub may aid relaxation. Feelings of heat or cold may be dealt with by adding or removing bedcovers. Besides decreasing discomfort, this care is emotionally comforting because it shows the clients that someone is concerned about them and that they are not alone.

Increasing Comfort

Knowing the potential discomforts a client is likely to feel can help you take steps to prevent the discomfort from occurring. For example, if you know that a client has a painful left shoulder, you can position the client and support the shoulder so that no pain is felt.

Some clients need to feel that their sleeping area is private and they will not be disturbed while they rest. Closing doors and curtains and posting "Do Not Disturb" signs may make these clients feel their concerns are understood, and they may sleep better. Other clients may require reassurance about the security precautions in the care facility because they feel there are too many people around who may be "up to no good."

Loneliness or a fear of being alone can prevent some clients from relaxing and resting. This fear

can be coupled with a fear of the dark. It is not always possible to stay with a client 24 hours a day, though this may be the client's wish, but staying until the client is asleep is often possible. In a care facility you may find that the lonely client sleeps better in a room shared with others. A radio left on at the bedside can be helpful if the station chosen operates all night and broadcasts programs acceptable to the client.

Adequate ventilation and a temperature preferred by the client encourage rest and relaxation. Some bedtime measures that promote rest and sleep are:

- A warm bath
- A warm, non-caffeine drink
- Soothing music to the client's taste
- A darkened room
- A position change and good body alignment
- A quiet environment
- Bedtime rituals; e.g., a bedtime story for a child, a security check or tour of the house for an adult
- A comfortable, dry bed
- Toileting
- Reporting pain that a client is having to the supervisor who may administer pain medication to relieve the discomfort and permit sleep

Examples of equipment that may increase comfort and enhance rest are: foot-stools, reclining chairs, pillows, pads, and blankets. Bed accessories that may also be beneficial to clients are:

Foot board. A smooth board placed at the foot of the bed to keep the client's feet properly aligned and to keep covers off the feet.

Bed cradle. A rack placed over part of the client's body to keep the weight of covers off that part of the body. A bed cradle can be made from a large cardboard box (Figure 4-64).

Bed board. A large board placed under the mattress to give added support for clients with back discomfort.

Side rails. Railings attached to both sides of the bed to protect clients. The rails may also be used by clients to turn and move.

Monkey bar. An overhead hand-hold that clients use to aid movement.

Sandbags. Weighted supports that can be used to keep limbs in good alignment.

Sheepskins. Real or synthetic sheepskins that help relieve pressure under limbs.

Be sure the comfort increasing equipment is appropriate for the client and check with your supervisor regarding its use. Remind the client why and how the equipment is used.

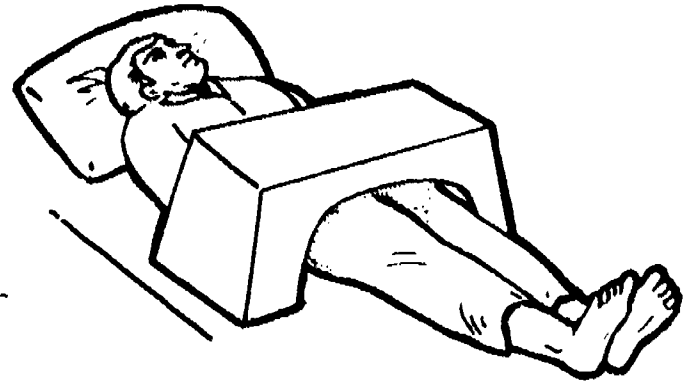
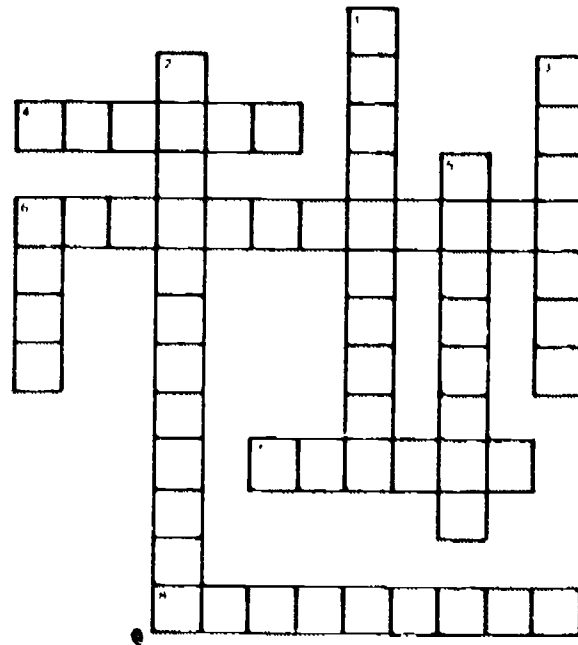

Figure 4-64. Bed Cradle.

EXERCISE 4-5

Crossword



Across:

- 4. Exercise done unassisted.
- 6. Tightening of muscles.
- 7. Walking device with support surrounding the client.
- 8. Moving a client from one location to another, usually by wheelchair or stretcher.

Down:

- 1. Movements carried out during normal activities.
- 2. Aid for lifting or turning a client.
- 3. Exercise of a client's body by a physiotherapist.
- 5. Moving a client from one piece of furniture or equipment to another.
- 6. Walking device held in the strong hand.

Questions

1. What is the basic rule of lifting?
2. True or false? Pulling is easier on the body than pushing.
3. When carrying a load and wanting to turn, turn your _____ and not your _____.
4. What is involved in changing a client's position?
5. What is the advantage of the log rolling technique to turn a client who is lying down?
6. What must you do before transferring a client?
7. Whenever possible transfer towards a client's _____ side.
8. What preparation is done to a wheelchair prior to transferring a client to the chair?
9. What is the purpose of a transfer belt?
10. What is the correct position to push a client in a wheelchair up or down a ramp? Onto or off an elevator?
11. When transporting a client on a stretcher, where should you be in relation to the client's head and feet:
 - a. On a flat hallway?
 - b. On an inclined ramp?
12. Poor circulation, poor appetite, elimination problems, and a weakening of the bones all can be caused by what?
13. The motions of active exercises and active-assisted exercises should be _____ and _____. There should be a _____ at the beginning and end of each motion.
14. In what order should the weak leg, walker, and strong leg be moved for the greatest security?
15. What is the aim of a motivation-activation program?
16. List six signs that indicate a client is uncomfortable.
17. What are three things that can be done for a client in a facility who fears being alone in the dark?
18. What routine could help someone whose sleep is disturbed by fears of the house not being secure?
19. What is a bed cradle? A monkey bar?

EMERGENCY CARE

As previously mentioned, the best way to keep yourself and clients free from danger is to prevent accidents from happening. However, even though you carefully follow safety rules, you may be faced with an accident that requires emergency attention. Common emergencies are fire, power outage, running out of fuel, cuts, falls, fever, convulsions, choking, and vomiting. Some general rules for dealing with emergencies are:

- Stay calm. Carefully think the problem through.
- Seek assistance. Ask for appropriate assistance from, for example, the supervisor, the client's doctor, the fire department.
- Apply your training. When necessary use the procedures and treatments that you have been trained to do.
- Protect the client and yourself. In an emergency the client's safety and your safety are all important.

Fire Safety

Fire safety involves fire prevention and fire emergency procedures. The three ingredients needed for a fire, fuel, heat, and oxygen are shown in the fire triangle in Figure 4-65. Whenever these three ingredients are together in the right amounts, a fire can start. If any one ingredient of the fire triangle is removed, fire can be prevented or put out. Thus keeping objects that will burn away from a source of heat is a basic rule to prevent fires.

Major causes of fires are:

Smoking and matches

- Keep matches out of reach of children.
- Supervise smokers who are unable to be responsible for their smoking.

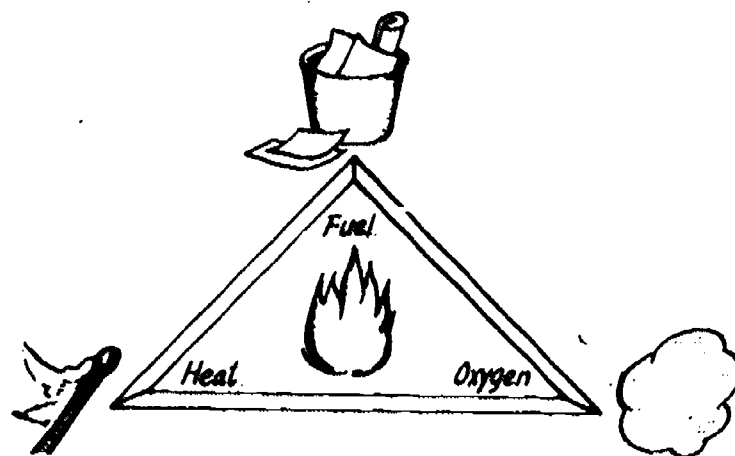

Figure 4-65. Fire Triangle.

Misuse of electricity

- Check all electrical cords for fraying or damage.
- Check the condition of appliances before using them.
- Don't overload electrical circuits.

Defects in the heating system

- Make sure that the heating system is functioning safely and correctly.

Spontaneous combustion

- Keep combustible objects away from heating vents or stoves.
- Store combustible items safely.
- Clean ovens and stove elements regularly.
- Prevent clutter.
- Label flammable liquids.

Improper rubbish disposal

- Don't allow rubbish to build up.
- Throw ashes into the toilet or into a bucket of sand or water.
- Don't burn or puncture aerosol cans.

Improper handling of oxygen equipment

- Post NO SMOKING signs near the oxygen equipment and see that the signs are obeyed.
- Don't use combustible alcohol or oils to rub clients while oxygen is running.
- Don't unplug appliances (because of the chance of a spark) while oxygen is running.

Fire Emergency

In an Institution

- Protect the clients. Remove clients from danger, either to a distant part of the building or outside. Make sure the clients are comfortable.
- Sound the alarm. Either ring the fire alarm or telephone the fire department directly. Depending on the immediate danger to the clients, this may be done prior to removing the clients to safety.
- Isolate the fire. Shut windows and doors to stop the fire from spreading. Turn off electrical appliances and oxygen where possible.
- Help where needed.

In the home

- Protect the client. Remove the client from the house and make sure the client is comfortable.

- Telephone the fire department from a neighbour's home, taking the client with you if possible. Be sure to give accurate information: your name, the client's name, the house address, and details of the fire. Don't reenter the house.
- Stay with your client.
- Notify your supervisor.
- Don't risk your life trying to fight a fire unassisted.

Fire Extinguishers

Fire extinguishers are designed to fight different types of fires. Table 4-11 lists the types of fire extinguishers commonly found in home or institutions.

TABLE 4-11: Fire Extinguishers

<i>Type of Fire Extinguisher</i>	<i>Type of Fire</i>
A—Usually Water	For paper and wood fires Good in a client's room
B—Carbon Dioxide or Dry Chemical	For grease or oil fires Good in the kitchen
C—Dry Chemical or Carbon Dioxide	For electrical fires
AB—	For paper, wood, grease, and oil fires
ABC—	For all types of fires in homes or institutions

Fire Extinguisher Safety

- Know the location and type of fire extinguishers.
- Check the gauge on extinguishers to see if the pressure is adequate.
- Know how to operate fire extinguishers before an emergency takes place. When a fire occurs, you don't have time to start learning how to operate the extinguisher. Read the extinguisher labels or ask your supervisor for directions.

Power Failure

In modern communities a lot depends on electricity. A power failure can eliminate lighting, heating, and cooking in many homes. Emergency lights, lanterns, or candles may solve the lighting problem, and it is possible to prepare cold meals, but the lack of heat may be very serious, especially for the elderly or ill. Cover the client with extra sweaters, blankets, etc. for a short-term power failure. For a long-term power outage it may be necessary to find other accommodation for the client. Notify the supervisor and explain the difficulty.

Unlike most homes, institutions usually have an emergency back up generator to take over necessary electrical functions in the event of a power failure.

Running Out Of Fuel

If the client's fuel has run out, find the reason. The client may not have been able to afford fuel. In this case phone your supervisor and explain the situation. Another reason could be that the fuel supplier may have simply overlooked the low fuel reserve. In this case phone for immediate delivery. Ask the fuel supplier to restart the furnace or heater for you, since restarting can be risky if you are not familiar with the procedure.

Cuts, Scrapes, Burns

If the client has a small, shallow cut or scrape, make sure the area is as clean as possible, apply disinfectant such as alcohol or peroxide, and cover the area with a bandaid or gauze bandage. Observe the area closely. If the wound is large, deep, or bleeding heavily, call for medical help. Notify the client's doctor and your supervisor. Keep the area as clean as possible and apply gentle pressure to stop the bleeding. You may need to call an ambulance to take the client to the hospital for emergency treatment. See the appendix "First Aid for Emergencies," points 8 and 10.

Falls

If the client complains of discomfort after a fall, check the area for cuts, scrapes, or bleeding. Difficulty in moving or severe pain are clues to seek medical assistance. Notify the client's doctor and your supervisor. An ambulance should be called to take the client to the hospital for a check-up and treatment. Do all you can to prevent falls to the elderly; their bones are brittle and break easily. A fall to an elderly person can be very serious.

Inflammation

Body tissues respond to injury by increasing the nourishing supply of blood to the injured area. The blood causes redness, heat, and some swelling at the site of the injury. These reactions apply extra pressure on the delicate nerves in the injured area and thus cause pain.

Resting and raising the injured part of the body will help healing by decreasing strain on the area. Extra fluid intake will help the body eliminate waste products from the injury.

Fever

Fever is one of the body's responses to infection. The normal body temperature is 37°C. A tem-

perature of 37.5°C or more is considered a fever. Signs of a fever are complaints of feeling warm, a flushed look, skin hot to the touch, perspiration, and chills or shivering.

Note that the body temperature of children is usually higher than that of adults, and the temperature of older adults is lower than younger adults. Each individual's temperature fluctuates during the day, being lowest in the early morning and highest in the early evening. Exercise, diet, and weather conditions all affect temperature.

The body's ability to control or regulate its temperature is less efficient in the very young, the aged, and the ill. In these cases more care must be taken to prevent overheating or chilling.

Extra fluid intake is very important for a person with a fever to prevent excessive loss of body fluid. Young children with a fever dehydrate quickly and must be carefully watched. When a person with a fever feels hot, all extra bed clothes or clothing should be removed to reduce the person's temperature. If shivering occurs, enough covers should be used to stop the shivering since it will cause the temperature to rise. Often a tepid or lukewarm bath will help decrease a fever, but the bath should be discontinued if shivering occurs.

If you suspect a fever, take the client's temperature orally (by mouth) or by axilla (armpit). Do not take an oral temperature for a client who is:

- Less than 5 years old
- Unconscious
- Restless or confused
- Very ill and weak
- Breathing with difficulty

- Coughing frequently
- Breathing through the mouth
- Eating, drinking, or smoking (wait 20 minutes)

General Rules For Taking A Temperature

- Be sure the thermometer is clean and in good working order.
- Position the client comfortably and safely.
- Place the thermometer correctly. Placed orally, it should go under the tongue, and placed axillary, it should go into the centre of the armpit.
- Stay with the client while the thermometer is in place.
- Leave the thermometer in place the required time. Check agency policy here, but 3 to 5 minutes is usually adequate for oral temperatures and 10 minutes for axilla.
- Remove the thermometer and wipe it with a tissue from tip to bulb.
- Read and record the temperature. Report an oral temperature higher than 37.4°C and an axillary temperature higher than 36.8°C.

To read a thermometer:

1. Hold the thermometer at eye level and turn it slowly until you can see the mercury column.
2. Each long line on the scale indicates one degree. The shorter lines are tenths ($\frac{1}{10}$ or .1) of a degree. The mercury in Figure 4-66 ends two short lines after 37 degrees; this temperature reading is 37 and two-tenths degrees or 37.2°C.



Figure 4-66. Reading a Thermometer.

Measuring Pulse and Respirations

It is common to measure the client's pulse and respirations when the temperature is taken. A change in one often relates to changes in the others. You may be asked to take the client's **vital signs** or to do a T.P.R. on the client. Both mean to measure the temperature, pulse, and respirations.

The pulse may be found in several locations (Figure 4-67). However, the most commonly used one is the radial pulse located on the inner side of the wrist (Figure 4-68).

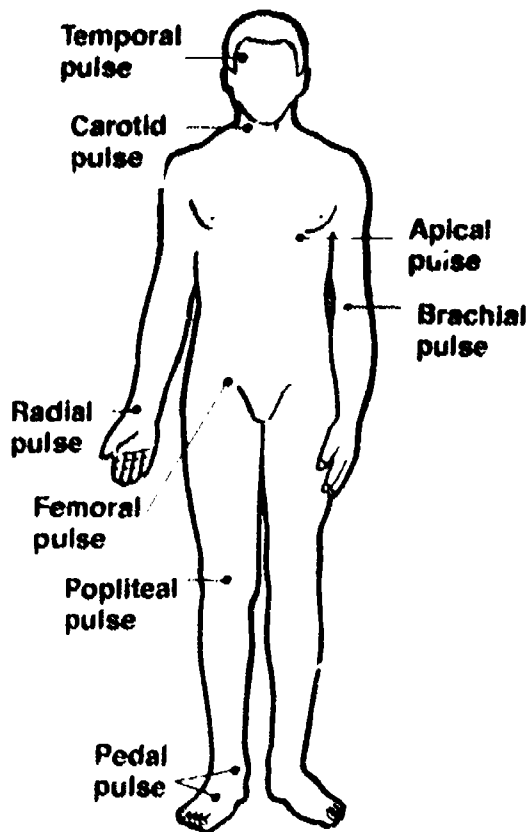

Figure 4-67. Pulse Locations.

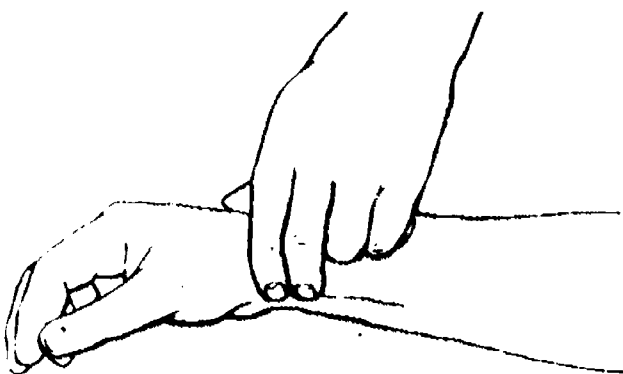

Figure 4-68. Radial Pulse.

Taking a Radial Pulse

Purpose: To determine the client's pulse rate.

Equipment: Watch with a second hand.

1. Position the client comfortably at rest, either sitting or lying.
2. Place your second, third, and perhaps fourth fingers lightly on the inner thumb side of the client's wrist (Figure 4-69). Don't use your thumb to count a pulse because it has a pulse of its own. Apply gentle pressure till you can feel a rhythmical throbbing.



Figure 4-69. Taking a Radial Pulse.

3. Count the throbs or beats for exactly one minute, noting the strength and regularity. Record.
4. Always report promptly any adult's pulse rate that is slower than 60 beats per minute or faster than 100. Also report a pulse that is unusually irregular or weak. Average pulse rates are given in Table 4-12.

**TABLE 4-12:
Average Pulse Rates**

Infants	120–140 per minute
Early Childhood	100–120 per minute
School Age	80–110 per minute
Adolescents	70–90 per minute
Adults	70–80 per minute
Elderly	60–80 per minute

Taking a Respiration Rate

Purpose: To count a client's respiration rate and to determine noisy or difficult breathing.

Equipment: Watch with a second hand.

1. Place the client's arm across the chest and hold the wrist as if to take the pulse (Fig. 4-70). Do not tell the client you are counting respirations as this will cause a change in breathing and make the count inaccurate.



Figure 4-70. Taking a Respiration Count.

2. Count respirations for 60 seconds, noting depth, regularity and any unusual qualities. Record.
3. Report unusual findings promptly.

Convulsions

A convulsion is the uncontrolled tightening of muscles. Signs of a convulsion are: shaking of the whole body, twitching or jerking of one body part, stiffening of the whole body, or a temporary loss of consciousness. Convulsions with shaking or stiffening are known as 'grand mal' (big sickness) convulsions, and those without are called 'petit mal' (little sickness) convulsions.

Some people have recurring convulsions and can tell when one is coming because their body gives them a warning signal. With clients who have recurring convulsions, discuss beforehand the care you will give them prior to, during, and after the convulsion.

The care of a convulsing client is mainly looking after the client's safety and comfort. To prevent injury provide adequate space for the client's movements by taking away furniture and other objects. Do not attempt to hold the client down, stop the movements, or otherwise restrain the client.

Instead, supply appropriate padding to protect against injuries caused by banging or bumping. If possible provide privacy so that the client is not later embarrassed and other clients are not upset. Remain with the client throughout the convulsion.

Most convulsions are over in a few minutes, although the client may be dazed or sleepy for some time afterwards. If the convulsion continues for more than a few minutes or if the client is injured, request assistance. Depending on the client's condition, your choice might be to call your supervisor, an ambulance, or the client's doctor. If the client has never convulsed before, even if the convulsion is a short one, seek assistance. Report all convulsions, noting:

- Time the convulsion began.
- Whether the client had a warning signal.
- Length of time the convulsion lasted.
- Type of convulsion.
- Whether the client lost consciousness.
- Whether the client was incontinent of urine or stool.

- Any other observations of unusual happenings.

After the convulsion the client will likely be drowsy. Assist the client with any hygiene needs such as bathing and changing clothing and make the client comfortable. A calm, matter-of-fact manner and efficient caring will help the client recover and feel less embarrassed.

Choking

If any substance blocks or partially blocks the air passages leading to the lungs, a person is said to be choking. The most common blockage is caused by food that is breathed into an air passage. A client who is choking may show the following:

- Coughing or spluttering
- Inability to speak
- Facial colouring becomes bluish or dusky red
- Clutching the throat
- Distressed expression

See the appendix "First Aid for Emergencies," point 6, for the choking assistance procedure.

Vomiting

Clients who are vomiting or sick to the stomach require prompt attention. The main concern with vomiting is to prevent clients from breathing in the liquid vomit, in other words, from choking on the vomit. A client who is vomiting should be positioned on the side with the head flat on the bed if in bed, or leaning forward with the head low if sitting up. Provide privacy if possible, as this will likely make the client feel more comfortable. Have a container and tissues within easy reach and remain with the client offering assistance. Call for help if necessary.

Once the vomiting has subsided, wash the client's face and hands and assist in rinsing the client's mouth. If the vomiting has gone on for a long period, encourage rest because the client will feel tired.

Be sure to observe the liquid vomited, the **emesis**, and to measure it if possible. The emesis should be observed for colour, consistency, and contents. If measuring is not possible, describe the amount as best you can; for example, saying that the emesis soaked a 2 foot circle of bedclothes. Promptly report the information on the emesis to your supervisor. Also mention the time, circumstances leading to the vomiting, and observations during the vomiting.

EXERCISE 4-6

1. List four general rules for dealing with emergencies.
2. What ingredients make up the fire triangle?
3. What are the first two steps to take in case of a fire in a home or an institution?
4. Match:
 - a. Type A extinguisher
 - b. Type B extinguisher
 - c. Type C extinguisher
 1. For grease and oil fires
 2. For electrical fires
 3. For paper and wood fires
5. How do you stop a cut from bleeding?
6. Why can falls be particularly serious to elderly people?
7. What are the symptoms of inflammation?
8. True or false? The temperature of a very ill and weak client should be taken by axilla, not by mouth.
9. Do eating, drinking, and smoking have any bearing on taking temperature by mouth?
10. Placed orally, a thermometer should go _____ for _____ minutes. Placed axillary, it should go _____ for _____ minutes.
11. Report oral temperatures higher than _____ and axillary temperatures higher than _____.
12. Why should you not use your thumb to count a client's pulse?
13. What is the difference between "petit mal" and "grand mal" convulsions?
14. List four things you would do when a client convulses.
15. What is the main concern with a vomiting client?
16. What is the universal signal for choking?
17. What can happen to a choking person's speech and face?
18. What are the two procedures to perform on a choking person who cannot speak?

MEASURING AND WEIGHING IN METRIC

You may be required to weigh or measure a client. Since many scales and tape measures are now using metric units, familiarity with the metric system is necessary. The standard units of measure are shown in Table 4-13. To these units are added the prefixes shown in Table 4-14. Note the value of each prefix.

TABLE 4-13: Metric and Imperial Units of Measurement

	Length	Mass or Weight	Volume	Temperature	Time
Metric	metre (m)	gram (g)	litre (L)	Celsius (°C)	second (s)
Imperial and Apothecary	inch foot yard mile	grain ounce pound ton	teaspoon tablespoon ounce cup pint quart gallon	Fahrenheit	second

TABLE 4-14: Common Metric Prefixes

Prefix	Value	Example
Kilo (k)	1000 times standard unit	1 kilometre = 1000 metres
Hecto (h)	100 times standard unit	1 hectolitre = 100 litres
Deca (da)	10 times standard unit	1 decagram = 10 grams
Deci (d)	1/10 of standard unit	1 decigram = 1/10 gram
Centi (c)	1/100 of standard unit	1 centimetre = 1/100 metre
Milli (m)	1/1000 of standard unit	1 millilitre = 1/1000 litre

Symbols for metric quantities are formed by combining the symbol of the prefix with the symbol of the standard unit. Note that no periods are used with these symbols.

Examples: kilogram — kg
millilitre — mL
kilometre — km
centimetre — cm
milligram — mg

It is best not to be constantly converting metric measure back to the apothecary or imperial system because this prevents you from learning and becoming comfortable with metric. However, you may have to make conversions for some clients since they will not understand the metric system. For example, if you tell a male client who is unfamiliar with the metric system that he weighs 104 kg, it won't mean anything to him. But if you tell the client he weighs 229 pounds, he may immediately consider dieting.

To convert kilograms to pounds use the conversion factor **1 kilogram = 2.2 pounds**. For example, a client weighing 104 kilograms weighs $104 \times 2.2 = 229$ pounds. Similarly, a client weighing 65 kilograms weighs $65 \times 2.2 = 143$ pounds.

To convert centimetres to inches use the conversion factor **1 inch = 2.54 centimetres**. For example, a client whose height is 163 centimetres is $163 \div 2.54 = 64$ inches or 5 feet 4 inches tall. A client who is 6 feet 2 inches in height is $74 \text{ inches} \times 2.54 = 188$ centimetres tall.

Weighing a Client

In order to make accurate weight comparisons over a period of time, a client should be weighed on the same scale and be dressed in the same clothing. The scale must be in good working order and properly balanced, and the client must not be supported by anything. For clients who cannot stand unsupported, many agencies have chair or sling scales.

Position the client appropriately on the scale, balance the scale, and record the weight promptly so that you don't forget it. Be sure to state whether the scale is in pounds or kilograms.

Measuring Client's Height

Some weight scales are equipped with height measures that can be rested lightly on the client's head while you are determining the weight. Read the correct height at the join in the mea-

sure. You can also measure height by backing a client barefoot against a wall, laying a ruler lightly on the client's head, and making a small

mark where the level ruler hits the wall. You can then measure the distance from the floor to the mark. Record the height in the correct units.

EXERCISE 4-7

1. Match:

- | | |
|----------|---|
| a. kilo | 1. one-tenth of a standard unit |
| b. hecto | 2. ten times a standard unit |
| c. deca | 3. one one-thousandth of a unit |
| d. deci | 4. one thousand times a standard unit |
| e. centi | 5. one hundred times a standard unit |
| f. milli | 6. one one-hundredth of a standard unit |

2. Write the symbols for:

- gram _____
millilitre _____
kilogram _____
metre _____
litre _____
centimetre _____

3. Calculate the following conversions:

- a. 96 kilograms = _____ pounds
b. 36 inches = _____ centimetres
c. 88 pounds = _____ kilograms
d. 31 centimetres = _____ inches

Appendix

First Aid For Emergencies.

"First Aid For Emergencies" is reprinted with the permission of B.C. Telephone. This information appears in telephone books as a public service. B.C. Telephone assumes no liability for the actions recommended.

1/DANGER

BEFORE STARTING ANY FIRST AID, ALWAYS ENSURE THAT THERE IS NO FURTHER DANGER

- A. TO THE VICTIM
 - B. TO YOURSELF
-

2/EMERGENCY AMBULANCE NUMBER

- A. When calling the emergency ambulance number
 - 1. Keep calm.
 - 2. Speak clearly (fig. 1).
 - 3. Answer questions.
- B. State type of emergency.
- C. Give precise address, including city and telephone number.
- D. Confirm that the emergency service has all necessary information before you hang up.

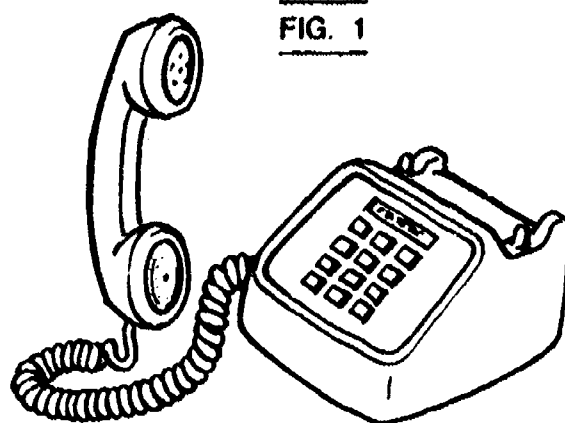

3/UNCONSCIOUSNESS

- A. Check for unconsciousness. (fig. 2)
 - 1. Shout at victim.
 - 2. Shake shoulders gently.
 - 3. Pinch or squeeze shoulders.
- B. If no response.
 - 1. Check for breathing.
 - (a) Look for chest movement.
 - (b) Listen for breathing.
 - (c) Feel for breath on your cheek.
- C. Unconscious breathing.

Place victim in recovery position (fig. 3):

 - 1. if breathing is noisy (gurgling or snoring sounds),
 - 2. if victim starts to vomit, or is bleeding from mouth, or
 - 3. if you must briefly leave victim.
- D. If breathing easily and no apparent injuries, do not move victim; await arrival of ambulance.
- E. If victim is not breathing, start the A B C of resuscitation. (See point 4)

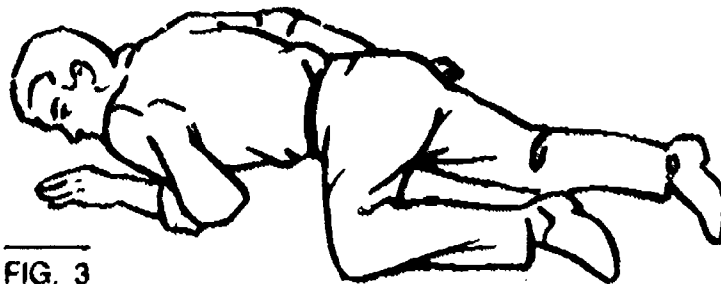
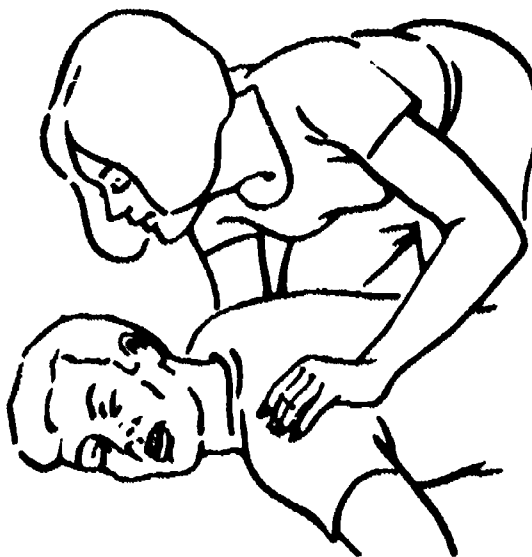

4/A B C OF RESUSCITATION

A. AIRWAY

1. Lift the neck
2. Tilt head well back (fig. 4).

If you suspect neck injury, handle with special care.

B. BREATHING (ARTIFICIAL RESPIRATION)

1. Look for chest movement.
2. Listen for breathing.
3. Feel for breath on your cheek (fig. 5).
4. If not breathing, start artificial respiration immediately:
 - (a) Pinch nostrils.
 - (b) Keep the head well back (fig. 6).
 - (c) Place your mouth over victim's mouth.
 - (d) Give 4 quick full breaths (fig. 7).
 - (e) Continue with one breath every 5 seconds until victim breathes normally or medical help arrives.
5. If on attempting artificial respiration air does not enter victim's chest:
 - (a) Tilt head further back and make a second attempt at artificial respiration.

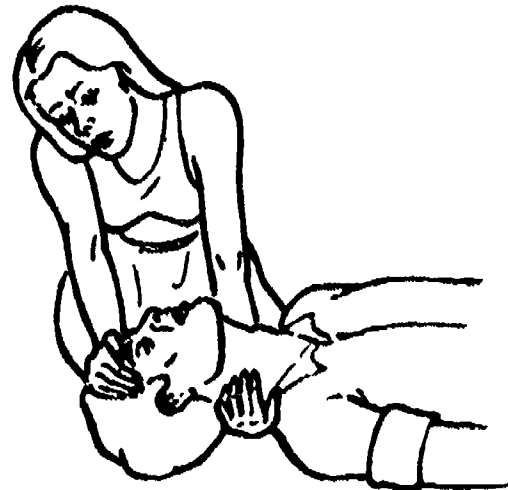

FIG. 4



FIG. 5



FIG. 6



FIG. 7

FOR INFANTS

Cover baby's mouth and nose with your mouth, and use small breaths.

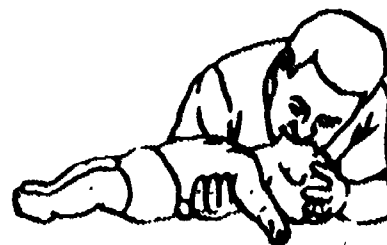

- (b) If no success on second attempt, support the head and neck with one hand and roll victim towards you onto his side.
- (c) To clear airway, give up to 4 firm back blows between the shoulder blades (fig. 8).
- (d) If no object comes out of the victim's mouth (such as food or dentures), then roll him onto his back on a firm, flat surface or floor.
- (e) Place the heels of both hands on the breastbone between the nipples (fig. 9).
- (f) Give up to 4 chest thrusts. Use less pressure on children.
- (g) Open mouth and remove objects loosened by back blows and chest thrusts.
- (h) Continue back blows and chest thrusts until the obstruction is cleared.
- (i) If victim is not now breathing naturally, start artificial respiration again.

FIG. 8

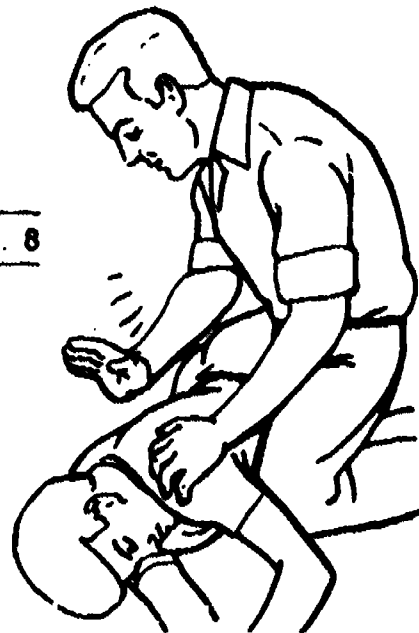

FIG. 9

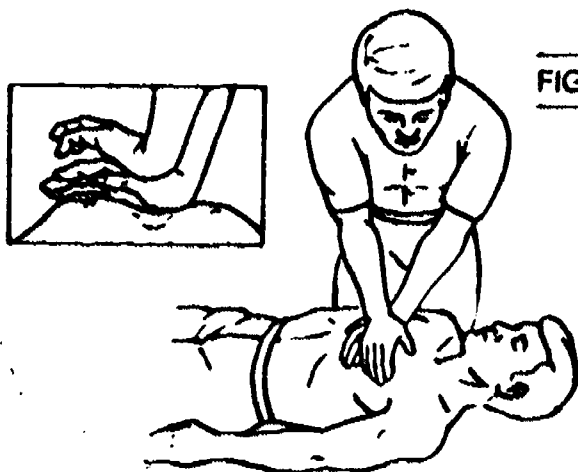

FIG. 10

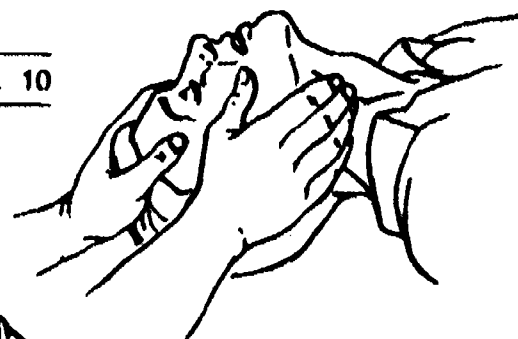
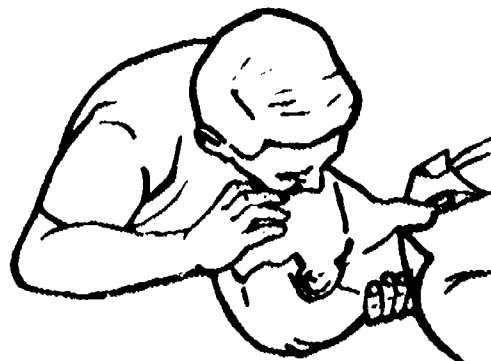

FIG. 11



FIG. 12



C. CIRCULATION (C.P.R.)

1. Feel neck pulse (fig. 10).
2. If neck pulse is not felt, Do C.P.R. (cardiopulmonary resuscitation).
 - (a) Place heels of both hands on the breastbone between the nipples. Do not press on the lower tip of the breastbone (fig. 9).
 - (b) (i) For an ADULT, press straight down to compress the chest 1 1/2" to 2" about 80 times a minute. Give 15 compressions (fig. 11) for every 2 ventilations (fig. 12).
 - (ii) For a CHILD, compress the chest 1" to 1 1/2" with the heel of only one hand about 80 times a minute.
 - (c) Continue until help arrives.

5/HEART ATTACK

A. The warning signals of heart attack may include:

1. Feeling of heavy pressure or squeezing pain in chest, arms or jaws.
2. Shortness of breath, pale skin, sweating and weakness.
3. Nausea and vomiting.
4. Abdominal discomfort with indigestion and belching.
5. Apprehension or fright.
6. Denial of impending heart attack.

B. ACTION

When you suspect a heart attack:

1. Help victim to rest, sitting or lying in most comfortable position.
2. Assist victim to take just the dose of medication prescribed for his condition.
3. Ensure prompt medical attention by calling emergency ambulance number and reassure victim, "Help is on the way."
4. Loosen collars, belts, and other tight clothing.
5. Keep patient quiet but avoid physical restraint.

6/CHOKING

A. Ask "Can you speak?"

If the victim can speak or cry out, the airway is probably open enough for him to force the object out.

B. If victim CAN speak, or cough,

1. reassure him and encourage him to cough.
2. do not hit him on the back.

C. If the victim CANNOT speak or cough, (with victim either standing or seated)

1. Give him up to four rapid, forceful blows between the shoulder blades with the heel of one hand (fig. 13).
2. Call the emergency ambulance number
3. Give up to four chest thrusts (fig. 14) standing, or (fig. 15), sitting.
4. Repeat 4 back blows and 4 chest thrusts until airway is clear or until victim becomes unconscious.
5. If victim becomes unconscious, proceed with artificial respiration. (See point 4)
6. Check the neck pulse, continue blowing air into the victim's mouth every five seconds until victim is breathing naturally or until help arrives.
7. If there is no neck pulse, proceed as for CPR (cardiopulmonary resuscitation). (See point 4-C)

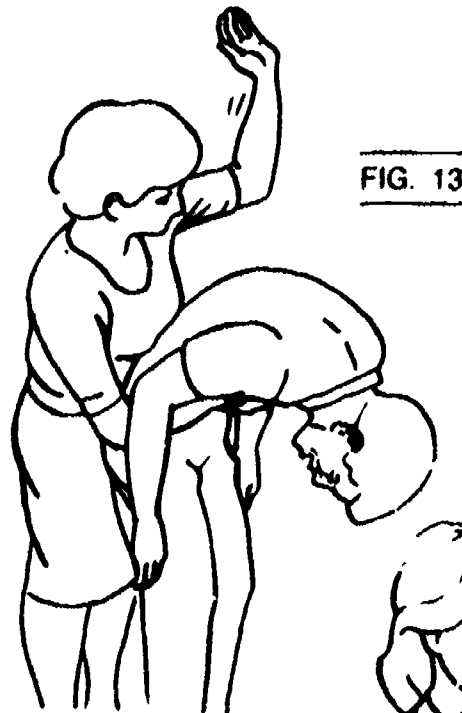

FIG. 13

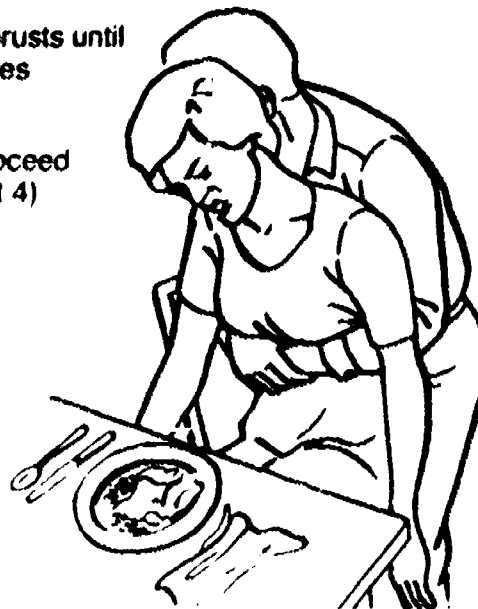

FIG. 15



FIG. 14

7/BLEEDING

Serious bleeding occurs with deep cuts and severed blood vessels.

A. Hazards

Ensure that there is no further danger to the victim or yourself.

B. Call emergency ambulance number.

C. Apply direct pressure.

1. Remove clothing to expose the wound.
2. Cover with sterile or clean cloth and apply firm pressure with your hand directly over the wound (fig. 16).
3. Use your bare hand if no dressing available.

D. Continue pressure until bleeding stops. (May be 15 to 20 minutes)

1. Lay the victim down.
2. Elevate the bleeding part unless the bone is broken.
3. When bleeding stops, apply a further dressing on top of original dressing and bandage firmly.
4. If blood soaks through the bandage, apply additional dressings and bandage more firmly.

E. Broken bone, glass or objects protruding from the wound.

1. **DO NOT REMOVE EMBEDDED OBJECTS** (fig. 17).
2. Apply pressure close to the wound but not pressing on the broken bone or object.
3. Place a sterile or clean dressing around the area and cover the wound.
4. Maintain pressure and prevent movement of the object by applying bulky pads and bandaging in place.

F. Nose Bleeds

1. Seat victim with head tilted forward.
2. Pinch the nostrils firmly for ten minutes.
3. Avoid blowing the nose.
4. If bleeding persists, call emergency ambulance number.

FIG. 16

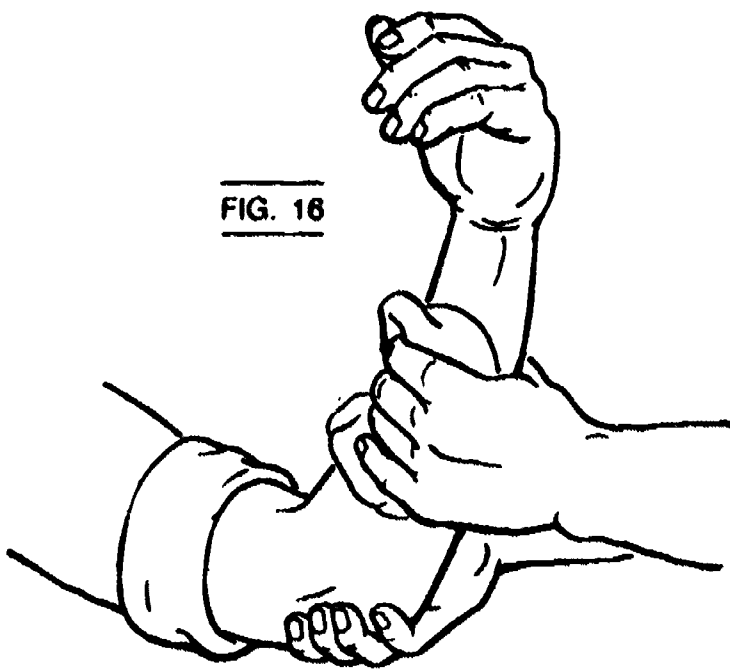
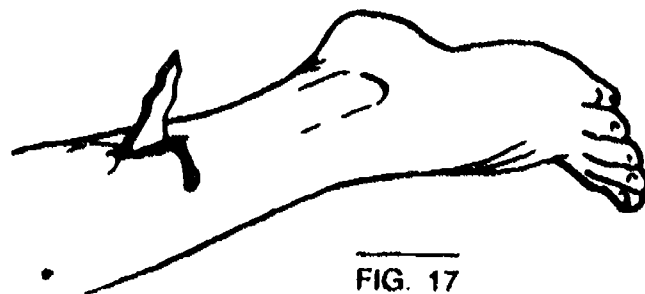

FIG. 17



8/BONE AND JOINT INJURIES

A. Hazards

1. Move victim only if in danger of further injury.

B. Call emergency ambulance number.

C. Ensure that breathing is normal. (See point 3)

D. Control bleeding by applying pressure close to the wound but not pressing directly on the broken bone.

E. Suspect a broken bone—

If, after injury, the limb is painful, swollen or deformed.

F. WHEN IN DOUBT, TREAT AS A BROKEN BONE.

G. Keep the injured part still.

1. Hold the limb with your hands or place pillows, bricks, rocks, on either side to keep it still (fig. 18).

FIG. 18

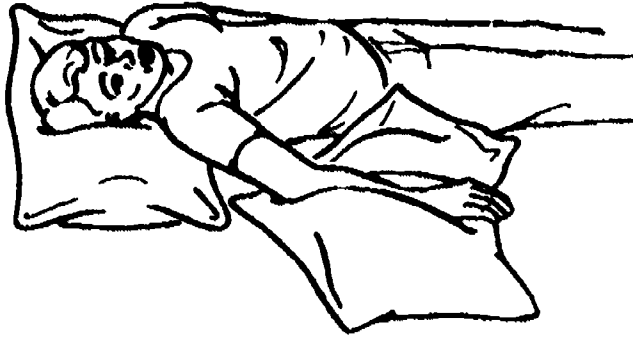

2. For neck or back injuries, keep the body still until trained help arrives (fig. 19).

H. Treat joint injuries as broken bones.

Apply cold, not heat, to injuries of bones and joints.

FIG. 19



9/EYE INJURIES

A. With all serious eye injuries call the emergency ambulance number.

B. CHEMICALS IN THE EYE

Wash the eye immediately with large amounts of cold, running water for at least 15 minutes (fig. 20).

C. FOREIGN BODY EMBEDDED IN THE EYE

1. Never rub the eye and do not try to remove particles.
2. Cover both eyes lightly with bandage.

D. PERFORATING WOUNDS

Perforating wounds are serious. Cover BOTH eyes lightly with bandage.

FIG. 20

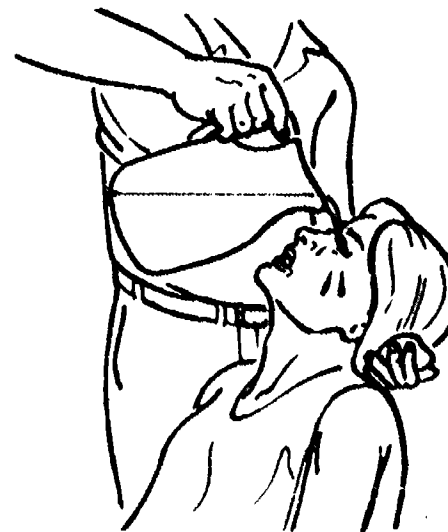

10/SEVERE BURNS AND SCALDS

A. Ensure that there is no further danger.

B. Call emergency ambulance number.

C. Burns or scalds caused by fire, hot objects, sun, or hot liquids:

1. Immerse affected part in cold water with ice to relieve pain.
2. Remove rings and bracelets before part starts to swell.

3. Do not breathe on, cough on, or touch burn.
4. Do not open blisters.
5. Do not tear away clothing stuck to burn.
6. Avoid applying medications, ointment or greasy substances to burn area.
7. Cover with clean cloth and secure lightly with bandage.
8. To avoid scarring, ensure hospital treatment for deep burns and scalds bigger in area than a 25 cent piece.

D. Burns with dry or liquid chemicals:

1. Brush off dry chemicals.
2. Flood with running water.
3. Cover with clean dressings and bandage lightly.

E. Electrical burns:

1. Before touching victim shut off electricity.
2. If breathing and circulation stop, start cardiopulmonary resuscitation. (See point 4)
3. Cover burns with dressing and bandage.

11/HEAT EXPOSURE

A. HEAT EXHAUSTION

1. Cause: Exposure to excessive heat with loss of body fluids, placing a strain on the circulatory system.
2. Treatment:
 - (a) Remove victim to a cool area.
 - (b) If conscious, give fluids to drink.
 - (c) If unconscious, maintain his airway (recovery position, see fig. 3).

B. HEAT STROKE

1. Cause: High body temperature with inability to sweat, and impairment of blood circulation to brain — serious, may be fatal.
2. Treatment:
 - (a) Remove patient to a cool area.
 - (b) Decrease body temperature rapidly by sponging with cold water and ice.
 - (c) Call emergency ambulance number. (see inside front cover)

12/COLD EXPOSURE

(Hypothermia)

A. Cause: Loss of body heat.

B. Treatment:

1. Remove wet clothing.

2. Wrap in sleeping bag, blankets, or warm clothing.
3. Warm victim by using your own body heat. Light a fire.
4. If conscious, give victim warm drinks.
5. Call emergency ambulance number.

13/POISONING

A. In all cases:

1. Ensure that there is no further danger.
2. If possible, identify poison and container.
3. Call your Poison Control Centre (inside front cover of this telephone book).
4. You may also have to call an ambulance. If so, ensure poison container and contents go with victim to hospital.

B. FOR INHALED POISONS such as exhaust fumes:

1. Be sure you don't also become a victim.
2. Remove source of fumes. For example, "turn off the engine."
3. Move victim to fresh air.
4. Call emergency ambulance number.
5. If needed, start artificial respiration. (See point 4)

C. FOR POISONS IN CONTACT WITH SKIN OR EYES

1. Flood area with cold running water for at least 15 minutes, (flush eyes gently).
2. Call ambulance emergency number while flooding area.

3. Remove contaminated clothing.
4. Do **not** use chemical antidotes.

D. FOR SWALLOWED HOUSEHOLD CHEMICAL POISON:

1. CONSCIOUS victim

- (a) Call Poison Control Centre
- (b) Give milk or water. For adult — 1-2 cups; For child — 1/2-1 cup.
- (c) Only induce vomiting on advice of Poison Control Centre or physician. Use Syrup of Ipecac (available without prescription at pharmacies).
- (d) To avoid inhalation of vomit, place victim's head low.
- (e) If poison is a hydrocarbon or corrosive, do NOT induce vomiting, but give milk or water.

2. UNCONSCIOUS victim

- (a) Call emergency ambulance number.
- (b) Place victim in recovery position. (See fig. 3)
- (c) Watch breathing. Start artificial respiration, if necessary. (See point 4)
- (d) Do not induce vomiting in unconscious victims.

Glossary

GLOSSARY

Abduction.	Movement away from the midline of the body.
Active — assisted exercise.	A movement performed by the client with some assistance.
Active exercise.	A movement performed by the client without assistance.
Acute.	Sharp or severe. An illness that comes on suddenly and usually lasts a short time.
Adduction.	Movement toward the midline of the body.
Affected.	The injured or disabled part of the body. The weak part.
Aids.	Equipment or supplies that assist a client or are useful in the care of a client.
Alzheimer's disease.	Deterioration of brain tissue leading to memory loss, confusion, and disorientation. The cause of this disease is unknown.
Angina.	A chest or heart pain usually coming from exertion or emotion. The pain may radiate down the left arm. Angina is relieved by rest or nitroglycerine.
Antibiotic.	Medication that weakens or kills pathogenic microorganisms.
Antiseptic.	A solution or agent that slows or prevents the growth of microorganisms.
Aphasia.	A partial or complete inability to speak. A person who has aphasia may be able to understand spoken or written words.
Arteriosclerosis.	Hardening of the arteries. Arteries become hardened and limit the flow of blood.
Arthritis.	Deterioration and pain of the joints. Osteoarthritis most often affects the weight-bearing joints of elderly people. Rheumatoid arthritis affects the joints such as wrists, fingers, ankles, and knees of people of all ages.
Asepsis.	Free of disease-causing microorganisms.
Asthma.	A difficulty breathing due to tightness of the smaller respiratory passageways. Asthma may be caused by allergy, swelling, or infection.
Atrophy.	A shrinking and weakening of a body part.
Axilla.	Underarm area: armpit.
Bed cradle.	A frame placed over the body to keep the pressure of the bed covers off a body part.
Bedpan.	A container used for urinary or bowel elimination by clients confined to bed.
Beliefs.	Personal convictions or opinions about people, things, or life in general.
Bladder.	The body reservoir or holding tank for urine.

Blood pressure.	The force of blood on the blood vessels.
Body alignment.	Ideal position of parts of the body with respect to function and comfort.
Body mechanics.	Safe, correct use of the body to do work.
Calories.	The amount of energy contained in food.
Carbohydrate.	A basic food element supplying the energy necessary for good body functioning. Sugar and starch are both carbohydrates.
Carbon dioxide (CO₂).	Waste gas produced by body cells. CO ₂ is eliminated from the body by the respiratory system.
Cardiac.	To do with the heart. The cardiac muscle is the heart.
Cataract.	The lens of the eye becomes cloudy, reducing sight. A cataract can be removed surgically, and then contact lenses or eye glasses can be used to improve vision.
Catheter.	A tube used to drain fluid from a body cavity. A urinary catheter drains urine from the bladder.
Cell.	Smallest living unit of the body. All body parts are made up of cells.
Cerebral vascular accident (C.V.A.).	A stroke. A clot or broken blood vessel in the brain that can cause loss of function such as paralysis, speech difficulties, and visual problems.
Chemical restraints.	Medications that calm clients in order to keep them safe.
Chronic.	An illness or condition that lasts a long time.
Colostomy.	An artificial opening through the abdomen into the large bowel for elimination of feces. The opening may be either temporary or permanent.
Commode.	A portable chair for toileting.
Communication.	Conveying a message through words, spoken or written, and body language.
Condom catheter.	A sheath of rubber or plastic worn over the penis and attached to a drainage system. Used for males incontinent of urine.
Confusion.	A mental state in which a person appears bewildered and may speak or behave inappropriately.
Congestive heart failure (C.H.F.).	A back-up or congestion of blood in the heart that slows the heart's pumping action. In time a C.H.F. can affect other organs besides the heart.
Constipation.	Infrequent bowel movements that are small, hard, and difficult to pass.
Contracture.	A tightening and shortening of a muscle due to lack of use. A contracted muscle does not function normally.
Conversion.	A psychological defense mechanism using illness as a means of escaping unpleasant situations.
Cyanosis.	Bluish or grayish colour of the skin caused by a lack of oxygen.
Cystitis.	Bladder infection.
Deceased.	Dead.

Decubitus ulcer.	A bedsore. An ulcer or open sore caused by prolonged pressure on an area of the body.
Defecation.	Elimination of feces from the bowel.
Defense mechanism.	A protective device used by the body to keep itself safe from physical or psychological harm.
Denial.	A psychological defense mechanism by which a person denies intolerable facts or feelings.
Development.	Changes that take place in an individual as a result of learning and the acquiring of new abilities.
Developmental tasks.	Tasks that most people learn to do at certain stages of development.
Diabetes.	Condition in which the body cannot convert sugar into energy.
Digestion.	The breaking down of foods into forms useable by the body cells.
Discrimination.	Singling out people for favor or disfavor.
Disorientation.	A condition in which an individual cannot recognize time, place, or persons.
Displacement.	A psychological defense mechanism transferring a feeling from one situation to another.
Distention.	State of being enlarged, inflated, or swollen.
Downs' syndrome.	A condition of retarded (slow) mental and physical growth and development that an individual is born with (congenital).
Eczema.	An irritating and often dry, scaly skin rash that may be due to an allergy. Usually not infectious.
Edema.	An abnormal swelling due to a collection of fluid in the area.
Emesis.	Vomited fluid.
Empathy.	Seeing or feeling the same about a situation as another person does.
Emphysema.	Shortness of breath due to lung tissue damage interfering with the oxygen — carbon dioxide exchange.
Endocrine glands.	Glands that produce hormones for regulating body functions.
Enema.	Introduction of a solution into the rectum stimulating the bowel to eliminate.
Environment.	Total surroundings affecting growth and development and all aspects of living.
Epilepsy.	A condition causing seizures or convulsions.
Extended family.	Parents, children, grandparents, aunts, uncles, and cousins living together as a family.
Extension.	Straightening of a body part.
Extremities.	Arms, hands, legs, and feet.

Fantasy.	A psychological defense mechanism using daydreaming and make-believe to escape reality.
Fat.	A basic food element supplying energy. Fat contains vitamins A,D, and K.
Feces.	Solid wastes eliminated by the digestive system through the rectum.
Feedback.	A response that shows whether a message is understood.
Fever.	Body temperature is higher than normal.
Flexion.	Bending of a body part.
Fracture.	A break in a bone.
Functional movement.	Movements carried out by the body during normal, daily activities.
Gastric ulcer.	An open area in the lining of the stomach that causes indigestion, pain, and often bleeding.
Geriatric.	A medical condition related to aging. Often wrongly used to mean any person over 65 years of age.
Glaucoma.	Increased pressure inside the eye. If glaucoma is not treated, it can interfere with sight.
Gout.	A disease that causes swelling, redness, and pain of joints thought to be caused by difficulty digesting protein.
Growth.	Increase in body size.
Haemorrhoids.	Varicose veins of the rectum that may make defecation difficult and painful.
Hemiplegic.	A person who is paralyzed on one side of the body.
Hiatus hernia.	A condition in which a portion of the stomach pushes through the muscular diaphragm beside the esophagus causing feelings of fullness and discomfort when lying flat.
Horizontal communication.	Communication between people at the same level in an organization.
Hormones.	Chemicals produced by the endocrine glands to regulate body functions.
Hygiene.	Habits that promote good health, e.g., cleanliness.
Incontinent.	Unable to control elimination. A person can be incontinent of urine or stool or both.
Involuntary.	Not under direct control.
Joints.	Place where two bones of the skeletal system meet. The joint allows the bones to move.
Kilogram.	A metric measure of weight equal to 1 000 grams or 2.2 pounds.
Lateral.	To the side.
Laxative.	A medication that stimulates the elimination of feces.
Lifting sheet.	A strong sheet placed under a client from the shoulders to mid-thigh and used as an aid in turning and lifting clients.

Lubricant.	A substance used to make a surface smooth or moist and lessen friction.
Masturbation.	Obtaining sexual pleasure by fondling one's own genitals.
Mechanical restraints.	Devices designed to safely secure clients.
Menopause.	The change of life. The time of life when a female stops menstruating, usually between 45 and 50 years of age.
Menstruation.	The monthly period. A regular discharge of blood from the uterus.
Metabolism.	The sum total of all body processes involved in producing the energy needed by the body cells for proper functioning.
Microorganism.	Tiny living things only visible through a microscope.
Minerals.	Basic food elements necessary for proper functioning.
Motor impulse.	A message from the brain telling the muscles to move.
Multiple sclerosis.	A condition in which there is an increasing loss of muscle control due to deterioration of nerve parts.
Muscular dystrophy.	An inherited disease in which there is increasing wasting of the muscles.
Myocardial infarction (M.I.).	A coronary. An abrupt clogging of an artery that carries blood to the heart muscle. An M.I. causes part of the heart muscle to die and thus the heart works less efficiently or stops.
Nephritis.	Kidney infection.
Nonjudgmental.	Accepting opinions and feelings of others without stating personal opinion. Does not necessarily mean being in agreement with.
Nonverbal communication.	Communicating or conveying a message using no words. Gestures, posture, facial expressions and other forms of body language are used to convey nonverbal messages.
Nuclear family.	Parents or parent and children living together.
Nutrients.	Nourishing elements in food.
Nutrition.	The nourishment of the body by food.
Objective reporting.	Reporting exactly what is observed without stating an opinion.
Organ.	A body part made of several types of tissue working together carrying out a function.
Ova.	Eggs released regularly by the female ovaries.
Oxygen.	Gas needed by body cells for proper functioning.
Paralysis.	A part of the body is unable to move because motor impulses don't get through to it.
Paraplegic.	A person who is paralyzed in the lower half of the body.
Parkinson's disease.	A progressive disease of the brain causing weakness or shaking of muscles usually during purposeful movements.

Pathogenic microorganisms.	Tiny living things (germs, bacteria, and viruses) capable of causing infection or disease.
Perineum.	Commonly used to refer to the genital and rectal area. In strict medical terminology it refers only to the area between the genitals and rectum.
Plegia.	Paralysis. Lack of movement of a body part due to interference in nerve control.
Prejudice.	Forming an opinion about someone or something before really understanding or knowing the person or thing.
Projection.	A psychological defense mechanism placing the blame for personal shortcomings onto someone or something else.
Prone.	Lying face downwards.
Prostatitis.	Enlargement or inflammation of the male prostate gland causing difficulty in the passing of urine. It may require surgery to correct.
Protein.	A basic food element needed for growth and repair of the body and for general body functioning.
Psoriasis.	A chronic, noninfectious, scaly skin rash of unknown cause.
Pulse.	The beat of the heart felt through the walls of the blood vessels (arteries).
Quadriplegic.	A person whose upper and lower parts of the body are paralyzed.
Radial pulse.	The beat of the heart felt at the thumb side of the inner wrist.
Range of motion (R.O.M.).	Exercises done under the direction of a physiotherapist.
Rationalization.	A psychological defense mechanism using an acceptable excuse for unacceptable behavior.
Repression.	A psychological defense mechanism forcing an unpleasant idea or memory out of consciousness.
Respiration.	Breathing.
Restraint.	Chemical or physical limitation of a person's movement or freedom.
Rotation.	Circular movement of a body part.
Roughage.	A basic food element aiding in proper elimination of solid waste.
Scapegoating.	Blaming someone or some group for a mistake or problem that they are innocent of or at most only partly responsible for.
Self-esteem.	A positive feeling of one's own worth or ability.
Self-image.	The way a person sees herself or himself.
Sensory impulse.	A message from body parts to the brain.
Significant others.	People other than family who are important to an individual.
Sperm.	The male reproductive cell.
Sphincter.	A muscle that encircles a body opening allowing it to be opened and closed.

Stereotyping.	Forming a standard, oversimplified view of people based on their being a member of a group.
Stool.	Solid wastes eliminated by the digestive system through the rectum.
Stroke.	A clot or broken blood vessel in the brain that can cause loss of function such as paralysis, speech difficulties, and visual problems. Medical term is cerebral vascular accident (C.V.A.).
Subjective reporting.	Reporting your opinion about an observation.
Supine.	Lying face upwards.
Suppository.	A bullet-shaped preparation of lubricant or laxitive medication inserted into the rectum usually to aid elimination of feces.
System.	Body unit made up of several organs working together to perform general functions. May also refer to a set of connected parts or agencies such as the health and social services system.
Temperature.	The measurement of body heat, normally about 37°C when taken by mouth.
Tissue.	A body part made up of various cells working together to perform a task.
Transfer.	Movement of clients from one piece of furniture or equipment to another.
Urine.	Liquid wastes eliminated by the urinary system through the urethra.
Values.	Personal feelings about the worth of people, things, or life in general.
Varicose veins.	Swollen, enlarged veins that slow down blood flow and cause discomfort.
Verbal communication.	Using words to state or write a message.
Vertical communication.	Communication between people at different levels in an organization.
Vital signs.	Temperature, pulse, and respirations.
Vitamins.	Basic food elements necessary for proper functioning of the body.
Voiding.	Elimination of urine.
Voluntary.	Under direct control.
Withdrawal.	A psychological defense mechanism by which a person physically or emotionally removes himself or herself from a situation.

Answer Key For Exercises.

EXERCISE 1-1

Crossword

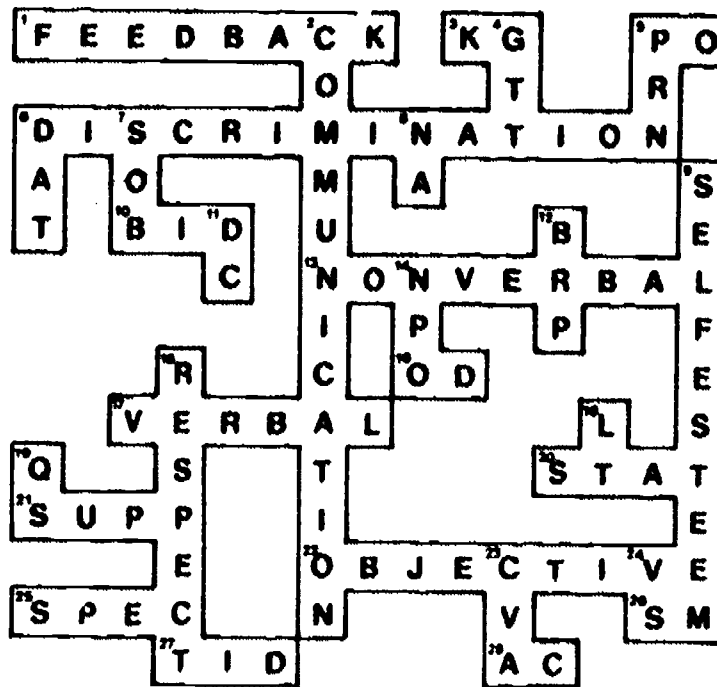

Questions

1. About 90% of communication is nonverbal.
To check that body language matches words.
Nonverbal communication is often more accurate than verbal communication.
Body language can leave a wrong impression that reduces a care giver's effectiveness.
2. Sender. Use the right words and appropriate body language.
Receiver. Listen carefully, observe the body language, and give feedback.
3. a. 3
b. 2
c. 1
4. People get frustrated and feel misunderstood if you do not recognize their feelings. Also, recognizing feelings encourages good communication.
5. If you do everything for clients, you take away their independence, and their self-image suffers.
6. a. 3
b. 4
c. 2
d. 1
7. Please, thank you, hello, goodbye, may I, excuse me, how are you, good morning, good afternoon, good evening, can I help you? These are a few of the many phrases showing courtesy.
8. To eliminate unwanted or upsetting surprises, allowing the client to gradually adjust to the event.
9. Prepare the client for the situation, and monitor the client in the situation. Or, if the situation is too upsetting, avoid it all together.

10. Don't form hard-and-fast opinions about clients. Remain open-minded.
11. No. The client could be angry at something totally different and is just using the food as an excuse to release anger.
12. Announce your arriving and leaving to the client.
13. Describe the location of the object, and, if possible, guide the blind person's hands to the object.
14. Face the client, and lower the tone of your voice.
15. Writing down the note or message.
16. High fever, anxiety, infection, medication problems, a change of living environment.
17. Appearance, behaviour, and conversation.
18. Your observations help to ensure that clients receive exactly the type of care they require.
19. Objective reporting. Reporting exactly what you observe. Subjective reporting. Giving your opinion about an observation. Objective reporting is used most often.

EXERCISE 2-1

Questions

1. a. 3
b. 4
c. 1
d. 2
2. a. 4
b. 7
c. 9
d. 6
e. 1
f. 2
g. 10
h. 3
i. 5
j. 8
3. Diaphragm.
4. Reduce.
5. Liver, gall bladder, and pancreas.
6. Dribbling or leakage of urine when sneezing or coughing.
7. The muscle can shrink and become weaker or atrophy.
8. Brain, spinal cord, and nerves.

EXERCISE 2-2

Crossword

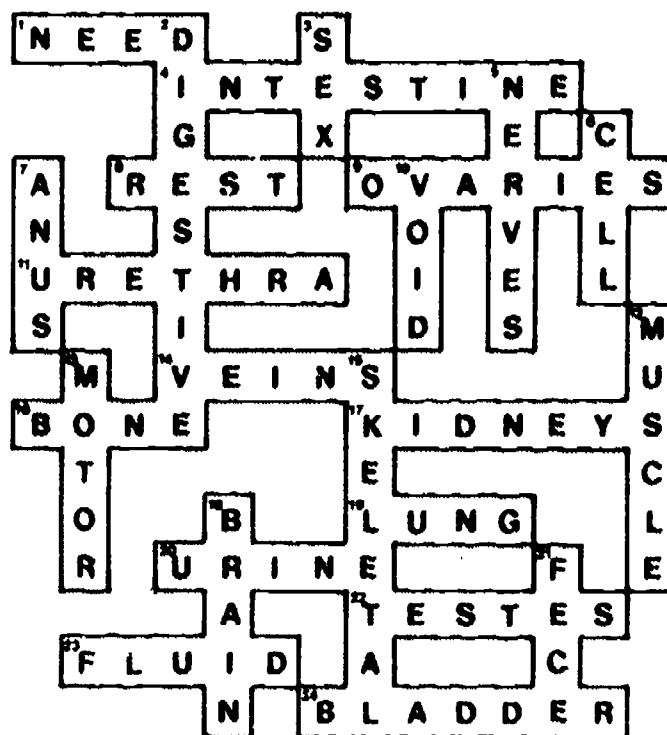

Questions

1. Oxygen, food, fluid, rest and sleep, mobility, elimination.
2. Government agencies may provide financial assistance or help with meal preparation.
3. They will sleep less at night, but have a rest during the day.
4. Constipation is a condition of hard, dry stool that is difficult and even painful to pass, and is passed less frequently than normal. Steps to prevent it are:
 - Exercise
 - Eating roughage
 - Drinking 2-3 litres of fluid per day
 - Regular routine for elimination
5. 24.
6. To neutralize and destroy infection that enters the body.
7. False. A single type of antibody is specially formed to fight a single disease.
8. Pain alerts people that they have an injury, infection, or illness and should do something about it.
9. Location, time started, type of pain, severity, and factors affecting the pain.
10. True.
11. Three reasons are:
 - To avoid problems
 - To make the world appear better than it is
 - To make their behaviour appear more reasonable and acceptable to themselves and others.

12. The client has inadequate stimulation.
13. Deteriorates, is reduced, etc.
14. Consenting adults have a right to private, sexual expression.
15. You should treat it as private space and knock or otherwise announce your presence before entering.
16. Recognize them as people and as achievers.
17. Respect the beliefs and values of your clients. They are entitled to their beliefs just as you are entitled to yours.
18. The belief that everyone, regardless of personal circumstances or personal qualities, has worth and is entitled to respect as a human being.
19. Excessive anxiety, depression, fearfulness, anger, instability, difficulty in sleeping, increased drinking, and uncharacteristic behaviour.
20. Stress can cause people to neglect their health by not getting the correct amount of food and fluid, rest and sleep, and mobility.
21. An understanding of the problems causing the stress.

EXERCISE 2-3

Crossword 1

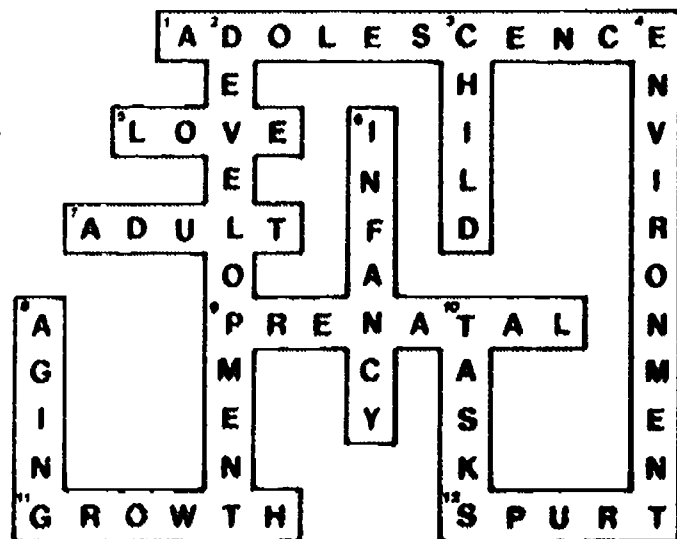

Crossword 2

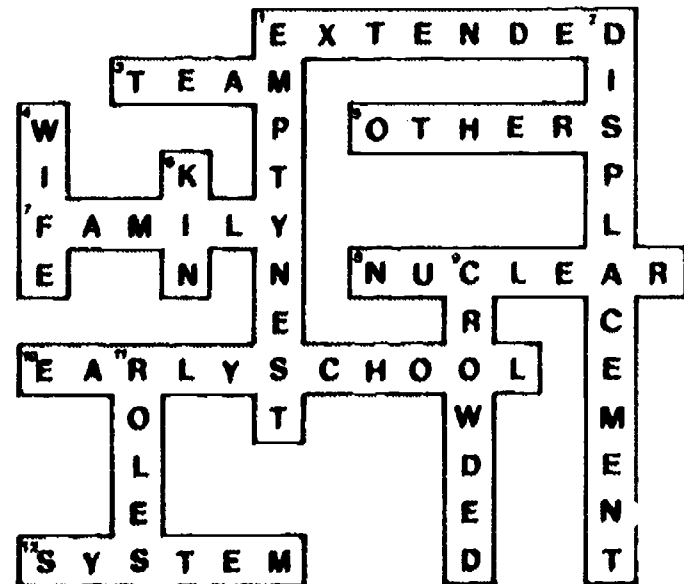

Questions

1. a. 4
b. 6
c. 1
d. 8
e. 2
f. 5
g. 3
h. 7
2. Their attitude.
3. People who closely identify with a job and who have not developed a very positive view of themselves as a person separate from their work.
4. Loss of independence
Separation from family and friends
Change in environment
5. Allow residents to bring personal possessions and furnishings.
Have community involvement with the institution.
Allow residents some say in their own schedule.
Have liberal visiting hours.
Allow the client to leave the institution and stay with friends or family.
Get the family involved in the client's care.
6. That the confusion is most likely a temporary reaction caused by difficulties in adjusting to institutional living.
7. Family.
8. The individual family member might be irresponsible and have a poor self-image and poor communication skills.
9. Because these problems can worry and depress your client.
10. If the client wants it, and if the family wants to.
11. Ignore your own feelings and go along with the family, but at the same time ensure that the client gets the required care.
12. Support their care, reassure them, and leave simple-to-follow care directions.
13. Personality, helpfulness of the family, physical ability, mental clarity, availability of a bed in an institution, the wishes of the client and the client's family, and the availability of home care assistance.
14. Denial, anger, bargaining, depression, acceptance.
15. Come to grips with your own feelings and fears about death.
16. Pain. Let the client know that with modern pain-killing medication people do not have to die in pain.
Being alone. Reassure the client that someone will always be close by. If family is not present, sit with the client when you can.
Losing control. Try to leave some decisions for the dying person to make or at least participate in.

Being a burden. Reassure the person that he or she is not a burden. Pay frequent, willing visits and carry out tasks without complaint.

17. Comfort.
18. Mouth. Special mouth care procedure.
Eyes. If eyes are open, drops may be needed.
Pressure areas. Turning and rubbing.
Respiratory distress. Humidifier, positioning, or whatever measure it takes to relieve the distress.
Fluids. Give fluids of choice as long as they are tolerated.
19. Ensure the body is clean and comfortably positioned and dentures and other prostheses are in place.
20. Be honest but gentle.

EXERCISE 3-1

Crossword

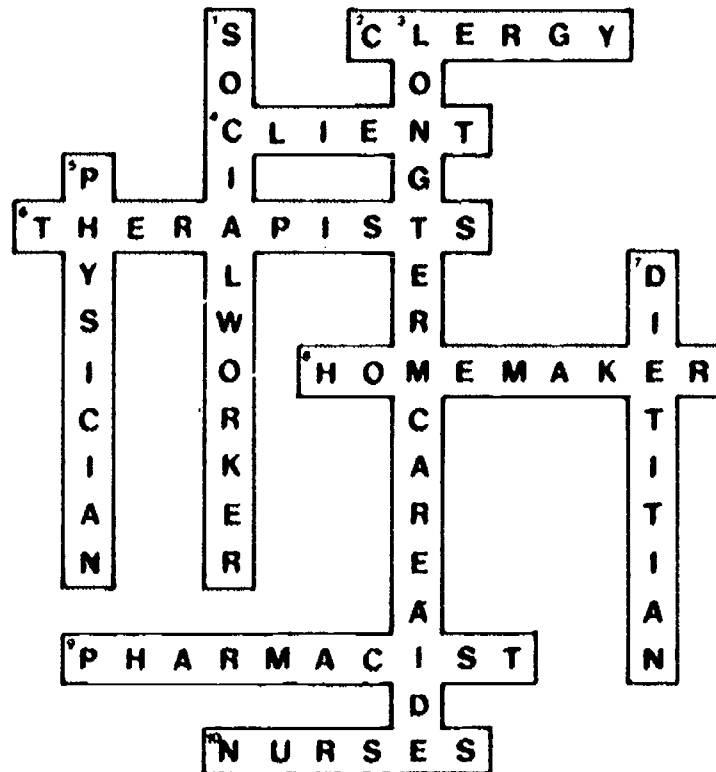

Questions

1. Horizontal communication occurs between people who are at the same level in an organization; vertical communication takes place between people at different levels.
2. Handyman services, homemaker services, and home care.
3. Registered nurse.
4. Municipal hall.
Community service centre.
Social services guide in the telephone directory.
Your supervisor.

5. a. 2
b. 3
c. 4
d. 1
6. Yes. Ignorance of the law is no excuse.
7. a. 3
b. 4
c. 7
d. 6
e. 1
f. 5
g. 2
8. Because if you accept money, you have to have special liability insurance that is much higher than the liability insurance you would normally carry.
9. Check it over; it should be clearly written, concise, accurate, and complete.
10. "The Supervisor" . . . "Dear Madam:"
11. The qualifications. You want to show that you have the qualifications for the job.
12. Resume.
13. Make arrangements for the interview in a business-like way.
Be punctual.
Pay special attention to dress and grooming.
Be well prepared for the interview.
Watch your non-verbal behaviour.
Communicate effectively.

EXERCISE 4-1

Questions

2. Cluttered surroundings.
Furniture that is broken or poorly balanced.
Poor lighting.
Poor smoking habits.
Electrical appliances with frayed cords.
Open stairways.
Hot liquids or heating devices.
Equipment in poor working order.
Poor body mechanics
3. Poor sight, poor hearing, lack of sensation, mental confusion.
4. Chemical restraints are medications that calm clients to keep them safe. Mechanical restraints are devices that physically and safely secure clients in a safe environment.
5. A physician.
6. Restrained clients must be checked at least hourly.

7. Restraints should be periodically loosened or removed during which time the client should be supervised.
8. Doctors and qualified nurses.

EXERCISE 4-2

Crossword

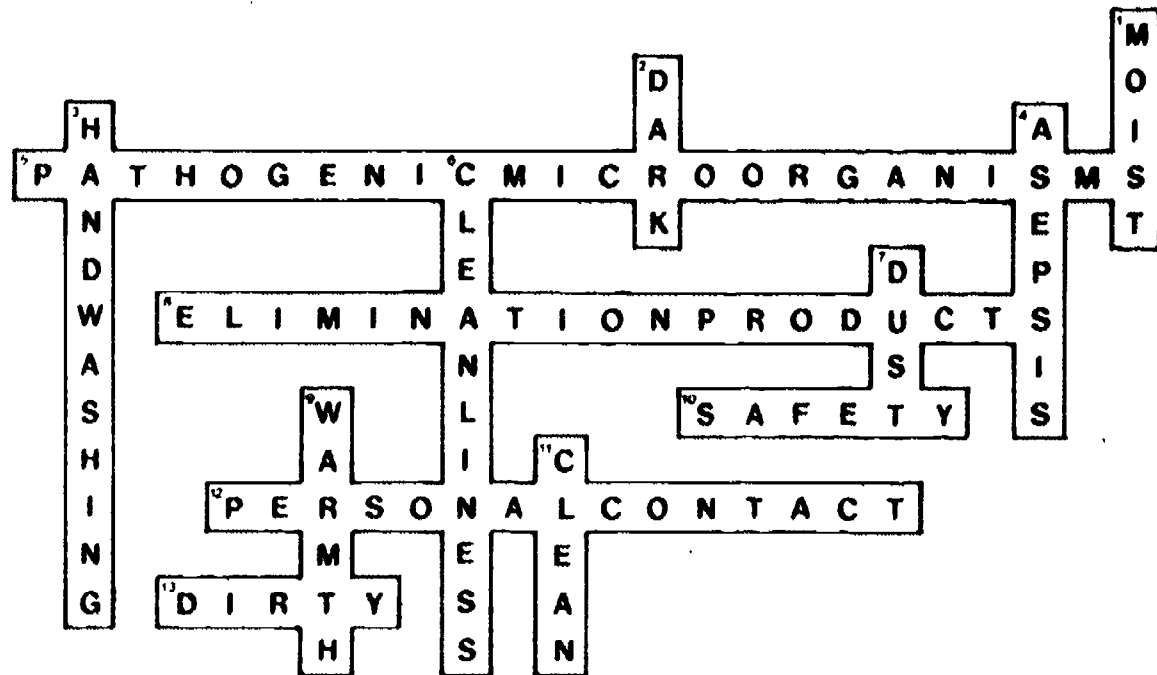

Questions

1. Work from clean to dirty.
Work from far to near and top to bottom.
Touch clean to clean and dirty to dirty.
3. Don't hug it to your clothing.
Don't place it on the floor.
Don't shake it.
4. It saves time and energy.
5. So as not to recontaminate your hands.
6. Just after it has been used.
7. The mixing could cause a chemical reaction that is harmful to you or the item you are cleaning.
8. False. The small appliance should be unplugged before it's wiped down.
9. A mixture of ammonia and water.
10. True.
11. Commercial.
12. A non-abrasive cleaner, since abrasive cleaners will scratch these surfaces.

13. Routinely.
14. Bed linen wrinkles can lead to bedsores from body pressure on the wrinkles.
15. 14 to 18 inches.
16. The bottom sheet, top sheet, and blanket.
17. Red means do not apply this procedure to this garment.
Yellow means use caution and seek further information on this procedure.
Green means go ahead, no special precautions needed.
18. a. 3
b. 4
c. 5
d. 1
e. 2
19. Ventilation, light, temperature, humidity, odours, and noise.

EXERCISE 4-3

Crossword

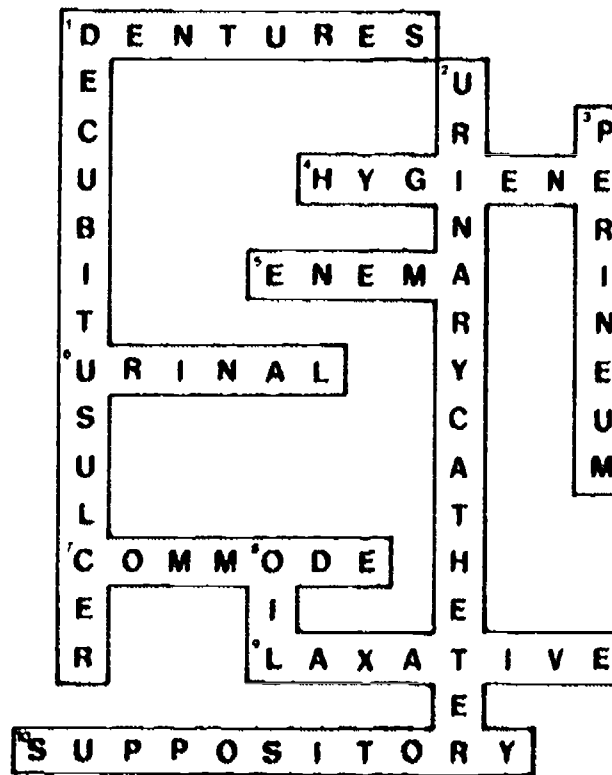

Questions

2. Because they may be embarrassed or ashamed that they cannot carry out their own hygiene care.
3. Before and after the procedure and anytime during the procedure that your hands become contaminated.

4. Have the bath area warm and bathing supplies and equipment handy.
5. Get the client to check the water temperature.
Leave the bath area door unlocked.
Wipe up water spills.
Use good body mechanics.
Encourage the client to use the hand rails and good body mechanics.
6. Face and hands, armpits, and the genital area.
7. False. Rinse and dry each part as it is washed.
8. Wash your hands before washing the baby.
Never turn your back on the baby.
Never leave the baby unattended.
Don't use Q-tips in the baby's nose or ears.
Support the baby's head.
9. Overdry skin.
Soiled skin.
Resting on wet surfaces.
Lying or sitting in one position too long.
10. Colour change, rash, bruise, break in the skin, pressure area.
11. Two.
12. To rid the mouth of foreign material.
To keep the mouth moist and in good condition.
To keep the breath fresh and the mouth pleasant tasting.
To help prevent tooth decay or denture problems.
13. False. They should be put in a cup filled with fresh water or mouthwash.
14. After a bath because the nails are softer.
15. With a washcloth.
16. The style must be according to the client's wishes.
17. Apply a hot, moist washcloth to the beard a few minutes before shaving.
18. a. Have the client bend the legs and push up with the feet to raise the hips. Assist as needed by raising the lower part of the client's back as you slip the bedpan into position.
b. Roll the client away from you on the client's side. Place the bedpan in position against the buttocks and hold it there while you assist the client to roll back onto the pan.
19. Ensure privacy by closing the door or curtain.
Expose as little of the client as possible.
Complete the task quickly and efficiently.
Use a calm, matter-of-fact approach.
Do not show distaste.
20. The urinary opening is the cleanest and the rectum (anus) is the dirtiest.
21. Dress the left side first, undress the right side first.
22. Exercise.
Diet.
Fluid intake.

Age.

Patterns of elimination.

Body position.

Stress and tension.

Privacy.

23. Changes in the:

Usual pattern of elimination.

Amount and frequency of elimination.

Elimination product.

Client's behaviour.

24. Straw coloured, clear, not strong smelling.

25. Right procedure.

Right method.

Right client.

Right time.

26. Right dosage or amount.

27. Selecting the right container.

Collect the right specimen.

Using the correct method.

Correctly label the container.

Use good cleanliness techniques.

Deliver the specimen to the correct location.

28. Sugar, acetone.

29. Check that the tubing is not pulled tight and is not kinked or blocked.

EXERCISE 4-4

Crossword

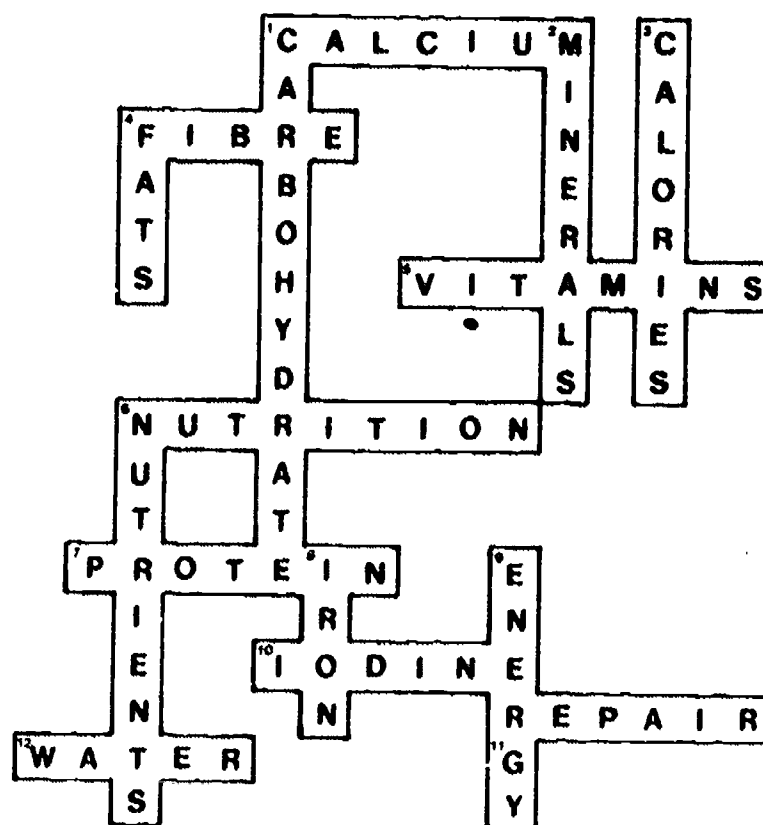

Questions

1. 1700 calories.
2. Milk and milk products.
Bread and cereals.
Fruits and vegetables.
Meat and meat alternatives.
3. A person should eat foods from all four food groups each day.
4. Stimulates or improves. Decrease.
5. Lack of nutrition knowledge.
Lack of cooking skills.
6. Make out a shopping list based on menu plans.
7. Calories.
Fibre; bulk, or roughage.
Chemicals.
Quantity of nutrients.
Irritating substances.
8. Provide meals and snacks at specified times.
Measure all foods prepared.
Follow the serving sizes in the menu outline.
Serve only foods listed on the diet.
Serve only the amounts listed on the diet.
Encourage eating of the entire meal or snack.

9. Vitamin B12, vitamin D, calcium, riboflavin.
10. Any of the following:
 - Cauliflower.
 - Green peas.
 - Lima Beans.
 - Brussels sprouts.
 - Broccoli (dark green and leafy).
11. Calcium and iron.
12. Unbalanced diets with low fluid and fiber intake. Irregular mealtimes.
13. Chewing difficulties because of missing teeth or poor fitting dentures.
14. Make up only as much orange juice as can be used in a few days because it loses its vitamin C in contact with air.
15. False. Nutrients are lost in cooking.
16. 4°C (40°F) to 60°C (140°F). Bacteria grows best at this temperature.
17. Before handling the food.
 - After going to the toilet.
 - After sneezing, coughing, blowing your nose, or touching your hair.
 - After touching unclean articles such as garbage.
18. The internal temperature of the meat will be 60°C (140°F).
19. Mix 1L of instant skim milk powder with 175 mL of cocoa and 25 mL of sugar.
20. Beat 50 mL of milk into 250 g of soft butter.
21.
 - a. 10
 - b. 5
 - c. 1
 - d. 6
 - e. 3
 - f. 4
 - g. 9
 - h. 8
 - i. 2
 - j. 7
22. Cost, time saved, quality, nutritional value, client's preference.
23. Clients are sensitive about not being able to feed themselves. Do what you can to protect their self-image and encourage them to do as much of the feeding as they can or are able.
24. The environment should be clean and pleasant. If possible, let clients eat where they want with whom they want. Assist with hand washing and toileting prior to the meal. Supply serviettes or aprons to those needing them. Make sure the client is comfortably positioned.
25. 3-6 months.
26. ¼ tsp. to 1 yolk.
27. Consistency: soft
Temperature: lukewarm, not hot

Amount of spice: little
Serving size: small, manageable

28. 2 to 3 litres.

29. Urine, vomit, wound drainage, blood loss, excessive perspiration.

EXERCISE 4-5

Crossword

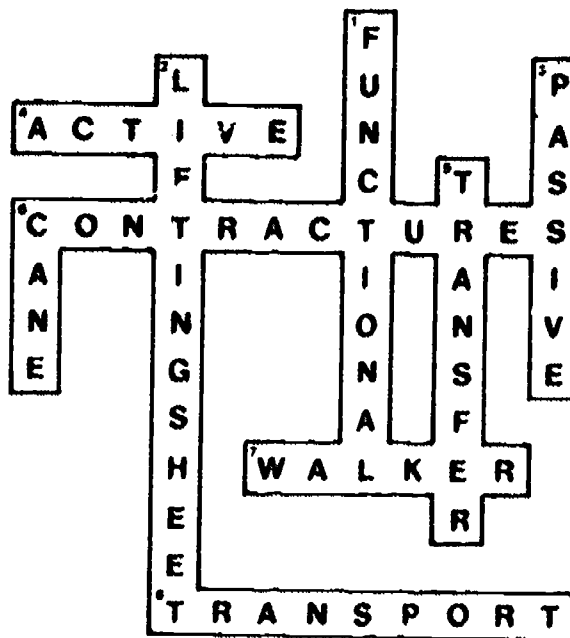

Questions

1. Bend your knees and keep your back straight.
2. True.
3. Feet, back.
4. Changing the position of the limbs and the degree of flex in the joints.
5. Log rolling prevents twisting of the client's back.
6. Plan the transfer: organize yourself, the client, and the environment for the move.
7. Strong.
8. Set the brakes and raise the footrests.
9. To give a firm holding place on which to grasp a client during a transfer.
10. Stay downhill from the client.
Back onto and off elevators.
11. a. Push from the head end.
b. Push from the feet end so that the client's head is uphill.
12. Inactivity.
13. Slowly . . . smoothly . . . pause.

14. a. Walker.
b. Weak leg.
c. Strong leg.
15. To keep clients interested and participating in activities.
16. Restlessness.
Tenseness.
Irritability.
Thought impairment.
Anxious or pained expression.
Distorted posture or position.
17. Stay with the client until he or she is asleep.
See that the client sleeps in a room with others.
See that the client has a bedside radio.
18. Prior to going to sleep do a security check or tour of the house with the client.
19. Bed cradle. A rack that keeps the covers off a part of a client's body.
Monkey bar. An overhead hand-hold.

EXERCISE 4-6

Questions

1. Stay calm.
Seek assistance.
Apply your training.
Protect clients and yourself.
2. Fuel, heat, and oxygen.
3. a. Protect the client.
b. Sound the alarm or telephone the fire department.
4. a. 3
b. 1
c. 2
5. By applying gentle pressure to the cut.
6. Their bones are brittle and break easily.
7. Redness, heat, swelling, pain.
8. True.
9. Yes. You should wait 20 minutes after a client eats, drinks or smokes to take the client's temperature by mouth.
10. Under the tongue . . . 3 to 5. Into the center of the armpit . . . 10.
11. Oral: 37.4°C. Axillary: 36.8°C.
12. Because your thumb has a pulse of its own that may interfere with counting the client's pulse.

13. Grand mal. Convulsions with shaking or stiffening.
Petit mal. Convulsions without shaking or stiffening.
14. Protect the client from injury.
Do not restrain the client.
Provide privacy.
Remain with the client.
15. To prevent breathing in (choking on) the liquid vomit.
16. The mouth open and the hand clutching the throat.
17. The person can be unable to speak and the face can turn bluish or dusky red.
18. a. Support the choking person's chest with one arm, then give four firm blows with your hand to the back between the shoulder blades.
b. Hugging the person from the back, squeeze your fist firmly with an upward motion into the top of the abdomen four times.
c. If the person still can't speak, repeat steps a and b.

EXERCISE 4-7

Questions

1. a. 4
b. 5
c. 2
d. 1
e. 6
f. 3
2. Gram g
Millilitre mL
Kilogram kg
Metre m
Litre L
Centimetre cm
3. a. $96 \text{ kilograms} \times 2.2 = 211.2 \text{ pounds}$.
b. $36 \text{ inches} \times 2.54 = 91.44 \text{ centimetres}$.
c. $88 \text{ pounds} \div 2.2 = 40 \text{ kilograms}$
d. $31 \text{ centimetres} \div 2.54 = 12.2 \text{ inches}$