

DOCUMENT RESUME

ED 249 090

SE 045 098

TITLE Engineering Aid 3 & 2, Vol. 1. Rate Training Manual and Nonresident Career Course.

INSTITUTION Naval Education and Training Command, Washington, D.C.; Naval Education and Training Program Development Center, Pensacola, Fla.

REPORT NO NAVEDTRA-10634-C

PUB DATE 80

NOTE 332p.

PUB TYPE Guides - Classroom Use - Materials (For Learner) (051)

EDRS PRICE MF01/PC14 Plus Postage.

DESCRIPTORS Administration; *Administrative Organization; *Drafting; *Engineering; *Equipment; Independent Study; *Mathematics; Metric System; Military Personnel; *Military Training; Postsecondary Education; Supplies

IDENTIFIERS Naval Education and Training Command

ABSTRACT

Designed for individual study and not formal classroom instruction, this rate training manual provides subject matter that relates directly to the occupational qualifications of the Engineering Aid (EA) rating. This eight-chapter volume focuses on administrative matters, mathematics, and basic drafting. Chapter 1 discusses the scope of the EA rating, requirements and procedures for advancement, and how to make the best use of the manual. Chapter 2 discusses the EA's administrative and supervisory duties, safety responsibilities, purpose of the Personnel Readiness Capacity Program, and other areas. Chapter 3 deals with EA mathematics, mechanical aids used for making computations, and units of measurements. Chapter 4 discusses basic drafting equipment and supplies. Chapter 5 explains basic drafting principles and techniques using the drafting equipment described. Chapter 6 examines the techniques of freehand and mechanical lettering. Chapter 7 describes the use of basic drafting equipment needed in preparing drawings. Methods of projection used in showing objects on drawings are described and illustrated in chapter 8, as well as methods and techniques used in freehand drawing. A glossary, information on the metric system, and sets of mathematical tables are included in appendices. Assignments (in multiple choice format) are also included for each chapter. (JN)

 * Reproductions supplied by EDRS are the best that can be made *
 * from the original document. *

ED249090

U.S. DEPARTMENT OF EDUCATION
 NATIONAL INSTITUTE OF EDUCATION
 EDUCATIONAL RESOURCES INFORMATION
 CENTER (ERIC)

- ✓ This document has been reproduced as received from the person or organization originating it.
- Minor changes have been made to improve reproduction quality.
- Points of view or opinions stated in this document do not necessarily represent official NIE position or policy.

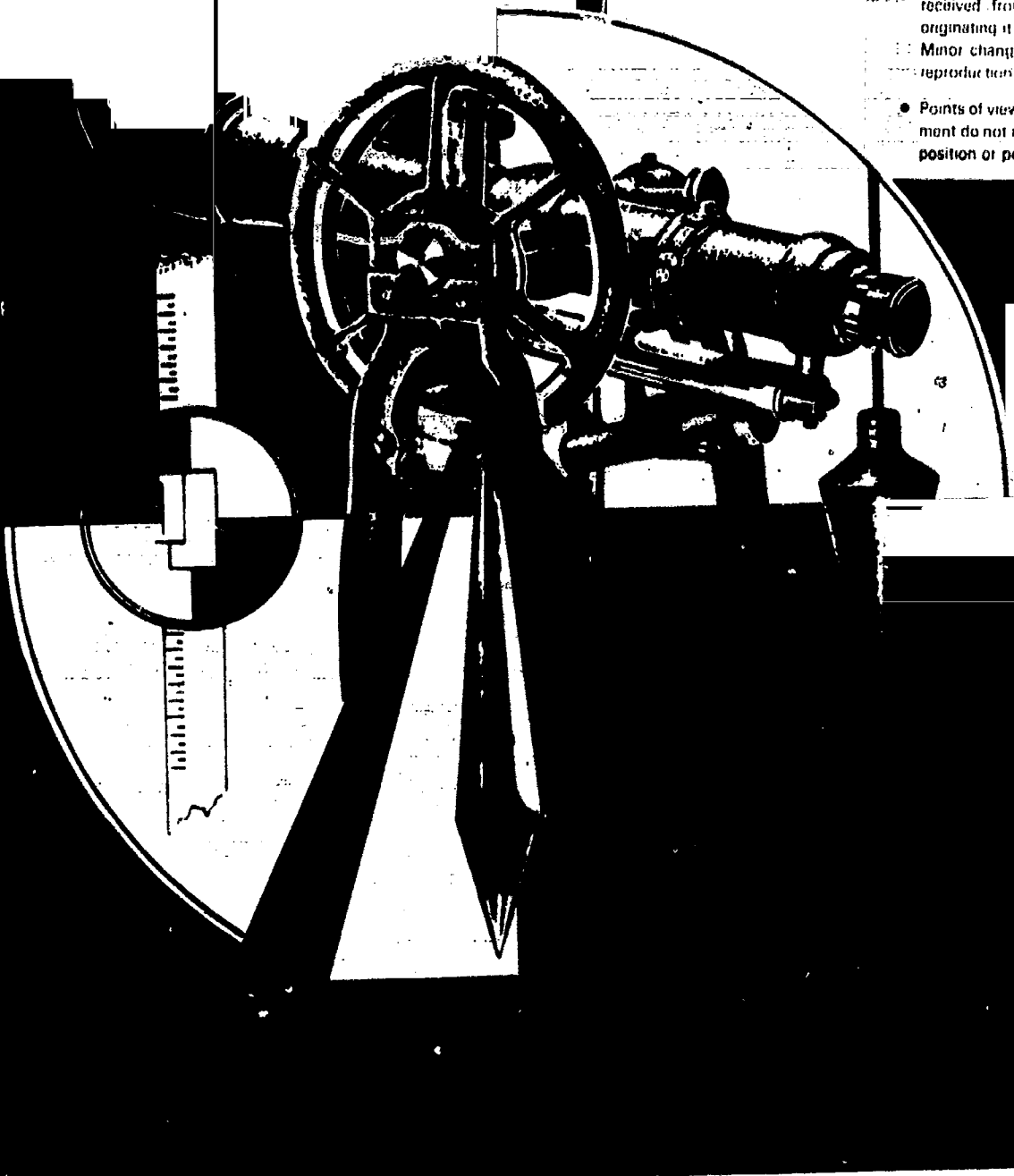

ENGINEERING AID 3 & 2, VOL. 1

NAVAL EDUCATION AND TRAINING COMMAND

RATE TRAINING MANUAL

AND NONRESIDENT CAREER COURSE

NAVEDTRA 10634 C

SE 045 098

PREFACE

This Rate Training Manual and Nonresident Career Course (RTM/NRCC) form a self-study package that will greatly aid ambitious Engineering Aids in fulfilling the requirements of their rating. Among these requirements are the abilities to perform tasks required in construction surveying, construction drafting, planning and estimating, and quality control; prepare progress reports, time records, construction schedules, and material and labor estimates; and establish and operate a basic quality control system for testing soils and concrete.

Designed for individual study and not formal classroom instruction, the RTM provides subject matter that relates directly to the occupational qualifications of the Engineering Aid rating. The NRCC provides the usual way of satisfying the requirements for completing the RTM. The set of assignments in the NRCC includes learning objectives and supporting items designed to lead students through the RTM.

This training manual and nonresident career course were prepared by the Naval Education and Training Program Development Center, Pensacola, Florida, for the Chief of Naval Education and Training. Technical assistance was provided by the Naval Facilities Engineering Command; the Naval Construction Training Center, Port Hueneme, California; the Naval Construction Training Center, Gulfport, Mississippi; and the Civil Engineer Support Office, Port Hueneme, California.

Revised 1976
Updated 1980

Stock Ordering No.
0502-LP-053-1710

Published by
NAVAL EDUCATION AND TRAINING SUPPORT COMMAND

UNITED STATES
GOVERNMENT PRINTING OFFICE
WASHINGTON, D.C.: 1976

THE UNITED STATES NAVY

GUARDIAN OF OUR COUNTRY

The United States Navy is responsible for maintaining control of the sea and is a ready force on watch at home and overseas, capable of strong action to preserve the peace or of instant offensive action to win in war.

It is upon the maintenance of this control that our country's glorious future depends; the United States Navy exists to make it so.

WE SERVE WITH HONOR

Tradition, valor, and victory are the Navy's heritage from the past. To these may be added dedication, discipline, and vigilance as the watchwords of the present and the future.

At home or on distant stations we serve with pride, confident in the respect of our country, our shipmates, and our families.

Our responsibilities sober us; our adversities strengthen us.

Service to God and Country is our special privilege. We serve with honor.

THE FUTURE OF THE NAVY

The Navy will always employ new weapons, new techniques, and greater power to protect and defend the United States on the sea, under the sea, and in the air.

Now and in the future, control of the sea gives the United States her greatest advantage for the maintenance of peace and for victory in war.

Mobility, surprise, dispersal, and offensive power are the keynotes of the new Navy. The roots of the Navy lie in a strong belief in the future, in continued dedication to our tasks, and in reflection on our heritage from the past.

Never have our opportunities and our responsibilities been greater.

CONTENTS

CHAPTER	Page
1. The Job Ahead	1
2. Administration and Organization	11
3. Mathematics and Units of Measurement	38
4. Drafting: Equipment and Supplies	92
5. Drafting: Basic Techniques, Format, and Conventions	120
6. Lettering	155
7. Drafting: Geometric Construction	169
8. Drafting: Projections and Sketching	188
APPENDIX	
I. Engineering Technical Library	225
II. Mathematics	
A. Mathematical Symbols	227
B. Weights and Measures	228
C. Geometric Formulas	229
D. Common Logarithms of Numbers	236
E. Squares, Square Roots, Cubes, and Cube Roots	237
F. Right Triangle and Oblique Triangle Formulas	238
G. Natural Sines and Cosines	242
H. Natural Tangents and Cotangents	251
III. The Metric System	263
IV. Glossary of Terms	265
Index	273
Nonresident Career Course follows Index	

CREDITS

The copyright illustrations listed below are included in this edition of *Engineering Aid 3 & 2, Volume 1*, through the courtesy of the designated sources. Permission to use these illustrations is gratefully acknowledged. Permission to reproduce illustrations and other materials in this publication must be obtained from the source.

<u>Source</u>	<u>Figures</u>
Eugene Dietzgen Co.	4-10, 4-17, 4-19, 4-27, 4-30
Keuffel and Esser Co.	4-4, 4-6, 4-9, 4-11, 4-13, 4-14, 4-21

CHAPTER 1

THE JOB AHEAD

If the Navy is to achieve Victory at Sea, each man must be well trained to ensure maximum performance of his assigned tasks. Adequate training requires every man to know his specific job and constantly keep abreast of new changes to his rating and improved professional techniques.

To get ahead you must meet certain requirements that have been specifically prescribed for each pay grade or rate level of your particular rating. These requirements are referred to as "standards." Since the standards for each rating deal with the technical or occupational subject matter of that rating, they are called "occupational standards."

In addition to the occupational standards prescribed for each rating, there are certain military requirements to be met. The military requirements for advancement are discussed briefly later in this chapter and are discussed in detail in special training manuals prepared to cover the military requirements for advancement. These military requirements are called "naval standards."

SCOPE OF THIS TRAINING MANUAL

In order to adequately cover the advancement qualifications for EA3 and EA2, this training manual has been expanded to more than one volume. Volume I is concerned with administrative matters, mathematics, and basic drafting. Subsequent volumes will deal with construction and construction drafting, surveying, and Quality Control.

This chapter deals with the scope of the Engineering Aid rating and the types of billets to which you may be assigned. Requirements and

procedures for advancement are discussed, as well as references that will help you—both in training for the future and in performing your duties as an Engineering Aid. This chapter also includes information on how to make the best use of Rate Training Manuals.

Chapter 2 of this volume discusses the EA's administrative and supervisory duties, safety responsibilities, purpose of the Personnel Readiness Capability Program (PRCP), and the organization and responsibilities of personnel assigned to the Operations Department of a Naval Mobile Construction Battalion and a Public Works activity.

Chapter 3 deals with Engineering Aid mathematics, mechanical aids used for making computations, and units of measurement. Chapter 4 introduces you to basic drafting equipment and supplies, as well as their proper care. Basic drafting principles and techniques with the use of drafting equipment are explained in chapter 5, along with the guidelines on standard drawing format and conventions. Chapter 6 deals with the techniques of freehand and mechanical lettering.

Chapter 7 describes the use of basic drafting equipment for making geometric constructions needed in preparing drawings. Methods of projection used in showing objects on drawings are described and illustrated in chapter 8, as well as methods and techniques used in freehand sketching.

THE ENLISTED RATING STRUCTURE

The two main types of ratings in the present enlisted rating structure are general ratings and service ratings.

GENERAL RATINGS identify broad occupational fields of related duties and functions. Some general ratings include service ratings; others do not. Both Regular Navy and Naval Reserve personnel may hold general ratings.

SERVICE RATINGS identify subdivisions or specialties within a general rating. Although service ratings can exist at any petty officer level, they are most common at the PO3 and PO2 levels. Both Regular Navy and Naval Reserve personnel may hold service ratings.

THE ENGINEERING AID RATING

The Engineering Aid rating is now a general rating as are all others in the Group VIII ratings. The scope of duties and responsibilities follows.

SCOPE OF DUTIES AND RESPONSIBILITIES

Engineering Aids plan, supervise, and perform tasks required in construction surveying, construction drafting, planning and estimating, and quality control; prepare progress reports, time records, construction schedules, and material and labor estimates; establish and operate a basic quality control system for testing soils, concrete, and other construction materials; prepare, edit, and reproduce construction drawings; perform topographic, land, and horizontal or vertical control surveys; perform such tasks as running and closing traverses, running level circuits, staking out construction projects, and obtaining other field data necessary for engineering studies or for actual construction of any type of structure that may come under the cognizance of the Naval Construction Force.

OCCUPATIONAL STANDARDS

A most important step in developing your career is to acquire the skills that have been prescribed specifically for each paygrade of the EA rating. These skills, expressed in terms of task statements called occupational standards, are contained in the *Manual of Navy Enlisted*

Manpower and Personnel Classifications and Occupational Standards, NAVPERS 18068-D. Other requirements, called naval standards, are not specifically rating oriented. These too are contained in NAVPERS 18068-D. Studying this rate training manual should help you meet the occupational standards for EA3 or EA2.

NAVY ENLISTED CLASSIFICATION CODES

The Engineering Aid rating is a source of two NEC's (Navy Enlisted Classification Codes) which are assigned only to personnel who are graduates of the applicable course of instruction. NEC's reflect special knowledge and skills in certain ratings. They are designed to facilitate management control over enlisted skills by accurately identifying billets and personnel, and to insure maximum utilization in distribution and in detailing personnel. EA's may qualify for the following NEC's:

1. CONSTRUCTION INSPECTOR (EA-5501)—Reviews and analyzes construction drawings and specifications and prepares a Construction Inspection Plan, including a checklist of inspection points, during critical phases of construction and installation; verifies that all materials and/or equipment ordered meets applicable project specifications and certifies their conformance to these specifications upon receipt; inspects all phases of construction and installation, including civil, architectural and structural, electrical and mechanical, for compliance with drawings, specifications, and acceptable safe operating, installation, and construction practices; schedules, coordinates, and observes tests on electrical and mechanical systems (includes operational tests on installed equipment) and arranges for quality control tests on such items as sub-base materials, aggregates, and cementitious binders and on related mixes before, during, and after installation; and prepares logs, records, and reports on all inspections and tests.

EA's, BU's, CE's, EO's, SW's, and UT's who are E-5 or above may acquire the NEC EA-5501 by successfully completing the Air Force

Inspectors School located at Shepard Air Force Base in Texas. A Navy Construction Inspector's school is being developed.

2. ADVANCED ENGINEERING AID (EA-5503) Employs the principles and techniques of foremanship. Solves mathematical problems commonly encountered by personnel in the Engineering Aid rating. Designs a twenty-four foot wide, one thousand eight hundred foot long segment of paved highway. Computes the optimum orientation for a single runway. Adjusts a quadrilateral triangulation system and computes the coordinates of each station. Estimates the material requirements for plans, and schedules the construction of an advanced base administration building, using the Network Analysis System concept. Explores, identifies, classifies and stabilizes soils. Identifies and tests bituminous paving mixes using the Marshall Method of mix design. Designs a concrete mix, tests mix ingredients, tests the wet mix, and performs both flexural and compressive strength tests upon the cured mix.

EA3's and above having one year's experience in an operational billet and course credits in trigonometry may acquire the NEC EA-5503 by attending C-7 "J" school. Personnel who attended C-7 "J" school after 1 October 1977 qualify for this NEC. Personnel who attended the C-7 "J" school prior to 1 October 1977 are required to attend the current C-7 "J" school to qualify for this NEC.

Besides the NEC's described above, there are other NEC's which may be assigned to qualified personnel in Occupational Field 13 ratings. They are as follows: Advanced Underwater Construction Technician (BU-5931), Basic Underwater Construction Technician (BU-5932), and Safety Inspector (SW-6021). Another type of NEC is the Special Series (General), which is not related to any particular general or service rating. These NEC's are used to identify billet requirements which are not sufficiently identified by rates, and to identify the personnel who are qualified to be distributed and detailed to fill these requirements. The Special Series NEC's which a SEABEE may be assigned include: Special

Instructor (9502), SEABEE Team Trainee (9526), SEABEE Team Technician (9527), and Career Recruiter (9586).

For further information concerning the scope and requirements for NEC's, refer to the *Manual of Navy Enlisted Manpower and Personnel Classifications and Occupational Standards*, NAVPERS 18068-D.

TYPICAL EA BILLETS

Most of the billets for the EA3 and EA2 are in the Naval Mobile Construction Battalions. Other billets for EA's include assignments to Public Works activities, SEABEE Teams, and various SEABEE staffs. Senior rated EA's are assigned to construction battalions and to SEABEE Headquarters, such as NAVFAC, COMCBLANT, and COMCEPAC. Senior EA's may also be assigned to the Naval Education and Training Program Development Center, Pensacola, Florida (as a writer of advancement examinations, training manuals, or other materials); the Bureau of Naval Personnel (as personnel detailer); or as instructors and supervisors at one of the Naval Construction Training Centers.

IMPORTANCE OF THE EA RATING

The necessity for naval construction need not be emphasized, and each of the Group VIII ratings performs a vital and indispensable function in naval construction. In one sense, however, the function of the EA is of special significance. By merely studying the scope of the EA's duties and responsibilities, one can deduce that the EA's functions relate to the WHOLE construction project, rather than to one particular phase of it. From the project's conception until its final completion report, the EA contributes directly or indirectly towards its completion. The design of the project may be the result of his collected field data. The construction drawings may be his work as well as the construction layout. Some of his efforts might not be measurable in terms of work-in-place, however, they may be the deciding factor as to the accuracy and quality of the finished project. The EA's alertness in

compiling man-hour expenditures and progress reports may have alerted the Operations Officer to see lagging work schedules. This enables the Operation Officer to readjust timetables and priorities in order to meet standing completion requirements.

The foregoing are just a few examples of your support to the mission of the Naval Construction Force. A majority of them you will learn through on-the-job training which, in turn, depends on the variety of your duty assignments. You must always strive to broaden your knowledge and skills, especially those related to your rating, so that you will have the ability and confidence to handle any task given you. By acquiring more knowledge and skills, you will be able to assume positions of greater responsibility, and thus be of more worth to your command and the Navy.

CAREER DEVELOPMENT

Some of the rewards of getting ahead are easy to see. You get more pay. Your job assignments become more interesting and more challenging. You are regarded with greater respect by officers and enlisted personnel. You enjoy the satisfaction of getting ahead in your chosen Navy career.

The advantages of developing your career and getting ahead are not yours alone. The Navy also profits. Highly trained personnel are essential to the functioning of the Navy. By each advancement, you increase your value to the Navy in two ways. First, you become more valuable as a specialist in your own rating. And second, you become more valuable as a person who can train others and thus make far-reaching contributions to the entire Navy.

Many of the rewards of Navy life are earned through the advancement system. The basic ideas behind the system have remained stable for many years, but specific portions may change rather rapidly. It is important that you know the system and follow changes carefully. BUPERS Notice 1418 series will normally keep you up to date.

The normal system of advancement may be easier to understand if it is broken into two parts:

1. Those requirements that must be met before you may be considered for advancement.
2. Those factors that actually determine whether or not you will be advanced.

QUALIFYING FOR ADVANCEMENT

In general, to QUALIFY (be considered) for advancement, you must first:

1. Have a certain amount of time in pay grade.
2. Demonstrate knowledge of material in your mandatory Rate Training Manuals by achieving a suitable score on your command's test, by successfully completing the appropriate NRCC's or, in some cases, by successfully completing an appropriate Navy school.
3. Demonstrate your eligibility according to the requirements of the Personnel Advancement Requirement (PAR) Program, NAVPERS 1414/4.
4. Be recommended by your commanding officer.
5. For petty officer third and second candidates ONLY, demonstrate knowledge of military subjects by passing a locally administered MILITARY/LEADERSHIP examination based on the naval standards (from NAVPERS 18068 series).
6. Demonstrate knowledge of the technical aspects of your rate by passing a Navy-wide advancement examination based on the occupational standards (from NAVPERS 18068 series) listed at and below your rate level.

If you meet all of the above requirements satisfactorily, you become a member of the group from which advancements will be made.

WHO WILL BE ADVANCED?

Advancement is not automatic. Meeting all of the requirements makes you eligible but does

not guarantee your advancement. Some of the factors that determine which person, out of all of those QUALIFIED, will actually be advanced in rate are: the score made on the advancement examination, the length of time in service, the performance marks earned, and the number of vacancies being filled in a given rate.

If the number of vacancies in a given rate exceed the number of qualified personnel, then ALL of those qualified will be advanced. More often, the number of qualified people exceeds the vacancies. When this happens, the Navy has devised a procedure for advancing those who are BEST qualified. This procedure is based on combining three personnel evaluation systems:

- Merit rating system (Annual evaluation and C.O. recommendation)
- Personnel testing system (Advancement examination score—with some credit for passing previous advancement exams)
- Longevity (seniority) system (Time in rate and time in service)

Simply, credit is given for how much the individual has achieved in the three areas of performance, knowledge, and seniority. A composite, known as the final multiple score, is generated from these three factors. All of the candidates who have PASSED the examination from a given advancement population are then placed on one list. Based on the final multiple score, the person with the highest multiple score is ranked first, and so on, down to the person with the lowest multiple score. For candidates E4, E5, and E6, advancement authorizations are then issued, beginning at the top of the list, for the number of persons needed to fill the existing vacancies. Candidates for E7, whose final multiple scores are high enough, will be designated PASS SELBD ELIG (Pass Selection Board Eligible). This means that their names will be placed before the Chief Petty Officer Selection Board, a BUPERS board charged with considering also-designated eligible candidates for advancement to CPO. Advancement authorizations for those being advanced to CPO are issued by this board.

Who, then, are the individuals advanced? Basically, they are the ones who achieved the most in preparing for advancement. They were

not content to just qualify, they went the extra mile in their training, and through that training and their work experience they developed greater skills, learned more, and accepted more responsibility.

While it cannot guarantee that any one person will be advanced, the advancement system does guarantee that all persons within a particular rate will compete equally for the vacancies that exist.

HOW TO PREPARE FOR ADVANCEMENT

What must you do to prepare for advancement? You must study the naval and occupational standards, demonstrate that you can perform required skills, study the required rate training manuals, and study other material that is required for advancement. To prepare for advancement, you will need to be familiar with (1) the *Manual of Navy Enlisted Manpower and Personnel Classifications and Occupational Standards*, (2) the Personnel Advancement Requirement (PAR) Program, (3) the *Bibliography for Advancement Study*, and (4) the applicable rate training manuals. The following sections describe each of these and give you some practical suggestions on how to use them in preparing for advancement.

Manual of Navy Enlisted Manpower and Personnel Classifications and Occupational Standards

The *Manual of Navy Enlisted Manpower and Personnel Classifications and Occupational Standards*, NAVPERS 18068-D, defines rates and ratings by describing the Navy's requirements for enlisted skills. The manual consists of two sections. The first section contains the occupational standards and naval standards that form the basis for what enlisted personnel are trained in and advanced upon. The second section contains the Navy Enlisted Classifications (NEC's) which were defined earlier in this chapter.

The naval standards contained in NAVPERS 18068-D express the minimum skills required of enlisted personnel which are not specifically rating oriented. For the most part they are

stated as knowledge requirements because they represent basic things which should be known, and not necessarily done as a matter of routine. The Occupational standards appear as task statements only since they define what enlisted personnel must do in their rate or rating. In other words, they are performance factors. The knowledge required to perform a task is inherent to the proper performance of the task.

Personnel Advancement Requirements

The Personnel Advancement Requirement (PAR) Program allows a command to evaluate the overall abilities of an individual on the day-to-day work situations and eliminates the need to complete a lengthy, detailed checkoff list (formerly, the Record of Practical Factors).

For each rating, the requirements for advancement to paygrades E-4 through E-7 are listed in one pamphlet. Section I of this pamphlet contains the individual's length of service, time in rate, and a checkoff for the individual having passed the E-4/E-5 Military/Leadership Examination. Section II contains a checkoff entry for the individual having completed the military requirements rate training manual and the applicable rate training manual for the rating. Section III is a checkoff list of task statements. Items in this section are to be interpreted broadly and do not demand actual demonstration of the item, or completion of an alternate local examination, although demonstration is a command prerogative. Individuals are evaluated on their ability to perform the task whether it be by observation of ability in related areas, training received or, if desired, by demonstration.

Bibliography for Advancement Study

The *Bibliography for Advancement Study*, NAVEDTRA 10052 (revised) is important to all enlisted personnel preparing for advancement. It lists the rate training manuals and other publications prescribed for use by naval personnel concerned with training and advancement examinations.

NAVEDTRA 10052 is revised and issued yearly by the Naval Education and Training Command. Each revised edition is identified by a letter following the number. When using this publication be sure that you have the most recent edition.

If extensive changes in standards occur in any rating between the annual revisions of NAVEDTRA 10052, a supplementary list of study material may be issued in the form of a BUPERS Notice. When you are preparing for advancement, check to see whether changes have been made in the standards for your rating. If so, look for a BUPERS Notice that supplements NAVEDTRA 10052 for your rating.

The required and recommended references are listed by pay grade in NAVEDTRA 10052. If you are working for advancement to third class, study the material that is listed for third class. If you are working for advancement to second class, study the material that is listed for second class; but remember that you are also responsible for the references listed at the third class level.

In using NAVEDTRA 10052 you will notice that some rate training manuals are marked with an asterisk (*). Any manual marked in this way is MANDATORY—that is, it must be completed at the indicated rate level before you can be eligible to take the servicewide examination for advancement. Each mandatory manual may be completed by (1) passing the appropriate nonresident career course that is based on the mandatory training manual; (2) passing locally prepared tests based on the information given in the training manual; or (3) in some cases, successfully completing an appropriate Navy school.

Do not overlook the section of NAVEDTRA 10052 which lists the required and recommended references relating to the naval standards. Personnel of ALL ratings must complete the mandatory military requirements training manual for the appropriate level before they can be eligible to advance.

The references in NAVEDTRA 10052 which are recommended but not mandatory should also be studied carefully. ALL references listed in NAVEDTRA 10052 may be used as source

material for the written examinations, at the appropriate rate levels.

Rate Training Manuals

There are two general types of rate training manuals. RATING manuals (such as this one) are prepared for most enlisted ratings. A rating manual gives information that is directly related to the occupational qualifications of ONE rating. SUBJECT MATTER manuals or BASIC manuals give information that applies to more than one rating.

Rate training manuals are revised from time to time to keep them up to date technically. The revision of a rate training manual is identified by a letter following the NAVEDTRA number. You can tell whether any particular copy of a training manual is the latest edition by checking the NAVEDTRA number and the letter following this number in the most recent edition of *List of Training Manuals and Correspondence Courses*, NAVEDTRA 10061. (NAVEDTRA 10061 is actually a catalog that lists all current training manuals and correspondence courses; you will find this catalog useful in planning your study program.)

Each time a rate training manual is revised, it is brought into conformance with the official publications and directives on which it is based; but during the life of any edition, discrepancies between the manual and the official sources are almost certain to arise because of changes to the latter which are issued in the interim. In the performance of your duties, you should always refer to the appropriate official publication or directive. If the official source is listed in NAVEDTRA 10052, the Naval Education and Training Program Development Center uses it as a source of questions in preparing the fleetwide examinations for advancement. In case of discrepancy between any publications listed in NAVEDTRA 10052 for a given rate, the examination writers will use the most recent material.

Rate training manuals are designed to help you prepare for advancement. The following suggestions may help you to make the best use

of this manual and other Navy training publications when you are preparing for advancement.

1. Look up the occupational standards for your rating before you study the training manual, and refer to them frequently as you study. Remember, you are studying the manual primarily in order to meet the standards.

2. Set up a regular study plan. It will probably be easier for you to stick to a schedule if you can plan to study at the same time each day. If possible, schedule your studying for a time of day when you will not have too many interruptions or distractions.

3. Before you begin to study any part of the manual intensively, become familiar with the entire book. Read the preface and the table of contents. Check through the index. Look at the appendixes. Thumb through the book without any particular plan, looking at the illustrations and reading bits here and there as you see things that interest you.

4. Look at the training manual in more detail, to see how it is organized. Look at the table of contents again. Then, chapter by chapter, read the introduction, the headings, and the subheadings. This will give you a pretty clear picture of the scope and content of the book. As you look through the book in this way, ask yourself such questions as:

- What do I need to learn about this?
- What do I already know about this?
- How is this information related to information given in other chapters?
- How is this information related to the occupational standards?

5. When you have a general idea of what is in the training manual and how it is organized, fill in the details by intensive study. In each study period, try to cover a complete unit—it may be a chapter, a section of a chapter, or a subsection. The amount of material that you can

cover at one time will vary. If you know the subject well, or if the material is easy, you can cover quite a lot at one time. Difficult or unfamiliar material will require more study time.

6. In studying any one unit—chapter, section, or subsection—write down the questions that occur to you. Many people find it helpful to make a written outline of the unit as they study, or at least to write down the most important ideas.

7. As you study, relate the information in the training manual to the knowledge you already have. When you read about a process, a skill, or a situation, try to see how this information ties in with your own past experience.

8. When you have finished studying a unit, take time out to see what you have learned. Look back over your notes and questions. Maybe some of your questions have been answered, but perhaps you still have some that are not answered. Without looking at the training manual, write down the main ideas that you have gotten from studying this unit. Don't just quote the book. If you can't give these ideas in your own words, the chances are that you have not really mastered the information.

9. Use nonresident career courses whenever you can. As mentioned before, completion of a mandatory rate training manual can be accomplished by passing an NRCC based on the rate training manual. You will probably find it helpful to take other NRCC's as well as those based on mandatory manuals. Taking an NRCC helps you to master the information given in the training manual, and also helps you see how much you have learned.

10. Think of your future as you study rate training manuals. You are working for advancement to third class or second class right now, but some day you will be working toward higher rates. Anything extra that you can learn now will help you both now and later.

SOURCES OF INFORMATION

One of the most useful things you can learn about a subject is how to find out more about

it. No single publication can give you all the information you need to perform the duties of your rating. You should learn where to look for accurate, authoritative, up-to-date information on all subjects related to the naval standards and occupational standards of your rating.

Some publications are subject to change or revision from time to time—some at regular intervals, others as the need arises. When using any publication that is subject to change or revision, be sure that you have the latest edition. When using any publication that is kept current by means of changes, be sure you have a copy in which all official changes have been made. Studying canceled or obsolete information will not help you to do your work or to advance; it is likely to be a waste of time, and may even be seriously misleading.

GOVERNMENT PUBLICATIONS

There are various Government publications which you may find useful as sources of reference. A number of publications issued by the Naval Facilities Engineering Command (NAVFAC), which will be of interest to you, are listed in the *NAVFAC Documentation Index (Keywords Out of Context-KWOC)*, NAVFAC P-349 (updated semiannually). A publications program is one of the principal communications media used by NAVFAC to provide a ready reference of current technical and administrative data for use by its subordinate units. NAVFAC publications are listed in alphabetical and numerical order in NAVFAC P-349 and are generally classified into four categories as follows:

Design Manuals (DM's)

Administrative Information (P)

Maintenance and Operations (MO's)

Technical Publications (TP's)

NAVFAC publications should be available in your battalion technical library or the Engineering Division of the Public Works activity. Their titles are self-explanatory and

you can consult the publications that contain the subject matter in which you are interested. Suggested publications which should be in the engineering section of the battalion technical library are listed in appendix I.

There are Air Force manuals (AFM's) and Army Technical manuals (TM's), the contents of which have subjects that are related to the Engineering Aid rating. They may be available in the battalion technical library; if not, they are easily ordered through the normal naval supply procurement system. TM's and AFM's of particular importance to you are included in the engineering section of the battalion technical library listing in appendix I of this manual.

To improve your ability in preparing any type of construction drawing, you must also refer to training manuals of other Group VIII ratings, especially those for the E-4 and E-5 levels, such as the current editions of *Builder 3 & 2*, *Steelworker 3 & 2*, *Utilitiesman 3 & 2*, and *Construction Electrician 3 & 2*.

Detailed standards for Armed Forces drawings are set forth in *Military Standards*, published by the Assistant Secretary of Defense (Supply and Logistics), Office of Standardization. Any Navy activity can obtain copies of these standards by writing to Commanding Officer, Naval Publications and Forms Center, 5801 Tabor Avenue, Philadelphia, Pennsylvania 19120. A complete and up-to-date copy of each of these standards is a must to have in any drafting room library of the SEABEES.

Available standards are listed in a publication called *Index of Military Standards*. Instructions in this index tell you how to determine the letter which indicates the latest revision for a particular standard. Applicable military standards are also included in the engineering section of the battalion technical library listing.

COMMERCIAL PUBLICATIONS

To keep up-to-date on the current progress of new equipment and on the new inventions

related to your rating, the best source of information is commercial publications. These publications may be in the form of a textbook or an operation manual for a particular instrument. The instrument operation manual can be obtained from instrument manufacturers or dealers. On the other hand, textbooks are to be purchased. Your technical library may have some of them on hand. The following commercial publications are nice to have:

Surveying; by Davis, Foote & Kelly (latest edition); published by McGraw-Hill Book Company; New York

Surveying; by Legault, McMaster & Marlette; published by Prentice-Hall, Inc.; Englewood Cliffs, New Jersey

Architectural Drafting; by William J. Hornung; also published by Prentice-Hall, Inc.

Architectural Graphic Standards; by Ramsey; published by John Wiley & Sons, Inc.; New York

Every EA should strive to acquire at least a few textbooks for his personal use, by purchasing them himself if feasible. The knowledge and skill you learned through formal studies and on-the-job training in the SEABEES must be supplemented continuously with off-hours studies on your own initiative. This will not only broaden your knowledge but will also enhance your getting the best score in Navy-wide professional examinations.

TRAINING FILMS

Training films available to naval personnel are a valuable source of supplementary information on many technical subjects. Films on various subjects that may be of interest are listed in the *United States Navy Film Catalog*, NAVAIR 10-1-777, published 1 July 1971. Copies may be ordered in accordance with the *Navy Stock List of Films and Publications*, NAVSUP 2002. Supplements to the *Film Catalog* are issued as appropriate.

ENGINEERING AID 3 & 2, VOLUME 1

When selecting a film, note its date of issue listed in the *Film Catalog*. As you know, procedures sometimes change rapidly. Thus, some films become obsolete rapidly. If a film is obsolete only in part, it may sometimes be shown effectively if, before or during its showing, you carefully point out to trainees the

procedures that have changed. For this reason, if you are showing a film to train other personnel, take a look at it in advance if possible, so that you may spot material that may have become obsolete and verify current procedures by looking them up in the appropriate sources before the formal showing.

CHAPTER 2

ADMINISTRATION AND ORGANIZATION

As an EA3 or EA2, you still have a great deal to learn about your profession, including the development of skills related to drafting, surveying, quality control, and eventually planning and estimating. However, now you will be called upon from time to time to demonstrate your supervisory abilities. Your duties and responsibilities as a supervisor will probably be limited, but they will gradually increase as you advance in your career development.

Becoming an EA3 or EA2 is a big step in your Navy career. The Navy imposes a special trust and confidence in you. In return, the Navy expects you to be professionally competent and capable of instructing and supervising others. Your example of leadership and responsibility will influence subordinates, so you must always exhibit a strong sense of personal integrity and dedication to your work and to the Navy. The most difficult task you will have is adjusting to your role as supervisor. Now is the time to start preparing yourself for the job ahead. Prior knowledge of your administrative duties and responsibilities, as well as professional knowledge, will put you far ahead. Proper training and diligent study will prove itself when you are called upon to lead others.

To help you prepare for the job ahead, this chapter will acquaint you with your duties and responsibilities concerning SEABEE administration and safety. We will not attempt to discuss the basic techniques of leadership; they are adequately covered in *Military Requirements for Petty Officer 3 & 2*, NAVEDTRA 10056 (latest revision). Carefully review those basic leadership techniques and apply them in all phases of your job, where applicable. Also in this chapter you will learn

where you fit into the overall organization of an NMCB Operations Department and a Public Works activity. The last part of the chapter deals with one of the most important SEABEE management tools, the Personnel Readiness Capability Program (PRCP).

ASSIGNMENT AS TEAM/PARTY OR CREW LEADER

As you gain experience in performing tasks related to Engineering Aid work, you will be called upon to serve as party chief of a survey crew or to supervise men assigned to the drafting room. Survey crews perform various types of work, such as route surveys, topographic surveys, construction layout/stakeout surveys, and as-built surveys. Work performed in the drafting room includes preparing charts, drawing sketches, revising drawings, preparing construction drawings and maps, reproducing drawings, maintaining print files, and maintaining an engineering technical library. In general, your duties as a party chief or drafting supervisor will involve planning work assignments, supervising, coordinating your work with the work of other teams, initiating requisitions, and keeping time cards. Information that will aid you in carrying out these duties is given below.

PLANNING WORK ASSIGNMENTS

For purposes of this discussion, planning is the process of determining requirements and devising and developing methods and schemes of action for supporting construction projects. Proper planning saves time and money for the

Navy and makes the job easier for all concerned. The following pointers will aid you in planning day-to-day work assignments.

When you are assigned a task, whether in writing or orally, the first thing you must do is to make sure you understand clearly just what is to be accomplished. Don't be afraid to ask questions. Find out the answers from those in a position to supply the information you need. Much confusion may be avoided by having a clear understanding of the task from the very beginning. Make sure you know the priority of the project, time of completion, and any special instructions that must be followed. When the task is assigned orally, take detailed notes. Don't leave anything to memory, you might forget important information or instructions. A good supervisor carries a small notebook in his pocket at all times.

In planning for the accomplishment of each assigned task, you must consider the capability of your men. With this in mind, you can determine who is to do what and how long it should take to accomplish the task. Realizing that idleness tends to breed discontent, plan to have another job ready to start as soon as the first one is finished.

Establish goals for each workday and encourage your men to work together as a team to accomplish these goals. You want your goals to be such that your men will be kept busy, but make sure they are realistic goals. During an emergency, most men will make a tremendous effort to meet the deadline. But men are not machines, and when there is no emergency, they cannot be expected to continuously achieve an excessive high rate of production. In your planning, you must allow for things which are not attributed to accomplishment of the assigned task, such as professional training, safety training, leave, liberty, and administrative matters.

When you are planning an assigned task, you must consider every possible method which could be used to accomplish the task. If there is more than one way of doing a particular job, make sure the method you select is the best way. After selecting a method, analyze it to see if it could be simplified with a resultant savings in time and effort.

A vital step when you are planning for surveying operations is the selection of proper equipment and supplies which are required. Proper selection of surveying equipment may greatly affect the end result of a survey. Forgetting to bring certain equipment or supplies to the jobsite is one of the most common mistakes made by supervisors. Nothing is more frustrating than to arrive at the jobsite only to discover that "someone" forgot to bring a tripod for the transit. The best way to minimize this embarrassing situation is to prepare an equipment and supply checklist for each job assignment, and doublecheck the list after gathering all the items to make sure nothing was omitted. If more than one job is planned, include sufficient equipment and supplies to accomplish all jobs.

The same planning steps apply to drafting assignments. Certain drafting assignments are difficult to accomplish without proper equipment and supplies. As you gain experience you will devise methods which will enable you to improvise with the equipment and supplies you have on hand.

SUPERVISING

After a job has been properly planned, it is necessary to supervise the job carefully to ensure that it is completed properly and on time. Some pointers that will aid you in supervising work teams are given below.

Prior to starting a job, make sure your men know what is to be done. Give instructions clearly, and urge your men to ask questions on any points that are not clear to them. Explain how the job is related to other jobs and to the overall mission. Make sure that each man knows exactly what is expected of him and what his responsibilities are. Keep your men informed. A well informed crew performs much more efficiently. Be sure the men know all pertinent safety precautions and wear safety apparel where required. Check all equipment and tools before use to ensure they are in safe condition. Do not permit the use of dangerously defective tools and equipment; see that they are turned in for repair immediately.

While the job is underway, check from time to time to ensure that the work is progressing

Chapter 2—ADMINISTRATION AND ORGANIZATION

satisfactorily. Determine if the proper methods and equipment are being used. If a man is doing a job wrong, stop him and point out what he is doing wrong. Then explain the correct procedure and check to see that he follows it. In checking the work of your men, try and do it in such a way that your men will feel that the purpose of your checking is to teach, guide and direct, rather than to criticize and find fault.

When time permits, rotate the men on various jobs. Rotation gives them varied experience and will help ensure your having men who can do the work if someone is hospitalized, transferred, or goes on leave.

A good supervisor should be able to get others to work together in getting the job accomplished. You should maintain an approachable attitude towards your men, making them feel free to come and seek your advice when in doubt as to any phases of the project. Emotional balance is especially important; a supervisor cannot become panicky before his men, unsure of himself in the face of conflicting forces, or pliable with influence. You should use tact and courtesy in dealing with your men and not show partiality to certain members of the work team. You should keep your men informed on matters that affect them personally or concern their work. You should also seek to maintain a high level of morale, keeping in mind that low morale can have a definite effect upon the quantity and quality of work turned out by your men.

The above is only a brief treatment on the subject of supervision. As you advance in rate you will be spending more and more of your time in supervising others, so let us urge that you make a continuing effort to learn more about the subject. Study books on supervision as well as leadership. Also, read articles on topics of concern to supervisors—such as safety, training, job planning, and so forth—that appear from time to time in trade journals and other publications. There is a big need in the Navy for petty officers who are skilled supervisors. So, consider the role of supervisor a challenge and endeavor to become proficient in all areas of the supervisor's job.

COOPERATION

If a project is to run smoothly and be completed on time, all crewmembers must work together as a team. All crew supervisors must also coordinate their work efforts and cooperate with one another as one big team. Most surveying operations are performed to guide the work done by other construction crews. You must work closely with other supervisors to ensure that your surveys are timely and do not delay the overall project. Cooperation with other supervisors will eliminate many problems which will arise when you are coordinating work efforts. In effect, you are merging your ideas and efforts to make the project run smoothly.

Cooperation is also essential to your success as a drafting supervisor. Consult the Builder crew supervisor on design problems and construction methods. Spending too much time on unnecessary details could delay the job if the Builders are awaiting the drawings to start the job. So right from the start, get in the habit of cooperating with other supervisors and you will soon gain their respect, as well as the respect of your superiors and your crewmembers.

PREPARING REQUISITIONS

One of the responsibilities which you will have as a crew supervisor is initiating requisitions for materials, supplies, and equipment. (The actual requisitioning may be the job of the Engineering Division Supply PO.) Occasionally, supplies and equipment contained in your kits will require replacement or replenishment. Standard kits are part of the NMCB Table of Allowance. The kits which will be of primary concern to you are Kit #0010, Surveying; Kit #0011, Drafting; and Kit #0026, Material Testing. You will learn more about these kits as you study this training manual. When these kits are checked out to the crew supervisor, they become his responsibility. When consumable items are used, they must be replenished by ordering new items. When equipment is lost or broken, it must be replaced or repaired.

To order supplies or equipment you will use standard requisition forms. The form currently used within a Naval Mobile Construction Battalion is the Single Line Item

A. MATL. REQUEST DATE		B. DEPT. NO.		C. ISSUE		TURN IN		D. FILE		E. LOCATION		F. REGR. QTY.		G. REQUISITION NO.	
H. MATL. ISSUE DATE		I. REC.		J. URGY.		K. NIS		L. M/C		M. INVENTORY		N. PROJ.		O. SHIP HULL NO.	
2. SOURCE COG		3. STOCK NUMBER			6. REFERENCE SYMBOL OR NOUN			7. U/I		8. QUANTITY		9. UNIT PRICE			
		75101897880			PENCIL 2H			DZ00001							
11. JOB CONTROL NO.				12. EIC		14. APL/AEL				15. FUND		16. EXT. PRICE			
10. EQUIPMENT COSAL SUPPORTED				YES <input type="checkbox"/>		NO <input type="checkbox"/>		17. TURN-IN		18. POSTED		19. REMARKS			
20. EQUIPMENT DATA								DATE CONTROL		S/N ISSUE					
								FIN. AL.							
U. APPROVED BY								V. RECEIVED BY							

Figure 2-1.—Single Line Item Consumption/Management Document (Manual), NAVSUP Form 1250.

17.84

Consumption/Management Document (Manual), NAVSUP Form 1250 (fig. 2-1), commonly referred to as a 1250. The Supply Department will prescribe the manner in which the requisitions are to be filled out and the procedures for their submission. Normally you will be required to identify the item, quantity required, and the cost of the item. In any event, don't try to bypass prescribed procedures; it will only cause delays in receiving the item. Plan ahead—don't wait until your supplies are depleted before submitting requisitions. If you are located overseas, it might take months to receive an item that is not on hand or carried by the Supply Department.

TIMEKEEPING

Timekeeping and labor reporting is of primary importance to the operation of SEABEE units and to the management of a Public Works activity. Timekeeping and labor reporting vary slightly among SEABEE units and Public Works activities, but this discussion will suffice as being typical. Your duties as crew supervisor may involve the posting of entries on time cards. Or, you may be assigned to the Operations Department's Management Division

as battalion timekeeper, responsible for coordinating the labor reporting for the entire battalion. Therefore, you should know the types of information called for on time cards and understand the importance of accuracy in labor reporting.

In order to record and measure the number of man-hours spent on various functions, a labor accounting system is mandatory. This system must permit the day-by-day accumulation of labor utilization data in sufficient detail and in a manner that allows ready compilation of information required by the Operations Officer in the management of the manpower resources, and in the preparation of the various reports to higher authority.

All labor expended in carrying out assigned tasks and functions must be accounted for. This accounting must include the work performed by the reporting unit and, when applicable, work performed by civilian labor and by military personnel of other activities. Labor expenditures must be accumulated under a number of reporting categories. This degree of reporting detail is required to provide the management data necessary to determine labor expenditures on project work for calculation of statistical

Chapter 2—ADMINISTRATION AND ORGANIZATION

labor costs, and comparison of actual construction performance with estimating standards. It also serves to determine the effectiveness of labor utilization in performing administrative and support functions, both for internal unit management and for development of planning standards by higher command.

For timekeeping and labor reporting purposes, total labor is considered as being either productive or overhead. **PRODUCTIVE LABOR** includes all labor that directly or indirectly contributes to accomplishment of the mission, including construction operations, military operations, and training. Productive labor is accounted for in two categories: direct and indirect labor.

1. **DIRECT LABOR** includes all labor expended directly on assigned construction tasks, either in the field or in the shop, and which contributes directly to the completion of the end product. Examples: Road and building layouts that are essential to the completion of a project.

2. **INDIRECT LABOR** comprises labor required to support construction operations, but which does not produce an end product itself. Examples: All drafting and reproduction; lab designs; and preliminary topographic and as-built surveys.

OVERHEAD LABOR is not considered to be productive labor in that it does not contribute directly or indirectly to the end product. It includes all labor that must be performed regardless of the assigned mission.

During the planning and scheduling of a construction project, each phase of the project is considered as direct labor and is assigned an identifying code by the Operations Department. For example, "site preparation" may be assigned code R-2 (R for the project and 2 for the phase of the project), "underground utilities" R-3, "forms for concrete slab" R-4, "placing concrete" R-5, "erect building" R-6, etc. These codes are used by the crew supervisor to identify the construction phase when he reports the hours spent (direct labor) by each member of his

crew during each workday on assigned construction tasks.

Codes are also used to report time spent by crewmembers in the following categories other than direct labor: indirect labor, military operations and readiness, disaster control operations, training, and overhead labor. These categories, broken down into sub-category labor codes, are shown in figure 2-2.

The crew supervisor's report is submitted on a daily labor distribution report form such as that shown in figure 2-3. The report is prepared by the crew supervisor for each phase of the construction project that each of his crewmembers is involved with, and immediately provides a breakdown by man-hours of the activities in the various labor codes for each man in the crew for any given day on any given project. By referring to the labor codes shown in figure 2-2, you can see what each code on the sample report in figure 2-3 represents. It was mentioned before that most of the time reported by the Engineering Division is considered as indirect labor; therefore, on the sample report form in figure 2-3 no time was reported under the direct labor column.

Engineering crew labor reports should be reviewed by the Engineering Chief and the Engineering Officer before they are forwarded to the battalion timekeeper in the Operations Department's Management Division. Each day the battalion timekeeper tabulates all of the reports received from each company and department. The tabulated data serves as the means by which the Operations Officer analyzes the labor distribution of his total manpower resources for any given day. In addition, the data serves as feeder information for the preparation of the monthly operations report, and any other resources reports which may be required by higher authority. Typical labor distribution for the battalion monthly operations report is shown in figure 2-4.

If you are assigned to the Operations Department's/Management Division as battalion timekeeper, you will be given detailed instructions on labor accounting procedures set forth by instruction and directives from higher authority.

PRODUCTIVE LABOR. Productive labor includes all labor that directly contributes to the accomplishment of the Naval Mobile Construction Battalion, including construction operations and readiness, disaster recovery operations, and training.

DIRECT LABOR. This category includes all labor expended directly on assigned construction tasks, either in the field or in the shop, and which contributes directly to the completion of the end product.

INDIRECT LABOR. This category comprises labor required to support construction operations, but which does not produce in itself. Indirect labor reporting codes are as follows:

- | | | |
|---|---|--------------------------------|
| X01 Construction Equipment Maintenance,
Repair and Records | X04 Project Expediting (Shop
Planners) | X06 Project Material Support |
| X02 Operation and Engineering | X05 Location Moving | X07 Tool and Spare Parts Issue |
| X03 Project Supervision | | X08 Other |

MILITARY OPERATIONS AND READINESS. This category comprises all manpower expended in actual military operations, unit embarkation, and planning and preparations necessary to insure unit military and mobility readiness. Reporting codes are as follows:

- | | | | |
|-------------------------|--------------------------|--|------------------------------------|
| M01 Military Operations | M04 Unit Movement | M06 Contingency | M08 Mobility & Defense
Exercise |
| M02 Military Security | M05 Mobility Preparation | M07 Military Administrative
Functions | M09 Other |
| M03 Embarkation | | | |

DISASTER CONTROL OPERATIONS

- | | |
|---------------------------------|-------------------------------|
| D01 Disaster Control Operations | D02 Disaster Control Exercise |
|---------------------------------|-------------------------------|

TRAINING. This category includes attendance at service schools, factory and industrial training courses, fleet type training, and short courses, military training, and organized training conducted within the battalion. Reporting codes are as follows:

- | | | |
|------------------------|-------------------------------|-----------------------------|
| T01 Technical Training | T03 Disaster Control Training | T05 Safety Training |
| T02 Military Training | T04 Leadership Training | T06 Training Administration |

OVERHEAD LABOR. This category includes labor which must be performed regardless of whether a mission is assigned, and which does not contribute to the assigned mission. Reporting codes are as follows:

- | | | |
|--|---|----------------------|
| Y01 Administrative & Personnel | Y06 Camp Upkeep & Repairs | Y10 Personal Affairs |
| Y02 Medical & Dental Department | Y07 Security | Y11 Lost Time |
| Y03 Navy Exchange and Special Services | Y08 Leave & Liberty | Y12 TAD not for unit |
| Y04 Supply & Disbursing | Y09 Sickcall, Dental &
Hospitalization | Y13 Other |
| Y05 Commissary | | |

Figure 2-2.—Sub-categories of labor.

45.825

SAFETY DUTIES OF SUPERVISORY PERSONNEL

Safety is a matter of chief concern to every supervisor. The supervisor who can continuously boast an outstanding safety record for his work crew has a lot to be proud of. Safety precautions

relating to specific operations performed by the EA are presented in various portions of this training manual. In this discussion, we are concerned with the safety organization of a Naval Mobile Construction Battalion, safety training responsibilities of a Crew Petty Officer, and the reporting procedures which the Crew

Chapter 2—ADMINISTRATION AND ORGANIZATION

Petty Officer must carry out if a subordinate is involved in an accident. Although these responsibilities may seem somewhat distant now, the sooner you start thinking about them, the better prepared you will be when it comes time to assume them. If you are an EA3 studying for advancement to EA2; then you can reasonably expect to assume these duties in the near future.

knowledge of the safety organization of the battalion. This is important since you cannot function as a Crew Petty Officer in an intelligent and informed manner unless you are aware of how you fit into the battalion's scheme of safety. In other words, you should know who (or what group) in the battalion arbitrates and establishes the safety policies and procedures you must follow. You should also know who will be your source of safety guidance in training and supervising your men. In addition, you should know to whom your accident reports are routed, and more importantly, why this information is sought.

BATTALION SAFETY ORGANIZATION

As a supervisor in a Naval Mobile Construction Battalion, you should have a

CREW LEADER Blair EA2 **CREW** Surveying **CREW SIZE** 5 **TRANSFERS THIS DATE** None

PROJECT Camp Covington **DATE** 9 July 19__

NAME	PRODUCTIVE LABOR CODE					OVERHEAD LABOR CODE (Y)			
	DIRECT		INDIRECT (X)		OTHER (M, D, T)	Y	Y		
		02			05	09	10		
Blair		7			1		1		
Fenton		6			1				
Enright		7			1		2		
Perry		5			1		1		
Garcla		6			1				

DAILY LABOR DISTRIBUTION COMCBPAC-GEN-5280 1 (REV 6-67)

Figure 2-3.—Daily Labor Distribution report form.



MONTHLY OPERATIONS REPORT
LABOR DISTRIBUTION
 COMCBPAC-GEN-3200 T F 2 (7-67)

UNIT		19			AVERAGE ON BOARD PERSONNEL * 500		PERIOD ENDING		
NMCB HMCSH-TEN		WORK DAYS THIS PERIOD			AT EMPLOYMENT SITE		30 JULY 1973		
LABOR CATEGORY	MAN DAYS			% TOTAL UNIT LABOR AVAILABLE	LABOR CATEGORY	MAN DAYS			% TOTAL UNIT LABOR AVAILABLE
	UNIT	OTHER	TOTAL			UNIT	OTHER	TOTAL	
DIRECT LABOR	3224		3224		DISASTER RECOVERY OPERATIONS				
TOTAL CI DIRECT					DO1 OPERATIONS	16		16	
TOTAL FILL-IN DIRECT					DO2 EXERCISES				
TOTAL DIRECT	3224		3224	31.56%	TOTAL DISASTER RECOVERY	16		16	0.2%
INDIRECT LABOR					TRAINING				
X01 CONST EQUIPMENT MAINT. REPAIR AND RECORDS	718		718		T01 TECHNICAL	285		285	
X02 OPERATIONS AND ENGINEERING	356		356		T02 MILITARY	1085		1085	
X03 PROJECT SUPERVISION	520		520		T03 DISASTER RECOVERY	2		2	
X04 PROJECT EXPEDITING					T04 LEADERSHIP	16		16	
ISHOP PLANNER	105		105		T05 SAFETY	29		29	
X05 LOCATION MOVING	89		89		T06 TRAINING ADMINISTRATION	73		73	
X06 PROJECT MATERIAL SUPPORT	431		431		TOTAL TRAINING	1490		1490	14.58%
X07 TOOL/SPARE PARTS ISSUE	282		282		TOTAL PRODUCTIVE LABOR	7450		7450	74.1%
X08 OTHER	11		11		OVERHEAD LABOR				
TOTAL INDIRECT	501		501	24.99%	Y01 ADMINISTRATION AND PERSONNEL	674		674	
MILITARY OPERATIONS AND READINESS					Y02 MEDICAL AND DENTAL APPTS	170		170	
M01 MILITARY OPERATIONS	2		2		Y03 NAVY EXCHANGE AND SPECIAL SERVICES	171		171	
M02 MILITARY SECURITY	1		1		Y04 SUPPLY AND DISBURSING	155		155	
M03 EMBARKATION	14		14		Y05 COMMISSARY	174		174	
M04 UNIT MOVEMENT	6		20		Y06 CAMP UPKEEP AND REPAIR	394		394	
M05 MOBILITY PREPARATION					Y07 SECURITY	172		172	
M06 CONTINGENCY MATERIAL READINESS	4		14		Y08 LEAVE AND LIBERTY	554		554	
M07 MILITARY ADMINISTRATIVE FUNCTIONS	8		40		Y09 SICK CALL, DENTAL, HOSP.	151		151	
M08 MOBILITY AND DEFENSE EXERCISES	77		77		Y10 PERSONAL AFFAIRS	34		34	
M09 OTHER					Y11 LOST TIME	53		53	
TOTAL MILITARY OPS & READINESS	14		114	1.05%	Y12 TAD NOT FOR UNIT	87		87	
					Y13 OTHER	10		10	
					TOTAL OVERHEAD	2750		2750	27.01%
					TOTAL LABOR AVAILABLE	10215		10215	100.0%

* Includes personnel TAD from NMCB

** Includes mandays TAD Personnel

Figure 2-4.—Typical monthly operations report (labor distribution).

45.827

BEST COPY AVAILABLE

Chapter 2--ADMINISTRATION AND ORGANIZATION

Every Naval Mobile Construction Battalion is required by COMBLANT/COMCBPAC instructions to implement a formal safety organization. (See figure 2-5.) The two principal agencies of this organization are the Safety Policy Committee and the Safety Division.

The SAFETY POLICY COMMITTEE, as its name suggests, formulates safety doctrine and policy for the battalion. The SAFETY DIVISION ensures that the procedures established through the Safety Policy Committee are carried properly and expeditiously throughout the battalion. The Safety Division is normally composed of the Safety Officer and the Safety Chief. Perhaps the

foremost responsibility of this division is to constantly survey and inspect the battalion for unsafe practices and conditions. Both the Safety Officer and the Safety Chief have the authority and duty to stop any operation or practices that might cause injury to personnel or damage to material or equipment. Another function of the Safety Division is the implementation of a safety training program throughout the battalion.

A third safety group which you as a petty officer and supervisor will perhaps have the most direct contact is the SUPERVISOR'S SAFETY COMMITTEE. This committee is composed of all the Project Safety Supervisors in the battalion. The purpose of this committee is to

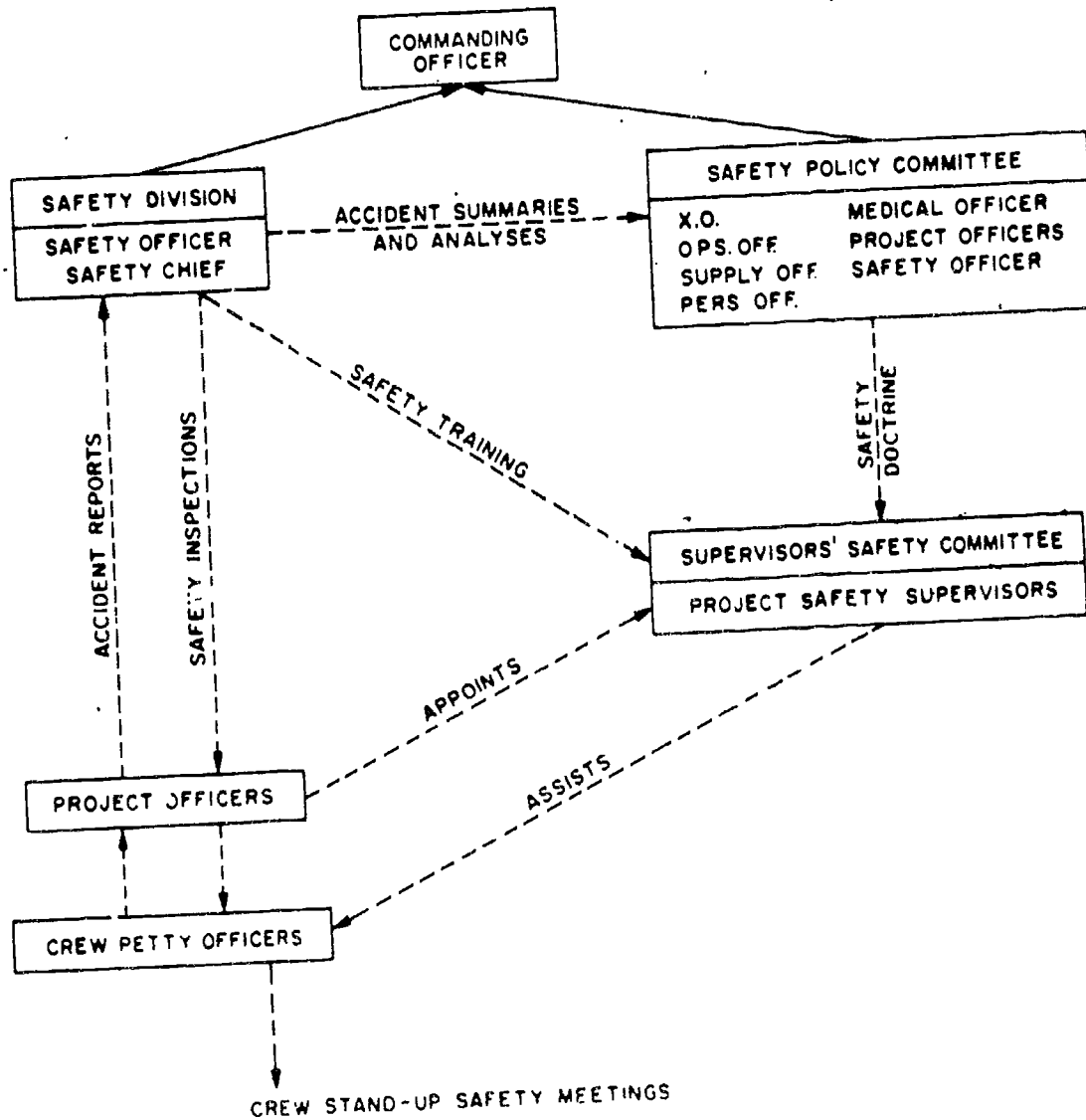

Figure 2-5.—NMCB safety organization.

act as a focal point for the exchange of safety information and policies between the various projects. If you should become a Crew Petty Officer, your primary contact in practically all matters concerning safety is the Project Safety Supervisor.

SAFETY DUTIES OF A SUPERVISOR

Every petty officer is responsible for the safety of personnel placed in his charge. Basically, your safety duties as a supervisor will revolve around training your subordinates, correcting unsafe practices and conditions should they occur, and being prepared to execute certain procedures should one of your men be involved in an accident.

Safety Training

New methods and procedures used in performing construction operations, and working in new and different situations, all require the supervisor to keep himself and his men informed of the latest in construction safety. Moreover, you can never assume that men transferred to your crew from some other crew are appropriately and fully trained in safety matters. For these reasons, the safety education and training of subordinates is a continuing responsibility of every supervisor.

To keep his men informed, every Crew Petty Officer periodically holds short (approximately 5 to 15 minute) safety meetings, called Stand-Up Safety Meetings, during which he briefs his crew on hazards and precautions relating to current work. Although the Crew Petty Officer is responsible for the actual conduct of the meetings, much of the content of the briefing is organized and assembled by the Safety Division and disseminated to the Crew Petty Officer through his Project Safety Supervisor.

In addition to the Stand-Up Safety Meetings, the Crew Petty Officer is, of course, also concerned with day-to-day instruction and training of his men on the job. It is beyond the scope of this text to go into a discussion of teaching or training methods (see *Military Requirements for Petty Officer 3 & 2*, NAVEDTRA 10056). However, a few words on

the petty officer's approach to safety and safety training at the crew level might be appropriate. The job of achieving safety in your crew is, like most other supervisory functions, essentially a matter of leadership. In studying and seeking to understand the practical aspects of directing and managing men, many new petty officers fail to recognize the power of personal example in leading and teaching subordinates. You will soon discover, in this regard, that subordinates are very quick to detect any difference between what you say and what you do. You cannot reasonably expect your men to measure up to standards of safety conduct and awareness which you yourself do not constantly DEMONSTRATE. It is not enough to be knowledgeable in the various aspects of construction safety. As a supervisor, you must make your genuine concern for the importance of crew safety visible and known to your men at all times. Leadership by example may not be the only technique of leadership, but it is one of the most eminently practical and time-proven methods of management available to you.

Accident Reporting Procedures

A well planned and conscientiously executed crew safety program will prevent accidents. Nevertheless, you must be prepared to carry out certain procedures should a man in your charge be injured or otherwise involved in an accident. It might be mentioned that for the purpose of accident reporting, an accident is defined as "Any unplanned act or event which results in damage to property, material or equipment and/or cargo, or personnel injury or death when not the result of hostile action." For purposes of this discussion, an injury may be defined as "Any physical impairment which prevents a Navy military person from performing his regularly established duty or work for a period of 24 hours or more subsequent to 2400 hours on the day of the injury." If an injury is the type which requires first aid or medical attention and the man can be returned to duty within 24 hours, or can resume some light form of work within 24 hours, the formal investigation and reporting procedures ordinarily will not be necessary. This is not to say, however, that you need not investigate these

Chapter 2—ADMINISTRATION AND ORGANIZATION

kinds of accidents on your own initiative. Small or seemingly harmless incidents often repeat themselves with more serious results. If an improper practice or condition exists in your crew, you must obviously identify and correct it before a serious accident occurs.

Supposing one of your men is injured, the first priority of course is to arrange for prompt medical treatment. At the same time, you must also take steps to prevent additional injuries or damage by shutting off power, stopping equipment or machinery, posting guards, and so on. Next, see to it that the Project Officer is notified of the accident. If the accident occurs outside of working hours, then the Officer of the Day is notified. If the accident is one that causes any physical impairment which will prevent the man from performing his regularly established duty for a period of 24 hours or more subsequent to 2400 of the day of injury, then it may be your responsibility as Crew Petty Officer to investigate the circumstances and submit a written report. The form you will use to report the accident is Accidental Injury/Death Report, OPNAV Form 5100/1. Figures 2-6 and 2-7 show the front and back, respectively, of this form. The form is filled out in triplicate and forwarded to the Safety Officer. If one of your crewmembers is injured during working hours, as crew leader, you are responsible for conducting the investigation and submitting the report. During nonworking hours, the Safety Chief is responsible.

An instruction sheet which accompanies OPNAV Form 5100/1 provides instructions for filling in various blocks on the form which are not self-explanatory. Figures 2-8 and 2-9 show the front and back, respectively, of this instruction sheet. Study the instruction sheet carefully and make sure you fill in all applicable items on the report properly and neatly. Remember that thorough investigations of accidents will help to identify and correct deficiencies, and reduce to a minimum injuries and deaths to personnel from accidental causes.

Accidental injuries or deaths under certain circumstances do not have to be reported on the Accidental Injury/Death Report, OPNAV Form 5100/1. If you have any questions as to when

this report is required, routing instructions, and so on, consult your Project Safety Supervisor for advice on what to do in the matter.

OPERATIONS DEPARTMENT (S-3)

Normally, EA's reporting to a SEABEE unit for duty will be assigned to the Operations Department. The organization of a SEABEE Operations Department—be it in a staff, in a battalion, or in any detached unit—is similar in basic composition, with minor variations to suit the type of unit, its mission, and the prevailing conditions. In support of the construction organization, the specific functions of the Operations Department include planning and estimating, engineering, safety, quality control, and resources control. Figure 2-10 presents a typical organization chart of a Naval Mobile Construction Battalion Operations Department. Using this chart as a guide, the Operations Officer may expand or modify the organization to suit the mission of the battalion and the availability of personnel to fill the billets.

In the following sections you will learn where you fit into the organization, and how your duties and responsibilities relate to the functions of the Operations Department. The information is taken mainly from *Naval Construction Force Manual*, NAVFAC P-315, and some actual observations currently prevailing in the NMCB's.

OPERATIONS OFFICER

You will notice in the organization chart shown in figure 2-10 that the Operations Officer heads the Operations Department. He is ultimately responsible for all work performed by Operations Department personnel. It is obvious that he cannot perform all of the tasks himself. Therefore, he must delegate certain duties and responsibilities to responsible personnel within the department. As an EA3 or EA2, you will assist your supervisor in accomplishing assigned tasks related to these duties and responsibilities, or you may be assigned the tasks yourself.

The specific responsibility of the Operations Officer is to manage the construction program for the Commanding Officer. Upon receipt of

ENGINEERING AID 3.& 2, VOLUME 1

ACCIDENTAL INJURY/DEATH REPORT OPNAV FORM 5100/1 (5-68) 3/M-0107-776-0010					FOR OFFICIAL USE ONLY				
SPECIAL HANDLING REQUIRED IN ACCORDANCE WITH OPNAVINST 5100.11					REPORT SYMBOL OPNAV 5100-3				
TO: COMMANDER, NAVAL SAFETY CENTER, NAVAL AIR STATION, NORFOLK, VA. 23511									
1. REPORTING COMMAND			2A. COMMAND AUTHORITY EXERCISED BY:			3. REPORT NUMBER			
			2B. GCM AUTHORITY EXERCISED BY:						
4. NAME OF PERSON INJURED/KILLED (FIRST, MIDDLE, LAST)					5A. SERVICE/BADGE NO.		6. RANK & DESIGNATOR/RATE AND NEC/CIVILIAN OCCUPATION		
					5B. SOCIAL SECURITY NO.				
7. SEX	8. AGE	9A. TIME IN SERVICE (MIL ONLY)			10A. MIL:		10B. CIV:		
		9B. YEARS EXPERIENCE (CIV ONLY)			<input type="checkbox"/> USN <input type="checkbox"/> USNR <input type="checkbox"/> OTHER <input type="checkbox"/> USMC <input type="checkbox"/> USNavy <input type="checkbox"/> USCG		<input type="checkbox"/> EMPLOYEE <input type="checkbox"/> DEPENDENT <input type="checkbox"/> OTHER		
11A. DUTY STATUS					11B. DUTY STATUS				
<input type="checkbox"/> EXT ACT DU <input type="checkbox"/> ACOUTRA <input type="checkbox"/> DRILL <input type="checkbox"/> TRAVEL <input type="checkbox"/> LVLTR <input type="checkbox"/> UA <input type="checkbox"/> OTHER					<input type="checkbox"/> REG. <input type="checkbox"/> TEMP. <input type="checkbox"/> TRAVEL <input type="checkbox"/> UNAUTH WORK <input type="checkbox"/> OTHER				
12. DATE AND TIME OF INJURY					13. PLACE OF OCCURRENCE			14. DAYS LOST/CHARGED	
					<input type="checkbox"/> ABOARD SHIP <input type="checkbox"/> ASHORE DESCRIBE LOCATION: _____				
15. WEATHER/NATURAL DISASTER					16. LIGHT CONDITIONS AT SITE				
17. DESCRIPTION OF EVENTS: (DESCRIBE THE CONTINUING EVENTS LEADING UP TO THE INJURY/DEATH SO THAT THE REVIEWING OFFICIAL WILL HAVE A CLEAR PICTURE OF WHAT CAUSED THE INJURY/DEATH, SELECT THE APPROPRIATE ENTRY FROM EACH MAJOR FACTOR CATEGORY LISTED ON BACK OF INSTRUCTION SHEET AND ENTER IT WITH AMPLIFYING DETAIL IN BOXES 18 THROUGH 25 BELOW.)									
WITNESSES: NAME, RANK/RATE, ADDRESS									
18. KIND OF INJURY:					19. BODY PART INJURED:				
20. SOURCE OF INJURY (OBJECT, SUBSTANCE, ETC WHICH CONTACTED THE BODY AND INJURED PERSON):					21. KIND OF ACCIDENT (FALL, CRUSHED, STRUCK BY, ETC.):				
22. HAZARDOUS CONDITION (WHAT CONDITION CAUSED, PERMITTED, CONTRIBUTED TO ACCIDENT WHICH RESULTED IN INJURY):					23. AGENCY (AND AGENCY PART) OF ACCIDENT (OBJECT, SUBSTANCE, ETC. TO WHICH THE HAZARDOUS CONDITION APPLIED):				
<input type="checkbox"/> NOT APPLICABLE					<input type="checkbox"/> NOT APPLICABLE				
24. UNSAFE ACT (WHAT PERSONAL ACTION CAUSED OR ALLOWED ACCIDENT TO OCCUR):					25. UNSAFE PERSONAL FACTOR (MENTAL OR PHYSICAL CONDITION WHICH RESULTED IN OR CONTRIBUTED TO THE UNSAFE ACT):				
<input type="checkbox"/> BY INJURED MAN <input type="checkbox"/> BY ANOTHER <input type="checkbox"/> NOT APPLICABLE									
26. REASON FOR BEING ON GOVERNMENT PROPERTY (REGULAR DUTY ASSIGNMENT, CIV EMP, PATIENT, VISITOR, BUSINESS, ETC.):									

29.52.1(2D)

Figure 2-6.--Accidental Injury/Death Report, OPNAV Form 5100/1 (front).



Chapter 2—ADMINISTRATION AND ORGANIZATION

OPNAV FORM 5100/1 (7-89) (BACK)
27 CORRECTIVE ACTION TAKEN/RECOMMENDED (WHAT ACTION WILL HELP PREVENT ANOTHER ACCIDENT OF THIS TYPE?):

Instructed Petty Officer ANDERSON in the use of the step stands with non-skid treads which are provided by the shop for this type work.

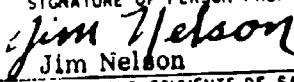
28. SIGNATURE OF PERSON PREPARING REPORT  Jim Nelson	29. TITLE AND GRADE CMCS, USN	30. DATE 19 Apr. 19-																								
31. REVIEW AND COMMENTS OF SAFETY OFFICER OR COMMANDING OFFICER																										
32. SIGNATURE	33. TITLE AND GRADE	34. DATE																								
ADDITIONAL INFORMATION WHEN REQUIRED BY JAG																										
35. CONDITION OF INDIVIDUAL AT TIME OF THIS OCCURRENCE: UNDER THE INFLUENCE OF: <input type="checkbox"/> ALCOHOL <input type="checkbox"/> NARCOTICS <input type="checkbox"/> S.701. TURBES <input type="checkbox"/> OTHER (SPECIFY) _____ <input type="checkbox"/> NOT APPLICABLE <input type="checkbox"/> UNABLE TO DETERMINE DUE TO PHYSICAL CONDITION EXAMINER _____																										
36. BASIS FOR ABOVE OPINION: A. CLINICAL FINDINGS: _____ B. BIOLOGICAL SPECIMEN TAKEN: <input type="checkbox"/> NO <input type="checkbox"/> YES TIME _____ LABORATORY TO WHICH SPECIMEN SENT _____ TYPE OF TEST _____ RESULT _____ OTHER TESTS/RESULTS _____																										
37. MEDICAL OFFICER'S FINDINGS RELATIVE TO NATURE AND EXTENT OF INJURY: _____																										
38. WAS SUBJECT HOSPITALIZED AS A RESULT OF THIS OCCURRENCE? <input type="checkbox"/> YES <input type="checkbox"/> NO	39. IF THE SUBJECT WERE ALREADY ON THE SICK LIST FOR OTHER REASONS AT TIME OF INJURY WOULD THIS INJURY IN ITSELF HAVE REQUIRED HOSPITALIZATION? <input type="checkbox"/> YES <input type="checkbox"/> NO <input type="checkbox"/> NOT APPLICABLE																									
40. IT IS POSSIBLE THAT THE FOLLOWING DISABILITY MAY RESULT: <input type="checkbox"/> PERMANENT PARTIAL <input type="checkbox"/> PERMANENT TOTAL	41. DATE OF EXPIRATION OF ENLISTMENT/TERM OF OBLIGATED SERVICE: _____																									
42. IF DECEASED, WAS AUTOPSY CONDUCTED? <input type="checkbox"/> YES <input type="checkbox"/> NO IF YES, ATTACH COPY OF AUTOPSY PROTOCOL																										
43. ADDITIONAL INFORMATION FOR RESERVISTS: (IF RESERVIST WAS ENGAGED IN ACTIVE-DUTY TRAINING OR INACTIVE DUTY (DRILL) SUPPLY THE FOLLOWING INFORMATION) <table border="1" style="width: 100%; border-collapse: collapse; margin-top: 5px;"> <thead> <tr> <th colspan="3">MEMBER REPORTED FOR DUTY OR DRILL</th> <th colspan="3">DISMISSED FROM DUTY OR DRILL</th> <th colspan="2">INJURY</th> </tr> <tr> <th>DATE</th> <th>TIME</th> <th>DATE</th> <th>TIME</th> <th>DATE</th> <th>TIME</th> <th>DATE</th> <th>TIME</th> </tr> </thead> <tbody> <tr> <td> </td> <td> </td> <td> </td> <td> </td> <td> </td> <td> </td> <td> </td> <td> </td> </tr> </tbody> </table>			MEMBER REPORTED FOR DUTY OR DRILL			DISMISSED FROM DUTY OR DRILL			INJURY		DATE	TIME	DATE	TIME	DATE	TIME	DATE	TIME								
MEMBER REPORTED FOR DUTY OR DRILL			DISMISSED FROM DUTY OR DRILL			INJURY																				
DATE	TIME	DATE	TIME	DATE	TIME	DATE	TIME																			
44. MEDICAL OFFICER'S SIGNATURE	45. GRADE	46. DATE																								
47. IT IS THE OPINION OF THE UNDERSIGNED THAT THE INJURY/DEATH IN QUESTION WAS INCURRED IN THE LINE OF DUTY AND NOT AS THE RESULT OF THE SUBJECT MAN'S OWN MISCONDUCT. <input type="checkbox"/> YES <input type="checkbox"/> NO																										
COMMANDING OFFICER (OR ONE AUTHORIZED TO SIGN BY HIS DIRECTION - IF LATTER SO INDICATE)																										
48. SIGNATURE	49. TYPED NAME AND GRADE	50. DATE																								
51. ACTION OF OFFICER EXERCISING GENERAL COURT-MARTIAL JURISDICTION: _____ DATE: _____ FROM _____ TO JUDGE ADVOCATE GENERAL OF THE NAVY																										
SIGNATURE AND TYPED NAME OF OFFICER EXERCISING GENERAL COURT-MARTIAL JURISDICTION (OR ONE AUTHORIZED TO SIGN BY DIRECTION)																										

29.52.2(2D)

Figure 2-7.—Accidental Injury/Death Report, OPNAV Form 5100/1 (back).

ENGINEERING AID 3 & 2, VOLUME 1

ACCIDENTAL INJURY/DEATH REPORT
OPNAV FORM 5100/1 (3-69)

Print with pen or type, items not applicable or contributory to the injury/death will be marked N.A.

INSTRUCTIONS FOR ACCIDENTAL INJURY/DEATH REPORT

- Block 1. Reporting Command - Self-explanatory.**
- Block 2A. Command Authority Exercised By.** In the case of ships and air units this is the Type Commander. For shore activities this is the command that provides command and support (ie COMSERVLANT in the case of NAVSTA NORVA, COMNAV.WIPSYSCOM in the case of a ship yard, etc.)
- Block 2B. COM Authority Exercised By.** Self-explanatory. Use only when report is required by JAG.
- Block 3. Report Number.** Reports will be serialized consecutively by each reporting command/activity during the fiscal year. (ie 2-69 is the second report of fiscal year 1969)
- Block 4. Name of Person Injured/Killed.** Self-explanatory.
- Block 5A. Service/Badge Number.** Self-explanatory.
- Block 5B. Social Security Number.** Self-explanatory.
- Block 6. Rank & Designator/Rate & NEC/Civilian Occupation.** Self-explanatory.
- Block 7. Sex.** Self-explanatory.
- Block 8. Age.** Self-explanatory.
- Block 9A. Time in Service (Mil Only).** Indicate in years only.
- Block 9B. Years Experience (Civ. Only).** Indicate number of years experience in present occupation, including years of experience gained in that occupation in other government or private industry employment. In cases of injury or death to civilians other than employees of the Department of the Navy, mark "N.A."
- Block 10. Employment Status.** In the event the line "Other" is selected for either military or civilian, specify as contract employee, visitor, Army, Air Force, etc.
- Block 11. Duty Status.** For either military or civilian check all applicable boxes.
- Block 12. Date and Time of Injury.** Give the hour on the basis of the 24 hour clock using four digits. Use two digits each for the date, month and year.
- Block 13. Place of Occurrence.** In describing the location enter paint locker, weather deck, flight deck, machine shop, galley, etc. as appropriate.
- Block 14. Days Lost/Charged.** For fatal injury or missing persons, enter 6000 days. For all other injuries enter the number of calendar days of disability, or time charges using the schedule of charges, Table 1, Appendix 1. Whenever the schedule of charges is used the actual number of calendar days of disability is not entered.
- Block 15. Weather/Natural Disaster.** If a factor, describe weather conditions or natural disaster which contributed to the injury.
- Block 16. Light Conditions at Site.** Describe outside or internal lighting conditions, as applicable, existing at the immediate site and time of accident.
- Block 17. Description of Events.** Enter narrative description of circumstances and events which directly or indirectly led to the injury, physical impairment or death. Include sufficient information to clarify or expand upon the character and scope of data to be entered in blocks 18 through 25 of the report. Accidental injury/death reports in all cases resulting from a ship accident will reference the applicable ship accident report serial in this block. Include in this block, as appropriate, comments on the following:
- a. Time injured person first seen by medical officer/representative.
 - b. Disposition of injured person; i.e. treated and retained aboard or transferred to another ship (military personnel) or transferred to a hospital for treatment (military and civilian personnel).
 - c. In cases of exposure to toxic fumes/chemical poisons, describe type of substance, concentration and type of exposure.
 - d. Describe additional causative/contributing factors not described in blocks 20 through 25 and indicate (D) for a definite cause, (S) for a suspected cause and (P) for condition present but not a factor. Enter name, rank/rate or grade and address of witnesses to the accident. If none, so indicate.
- Block 18. Kind of Injury.** Enter words from Block 18 (on reverse side of this sheet) which best describes nature of injury.
- Block 19. Body Part Injured.** Enter word(s) from block 19 (on reverse side of this sheet) which best describes body part affected by nature of injury
- Block 20. Source of Injury.** Enter object or environment from block 20 (on reverse side of this sheet) which best describes source of injury. (NOTE: A direct logical relationship between "Source of Injury" and "Kind of Injury" must be established).
- Block 21. Kind of Accident.** Enter action, action or type of contact from block 21 (on reverse side of this sheet) which best describes cause by which injured person came in contact with previously selected "Source of Injury". (NOTE: A direct logical relationship between the "Source of Injury" and "Kind of Accident" must be established.)
- Block 22. Hazardous Condition.** Enter the condition from Block 22 (on reverse side of this sheet) which best describes the hazardous condition which permitted or occasioned occurrence of previously selected "Kind of Accident". (NOTE: A direct logical relationship between "Kind of Accident", "Hazardous Condition" and "Agency of Accident", which is to follow, must be established).
- Block 23. Agency (and Agency Part) of Accident.** Enter the object or environment from Block 20 (on reverse side of this sheet) which best describes the agency to which the hazardous condition applies. In addition, describe the part of the agency which is unsafe. For instance, if the agency is a table saw from which the blade guard has been removed, enter the words "crag cut saw - blade." If some agencies such as a length of pipe, rope, lumber, etc., no agency part is required to be named. The rule for agency part is: if corrective or preventive action for the part involved is different from the action on any other part of the agency, name the agency part involved. (NOTE: A direct logical relationship between "Hazardous Condition" and "Agency of Accident" must be established). If there is no hazardous condition there can be no agency or agency part of accident, and all three items shall be described as "Not Applicable".
- Block 24. Unsafe Act.** Enter the act or omission from Block 24 (on reverse side of this sheet) which best describes unsafe act which permitted or caused occurrence of previously named kind of accident. (NOTE: A direct logical relationship between "Unsafe Act" and "Kind of Accident" must be established).
- Block 25. Unsafe Personal Factor.** Enter the reason from Block 25 (on reverse side of this sheet) which best describes the unsafe personal factor which led to the "Unsafe Act" attributed to the injury. (NOTE: If there was an unsafe act committed, an unsafe personal factor should always be selected. If no unsafe act was committed there may still, however, be an unsafe personal factor which contributed to the accident).
- Block 26. Reason for Being on Government Property.** Self-explanatory.
- Block 27. Corrective Action Taken/Recommended.** List specific remedial actions which have been or should be taken to prevent recurrence of similar injury. If an entry of "unknown" or "none" seems appropriate, an explanation shall be given as to why corrective action can not be recommended. Specify whether actions have been taken or are only recommended. If the latter, what action is expected?
- Blocks 28 through 30. First Signature Line.** Report is to be signed and dated by the individual who prepared the report to this point.
- Block 31. Review and Comments of Safety Officer or Commanding Officer.** Additional recommendations may be made if appropriate.
- Blocks 32 through 34. Second Signature Line.** Self-explanatory.
- The remainder of the report form will only be filled out in those instances where the injury/death to the military member is reportable to JAG.
- a. Blocks 1-34. Prepared in accordance with above instructions.
 - b. **Blocks 35-50.** Self-explanatory.
 - c. Blocks 35 through 40, 42, and 44 through 46 shall be completed and signed by the medical officer on the basis of his observation or examination of the injured or deceased member and information then available to him.
 - d. Blocks 41, 43 and 47 through 50 shall be completed and signed by the commanding officer on the basis of his investigation (or by an officer authorized and directed by the commanding officer to investigate the incident and sign the report by direction).

29.52.3(127E)

Figure 2-8.—Instructions for Accidental Injury/Death Report (front).

Chapter 2—ADMINISTRATION AND ORGANIZATION

<p>BLOCK 18. KIND OF INJURY</p> <ul style="list-style-type: none"> AMPUTATION OR ENUCLEATION ASPHYXIA, STRANGULATION BURN OR SCALD (THERMAL) BURN (CHEMICAL) CALLOSUS DISEASE, BENDS CONCUSSION, BRAIN CONTUSION, CRUSHING, BRUISE CUT, LACERATION, PUNCTURE, OPEN WOUND DISLOCATION DROWNING ELECTRIC SHOCK, ELECTROCUTION FOREIGN BODY LOOSE (DUST, RUST, SOOT) FOREIGN BODY, RETAINED OR EMBEDDED FRACTURE FREEZING, FROSTBITE HEARING LOSS, OR IMPAIRMENT HEAT STROKE, SUNSTROKE, HEAT EXHAUSTION HERNIA INJURIES, INTERNAL POISONING, SYSTEMIC RADIATION, IONIZING RADIATION, NONIONIZING RADIATION, ACTINIC SCRATCHES, ABRASIONS SPRAINS, STRAINS SUBMERSION, NONFATAL MULTIPLE INJURIES UNDETERMINED OCCUPATIONAL DISEASE, NEC OTHER INJURY, NEC <p>BLOCK 19. BODY PART INJURED</p> <ul style="list-style-type: none"> HEAD (INCLUDING FACE) NECK UPPER EXTREMITIES TRUNK LOWER EXTREMITIES MULTIPLE PARTS BODY SYSTEM BODY PARTS, NEC <p>BLOCKS 20 & 23. SOURCE OF INJURY AND AGENCY OF ACCIDENT</p> <ul style="list-style-type: none"> AIR PRESSURE ANIMALS BODILY MOTION BOILERS, PRESSURE VESSELS - PARTS BOXES, BARRELS, CONTAINERS, PACKAGES (EMPTY OR FULL, EXCEPT GLASS) BUILDINGS & STRUCTURES - PARTS CHEMICALS & CHEMICAL COMPOUNDS CLOTHING, APPAREL, SHOES COAL AND PETROLEUM PRODUCTS CONSTRUCTION MATERIALS (NOT PART OF A STRUCTURE) CONVEYORS, GRAVITY OR POWERED (EXCEPT PLANT & INDUSTRIAL VEHICLES) DRUGS AND MEDICINES 	<ul style="list-style-type: none"> ELECTRIC & ELECTRONIC APPARATUS, NEC FLAME, FIRE, SMOKE FOREIGN BODIES OR UNIDENTIFIED ARTICLES FURNITURE, FIXTURES, FURNISHINGS GLASS & CERAMIC ITEMS, NEC HAND TOOLS (NOT POWERED; WHEN IN USE, CARRIED BY A PERSON) HAND TOOLS (MECH. & ELEC. MOTOR POWERED, IN USE, CARRIED AND HELD BY A PERSON) HEATING EQUIPMENT, NEC (NOT ELEC.) WHEN IN USE (FOR ELEC. FURNACES SEE ELECTRONIC APPARATUS) HOISTING APPARATUS ELEVATORS HUMAN BEING INSTRUMENTALITIES OF WAR MACHINES (PORTABLE & FIXED, EXCEPT WHEELED VEHICLES) METAL ITEMS, NEC MINERAL ITEMS, NEC NATURAL POISONS AND TOXIC AGENTS, NEC NOISE PERSONNEL SUPPORTING SURFACES (DECK, LAOGER, STAGE, BROW, PLATFORM) PLASTIC ITEMS, NEC PUMPS, ENGINES, TURBINES (NOT ELEC.) RADIATING SUBSTANCES AND EQUIPMENT (USE ONLY FOR RADIATION INJURIES) SCRAP, DEBRIS, WASTE MATERIAL, ETC., NEC (EXCEPT RADIOACTIVE) SHIP STRUCTURE - PARTS SPORTS TEMPERATURE (ATMOSPHERIC, ENVIRONMENTAL) TEXTILE ITEMS, NEC VEHICLES, (AIR, LAND, SEA) INCLUDING MILITARY AND INDUSTRIAL WATER AND STEAM WOOD ITEMS, NEC MISCELLANEOUS, NEC UNDETERMINED OTHER, NEC <p>BLOCK 21. KIND OF ACCIDENT</p> <ul style="list-style-type: none"> STRUCK AGAINST STRUCK BY FALL OR JUMP FROM ELEVATION FALL OR JUMP ON SAME LEVEL CAUGHT IN, UNDER, OR BETWEEN BITE OR STING, VENOMOUS AND NON-VENOMOUS RUBBED, ABRADED, PUNCTURED OR CUT BODILY REACTION OR MOTION OVEREXERTION CONTACT WITH UNDETERMINED OTHER, NEC <p>BLOCK 22. HAZARDOUS CONDITION</p> <ul style="list-style-type: none"> DEFECT OF THE AGENCY OF ACCIDENT DRESS OR APPAREL HAZARD IMPROPER ILLUMINATION IMPROPER VENTILATION 	<ul style="list-style-type: none"> ENVIRONMENTAL HAZARD, NEC HAZARD OF OUTSIDE WORK ENVIRONMENT - OTHER INADEQUATELY GUARDED PLACEMENT HAZARD PUBLIC HAZARD UNDETERMINED NO HAZARDOUS CONDITION HAZARDOUS CONDITION, NEC <p>BLOCK 24. UNSAFE ACT</p> <ul style="list-style-type: none"> WORKING ON MOVING OR DANGEROUS EQUIPMENT DRIVING ERRORS BY VEHICLE OPERATOR FAILURE TO USE PERSONAL PROTECTIVE EQUIPMENT FAILURE TO WEAR SAFE PERSONAL ATTIRE FAILURE TO SECURE OR WARN MORSEPLAY AND SKYLARKING QUARRELING OR FIGHTING IMPROPER USE OF EQUIPMENT IMPROPER USE OF HANDS OR BODY PARTS INATTENTION TO FOOTING OR SURROUNDINGS FAILURE TO USE SAFETY DEVICES OPERATING OR WORKING AT UNSAFE SPEED TAKING UNSAFE POSITION OR POSTURE UNSAFE PLACING, MIXING, COMBINING, ETC. USING UNSAFE EQUIPMENT OTHER UNSAFE ACTS, NEC UNDETERMINED NO UNSAFE ACT NEC - NOT ELSEWHERE CLASSIFIED <p>BLOCK 25. UNSAFE PERSONAL FACTOR</p> <ul style="list-style-type: none"> UNDER INFLUENCE DRUG/ALCOHOL FATIGUE ILLNESS IMPROPER ATTITUDE LACK OF KNOWLEDGE OR SKILL BODILY DEFECTS UNDETERMINED NO UNSAFE PERSONAL FACTOR OTHER UNSAFE PERSONAL FACTOR, NEC <p style="text-align: right;">• SPECIFY/DETAIL</p>
---	--	---

U-33880

29.52.4(127E)

Figure 2-9.—Instructions for Accidental Injury/Death Report (back).

BEST COPY AVAILABLE

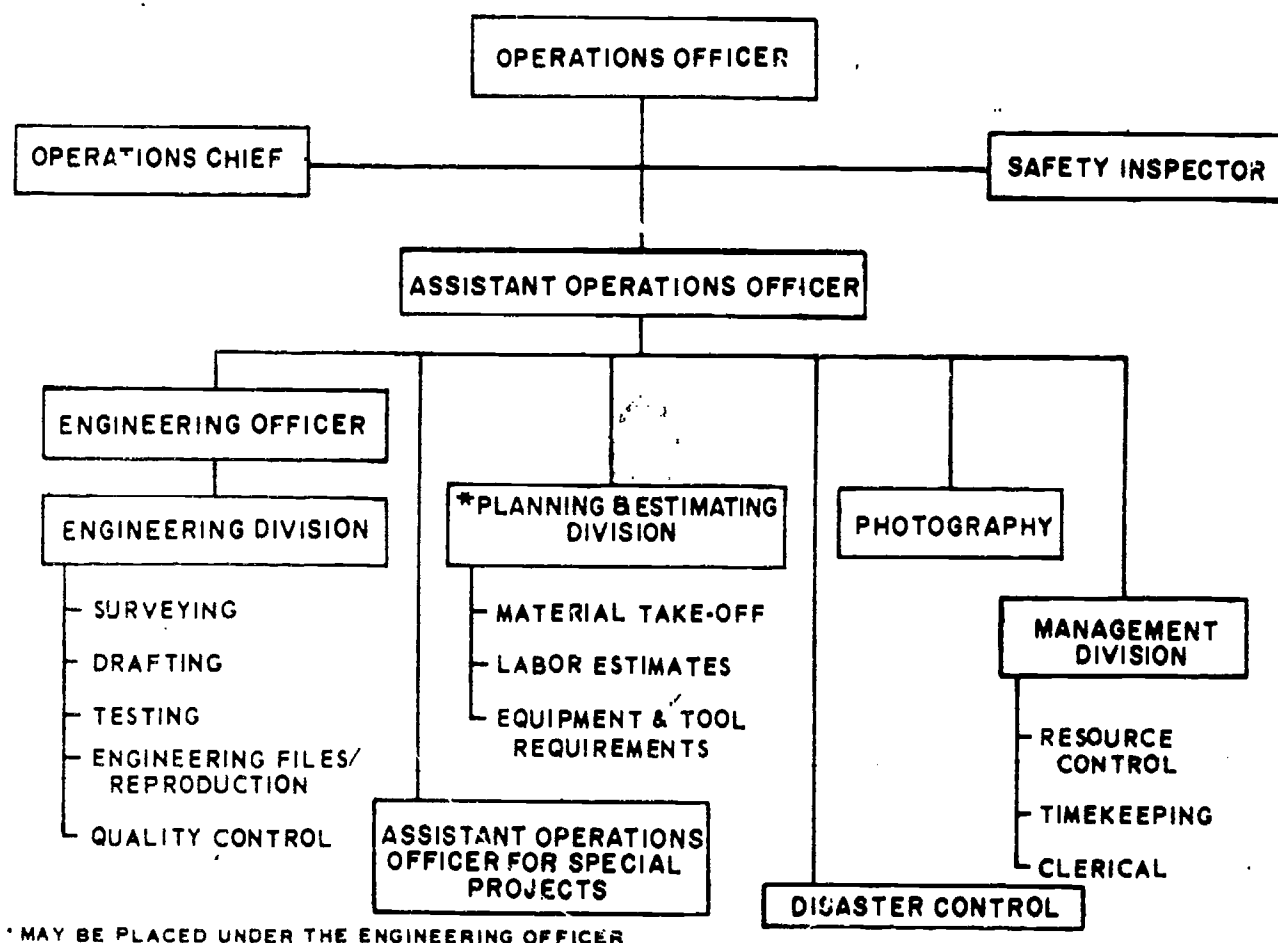

Figure 2-10.—Standard NMCB Operations Department organization.

82.145

the Operations Order (authority issued by CBPAC or CBLANT telling the battalion when and where to deploy and what construction projects are to be accomplished in what time frame) planning by the battalion may start. Timely preparation for and successful completion of all construction projects assigned to the battalion will be the main concern of the Operations Officer. This will involve a thorough analysis of the requirements of the tasks, the determination of the unit's capability and resources such as manpower, equipment and tools, selection of construction methods, establishing priorities and construction schedules, and determination of logistic support for the unit.

Once the planning stages are completed, the Operations Officer assigns the projects to the companies for execution. He maintains constant supervision and liaison with the company

commanders to ensure that quality control is exercised and safety is enforced. Also at this stage, he evaluates the effectiveness of the original planning, scheduling and estimation of the resources. And when necessary, adjustments are made. He is also responsible for the preparation of the construction reports for upper echelon authorities, and the maintenance of liaison with other commands who have interest in the projects.

SAFETY CHIEF

The Safety Chief, or Safety Inspector, is under the direct supervision and control of the Operations Officer, who is assigned the functional responsibility for the battalion safety program. Assisted by the Safety Chief, the Operations Officer is the battalion Safety Officer. Together, they make up the Safety

Chapter 2-ADMINISTRATION AND ORGANIZATION

Division mentioned earlier in this chapter. Basically, they are responsible for conducting a continuing accident prevention program, coordinating safety training with the Training Officer, inspecting jobsites for safety, investigating accidents, and submitting safety reports to higher authority.

OPERATIONS CHIEF

The Operations Chief works directly under the Operations Officer, serving in an advisory capacity. You might say that he is the Operations Officer's right-hand man. This position is usually assigned to a Master Chief Constructionman (CUCM) or an experienced Senior Chief Petty Officer. In assisting the Operations Officer the normal responsibilities of the Operations Chief include:

1. Keeping abreast of all battalion projects from the planning stages to the completion.
2. Maintaining constant liaison with the Material Liaison Officer concerning control of project materials.
3. Coordinating project equipment priorities.
4. Approving field design changes within the scope prescribed by the Operations Officer.
5. Maintaining customer and command liaison.
6. Ensuring that a construction quality control program is implemented.
7. Administering the battalion tool kit inventory and inspection program.
8. Coordinating and scheduling concrete and asphalt requirements.

Almost all of your day-to-day work will be related to the responsibilities of the Operations Chief. For example, for the Operations Chief to be able to coordinate concrete requirements for a certain project, you may be called upon to estimate the amount of concrete which is required.

MANAGEMENT DIVISION

The Management Division of the Operations Department is headed by either the Assistant Operations Officer or the Operations Chief. This division is sometimes referred to as the

Administrative Division of the Operations Department. The division is normally staffed by the Operations Yeomen and the battalion timekeeper. Sometimes these positions are assigned to capable EAs.

The Management Division collects, compiles, and analyzes all information related to the construction operations. This information is used in the preparation of construction operations reports, including the Deployment Completion Report, the Monthly Operations Report, the Weekly Construction Status Report, and any other special reports which may be required by higher authority. The Engineering Division will be required to assist in the preparation of these reports by supplying technical information concerning construction projects. Some reports may be compiled from existing records; and others may require special investigation and research.

For example, let us take the preparation of a Monthly Operations Report. Each battalion submits a monthly report of operations to either COMCBLANT or COMCBPAC (depending on what theater of operation it is in). Copies are sent to the Commander, NAVFAC, and to administrative, military, and operational commanders concerned. This report is a concise review of the battalion's activities during the month, regarding accomplishments, problems, and capabilities. It includes such information as planning, construction, welfare, morale, discipline, safety, training, and equipment. The numbers of officers and enlisted men are shown for the battalion, and for all detachments, specifying the method of movement.

Enclosures to the monthly report are specified by the Commander, Naval Construction Force. The following are generally included:

1. Progress and performance reports
2. Progress photographs
3. Labor distribution reports (fig. 2-4)
4. Financial reports
5. Equipment status reports
6. Training reports
7. Summary of important events that occurred in the battalion during the reporting period.

There are detailed instructions covering the preparation of the Monthly Operations Report and other reports, so your only problem is the compilation of the data that will go with them.

Besides the aforementioned reports, the Management Division Head is responsible for:

1. Maintaining a complete status folder on each project.
2. Maintaining complete and accurate timekeeping records and labor analysis reports.
3. Maintaining and updating visual status boards required for effective construction management including: (a) company personnel strength, (b) project status, (c) labor analysis, and (d) project schedules.
4. Preparing project completion letters in accordance with applicable instructions from higher authority.
5. Maintaining constant liaison with the Material Liaison Officer.

The Management Division maintains constant coordination and works closely with the Planning and Estimating Division and the Deployment Planning Team on the technical aspects of the project, progress reports and master scheduling.

ENGINEERING DIVISION

With only a few exceptions, most EAs are assigned to the Engineering Division of the Operations Department. Therefore, it is important that you become familiar with the overall organizational breakdown of the division and the duties and responsibilities of personnel within the division. As you study the following sections, try to visualize how your contributions to the division will assist in accomplishing the overall mission of the division and the mission of the Operations Department. In other words, see where you fit into the "big picture."

The Engineering Division is under the direction of the Engineering Officer, who is normally a Civil Engineer Corps Officer. The Engineering Officer and his staff are responsible for providing all engineering services and design necessary for the successful conduct of the

construction program. Their specific responsibilities are as follows:

1. Providing guidance and support to the Deployment Planning Team.
2. Reviewing all plans for sound engineering practices and practicability of planning.
3. Resolving field problems relative to errors or revisions in design with the consent of the proper authority.
4. Briefing Company Commanders on engineering aspects of new projects.
5. Liaison with the customer concerning engineering and design.
6. Liaison with the Management Division and the Planning and Estimating Division, if they are not organizationally under the Engineering Officer.

The Engineering Division is also responsible for, and renders technical support in, the following areas:

1. Provides construction inspection by the Engineering Officer to ensure that projects are built in accordance with the plans and specifications, and that quality workmanship prevails at all times. In this respect, the Engineering Officer is responsible for maintaining a continuing and aggressive quality control program. The responsibility for quality control is vested in every member of the construction organization, down to the man on the job.
2. Providing survey services for the construction companies as required.
3. Providing up-to-date drawings and specifications for projects in progress.
4. Providing soils and materials testing and evaluation services.
5. Maintaining as-built drawings and providing copies, as appropriate, to customer commands.

Engineering Chief

The Engineering Chief, usually the senior EA or an EAC, is responsible for all work performed by the drafting section, field survey crews, and material testing personnel. In addition,

depending on the organization, he may directly supervise either the Quality Control Section, the Planning and Estimating Section, or both sections. In effect, the Engineering Chief is the Engineering Officer's assistant.

For military organization, Operations Department personnel not assigned to the battalion staff are assigned to Headquarters Company. Normally the Engineering Chief will act as Platoon Commander or Platoon Chief, with Operations Department personnel organized into his platoon. As an EA3 or EA2, you may act either as fireteam leader or squad leader as well as a work crew supervisor. This dual role means that you will be responsible for the actions of your subordinates continuously, 24 hours a day.

Drafting and Reproduction Section

One of the sections within the Engineering Division to which you may be assigned is the Drafting and Reproduction Section. This section is usually supervised by an EA1 or highly skilled EA2. Depending on your professional capabilities and your potential as a leader, you may be called upon to act as Drafting Room Supervisor. Personnel of this section perform drafting and make reproductions of engineering drawings. Although these are the primary functions of the section, there are many related tasks which are performed by drafting room personnel. Some of these tasks include:

1. Preparation of construction drawings for roads, structures, and utilities
2. Revisions to existing drawings
3. Site adaptation of standard drawings
4. Preparation of maps from survey notes and data
5. Preparation of shop or fabrication drawings
6. Reflection of as-built information
7. Preparation of signs, charts, and sketches
8. Reproduction of drawings (blueprints)
9. Maintaining a complete up-to-date technical library
10. Maintaining indexed print and drawing files
11. Ordering and storing drafting and reproduction supplies

12. Performing operator's maintenance of reproduction machine
13. Providing technical data to the Management Division
14. Assisting other divisions and sections within the Operations Department as directed by the Engineering Officer

It is quite evident from the above list of responsibilities that the drafting room supervisor has his hands full. With a limited number of personnel, he must delegate numerous responsibilities to each draftsman. Failure to produce accurate drawings on time could have an adverse affect on the whole construction project. To achieve maximum production, it is essential that every draftsman be properly trained to perform his assigned tasks. As you study this training manual, you will learn basic drafting techniques and procedures for preparing drawings. With this knowledge and well supervised on-the-job training, you will soon become a proficient draftsman and be able to carry your share of the team effort.

The number of personnel assigned to the drafting section will depend upon the anticipated workload of the entire Engineering Division. Normally, the Drafting Section will consist of from 3 to 6 draftsmen. Unlike specialized civilian draftsmen, personnel assigned to SEABEE drafting offices must be flexible enough to perform many different types of drafting tasks. An experienced SEABEE draftsman must be able to prepare a complete set of construction drawings based upon engineering sketches and technical data.

When an inexperienced EACN or EA3 is first assigned to the Drafting Section, he is usually tasked with the simplest drafting tasks in order to free the experienced draftsmen for more complicated drafting work. These tasks also serve as training for the inexperienced draftsman. His drafting assignments should include preparing various types of charts, making tracings of existing drawings, making revisions to drawings, preparing simple construction and fabrication drawings from sketches, and reflecting as-built information on original drawings.

Very often personnel new to the EA rating will possess skills acquired in civilian life or may

even have an engineering or architectural degree. These individuals must be trained to do things the Navy way; that is, their drawings must conform to Military Standards and be clearly interpreted by field crews.

The reproduction of drawings is a very important phase of the draftsman's work. A drawing, when completed, represents too much time and effort to be treated casually. It is a valuable record, and must be preserved with care. If an original drawing were to be used in the field and passed from man to man, it would soon become worn and too dirty to read. Therefore, it is imperative that reproductions (blueprints) be made from original drawings and the originals be filed for safekeeping. Reproduction is one of the first tasks that a new draftsman must learn. He must learn to operate the reproduction machine and perform periodic operator's maintenance. Along with this, he must learn to properly store blueprint paper and ammonia. Procedures related to care and use of the reproduction machine and supplies will be discussed later in volume II along with suggested procedures for filing drawings and maintaining drawing file records.

Supply PO

When assigned to the Drafting Section, one of your collateral duties may be that of Engineering Division Supply PO. It is practical to assign a draftsman to this duty since he works in the office.

Each crew leader must periodically inventory drafting, reproduction, surveying, and material testing supplies and equipment, in order to maintain a reasonable supply level at all times. From these inventories, the Supply PO prepares requisitions for the Engineering Chief's approval and submits the requisitions to the Supply Department. Requisition procedures were discussed earlier in this chapter. It is the Supply PO's responsibility to maintain a requisition log and file copies of all requisitions. By logging all material receipts and checking with the Supply Department, he provides the Engineering Chief and crew leaders with the up-to-date status of all requisitions. In essence, the Supply PO is the link between the Engineering Division and the Supply

Department with regards to supply and equipment requisitions.

The alert Supply PO does not rely solely on inventories made by the crew leaders. He anticipates the depletion of critical consumable supplies which could cause work delays. For example, there should be a reserve of spare parts for the reproduction machine because they frequently break down or lamps may burn out. You should have a good supply of applicable fuses, roller guide plates, spare belts of right size, spare lamps, and the necessary cleaning and lubricating substances for proper cleaning. And most of all, have an ample supply of blueprint and sepia paper stored in a cool dark space away from ammonia fumes or vapors.

Another collateral duty which might be assigned to the Supply PO is that of embarkation representative. An NMCB must be prepared to mount-out (move) at a moment's notice. In order to do this, every company or department must have embarkation representatives to ensure that all equipment and supplies are packed, marked, and packing lists provided for transportation.

Procedures and guidelines are provided by the battalion Embarkation Officer. All mount-out boxes must be painted olive drab in color, must be properly stenciled, and must contain a packing list.

The packing lists include such information as item descriptions, cubic footages, and approximate weights. Copies of the lists are given to the Supply Department as directed. Copies are also retained in a file which each embarkation representative is responsible for maintaining. The representative should keep copies of up-to-date guidelines in his embarkation file.

Technical Library

Another important responsibility of the Engineering Division is that of establishing and maintaining an Engineering Technical Library of current reference publications. The library is utilized by all personnel of the Operations Department, as well as anyone else in the battalion who requires technical information. In order to render service to others, the library must be maintained in an orderly manner.

Chapter 2 ADMINISTRATION AND ORGANIZATION

Normally, at the beginning of the homeport deployment, the collateral duty of librarian will be assigned to an EA working in the drafting room. He is responsible for arranging the publications, indexing, checking in and checking out publications, and ordering new and revised publications. He is also tasked with packing the entire library for embarkation.

Minimum requirements for a technical library are contained in a current COMCBPAC 5070 series instruction. The instruction includes all administrative, military, and technical library requirements that must be met by each construction battalion. Publications not listed in the COMCBPAC instruction are included in Appendix I of this training manual. Additional publications may be required depending on the particular mission of each deployment of the battalion.

It is essential that the librarian constantly monitor the technical library and know where each publication is at all times. Loss of important reference publications could cause delays in solving engineering problems. Security of commonly "borrowed" publications and a good checkout system will help prevent the loss of important publications.

Surveying Section

One of the main elements of the Engineering Division is the Surveying Section or Field Engineering Section. This section will fall under the direct supervision of the Engineering Chief or an EA1, depending on the number of senior EAs on board and their surveying experience. The size and organization of the entire Surveying Section will vary with the anticipated workload.

The primary responsibility of the Surveying Section, as stated before, is providing surveying services for the companies as required. Actually the scope of tasks performed by the section encompasses a wide range of responsibilities. Depending on the overall mission of the battalion, surveying tasks may include:

1. Developing triangulation networks to establish horizontal control.
2. Developing level nets and level loops to establish vertical control.

3. Collecting field data for the preparation of topographic maps.

4. Providing field data and sketches for design purposes.

5. Conducting route surveys for horizontal construction (roads, airfields, aboveground utilities, and belowground utilities).

6. Conducting layout and stakeout surveys for vertical construction (buildings, sidewalks, bridges, culverts, and waterfront structures).

7. Measuring structures in place for the purpose of preparing as-built drawings.

Large construction projects require continuing survey activity—that is, the surveying can seldom be done in a single operation. Very often the phases of construction surveying overlap preceding phases. When two or more survey missions are being carried on at the same time, the question of where and when to use available crews must be decided. Sometimes all crews are used on one phase of the surveying task; at other times, crews are shuttled from one phase to another. Versatility of the Surveying Section is essential to accomplish all of the assigned tasks. Basically, for most surveying tasks, personnel are organized into two types of surveying parties: the TRANSIT PARTY and the LEVEL PARTY. They are named after the type of surveying instrument used.

Quality Control Section

Quality Control consists of (1) the testing of materials to ensure that their inherent character meets minimum quality requirements (2) the inspection of structures to ensure that materials are installed (or, more frequently, are being installed) in the manner prescribed by design. Therefore, inspectors and materials testing personnel make up the elements of this section. As an EA3/EA2 your main concern will be materials testing. However, you will work closely with the inspectors, and at times, assist the inspectors with their work. Normally, to be assigned in charge of the materials testing section you must possess an NEC of Quality Controlman (EA 5502). Other personnel assigned to the soils laboratory are not required to have this NEC. There are many simple tests that could be performed easily, and assistance is

needed on some of the tests that are more involved. The reports submitted by the construction inspectors will include the results of the test performed by the testing section.

The materials testing section is tasked with performing tests on such items as sub-base materials, aggregates, concrete and bituminous mixes to determine if these materials meet specified quality requirements. As an example, a soil sample for fill material is run through a series of tests to determine its capability to support a structure or how well it could be compacted. Testing the quality of concrete mixtures is one of the common and simple tests that you might be called on to perform. The interpretation of the test results is a responsibility for the more experienced personnel. Materials testing will be covered thoroughly in volume III of this training manual.

Construction inspection is a highly responsible job. The inspectors must be thoroughly knowledgeable of all phases of construction, to back up their recommendations and comments. Their main source of quality criteria is the project specifications and drawings. Therefore, they must analyze and review these materials prior to start and during construction. They inspect all phases of construction and installation, including civil, architectural and structural, electrical and mechanical, for compliance with drawings and specifications. They also observe construction practices and testing of utility lines, and arrange for quality control tests on soils, aggregates, or on concrete and asphalt mixes. Personnel assigned as inspectors normally have the NEC of Construction Inspector (EA-5501), and they could be from any of the Group VIII rating except Construction Mechanic.

Planning and Estimating Section

The Planning and Estimating Section is usually a branch of the Engineering Division headed by the Engineering Officer, or it may be a separate division headed by the Assistant Operations Officer or the Operations Chief. In any case, the Planners and Estimators function solely to provide a planning and estimating capability of the resources required for the construction program. The Planners and

Estimators will normally be under the direct supervision of the Engineering Chief or a chief petty officer of the Builder rating. The Planners and Estimators are taken from each of the Group VIII ratings with the exception of the Construction Mechanic. EA3's and EA2's are not normally assigned to the Planning and Estimating Section except to assist in preparing construction schedules and sketches. However, the Draftsmen and the estimators must work closely to ensure that the drawings and the materials purchased for projects are in agreement. By working closely together, discrepancies are easily corrected before construction begins.

Primary responsibilities of the Planning and Estimating Section are as follows:

1. Preparing material takeoffs or bills of material required for the task assignment.
2. Assisting in estimating manpower, equipment, and special tool requirements necessary to perform the task assignment.
3. Assisting in preparing and updating critical path charts and progress schedules for management of the construction program.
4. Receiving and checking shop drawings.

Planning and estimating methods, procedures, and techniques are explained in *Engineering Aid 1 & C, NAVEDTRA 10635-B*.

PUBLIC WORKS DEPARTMENT

SEABEES receiving orders to a shore or overseas shore activity other than a SEABEE staff or school command, are normally assigned to the activity's Public Works Department (PWD). EA's assigned to Public Works Departments may fill several different types of billets, depending on the department's organization and the capabilities of the EA's assigned. Although most Public Works Department jobs are filled by civilians, military billets do exist in order to implement rotation of Group VIII personnel from sea to shore duty. Most of the existing EA Public Works billets are in the Engineering Division, where the EA works hand-in-hand with civilians in performing drafting and/or surveying tasks. Senior EA's,

Chapter 2—ADMINISTRATION AND ORGANIZATION

with planning and estimating or inspecting experience, may be assigned to the Maintenance Control Division to work as planners and estimators or maintenance inspectors. Sometimes, when there is a shortage of senior military personnel in the Maintenance Control Division, EA's, and other Group VIII petty officers are trained for planning and estimating or maintenance inspecting.

A unique situation exists at most Public Works Departments. Your military duties and responsibilities will fall under military supervision, whereas your professional work will be directly supervised by a civilian engineer. Adjusting to this situation may be difficult at first, but as an alert EA, you will benefit from the vast experience of the professional civilian engineer. A good working relationship between you and your civilian coworker is of the utmost importance. Once this relationship is established, duty at a Public Works Department becomes very interesting and rewarding.

The intent here is only to acquaint you with the basic organization and function of a typical Public Works Department and show how you might fit into the organization. A more detailed discussion is found in *Engineering Aid 1 & C*, NAVEDTRA 10635-B.

PUBLIC WORKS ORGANIZATION AND FUNCTION

At a shore activity, the first organizational breakdown within the activity is that of the department. Departments are established to perform a clearly defined major function or functions that are closely related or homogeneous. Thus, the maintenance and operation of public works and public utilities are the principal functions for which the Public Works Department has been established.

The basic organization for a Public Works Department is shown in figure 2-11. Organizational components of a PWD are: Divisions, Branches, Sections, and Units. Certain traditional names may be used: for instance, paint shop.

The organization consists of two basic parts that are broadly termed the Administrative and Technical Divisions and Operating Divisions. With the exception of the Maintenance Control

Division, these divisions are predominately staffed with graded Civil Service employees. The administrative and technical divisions are listed below:

1. Administrative Division
2. Engineering Division
3. Maintenance Control Division

Administrative Division

The Administrative Division is responsible for all matters pertaining to organization, methods, procedures, work flow, civilian personnel, office services, reproduction reports and statistics, budget and finance, and housing management. The Administrative Division normally has four or five branches. The PERSONNEL BRANCH is concerned with timekeeping and personnel records.

The OFFICE SERVICES BRANCH procures and distributes office supplies, furniture, and office equipment. It is responsible for providing stenographic, typing, and duplicating services, messenger assignments, central files, and other internal matters.

The FINANCIAL BRANCH is responsible for fiscal auditing and accounting matters; compiling, recording, and reporting real property data; and the inventory and records of Public Works materials.

The MANAGEMENT ANALYSIS BRANCH conducts analysis studies (except shop work methods and techniques) pertaining to organization, staffing, workflow, and civilian personnel utilization.

The establishment of a HOUSING BRANCH or division to perform functions of management of HOUSING PROJECTS is optional.

Engineering Division

The Public Works Engineering Division is responsible for all matters pertaining to engineering studies and reports, including preliminary designs and estimates for special repair and improvement projects; for engineering design, including development of plans and specifications, and for the maintenance of technical plan files and records. This division is responsible for preparation of shore facilities

development reports and for the submission of basic data required by the NAVFAC Engineering Field Division Director for preliminary engineering studies.

Whenever the workload justifies or requires such action, the Engineering Division may be subdivided into the following branches:

1. Electrical Branch
2. Mechanical Branch
3. Architectural and Structural Branch
4. Civil Branch
5. Plans and Specifications Branch

In some PW Departments, it will be desirable to combine the Mechanical and Electrical Branches, or to merge the Civil Branch into the Architectural and Structural Branch. In all cases, surveying work is performed as a part of the Civil component.

The PW Officer establishes an Engineering Division to handle only routine work. He relies upon the Engineering Field Division of NAVFAC for the design of major public works and public utilities, for the preparation of specifications in connection with them, and for the engineering investigations in specialized fields.

PW Departments with limited workload and staffing may combine the engineering and maintenance control components into a single Engineering Division.

As mentioned previously, the majority of the EA's assigned to Public Works activities will work in the Engineering Division. With the exception of supervision, your tasks will be similar to those performed in the Engineering Division of the NMCB, such as design, reproduction, surveying, and so forth. Often you will be the only EA assigned to a particular Public Works activity; therefore, your supervisory duties, if any, will be limited.

Maintenance Control Division (MCD)

This is the division in the Public Works Department whose entire effort is directed toward maintenance management. It is responsible for the integration of a maintenance workload program; the screening

and classifying of all work requests, including emergency service type work, prior to submission to shops for accomplishment; the continuous inspection of public works and public utilities to reveal the need for maintenance work; the preparation of manpower and material estimates for job orders; the determination of the need for engineering advice and assistance; and the initiation of requests to the Public Works Officer for approval to perform work by contract. The Maintenance Control Division may be composed of the following Branches:

1. Inspection Branch
2. Planning and Estimating Branch
3. Work Reception & Control Branch

At some PWD's, the Inspection Branch is supplemented with experienced BU's, CE's, UT's, SW's, and a few EA's with broad construction experience. Public Works Departments that are primarily staffed with SEABEES may have senior or master chief petty officers for Inspection Branch and Planning and Estimating Branch supervisors.

Operating Divisions

The Operating Divisions of the PWD are predominately staffed with nongraded civil services employees, consisting of supervisors and various craft workers. The operating divisions of a standard PWD consist of a Maintenance Division, a Utilities Division, and a Transportation Division as shown in figure 2-11. The operating divisions are under the direction of the Shops Engineer, which is a military billet. The Shops Engineer will have under his immediate direction one to three division officers who are designated as Maintenance Officer, Utilities Officer, and/or Transportation Officer. These officers normally function in a line capacity (have direct authority like a company commander of a NMCB), when determined to be qualified by the Public Works Officer to carry these functions.

At PWD's where SEABEES are assigned, BU's, SW's, UT's, and CE's will normally work in the Maintenance and Utilities Divisions, whereas the EO's and CM's will work in the

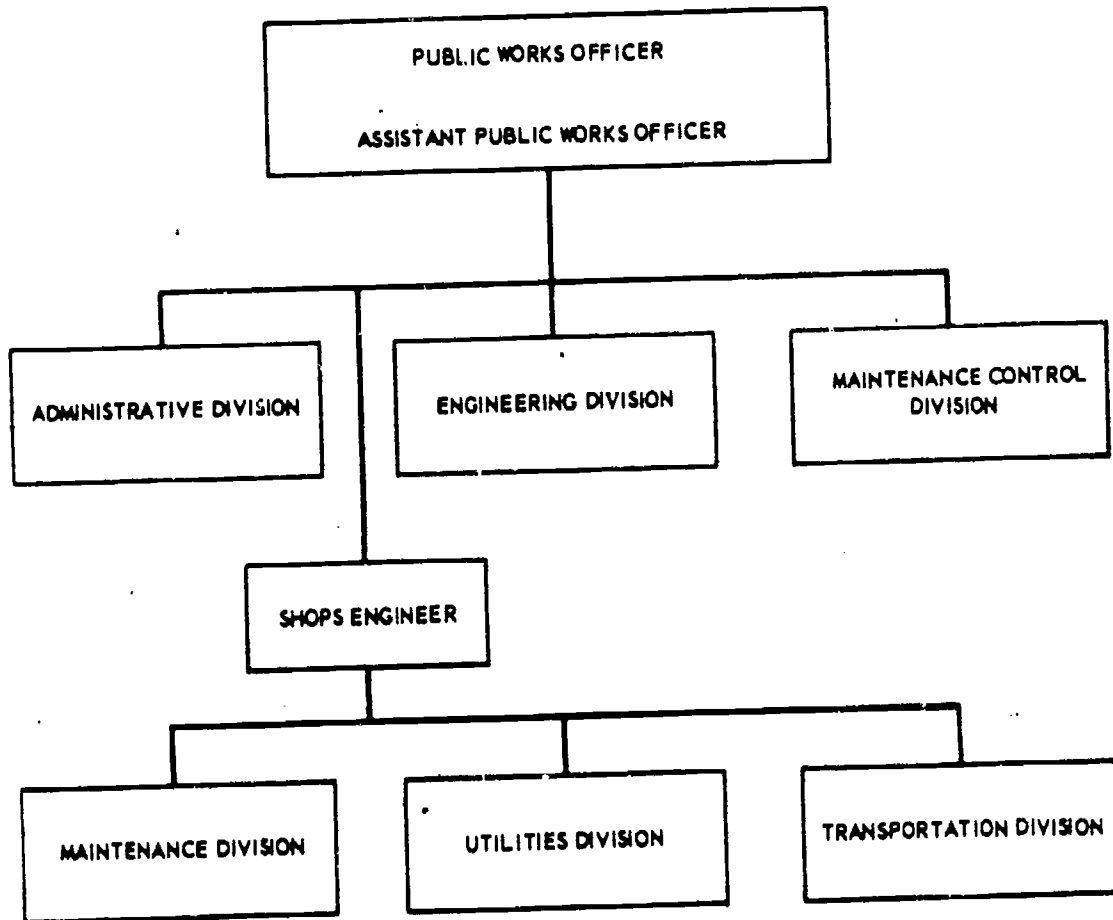

16.8

Figure 2-11.—Public Works Department organization (standard).

Transportation Division. The SEABEES may perform only special project tasks, or they may work hand-in-hand with their civilian coworkers.

Maintenance Division

The Maintenance Division is responsible for the maintenance of buildings, grounds, ground structures, refrigeration units, government owned internal communication and fire alarm systems, roads and railroads trackage; and public utilities including electrical, water, steam, air, gas, fuel oil, and sanitary systems. The following shops are established within the Maintenance Division as required.

BUILDING TRADES BRANCH which may consist of the Carpentry, Paint, Wharf Building, Masonry, and Rigger shops.

METAL TRADES BRANCH consisting of plumbing and pipe fitting, boiler, sheetmetal,

metal and machine shops. The **ELECTRICAL BRANCH** may have electrical, communications, and fire alarms, and refrigeration and air-conditioning shops. The General Services Branch will normally have janitorial and grounds, refuse disposal and pest control, and grounds structures. The **EMERGENCY SERVICE BRANCH** is responsible for accomplishing work of an emergency/service nature, thus allowing other shops to devote their time to scheduled maintenance work. At overseas activities, Emergency/Service request may be handled by SEABEES assigned to the Maintenance Division.

Utilities Division

This division is responsible for the operation, inspection, preventive maintenance and service work for power, heating, refrigerating, compressed air, water, and sewage treatment

plants; fixed pumping stations and substations; also of electric, water, steam, air, gas, and fuel oil distribution systems. The components of the Utilities Division will vary among types and sizes of activities and will also depend on the degree to which utilities are generated or purchased. The following components are established within the Utilities Division as required:

GENERATION AND DISTRIBUTION BRANCH consisting of Steam Electric and Miscellaneous Sections.

WATER AND SEWAGE BRANCH with Water Treatment and Sewage Treatment Sections.

Transportation Division

This Division is responsible for providing transportation and equipment services to all components of the activity. These include: operating vehicle and equipment pools; operating scheduled and unscheduled passenger and freight transport systems; maintaining automotive, construction, railroad, mobile fire fighting, weight handling, and materials handling equipment. Normally this division will have two branches: **OPERATIONS BRANCH** and **REPAIR BRANCH**.

NAVFAC ENGINEERING FIELD DIVISIONS

In discussing the organization and functions of a Public Works Department, mention was made of NAVFAC Engineering Field Divisions. The Engineering Field Divisions exercise middle management responsibilities for the Commander, NAVFACENGCOM in the latter's capacity as the single executive responsible for the maintenance of buildings, grounds, and structures and the operation of utilities at naval installations.

The basic functions of a Field Division are as follows:

1. Provides technical facility planning service, conducts readiness planning, and provides technical and engineering guidance and

assistance in connection with mobilization and emergency plans for all commands and activities.

2. Provides architectural and engineering design of public works and public utilities.

3. Provides for construction of public works and public utilities.

4. Prepares, awards, and administers contracts for planning, architectural and engineering services, utilities, and construction; supervises the contractual practices, procedures, performance, and staffing of subordinate contracting offices; designates Resident Officers in Charge of Construction; and establishes local Resident Officers in Charge of Construction to service an activity or group of activities.

5. Determines, manages, and disposes of real estate according to requirements generated by command or activity missions.

6. Represents NAVFAC in coordination, development, and reporting of requirements for acquisition, operation, maintenance, repair, and improvement of family housing.

7. Represents NAVFAC in performance of single executive responsibilities for facilities maintenance, utilities, and transportation operation.

8. Provides consulting services and technical assistance to all shore activities.

Because of their professional and technical backgrounds, the personnel of the Engineering Field Divisions can render valuable assistance to an activity in building up the Public Works Department's professional technical capacity at the activity.

The Engineering Field Division is available for consultation in matters relating to the organization of Public Works Departments at the individual activities. For small activities, it can render services similar to those provided by a well-staffed Engineering Division at a larger activity. For example, its staff can furnish designs for public works and utilities, prepare specifications in connection with these designs, and make engineering investigations into specialized fields.

When a Public Works Officer has need of a technical engineering review and approval of proposed plans or specifications, he should request the assistance of the cognizant Engineering Field Division.

THE PERSONNEL READINESS CAPABILITY PROGRAM

The Personnel Readiness Capability Program (PRCP) provides a standard means of identifying, collecting, processing, and utilizing information on all members of the Naval Construction Force, both active and reserve. This information can be used by all levels of management and supervision to determine a unit's readiness capability by comparing it to actual or planned requirements.

The majority of PRCP information consists of an inventory of individual skills acquired through formal or on-the-job training. A record of these skills, combined with other data from the service record, such as expiration of enlistment, rotation data, etc., provides a ready means of predicting future capabilities and requirements. Some of these may be:

- a. Construction and military capabilities.
- b. Personnel, logistics, and training requirements.
- c. Berthing, messing, and housing requirements.
- d. Contingency requirements.

Your initial PRCP skill inventory will be based upon an interview with your crew/squad leader or another senior petty officer of your rating. Special *PRCP Interviewer's Standards and Guides* have been prepared to assist persons conducting interviews. Each "Guide" contains a detailed explanation of every skill identified in the PRCP. These definitions are now standard throughout the entire Naval Construction Force, and any man, regardless of duty assignment, can turn to these standards and know what is expected in a given skill area.

During an interview, it is imperative that you discuss your capabilities openly and honestly. Remember, if you exaggerate, you may be depriving yourself of valuable and needed training. Then too, you may be the one selected to do that special job all on your own. Will you be ready?

It will be the responsibility of your supervisors to provide you with the opportunity to learn new skills. This may be done through training or by assigning your team to various types of work whenever possible. You can help by learning what is required in the *PRCP Interviewer's Standards and Guides* for your rating; then as you satisfy those requirements, you can report this to your PRCP coordinator; and, he will have the information added to your inventory of capabilities. By keeping your PRCP record current, you can avoid the unpleasantness of attending training sessions in areas in which you are already proficient. Like practical factors, it is primarily your responsibility for seeing that this information is kept current and accurate. After all, you will be the first to feel that you are qualified in a new skill.

All PRCP information is ultimately stored in a computer data bank. People who work with computers have developed a very realistic saying: "Garbage in: Garbage out." In other words, the accuracy of reports devised for the Personnel Readiness Capability Program will only be as accurate as the information you provide.

A more detailed discussion of the Personnel Readiness Capability Program may be found in chapter 2 of *Engineering Aid 1 & C*, NAVEDTRA 10635-B.

CHAPTER 3

MATHEMATICS AND UNITS OF MEASUREMENT

Mathematics is the Engineering Aid's basic tool. The use of mathematics is found in every rating in the Navy, from the simple arithmetic of counting for inventory purposes to the complicated equations encountered in computer and engineering designs. In the Group VIII ratings, the Engineering Aid is looked upon as superior in knowledge when it comes to the subject of mathematics, which generally is a fact; however, to be worthy of this calling, the responsibility lies upon you to learn more about it. Mathematics is a broad science which cannot be covered fully in formal service school training, so it is up to you to devote some of your own time to study of the subject.

The EA must have the ability to compute easily, quickly, systematically, and accurately. This requires a knowledge of the fundamental properties of numbers and the ability to estimate the accuracy of computations based on field measurements or field data collected. In order to compute rapidly, you need constant practice and should be able to use any available device to speed up and simplify computation. In solving mathematical problems, the solution should never be attempted as if it were a puzzle. Guesswork has no place in its consideration and the statement of the problem itself should be devoid of anything which might obscure its true meaning. Mathematics is not a course in memory, but one in reasoning. Mathematical problems should be read and so carefully analyzed that all conditions are well fixed in mind. Avoid all unnecessary work and shorten the solution wherever possible. Always apply some proof or check to your work. Accuracy is of the greatest importance; a wrong answer is valueless.

This chapter covers various principles of mathematics. The instructions given will aid the EA in making mathematical computations in the field and office. This chapter will also cover units of measurement and the conversion from one system to the other—i.e., from the English to the metric system.

FUNDAMENTALS OF MATHEMATICS

MATHEMATICS is, by broad definition, that science which deals with the relationships which exist between quantities and operations, and with methods by which these relationships can be applied to determine unknown quantities from given or measured data. The fundamentals of mathematics remain the same, no matter to what field they are applied. Various authors have attempted to classify mathematics according to its use. It has been subdivided into a number of major branches; however, those with which you will be principally concerned are: arithmetic, algebra, geometry, and trigonometry.

ARITHMETIC is the art of computation by the use of positive real numbers. Starting with the review of arithmetic, your endeavor builds up to a study of algebra.

ALGEBRA is that branch of mathematics which treats of the relations and properties of numbers by means of letters, signs of operation, and other symbols. Algebra includes solution of equations, polynomials, verbal problems, graphs, and so on.

GEOMETRY is that branch of mathematics which investigates the relations, properties, and measurement of solids, surfaces, lines, and

angles; it also deals with the theory of space and of figures in space.

TRIGONOMETRY is that branch of mathematics which deals with certain constant relationships which exist in triangles, and with methods by which they are applied to compute unknown values from known values.

STUDY GUIDES

Mathematics is an exact science, and there are many books on the subject. These numerous books are the results of the mathematicians' efforts to solve mathematical problems with ease. Methods of arriving at solutions may differ, but the end results or answers are always the same. These different approaches to mathematical problems make the study of mathematics more interesting, either by individual study or as a group.

Recently a programmed math course was developed to teach the mathematics you must know to function as an Engineering Aid. This self-study course requires the use of these four books:

1. *Engineering Aid Applied Mathematics Workbook*, NAVPERS 94470
2. *Engineering Aid Programmed Mathematics, Part I*, NAVPERS 94469-1
3. *Engineering Aid Programmed Mathematics, Part II*, NAVPERS 94469-2
4. A book containing tables of logarithms, trig functions, and the logarithms of trig functions.

This course allows you to work at your own speed and to evaluate your own progress. It also provides a means of reviewing your knowledge of mathematics without completing every step of the course.

You can supplement your study of mathematics with the following Rate Training Manuals:

1. *Mathematics*, Vol. 1, NAVPERS 10069-C
2. *Mathematics*, Vol. 2, NAVPERS 10071-B
3. *Mathematics*, Vol. 3, NAVPERS 10073-A

TYPES OF NUMBERS

Positive and negative numbers belong to the class called REAL NUMBERS. Real numbers and imaginary numbers make up the number system in algebra. However, in this training manual, we will deal only with real numbers unless otherwise indicated.

A real number may be rational or irrational. The word "rational" comes from the word "ratio." A number is rational if it can be expressed as the quotient, or ratio of two whole numbers. Rational numbers include fractions like $\frac{2}{7}$, whole numbers (integer), and radicals if the radical is removable. Any whole number is rational, because it could be expressed as a quotient with 1 as its denominator. For instance, 8 equals $\frac{8}{1}$, which is the quotient of two integers. A number like $\sqrt{16}$ is rational, since it can be expressed as the quotient of the two integers in the form $\frac{4}{1}$. An irrational number is a real number that cannot be expressed as the ratio of two integers. The numbers

$$\sqrt{3}, 5\sqrt{2}, \sqrt{7+5}, \frac{3}{8}\sqrt{20}, \frac{3}{\sqrt{5}}$$

and 3.1416 (π) are examples of irrational numbers.

An integer may be prime or composite. A number that has factors other than itself and 1 is a composite number. For example, the number 15 is composite. It has the factors 5 and 3. A number that has no factors except itself and 1 is a prime number. Since it is advantageous to separate a composite number into prime factors, it is helpful to be able to recognize a few prime numbers. The following are examples of prime numbers: 1, 2, 3, 5, 7, 11, 13, 17, 19, and 23.

A composite number may be a multiple of two or more numbers other than itself and 1, and it may contain two or more factors other than itself and 1. Multiples and factors of numbers are as follows: Any number that is exactly divisible by a given number is a multiple of the given number. For example, 24 is the multiple of 2, 3, 4, 6, 8, and 12, since it is

divisible by each of these numbers. Saying that 24 is a multiple of 3, for instance, is equivalent to saying that 3 multiplied by some whole number will give 24. Any number is a multiple of itself and also of 1.

**FRACTIONS, DECIMALS,
AND PERCENTAGE**

The most general definition of a fraction states that "a fraction is an indicated division." Any division may be indicated by placing the dividend over the divisor with a line between them. By the above definition, any number, even a so-called "whole" number, may be written as a common fraction. The number 20, for example, may be written as 20/1. This or any other fraction which amounts to more than 1 is an IMPROPER fraction. For example, 8/3 is an improper fraction. The accepted practice is to reduce an improper fraction to a MIXED number (a whole number plus a proper fraction). Perform the indicated division and write the fractional part of the quotient in its lowest term. In this case, 8/3 would be 2-2/3. A fraction which amounts to less than 1 is a PROPER fraction, like the fraction 1/4.

To refresh your memory, the following rules in the solution of fractions are included:

1. It will not change the value of a fraction, if you multiply or divide both its numerator and denominator by the same number. The resulting fraction is called an EQUIVALENT fraction.
2. You can add or subtract fractions only if the denominators are alike.
3. To multiply fractions, simply find the products of the numerators and the products of the denominators. The resulting fractional product must be reduced to the lowest term if possible.
4. To divide a fraction by a fraction, invert the divisor and proceed as in multiplication.
5. The method of CANCELLING could be used to advantage before multiplying fractions (using the principle of rule No. 1) to avoid operations with larger numbers.

A decimal fraction is a fraction whose denominator is 10, or some power of 10, such as 100, 1000, and so on. For example,

$$\frac{7}{10}, \frac{23}{100}, \text{ and } \frac{87}{1000}$$

are decimal fractions. Accordingly, they could be written as 0.7, 0.23, and 0.087, respectively. Decimal fractions have certain characteristics that make them easier to use in computations than other fractions. Chapter 5 of NAVPERS 10069-C deals entirely with decimal fractions. A thorough understanding of decimals will be useful to the Engineering Aid in making various engineering computations. Figure 3-1 shows decimal equivalents of fractions commonly used by Builders, Steelworkers, Utilitiesmen, and other trades.

In connection with the study of decimal fractions, businessmen as early as the 15th century made use of certain decimal fractions so much that they gave them the special designation PERCENT. The word "percent" is derived from Latin. It was originally "per centum," which means "by the hundredths." In banking, interest rates are always expressed in percent; statisticians use percent; in fact, people in most all walks of life use percent to indicate increases or decreases in production, population, cost of living, and so on. The Engineering Aid uses percent to express change in grade (slope), as illustrated in figure 3-2. Percent is also used in earthwork computations, progress reports, and other graphical representations. Study chapter 6 of NAVPERS 10069-C for a clear understanding of percentage.

**POWERS, ROOTS, EXPONENTS,
AND RADICALS**

Any number is a higher power of a given root. To raise a number to a power means to multiply, using the number as a factor as many times as the power indicates. A particular power is indicated by a small numeral called the EXPONENT; for example, the small 2 on 3² is an exponent indicating the power.

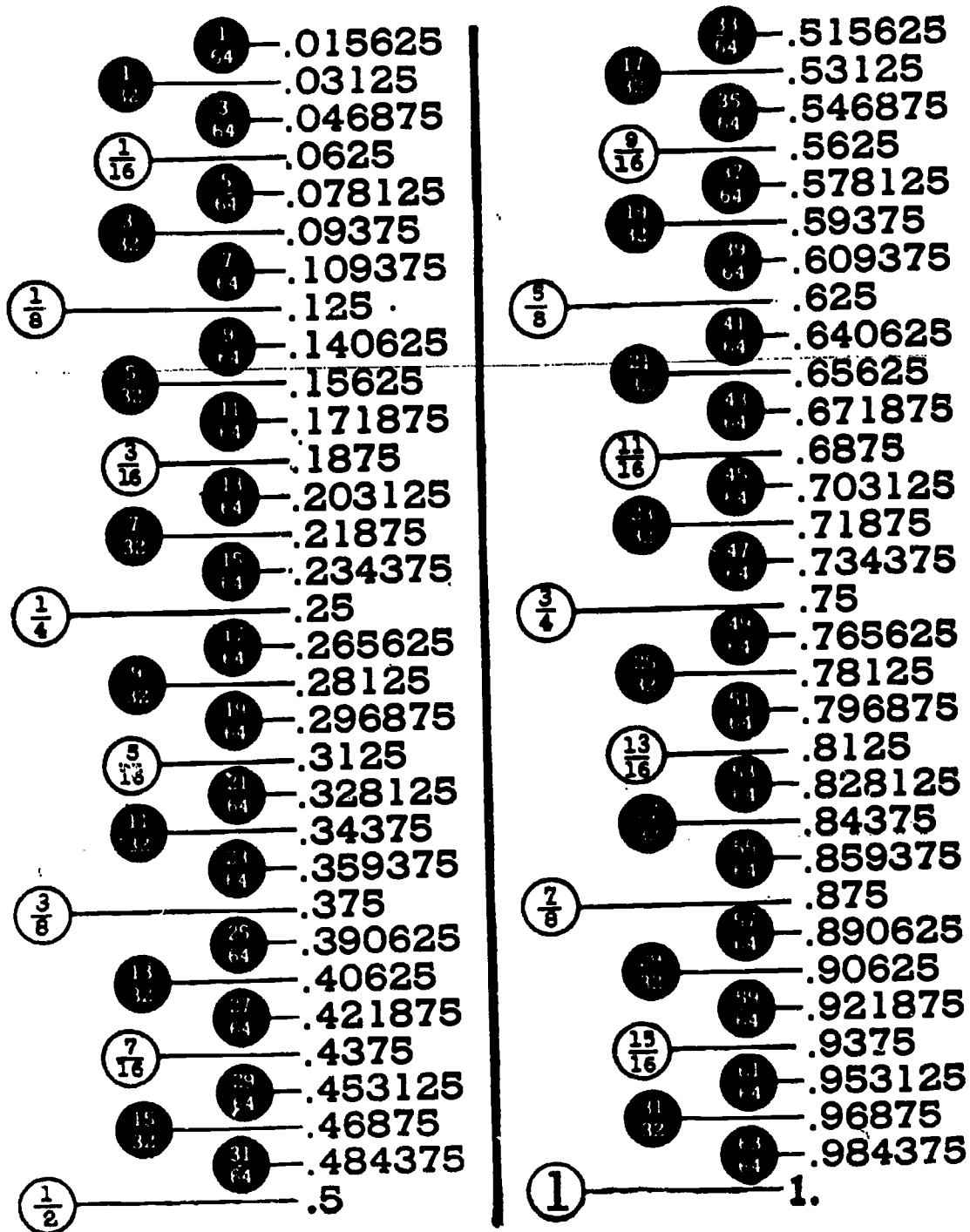

Figure 3-1.—Decimal equivalents.

142.1

Examples:

$$3^2 = 3 \times 3 = 9$$

$$3^3 = 3 \times 3 \times 3 = 27$$

$$6^2 = 6 \times 6 = 36$$

$$6^3 = 6 \times 6 \times 6 = 216$$

There are lots of formulas which require the power or roots of a number. When an exponent

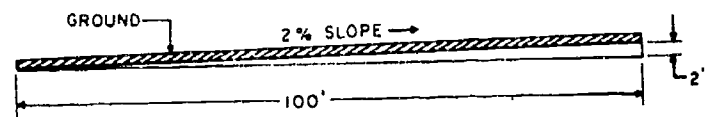

Figure 3-2.—2% grade.

45.703

occurs, it must always be written unless its value is 1.

A particular ROOT is indicated by the radical sign ($\sqrt{\quad}$), together with a small number called the INDEX of the root. The number under the radical sign is called the RADICAND. When the radical sign is used alone, it is generally understood to mean a square root, and ($\sqrt[3]{\quad}$, $\sqrt[5]{\quad}$, and $\sqrt[7]{\quad}$) indicate cube, fifth and seventh root, respectively. The square root of a number may be either + or -. The square root of 36 may be written thus: $\sqrt{36} = \pm 6$, since 36 could have been the product of (+6) (+6) or (-6) (-6). However, in practice, it is more convenient to disregard the double sign (\pm). This example is what we call the root of a perfect square. Sometimes it is easier to extract part of a root only after separation of the factors of the number, such as: $\sqrt{27} = \sqrt{9 \times 3} = 3\sqrt{3}$. As you can see, we were able only to extract the square root of 9, and 3 remains in the radical, because it is an irrational factor. This simplification of the radical makes the solution easier, because you will be dealing with perfect squares and smaller numbers.

Examples:

$$\sqrt{25} = \sqrt{5 \times 5} = 5$$

$$\sqrt{24} = \sqrt{4 \times 6} = 2\sqrt{6} = 2 \times 2.236 = 4.472$$

$$\sqrt[3]{40} = \sqrt[3]{8 \times 5} = 2\sqrt[3]{5} = 2 \times 1.710 = 3.420$$

Radicals are multiplied or divided directly.

Examples:

$$\sqrt{3} \times \sqrt{6} = \sqrt{18} = \sqrt{9 \times 2} = 3\sqrt{2}$$

$$\frac{\sqrt{12}}{\sqrt{3}} = \frac{\sqrt{4} \times \sqrt{3}}{\sqrt{3}} = \sqrt{4} = \pm 2$$

Like fractions, radicals can only be added or subtracted if they are similar.

Examples:

$$2\sqrt{5} + \sqrt{5} = 3\sqrt{5}$$

$$\begin{aligned} \sqrt{2 \times 4} + \sqrt{2 \times 9} &= \sqrt{2}(\sqrt{4}) + \sqrt{2}(\sqrt{9}) \\ &= 2\sqrt{2} + 3\sqrt{2} \\ &= 5\sqrt{2} \end{aligned}$$

When you encounter a fraction under the radical, you have to RATIONALIZE the denominator before performing the indicated

operation. If you multiply the numerator and denominator by the same number, the denominator may be extracted as indicated by the following example:

$$\sqrt{\frac{2}{5}} = \frac{\sqrt{2}}{\sqrt{5}} \times \frac{\sqrt{5}}{\sqrt{5}} = \frac{\sqrt{10}}{\sqrt{25}} = \frac{10}{5} \sqrt{10}$$

The same is true in the division of radicals; for example:

$$\frac{\sqrt{3}}{\sqrt{6}} = \frac{\sqrt{3}}{\sqrt{6}} \times \frac{\sqrt{6}}{\sqrt{6}} = \frac{\sqrt{18}}{\sqrt{36}} = \frac{3}{6} \sqrt{2} \text{ or } \frac{1}{2} \sqrt{2}$$

Any radical expression has a decimal equivalent which may be exact if the radicand is a rational number. If the radicand is not rational, the root may be expressed as a decimal approximation, but it can never be exact. A procedure similar to long division may be used for calculating square root and cube root, and higher roots may be calculated by means of methods based on logarithms and higher mathematics. Tables of powers and roots have been calculated for use in those scientific fields in which it is frequently necessary to work with roots. Such tables may be found in Appendix I of *Mathematics*, Vol. 1, NAVPERS 10069-C and in *Surveying Tables and Graphs*, Army TM 5-236.

Extracting Square Root Arithmetically

In the absence of logarithm tables or a slide rule, square root may be extracted arithmetically, as follows:

Suppose you want to extract the square root of 2034.01. First divide the number into 2-digit groups, working away from the decimal point. Thus set off, the number appears as follows:

$$\sqrt{20,34.01}$$

Next, find the largest number whose square can be contained in the first group. This is the number 4, whose square is 16. The 4 is the first digit of your answer. Place the 4 above the 20,

Chapter 3—MATHEMATICS AND UNITS OF MEASUREMENT

and place its square (16) under the first group, thus:

$$\begin{array}{r} 4 \\ \sqrt{20\ 34.01} \\ \underline{16} \end{array}$$

Now perform the indicated subtraction and bring down the next group to the right, thus:

$$\begin{array}{r} 4 \\ \sqrt{20\ 34.01} \\ \underline{16} \\ 434 \end{array}$$

Next, double the portion of the answer already found (4, which doubled is 8), and set the result down as the first digit of a new divisor, thus:

$$\begin{array}{r} 4 \\ \sqrt{20\ 34.01} \\ \underline{16} \\ 8\ \overline{)434} \end{array}$$

The second digit of the new divisor is obtained by a trial-and-error method. Divide the single digit 8 into the first two digits of the remainder 434 (that is, into 43) until you obtain the largest number which you can (1) add as another digit to the divisor, and (2) use as a multiplier which, when multiplied by the increased divisor, will produce the largest result containable in the remainder 434. In this case, the first number you try is $43 \div 8$, or 5. Add this to the 8 and you get 85. Multiply 85 by 5 and you get 425, which is containable in 434.

The second digit of your answer is therefore 5. Place the 5 above 34. Your computation will now look like this:

$$\begin{array}{r} 4\ 5 \\ \sqrt{20\ 34.01} \\ \underline{16} \\ 85\ \overline{)434} \\ \underline{425} \end{array}$$

Proceed as before to perform the indicated subtraction and bring down the next group, thus:

$$\begin{array}{r} 4\ 5 \\ \sqrt{20\ 34.01} \\ \underline{16} \\ 85\ \overline{)434} \\ \underline{425} \\ 901 \end{array}$$

Again double the portion of the answer already found, and set the result (45×2 , or 90) down as the first two digits of a new divisor, thus:

$$\begin{array}{r} 4\ 5 \\ \sqrt{20\ 34.01} \\ \underline{16} \\ 85\ \overline{)434} \\ \underline{425} \\ 90\ \overline{)901} \end{array}$$

Proceed as before to determine the largest number which can be added as a digit to the divisor 90 and used as a multiplier which, when multiplied by the increased divisor, will produce a result containable in the remainder 901. This number is obviously 1. The increased divisor is 901, and this figure, multiplied by the 1, gives a result exactly equal to the remainder 901.

The figure 1 is therefore the third and final digit in the answer. The square root of 2034.01 is therefore 45.1.

Your completed computation appears thus:

$$\begin{array}{r} 4\ 5.1 \\ \sqrt{20\ 34.01} \\ \underline{16} \\ 85\ \overline{)434} \\ \underline{425} \\ 901\ \overline{)901} \\ \underline{901} \end{array}$$

Tables of Roots

The decimal value of square roots and cube roots of numbers with as many as 3 or 4 digits can be obtained from tables. The table in appendix II of this manual gives the square roots and cube roots of numbers from 1 to 100. Most of the values given in such tables are approximate numbers which have been rounded off.

For example, the fourth column in appendix II shows that $\sqrt{72} = 8.4853$, to 4 decimal places. By shifting the decimal point we can obtain other square roots. A shift of two places in the decimal point in the radicand corresponds to a shift of one place in the same direction in the square root.

The following examples show the effect, as reflected in the square root, of shifting the

location of the decimal point in the number whose square root we seek:

$$\begin{aligned}\sqrt{72} &= 8.4853 \\ \sqrt{0.72} &= 0.84853 \\ \sqrt{0.0072} &= 0.084853 \\ \sqrt{7,200} &= 84.853\end{aligned}$$

The fifth column in appendix I shows that the cube root of 72 is 4.1602. By shifting the decimal point we immediately have the cube roots of certain other numbers involving the same digits. A shift of three places in the decimal point in the radicand corresponds to a shift of one place in the same direction in the cube root.

Compare the following examples:

$$\begin{aligned}\sqrt[3]{72} &= 4.1602 \\ \sqrt[3]{0.072} &= 0.41602 \\ \sqrt[3]{72,000} &= 41.602\end{aligned}$$

Many irrational numbers in their simplified forms involve $\sqrt{2}$ and $\sqrt{3}$. Since these radicals occur often, it is convenient to remember their decimal equivalents as follows:

$$\sqrt{2} = 1.4142 \text{ and } \sqrt{3} = 1.7321$$

Thus any irrational numbers that do not contain any radicals other than $\sqrt{2}$ or $\sqrt{3}$ can be converted to decimal forms quickly without referring to tables.

For example consider

$$\begin{aligned}\sqrt{72} &= 6\sqrt{2} = 6(1.4142) = 8.485 \\ \sqrt{27} &= 3\sqrt{3} = 3(1.7321) = 5.196\end{aligned}$$

Keep in mind that the decimal equivalents of $\sqrt{2}$ and $\sqrt{3}$ as used in the foregoing examples are not exact numbers and the results obtained with them are approximate in the fourth decimal place.

Fractional and Negative Exponents

In some formulas, like the velocity (V) of liquids in pipes which you will encounter later in *Engineering Aid 1 & C*, it is more convenient to use FRACTIONAL EXPONENTS instead of radicals.

Examples:

$$\begin{aligned}\sqrt{3} &= 3^{1/2} \\ \sqrt[3]{3} &= 3^{1/3} \\ \sqrt[3]{3^2} &= 3^{2/3}\end{aligned}$$

It is readily observed that the index of the root in the above examples is the denominator of the fractional exponent. When an exponent occurs in the radicand, this exponent becomes the numerator of the fractional exponent. Roots of numbers not found in tables may be easily computed by proper treatment of the radical used.

Examples:

$$\sqrt{\frac{7}{16}} = \frac{\sqrt{7}}{\sqrt{16}} = \frac{1}{4}\sqrt{7} = \frac{2.646}{4} = 0.6615$$

$$\sqrt[4]{8^3} = \sqrt[4]{\frac{35}{4}} = \frac{\sqrt[4]{35}}{\sqrt[4]{4}} = \frac{1}{2}\sqrt[4]{35} = \frac{5.916}{2} = 2.958$$

In some work, NEGATIVE exponents are used instead of the reciprocals of numbers.

Examples:

$$\begin{aligned}3^{-1} &= \frac{1}{3} & 10^{-1} &= \frac{1}{10} \\ 3^{-2} &= \frac{1}{3^2} = \frac{1}{9} & 10^{-2} &= \frac{1}{100} \\ \frac{1}{5^{-1}} &= 5 & 10^{-3} &= \frac{1}{1000}\end{aligned}$$

Very small or very large numbers used in science are expressed in the form 5.832×10^{-4} or 8.143×10^6 to simplify computation. To write out any of these numbers in full, just move the decimal point to either left or right, the number of places equal to the exponent, supplying a sufficient number of zeros depending upon the sign of the exponent as shown below:

$$\begin{aligned}5.832 \times 10^{-4} &= 0.0005832 \text{ (decimal point moved four places to left)} \\ 8.143 \times 10^6 &= 8,143,000 \text{ (decimal point moved six places to the right)}\end{aligned}$$

In this connection, we also have numbers whose exponents are in the decimal form, which will be

explained later under the section entitled "Logarithms."

RECIPROCAL

The reciprocal of a number is 1 divided by the number. The reciprocal of 2, for example, is $1/2$, and the reciprocal of $2/3$ is 1 divided by $2/3$, which amounts to $1 \times 3/2$, or $3/2$. The reciprocal of a whole number, then, equals 1 over the number, while the reciprocal of a fraction equals the fraction inverted.

In problems containing the power of 10, generally, it is more convenient to employ reciprocals rather than write out lengthy decimals or whole numbers.

Example:

$$\begin{aligned} \frac{1}{250,000 \times 300 \times 0.02} &= \frac{1}{2.5 \times 10^5 \times 3 \times 10^2 \times 2 \times 10^{-2}} \\ &= \frac{10^{-5}}{2.5 \times 3 \times 2} = \frac{10^{-5}}{15} \\ &= \frac{10^2 \times 10^{-7}}{15} = \frac{100 \times 10^{-7}}{15} \\ &= 6.67 \times 10^{-7} \\ &= 0.000000667 \end{aligned}$$

Reciprocal is also employed in problems involving trigonometric functions of angles, as you will see later in this chapter in the solutions of problems containing identities.

RATIO AND PROPORTION

Almost every computation you will make as an EA, which involves determining an unknown value from given or measured values, will involve the solution of a proportional equation. A thorough understanding of ratio and proportion will greatly help you in the solution of both surveying and drafting problems.

The results of observation or measurement often must be compared with some standard value in order to have any meaning. For example, if the magnifying power of your telescope is 20 diameters and you see one in the market which says 50 diameter magnifying power, then one can see that the latter has a greater magnifying power. How powerful? To

find out, we will divide the second by the first number, which is

$$\frac{50}{20} = \frac{5}{2}$$

The magnifying power of the second telescope is $2\frac{1}{2}$ times as powerful as the first. When the relationship between two numbers is shown this way, they are compared as a **RATIO**. A ratio is a comparison of two like quantities.

Comparison by means of a ratio is limited to quantities of the same kind. For example, in order to express the ratio between 12 ft and 3 yds, both quantities must be written in terms of the same unit. Thus, the proper form of this ratio is 4 yd:3 yd, not 12 ft:3 yd. When the parts of the ratio are expressed in terms of the same unit, the units cancel each other and ratio consists simply of two numbers. In this example, the final form of the ratio is 4:3.

Since a ratio is also a fraction, all the rules that govern fractions may be used in working with ratios. Thus, the terms may be reduced, increased, simplified, and so forth, according to the rules for fractions.

Closely allied with the study of ratio is the subject of proportion. A **PROPORTION** is nothing more than an equation in which the members are ratios. In other words, when two ratios are set equal to each other, a proportion is formed. The proportion may be written in three different ways, as in the following examples:

$$15:20 :: 3:4$$

$$15:20 = 3:4$$

$$\frac{15}{20} = \frac{3}{4}$$

The last two forms are the most common. All these forms are read, "15 is to 20 as 3 is to 4." In other words, 15 has the same ratio to 20 as 3 has to 4.

The whole of chapter 13, NAVPERS 10069-C is devoted to an explanation of ratio and proportion, the solution of proportional equations, and the closely related subject of variation. In addition to this knowledge, you should develop the ability to recognize a

computational situation as one that is available to solution by proportional equation. A very large area of surveying computations—that which involves triangle solutions—utilizes the proportional equation as the principal key to the determination of unknown values on the basis of known values. Practically any problem involving the conversion of measurement expressed in one unit to the equivalent in a different unit is solvable by proportional equation. Similarly, if you know the quantity of a certain material required to produce a certain number of units of product, you can determine by proportional equation the quantity required to produce any given number of units.

In short: it is difficult to imagine any mathematical computation involving the determination of unknown values on the basis of known values that is not available to solution by proportional equation.

Your knowledge of equations need not extend beyond that required to solve linear equations—that is, equations in which the unknown appears with no exponent higher than 1. The equation

$$4x + 7 = \frac{15}{6}$$

for example, is a linear equation, because the unknown (technically known as the “variable”) x appears to only the 1st power. The equation $x^2 + 2x = -1$, however, is not a linear but a quadratic equation, because the variable appears to the second power.

The whole of chapter 11 of NAVPERS 10069-C is devoted to an explanation of linear equations in one variable. The whole of chapter 12 is devoted to an explanation of linear equations in two variables.

ARITHMETIC

The common arithmetical operations are addition, subtraction, multiplication, and division. Arithmetical operations with positive whole numbers are explained in chapter 2 of NAVPERS 10069-C, and arithmetical operations with signed numbers in chapter 3. Arithmetical operations with common fractions are explained in chapter 4, and arithmetical operations with decimal fractions in chapter 5.

ALGEBRAIC NOTATION AND ALGEBRAIC OPERATIONS

Algebraic notation—meaning generally the substitution of symbols (usually letters) for numerical values—is explained in chapter 9 of NAVPERS 10069-C. Algebraic fundamentals, such as the meanings of terms; systems of groupings; and the addition, subtraction, multiplication, and division of algebraic monomials and polynomials are explained in the same chapter. The factoring of algebraic expressions is explained in chapter 10.

LOGARITHMS

The arithmetical operations of multiplication and division of numbers, and the extraction of roots or the determination of powers of numbers, can be greatly simplified by the use of logarithms. There are two types of logarithms: “natural” (also called “Naperian”) logs, and “common” logs. Natural logs are used mainly in higher mathematics. You will be working exclusively with common logs.

NATURAL LOGARITHMS

Many natural phenomena, such as rates of growth and decay, are most easily described in terms of logarithmic or exponential formulas. For instance, the geometric pattern in which certain seeds (such as sunflower seeds) grow is a logarithmic spiral. These facts explain the name “natural logarithms.” Natural logarithms use the base e , which is an irrational number approximately equal to 2.71828. This system is sometimes called the Napierian system of logarithms, in honor of John Napier, who is credited with the invention of logarithms.

To distinguish natural logarithms from other logarithmic systems, the abbreviation, \ln , is sometimes used. When \ln appears, the base is understood to be e and need not be shown. For example, either $\log_e 45$ or $\ln 45$ signifies the natural logarithm of 45.

COMMON LOGARITHMS

In 1617, Henry Briggs, an English mathematician, found that base 10 possessed many advantages not obtainable in ordinary calculations with other bases. The selection of a

logarithmic base is a matter of convenience. The selection of 10 as a base has proved so satisfactory that today it is used almost exclusively for ordinary calculations. Logarithms with 10 as a base are called **COMMON LOGARITHMS**.

Common logarithms may be used to advantage in all calculations which involve multiplication, division, powers, and roots. When the slide rule is not available, then logarithmic tables may be used for all calculations. Bear in mind that common logarithms cannot be used for addition and subtraction of numbers.

In this section, we will explain the use of common logarithms for calculations involving problems which you as an EA will generally encounter. For a thorough understanding of the various uses of logarithms in computations, study carefully chapter 8 of NAVPERS 10069-C.

The fractional part of a logarithm is usually written as a decimal. The whole number part of a logarithm and the decimal part have been given separate names because each plays a special part in relation to the number which the logarithm represents. The whole number part of a logarithm is called the **CHARACTERISTIC**. This part of the logarithm shows the position of the decimal point in the associated number. The decimal part of a logarithm is called the **MANTISSA**.

For a particular sequence of digits making up a number, the mantissa of a common logarithm is always the same regardless of the position of the decimal point in that number. For example, $\log 5270 = 3.72181$; the mantissa is 0.72181 and the characteristic is 3, which indicates the position of the decimal point in the associated number. The characteristic for a given number may be determined by inspection. It should be remembered that a common logarithm is simply an exponent of the base 10.

When we write $\log 360 = 2.55630$, we understand this to mean $10^{2.55630} = 360$. We know that the number is 360 and not 36 or 3,600 because the characteristic is 2. We know 10^1 is 10, 10^2 is 100, and 10^3 is 1,000. Therefore, the number whose value is $10^{2.55630}$ must lie between 100 and 1,000, and, of course, any number in that range has 3

digits. Notice how the position of the decimal point changes with the value of the characteristic in the following examples:

$$\begin{aligned} \log 36,000 &= 4.55630 \\ \log 3,600 &= 3.55630 \\ \log 360 &= 2.55630 \\ \log 36 &= 1.55630 \\ \log 3.6 &= 0.55630 \end{aligned}$$

Note that it is only the characteristic that changes when the decimal point is moved. An advantage of using the base 10 is thus revealed: If the characteristic is known, the decimal point may easily be placed. If the number is known, the characteristic may be determined by inspection; that is, by observing the location of the decimal point.

Although an understanding of the relation of the characteristic to the powers of 10 is necessary for thorough comprehension of logarithms, the characteristic may be determined mechanically by application of the following rules:

1. For a number greater than 1, the characteristic is positive and is one less than the number of digits to the left of the decimal point in the number.
2. For a positive number less than 1, the characteristic is negative and has an absolute value one more than the number of zeros between the decimal point and the first nonzero digit of the number.

The effect on the characteristics of change in the position of the decimal point is shown in figure 3-3.

When a characteristic is negative, such as -2, we do not carry out the subtraction, since this would involve a negative logarithm. There are several ways of indicating a negative characteristic. Mantissas as presented in the table are always positive and the sign of the characteristic is indicated separately. For example, where $\log 0.023 = \bar{2}.36173$, the bar over the 2 indicates that only the characteristic is negative—that is, the logarithm is $-2 + 0.36173$.

Another way to show the negative characteristic is to place it after the mantissa, as shown in figure 3-3.

Number	Characteristic	Mantissa	Logarithm
45,600	4	0.6590	4.6590
4,560	3	0.6590	3.6590
456	2	0.6590	2.6590
45.6	1	0.6590	1.6590
4.56	0	0.6590	0.6590
0.456	-1	0.6590	0.6590 -1
0.0456	-2	0.6590	0.6590 -2
0.00456	-3	0.6590	0.6590 -3

45.710

Figure 3-3.—Effect on the characteristics of change in the location of the decimal point.

Common logs are explained in NAVPERS 10069-C, chapter 8 and 10071-B, chapter 2. Appendix I of NAVPERS 10069-C contains a table which gives the logarithms for numbers from 1 through 134. This table follows the unusual procedure of giving the characteristic as well as the mantissa for each number. Mantissas are given to 5 places.

Appendix II of NAVPERS 10071-B contains a table which gives mantissas to 4 places of numbers from 10 through 999.

Neither of these tables is of the type generally used in modern surveying practice. A modern table usually gives mantissa to 6 places for numbers from 1 through 9,999, and usually contains as well a table of proportional parts which makes the determination of mantissa for numbers greater than those actually shown in the table.

A sample page from a table of this type is shown in figure 3-4. Suppose you want to find the mantissa for the number 17527. You run down the left-hand column (the one headed by "N") to 175, then work across horizontally to the column headed by the figure 2. There you read the mantissa for 1752, which is 243534. This is also the mantissa for 17520.

The mantissa for 17527 lies seven-tenths of the way, as it were, between the mantissa for 17520, which is 243534, and the mantissa for 17530, which is 243782. The difference between these two mantissa is 248, and

seven-tenths of 248 is 173.6, which rounds off at 174. Therefore, if you add 174 to the mantissa for 17520 (which is 243534), you will have the mantissa for 17527 (which is 243534 + 174), or 243708.

What you did here was "interpolate" between the mantissa for 17520 and the mantissa for 17530 to get the mantissa for 17527. In figure 3-4 this interpolation can be done partly by inspection. Note that there is a column to the right of the page which is headed "Diff." Figures in this column give you the numerical differences between adjacent mantissa. You can see that the figure adjacent to the row containing the mantissa for 17520 and 17530 is 248, which is the difference between the mantissa for those two numbers.

At the bottom of the page, you see a table headed "Proportional Parts." To the left of this table there is a column headed "Diff." Run down this column to your "Diff.", which is 248. Because you are interpolating for the figure 7, run horizontally to the right to the column headed by the figure 7. There you see the figure 173.6, which, rounded off to 174, is the figure you add to the mantissa for 17520 to get the mantissa for 17527.

The mantissa for 17527, then, is 243708. Because there are 5 digits in 17527, you know that the characteristic of the log for 17527 is 4. The complete log for 17527, then, is 4.243708.

No. 170 I. 230 I											[No. 189 I. 278
N.	0	1	2	3	4	5	6	7	8	9	Diff.
170	24049	0704	0880	1215	1470	1724	1979	2234	2488	2742	255
1	24050	0705	0881	1216	1471	1725	1980	2235	2489	2743	254
2	24051	0706	0882	1217	1472	1726	1981	2236	2490	2744	253
3	24052	0707	0883	1218	1473	1727	1982	2237	2491	2745	252
4	24053	0708	0884	1219	1474	1728	1983	2238	2492	2746	251
5	24054	0709	0885	1220	1475	1729	1984	2239	2493	2747	250
6	24055	0710	0886	1221	1476	1730	1985	2240	2494	2748	249
7	24056	0711	0887	1222	1477	1731	1986	2241	2495	2749	248
8	24057	0712	0888	1223	1478	1732	1987	2242	2496	2750	247
9	24058	0713	0889	1224	1479	1733	1988	2243	2497	2751	246
180	24059	0714	0890	1225	1480	1734	1989	2244	2498	2752	245
1	24060	0715	0891	1226	1481	1735	1990	2245	2499	2753	244
2	24061	0716	0892	1227	1482	1736	1991	2246	2500	2754	243
3	24062	0717	0893	1228	1483	1737	1992	2247	2501	2755	242
4	24063	0718	0894	1229	1484	1738	1993	2248	2502	2756	241
5	24064	0719	0895	1230	1485	1739	1994	2249	2503	2757	240
6	24065	0720	0896	1231	1486	1740	1995	2250	2504	2758	239
7	24066	0721	0897	1232	1487	1741	1996	2251	2505	2759	238
8	24067	0722	0898	1233	1488	1742	1997	2252	2506	2760	237
9	24068	0723	0899	1234	1489	1743	1998	2253	2507	2761	236
190	24069	0724	0900	1235	1490	1744	1999	2254	2508	2762	235
1	24070	0725	0901	1236	1491	1745	2000	2255	2509	2763	234
2	24071	0726	0902	1237	1492	1746	2001	2256	2510	2764	233
3	24072	0727	0903	1238	1493	1747	2002	2257	2511	2765	232
4	24073	0728	0904	1239	1494	1748	2003	2258	2512	2766	231
5	24074	0729	0905	1240	1495	1749	2004	2259	2513	2767	230
6	24075	0730	0906	1241	1496	1750	2005	2260	2514	2768	229
7	24076	0731	0907	1242	1497	1751	2006	2261	2515	2769	228
8	24077	0732	0908	1243	1498	1752	2007	2262	2516	2770	227
9	24078	0733	0909	1244	1499	1753	2008	2263	2517	2771	226

Proportional Parts										
Diff.	1	2	3	4	5	6	7	8	9	
255	25.5	51.0	76.5	102.0	127.5	153.0	178.5	204.0	229.5	
254	25.4	50.8	76.2	101.6	127.0	152.4	177.8	203.2	228.6	
253	25.3	50.6	75.9	101.2	126.5	151.6	177.1	202.4	227.7	
252	25.2	50.4	75.6	100.8	126.0	151.2	176.4	201.6	226.8	
251	25.1	50.2	75.3	100.4	125.5	150.6	175.7	200.8	225.9	
250	25.0	50.0	75.0	100.0	125.0	150.0	175.0	200.0	225.0	
249	24.9	49.8	74.7	99.6	124.5	149.4	174.3	199.2	224.1	
248	24.8	49.6	74.4	99.2	124.0	148.8	173.6	198.4	223.2	
247	24.7	49.4	74.1	98.8	123.5	148.2	172.9	197.6	222.3	
246	24.6	49.2	73.8	98.4	123.0	147.6	172.2	196.8	221.4	
245	24.5	49.0	73.5	98.0	122.5	147.0	171.5	196.0	220.5	
244	24.4	48.8	73.2	97.6	122.0	146.4	170.8	195.2	219.6	
243	24.3	48.6	72.9	97.2	121.5	145.8	170.1	194.4	218.7	
242	24.2	48.4	72.6	96.8	121.0	145.2	169.4	193.6	217.8	
241	24.1	48.2	72.3	96.4	120.5	144.6	168.7	192.8	216.9	
240	24.0	48.0	72.0	96.0	120.0	144.0	168.0	192.0	216.0	
239	23.9	47.8	71.7	95.6	119.5	143.4	167.3	191.2	215.1	
238	23.8	47.6	71.4	95.2	119.0	142.8	166.6	190.4	214.2	
237	23.7	47.4	71.1	94.8	118.5	142.2	165.9	189.6	213.3	
236	23.6	47.2	70.8	94.4	118.0	141.6	165.2	188.8	212.4	
235	23.5	47.0	70.5	94.0	117.5	141.0	164.5	188.0	211.5	

Figure 3-4.—Sample page from 6—Place Table of Common Logarithms of Numbers.

45.45.1

Suppose, now, that you have this log to start with, and you want to use the table to find the antilog—that is, the corresponding number. The procedure is simply the reverse of that described for finding the mantissa. You run through the mantissa on the appropriate page (which you locate by means of the figures at the head of the page) until you locate one which is less than the one you have, and which has a next higher value than the one you have. This mantissa is 243534. Because it is located horizontally to the right of

175 (in the column headed "N") and in the column headed by the figure 2, you know that the first 4 digits of the antilog are 1752.

To get the fifth digit, run across horizontally to the right and note the "Diff.," which is 248. Then determine the difference between the mantissa for 1752 and the mantissa you have, which is (243708 - 243534), or 174. Now run down the left-hand column of the "Proportional Parts" table to your "Diff.," which is 248. Then work across horizontally to the right to the

figure which comes nearest to the determined difference between the mantissa for 1752 and the mantissa you have. This determined difference is 174; the figure which comes nearest to it is 173.6. This figure is located in the column headed by the figure 7. The fifth digit of the antilog is therefore 7, and the complete antilog is 17527. Because the characteristic of your log is 4, you know that there are 5 digits before the decimal point in the antilog.

Now let us take some practical applications of logarithms. You have to get a 5- or 6-place logarithmic table, because a complete set is beyond the scope of this training manual.

EXAMPLE 1: Multiply 1471.50 by 931.26

$$\begin{array}{r} 1471.50 \times 931.26 = \\ \text{Log } 1471.50 = 3.16776 \\ +\text{Log } 931.26 = 2.96907 \\ \hline \text{The sum} = 6.13683 \end{array}$$

$$\text{Antilog } 6.13683 = 1,370,400$$

As you can see from the above computation, in multiplication, the product of two or more numbers is equal to the antilog of the sum of the logarithms of the numbers.

EXAMPLE 2: Divide 1984.90 by 46

$$\begin{array}{r} 1984.90 \div 46 = \\ \text{Log } 1984.90 = 3.29774 \\ -\text{Log } 46 = 1.66276 \\ \hline \text{The difference} = 1.63498 \end{array}$$

$$\text{Antilog } 1.63498 = 43.15$$

As a general rule, the above operation is stated as follows: The quotient of two numbers is equal to the antilog of the difference between the logarithm of the dividend minus the logarithm of the divisor.

Dividing one number by another may be computed logarithmically by addition rather than by subtraction, if the cologarithm is employed. The cologarithm of a number is the logarithm of the reciprocal of the number. It is easily derived by subtracting the logarithm of the number from the logarithm of 1. Thus,

$$\text{colog } 46 = \log \frac{1}{46} = \log 1 - \log 46$$

But, $\log 1 = 0$, and 0 may be written as $10.00000 - 10$

$$\begin{aligned} \text{then, colog } 46 &= (10.00000 - 10) - \log 46 \\ &= (10.00000 - 10) - 1.66276 \\ &= 8.33724 - 10 \end{aligned}$$

Now, returning to example 2, above:

$$\begin{array}{r} 1984.90 \div 46 = \\ \text{log } 1984.90 = 3.29774 \\ + \\ \text{colog } 46 = 8.33724 - 10 \end{array}$$

$$\text{The sum} = 11.63498 - 10 \text{ or } 1.63498$$

$$\text{ant.log } 1.63498 = 43.15$$

If the dividend and the divisor are composed of products of two or more numbers, the quotient is equal to the antilog of the difference of the sum of the logarithms of the dividend minus the sum of the logarithms of the divisor.

EXAMPLE 3: Raise 132 to the third power

$$\begin{array}{r} (132)^3 = \\ \text{Log } 132 = 2.12057 \\ 3 \text{ Log } 132 = 2.12057 \times 3 \\ = 6.36171 \end{array}$$

$$\text{Antilog } 6.36171 = 2,300,000$$

The general rule for the above operations is: The power of a number is equal to the anti-logarithm of the logarithm of the number after the logarithm of the number is multiplied by its exponent.

EXAMPLE 4: Extract the square root of 3754

$$\sqrt{3754} =$$

$$\begin{array}{r} \text{Log } 3754 = 3.57449 \\ \frac{1}{2}\text{Log } 3754 = 3.57449 \div 2 \\ = 1.78724 \end{array}$$

$$\text{Antilog } 1.78724 = 61.27$$

You have seen that the root of a number is equal to the antilogarithm of the logarithm of the number divided by the index of the root.

After a little practice in the use of logarithmic tables, in interpolation, and in logarithmic computations, you will realize that logarithms are your best tool for Engineering Aid computations.

GEOMETRY

Since geometry is that branch of mathematics which investigates the relations, properties, and measurement of solids, surfaces, lines, and angles, it follows that just about everything a surveyor does involves geometry in some way or other. Whenever you establish a point, chain a linear distance, measure a vertical distance, turn an angle, or determine an area or a volume, you are working with geometry.

To begin with, you must know how to recognize the common types of geometrical plane and solid figures, and how to compute the areas of the plane figures and the volumes of the solids.

SURFACES AND FIGURES

There is a surface on this sheet of paper. A geometrical surface has length and breadth. It

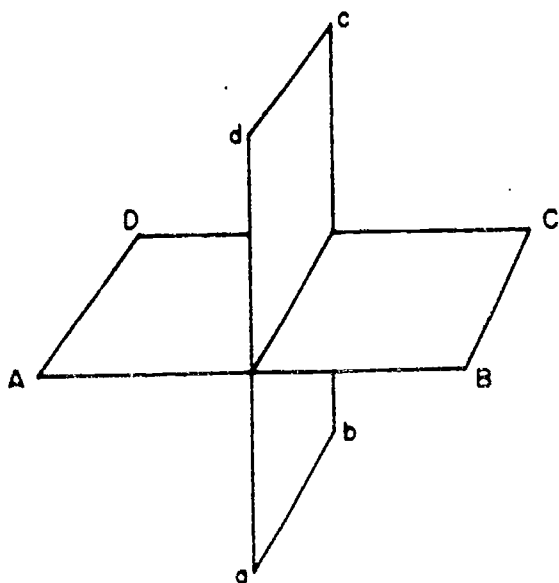

Figure 3-5.—Intersecting planes.

45.633

has no thickness. A surface may be either a plane surface or a curved surface. When this page is held perfectly level at every point, the surface is then a plane surface. When the page is rolled to resemble a tube, the plane surface becomes a curved surface.

A plane is a real or imaginary surface in which a straight line between any two points lies wholly in that surface. Figure 3-5 shows two intersecting planes. Plane ABCD is shown to be a horizontal plane; plane abcd is a vertical plane perpendicular to ABCD.

A plane surface is a surface on which every point lies in the same plane.

Plane figures are plane surfaces bounded by either straight lines or curved lines.

POLYGONS

A plane figure which is bounded by straightline sides is called a polygon. The smallest possible number of sides for a polygon is three, and a three-sided polygon is called a triangle.

Some terms and definitions relating to polygons are as follows:

Sides: the boundary lines of a polygon.

Perimeter: the sum of the sides.

Triangle: a polygon bounded by three sides.

Quadrilateral: a polygon bounded by four sides.

Pentagon: a polygon bounded by five sides.

Hexagon: a polygon bounded by six sides.

Heptagon: a polygon bounded by seven sides.

Octagon: a polygon bounded by eight sides.

Equilateral: a polygon with sides of equal length.

Regular: an equilateral polygon.

Irregular: a nonequilateral polygon.

Parallelogram: a quadrilateral with both pairs of opposite sides parallel.

Rectangle: a parallelogram in which adjacent sides join at right angles.

Square: an equilateral rectangle.

Oblong: a nonequilateral rectangle.

Trapezoid: a quadrilateral with only one pair of opposite sides parallel, the other pair being not parallel.

1. TRIANGLE

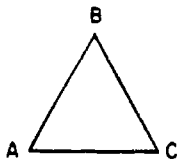

4. HEXAGON

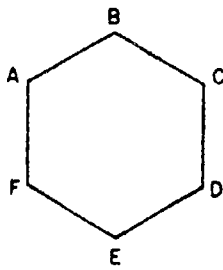

2. QUADRILATERAL

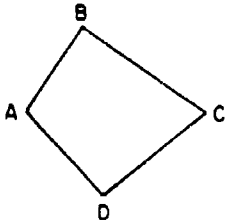

5. HEPTAGON

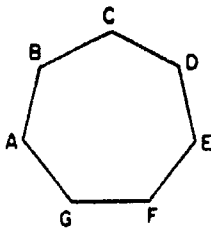

3. PENTAGON

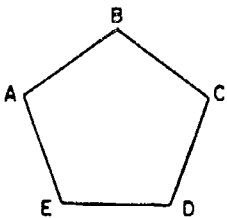

6. OCTAGON

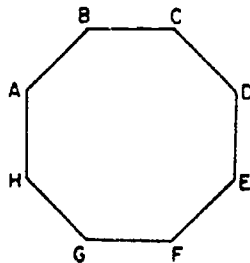

45.634(45B)

Figure 3-6.—Geometric figures of triangle, quadrilateral, pentagon, etc.

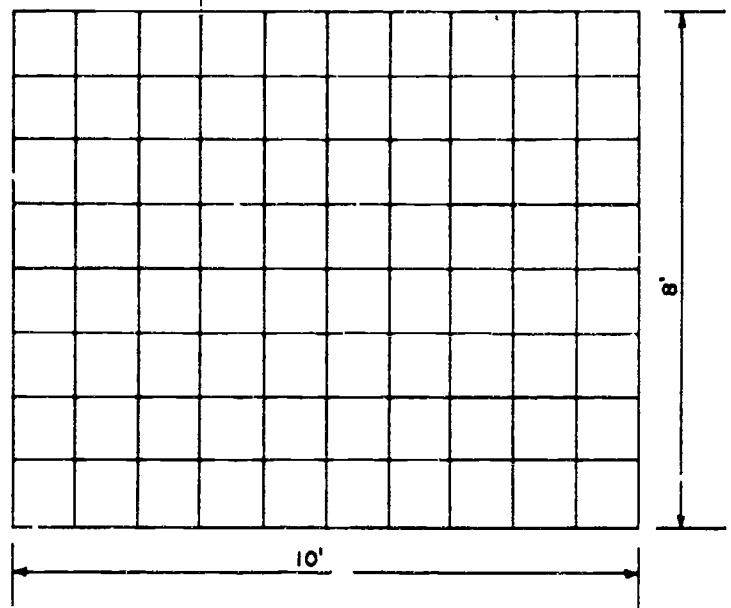

45.635

Figure 3-8.—Area of rectangle.

Trapezium: a quadrilateral with no sides parallel.

Rhombus: an equilateral parallelogram in which adjacent sides join at oblique (other than right) angles

Rhomboid: a nonequilateral parallelogram in which adjacent sides join at oblique angles.

A triangle, quadrilateral, pentagon, hexagon, heptagon, and octagon are shown in figure 3-6. A trapezoid, trapezium, rhombus, and rhomboid are shown in figure 3-7.

DETERMINING AREAS

The area of any surface is the number of units of area measure the surface contains. A unit of area measure is a square unit. The main thing to remember when computing for areas is that the dimensions used must be of the same unit of measure—if in inches all units must be in inches and if in feet all must be in feet.

Area of a Rectangle

Figure 3-8 shows a rectangle measuring 10 ft x 8 ft, divided up into units of area measure, each consisting of 1 square foot. If you counted the units, one after the other, you would count

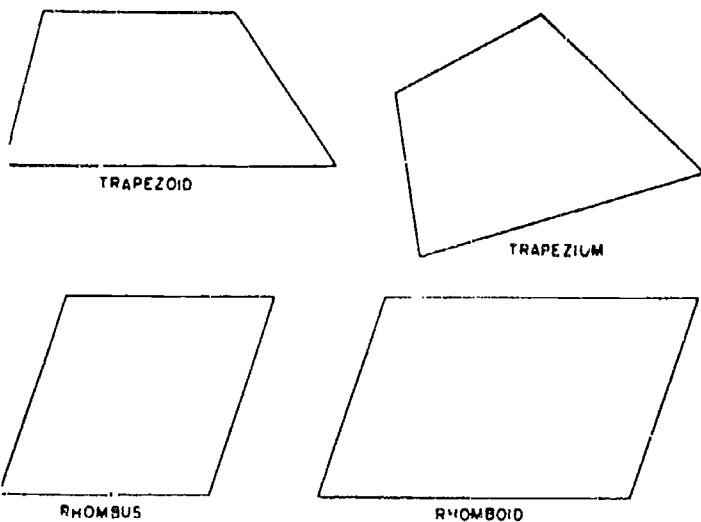

45.634(45A)

Figure 3-7.—Trapezoid, trapezium, rhombus and rhomboid.

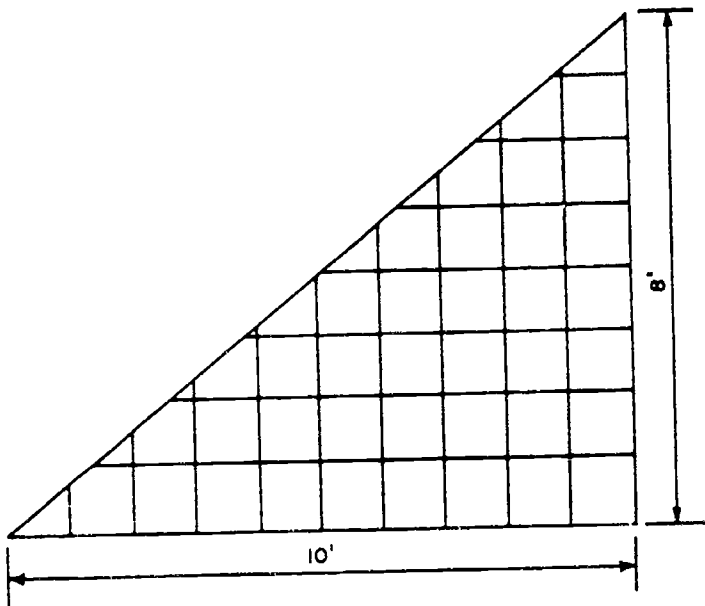

Figure 3-9.—Area of triangle.

45.636

a total of 80 units. However, you can see that there are 8 rows of 10 units, or 10 rows of 8 units. Therefore, the quickest way to count the units is simply to multiply 10 by 8, or 8×10 .

You could call the 8-ft dimension the width and the 10-ft dimension the length, in which case you would say that the formula for determining area of a rectangle is width times length or $A = wl$. Or, you could call the 10-ft dimension the base and the 8-ft dimension the altitude (meaning height), in which case your formula for area of a rectangle would be $A = bh$.

Area of a Triangle

Figure 3-9 shows a triangle consisting of one-half of the rectangle shown in figure 3-8. It is obvious that the area of this triangle must equal one-half of the area of the corresponding rectangle, and the fact that it does can be demonstrated by geometrical proof. Therefore, since the formula for the area of the rectangle is $A = bh$, it follows that the formula for the triangle is $A = \frac{1}{2}bh$.

The triangle shown in figure 3-9, because it is half of a corresponding rectangle, contains a right angle, and is therefore called a right triangle. In a right triangle the dimension h

corresponds to the length of one of the sides. The triangle shown in figure 3-10, however, is a scalene triangle, so-called because no two sides are equal. Classification of triangles will be discussed later in this chapter.

Now, a perpendicular CD drawn from the apex of the triangle (from angle C) divides the triangle into two right triangles, $\triangle ADC$ and $\triangle BDC$. The area of the whole triangle equals the sum of the areas of $\triangle ADC$ and $\triangle BDC$. The area of $\triangle ADC$ equals $\frac{1}{2}(AD)(DC)$, and the area of $\triangle BDC$ equals $\frac{1}{2}(DB)(DC)$. Therefore, the area of the whole triangle equals

$$\frac{AD}{2}(DC) + \frac{DB}{2}(DC), \text{ or } DC\left(\frac{AD + DB}{2}\right).$$

But since $AD + DB = AB$, it follows that the area of the whole triangle equals

$$DC\left(\frac{AB}{2}\right).$$

The length of AB is called the base (b), and the length of DC the altitude (h); therefore, your formula for determining the area of an oblique triangle is again $A = \frac{1}{2}bh$.

You must remember that in a right triangle h corresponds to the length of one of the sides, while in an oblique triangle it does not. Therefore, for a right triangle with length of sides given, you can determine the area by the formula $A = \frac{1}{2}bh$. For an oblique triangle with length of sides given, you cannot use this formula unless you can determine the value of h . Later in this chapter you will learn trigonometric methods of determining areas of

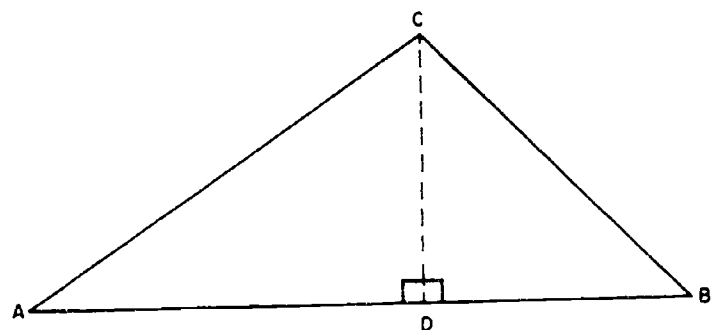

45.637

Figure 3-10.—Triangle.

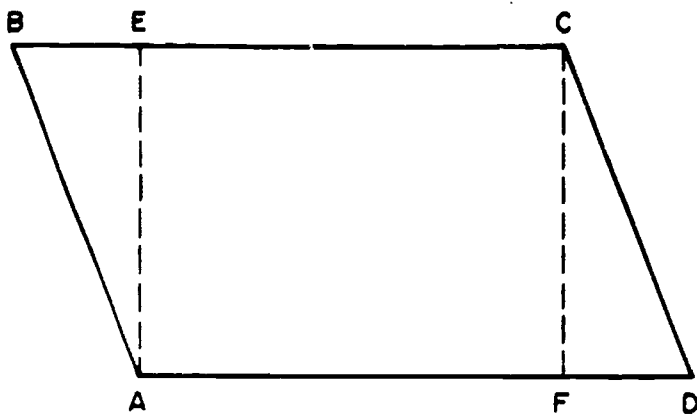

Figure 3-11.—Rhomboid.

45.638

various forms of triangles on the basis of length of sides alone.

Area of a Rhombus or Rhomboid

Figure 3-11 shows a rhomboid ABCD. If you drop a perpendicular CF from ∠C to AD, and project another from ∠A to BC, you will create two right triangles, ΔAEB and ΔCFD, and the rectangle AECF. It can be shown geometrically that the right triangles are similar and equal.

You can see that the area of the rectangle AECF equals the product of AF x FC. The area of the triangle CFD equals ½(FD) (FC). Because the triangle AEB is equal and similar to CFD, the area of that triangle also equals ½(FD) (FC). Therefore, the total area of both triangles equals (FD) (FC). The total area of the rhomboid equals the area of the rectangle AECF + the total area of both triangles.

The total area of the rhomboid equals (AF) (FC) + (FD) (FC), or (AF + FD) (FC). But AF + FD equals AD, the base. FC equals the altitude. Therefore, the formula for the area of a rhomboid is $A = bh$. Here again you must remember that h in a rectangle corresponds to the length of one of the sides, but h in a rhombus or rhomboid does not.

Area of a Trapezoid

Figure 3-12 shows a trapezoid ABCD. If you drop perpendiculars BE and CF from points B and C, respectively, you create the right triangles

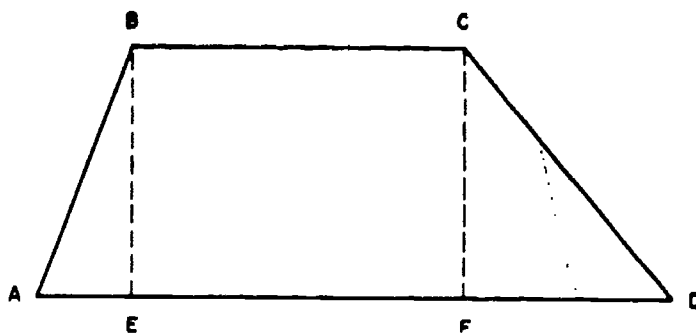

45.639

Figure 3-12.—Trapezoid.

AEB and DFC and the rectangle EBCF between them. The area of the trapezoid obviously equals the sum of the areas of these figures.

The area of ΔAEB equals ½(AE) (FC), the area of ΔDFC equals ½(FD) (FC), and the area of EBCF equals (EF) (FC). Therefore, the area of the trapezoid ABCD equals ½(AE) (FC) + (EF) (FC) + ½(FD) (FC) or

$$\frac{(AE + FD + 2EF) (FC)}{2}$$

However, $2EF = EF + BC$. Therefore, the area of the trapezoid equals

$$\frac{(AE + FD + EF + BC) (FC)}{2}$$

But $AE + FD + EF = AD$. Therefore, the area of the trapezoid equals

$$\frac{(AD + BC) (FC)}{2}$$

AD and BC are the bases of the trapezoid and are usually designated as b_1 and b_2 , respectively. FC is the altitude and generally designated as h. Therefore, the formula for area of a trapezoid is:

$$A = \frac{1}{2}(b_1 + b_2)h$$

Stated in words, the area of a trapezoid is equal to one-half the sum of its bases times its altitude.

Area by Reducing to Triangles

Figure 3-13 shows you how you can determine the area of a trapezium, or of any

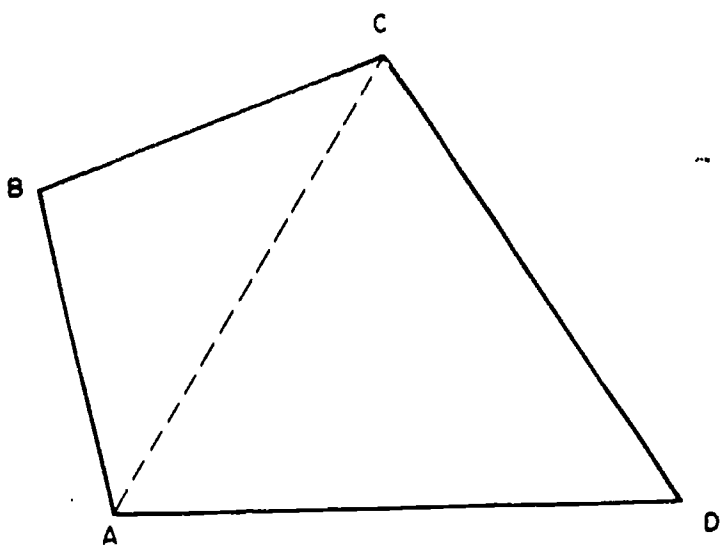

45.640

Figure 3-13.—Trapezium.

polygon, by reducing to triangles. The dotted line connecting A and C divides the figure into the triangles ABC and ACD. The area of the trapezium obviously equals the sum of the areas of these triangles.

Area of a Circle

Figure 3-14 shows how you could cut a disk up into 12 equal sectors. Each of these sectors

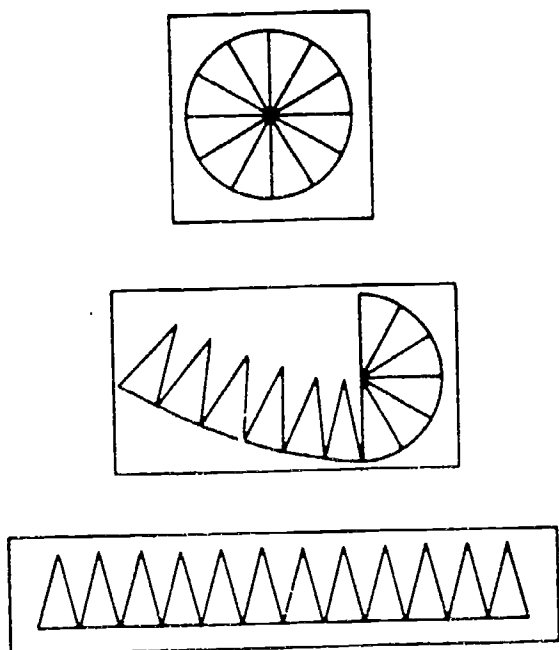

45.641

Figure 3-14.—Area of a circle.

would constitute a triangle, except for the slight curvature of the side which was originally a segment of the circumference of the disk. If this side is considered the base, then the altitude for each triangle equals the radius (r) of the original disk. The area of each triangle, then, equals

$$\frac{br}{2}$$

and the area of the original disk equals the sum of the areas of all the triangles. The sum of the areas of all the triangles, however, equals the sum of all the b 's, multiplied by r and divided by 2.

But the sum of all the b 's equals the circumference (c) of the original disk. Therefore, the formula for the area of a circle can be expressed as

$$A = \frac{cr}{2}$$

However, the circumference of a circle equals the produce of the diameter times π (Greek letter, pronounced "pi"). π is equal to 3.14159... The diameter equals twice the radius; therefore, the circumference equals $2\pi r$. Substituting $2\pi r$ for c in the formula

$$A = \frac{cr}{2}, \text{ we have } A = \frac{(2\pi r)(r)}{2}, \text{ or } \frac{2\pi r^2}{2}, \text{ or } \pi r^2.$$

This is the most commonly used formula for the area of a circle. If we find the area of the circle in terms of circumference,

$$A = \frac{c^2}{4\pi}$$

Area of a Segment and a Sector

A segment is a part of a circle bounded by a chord and its arc, as shown in figure 3-15. The formula for its area is

$$A = \frac{r^2}{2} \left(\frac{\pi n}{180} - \sin n \right)$$

where r = the radius and n = the central angle in degrees.

A sector is a part of a circle bounded by two radii and their intercepted arc. The formula for its area is

$$A = \frac{\pi r^2 n}{360}$$

where r and n have the same designation as above.

Area of Regular Polygons

Figure 3-16 is a regular polygon. In any regular polygon, the area is equal to one-half the perimeter of the polygon times the radius of the inscribed circle. This is expressed in formula form as follows:

$$A = \frac{\text{perimeter} \times r}{2}$$

You can verify the above formula by dividing the polygon into equal triangles, with each side as their base and with r as their altitudes; if you multiply the areas of the individual triangles by the number of sides in the polygon, you will arrive at the above formula.

Area of an Ellipse

The derivation of an ellipse from a conic section, and methods of drawing ellipses, are explained in chapter 5. An ellipse is shown in figure 3-17. The longer axis AB is called the major axis, the shorter axis CD the minor axis. Call the length of the major axis a and that of the minor axis b . The area equals the product of

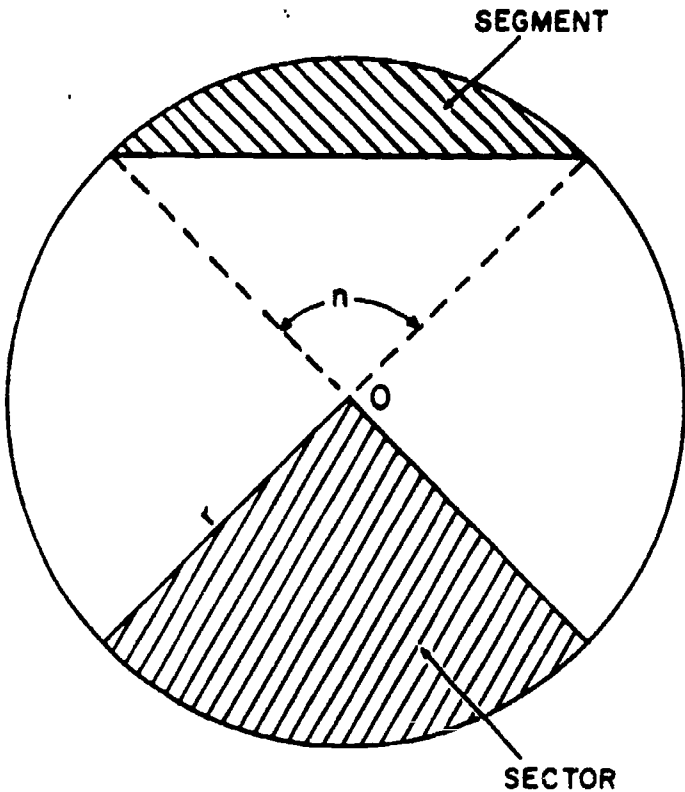

45.704

Figure 3-15.—Segment and sector of a circle.

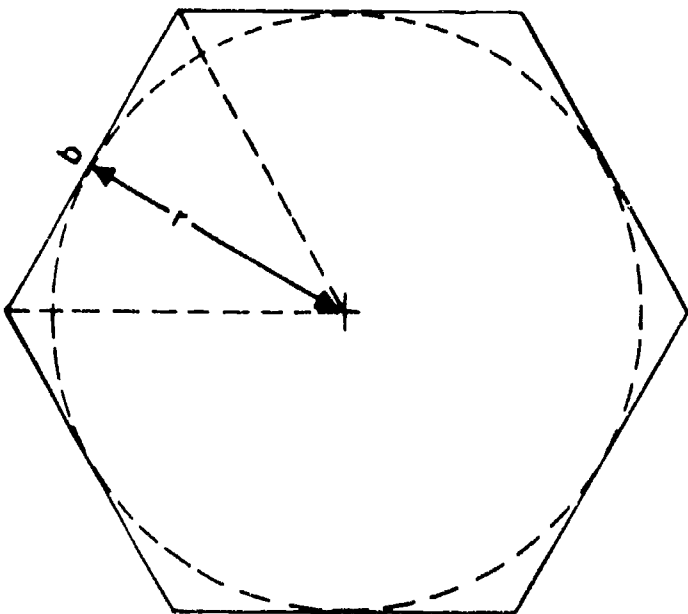

45.680(45B)

Figure 3-16.—Regular polygon.

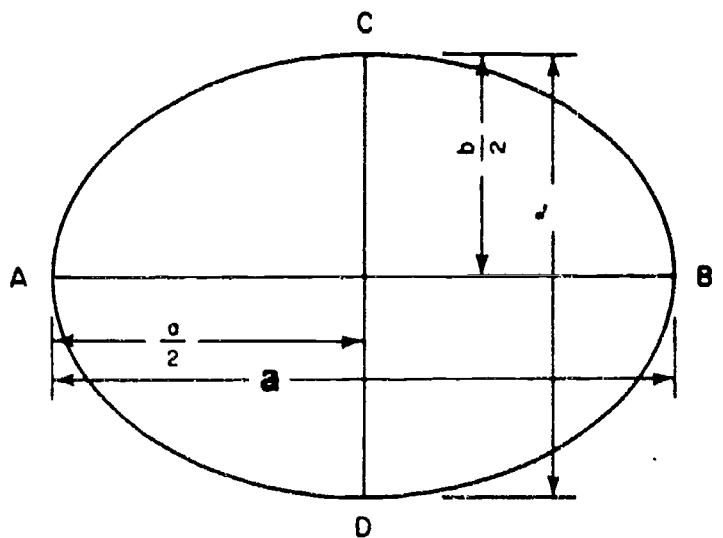

23.245

Figure 3-17.—Ellipse.

half the major axis times half the minor axis times π . In formula form, it is stated as:

$$A = \pi \left(\frac{a}{2} \times \frac{b}{2} \right)$$

$$= \pi \left(\frac{ab}{4} \right)$$

$$= 0.7854ab$$

Irregular Areas

Irregular areas are those areas that do not fall within a definite standard shape. As you already have learned, there are formulas for computing the area of a circle, a rectangle, a triangle, and so on. However, we do not have a standard formula for computing the area of an irregular shaped plane, unless we utilize higher mathematics (calculus), and integrate incremental areas utilizing lower and upper limits that define the boundaries.

As an EA however, most areas you will be concerned with are those you will meet in plane surveying. In most surveys, the computed area is the horizontal projection of the area rather than the actual surface of the land. The fieldwork in finding area consists of a series of angular and linear measurements, defining the outline of whatever the shape is of the area concerned, and forming a closed traverse. The following office computation methods, which you will learn later when you advance in rate, are explained in *Engineering Aid 1 & C*:

1. Plotting the closed traverse to scale and measuring the enclosed area directly with a polar planimeter (used only where approximate results are required, or for checking purposes).
2. Subdividing the area into a series of triangles, and taking the summation of all the areas of these triangles.
3. Computing the area using the coordinates of the individual points of the traverse (called coordinate method).
4. Computing the area by means of the balanced latitude and departure, and calculated double meridian distances of each course (called the D.M.D. method).
5. Computing the area by counting squares; this method is nothing but just superimposing small squares plotted on a transparent paper having the same scale as the plotted traverse (or

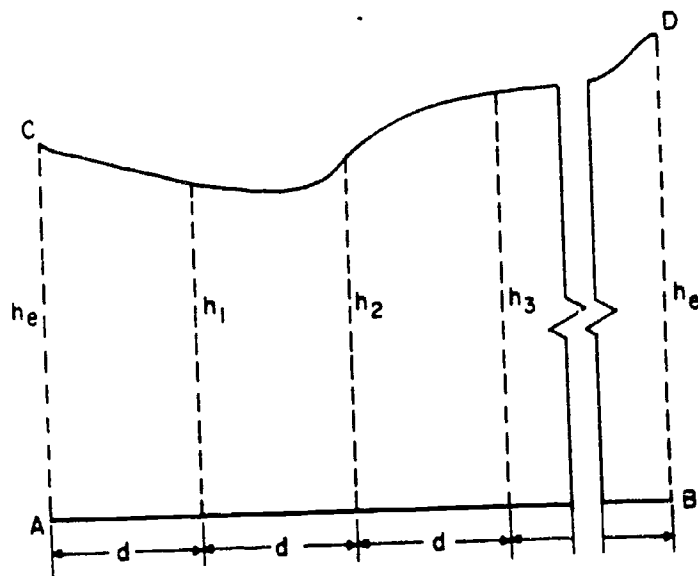

45.54(45B)

Figure 3-18.—Irregular areas by trapezoidal rule.

of known graphical ratio) and counting the number of squares within the traverse. The smaller the squares, the closer to the approximate area you will get.

6. Computing an irregular area bounded by a curve and perpendicular lines, as shown in figure 3-18. Here, you can use the **TRAPEZOIDAL RULE**. The figure is considered as being made up of a series of trapezoids, all of them having the same base and having common distances between offsets. The formula in computing the total area is as follows:

$$A = \left(\frac{h_e}{2} + \Sigma h + \frac{h'_e}{2} \right) d$$

- Where h_e and h'_e = the end offsets of the series of trapezoids
- Σh = the sum of the intermediate offsets ($h_1 + h_2 + h_3 + \dots$)
- and d = the common distance between the offsets.

As mentioned earlier, all the above methods are explained in *Engineering Aid 1 & C*. For the present time, try to find the areas of irregular figures by subdividing the area to series of triangles and by counting the squares method.

There are also areas of spherical surfaces and areas of portions of a sphere. For other figures

not covered in this training manual, consult any text on plane and solid geometry.

DETERMINING VOLUMES

From the preceding section you learned the formulas for computing the areas of various plane figures. These plane areas are important in the computation of **VOLUMES** as you will see later in this section.

When plane figures are combined to form a three-dimensional object, the resulting figure is a solid. For example, three rectangles and two triangles may be combined as shown in figure 3-19. The flat surfaces of the solid figure are its **FACES**, the top and bottom faces are the **BASES**, and the faces forming the sides are the **LATERAL FACES** or **SURFACES**.

Some solid figures do not have any flat faces, and some have a combination of curved surfaces and flat surfaces. Examples of solids with curved surfaces include cylinders, cones, and spheres. Those solids having no flat faces include a great majority of natural objects, such as rocks, living matter, and many other objects that have irregular surfaces that you could think of.

A solid figure whose bases or ends are similar, equal, and parallel polygons, and whose faces are parallelograms, is known geometrically

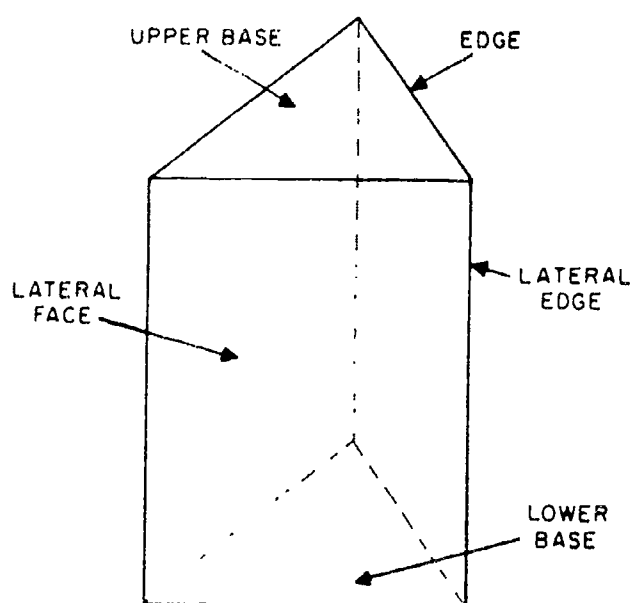

45.706

Figure 3-19.—Parts of prism (triangular).

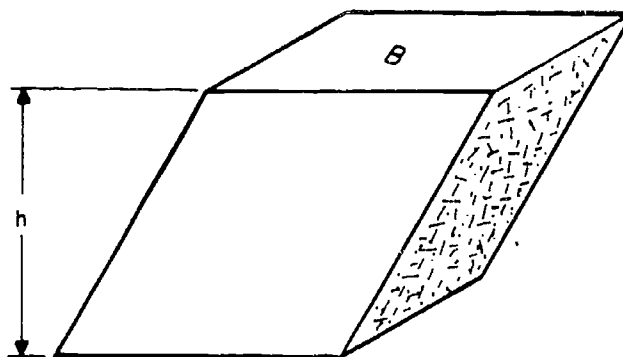

45.707

Figure 3-20.—Rectangular prism—showing its height when not a right prism.

as a **PRISM**. The name of a prism depends upon its base polygons. If the bases are triangles, as in figure 3-19, the figure is a **TRIANGULAR PRISM**. A **RECTANGULAR PRISM** has bases which are rectangles, as shown in figure 3-20. If the bases of a prism are perpendicular to the planes forming its lateral faces, the prism is a **RIGHT prism**.

A **PARALLELEPIPED** is a prism with parallelograms for bases. Since the bases are parallel to each other, this means that they cut the lateral faces to form parallelograms. If a parallelepiped is a right prism, and if its bases are rectangles, it is rectangular solid. A **CUBE** is a rectangular solid in which all of the six rectangular faces are squares.

In determining the volume of most solids, the general formula is as follows:

$$V = Bh$$

Where: V = the volume
 B = the area of the base or end area
 h = the height of the solid (the perpendicular height from its base)

Volume of a Prism

For the volume of any prism, then, you simply determine the end-area or the base area by the appropriate method and multiply the end-area by the length or the base area by the height.

Volume of a Cylinder

From the standpoint of volume calculation, the only difference between a cylinder and a prism lies in the fact that the end or base of a cylinder is a circle rather than a polygon. Therefore, the volume of a cylinder is equal to its end area times its length. But you determine its end-area from the formula πr^2 —which is the formula used for computing the area of a circular plane. Therefore, the volume of a cylinder is $\pi r^2 L$.

Volume of a Cone or Pyramid

The best way to approach the problem of determining volume of a cone or pyramid is on the basis of the fundamental fact that the volume of a cone equals one-third of the volume of the corresponding cylinder, while the volume of a pyramid equals one-third of the volume of the corresponding prism. For any of these solids, volume equals base area times height divided by 3. Therefore, the formula for computing the volume of a cone is:

$$V = \frac{1}{3} \pi r^2 h;$$

and that for a pyramid is:

$$V = \frac{1}{3} Bh.$$

A pyramid may have either a rectangular or a triangular base.

Other Geometric Figures

There will be no attempt to illustrate the derivation of formulas presented in this section. The formulas for the computations of volumes and surface areas of the following geometric figures are presented here only for additional information.

A frustum is that portion of a cone or pyramid which remains after cutting off the upper part by a plane parallel to the base.

1. SPHERE

$$\text{Volume of a sphere} = \frac{4}{3} \pi r^3$$

$$\text{Surface Area} = 4\pi r^2$$

Where r = the radius of the sphere

2. FRUSTUM OF A CONE

Volume of frustum = Volume of large cone - volume of small cone

$$= \frac{1}{3} \pi h (r_1^2 + r_1 r_2 + r_2^2)$$

cubic units

$$\text{Lateral area} = \pi (r_1 + r_2) s \text{ square units}$$

Where: h = the altitude of the frustum

r_1 = the radius of the base

r_2 = the radius of the top

s = the slant height

3. FRUSTUM OF A PYRAMID

Volume of a frustum = Volume of large pyramid - volume of small pyramid

$$= \frac{1}{3} h (B_1 + B_1 B_2 + B_2)$$

Where h = the altitude of frustum

B_1 = the area of lower base

B_2 = the area of upper base

TRIGONOMETRY

As mentioned earlier in this chapter, trigonometry is that branch of mathematics dealing with the relations occurring among the sides and angles of triangles. It deals primarily with six ratios called the TRIGONOMETRIC FUNCTIONS. Chapter 19 of *Mathematics, Vol. 1*, NAVPERS 10069-C, introduces the numerical aspects of trigonometry as they relate to measurement of lengths and angles. Chapters 3, 4, and 8 of *Mathematics, Vol. 2*, NAVPERS 10071-B discuss trigonometry in greater detail. This discussion is intended only as a review of trigonometry based on the information presented in NAVPERS 10069-C and NAVPERS 10071-B.

MEASURING ANGLES

When two straight lines intersect, an angle is formed. You can also generate an angle by

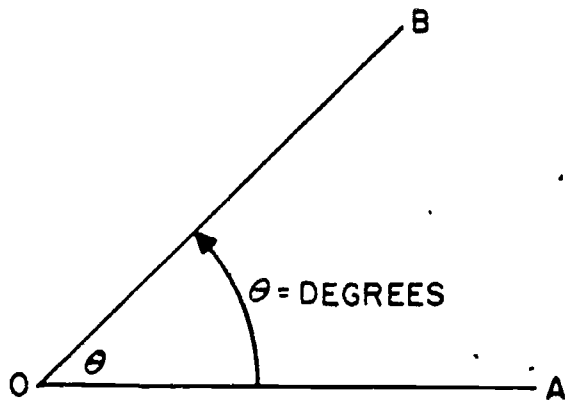

45.708

Figure 3-21.—Generation of an angle—resulting angle measured in degrees.

rotating a line having a set direction. Figure 3-21 depicts the generation of an angle. The terminal line OB is generated from the initial point OA and forms $\angle AOB$, which we will call θ (Greek letter, pronounced "theta"). Angle θ is generally expressed in degrees. The following paragraphs will discuss the degree and the radian systems which are generally used by Engineering Aids.

The DEGREE SYSTEM is the most common system used in angular measurement. Angular measurement by REVOLUTION is perhaps the unit you are most familiar with.

In the degree system, a complete revolution is divided into 360 equal parts called degrees (360°). Each degree is divided into 60 minutes ($60'$), and each minute into 60 seconds ($60''$). For convenience in trigonometric computations, the 360° is divided into four parts of 90° each. The 90° sectors, called QUADRANTS, are numbered counterclockwise starting at the upper right-hand sector.

When the unit radius r (the line generating the angle) has traveled less than 90° from its starting point in a counterclockwise direction (or, as conventionally referred to as, in a positive direction), the angle is in the FIRST quadrant (I). When the unit radius lies between 90° and 180° , the angle is in the SECOND quadrant (II). Angles between 180° and 270° are said to lie in the THIRD quadrant (III), while angles greater than 270° and less than 360° are in the FOURTH quadrant (IV).

When the line generating the angle passes through more than 360° , the quadrant in which the angle lies is found by subtracting from the angle the largest multiple of 360 that the angle contains, and determining the quadrant in which the remainder falls.

The RADIAN SYSTEM of measuring angles is even more fundamental than the degree system. It has certain advantages over the degree system, for it relates the length of arc generated to the size of the angle and the radius. The radian measure is illustrated in figure 3-22. If the length of the arc (s) described by the extremity of the line segment generating the angle is equal to the length of the line (r), then it is said that the angle described is exactly equal to one radian in size; that is, for 1 radian, $s = r$.

The circumference of a circle is related to the radius by the formula

$$C = 2\pi r$$

This says that the circumference is 2π times the length of the radius. From the relationship of arc length, radius, and radians in the preceding paragraph, this could be extended to say that a circle contains 2π radians and the circumference encompasses 360° of rotation. It follows that:

$$\begin{aligned} 2\pi \text{ radians} &= 360^\circ \\ \pi \text{ radians} &= 180^\circ \end{aligned}$$

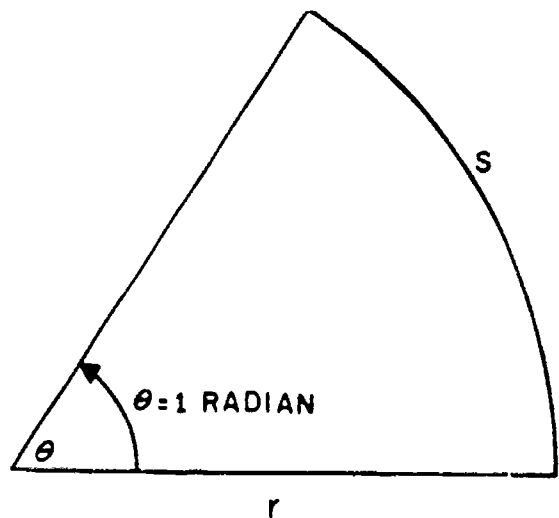

45.709

Figure 3-22.—Radian measure.

By dividing both sides of the above equation by π , we find that

$$1 \text{ radian} = \frac{180^\circ}{\pi} = 57.2959^\circ \text{ or } \\ = 57.3^\circ \text{ (approximately)}$$

As in any other formula, you can always convert radian to degrees or vice versa by using the above relationship.

FUNCTIONS OF ANGLES

The functions of angles can best be illustrated by means of a "circle of unit radius" like the one shown in figure 3-23. A so-called "Cartesian axis" is inscribed within the circle. Coordinates measured from 0 along the x axis to the right are positive; coordinates measured from 0 along the x axis to the left are negative. Coordinates measured along the y axis from 0 upward are positive; coordinates measured along the y axis from 0 downward are negative.

Angles are generated by the motion of a point P counterclockwise along the circumference of the circle. The initial leg of any

angle is the positive leg of the x axis. The other leg is the radius r, at the end of which the point P is located; this radius always has a value of 1. The unit radius ($r = OC$) is subdivided into 10 equal parts, so that the value of each of the 10 subdivisions shown is 0.1.

For any angle, the point P has three coordinates: the x coordinate, the y coordinate, and the r coordinate (which always has a value of 1 in this case). The functions of any angle are, collectively, various ratios which prevail between these coordinates.

The ratio between y and r (that is, $\frac{y}{r}$) is called the "sine" of the angle. In figure 3-23, AP seems to measure about 0.7 of y; therefore, the sine θ , which is equal to 45° in this case, would seem to be $\frac{0.7}{1}$, or about 0.7. Actually, the sine of 45° is 0.70711. Graphically, the sine is indicated in figure 3-23 by the line AP, which measures 0.7 to the scale of the drawing.

The ratio between x and r (that is, $\frac{x}{r}$) is called the "cosine" of the angle. You can see that for 45° , x and y are equal, and the fact that they are, can be proved geometrically. Therefore, the cosine of 45° is the same as the sine of 45° , of 0.70711. Graphically, the length of line OA represents the cosine of angle θ when the radius (r) is equal to 1.

The ratio between y and x (that is, $\frac{y}{x}$) is known as the "tangent" of the angle. Since y and x for an angle of 45° are equal, it follows that the tangent of an angle of 45° equals 1. The tangent is also indicated graphically by the line BC, drawn tangent to the circle at C and intersecting the extended r at B and DB which is also drawn tangent at D. As shown in the figure, you can deduce that BC is equal to OC. OC is equal to the unit radius r.

The three functions illustrated in figure 3-23 are called the "direct" functions. For each direct function there is a corresponding "reciprocal" function—meaning, a function which results when you divide 1 by the direct function. You know that the reciprocal of any fraction is simply the fraction inverted. Therefore, for the direct function "sine," which is $\frac{y}{r}$, the reciprocal function (called the "cosecant") is $\frac{r}{y}$. For the direct function "cosine," which is $\frac{x}{r}$, the reciprocal function (called the "secant") is $\frac{r}{x}$. For the direct function "tangent," which is $\frac{y}{x}$,

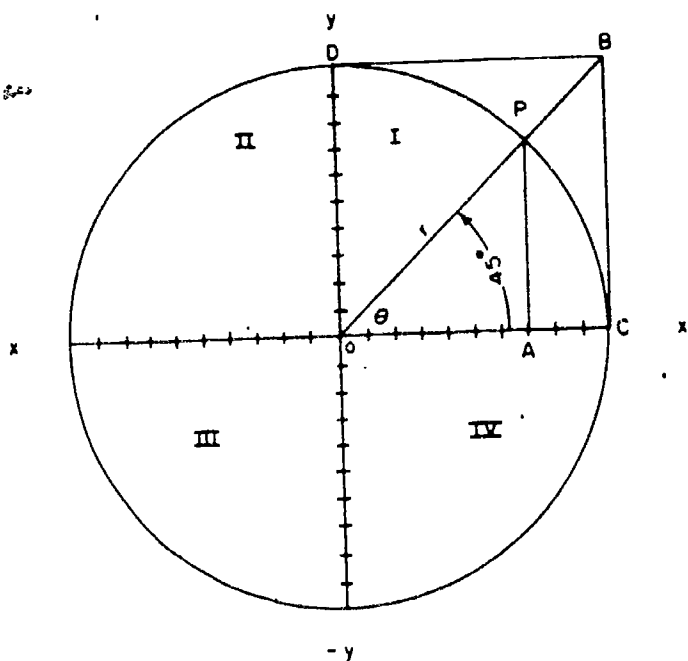

Figure 3-23.—Circle of unit radius with quadrants shown.

45.642

the reciprocal function (called the "cotangent") is $\frac{x}{y}$.

Since y for 45° equals about 0.7, the cosecant for 45° is

$$\left(\frac{r}{y}\right) \text{ is } \frac{1}{0.7},$$

or about 1.4. The cosecant is indicated graphically by the line QB in figure 3-23. If you measure this line, you will find that it measures just about 1.4 units to the scale of the drawing.

Since x for 45° also measures about 0.7, it follows that the secant for 45° ($\frac{r}{x}$) is the same as the cosecant, or also about 1.4. The secant is indicated graphically in figure 3-23 also by the line OB .

Since x and y for 45° are equal, it follows that the cotangent for 45° ($\frac{x}{y}$) is the same as the tangent, or 1. The cotangent is shown graphically in figure 3-23 by the line DB , drawn tangent to the circle at D .

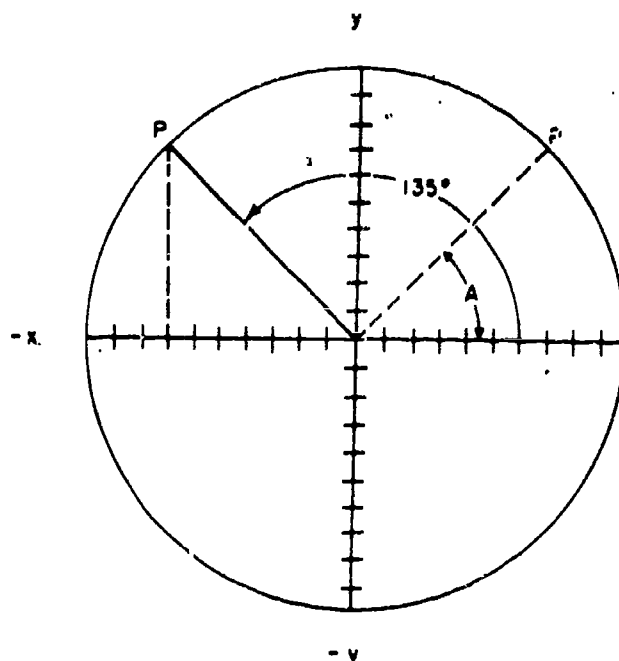

45.644

Figure 3-24.—Function of an obtuse angle.

FUNCTIONS AND COFUNCTIONS

The functions cosine, cosecant, and cotangent are cofunctions of the functions sine, secant, and tangent, respectively. A cofunction of an angle A has the same value as the corresponding function of $(90^\circ - A)$ —that is, the same value as the corresponding function of the complement of the angle. The sine of 30° , for example, is 0.50000. The cosine of 60° (the complement of 30°) is likewise 0.50000. The tangent of 30° is 0.57735. The cotangent of 60° (the complement of 30°) is likewise 0.57735.

Commonly used functions and cofunctions are as follows:

$$\sin A = \cos (90^\circ - A)$$

$$\sec A = \csc (90^\circ - A)$$

$$\tan A = \cot (90^\circ - A)$$

FUNCTIONS OF OBTUSE ANGLES

In figure 3-24, the point P has generated an obtuse (larger than 90°) angle of 135° . This angle is the supplement of 45° (two angles are supplementary when they total 180°). We have left a dotted image of the reference angle A , which is equal to the supplementary angle of

135° . You can see that the values of x , y , and r are the same for 135° as they are for 45° —except that the value of x is negative. From this it follows that the functions of any obtuse angle are the same as the functions of its supplement, except that any function in which x appears has the opposite sign.

The sine of an angle is $\frac{y}{r}$. Since x does not appear in this function, it follows that $\sin A = \sin (180^\circ - A)$.

The cosine of an angle is $\frac{x}{r}$. Since x appears in this function, it follows that $\cos A = -\cos (180^\circ - A)$.

The tangent of an angle is $\frac{y}{x}$. Since x appears in this function, it follows that $\tan A = -\tan (180^\circ - A)$.

The importance of knowing this lies in the fact that many tables of trigonometric functions list the functions only for angles to a maximum of 90° . Many oblique triangles, however, contain angles larger than 90° . To determine a function of an angle larger than 90° from a table which stops at 90° , you look up the function of the supplement of the angle. If the function is a sine, you use it as is. If it is a cosine or tangent, you give it a negative sign.

The relationships of the functions of obtuse angles are as follows:

$$\begin{aligned} \sin A &= \sin (180-A) \\ \cos A &= -\cos (180-A) \\ \tan A &= -\tan (180-A) \\ \cot A &= -\cot (180-A) \\ \sec A &= -\sec (180-A) \\ \csc A &= \csc (180-A) \end{aligned}$$

The above relationships apply only when angle A is greater than 90° and less than 180°.

FUNCTIONS OF ANGLES IN A RIGHT TRIANGLE

For an acute angle in a right triangle, the length of the side opposite the angle corresponds to y and the length of the side adjacent to the angle to x, while the length of the hypotenuse corresponds to r. Therefore, the functions of an acute angle in a right triangle can be stated as follows:

Sine	=	$\frac{\text{side opposite}}{\text{hypotenuse}}$	Cosecant	=	$\frac{\text{hypotenuse}}{\text{side opposite}}$
Cosine	=	$\frac{\text{side adjacent}}{\text{hypotenuse}}$	Secant	=	$\frac{\text{hypotenuse}}{\text{side adjacent}}$
Tangent	=	$\frac{\text{side opposite}}{\text{side adjacent}}$	Cotangent	=	$\frac{\text{side adjacent}}{\text{side opposite}}$

If you consider a 90° angle with respect to the "circle of unit radius" diagram, you will realize that for a 90° angle $x = 0$, $y = 1$, and r (as always) equals 1. Since $\text{sine} = \frac{y}{r}$, it follows that the sine of 90° = 1. Since $\text{cosine} = \frac{x}{r}$, it follows that the cosine of 90° = $\frac{0}{1}$, or 0. Since $\text{tangent} = \frac{y}{x}$, it follows that $\tan 90^\circ = \frac{1}{0} = \infty$ (infinity). From one standpoint, division by 0 is a mathematical impossibility, since it is impossible to state how many zeros there are in anything. From this standpoint, $\tan 90^\circ$ is simply impossible. From another standpoint it can be said that there are an "infinite" number of zeros in 1. From that standpoint, $\tan 90^\circ$ can be said to be infinity.

In real-life, the sides of a right triangle y, x, and r, or side opposite, side adjacent, and hypotenuse, are given other names according to

the circumstances. In connection with a pitched roof rafter, for instance, y or side opposite is "total rise," x or side adjacent is "total run," and r or hypotenuse is "rafter length." In connection with a ground slope, y or side opposite is "vertical rise," x or side adjacent is "horizontal distance," and r or hypotenuse is "slope distance."

LOGARITHMS OF TRIGONOMETRIC FUNCTIONS

In surveying computations there are many triangle solutions which involve the multiplication or division of trigonometric functions (which are usually given to at least 5 decimal places) by linear distances which may contain 5 or more digits. In the absence of a calculating machine an immense amount of tiresome arithmetic is required for computations of this kind, and there are many opportunities for arithmetical errors.

For this reason, the logarithmic equivalents of the principal natural functions have long since been worked out, and are available in tables, so that the necessary multiplication or division may be performed by the use of logarithms.

A table of "common logarithms of trigonometric functions" usually lists the logs for the sine, cosine, tangent, and cotangent of angles from 0° through 180°. Table 3-1 shows a sample page from such a table. You use the table as follows.

Note, first, that both characteristics and mantissa are listed. Now, you must bear in mind that, for every characteristic listed (in table 3-1 characteristics of 9 and 10 are listed), a characteristic of -10 at the end of the log is understood. Take the log listed for the sine of 38° 00' 00", for example. This is listed as 9.789342. What this actually means is 9.789342-10, which in turn means that the log of this function is actually -1+.793721. On the other hand, the log listed for the tangent of 51° 10' 00" is 10.094215. What this means is 10.094215-10, which means that the log of this function is 0.094215. The logs are printed in this manner simply to avoid the necessity for printing minus characteristics. Note that, even when a characteristic is minus, the mantissa is considered as plus.

Suppose that you are working a computation in which you must multiply the sine of $38^{\circ}27'18''$ by 178.13 feet. To find the log sine, run down the left-hand (minutes) column in table 3-1 to 27; there you find the log sine of $38^{\circ}27'00''$ listed as 9.793673-10. In the column to the right (which is headed by "D.1," which means "delta for 1 second," which means "amount to be added for every second over $38^{\circ}27'00''$ "), you observe that you add 2.65 for every second over $38^{\circ}27'00''$. In this case you add (18×2.65) , or 47.7, which rounds off at 48. The log sine of $38^{\circ}27'18''$ is therefore $(9.793673-10+48)$, or 9.793721-10.

Using the table shown in figure 3-4, you find that the log of 178.13 is 2.250737. You make the characteristic of this log conform to the system used in table 3-1 by calling the log 12.250737-10.

To multiply you add the logs as follows:

$$\begin{array}{r} 9.793721-10 \\ 12.250737-10 \\ \hline 22.044458-20 \end{array}$$

The log of the product, then, is 2.044458. Using any common logarithms table of numbers like the one shown in figure 3-4, you find that the antilog is 110.78. The product, then, of the sine of $38^{\circ}27'18''$ multiplied by 178.13 ft is 110.78 ft.

SOLUTIONS OF TRIANGLES

To "solve" a triangle means to determine one or more unknown values (such as the length of a side or the size of an angle) from given known values.

Pythagorean Theorem

When you know the lengths of two sides of a right triangle, or its hypotenuse and one side, you can determine the length of the remaining side, or the length of the hypotenuse, by applying the Pythagorean Theorem. The Pythagorean Theorem states that the square of the length of the hypotenuse of any right triangle equals the sum of the squares of the lengths of the other two sides.

Figure 3-25 shows a right triangle with acute angles A and B and right angle C. Sides opposite A and B are designated as a and b; the hypotenuse (opposite C) is designated as c. Side a measures 3.00 ft, side b measures 4.00 ft, and the hypotenuse measures 5.00 ft. Any triangle with sides and hypotenuse in the ratio of 3:4:5 is a right triangle.

If $c^2 = a^2 + b^2$, it follows that $c = \sqrt{a^2 + b^2}$. The formulas for solving for either side, given the other side and the hypotenuse; or for the hypotenuse, given the two sides, are:

$$a = \sqrt{c^2 - b^2}$$

$$b = \sqrt{c^2 - a^2}$$

$$c = \sqrt{a^2 + b^2}$$

In figure 3-25, $a^2 = 9$, $b^2 = 16$, and $c^2 = 25$. Therefore, $a =$ the square root of $(25 - 16)$, or 3; $b =$ the square root of $(25 - 9)$, or 4; and $c =$ the square root of $(9 + 16)$, or 5.

Acute Angle in a Right Triangle by Tangent

One of the angles in a right triangle always measures 90° . Because the sum of the three angles in any triangle is always 180° , it follows

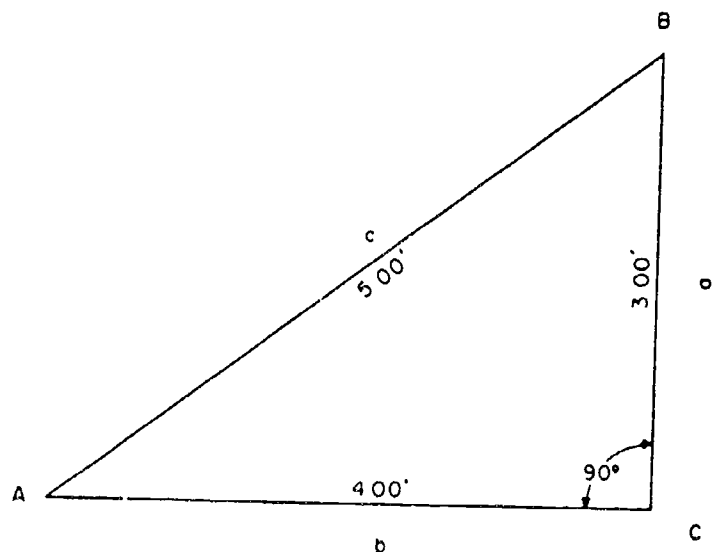

45.645

Figure 3-25.—A right triangle.

Chapter 3—MATHEMATICS AND UNITS OF MEASUREMENT

Table 3-1.—Sample Page From Table of Common Logarithms of Trigonometric Functions

38°	Sine.	D. 1".	Cosine.	D. 1".	Tang.	D. 1".	Cotang.	141°
0	9.789342	2.70	9.896532	1.65	9.892810	4.33	10.107190	60
1	.789504	2.68	.896433	1.63	.893070	4.35	.106930	59
2	.789665	2.70	.896335	1.65	.893331	4.33	.106669	58
3	.789827	2.68	.896236	1.65	.893591	4.33	.106409	57
4	.789988	2.68	.896137	1.65	.893851	4.33	.106149	56
5	.790149	2.68	.896038	1.65	.894111	4.35	.105889	55
6	.790310	2.68	.895939	1.65	.894372	4.33	.105628	54
7	.790471	2.68	.895840	1.65	.894632	4.33	.105368	53
8	.790632	2.68	.895741	1.67	.894892	4.33	.105108	52
9	.790793	2.68	.895641	1.65	.895152	4.33	.104848	51
10	.790954	2.68	.895542	1.65	.895412	4.33	.104588	50
11	9.791115	2.67	9.895443	1.67	9.895672	4.33	10.104328	49
12	.791275	2.68	.895343	1.65	.895932	4.33	.104068	48
13	.791436	2.67	.895244	1.65	.896192	4.33	.103808	47
14	.791596	2.68	.895145	1.67	.896452	4.33	.103548	46
15	.791757	2.67	.895045	1.67	.896712	4.32	.103288	45
16	.791917	2.67	.894945	1.67	.896971	4.33	.103029	44
17	.792077	2.67	.894846	1.65	.897231	4.33	.102769	43
18	.792237	2.67	.894746	1.67	.897491	4.33	.102509	42
19	.792397	2.67	.894646	1.67	.897751	4.32	.102249	41
20	.792557	2.65	.894546	1.67	.898010	4.33	.101990	40
21	9.792716	2.67	9.894446	1.67	9.898270	4.33	10.101730	39
22	.792876	2.65	.894346	1.67	.898530	4.32	.101470	38
23	.793035	2.67	.894246	1.67	.898789	4.33	.101211	37
24	.793195	2.65	.894146	1.67	.899049	4.32	.100951	36
25	.793354	2.67	.894046	1.67	.899308	4.33	.100692	35
26	.793514	2.65	.893946	1.67	.899568	4.32	.100432	34
27	.793673	2.65	.893846	1.67	.899827	4.33	.100173	33
28	.793832	2.65	.893745	1.68	.900087	4.32	.099913	32
29	.793991	2.65	.893645	1.67	.900346	4.32	.099654	31
30	.794150	2.63	.893544	1.67	.900605	4.32	.099395	30
31	9.794308	2.65	9.893444	1.68	9.900864	4.33	10.099136	29
32	.794467	2.65	.893343	1.67	.901124	4.32	.098876	28
33	.794626	2.63	.893243	1.68	.901383	4.32	.098617	27
34	.794784	2.63	.893142	1.68	.901642	4.32	.098358	26
35	.794942	2.65	.893041	1.68	.901901	4.32	.098099	25
36	.795101	2.63	.892940	1.68	.902160	4.33	.097840	24
37	.795259	2.63	.892839	1.67	.902420	4.32	.097580	23
38	.795417	2.63	.892739	1.68	.902679	4.32	.097321	22
39	.795575	2.63	.892638	1.70	.902938	4.32	.097062	21
40	.795733	2.63	.892536	1.68	.903197	4.32	.096803	20
41	9.795891	2.63	9.892435	1.68	9.903456	4.30	10.096544	19
42	.796049	2.62	.892334	1.68	.903714	4.32	.096286	18
43	.796206	2.63	.892233	1.68	.903973	4.32	.096027	17
44	.796364	2.62	.892132	1.70	.904232	4.32	.095768	16
45	.796521	2.63	.892031	1.68	.904491	4.32	.095509	15
46	.796679	2.62	.891929	1.70	.904750	4.30	.095250	14
47	.796836	2.62	.891827	1.68	.905008	4.32	.094992	13
48	.796993	2.62	.891726	1.70	.905267	4.32	.094733	12
49	.797150	2.62	.891624	1.68	.905526	4.32	.094474	11
50	.797307	2.62	.891523	1.70	.905785	4.30	.094215	10
128°	Cosine	D. 1"	Sine	D. 1"	Cotang.	D. 1"	Tang.	51°

that each of the other two angles in a right triangle must be an acute (less than 90°) angle. Also, if you know the size of one of the acute angles, you can determine the size of the other from the formulas $A = (90^\circ - B)$ and $B = (90^\circ - A)$.

In any right triangle in which you know the lengths of the sides, you can determine the size of either of the acute angles by applying the tangent of the angle. Take angle A in figure 3-25, for example. You know that

$$\tan A = \frac{a}{b}, \text{ or } \frac{3.00}{4.00}, \text{ or } 0.75.$$

Reference to a table of natural tangents shows that an angle with tangent 0.75 measures, to the nearest minute, $36^\circ 52'$.

Side of Right Triangle by Tangent

If you know the length of one of the sides of a right triangle and the size of one of the acute angles, you can determine the length of the other side by applying the tangent. Suppose that for the triangle shown in figure 3-25 you know that angle A measures $36^\circ 52'$ and that side b measures 4.00'. You want to determine the length of side a. Since

$$\tan A = \frac{a}{b}$$

it follows that $a = b (\tan A)$. From a table of natural tangents, you find that $\tan 36^\circ 52' = 0.74991$. Therefore, $a = 4.00(0.74991)$, or 3.00 ft.

Side of Right Triangle by Cotangent

Suppose that for the triangle shown in figure 3-25, you know that angle B measures $53^\circ 08'$ and that side a measures 3.00 ft. You want to determine the length of side b. You could do this as previously described, by applying

$$\tan B = \frac{b}{a}$$

However, the fact that side b is larger than size a means that $\tan B$ is larger than 1 (you recall that

any angle larger than 45° has a tangent larger than 1).

For slide-rule solutions of triangles, you cannot read tangents of angles larger than 45° on the slide rule but you can read cotangents of these angles. Some computers prefer not to deal with tangents greater than 1 for other reasons. To avoid this, you can use the cotangent rather than the tangent.

You know that the cotangent is the reciprocal function of the tangent. Therefore, if

$$\tan B = \frac{b}{a}, \text{ cot } B = \frac{a}{b}$$

It follows that

$$b = \frac{a}{\text{cot } B}$$

A table of natural functions tells you that $\text{cot } 53^\circ 08' = 0.74991$. Therefore,

$$b = \frac{3}{0.74991}, \text{ or } 4.00.$$

Acute Angle of Right Triangle by Sine or Cosine

If you know the length of the hypotenuse and length of a side of a right triangle, you can determine the size of one of the acute angles by applying the sine or the cosine of the angle. Suppose that for the triangle shown in figure 3-25 you know that the hypotenuse c is 5.00 ft long and that the length of side a is 3.00 ft long. You want to determine the size of angle A. Side a is opposite angle A; therefore,

$$\sin A = \frac{a}{c}, \text{ or } \frac{3}{5}, \text{ or } 0.6.$$

A table of natural functions tells you that an angle with sine 0.6 measures, to the nearest minute, $36^\circ 52'$.

Suppose that, instead of knowing the length of a, you know the length of b (4.00 ft). Side b is the side adjacent to angle A. You know that

$$\cos A = \frac{b}{c}, \text{ or } \frac{4}{5}, \text{ or } 0.8.$$

A table of natural functions tells you that an angle with cosine 0.8 measures $36^\circ 52'$.

If you know the size of one of the acute angles in a right triangle and the length of the

side opposite, you can determine the length of the hypotenuse from the sine of the angle. Suppose that for the triangle shown in figure 3-25, you know that angle A = 36°52' and side a = 3.00 ft.

$$\sin A = \frac{a}{c}; \text{ therefore, } c = \frac{a}{\sin A}, \text{ or } \frac{3}{0.6}, \text{ or } 5.00 \text{ ft.}$$

If you know the size of one of the acute angles in a right triangle and the length of the side adjacent, you can determine the length of the hypotenuse from the cosine of the angle. Suppose that for the triangle in figure 3-25, you know that angle A = 36°52' and side b = 4.00 ft.

$$\cos A = \frac{b}{c}; \text{ therefore, } c = \frac{b}{\cos A}.$$

Tables show that $\cos 36^\circ 52' = 0.80003$. Therefore,

$$c = \frac{4.00}{0.80003}, \text{ or } 5.00 \text{ ft.}$$

Solution by Law of Sines

When you know, for any triangle (right or oblique), the lengths of two sides and the size of the angle opposite one of them, or the sizes of two angles and the length of the side opposite one of them, you can solve the triangle by applying the law of sines. The law of sines (which is explained and proved in NAVPERS 10071-B, chapter 5) states that the lengths of the sides of any triangle are proportional to the sines of their opposite angles. It is expressed in formula form as follows:

$$\frac{a}{\sin A} = \frac{b}{\sin B} = \frac{c}{\sin C}$$

In the triangle shown in figure 3-26, $\angle A = 41^\circ 24'$, $a = 8.00$ ft, and $b = 12.00$ ft. If

$$\frac{b}{\sin B} = \frac{a}{\sin A},$$

it follows that

$$\sin B = \frac{b \sin A}{a}$$

The sine of $41^\circ 24'$ is 0.66131; therefore,

$$\sin B = \frac{12(0.66131)}{8},$$

or 0.99196. Tables show that the angle with sine 0.99196 measures $82^\circ 44'$. Therefore, $\angle B = 82^\circ 44'$. Angle C = $180^\circ - (A + B)$, or $180^\circ - (41^\circ 24' + 82^\circ 44')$, or $180^\circ - 124^\circ 08'$, or $55^\circ 52'$.

If $\frac{c}{\sin C} = \frac{a}{\sin A}$, then $c = \frac{a \sin C}{\sin A}$. The

sine of $55^\circ 52'$ is 0.82773. Therefore,

$$c = \frac{8(0.82773)}{0.66131}, \text{ or } 10.01 \text{ ft.}$$

Solution by Law of Cosines

Suppose you know two sides of a triangle and the angle between the two sides. You cannot solve this triangle by the law of sines, since you do not know the length of the side opposite the known angle or the size of an angle opposite one of the known sides. In a case of this kind you must begin by solving for the third side by applying the law of cosines. The law of cosines is explained and proved in chapter 5 of NAVPERS 10071-B. If you are solving for a side on the basis of two known sides and the known included angle, the law of cosines states that, in any triangle the square of one side is equal to the sum of the squares of the other two sides minus twice the product of these two sides multiplied by the cosine of the angle between them. This statement may be expressed in formula form as follows:

$$\begin{aligned} a^2 &= b^2 + c^2 - 2bc \cos A \\ b^2 &= a^2 + c^2 - 2ac \cos B \\ c^2 &= a^2 + b^2 - 2ab \cos C \end{aligned}$$

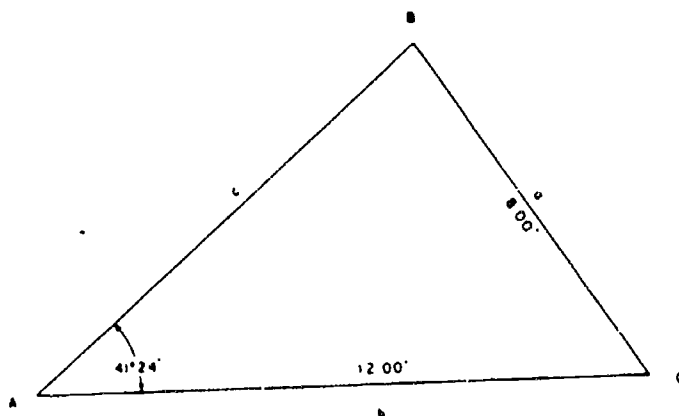
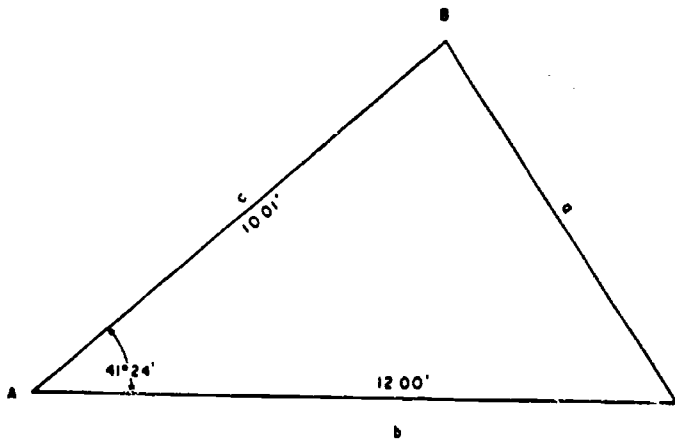

Figure 3-26.—Oblique triangle (law of sines).



45.647

Figure 3-27.—Oblique triangle (law of cosines).

For the triangle shown in figure 3-27, you know that side c measures 10.01 ft, side b 12.00 ft, and angle A (included between them) $41^{\circ}24'$. The cosine of $41^{\circ}24'$ is 0.75011. The solution for side a is as follows:

$$a = \sqrt{b^2 + c^2 - 2bc \cos A}$$

$$a = \sqrt{144 + 100.20 - 2(12)(10.01)(0.75011)}$$

$$a = \sqrt{244.20 - 180.20}$$

$$a = \sqrt{64}$$

$$a = 8.00 \text{ ft}$$

Knowing the length of this side, you can now solve for the remaining values by applying the law of sines.

If you know all three sides of a triangle, but none of the angles, you can determine the size of any angle by the law of cosines, using the following formulas:

$$\cos A = \frac{b^2 + c^2 - a^2}{2bc}$$

$$\cos B = \frac{a^2 + c^2 - b^2}{2ac}$$

$$\cos C = \frac{a^2 + b^2 - c^2}{2ab}$$

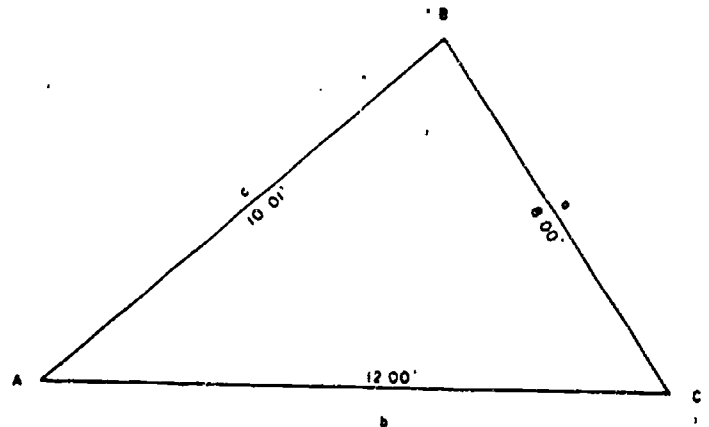

45.648

Figure 3-28.—Any triangle—three sides given.

For the triangle shown in figure 3-28, you know all three sides but none of the angles. The solution for angle A is as follows:

$$\cos A = \frac{b^2 + c^2 - a^2}{2bc}$$

$$\cos A = \frac{144 + 100.20 - 64}{2(12)(10.01)}$$

$$\cos A = \frac{180.20}{240.24}$$

$$\cos A = 0.75008$$

The angle with cosine 0.75008 measures, to the nearest minute, $41^{\circ}24'$.

Solution by Law of Tangents

The law of tangents is expressed in words as follows: In any triangle the difference between two sides is to their sum as the tangent of half the difference of the opposite angles is to the tangent of half their sum.

For any pair of sides—as, side a and side b—the law may be expressed as follows:

$$\frac{a - b}{a + b} = \frac{\tan \frac{1}{2}(A - B)}{\tan \frac{1}{2}(A + B)}$$

For the triangle shown in figure 3-29, you know the lengths of two sides and the size of the angle between them. You can determine the

sizes of the other two angles by applying the law of tangents as follows.

First note that you can determine the value of angles (B + C), because (B + C) obviously equals $180^\circ - A$, or $180^\circ - 34^\circ$, or 146° . Now, if you know the sum of two values and the difference between the same two, you can determine each of the values as follows:

$$\begin{aligned} x + y &= 5 \\ x - y &= 1 \\ \text{(add)} \quad \frac{2x}{2} &= 6 \\ x &= 3 \\ y &= 5 - x = 2 \end{aligned}$$

Now, you know the sum of (B + C). Therefore, if you could determine the difference, or (B - C), you could determine the sizes of B and C. You can determine $\frac{1}{2}(B - C)$ from the law of tangents, written as follows:

$$\tan \frac{1}{2}(B - C) = \frac{(b - c) \tan \frac{1}{2}(B + C)}{b + c}$$

One-half of (B + C) means one-half of 146° , or 73° . The tangent of 73° is 3.27085. The solution for $\frac{1}{2}(B - C)$ is therefore as follows:

$$\begin{aligned} \tan \frac{1}{2}(B - C) &= \frac{(10 - 8)(3.27085)}{10 + 8} \\ \tan \frac{1}{2}(B - C) &= \frac{6.54170}{18} = 0.36342 \end{aligned}$$

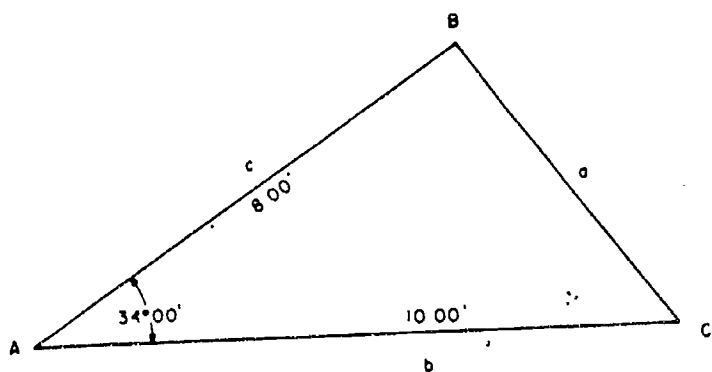

45.849
Figure 3-29.—Oblique triangle (law of tangents).

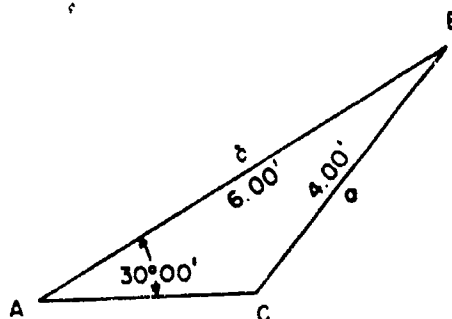
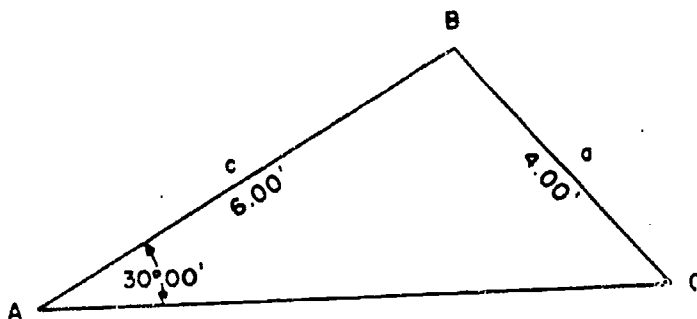

45.650
Figure 3-30.—Two ambiguous case triangles (solution of one will satisfy the other).

$$\begin{aligned} \text{(from table of natural tangents)} \quad \frac{1}{2}(B - C) \\ = 19^\circ 58' \end{aligned}$$

$$(B - C) = 2(19^\circ 58') = 39^\circ 56'$$

Knowing both the sum (B + C) and the difference (B - C), you can now determine the sizes of B and C as follows:

$$\begin{aligned} B + C &= 146^\circ 00' \\ B - C &= 39^\circ 56' \\ \hline 2B &= 185^\circ 56' \end{aligned}$$

$$B = 92^\circ 58'$$

$$C = (146^\circ - 92^\circ 58') = 53^\circ 02'$$

The Ambiguous Case

When the given data for a triangle consists of two sides and the angle opposite one of them, it may be the case that there are two triangles which conform to the data. A situation in which there can be two triangles is called the

"ambiguous case." Figure 3-30 shows two possible triangles that might satisfy this situation. Both triangles shown are with given angle $A = 30^\circ 00'$, given side $a = 4.00$ ft, and given side $c = 6.00$ ft.

The best way to determine whether or not the given data for a triangle involves an ambiguous case is to lay out a figure to scale on the basis of the data, as shown in figure 3-31. Suppose, for example, that the data describes a triangle with angle $A = 22^\circ 00'$, side opposite 5.40 ft, and other side 14.00 ft. Lay off a line AB 14.00 ft long (to scale, of course), as shown in the upper triangle of figure 3-31. Use a protractor to lay off a line from A at $22^\circ 00'$. Set a compass to the graphical distance of 5.40 ft (length of side opposite A) and with B as a center strike an arc. You observe that this arc intersects the line from A at two places. Therefore, the triangle ACB and the triangle ADB will both satisfy the data, and you have an ambiguous case.

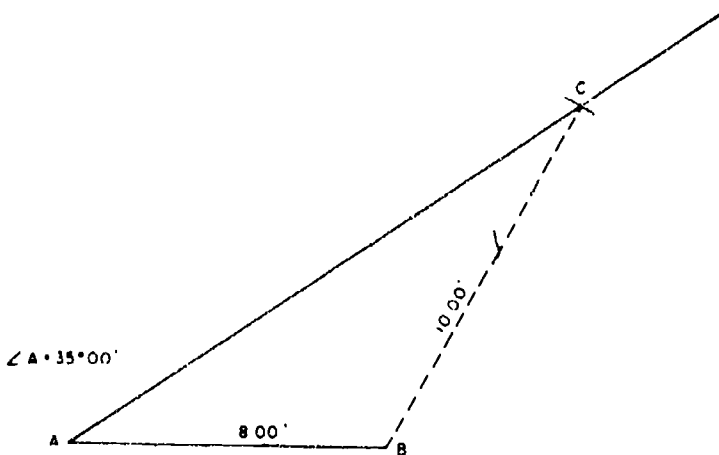
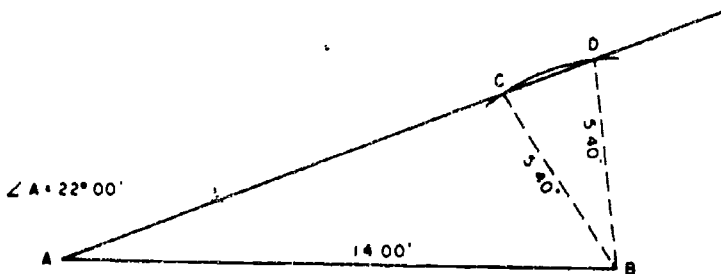

45.651

Figure 3-31.—Comparison of an ambiguous case triangle to a standard triangle.

Suppose now that the data describes a triangle with angle $A = 35^\circ 00'$, side opposite 10.00 ft, and other side 8.00 ft. Lay off the line AB 8.00 ft long as shown in the lower triangle of figure 3-31, and lay off a line from A at $35^\circ 00'$. Set a compass to 10.00 ft (length of side opposite A), and with B as a center strike an arc. This arc will intersect the line from A at only one point. Therefore, only one triangle will satisfy the data.

Determining Angle from Three Known Sides

There are several formulas for determining the size of an angle in a triangle from three known sides. The most convenient involves the versed sine of the angle, which means $(1 - \cos)$ of the angle. The formula goes as follows:

$$1 - \cos A = \frac{2(s - b)(s - c)}{bc}$$

$$1 - \cos B = \frac{2(s - a)(s - c)}{ac}$$

$$1 - \cos C = \frac{2(s - a)(s - b)}{ab}$$

The value s means one-half the sum of sides a , b , and c , or

$$\frac{a + b + c}{2}$$

For the triangle shown in figure 3-32, you would determine the size of angle A as follows:

$$s = \frac{10.00 + 12.00 + 15.00}{2} = \frac{37.00}{2} = 18.50$$

$$1 - \cos A = \frac{2(18.50 - 15)(18.50 - 10)}{(15)(10)}$$

$$= \frac{2(3.50)(8.50)}{150}$$

$$1 - \cos A = \frac{59.50}{150} = 0.39667$$

$$\cos A = 1 - 0.39667 = 0.60333$$

The angle with cosine 0.60333 measures, to the nearest minute, $52^\circ 53'$.

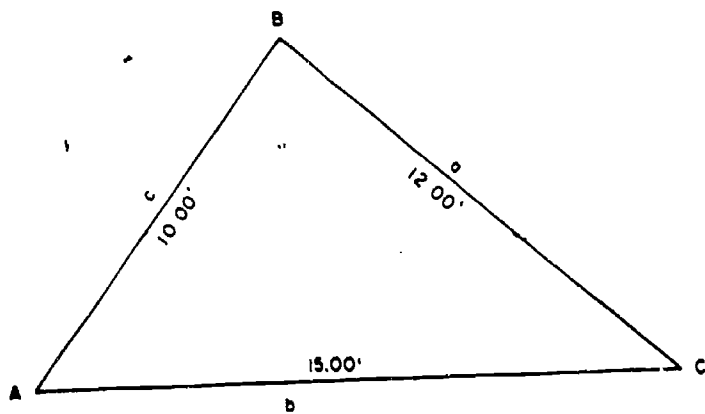

45.652

Figure 3-32.—Oblique triangle with three sides given and solved by versed sine formula.

Trigonometric Determination of Area

If you know all three sides of a triangle, you can determine the area by applying the following formula:

$$\text{area} = \sqrt{s(s-a)(s-b)(s-c)}$$

Where: $s = 1/2$ perimeter of a triangle

For the triangle shown in figure 3-32, the area computation is:

$$\text{area} = \sqrt{18.50(18.50 - 12.00)(18.50 - 15.00)(18.50 - 10.00)}$$

$$\text{area} = \sqrt{18.50(6.50)(3.50)(8.50)}$$

$$\text{area} = \sqrt{3577.44}$$

$$\text{area} = 59.81 \text{ sq ft}$$

When you know two sides of a triangle and the angle included between them, you can determine the area by applying, appropriately, one of the following formulas:

$$\text{area} = \frac{1}{2}bc \sin A$$

$$\text{area} = \frac{1}{2}ac \sin B$$

$$\text{area} = \frac{1}{2}ab \sin C$$

In figure 3-33, two sides $b = 13.00$ ft and $c = 9.00$ ft, and the included angle $A = 40^\circ 00'$, are

given. The sine of $40^\circ 00'$ is 0.64279. The area computation is as follows:

$$\text{area} = \frac{1}{2}bc \sin A$$

$$\text{area} = \frac{1}{2}(13.00)(9.00)(0.64279)$$

$$\text{area} = 58.50(0.64279)$$

$$\text{area} = 37.60 \text{ sq ft}$$

SPHERICAL TRIGONOMETRY

Spherical trigonometry is beyond the scope of this training manual; however, a preview of the subject is discussed here briefly. As you already know, we have been dealing with plane triangles, so actually a more appropriate title for the preceding section might be Plane Trigonometry.

Just as plane trigonometry has for its object the study of the relations existing among the sides and angles of a plane triangle, so spherical trigonometry has for its object the study of the relations connecting the sides and angles of a spherical triangle. Since the earth is approximately a sphere, this theory will apply when distances and directions on the earth are in question. Hence, the subject of spherical trigonometry is basic or a prerequisite in the study of navigation, geodesy, and astronomy. As you advance in rate, you will be concerned with geodesy and astronomy.

Spherical trigonometry is covered in the Engineering Aid Class "B" School Curriculum, but there are various spherical trigonometric

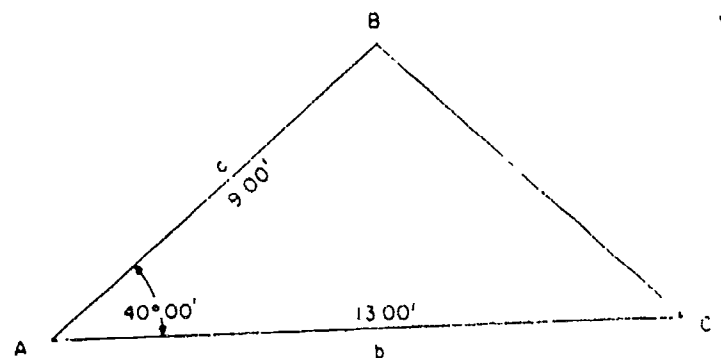

45.653

Figure 3-33.—Area of triangle with two sides and one angle given.

terms and definitions that you should understand very well in order to solve spherical trigonometric problems. We could also add that "plane trigonometry is 2-dimensional, whereas spherical trigonometry is 3-dimensional."

THE SLIDE RULE

The slide rule is a device for expediting the arithmetical operations of multiplication, division, raising to a higher power, determining a root, determining logarithms of numbers, and solving proportional equations. A modern slide rule is also equipped for the solutions of triangles.

Because the slide rule actually adds and subtracts the logarithms of the numbers set on its scales, logarithms and the slide rule are usually discussed together.

Because a modern slide rule may be used to solve triangles, we have postponed the slide rule discussion to follow explanations of triangle solutions.

The basic theory of the slide rule, the method of reading the scales on the rule and on the front face of the slide, and the use of the instrument for multiplication, division, squaring or cubing a number, and extracting a square or cube root of a number, are explained in NAVPERS 10069-C, chapter 8. This discussion omits a number of matters which will be explained in that chapter. However, the best source of information on the method of using a particular slide rule is the instruction manual provided by the manufacturer.

The slide rule shown in the figures and used for purposes of explanation is typical of the type found in the NMCB drafting kit. This is a 10-in. Mannheim type slide rule. The sliding part of the rule is called the slide. On the reverse face of the slide there are trigonometric scales. When the front face of the slide is up, the body of the rule and the face of the slide present the following scales (see fig. 3-34):

- K A three unit logarithmic scale, giving directly cubes and cube roots.
- DF A full length D scale folded. The method of using the so-called "folded" scales will be explained.

- CF A full length C scale, folded like the DF scale.
- L A scale of equal parts for finding common logarithms of numbers.
- CI A full length C scale, inverted for determining reciprocals as explained later. (CI means C inverted.)
- C A single logarithmic scale.
- D A single logarithmic scale like the C.
- A A two unit logarithmic scale giving directly squares and square roots.

Of the above-mentioned scales, the CF, L, CI, and C are on the front face of the slide. When the slide is reversed, these scales are supplanted by the following scales on the reverse face (see fig. 3-35):

- T A full length scale of tangents and cotangents, double numbered from 5.72° to 84.28° . A slide rule which gives angles in degrees and decimals of degrees, rather than in degrees, minutes, and seconds, is called a "deci-trig" slide rule. One which gives angles in degrees, minutes, and seconds is called a "trig" slide rule.
- ST A full length scale of sines and tangents, numbered from 0.58° to 5.73° . For any angle in this range, the sine and the tangent are so nearly the same as to make the difference between them insignificant.
- S A full length scale of sines and cosines, double numbered from 5.73° to 90° for sines and from 0° to 84.26° for cosines.
- C A single logarithmic scale.

SHIFTING THE INDEX

The procedure called "shifting the index" is not mentioned in NAVPERS 10069-C. Suppose that, in multiplying 2 by 6, you begin by setting the left index (numeral 1 at the left end of the C scale) over the 2 on the D scale. When you want then to move the hairline to the 6 on the C scale, you find the 6 beyond the body of the

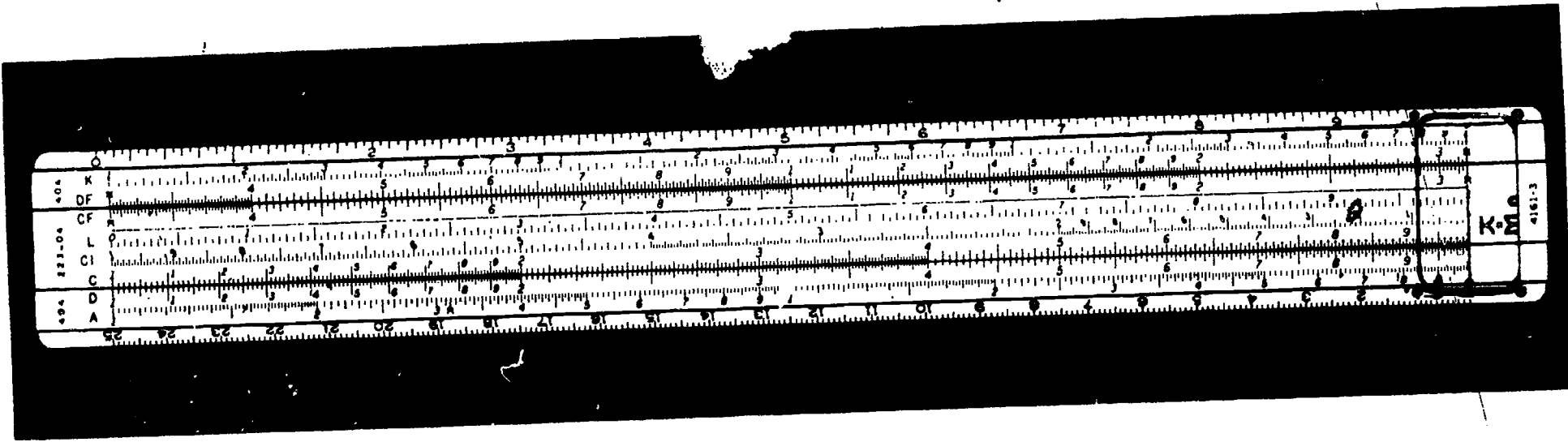

45.52.1

Figure 3-34.—Front face of a K & E slide rule.

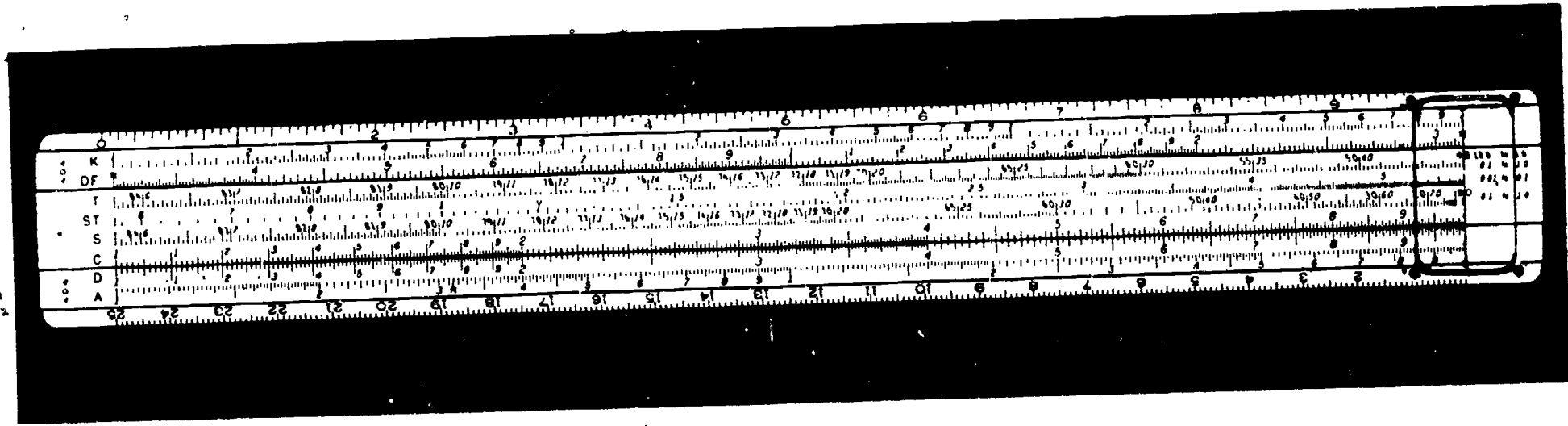

45.52.2

Figure 3-35.—Back side of a K & E slide rule.

73

79

rule. In this situation you must "shift the index"—that is, move the right index to the position now occupied by the left index. First move the hairline to the position occupied by the left index to hold that position. Then bring the right index under the hairline. Then move the hairline to 6 on the C scale.

USE OF THE FOLDED SCALES

The use of the folded scales almost entirely eliminates the necessity for shifting the index. Say again that you begin the multiplication of 2 by 6 by setting the left index of the C scale over the 2 on the D scale. The 6 on the C scale is now beyond the body of the rule. However, the 6 on the CF scale is now opposite the proper reading (12) on the DF scale.

In general, then, whenever you find, in multiplying, that the figure on the C scale where you want to set the hairline is beyond the body of the rule, simply set the hairline at the same figure on the CF scale and read the answer on the DF scale.

SLIDE RULE SOLUTIONS OF PROPORTIONAL EQUATIONS

The use of the slide rule for solving proportional equations is not covered in NAVPERS 10069-C. The usefulness of the instrument for this purpose is occasioned by the fact that, for any position of the slide, the ratio between any matching pair of numbers on the C and D scales is the same as that between any other matching pair.

Assume now that you want to convert $113^{\circ}15'$ to radians, using the formula 1 radian = 57.29° . First convert the $15'$ to degrees to the nearest 0.01° . There are $60'$ in 1° . Therefore, to convert $15'$ to degrees the equation is as follows:

$$\frac{60}{1} = \frac{15}{x}$$

Bring the 60 mark on the C scale over the 1 on the D scale. To determine the value of x (the number of hundredths of a degree in $15'$), simply observe the numerical value on the D scale which is below the 15 on the C scale. The value is 25. Therefore, $15' = 0.25^{\circ}$, and $113^{\circ}15' = 113.25^{\circ}$.

If there are 57.29° in 1 radian, the equation for converting 113.25° to radians is as follows:

$$\frac{57.29}{1} = \frac{113.25}{x}$$

Bring 57.29 on the C scale (you'll have to estimate the 0.29) over 1 on the D scale, and observe the value on the D scale which is below 113.25 (you'll have to estimate the 0.25) on the C scale. The value is 1.98. Therefore, in $113^{\circ}15'$ there are 1.98 radians.

USE OF THE LOG SCALE

For any number on the C scale on the slide front face, you read the mantissa in the corresponding position on the L (log) scale. Take the number 7776, for example. If you set the hairline at 7776 on the C scale (you'll have to estimate the position for the last 2 digits), the hairline will indicate the mantissa for 7776 (which is .891 to three places) on the L scale.

The principal practical use of the L scale is in the determination of roots other than square roots (which can be determined on the A scale) and cube roots (which can be determined on the K scale). For 7776, for example, the characteristic of the log is 3. Therefore, the log with mantissa to three places (found on the slide rule) is 3.891. Suppose you wanted to extract the 5th root. The log of the fifth root is $3.891 \div 5$, or 0.778. Set the hairline at .778 on the L scale (you'll have to estimate the position for the 8), and you read 6 under the hairline on the C scale. The characteristic of the root is 0; therefore, the 5th root of 7776 is 6.

You can use the L scale similarly to raise a number to a higher power.

USE OF THE CI (RECIPROCAL) SCALE

On the CI or reciprocal scale you read the reciprocal (given decimally) of any matching number on the C scale. If, for example, you set the hairline at 2 on the C scale, you read 5 (for 0.5 or $\frac{1}{2}$) on the CI scale.

Conversely, for any figure you set on the CI scale, you read the decimal equivalent of the reciprocal on the C scale. If, for example, you set the hairline at 4 on the CI scale, you read 25 (for 0.25, or $\frac{1}{4}$) on the C scale. It follows that whenever you set a figure on the CI scale, you

are automatically setting the decimal equivalent of the reciprocal (that is, of 1 over the figure) on the C scale.

Now, you know that to multiply a by b comes to the same thing as to divide a by the reciprocal of b —that is, by $\frac{1}{b}$. Therefore, you can determine the product of two numbers on the slide rule by dividing one of the numbers by the reciprocal of the other, using the CI or reciprocal scale.

Suppose, for example, you want to multiply 35 by 25. Set the hairline at 35, and bring 25 on the CI scale under the hairline. Remember when reading the CI scale, that this scale reads FROM RIGHT TO LEFT, not from left to right. The right index on the C scale indicates the answer, 875, on the D scale. What you actually did here was divide 35 by $\frac{1}{25}$, which expressed decimally is 0.04. If you observe the slide rule after the final setting, you will see that the 4 on the C scale (which matches the 25 on the CI scale) is in line with the 35 on the D scale.

For multiplication, many surveyors prefer to use the D and CI scales and the division process, rather than the C and D scales and the multiplication process, because of the fact that shifting the index is never required for the division process.

USE OF THE TRIGONOMETRIC SCALES

The first thing you must do with the trigonometric scales on the reversed face of the slide is study the scales very carefully to determine the actual values of the intervals between pairs of adjacent graduations. Consider, for example, the values on the S scale, reading from left to right. Between 6° and 10° each interval between adjacent graduations represents 0.05° . Between 10° and 20° each interval represents 0.10° . Between 20° and 30° each interval represents 0.20° . Between 30° and 60° each interval represents 0.50° . Between 60° and 80° each interval represents 1.00° . Between 80° and 90° there is only a single graduation, representing the 85° mark. Read the opposite way (from right to left), this graduation represents the 5° mark.

Consider similarly the T scale, read from left to right. Between 6° and 10° each interval represents 0.05° . Between 10° and 30° each

interval represents 0.10° . Between 30° and 45° each interval represents 0.20° .

For the entire length of the ST scale, each interval between adjacent graduations represents 0.02° .

It should be noted here that in order to use the trigonometric scales, you must convert all minutes and seconds to decimals of a degree. Conversions of minutes into decimals of a degree are given in Table XIII of Army TM 5-236, *Surveying Tables and Graphs*. However, by multiplying 0.0167 (decimal equivalent of one minute) by the number of minutes, you can easily convert to decimals without the use of tables.

The S Scale

The "S" in "S scale" means "sine," but actually the S scale is both a sine and a cosine scale. Note that every figure slanted to the right is paired with a corresponding figure slanted to the left. Note, too, that each pair of figures totals 90° . You know that the cosine is the cofunction of the sine, and you know that the function of an angle is the same as the cofunction of its complement.

Opposite any reading on the S scale you read on the C scale (1) the sine of the angle you read right-slanted, and (2) the cosine of the angle you read left-slanted. The angle you read left-slanted is in each case the complement of the angle you read right-slanted.

Therefore, to determine the sine of any angle from 5.73° to 90° , you read the S scale right-slanted. To determine the cosine of any angle from 0° to 84.26° , you read the S scale left-slanted.

To eliminate confusion, most slide rules have red and black figures on both the S and T scales. Right-slanted figures are black and left-slanted figures are red.

The T Scale

Note that numerals on the T scale are paired similarly to those on the S scale, each numeral representing the complement of the other in the pair.

However, here the similarity between the T scale and the S scale ceases. For any angle read right-slanted on the T scale, you read the tangent of the angle on the C scale in the

corresponding position. However, right-slanted angles can be read only to a maximum of 45° , which has a tangent of 1.00000.

For any angle read left-slanted on the T scale you read, not the tangent, but the cotangent on the C scale. Left-slanted angles run from 45.00° to 84.28° . How, then, do you determine the tangent of an angle larger than 45° on the slide rule?

Note, again, that you read cotangents of angles from 45° to 84.28° left-slanted on the T scale. Now, you know that the cotangent, besides being the cofunction of the tangent, is also the reciprocal function of the tangent. Therefore, if you divide 1 by the cotangent of an angle, you get the tangent of the angle.

Suppose, now, that you want to determine the tangent of 60 degrees by the T scale. You know that the 60° mark on the T scale matches with the cotangent of 60° on the C scale. If you divide this cotangent into 1, you can read the tangent of 60° . Set the hairline at 1 on the D scale, and bring 60° on the T scale under the hairline. The index on the C scale now points to 1.73 on the D scale. You know that 60° is larger than 45° , and therefore that the tangent is larger than 1. Therefore, you know that the tangent you are reading is 1.73.

To sum up: to read the tangent of an angle between 5.72° and 45° on the T scale, set the hairline to the angle and read the figure indicated by the hairline on the C scale. To read the tangent of an angle between 45° and 84.28° on the T scale, set the hairline at 1 on the D scale, bring the angle on the T scale under the hairline, and read the tangent as indicated by the C scale index on the D scale.

The ST Scale

For sines or tangents of small angles from 0.58° to 5.73° you use the ST scale. For any angle this small, the sine and tangent are very nearly the same. For any angle set on the ST scale, you read the sine or tangent in the corresponding or matching position on the C scale.

Decimal Point Placement in Functions

Note the convenient small figures to the right of the trigonometric scales. These help you

to place the decimal point properly in a function you are reading. At the top are left-slanted figures 1.0 to 10.0 on the T scale. The figures tell you that angles from 45° to 84.28° degrees have tangents running from 1.00000 to 10.00000. For example, you set the hairline at 1 on the D scale and bring 50° under the hairline to determine the tangent. You read 1.19 on the D scale at the C scale index. The small figures tell you that the tangent of 50° is 1.19. More precisely it is 1.19175.

Similarly, the small figures 0.1 to 1.0, right-slanted, on the T scale tell you that the tangents you read for right-slanted angles (which are angles from 5.72° to 45°) run from 0.1 to 1.0.

For the sines/tangents you read for small angles from 0.58° to 5.73° on the ST scale, the small figures by that scale show values from 0.01 to 0.1.

The small figures on the S scale tell you that sines of angles from 5.73° up to 90° , and cosines of angles from 84.26° down to 0° , run from 0.1 to 1.0.

Functions of Angles Larger Than Those Shown

The S scale shows cosines for angles up to 84.26° . Suppose you want to determine the cosine of an 86.00° angle. You know that the cosine of 86.00° is the same as the sine of ($90.00^\circ - 86.00^\circ$), or 4.00° . You can read the sine of 4.00° on the ST scale.

The largest angle shown on the T scale is 84.28° . To determine the tangent of an angle larger than this, you work with the cotangent of the complement. You will recall that the tangent of an angle is equal to the cotangent of its complement.

Suppose, for example, you want the tangent of 89.00° . This is the same as the cotangent of ($90.00^\circ - 89.00^\circ$), or 1.00° . Now, the cotangent of 1.00° is the same as 1 divided by the tangent of 1.00° . You can divide 1 by the tangent of 1.00° by using the ST scale. Set the hairline at 1 on the D scale, and bring 1.00° on the ST scale under the hairline. The index on the C scale now shows 573 on the D scale. Since the tangent of 84.28° is 10.00 (small left-slanted figure on the T scale), the tangent of 89.00° must be 57.3. More precisely it is 57.28996.

Functions of Angles Smaller Than Those Shown

The smallest angle on the ST scale is 0.58° (about $0^\circ 35'$). For functions of angles smaller than this, you apply the fact that the sine or tangent of one of these very small angles is very nearly equal to the size of the angle expressed in radians.

To facilitate the conversion of . . . small angle from minutes and/or seconds to radians, there are two small "gage points" on the ST scale. The gage point for seconds, indicated by the symbol $''$, is located near the 1.18° mark on the scale. The gage point for minutes, marked by the symbol $'$, is located near the 1.96° mark.

To convert from degrees, minutes, and seconds to radians (and therefore to the sine or tangent of the angle), you express a small angle in all minutes or all seconds and apply the appropriate gage point as follows.

Suppose you want to determine the radians equivalent (and therefore also the sine or tangent) of $00^\circ 26' 00''$. Set the hairline at 26 on the D scale and bring the minutes gage point under the hairline. The index of the C scale now indicates 756 on the D scale. To place the decimal point, remember the following:

1 minute = approximately 0.0003 radians.

If you multiplied 26 by 0.0003, you would get 0.0078. Therefore the number of radians in $00^\circ 26' 00''$, and the sine or tangent of the same angle, must be 0.00756.

Suppose you want to determine the sine or tangent of $00^\circ 15' 39''$ by converting this angle to radians. Expressed in seconds, this angle measures 939". Set the hairline at 939 on the D scale and bring the seconds gage point under the hairline. The index on the C scale now indicates 455 on the D scale. To place the decimal point, remember the following:

1 second = approximately 0.000005 radians.

If you multiply 939 by 0.000005, you get 0.004695. Therefore, the number of radians in $00^\circ 15' 39''$, or the sine or tangent of the same angle, must be 0.00455.

This method may also be used for determining the cosine or cotangent of angles very close to 90° . Suppose you want to determine the cosine of $89^\circ 37' 45''$. This is the same as the sine of $(90^\circ 00' 00'' - 89^\circ 37' 45'')$, or

$00^\circ 22' 15''$. You can convert this into all seconds and determine the sine (which is the same as the cosine of $89^\circ 37' 45''$) by applying the seconds gage point on the ST scale.

Suppose you want to determine the cotangent of $89^\circ 54' 16''$. This is the same as the tangent of $(90^\circ 00' 00'' - 89^\circ 54' 16'')$, or $00^\circ 05' 44''$. You can convert this into all seconds and determine the tangent (which is the same as the cotangent of $89^\circ 54' 16''$) by applying the seconds gage point on the ST scale.

Triangle Solutions With the Slide Rule

You've already seen that triangle solutions involve multiplication or division of linear distances by trigonometric functions of angles. In this respect, solutions with a slide rule involve nothing new. However, with the slide rule you don't need to determine the numerical value of the particular function, because when you set the hairline to 30 degrees (for example) on the T scale, you are automatically setting it to the tangent of 30 degrees (0.577) on the C scale. The multiplication or division then proceeds just as it would with any ordinary pair of numbers.

Take the triangle shown in figure 3-36. By the law of sines, the solution for angle B is as follows:

$$\frac{9.00}{\sin B} = \frac{5.50}{\sin A}$$

$$\frac{9.00}{\sin B} = \frac{5.50}{\sin 32.00^\circ}$$

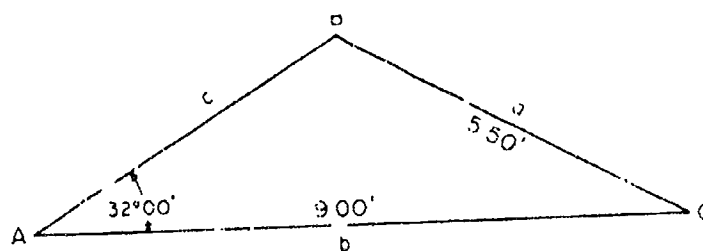

45.655

Figure 3-36.—Solution of an oblique triangle by slide rule.

Set the hairline to 5.50 on the D scale and bring 32.00° on the S scale under the hairline. Move the hairline to 9.00 on the D scale. The hairline now indicates the sine of B on the C scale (about 0.866). It also indicates 60.00° on the S scale. Does this mean that B measures 60.00°? Watch out on that one. Figure 3-36 shows you that B is larger than 90°. You know that for an angle larger than 90°, you apply the formula $\sin A = \sin (180^\circ - A)$. Therefore, the size of B is not the 60.00° you are reading on the S scale, but $(180.00^\circ - 60.00^\circ)$, or 120.00°.

Now that you know the sizes of A and B, you can find the size of C, which is $180.00^\circ - (A + B)$, or $180.00^\circ - (32.00^\circ + 120.00^\circ)$, or 28.00°.

By the law of sines the solution for side c is as follows:

$$\frac{c}{\sin C} = \frac{a}{\sin A}$$

$$c = \frac{a \sin C}{\sin A} = \frac{5.50(\sin 28.00^\circ)}{\sin 32.00^\circ}$$

Proceed with this on the slide rule by first dividing 5.50 by $\sin 32.00^\circ$, then multiplying the result by $\sin 28.00^\circ$. Set the hairline at 5.50 on the D scale and bring $\sin 32.00^\circ$ on the S scale under the hairline. You just divided 5.50 by $\sin 32.00^\circ$. To multiply the result by $\sin 28.00^\circ$,

simply hold the slide just where it is and move the hairline to $\sin 28.00^\circ$ on the S scale. The hairline now indicates the length of side a, which is 4.87 ft, on the D scale.

Take the right triangle shown in figure 3-37. The solution for angle A is as follows:

$$\tan A = \frac{a}{b} = \frac{8.30}{11.00}$$

Set the hairline at 8.30 on the D scale and bring 11.00 on the C scale under the hairline. The C scale index now indicates the tangent of A on the D scale. Hold this position by moving the hairline to the C scale index. Then close the slide exactly. The hairline now indicates the tangent of A on the C scale, and the size of A (which is 37.00°) on the T scale.

The solution for angle B is simply $B = 180.00^\circ - (A + C) = 180.00^\circ - (37.00^\circ + 90.00^\circ) = 53.00^\circ$.

By the law of sines the solution for side c is as follows:

$$\frac{c}{\sin C} = \frac{a}{\sin A}$$

The sine of 90.00° is 1.00000. Therefore:

$$c = \frac{8.30}{\sin 37.00^\circ}$$

Set the hairline at 8.30 on the D scale, and bring 37.00° on the S scale under the hairline. The C scale index now indicates the length of side c (which is 13.80 ft) on the D scale.

Now take the right triangle shown in figure 3-38. From the fact that side a is larger than side b, you know that the tangent of angle A (which is $\frac{a}{b}$) is larger than 1, and that A is therefore larger than 45°. You know that, for angles larger than 45°, the slide rule T scale gives you, not tangents, but cotangents. Therefore, you apply the cotangent solution for angle A as follows:

$$\cot A = \frac{b}{a} = \frac{4.50}{6.00}$$

Set the hairline at 4.50 on the D scale and bring 6.00 on the C scale under the hairline. The C scale index now indicates the cotangent of A on the D scale. Hold this position by moving the hairline to the index; then close the slide exactly. The hairline now indicates the

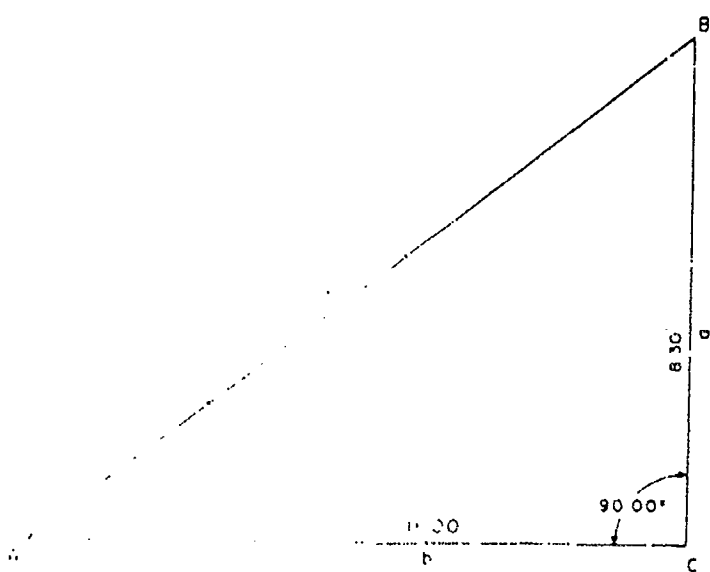

45.656
Figure 3-37.—Solution of a right triangle by slide rule.

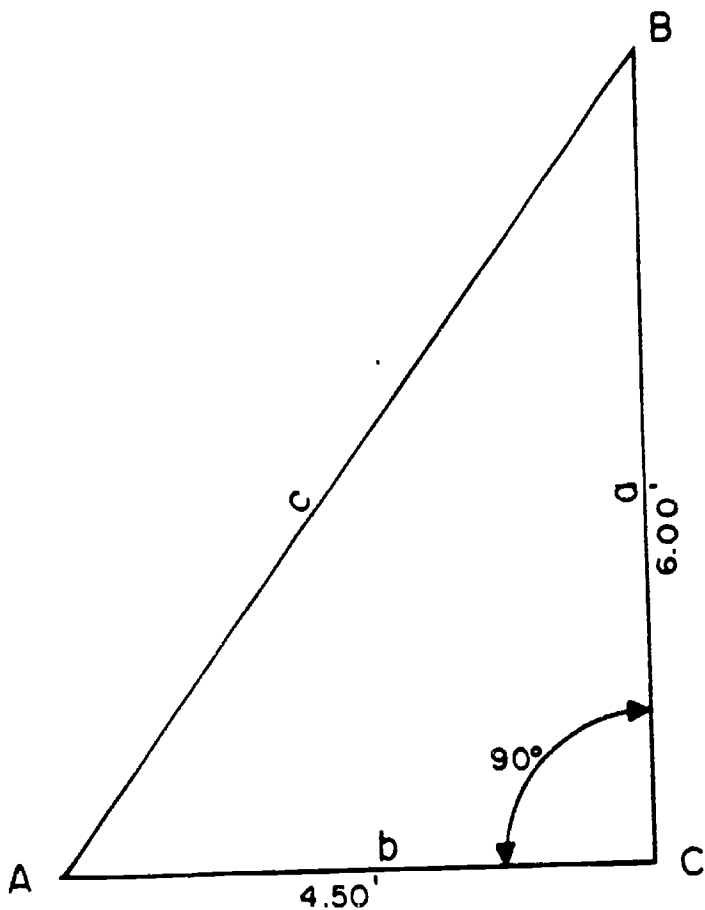

45.657

Figure 3-38.—Another solution of a right triangle by slide rule.

cotangent of A on the C scale. The size of angle A is the angle you read LEFT-SLANTED on the T scale. This angle is 53.10° .

The solution for B is simply $B = 180.00^\circ - (A + C)$, or $180.00^\circ - (53.10^\circ + 90.00^\circ)$, or 36.90° , or $36^\circ 54'$.

The solution for side c is as follows:

$$c = \frac{a}{\sin A} = \frac{6.00}{\sin 53.10^\circ}$$

Set the hairline at 6.00 and bring 53.10° (right-slanted) on the S scale under the hairline. The C scale index now indicates the size of c (which is 7.50 ft) on the D scale.

CALCULATING MACHINE

For computations involving the multiplication or division of multi-digit numbers

the disadvantage of the slide rule is the fact that it can be read to only the first three or four digits of a number. An additional digit may be estimated; after that, digits in front of the decimal point must be set down as zeros. Also, the slide rule cannot be used to expedite the arithmetical operations of addition and subtraction.

The average calculating machine can work directly with numbers containing as many as 9 digits (up to 999,999,999), and besides multiplication and division can perform addition and subtraction. Some calculating machines can even perform these various arithmetical operations simultaneously and continuously—thus tabulating the balance. For these reasons, practically all SEABEE engineering offices are equipped with some type of calculating machine.

Calculating machines vary considerably and no attempt can be made here to describe each of the numerous varieties in detail. For a particular machine, the only complete and fully accurate source of information on operation, care, and maintenance is the manufacturer's manual. This training manual can only discuss some aspects of machines in general.

There are three general types of calculating machines commonly used in engineering offices: the rotary calculator (fig. 3-39), the



model CW
45.658

Figure 3-39.—Friden model CW automatic calculator.

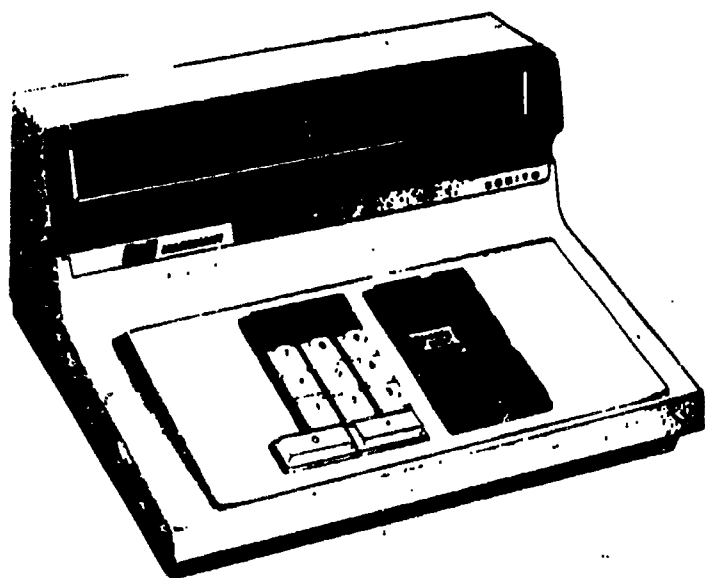

45.828

Figure 3-40.—Electronic solid-state calculator.

rotary-printing calculator (not shown), and the electronic solid-state calculator (fig. 3-40). The basic difference between the two types of rotary calculators is that the rotary-printing calculator produces a tape in much the same manner as an adding machine while the rotary calculator does not. Instead, values entered into and computed by the machine are read on "dials" (rows of apertures in which digits appear) on the machine. The third type of calculator, the electronic solid-state calculator, is rapidly replacing the rotary type calculator. The electronic solid-state calculator, in reality, is a miniature electronic computer.

Due to advanced technology and the need for performing complex mathematical computations, the electronic solid-state calculator has emerged as a major breakthrough in the market of calculators. All of the well-known calculator manufacturers have developed many calculator models, and each model has its own unique features. Regardless of the make or model, all electronic calculators have a number of distinct advantages over the rotary type calculator. Electronic calculators are generally less expensive than rotary calculators, simpler to operate, produce faster computations, operate silently, are smaller and much lighter in weight, and require very little maintenance.

The electronic solid-state calculator shown in figure 3-40 is a typical desk model used for engineering calculations. Its keyboard is arranged in the standard 10-key pattern and operating keys are similar to those of standard rotary calculators. However, it has additional keys used to insert mathematical signs such as decimal points, and for storage and recall of numbers. Numbers inserted for the computations and the answers are instantly projected by a cathode ray onto a small TV-like screen located at the top of the machine. As we mentioned before, operation of the electronic solid-state calculator is relatively simple if you follow the instructions given in the operator's manual.

HINTS ON COMPUTATIONS

It is a general rule that, when you are expressing dimensions, you express all dimensions with the same precision. Suppose, for example, you have a triangle with sides 15.75, 19.30, and 11.20 ft long. It would be incorrect to express these as 15.75, 19.3, and 11.2 ft, even though the numerical values of 19.3 and 11.2 are the same as those of 19.30 and 11.20.

It is another general rule that it is useless to work computations to a precision which is higher than that of the values applied in the computations. Suppose, for example, you are solving a right triangle for the length of side a , using the Pythagorean theorem. Side b is given as 16.5 ft, and side c as 20.5 ft. By the theorem you know that side a equals the square root of $(20.5^2 - 16.5^2)$, or the square root of 148.0. You could carry the square root of 148.0 to a large number of decimal places. However, any number beyond 2 decimal places to the right would be useless, and the second would be determined only for the purpose of "rounding off" the first.

ROUNDING OFF

The square root of 148.0, to two decimal places, is 12.16. As the 0.16 represents more than one-half of the difference between 0.10 and 0.20, you round off at 0.2, and call the

length of side a 12.2 ft. If the hundredth digit had represented less than one-half of the difference between 0.10 and 0.20, you would have rounded off at the lower tenth digit, and called the length of side a 12.1 ft.

Suppose that the hundredth digit had represented one-half of the difference between 0.10 and 0.20, as in 12.15. Some computers in a case of this kind always round off at the lower figure, as, 12.1. Others always round off at the higher figure, as, 12.2. Better balanced results are usually obtained by rounding off at the nearest even figure. By this rule, 12.25 would round off at 12.2, but 12.35 would round off at 12.4.

USING TABLES

Each publisher may have his own concept of the most convenient arrangement of tables. When starting to use a new set of tables, check carefully to see the arrangement. If there is any doubt, read the explanation which precedes the table.

In many tables of natural functions you read the tables from the top down for angles from 0° to 45° and from the bottom up for angles from 45° to 90° . When you are reading from the top down, you read minutes in the left-hand minutes column. When you are reading from the bottom up, you read minutes in the right-hand minutes column.

A table of natural functions is usually divided into a table of natural sines and cosines and a table of natural tangents and cotangents. When you are reading from a table of natural sines and cosines from the top down, each column under an angle usually lists the sine to the left and the cosine to the right. When you read the same page from the bottom up, however, the cosine is to the left and the sine to the right.

Similarly, with a table of natural tangents and cotangents, when you are reading a page down the tangent is to the left and the cotangent to the right in each column. Reading upward it is the other way around.

A table of logs of functions usually lists sine, cosine, tangent, and cotangent on the same page. When you are reading a page downward, columns usually list, from left to right, sine,

cosine, tangent, and cotangent. Reading upward, however, the listings from left to right are cosine, sine, cotangent, and tangent.

It is a very common mistake for a beginner, reading a table of functions from the bottom up, to refer to the top of the column instead of the bottom for identification of the function.

If you refer back to figure 3-4, you will see that it is a common custom, in tables of logs of numbers, to economize on printing by printing the first two digits of mantissa only once in a series of mantissa in which those digits occur. You must study your tables closely to ensure that you associate a mantissa in which the first two digits are missing with the correct pair of digits. Take, for example, the mantissa for 1738 shown in figure 3-4. This is printed as 0050; the first two digits are missing. The horizontal line tells you that the first two digits are 24 (appearing printed in the mantissa for 1740).

READING THE SLIDE RULE

The most common mistake made by beginners on the slide rule is misreading the values represented by the interval between two graduations. For example: the first graduation to the right of the left-hand numeral 1 on the C and D scales (fig. 3-34) is frequently misread as indicating 11. Actually this graduation indicates 101. The first graduation to the right of the numeral 2, frequently misread as indicating 21, actually indicates 202. The first graduation to the right of the numeral 4, frequently misread as 41, actually indicates 405.

Other common beginner's mistakes are as follows:

1. Forgetting that the values on the CI scale increase to the left, not to the right. When you do this, you are likely to read 35 as 45.
2. Using the wrong section of the A scale to determine a square root, or the wrong section of the K scale to determine a cube root. There are several rules for guidance in this matter; the most convenient seem to be the following:

For a square root, move the decimal point in the number 2 places at a time, in the appropriate direction, until you obtain a number between 1 and 100. Then follow the rule that, for a

number with only a single digit in front of the decimal you use A left; for one with two digits in front of the decimal you use A right.

For a cube root, move the decimal point 3 places at a time, in the appropriate direction, until you obtain a number between 1 and 1000. Then follow the rule that, for a number with only a single digit in front of the decimal point you use K left; for one with two digits in front of the decimal point you use K center; and for one with three digits in front of the decimal point you use K right.

3. Forgetting that on the S and T scales the values increase to the left when you are reading left-slanted (cosines on the S scale, cotangents of angles larger than 45° on the T scale) and to the right when you are reading right-slanted (sines on the S scale, tangents of angles up to 45° on the T scale). When you do this, you are likely to read (for example) 62° on the S scale as 68° .

UNITS OF MEASUREMENT

Engineering science would not be so precise as it is today if it did not make use of systems of measurement. In fieldwork, drafting, office computation, scheduling and quality control, it is important to be able to measure accurately the magnitudes of the various variables necessary for engineering computations, such as, directions, distances, materials, work, passage of time, and many other things.

The art of measuring is fundamental in all fields of engineering and even in our daily lives. We are familiar, for instance, with "gallons," which determines the amount of gasoline we put in our car and with "miles," which tells us the distance we have to drive to and from work. It is also interesting to note that the development of most of these standard units of measure parallels the development of civilization itself, for there has always been a need for measurement. In the early days, men utilized night and day and the cycle of the four seasons as their measure of time. The units of linear measure were initially adopted as comparison to the dimensions of various parts of a man's body. For example, a "digit" was at that time the width of a man's

middle finger, and a "palm" was the breadth of an open hand. The same applies to most other units of linear measure that we know today—like the "foot," the "pace," and the "fathom." The only difference between today's units of measure and those of olden days is that those of today are standardized. It is with the standard types of measurements that we are concerned in this training manual.

At present, two units of measurement are used throughout the world. They are the English system and the metric system. Many nations use the metric system. Before Great Britain switched to the metric system, she was among the United States, Canada, Australia, and some countries in South Africa who preferred to use the English system. Generally, those countries using the English system today are members of the British Commonwealth or have British influence in their history in one way or the other. The present trend, however, seems to point to the probability that the United States will eventually switch to the metric system.

The metric system is the most practical method of measurement for it is based on the decimal system, in which units differ in size by multiples of tens, like the U.S. monetary system in which 10 mills equal 1 cent; 100 mills or 10 cents equal 1 dime; and 1,000 mills, 100 cents, or 10 dimes equal one dollar. When we perform computations with multiples of 10, it is convenient to use an exponential method of expression as you may recall from your study of mathematics.

A unit of measurement is simply an arbitrary length, area, or volume, generally adopted and agreed upon as a standard unit of measurement. The basic standard for linear measurement, for example, is the meter, and the actual length of a meter is, in the last analysis, equal to the length of a bar of metal called the International Meter Bar, one replica of which is kept in the National Bureau of Standards, Washington, D.C.

As an EA, you will not necessarily be working with all the units described in this chapter, and therefore need not attempt to memorize them all. Many are included simply to

Table 3-2.--Linear Conversion Factors

	Inches	Feet	Yards	Statute miles	Centimeters	Meters	Kilometers
Inch.....	1	.083333	.0277	2.540005	.0254
Foot.....	12	1	.333	30.48006	0.304801
Yard.....	36	3	1	.000568	91.44018	.914402	.000014
Statute mile.....	63,360	5280	1760	1	1609.347	1.609347
International nautical mile.....	6076.10	2025.36	1.150777
United States nautical mile.....	6080.20	2026.73	1.151553
Centimeter.....	.3937	1	.01
Meter.....	39.37	3.280833	1.093611	100	1	.001
Kilometer.....	0.62137	1000	1
Decimeter.....	3.937	.3281
Decameter.....	393.7	32.8	10
Hectometer.....	328'-1"1
Myriameter.....	6.213712	10

45.76

show that units are arbitrary and that there are many different kinds of units in use.

UNITS OF LINEAR MEASURE

Linear measure is used to express distances and to indicate the differences in their elevations. The standard units of linear measure are the foot and the meter. In surveying operations, both these standard units are frequently divided into tenths, hundredths, and thousandths for measurements. When dealing with the longer distances, the foot is expanded into a statute or to a nautical mile and the meter into a kilometer. Table 3-2 shows the conversion factors for the common linear measurements.

English Units

In the English system, the most commonly used basic unit of linear measurement is the foot, a unit which amounts to slightly more than three-tenths of the international meter. In what is called "engineer's" measurement, the foot is subdivided decimally—that is, into tenths, hundredths, or thousandths of a foot. In what is called "carpenter's" measurement, or English units, the foot is subdivided into twelfths called inches, and the inch is further subdivided into even-denominator fractional parts, as: 1/2 in., 1/4 in., 1/8 in., 1/16 in., and so on.

Fractions or multiples of the basic 1-ft unit are used to form larger units of linear measure, as follows:

- 1 link = 0.66 ft
- 1 yard = 3.00 ft
- 1 rod, pole, or perch = 16.50 ft
- 1 Gunter's chain = 66.00 ft
- 1 engineer's chain = 100.00 ft
- 1 statute mile U.S. = 5280.00 ft
- 1 nautical mile (international) = 6076.10 ft

A unit of linear measurement called a "vara," of Spanish and Portuguese origin, was formerly used to measure land boundaries in those areas of the U.S. which were at one time under Spanish control. In those areas old deeds and other land instruments still contain property descriptions in varas. The length of a vara varies in different parts of Arizona, California, Florida, New Mexico, and Texas. For instance, in Texas, the unit length of vara is equal to 33.33 in.

Metric Units

In many of the non-English-speaking countries of the world the most commonly used basic unit of linear measure is the meter. The length of a meter was originally designed to equal (and does equal very nearly) one ten-millionth part of the distance, measured



along a meridian, between the earth's Equator and one of the poles. A meter equals slightly more than 1.09 yd.

The big advantage of the metric system is the fact that it is a decimal system throughout—that is, the fact that the basic unit can be both subdivided into smaller units decimally and converted to larger units decimally, by simply moving the decimal point in the appropriate direction. Names of units smaller than the meter are indicated by the Latin prefixes deci- (one-tenth), centi- (one-hundredth), milli- (one-thousandth), and micro- (one-millionth), as follows:

- 1 decimeter = 0.1 meter (1×10^{-1})
- 1 centimeter = 0.01 meter (1×10^{-2})
- 1 millimeter = 0.001 meter (1×10^{-3})
- 1 micrometer = 0.000001 meter (1×10^{-6})

Names of units larger than the meter are indicated by the Greek prefixes deca- (ten), hecto- (one hundred), kilo- (one thousand), myria- (ten thousand), and mega- (one million), as follows:

- 1 decameter = 10.00 meters (1×10)
- 1 hectometer = 100.00 meters (1×10^2)
- 1 kilometer = 1,000.00 meters (1×10^3)
- 1 myriameter = 10,000.00 meters (1×10^4)
- 1 megameter = 1,000,000.00 meters (1×10^6)

UNITS OF AREA MEASUREMENT

In the English and metric system, area is most frequently designated in units which consist of squares of linear units, as: square inches, feet, yards, or miles; or square centimeters, meters, or kilometers. In the English system the land-area measurements most commonly used are the square foot and the acre. Formerly the square rod (1 rod = 16.5 ft.) and the square Gunter's chain (1 Gunter's chain = 66 ft.) were used. One of the area measurements, with its equivalents, is as follows:

- 1 acre = 10 sq Gunter's chains
- = 160 sq rods
- = 43,560 sq ft

An equilateral rectangular (square) acre measures 208.71 ft on a side. There are 640 acres in a square mile.

Other area equivalents that might be of value to you are as follows:

- 1 square inch (sq in.) = 6.4516+ square centimeters (sq cm)
- 1 square foot (sq ft) = 144 sq in.
= 0.0929+ square meter (sq m)
- 1 square yard (sq yd) = 9 sq ft
= 0.8361- sq m
- 1 square meter (sq m) = 10.7639 sq ft
= 1.1960+ sq yd

Actually, more attention should be given to linear equivalents. If you know the linear conversion factor from one unit to the other, you can always compute for any equivalent area or even volume. Just remember, area is expressed in square units and volume is expressed in cubic units.

Example: Find the area of a rectangle 2' x 3' in square inches.

$$\text{Area} = 2' \times 3' = (2 \times 12)(3 \times 12) = 864 \text{ sq in.}$$

UNITS OF VOLUME MEASUREMENT

From your study of mathematics, you learned that volume is the measure of the amount of space which matter occupies. It is expressed in certain cubic units, depending upon the linear measurements or dimensions of the object.

As an EA, your interest in unit volume of measurements will be from the standpoint of earthwork, construction materials, material testing, rainfall runoff, and capacities of structures—like for example, a reservoir. The accuracy of your computations will depend upon your knowledge of the correct conversion factors and the units used. Remember that your dimensions must always be expressed in one kind of unit of measure; for instance, if you are using meter, all dimensions must be in meters.

Chapter 3--MATHEMATICS AND UNITS OF MEASUREMENT

The basic units of volume that you might be using are as follows:

1 cubic inch (cu in)	= 16.3872 cubic centimeters (cc)
1 cubic foot (cu ft)	= 1728 cu in = 0.0283 cubic meter (cu m)
1 cubic yard (cu yd)	= 27 cu ft = 0.7646 cubic meter
1 cubic meter (cu m)	= 1,000,000 cc = 35.3145 cu ft = 1.3079 cu yd
1 U.S. gallon	= 231 cu in = 7.4805 cu ft
1 acre ft	= 43,560 cu ft = 1233.49 cu m

UNITS OF WEIGHT

The units of weight most frequently used in the U.S. for weighing all commodities except precious stones, precious metals, and drugs are the units of the so-called "avoirdupois" system. Avoirdupois units of weight are as follows:

437-1/2 grains (gr)	= 1 ounce (oz)
16 ounces (oz)	= 1 pound (lb)
100 pounds (lb)	= 1 hundred-weight (cwt)
1,000 pounds (lb)	= 1 kip (K)
2,000 pounds (or 20 cwt)	= 1 short ton (T)
2,200 pounds (lb)	= 1 long ton

Precious stones and precious metals are usually weighed in the U.S. by the system of "troy" weight, in which there are 12, rather than 16, oz in the pound. Drugs are weighed by "apothecaries'" weight, in which there are also 12 oz in the pound.

The basic unit of the metric system of weight is the "gram," which contains 15.432 grains. The grain was originally supposed to be equal to the weight of a single grain of wheat. The gram of 15.432 grains is also used in the avoirdupois, troy, and apothecaries' system of weights.

Multiples and subdivisions of the basic unit of metric weight (the gram) are named in

accordance with the usual metric system of nomenclature, as follows:

0.000001 gm	= 1 microgram
0.001 gm	= 1 milligram
0.01 gm	= 1 centigram
0.10 gm	= 1 decigram
10.00 gm	= 1 decagram
100.00 gm	= 1 hectogram
1000.00 gm	= 1 kilogram

A "metric ton" equals 1,000 kilograms, which equals 1.1 short tons.

The Engineering Aid is interested in the weight of his instruments and the pull to be applied to the ends of the tape to give correct linear measurements. The common units of weight in surveying are the ounce, the pound, the gram, and the kilogram. The following tabulation gives the relationship between these units:

1 ounce (oz)	= 28.3495 grams (g)
1 pound (lb)	= 453.5924 g = 0.4536 Kg.
1 kilogram (kg)	= 2.2045 lb = 35.27 oz

UNITS OF ANGULAR MEASUREMENT

Angular or circular measure is used for designating the value of horizontal and vertical angles. For general use in the measurement of angles, the circumference of the circle is divided into some even number of equal parts. The unit of angular measure is the angle at the center of the circle subtended by one of the small subdivisions of the circumference. The various units of angular measure are known as UNITS OF ARCS. In practice these units of arcs may be further expressed in decimal or fractional parts.

There are three systems of angular measure that may be encountered by the Engineering Aid in the use of surveying instruments. They are the sexagesimal, centesimal or metric, and the mil system.

Sexagesimal or North American System

In the sexagesimal or North American system, the circle is divided into 360 equal parts

known as DEGREES of arc, each degree into 60 equal parts known as MINUTES of arc, and each minute into 60 equal parts known as SECONDS of arc. As an example, angles in this system are written as:

$$263^{\circ}47'16''.48$$

which is read as "two hundred sixty-three degrees, forty-seven minutes, and sixteen point four eight seconds of arc." In the United States, this is the most commonly used system of angular measurement.

Centesimal or Metric System

In the centesimal or metric system, the full circle is divided into four quadrants, and each quadrant is divided into 100 equal parts known as GRADS or GRADES. Each grad is further divided into decimal parts. As an example, angles in this system are written as:

$$376^{\text{g}}.7289, \text{ or } 376^{\text{g}} 72'89''$$

which is read as "three hundred seventy-six point seven two eight nine grads," or as "three hundred seventy-six grads, seventy-two centesimal minutes, and eighty-nine centesimal seconds."

Mil System

In the mil system, the circle is divided into 6,400 equal parts known as MILS. The mil (symbolized by m) is divided into decimal parts. As an example, angles in this system are written as:

$$1728.49\text{m}$$

which is read as "one thousand seven hundred twenty-eight point four nine mils." This system is used principally by the artillery people. The significance of this unit of angular measure is the fact that 1 mil is the angle which will subtend 1 yard at a range of 1,000 yds.

The relationship among values in the three systems of angular measure are as follows:

$$1 \text{ circle} = 360 \text{ degrees} = 400 \text{ grads} = 6,400 \text{ mils}$$

$$\begin{aligned} 1 \text{ degree} &= 1.1111 \text{ grads} = 17.7778 \text{ mils} \\ 1 \text{ minute} &= 0.2963 \text{ mils} \\ 1 \text{ grad} &= 0.9 \text{ degree} = 0^{\circ}54'00'' = 16 \text{ mils} \\ 1 \text{ mil} &= 0.0562 \text{ degree} = 0^{\circ}03'22''.5 \text{ or} \\ &= 3.3750 \text{ minutes} \\ &= 0.0625 \text{ grad} \end{aligned}$$

MORE UNITS OF MEASUREMENT

Aside from the units of measurement discussed above, the EA must also deal with other units of measurement, such as TIME, TEMPERATURE, PRESSURE, etc. He must have exact time in computing problems in astronomy and some laboratory works. He must be able to apply temperature corrections to his tape readings. He must also evaluate the effect of atmospheric pressure at different elevations, and get involved in some other types of measure which will be discussed in the following paragraphs.

Time Measurement

For practical purposes in everyday affairs and in surveying, the measurement of time intervals is of great concern. The time used in everyday life is known as STANDARD TIME, and is based on the mean apparent revolution of the sun around the earth due to the earth's rotation on its axis. Standard time is used in surveying to regulate the normal day's operations. But, when it is necessary to observe the sun or the stars to determine the azimuth of a line or the position of a point on the earth's surface, the surveyor uses three other kinds of time. They are: APPARENT (true) SOLAR TIME, CIVIL (mean solar) TIME, and SIDEREAL (star) TIME. You will learn more about these different times when you study the chapter on Geodesy and Field Astronomy in *Engineering Aid 1 & C*.

In all four kinds of time, the basic units of measure are the year, day, hour, minute, and second of time. The duration of any one of these units is not the same for all kinds of time. For example, the sidereal day is approximately 4 minutes shorter than a Standard- or civil-time day.

In the practice of surveying it is customary to say, or write, the time of day as the number

of hours, minutes, and seconds since midnight. Then the recorded time would appear, for example, as:

$$16^{\text{h}} 37^{\text{m}} 52^{\text{s}}.71$$

which is read as "sixteen hours, thirty-seven minutes, and fifty-two point seven one seconds of time."

Units of time measure are sometimes used to designate the sizes of angles. The longitude of a point on the earth's surface is often expressed in this manner. The relationship between the units of time measure and the units of angular measure in the sexagesimal system are as follows:

- 1 hour = 15 degrees ($1^{\text{h}} = 15^{\circ}$)
- 1 minute of time = 15 minutes of arc ($1^{\text{m}} = 15'$)
- 1 second of time = 15 seconds of arc ($1^{\text{s}} = 15''$)
- 1 degree = 4 minutes of time ($1^{\circ} = 4^{\text{m}}$)
- 1 minute of arc = 4 seconds of time ($1' = 4^{\text{s}}$)
- 1 second of arc = 0.0667 second of time ($1'' = 0.0667^{\text{s}}$)

Temperature Measurement

When the existing temperature differs from a standard temperature for certain types of measurement, the measured values will be in error and must be corrected. In each of the several temperature-measurement scales, the unit of measure is called a degree, which varies for the different temperature scales. When the scale extends below zero, values below zero are identified by a minus sign. Temperatures are written, for example, as 23°F or -5°C , the letter designating the particular temperature scale. When writing or talking about temperature, it is always important to indicate the type of scale used, to avoid any doubt. Two of the most commonly used temperature scales are the Centigrade scale and the Fahrenheit scale.

On the Centigrade scale (also known internationally as "Celsius Scale" after Anders Celsius, a Swedish astronomer who first devised it), zero is the freezing point of water, and PLUS 100 is its boiling point. Temperatures on the Centigrade scale are written:

$$18^{\circ}\text{C.}, \text{ or } -21^{\circ}\text{C.}$$

On the Fahrenheit scale, the temperature of the freezing point of water is PLUS 32° , and its boiling point is PLUS 212° .

Now let us examine the comparison of these scales. A Fahrenheit degree represents five-ninths of the change in heat intensity indicated by a degree on the Centigrade scale. Temperatures on either of the two scales can be converted to the other by the following formulas:

$$\begin{aligned} \text{Degrees C} &= 5/9 (\text{degrees F} - 32^{\circ}) \\ \text{Degrees F} &= (9/5 \text{ degrees C}) + 32^{\circ} \end{aligned}$$

Note that, when converting Fahrenheit to Centigrade, the 32° is subtracted first, then multiplied by $5/9$. When converting Centigrade to Fahrenheit, the $9/5$ is computed first, then the 32° is added.

Pressure Measurement

Measurements of atmospheric pressure are used in surveying to determine approximate differences in elevation between points on the earth's surface, and to determine the best approximate correction for the effect of atmospheric refraction. The units of measure for atmospheric pressure, and their relationships are:

- 1 Atmosphere = 29.9212 inches of mercury
- = 760 millimeters of mercury
- = 14.6960 pounds per square inch
- = 1.03323 kilograms per square centimeter
- = 33.899 feet of water
- = 1.01325 bars, or 1013.25 millibars

Dry Measure

Dry measure is a system of measure of volume used in the U.S. for dry commodities, such as grains, fruits, and certain vegetables. The basic unit in dry measure is the bushel. The standard U.S. bushel contains about 77.6 lbs of water. Since there are about 62.4 lbs of water in

a cu ft, it follows that a U.S. bushel has a volume of

$$\frac{77.6}{62.4}, \text{ or about } 1\text{-}1/4 \text{ cu ft.}$$

Units of dry measure are as follows:

- 1 bushel = 4 pecks
- 1 peck = 8 quarts
- 1 quart = 2 pints

Board Measure

Board measure is a method of measuring lumber in which the basic unit is a board foot (bf). A board foot is an abstract volume 1 ft long by 1 ft wide by 1 inch thick. The chief practical use of board measure is in cost calculations; lumber is sold by the board foot just as sugar is sold by the pound.

There are several formulas for calculating the number of board feet in any given length of lumber of given section dimensions. Because lumber dimensions are most frequently given by length in feet and width and thickness in inches, the following formula is probably the most practical:

$$bf = \frac{\text{thickness in in.} \times \text{width in in.} \times \text{length in ft}}{12}$$

Board measure is calculated on the basis of the nominal, not the actual, section dimensions. The actual section dimensions of (for example) 2 x 4 stock, which is surfaced on all four surfaces (S4S), are about 1-5/8 in. thick by 3-5/8 in. wide. Nevertheless, the computation for the number of (for example) 300 linear ft of 2 x 4 stock would be as follows:

$$\frac{1 \quad 2 \quad 100}{2 \times 4 \times 300} = 200 \text{ bf}$$

12
~~6~~
~~8~~
 1

Liquid Measure

In the U.S. the basic unit of liquid measure is the gallon, which has a volume of 231 cu in.,

or 0.13 cu ft. The gallon is subdivided into smaller units as follows:

- 1 gallon = 4 quarts
- 1 quart = 2 pints
- 1 pint = 4 gills

Units larger than the gallon in liquid measure are as follows:

- 1 barrel = 31.5 gallons
- 1 hogshead = 63 gallons or 2 barrels

For petroleum products the standard barrel contains 42 gals.

In the metric system the basic unit of liquid measure is the liter, equal in volume to a cubic decimeter, or about 61 cu in. There are 3.785 liters in a U.S. gallon.

Following the usual metric system of nomenclature, subdivisions and multiples of the liter are as follows:

- 0.000001 liter = 1 microliter
- 0.001 liter = 1 milliliter
- 0.01 liter = 1 centiliter
- 0.1 liter = 1 deciliter
- 10.00 liter = 1 decaliter
- 100.00 liter = 1 hectoliter
- 1,000.00 liter = 1 kiloliter

Electrical Measure

In an electrical circuit there is a flow of electrons, roughly similar to the flow of water in a water pipe. The flow is occasioned by the production, at a generating station, battery, or other source, of an "electromotive force" (E), roughly similar to the "head" of water in a water system. The size of the electromotive force is measured in units called "volts."

The rate of flow of the electrons through the circuit is called the "current", designated by the letter I. Current is measured in units called "amperes."

The usual conductor for transporting a flow of electrons through a circuit is wire. Generally speaking, the smaller the diameter of the wire, the more will be the "resistance" (R) to the flow, and the larger the diameter, the less the

resistance. Resistance is measured in units called "ohms."

The definitions of the units volt, ampere, and ohm are as follows:

- 1 volt = electromotive force required to send a current of 1 ampere through a system in which the resistance measures 1 ohm.
- 1 ampere = rate of flow of electrons in a system in which the electromotive force is 1 volt and the resistance 1 ohm.
- 1 ohm = resistance offered by a system in which the electromotive force is 1 volt and the current 1 ampere.

The ohm is named for Georg Simon Ohm, a German scientist and early electrical pioneer, who discovered that there is a constant relationship between the electromotive force (E), the current (I), and the resistance (R) in any electrical circuit. This relationship is expressed in "Ohm's law" as follows:

$$I = \frac{E}{R}$$

From the basic law it follows that:

$$E = IR$$

$$R = \frac{E}{I}$$

From Ohm's law you can (1) determine any one of the three values when you know the other two, and (2) determine what happens in the circuit when a value is varied.

Suppose, for example, that the resistance (R) is increased, while the electromotive force (E) remains the same. It is obvious that the current (I) must drop proportionately. To avoid a drop in the current, it would be necessary to increase the electromotive force proportionately.

When an electrical circuit is open (that is, when there is a break in the circuit, such as an open switch), there is no flow of electrons through the circuit. When the circuit is closed, however, the current will begin to flow. With a constant electromotive force (E), the rate at which the current (I) flows will depend on the size of the resistance (R). The size of the resistance will increase with the number of

electrical devices (such as lights, motors, and the like) which are placed on the circuit, and the amount of "power" each of these consumes.

Power may be defined as "electrical work per unit of time." James Watt, another early pioneer in the electrical field, discovered that there is a constant relationship between the electromotive force (E), the current (I), and the power consumption (P) in a circuit. This relationship is expressed in the formula $P = IE$, from which it follows that

$$I = \frac{P}{E}, \text{ and } E = \frac{P}{I}$$

P is measured in units called "watts," a watt being defined as the work done in 1 second when 1 ampere flows under an electromotive force of 1 volt.

Suppose, now, that you have a 110-volt circuit in your home. The constant E of this circuit, then, is 110-volts. In the circuit there is probably a 15-ampere "fuse." This is a device which will open the circuit, by "burning out," if the current in the circuit exceeds 15 amperes. The reason for the existence of the fuse is the fact that the wiring in the circuit is designed to stand safely a maximum current of 15 amperes. A current in excess of this amount would cause the wiring to become red-hot, eventually to "burn out," and perhaps to start an electrical fire.

Suppose you light a 60-watt bulb on this circuit. Your E is 110 volts. By the formula

$$I = \frac{P}{E}$$

You know that the current in the circuit with the 60-watt bulb on is

$$\frac{60}{110}$$

or about 0.54 amperes, which is well within the margin of safety of 15 amperes. Dividing 15 amperes by .54 amperes you find that this fuse will protect a 27-lamp circuit.

But suppose now that you place on the same one-lamp circuit an electric toaster taking about 1500 watts (electrical devices are usually marked with the number of watts they consume) and an electrical clothes dryer taking about 1200 watts.

The total P is now 60 + 1500 + 1200, or 2760 watts. The current will now be

$$\frac{2760}{110}$$

or 25 amperes. Theoretically, before it reaches this point, the 15-ampere fuse will burn out and open the circuit.

Mechanical Power Measure

Mechanical power (such as that supplied by a bulldozer) is measured in units called "foot-pounds per second" (ft-lb/sec) or "foot-pounds per minute" (ft-lb/min). A foot-pound is the amount of energy required to raise 1 lb a distance of 1 ft against the force of gravity.

One "horsepower" equals 33,000 ft-lb/sec or 550 ft-lb/min. One watt equals about 44.2 ft-lb/sec. One horsepower equals about 746 watts.

CONVERSION OF UNITS

To convert a measure expressed in terms of one unit to the equivalent in terms of a different unit is, when you know the ratio between the units, a simple proportional equation problem. Suppose, for example, that you want to convert a linear distance in engineer's measure (feet and decimals of feet) to the equivalent in carpenter's measure to the nearest 1/8 in. Suppose that the original distance is 12.65 ft. This means "12 ft and 65 hundredths of a foot." In carpenter's measure the foot is divided into inches, or twelfths of a foot. You want to determine first, then, how many twelfths of a foot there are in 65 hundredths of a foot. The original ratio is 12/100. The proportional equation solution is:

$$\frac{x}{65} = \frac{12}{100}$$

$$x = \frac{12 \times 65}{100} = \frac{780}{100} = 7.8$$

Therefore, there are 7.8 in. in 0.65 ft. The next step is to determine how many eighths of an in. there are in 0.8 in., that is, in 8 tenths of

an in. The initial ratio is 8/10, and the proportional equation solution is:

$$\frac{x}{8} = \frac{8}{10}$$

$$x = \frac{8 \times 8}{10} = \frac{64}{10} = 6.4$$

Therefore, there are (rounded off) 6/8 in., or 3/4 in., in 0.8 in. In 12.65 ft then, there are 12 ft 7-3/4 in. to the nearest 1/8 in.

Actually, the proportional method used above can be simplified by using the following solution:

Convert 12.65' to the nearest 1/8 in carpenter's measure.

$$12.65' = 12' + (0.65 \times 12 = 7.8'')$$

$$= 12' 7.8''$$

$$= 12' 7.0'' + (0.8 \times 8 = 6.4 \text{ eighths})$$

$$= 12' 7.0'' + 6/8'' \text{ or } 3/4'' \text{ to the nearest eighth}$$

$$= 12' 7-3/4''$$

In converting from engineer's to carpenter's linear measure, or vice-versa, surveyors working with values to only the nearest 0.01 ft frequently use the following conversions to decimal equivalents of inches from 1 through 11 and decimal equivalents of the common carpenter's-measure subdivisions of the inch.

- 1 in. = 0.08 ft
- 2 in. = 0.17 ft
- 3 in. = 0.25 ft
- 4 in. = 0.33 ft
- 5 in. = 0.42 ft
- 6 in. = 0.50 ft
- 7 in. = 0.58 ft
- 8 in. = 0.67 ft
- 9 in. = 0.75 ft
- 10 in. = 0.83 ft
- 11 in. = 0.92 ft
- 1/8 in. = 0.01 ft
- 1/4 in. = 0.02 ft
- 1/2 in. = 0.04 ft
- 3/4 in. = 0.06 ft

Chapter 3—MATHEMATICS AND UNITS OF MEASUREMENT

Using these values, you can convert decimals of a foot to inches carpenter's measure, or inches carpenter's measure to decimals of a foot, very easily. To convert (for example) 0.37 ft to inches carpenter's measure you have:

$$0.33 \text{ ft} = 4 \text{ in.}$$

$$\underline{0.04 \text{ ft} = \frac{1}{2} \text{ in.}}$$

$$0.37 \text{ ft} = 4 \frac{1}{2} \text{ in.}$$

To convert (for example) $7\frac{3}{8}$ in. carpenter's measure to engineer's measure you have:

$$\begin{array}{r} 7 \text{ in.} = 0.58 \text{ ft} \\ \frac{3}{8} \text{ in.} = (3 \times 0.01) = 0.03 \text{ ft} \end{array}$$

$$\underline{7\frac{3}{8} \text{ in.} = 0.61 \text{ ft}}$$

For a great many types of conversions there are tables in which you can find the desired values by inspection. Various publications contain tables for making the following conversions:

Meters to feet

Feet to meters

Degrees Centigrade to degrees Fahrenheit

Degrees Fahrenheit to degrees Centigrade

Inches and sixteenths to decimals of a foot

Sixteenths of an inch to decimals of a foot

Minutes to decimals of a degree

Degrees to mils and mils to degrees

Grads to degrees, minutes, and seconds

A conversion factor is a number which, multiplied by a value expressed in terms of one

unit, will produce the equivalent value expressed in terms of a different unit. The factor for converting linear feet to miles, for instance, is 0.00019. If you multiply 5,280 ft by 0.00019, you get 1.0032 miles, which is close enough to a mile to satisfy most practical purposes.

When you know the ratio between two different units, you can easily work out your own conversion factor. For example, you know that the ratio of degrees to mils is

$$\frac{9}{160}$$

The conversion factor for converting degrees to mils is the number of mils in 1 degree, which is

$$\frac{160}{9}, \text{ or } 17.8.$$

The conversion factor for converting mils to degrees is the number of degrees in a mil, which is

$$\frac{9}{160}, \text{ or } 0.0562.$$

Some of the common conversion factors are as follows:

Linear feet	x 0.00019	= miles
Linear yards	x 0.0006	= miles
Square inches	x 0.007	= square feet
Square feet	x 0.111	= square yards
Square yards	x 0.0002067	= acres
Acres	x 4840.0	= square yards
Cubic inches	x 0.00058	= cubic feet
Cubic feet	x 0.03704	= cubic yards

CHAPTER 4

DRAFTING: EQUIPMENT AND SUPPLIES

Drawing is often called the universal language. Drafting is the particular phase of drawing that engineers and designers use to convey and record ideas or information necessary for the construction of structures and machines. There are definite rules of usage to ensure that the same meaning is conveyed at all times, and to enable those who learn the rules to interpret what is presented in a drawing. In contrast to pictorial drawings, such as paintings of landscapes and living things, engineering drawings use a graphical language to describe every integral part of an object. As an Engineering Aid, you will specialize in engineering drawings, whereas the Illustrator Draftsman will specialize in pictorial drawings.

In studying this chapter you will learn that drafting is classified into types, such as technical, illustrative, mechanical, freehand, and engineering drafting. Then you will go on to find that there exist charts, graphs, publications, drafting guidelines, and variety of instruments and materials all of which are designed to help you perform your drafting duties. This chapter also contains many pointers that will help you operate, adjust, and maintain your drafting instruments.

TYPES OF DRAFTING

Generally, drafting is classified according to its purpose or the means by which it is accomplished.

TECHNICAL AND ILLUSTRATIVE DRAFTING

A distinction is often made between technical drafting and illustrative drafting.

TECHNICAL DRAFTING presents technical information in a graphic form; for example, a drawing which shows the type and proper placement of structural members in a building. **ILLUSTRATIVE DRAFTING** presents a pictorial image only; an example is a perspective drawing of a proposed structure. The term **ILLUSTRATIVE DRAFTING** is not commonly used in construction drafting.

MECHANICAL AND FREEHAND DRAFTING

MECHANICAL DRAFTING, as distinguished from freehand drafting, is any drawing in which the pencil or pen is guided by mechanical devices, such as compasses, straightedges, and french curves. In **FREEHAND DRAFTING**, the pencil or pen is guided solely by the hand of the draftsman. Sketches are the result of freehand drafting. With the exception of freehand lettering, most technical drafting is mechanical drafting in this sense of the term.

In a different sense, the term "mechanical" applies to certain types of industrial or engineering drawings, regardless of whether the drawings are done mechanically or freehand. Some authorities confine the term, used in this sense, to the drawing of machinery details and parts. Others confine it to the drawing of plumbing, heating, air-conditioning, and ventilating systems in structures. In the SEABEES, mechanical drawing means the arrangements of machinery, utility systems, heating, air-conditioning, and ventilating systems.

ENGINEERING DRAFTING

As an Engineering Aid, you will be primarily concerned with the following broad types of engineering drafting:

1. Topographic drafting, or drafting done in connection with topographic and civil engineering surveys. It may include drawings not directly related to topographic maps, such as plotted profiles and cross sections.
2. Construction drafting, or drafting of architectural, structural, electrical, and mechanical drawings related to structures.
3. Administrative drafting, or drafting done in support of the administrative functions of your unit, such as technical and display charts or graphs, safety signs, and arrow diagrams for the Network Analysis System (formerly Critical Path Method).

In performing drafting duties, you will be working from sketches, field notes, or direct instructions from your drafting supervisor.

Engineering Charts and Graphs

Graphic presentation of engineering data means using CHARTS and GRAPHS, rather than numerical tables or word descriptions, to present statistical engineering information. Properly constructed, each form of chart or graph offers a sharp, clear, visual statement about a particular aspect or series of related facts. The visual statement either emphasizes the numerical value of the facts or shows the way in which they are related. A chart or graph that emphasizes numerical value is called **QUANTITATIVE**; one that emphasizes relationships is called **QUALITATIVE**. The trend of an activity over a period of time, such as the monetary value of the A & E (Architectural and Engineering) services rendered over a 10-year period, is more easily remembered from the shape of a curve describing the trend than from numerical statistics. Successful graphic presentation of engineering data requires as much drafting ability as the graphic representation of engineering objects. Lines must be sharp, opaque, well contrasted, and of uniform weight. Letters and figures are normally executed with

the standard lettering set in accordance with accepted conventions.

Graphs and charts are classified as Technical or Display charts.

TECHNICAL ENGINEERING CHARTS usually are based on a series of measurements of laboratory experiments or work activities. Such measurements examine the quantitative relationship between a set of two factors or variables. Of the two variables, one has either a controlled or regular variation and is called the independent variable. The other is called the dependent variable, because its values are related to those of the independent variable. The line connecting plotted points is called a curve, although it may be broken, straight, or curved. The curve demonstrates the relationship between the variables and permits reading approximate values between plotted points.

DISPLAY CHARTS are organized primarily to convey data to nontechnical audiences. The message presents a general picture of a situation, usually comparative. There are many varieties of display charts, including bar charts, pictorial charts and training aids. A frequent use of display charts is in Management Information Centers (MIO's). When so used they must conform to minimum standards prescribed by higher authority.

Any construction job involves quantities of men, materials, and equipment. Efficient operation and completion of the job results from planning, organization, and supervision. Graphic presentation of data is important. Statistics based on the results of past jobs with similar working conditions provide a basis for predicting the amount of time that a proposed job will take. These statistics offer the best possibilities for study when presented graphically, usually in the form of a curve. The prediction of expected achievement usually is presented as a bar chart and is called a **TIME-AND-WORK SCHEDULE**. When the scheduled work progress is compared with the actual progress (work in place), the chart is called a **PROGRESS CHART**.

Drafting Guidelines

As stated earlier, there are definite guidelines in drafting. These guidelines provide uniform

interpretation of all engineering drawings. Any drawing prepared by or for the Navy must be prepared in accordance with definitely prescribed standards. Your "bible" for engineering drafting in the SEABEES will be the Military Standards and NAVFAC Design Manuals. For subjects not covered by these references, you might refer to civilian publications, such as the *Architectural Graphic Standard*. Or, you may devise your own symbols, provided that any nonstandard features in your drawing are supported with adequate explanation by notes or by legend.

Many drawings continue in use for years. Therefore, you will have occasion to work with drawings which contain obsolete symbols. Look for a legend on the drawings; it should help you in reading symbols with which you are not familiar. If there is no legend, study the drawing carefully and you should be able to interpret the meaning of unfamiliar symbols and abbreviations.

MILITARY STANDARDS.—Detailed standards are set forth in *Military Standards*, published by the Assistant Secretary of Defense (Supply and Logistics), Office of Standardization. Any Navy activity can obtain copies of these standards by writing to: Naval Publications and Forms Center, 5801 Tabor Avenue, Philadelphia, Pa., 19120. All requests should state the title and identifying number, and should be submitted on DD Form 1425. To ensure that you have the latest edition of a standard, check the *Department of Defense Index of Specifications and Standards*, which is issued 31 July of each year. Also check the supplements to the *Index*.

Current editions of the following Military Standards should be available to the EA:

MIL-STD-12C	Abbreviations for Use on Drawings and in Technical Type Publications
MIL-STD-14A	Architectural Symbols
MIL-STD-15-1A	Graphical Symbols for Electrical and Electronic Diagrams
MIL-STD-15-3	Electrical Wiring Symbols for Architectural and Electrical Layout Drawings (Part 3 of 15-1A)

MIL-STD-17E	Mechanical Symbols
MIL-STD-18A	Structural Symbols
MIL-STD-20	Welding Terms and Definitions
MIL-STD-24A	Revision of Drawings
MIL-STD-100A	Engineering Drawing Practices

In addition, the following civilian industry standards should be on hand in the drafting room:

USA Standard	Dimensioning and Tolerancing for Engineering Drawings
USAS Y14.5-66	
AWS Standard	Welding Symbols
ASW A3.0-61	

NAVFAC GUIDELINES FOR DRAFTSMEN.—Guidelines for Navy technical draftsmen are contained in the NAVFAC Design Manual *Drawings and Specifications*, NAVFAC DM-6. This publication deals with the various types of drawings prepared and provided by NAVFAC. DM-6 explains types of drawings, such as sketches, schematics, renderings, models, construction drawings (also called working drawings), shop drawings, and record drawings. It also explains the drawing requirements, such as style requisites; order of drawings for a structure; drawing formats and sizes; title blocks; scales; line characteristics, conventions, and lettering; dimensioning and tolerancing; drawing notes; numbering of drawings; and drawing revisions.

DM-6 contains a section dealing with the various methods of reproduction of drawings. It includes a table showing the essential features of each of the numerous methods of reproducing drawings, including the advantages and disadvantages of each method. It also explains NAVFAC requirements for survey-based plans and maps, such as layout and grading plans, utilities plans, topographic maps, hydrographic maps, and property plats.

DRAFTING EQUIPMENT AND SUPPLIES

To be a proficient draftsman, you must be familiar with the tools of your trade and the proper techniques of using them. Great care

must be given to the proper choice of drafting equipment and accessories. To have a few good pieces of equipment is much better than to have a large stock of undependable and shoddy equipment.

NMCB STANDARD DRAFTSMAN KIT

To ensure that every NMCB Drafting Section is properly outfitted with adequate drafting equipment and accessories, standard draftsman kits are provided in each NMCB allowance. The drafting equipment and supplies contained in the Draftsman Kit #0011 are listed in the *NMCB TABLE OF ALLOWANCE*. For this reason, no attempt will be made here to list all equipment and supplies currently carried in the standard draftsman kit. One complete NMCB draftsman kit is designed to be used by three draftsmen. Normally two complete draftsman kits will be carried in a battalion allowance, available for check-out to the Drafting Section Supervisor or Engineering Chief. It is the responsibility of each crew leader to make sure that the kits assigned to him are complete. The kits are continuously reviewed and updated in accordance with current battalion requirements.

Most of the consumable items contained in the kit—such as pencils, pencil leads, and ink—are stocked in the battalion Supply Department for kit replenishment. Additional drafting equipment and supplies are also stocked in most battalion drafting rooms to supplement the drafting kits.

To avoid losing any equipment and supplies not included in the draftsman kit, they should not be packed with the kit when the kit is turned into the Supply Department at the end of a deployment.

The following sections will acquaint you with general drafting equipment and supplies, with emphasis being placed on items used by SEABEE draftsmen.

DRAFTING MEDIA

Materials used to draw on are referred to as drafting media. Generally there are three types: paper, cloth, and film. For all practical purposes, you, as a SEABEE draftsman, will use tracing

paper, profile paper, plan/profile paper, and graph paper. Although it is not found in the draftsman kit, illustration board is used for preparing signs and charts. Tracing cloth and film rarely used by SEABEE draftsmen, and hence will not be described here.

DETAIL PAPER (which is usually buff or neutral green in color) takes pencil well, but pencil lines drawn on it are difficult to erase because of the deep impression a pencil makes in the heavy texture of the paper. Because of this and other disadvantages, the use of detail paper for original drawings has largely given way to the use of TRACING PAPER. However, one roll of detail paper is still included in each draftsman kit.

TRACING PAPER (also called TRACING VELLUM) is a high grade white (or slightly tinted) transparent paper which takes pencil well, and from which pencil lines can be easily erased. Also, reproductions can be made directly from pencil drawings on tracing paper, which is not the case with detail paper. However, for better results in reproduction, a pencil drawing on tracing paper is usually inked over.

PROFILE, PLAN/PROFILE, and CROSS SECTION PAPER are referred to as GRIDDED MEDIA. Each type of gridded media is designed for a specific purpose. Most gridded media used by EAs are suitable for reproduction. Grid lines are usually green or orange and will not appear on the reproductions.

PROFILE PAPER is normally available in two grid patterns: 4 x 20 lines (4 lines vertical and 20 lines horizontal) per inch, and 4 x 30 lines per inch with the vertical lines accented every 10th line. Horizontal lines on the 4 x 20 are accented mediumweight every 5th line and heavyweight every 50th line. Horizontal lines on the 4 x 30 have heavyweight accent lines every 25th line. Profile paper is generally used for road design profiles.

PLAN/PROFILE PAPER has rulings and grid accents similar to those of 4 x 20 and 4 x 30 profile paper, except that the grid patterns occupy only the lower half of the paper. The upper half is plain paper, used to draw the plan view in relation to the profile or to add explanatory notes to the profile. Plan/profile paper is also used for road design.

GRAPH PAPER, more commonly referred to as cross section paper, is available in a variety of grid patterns. Generally graph paper used by the EA has a grid scale of 10 x 10 lines per square inch. It is used for drawing road cross sections, rough design sketching, preparing schedules, plotting graphs, and many other uses.

Most drafting media are available in three styles: plain sheets or rolls, preprinted sheets with borders and title blocks, and sheets with nonreproducible grids. For further information on the many varieties of drafting media available, refer to supplier's catalogs, such as those published by Keuffel & Esser Co. or Dietzgen.

ILLUSTRATION BOARD is a drawing paper with a high rag content mounted on cardboard backing. The type normally found in a SEABEE Drafting Section has a smooth white drawing surface which takes ink readily. Normally the board is 30" x 40" and comes in 50-sheet packages. Illustration board is used by the EA for signs, large unmounted charts, and mounting maps, photos, and drawings that require a strong backing. A thinner board, called BRISTOL BOARD, is also used for making small signs and charts. The thickness of bristol board is about the same thickness as an ordinary index card. Unlike illustration board, bristol board has two white, smooth sides which take ink very well. Bristol board is less expensive than illustration board and is easily cut to size with a paper trimmer. It is available in many sizes; the most popular size is 20" x 30" in 50 or 100 sheet packages.

DRAWING PENCILS

There are two types of drawing pencils—wooden and mechanical. The latter is actually a lead holder and may be used with leads of different hardness.

Drawing pencils are graded according to the relative softness or hardness of the lead. A pencil in the category considered soft is designated by the letter B; one in the hard category is designated by the letter H. In the soft or B category the numerals from 6B down to B indicate descending order of softness (that is, 6B is the softest pencil, B not so soft). In the H or hard category, the numbers from 2 through 9

indicate increasing order of hardness (that is, 9H is the hardest pencil available). Pencils located in the middle, as it were, are B, HB, F, and H.

To sum up: There are 17 common grades of drawing pencil, in order from softest to hardest as follows: 6B, 5B, 4B, 3B, 2B, B, HB, F, H, 2H, 3H, 4H, 5H, 6H, 7H, 8H, and 9H.

Selection of drawing pencils will be covered in chapter 5.

ERASERS AND ERASING ACCESSORIES

You must be very careful in selecting an eraser which will remove pencil or ink lines without damaging the surface of the drawing sheet.

A vinyl eraser is designed for erasing lines drawn on tracing cloth. An ordinary double-beveled pencil eraser generally comes in red or in pink color (sometimes called a PINK PEARL). A harder eraser (sometimes called a RUBY RED) is designed for erasing lines in ink. The ART GUM eraser, made of soft pliable gum, will not mar or scratch. It is ideally suited for removing pencil or finger marks and smudges.

You can also use a kneaded eraser, the type used by artists. It is a rubber dough, kneadable in your hand, and has the advantage of leaving very little refuse on the drawing sheet.

The so-called STEEL ERASER shown in figure 4-1 is, of course, actually a scraper. It is used principally for scraping off erroneous ink lines, especially from tracing cloth. The figure shows a short-bladed steel eraser; long-bladed steel erasers are also available. A steel eraser is not generally recommended for use by beginners because it has a tendency to damage the surface of the drawing sheet.

Figure 4-2 shows an ELECTRIC ERASER. The control switch is directly under the finger tip; the body of the machine fits comfortably in the palm of the hand, and the rotating eraser can



Figure 4-1.—Steel eraser.

45.673

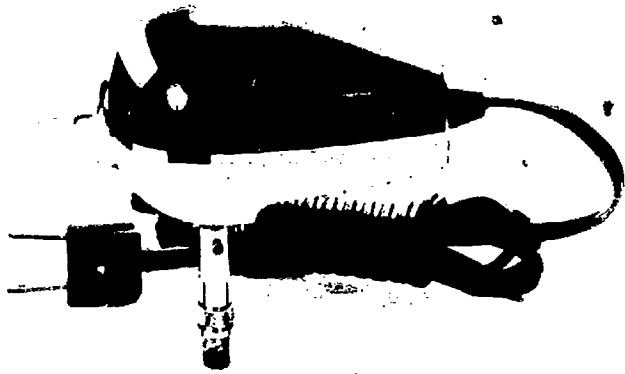

Figure 4-2.—Electric eraser.

45.674

Finely pulverized gum eraser particles are available in squeeze-bottles or in DRY-CLEAN PADS for keeping a drawing clean while you work on it. If a drawing or tracing is sprinkled occasionally with gum eraser particles, triangles, T-squares, scales, french curves and the like not only tend to stay clean themselves, but also tend to clean the drawing or tracing as they are moved over the surface.

Before a drawing is inked, it is usually prepared by sprinkling on POUNCE (a very fine bone-dust) and then rubbing in the pounce with a felt pad on the container. Pounce helps to prevent a freshly inked line from spreading. A draftsman's DUST BRUSH should be used for brushing dust and erasure particles off a drawing.

be directed as accurately as a pencil point. Refills for either ink or pencil-erasing are available. CAUTION: Do not hold steady in one spot as it is easy to wear a hole or damage the surface of material being erased.

DRAWING BOARD

When there are many lines close together and only one needs to be removed or changed, the desired lines may be protected by using an erasing shield, as shown in figure 4-3.

The drawing boards contained in the draftsman kit are constructed of joined strips of softwood, usually clear white pine or basswood. You should consider only the left-hand vertical edge as a working edge for the T-square if you are right handed (the right-hand edge if you are left handed). The T-square should never be used with head set against the upper or lower edge of the board, as the board may not be perfectly square.

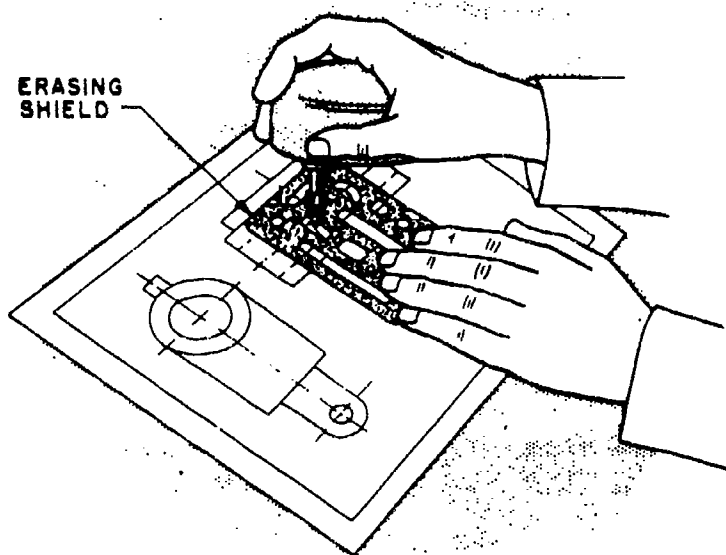

Drawing boards in the draftsman kit are equipped with hinged attachments for securing the board to a table or fabricated base. If suitable tables are not available, table bases must be made in the battalion carpenter shop. The height of the table should be such that if you desire to work in a standing position, you can do so without stooping or holding your arms in a raised position. Hinged attachments for the drawing board are provided to adjust the incline so that your line of sight will be approximately perpendicular to the drawing surface.

T-SQUARES

The T-square gets its name from its shape. It consist of a long, straight strip, called the blade, which is mounted at right angles on a short strip, called the head. The head is mounted under the blade so that it will fit against the edge of the

Figure 4-3.—Use of erasing shield.

29.273(45B)

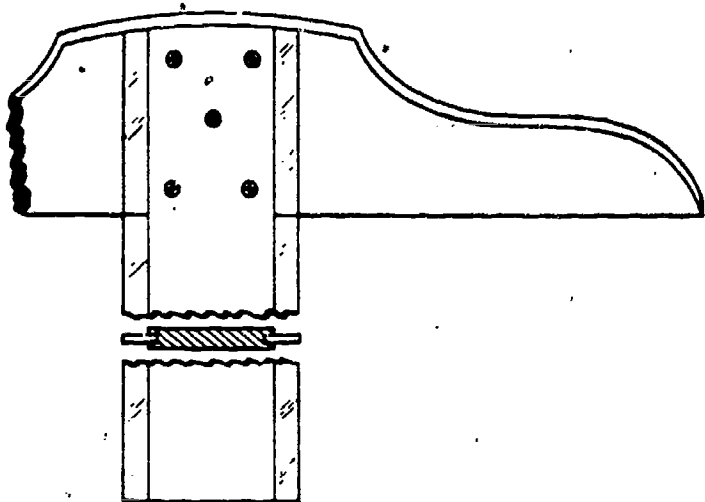

Figure 4-4.—T-square.

45.829

drawing board while the blade rests on the surface. T-squares vary in size, ranging from 15 inches to 72 inches in length, with the 36-inch length being the most common.

The T-square shown in figure 4-4 is typical of the ones used by an EA. The head is made of

hardwood and the blade usually of maple with a natural or mahogany finish. The edges of the blade are normally transparent plastic strips glued into grooves on both edges of the blade, as shown in the cross section in figure 4-4. This allows the edge of the T-square to ride above the drawing as the blade is moved up and down the board. This arrangement is a great advantage when you are drawing with ink. Since the tip of the ruling pen does not come in contact with the blade, but is below it, ink cannot be drawn under the blade to blot the drawing.

The T-square is used for drawing horizontal lines only. Always draw lines along the upper edge of the blade. The T-square also serves as a base for the triangle when vertical and inclined lines are drawn.

Some T-squares are designed with adjustable heads to allow angular adjustments of the blade.

Handle your T-square carefully. If dropped, it may be knocked out of true and become useless. Additionally, to prevent warping, hang the T-square by the hole in the end of the blade or lay it on a flat surface so that the blade rests flat.

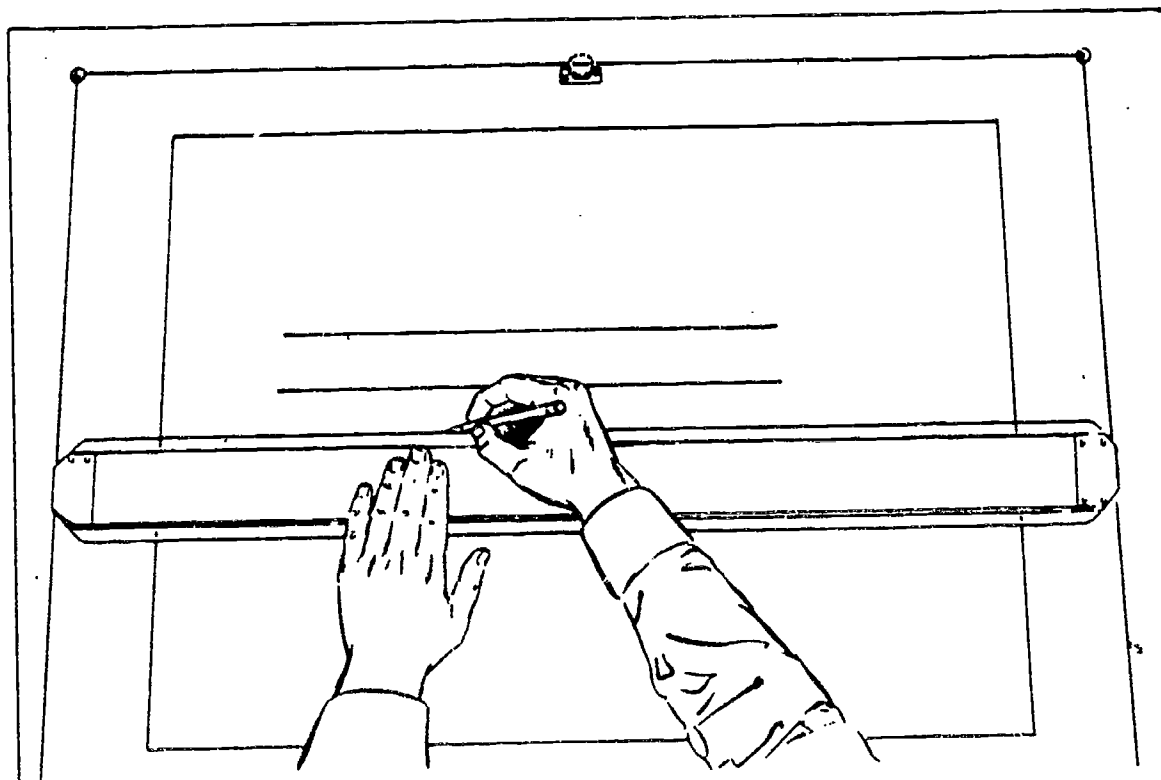

Figure 4-5.—Parallel straightedge.

29.275JX

Before beginning a new job, you should test the top edge of your T-square for warp or nicks, by drawing a sharp line along the top of the blade. Turn the T-square over and redraw the line with the same edge. If the blade is warped, the lines will not coincide.

If the blade swings when the head is held firmly against the edge of the drawing board, the blade may be loose where it is joined to the head, or the edge of the T-square head may be warped. You can usually tighten a loose blade by adjusting the screws which connect it to the head, but if it is out of square, warped, or in bad condition, you should select a new T-square.

PARALLEL STRAIGHTEDGE

Many draftsmen prefer to use a parallel straightedge (fig. 4-5) rather than a T-square. The primary purpose of the parallel straightedge is the same as the T-square.

The parallel straightedge is a laminated maple blade, with transparent plastic edges similar to those on the T-square. The parallel straightedge utilizes a system of cords and pulleys so that it is supported at both ends by a cord tacked to the drawing board. You can move the straightedge up or down the board with pressure at any point along its length, and maintain parallel motion automatically. It comes complete with cord, tacks, cord tension adjuster, and mounting instructions. Some straightedges, like the one shown in figure 4-5, are equipped with a cord lock on one end of the blade. The straightedge is locked into place by turning the cord lock clockwise. This permits use of the straightedge on an inclined board. It also prevents accidental movement when inking or using mechanical lettering devices. The advantages of the parallel straightedge become particularly significant when you are working on large drawings. While the T-square works well for small work, it becomes unwieldy and inaccurate when you are working on the far right-hand side of large drawings.

STEEL STRAIGHTEDGE

When you are drawing long straight lines, a steel straightedge (fig. 4-6) should be used, because its heavy weight helps keep the



45.677X

Figure 4-6.—Steel straightedge.

straightedge exactly in position. The steel straightedge is also excellent for trimming blueprints and cutting heavy illustration board.

Steel straightedges are usually made of stainless steel and are available in lengths of 15 inches up to 72 inches. The one included in the draftsman kit is 42 inches long. Some have a beveled edge like the one shown in figure 4-6.

LIGHTING

Since you will be constantly using your eyes, it is important that your working area be well lighted. Natural light is best, if available and ample, although in the majority of cases acceptable natural light will be the exception rather than the rule. Drafting rooms are usually lighted with overhead fluorescent fixtures. Ordinarily, these fixtures are inadequate in quality and intensity of light. Adjustable lamps will improve the lighting conditions. The most popular type of adjustable lamp is the floating-arm fluorescent fixture which clamps onto the drafting table. Arrange your lighting to come from the front-left, if you are right handed; from the front-right if you are left handed. This minimizes shadows cast by drawing instruments and your hands.

Never place your drafting board so that you will be subjected to the glare of direct sunlight. North windows are best for admitting daylight in the northern hemisphere. Conservation of vision is of the utmost importance. You must make every possible effort to eliminate eyestrain.

TRIANGLES

Triangles are used in combination with the T-square or straightedge to draw vertical and inclined lines. They are usually made of transparent plastic which allows you to see your work underneath the triangle.

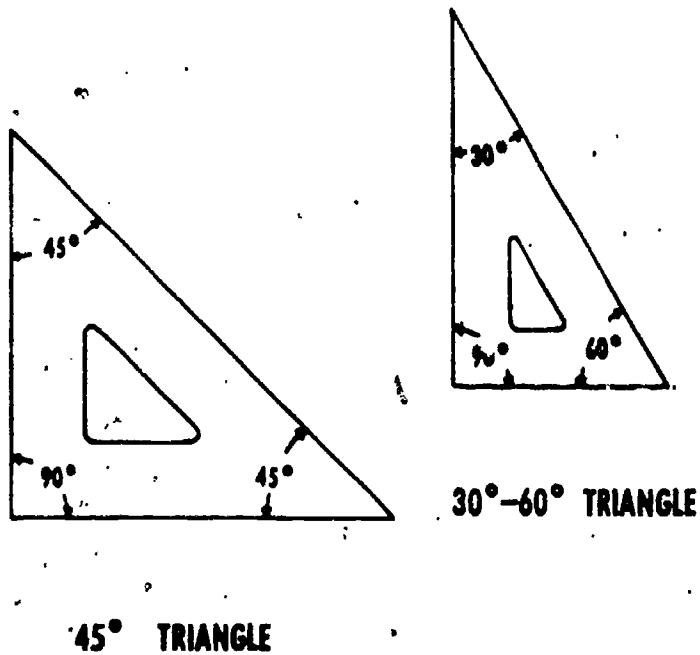

45° TRIANGLE

30°-60° TRIANGLE

29.277

Figure 4-7.—45 degree and 30-60 degree drafting triangles.

Triangles are referred to by the size of their acute angles. Figure 4-7 shows two basic drafting triangles: the 45 degree (each acute angle measures 45°), and the 30-60 degree (one acute angle measures 30°, the other 60°). The size of a 45° triangle is designated by the length of the sides that form the right angle (both sides are

equal). The size of a 30°-60° triangle is designated by the length of the longest side which forms the right angle. Sizes of both types of triangles range from 4 inches through 18 inches, in 2-inch increments.

Like all other drafting equipment, triangles must be kept in good condition. If plastic triangles are dropped, their tips may be damaged. Also, triangles may warp so that they do not lie flat on the drawing surface, or the edge may deviate from true straightness. To prevent warping, or chipping, you should always lay them flat or hang them up when they are not in use. Since there is seldom enough drawer space available to permit laying triangles flat, it is best to develop the habit of hanging them up. If the tips are bent, use a sharp knife to cut off the damaged part. If the triangle warps, you may be able to bend it back by hand. If this does not straighten it, leave the triangle lying on a flat surface with weights on it or hold the triangle to the opposite curvature with weights. If the triangle becomes permanently warped, so that the drawing edges are curved or the angles are no longer true, throw it away and get another.

PROTRACTORS

Protractors are used for measuring and laying off angles other than those which may be drawn with the triangle or a combination of

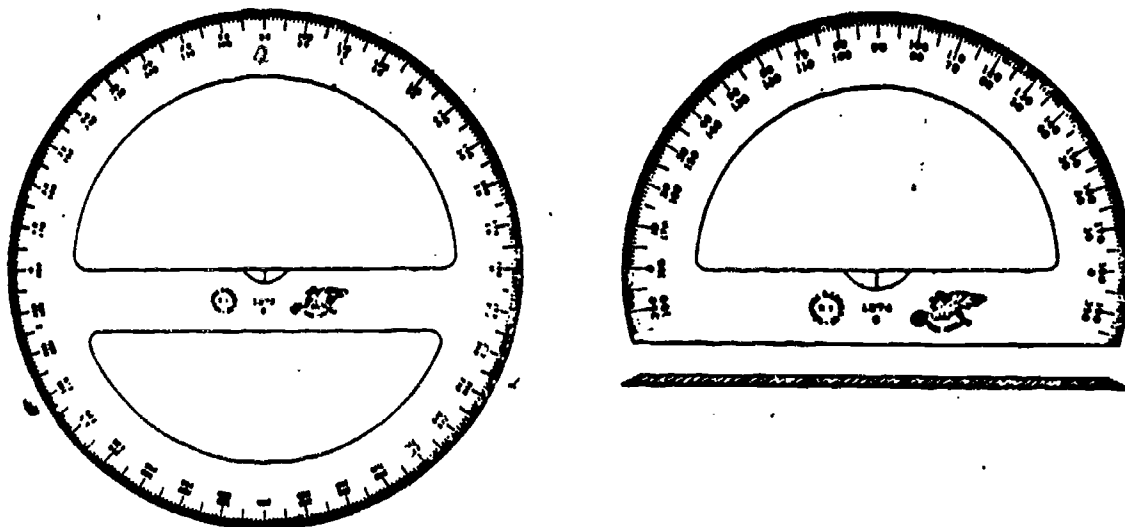
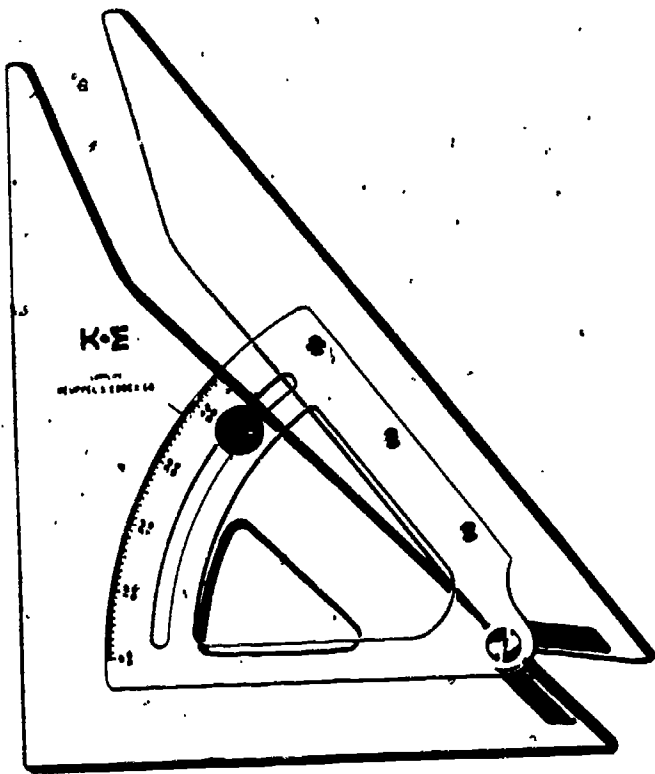

Figure 4-8.—Types of protractors.

45.126



142.318X

Figure 4-9.—Adjustable triangle.

triangles. Most of the work you will do involving the use of the protractor will involve plotting information obtained from field surveys.

Like the triangle, most protractors are made of transparent plastic. They are available in 6, 8, and 10 inch sizes and either circular or semicircular in shape as shown in figure 4-8. Protractors used by the EA, are usually graduated in increments of $1/2^\circ$. By careful estimation, angles of $1/4^\circ$ may be obtained. Protractor numbering arrangement varies. Semicircular protractors are generally labeled from 0° to 180° in both directions. Circular protractors may be labeled from 0° to 360° (both clockwise and counterclockwise), or they may be labeled from 0° to 90° in four quadrants.

Protractors should be stowed and cared for in the same manner as triangles.

ADJUSTABLE TRIANGLE

The adjustable triangle, shown in figure 4-9, combines the functions of the triangle and the

protractor. As a right triangle the hypotenuse can be set and locked at any desired angle to one of the bases. The transparent protractor portion is equivalent to a protractor graduated in $1/2^\circ$ increments. The upper row of numbers indicates angles from 0° to 45° to the longer base; the lower row indicates angles from 45° to 90° to the shorter base. By holding either base against a T-square or straightedge, any angle between 0° and 90° may be measured or drawn.

The adjustable triangle is especially helpful in drawing building roof pitches. It also allows you to transfer parallel inclined lines by sliding the base along the T-square or straightedge.

FRENCH CURVES

Irregular curves (called french curves) are used for drawing smooth curved lines which are not arcs of circles, such as ellipses, parabolas, and spirals. Transparent plastic french curves come in a variety of shapes and sizes. Figure

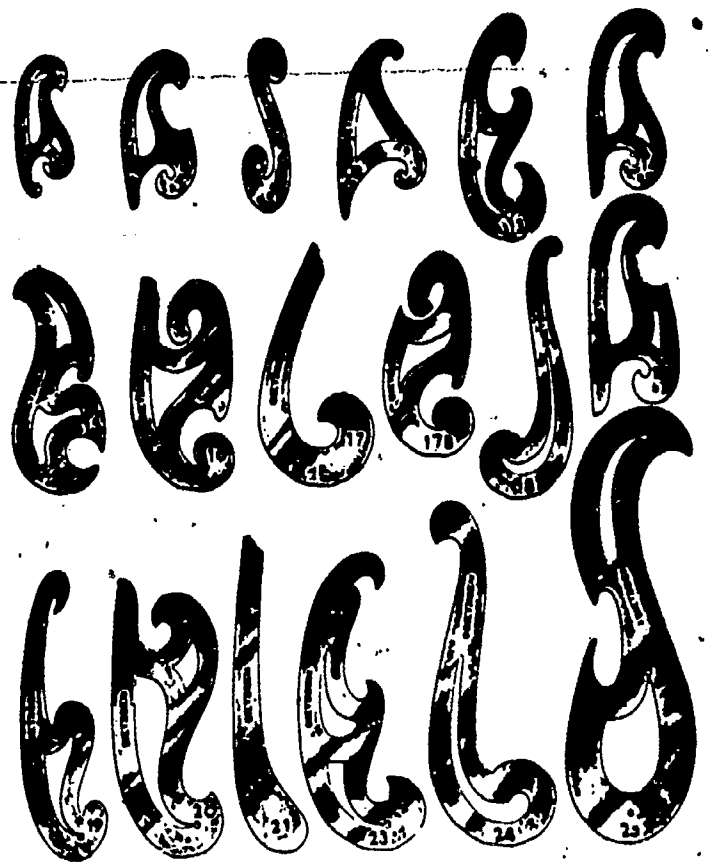

45.127X

Figure 4-10.—French curves.

4-10 shows an assortment of french curves. In such an assortment you can find edge segments which can be fitted to any curved line that you need to draw.

French curves are cared for and stowed in the same manner as triangles.

DRAWING INSTRUMENT SET

So far we have discussed only those instruments and materials which you will need for drawing straight lines (with the exception of french curves). Many drawings that you will

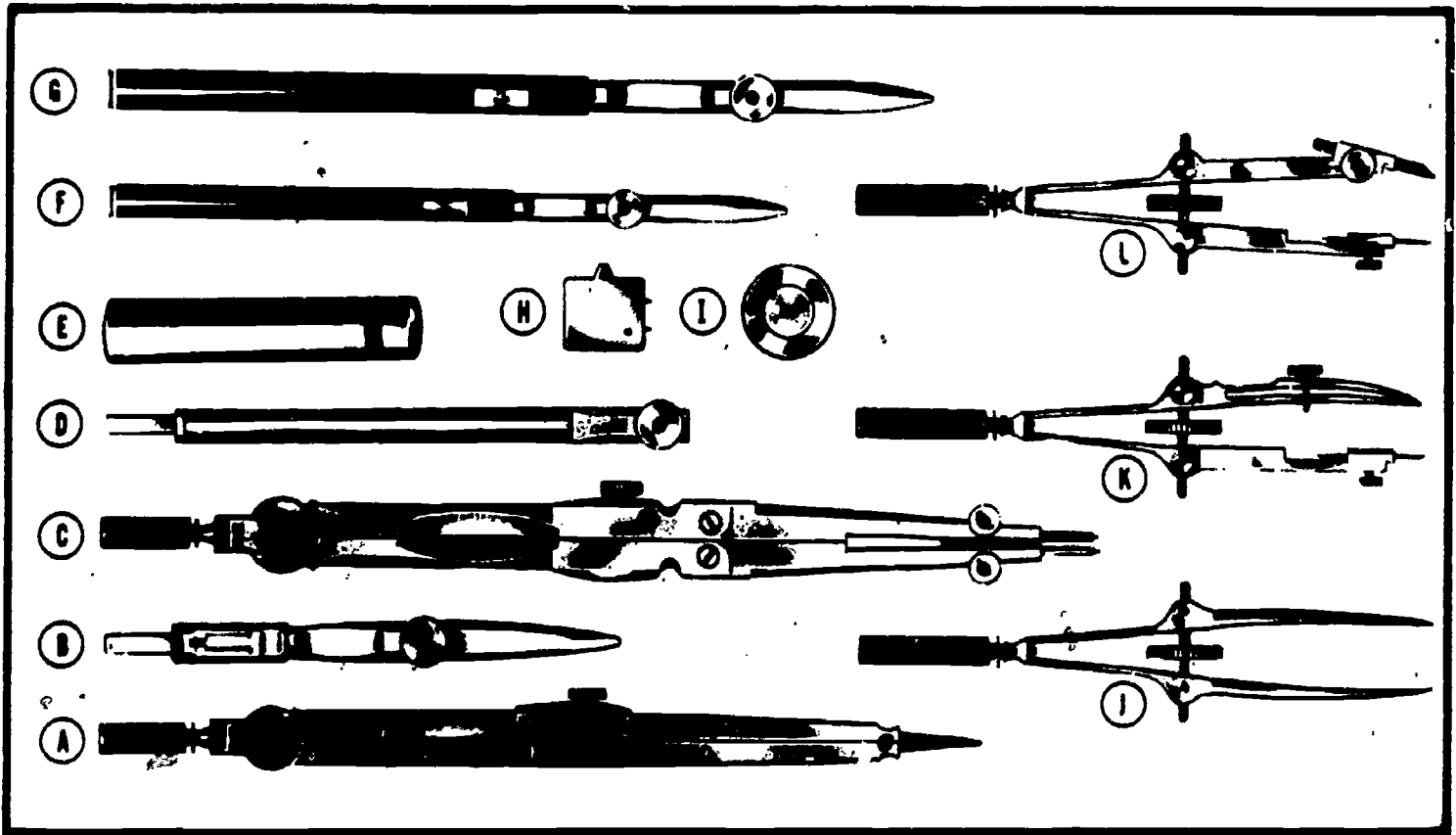

INSTRUMENT SET CONTENTS

- | | |
|--|--|
| (A) HAIRSPRING DIVIDERS, 6" | (H) KEY-SCREWDRIVER COMBINATION |
| (B) COMPASS PEN ATTACHMENT | (I) HORN CENTER, 1/2" DIAMETER |
| (C) FRICTION HEAD PIVOT JOINT COMPASS, 6 1/2" | (J) CENTRAL THUMBSCREW BOW DIVIDERS, 3 3/4" |
| (D) COMPASS EXTENSION BAR | (K) CENTRAL THUMBSCREW BOW PEN, 3 3/4" |
| (E) CONTAINER W/PENCIL LEADS | (L) CENTRAL THUMBSCREW BOW PENCIL, 3 3/4" |
| (F) RULING PEN, 4 1/2" | |
| (G) RULING PEN, 5 1/2" | |

Figure 4-11.—Typical drawing instrument set.

prepare will require circles and circular arcs. For this purpose, instruments contained in a drawing instrument set are used. Many types of drawing instrument sets are available; however, it is sometimes difficult to judge the quality of drafting instruments by appearance alone. Often their characteristics become evident only after they are used.

The drawing instrument set shown in figure 4-11 is typical of those sets found in the standard draftsman kit. The following sections describe these instruments. Some special purpose instruments will also be described which are not found in the set. They may be purchased separately or found in other instrument sets.

Compasses

Circles and circular curves of relatively short radius are drawn with compasses. The large **PIVOT JOINT COMPASS** (fig. 4-11C) is satisfactory for drawing circles of 1 inch to about 12 inches in diameter, without an extension bar. The pivot joint provides enough friction to hold the legs of the compass in a set position. One of the legs is equipped with a setscrew for mounting either a pen (fig. 4-11B) or a pencil attachment on the compass. There is also an extension bar (fig. 4-11D) which can be inserted to increase the radius of the circle drawn.

The other type of compass found in the drawing instrument set is the **BOW COMPASS** (fig. 4-11K and 4-11L). Many experienced draftsmen prefer the bow compass over the pivot joint compass. The bow compass is much sturdier and is capable of taking the heavy pressure necessary to produce opaque pencil lines without losing the radius setting.

There are two types of bow compasses. The location of the adjustment screw determines the type. The bow pen (fig. 4-11K) and bow pencil (fig. 4-11L) are the center adjustment type, whereas the bow instruments shown in figure 4-12 are the side adjustment type. Each type comes in two sizes, large and small. Large bow compasses are usually of the center adjustment type, although the side adjustment type is available. The large bow compasses are usually about 6 inches long; the small, approximately 4 inches long. Extension bars are available for

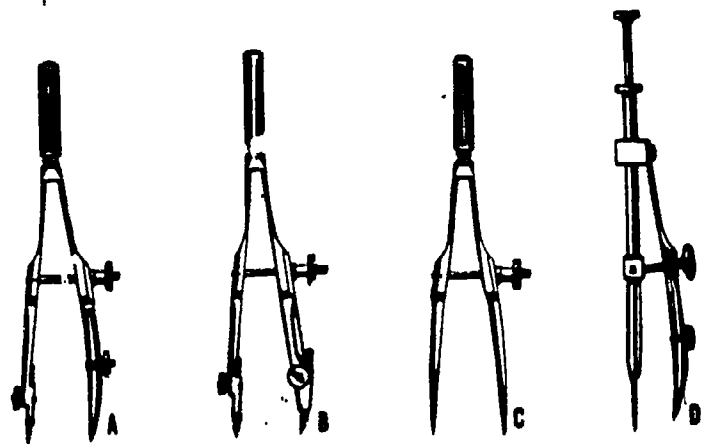

45.133

Figure 4-12.—Bow instruments: (A) bow pen; (B) bow pencil; (C) bow dividers; (D) drop bow pen.

large bow compasses. Bow compasses are available as separate instruments, as shown in figures 4-11 and 4-12, or as combination instruments with pen and pencil attachments.

Most compasses have interchangeable needlepoints. The conical or plain needlepoint is used when the compass is employed as dividers. The shoulder-end needlepoint is used with pen or pencil attachments.

When many circles are drawn using the same center, the compass needle may tend to bore an oversized hole in the drawing. To prevent these holes, a device called a **HORN CENTER** or center disk (fig. 4-11I) is used. This disk is placed over the center point. The compass needle point is then placed into the hole in its center.

Dividers

Dividers are similar to compasses, except that both legs are provided with needlepoints. The instrument set (fig. 4-11) contains two different types and sizes of dividers; a large 6-inch hairspring dividers (fig. 4-11A), and a small center adjustment bow dividers (fig. 4-11J). The large pivot joint compass (fig. 4-11C) may also be used as dividers. As with compasses, dividers are available in large and small sizes, and in pivot joint, center adjustment bow, and side adjustment bow types. Figure

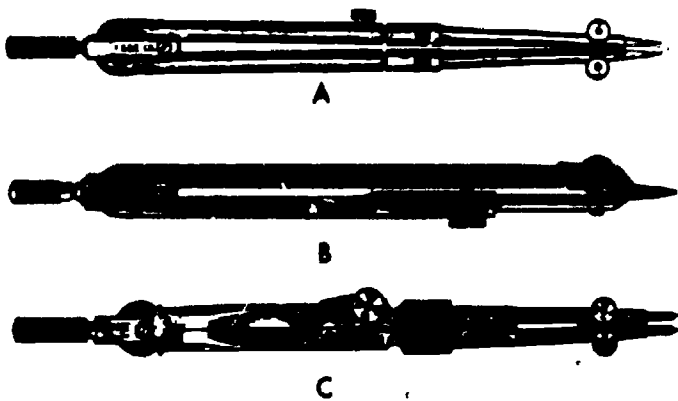

45.158(1 & 2)DX

Figure 4-13.—Shapes of compasses and dividers:
(A) round, (B) flat, (C) bevel.

4-12C shows a small side adjustment bow dividers. Pivot joint dividers are used for measurements of approximately 1 inch or more. For measurements of less than 1 inch, bow dividers should be used. Dividers are used to transfer measurements, to step off a series of equal distances, and to divide lines into a number of equal parts.

Maintaining Compasses and Dividers

Figure 4-13 shows the three shapes in which compasses and dividers are made: round, flat, and bevel. Figure 4-14 shows two types of pivot joints commonly found on compasses and dividers. When you select compasses and dividers, test them for alignment by bending the joints and bringing the points together. New instruments are factory adjusted for correct friction setting. They rarely require adjustment. A small jeweler's screwdriver or the screwdriver found in some instrument sets (fig. 4-11H) is used for adjusting most pivot joint instruments. Instruments which require a special tool should be adjusted by skilled instrument repairmen.

Pivot joint compasses and dividers should be adjusted so that they may be set without undue friction. They should not be so rigid that their manipulation is difficult, nor so loose that they will not retain their setting.

Divider points should be straight and free from burrs. When the dividers are not in use, the points may be protected by sticking them into a small piece of soft rubber eraser or cork. When points become dull or minutely uneven in length, make them even by holding the dividers vertically, placing the legs together, and grinding them lightly back and forth against a whetstone. (See fig. 4-15A.) Then hold the dividers horizontally and sharpen each point by whetting the outside of it back and forth on the stone, while rolling it from side to side with your fingers. (See fig. 4-15B.) The inside of the leg should remain flat and should not be ground on the stone. The outside of the point should not be ground so that a flat surface results. In shaping the point, be careful to avoid shortening the leg.

Needles on compasses and dividers should be kept sharpened to a fine taper. When they are

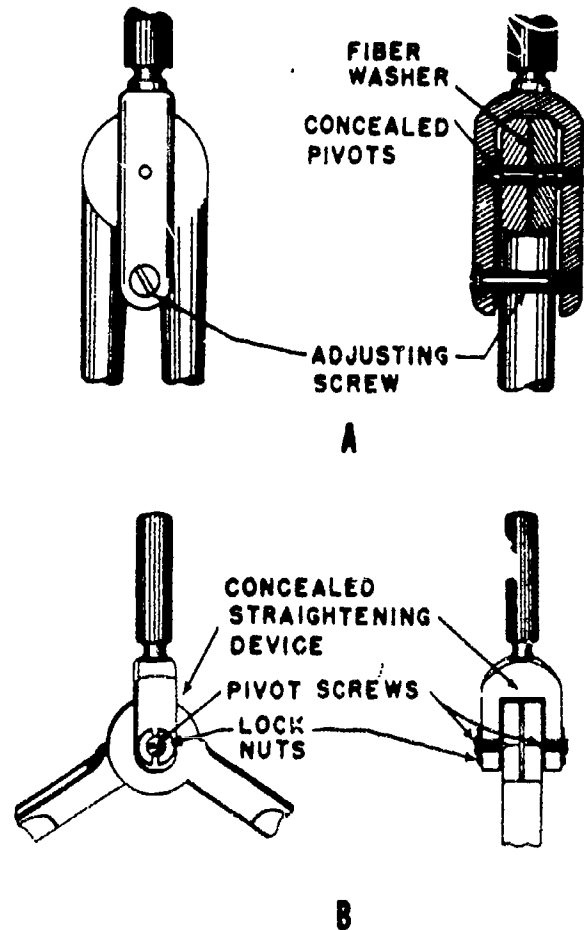

142.34X

Figure 4-14.—Types of pivot joints.

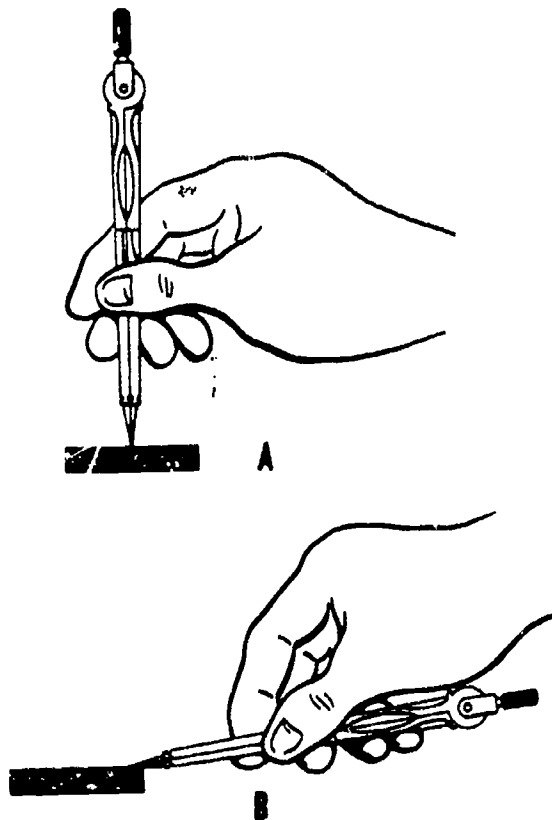

45.132E
Figure 4-15.—(A) Evening legs of dividers;
(B) sharpening divider needlepoints.

pushed into the drawing, they should leave a small, round hole in the paper no larger than a pinhole. Since the same center is often used for both the compasses and dividers, it is best that needles on both be the same size. If the compass needle is noticeably larger, grind it until it is the correct size.

To make a compass needle smaller, wet one side of the whetstone and place the needle with its shoulder against this edge. Then grind it against the whetstone, twirling it between your thumb and forefinger. (See fig. 4-16.) Test it for size by inserting it in a hole made by another needle of the correct size. When it is pushed as far as the shoulder, it should not enlarge the hole.

The screw threads on bow instruments are delicate. Because of this, care should be taken never to force the adjusting nut. Threads must be kept free from rust or dirt.

If possible, it is best to keep drawing instruments in a case, since the case protects them from falls or unnecessary pressures. Then, too, the lining of the case is usually treated with a chemical which helps prevent the instruments from tarnishing or corroding.

To protect instruments from rusting when they are not in use, clean them frequently with a soft cloth and apply a light film of oil to their surface with a rag. Joints on compasses and dividers should not be oiled. When the surface finish of instruments becomes worn or scarred, it is subject to corrosion; therefore, a knife edge or an abrasive should never be used to clean drafting instruments.

Drop Bow Pen

The drop bow pen (fig. 4-12D) is not one of the standard instruments. However, for some jobs it is essential. It is used to ink small circles with diameters of less than a quarter of an inch. As the name indicates, the pen assembly is free to move up and down and to rotate around the main shaft. When using this instrument, hold the pen in the raised position, adjust the setscrew to give the desired radius, and then gently lower the pen to the paper surface and draw the circle by rotating the pen around the shaft.

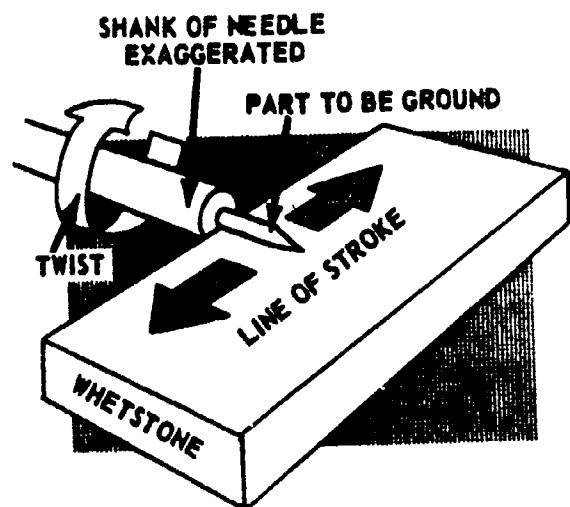

142.35
Figure 4-16.—Shaping a compass needle.

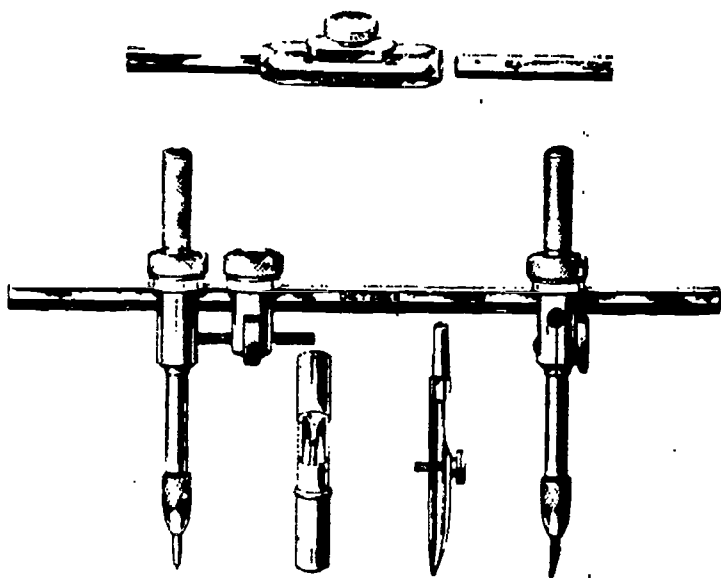

45.134X

Figure 4-17.—Beam compass.

Beam Compass

The beam compass (fig. 4-17) is used for drawing circles with radii larger than can be set on a pivot joint or bow compass. Both the needlepoint attachment and the pen or pencil attachment on a beam compass are slide-mounted on a metal bar called a beam. The slide-mounted attachments can be locked in any desired position on the beam. Thus, a beam compass can be used to draw circles of any radii up to the length of the beam. With one or more beam extensions, the length of the radius of a beam compass ranges from about 18 inches to 70 inches.

Ruling Pens

The ruling pen (fig. 4-11F and 4-11G) is used for inking lines of uniform width with the T-square, triangles, or other straightedges. It consists of two steel blades, called NIBS, attached to a handle. The nibs are of equal length, narrowed at their tips. (See fig. 4-18.) A setscrew is used for adjusting the distance between the nibs at the tip to correspond to the width of line desired. Tightening the screw brings the nibs closer together so that the pen makes a thinner line.

The standard ruling pen (fig. 4-18A) has an adjustable spring blade, limber enough to permit opening it wide to clean the inside of the nibs. Another type (fig. 4-18B) has a hinged blade, which allows the pen to be opened, cleaned and snapped carefully back in place with the nibs remaining set at the desired width. This is convenient if you have to do a long piece of work which requires many lines of the same width.

There are several useful variations of the standard spring-type ruling pen (See fig. 4-19). The detail pen is similar to the standard pen except that the blades are wider and have a greater ink capacity. The detail pen can be used for very heavy ink lines as well as for light lines. The contour pen has blades attached to a shaft which rotates inside the hollow handle, and it is

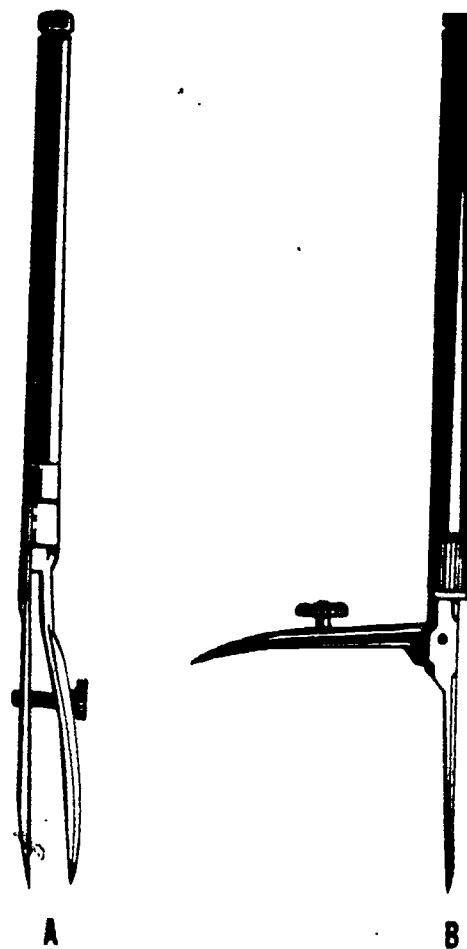

45.116

Figure 4-18.—Ruling pens: (A) standard spring type; (B) hinged-blade type.

reflects the light is an indication of a worn or dull nib (see fig. 4-20A).

Nibs must also be correctly shaped, as shown in figure 4-20B. If the nibs are missnappen as in figure 4-20C and 4-20E, the ink will hang above the tips and be difficult or impossible to start flowing. If they are too rounded, as shown in figure 4-20D, the ink will flow much too freely, probably causing blots.

If the nibs are of unequal length, you begin the sharpening job by grinding them equal on a fine whetstone, in the same way that you equalize the legs of a pair of dividers. You then shape the nibs correctly (See fig. 4-20B.) Finally, you sharpen each nib by grinding it, on the back only, with a rocking motion.

After you have sharpened a ruling pen, you will probably find a burr on the edges of the nibs. If you have sharpened the pen correctly by grinding each nib on the back only, the burr will be on the inner faces of the nibs. To remove it, rub the inner face of each nib on fine emery paper. Never grind the inner face of a nib. If you do this, you will eventually grind a curve, causing the defect shown in figure 4-20E.

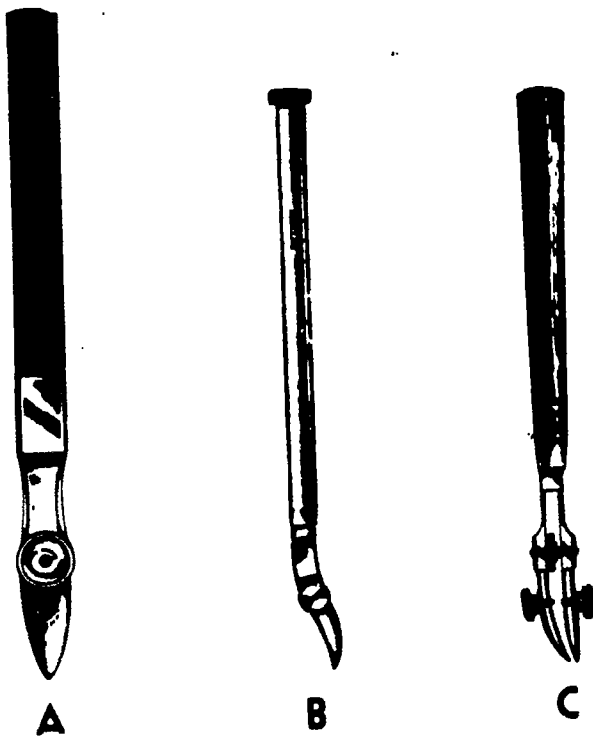

45.117X

Figure 4-19.—Special varieties of the ruling pen: (A) detail pen; (B) contour pen; (C) railroad pen.

particularly useful for drawing sharp, precise curves. Unlike other ruling pens, the contour pen is intended for freehand use rather than with a straightedge. The railroad pen has two sets of blades which can be set to draw parallel lines of equal width or of different widths.

The bow pen and the pen attachment for the compass (previously described) are also variations of the standard spring-type ruling pen.

Shaping and Sharpening A Ruling Pen

The nibs of a ruling pen must be exactly equal in length. If one nib is longer than the other, the ink will not flow unless you bear down harder than you should, and when you do this the longer nib will scratch the paper and the line drawn will be imperfect.

The nibs must also be sharp. If they are dull, once again, the ink will not flow without excessive pressure, and when it does the line will appear ragged. A bright spot on a nib which

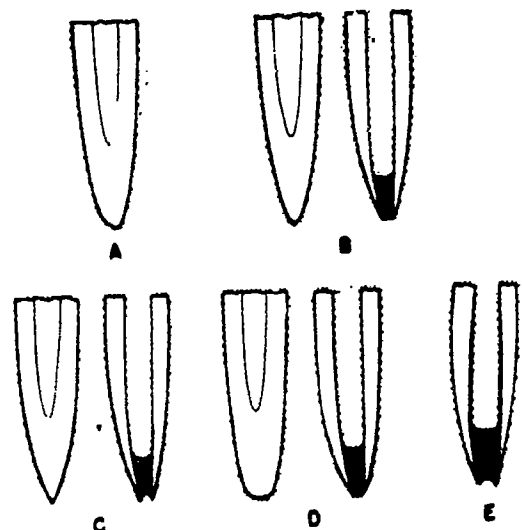

45.142

Figure 4-20.—Shapes of ruling pen nibs: (A) worn; (B) correct; (C) too pointed; (D) too rounded; (E) too curved.

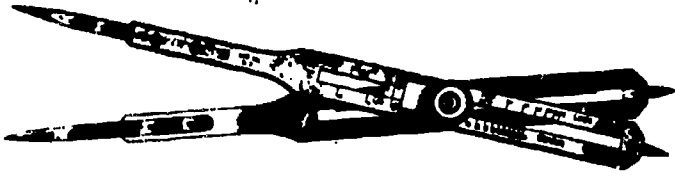

45.132(142)BX

Figure 4-21.—Proportional dividers.

PROPORTIONAL DIVIDERS

Proportional dividers (fig. 4-21) are used for transferring measurements from one scale to another. This capability is necessary when drawings are to be made to a larger or smaller scale. They can also be used to divide lines or circles into equal parts.

Proportional dividers consist of two legs, of equal length, pointed at each end, and held together by a movable pivot. By varying the position of the pivot, the lengths of the legs on opposite sides of the pivot are adjusted so that the ratio between them is equal to the ratio between two scales. Therefore, a distance spanned by the points of one set of legs has the same relation to the distance spanned by the points of the other set as one scale has to the other.

On the proportional dividers shown in figure 4-21, a thumb nut moves the pivot in a rack-and-gear arrangement. When the desired setting is reached, a thumb-nut clamp on the opposite side of the instrument locks the pivot in place. A scale and vernier are provided on one leg to facilitate accurate setting. On less expensive models, the movable pivot is not on a rack-and-gear and there is no vernier. The dividers may be set by reference to the table of settings which is furnished with each pair; they will accommodate varying ranges of scales from 1:1 up to 1:10. However, it is better not to depend entirely on the table of settings. You can check the adjustment by drawing lines representing the desired proportionate lengths, and then applying the points of the instrument to them in turn until, by trial and error, the correct adjustment is reached.

To divide a line into equal parts, set the divider to a ratio of 1 to the number of parts desired on the scale marked "lines." For

instance, to divide a line into 3 parts, set at 3 on the scale. Measure off the length with the points of the longer end. The span of the points at the opposite ends will be equal to $1/3$ the measured length. To use proportional dividers to transfer measurements from feet to meters, draw a line 1 unit long and another line 3.28 units long and set the dividers by trial and error accordingly.

Some proportional dividers have an extra scale for use in getting circular proportions. The scale marked "circie" indicates the setting for dividing the circumference into equal parts.

The points of the dividers are of hardened steel, and if they are handled carefully these points will retain their sharpness during long use. If they are damaged, they may be sharpened and the table of settings will still be usable, but the scale on the instrument will no longer be accurate.

SCALES

In one sense, the term "scale" means the succession of graduations on any graduated standard of linear measurement—such as the graduations on a steel tape or a thermometer. In another sense, when we refer to the "scale of a drawing," the term means the ratio between the dimensions of the graphic representation of an object and the corresponding dimensions of the object itself.

Suppose, for example, that the top of a rectangular box measures 6 in. x 12 in. If you draw a 6 in. x 12 in. rectangle on the paper, the dimensions of the drawing would be the same as those of the object. The drawing would, therefore, be a full-scale drawing. This scale could be expressed fractionally as $1/1$, or it could be given as 1 in. = 1 in.

Suppose that, instead of making a full-scale drawing, you decided to make a half-scale drawing. You would then draw a 3 in. x 6 in. rectangle on the paper. This scale could be expressed fractionally as $1/2$, or it could be given as 1 in. = 2 in., or as 6 in. = 1 ft.

In this case you made a drawing on a smaller scale than the scale of the original object, the scale of an original object being always $1/1$, or unity. The relative size of a scale is indicated by the fractional representation of the scale. A scale whose fractional representation equals less than

unity is a less-than-full scale. One whose fractional representation is greater than unity (such as a scale of 200/1) is a larger-than-full scale. A scale of 1/10,000 is, of course, smaller than a scale of 1/100.

A scale expressed as an equation can always be expressed as a fraction. For example, the scale of 1 in. = 100 ft, expressed fractionally, comes to 1 over (100 x 12), or 1/1200.

It is obvious that any object which is larger than the drawing paper on which it is to be represented must be "scaled down" (that is, reduced to less-than-full scale) for graphic representation. Conversely, it is often desirable to represent a very small object on a scale larger than full scale, for purposes of clarity and to show small details. Because the drawings prepared by an EA frequently require scaling down, the following discussion refers mostly to that procedure. However, scaling up rather than down simply means selecting a larger-than-full rather than a smaller-than-full scale for your drawing.

You could, if necessary, determine the dimensions of your drawing by arithmetic calculation—for example; on a half-scale drawing, you divide each of the actual dimensions of the object by 2. However, this might be a time-consuming process if you were drawing a map of a certain area to a scale of 1 in. = 1,000 miles, or 1/6,336,000 feet.

Consequently, you will usually scale a drawing up or down by the use of one or another of a variety of scales. This sense of the term "scales" refers to a graduated, ruler-like

instrument on which scale dimensions for a drawing can be determined by inspection.

Scales vary in types of material, shapes, style of division and scale graduations. Good quality scales are made of high grade boxwood or plastic, while inexpensive scales are sometimes made of yellow hardwood. The boxwood scales have white plastic scale faces which are permanently bonded to the boxwood. The graduation lines on the boxwood scales are cut by a highly accurate machine. Plastic scales, while less expensive than boxwood scales, have clear graduations and are reasonably accurate.

Scales are generally available in four different shapes, as shown in figure 4-22. The numbers in the figure indicate the location of the scale face. The triangular scale provides six scale faces on one rule. The two-bevel flat scale provides two scale faces, on one side of the rule only. The opposite-bevel flat scale provides two scale faces, one on each side of the rule. And the four-bevel flat scale provides four scale faces, two on each side of the rule. The most common types of scales are the architect's, the engineer's, the mechanical engineer's, and the metric. All of these scales are found in the EA draftsman kit with the exception of the mechanical engineer's scale, which is primarily used by machine draftsmen.

In order to gain a better understanding of the architect's and engineer's scales, which will be described in the following sections, it may be helpful to have the actual scales at hand as you study.

Architect's Scale

Architect's scales are usually triangular in shape and are used wherever dimensions are measured in feet and inches. Major divisions on the scale represent feet which, in turn, are subdivided into 12ths or 16ths depending on the individual scale.

Figure 4-23 shows the triangular architect's scale. Also shown are segments of each of the eleven scales found on this particular type of scale. Notice that all scales except the 16th scale are actually two scales which read from either left to right or right to left. When reading a scale numbered from left to right, notice that the numerals are located closest to the outside edge.

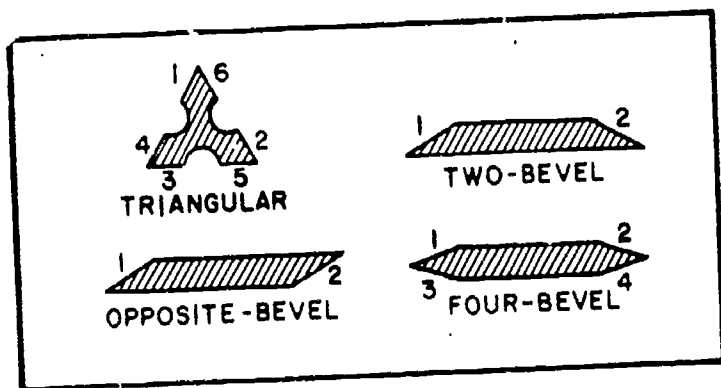

45.831

Figure 4-22.—Types of scales in cross section.

ENGINEERING AID 3 & 2, VOLUME 1

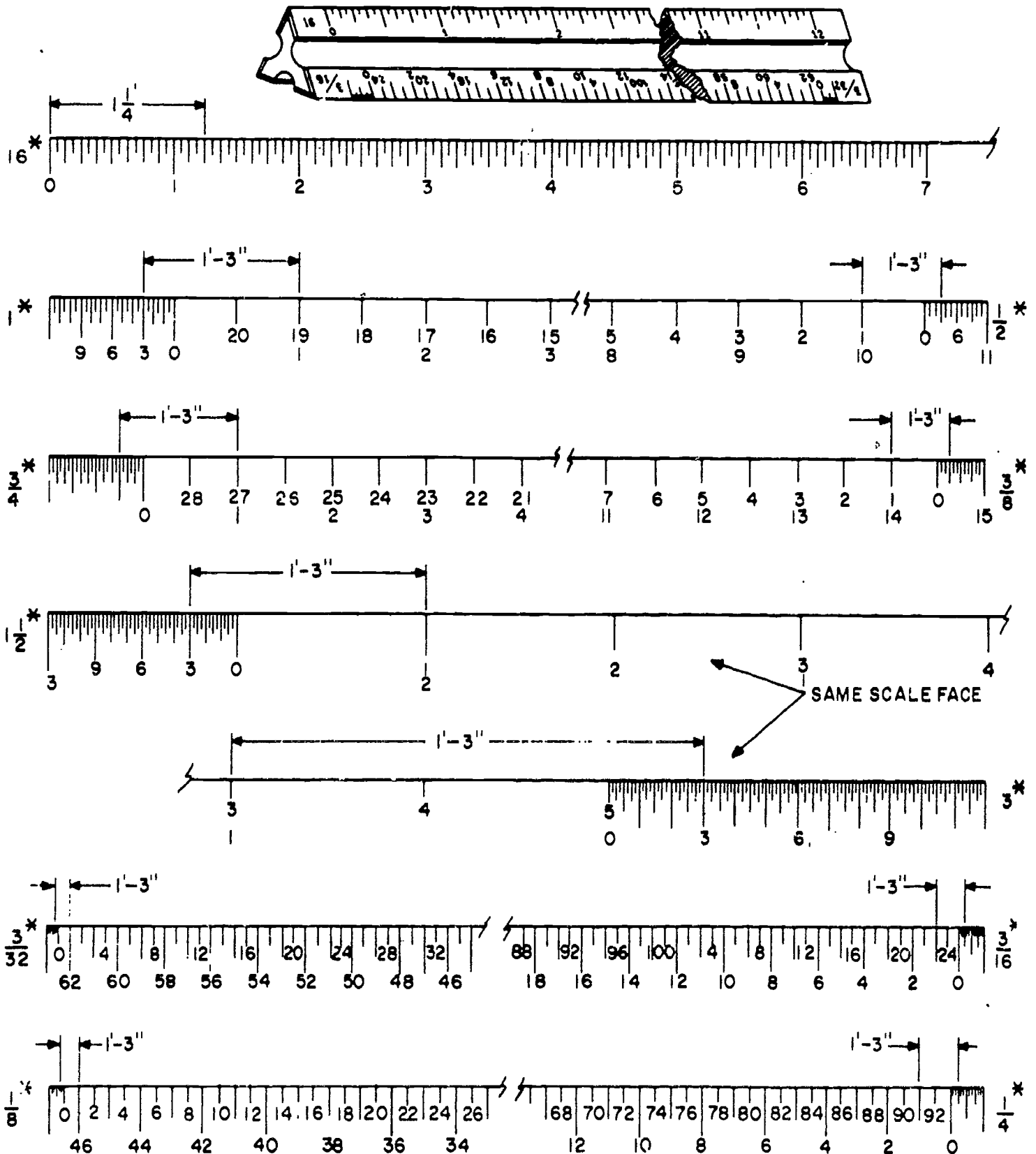

NOTE:
 16 SCALE IS SUBDIVIDED INTO SIXTEENTHS.
 ALL OTHERS ARE SUBDIVIDED INTO TWELFTHS.
 * SCALE DESIGNATION NUMBERS.

142.320

Figure 4-23.—Architect's scale.



On scales that are numbered from right to left, notice that the numerals are located closer to the inside edge.

Architect's scales are "open" divided (only the main divisions are marked throughout the length), with the only subdivided interval being an extra interval below the 0-ft mark. These extra intervals are divided into 12ths. To make a scale measurement in feet and inches, you lay off the number of feet on the main scale and add the inches on the subdivided extra interval. However, notice that the 16th scale is fully divided with its divisions being divided into 16ths.

Now let's measure off a distance of 1 foot 3 inches to see how each scale is read and how the scales compare to one another (Refer to fig. 4-23). Since the graduations on the 16 scale are subdivided into 16ths we will have to figure out that 3 inches actually is 3/12 or 1/4 of a foot. Changing this to 16ths we now see we must measure off 4/16ths to equal the 3-inch measurement. Note carefully the value of the graduations on the extra interval, which varies with different scales. On the 3 in. = 1 ft scale, for example, the space between adjacent graduations represents 1/8 in. On the 3/32 in. = 1 ft scale, however, each space between adjacent graduations represents 2 in.

The scale 3/32 = 1 ft, expressed fractionally, comes to 3/32 = 12, or 1/128. This is the smallest scale provided on an architect's scale. The scales on the architect's scale, with their fractional equivalents, are as follows:

3 in. = 1 ft	$\frac{1}{4}$ scale
$\frac{1}{2}$ in. = 1 ft	$\frac{1}{8}$ scale
1 in. = 1 ft	$\frac{1}{12}$ scale
$\frac{3}{4}$ in. = 1 ft	$\frac{1}{16}$ scale
$\frac{1}{2}$ in. = 1 ft	$\frac{1}{24}$ scale
$\frac{3}{8}$ in. = 1 ft	$\frac{1}{32}$ scale

$\frac{1}{4}$ in. = 1 ft	$\frac{1}{48}$ scale
$\frac{3}{16}$ in. = 1 ft	$\frac{1}{64}$ scale
$\frac{1}{8}$ in. = 1 ft	$\frac{1}{96}$ scale
$\frac{3}{32}$ in. = 1 ft	$\frac{1}{128}$ scale

Engineer's Scale

The chain or civil engineer's scale, commonly referred to as the engineer's scale, is usually a triangular scale, containing six fully divided scales which are subdivided decimally, each major interval on a scale being subdivided into 10ths. Figure 4-24 shows the engineer's scale and segments of each of the six scales. Each of the six scales is designated by a number representing the number of graduations that that particular scale has to the linear inch. On the 10 scale, for example, there are 10 graduations to the inch; on the 50 scale there are 50. You can see that the 50 scale has 50 graduations in the same space occupied by 10 on the 10 scale. This space is 1 linear inch.

To determine the actual number of graduations represented by a numeral on the engineer's scale, multiply the numeral by 10. On the 50 scale, for instance, the numeral 2 indicates 2 x 10, or 20 graduations from the 0. On the 10 scale, the numeral 11 indicates 11 x 10, or 110 graduations from the 0. Note that the 10 scale is numbered every major graduation, while the 50 scale is numbered every other graduation. Other scales on the engineer's scale are the 20, 30, 40, and 60.

Because it is decimally divided, the engineer's scale can be used to scale dimensions down to any scale in which the first figure in the ratio is 1 in. and the other is 10, or a multiple of 10.

Suppose, for example, that you wanted to scale a dimension of 150 miles down to a scale of 1 in. = 60 miles. You would use the 60 scale, allowing the interval between adjacent graduations to represent 1 mile. To measure off 150 miles to scale on the 60 scale, you would

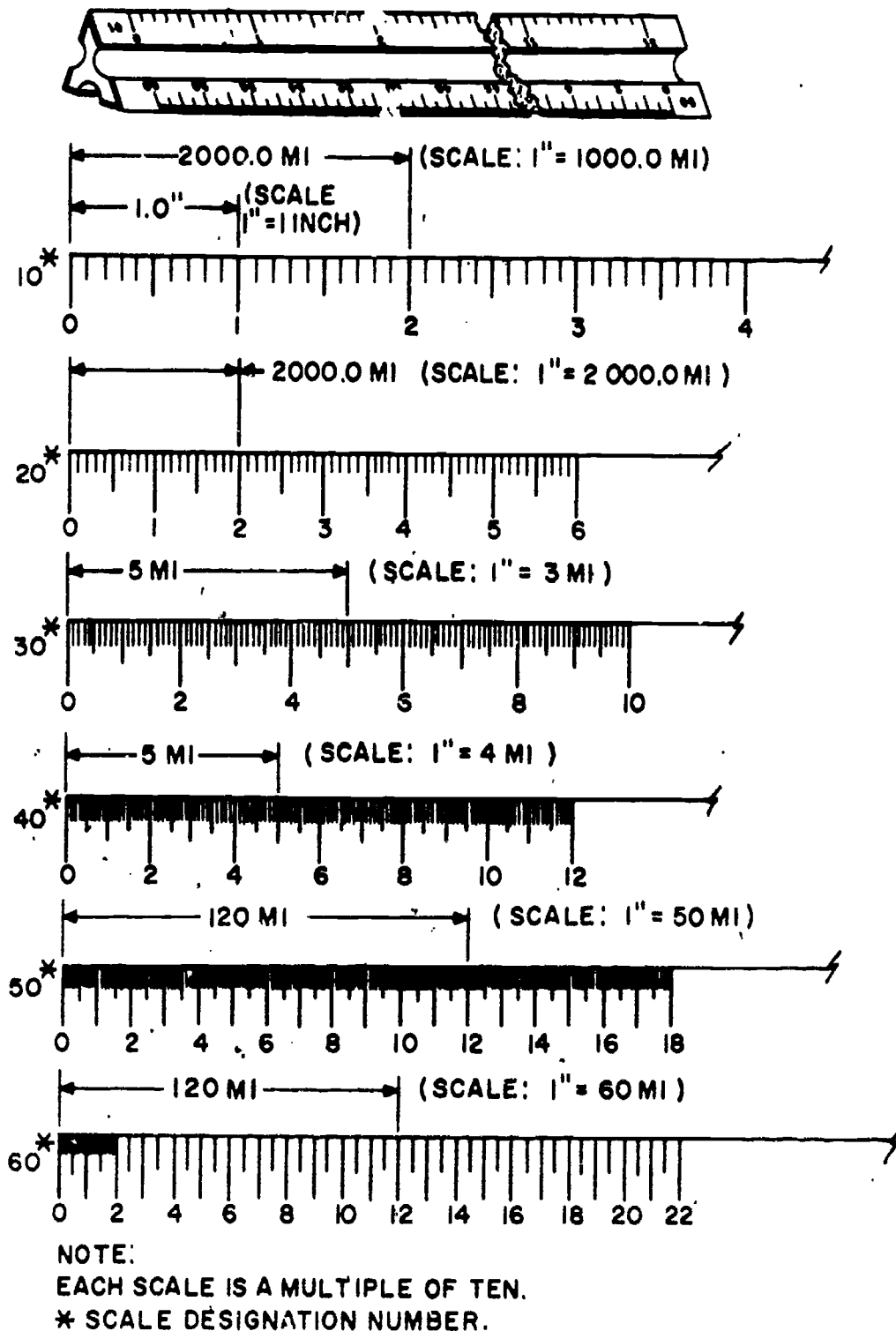

Figure 4-24.—Engineer's scale.

142.321

measure off 2.5 in., which falls on the 15th major graduation.

Suppose now that you want to scale a dimension of 6,500 ft down to a scale of 1 in. = 1,000 ft. The second figure in the ratio is a multiple of 10 times a multiple of 10. You

would therefore use the 10 scale, allowing the interval between adjacent graduations on the scale to represent 100 ft, in which case the interval between adjacent numerals on the scale would indicate 1000 ft. To measure off 6,500 ft, you would simply lay off from 0 to 6.5 on the scale.

To use the engineer's scale for scaling to scales which are expressed fractionally, you must be able to determine the fractional equivalent of each of the scales. For any scale, this equivalent is simply 1 over the total number of graduations on the scale, or 1 over the product of the scale number times 12, which comes to the same thing. Applying this rule, the fractional expression of each of the scales is as follows:

$$10 \text{ scale} = \frac{1}{120}$$

$$20 \text{ scale} = \frac{1}{240}$$

$$30 \text{ scale} = \frac{1}{360}$$

$$40 \text{ scale} = \frac{1}{480}$$

$$50 \text{ scale} = \frac{1}{600}$$

$$60 \text{ scale} = \frac{1}{720}$$

Suppose you wanted to scale 50 ft down to a scale of 1/120. The 10 scale gives you this scale; you would therefore use the 10 scale, allowing the space between graduations to represent 1 ft, and measuring off 5 (for 50 ft). The line on your paper would be 5 inches long, representing a line on the object itself which is (120 x 5 in.), or 600 in., or 50 ft long.

Similarly, if you wanted to scale 50 ft down to a scale of 1/600, you would use the 50 scale

and measure off 5 for 50 ft. In this case the line on your paper would be 1 in. long, representing a line on the object itself which is (1 x 600), or 600 in., or 50 ft long.

When it is not required that the drawing be made to a specified scale—that is, when the dimensions of lines on the drawing are not required to bear a specified ratio to the dimensions of lines on the object itself—the most convenient scale on the engineer's scale is used. Suppose, for example, that you want to draw the outline of a 360-ft x 800-ft rectangular field on an 8-in. x 10-1/2-in. sheet of paper, with no specific scale prescribed. All you want to do is reduce the representation of the object to one which will fit the dimensions of the paper. You could use the 10 scale, allowing the interval between adjacent graduations to represent 10 ft. In this case the numerals on the scale, instead of representing 10, 20, and so on, will represent 100, 200, and so on. To measure off 360 ft to scale you would measure from 0 to the 6th graduation beyond the numeral 3. For 800 ft you would measure from 0 to the numeral 8.

Because you allowed the interval between adjacent graduations to represent 10 ft, and because the 10 scale has 10 graduations to the inch, the scale of your drawing would be 1 in. = 100 ft, or 1/1200.

Metric Scale

The metric scale is used in the place of the architect's and the engineer's scale when measurements and dimensions are in meters and centimeters. Metric scales are available in flat and triangular shapes. The flat 30 cm. metric scale is shown in figure 4-25. The top scale is

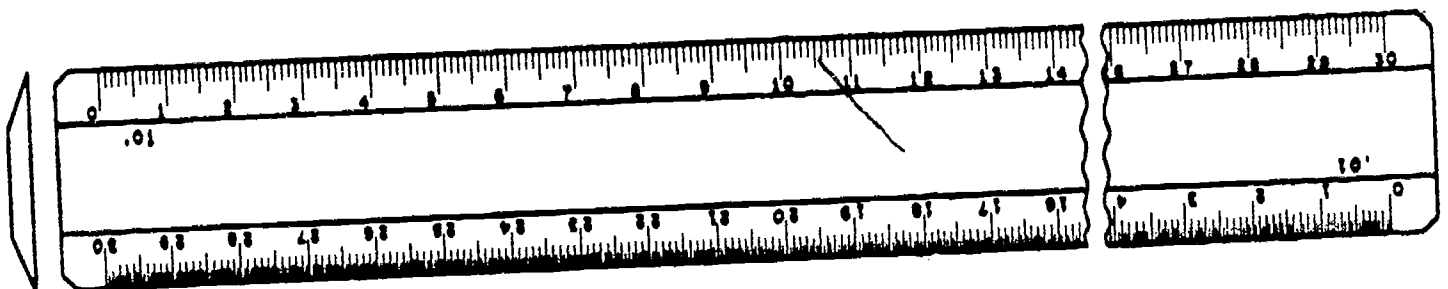

Figure 4-25.—Flat metric scale.

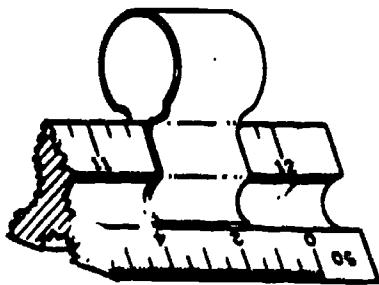

Figure 4-26.—Triangular scale clip.

29.276

calibrated in millimeters and the bottom scale in half millimeters. The triangular metric scale has six fully divided scales which are 1:20, 1:33 1/3, 1:40, 1:50, 1:80, and 1:100.

When you are using scales on a drawing, do not confuse the engineer's scale with the metric scale. They are very similar in appearance. Whenever conversions are made between the metric and English system, remember that 2.54 centimeters equals 1 inch.

It is predicted that the metric system will become the worldwide standard system of linear measurement in the near future. Since most of your work as an EA involves measurements, a thorough knowledge of the metric system is a must. If you are not completely familiar with the subject at this point, go back to chapter 2 and review the section which deals with the metric system.

Triangular Scale Clip

For use with a triangular scale, a scale clip like the one shown in figure 4-26 is very helpful. The clip makes it easy for you to identify what scale you are using. Large spring-type paper clips will serve the same purpose when scale clips are not available.

MAP MEASURES

Map measures are precision instruments for measuring the lengths of roads, pipelines, and other irregular outlines on maps and drawings. Distances are measured by first setting the instrument to zero, then tracing the line to be measured with the small, projecting tracing

wheel, like that on the map measures shown in figure 4-27.

In using map measures, do not depend entirely on the indicated numerical scale. Always check it against the graphical scale on the map or drawing. Verify if, for example, 1 inch traversed on the graphical scale really registers 1 inch on the dial; if not, make the proper correction to the distance measured. Actually, a map measure is just another odometer. Odometers are used to measure actual distances, while the map measures are used to measure scaled distances.

DRAFTING TEMPLATES

Drafting templates are timesaving devices which are used for drawing various shapes and standard symbols. They are especially useful when shapes and symbols must appear on the drawing a number of times. Templates are usually made of transparent green or clear plastic. They are available in a wide variety of shapes, including circles, ellipses, hexagons,

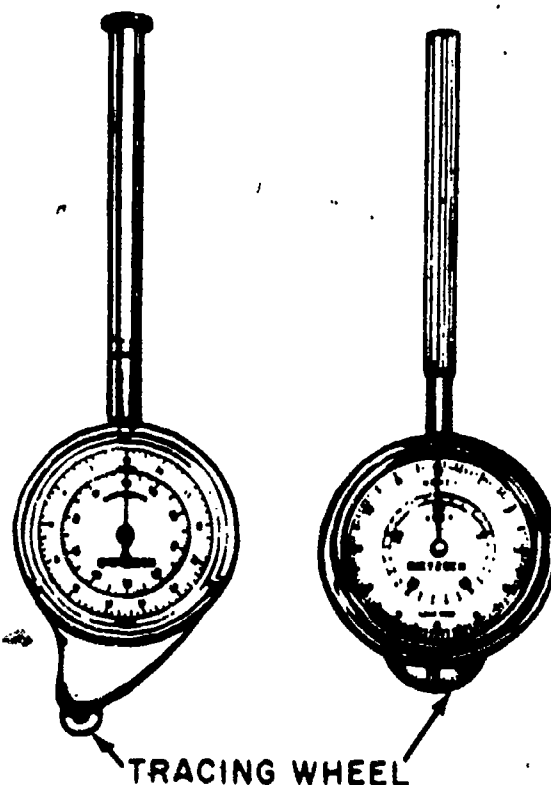

45.712X

Figure 4-27.—Types of map measures.

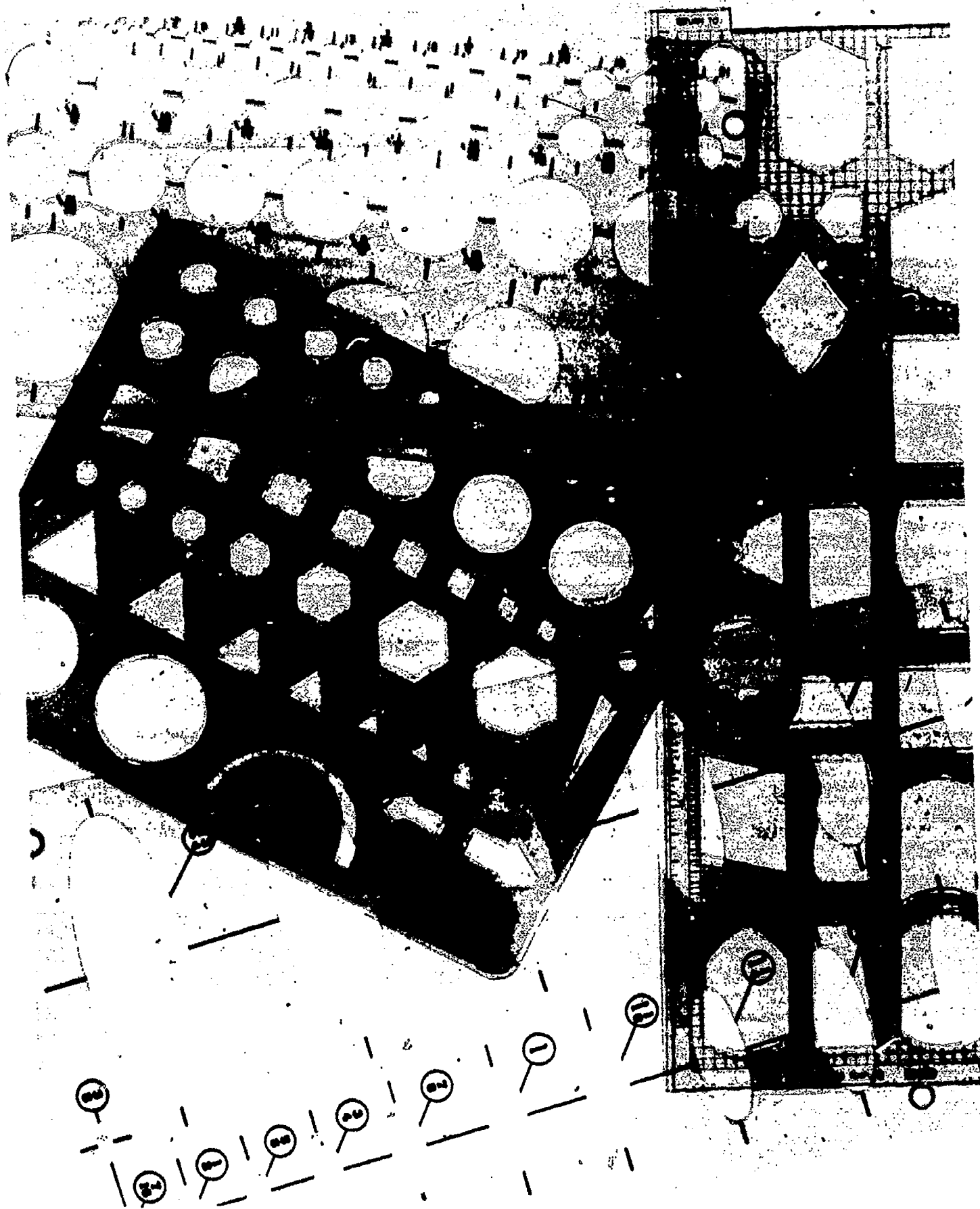

Figure 4-28.—Drafting templates.

triangles, rectangles, and arcs. Special templates are available for symbols used on architectural drawings, electrical drawings, mechanical drawings, and maps. Templates for almost every purpose are available from the well-known drafting supply companies. Figure 4-28 shows only a few of the more common types of drafting templates. One set of commonly used drafting templates is included in the EA draftsman kit.

FREEHAND LETTERING PENS

In a previous section we discussed the ruling pen with which you are limited to drawing only straight lines. Frequently you will prepare inked drawings, maps, or charts which require freehand lines and lettering. There are many types of freehand pens available. But here we will be concerned only with those pens used by the EA. In the draftsman kit you will find two types of pens used strictly for freehand lettering; the quill pen and speedball pen. Also included in the kit is a reservoir pen set which may be used either with a penholder, as a freehand pen, or fitted into a mechanical lettering device for template lettering.

Quill Pens

Various types of quill pens are shown in figure 4-29. A quill pen is one with a split point similar to that on an ordinary writing pen. Quill pens are usually designated by a number which indicates the relative fineness of the lines which they will draw. Pen sizes may vary with different manufacturers, but generally a No. 1 is the finest

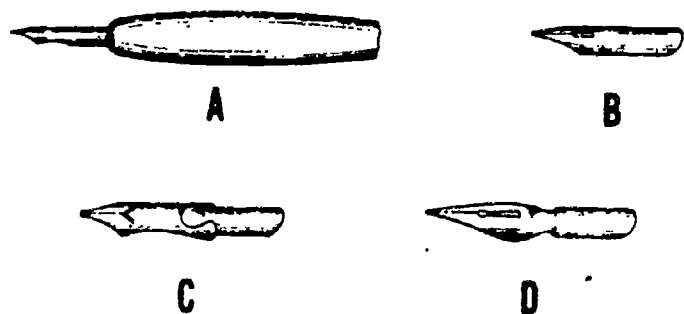

45.122

Figure 4-29.—Quill drawing pens.

while a No. 12 is the coarsest. Quill pens in the coarsest range may be "square tipped" or "round tipped"—that is, the point may consist of a small rectangle or disk which ensures that all lines will be uniform in thickness regardless of the direction in which the pen is moved. An advantage of the quill pen over other styles of pens is that it is capable of producing a graded line. Varying the pressure evenly while drawing with the quill pen will produce a line that ranges in size from thin to thick, or thick to thin. If an evenly graded line is desired, other types of pens should be used. The biggest disadvantage of the quill pen is its lack of ability to hold quantities of ink. The pen must be dipped into the ink bottle frequently.

Pen holders are generally available in two sizes. The No. 1 and No. 2 pens require a small diameter holder, whereas the coarser pens require a holder (usually with a cork grip) which is a little larger than an ordinary pencil.

Speedball Pens

For single-stroke lettering, in which each line in a letter is drawn with a single stroke of the pen, you will find it difficult to maintain a uniform line width around a curve using an ordinary quill pen. For most of your lettering you will use SPEEDBALL pens, particularly when lettering is 1/2" or larger. Speedball pens are especially useful for chartwork and making signs.

As shown in figure 4-30, speedball pens are available with tips of various sizes and shapes. Tip shapes include square (style A), round (style B), oblong (style C), and oval (style D). Styles A and B, which produce uniform lines, are the ones that you will use the most. Styles C and D, which produce lines that range from thick to thin, are used mostly for art work by an Illustrator Draftsman. Unlike quill pens, speedball pen size designations range from high number to low number. For example, in Style A, A-1 is coarse and A-5 is fine. A complete set of speedball pens include all four styles.

Speedball pens are equipped with a brass clip that serves as a reservoir for the ink. Instead of dipping the pen into ink, the dropper from the ink bottle is used in the same manner as with a



45.124(142A)X

Figure 4-30.—Speedball pens.

ruling pen. This will ensure that the outside of the pen nibs are kept free of ink; and will prevent blotting.

Felt Marking Pens

Felt marking pens (commonly called felt tip pens or Magic Markers) are very handy for preparing hasty charts or signs, sketching, and marking on blueprints. The felt marking pen has a permanent felt tip and is not refillable. Applying a slight pressure to the pen will cause the felt tip to become saturated with ink.

Basically there are two sizes of felt marking pens. The smaller pen is about the same size as the ordinary pencil and has a small, hard, conical point. The large pen has a larger diameter and has a blunt square tip. The tip of the large pen may be reshaped with a sharp knife. Both sizes of felt tip pens are available through the supply system in a variety of colors including black, red, blue, green, purple, orange, yellow, and brown. Excessive pressure on the pens will soon damage the felt points, producing a fuzzy, uneven line. When the color of the line starts to fade, it is an indication that the pen is running low on ink.

Technical Fountain Pens

The technical fountain pen—sometimes called a Rapidograph pen or reservoir pen—may be used for ruling straight lines of uniform

width, with the aid of a T-square, triangle, or other straightedge. Unlike the ruling pen, it may also be used for freehand lettering and drawing. It may also be used with templates for drawing and lettering. One of the best features of the technical fountain pen is its ink reservoir. The reservoir, depending on the style of pen, is either built into the barrel of the pen or is a translucent plastic ink cartridge attached to the body of the pen. The large ink capacity of the reservoir saves time because you do not have to constantly replenish the ink supply. Therefore, many EA's prefer the technical fountain pen to the ruling pen.

A typical technical fountain pen is shown in figure 4-31. Variations in pen style and line size are offered from various manufacturers. Some pens are labeled by the metric system according to the line weight they make. Other pens are labeled with a code that indicates line width measured in inches. For instance, a No. 2 pen draws a line .026 inches in width. Most technical fountain pens are color-coded for easy identification of pen size. These pens are available either as individual fountain pen units resembling a typical fountain pen, or as a set having a common handle and interchangeable pen units. The pen shown in figure 4-31 is a part of a set of technical fountain pens.

Some reservoir pens for lettering are made so the point section will fit in a Leroy scriber. (The Leroy letter set will be discussed in chapter 5.)

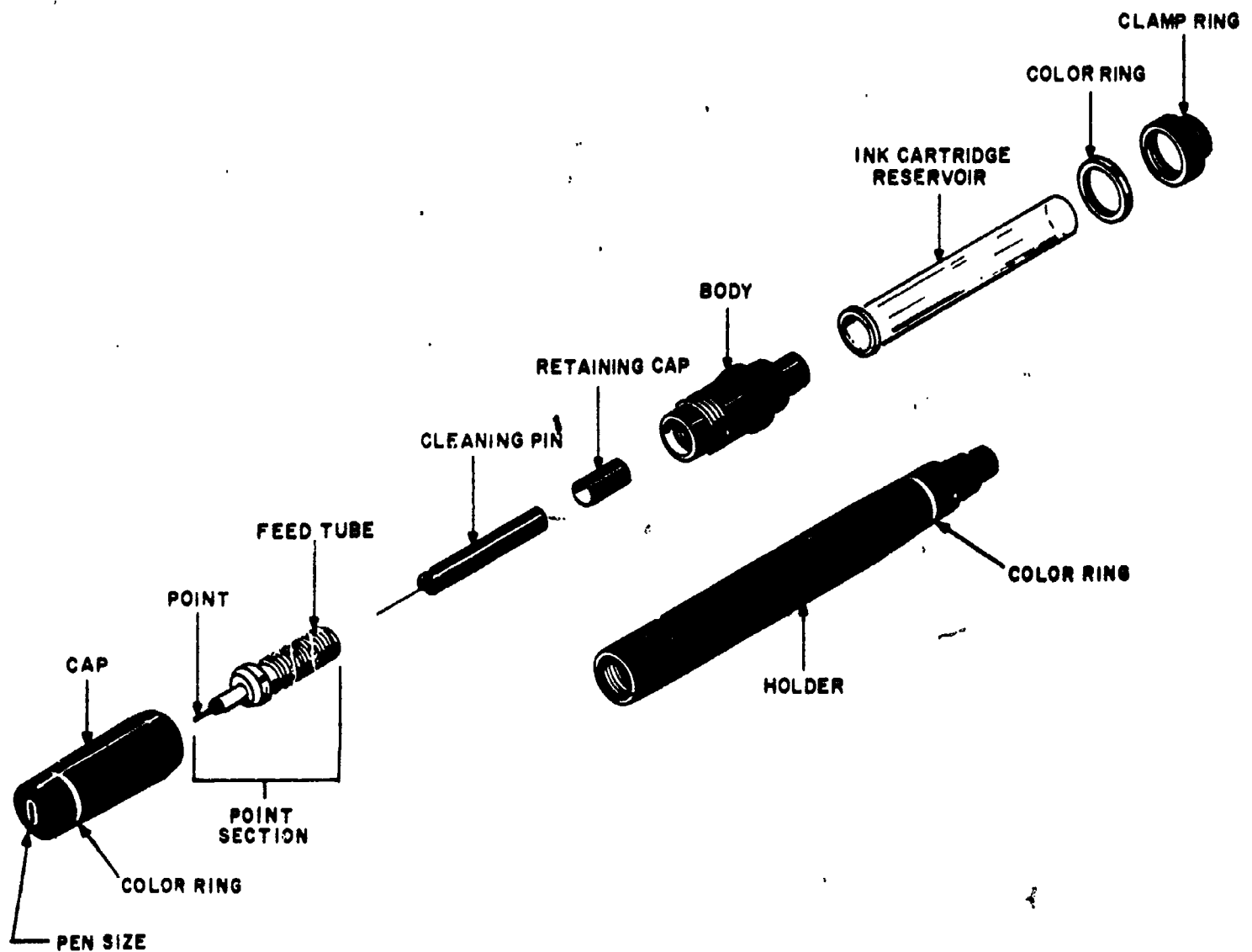

Figure 4-31.—Technical fountain pen.

142.326

These pens may also be used for any work that a regular technical fountain pen is used for.

USING THE TECHNICAL FOUNTAIN PEN.—As shown in figure 4-32, you must hold the technical fountain pen so that it is perpendicular to the drawing surface at all times. If you don't hold the pen in the correct manner the point will bevel or wear unevenly and eventually form an elliptical point. With the point in this condition, the pen will produce lines of inconsistent widths.

To fill the reservoir of a fountain pen, use the knob located on the barrel opposite the point. When you turn the knob counterclockwise, a plunger is forced down into

the barrel forcing out any ink remaining in the reservoir. Place the point end of the pen into the ink and turn the knob clockwise to pull the plunger up. As the plunger is pulled up, ink is drawn through the point, filling the reservoir.

To fill the ink cartridge type of pen shown in figure 4-31, remove the cartridge from the body and insert the ink bottle dropper all the way into the reservoir cartridge. Place the dropper in contact with the bottom of the reservoir cartridge to prevent the ink from forming air bubbles. Fill the cartridge to approximately $\frac{3}{8}$ of an inch from the top, then replace the cartridge and clamp ring.

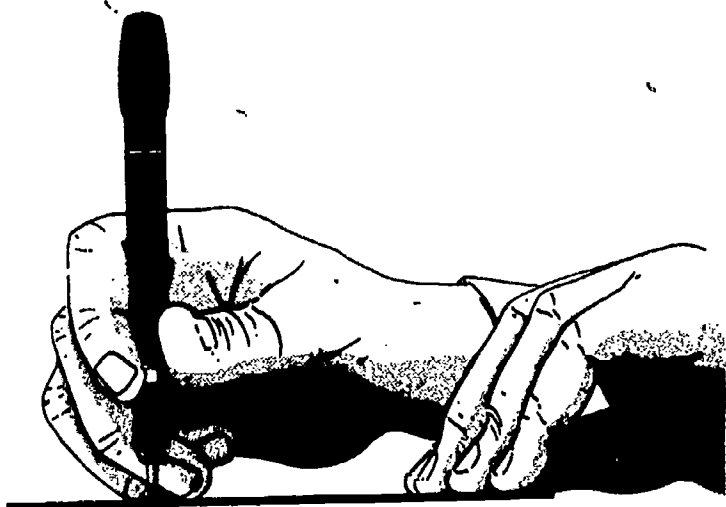

142.327

Figure 4-32.—Drawing with a technical fountain pen.

CARE AND CLEANING.—The feed tube of the penpoint is threaded (fig. 4-31). Along this threaded portion is an inclined channel that allows air to enter the ink reservoir. To ensure correct ink flow, this channel must be free of dried ink or foreign particles. When cleaning the pen, scrub the threads and channel with a brush, such as a toothbrush, wetted with a cleaning solution of soap and water. A cleaning pin (a tiny weighted needle) is made so that it fits into the feed tube and point (See fig. 4-31). This cleaning pin assures a clear passage of ink from the reservoir to the point. Usually a light shake of the pen will set the cleaning pin in motion, removing any particles which settle in the tube when not in use. (Do not shake the pen over your drawing board.)

If the pen is not used frequently, the ink will dry, clogging the point and feed tube. When the

pen becomes clogged, soak the pen in pen cleaner or ammonia water until it will unscrew with little or no resistance. A better practice is to clean the pen before you put it away if you know in advance that you will not be using it for several days.

The cleaning pin must be handled with care, especially the smaller sizes. A bent or damaged cleaning pin will never fit properly into the feed tube and point.

DRAWING INK

Draftsman's drawing ink is commonly called **INDIA INK**. Drawing ink consists of a pigment (usually powdered carbon) suspended in an ammonia-water solution. Ink that has thickened by age or evaporation may be thinned slightly by adding a few drops of a solution of 4 parts aqua ammonia to 1 part distilled water. After the ink dries on paper, it is waterproof. Drawing ink is available in many different colors, but for construction and engineering drawings black ink is preferred for reproduction and clarity. Small 3/4- or 1-ounce bottles of black, red, and green ink are found in the standard draftsman kit. Larger bottles are available for refilling the small bottles. The stopper for a small ink bottle is equipped with either a squeeze dropper or a curved pipette for filling pens.

When you are working with ink, always keep the stopper on the ink bottle when you are not filling the pen, and keep the bottle far away from your drawing. Nothing is more frustrating for a draftsman than to spill a bottle of ink on a finished drawing. To minimize this hazard, special bottle holders are available. If you do not have a bottle holder, it would be to your advantage to devise your own.

CHAPTER 5

DRAFTING: BASIC TECHNIQUES, FORMAT, AND CONVENTIONS

In this chapter you will learn basic drafting techniques used by the EA in preparing drawings and charts. The techniques are based on the use of the drafting equipment and accessories described in chapter 4.

This chapter also covers basic standard drawing format and conventions used on SEABEE drawings. These guidelines are described in detail in various publications listed in chapter 4. It is your responsibility to keep up to date on this reference material to ensure that your drawings are prepared according to the latest revisions. This training manual will not cover these items in depth, but will describe drawing format and conventions according to two of the publications you will use most often: MIL-STD 100A, *Engineering Drawing Practices* and NAVFAC DM-6, *Drawings and Specifications*. Local policy will direct you to specific publications in your actual drafting assignments.

WORK PREPARATION

Before you begin work, you should devote some time and thought to organizing your working area. Drafting furniture should be arranged so you can work comfortably without fatigue and eyestrain. Be sure to check the lighting before you set up your drafting table. You can devise a system of stowing your equipment and supplies so that they are handy and in order.

WORK AREA

Your immediate work area should be large enough to allow sufficient freedom of

movement, but not so large that you waste time reaching for equipment, supplies, and reference publications. An ideal working area allows each draftsman approximately 50 square feet of space, although you may actually have more or less depending on the total area of the drafting room and the number of draftsmen who will work there.

If you are easily distracted, do not butt your drafting table up against and facing another draftsman's table.

Ensure that you have adequate lighting. The best light for drafting is natural light, coming over the left shoulder and from the front left to avoid shadows cast by your hands, T-square, and triangles. Avoid a glaring light as it will cause eyestrain. Utilize the drafting lamp which was described in chapter 4. Your drafting table height should be from 36 to 40 inches above floor level. Your drafting chair or stool should be high enough that you can see the whole drawing board, but not so high that you have to lean over uncomfortably to draw. As mentioned in chapter 4, the board may be inclined or left flat according to your preference. A slope of 1 to 8 works well for the inclined position. By shifting your body or head slightly, you should be able to look directly at any point on an average-sized drawing sheet; that is, your line of sight should be approximately perpendicular to the drawing surface.

Before you begin to draw, arrange your equipment in an orderly manner. Place each article so that you can reach it easily, and keep it in place when you are not using it. A systematic arrangement is timesaving and efficient. You decrease the likelihood of accidentally dropping your tools or pushing them off the table if you keep them in order.

You will find it very convenient to have a small work table adjacent to your drafting board. Placing your drafting tools and reference publications on the work table leaves you with an uncluttered drawing board surface. When you use the drafting board in the inclined position, a separate work table becomes a necessity.

YOUR EQUIPMENT AND MATERIALS

Selection of drafting equipment and materials will depend largely upon each of your drafting assignments. Let your good judgment and common sense guide you in their selection. After some experience, you will automatically select proper equipment and materials as they are required. Until you become proficient, don't hesitate to seek the advice of your drafting supervisor or an experienced draftsman.

Drafting Board

As a SEABEE draftsman, you will probably not be able to select your drafting board. Unless the board is new, it will probably be marred and full of small pinholes. To obtain a smooth drawing surface, you would cover the board with a vinyl material or heavy manila paper. Laminated vinyl covering minimizes pencil scoring, is nonglaring, and is easily kept clean by wiping with a damp cloth. Heavy manila paper will serve the same purpose, but must be replaced when it becomes soiled or marked with use.

Drawing Paper

Most of the drawings that you will prepare will be drawn on tracing paper, which was described in chapter 4. You will use tracing paper to copy or trace drawings either in pencil or in ink. You will also prepare most of your original pencil drawings on tracing paper. This type of paper is especially suited for reproduction of blueprints. However, it tears easily and becomes soiled after repeated handling.

When making a drawing directly on tracing paper, you should place a smooth sheet of white paper below it (detail paper works well). The whiteness of this sheet (called a platen sheet)

gives better line visibility and its hard surface makes it possible to draw good pencil lines without grooving the tracing paper.

Do not use gritty erasers on tracing paper, especially when ink is to be applied. If erasures must be made, use a red Ruby eraser which is only slightly abrasive. Abrasive erasers wear away the surface. Erase carefully so you don't tear the drawing. A light back-and-forth motion works best. If the surface of the drawing becomes scratched by erasing, it can be partially smoothed by burnishing the damaged area with a hard, smooth object or your thumbnail. Avoid using the electric eraser on tracing paper, as it will quickly "burn" a hole through the paper. To clean up smudges and dust, use a soft art gum eraser or sprinkle pounce on the drawing and rub lightly with your hand or a triangle.

Water, perspiration, or graphite from your pencil will ruin drawing paper. In order to keep moist hands or arms from marring the drawing, use a clean sheet of paper as a mask to protect the drawing surface next to the work area. Between drawing sessions you should protect unfinished drawings by covering them.

Tracing paper must not be folded. The crease marks will damage the lines on the drawing and cause blurred prints when the drawing is reproduced. For that matter, no drawing should ever be folded. Drawings and tracings should be either stored flat or rolled and placed in cylindrical containers. Prints of drawings larger than 8 1/2" x 11" may be folded so that they can be filed in standard filing cabinets.

Besides tracing paper, you will select other types of paper for special uses. You will be mainly concerned with the gridded papers described in chapter 4. The quality of the gridded paper that you will use is similar to that of tracing paper, and should be used in the same manner.

As you gain experience, you will learn which type of paper to use for each drafting assignment. Of course, you will be limited by the types of paper available and the guidelines given to you by your drafting supervisor.

Drawing Pencils

For the average drafting assignment, three or four pencils are usually sufficient. A hard pencil, 4H or 5H, should be used to lay out the drawing in light construction and projection lines. A medium pencil, H or F, is then used to darken the required lines and to make arrowheads and lettering. The grade of drawing paper you use will also determine which pencil you choose for making a drawing. A soft, rough-textured paper usually requires a softer pencil for layout work, since a hard pencil would leave indentations in the paper and thus spoil the appearance of the drawing.

One way to find out if you are using the proper pencils on a drawing is to make a blueprint (reproduction) of the drawing. If the reproduced lines do not appear, or appear too light, use a softer pencil. If, on the other hand, lines appear too dark in relation to other lines, use a harder pencil. You may be able to vary the weight of lines by the amount of pressure exerted on the pencil, but this should not be attempted without experience. Bearing down on

a hard pencil to produce darker lines may cause grooves in the paper.

Another way to find out if you are using the proper pencil is to hold your drawing up to a light and view it from the back side. Pencil adjustment is the same as in the previous method. Of course, both methods apply only when transparent drawing paper is used.

To sharpen a pencil, cut the wood away from the unlettered end (fig. 5-1A) with a draftsman's pencil sharpener or a penknife. The lettered end should be left intact so that the grade of pencil can always be identified. The cut should be started about 1 1/2 inches from the end, leaving a half-inch of lead exposed. To produce a conical or needlepoint (fig. 5-1B), which is best for general use, rotate the pencil between the fingers at the same time as the exposed lead is rubbed back and forth across the full length of the sandpaper pad (fig. 5-1C). Many draftsmen prefer to use a mechanical lead pointer instead of the sandpaper pad. The mechanical pointer quickly produces a uniform conical or needlepoint. However, the sandpaper pad must still be used to produce other types of points. The resulting needlepoint should be dulled slightly by drawing it lightly across a

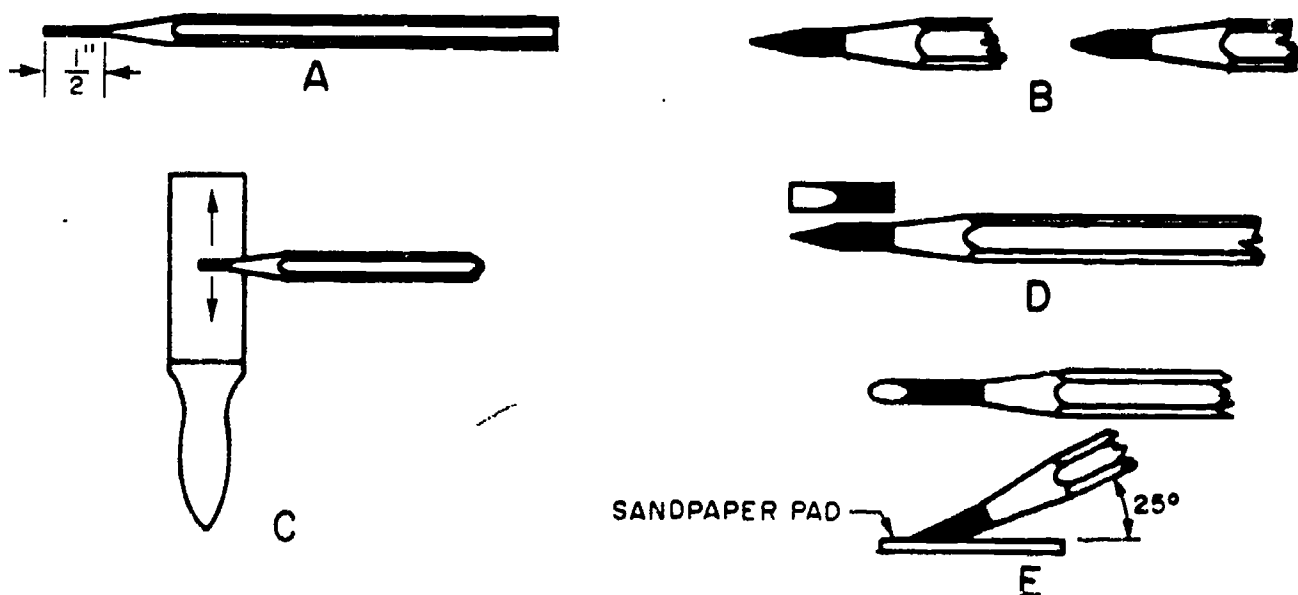

Figure 5-1.—Sharpening pencil points.

piece of scrap paper several times. Avoid sharpening pencils near your drawing. Graphite particles will cause smudges which are difficult to erase. A cloth or tissue should be used to wipe away graphite particles which cling to the pencil after it is sharpened. A wedge point (fig. 5-1D) will aid an experienced draftsman in the extensive drawing of straight lines. This point is produced by sharpening a pencil to the conical point just described, then flattening both sides on the sandpaper pad. For an elliptical point, hold the pencil firmly with thumb and fingers and cut lead on sandpaper pad by a back-and-forth motion, keeping the pencil at an angle of about 25° to the pad. Continue until a flat ellipse is formed as shown in figure 5-1E. Frequency of sharpening is comparable to the frequency of inking an ordinary writing pen. A good draftsman never uses a dull pencil.

Some draftsmen prefer to use mechanical drafting pencils instead of wooden pencils. The lead of a mechanical pencil is sharpened in the same manner as the lead of a wooden pencil. However, the length of the mechanical pencil is not depleted as the lead is sharpened. This is an advantage over wooden pencils which become difficult to use when they are less than 3" in length. When leads for the mechanical pencil are exchanged, ensure the changeable lead grade designator on the mechanical pencil corresponds to that of the lead used.

BASIC DRAFTING TECHNIQUES

You should practice handling and using instruments before attempting complex drawing problems. Developing correct drawing habits will enable you to make continuous improvement in the quality of your drawings. The main purpose of making your first drawings is learning to use instruments. Each drawing will offer an opportunity for practice. Later on, good form in the use of instruments will become a natural habit.

Accurate pencil drawings are of first importance since all inked drawings and tracings are made from finished pencil drawings. It is a mistake to believe that a poor pencil drawing can be corrected when making the ink tracing. Any drawing important enough to be inked or

traced in ink must be accurate, legible, and neat. Because most military and commercial blueprints are made from pencil drawings, the ambitious student of drafting will work to acquire skill in pencil drawing as he perfects his technique. Good technique and skillful pencil drawing are basic to proficiency in drafting.

The following sections will guide you in attaching your drawing paper to the board, and in drawing basic lines with the T-square, triangles, and pencil.

ATTACHING PAPER TO THE BOARD

Now that you have become relatively familiar with your equipment and materials, it is time to get started by attaching your drawing paper to the board. The drawing paper should be placed close to the left edge of the drawing board. Working in this area makes the T-square easier to handle and reduces the likelihood of error because of T-square "swing". The drawing sheet should be far enough from the bottom of the board (about 3 in.) to ensure firm support for the head of the T-square when you are drawing at the lower part of the sheet. A drawing sheet properly attached to the board using a T-square is shown in figure 5-2. After aligning the drawing sheet, smooth out any wrinkles and fasten the four corners with short strips of drafting tape. If you are attaching large sheets, additional strips of tape should be placed at the top and bottom edge of the sheet. Drafting tape has a lighter coating of adhesive

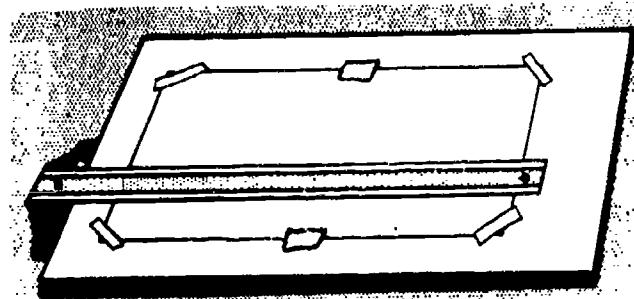

Figure 5-2.—Attaching drawing paper to the board.

29.275D

than does masking tape. Consequently, it will hold the drawing firmly, yet can be removed without tearing or marring the drawing. If you use masking tape or transparent tape, leave a large margin in the event you tear the paper when removing the tape. When placed diagonally across the corners of the sheet, as shown in figure 5-2, the drafting tape offers little obstruction to movement of the T-square and triangles. Avoid the use of thumbtacks; they will eventually ruin the drafting board.

If you are using a parallel straightedge instead of a T-square, the above procedure is the same with one exception. Instead of placing the paper close to the left edge of the board, you should center it approximately at the midpoint of the length of the parallel straightedge.

HORIZONTAL LINES

The draftsman's horizontal line is constructed by drawing from left to right along the working edge of a T-square, as shown in figure 5-3A. This working edge, when true, is perpendicular to the working edge of the drawing board. When drawing horizontal lines, the working edge of the T-square head should be in firm contact with the working edge of the drawing board. The pencil should be inclined to the right at an angle of about 60° , with the point close to the junction of the working edge and the paper. The pencil is held lightly and, if sharpened with a conical point, is rotated slowly while the line is being drawn to achieve a uniform line width and preserve the shape of the point. Normally, when a series of horizontal lines is being drawn, the sequence of drawing is from the top down.

VERTICAL LINES

Vertical lines are produced parallel to the working edge of the drawing board by using triangles in combination with a T-square. One leg of a triangle is placed against the working edge of the blade and the other faces the working edge of the board to prevent the draftsman from casting a shadow over his work.

Lines are drawn from the bottom up, as shown in figure 5-3B. The pencil is inclined toward the top of the working sheet at an angle of approximately 60° , with the point as close as possible to the junction of triangle and drawing paper. Sequence in drawing a series of vertical lines is from left to right. At no time should the lower edge of the T-square blade be used as a base for triangles.

INCLINED LINES

The direction or angle of inclination of an inclined line on a drawing sheet is measured by reference to the baseline from which it is drawn. Inclined lines at standard angles are constructed with the T-square as a base for triangles used either singly as shown in views C and D of figure 5-3, or in combination as shown in view E of figure 5-3.

Used in combination with the T-square as a base, the triangles serve as guides for producing lines at intervals of 15° , as shown in figure 5-4. Used singly, the 45° triangle will divide a circle into 8 equal parts; the $30^\circ \times 60^\circ$ triangle will divide a circle into 12 equal parts. For drawing lines at angles other than those described above, the protractor is used.

PROTRACTING ANGLES

To measure an angle, place the center mark of the protractor at the vertex of the angle, with the 0° line along one side. Then note the degree mark which falls on the side. To lay off an angle, position the protractor as above and use a needlepoint or a sharp pointed pencil to mark the desired values. Then project lines from the vertex to these marks.

Using only the three points on the protractor, as described above, may result in considerable inaccuracy, particularly if the lines of an angle are to be extended for some distance beyond the protractor. A refinement of the procedure is indicated in figure 5-5. Suppose angle BOA is to be measured. Extend line AO on

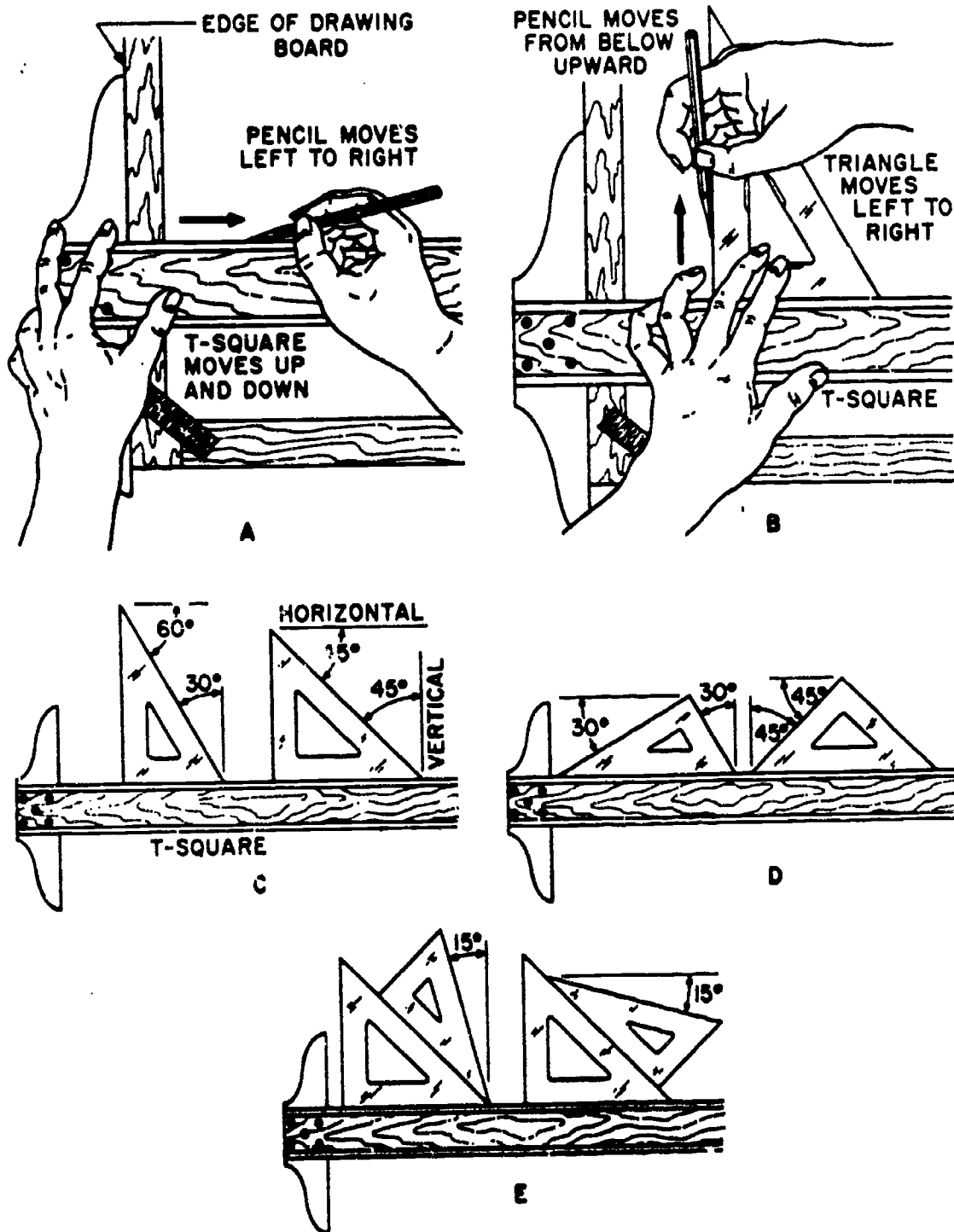

29.275H

Figure 5-3.—Construction of basic lines.

to C; extend line BO on to D. When you set the center of the protractor at O, make sure that both points c and a are on line AC. Take your reading at point d as well as at point b when you measure the angle. If you are laying off the angle BOA, protract and mark point d as well as point

b; this gives you three points (d, O, and b) for establishing line DB. If you are using a semicircular protractor you can't of course, locate point d; but your accuracy will be improved by lining up c, O, and a before you measure or lay off the single angle BOA.

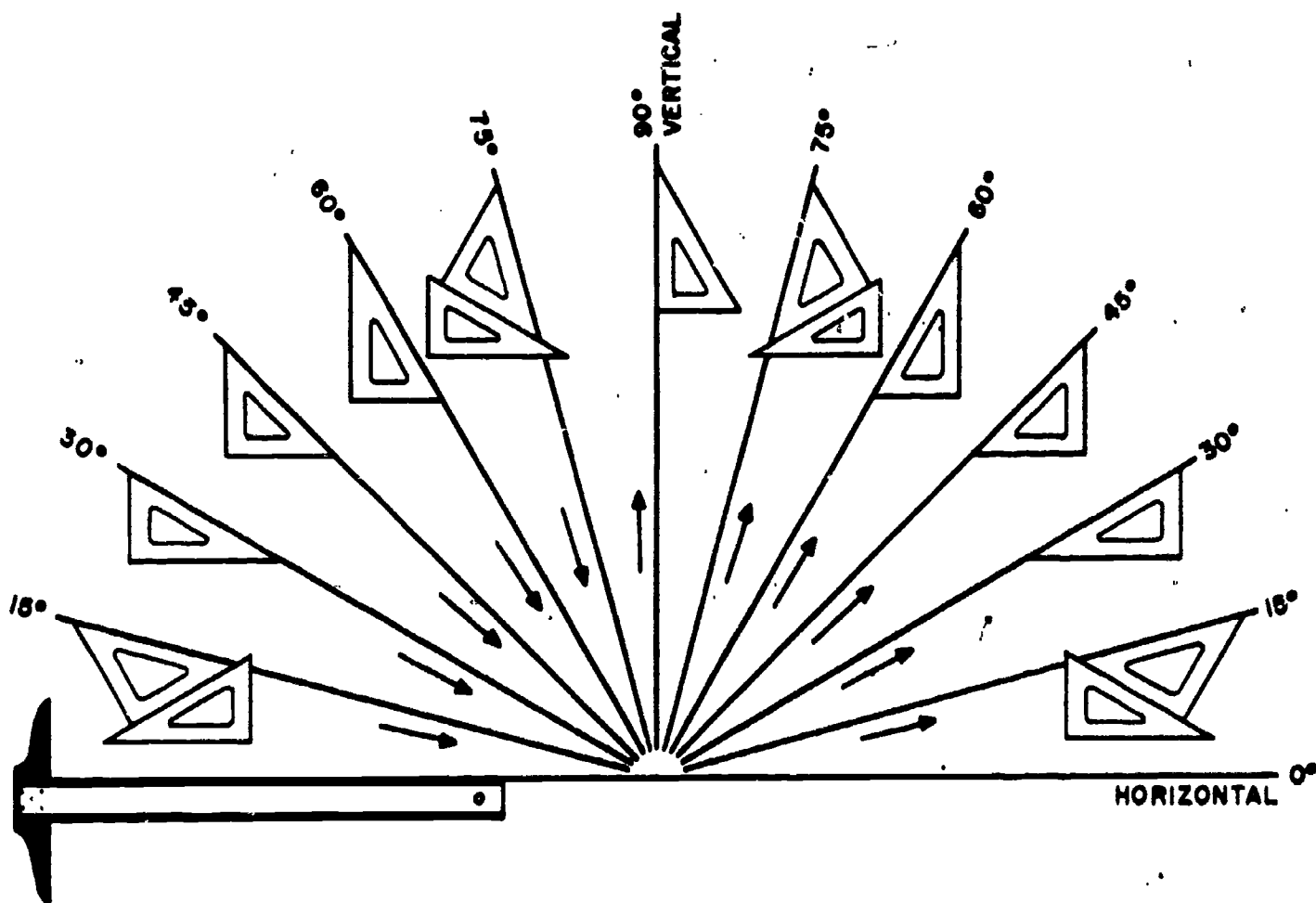

Figure 5-4.—Using T-square and triangles to draw lines at angles of 15°, 30°, 45°, 60° and 75° to the horizontal. Arrows indicate the direction in which the lines should be drawn.

142.319

PARALLEL AND PERPENDICULAR LINES

To draw a line parallel to a given line (fig. 5-6A), adjust the hypotenuse of a triangle in combination with a straightedge (T-square or triangle) to the given line; then, holding the straightedge firmly in position, slip the triangle to the desired position and draw the parallel line along the hypotenuse.

To construct a line perpendicular to an existing line, use the triangle and straightedge in combination, with the hypotenuse of the triangle resting against the upper edge of the straightedge (fig. 5-6B). Adjust one leg of the triangle to a given line. Then slide the triangle along the supporting straightedge to the desired position. The line is drawn along the leg, perpendicular to the leg that was adjusted to the

given line. In the same manner, angles with multiples of 15° may be drawn using the triangle combinations shown in figure 5-4.

CURVED LINES

Many drawings that you will prepare required the construction of various curved lines. Basically there are two types of curved lines: circles and segments of circles, called arcs, which are drawn with a compass; and noncircular curves which are usually drawn with french curves. In this chapter we will discuss only techniques for using the compass and the french curve. Application of compass techniques in geometric construction will be covered in chapter 7.

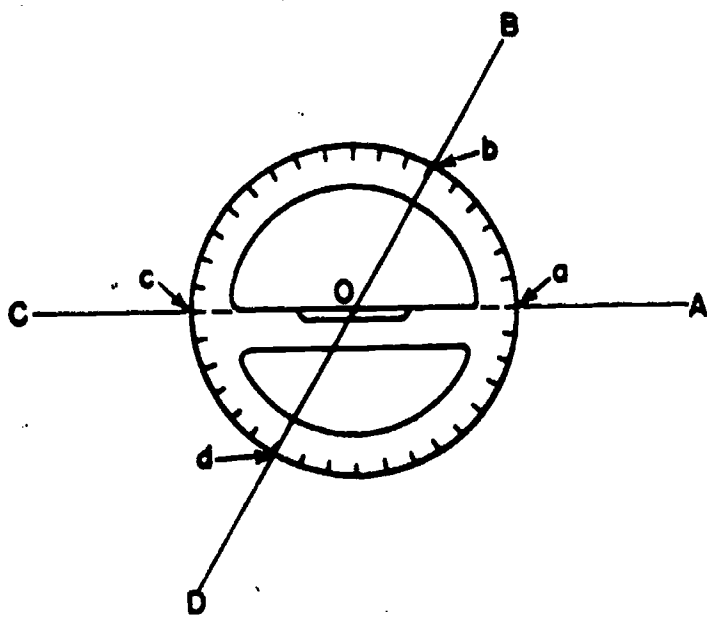

45.126

Figure 5-5.—Protracting an angle.

Use of Compass

When you are drawing circles and arcs, it is important that the lines produced with the compass are the same weight as corresponding

pencil lines. Since you cannot exert as much pressure on the compass as you can with pencils, you should use a compass lead that is about one grade softer than the pencil used for corresponding line work. For dim construction lines, use 4H to 6H leads. Avoid using leads that are too short.

The compass lead should be sharpened with a single elliptical face as shown in figure 5-7. A sandpaper pad works best for sharpening compass leads. The elliptical face of the lead is normally placed in the compass so that it faces outward from the other compass leg. Adjust the shoulder-end needlepoint so that the point extends slightly farther than the lead. With needlepoint pressed lightly in the paper, the compass should be centered vertically when the legs are brought together.

Bow compasses and pivot joint compasses are used in the same manner. To draw a circle with a compass, lightly press the needlepoint into the drawing paper and rotate the marking leg around it. Always rotate the compass clockwise. As you rotate, lean the compass slightly forward. With a little practice you will find that you can easily draw smooth circles using only the thumb and forefinger of one hand. It is important that you use an even pressure as you rotate the compass. You may find it necessary to rotate the compass several times to produce a circle with a uniform dense black line.

When you wish to set the compass to draw a circle of a given diameter, use a piece of scratch paper and follow the steps listed below, referring to figure 5-8.

1. Draw a horizontal line with a straightedge.

2. With the straightedge as a base, use a triangle and draw a vertical line intersecting the horizontal line (fig. 5-8A).

3. Measure the radius of the circle with a scale, as shown in figure 5-8B, and draw a second vertical line from this point.

4. Set the needlepoint at the intersection of the first vertical line and the horizontal line (fig. 5-8C). This is the center of the circle.

5. Set the marking leg to fall on the intersection of the second vertical line and the horizontal line (fig. 5-8D).

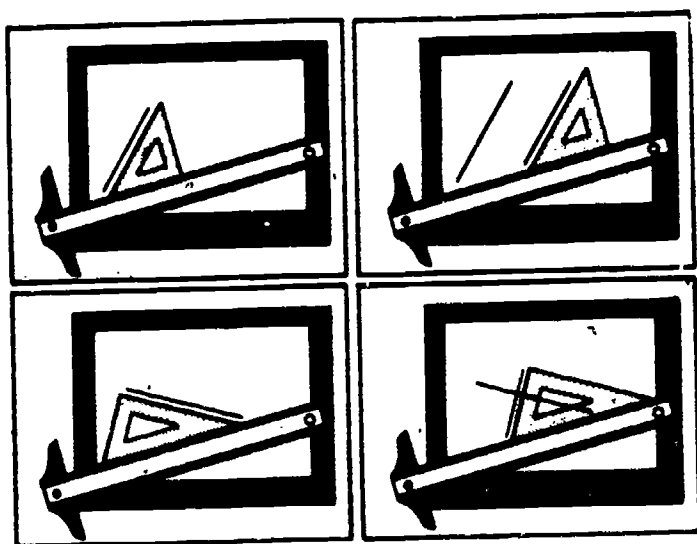

29.27G

Figure 5-6.—Drawing parallel and perpendicular lines.

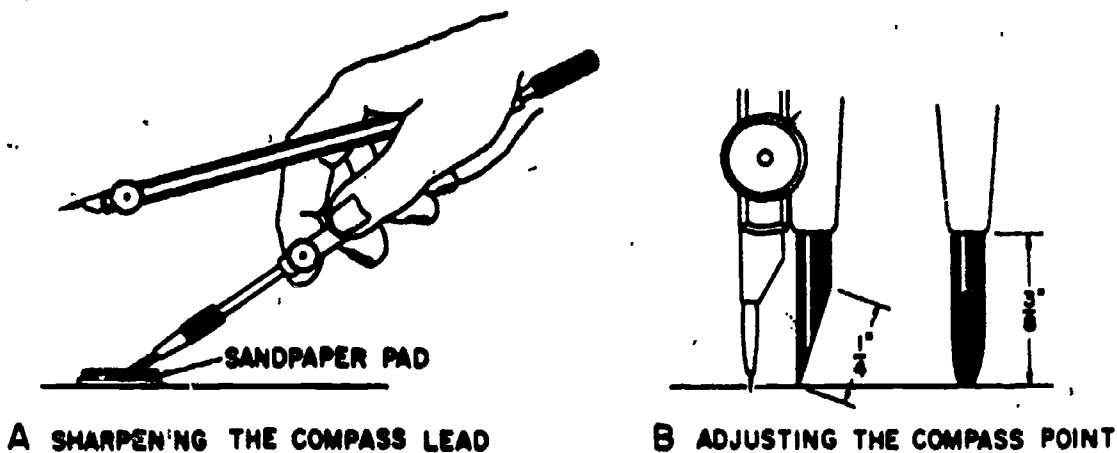

Figure 5-7.—Sharpening the compass lead and adjusting the point.

45.853

6. Draw a half circle with the compass (fig. 5-8E).

7. Check your work by measuring the diameter established by this half circle with a scale (fig. 5-8F).

Once you have set the compass to the exact radius of the circle, handle it very carefully so that you don't disturb the setting. Set the needlepoint at the center of the circle and carefully rotate the compass to draw a line describing the circumference of the circle. Do not apply too much pressure on the needlepoint or it will bore a hole in the paper and you will lose the accurate center mark.

When you are using the pencil leg to draw circles smaller than 1 inch in radius, keep the adjustable pencil and needle legs straight. For larger circles, both legs should be adjusted so that they are perpendicular to the paper. On the other hand, when you are using the compass with the pen leg, you **MUST** adjust it at the hinge joint to keep it perpendicular to the paper for all size circles. (See fig. 5-9A.) If the pen is not perpendicular to the paper, ink will not flow properly. To draw large circles, insert the extension bar in the pen or pencil leg, as shown in figure 5-9B. When the extension bar is used to draw large circles, the compass becomes awkward to use with only one hand. Both hands should be used as shown in figure 5-9B.

Use of French Curves

The french curve is used to draw a smooth line through predetermined points. After the points are plotted, a light pencil line should be sketched to connect the points in a smooth flowing line. To draw the finished line over the freehand line, match the various parts of the french curve to various segments of the freehand curve. Avoid abrupt changes in curvature by placing the short radius of the french curve toward the short radius portion of the line to be drawn. Change your position around the drawing board when necessary so that you can work on the side of the french curve which is away from you. You should avoid working on the "under" side of the french curve. Place the french curve so that it intersects at least two points of the line. When drawing the line along the edge of the french curve, stop short of the last point intersected. Then move the french curve along to intersect two or three more points and make sure that the edge of the curve connects smoothly with the line already drawn. When using the irregular curve, you can draw a perfectly smooth curved line by plotting enough points (the sharper the curve, the more points you need) and by drawing in short steps.

Figure 5-10 shows how a smooth line is drawn through a series of plotted points. The french curve in view A matches points 1, 2, 3, and 4. Draw a line from 1 to 3 only (not to 4).

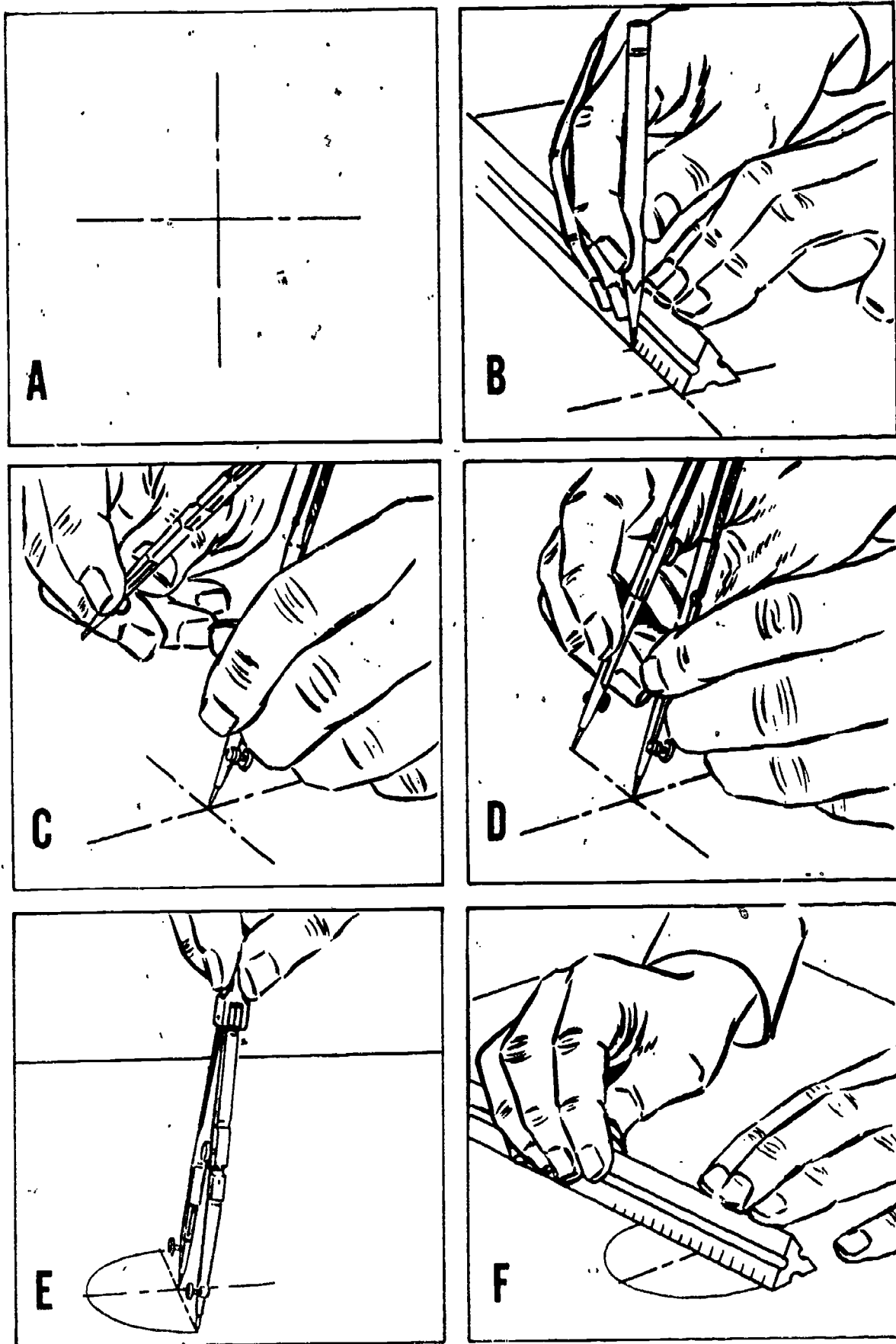
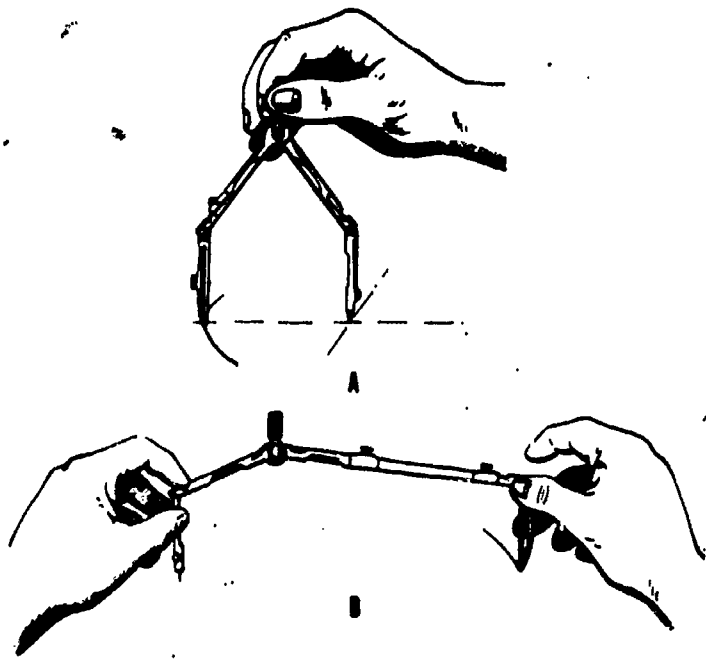

Figure 5-8.—Drawing a circle of given radius in pencil.



45.159

Figure 5-9.—Drawing a circle in ink.

At (B), the curve matches points 3 to beyond 4. Draw a line from 3 to 4 only (not to 5).

At (C), it matches points 4, 5, and 6. Draw a line from 4 to just short of 6.

At (D), it matches a point short of 6 to beyond 7. Draw a line from 6 to 7.

At (E), it matches a point short of 7 to beyond 9. Draw a line from 7 to 9.

At (F), it matches a point short of 9 to beyond 11. Draw a line from 9 to 11.

You will probably notice how the french curve is turned over and reversed to find portions which fit the points on the line with increasing or decreasing changes in curvature.

When you are drawing a curved line that extends into a straight line, the curve should be drawn first, and the straight line joined to it.

USE OF DRAFTING TEMPLATES

Drafting templates should be used only when accuracy can be sacrificed for speed.

Circles or arcs, for example, can be drawn more quickly with a template than with a compass. Templates must be used properly to be effective.

To draw a circle with the circle template (fig. 5-11), lay out centerlines on the drawing where the circle is to be drawn. Then place the correct circle opening over the centerlines so that the quadrant lines on the template coincide with the centerlines on the paper. Draw the circle, using a sharp, conical point on the pencil. Allowance must always be made for the width of the pencil line in placing the template opening in the right position on the drawing.

To draw an arc, lay out tangent lines on the drawing. Then place the correct size circle of the template on the paper so that the template quadrant lines coincide with the tangent lines, and draw the arc.

When using a template, you must hold it down firmly to keep it from slipping out of position. Figures or circles from the template must be drawn with the correct line weight on the first setting as it is difficult to reset the template in the exact position.

USING THE DIVIDERS

As we stated in chapter 4, dividers are used to transfer measurements, to step off a series of equal distances, and to divide lines into a number of equal parts. Dividers are manipulated with one hand. In setting dividers (fig. 5-12A), one leg is held between the thumb and the first and second fingers and the other is held between the third and fourth fingers; the second and third fingers are placed on the inside of the legs and the dividers are opened by spreading these fingers apart. Dividers are closed by squeezing the thumb and first finger toward the fourth finger while gradually slipping out the other two fingers.

To transfer measurements on a drawing, set the dividers to the correct distance, then transfer the measurements to the drawing by pricking the drawing surface very lightly with the points of the dividers.

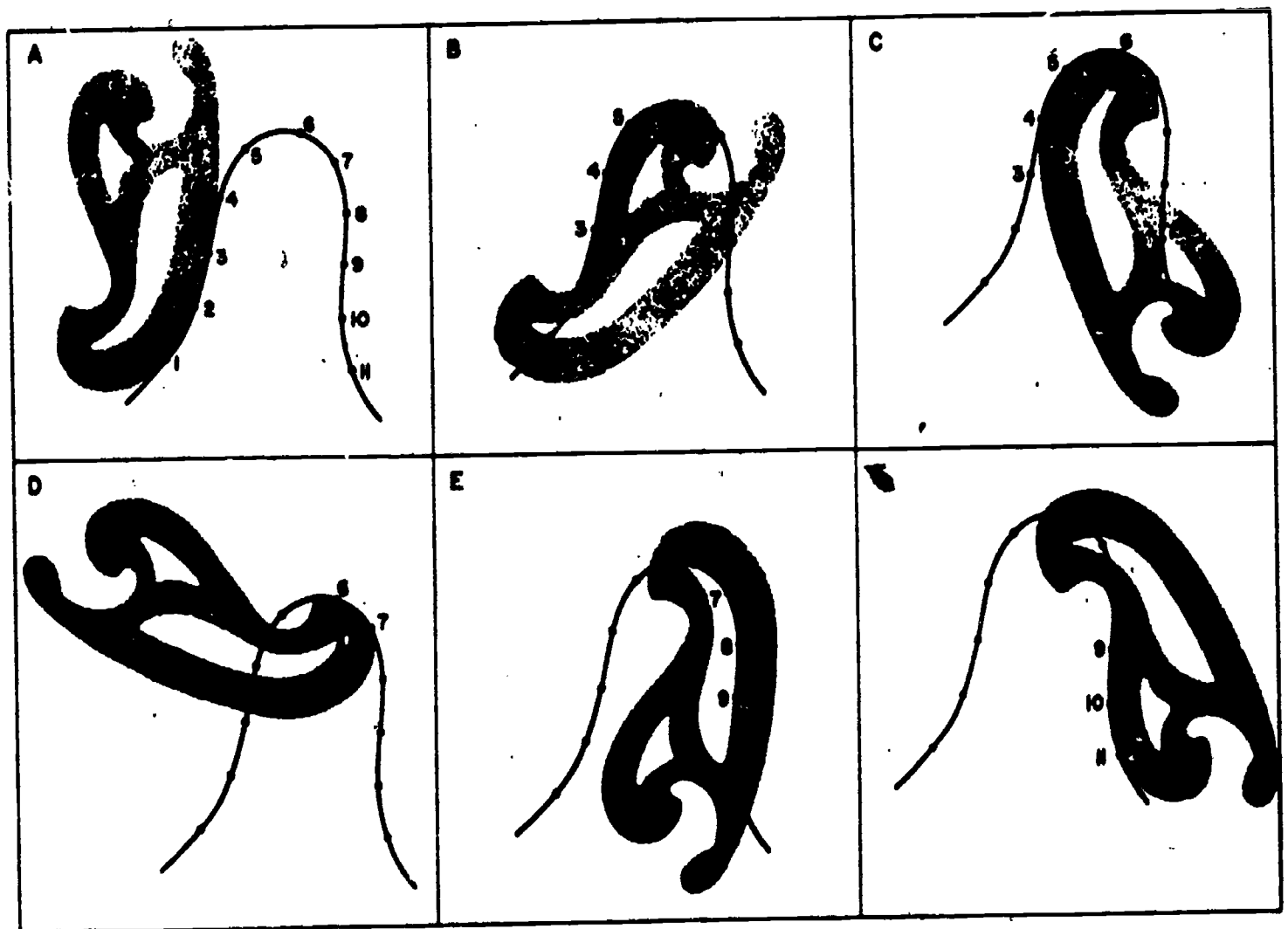

45.128

Figure 5-10.—Use of the french curve.

To measure off a series of equal distances on a line, set the dividers to the given distance. Then step off this distance as many times as desired by swinging the dividers from one leg to the other along the line, first swinging clockwise 180° , then counterclockwise 180° , and so on.

In dividing either a straight line (fig. 5-12B) or a curved line (fig. 5-12C) into a given number of equal parts by trial (for example, four), open the dividers to a rough approximation of the first division (in this case, one quarter of the line length) and step off the distance lightly, holding the dividers by the handle and pivoting the instrument on alternate sides of the line at each step. If the dividers fall short of the end of the line after the fourth step, hold the back leg in

place and advance the forward leg, by guess, one quarter of the remaining distance. The procedure is repeated until the last step falls at the end of the line. Be careful during this process not to punch holes in the paper, but just barely mark the surface for future reference. To identify prick marks made with small dividers for future reference, circle the mark lightly with a pencil.

USING THE SCALE

Accuracy in drawing depends to a great extent upon correct use of the scale in marking off distances. You should place the edge of the scale parallel to the line being measured (fig.

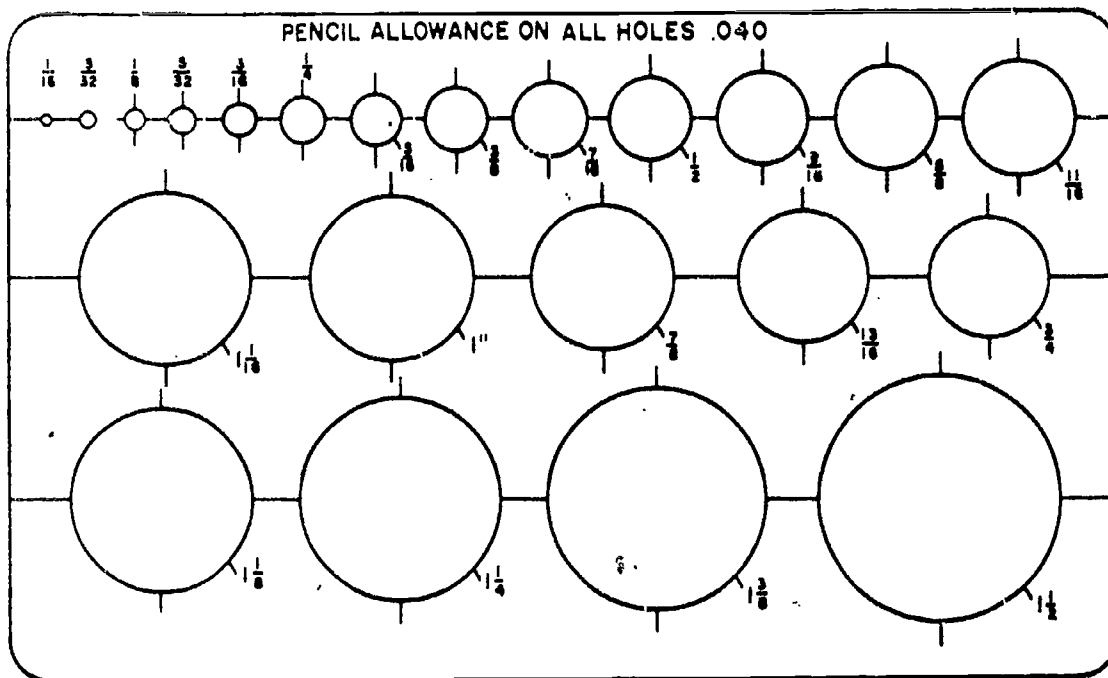

45.854

Figure 5-11.—Circle template.

5-13). To eliminate shadows cast by your body or hands, point the desired scale face away from you for horizontal measurements and toward your left for vertical measurements. With a sharp pencil, mark off short dashes at right angles to the scale at the correct distances, aligning the mark carefully with the scale graduation. Have your eye approximately over the point being measured, and make light marks to denote the point of measurement.

When setting the compass to a given radius or when setting divider points, never place the sharp points of these instruments on the scale. Lay out the desired radius or distance on a straight pencil line by using the scale in the manner described above. Then adjust the compass or dividers to the indicated length by using the measured line. A scale surface marred by pin pricks is difficult to read and is unsuitable for accurate work.

In making successive measurements along the same line, make as many measurements as possible without moving the scale. If a number of distances are to be laid out end to end, hold the scale in one position and add each successive

measurement to the preceding one. If the scale is moved to a new position each time, slight errors in measurement may accumulate. For example, four successive measurements of $1\frac{5}{8}$ " each should give an overall length of $6\frac{1}{2}$ ", not $6\frac{9}{16}$ ". Therefore, make as many measurements as you can without changing the reference point. This will avoid cumulative errors in the use of the scale.

Note that your pencil touches the scale only for the purpose of marking a point on the paper. Never use a scale as a straightedge for drawing lines. A typical office ruler has a metal edge—it is a scale and straightedge combined. But a draftsman's measuring scale is for measuring only—it is not a ruler. A scale properly used will last for decades, but a scale used as a straightedge will soon have the graduations worn away.

USING THE RULING PEN

The beginner is usually frightened at the prospect of trying to ink a drawing without spoiling it. Once you have learned how to use

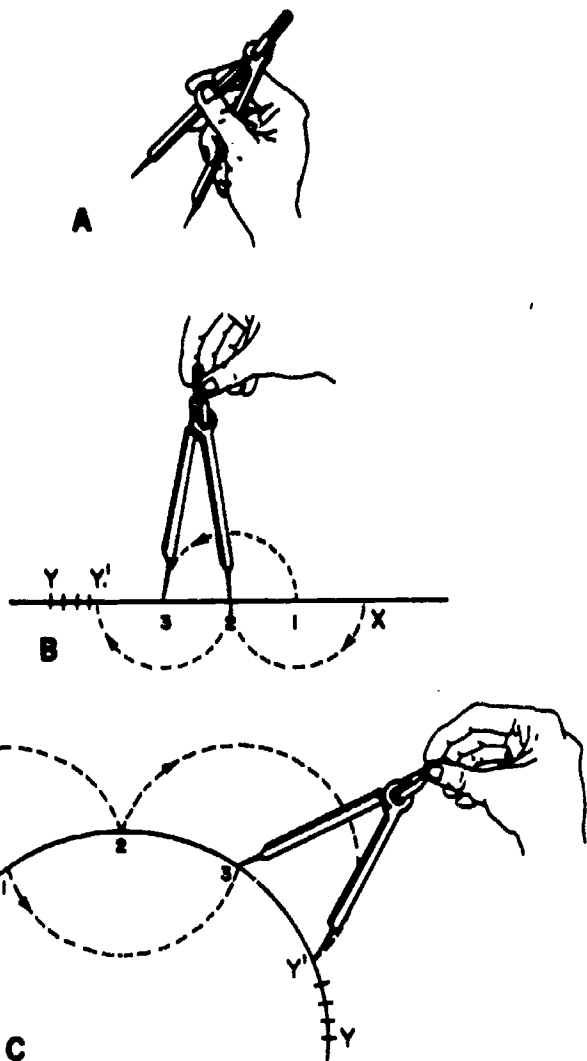

45.132

Figure 5-12.—Using dividers.

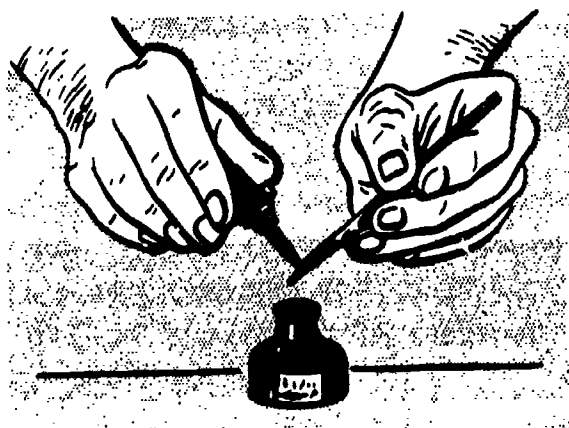

45.126

Figure 5-14.—Using ink-bottle dropper to fill a ruling pen.

drawing instruments and to follow a definite order of inking (described later in this chapter), you will have greatly reduced the danger of spoiling a drawing.

The basic instrument used for inking lines is the ruling pen (described previously in chapter 4). It is used with the straightedge or french curve to ink straight and curved lines. The ruling pen should never be used to ink freehand lines.

FILLING THE PEN.—Before filling a ruling pen, be sure it is clean. (New pens should be washed to remove the thin film of oil that is usually applied by the manufacturer.) Adjust the nibs to the approximate line width you want. The ordinary 2-ounce bottle of India ink is provided with a dropper, which is fastened to the stopper, for use in filling a ruling pen. Figure 5-14 shows how the dropper from the ink bottle is used to fill the pen. Insert it between the nibs of the pen until the ink rises to about $\frac{3}{16}$ of an inch from the tip. (Overloading will cause a blot or an uneven line.) If you do not have a dropper attached to the top of the ink bottle, an ordinary writing pen dipped in ink and passed between the blades of the ruling pen will fill it satisfactorily.

Before you start to draw with the ruling pen, carefully remove any ink from the outside of the

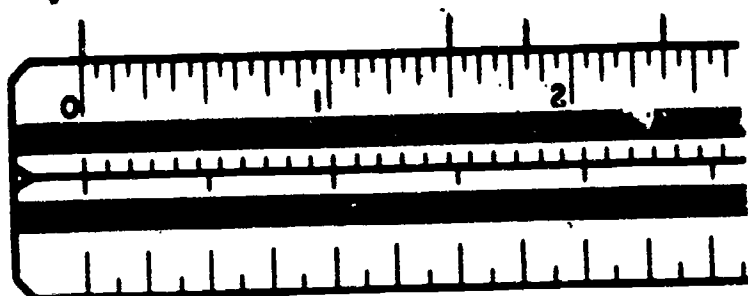

45.855

Figure 5-13.—Use of the scale.

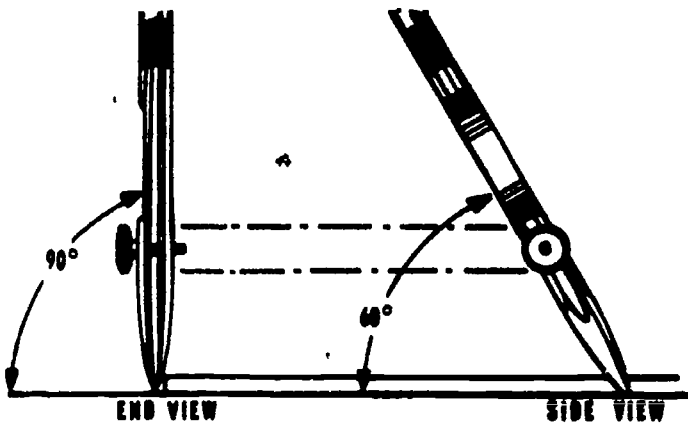

45.116A

Figure 5-15.—Drawing lines with a ruling pen.

nibs and test the width of the line on a scrap of your drawing paper. If the line is not the right width, make an adjustment of the setscrew.

One last word about filling and adjusting the ruling pen: **NEVER FILL OR ADJUST THE PEN OVER YOUR DRAWING.** Ink spilled on a finished drawing could be disastrous.

DRAWING LINES.—When drawing, hold the ruling pen with the setscrew pointed away from you, ensuring that both nibs touch the paper lightly. The pen should be held at approximately

a 60°-70° angle leaning in the direction in which you are inking (fig. 5-15).

If the handle is tilted toward the straightedge, one of the nibs will lift from the paper and your line will be weak. If the nibs are pressed too hard against the straightedge, you will force one closer to the other and your line will not be uniform in width. If you tilt the handle of the pen away from the straight edge, the nibs will be thrown in contact with the straightedge and ink may bleed under it. Some of the results of improper use of the pen are shown in figure 5-16.

One good way to avoid smeared ink lines is shown in figure 5-17. This method consists of fastening several strips of tape, or thin pieces of plastic, to both faces of the triangles and french curves. These strips, called **SPACE BLOCKS**, raise the edges of the triangles and french curves from the paper and prevent ink from running under the edge. The strips must be placed back from the edges far enough to leave an open space between the triangle edge and the paper. If you have extra triangles and french curves, it is best to use one set, with space blocks attached, only for inking.

When you use a ruling pen with a T-square or straightedge, make long lines with a whole

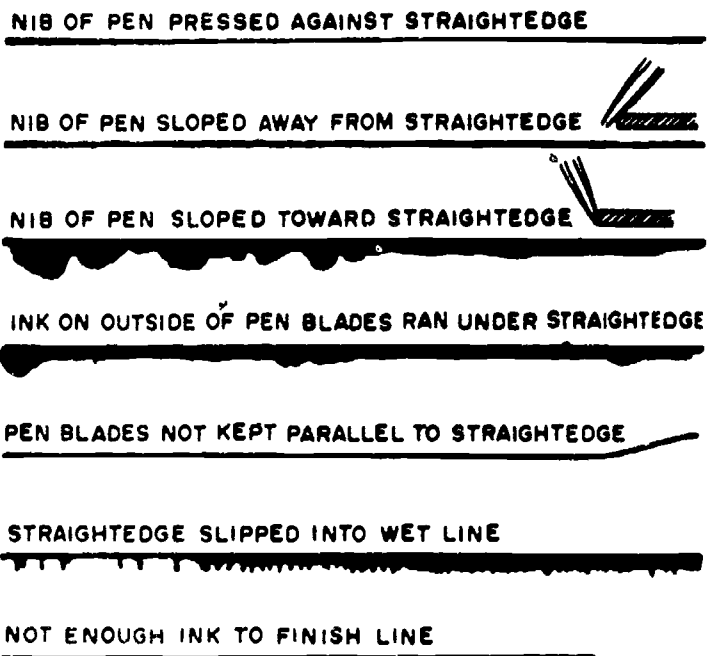

45.156

Figure 5-16.—Defective ink lines and their causes.

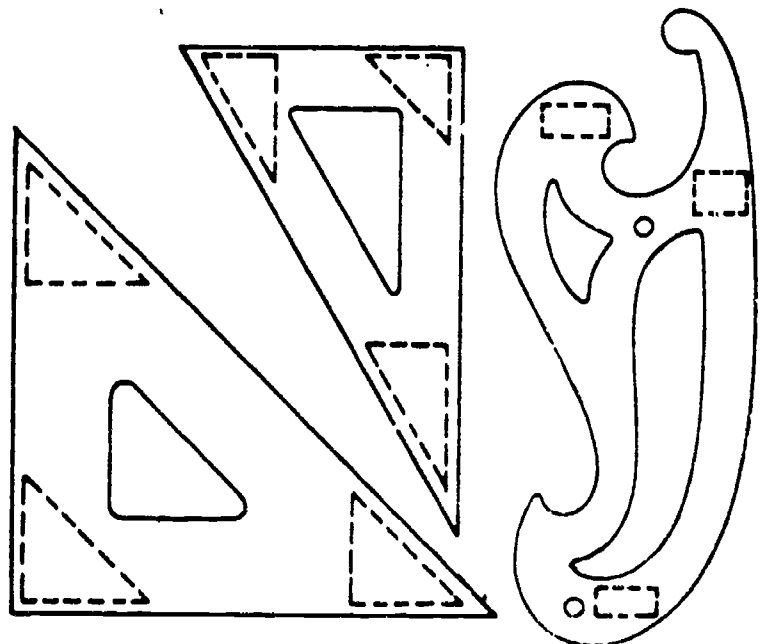

45.856

Figure 5-17.—Space blocks.

arm movement by sliding your pen hand along the blade, while you keep the straightedge steady with your other hand. Just before reaching the end of a line, slow down and finish with a finger movement to keep from overrunning the line. For greater control in stopping, short lines and the ends of long lines, should be drawn with a finger movement. When the end of a line is reached, lift the pen vertically, and carefully remove the guide.

Draw horizontal lines from left to right, starting at the top of the drawing and working down. (If you are left handed, you will, of course, draw these lines from right to left, and similarly reverse many of the directions given in this training manual.)

Vertical lines are usually drawn in an upward direction, moving from left to right across the drawing. However, when you have to draw a number of vertical lines or lines slanted in the same direction, how you draw them will be governed by the source of your light and the way you have found that you can draw vertical lines with greatest control.

Let the first lines dry before starting to draw any intersecting lines. Watch carefully when you draw one line across another line. If the ink starts to run down the dry line under your straightedge, lift the pen quickly from the drawing and move the straightedge carefully.

If the ink is stubborn and refuses to flow, draw the pen tip quickly over a piece of scratch paper. If it is still sluggish, examine your pen to see if it needs cleaning or if it is worn.

CARING FOR THE PEN.—Clean your pen by dipping the tip in water, in a mixture of water with a little ammonia, or in a pen cleaning solution. Then wipe the balde thoroughly, inside and out, with a soft, lint-free cloth.

Because ink hardens in the pen rapidly, you will have to wipe your pen several times during the course of a few hours of work. Don't subject your pen to unnecessary wear by stroking it too often on scratch paper when the ink fails to flow easily; clean it instead. Always put it away clean,

with its nibs well separated to release the tension on the steel.

DRAWING FORMATS

Drawing format is the systematic arrangement of sheet space to standardize the location of required information. This information is used to identify, process and file drawings methodically. Sizes and formats for military drawings are arranged in accordance with certain standards. Standard drawing sizes and basic format used for all Navy drawings are specified in Military Standard MIL-STD-100A, *Engineering Drawing Practices*. With the exception of specific NAVFAC and local command requirements, MIL-STD-100A is your guideline for preparing SEABEE drawings. Unless otherwise stated, the following format is in accordance with MIL-STD-100A.

SHEET SIZES

Standard drawing sheet sizes are used to facilitate uniform filing. Blueprints produced from standard size drawing sheets are easily assembled in sets for project stick files. Since standard drawing sheet sizes are modulars of a standard letter (8 1/2" x 11"), blueprints can readily be folded for mailing and neatly filed in project letter size or legal size folders. (Filing drawings and folding blueprints will be covered later in this training manual.)

Finished format sizes for drawings are shown in figure 5-18. Flat size refers to drawings that, because of their relatively small size, should be stored or filed flat. Roll size refers to drawings that, because of their length, are filed in rolls. Finished format sizes for a drawing refer to the dimensions between trim lines (X and Y in figure 5-18). The TRIM LINE is the outside line of the margin (Z). The inside lines of the margin (Z) are called BORDERLINES. Width (X) is always PARALLEL to the working edge of the drawing board; length (Y) is always PERPENDICULAR to the working edge of the drawing board.

Notice, in figure 5-18, that 2 inches should be added to the left margin and 4 inches added to the right margin for protection of roll-size

FLAT SIZES				ROLL SIZES				
SIZE DES (LTR)	X (WIDTH)	Y (LENGTH)	Z (MARGIN)	SIZE DES (LTR)	X (WIDTH)	Y MIN (LENGTH)	Y MAX (LENGTH)	Z (MARGIN)
A (HORIZ)	8.50	11	.25 & .38*	G	11	42	144	.38
A (VERT)	11	8.50	.25 & .38*	H	28	48	144	.50
B	11	17	.38	J	34	48	144	.50
C	17	22	.50	K	40	48	144	.50
D	22	34	.50					
E	34	44	.50					
F	28	40	.50					

* HORIZONTAL MARGINS .38-INCH; VERTICAL MARGIN .25-INCH, SEE FIGS. 5-19 & 5-20

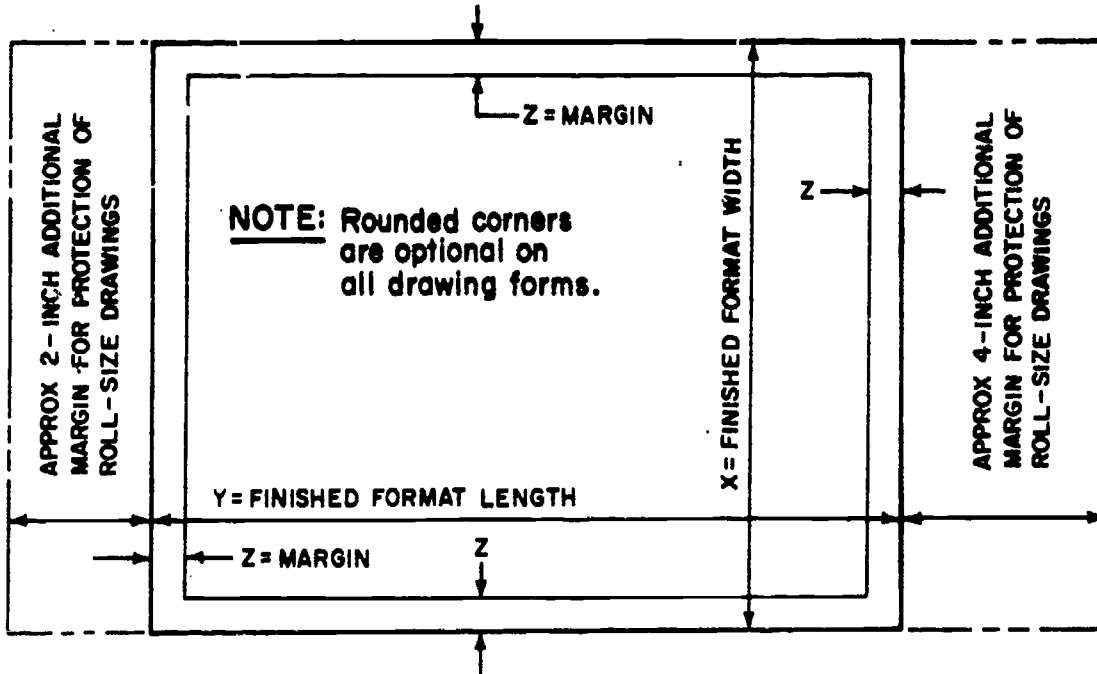

45.857

Figure 5-18.—Finished format sizes (inches).

drawings. The edge of a drawing prepared on tracing paper will tear easily after it is rolled and unrolled several times.

SHEET LAYOUT

Sheets of drawing or tracing paper are cut slightly larger than their required finished sizes and are fastened to the drawing board as previously described. Using a hard (4H to 6H)

pencil and a T-square (or parallel straightedge), draw a horizontal trim line near the lower edge of the paper. Then draw a vertical trim line near the left edge of the paper with a T-square (or parallel straightedge), pencil, and triangle as previously described. Dimensions establishing the finished length of the sheet (distance between vertical trim lines) and the location of the vertical borderlines are marked off on the horizontal trim lines. The full-size scale should

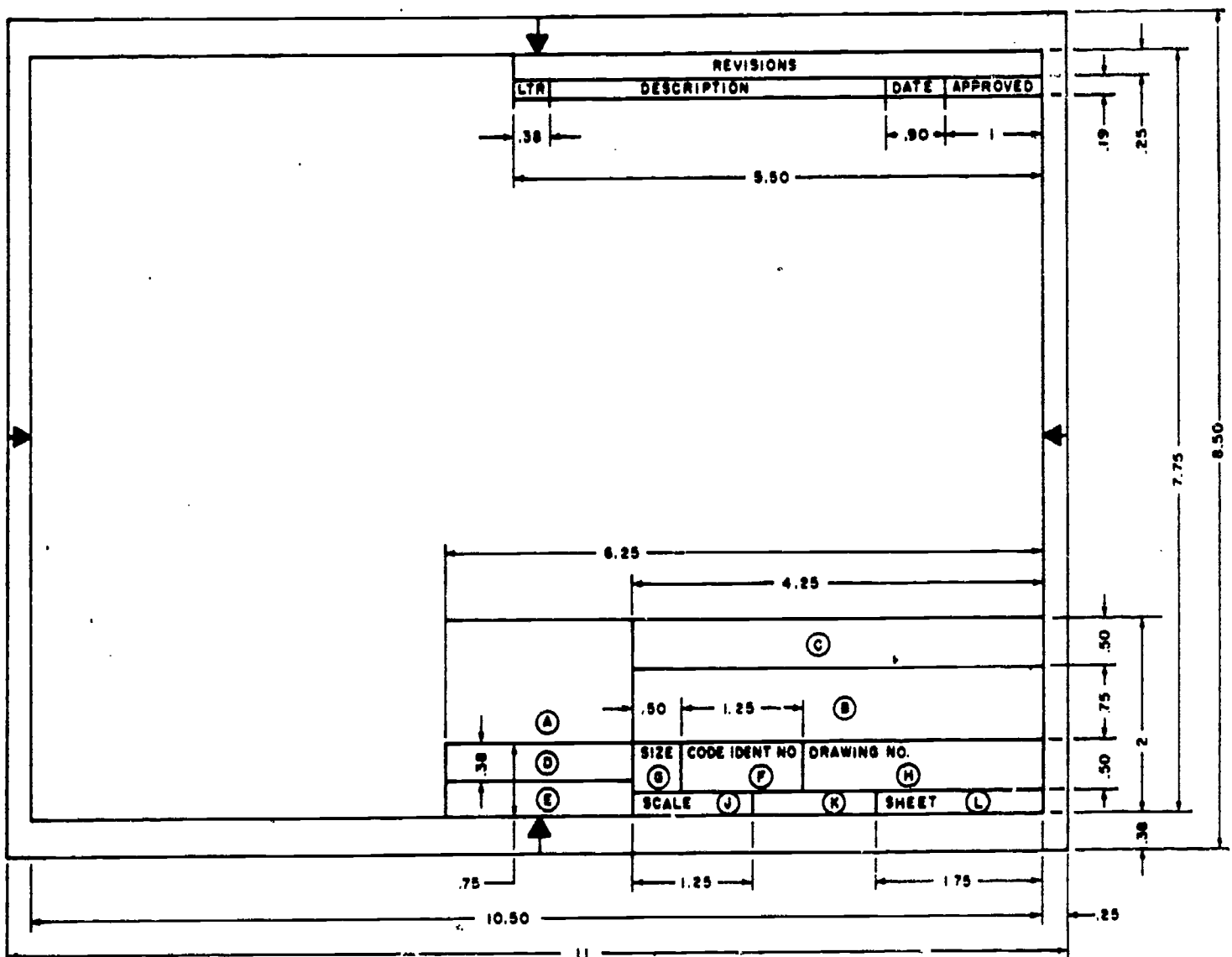

45,858

Figure 5-19.—Horizontal format for "A" size drawings.

be used when laying off a series of measurements along a line. Dimensions establishing the finished width of the sheet (distance between horizontal trim lines) and the location of the horizontal borderlines, are marked off on the vertical trim lines. Dimensions may be scaled along the borderlines.

After the drawing is completed, borderlines are given the required weight. After the completed drawing has been removed from the board, it is cut to its finished size along the trim line. If blueprints are to be made on paper that is not pre-cut to the standard drawing size, you may find it necessary to leave an extra margin

outside the trim lines. By leaving an extra margin, the trim lines can be darkened. The darkened trim lines, when reproduced, will provide a visible line for trimming the blueprints to size. The extra margin will also help protect the drawing when it is repeatedly handled or attached to the drawing board later for revisions.

BASIC FORMAT

The following discussion deals with basic drawing format. By basic format, we mean the title block, revision block, and other information which must be placed on applicable

size drawing sheets. Although you may find slight variations on local command prepared drawings, basic format specified in MIL-STD-100A is required on all Navy drawings. In addition, for all drawings which are assigned NAVFAC drawing numbers, you must also follow certain NAVFAC guidelines specified in NAVFAC DM-6, *Drawings and Specifications*. Therefore, to provide you with a clear interpretation of both publications, the following format combines and modifies their requirements to serve as a useful training guide.

Title Block

The primary purpose of a drawing title block is to identify a drawing. Title blocks must be uniform in size and easy to read. They may be mechanically lettered, neatly lettered freehand, or preprinted commercially on standard size drawing sheets.

The title block is always placed in the lower right-hand corner of the drawing, regardless of the size of the drawing. Generally there are three sizes of title blocks: a small block used on A-size

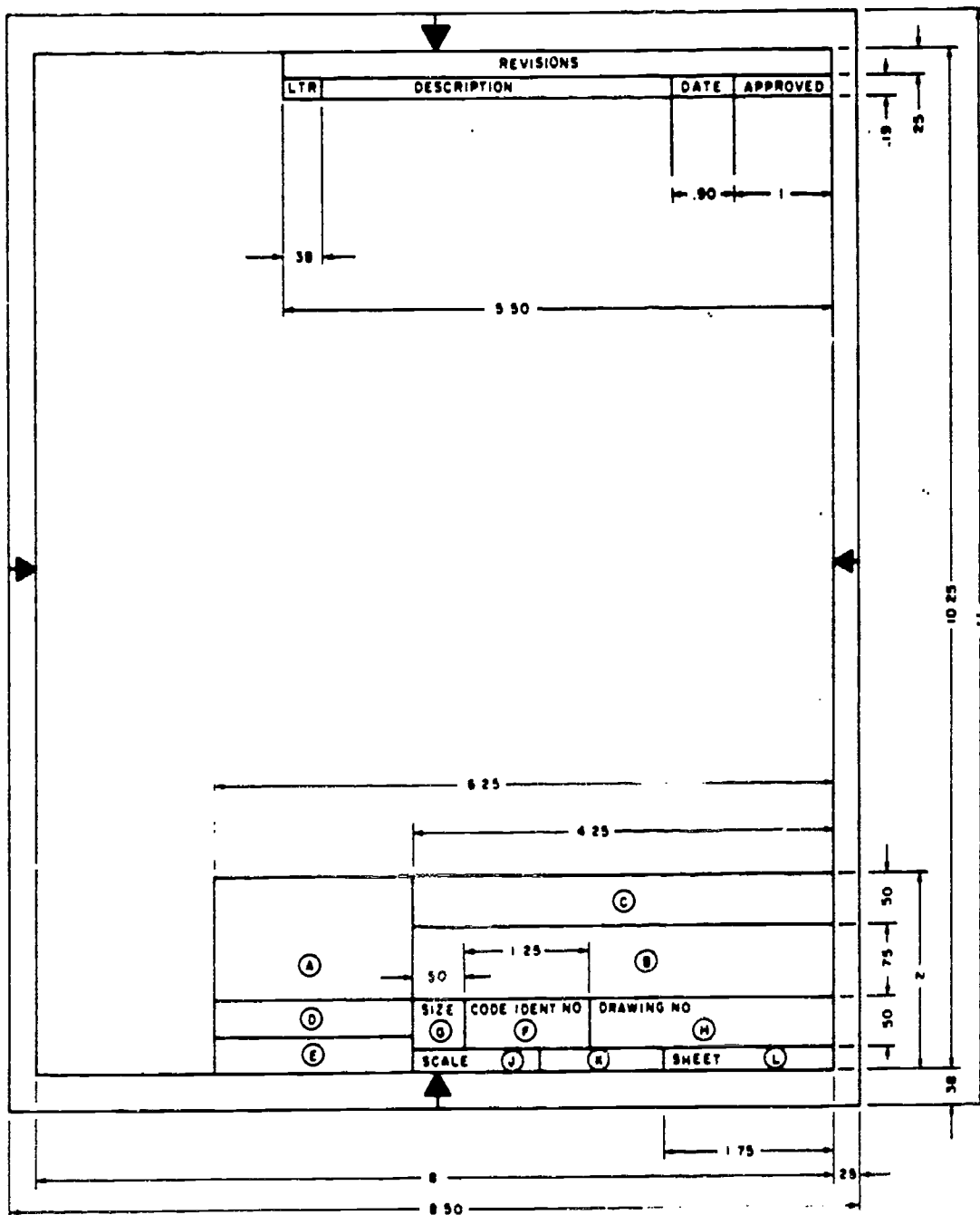

Figure 5-20.—Vertical format for "A" size drawings.

45.859

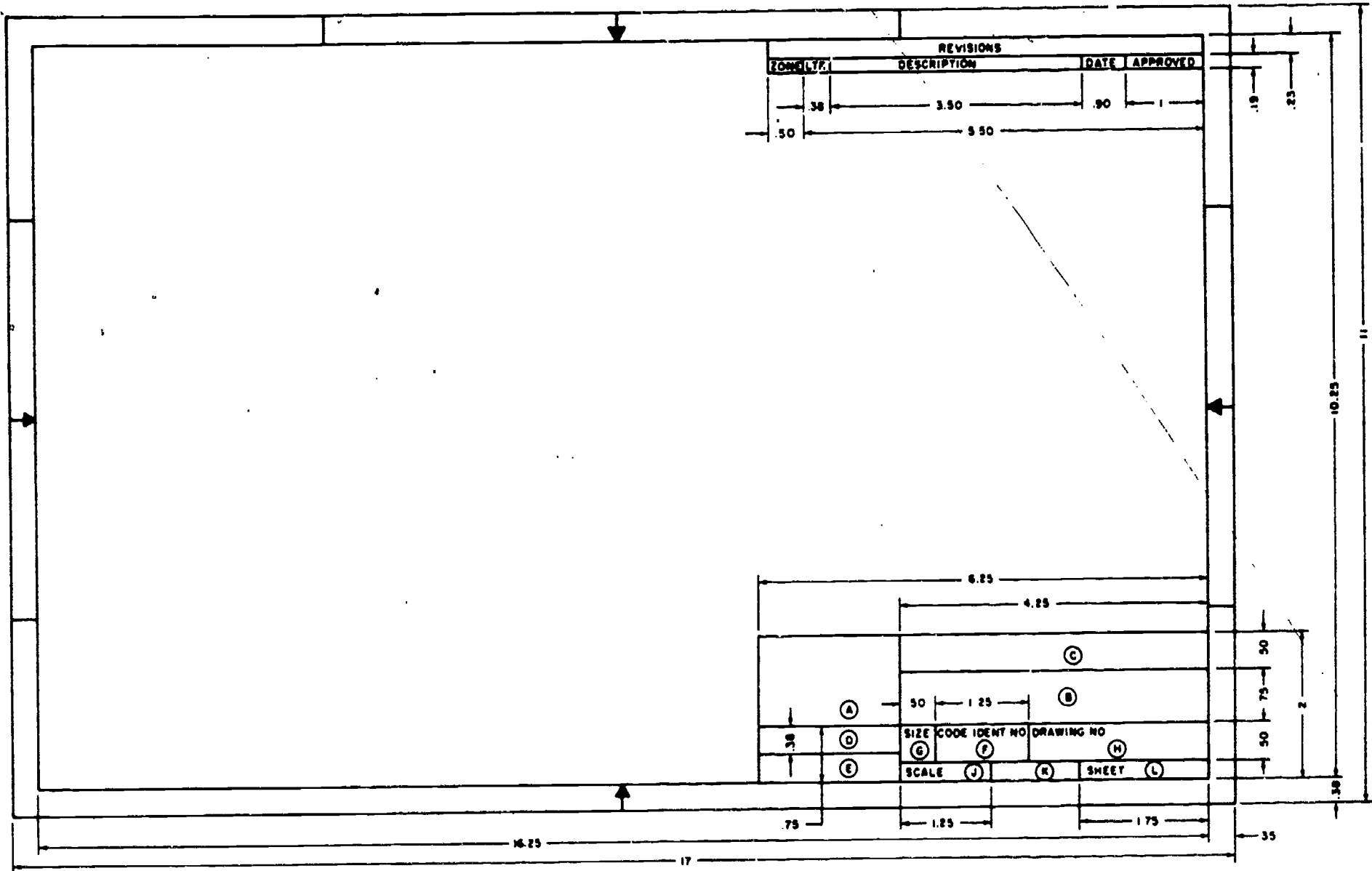

Figure 5-21.—Format for "B" size drawings.

BEST COPY AVAILABLE

drawings (figs. 5-19 and 5-20), a slightly larger block for B-size drawings (fig. 5-21), and a large block for all drawing larger than B size (fig. 5-22). The letter designations shown in figures 5-19 through 5-22 are used to locate the following general title block information.

(A) Record of preparation. This information will vary with each command or activity, but will normally include the surnames of the persons concerned with the preparation of the drawing. The applicable work request number or locally assigned drawing number may also be placed in the upper portion of this space.

(B) Drawing Title. In the space provided for the drawing title, the general project and the specific features shown on the drawing should be included.

The general project (RESTROOM FACILITIES; SEABEE PARK, in example 1) must be repeated in the title for each sheet of a set of project drawings. Example 2 is the title taken from the title block of a drawing contained in NAVFAC P-272, *Definitive Designs for Naval Shore Facilities*. In this example the general project or common title, DEFINITIVE DRAWING, appears as the top line title on all drawings in NAVFAC P-272.

(C) This space is reserved for the name and location of the activity preparing the drawing. In addition, the words DEPARTMENT OF THE NAVY are placed in this space.

The information placed in spaces (D) and (E) (figs. 5-19 through 5-22) varies with each command and the purpose of the drawing (See fig. 5-23.) One space is usually reserved for the signature of (APPROVED BY) your commanding officer or officer-in-charge, and the other space is for the signature of the commander of the activity or command requiring the drawing (SATISFACTORY TO). As shown in the examples in figure 5-23, these two spaces may be used interchangeably. This is acceptable as long as consistency is maintained. It is also acceptable to use only space E when a

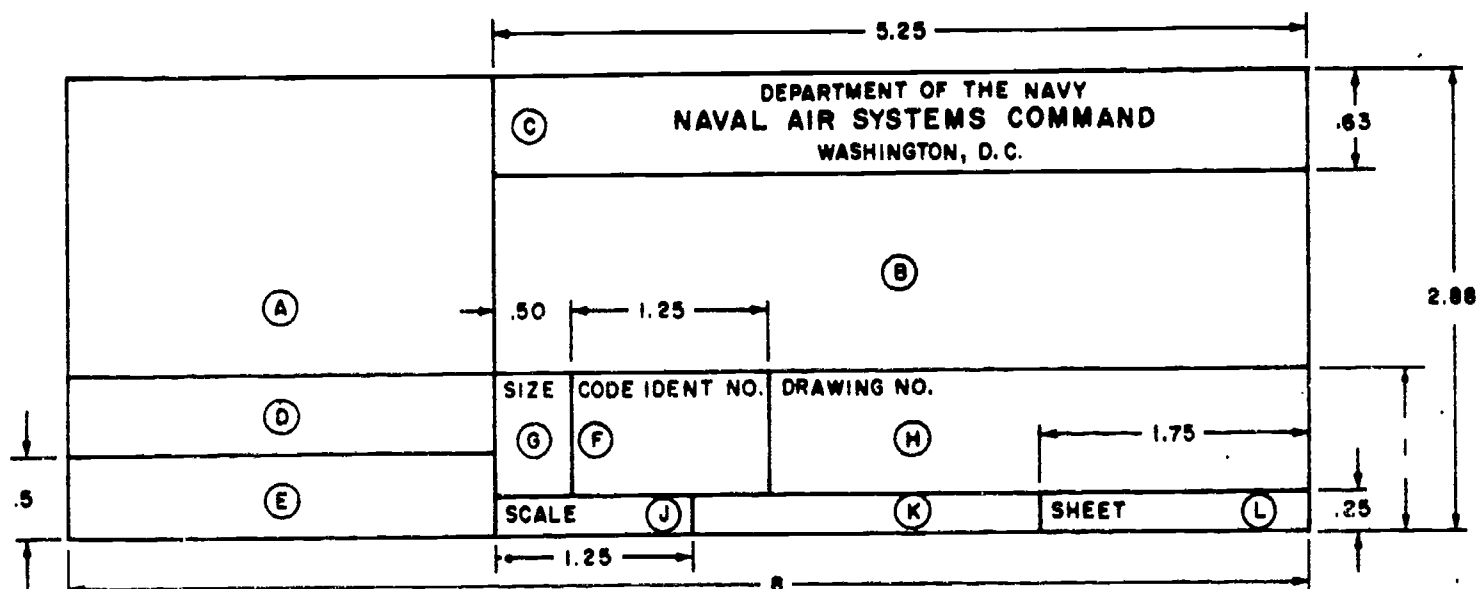
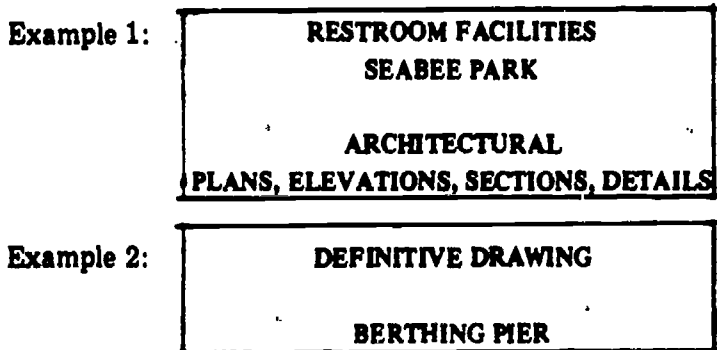

Figure 5-22.—Title block. All sizes except "A" and "B".

Chapter 5--DRAFTING: BASIC TECHNIQUES, FORMAT, AND CONVENTIONS

MCB-10 DRAWING NO.		DEPARTMENT OF THE NAVY		NAVAL FACILITIES ENGINEERING COMMAND	
		US NAVAL MOBILE CONSTRUCTION BATTALION TEN		CALIFORNIA, U.S.A.	
		FPO SAN FRANCISCO			
DES					
OR					
CHK					
ENGR OFF					
OPERATIONS OFF					
APPROVED	DATE	SIZE	CODE INDENT NO.	NAVFAC DRAWING NO.	
			80091		
COMMANDING OFFICER					
SATISFACTORY TO	DATE			CONSTRUCTION CONTR NO.	
		SCALE		SPEC	SHEET ____ OF ____

REQUEST NO.	31st NAVAL CONSTRUCTION REGIMENT PORT HUENEME, CALIFORNIA				
REF. DRG.					
DESIGNED BY					
DRAWN BY					
CHECKED BY					
DEPT. HEAD					
SATISFACTORY TO	DATE				
		PWKS APPROVED		DATE	31 NCR DWG. NO.
TITLE					
31 NCR APPROVED	DATE				
		SCALE		SHEET ____ OF ____	
OPERATIONS OFFICER					

45.862

Figure 5-23.—Examples of title blocks used on Naval Construction Battalion and Naval Construction Regiment drawings.

SATISFACTORY TO space is not required for the drawing, as shown on the NAVFAC title blocks in figures 5-24 and 5-25. In this case the (E) space is extended upward or the (A) space may be extended downward if additional room is required in the (A) space.

(F) Code Identification Number. A five-digit number is used to identify the Government design activity—that is, the activity having responsibility for the design of an item. For most of your drawings, NAVFAC has the

ultimate design responsibility. Therefore, the identification number for most of your drawings will be 80091.

(G) Drawing Size. This space is reserved for the letter designating the drawing format size.

(H) Drawing Number. If the drawing is prepared for or by NAVFAC, a NAVFAC drawing number will be assigned. Assignment of NAVFAC drawing numbers is covered in NAVFAC DM-6. If the drawing does not require a NAVFAC drawing number, this space will be

ENGINEERING AID 3 & 2, VOLUME 1

PWO DWG REF		DEPARTMENT OF THE NAVY NAVAL FACILITIES ENGINEERING COMMAND			
SPACE SUBDIVIDED TO SUIT PRACTICE OF PWO		NAVAL SHIPYARD, LONG BEACH, CALIF			
APPROVED	DATE	SIZE	CODE IDENT NO.	NAVFAC DRAWING NO.	
			80091		
				CONSTR CONTR NO.	
OFFICER IN CHARGE		SCALE		SPEC	SHEET OF

45.863

Figure 5-24.—Example of title block prepared by an activity and not requiring NAVFAC or division approval. (For dimensions, see MIL-STD-100.)

left blank, and a local command drawing number will be placed in space (A). Occasionally, local title blocks require the drawing number to be placed in space (H) (Refer to fig. 5-23B).

(J) Scale. This space is reserved for the scale to which the drawing is prepared. When more

than one scale is used on the drawing, the words AS SHOWN or AS NOTED are entered after the word SCALE in the space (J). If the drawing was not to scale, the word NONE is entered.

(K) Specification Number. On drawings which are prepared for or by NAVFAC, this space is reserved for the project specification or

DSGN	DEPARTMENT OF THE NAVY				WASHINGTON, D.C.
DR	NAVAL FACILITIES ENGINEERING COMMAND				
CHK					
PROJ LDR					
BR HD					
SPL DES HD					
DIRECTOR					
APPROVED	DATE	SIZE	CODE IDENT NO.	NAVFAC DRAWING NO.	
			80091		
				CONSTR CONTR NO.	
FOR COMMANDER, NAVFAC		SCALE		SPEC	SHEET OF

45.864

Figure 5-25.—Example of title block prepared by NAVFAC HQ. (For dimensions, see MIL-STD-100.)

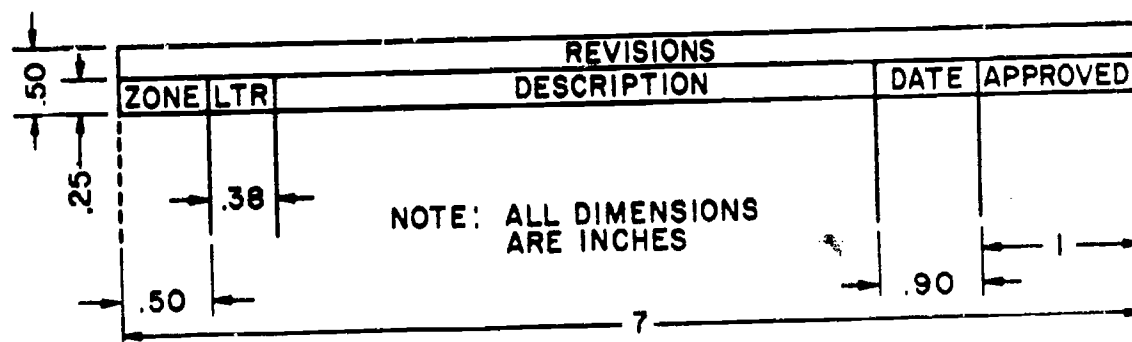

45.865

Figure 5-26.—Revision block. All sizes except "A" and "B".

contract number. If the drawing does not pertain to a particular project specification or contract, this space will normally be left blank.

Ⓛ **Sheet Number.** On a single construction drawing, SHEET 1 of 1 will be entered in this space. For a set of drawings which pertain to a complete project, sheets are numbered consecutively with the total number of sheets indicated on each sheet. For example: SHEET 1 of 3, SHEET 2 of 3, and SHEET 3 of 3.

Satisfactory To Block

In addition to spaces ⓓ and ⓔ on the title block, which are provided for approval signatures, a second SATISFACTORY TO block may be required when an outside activity requests a drawing. The extra SATISFACTORY TO block is identical to the SATISFACTORY TO space in the title block, but is located adjacent to title block space ⓔ.

Revision Block

A revision block contains a list of all revisions made to the drawing. On construction drawings, the revision block is placed in the upper right-hand corner. Basically, all revision blocks provide the same information, only the sizes of the blocks differ. (See figs. 5-19, 5-20, and 5-21 for A and B size drawings, and figure 5-26 for all other size drawings.) Revision information is entered chronologically starting at the top of the revision block.

Revision letters are used to identify a change or revision to a drawing. Upper-case letters are used in alphabetical sequence, omitting the letters "I", "O", "Q", and "X". The first revision to a drawing is assigned the "A". All changes to a drawing, incorporated at one time, are identified by the same revision letter. The changes may be numbered sequentially to permit ready identification of a specific change. In this case, the appropriate serial number will appear as a suffix to the revision letter (for example, A1, A2, A3, etc). Whenever possible, the revision letter will be placed near the actual change on the drawing. It should be placed so it is not confused with other symbols on the drawing. Usually the revision letter is placed inside of a circle or triangle (Ⓐ or ⚠). If a circle or triangle is used on the drawing, it should also be used in the revision block.

A brief description of each change is made in the description column, adjacent to its revision letter, in the revision block. The approval signature and date of revision are also entered in the appropriate columns.

The zone column on the standard revision block is normally omitted on construction drawings but may be used in reviewing maps. Zones are evenly spaced marks placed in the margin for locating an object on the drawing or map. (See fig. 5-21.) Use of zoning is described in MIL-STD-100A.

Like title blocks, revision blocks may vary with each command, and you will be required to

follow command guidelines. The procedure for making revisions to drawings is covered in MIL-STD-100A and in NAVFAC DM-6 for NAVFAC prepared drawings.

Bill of Materials

When a BILL OF MATERIALS block is used on a construction drawing, it is placed directly above the title block against the right-hand margin. A bill of materials is a tabulated list of material requirements for a given project. The size of the BILL OF MATERIALS block will depend on the size of the drawing and the number of material items listed. On most construction projects, it is impossible to list all items in a single BILL OF MATERIALS block; therefore, it is omitted from the drawings, and a separate list of materials is prepared by an estimator.

LINE CONVENTIONS

When you are preparing drawings, you will use different types of lines to convey information. Line characteristics, such as widths, breaks in the line, and zigzags, all have definite meanings. Figure 5-27, taken from MIL-STD-100A, shows the different types of lines which should be used on your drawings.

The widths of the various lines on a drawing are very important in interpreting the drawing. MIL-STD-100A specifies that three widths of line should be used: thin, medium, and thick. As a general rule, on ink drawings, these three line widths are proportioned 1:2:4, respectively. However, the actual width of each type of line should be governed by the size and the type of drawing.

On pencil drawings, the width of lines cannot be controlled as well as the width of lines drawn with pen and ink. However, pencil lines should be opaque and of uniform width throughout their length. Cutting plane and viewing plane lines should be the thickest lines on the drawing. Lines used for outlines and

other visible lines should be differentiated from hidden, extension, dimension, or centerlines.

CONSTRUCTION LINES

Usually the first lines that you will use on a drawing are construction lines. These are the same lines which you used to lay out your drawing sheet. They will also be used to lay out the rest of your drawing. Line weight for construction lines is not important since they will not appear on your finished drawing. They should be heavy enough to see, but light enough to erase easily. A 4H to 6H pencil with a sharp conical point should be used. With the exception of light lettering guidelines, all construction lines must be erased or darkened before the drawing is reproduced.

CENTERLINES







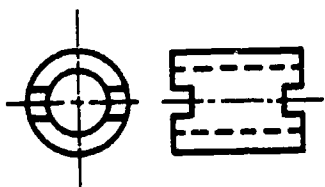

Centerlines are used to indicate the center of a circle, arc, or any symmetrical object. (See fig. 5-28.) Centerlines are composed of long and short dashes, alternately and evenly spaced, with a long dash at each end. They should extend at least 1/4 inch outside the object. At intersecting points, centerlines should be drawn as short dashes.

A very short centerline may be drawn as a single dash if there is no possibility of confusing it with other lines. Centerlines may also be used to indicate the travel of a moving center, as shown in figure 5-28.

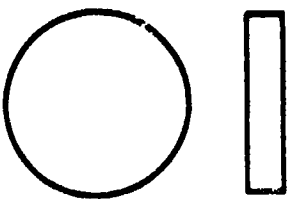
VISIBLE LINES

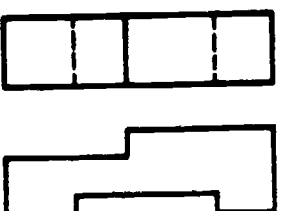
The visible edge lines of the view are drawn as solid, thick lines. These include not only the outlines of the view, but lines defining edges which are visible within the view. (See fig. 5-29.)

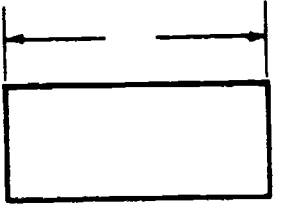

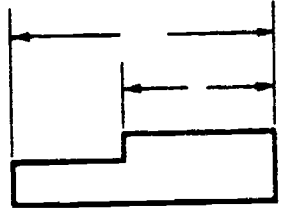





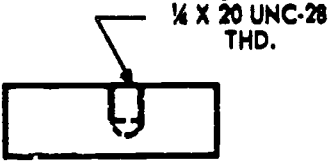

Hidden edge lines are drawn with short dashes and are used to show the hidden features of an object. A hidden line should begin with a

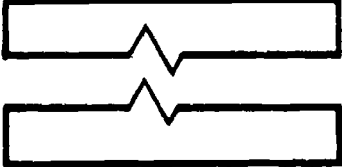
LINE STANDARDS			
NAME	CONVENTION	DESCRIPTION AND APPLICATION	EXAMPLE
CENTER LINES		THIN LINES MADE UP OF LONG AND SHORT DASHES ALTERNATELY SPACED AND CONSISTENT IN LENGTH USED TO INDICATE SYMMETRY ABOUT AN AXIS AND LOCATION OF CENTERS	
VISIBLE LINES		HEAVY UNBROKEN LINES USED TO INDICATE VISIBLE EDGES OF AN OBJECT	
HIDDEN LINES		MEDIUM LINES WITH SHORT EVENLY SPACED DASHES USED TO INDICATE CONCEALED EDGES	
EXTENSION LINES		THIN UNBROKEN LINES USED TO INDICATE EXTENT OF DIMENSIONS	
DIMENSION LINES		THIN LINES TERMINATED WITH ARROW HEADS AT EACH END USED TO INDICATE DISTANCE MEASURED	

142.46.1

Figure 5-27.—Line characteristics and conventions.

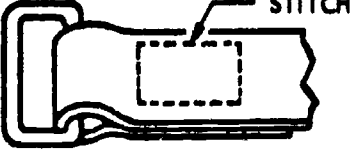
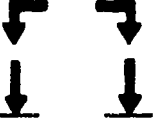
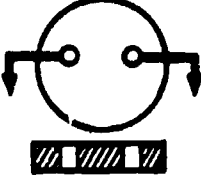
ENGINEERING AID 3 & 2, VOLUME 1

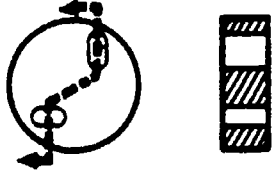
NAME	CONVENTION	DESCRIPTION AND APPLICATION	EXAMPLE
LEADER		THIN LINE TERMINATED WITH ARROW-HEAD OR DOT AT ONE END USED TO INDICATE A PART, DIMENSION OR OTHER REFERENCE	
BREAK (LONG)		THIN SOLID RULED LINES WITH FREEHAND ZIG-ZAGS USED TO REDUCE SIZE OF DRAWING REQUIRED TO DELINEATE OBJECT AND REDUCE DETAIL	
BREAK (SHORT)		THICK SOLID FREE HAND LINES USED TO INDICATE A SHORT BREAK	
PHANTOM OR DATUM LINE		MEDIUM SERIES OF ONE LONG DASH AND TWO SHORT DASHES EVENLY SPACED ENDING WITH LONG DASH USED TO INDICATE ALTERNATE POSITION OF PARTS, REPEATED DETAIL OR TO INDICATE A DATUM PLANE	
STITCH LINE		MEDIUM LINE OF SHORT DASHES EVENLY SPACED AND LABELED USED TO INDICATE STITCHING OR SEWING	
CUTTING OR VIEWING PLANE VIEWING PLANE OPTIONAL		THICK SOLID LINES WITH ARROWHEAD TO INDICATE DIRECTION IN WHICH SECTION OR PLANE, IS VIEWED OR TAKEN	
CUTTING PLANE FOR COMPLEX OR OFFSET VIEWS		THICK SHORT DASHES USED TO SHOW OFFSET WITH ARROW-HEADS TO SHOW DIRECTION VIEWED	

142.46.2

Figure 5-27.—Line characteristics and conventions—continued.

dash in contact with the line from which it starts, except when it is the continuation of an unbroken line. (See fig. 5-30.)

To prevent confusion in the interpretation of hidden edge lines, you must apply certain

standard techniques in drawing these lines. A hidden edge line which is supposed to join a visible or another hidden line must actually contact the line, as shown in the upper views of figure 5-31; the incorrect procedure is shown in the lower views.

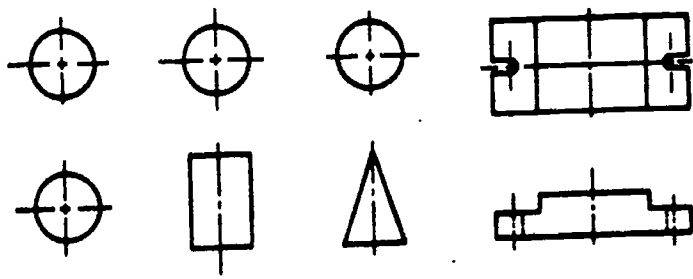

45.145:151

Figure 5-28.—Use of centerlines.

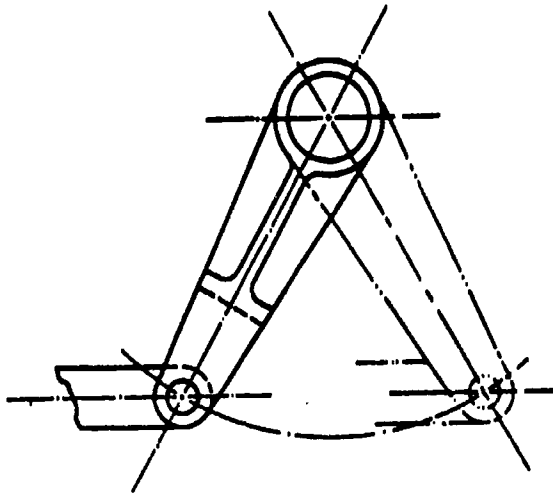

142.47

Figure 5-29.—Use of visible edge lines.

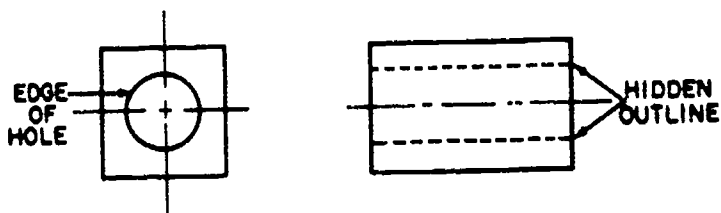

45.155

Figure 5-30.—Use of hidden edge lines.

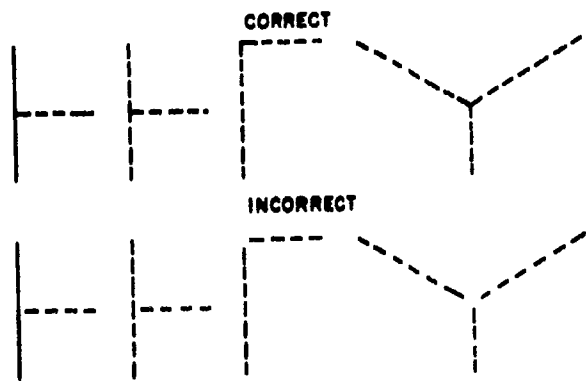

45.250

Figure 5-31.—Correct and incorrect procedures for drawing adjoining hidden lines.

Figure 5-32 shows an intersection between a hidden edge line and a visible edge line. Obviously, on the object itself the hidden edge line must be below the visible edge line. You indicate this face by drawing the hidden edge line as shown in the upper view of figure 5-32. If

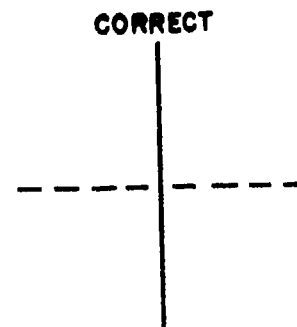

INCORRECT

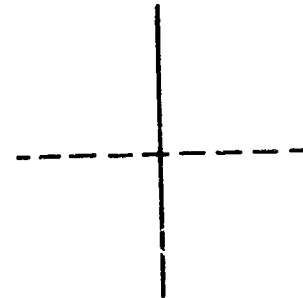

45.251

Figure 5-32.—Correct and incorrect procedures for drawing a hidden edge line which intersects a visible edge line.

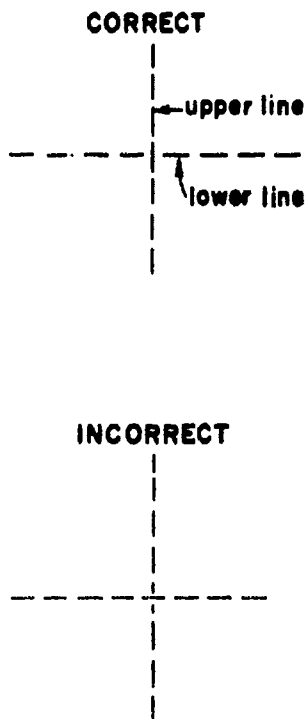

45.252

Figure 5-33.—Correct and incorrect procedures for drawing intersecting hidden edge lines which are on different levels.

you drew it as indicated in the lower view, the hidden edge line would appear to be above, rather than beneath, the visible edge line.

Figure 5-33 shows an intersection between two hidden edge lines, one of which is beneath the other on the object itself. You indicate this fact by drawing the lines as indicated in the upper view of figure 5-33. If you drew them as indicated in the lower view, the wrong line would appear to be uppermost.

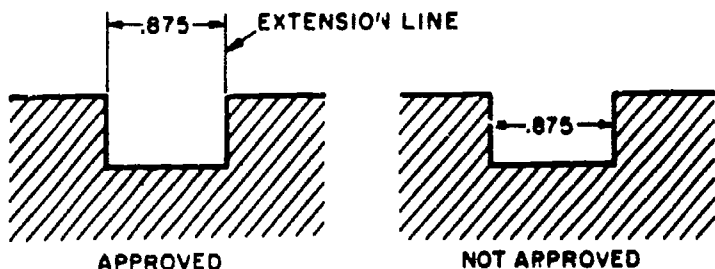

Figure 5-34.—Use of extension lines.

142.48

EXTENSION LINES

Extension lines are used to extend dimensions beyond the outline of a view so that they can be read easily. These thin, unbroken lines are started about 1/16 of an inch from the outline of the object and extend about 1/8 of an inch beyond the outermost dimension line. They are drawn parallel to each other and perpendicular to the distance to be shown. (See fig. 5-34.) In unusual cases, extension lines may be drawn at other angles if their meaning is clear.

As far as practicable, avoid drawing dimension lines directly to the outline of an object. When it is necessary for extension lines to cross each other, they should be broken, as shown in figure 5-35.

DIMENSION LINES

A dimension line, terminating at either end in a long, pointed arrowhead, is inserted between each pair of extension lines. It is a thin line, and except in structural drafting, it is usually broken to provide a space for the dimension numerals. Occasionally, when the radius of an arc is to be indicated, there is an

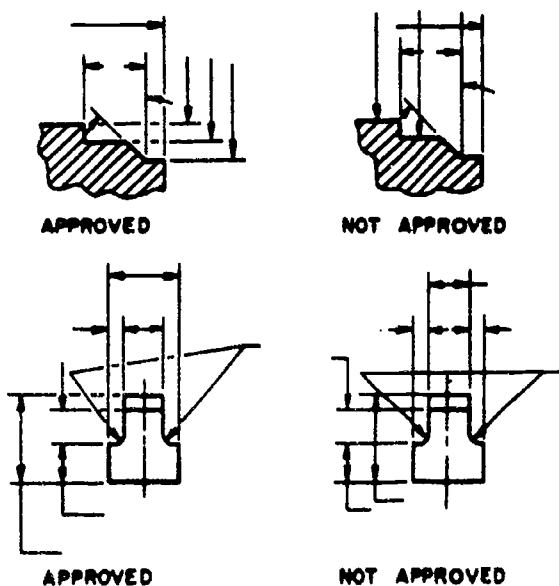
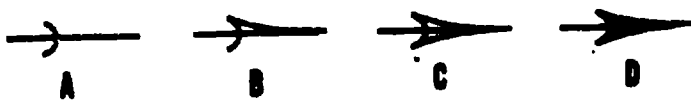

Figure 5-35.—Breaking extension lines and leaders at points of intersection.

45.154



45.148

Figure 5-36.—Method of drawing an arrowhead.

arrow at only the end of the line which touches the arc. The other end, without an arrow, terminates at the point used as the center in drawing the arc.

The arrowhead on a dimension or leader line is an important detail of a drawing. If these arrowheads are sloppily drawn and vary in size, the drawing will not look finished and professional. The size of the arrowhead used on a drawing may vary with the size of the drawing, but all arrowheads on a single drawing should be the same size, except occasionally when a space is very restricted.

The arrowheads used on Navy drawings are usually solid, or filled in, and are between one-eighth and one-fourth of an inch long, with the length about three times the spread. (See fig. 5-36.)

With a little practice, you can learn to make good arrowheads freehand. Referring to figure 5-36, first define the length of the arrowhead with a short stroke as shown at A. Then draw the sides of the arrowhead as indicated at B and C. Finally, fill in the area enclosed by the lines, as shown at D.

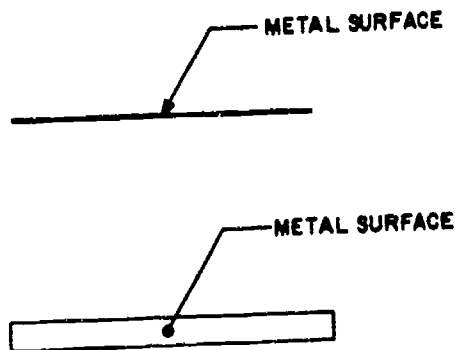

45.147

Figure 5-37.—A leader.

LEADERS

Leaders are used to connect numbers, references, or notes to the appropriate surfaces or lines on the drawing. From any suitable portion of the reference, note, or number, a short line is drawn parallel to the lettering. From this line the remainder of the leader is drawn at an angle (dog leg) to an arrowhead or dot. In this way, the leader will not be confused with other lines of the drawing. If the reference is to a line, the leader is always terminated at this line with an arrowhead, as shown in figure 5-37. However, a reference to a surface terminates with a dot within the outline of that surface.

BREAKLINES

The size of the graphic representation of an object is often reduced (usually for the purpose of economizing on paper space) by the use of a device called a break. Suppose, for example, you want to make a drawing of a rectangle 1 ft wide x 100 ft long to the scale of 1/12, or 1 in. = 1 ft. If you drew in the full length of the rectangle, you would need a sheet of paper 100 in. long. By using a break, you can reduce the length of the figure to a feasible length, as shown in figure 5-38.

On the original object, the ratio of width to length is 1:100. You can see that on the drawing the ratio is much larger (roughly about 1:8).

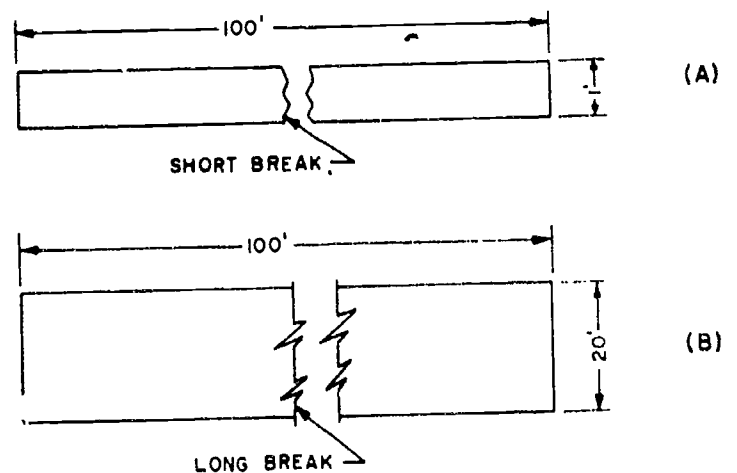

45.149

Figure 5-38.—Line conventions for (A) short break, and (B) long break.

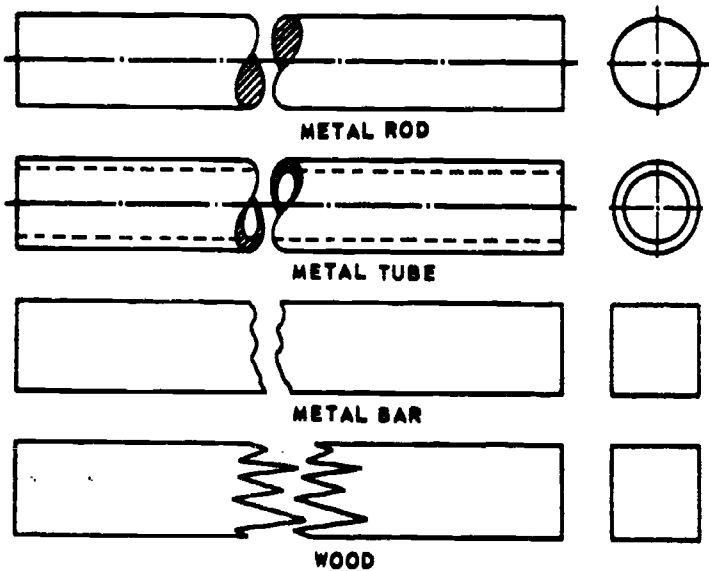

45.150

Figure 5-39.—Special breaks.

However, the break tells you that a considerable amount of the central part of the figure is presumed to be removed.

The thick, wavy lines shown in view A, figure 5-38 are used for a short break. A short break is indicated by solid, freehand lines, and is generally used for rectangular sections. For wooden rectangular sections, the breaks are made sharper (serrated appearance) rather than wavy.

For long breaks, full, ruled lines with freehand zigzags are used, as shown in view B,

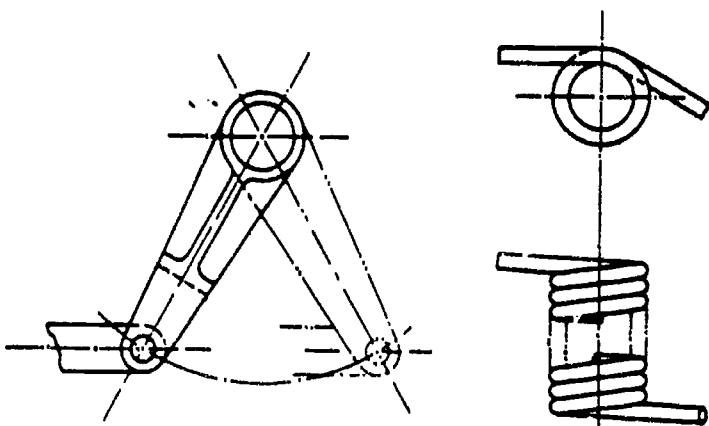

45.151

Figure 5-40.—Uses of phantom lines.

figure 5-38. For wider objects, a long break might have more than one pair of zigzag lines.

For drawings made to a large scale, special conventions are used that apply to drawing breaks in such things as metal rods, tubes, or bars. The methods of drawing these breaks are shown in figure 5-39.

PHANTOM LINES

Phantom lines are used most frequently to indicate an alternate position of a moving part, as shown in the left-hand view of figure 5-40. The part in one position is drawn in full lines, while in the alternate position it is drawn in phantom lines.

Phantom lines are also used to indicate a break when the nature of the object makes the use of the conventional type of break unfeasible. An example of this use of phantom lines is illustrated in the right-hand view of figure 5-40.

SECTION LINES

Sometimes the technical information conveyed by a drawing can best be shown by a view which represents the object as it would look if part of it were cut away. A view of this kind is called a section.

The upper view of figure 5-41 shows a plan view of a pipe sleeve. The lower view is a section, showing the pipe sleeve as it would look, viewed from one side, if it were cut exactly in half vertically. The surface of the imaginary cut is cross-hatched with lines called section lines. According to MIL-STD-100A, "section lining shall be composed of uniformly spaced lines at an angle of 45 degrees to the baseline of the section. On adjacent parts, the lines shall be drawn in opposite directions. On a third part, adjacent to two other parts, the section lining shall be drawn at an angle of 30 to 60 degrees."

The crosshatching shown in figure 5-41 could be used on any drawing of parts made of only one material (like machine parts, for example, which are generally made of metal). The crosshatching is the symbol for metals and may be used for a section drawing of any type of material.

A section like the one shown in figure 5-41, which goes all the way through and divides the

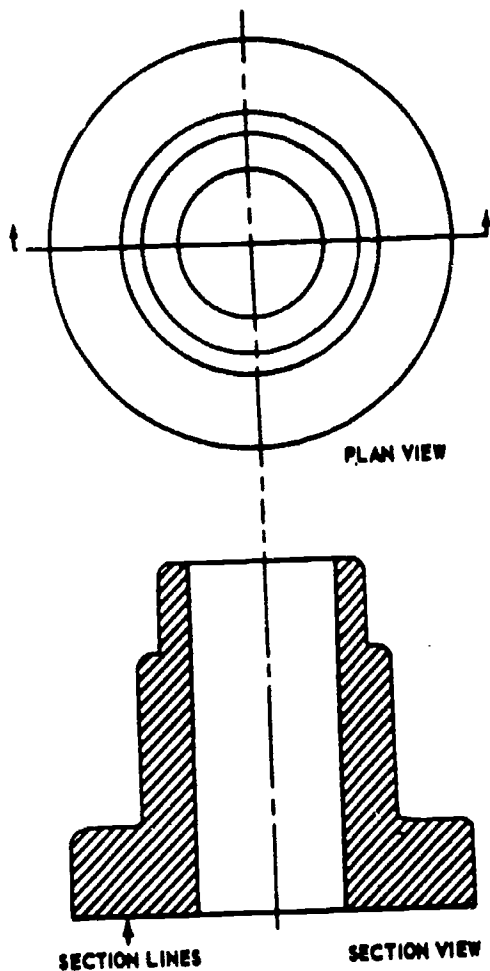

45.152

Figure 5-41.—Plan view and section.

object into halves, is called a full section. If the section showed the sleeve as it would look if cut vertically into unequal parts, or cut only part way through, it would be a partial section. If the cut followed one vertical line part way down and then was offset to a different line, it would be an offset section.

VIEWING OR CUTTING PLANE LINES

VIEWING PLANE LINES are used to indicate the plane or planes from which a surface or several surfaces are viewed.

CUTTING PLANE LINES are used to indicate a plane or planes in which a sectional view is taken.

Section views are used to give a clearer view of the interior or hidden feature of an object which normally cannot be clearly observed in conventional outside views.

A section view is obtained by cutting away part of an object to show the shape and construction at the cutting plane.

Notice the **CUTTING PLANE LINE AA** in figure 5-42A. It shows where the imaginary cut has been made. The single view in figure 5-42B helps you to visualize the cutting plane. The arrows point in the direction in which you are to look at the sectional view.

Figure 5-42C is a front view showing how the object would look if it were cut in half.

The orthographic section view of section A-A, figure 5-42D, is placed on the drawing

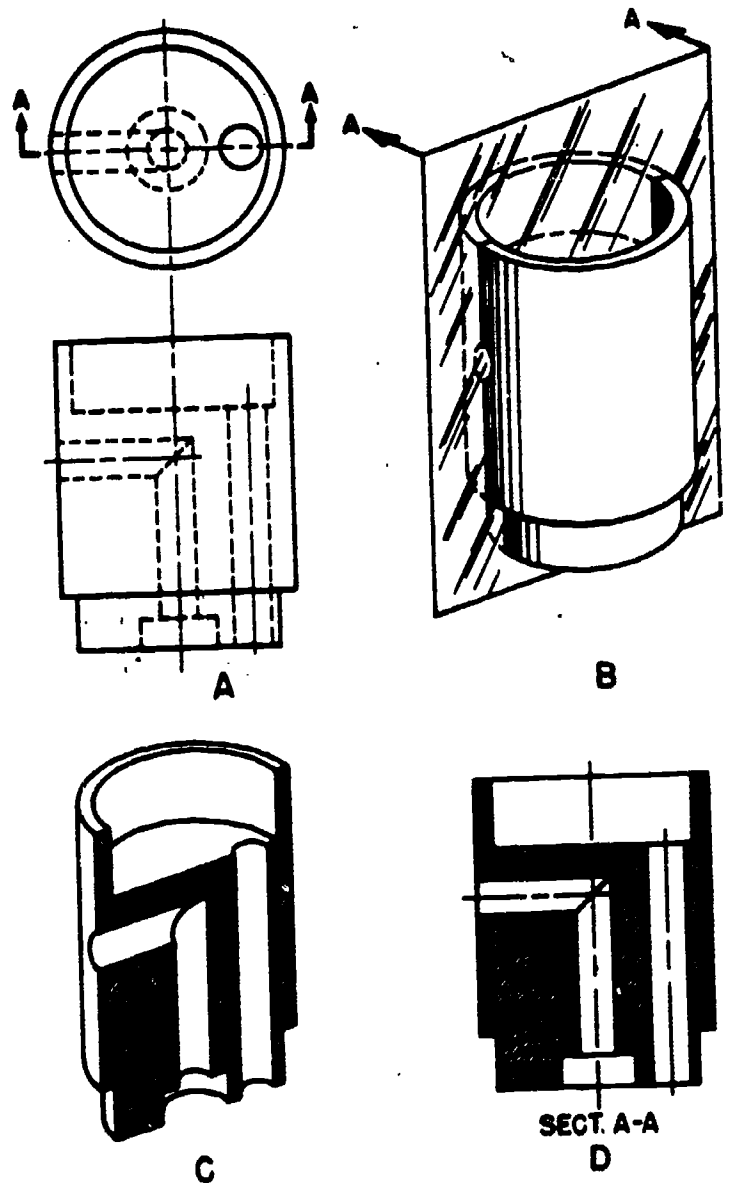

65.25

Figure 5-42.—Action of a cutting plane.

instead of the confusing front view in figure 5-42A. Notice how much easier it is to read and understand.

Note that hidden lines behind the plane of projection are omitted in the sectional view. These lines are omitted by general custom, the custom being based on the fact that the elimination of hidden lines is the basic reason for making a sectional view. However, lines which would be visible behind the plane of projection must be included in the section view.

Cutting plane lines, together with arrows and letters, make up the cutting plane indications. The arrows at the end of the cutting plane lines are used to indicate the direction in which the sections are viewed. The cutting plane may be a single continuous plane, or it may be offset if the detail can be shown to better advantage. On simple views, the cutting plane should be indicated as shown in figure 5-42A. On large, complex views or when the cutting planes are offset, they should be shown as in figure 5-43.

All cutting plane indications should be identified by the use of reference letters placed at the point of the arrowheads. Where a change

in direction of the cutting plane is not clear, reference letters may also be placed at each change of direction. Where more than one sectional view appears on a drawing, the cutting plane indications should be lettered alphabetically.

The letters which are part of the cutting plane indication should always appear as part of the title; for example, SECTION A-A, SECTION B-B. If the single alphabet is exhausted, multiples of letters may be used. The word SECTION may be abbreviated, if desired. Place the title directly under the section drawing.

DATUM LINES

A datum line is a line used to indicate a line or plane of reference, such as the plane from which an elevation is measured. Datum lines consist of one long dash and two short dashes (medium thickness), equally spaced. Datum lines differ from phantom lines only in the way they are used.

STITCH LINES

Stitch lines are used to indicate the stitching or sewing lines on an article. They consist of a series of very short dashes (medium thickness), approximately half the length of the dash of hidden lines, evenly spaced. Long lines of stitching may be indicated by a series of stitch lines connected by phantom lines.

MATCH LINES

Match lines are used when an object is too large to fit on a single drawing sheet and must be continued on another sheet. The points where the object stops on one sheet and continues on the next sheet must be identified with corresponding match lines. They are medium weight lines indicated with the words MATCH LINE and referenced to the sheet which has the corresponding match line. Examples of construction drawings which may require match lines are maps and road plans where the length is much greater than the width and it is impractical to reduce the size of the drawing to fit a single sheet.

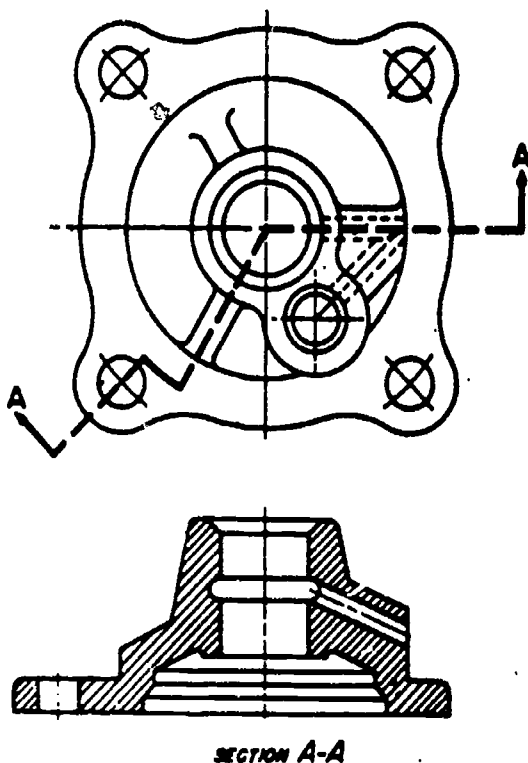
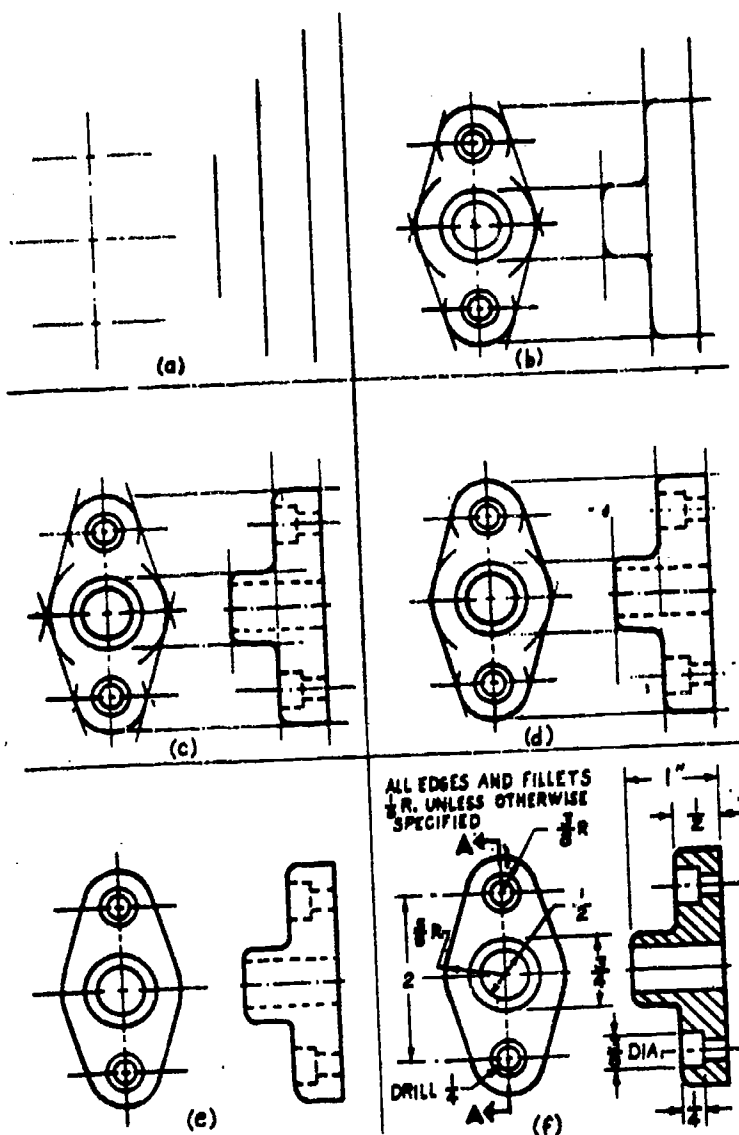

Figure 5-43.—Offset section.

65.26



45.161

Figure 5-44.—Order of penciling a drawing.

ORDER OF PENCILING

Experience has shown that a drawing can be made far more efficiently and rapidly if all the lines in a particular category are drawn at the same time, and if the various categories of lines are drawn in a specific order or succession. Figure 5-44 shows the order in which the lines of the completed drawing (shown in the last view) were drawn. This order followed the recommended step-by-step procedures, which is as follows:

1. Draw all centerlines.
2. Draw the principal circles, arcs, fillets, rounds, and other compass-drawn lines. A fillet

is a small arc which indicates a rounded concave joint between two surfaces. A round is a small arc which indicates a rounded convex joint between two surfaces.

3. Draw the horizontal and vertical outlines, visible lines, and hidden lines.

4. Draw the nonhorizontal and nonvertical outlines, visible lines, and hidden lines.

5. Clean up the drawing, erasing all excess lines and construction lines. A construction line is a light line used as a drawing guide only.

6. Draw extension lines, dimension lines, section lines, and any other lines required.

7. Inscribe the dimensions and lettering.

To a limited extent you can vary the thickness of a pencil line by varying the extent to which you bear down on the pencil. However, you can't bear down very hard without troughing the paper. Therefore, you can't get much variety in line weight with a pencil. For a drawing which will be inked over, this doesn't make any difference. However, for one which will not be reproduced, or which will be reproduced directly from the pencil original, you must follow, as nearly as you can, the line conventions.

ORDER OF INKING

You vary the thickness of ink lines by varying the space between the nibs of the pen. When you have set your pen for a thick line, you should, if possible, draw all the thick lines on the drawing before resetting the pen for medium or thin lines. Also, after you draw an ink line, you must let it dry before you can slide a T-square or triangle over it. The order in which you ink the lines on a drawing will be influenced by both of these considerations.

The order generally recommended for inking is as follows:

1. Inking of a drawing must start from the top of the paper and progress toward the bottom.
2. Start inking all arcs of circles, fillets, rounds, small circles, large circles, and other compass-drawn lines.

ENGINEERING AID 3 & 2, VOLUME 1

3. Ink all irregular curves using a french curve or a spline as a guide.

4. Ink all thick horizontal lines, then all medium and thin lines.

5. Start at the left edge and ink first the thick, next the medium, and finally the thin vertical lines from left to right.

6. Follow the same procedure described in (4) and (5) for slanting lines.

7. Ink section lines, dimensions, and arrowheads.

8. Ink notes and title, meridian symbol, and graphic scales.

9. Ink borders and check inked drawing for completeness.

10. Use art gum or kneaded eraser to erase pencil marks or for final cleanup of the drawing.

CHAPTER 6

LETTERING

The information that a drawing must present cannot be revealed by graphic shapes and lines alone. To make a drawing informative and complete, you must include lettering in the form of dimensions, notes, legends, and titles. Lettering can either enhance your drawing by making it simple to interpret and pleasant to look at, or it can ruin your drawing by making it difficult to read and unsightly in appearance. Therefore, it is essential that you master the techniques and skill required for neat, legible lettering.

In this chapter you will learn the basic techniques of both freehand and mechanical lettering.

FREEHAND LETTERING

As you work with experienced draftsmen, you will notice that their freehand lettering adds style and individuality to their work. They take great pride in their freehand lettering ability. By learning basic letter forms and with constant practice, you will soon be able to do a creditable job of lettering and acquire your own style and individuality. Anyone who can write can learn to letter. As you practice you will steadily improve both your style and the speed with which you can letter neatly. Don't give up if your first attempts do not produce neat lettering. Don't be afraid to ask your supervisor for a few pointers.

An understanding of the letter shapes and the ability to visualize them can be accomplished by drawing them until the muscles of your hand are accustomed to the pattern of the strokes which make up the letters. You should be able to draw good letters without consciously thinking of this pattern.

Your position and how you hold your pencil will greatly affect your lettering. You should sit up straight and rest your forearm on the drawing board or table. Hold the pencil between the thumb, forefinger, and second finger; the third and fourth fingers and the ball of the palm rest on the drawing sheet. Do not grip the pencil tightly. A tight grip will cramp the muscles in your fingers, causing you to lose control. If you get "writer's cramp" easily, you are probably holding your pencil too tightly. The pencil should be kept sharpened to produce uniform line weights. A conical-shaped pencil point works best for most lettering. Usually an F or H pencil is used for lettering. A pencil which is too hard may cut into the paper, or it may produce lettering which will not reproduce easily. A pencil which is too soft will require frequent sharpening and it will produce lettering which may smear easily on a drawing.

GUIDELINES

Figure 6-1 illustrates the use of light pencil lines called guidelines. Guidelines ensure consistency in the size of the letter characters. If your lettering consists of capitals, draw only the capline and baseline. If lowercase letters are



45.211

Figure 6-1.—Guidelines.

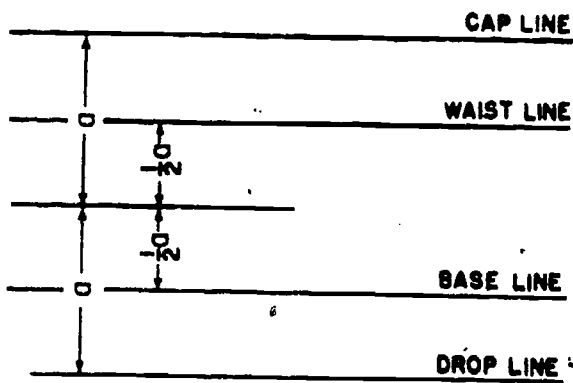

45.212

Figure 6-2.—Laying off guidelines.

included as well, draw the waistline and dropline.

The waistline indicates the upper limit of the lowercase letters. The ascender is the part of the lowercase letter that extends above the body of the letter; for example, the dot over the character "i" in figure 6-1. All ascenders are as high as the caps.

The dropline indicates the lower limit of the lowercase letters. The descender is the part of the lowercase letter that extends below the body of the letter, an example being the tail of the character "g" in figure 6-1. The vertical distance from the dropline to the baseline is the same as the vertical distance from the waistline to the capline. It is about one-third of the vertical distance between the baseline and the capline, or about one-half of the vertical distance between the baseline and the waistline.

Figure 6-2 shows an easy way to lay out guidelines for caps and lower case. Let the height of a capital be $1 \frac{1}{2}$ times the distance "a". Set a compass or dividers to distance "a", and lay off distance "a" above and below the midline selected for the guidelines. This method locates the cap line and the drop line. Then set compass or dividers to one-half of "a", and lay off this distance above and below the midline. This method locates the waistline and the baseline.

To help you keep your lettering vertical, it is a good idea to construct vertical guidelines, spaced at random along the horizontal guidelines. For inclined lettering, lay off lines inclined at the angle you wish your lettering to

be slanted. (See fig. 6-3A.) Inclined lines are known as direction lines and are normally slanted at a maximum of 68° .

Ames Lettering Instrument

If you have many lines of lettering to do you will find that a lettering instrument, such as the Ames lettering instrument shown in figure 6-3B, is quite useful and timesaving. The top-left section of figure 6-3B shows how to use this instrument in conjunction with a T-square to draw properly spaced horizontal guidelines. You insert the point of your pencil through one of the holes and the instrument slides along the T-square as you move the pencil across the page. The enlarged drawing of the instrument in the

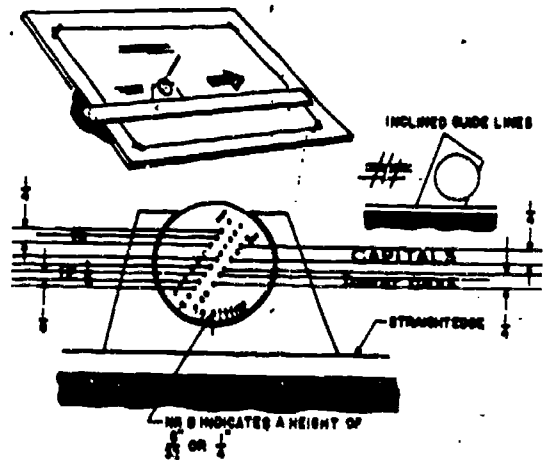
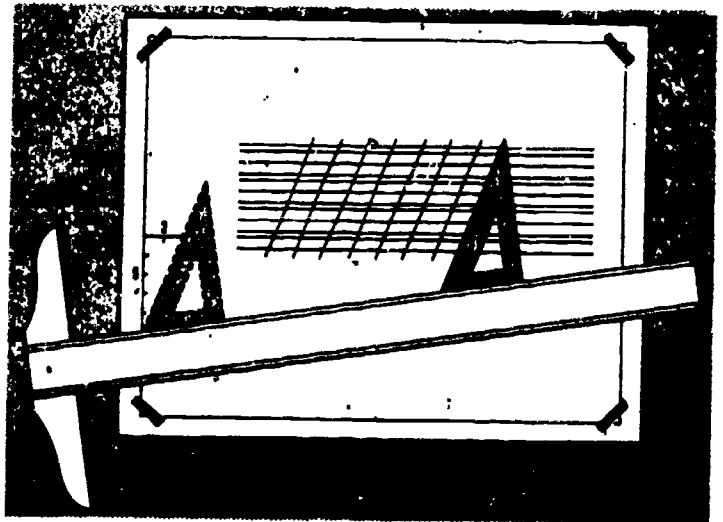

29.275A

Figure 6-3.—Laying off lines for lettering.

lower part of the figure shows the details of how the instrument is used. Notice the three rows of holes in the circular disc of the instrument. The holes in the center row are equally spaced and are used to draw equally spaced guidelines. The two outside rows are used for drawing both capital and lowercase guidelines. The left row gives a proportion of 3 to 5 for lowercase and capital letters, and the right row gives a proportion of 2 to 3.

The design of the Ames lettering instrument permits you to use it for lettering ranging in height from 1/16 to 5/16 inch. These various heights are attainable by rotating the circular disc within the outer section of the instrument. The numbers along the bottom edge of the disc are used to set the instrument for a particular letter height. A number aligned with the index line on the outer section of the instrument indicates the height of the lettering in 32nds of an inch. In figure 6-3B the number 8 is aligned with the index; therefore, the distance between the capital letter guides produced by this setting is 8/32 inch or 1/4 inch.

By standing the Ames lettering instrument on its greater sloping side, you can use it for drawing guidelines for inclined lettering which slope at an angle of 67 1/2 degrees with the horizontal (see the upper-right portion of figure 6-3B).

Spacing Between Guidelines

The spacing between two lines of capitals may vary from one-half the height to the full height of a capital. Two-thirds of the height is customarily used.

The spacing commonly used between lines of lowercase letters is illustrated in figure 6-4.

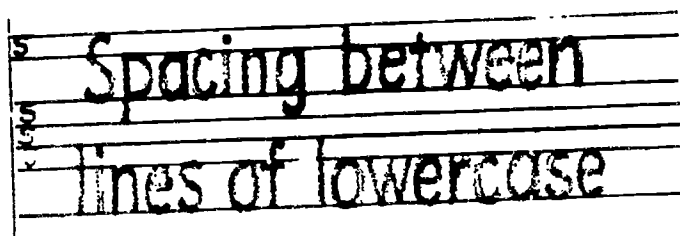

45.214

Figure 6-4.—Spacing between lines of lowercase letters.



45.832

Figure 6-5.—Vertical single-stroke Gothic capitals and numerals.

The space indicated by the letter S equals the vertical distance between the waist line and the cap line.

VERTICAL SINGLE-STROKE GOTHIC LETTERING

The generally accepted style of lettering for SEABEE drawings is the single-stroke Gothic vertical (see fig. 6-5) or inclined lettering. The term "Gothic" refers to the style of letters. Gothic lettering is the simplest style to make and the easiest to read on a drawing. Single-stroke means that each stroke of the letter is made by one stroke of the pencil. Figure 6-6 shows the basic strokes which are required for single-stroke lettering. Vertical strikes are drawn from the top down with an even finger movement. (Inclined strokes are drawn in the same manner.) Horizontal strokes are drawn from left to right with a complete hand movement, pivoting at the wrist. Curved strokes

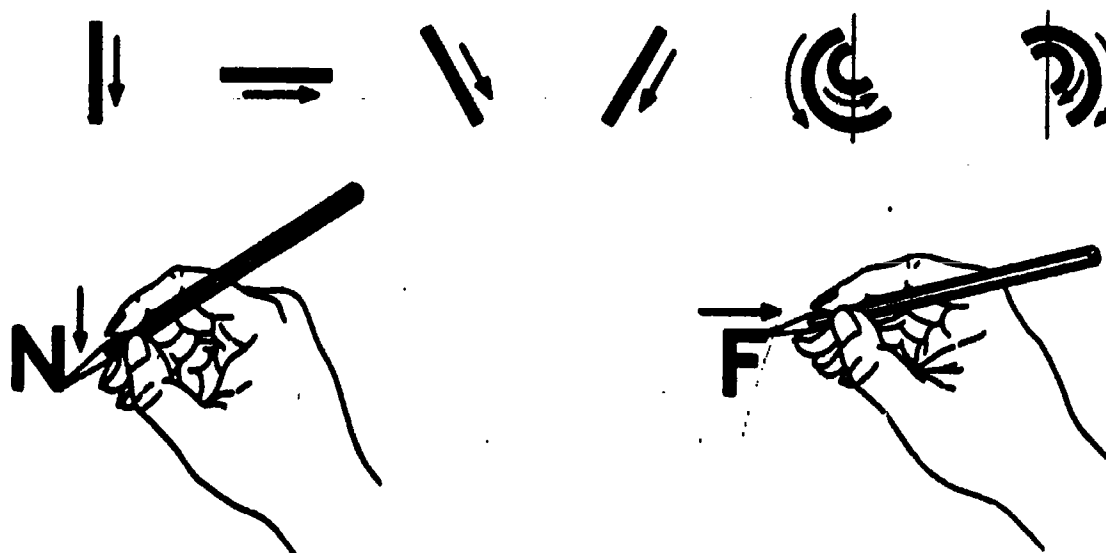

Figure 6-6.—Basic lettering strokes.

45.833

proceed from above downward, using a combined finger and wrist motion. Lettering strokes are drawn, not sketched. It is important that you use the correct direction and sequence of strokes recommended for each letter.

Figures 6-7, 6-8, 6-9, and 6-10 show the required shape of vertical single-stroke Gothic letters and numerals. To emphasize the proportions of the letters and numerals, each character is shown in a grid, 6 units high. The grid serves as a reference for comparing the height of the various characters in proportion to their width as well as locating the individual strokes that compose the characters. For learning purposes, the characters are grouped by the type of strokes which are required to form each character.

Straight Line Capitals

The capital letters shown in figure 6-7 are formed with only straight line strokes.

Z, X, Y, K. Stroke 2 of the Z is longer than stroke 1. The inclined strokes of the X are closer together at their starting than at their finishing points. The 3 strokes of the Y intersect slightly below the center of the square. Stroke 2 of the K intersects stroke 1 at a point one-third of the

distance up from the baseline. Stroke 3, if extended, would intersect stroke 1 at the top.

I, A, L, T. The letter I is the basic vertical stroke. Inclined strokes 1 and 2 of the A intersect just above the capline; stroke 3 is located one-third of the distance up from the baseline. The horizontal stroke of the T is drawn first; the vertical stroke, or stem is drawn from the center. With both L and T, the horizontal stroke may be lengthened or shortened to balance the letters in a word. If, for example, L precedes A, its horizontal stroke is reduced slightly; if T precedes A, its horizontal stroke is extended slightly.

H, F, E. In H, F, and E, the central horizontal bar is placed slightly above the center for stability. In both E and F, the capline stroke is 4 units long and the central stroke is 3/5 of this length. The baseline of E is 1/2 unit longer than its cap line.

V, W, M, N. The two inclined strokes of the V intersect just below the baseline. The W is 1 1/3 times the width of a normal letter; note that it is wider than the M. Strokes 1, 2, 3, and 4 of the W intersect below the baseline. Strokes 3 and 4 of the M and 2 and 3 of the N intersect on the baseline. Note that the outside strokes of the M and N are drawn first.

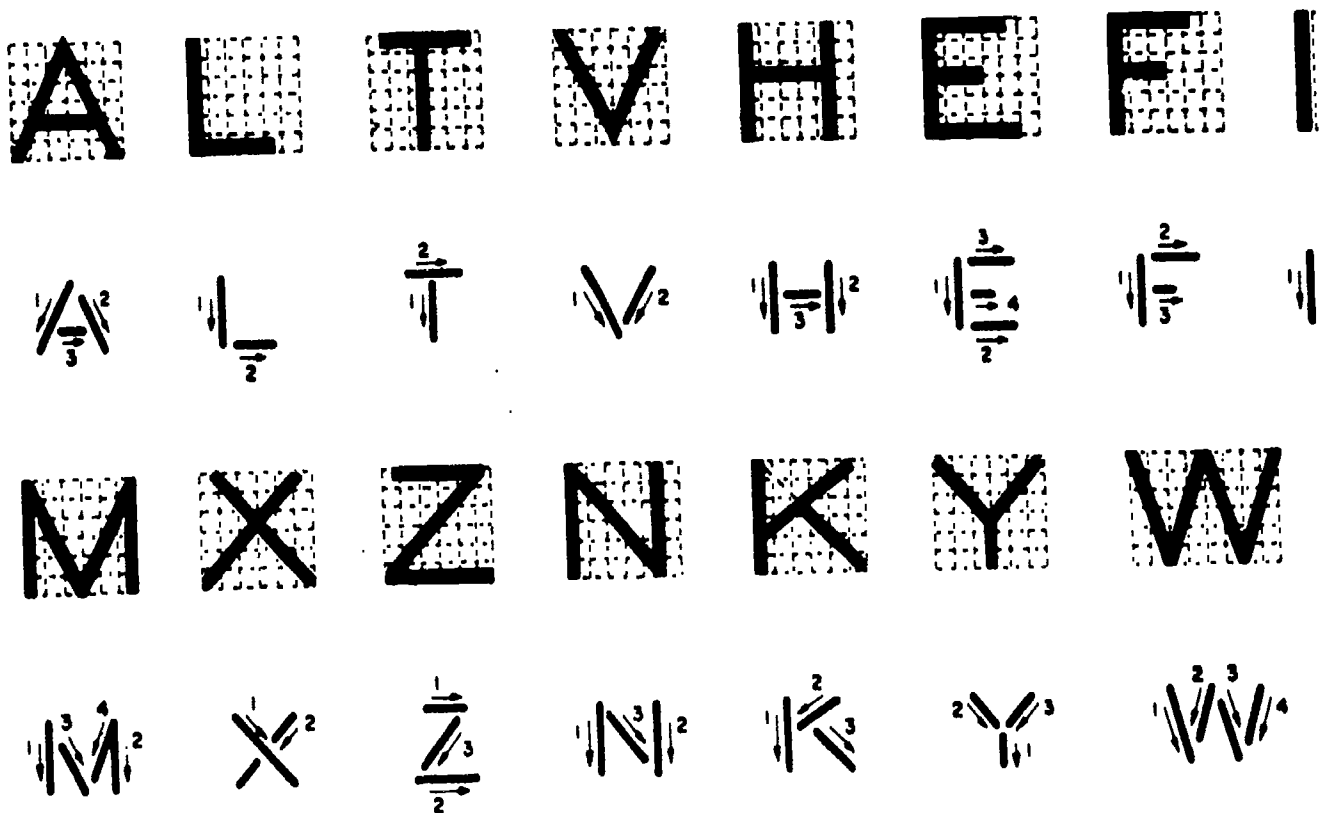

45.834

Figure 6-7.—Vertical straight line capitals.

Curved and Straight Line Combinations

The capital letters shown in figure 6-8 are formed by either curved line strokes or by a combination of curved and straight line strokes.

O, Q, C, G. The O and Q are complete circles; C and G are not the full width of the square because they are not full circles. The tail of Q, if extended, would intersect the center of the circle. Stroke 4 of G begins at the center of the circle.

U, J, D. Stroke 3 of U is elliptical and connects two parallel vertical lines a third of the distance above the baseline. Stroke 2 of J is similar but not so broad. Stroke 4 of D is circular, joining two horizontal segments.

P, R, B. The horizontal midstrokes of P and R lie just below the midpoint, and the horizontal midstroke of B lies just above the midpoint. Horizontal stroke 4 in R is slightly longer than strokes 2 and 3, which are the same length.

S and &. The upper and lower portions of S are ellipses, the upper slightly smaller than the lower. The ampersand (&) is basically similar despite a greater difference in the sizes of the ellipses.

Numerals and Fractions

The need for extreme care in drawing numerals cannot be overstressed, particularly in the preparation of construction drawings in which a poorly drawn numeral can cause costly errors and delays.

Numerals are drawn using the size guidelines as the capital letters on a drawing. Vertical guidelines are spaced at random. Numerals should not be made so small or be crowded so closely as to impair their legibility.

In figure 6-9 the vertical stroke of the numeral 4 is placed 2 units from the right side. The horizontal bar is one-quarter the height of the number above the baseline. Note that the closed curves of 0, 6, and 9 are elliptical, not circular. The 6 is an inverted 9. The 8 is

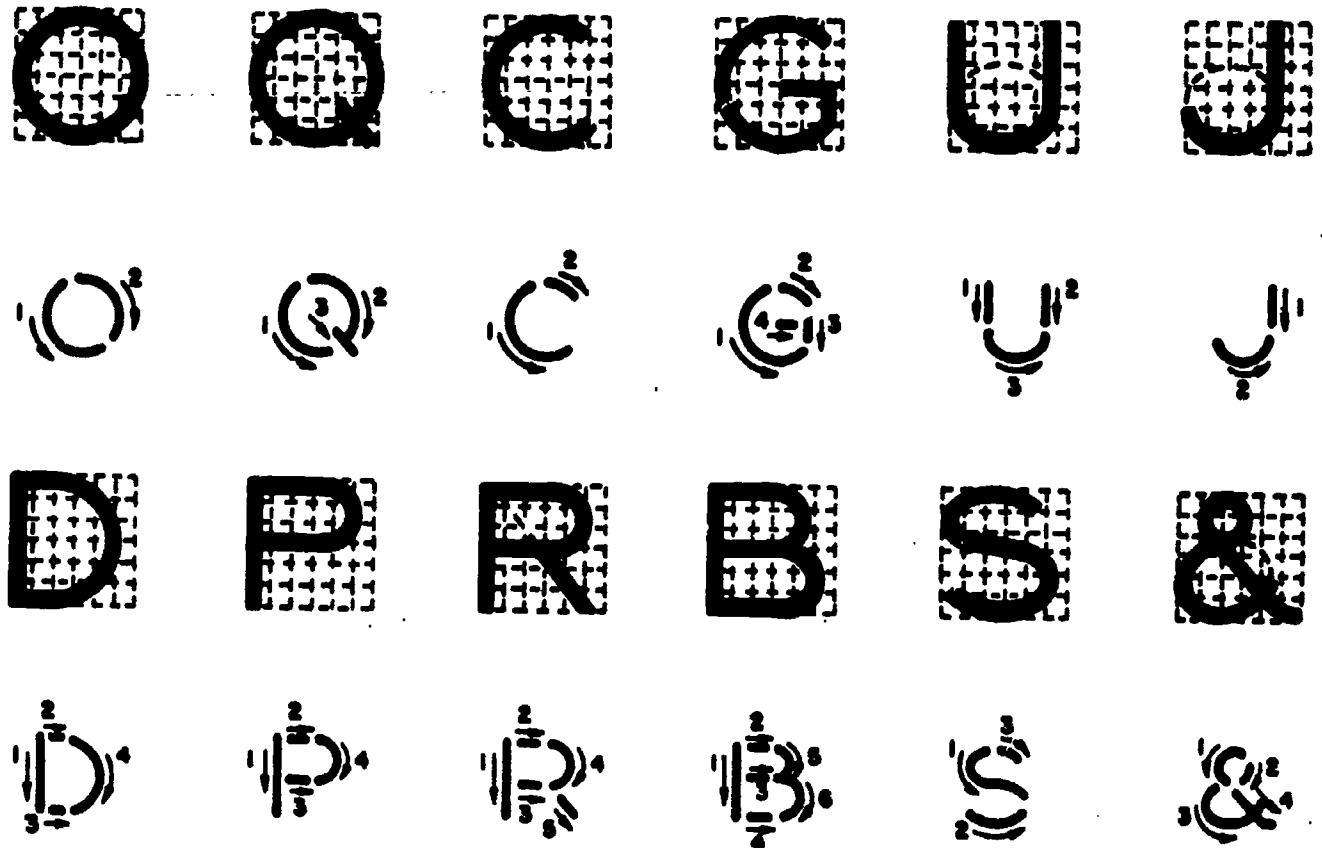

Figure 6-8.—Vertical capitals, curved and straight line combinations.

45.835

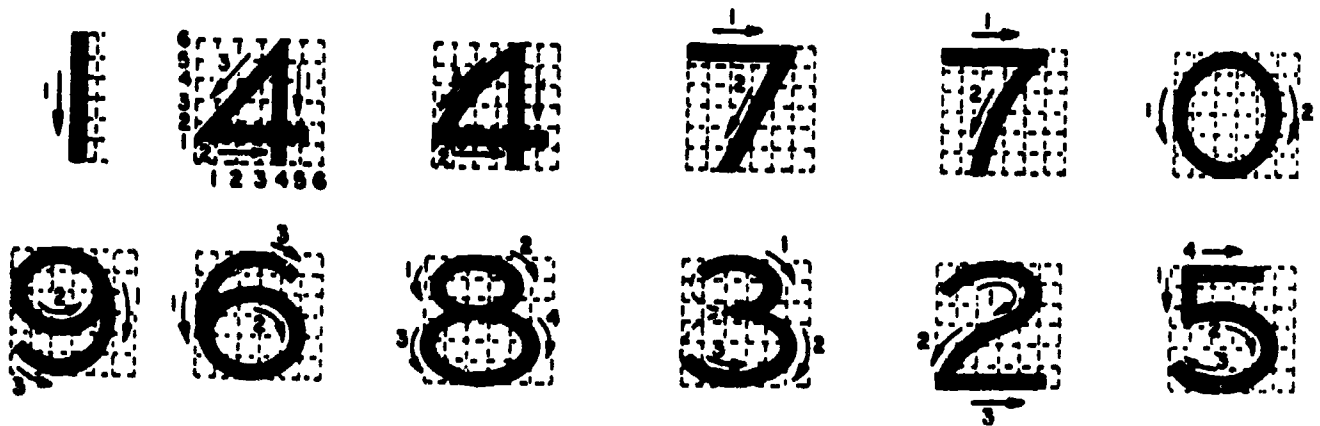
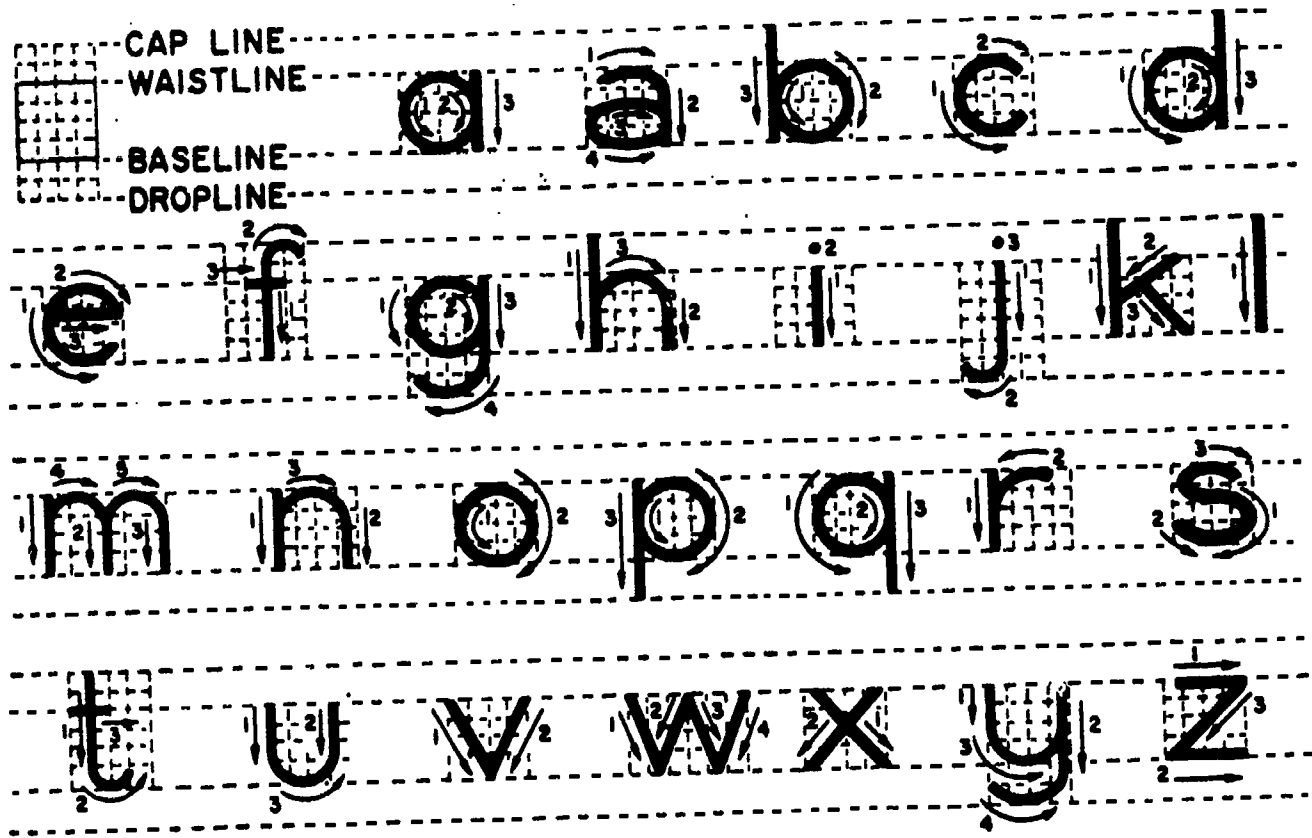

Figure 6-9.—Vertical numerals.

45.836



45.837

Figure 6-10.—Vertical lowercase letters.

composed of two ellipses tangent slightly above the center point. The top ellipse also is narrower. The 3 is the same as the 8 with the left portions of the loops cut off. The curved lines of 2 follow the elliptical contours of 8. The top portion of the 5 is slightly narrower than the bottom. The bottom ellipse is two-thirds the height of the figure from the baseline.

The division bar between the numerator and denominator of the fractions is always drawn parallel to the guidelines, as shown in figure 6-11. The complete height of a fraction is twice that of a whole number. The division bar is centered midway between the baseline and capline. The top guideline of the numerator and the bottom guideline of the denominator are spaced a full number height from the division bar. The numbers composing a fraction are three-quarters the height of a full number. The clear space on either side of the division bar is one-quarter of a full number. Numbers in a fraction are centered about a vertical guideline that cuts the fraction bar in half.

Lowercase Letters

Lowercase letters are not normally used on construction drawings, although it is acceptable to use them in combination with upper case letters for small lettering, such as drawing notes. Lowercase letters should NEVER be used on drawing title blocks. Figure 6-10 shows lowercase letters along with guidelines and strokes used to form each letter.



45.209

Figure 6-11.—Vertical fractions.

The crosses of f and t are on the waistline and extend the same distance on either side of stroke 1. The horizontal stroke of e is just above midheight. The bodies of a, b, g, p, and q are circular and the vertical strokes of these letters do not increase their width at the points of tangency. The vertical strokes of p and q terminate at the dropline. The vertical strokes of g, j, and y terminate in curves that are tangent to the dropline.

INCLINED LETTERING

Inclined single-stroke Gothic lettering is also acceptable on SEABEE drawings, although it is not recommended for the beginner and should not be attempted until you have mastered vertical lettering techniques. Inclined and vertical lettering should never appear on the same drawing. The lettering style used must always be consistent.

Figures 6-12 and 6-13 illustrate the required formation of inclined letters. The angle of inclination is $67\frac{1}{2}^\circ$ from the horizontal. Inclined guidelines may be drawn with the lettering triangle as described, or a line at the proper angle may be laid off with the protractor and parallel lines constructed from it. Horizontal guidelines and sequence of strokes are the same as for vertical letters. Rules of stability, proportion, and balance are similar. The circles and circular arcs used in vertical letters become elliptical in inclined letters, their major axes making angles of 45° with the horizontal. Letters such as A, M, V, and Y should be made symmetrically about a guideline. Inclined lowercase letters follow the same principles as inclined capitals.

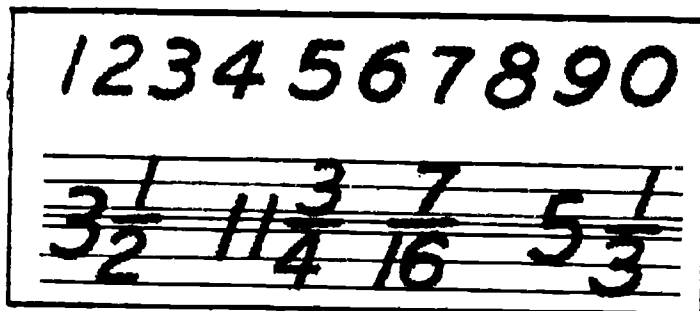
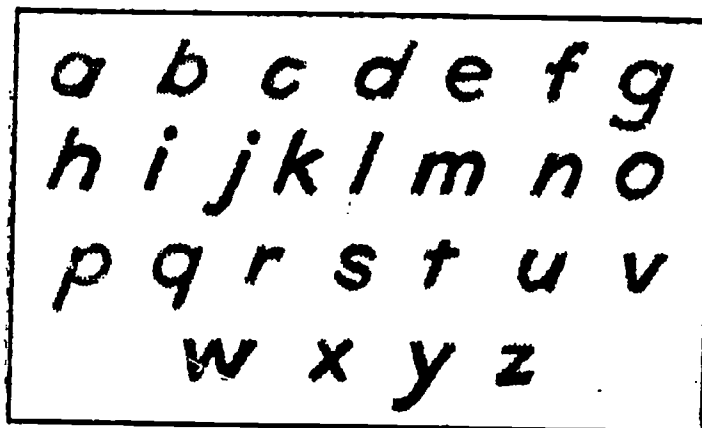
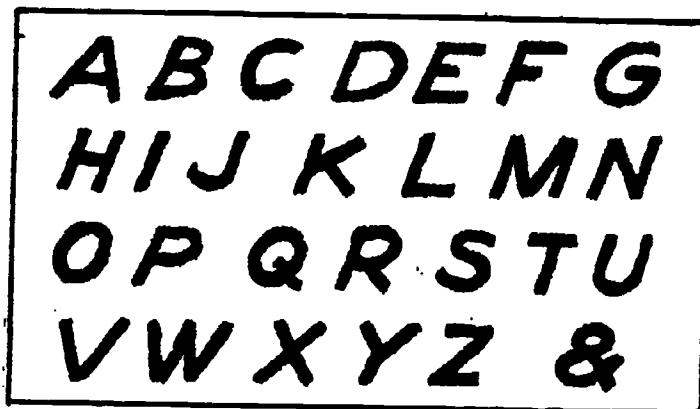

45.210

Figure 6-12.—Inclined single-stroke Gothic.

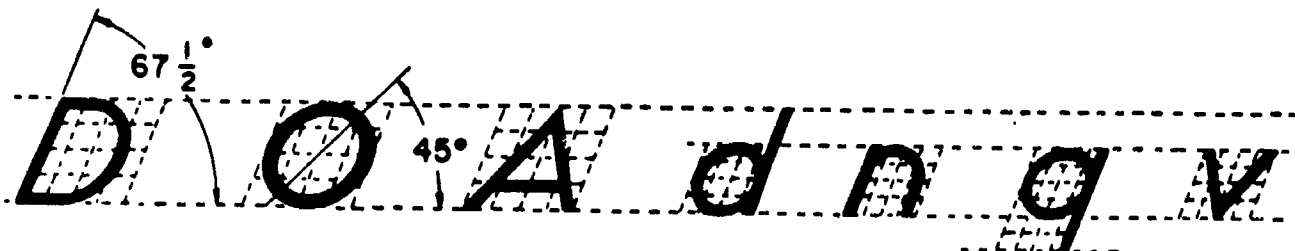

45.838

Figure 6-13.—Inclined letter formation.

POOR SPACING
GOOD SPACING

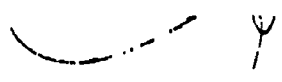

Figure 6-14.—Letter spacing.

45.215

COMPOSITION OF LETTERING

Once you have learned the proper shapes and strokes required to form each letter and numeral, you should concentrate on practicing the composition of words and sentences. Proper spacing of letters and words does more for the appearance of a block of lettering than the forms of the letters themselves. But this does not mean that you should discontinue further practice of correctly forming each letter.

Letter Spacing

In straight line lettering, determine the spacing between letters by eye after making the first letter and before making each succeeding letter. To give a word the appearance of having uniformly spaced letters, make the areas between the letters nearly equal as shown in figure 6-14. The areas between adjacent letters in a word vary with respect to whether the letters have straight sides (H, I, M, N) or slanted sides (A, V, W) and whether the letters are round (O, Q, C, G) or open (L, J). Adjacent straight-sided letters are drawn farther apart than are adjacent round letters. Adjacent slant-sided and open letters are drawn nearer together than are adjacent round letters. Where letters L and T, L and V, A and V, and other pairs of like shape come together in a word, the top of one may have to be drawn above the bottom of the other to avoid having the word appear as two or more words. In letter spacing, the six problems listed below are the hardest to solve. The first five problems are solved by moving the letters closer together; the sixth by moving the letters farther apart.

1. Round next to round. (Increasing area at top and bottom where letters curve away from each other as in figure 6-15A.)
2. Round next to slant. (Increasing area at top or bottom where letters move away from each other as in figure 6-15B.)
3. Vertical next to slant. (Increasing area at top or bottom where one letter slants away from the other as in figure 6-15C.)
4. Slant next to slant. (Increasing area at top or bottom where letters slant in opposite directions as in figure 6-15D.)
5. Round next to vertical. (Increasing area at top and bottom where round letter curves away as in figure 6-15E.)
6. Vertical next to vertical. (Decreasing area at top and bottom where stems move together as in figure 6-15F.)

A good way to evaluate the spacing of letters is to hold the lettering away from you and

A **GOOD** good
ROUND TO ROUND

B **ACE** vote
ROUND NEXT TO SLANT

C **HAND** live
VERTICAL NEXT TO SLANT

D **WAVE** wavy
SLANT NEXT TO SLANT

E **ONC** hope
ROUND NEXT TO VERTICAL

F **LIME** limp
VERTICAL NEXT TO VERTICAL

45.207(142)F

Figure 6-15.—Common spacing problems.

squint your eyes, observing the gray tone throughout the lettering. If the tone appears spotty or varies too much, the letters are poorly spaced.

Word Spacing

Proper spacing between words is an important factor in making them easy to read. Allow enough space between words and sentences to keep them from running together, but not so much as to cause words to be read one at a time. A good practice to follow is making spaces between words equal to the space that the letter O occupies as shown in figure 6-16. If you prefer, you can use the letter N or a correctly spaced letter I instead.

Naturally, the design of the last letter of a word and of the first letter of the following word must be considered in determining the amount of space you leave between words. You should leave a space equal to a capital O between two full-height straight-stemmed letters, such as H and E or D and B. Of course, if one or both of the letters are curved, the space should be appropriately reduced. If the two letters involved are lowercase, use the lowercase "o" to determine the width of the space. If one letter is full height and the other is lowercase height, such as in the words "bid now" or "on him," the space would be equal to half a capital O and half a lowercase "o".

Line Spacing

In addition to the spacing between letters and words, the spacing between lines of lettering adds to the readability of the lettering. Again your eye and your artistic ability must be your

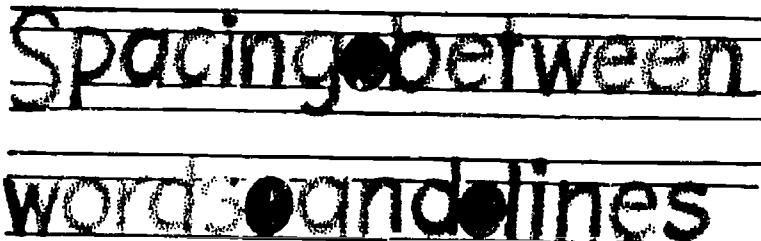

45.207(142)A

Figure 6-16.—Spacing between words and lines.

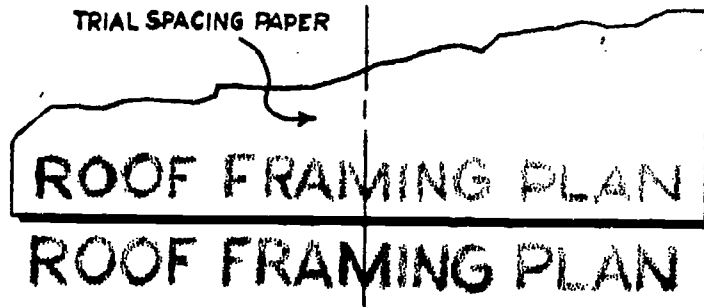

45.217

Figure 6-17.—Centering with trial spacing paper.

guide. Except when you are trying for a special effect, you should have enough space between the lines to make it easy for the reader to see what he is reading.

The distance between lines may vary from 1/2 to 1 1/2 times the height of the letter, but for sake of appearance it should not be exactly the same as the letter height. As a general rule, two-thirds of the letter height is a good distance between lines. This spacing allows room for descender of lowercase letters, and still maintains a clear space of one-third letter height between the descenders and capital letters, or ascenders of lowercase letters of the following line. Figure 6-16 shows proper word line spacing.

Centering

Since the letters of the alphabet vary in width, it is rather difficult to center a line of lettering. Figure 6-17 shows one way of solving this problem. First, take a piece of scratch paper and letter in the required line. Then, place this line of lettering above the area in which your lettering is to go and center it. Finally, use the sample as a guide to lettering the desired line.

Ending a line of lettering at a given point is equally difficult. As in centering, first letter the line on a piece of scratch paper in order to achieve the proper line length.

To make lines of lettering come out to a specified length you must adjust the word and/or letter spacing. This adjustment in spacing

is called JUSTIFYING. A good example of justifying is found in the columns of this manual. Notice how all full lines start and stop on the right and left hand margins. Usually you will only find justified lettering type set, or typewritten by mechanical means. However, if you do have an occasion to justify your lettering, you should try to keep the spacing between the words as uniform as possible. Uneven spacing detracts from the appearance of the job. When it is impossible to divide the spacing evenly, insert wider spacing at points where one word ends and the next begins with tall letters, like "d", "b", and "l"

If you use too much space between the words, the paragraph will tend to fall apart, because it is filled with rivers of white-space that will disturb the eye.

When a line is so short that it calls for an undue amount of space between words to lengthen the line, allow more space between the letters in each word. This is known as letterspacing. When words are letterspaced, always allow extra space between each word so that they will not seem to run together when they are read.

Letterspacing makes short words in titles or headings appear longer. Though it frequently improves the appearance of words in caps, letterspacing reduces the legibility of words in

lowercase. Therefore, the process must be used with caution.

MECHANICAL LETTERING

In chapter 4 we discussed pens which are used primarily for freehand lettering. At times, however, you will be tasked with preparing drawings, charts, maps, or signs which require the use of mechanical lettering. When we refer to mechanical lettering, we mean standard uniform characters which are executed with a special pen held in a scribe and guided by a template. Mechanical lettering does not normally require the use of lettering guidelines. You will use mechanical lettering principally for title blocks and notes on drawings, marginal data for special maps, briefing charts, display charts, graphs, titles on photographs, signs, and any other time that clear, legible, standardized lettering is required. It should be noted that freehand lettering is the required lettering on most of your drawings; mechanical lettering should be confined to the special uses similar to those described above. The availability of mechanical lettering devices should not deter you from the daily practice required to execute freehand lettering. With continuous practice you will become proficient with both mechanical and freehand lettering.

One of the most popular types of mechanical lettering sets is the LEROY lettering

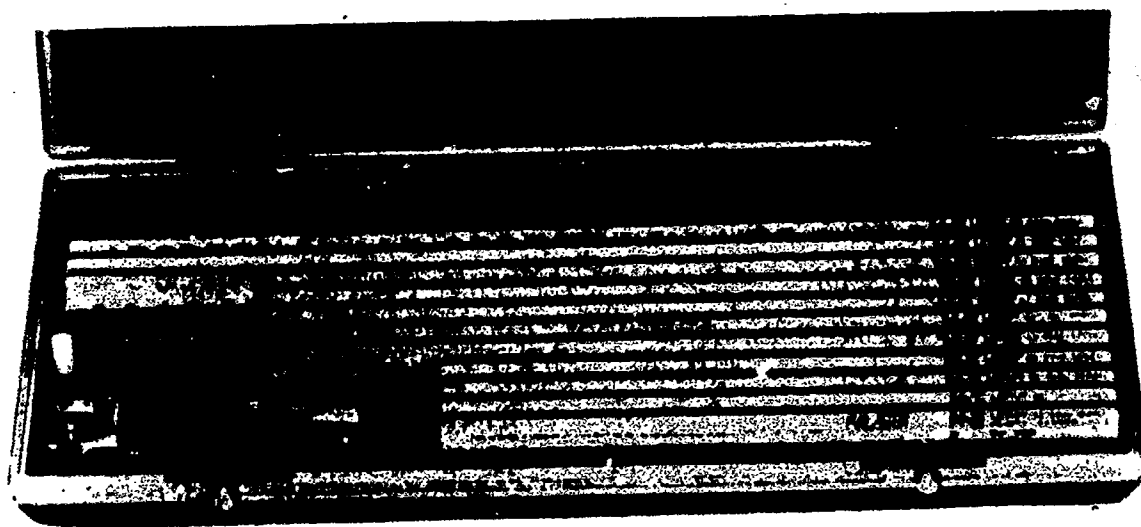

Figure 6-18.—Leroy lettering set.

set. A standard Leroy lettering set consists of a set of templates, a scribe, and a set of pens. (See fig. 6-18.)

TEMPLATES.—Templates are made of laminated plastic with the characters engraved in the face so that the lines serve as guide grooves for the scribe. The height of the characters, in thousandths of an inch, is given by a number on the upper right-hand side of the template. For example, 3240-500CL indicates a No. 500 template. The entire number and letter designation identifies the template in the manufacturer's catalog. The range of character heights offered by a standard set of templates is from 80 (0.08 inch or 5/64 inch) to 500 (0.5 inch or 1/2 inch). The scale at the bottom of each template has the zero in the center and is arranged for proper spacing in relation to character heights. The distance between each scale division represents the center-to-center distance of normal-width letters.

PENS.—A standard set of pens for producing various line weights consists of 11 sizes ranging from 000, the finest, to 8. Each pen is composed of two parts: the ink reservoir and the cleaning pin. The reservoir is a series of connected tubes of decreasing diameters, the smallest establishing line thickness. The cleaning pin acts as a valve, protruding beyond the edge of the bottom tube when the pen is not touching the drawing surface. In this position, no ink flows. When the pen is resting on a drawing surface the cleaning pin is pushed up, allowing a flow of ink. Action of the pin in the tube minimizes ink clogging.

SCRIBERS.—The scribe holds the pen in alignment and controls its motion as the tracing pin is guided through the character grooves of the template. Two types of scribes are available: adjustable and fixed. An adjustable scribe produces letters with any slant from vertical to 22 1/2° forward from a single template; a fixed scribe produces only vertical letters. Both scribes consist of a tracing pin, pen socket, socket screw, and a tail pin. Figure 6-19 shows a fixed scribe. The tracing pin on most Leroy scribes is reversible. One point is used with fine groove templates (Nos. 060, 080, and 100) and the other point is for wider groove templates (No. 120 to No. 500).

LINE WEIGHT

Recommended combinations of template and pen for best proportion between line thickness and letter size are shown below.

Template No.	Pen No.
060	000
080	000 or 00
100	00
120	0
140	1
175	2
200	3
240	3
290	4
350	4
425	5
500	6

This list is also found inside the lid of the Leroy lettering set case.

OPERATING PROCEDURE

A certain technique is required to manipulate the Leroy scribe with the template, and at the same time, hold the template against the working edge of the T-square or straightedge without slipping.

The T-square or straightedge must be held in position with the ball of your left hand resting on the blade, while the fingers of the left hand hold the template against the working edge and change the position of the template when necessary. The scribe is held between the thumb and first three fingers of your right hand. The little finger of the right hand presses the right side of the template against the working edge, preventing the tracing pin from slipping out of the character grooves of the template. Care must be taken to keep the tail pin in the straight line groove at the bottom of each template. When you are making the long lines of large lettering, you may find it helpful to secure the T-square or straightedge at both ends of the drawing board with drafting tape.

Using the above techniques to manipulate the scribe and template, follow the steps listed below to form uniform letters, words, and

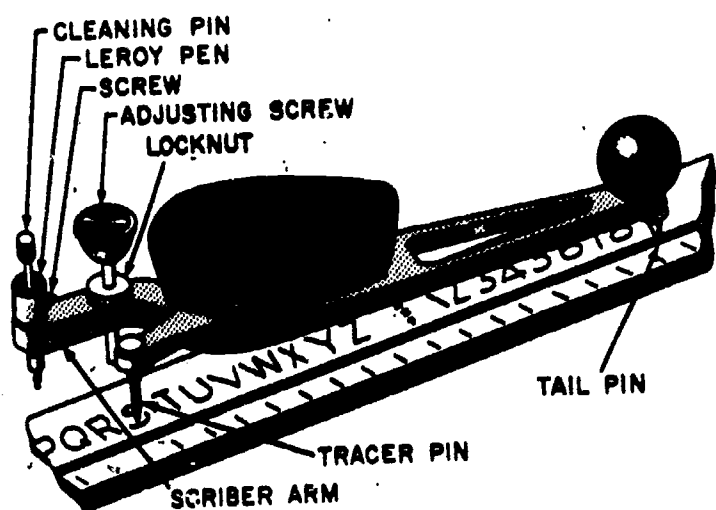

Figure 6-19.—Leroy scriber and template. 45.120

sentences. As you follow the steps, refer to figure 6-19.

1. Select the template with letters of the desired height. The distance between each graduation at the bottom of the template is equal to the height of the letter that can be made with the template. The numbers in a fraction are made by using a template one size smaller than that used for whole numbers.

2. Lay the template along the top edge of a T-square or straightedge.

3. Using the table of recommended template and pen sizes previously mentioned, select the proper pen to give a well-proportioned letter.

NOTE: On drawings with a great deal of lettering, the recommended combinations may be altered, either one pen-size under or over the recommended size, for variation and appearance. Never use a pen-size more than two over the recommended size.

4. Insert the selected pen into the socket of the scriber arm until the shoulder of the pen rests on the scriber arm.

5. Tighten the screw on the side of the scriber arm.

6. Loosen the locknut on the adjusting screw in the scriber arm.

the tail pin of the scriber in the straight groove of the template.

Set the tracer pin of the scriber in the groove of a character.

9. Lower the pen gently to the drawing surface.

10. Raise or lower the scriber arm by turning the adjusting screw until the tip of the cleaning pin within the pen just touches the drawing surface. Tighten the locknut when the desired height is reached. To prevent blotting, this rough adjustment is made before ink is put into the pen.

11. Remove the scriber from the template.

12. Remove the cleaning pin from the pen.

NOTE: To prevent the ink from flowing straight through the pen, the cleaning pin of a Leroy pen No. 4 or larger should not be removed from the pen.

13. Fill the reservoir of the pen with drawing ink. The Leroy pen should be filled with ink in the same manner as any common drafting inking instrument. The reservoir should be kept from 1/4 to 3/4 full; too low an ink level results in irregular lines.

14. If the cleaning pin was removed, reinsert it into the pen.

15. Wipe the lower tip of the pen with a cloth to remove any excess ink that may have been pushed through by the cleaning pin.

16. Draw a test line on a piece of scratch paper to ensure that the ink will flow smoothly.

17. Gently lower the pen to the drawing surface after inserting the tail and tracer pins in their proper grooves.

18. Proceed with the lettering by moving the tracer pin in the grooves of the characters, keeping the tail pin in the straight-guide groove.

If the ink does not flow properly, turn the cleaning pin inside the pen and wipe the tip with a cloth; also, make any necessary minor adjustments to the adjusting screw to allow the ink to flow properly. Tighten the locknut. When you will not be lettering for short periods of time, place the tip of the pen, still in the socket of the scriber arm, on a piece of moist paper. This will prevent the ink from drying around the opening of the pen and will help the ink to flow properly when you begin lettering again.

SPACING AND CENTERING

The rules for freehand letter and word spacing also apply to mechanical lettering. Guidelines are not necessary for mechanical lettering; however, when you are making more than one line of lettering, you may draw horizontal baselines at intervals to help you maintain the proper spacing between the lines. Spacing between lines of mechanical lettering is the same as for freehand lettering.

When lettering must be centered above a certain part of a drawing, or within a certain space, use the scales along the bottom edges of the templates. Each space on the scale represents the center-to-center distance of normal-width letters. For example, to center the words "LEROY LETTERING," about a certain line, proceed as follows:

1. Count the letters in each word and the spaces between words. Result: 15.
2. Considering the letter "I" and the space between the words as half value for each, reduce the total by one. Result: 14.
3. Divide the result of No. 2 above by two. Result: 7.

NOTE: If there had been an odd number of half values, you would use the next lower even number and allow more space between words than normally required.

4. Set the zero of the scale at the vertical line about which the lettering is to be centered and mark off seven spaces to the left and right of zero.

5. Start the "L" of the word "LEROY" in the title at the left mark and continue to the

end. The right edge of the "G" should fall on the mark to the right.

MAINTENANCE OF MECHANICAL LETTERING EQUIPMENT

Pens should be cleaned thoroughly after use with water and stored properly in the lettering set case. Never wash them under running water in a sink. The pen and cleaning pin may accidentally be washed down the drain. If water does not clean a pen satisfactorily, a diluted solution of ammonia may be used. Commercial pen cleaning solutions and pen cleaning kits are available. Caked or dried ink can be removed by soaking the pens overnight in cleaning solution; however, the pens may corrode if soaked longer. Cleaning pins should be handled with care because they are fragile and easily bent, especially the smaller ones.

The screw that holds the pen in the scribe should never be screwed too tightly as the fine threads tend to strip very easily.

Templates should be cleaned after every use. Dirt and dried-on ink are very easily transferred onto an otherwise clean drawing. You must ensure that the template grooves are kept free from all foreign matter and that the tracer pin does not cut into the sides of the grooves. In order to form perfect letters every time, the tracer pin must slide along the grooves smoothly. When small templates are used, a small sharp tracing pin must be inserted in the scribe. If a sharp tracing pin is used in the larger templates, the grooves of the template will be damaged.

CHAPTER 7

DRAFTING: GEOMETRIC CONSTRUCTIONS

As an Engineering Aid, you will be concerned principally with line drawings. A line drawing is one in which the graphic representation consists exclusively of lines, as distinguished from a drawing in which the representation is made up of, or includes, light and dark areas.

A line in a line drawing may be a straight line, a circle, an arc of a circle, or a noncircular curve; or it may be a line which is a compound of more than one of these basic types of lines. A noncircular curve may be a random curve, or it may be one derived from conic sections. The noncircular curves derived from conic sections are the ellipse, the parabola, and the hyperbola.

As a draftsman, you must be able to "construct" any of the various types of straight and curved lines used in a line drawing. You must also be able to construct lines at specified angles to each other, and to construct the various plane figures, circular curves, and noncircular curves. The general term applied to this phase of draftsmanship is "geometric constructions." This chapter provides information that will aid you in making different types of geometric constructions.

CONSTRUCTIONS INVOLVING ANGLES

You already know how to lay off an angle of given size with a protractor, or trigonometrically by the use of the tangent or the chord method.

TRANSFERRING AN ANGLE

There is a geometric construction for laying off, on another part of the same drawing or on a different drawing, an angle equal in size to one which is already drawn. This procedure, called

transferring the angle, is illustrated in figure 7-1. Here, the draftsman desired to lay off from O' a line which would make an angle with $B'O'$ equal to angle BOA . To do this, draw an arc through OB and OA , with O as a center, as shown in figure 7-1(A). Then, draw an arc of the same radius from $B'O'$, with O' as a center, as shown in figure 7-1(B). Next, measure the length of the chord of the arc between OB and OA and lay off the same length on the arc from $B'O'$, as shown in figure 7-1(C). A line drawn from O' through A' makes an angle with $B'O'$ equal to angle BOA , as shown in figure 7-1(D).

BISECTING AN ANGLE

To bisect an angle means to divide it in half. If you know the size of the angle, you can bisect

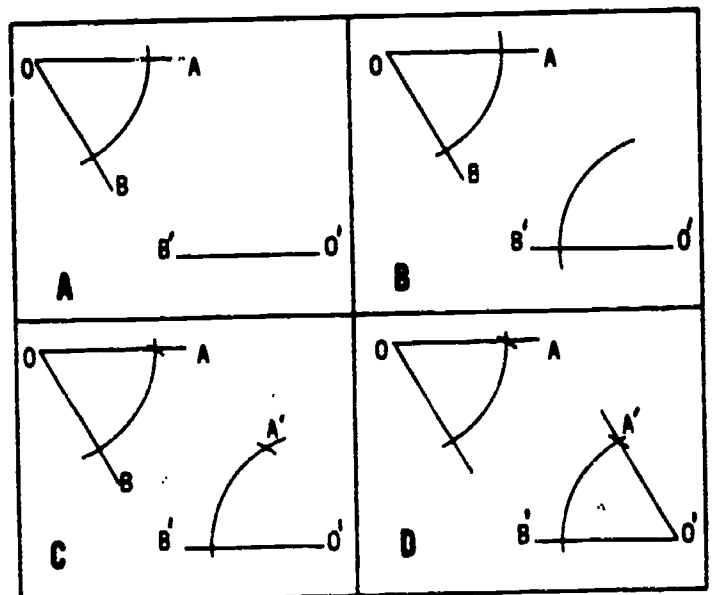

Figure 7-1.—Transferring an angle.

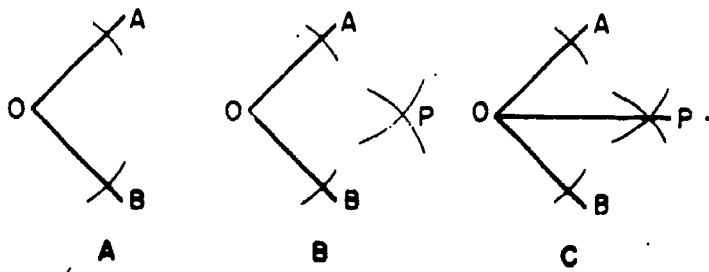

Figure 7-2.—Bisecting an angle.

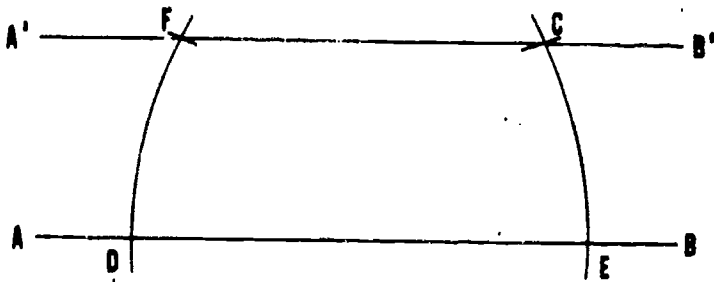

Figure 7-3.—Drawing a line through a given point, parallel to another line.

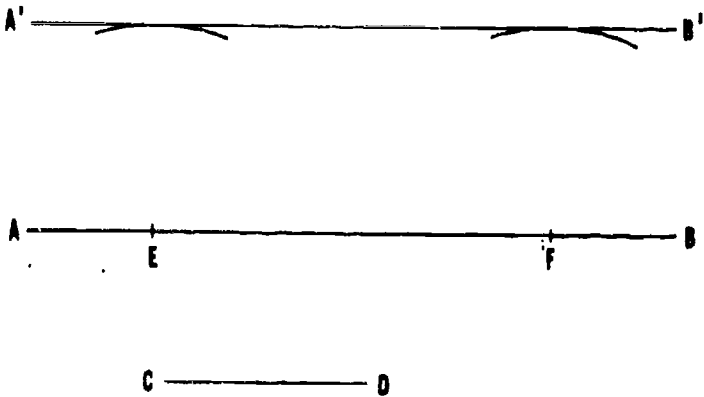

Figure 7-4.—Drawing a parallel line at a given distance from another line.

it by simply dividing the size by 2 and laying off the result with a protractor.

Geometric construction for bisecting an angle is shown in figure 7-2. To bisect the angle AOB, first lay off equal intervals from O on OA and OB. With the ends of these intervals as centers, strike intersecting arcs of equal radius at

P. Draw a line from O through the point of intersection of the arcs, P. The line OP bisects angle AOB.

CONSTRUCTIONS INVOLVING STRAIGHT LINES

In the preceding chapter, you learned how to draw a line parallel to another line by the use of a straightedge and a sliding triangle. Another method of drawing parallel lines is illustrated in figure 7-3. Here the line was to be drawn through given point C. To draw a line through C parallel to AB, place the needlepoint of a compass on any point D on AB, and strike arc CE. Shift the needlepoint to E, maintaining the same radius, and strike arc DF. Set compass or dividers to chord of arc CE, and lay off the chord DF from D, thus locating point F. A line drawn through F and C is parallel to AB.

Figure 7-4 shows another method of drawing one line parallel to another, this one being used when the second line is to be drawn at a given distance from the first. To draw a line parallel to AB at a distance from AB equal to CD, set the compass to the length of CD and from any points E and F on AB strike two arcs. A line A'B' drawn tangent to (barely touching) the arcs is parallel to AB, and located CD distance from AB.

In the preceding chapter, you learned how to draw a line perpendicular to another by the use of a straightedge and a sliding triangle. Two other methods of solving this problem are explained below.

Figure 7-5 shows a method of dropping a perpendicular from a given point to a line. To drop a perpendicular from point P to AB, set the needlepoint of a compass at P and strike an arc intersecting AB at C and D. With C and D as centers and any radius larger than one-half of CD, strike arcs intersecting at E. A line from P through E is perpendicular to AB.

Figure 7-6 illustrates a method of erecting a perpendicular from a given point on a line. To erect a perpendicular from point P on AB, set a

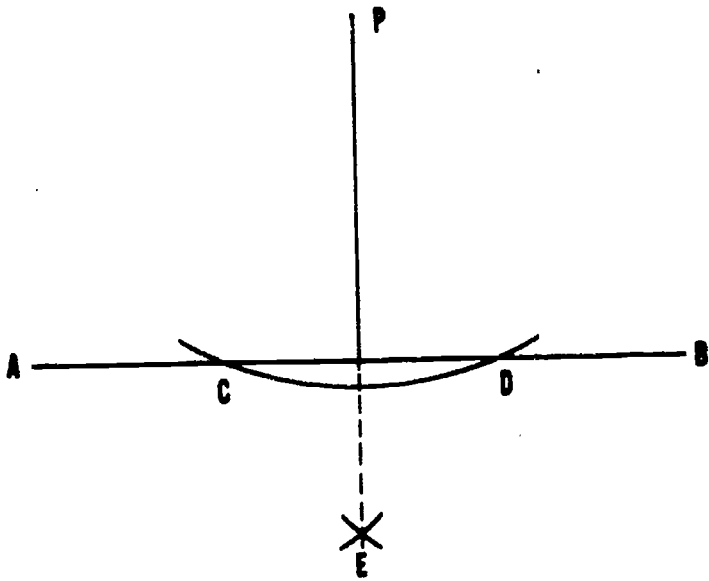

Figure 7-5.—Dropping a perpendicular from a given point to a line.

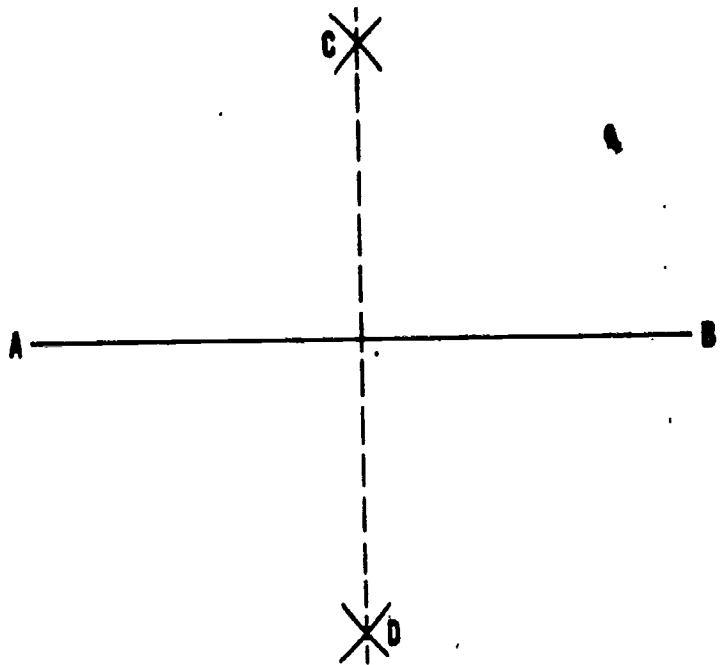

Figure 7-7.—Bisecting a line.

compass to any convenient radius and with P as a center, strike arcs intersecting AB at C and D. With C and D as centers and any radius larger than one-half of CD, strike arcs intersecting at E. A line from P through E is perpendicular to AB.

BISECTING A LINE

A line can be bisected by trial and error with dividers—that is, by setting the dividers to various spreads until you get one which tries out as one-half the length of the line.

Geometric construction for bisecting a line is shown in figure 7-7. To bisect the line AB, use the ends of the line, A and B, as centers, set a compass to a radius greater than one-half the length of AB, and strike arcs intersecting at C and D. A line drawn from C through D bisects AB.

DIVIDING A LINE INTO ANY NUMBER OF EQUAL PARTS

A line may be divided into more than two equal parts by trial and error with the dividers. Geometric construction for dividing a line into any number of equal parts is shown in figure 7-8. To divide AB into 10 equal parts, draw a ray line CB from B at a convenient acute angle to AB. Set a compass to spread less than one-tenth of the length of CB, and lay off this interval 10 times from B on CB. Draw a line from the 10th interval to A, and project the other points of intersection from CB to AB by lines parallel to the first one. The projected points of intersection divide AB into 10 equal parts.

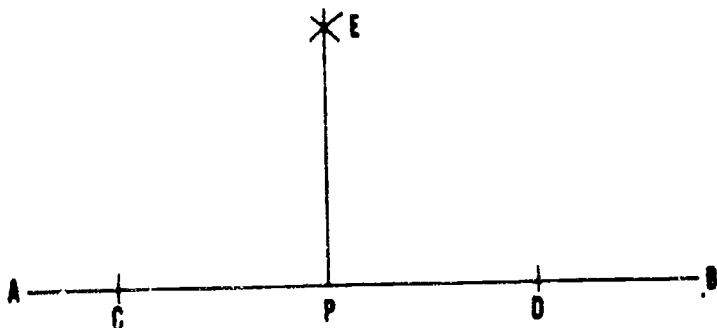

Figure 7-6.—Erecting a perpendicular from a given point on a line.

Figure 7-9 shows how you can use a scale to lay off equal intervals on the ray line.

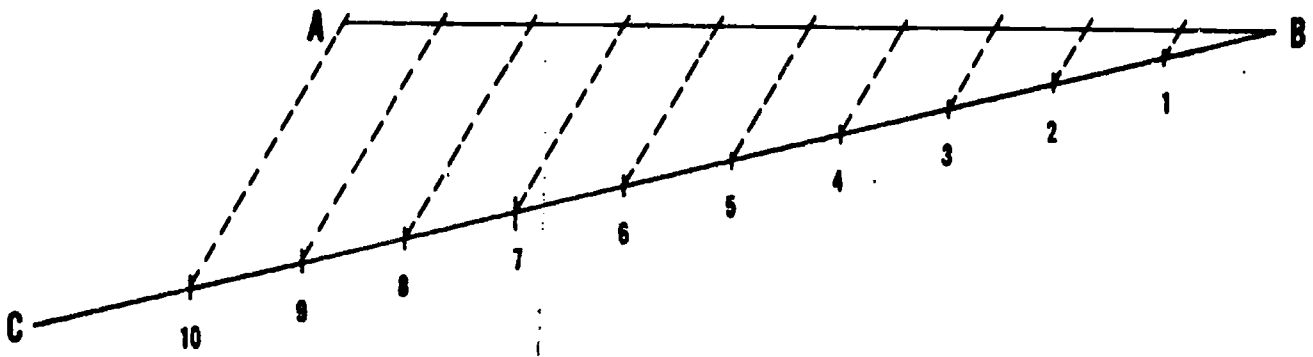

Figure 7-8.—Dividing a line into any number of equal parts.

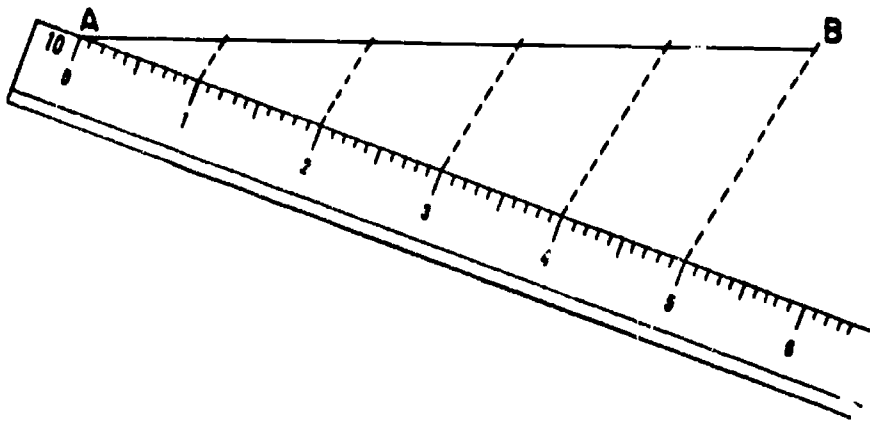

Figure 7-9.—Using a scale to lay off equal intervals on random line.

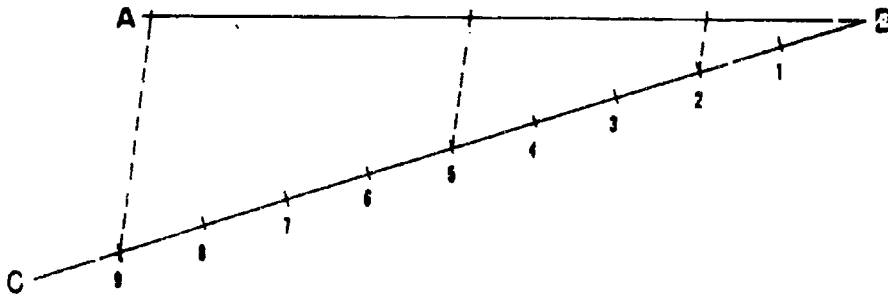

Figure 7-10.—Dividing a line into proportional parts.

PROPORTIONAL PARTS

Figure 7-10 shows a method of dividing a line into given proportional parts. The problem here is to divide the line AB into parts which are proportional as 2:3:4. Lay off ray line CB from B at a convenient acute angle to AB. Set a

compass to a convenient spread, and lay off this interval from B on CB a number of times equal to the sum of the figures in the proportion (2+3+4=9). Draw a line from the point of intersection of the last interval to A, and use a straightedge and sliding triangle to project the second and fifth intercepts on CB to AB by lines

parallel to the first one. The projected intercepts divide AB into segments which are proportional as 2:3:4.

Here again you could use a scale to lay off 9 equal intervals on CB.

PARTS ACCORDING TO A GIVEN RATIO

You may be required to divide a line into parts so that the ratio between the whole line and one of the parts is the same as that between two other lines. A method of doing this is shown in figure 7-11. Here it is required that AB be divided so that the ratio between AB and a part of AB is the same as the ratio between CD and EF. From A draw a ray line AG at a convenient acute angle from AB. On AG lay off AH equal to EF and AI equal to CD. Draw a line from I to B, and use a straightedge and sliding triangle to project H to J on a line parallel to IB. The ratio of AB to AJ is the same as that of CD to EF.

CONSTRUCTIONS INVOLVING PLANE FIGURES

This section explains how to construct certain plane figures, such as the triangle, rectangle, square, and regular polygon. You must understand the geometrical construction of plane figures because they appear in engineering drawings.

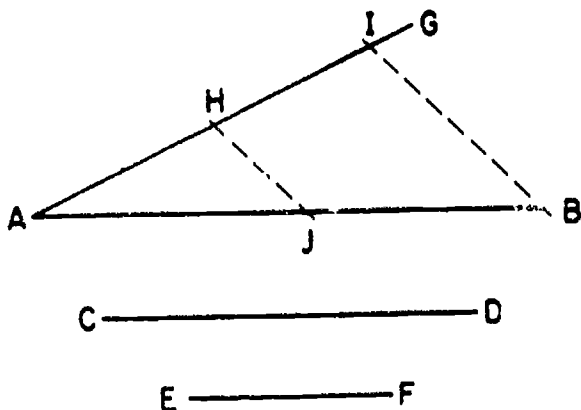

Figure 7-11.—Dividing a line into parts according to a given ratio.

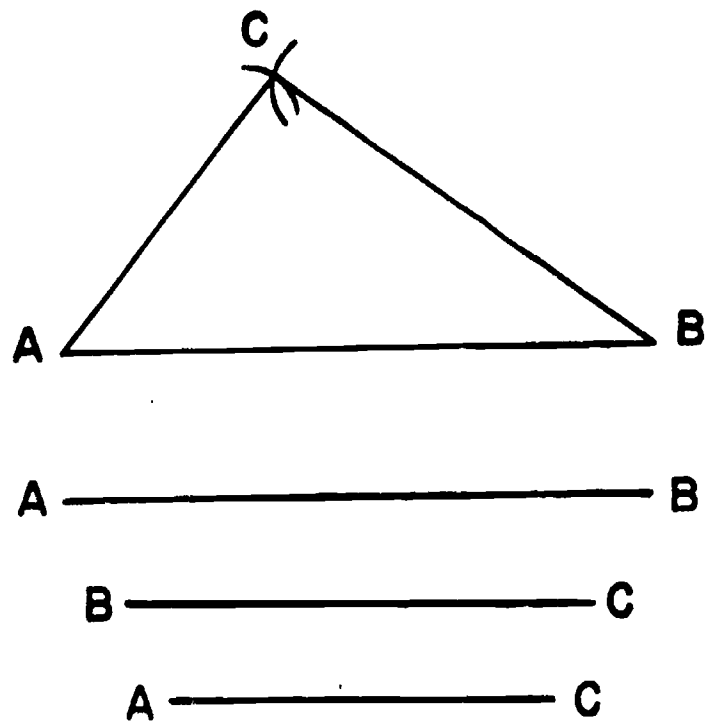

Figure 7-12.—Constructing a triangle with three sides given.

TRIANGLE: THREE SIDES GIVEN

To draw a triangle with three sides given, first draw a straight line AB, equal in length to one of the given sides (fig. -12). With A as a center, strike an arc with radius equal to the given length of the second side. With B as a center, strike an intersecting arc with radius equal to the length of the third side. Draw lines from A and B to the point of intersection of the arcs.

RIGHT TRIANGLE: HYPOTENUSE AND ONE SIDE GIVEN

Figure 7-13 illustrates a method of drawing a right triangle when the hypotenuse and one side are given. The line H is the given hypotenuse; the line S is the given side. Draw AB equal to H. Locate the center of AB (by bisection), and with the midpoint as a center and a radius equal to one-half of AB, draw the semicircle from A to B as shown. Set compass or dividers to the length of S, and with A as a center strike an arc intersecting the semicircle at C. Draw AC and BC.

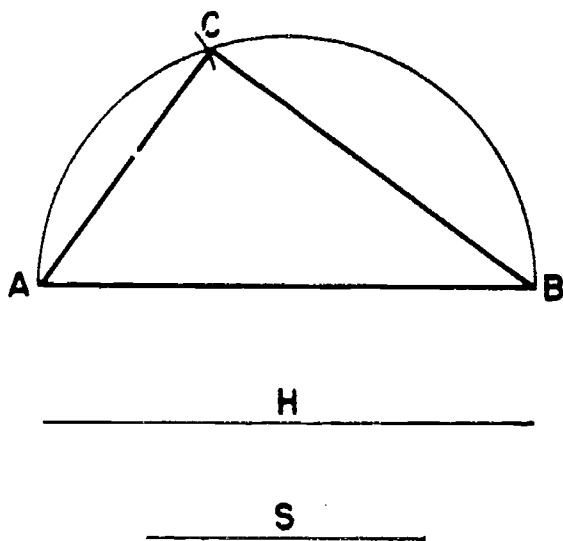

Figure 7-13.—Constructing a right triangle with hypotenuse and one side given.

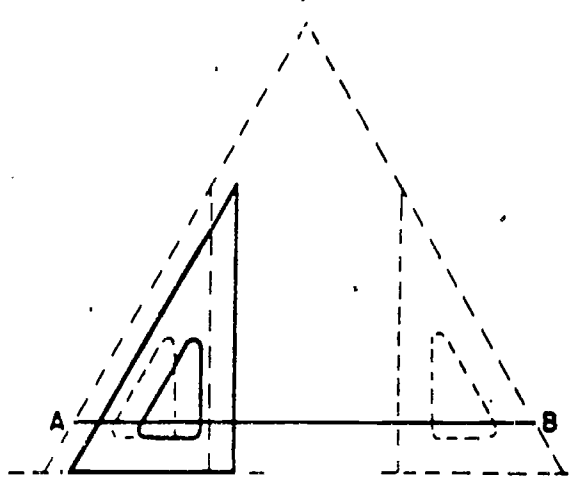

Figure 7-14.—Equilateral triangle with given length of side AB.

EQUILATERAL TRIANGLE: LENGTH OF SIDE GIVEN

To construct an equilateral triangle when the length of a side is given, you can follow the method previously described for constructing a triangle when the length of each side is given. The sides of an equilateral triangle are equal in length.

Each angle in an equilateral triangle measures 60° . This fact is applied in the method

of constructing an equilateral triangle with given length of side which is shown in figure 7-14. Simply use a $30-60^\circ$ triangle and a T-square or straightedge to erect lines from A and B at 60° to AB.

EQUILATERAL TRIANGLE IN GIVEN CIRCUMSCRIBED CIRCLE

A circumscribed plane figure is one which encloses another figure, the circumscribed figure being tangent to the extremities of the enclosed figure. An inscribed plane figure is one which is enclosed by a circumscribed figure.

Figure 7-15 shows you how to inscribe an equilateral triangle within a given circumscribed circle. Draw a vertical centerline intersecting the given circle at A and B. With B as a center and a radius equal to the radius of the circle, strike arcs intersecting the circle at C and D. Lines connecting A, C, and D form an equilateral triangle.

EQUILATERAL TRIANGLE ON GIVEN INSCRIBED CIRCLE

Figure 7-16 illustrates one method of circumscribing an equilateral triangle on a given inscribed circle. Draw AB parallel to the

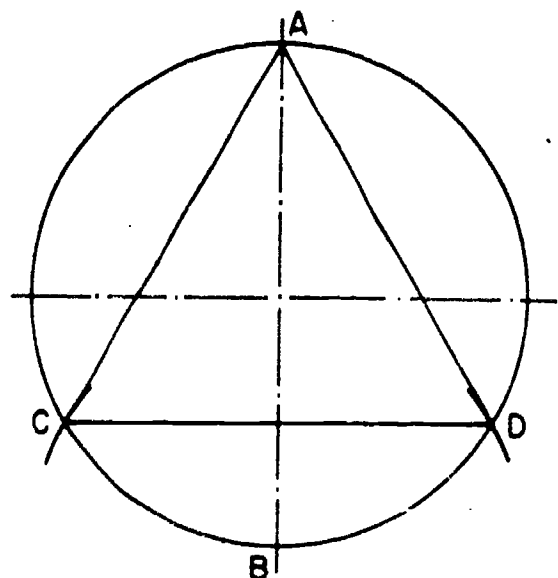

Figure 7-15.—Equilateral triangle in given circumscribed circle.

horizontal centerline of the circle and tangent to the circumference. Then use a 30-60° triangle to draw AC and BC at 60° to AB and tangent to the circle.

Another method of accomplishing this construction is shown in figure 7-17. Draw radii at 30° to the horizontal centerline of the circle, intersecting the circumference at C and B. There is a third point of intersection at A, so that you now have three radii: OA, OB, and OC. Draw the sides of the triangle at A, B, and C, tangent to the circle and perpendicular to the relevant radius.

RECTANGLE: GIVEN LENGTH AND WIDTH

To construct a rectangle of given length and width, draw a horizontal line AB with the T-square, equal to the given length. With T-square and triangle, erect perpendiculars from A and B, each equal to the given width. Connect the ends of the perpendiculars.

SQUARE: GIVEN LENGTH OF SIDE

You can construct a square of given length of side by the method described for constructing

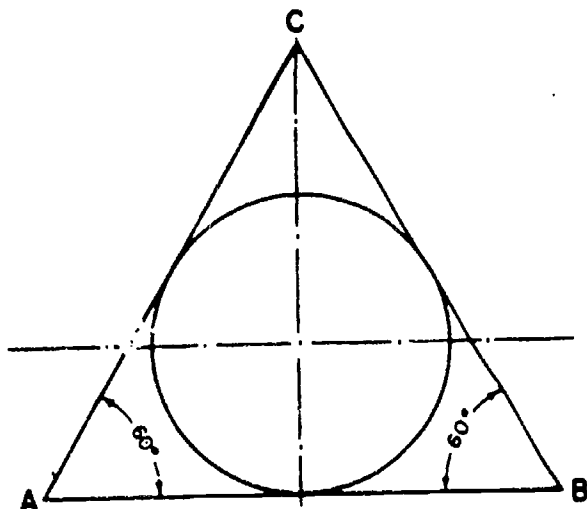

Figure 7-16.—Equilateral triangle on given inscribed circle: one method.

a rectangle. Another method is illustrated in figure 7-18. Draw horizontal line AB with the T-square, equal to the given length of side. With the T-square and a 45° triangle, draw diagonals from A and B at 45° to AB. Erect perpendiculars from A and B, intersecting the diagonals, and connect the points of intersection.

SQUARE: GIVEN LENGTH OF DIAGONAL

Figure 7-19 shows a method of constructing a square with a given length of diagonal. Draw horizontal line AB, equal to given length of diagonal. Locate O at the center of AB, and lay off CD through O, perpendicular to and slightly longer than AB. Use T-square and 45° triangle to draw AF and EB at 45° to AB and CD. Connect AE and FB.

SQUARE IN GIVEN CIRCUMSCRIBED CIRCLE

Figure 7-20 shows a method of drawing a square in a given circumscribed circle. Draw the

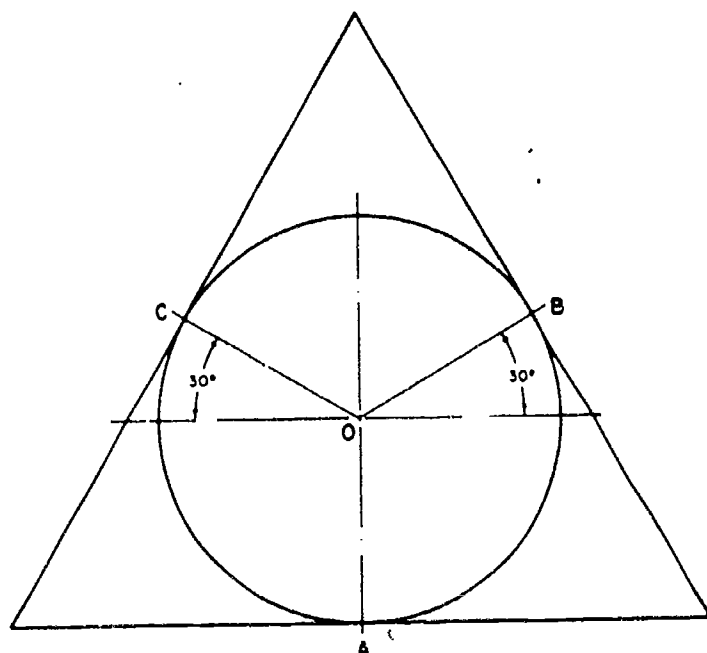

Figure 7-17.—Equilateral triangle on given inscribed circle: another method.

diameters AB and CD at right angles to each other, and connect the points where the diameters intersect the circumference of the circle.

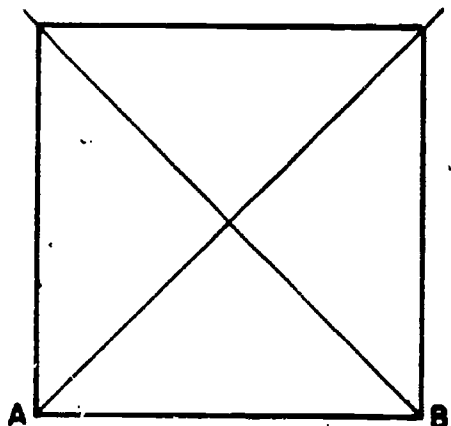
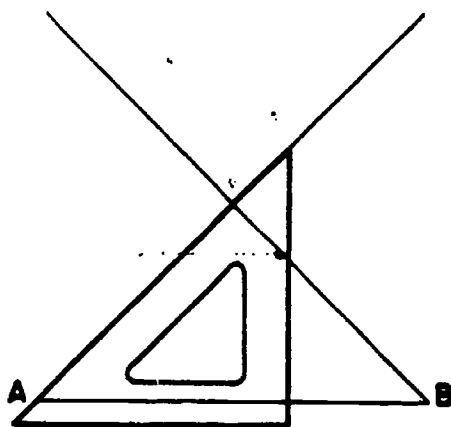

Figure 7-18.—Square with given length of side.

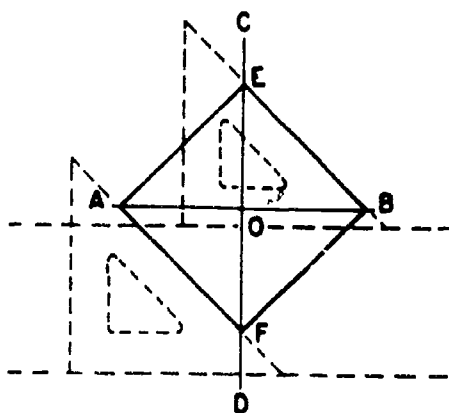

Figure 7-19.—Square with given length of diagonal.

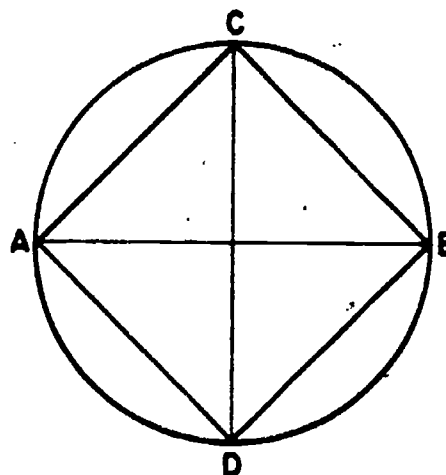

Figure 7-20.—Square in given circumscribed circle.

SQUARE CIRCUMSCRIBED ON GIVEN INSCRIBED CIRCLE

Figure 7-21 illustrates a method of circumscribing a square on a given inscribed circle. Draw the diameters AB and CD at right angles to each other. Then draw each side of the square tangent to the point where a diameter intersects the circumference of the circle, and perpendicular to the diameter.

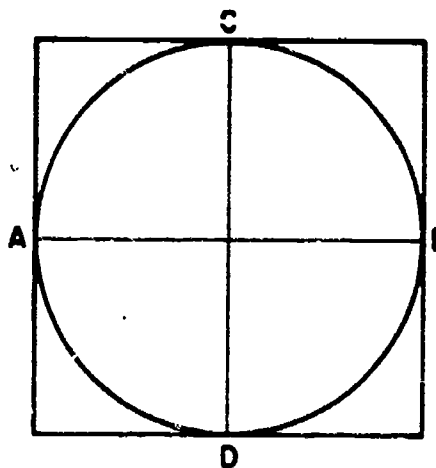

Figure 7-21.—Square on given inscribed circle.

ANY REGULAR POLYGON IN GIVEN CIRCUMSCRIBED CIRCLE

You can construct any regular polygon in a given circumscribed circle by trial and error with compass or dividers as shown in figure 7-22. To draw a 9-sided regular polygon in the circle shown, divide the circumference by trial and error with compass or dividers into 9 equal segments, and connect the points of intersection. To get a trial spread for the compass or dividers, divide the central angle subtended by the entire circle (360°) by the number of sides of the polygon (in this case, by 9). Then, lay off the central angle quotient from the center of the circle to the circumference with a protractor.

ANY REGULAR POLYGON ON GIVEN INSCRIBED CIRCLE

The same method (dividing the circumference into equal segments) can be used to construct a regular polygon on a given inscribed circle. In this case, however, instead of connecting the points of intersection on the circumference, you draw each side tangent to the circumference and perpendicular to the radius at each point of intersection, as shown in figure 7-23.

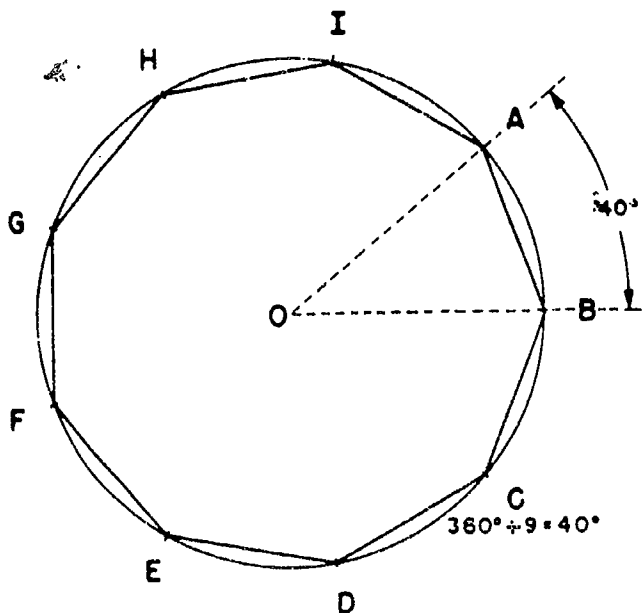

Figure 7-22.—Regular polygon in given circumscribed circle.

ANY REGULAR POLYGON WITH GIVEN LENGTH OF SIDE

Figure 7-24 illustrates a method of drawing any regular polygon with a given length of side. To draw a 9-sided regular polygon with length of side equal to AB, first extend AB to C, making CA equal to AB. With A as a center and AB (or CA) as a radius, draw a semicircle as shown. Divide the semicircle into 9 equal segments from C to B, and draw radii from A to the points of intersection. The radius A2 is always the second side of the polygon.

Draw a circle through points A, B, and D. To do this, first erect perpendicular bisectors from DA and AB. The point of intersection of the bisectors is the center of the circle. The circle is the circumscribed circle of the polygon. To draw the remaining sides, extend the radii from the semicircle as shown, and connect the points where they intersect the circumscribed circle.

REGULAR PENTAGON, HEXAGON, OR OCTAGON

Besides the methods described for constructing any regular polygon, there are particular methods for constructing a regular pentagon, hexagon, or octagon.

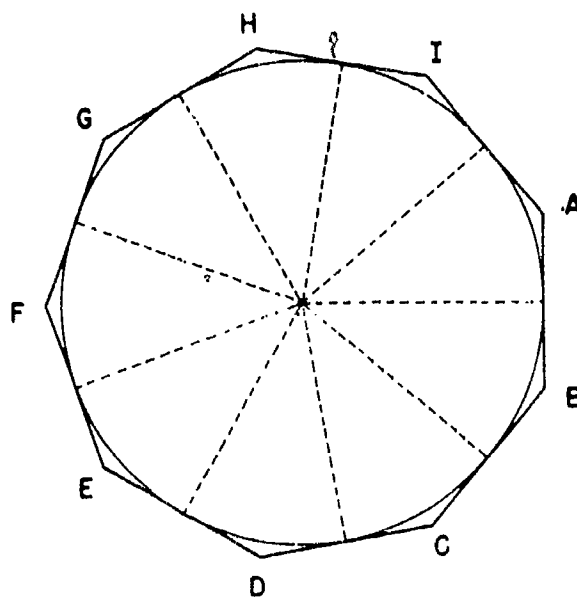

Figure 7-23.—Regular polygon on given inscribed circle.

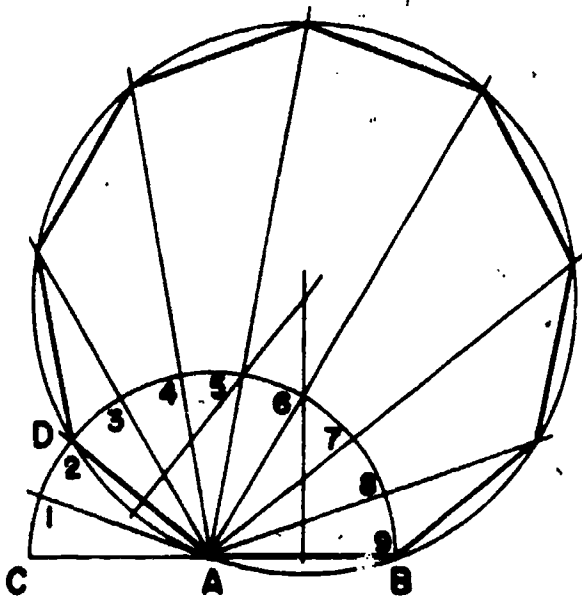

Figure 7-24.—Any regular polygon with given length of side.

spread between E and C, and with E as a center strike the arc CF. Set the compass to the spread between C and F, and with C as a center strike the arc GF. A line from G to C forms one side of the pentagon. Set a compass to GC and lay off this interval from C around the circle. Connect the points of intersection.

Regular Pentagon on Given Inscribed Circle

To construct a regular pentagon on a given inscribed circle, determine the 5 equal intervals on the circle in the same manner. However, instead of connecting these points, draw each side of the figure tangent to the circle at a point of intersection.

Regular Hexagon in Given Circumscribed Circle

Many bolt heads and nuts are hexagonal (6-sided) in shape. Figure 7-26 shows a method of constructing a regular hexagon in a given circumscribed circle. The diameter of the

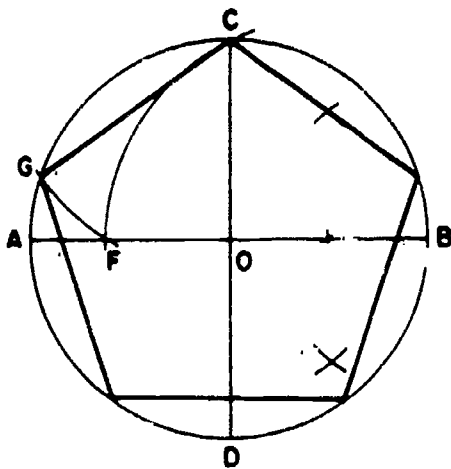

Figure 7-25.—Regular pentagon in given circumscribed circle.

Regular Pentagon in Given Circumscribed Circle

Figure 7-25 illustrates a method of constructing a regular pentagon in a given circumscribed circle. Draw a horizontal diameter AB and a vertical diameter CD. Locate E, the midpoint of the radius OB. Set a compass to the

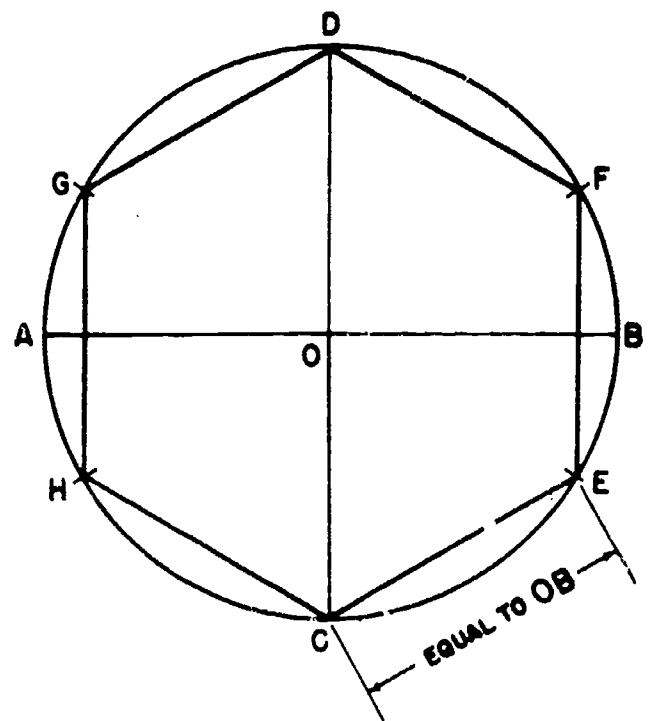

Figure 7-26.—Regular hexagon in given circumscribed circle: one method.

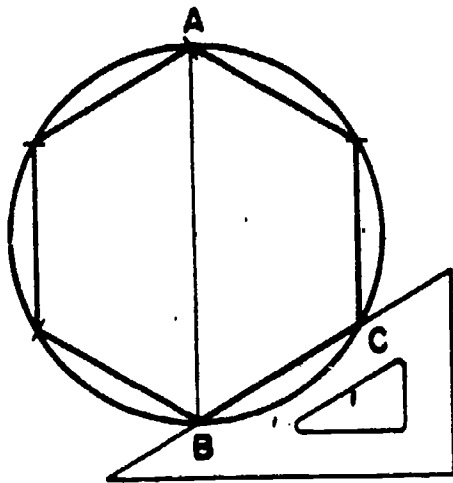

Figure 7-27.—Regular hexagon in given circumscribed circle: another method.

circumscribed circle has the same length as the long diameter of the hexagon. The radius of the circumscribed circle (which equals one-half the long diameter of the hexagon) is equal in length to the length of a side. Lay off the horizontal diameter AB and vertical diameter CD. OB is the radius of the circle. From C, draw a line CE equal to OB; then lay off this interval around the circle, and connect the points of intersection.

Figure 7-27 shows another method of constructing a regular hexagon in a given circumscribed circle. Draw vertical diameter AB, and use T-square and 30-60° triangle to draw BC from B at 30° to the horizontal. Set a compass to BC, lay off this interval around the circumference, and connect the points of intersection.

Regular Hexagon on Given Inscribed Circle

Figure 7-28 shows a method of constructing a regular hexagon on a given inscribed circle. Draw horizontal diameter AB and vertical centerline. Draw lines tangent to the circle and perpendicular to AB at A and B. Use T-square and 30-60° triangle to draw remaining sides of the figure tangent to the circle and at 30° to the horizontal.

Regular Octagon in Given Circumscribed Circle

Figure 7-29 shows a method of constructing a regular octagon in a given circumscribed circle. Draw horizontal diameter AB and vertical diameter CD. Use T-square and 45° triangle to draw additional diameters EF and GH at 45° to the horizontal. Connect the points where the diameters intersect the circle.

Regular Octagon Around Given Inscribed Circle

Figure 7-30 shows a method of constructing a regular octagon around a given inscribed circle. Draw horizontal diameter AB and vertical diameter CD. Draw tangents at A, B, C, and D perpendicular to the diameters. Then use a T-square and 45° to the horizontal, intersecting the first tangents drawn.

CONSTRUCTION OF CURVES

Many of the common geometrical constructions occurring in the drafting room are

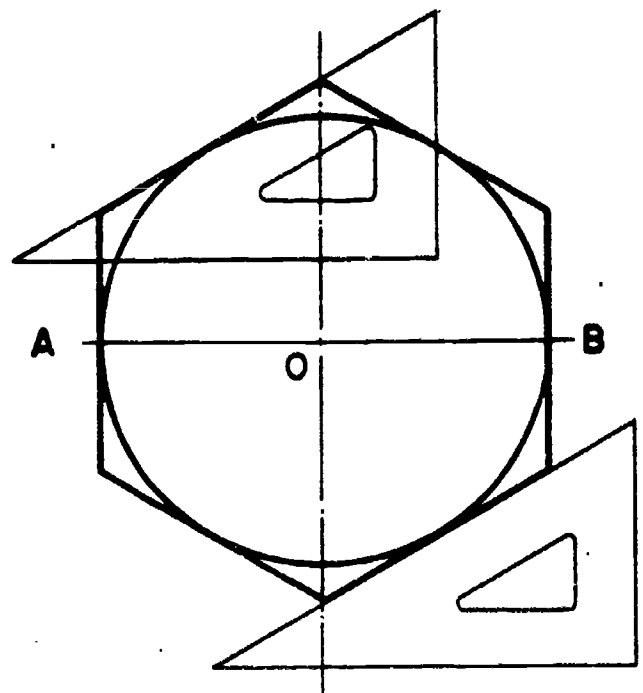

Figure 7-28.—Regular hexagon on given inscribed circle.

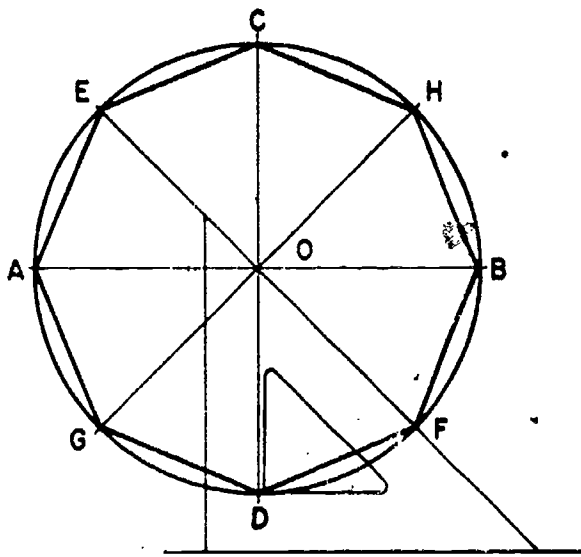

Figure 7-29.—Regular octagon in given circumscribed circle.

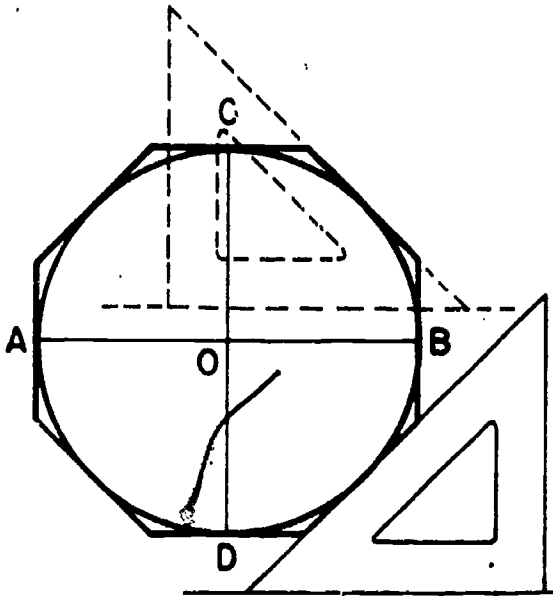

Figure 7-30.—Regular octagon around given inscribed circle.

those involving circular curves. This section explains how to construct circular curves that may be required to satisfy varying conditions.

CIRCLE THROUGH THREE POINTS

In figure 7-31 the problem is to draw a circle (or a circular arc) which passes through points

A, B, and C. Connect the points by lines and erect perpendicular bisectors as shown. The point of intersection of the perpendicular bisectors is the center of the circle or arc passing through all three points.

LINE TANGENT TO A CIRCLE AT A GIVEN POINT

A line which is tangent to a circle at a given point, is perpendicular to the radius which intersects the point. It follows that one method of drawing a line tangent to a circle at a given point is to draw the radius which intersects the point, and then draw the line tangent at the point of intersection and perpendicular to the radius.

Another method is shown in figure 7-32. To draw a line tangent to the circle at P, set a compass to the radius of the circle and, with P as a center, strike an arc which intersects the circle at A. With the compass still set to the radius of the circle, use A as a center and strike an arc which intersects the first arc at B. With B as a center and the compass still set to the radius of

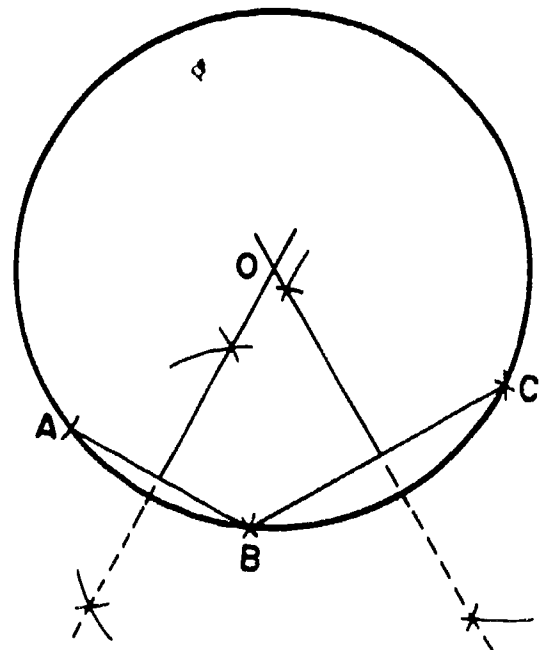

Figure 7-31.—Circle or arc through three points.

the circle, strike another arc. A line through the point of intersection (O) of the last drawn arc and through P is tangent to the circle at P.

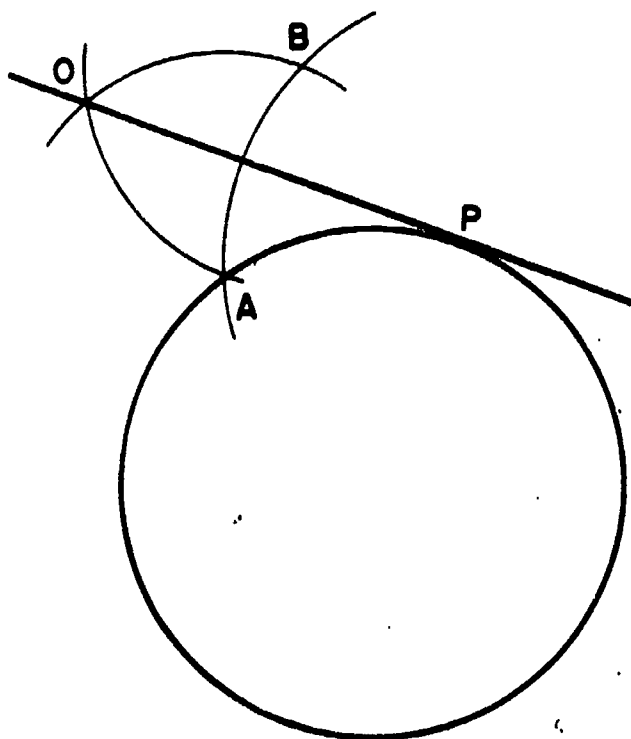

Figure 7-32.—Line tangent to given point on circle.

CIRCULAR ARC OF GIVEN RADIUS TANGENT TO TWO STRAIGHT LINES

The problem of drawing a fillet or round (explained in the next chapter) comprises the problem of drawing a circular arc of given radius tangent to two nonparallel lines.

Figure 7-33 shows a method which can be used when the two nonparallel lines form a right angle. AB is the given radius of the arc. Set a compass to this radius, and with the point of intersection of the lines as a center, strike an arc intersecting the lines at C and D. With C and D as centers and the same radius, strike intersecting arcs as shown. The point of intersection of these arcs is the center of the circle of which an arc of the given radius is tangent to the lines.

Figure 7-34 shows a method which can be used regardless of the size of the angle formed by the lines. Again AB equals the given radius of the arc, and the problem is to draw an arc with radius equal to AB, tangent to CD and EF. Draw GH parallel to CD, and at a distance from CD equal to the given radius of the arc. Draw IJ parallel to EF, also at a distance equal to the

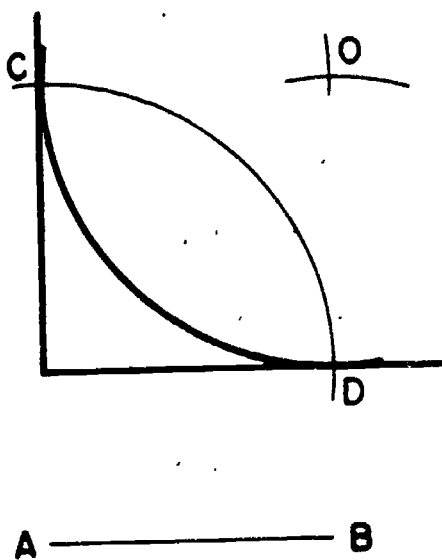

Figure 7-33.—Circular arc tangent to two lines which form a right angle.

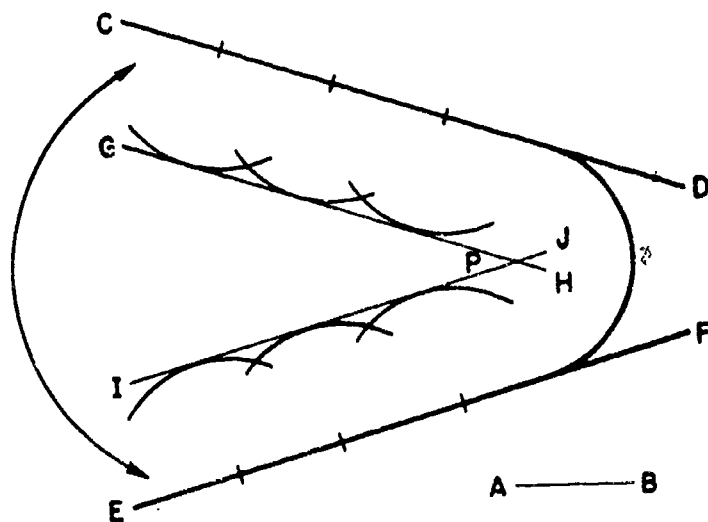

Figure 7-34.—Circular arc tangent to two lines which form any angle.

given radius of the arc. The point of intersection between GH and IJ is the center of the circle of which an arc of the given radius is tangent to CD and EF.

CIRCULAR ARC OF GIVEN RADIUS TANGENT TO STRAIGHT LINE AND TO ANOTHER CIRCULAR ARC

The problem in figure 7-35 is to draw a circular arc with radius equal to AB, tangent to the circular arc CD and to the straight line EF. Set a compass to a radius equal to the radius of the circular arc CD plus the given radius AB (which is indicated by the dashed line shown), and with O as a center strike the arc GH. Draw a line IJ parallel to EF, at a distance from EF equal to AB. The point of intersection (P) between GH and IJ is the center of the circle of which an arc of the given radius is tangent to CD and EF.

CIRCULAR ARC OF GIVEN RADIUS TANGENT TO TWO OTHER CIRCULAR ARCS

The problem in figure 7-36 is to draw an arc with radius equal to AB, tangent to the circular arcs CD and EF. Set a compass to a spread equal to the radius of arc CD plus AB (indicated by the left-hand dashed line), and with O as a

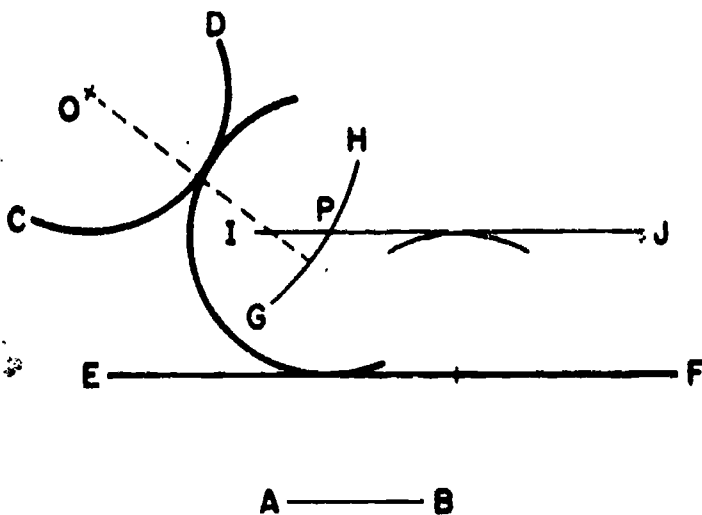

Figure 7-35.—Circular arc tangent to a straight line and another circular arc.

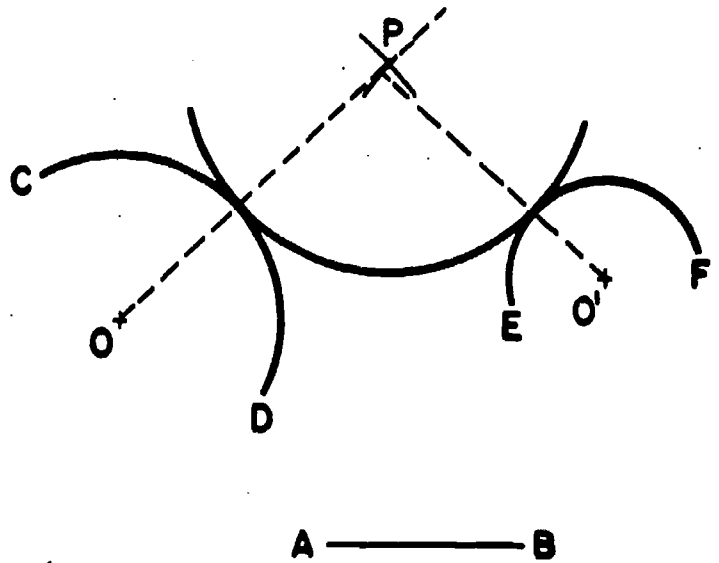

Figure 7-36.—Circular arc tangent to two other circular arcs.

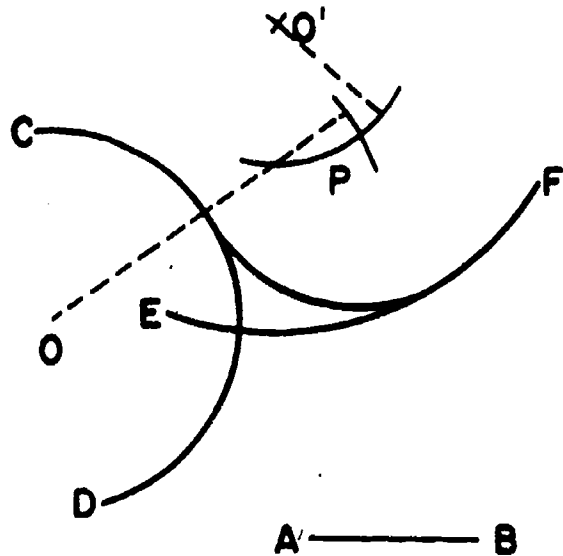

Figure 7-37.—Circular arc tangent to arcs which curve in the same direction.

center strike an arc. Set the compass to a spread equal to the radius of arc EF plus AB (indicated by the right-hand dashed line), and with O' as a center strike an intersecting arc. The point of intersection between the two arcs is the center of the circle of which an arc of given radius is tangent to arcs CD and EF.

In figure 7-36, the circular arcs CD and EF curve in opposite directions. In figure 7-37, the

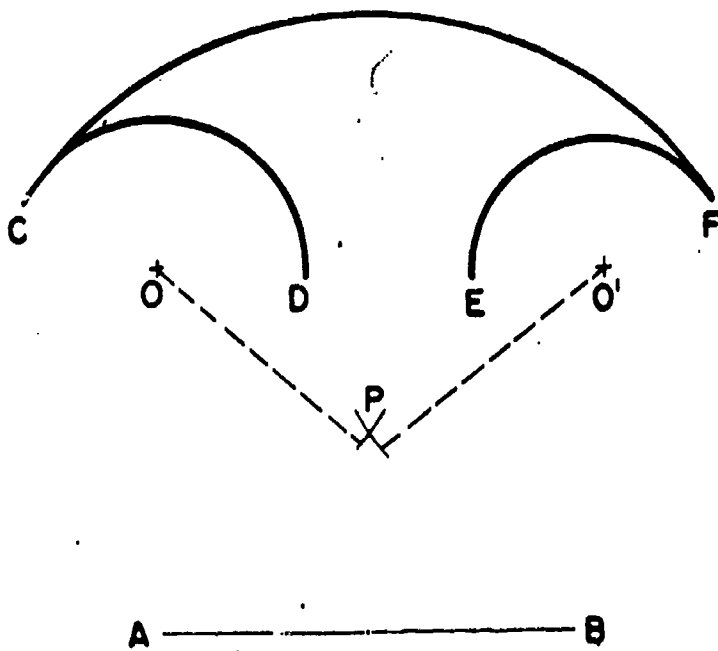

Figure 7-38.—Circular arc tangent to and enclosing two other circular arcs.

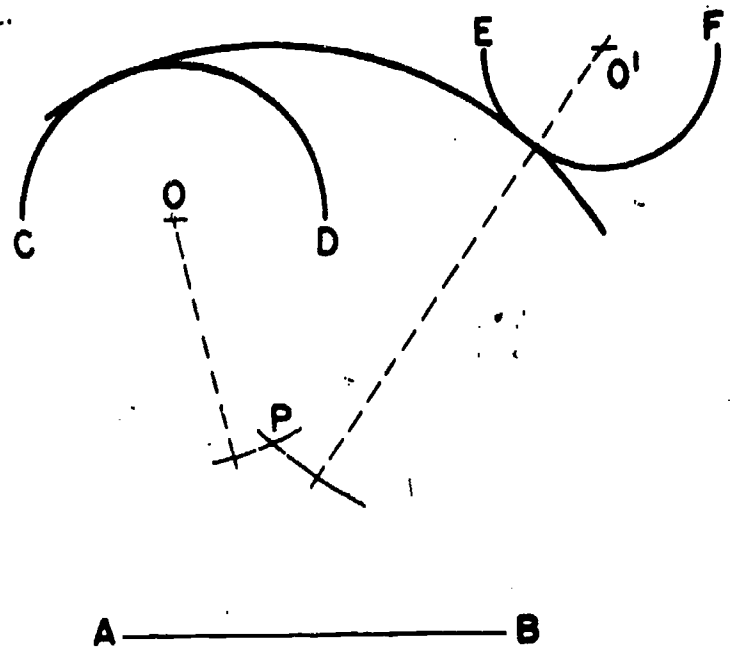

Figure 7-39.—Circular arc tangent to and enclosing one arc, and tangent to but not enclosing another.

problem is to draw an arc with radius equal to AB, tangent to two circular arcs, CD and EF, which curve in the same direction.

Set compass to a radius equal to the radius of EF LESS AB, and with O' as a center strike an arc. Then, set the compass to a radius equal to the radius of arc CD plus line AB, and with O as center strike an intersecting arc at P. The point of intersection between these two arcs is the center of the circle of which an arc of the given radius is tangent to CD and EF.

When a circular arc is tangent to another, it is commonly the case that the two arcs curve in opposite directions. However, an arc may be drawn tangent to another with both curving in the same direction. In a case of this kind, the tangent arc is said to enclose the other.

An arc tangent to two others may enclose both, or it may enclose only one and not the other. In figure 7-38, the problem is to draw a circular arc with radius equal to AB, tangent to and enclosing both arcs CD and EF. Set a compass to a radius equal to AB less the radius of CD (indicated by the dashed line from O), and

with O as a center strike an arc. Set the compass to a radius equal to AB less the radius of EF (indicated by the dashed line from O'), and with O' as a center strike an intersecting arc at P. The point of intersection between these two arcs is the center of a circle of which an arc of given radius is tangent to, and encloses, both arcs CD and EF.

In figure 7-39, the problem is to draw a circular arc with radius equal to AB, tangent to and enclosing CD, and tangent to but NOT enclosing EF. Set a compass to a radius equal to AB less the radius of arc CD (indicated by the dashed line from O), and with O as a center strike an arc. Set the compass to AB PLUS the radius of EF (as indicated by the dashed line from O') and with O' as a center strike an intersecting arc at P. The point of intersection between the two arcs is the center of a circle of which an arc of the given radius is tangent to and encloses arc CD, and also tangent to, but does not enclose, arc EF.

COMPOUND CURVE

A curve which is made up of a series of successive tangent circular arcs is called a

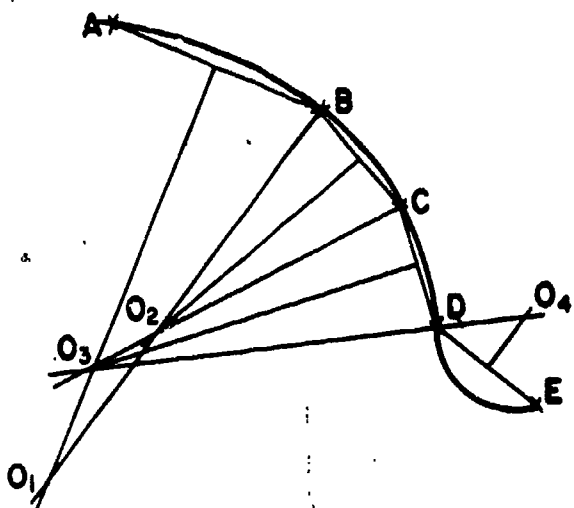

Figure 7-40.--Curve composed of a series of consecutive tangent circular arcs.

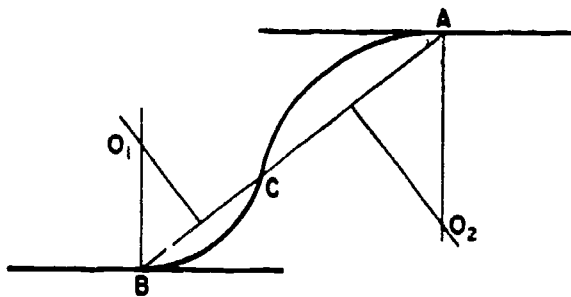

Figure 7-41.--Reverse curve connecting and tangent to two parallel lines.

compound curve. In figure 7-40, the problem is to construct a compound curve passing through given points A, B, C, D, and E. First connect the points by straight lines. The straight line between each pair of points constitutes the chord of the arc through the points.

Erect a perpendicular bisector from AB. Select an appropriate point O_1 on the bisector as a center, and draw the arc AB. From O_1 draw the radius O_1B . From BC erect a perpendicular bisector. The point of intersection O_2 between this bisector and the radius O_1B is the center for the arc BC. Draw the radius O_2C , and erect a perpendicular bisector from CD. The point of

intersection O_3 between this bisector and the extension of O_2C is the center for the arc CD.

To continue the curve from D to E you must reverse the direction of curvature. Draw the radius O_3D , and erect a perpendicular bisector from DE on the opposite side of the curve from those previously erected. The point of intersection between this bisector and the extension of O_3D is the center of the arc DE.

REVERSE OR OGEE CURVE

A reverse or ogee curve is composed of two consecutive tangent circular arcs which curve in opposite directions.

Figure 7-41 shows a method of connecting two parallel lines by a reverse curve tangent to the lines. The problem is to construct a reverse curve tangent to the upper line at A and to the lower line at B.

Connect A and B by straight line AB. Select on AB point C where you want to have the reverse curve change direction. Erect perpendicular bisectors from BC and CA, and erect perpendiculars from B and A. The points of intersection between the perpendiculars (O_1 and O_2) are the centers for the arcs BC and CA.

Figure 7-42 shows a method of constructing a reverse curve tangent to three intersecting straight lines. The problem is to draw a reverse curve tangent to the three lines which intersect at points A and B. Select on AB point C where you want the reverse curve to change direction. Lay off from A a distance equal to AC to

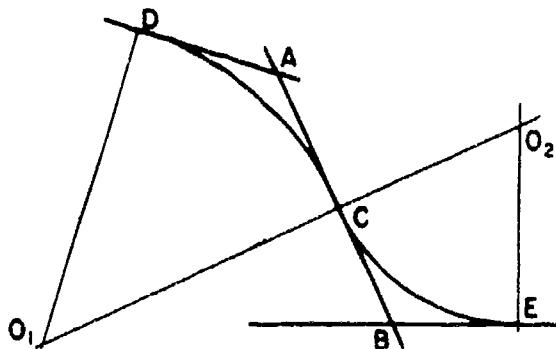

Figure 7-42.--Reverse curve tangent to three intersecting straight lines.

establish point D. Erect a perpendicular from D and another from C. The point of intersection of these perpendiculars (O_1) is the center of the arc DC.

Lay off from B a distance equal to CB to establish point E. Erect a perpendicular from E, and extend O_1C to intersect it. The point of intersection (O_2) is the center of the arc CE.

CONSTRUCTIONS INVOLVING NONCIRCULAR CURVES

The basic uniform noncircular curves are the ellipse, the parabola, and the hyperbola. These curves are derived from conic sections as shown in figure 7-43. The circle itself (not shown, but a curve formed by a plane passed through a cone perpendicular to the vertical axis) is also derived from a conic section.

This section describes methods of constructing the ellipse only. Methods of constructing the parabola and the hyperbola are given in Engineering Drawing, by French and Vierck or Architectural Graphic Standards.

Of the many different ways to construct an ellipse, the three most common are: pin-and-string method, the four center method,

and the concentric circle method. The method you use will depend on the size of the ellipse and where it is to be used.

ELLIPSE BY PIN-AND-STRING METHOD

The dimensions of an ellipse are given in terms of the lengths of the major (longer) and minor (shorter) axes. Figure 7-44 shows a method of constructing an ellipse which is called the pin-and-string method. The problem is to construct an ellipse with major axis AB and minor axis CD. Set a compass to one-half the length of AB, and with C as a center, strike arcs intersecting AB at F and F' . The points F and F' are called the foci of the ellipse. Set a pin at point C, another at F, and a third at F' . Tie the end of a piece of string to the pin at F, pass the string around the pin at C, draw it taut, and fasten to the pin at F' . Remove the pin at C, place the pencil point in the bight of the string, and draw the ellipse as shown in view C, keeping the string taut all the way around.

ELLIPSE BY FOUR CENTER METHOD

The four center method is used for small ellipses. Given major axis AB and minor axis CD, mutually perpendicular at their midpoint O, as shown in figure 7-45, draw AD, connecting the

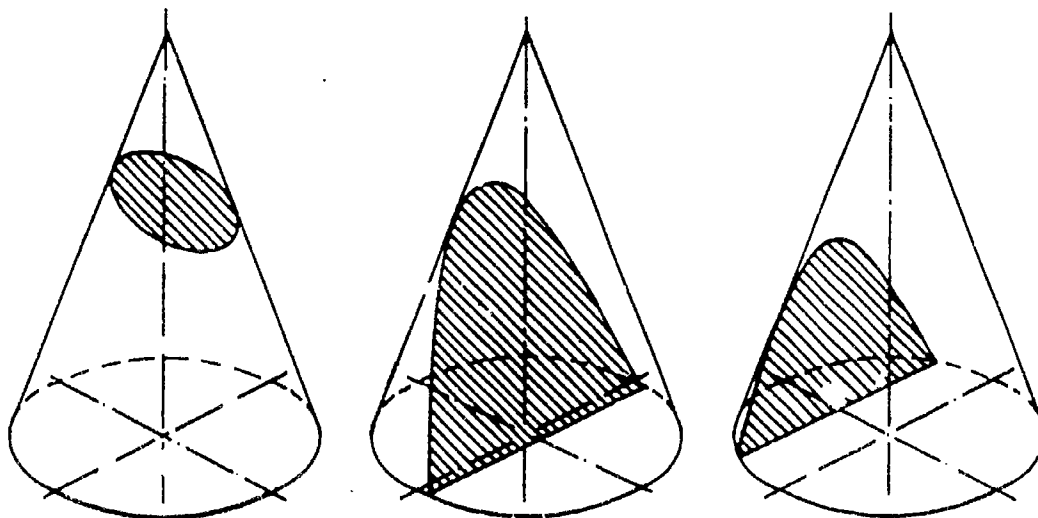

Figure 7-43.—Conic sections: (A) ellipse; (B) parabola; (C) hyperbola.

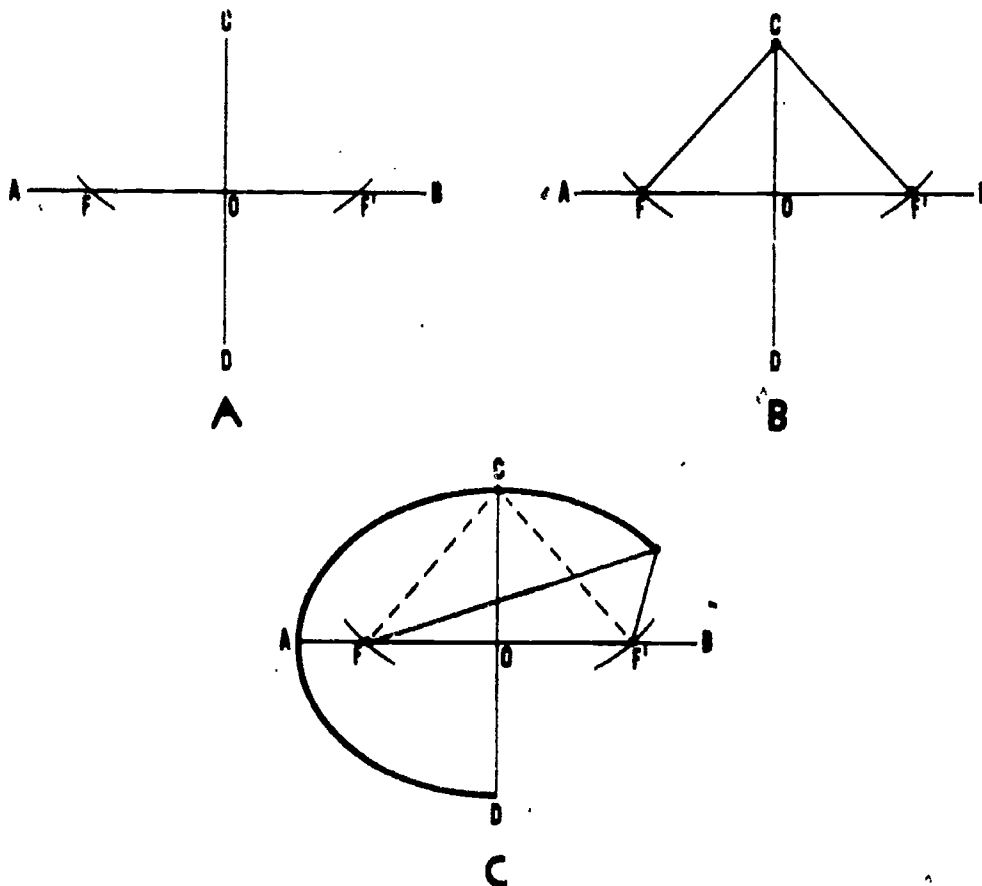

Figure 7-44.—Ellipse by pin-and-string method.

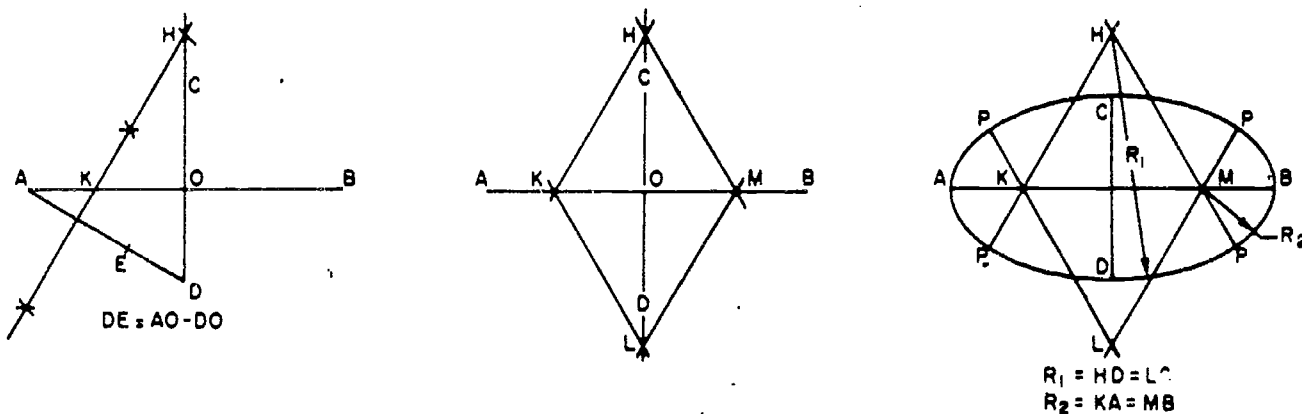

Figure 7-45.—Ellipse by four center method.

end points of the two axes. With dividers set to DO , measure DO along AO and reset dividers on remaining distance to O . With the difference of semi-axes thus set on dividers, mark off DE equal to AO minus DO . Draw perpendicular bisector AE , and extend it to intersect the major axis at

K and the minor axis extended at H . With dividers, mark off OM equal to OK , and OL equal to OH . With H as a center and radius R_1 equal to HD , draw the bottom arc. With L as a center and the SAME radius as R_1 , draw the top arc. With M as a center and the radius R_2

equal to MB, draw the end arc. With K as a center and the SAME radius R_2 , draw the end arc. The four circular arcs thus drawn meet, in common points of tangency P, at the ends of their radii in their lines of centers.

**ELLIPSE BY CONCENTRIC
CIRCLE METHOD**

Figure 7-46 shows the concentric circle method of drawing an ellipse. With the point of intersection between the axes as a center, draw two concentric circles (circles with a common center), one with diameter equal to the major axis and the other with diameter equal to the minor axis, as shown in figure 7-46(A). Draw a number of diameters as shown in 7-46(B). From the point of intersection of each diameter with the larger circle draw a vertical line; and from the point of intersection of each diameter with the smaller circle draw an intersecting horizontal line, as shown in 7-46(C). Draw the ellipse through the points of intersection, as shown in 7-46(D), with a french curve.

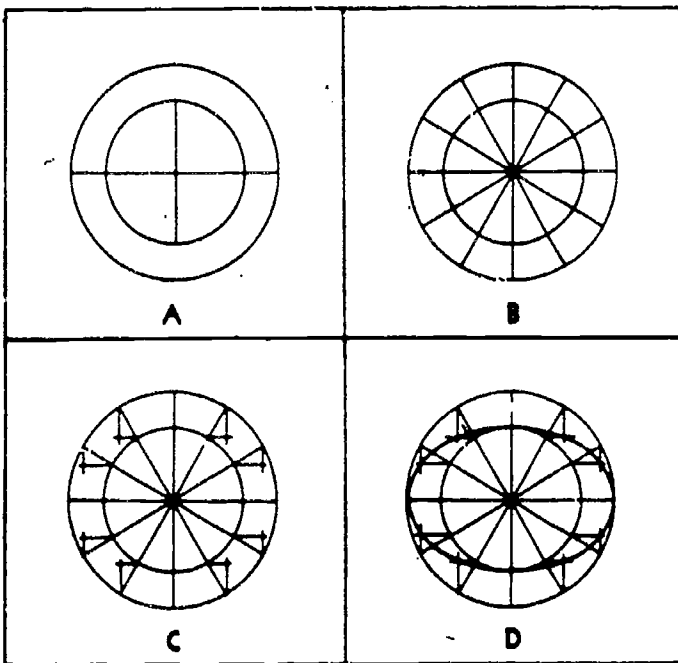

Figure 7-46.—Ellipse by concentric circle method.

CHAPTER 8

DRAFTING: PROJECTIONS AND SKETCHING

This chapter deals with the theory of projections and methods of preparing projection drawings. By applying basic geometric construction (described in the preceding chapter) to the various projection methods, you should be able to clearly represent any given object or structure on paper. Although the methods discussed here are basic to all drawings, they are easily adapted to construction drawings. This chapter also covers various techniques of freehand sketching. You will learn how to prepare quick sketches to convey or develop your ideas.

THEORY OF PROJECTION DRAWING

Every object or structure which you draw has length, width, and depth, regardless of its size. However, you must draw the object or structure on paper, which is a flat two-dimensional plane. In order to show the three dimensions by lines alone, you must use a system of related views or a single pictorial projection. You must be able to show clearly the shape of the object, give the exact size of each part, and provide necessary information for constructing the object. In order to satisfy these requirements, two types of projections may be used: **ORTHOGRAPHIC AND PICTORIAL**.

ORTHOGRAPHIC PROJECTIONS consist of two or more separate views of an object generally at right angles to each other. When drawn, the views are arranged in a definite manner in relation to each other. Each independent view shows the shape of the object from a particular viewing direction. Orthographic projections show only two dimensions. Collectively the views describe the object completely.

PICTORIAL PROJECTION has three main divisions: **AXONOMETRIC, OBLIQUE, AND PERSPECTIVE**. Pictorial projections consist of a single view of the object as it would be seen by the eye. They give the viewer a three dimensional picture of the object. All types of projections describe the shape of an object, but only orthographic and oblique pictorial projections utilize dimensions to specify exact size.

To understand the theory of projection you must become familiar with certain terms which are common to each type of projection. Some of these terms are defined below.

The **POINT OF SIGHT** (or **STATION POINT**) is the position of the observer in relation to the object and the plane of projection (fig. 8-1). It is from this point that the view of the object is taken. The point of sight is changed to give different views of the same object.

The observer views the features of the object through an imaginary **PLANE OF PROJECTION** (or **IMAGE PLANE**). This theoretical transparent plane is placed between the point of sight and the object, as shown in figure 8-1. For the purpose of studying any type of projection, it must be assumed that the planes of projection are in fixed positions. Once the object is placed in a definite imagined position, it should never be changed. If a different view of the object is desired, the location of the point of sight is changed.

The **PROJECTION LINES** (or **LINES OF SIGHT**) are the imaginary lines from the eye of the viewer (point of sight) to points on the object (fig. 8-1). By the use of projection lines, points on the object are projected on the image plane. These points are the points where the

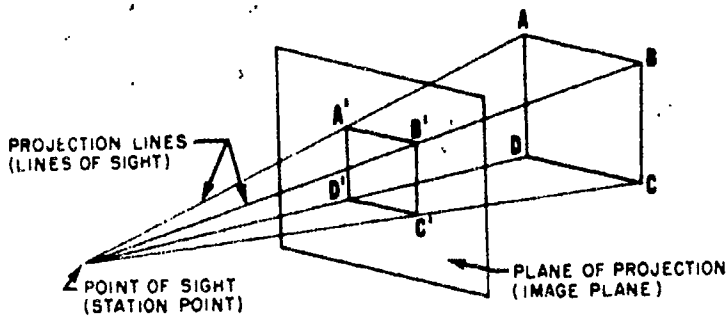

(A) PERSPECTIVE PICTORIAL PROJECTION

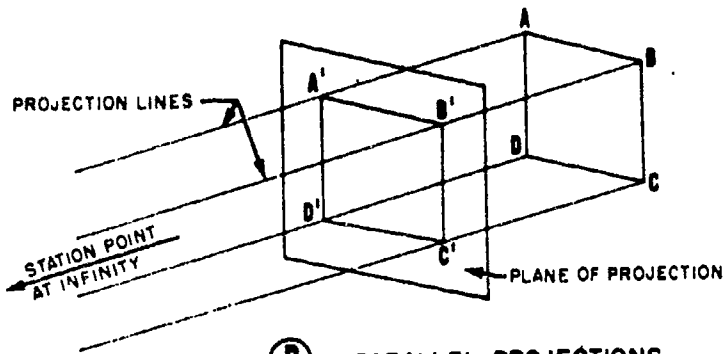

(B) PARALLEL PROJECTIONS

projection lines appear to pierce the image plane. By projecting the prominent points, lines and surfaces of an object, a complete view of that object can be projected on the plane of projection.

In a **PERSPECTIVE PICTORIAL PROJECTION** (fig. 8-1, view A) the lines of sight converge at the point of sight. Therefore, each line of sight forms a different angle with the plane of projection. The station point (or point of sight) is always a known, measurable (**FINITE**) distance from the object. In all other projections (fig. 8-1, view B), the lines of sight are parallel with each other and are considered to converge at infinity. Therefore, in all projections other than perspective, the point of sight is an infinite distance from the object.

The relationship between the point of sight (station point), the plane of projection (image plane), the projection lines (lines of sight), and the manner in which they are utilized for each individual type of projection will be fully discussed in the following sections.

ORTHOGRAPHIC PROJECTION

When an object is viewed through a plane of projection from a point at infinity, an accurate

45.224

Figure 8-1.—Projections.

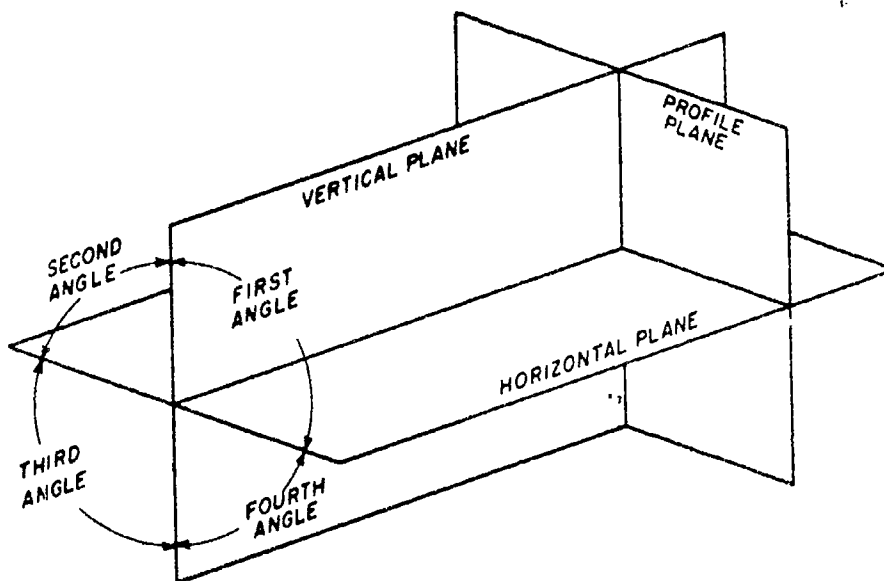
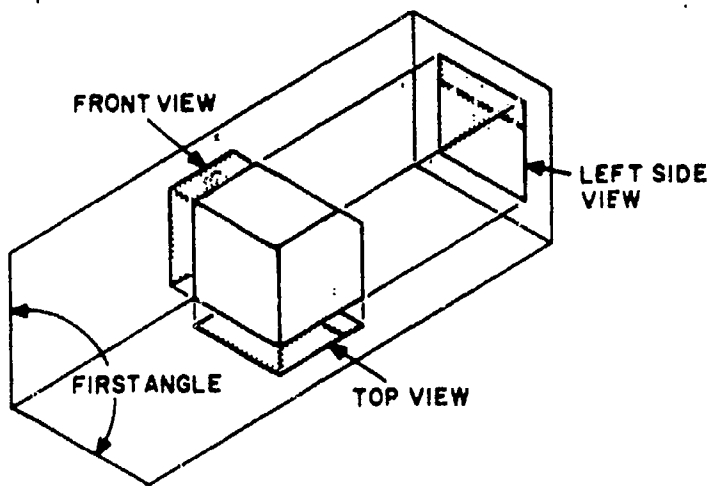

Figure 8-2.—Multiview planes of projection.

45.236



45.237

Figure 8-3.—First-angle projection of a cube.

outline of the visible face of the object is obtained. However, the projection of one face usually will not provide an overall description of the object; other planes of projection must be used. Establishing an object's true height, width, and depth requires front, top, and side views which are called the principal planes of projection. Projecting these essential multiview planes into a single plane is known as orthographic projection.

Figure 8-2 shows the three principal multiview planes of projection, known as the VERTICAL PLANE, HORIZONTAL PLANE, and PROFILE PLANE. As you can see, they intersect each other at right angles, hence the term "orthographic" ("orthos" meaning perpendicular or at right angles). The angles between the horizontal and the vertical planes are called the first, second, third, and fourth angles, as indicated in the figure.

FIRST-ANGLE PROJECTION

You could place the object to be projected in any one of the four angles. For technical reasons, second-angle and fourth-angle projections are not used. Figure 8-3 shows a cube placed for first-angle projection. The cube is supposed to be fronting toward the vertical plane of projection. As you can see, you get a front view on the vertical plane, a left-side view

on the profile plane, and a top view on the horizontal plane.

Now, to put these views on a sheet of drawing paper, you must get them all into the same plane. You presume that the vertical plane of projection is already in the plane of the paper. To get the other two views into the same plane, you rotate the profile plane counterclockwise and the horizontal plane clockwise. The projection now appears as shown in figure 8-4.

This first-angle projection arrangement of views is considered satisfactory in most European drafting practice. In the U.S. it is considered illogical, because the top view is below the front view; because the right side of the object, as shown in the front view, is toward the left side view of the object; and because the bottom of the object, as shown in the front view, is toward the top view of the object. For these and other reasons, first-angle projection is not used much in the U.S.

THIRD-ANGLE PROJECTION

Figure 8-5 shows a third-angle projection of a cube. As you can see, you get a front view on the vertical plane, a top view on the horizontal plane, and a right side view on the profile plane.

Again you assume that the vertical plane is already in the plane of your drawing paper. To get the other two into the same plane, you

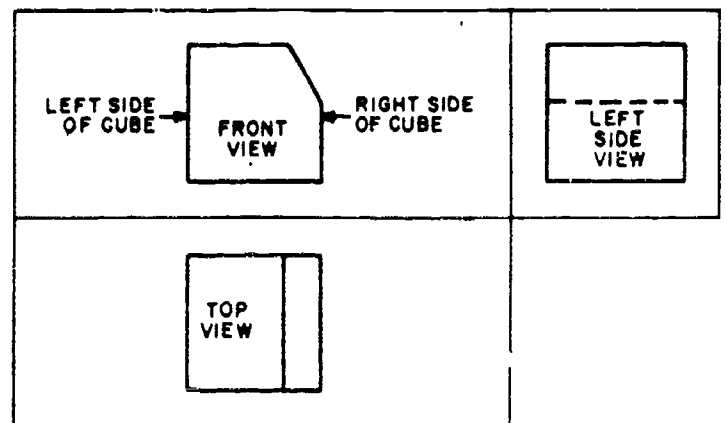

45.238

Figure 8-4.—First-angle projection brought into a single plane.

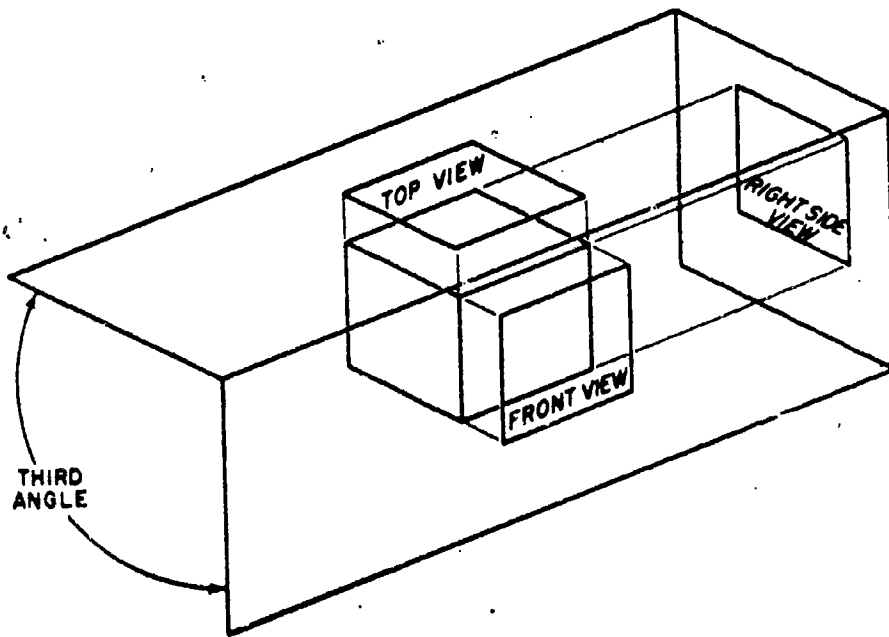

45.239

Figure 8-5.—Third-angle projection of a cube.

rotate them both clockwise. The projection now appears as shown in figure 8-6. The top view is above the front view; the right side of the cube, as shown in the front view, is toward the right side view; and the top, as shown in the front view, is toward the top view.

Figure 8-7 illustrates the basic principles of the method by which you would actually make the projection shown in figure 8-6. Draw a horizontal line AB and a vertical line CD,

intersecting at O. AB represents the joint between the horizontal and the vertical plane; CD represents the joint between these two and the profile plane. Any one of the three views could be drawn first, and the other two projected from it. Assume that the front view is drawn first on the basis of given dimensions of the front face. Draw the front view, and project

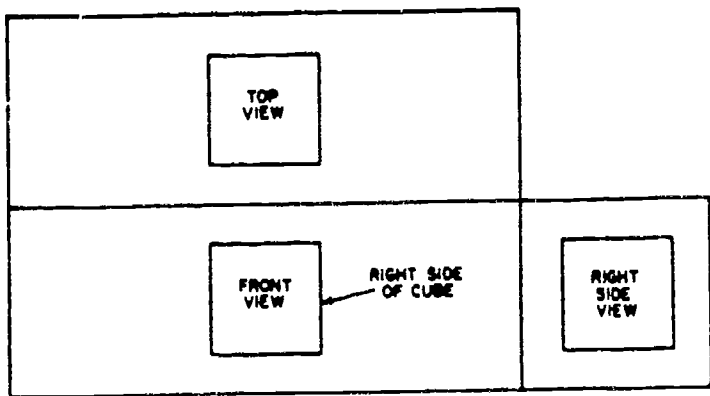

45.240

Figure 8-6.—Third-angle projection brought into a single plane.

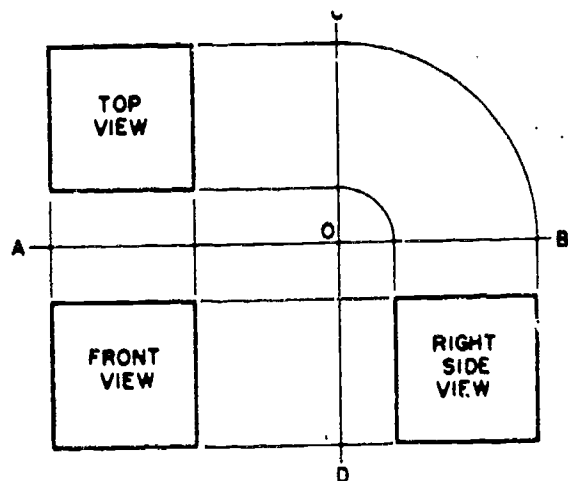

45.241

Figure 8-7.—Method of making a third-angle projection.

Arrangement of Views

The projection shown in figures 8-7 and 8-8 is a three-view multiview projection, showing 3 surfaces of the cube. A cube has 6 surfaces, however, and all 6 can be shown in a multiview projection. Technically speaking, there are still only 3 planes of projection, but for a back view, for example, the vertical plane is presumed to be moved to a position between the observer and the back surface of the block. Actually, this amounts to the assumption that there are 6, rather than only 3, planes of projection: the front and back planes (both of which are vertical), the top and bottom planes (both of which are horizontal), and the right and left side planes (which are perpendicular to the other two pairs of planes).

If only the front, top, and right side views are shown, the standard American arrangement of views is the third-angle arrangement shown in figures 8-7 and 8-8. If a left side, bottom and back view are shown as well, the American standard arrangement is that illustrated in figure 8-9.

However, the rear view may be shown as if it were hinged to the right profile plane, or to the top or bottom planes, as well as to the left profile plane.

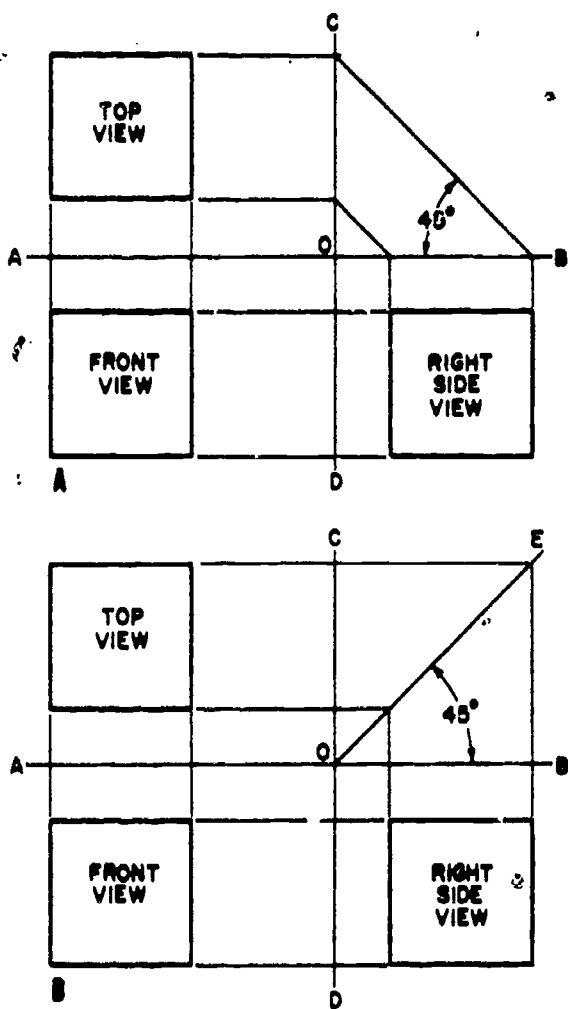

45.242

Figure 8-8.—Alternate methods of extending top view projectors.

it upward with vertical projectors to draw the top view. Project the top view to CD with horizontal projectors. With O as a center, use a compass to extend these projectors to AB. Draw the right side view by extending the projectors from AB vertically downward, and by projecting the right side of the front view horizontally to the right.

Many draftsmen prefer to extend the top view projectors to the right side view by one of the methods illustrated in figure 8-8. In figure 8-8 (A) the projectors are extended from CD to AB by lines drawn at 45° to AB. In figure 8-8 (B) the line OE is drawn at 45° to AB, and the top view projectors are extended horizontally to OE and then vertically downward.

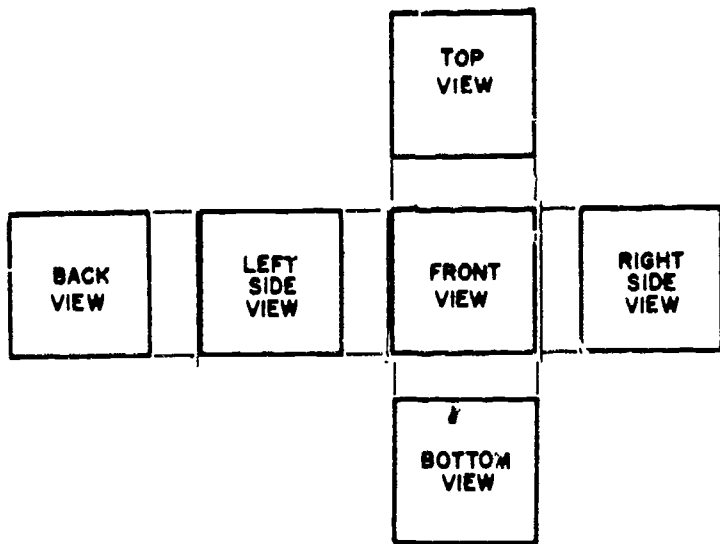

45.243

Figure 8-9.—American standard arrangement of views in 6-view third-angle multiview projection.

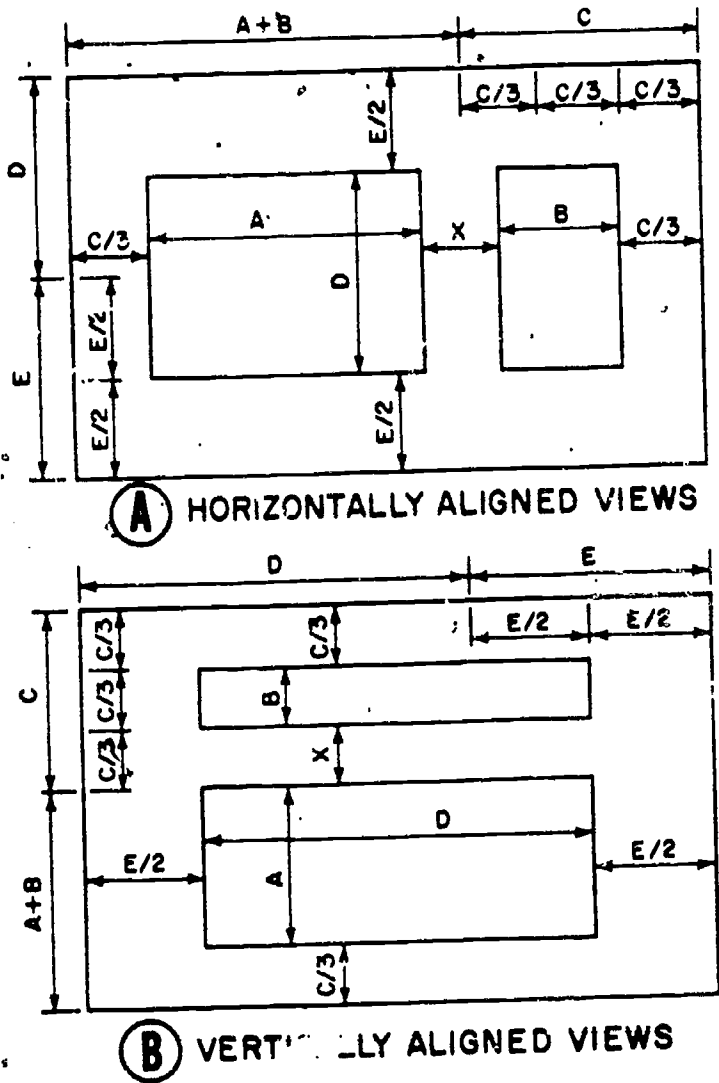

Figure 8-10.—Spacing views.

45.246

In architectural drawings, a top view is called a **PLAN**, and a front, back or side view an **ELEVATION**. A top view of a house, for instance, is a plan; a **FLOOR PLAN** shows a top view of the house as it would look if it were cut away at the level of the particular floor. A front view of a house is a **FRONT ELEVATION**, a back view is a **REAR ELEVATION**, and a right side view is a **RIGHT SIDE ELEVATION**.

Spacing Views

Views should be spaced on the paper in such a manner to give the appearance of a balanced drawing. An easy way to locate horizontally

aligned views on a standard size drawing sheet is shown in figure 8-10, view A. With a compass or scale, lay off the length plus the width of the object (A+B) from one end of the horizontal margin. Divide the remaining distance C into 3 equal parts (C/3). This will be the approximate distance from either view to the vertical margin. Both views should be equidistant from the vertical margin. The spacing between views should be adjusted so that the apparent area is close to the apparent area between either view and the vertical margin. The shape of the object will basically determine the space between views. Generally, the distance from the views to the vertical margins and the distance between views (X) will be approximately equal. To locate the views vertically on the paper, lay off the depth of the object (D) on the vertical margin. Divide the remaining distance (E) into two equal parts (E/2). This will be the approximate distance from the top or bottom of the view to the horizontal margins.

The same method also applies to vertically aligned views on a standard size drawing sheet, as shown in figure 8-10, view B.

Proper spacing of a three-view drawing is shown in figure 8-11. As you can see, the principle is the same as that applied in spacing a two-view drawing. Distances are again equal as

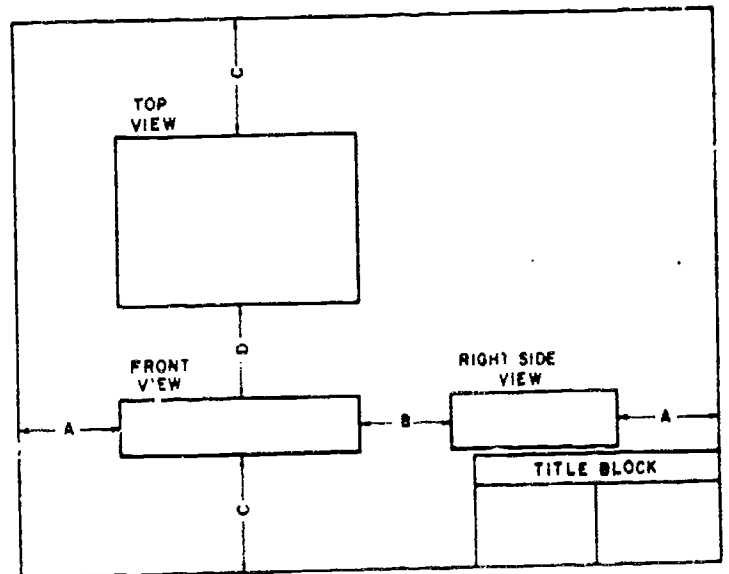
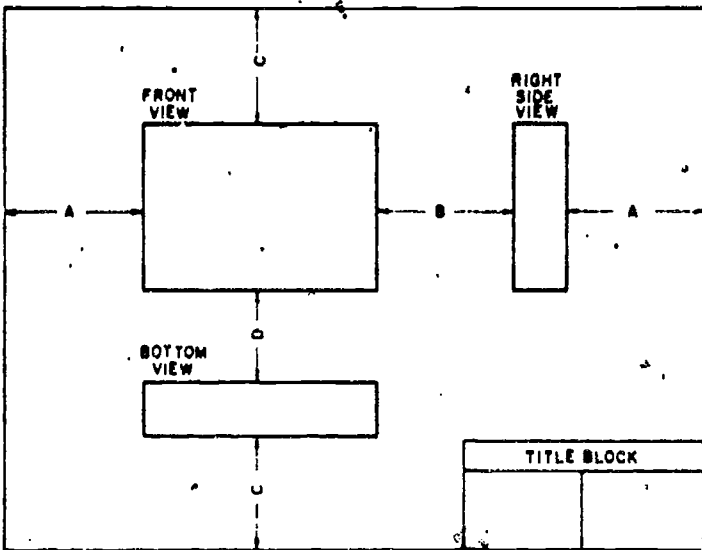

Figure 8-11.—Proper spacing of views on a three-view projection.

45.247



45.248

Figure 8-12.—Improved spacing for three-view projection of object shown in figure 8-15.

indicated, with distance B equal to, or slightly less than, distance A, and distance D equal to, or slightly less than, distance C.

While the spacing of views in figure 8-11 is technically correct, the drawing has an unbalanced appearance, because of the large area of empty space in the upper right corner, and because the right side view crowds the title block. If the drawing will contain a sizeable bill of materials in the upper right corner, this spacing will be satisfactory. If not, it should be improved, if possible.

If the object is one which allows an arbitrary choice with regard to the designation of surfaces as top, front, and so on, the spacing can be improved by changing the designation shown in figure 8-11, and projecting the object as shown in figure 8-12. What appears as the top in figure 8-11 you can now call the front; it follows that what appears as the front in figure 8-11 appears as the bottom in figure 8-12. Again the right side view appears, but it now appears in the upper rather than the lower right corner, and vertically rather than horizontally.

Spacing views in a drawing of a circular object is like spacing letters—you try to equalize the areas of the spaces around and between the views. Figure 8-13 shows properly spaced

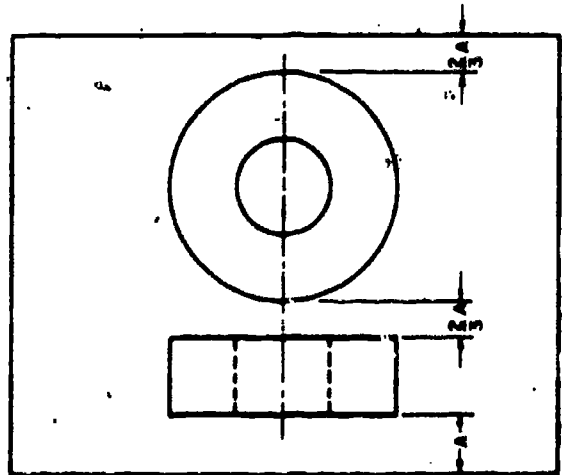
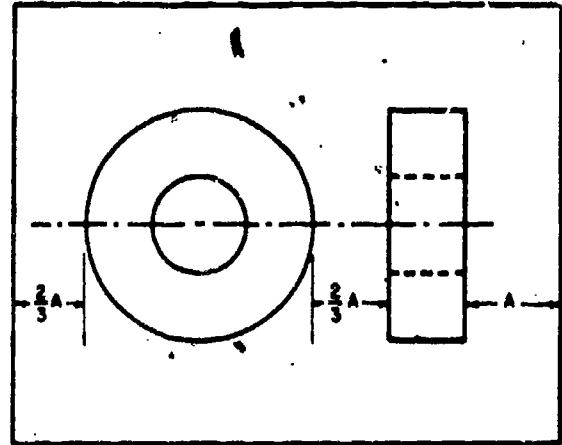

45.249

Figure 8-13.—Spacing of views of a circular object.

two-view drawings of a perforated disk. For the views which are horizontally in line, you locate the horizontal center line midway between the horizontal margins; for the views which are vertically in line, you locate it midway between the vertical margins. The other spacing is as indicated. To determine the lengths of distances A and $\frac{2}{3} A$, set a compass to the diameter plus the thickness of the disk, and lay off this distance on the margin. Then divide the remaining segment of the margin into three intervals, two of them being equal, and the third one and one-half times as long as each of the others.

View Analysis

You must be able to analyze a multiview projection—meaning, to determine what each line in a particular view represents. In this connection, it is helpful to remember that in a

third-angle projection the plane of projection is always presumed to be between the object and the observer, regardless of which view you are considering. This means that, in a third-angle projection, each view of a surface of an object is a view of that surface as it would appear to an observer looking directly at it.

Figure 8-14 shows a 6-view multiview third-angle projection of the block shown in a single view projection in the upper left corner of the figure. You should not have any trouble analyzing the front view; you know that the top is up, the bottom is down, the left side is to the left, and the right side is to the right.

In the top and bottom views it's easy to see that the right-hand vertical line represents the right side and the left-hand vertical line the left side. But you might have to think a minute to realize that the upper horizontal line in the top view represents the back face of the block, while the upper horizontal line in the bottom view represents the front face of the block. Note, also, that there is a line which appears as a visible line in the top view and as a hidden line in the bottom view.

In the right side and left side views, you can readily see that the upper horizontal line represents the top of the block and the lower horizontal line the bottom. But you may have to think a minute to realize that the left-hand vertical line in the right side view represents the front face of the block, while the left-hand vertical line in the left side view represents the back face. Again there is a line which appears as a visible line in the right side view and as a hidden line in the left side view.

In the back view the block is shown reversed, so that the cutaway part which appears to the right in the front view appears to the left in the back view. Similarly, the right-hand vertical line in the front view represents the right side of the block, while the right-hand vertical line in the back view represents the left side.

As a general observation, it is helpful in view analysis to note that in the top, bottom, and side views the line which represents the front face of the block faces toward the front view of the block. Similarly, in the back view the line which represents the left side faces toward the left side view of the block. This applies to third-angle projection only.

CORNER POINT NUMBERING.—A point which constitutes a corner on an object is sometimes numbered for purposes of identification in various views of the object. In a particular view of an object, a corner point may be visible or it may be hidden, as shown in figure 8-15. In the upper left corner of the figure there is an oblique projection of a block, with a corner numbered 2. You can see that this corner is visible in top, back, and left side views, but hidden in bottom, front, and right side views.

The rule for numbering is that for a hidden corner point the number is placed within the outline, and for a visible corner point outside the outline. You can see how the rule has been followed in figure 8-15.

CHOICE OF VIEWS.—A multiview projection should contain only as many views as are required to describe the object fully. If you refer back to figure 8-14, you can see at once that the back view does not convey any information which is not available in the front view; the back view is therefore superfluous and

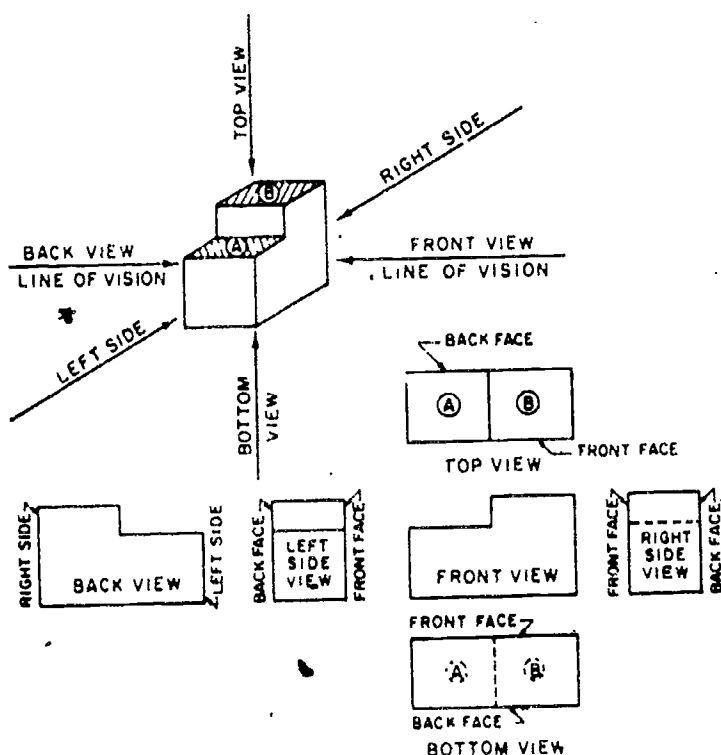

45.244

Figure 8-14.—Multiview analysis.

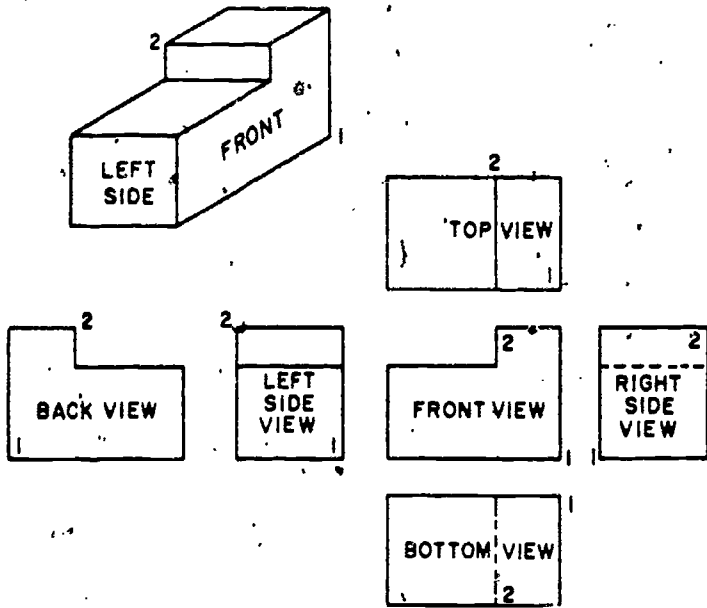

45.253

Figure 8-15.—Procedure for numbering hidden and visible corner points.

should be omitted. The same applies to the bottom view, which conveys no information not available in the top view. Likewise, the left side view conveys no information not available in the right side view.

You have the choice of omitting either the top or bottom view and either the right side or left side view. One general rule in this instance is that a top view is preferable to a bottom view and a right side view to a left side view; another rule is that a view with a visible line is preferable to a view with the same line shown as a hidden line. Both rules apply here to eliminate the bottom and the left side views. All you need here is a three-view projection, showing the top, front, and right side views.

It is often the case that a two-view projection is all that is required. The view at the top of figure 8-16 shows a single view projection of an object. It is obvious that a top view of this object tells you everything you need to know except the thickness; a right side view tells you everything you need to know except the length; and a front view tells you everything you need to know except the width. All you need to do, then, is to select a particular view and couple it with another view which gives you the dimension which is missing in the first view.

There are three possible two-dimension projections of the object, illustrated in (A), (B), and (C). In the selection of one of these three, everything else being equal, the balance of the drawing would be the deciding factor. Either (A) or (B) appears better balanced than (C), and between (A) and (B), (A) would look better on a long oblong sheet of paper and (B) better on a shorter oblong sheet.

The object shown in figure 8-16 has a definitely designated top and front; it follows that the right and left sides are also definitely designated. This is the case with many objects; you have no choice, for example, with regard to the top, bottom, front, and back of a house. Many objects, however, have no definite top or bottom, or front or back—many types of machine parts, for example. With an object of this kind, you can select a surface and call it the front, select another and call it the top, according to convenience. However, it is a general rule that an object should be shown in the position it customarily occupies.

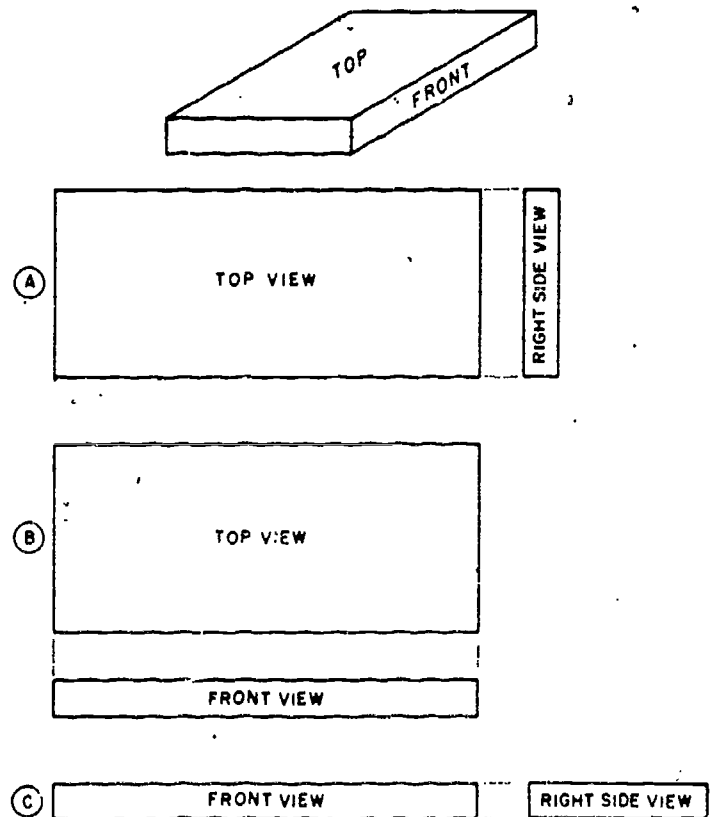

45.245

Figure 8-16.—Two-view multiview projections.

One-view drawings are permissible for objects where one view and such features as thickness or length, stated as a dimension or note, can completely define the object.

Normal and Non-Normal Lines

In a multiview orthographic projection a **NORMAL** line is one which is parallel to two of the planes of projection and perpendicular to the third. A line which is parallel to a plane of projection will appear on that plane in its true length (to the scale of the drawing). A line which is perpendicular to a plane of projection will appear on that plane as a point.

A line which is perpendicular to one plane of projection must of necessity be parallel to the other two. But a line which is parallel to one plane of projection may be oblique (neither parallel nor perpendicular) to one or both of the others. A line which is oblique to one or more of the planes of projection is called a **NON-NORMAL LINE**.

If a non-normal line is parallel to a plane of projection, it will appear on that plane in its true length. However, it will appear foreshortened in a view on a plane to which it is oblique. A non-normal line may, of course, be oblique to all three planes of projection, in which case it will appear foreshortened in all regular views of the object. A **REGULAR VIEW** is a view on one of the three regular planes of projection (horizontal, vertical, or profile). Views on planes other than the regular planes are called **AUXILIARY VIEWS** (see later).

In the upper left corner of figure 8-17 there is a single view projection of a block. This block is presumed to be placed for multiview projection with front parallel to the vertical plane, bottom parallel to the horizontal plane, and right side parallel to the profile plane. The line AB, then, is parallel to the vertical plane, but oblique to both the horizontal and the profile planes.

In the multiview projections you can see that it is only in the views on the vertical plane (the front and back views) that the line AB appears in its true length. In the views on the horizontal plane (top and bottom views) and in the views on the profile plane (right and left side

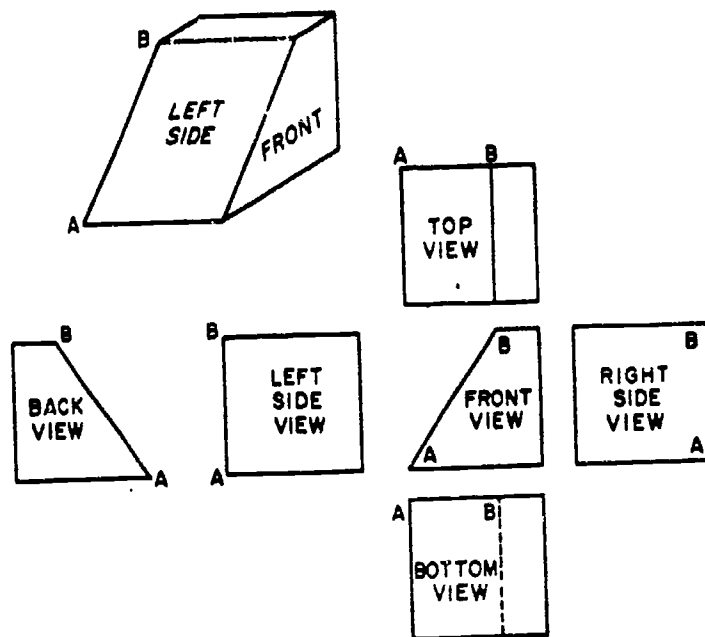

45.254

Figure 8-17.—Foreshortening of a line in a multi-view projection.

views) the line appears foreshortened. Note, however, that you don't need to calculate the amount of the foreshortening, since it works itself out as you project the various views.

Circles in Multiview Orthographic Projection

A circle on a surface which is parallel to the plane of projection will project as a circle. One on a surface which is oblique to the plane of projection, however, will project as an ellipse, as shown in figure 8-18. The upper view in this figure is a top view of a wedge, the wedge having a hole bored through it perpendicular to the inclined face. The outline of this hole on the front face of the wedge projects as an ellipse in the front view. You get the minor axis of the ellipse by projecting downward as shown. The length of the major axis is equal to the diameter of the hole.

There is another ellipse in the front view: the partly hidden and partly visible outline of the hole as it emerges through the back of the wedge. The back of the wedge is parallel to the front view plane of projection; therefore, this ellipse is the true outline of the hole on the back

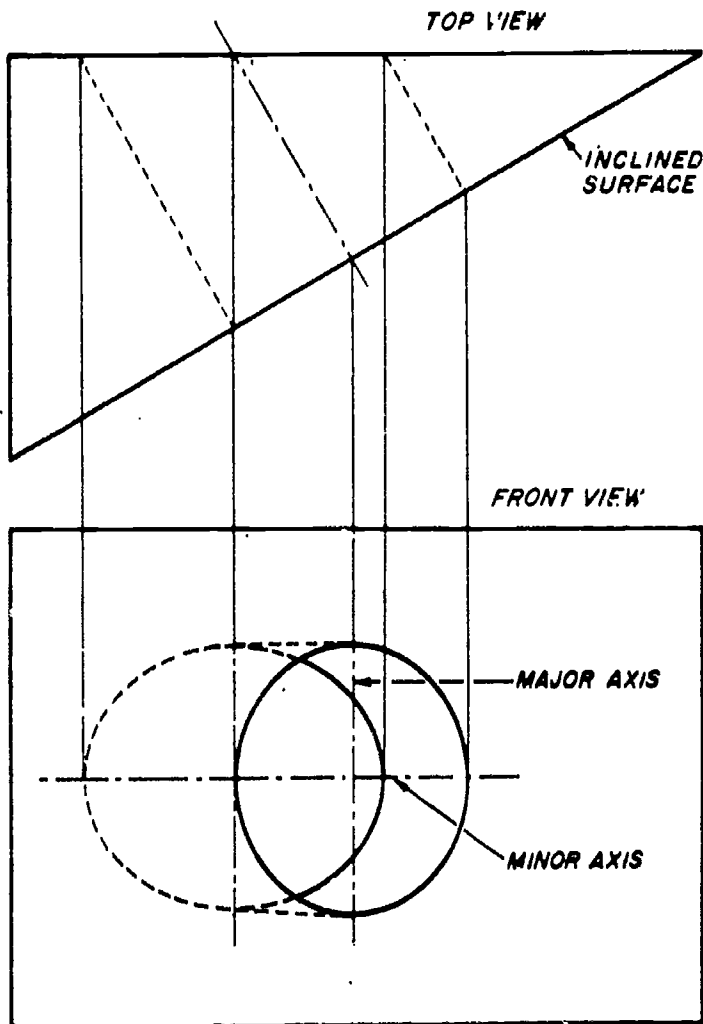

45.256

Figure 8-18.—A circle of a surface oblique to the plane of projection projects as an ellipse.

of the wedge. The outline is elliptical because the hole, though it is circular, is bored oblique to the back face of the wedge.

To draw these ellipses you could use any of the methods of drawing an accurate ellipse explained in the previous chapter on geometric construction, or you could use an ellipse template.

Auxiliary Views

In theory, there are only three regular planes of projection: the vertical, the horizontal, and the profile. Actually, it is presumed that each of these is, as it were, double; there is, for example, one vertical plane for a front view and another for a back view.

We assume, then, a total of six regular planes of projection. A projection on any one of the six is a regular view. A projection NOT on one of the regular six is an AUXILIARY VIEW.

The basic rule of dimensioning requires that a line be dimensioned only in the view where its true length is projected and that a plane with its details be dimensioned only in the view where its true shape is represented. In order to satisfy this rule, we have to create an imaginary plane that is parallel with the line or surface we want to project in its true shape. A plane of this kind—which is not one of the regular planes—is called an AUXILIARY PLANE.

In the upper left of figure 8-19 there is a single view projection of a triangular block, the base of which is a rectangle. This block is presumed to be placed for multiview projection with the right side parallel to the profile plane. The block is then drawn, using all six views of multiview projection.

By careful examination of figure 8-19, you will see that the lines AB, AE, BD and BC and the surfaces ABC, ABE, and BDE are oblique to three regular planes of projection. The lines are foreshortened and the surfaces are not shown in their true shape in any of the six normal views.

The first step in the drawing of any auxiliary view is to draw the object in normal multiview

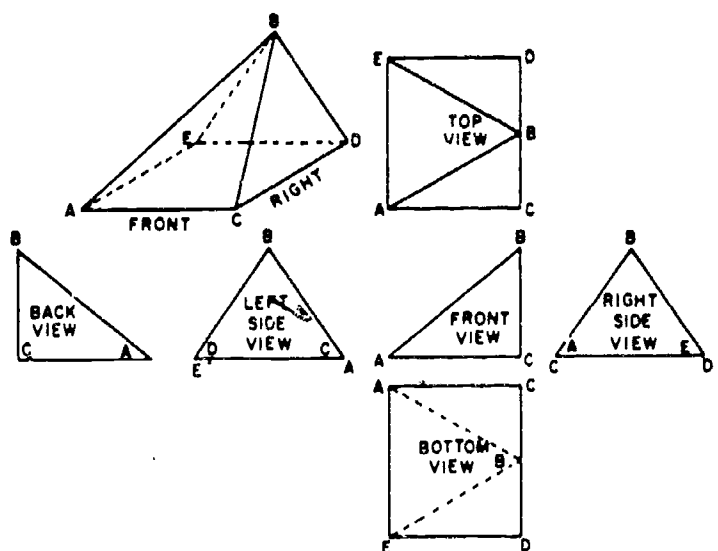

45.255

Figure 8-19.—A line oblique to all planes of projection is foreshortened in all views.

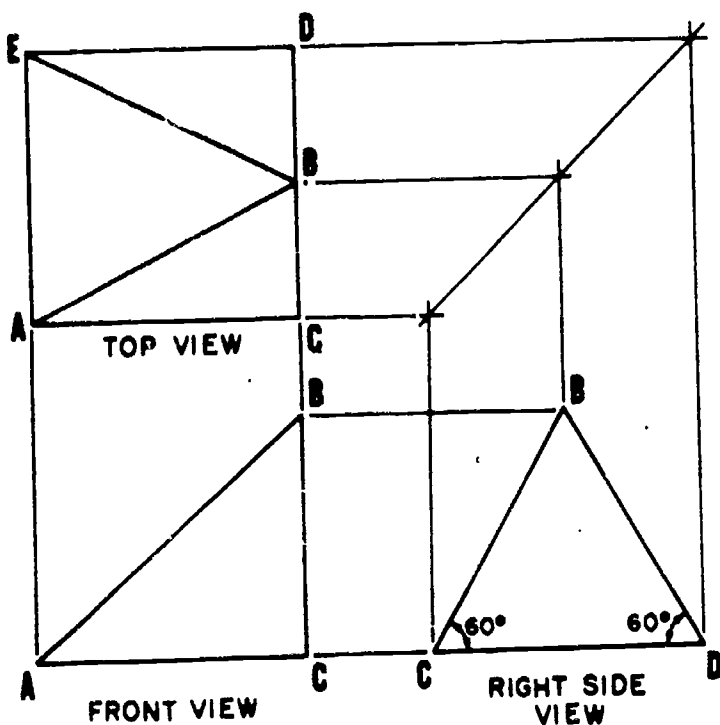

45.264

Figure 8-20.—Normal multiview projection.

projection, as shown in figure 8-20. A minimum of two orthographic views is necessary. The space between these views is generally greater than normal. The reason for this will become apparent. Notice in figure 8-20, in the front view, that A is the end point of line AE (top view) and C is the end point of CD.

The second step is to decide which line or surface is to be shown in an auxiliary view and which orthographic view it will be projected from. The following facts must be considered when rendering this decision:

1. Front or rear auxiliary views are always projected from a side view.
2. Right or left auxiliary views are always projected from a front view.
3. An elevation auxiliary view is always projected from the top view.

The selection of the auxiliary and reference planes is the third step. The auxiliary plane is simply a plane parallel to the desired line or lines representing an edge view of the desired surface. In figure 8-21, the true length of line AB and the true shape of surface ABE is desired. A left side

auxiliary view is needed. The auxiliary plane is drawn parallel to line AB in the front view. Line AB actually represents an edge view of surface ABE. The reference plane (top view) represents an edge view of the orthographic view (front view) from which the auxiliary view will be projected. Therefore, when front, rear, or side auxiliary views are desired, the reference plane will always be in the top view. When elevation auxiliary views are drawn, the reference plane may be in any view where the top view is represented by a straight line. The reference plane in figure 8-21 is the edge of the top view that represents the front view. Remember that, although these planes are represented by lines, they are actually planes running perpendicular to the views.

Step four is the projecting and locating of the points describing the desired line or surface. The projection lines are drawn from the orthographic view perpendicular to the auxiliary plane. The distances are then taken from the reference plane either by scaling or with a compass. The distances are the perpendicular distances from the reference plane to the desired point. In figure 8-21, the projection lines are drawn from points A, B, and C in the front view, perpendicular to the auxiliary plane. The projection line from point A indicates the line on which point E will also be located. The projection line from point C designates the line of both C and D, and that from B locates B only. To transfer the appropriate distances, first, look for any points lying on the reference plane. These points will also lie on the auxiliary plane where their projection lines intersect it (points A and C). To locate points B, D, and E, measure the perpendicular distance they are in the top view from the reference plane and transfer these distances along their respective projection lines in the auxiliary view. The points are equidistant from both the reference and auxiliary planes. Therefore, any line parallel to the reference plane is also parallel to the auxiliary plane and equidistant from it.

The fifth step is to connect these points. When the total auxiliary view is drawn, it is sometimes hard to discern which lines should be indicated as hidden lines. A rule to remember is:

207

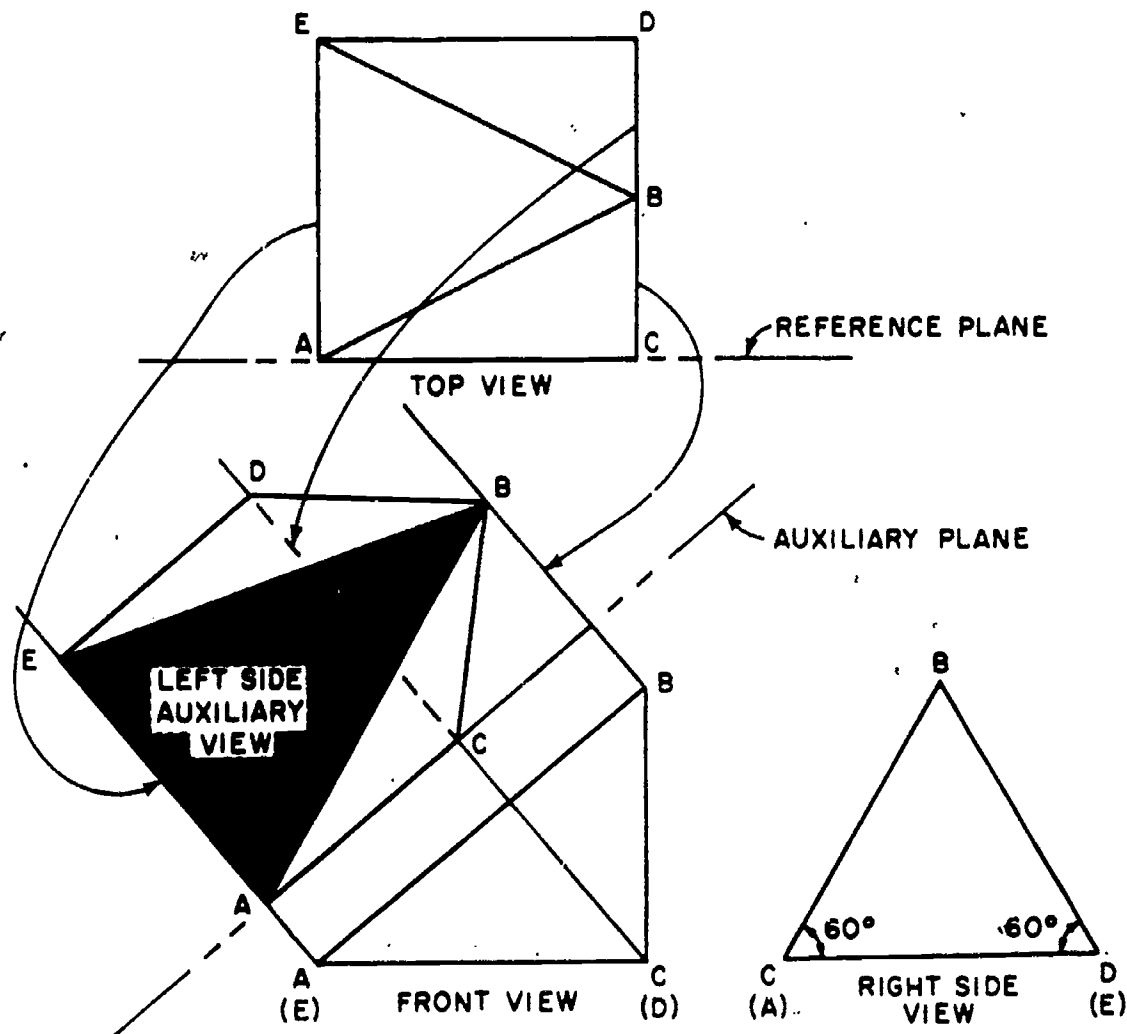

Figure 8-21.—Projection of left side auxiliary view.

45.258

Those points and lines lying furthest away from the auxiliary plane, in the orthographic view being projected from, always are beneath any point or line which is closer. In figure 8-21, point C (representing line CD) in the front view is further from the auxiliary plane than any line or surface it will cross in the auxiliary view. Therefore, it will appear as a hidden line.

The final step is labeling and dimensioning the auxiliary view. The labeling must include an adequate description. The term **AUXILIARY** must be included along with the location of the view in relation to the normal orthographic views (**LEFT SIDE AUXILIARY VIEW**, **REAR ELEVATION AUXILIARY VIEW**, etc). Dimensions are given only to those lines

appearing in their true length. In figure 8-21, only lines AB, AE, and BE on the auxiliary view would be dimensioned.

Utilizing the procedures previously described, follow the steps taken to project and draw the back side auxiliary view in figure 8-22.

Sometimes the total auxiliary view is not needed or could possibly make the drawing confusing. In this case a **PARTIAL AUXILIARY VIEW** is used. Only the points or lines needed to project the line or surface desired are utilized. This reduces the number of projection lines and greatly enhances the clarity of the view. If a partial auxiliary view is used, then it must be labeled **PARTIAL** to avoid confusion. In figure

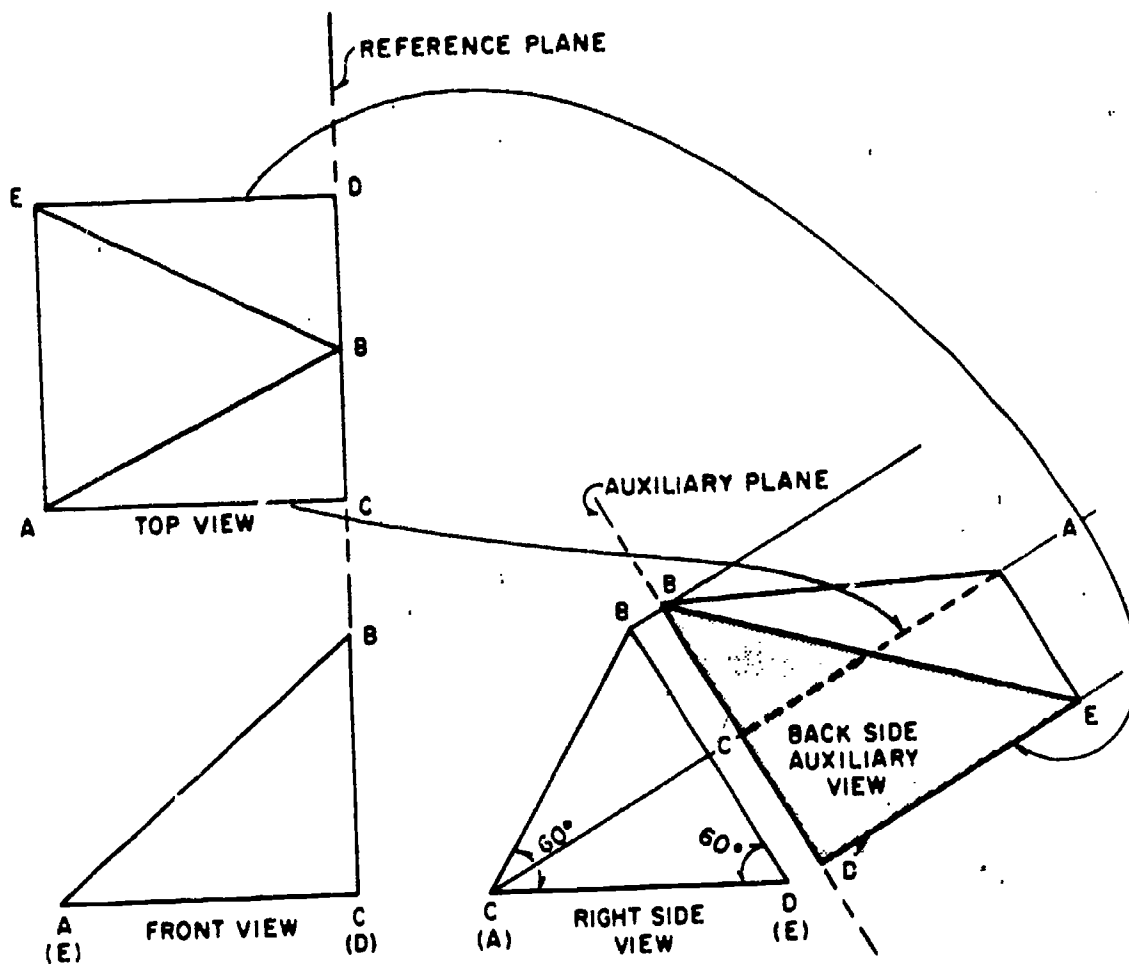

45.258.1

Figure 8-22.—Projection of back side auxiliary view.

8-21, if only the true length of line AB is desired, the points A and B would be projected and connected. The view would be complete after it was labeled and dimensioned.

In some cases the shape of an object will be such that neither the normal orthographic view nor the auxiliary views will show the true size and shape of a surface. When this occurs a **SECONDARY AUXILIARY VIEW** is needed to describe the surface. The procedures for projecting and drawing a secondary auxiliary view are the same as those for a normal (or primary) auxiliary view. The reference plane for a secondary auxiliary view is located in the orthographic view from which the primary auxiliary view is projected. Usually the primary auxiliary plane becomes the secondary reference plane. The secondary auxiliary plane is in the primary auxiliary view and its location is

determined in the same manner that the primary auxiliary plane is determined.

Auxiliary Section

An auxiliary view may be a sectional rather than a surface view. In the upper left of figure 8-23 there is a single view projection of a block. It is desired to show the right side of the block as it would appear if the block were cut away on the plane indicated by the dotted line, the angle of observation to be perpendicular to this plane. The desired view of the right side is shown in the auxiliary section, which is projected from a front view as shown. Because the auxiliary plane of projection is parallel to the cutaway surfaces, these surfaces appear in true dimensions in the auxiliary section.

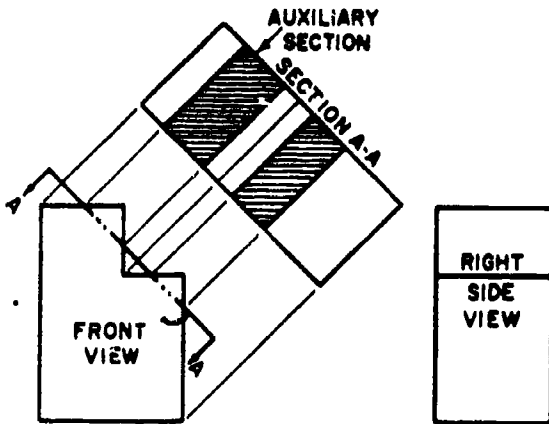
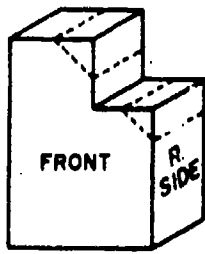

45.263

Figure 8-23.—Auxiliary section.

Revolutions

A regular multiview of an orthographic drawing is one which is projected on one of the regular planes of projection. An auxiliary view is one which is projected on a plane other than one of the regular planes.

A rectangular object is in normal position for regular multiview orthographic projection when each of its faces is parallel to one regular plane of projection and perpendicular to the other two. This is the case with the object shown in figure 8-24(A).

In a REVOLUTION the object is projected on one or more of the regular planes of projection. However, instead of being placed in normal position, the object is revolved on an axis perpendicular to one of the regular planes.

Figure 8-24(B) is a three-view multiview projection showing the block in 8-24(A) as it would appear if it were revolved 30° on an axis perpendicular to the profile plane of projection. Figure 8-25(A) shows how the block would look if it were revolved 30° on an axis perpendicular to the horizontal plane. Figure 8-25(B) shows

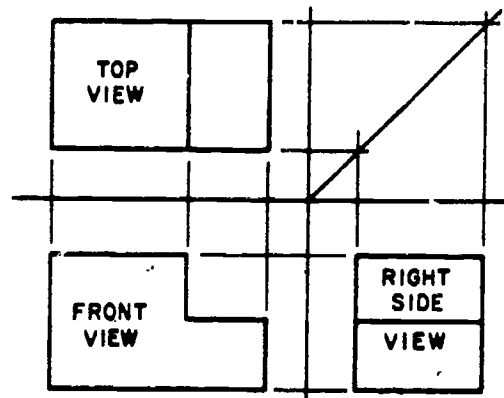

(A)

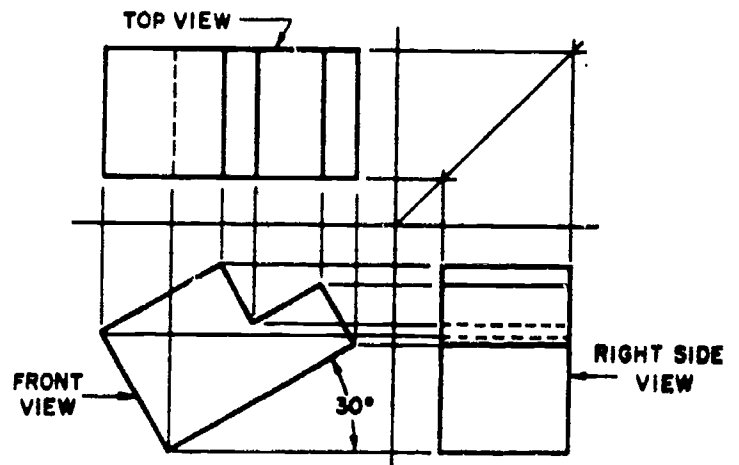

(B)

45.264

Figure 8-24.—(A) Multiview view of block in normal position. (B) Multiview view of block revolved 30° on axis perpendicular to vertical plane.

the block as it would appear if it were revolved 30° on an axis perpendicular to the vertical plane.

Revolved Sections

A common use of the revolution is the revolved section illustrated in figure 8-26. At the top of this figure there is a single view projection of a triangular block. You can show all required information about this block in two-view projection by including a revolved section in the front view as shown. You first assume that the block is cut by a plane perpendicular to the

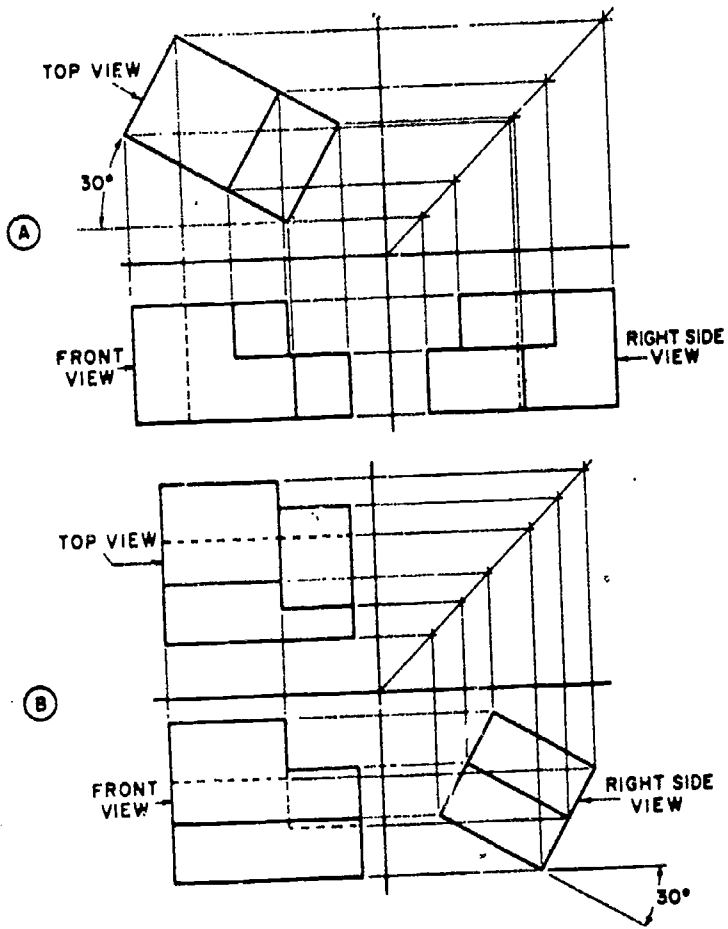

45.265

Figure 8-25.—(A) Revolution on axis perpendicular to horizontal plane. (B) Revolution on axis perpendicular to vertical plane.

longitudinal axis. You then revolve the resulting section 90° on an axis perpendicular to the horizontal plane of projection.

Sectioning Techniques

A section view is called for when the internal structure of an object can be better shown in such a view than it can by hidden lines. In the upper part of figure 8-27 there is a single view projection of a pulley. The same object is shown below in a two-view multiview projection. The internal structure of the pulley is shown by the hidden lines in the top view.

In figure 8-28 the internal structure of the pulley is much more clearly shown by a section view. Note that hidden lines behind the plane of

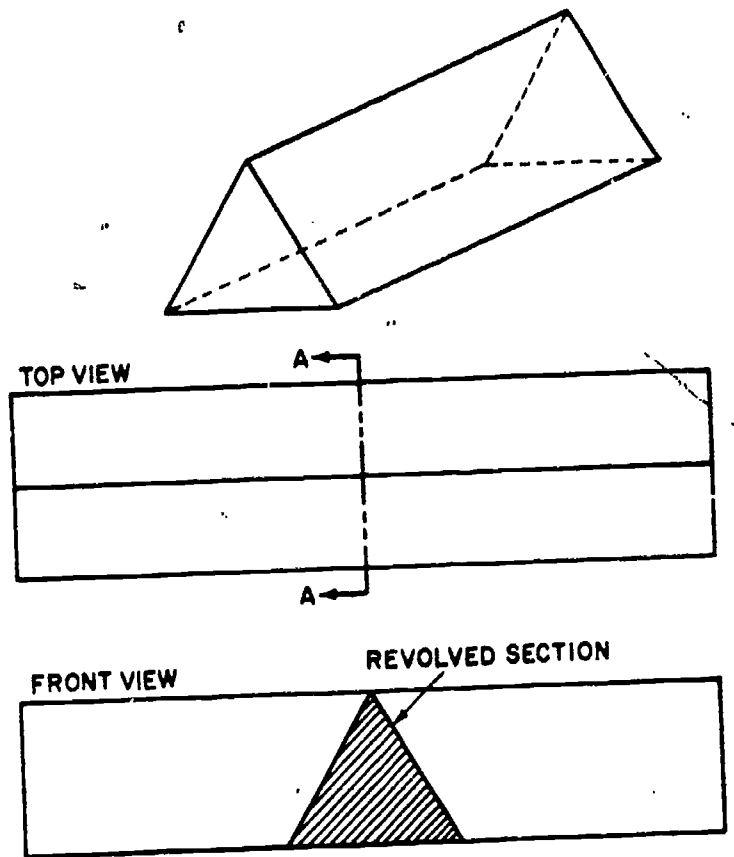

45.266

Figure 8-26.—Revolved section A-A.

projection of the section are omitted in the section view. These lines are omitted by general custom, the custom being based on the fact that the elimination of hidden lines is the fundamental reason for making a section view. However, any lines which would be **VISIBLE** behind the section plane of projection must be included in the section view.

FULL AND HALF SECTIONS.—The section shown in figure 8-28 is called a full section, because the cutting plane passes entirely through the object and divides it into two equal parts. Also, the object shown in figure 8-28 is a symmetrical object—meaning, in general, that the shape of one half is identical with the shape of the other. This being the case, you could have used a half section like the one shown in figure 8-29. This half section constitutes one-half of the full section. Because the other half of the full section would be identical with the half shown, it need not be drawn.

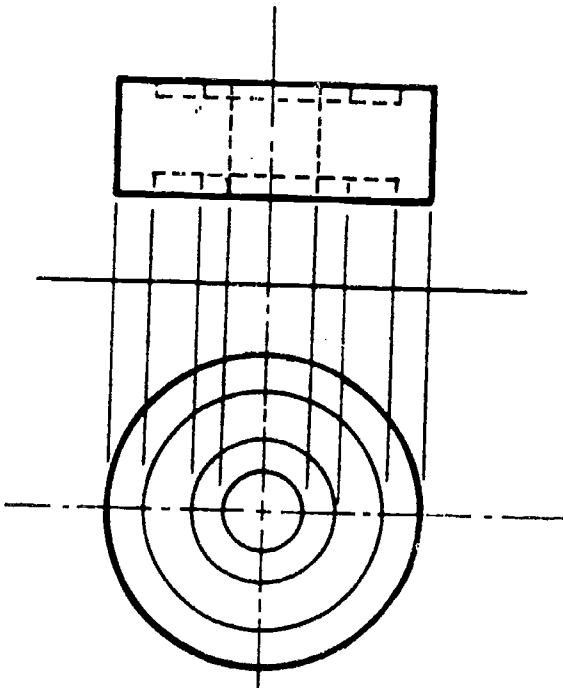
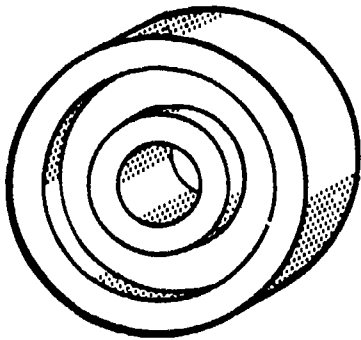

45.267

Figure 8-27.—Internal structure shown by hidden lines.

Note that a centerline, rather than a visible line, is used to indicate the division between the sectioned and the unsectioned part of the section view. A visible line would imply a line which is actually nonexistent on the object. Another term used in place of centerline is **LINE OF SYMMETRY**.

PARTIAL OR BROKEN SECTION.—A section consisting of less than a half section is called a partial section (See fig. 8-30.) Note that here you use a break line to indicate the division between the sectioned and unsectioned part. For

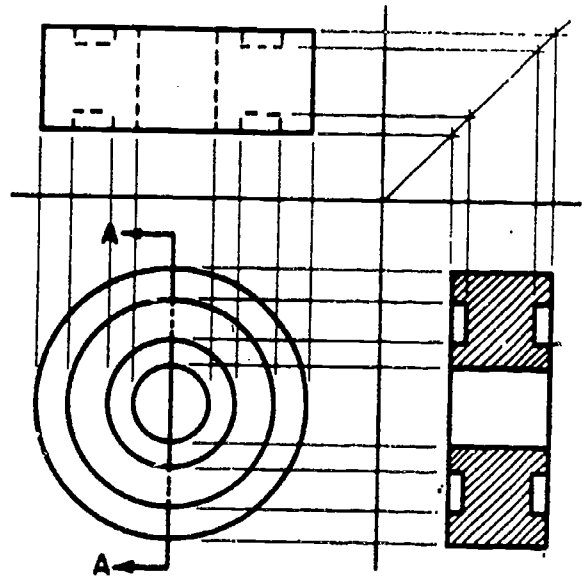

45.268

Figure 8-28.—Internal structure more clearly shown by sectional view.

this reason a partial section is often called a broken section.

SECTION LINING TECHNIQUES.—The lines drawn on a sectional surface always serve the basic purpose of indicating the limits of the sectional or cutaway surface. They may also

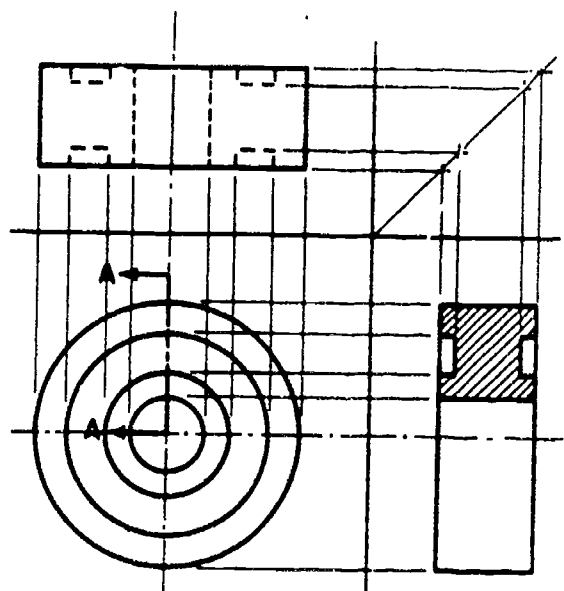

45.269

Figure 8-29.—Half section.

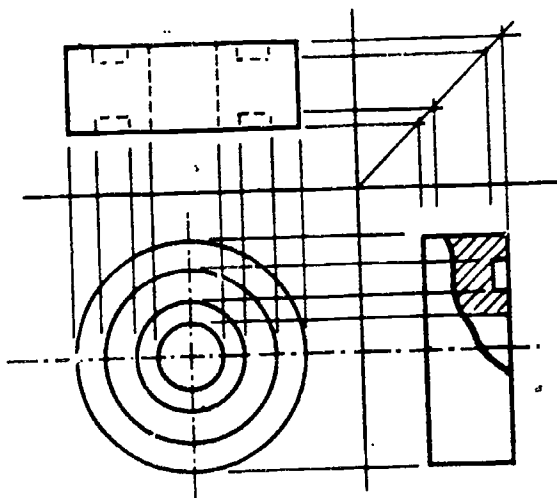

45.270

Figure 8-30.—Partial or broken section.

serve to indicate the kind of material of which the sectioned surface consists, as explained in a previous chapter.

When the section lines are intended to indicate material, cast iron is indicated by a pattern of slanting, parallel lines called diagonal hatching. On drawings on which the section lines are not intended to indicate material, diagonal hatching is used for all sectioned surfaces.

ANGLE OF DIAGONAL HATCHING.—On a regular multiview section on an object in normal position the diagonal hatching should be drawn at 45° to the horizontal, as shown in

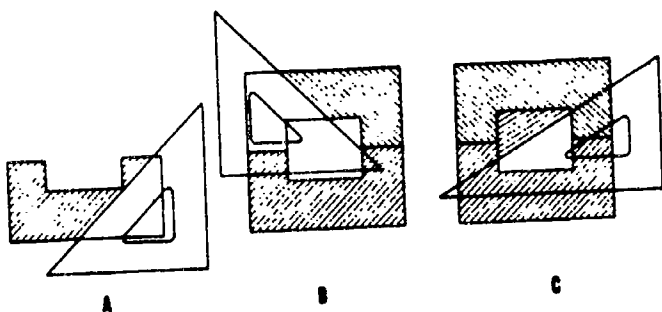

45.272

Figure 8-31.—Diagonal hatching on separate sectional surfaces shown in normal position.

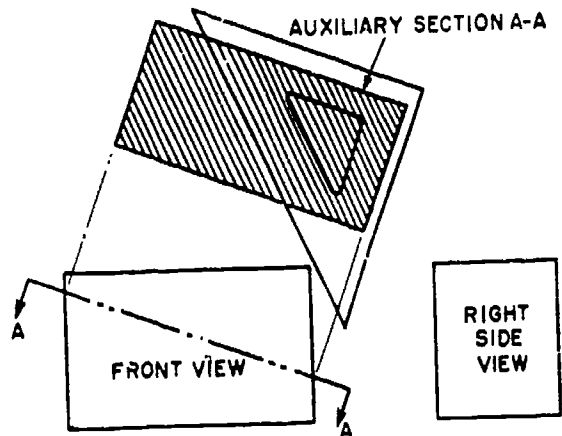
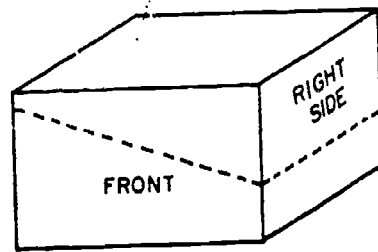

45.273

Figure 8-32.—Diagonal hatching on auxiliary section.

figure 8-31(A). If two adjacent sectioned surfaces are shown, the hatching should be inclined in opposite directions as shown in figure 8-31(B). If still a third surface is included, it should be hatched at an angle of 30° , as shown in figure 8-31(C). Note that the hatching lines on one surface are not permitted to meet those on an adjacent surface.

Diagonal hatching on an auxiliary section should be drawn at 45° to the horizontal, as the horizontal exists with respect to the section. Figure 8-32 illustrates this rule.

In a revolution or other view of an object in other than normal position the diagonal hatching on a section should be drawn at 45° to the horizontal or vertical axis of the object as it appears in the revolution. Figure 8-33 illustrates this rule.

OBLIQUE SINGLE-PLANE PROJECTION

We have seen that an object may be drawn showing length and width on a single plane.

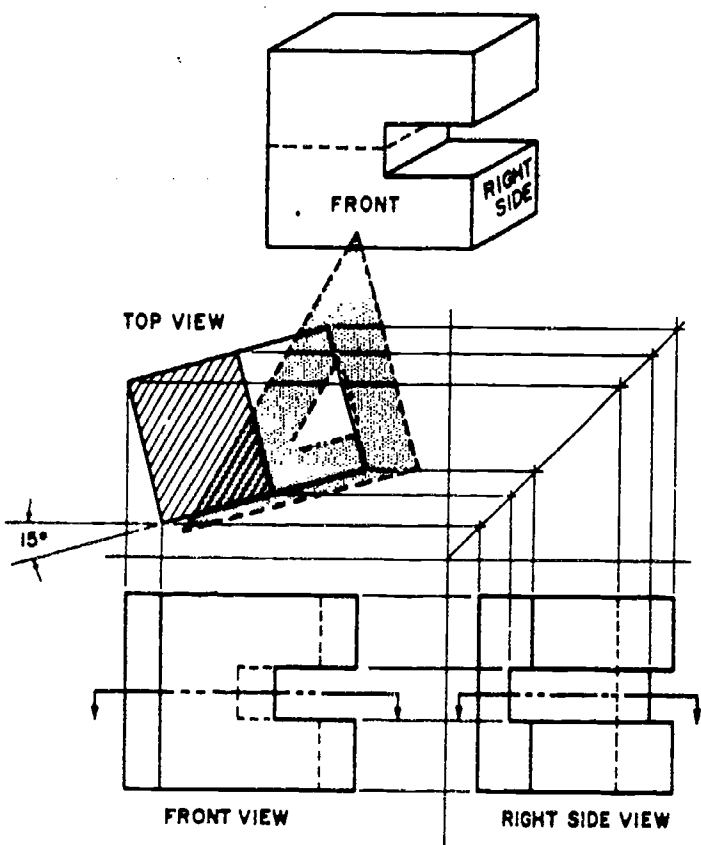

45.274

Figure 8-33.—Diagonal hatching on a revolution.

Depth may also be shown on this single plane by constructing the receding projectors of the object at an angle other than perpendicular to the plane of projection.

Figure 8-34 shows the same object by both orthographic and oblique projection. The block is placed so that its front surface (the surface toward the plane of projection) is parallel to the plane of projection. You can see that the orthographic projection shows only this surface of the block. The oblique projection, on the other hand, shows the front surface and also the top and side surfaces. The orthographic projection shows only two dimensions: length and width. The oblique projection shows three: length, width, and thickness. Oblique projection, then, is one method by which an object can be shown, in a single view, in all three dimensions.

There are two types of oblique single-plane projections—cavalier and cabinet.

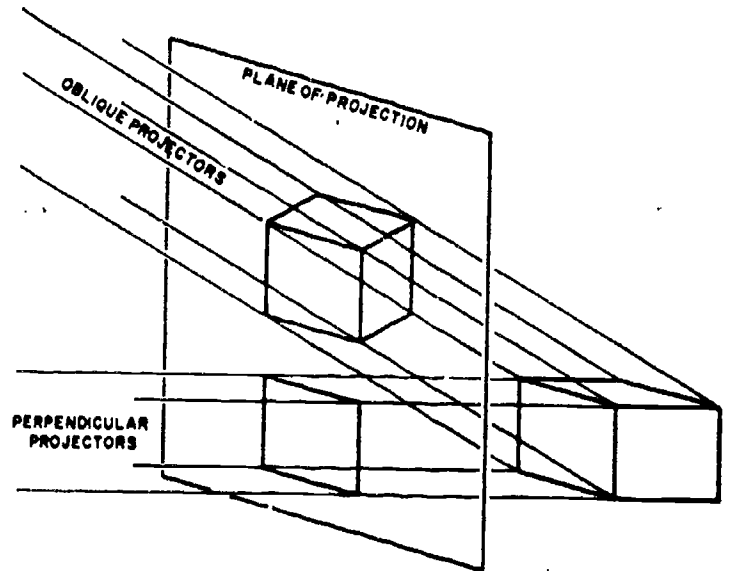

45.226

Figure 8-34.—Oblique and orthographic projections of the same object.

CAVALIER PROJECTION

Cavalier projection is a form of oblique projection in which the projectors are presumed to make a 45-degree vertical and a 45-degree horizontal angle with the plane of projection. Assume that in figure 8-35 the line XX' represents a side-edge view of the plane of projection, and that the square $ABCD$ represents a side of a cube, placed with its front face parallel to, and its top face perpendicular to, the plane of projection. You can see that the projected lengths of AB and AC are the same as the actual lengths.

Now assume that the line XX' in figure 8-35 represents a top-edge view of the plane of projection, and that the square $ABCD$ represents the top of the cube. You can see again that the projected lengths of AB and AC are the same as the actual lengths of AB and AC .

In a cavalier projection, then, any line parallel to or perpendicular to the plane of projection is projected in its true length. Figure 8-36 shows a cavalier projection of the cube shown in figure 8-35. You start by drawing the axis, which consists of the front axes OA and OB and the receding axis OC . The front axes are always perpendicular to each other; the receding axis may be drawn from O at any convenient

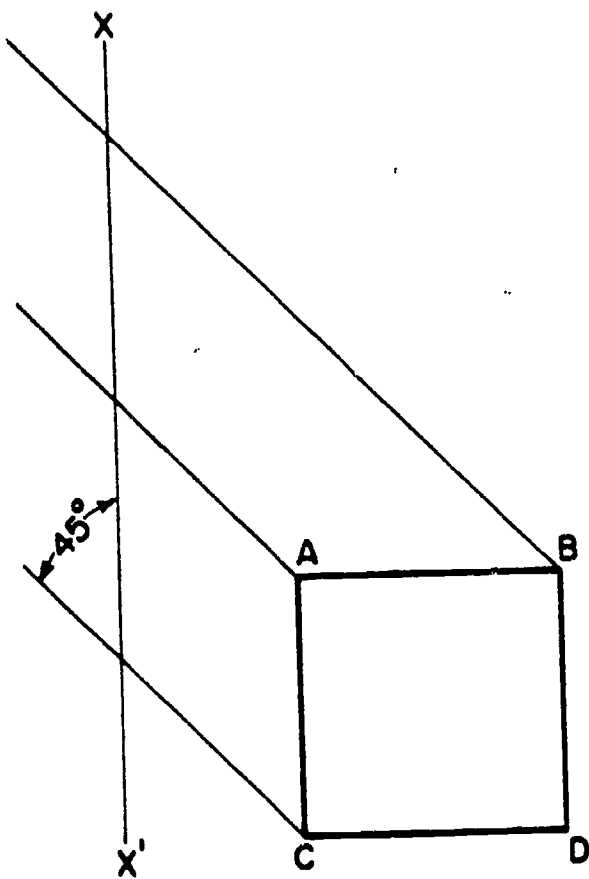

45.227

Figure 8-35.—Angle of projectors in a cavalier projection.

angle. All three are equal in length, the length being the length of an edge of the original cube (which may be scaled down or up if the drawing is made other than full scale). After you draw the axis, complete the projection by drawing the required parallel lines. All the edges shown in the projection are, like the edges on the original cube, equal in length.

CABINET PROJECTION

The first thing you notice about the cube shown in figure 8-36 is the fact that it doesn't look like a cube, because the depth dimension appears to be longer than the height and width dimensions. The reason for this is the fact that a cavalier projection corrects a human optical illusion—the one which causes an object to appear to become smaller as its distance from the eye increases. This illusion in turn causes receding parallel lines to appear to the eye to be shorter than they really are, and also to be

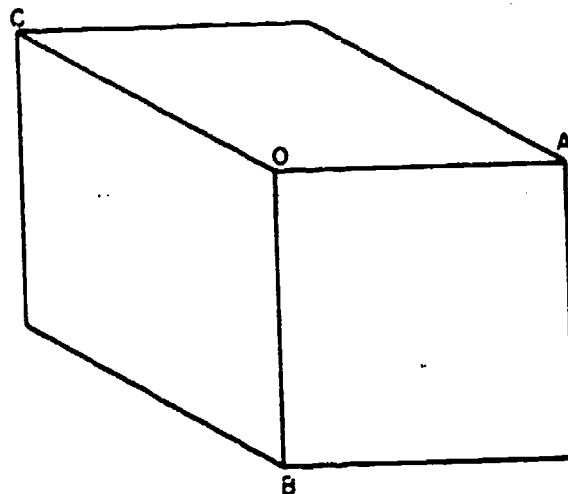

45.228

Figure 8-36.—Cavalier projection of a cube.

converging toward a point in the distance. But receding parallel lines on a cavalier projection appear in their true lengths, and they remain constantly parallel. Also, the far edges of the cube shown in figure 8-36 are equal in length to the near edges.

The distortion in figure 8-36 is only apparent. It is sometimes desirable to reduce this appearance of distortion.

This can be done by reducing the length of the receding axis (OC in fig. 8-37). This axis can be reduced by any desired amount, but it is customary to reduce it by one-half. When the

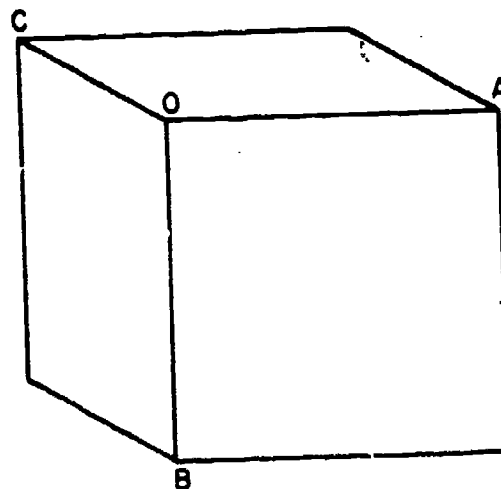

45.229

Figure 8-37.—Cabinet projection of a cube.

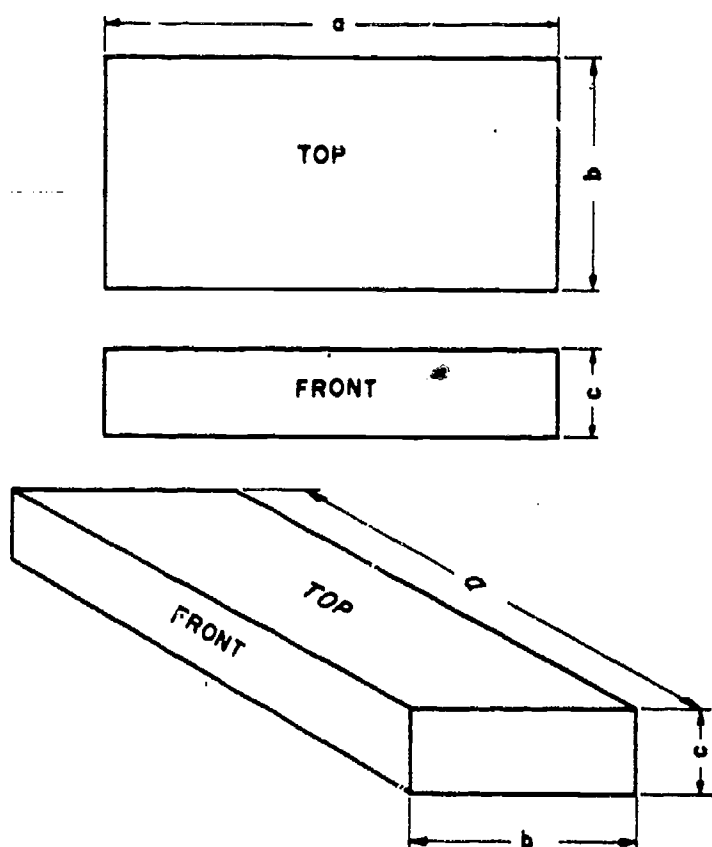

45.283

Figure 8-38.—Cavalier projection. Distances along front axis and along receding axis are all true.

When drawing these features various techniques can be employed to aid you in their construction.

For convenience, the angles chosen for the receding axis are either 30° , 45° , or 60° because they are easily constructed with triangles. (See fig. 8-40.)

Irregular Lines

An irregular line in an oblique drawing is a line which would be an oblique line in a normal multiview projection. In the upper part of figure 8-41 there is a 2-view multiview projection of a block; the line AB is an irregular line and will not appear in its true length in an oblique projection. To transfer the line you draw the projection by transferring measurements taken along regular lines; these measurements locate the end points of the irregular line. Figure 8-41 shows the cavalier projection of an irregular line.

receding axis is reduced by one-half, the projection is called a cabinet projection. Figure 8-37 shows a cabinet projection of a cube. The length of the receding axis OC has been reduced by one-half. As you can see, this representation looks more like a cube.

Cavalier and cabinet projections are compared in figures 8-38 and 8-39.

OBLIQUE DRAWING TECHNIQUES

In an oblique projection drawing of a rectangular object, one face (usually the most prominent or most important) is parallel to the plane of projection. All features appearing on this plane, such as circles or oblique lines, are in their true dimension. However, in the side or top views these same features are somewhat distorted because of the receding axis angle.

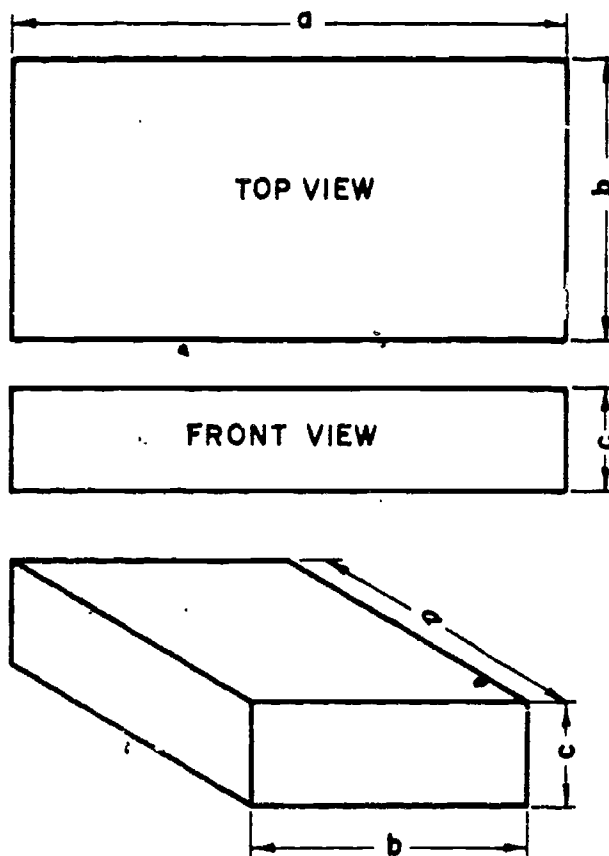

45.284

Figure 8-39.—Cabinet projection. Distances along front axis true; distances along receding axis reduced by one-half.

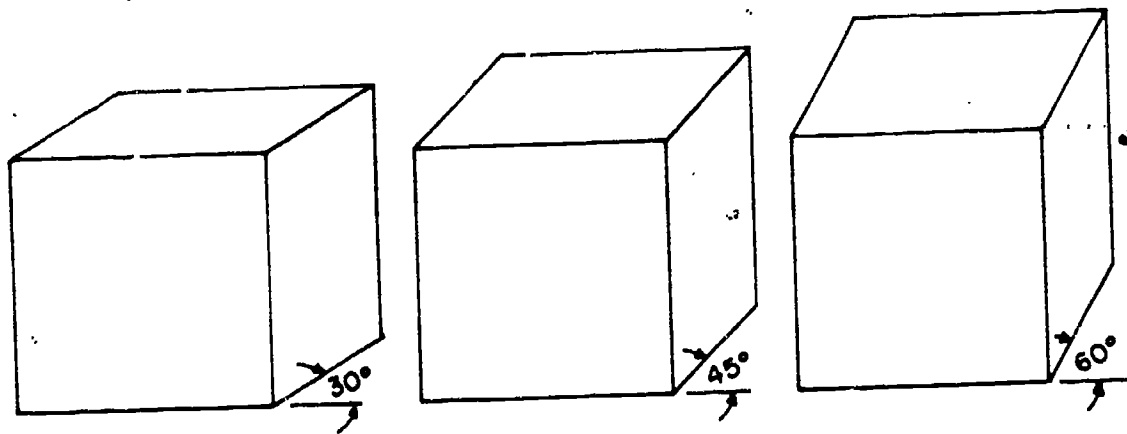

65.19

Figure 8-40.— 30° , 45° , and 60° are the normal angles chosen for the receding axis in oblique projection because they are easily drawn with triangles.

The procedure for cabinet projection would be the same, except that all measurements along the receding axis would be reduced by one-half.

Angles in Oblique

In an oblique projection an angle on the surface which is parallel to the plane of projection will appear in its true size; an angle on any other surface will not. In the upper part

of figure 8-42 there is a 2-view multiview projection of a block. There is a 30-degree angle on the top face and another on the front face. In the cavalier projection below, the angle on the front face still measures 30° ; that on the top face measures only about 9° . You transfer the top face angle by locating the end points of the line by measurements along regular lines.

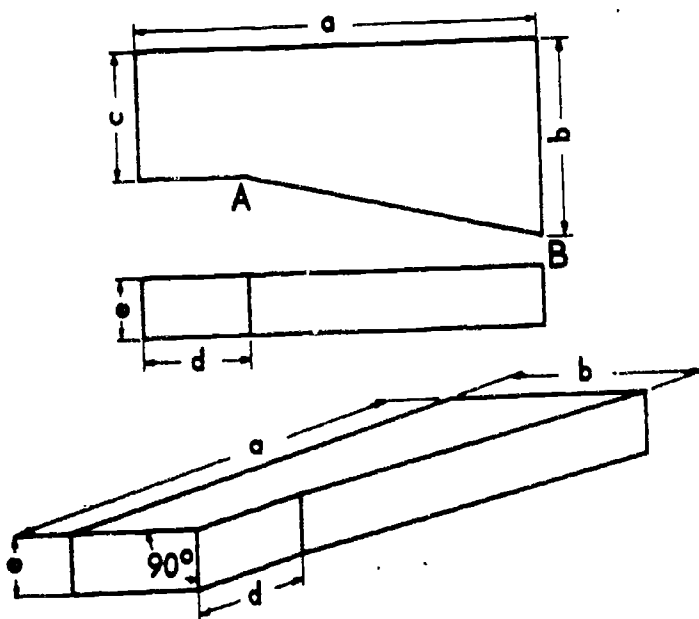

45.285

Figure 8-41.—Cavalier projection of an object with irregular lines.

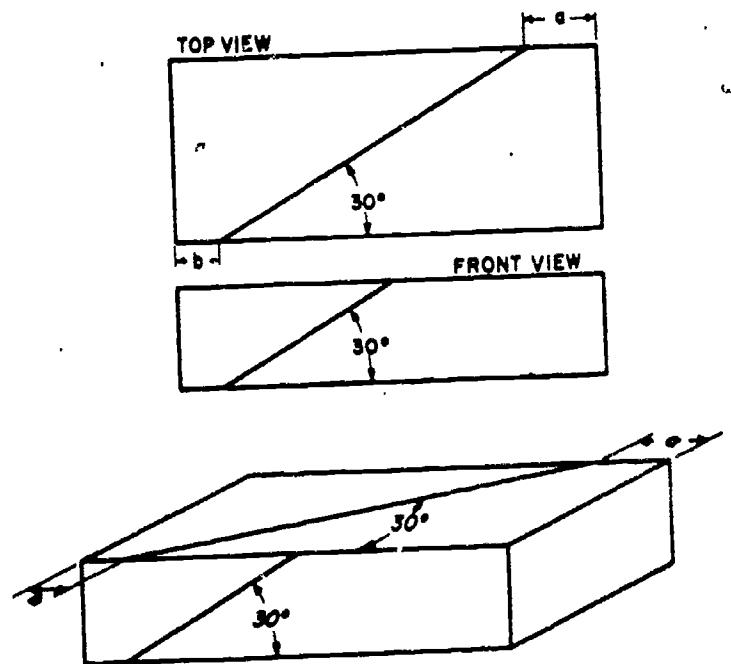

45.286

Figure 8-42.—Transferring an angle in oblique.

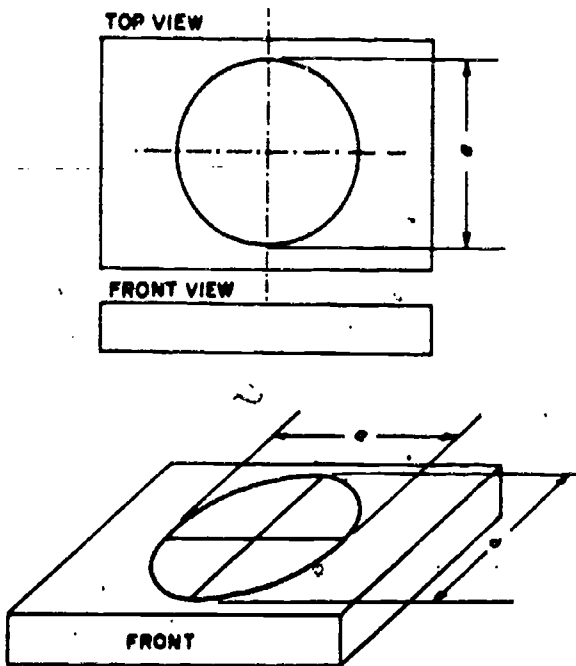

45.287

Figure 8-43.—Cavalier projection of a circle on a receding surface.

Circles in Oblique

In an oblique projection, a circle on the surface parallel to the plane of projection will appear as a circle. A circle on any other surface will appear as an ellipse, as illustrated in figure 8-43. In the upper part of this figure there is a 2-view multiview projection of a block with a

circle on its upper face. Below there is a cavalier projection, in which the circle appears as an ellipse. Each of the conjugate (joined together) diameters of the ellipse is equal to the diameter of the circle.

AXONOMETRIC PROJECTION

Axonometric single-plane projection is another way of showing an object in all three dimensions in a single view. Theoretically, axonometric projection is orthographic projection in that only one plane is used and the projectors are perpendicular to the plane of projection. It is the object itself, rather than the projectors, that is inclined to the plane of projection.

ISOMETRIC PROJECTION

Figure 8-44 shows a cube projected by isometric projection, the most frequently used type of axonometric projection. The cube is inclined so that all of its surfaces make the same angle ($35^{\circ}16'$) with the plane of projection. As a result of this inclination, the length of each of the edges shown in the projection is somewhat shorter than the actual length of the edge on the object itself. This reduction is called **EQUISHORTENING**. The degree of reduction amounts to the ratio of 1 to the cosine of $35^{\circ}16'$, or $1/0.8165$. This means that if an edge on the cube is 1 in. long, the projected edge will

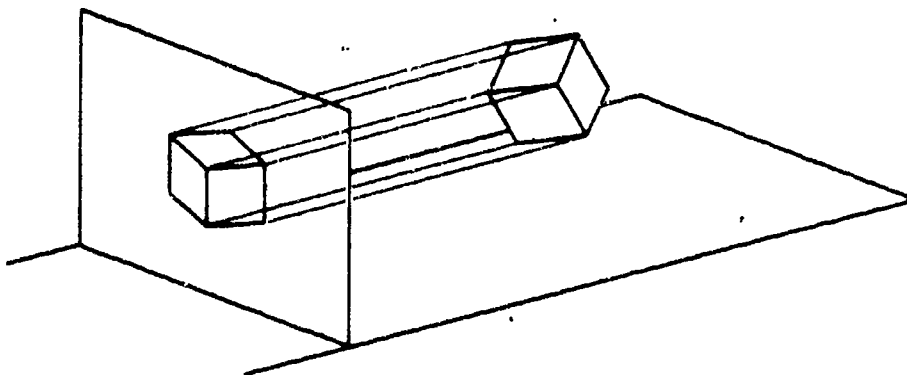
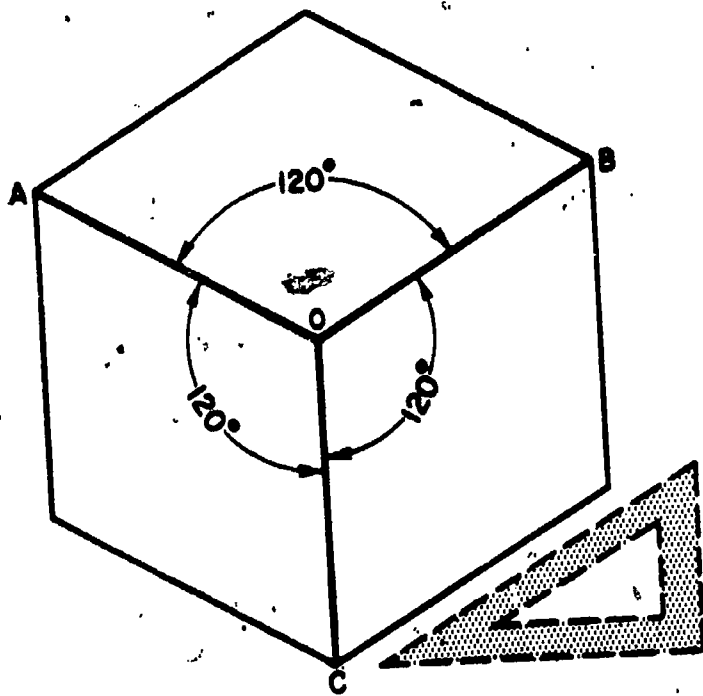

Figure 8-44.—Isometric projection of a cube.

45.230



45.231

Figure 8-45.—Isometric axis.

be 0.8165 in. long. As all of the surfaces make the same angle with the plane of projection, the edges all foreshorten in the same ratio. Therefore, one scale can be used for the entire layout; hence the term "isometric," which literally means "one-scale."

Figure 8-45 shows an isometric projection as it would look to an observer whose line of sight was perpendicular to the plane of projection. Note that the figure has a central axis, formed by the lines OA, OB, and OC. The existence of this axis is the origin of the term "axonometric projection." In an isometric projection, each line in the axis forms a 120-degree angle with the adjacent line, as shown. A quick way to draw the axis is to draw the perpendicular OC, then use a T-square and 30-60 degree triangle to draw OA and OB at 30° to the horizontal. Since the projections of parallel lines are parallel, the projections of the other edges of the cube will be respectively parallel to these axes.

ISOMETRIC DRAWING

A rectangular object can be easily drawn in isometric by the procedure known as box

construction. In the upper part of figure 8-46 there is a 2-view normal multiview projection of a rectangular block. An isometric drawing of the block is shown below. You can see how you build the figure on the isometric axis, and how you lay out the dimensions of the object on the isometric drawing. Because you laid out the identical dimensions, it is an isometric drawing rather than an isometric projection.

Nonisometric Lines

If you examine the isometric drawing shown in figure 8-46 you will note that each line in the drawing is parallel to one or another of the legs of the isometric axis. You will also notice that each line is a normal line in the multiview projection. Recall that a normal line is a line which, in a normal multiview projection, is parallel to two of the planes of projection and perpendicular to the third. Thus a nonisometric

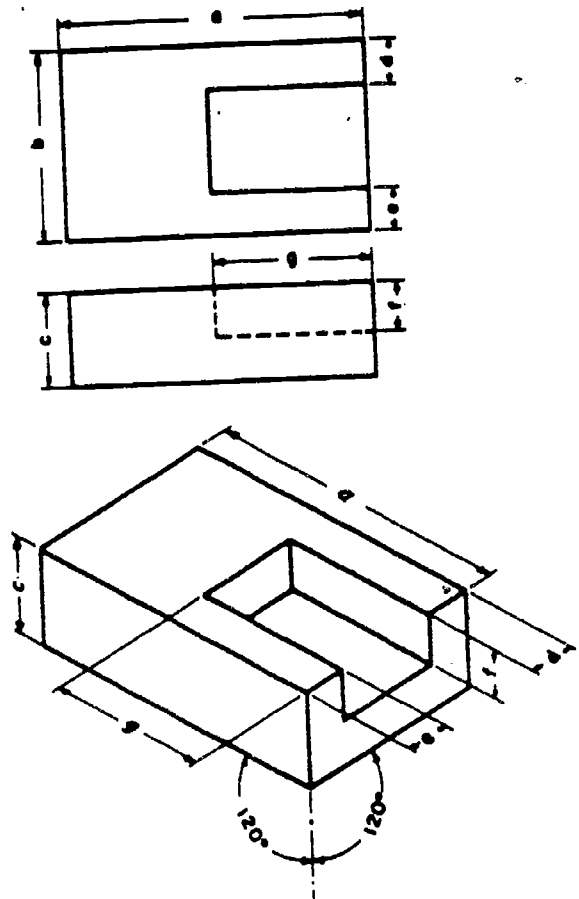

45.275

Figure 8-46.—Box construction.

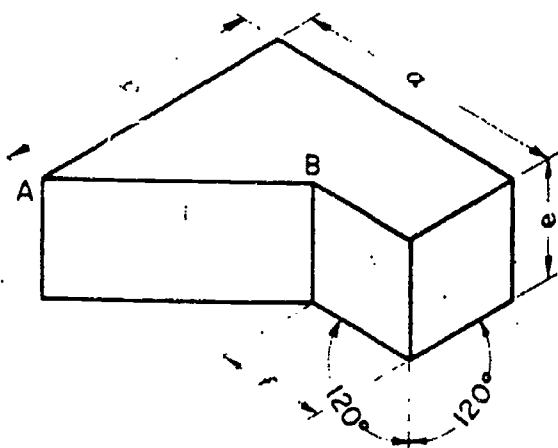
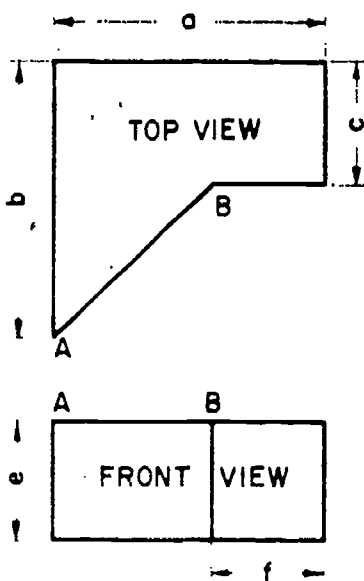

45.276

Figure 8-47.—The line AB is a nonisometric line.

line is a line which is not parallel to any one of the three legs of the isometric axis. It is not a normal line in a normal multiview projection of the object.

In the upper part of figure 8-47 there is a 2-view normal multiview projection of a block. Though the line AB is parallel to the horizontal plane of projection, it is oblique to both the vertical and the profile planes. It is therefore not a normal but an oblique line in the multiview projection, and it will be a nonisometric line in an isometric projection or drawing of the same object.

The line AB appears in its true length in the top multiview view, because it is parallel to the

plane of the view (the horizontal plane). But it will appear as a nonisometric line, and therefore not in its true length, in an isometric drawing. It follows that you cannot transfer AB directly from the multiview projection to the isometric drawing. You can, however, transfer directly all the normal lines in the multiview projection, which will be isometric lines, appearing in their true lengths, in the isometric drawing. When you have done this, you will have constructed the entire isometric drawing, exclusive of line AB, and of its counterpart on the bottom face of the block. The end points of AB and of its counterpart will be located, however, and it will only be necessary to connect them by straight lines.

Angles In Isometric

In a normal multiview view of an object an angle will appear in its true size. In an isometric projection or drawing, an angle never appears in its true size. Even an angle formed by normal lines, such as each of the 90-degree corner angles of the block shown in figure 8-47, appears distorted in isometric.

The same principle used in transferring a nonisometric line is used to transfer an angle in isometric. In the upper part of figure 8-48 there is a 2-view multiview projection of a block. On the top face of the block the line AB makes a 40-degree angle with the front edge. The line AB is an oblique (that is, not normal) line, which will appear as a nonisometric line in the isometric drawing. You locate the end points of AB on the isometric drawing by distances measured along normal lines on the multiview projection, and laid off along the corresponding isometric lines on the isometric drawing. The angle which measures 40° on the top multiview view measures only about 32° on the isometric drawing. Note, however, that it is labeled 40° on the isometric drawing. This is because it is, actually, a 40-degree angle, as it would look on a surface plane at the isometric angle of inclination.

Circles in Isometric

A circle in a normal multiview view will appear as an ellipse in an isometric drawing. This is illustrated in figure 8-49.

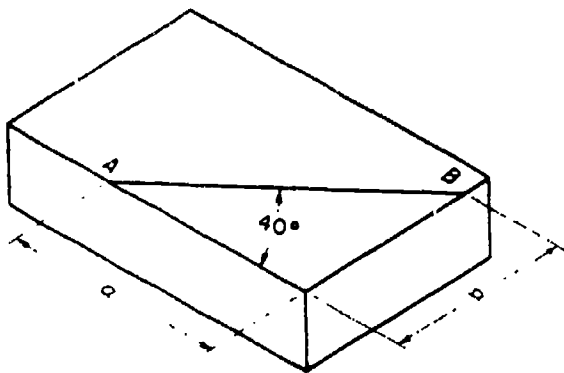
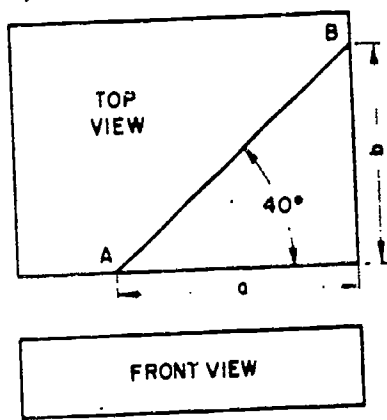

45.277

Figure 8-48.--Drawing an angle in isometric.

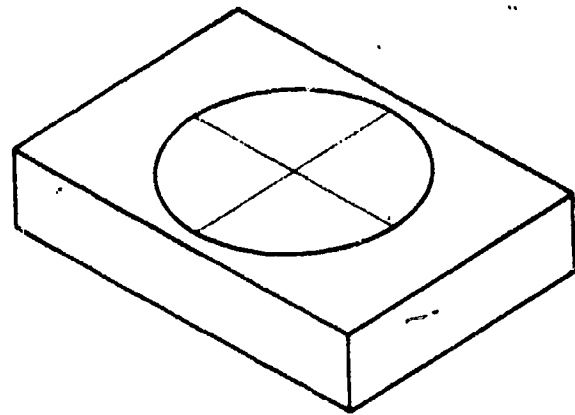
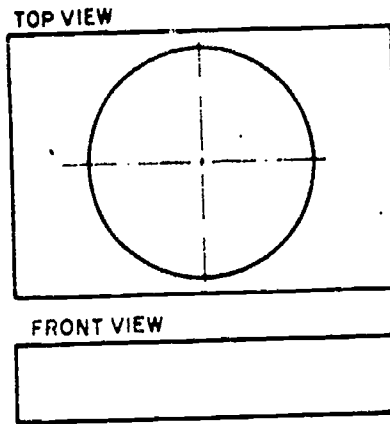

45.278

Figure 8-49.--Circle on a normal multiview view appears as ellipse in isometric drawing.

Noncircular Curves in Isometric

A line which appears as a noncircular curve in a normal multiview view of an object will appear as a nonisometric line in an isometric drawing. To transfer such a line to an isometric drawing, you must plot a series of points by measurements made along normal lines in the multiview view and transfer these measurements to corresponding isometric lines in the isometric drawing.

In the upper part of figure 8-50 there is a 2-view multiview projection of a block with an elliptical edge. To make an isometric drawing of this block, draw the circumscribing rectangle on the top multiview view, lay off equal intervals as shown, and draw perpendiculars at these intervals from the upper horizontal edge of the rectangle to the ellipse. Then draw the rectangle in isometric, as shown below, and plot a series of points along the elliptical edge by laying off the

same perpendiculars shown in the top multiview view. Draw the line of the ellipse through these points with a french curve.

Alternate Positions of Isometric Axis

Up to this point the isometric axis has been used with the lower leg vertical. The axis may, however, be used in any position, provided the angle between adjacent legs is always 120° . Figure 8-51 shows how varying the position of the axis varies the view of the object.

Diagonal Hatching in Isometric

Diagonal hatching on a sectional surface shown in isometric should have the appearance of making a 45-degree angle with the horizontal or vertical axis of the surface. If the surface is an

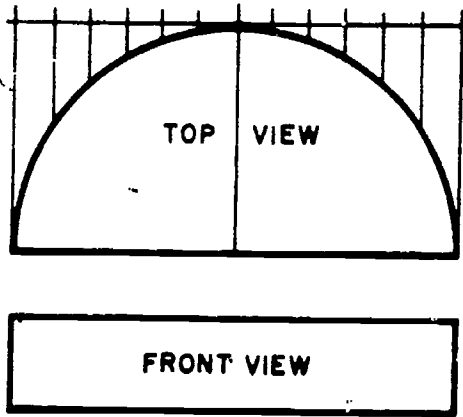

isometric surface (one which makes an angle of $35^{\circ}16'$ with the plane of projection), lines drawn at an angle of 60° to the horizontal margin of the paper, as illustrated in figure 8-52, present the required appearance. For diagonal hatching on a nonisometric surface, you must experiment to determine the angle which presents the required appearance.

PERSPECTIVE DRAWINGS

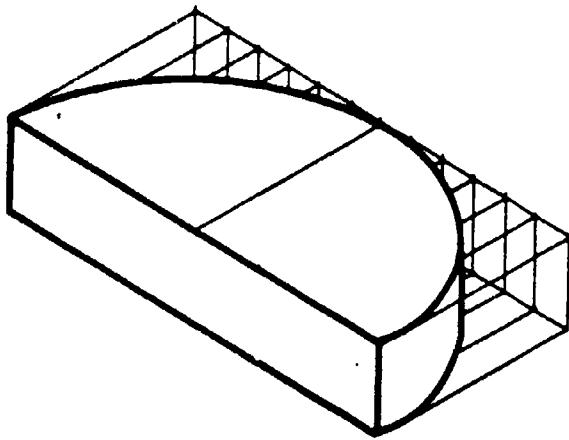

Of all the 3-dimensional single-plane drawings, the perspective drawing is the one which looks the most natural, and which at the same time contains the most errors. Lines which have the same length on the object have different lengths on the drawing. Most of the lines which are parallel on the object are not parallel on the drawing. Most of the angles which are equal on the object are not equal on the drawing. No single line or angle on the drawing has a length or size which has any known relationship to its true length or size.

Perspective drawing is used only in drawings of an illustrative nature, in which an object is deliberately made to appear the way it looks to the human eye. Most of the drawings you will prepare will be drawings in which accuracy, rather than eye appearance, will be the chief

45.280

Figure 8-50.—Method of drawing a noncircular curve in isometric.

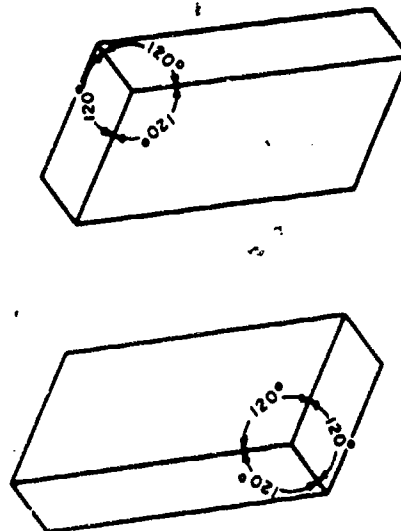
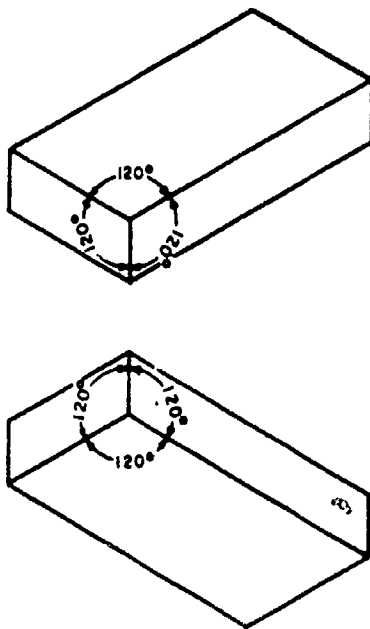

45.281

Figure 8-51.—Varying position of isometric axis varies view of the object.

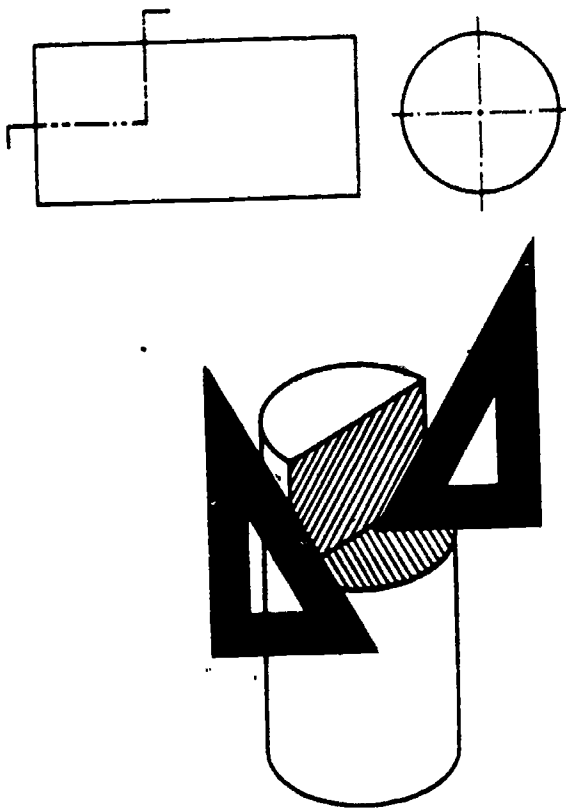

45.282

Figure 8-52.—Diagonal hatching in isometric.

consideration. Consequently, you will not be concerned much with perspective drawing.

If you are required to prepare perspective drawings, refer to *Illustrator Draftsman 3 & 2* or any one of several civilian publications such as *Architectural Drawing and Light Construction*.

SKETCHING

The EA who possesses the ability to make quick, accurate sketches will find this a valuable asset when it comes to conveying technical information or ideas. Without this ability you are handicapped in many of your day-to-day situations. Almost every drawing or graphic problem originates with a sketch. The sketch becomes an important thinking instrument, as well as a means of conversing effectively with technically trained people. Sketching is not just another trick of the trade; it is a skill which is essential and should be an important part of your training. To gain proficiency in freehand

sketching, invite situations entailing sketches at every opportunity. Do not worry about your first attempts at sketching—appearance will improve with experience.

A sketch is usually thought of as being made freehand, although in practice you may use graph paper or a small triangle for a straightedge. A sketch may be of an object or an idea, or a combination of both. Sketches are used to solve graphic problems before an object or structure is put in final form on a drawing. Preliminary sketches are used to plan and organize intelligently the sheet layout of a complete set of drawings for a construction project, which often includes many views and details. There are no set standards for technical freehand sketching; however, you should use standard line conventions for clarity.

A sketch may be drawn pictorially, so that it actually looks like the object, or it can be an orthographic sketch of the object showing different views. The degree of perfection required for any sketch will depend upon its intended use.

SKETCHING MATERIALS

One of the main advantages of sketching is that few materials are required. Basically all you need are a pencil and paper. However, the type of sketch prepared and your personal preference will determine the materials used.

You should use a soft pencil in the grade range from F to 3H, with H being a good grade for most sketching. The pencil should be long enough to permit a relaxed but stable grip. As you gain experience, you may even prefer to use fine tip felt pens. (Dark or bright colored pens should be used.) Felt tip pens work very well on overlay sketches (discussed later).

Most of your sketches will be done on scratch paper, which can be any type or size of paper. An experienced draftsman will keep a pad of 3" x 5" or 5" x 8" scratch paper handy at all times. For planning the layout of a drawing, tracing paper is convenient. The advantage of sketching on tracing paper is the ease with which sketches can be modified or redeveloped simply by placing transparent paper over previous sketches or existing drawings. Sketches prepared in this manner are referred to as overlay

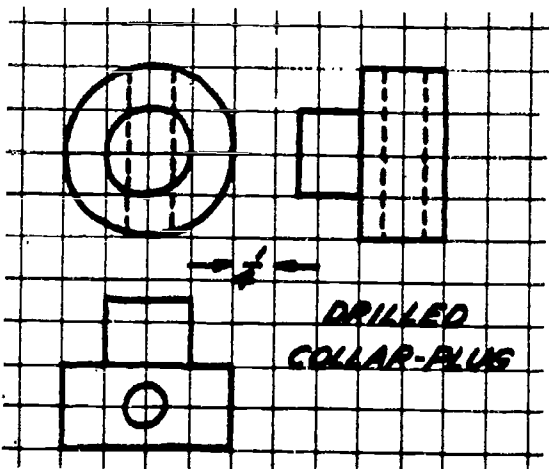

65.34

Figure 8-53.—Cross-section paper.

sketches. Cross section or graph paper may be used to save time when you are required to draw sketches to scale. (See fig. 8-53.) Isometric sketches are easily done on specially ruled isometric paper. (See fig. 8-54.)

An eraser may be used but you will probably do very little erasing. Sketches usually can be redrawn more quickly than mistakes can be erased.

For making dimensioned sketches in the field, you will need some sort of measuring tape, either a pocket rule or a surveyor's tape,

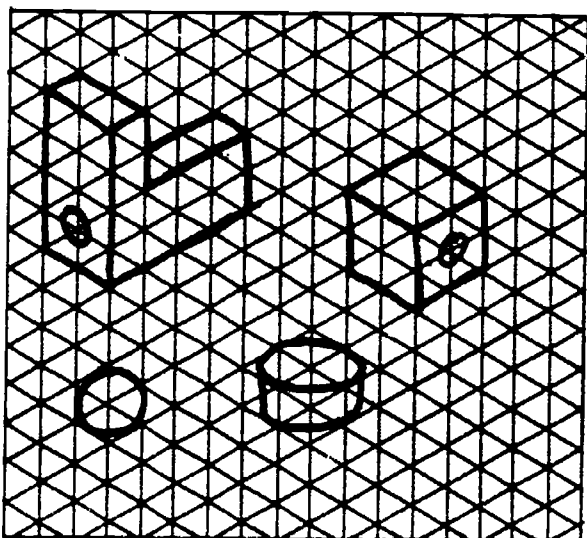

65.35

Figure 8-54.—Ruled isometric paper.

depending on the extent of the measurements taken. If you are required to collect extensive field data, it would be to your benefit to maintain a sketch notebook. A surveyor's field notebook works well for this purpose.

TECHNIQUES OF SKETCHING

In freehand pencil sketching draw each line with a series of short strokes instead of with one stroke. Using short strokes, you can better control the direction of your line and the pressure of your pencil on the paper. Hold the pencil about three-quarters of an inch to an inch from the point so that you can see what you are doing. Strive for a free and easy movement rather than a cramped finger and wrist movement.

To keep your sketch neat, first sketch your lines lightly. Lines not essential to the drawing can be sketched so lightly that you need not erase them. Darken essential lines by running your pencil over them with more pressure.

Straight Lines

In sketching lines, place a dot where you want a line to begin and one where you want it to end. In sketching long lines, place one or more dots between the end dots. Then swing your hand in the direction your line should go, and back again a couple of times before you touch your pencil to the paper. In this way you get the feel of the line. Then use these dots to guide your eye and your hand as you draw the line.

Another useful technique in drawing straight lines is to use the side of the paper, pad, or table as a guide for your hand. Hold the pencil at the desired starting point of the line and place the heel of your hand and one finger on the guide, as shown in figure 8-55. Move the pencil, in this case, with one uniform stroke to complete the line. Try drawing several light horizontal lines and, after each one is drawn, examine it for straightness, weight, and neatness. If it is too light, either a softer pencil or a little more pressure is necessary.

Vertical lines are usually sketched downward on the paper. The same suggestions for using

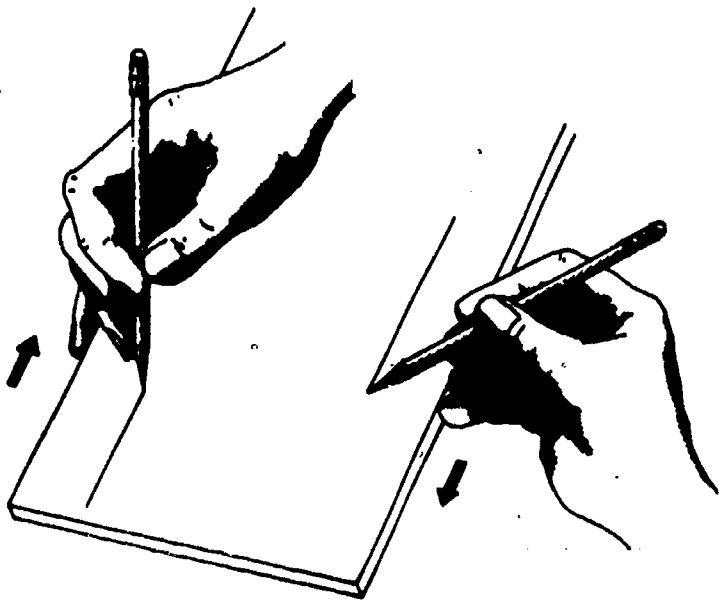

142.387

Figure 8-55.—Using the paper, pad or table as a guide when drawing straight lines.

locator dots, free movement of the entire arm, and guides apply to vertical lines as they do to horizontal lines.

Slanting lines may be drawn from either end toward the other. For better control, you might find it helpful to rotate the paper, thus placing the desired slanting line in either the horizontal or vertical position.

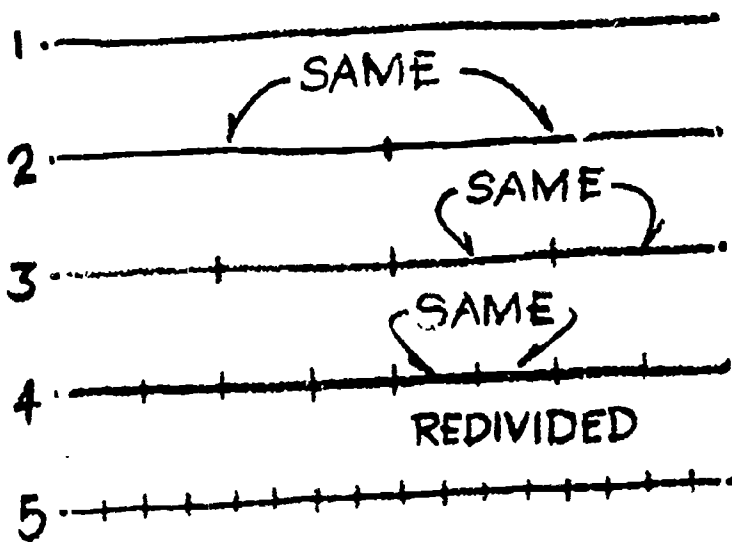

45.165.1

Figure 8-56.—Bisecting a line by visual comparison.

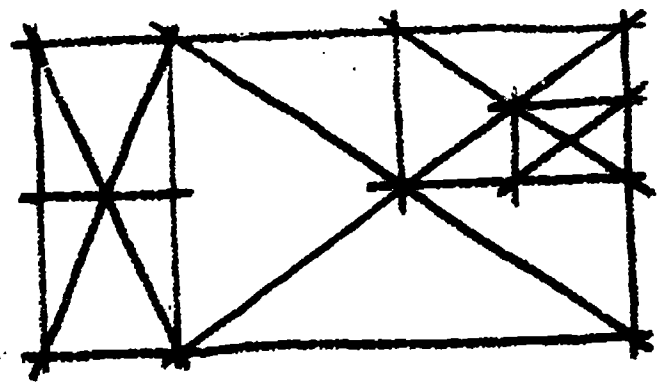

45.288

Figure 8-57.—Finding centers by sketching diagonals.

Dividing Lines and Areas Equally

You ability to divide lines and areas into equal parts is necessary in arriving at many of the common geometric forms required in sketching. The simplest method of bisecting lines is by visual comparison as shown in figure 8-56. The entire line is first observed and weighed optically to determine its fulcrum or point of balance. Each half is compared visually before placing the bisecting point. This procedure can be repeated any number of times to divide a line into any number of equal divisions, merely by dividing and redividing its line segments.

Centers of rectangular areas are easily determined by drawing their diagonals. If necessary the halves can be divided with diagonals for smaller divisions, as shown in figure 8-57.

Sketching Angles

The 90° angle is predominant in the majority of your sketches. Thus it is important that you learn to sketch right angles accurately, even if it entails checking them with the triangle occasionally. Frequently the perpendicular edges of your paper can serve as a visual guide for comparison. It is also helpful to turn your sketch upside down; nonperpendicular tendencies of horizontal and vertical lines will become evident. Correct shape of right angles will give your sketch stability, without which effectiveness is lost.

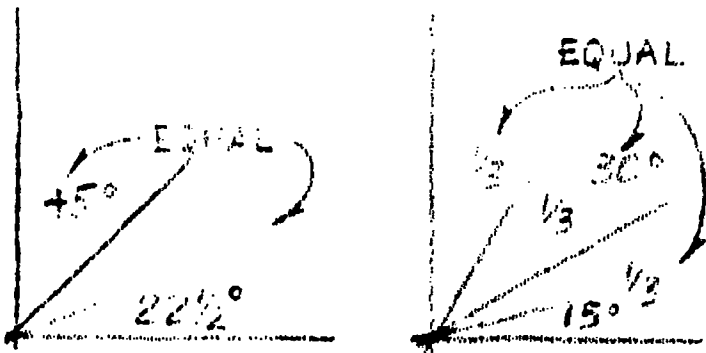

45.289

Figure 8-58.—Sketching angles by visual comparison.

A 45° angle is made by dividing a right angle by visual comparison; and a 30° or 60° angle by dividing the right angle into three equal parts. The 30° or 45° angle may be divided into equal parts in the same manner. (See fig. 8-58.) Always start with the right angle for the most accurate estimation of angle shape.

Sketching Circles and Arcs

Perfectly round circles are the most difficult to draw freehand. Figure 8-59 shows methods of drawing circles and curves using straight lines as construction lines. First draw two straight lines crossing each other at right angles, as in figure 8-59A. The point where they cross will serve as the center of the circle. The four lines radiating from this center will serve as the radii of the circle. You can use a piece of marked scrap paper to measure an equal distance on each radius from the center. Sketch a square, with the center of each side passing through the

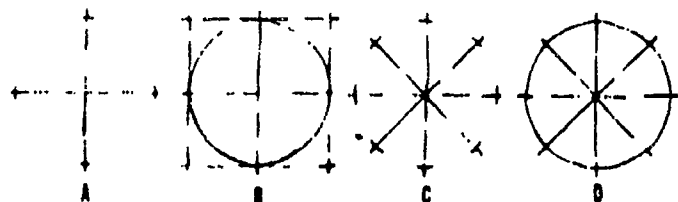

65.41

Figure 8-59.—Sketching circles.

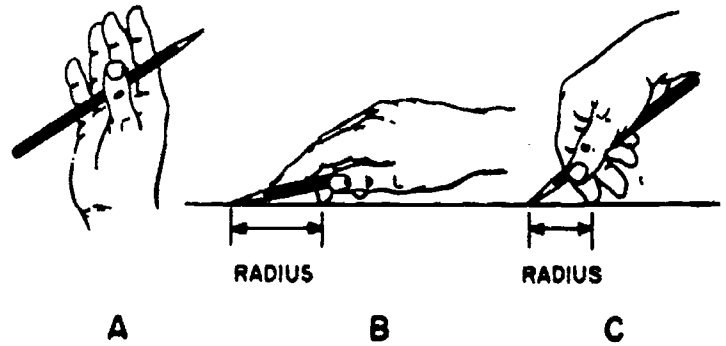

Figure 8-60.—Circles and arcs.

65.39

mark defining a radius. (See fig. 8-59B.) Now sketch in your circle, using the angles of the square as a guide for each arc. When larger circles are required, 45° angles can be added to the square to form an octagon. This will provide four additional points of tangency for the inscribed circle.

In figure 8-59C and 8-59D, four lines, instead of two, are sketched crossing each other. The radii are measured as in constructing the other circle, but a square is not drawn. For this method, you will find it helpful to rotate the paper and sketch the circle in one direction.

For drawing large circles you can make a substitute for a compass with a pencil, a piece of string, and a thumbtack. Tie one end of the string to your pencil near the tip. Measure the radius of the circle you are drawing on the string, and insert your tack at this point. Now swing your pencil in a circle, taking care to keep it vertical to the paper.

Another technique for drawing circles is shown in figure 8-60.

In A of figure 8-60 observe how the pencil is held beneath the four fingers with the thumb. This grip tends to produce a soft or easy motion for sketching large circles or curves and also makes it possible to sketch small circles as shown in figure 8-60B and C. You notice in figure 8-60B that the second finger rests at the center of the circle and forms the pivot about which the pencil lead can swing. The distance from the finger tip to the pencil lead determines the radius of the circle. To draw smaller circles a somewhat different grip on the pencil is necessary, as shown in C of figure 8-60 but the

and round circle, but only with a very light line which must be made heavier. Do this as shown in B. Notice that you do NOT PIVOT on the second finger during this step. You rest your hand on its side and, keeping it within the circle, trace over the light line with your hand pivoting naturally at the wrist. As you work around the circle in this way, rotate the paper counterclockwise so that your hand can work in its most natural and easy position. Of course with smaller circles you cannot work with your hand within the circle, but the same general approach can be used with success.

Probably one of the best methods to sketch curves connected to straight lines if the 6-step method illustrated and explained below:

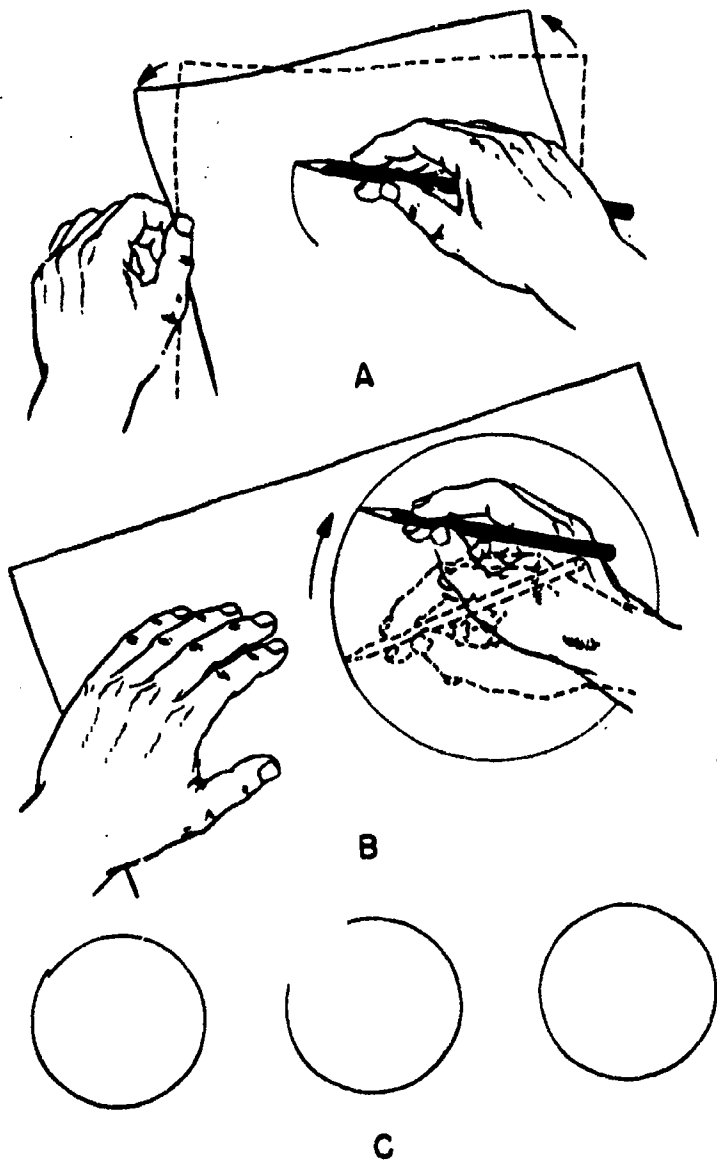

65.40
Figure 8-61.—Steps in sketching a circle.

principle is the same. Figure 8-60 shows the proper way to grip the pencil; figure 8-61 shows how to draw the circles using these grips.

As shown in A in figure 8-61 the first step in sketching either large or small circles with the grips shown in the previous figure is placing the second finger on the paper at the center of the proposed circle. Then, with the pencil lightly touching the paper, use the other hand to rotate the paper to give you a circle that may look like the one in figure 8-61B. To correct the slight error of closure shown in C, erase a substantial section of the circle and correct it by eye as shown at the right. You now have a complete

1. Intersect a vertical and horizontal line, lightly.
2. Mark off on the horizontal and vertical lines the same distance from the intersection.
3. Draw a light diagonal line through the two points marked.
4. Place an x or a dot in the exact center of the triangle formed.
5. Start your curve from one point of the triangle (preferably on the vertical line) touching the x or dot and ending at the other point of the triangle.
6. Erase all the unnecessary guidelines and darken the curve and necessary adjoining straight lines.

A little practice with this method should improve your ability to sketch curves properly.

Figure 8-62 shows a convenient way of sketching arcs and curves by blocking them in with straight lines.

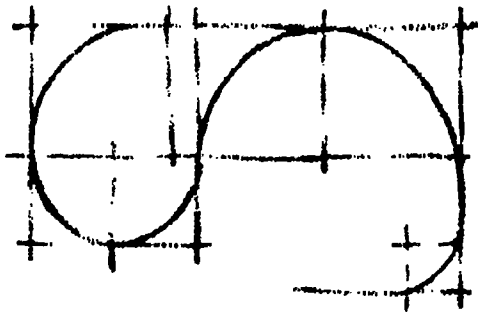

65.42

Figure 8-62.—Sketching curves.

Construction Lines

When you are sketching an object such as that shown in figure 8-63, don't start at one corner and draw it detail by detail and expect it to come out with the various elements in correct proportion. It is better to block in the overall shape of the object first. (See fig. 8-63A.) Then draw light guidelines at the correct angle for the various outlines of the object. (See fig. 8-63B and C.)

Finish the sketch, by first making an outline of the object, and then drawing in the details, as shown in figure 8-63D.

Order of Sketching

To make a working sketch, first choose a clean sheet of paper, either plain or ruled.

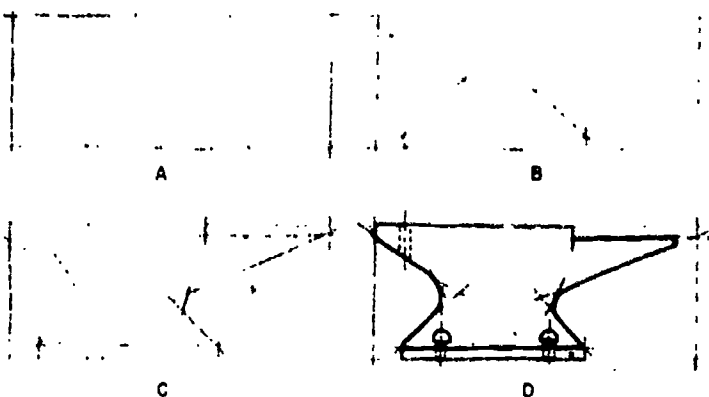

65.44

Figure 8-63.—The use of construction lines in sketching an object.

Estimate the size the sketch should be, and select the views which will give the best picture of the object. Then draw the orthographic projections of these views, leaving adequate space between them for dimensions. In sketching, progress as follows:

1. Draw the centerlines, as shown in figure 8-64A.
2. Block in the views.
3. Draw the outlines, aligning them as in figure 8-64B.
4. Add the details on the surface of the views.
5. Darken the lines of the finished sketch.
6. Use an artgum or a kneaded eraser to erase the construction lines which are no longer needed. If necessary, touch up the lines you may have inadvertently erased.
7. Draw all necessary extension and dimension lines.
8. Letter in the dimensions. (See fig. 8-64C.)

You can see that a working sketch such as the one shown in figure 8-64 could easily be followed in preparing a finished drawing of the object. The sketch provides you with all the necessary information needed on the finished drawing.

Pictorial Sketches

Often it will be more convenient, or even necessary, to prepare isometric or oblique pictorial sketches instead of multiview orthographic sketches. Pictorial sketches provide you with a quick method of examining tentative construction details. A quick pictorial sketch will also help you in the layout of isometric and oblique drawings.

The principles of pictorial and orthographic sketching are similar, except that in pictorial sketching you will be dealing with volumes rather than flat planes. Basically, pictorial sketches and pictorial drawings are practically the same except for the drawing materials used in their development and the fact that pictorial sketches are not normally drawn to scale. By

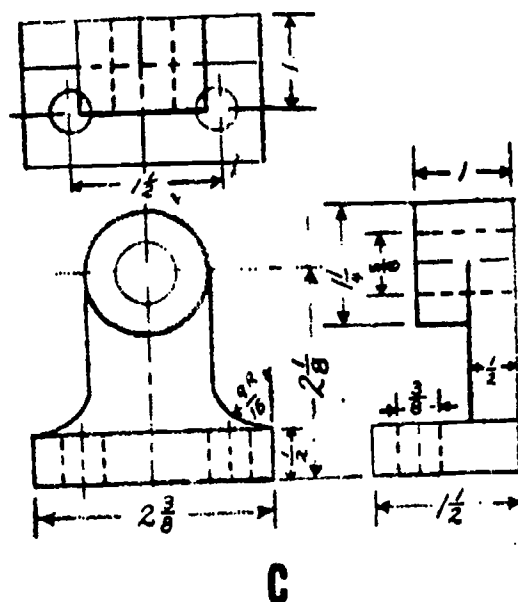
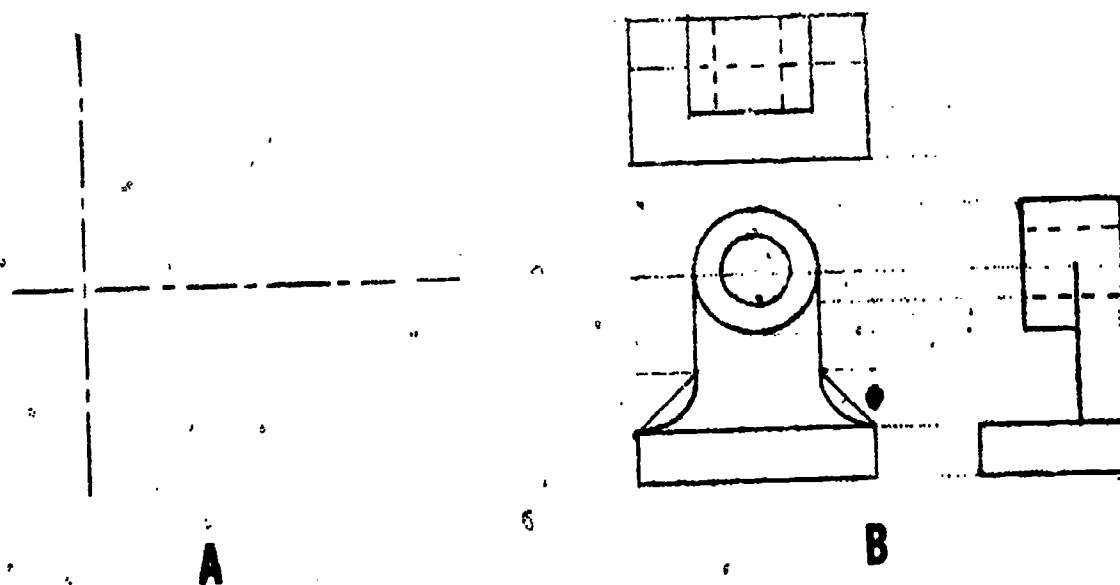

65.44.0

Figure 8-64.—Progress of a working sketch.

following a few simple steps, based on pictorial drawing construction principles, you should be able to prepare meaningful pictorial sketches.

ISOMETRIC SKETCH.—Select a position (view) that will show the object to the best advantage. You will know what you want included in your sketch, so move either the object or yourself until you can actually see

everything you want to show. If the object is something you have in mind or if you intend to sketch an isometric view from an orthographic drawing, you will have to visualize the object and assume a viewing position. In making your isometric sketch, remember that you start by sketching 3 isometric axes 120° apart, using two angles of 30° and a vertical axis of 90° . Figure 8-65A shows in a step-by-step procedure used in

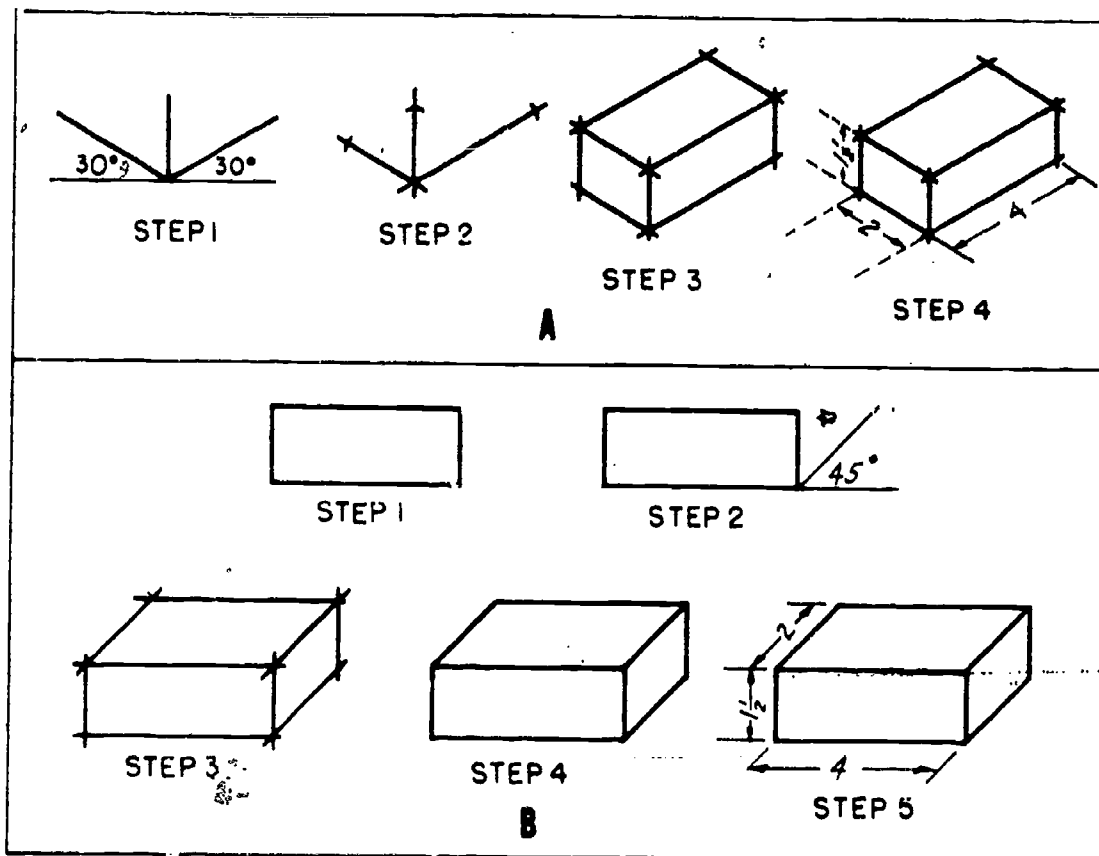

Figure 8-65.—Sketching a rectangular block. (A) Isometric; (B) Oblique.

65.46:48X

making an isometric sketch of a wooden rectangular block measuring 1 1/2 x 2 x 4 inches.

The first step is to sketch the three isometric axes, as mentioned earlier. The second step is to mark off the 1 1/2 inches for height on the vertical axis, the 2-inch width along the left axis, and the 4-inch length along the right axis. The third step is to draw two vertical lines 1 1/2 inches high (starting with the marks on the right and left axis), then sketch parallel lines from each of the marks on the sketch. Note that the lines that are parallel on the object are parallel on the sketch. The fourth step is to dimension the sketch. The dimensions on an isometric sketch are placed parallel to the ends or edges. The final step is to check the sketch for completeness and accuracy.

OBLIQUE SKETCH.—The front face or view of an oblique sketch is drawn the same way as an orthographic front view. Using the same

wooden block that was sketched isometrically for a model, an oblique sketch would be drawn following the basic steps shown in figure 8-65B.

The first step is to draw a rectangle of the front view (using light lines). Then, second, draw an oblique base line at a 45° angle starting at the corner (intersection) of the horizontal and vertical base lines. Third, sketch the remaining horizontal and vertical lines parallel to the other base lines. Fourth, erase any unnecessary lines, and fifth, dimension and darken the completed drawing for easier reading. Remember, place the dimensions so they are parallel to the axis lines. The final step is to check the sketch for completeness and accuracy.

In the above procedures for development of pictorial sketches, a simple rectangular form was used. All objects may be simplified to their basic geometric forms. These forms are the first consideration in the pictorial sketch. Basic volumetric forms are shown in figure 8-66. By carefully analyzing any object which you sketch,

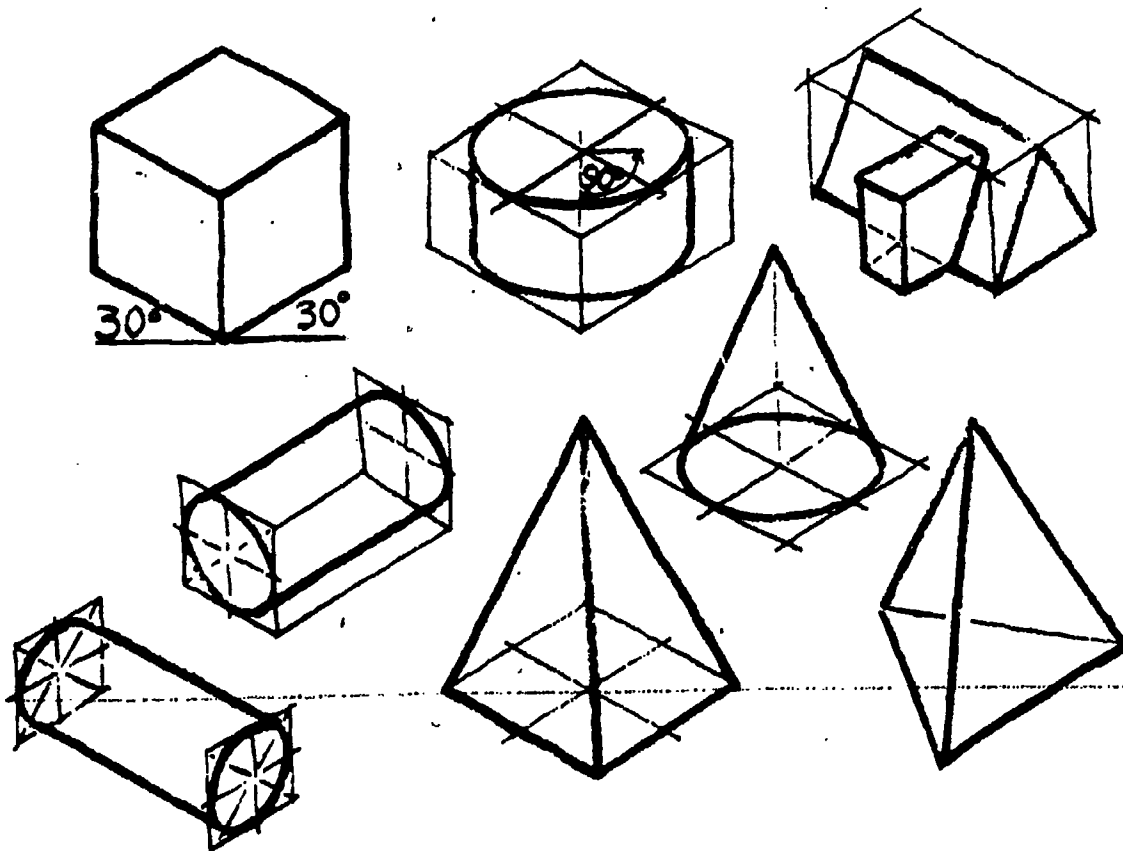

45.290

Figure 8-66.—Basic isometric forms.

you will see one or more of the forms shown in figure 8-66. However, at times only a part of a form is present.

Before attempting detailed sketches, practice sketching the basic forms. Then, look for these forms in the object you are about to sketch and concentrate on the basic form representation. Enclose the object in a basic form, or build it up with a series of different forms, depending on the nature of the object. Details are added or “carved” from these forms after shape and proportion have been determined.

Overlay Sketches

Overlay sketches are made by sketching freehand on transparent paper placed over existing drawings or other sketches. Sometimes when you make overlay sketches you merely trace, freehand, objects or lines from another drawing or sketch. But more often you will prepare overlay sketches by tracing and then adding supplementary sketched lines or objects.

Usually when this type of sketch is prepared, only the prominent or desired features are traced. Overlay sketches are primarily used for planning purposes.

A suggested procedure for the use of overlay sketches, as a tool for planning, is explained in the following example:

The drafting room is being relocated. You are tasked with developing a proposed furniture and equipment layout. You have the latest prints of the floor plan and an electrical plan, and you know what furniture and equipment will be moved to the new area. The steps which you take to develop the proposed layout are as follows:

1. Check the floor plan and electrical plan against the actual room layout. If necessary, check the dimensions. Correct any discrepancies with a dark colored fine tip felt pen or colored pencil.
2. Place a piece of tracing paper over the floor plan on the print and secure it with small strips of drafting tape.

3. Trace the outline of the walls with single freehand lines (preferably with a dark colored felt tip pen). Terminate the lines, where applicable, to indicate window and door openings.

4. Remove the tracing paper from the floor plan and place it over the electrical plan, lining the traced wall outlines up with the corresponding walls on the electrical plan. Using appropriate symbols, locate, on the traced floor plan, all electrical outlet location.

5. You now have a clear overlay sketch of the existing floor plan without the unnecessary dimensions and information which are on the original print of the floor plan. This is your basic planning overlay. Check your overlay with the original prints to make sure that relevant lines were not omitted.

6. Place another sheet of tracing paper over the basic planning overlay. This becomes your

second overlay. On this second overlay, sketch in your desired location of all the furniture and equipment. Use simple shapes for each and estimate sizes. Use letters or symbols for identification. Repeating the outline of the walls is not necessary because you can still see the outline from the basic planning overlay.

7. If this first location sketch on the second overlay does not suit you, or does not provide an adequate layout, lay another piece of tracing paper over the second layout and sketch another layout. Repeat this procedure with additional overlays until you have developed a good layout.

8. Once you have a good layout, trace the wall outlines from the basic planning overlay. This final overlay sketch is your proposed furniture and equipment layout for the new location of the drafting room.

APPENDIX I

ENGINEERING TECHNICAL LIBRARY

The technical library is set up and maintained in accordance with guidelines set forth in the COMCBPAC/LANT 5070 series instructions. These instructions contain a list of both civilian and military publications which are pertinent to most normal construction. It is the responsibility of the Engineering Aid to ensure that the library contains up-to-date publications. This is done by checking the contents of the library against the latest instructions. As the instructions give only the title and not the year of the publication, they must be compared with (1) the NAVFAC *Documentation Index*, P-349, a list of current publications available through the Navy, and (2) the Department of the Army Pamphlet 310-4, *Military Publications*, a list of current Army Technical Manuals (TM's). If special construction is anticipated, it may be necessary to add publications not included in the COMCBPAC/LANT 5070 instructions.

The following is a suggested list of civilian publications that could be added to the technical library:

AASHO Standard Method of Tests, American association of State Highway Officials

Annual Book of ASTM Standards, American Society of Testing Materials

Architectural and Building Trades Dictionary, American Technical Society

Architectural Drawing and Light Construction, Muller

Concrete Topics, Kaiser Cement and Gypsum Corporation

Construction Formwork, Design and Erection, Boley

Design and Construction of Asphalt Pavements, Rogers and Wallace

Handbook of Standard Structural Details For Buildings, Ketchum

Placing Reinforcing Steel, Concrete Reinforcing Steel Institute

Principles and Practices of Heavy Construction, Smith

Reinforcing Bar Detailing, Concrete Reinforcing Steel Institute

Route Surveys and Design, Hickerson

Surveying: Theory and Practice, Davis, Foote and Kelley

APPENDIX II
MATHEMATICS

234

226

A. MATHEMATICAL SYMBOLS

SYMBOL	NAME OR MEANING	SYMBOL	NAME OR MEANING
+	Addition or positive value	$\sqrt{\quad}$	Square root symbol
-	Subtraction or negative value	$\sqrt{\quad}$	Square root symbol with vinculum. Vinculum is made long enough to cover all factors of the number whose square root is to be taken.
\pm	Positive or negative value	$\sqrt[n]{\quad}$	Radical symbol. Letter n represents a number indicating which root is to be taken.
.	Multiplication dot (Centered; not to be mistaken for decimal point.)	i or j	Imaginary unit; operator j for electronics; represents $\sqrt{-1}$.
\times	Multiplication symbol	∞	Infinity symbol
()	Parentheses	...	Ellipsis. Used in series of numbers in which successive numbers are predictable by their conformance to a pattern; meaning is approximated by "etc."
[]	Brackets	$\log_a N$	Logarithm of N to the base a.
{ }	Braces	$\log N$	Logarithm of N to the base 10. (understood)
—	Vinculum (overscore)	$\ln N$	Natural or Napierian logarithm of N.
%	Percent	e	Base of the natural or Napierian logarithm system: 2.71828 (Approx.)
\div	Division symbol	$ X $	Absolute value of X.
:	Ratio symbol	π	π . The ratio of the circumference of any circle to its diameter. Approximate numerical value is 22/7.
::	Proportion symbol	\therefore	Therefore
=	Equality symbol	\sphericalangle or \sphericalangle	Angle
\neq	"Not equal" symbol		
<	Less than		
\leq	Less than or equal to		
>	Greater than		
\geq	Greater than or equal to		
\propto	"Varies directly as" or "is proportional to" (Not to be mistaken for Greek alpha (α).)		

B. WEIGHTS AND MEASURES

Dry Measure

2 cups = 1 pint (pt)
 2 pints = 1 quart (qt)
 4 quarts = 1 gallon (gal)
 8 quarts = 1 peck (pk)
 4 pecks = 1 bushel (bu)

Liquid Measure

3 teaspoons (tsp) = 1 tablespoon (tbsp)
 16 tablespoons = 1 cup
 2 cups = 1 pint
 16 fluid ounces (oz) = 1 pint
 2 pints = 1 quart
 4 quarts = 1 gallon
 31.5 gallons = 1 barrel (bbl)
 231 cubic inches = 1 gallon
 7.48 gallons = 1 cubic foot (cu ft)

Weight

16 ounces = 1 pound (lb)
 2,000 pounds = 1 short ton (T)
 2,240 pounds = 1 long ton

Distance

12 inches = 1 foot (ft)
 3 feet = 1 yard (yd)
 5-1/2 yards = 1 rod (rd)
 16-1/2 feet = 1 rod
 1,760 yards = 1 statute mile (mi)
 5,280 feet = 1 statute mile

Area

144 square inches = 1 square foot (sq ft)
 9 square feet = 1 square yard (sq yd)
 30-1/4 square yards = 1 square rod
 160 square rods = 1 acre (A)
 640 acres = 1 square mile (sq mi)

Volume

1,728 cubic inches = 1 cubic foot
 27 cubic feet = 1 cubic yard (cu yd)

Counting Units

12 units = 1 dozen (doz)
 12 dozens = 1 gross
 144 units = 1 gross
 24 sheets = 1 quire
 480 sheets = 1 ream

Equivalents

1 cubic foot of water weighs 62.5 pounds (approx) = 1,000 ounces
 1 gallon of water weighs 8-1/3 pounds (approx)
 1 cubic foot = 7.48 gallons
 1 inch = 2.54 centimeters
 1 foot = 30.4801 centimeters
 1 meter = 39.37 inches
 1 liter = 1.05668 quarts (liquid) = 0.90808 quart (dry)
 1 nautical mile = 6,080 feet (approx)
 1 fathom = 6 feet
 1 shot of chain = 15 fathoms

C. GEOMETRIC FORMULAS

(Area, Perimeter, Volume, Surface Area)

In the geometric formulas listed in this appendix the following letter designations are used except as noted otherwise:

a, b, c, d and e denote lengths of sides

h denotes perpendicular height

s denotes slant height

A denotes area (plane figures)

C denotes circumference

D denotes diameter

I denotes interior angles

L denotes lateral area (lateral area)

P denotes perimeter

R denotes radius

S denotes surface area (solid figures)

V denotes volume



TRIANGLES

$$A = \frac{bh}{2}$$

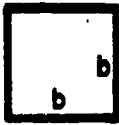

SQUARE

$$A = b^2$$

$$P = 4b$$

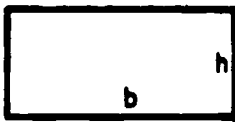

RECTANGLE

$$A = bh$$

$$P = 2b + 2h$$

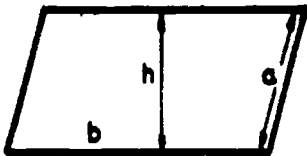

PARALLELOGRAM

$$A = bh$$

$$P = 2a + 2b$$

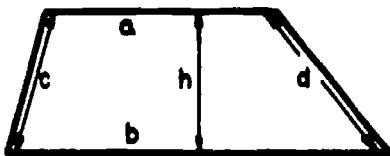

TRAPEZOID

$$A = \frac{h(a+b)}{2}$$

$$P = a + b + c + d$$

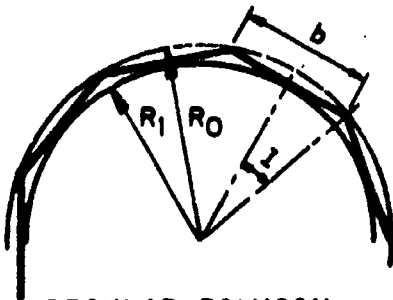

REGULAR POLYGON

$$A = \frac{nb R_1}{2}$$

WHERE n DENOTES THE NUMBER OF SIDES

$$b = 2 \sqrt{R_0^2 - R_1^2}$$

$$R_0 = \frac{b}{2 \tan I}, \quad R_1 = \frac{b}{2 \sin I}$$

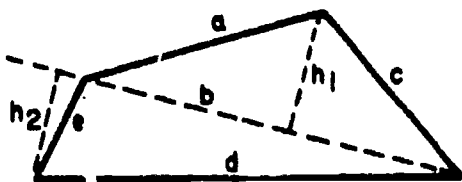

TRAPEZIUM

$$A = \frac{b(h_1 + h_2)}{2} \quad \text{WHERE } b \text{ IS A COMMON BASE}$$

$$P = a + c + d + e$$

Appendix II—MATHEMATICS

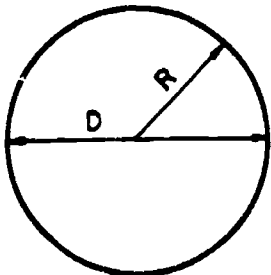

CIRCLE
ARC a

$$A = \pi R^2, A = \frac{1}{4} \pi D^2$$

$$C = 2\pi R, C = \pi D$$

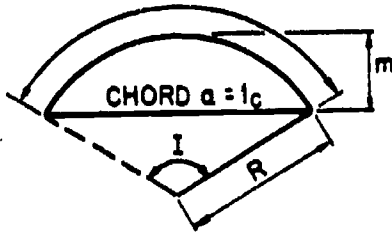

CIRCULAR SEGMENT

$$A = \frac{a(R - l_c)(R - m)}{2}$$

$$l_c = 2 \sqrt{2mR - m^2}$$

$$l_c = 2R \sin \frac{I}{2}$$

$$a = \frac{\pi R I}{180^\circ}, a = 0.0175 R I \text{ (APPROX.)}$$

WHERE a DENOTES LENGTH OF ARC
 l_c DENOTES CHORD LENGTH
 m DENOTES MIDDLE ORDINATE

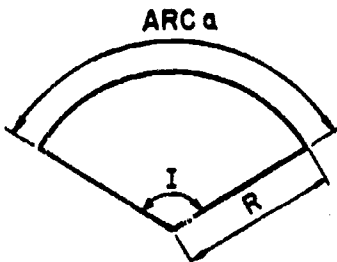

CIRCULAR SECTOR

$$A = \frac{aR}{2}, A = \frac{\pi R^2 I}{360}, A = 0.0087 R^2 I \text{ (APPROX.)}$$

$$a = \text{(SEE FORMULAS FOR CIRCULAR SEGMENT)}$$

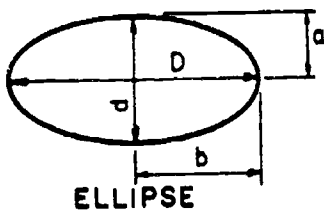

ELLIPSE

$$A = \frac{\pi D d}{4}$$

WHERE D = THE MAJOR AXIS
 d = THE MINOR AXIS

$$P = \pi \sqrt{2(a^2 + b^2)} \text{ (APPROX.)}$$

WHERE

$a = \frac{1}{2}$ THE MINOR AXIS

$b = \frac{1}{2}$ THE MAJOR AXIS

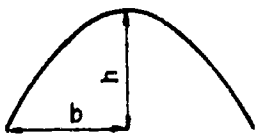

PARABOLA

$$A = \frac{4hb}{3}$$

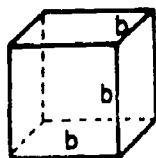

CUBE

$$V = b^3$$

$$S = 6b^2$$

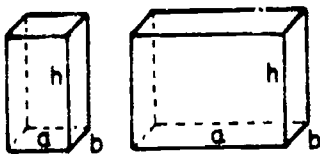

RIGHT RECTANGULAR PRISMS

$$V = abh$$

$$S = 2ab + 2ah + 2bh$$

ENGINEERING AID 3 & 2, VOLUME 1

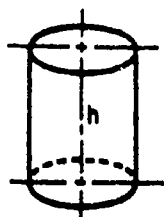

RIGHT CIRCULAR

$$V = \pi R^2 h$$

$$L = 2\pi R h$$

$$S = 2\pi R^2 + 2\pi R h$$

$$S = 2 (\text{AREA OF BASE}) + (\text{CIRCUMFERENCE} \times \text{HEIGHT})$$

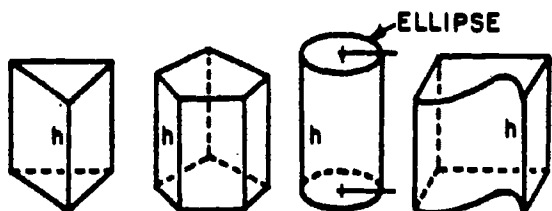

ANY RIGHT PRISM OR CYLINDER
REGULAR OR IRREGULAR

$$V = \text{AREA OF THE BASE} \times \text{THE HEIGHT}$$

$$L = \text{PERIMETER OF BASE} \times \text{HEIGHT}$$

$$S = 2 (\text{AREA OF BASE}) + (\text{PERIMETER OF BASE} \times \text{HEIGHT})$$

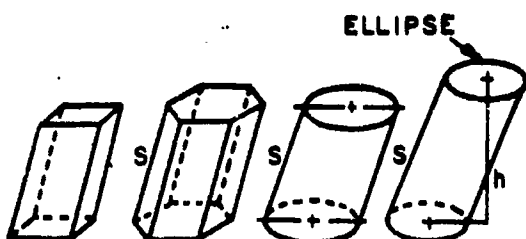

ANY OBLIQUE PRISM OR CYLINDER
REGULAR OR IRREGULAR

$$V = \text{AREA OF BASE} \times \text{HEIGHT}$$

$$L = \text{PERIMETER} \times \text{SLANT HEIGHT}$$

$$S = 2 (\text{AREA OF BASE}) + (\text{PERIMETER OF BASE} \times \text{SLANT HEIGHT})$$

WHERE HEIGHT = PERPENDICULAR DISTANCE
BETWEEN BASES

SLANT HEIGHT = DISTANCE ALONG SLANTED
SURFACE BETWEEN BASES

V = COMPUTE VOLUME THE SAME AS IF BASES ARE PARALLEL
BUT LET THE HEIGHT EQUAL THE AVERAGE PERPENDICULAR
DISTANCES BETWEEN BASES

NOTE: PRISMS MUST HAVE AN EVEN NUMBER OF SIDES (2,4,6,...)
THERE IS NO SIMPLE METHOD OF COMPUTING THE
VOLUME OF PRISMS WITH AN ODD NUMBER OF SIDES
OR FACES.

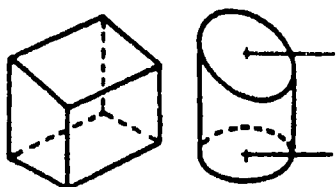

ANY REGULAR RIGHT PRISM OR
CYLINDER WITH NONPARALLEL
BASES

AREAS - (CYLINDERS AND EVEN-SIDED PRISMS)

$$L = \text{PERIMETER OF BASE} \times \text{AVERAGE HEIGHT}$$

(ODD-SIDED PRISMS)

L = DIVIDE EACH SIDE INTO SIMPLE GEO-
METRIC FIGURES COMPUTE AREA AND TOTAL

$$S = \text{LATERAL AREA} + \text{AREA OF BASES}$$

NOTE: THE AREA OF THE OBLIQUE BASE MAY NOT BE
COMPUTABLE BY A SIMPLE METHOD.

Appendix II—MATHEMATICS

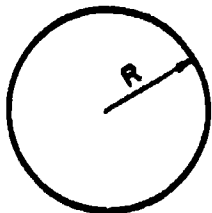

SPHERE

$$V = \frac{4\pi R^3}{3}, \quad V = 0.5236D^3 \text{ (APPROX.)}$$

$$S = 4\pi R^2, \quad S = \pi D^2$$

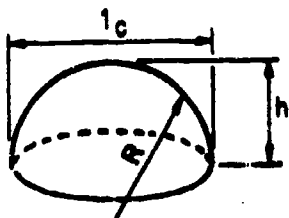

SEGMENT OF SPHERE

$$V = \frac{\pi h^2(3R-h)}{3}$$

$$S = 2\pi R h \text{ (NOT INCLUDING CIRCULAR BASE)}$$

$$S = 2\pi R h + \frac{l_c^2}{4} \text{ (TOTAL) WHERE } l_c = \text{CHORD LENGTH}$$

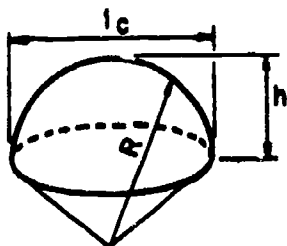

SECTOR OF SPHERE

$$V = \frac{2\pi R^2 h}{3}$$

$$S = \frac{\pi R(4h + l_c)}{2} \text{ WHERE } l_c = \text{CHORD LENGTH}$$

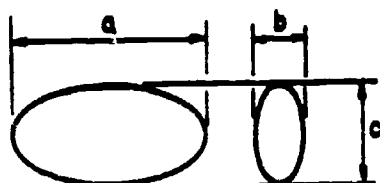

ELLIPSOID

$$V = \frac{\pi abc}{6}$$

SURFACE AREA - NO SIMPLE METHOD OF COMPUTATION

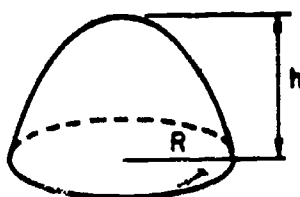

PARABOLOID OF
REVOLUTION

$$V = \frac{\pi R^2 h}{2}$$

SURFACE AREA - NO SIMPLE METHOD OF COMPUTATION

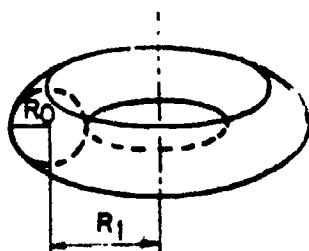

CIRCULAR RING (TORUS)

$$V = 2\pi^2 R_0^2 R_1$$

$$S = 4\pi^2 R_0 R_1$$

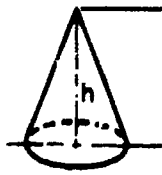

RIGHT CIRCULAR CONE

$$V = \frac{\pi R^2 h}{3}$$

$$L = s\pi R$$

$$S = s\pi R + \pi R^2 \text{ (TOTAL)}$$



ANY REGULAR RIGHT PYRAMID

$$V = \frac{1}{3} \text{ HEIGHT X AREA OF THE BASE}$$

$$L = \frac{1}{2} \text{ SLANT HEIGHT X PERIMETER OF THE BASE}$$

NOTE: TO OBTAIN TOTAL SURFACE, ADD AREA OF BASE TO GIVEN SURFACE FORMULA.

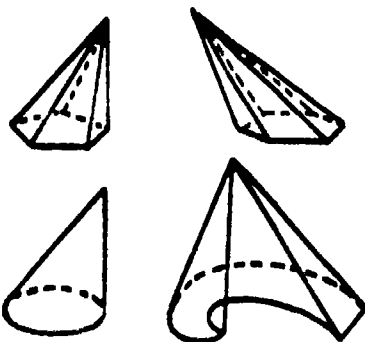

ANY OBLIQUE PYRAMID OR CONE (REGULAR OR IRREGULAR)

$$V = \frac{1}{3} \text{ HEIGHT X AREA OF THE BASE}$$

WHERE THE HEIGHT IS THE PERPENDICULAR DISTANCE FROM THE BASE TO THE VERTEX

L, S, - NO SIMPLE METHOD OF COMPUTATION

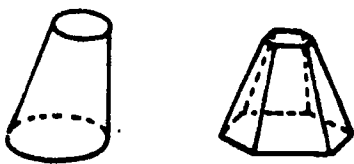

FRUSTUM OF ANY PYRAMID OR CONE

IN ANY FRUSTUM THE BASES ARE PARALLEL:

1. TOTAL HEIGHT OF FIGURE MUST BE KNOWN OR COMPUTED (PERPENDICULAR AND SLANT HEIGHT)
2. HEIGHT OF FRUSTUM MUST BE KNOWN OR COMPUTED (PERPENDICULAR AND SLANT HEIGHT)
3. COMPUTE VOLUME OR SURFACE AREA OF TOTAL FIGURE
4. COMPUTE VOLUME OR SURFACE AREA OF PORTION REMOVED
5. SUBTRACT REMOVED PORTION FROM TOTAL
6. ADD AREA OF BOTH BASES TO OBTAIN TOTAL SURFACE AREA

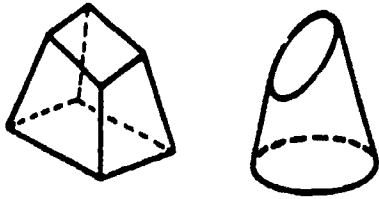

TRUNCATED PORTION OF
ANY PYRAMID OR CONE

IN ANY TRUNCATED FIGURE THE BASES ARE NOT PARALLEL:

1. TOTAL HEIGHT OF FIGURE MUST BE KNOWN OR COMPUTED (PERPENDICULAR AND SLANT HEIGHT)
2. AVERAGE HEIGHT OF TRUNCATED FIGURE MUST BE KNOWN OR COMPUTED (PERPENDICULAR AND SLANT HEIGHT)
3. COMPUTE VOLUME OR SURFACE AREA OF TOTAL FIGURE
4. COMPUTE VOLUME OR SURFACE AREA OF PORTION REMOVED (HEIGHT = HEIGHT OF TOTAL FIGURE MINUS THE AVERAGE HEIGHT OF THE TRUNCATED FIGURE)
5. SUBTRACT REMOVED PORTION FROM TOTAL
6. ADD AREA OF BOTH BASES (IF THEY ARE OBTAINABLE) TO OBTAIN TOTAL AREA

NOTE: TRUNCATED PYRAMIDS MUST HAVE AN EVEN NUMBER OF SIDES (2, 4, 6, etc.) TO BE COMPUTED.
OBLIQUE TRUNCATED PYRAMIDS AND CONES ARE TREATED IN THE SAME MANNER AS FULL OBLIQUE PYRAMIDS AND CONES

45.834

D. COMMON LOGARITHMS OF NUMBERS

No.	0	1	2	3	4	5	6	7	8	9
10	0000	0043	0086	0128	0170	0212	0253	0294	0334	0374
11	0414	0453	0492	0531	0569	0607	0645	0682	0719	0755
12	0792	0828	0864	0899	0934	0969	1004	1038	1072	1106
13	1139	1173	1206	1239	1271	1303	1335	1367	1399	1430
14	1461	1492	1523	1553	1584	1614	1644	1673	1703	1732
15	1761	1790	1818	1847	1875	1903	1931	1959	1987	2014
16	2041	2068	2095	2122	2148	2175	2201	2227	2253	2279
17	2304	2330	2355	2380	2405	2430	2455	2480	2504	2529
18	2553	2577	2601	2625	2648	2672	2695	2718	2742	2765
19	2788	2810	2833	2856	2878	2900	2923	2945	2967	2989
20	3010	3032	3054	3075	3096	3118	3139	3160	3181	3201
21	3222	3243	3263	3284	3304	3324	3345	3365	3385	3404
22	3424	3444	3464	3483	3502	3522	3541	3560	3579	3598
23	3617	3636	3655	3674	3692	3711	3729	3747	3766	3784
24	3802	3820	3838	3856	3874	3892	3909	3927	3945	3962
25	3979	3997	4014	4031	4048	4065	4082	4099	4116	4133
26	4150	4166	4183	4200	4216	4232	4249	4265	4281	4298
27	4314	4330	4346	4362	4378	4393	4409	4425	4440	4456
28	4472	4487	4502	4518	4533	4548	4564	4579	4594	4609
29	4624	4639	4654	4669	4683	4698	4713	4728	4742	4757
30	4771	4786	4800	4814	4829	4843	4857	4871	4886	4900
31	4914	4928	4942	4955	4969	4983	4997	5011	5024	5038
32	5051	5065	5079	5092	5105	5119	5132	5145	5159	5172
33	5185	5198	5211	5224	5237	5250	5263	5276	5289	5302
34	5315	5328	5340	5353	5366	5378	5391	5403	5416	5428
35	5441	5453	5465	5478	5490	5502	5514	5527	5539	5551
36	5563	5575	5587	5599	5611	5623	5635	5647	5658	5670
37	5682	5694	5705	5717	5729	5740	5752	5763	5775	5786
38	5798	5809	5821	5832	5843	5855	5866	5877	5888	5899
39	5911	5922	5933	5944	5955	5966	5977	5988	5999	6010
40	6021	6031	6042	6053	6064	6075	6085	6096	6107	6117
41	6128	6138	6149	6160	6170	6180	6191	6201	6212	6222
42	6232	6243	6253	6263	6274	6284	6294	6304	6314	6325
43	6335	6345	6355	6365	6375	6385	6395	6405	6415	6425
44	6435	6444	6454	6464	6474	6484	6493	6503	6513	6522
45	6532	6542	6551	6561	6571	6580	6590	6599	6609	6618
46	6628	6637	6646	6656	6665	6675	6684	6693	6702	6712
47	6721	6730	6739	6749	6758	6767	6776	6785	6794	6803
48	6812	6821	6830	6839	6848	6857	6866	6875	6884	6893
49	6902	6911	6920	6928	6937	6946	6955	6964	6972	6981
50	6990	6998	7007	7016	7024	7033	7042	7050	7059	7067
51	7076	7084	7093	7101	7110	7118	7126	7135	7143	7152
52	7160	7168	7177	7185	7193	7202	7210	7218	7226	7235
53	7243	7251	7259	7267	7275	7284	7292	7300	7308	7316
54	7324	7332	7340	7348	7356	7364	7372	7380	7388	7396

No.	0	1	2	3	4	5	6	7	8	9
55	7404	7412	7419	7427	7435	7443	7451	7459	7466	7474
56	7482	7490	7497	7505	7513	7520	7528	7536	7543	7551
57	7559	7566	7574	7582	7589	7597	7604	7612	7619	7627
58	7634	7642	7649	7657	7664	7672	7679	7686	7694	7701
59	7709	7716	7723	7731	7738	7745	7752	7760	7767	7774
60	7782	7789	7796	7803	7810	7818	7825	7832	7839	7846
61	7853	7860	7868	7875	7882	7889	7896	7903	7910	7917
62	7924	7931	7938	7945	7952	7959	7966	7973	7980	7987
63	7993	8000	8007	8014	8021	8028	8035	8041	8048	8055
64	8062	8069	8075	8082	8089	8096	8102	8109	8116	8122
65	8129	8136	8142	8149	8156	8162	8169	8176	8182	8189
66	8195	8202	8209	8215	8222	8228	8235	8241	8248	8254
67	8261	8267	8274	8280	8287	8293	8299	8306	8312	8319
68	8325	8331	8338	8344	8351	8357	8363	8370	8376	8382
69	8388	8395	8401	8407	8414	8420	8426	8432	8439	8445
70	8451	8457	8463	8470	8476	8482	8488	8494	8500	8506
71	8513	8519	8525	8531	8537	8543	8549	8555	8561	8567
72	8573	8579	8585	8591	8597	8603	8609	8615	8621	8627
73	8633	8639	8645	8651	8657	8663	8669	8675	8681	8686
74	8692	8698	8704	8710	8716	8722	8727	8733	8739	8745
75	8751	8756	8762	8768	8774	8779	8785	8791	8797	8802
76	8808	8814	8820	8825	8831	8837	8842	8848	8854	8859
77	8865	8871	8876	8882	8887	8893	8899	8904	8910	8915
78	8921	8927	8932	8938	8943	8949	8954	8960	8965	8971
79	8976	8982	8987	8993	8998	9004	9009	9015	9020	9025
80	9031	9036	9042	9047	9053	9058	9063	9069	9074	9079
81	9085	9090	9096	9101	9106	9112	9117	9122	9128	9133
82	9138	9143	9149	9154	9159	9165	9170	9175	9180	9186
83	9191	9196	9201	9206	9212	9217	9222	9227	9232	9238
84	9243	9248	9253	9258	9263	9269	9274	9279	9284	9289
85	9294	9299	9304	9309	9315	9320	9325	9330	9335	9340
86	9345	9350	9355	9360	9365	9370	9375	9380	9385	9390
87	9395	9400	9405	9410	9415	9420	9425	9430	9435	9440
88	9445	9450	9455	9460	9465	9469	9474	9479	9484	9489
89	9494	9499	9504	9509	9513	9518	9523	9528	9533	9538
90	9542	9547	9552	9557	9562	9566	9571	9576	9581	9586
91	9590	9595	9600	9605	9609	9614	9619	9624	9628	9633
92	9638	9643	9647	9652	9657	9661	9666	9671	9675	9680
93	9685	9689	9694	9699	9703	9708	9713	9717	9722	9727
94	9731	9736	9741	9745	9750	9754	9759	9763	9768	9773
95	9777	9782	9786	9791	9795	9800	9805	9809	9814	9818
96	9823	9827	9832	9836	9841	9845	9850	9854	9859	9863
97	9868	9872	9877	9881	9886	9890	9894	9899	9903	9908
98	9912	9917	9921	9926	9930	9934	9939	9943	9948	9952
99	9956	9961	9965	9969	9974	9978	9983	9987	9991	9996

Appendix II—MATHEMATICS

E. SQUARES, SQUARE ROOTS, CUBES, AND CUBE ROOTS

No.	Square	Cube	Square Root	Cube Root	No.	Square	Cube	Square Root	Cube Root	No.	Square	Cube	Square Root	Cube Root
1	1	1	1.0000	1.0000	45	2025	91125	6.7082	3.5569	90	8100	729000	9.4868	4.4814
2	4	8	1.4142	1.2599	46	2116	97336	6.7823	3.5830	91	8281	753571	9.5394	4.4979
3	9	27	1.7321	1.4422	47	2209	103823	6.8557	3.6088	92	8464	778688	9.5917	4.5144
4	16	64	2.0000	1.5874	48	2304	110592	6.9282	3.6342	93	8649	804357	9.6437	4.5307
5	25	125	2.2361	1.7100	49	2401	117649	7.0000	3.6593	94	8836	830584	9.6954	4.5468
6	36	216	2.4495	1.8171	50	2500	125000	7.0711	3.6840	95	9025	857375	9.7468	4.5629
7	49	343	2.6458	1.9129	51	2601	132651	7.1414	3.7084	96	9216	884736	9.7980	4.5789
8	64	512	2.8284	2.0000	52	2704	140508	7.2111	3.7325	97	9409	912673	9.8489	4.5947
9	81	729	3.0000	2.0801	53	2809	148687	7.2801	3.7563	98	9604	941192	9.8995	4.6104
10	100	1000	3.1623	2.1544	54	2916	157464	7.3485	3.7798	99	9801	970299	9.9499	4.6261
11	121	1331	3.3166	2.2240	55	3025	166375	7.4162	3.8030	100	10000	1000000	10.0000	4.6316
12	144	1728	3.4641	2.2894	56	3136	175616	7.4833	3.8259	101	10201	1030301	10.0499	4.6370
13	169	2197	3.6056	2.3513	57	3249	185193	7.5498	3.8485	102	10404	1061208	10.0995	4.6423
14	196	2744	3.7417	2.4101	58	3364	195112	7.6158	3.8709	103	10609	1092727	10.1489	4.6475
15	225	3375	3.8730	2.4662	59	3481	205379	7.6811	3.8930	104	10816	1124864	10.1980	4.7027
16	256	4096	4.0000	2.5198	60	3600	216000	7.7460	3.9149	105	11025	1157625	10.2470	4.7177
17	289	4913	4.1231	2.5713	61	3721	226981	7.8102	3.9365	106	11236	1191016	10.2956	4.7326
18	324	5832	4.2426	2.6207	62	3844	238328	7.8740	3.9579	107	11449	1225043	10.3441	4.7475
19	361	6859	4.3589	2.6684	63	3969	250047	7.9373	3.9791	108	11664	1259712	10.3923	4.7622
20	400	8000	4.4721	2.7144	64	4096	262144	8.0000	4.0000	109	11881	1295029	10.4403	4.7769
21	441	9261	4.5826	2.7589	65	4225	274625	8.0623	4.0207	110	12100	1331000	10.4881	4.7914
22	484	10648	4.6904	2.8020	66	4356	287496	8.1240	4.0412	111	12321	1367631	10.5357	4.8059
23	529	12167	4.7958	2.8439	67	4489	300763	8.1854	4.0615	112	12544	1404928	10.5830	4.8203
24	576	13824	4.8990	2.8845	68	4624	314432	8.2462	4.0817	113	12769	1442897	10.6301	4.8346
25	625	15625	5.0000	2.9240	69	4761	328509	8.3064	4.1016	114	12996	1481544	10.6771	4.8488
26	676	17576	5.0990	2.9625	70	4900	343000	8.3664	4.1213	115	13225	1520875	10.7238	4.8629
27	729	19683	5.1962	3.0000	71	5041	357911	8.4261	4.1408	116	13456	1560896	10.7703	4.8770
28	784	21952	5.2915	3.0366	72	5184	373248	8.4853	4.1602	117	13689	1601613	10.8167	4.8910
29	841	24389	5.3852	3.0723	73	5329	389017	8.5440	4.1793	118	13924	1643032	10.8628	4.9049
30	900	27000	5.4772	3.1072	74	5476	405224	8.6023	4.1983	119	14161	1685159	10.9087	4.9187
31	961	29791	5.5678	3.1414	75	5625	421875	8.6603	4.2172	120	14400	1728000	10.9545	4.9324
32	1024	32768	5.6569	3.1748	76	5776	438976	8.7178	4.2358	121	14641	1771561	11.0000	4.9461
33	1089	35937	5.7446	3.2075	77	5929	456533	8.7750	4.2543	122	14884	1815848	11.0454	4.9597
34	1156	39304	5.8310	3.2396	78	6084	474552	8.8318	4.2727	123	15129	1860867	11.0905	4.9732
35	1225	42875	5.9161	3.2711	79	6241	493039	8.8882	4.2908	124	15376	1906624	11.1355	4.9866
36	1296	46656	6.0000	3.3019	80	6400	512000	8.9443	4.3089	125	15625	1953125	11.1803	5.0000
37	1369	50653	6.0828	3.3322	81	5561	531441	9.0000	4.3267	126	15876	2000376	11.2250	5.0133
38	1444	54872	6.1644	3.3620	82	6724	551368	9.0554	4.3445	127	16129	2048383	11.2694	5.0265
39	1521	59319	6.2450	3.3912	83	6889	571787	9.1104	4.3621	128	16384	2097152	11.3137	5.0397
40	1600	64000	6.3246	3.4200	84	7056	592704	9.1652	4.3795	129	16641	2146689	11.3578	5.0528
41	1681	68921	6.4031	3.4482	85	7225	614125	9.2195	4.3968	130	16900	2197000	11.4018	5.0653
42	1764	74088	6.4807	3.4760	86	7396	636056	9.2736	4.4140	131	17161	2248091	11.4455	5.0788
43	1849	79507	6.5574	3.5034	87	7569	658503	9.3274	4.4310	132	17424	2299968	11.4891	5.0916
44	1936	85184	6.6332	3.5303	88	7744	681472	9.3808	4.4480	133	17689	2352637	11.5326	5.1045
					89	7921	704969	9.4340	4.4647	134	17956	2406104	11.5758	5.1172

BEST COPY AVAILABLE

45.836

F. RIGHT AND OBLIQUE TRIANGLE FORMULAS

1. Solution of triangles

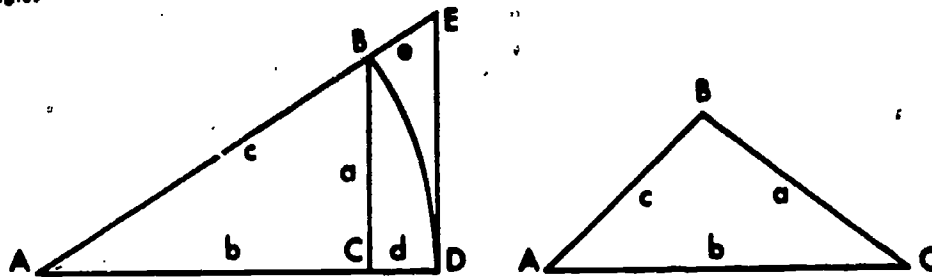

SOLUTION OF RIGHT TRIANGLES

1. $\sin A = \frac{a}{c} = \cos B$
2. $\cos A = \frac{b}{c} = \sin B$
3. $\tan A = \frac{a}{b} = \cot B$
4. $\cot A = \frac{b}{a} = \tan B$
5. $\sec A = \frac{c}{b} = \operatorname{cosec} B$
6. $\operatorname{cosec} A = \frac{c}{a} = \sec B$
7. $\operatorname{vers} A = \frac{c-b}{c} = \frac{d}{c}$
8. $\operatorname{exsec} A = \frac{e}{c}$
9. $a = c \sin A = b \tan A = c \cos B = b \cot B = \sqrt{(c+b)(c-b)}$
10. $b = c \cos A = a \cot A = c \sin B = a \tan B = \sqrt{(c+a)(c-a)}$
11. $d = c \operatorname{vers} A$
12. $e = c \operatorname{exsec} A$
13. $c = \frac{a}{\cos B} = \frac{b}{\sin B} = \frac{a}{\sin A} = \frac{b}{\cos A} = \frac{d}{\operatorname{vers} A} = \frac{e}{\operatorname{exsec} A}$

SOLUTION OF OBLIQUE TRIANGLES

Given	Sought	Formulas
14. A, B, a	b, c	$b = \frac{a}{\sin A} \cdot \sin B$ $c = \frac{a}{\sin A} \sin (A' + B)$
15. A, a, b	B, c	$\sin B = \frac{\sin A}{a} b$ $c = \frac{a}{\sin a} \cdot \sin C$
16. C, a, b	A - B	$\tan \frac{1}{2}(A - B) = \frac{a - b}{a + b} \tan \frac{1}{2}(A + B)$
17. a, b, c	A	Let $s = \frac{1}{2}(a + b + c)$; $\sin \frac{1}{2} A = \sqrt{\frac{(s - b)(s - c)}{bc}}$
18.		$\cos \frac{1}{2} A = \sqrt{\frac{s(s - a)}{bc}}$; $\tan \frac{1}{2} A = \sqrt{\frac{(s - b)(s - c)}{s(s - a)}}$
19.		$\sin A = \frac{2 \sqrt{s(s - a)(s - b)(s - c)}}{bc}$
20.		$\operatorname{vers} A = \frac{2(s - b)(s - c)}{bc}$
21.	area	$\text{area} = \sqrt{s(s - a)(s - b)(s - c)}$
22. A, B, C, a	area	$\text{area} = \frac{a^2 \sin B \cdot \sin C}{2 \sin A}$
23. C, a, b	area	$\text{area} = \frac{1}{2} a b \sin C$

Appendix II—MATHEMATICS

	0°	30°	45°	60°	90°	120°	135°	150°	180°	270°
Sine.....	0	$\frac{1}{2}$	$\frac{1}{2}\sqrt{2}$	$\frac{1}{2}\sqrt{3}$	1	$\frac{1}{2}\sqrt{3}$	$\frac{1}{2}\sqrt{2}$	$\frac{1}{2}$	0	-1
Cosine.....	1	$\frac{1}{2}\sqrt{3}$	$\frac{1}{2}\sqrt{2}$	$\frac{1}{2}$	0	$-\frac{1}{2}$	$-\frac{1}{2}\sqrt{2}$	$-\frac{1}{2}\sqrt{3}$	-1	0
Tangent.....	0	$\frac{1}{2}\sqrt{3}$	1	$\sqrt{3}$	$\pm\infty$	$-\sqrt{3}$	-1	$-\frac{1}{2}\sqrt{3}$	0	$\pm\infty$
Cotangent.....	$\pm\infty$	$\sqrt{3}$	1	$\frac{1}{2}\sqrt{3}$	0	$-\frac{1}{2}\sqrt{3}$	-1	$-\sqrt{3}$	$\pm\infty$	0
Secant.....	1	$\frac{2}{3}\sqrt{3}$	$\sqrt{2}$	2	$\pm\infty$	-2	$-\sqrt{2}$	$-\frac{2}{3}\sqrt{3}$	-1	$\pm\infty$
Cosecant.....	$\pm\infty$	2	$\sqrt{2}$	$\frac{2}{3}\sqrt{3}$	1	$\frac{2}{3}\sqrt{3}$	$\sqrt{2}$	2	$\pm\infty$	-1

a. *Trigonometrical formulas.*—The six most usual trigonometrical functions are the ratios defined for a right-angled triangle, as follows:

$$\text{sine} = \frac{\text{opposite side}}{\text{hypotenuse}}$$

$$\text{cosine} = \frac{\text{adjacent side}}{\text{hypotenuse}}$$

$$\text{tangent} = \frac{\text{opposite side}}{\text{adjacent side}}$$

$$\text{cotangent} = \frac{\text{adjacent side}}{\text{opposite side}}$$

$$\text{secant} = \frac{\text{hypotenuse}}{\text{adjacent side}}$$

$$\text{cosecant} = \frac{\text{hypotenuse}}{\text{opposite side}}$$

Right-angled triangles can be solved by the above and oblique triangles may be solved by the use of the additional relations for any triangle

$$\frac{a}{\sin A} = \frac{b}{\sin B} = \frac{c}{\sin C}$$

$$\frac{a-b}{a+b} = \frac{\tan \frac{1}{2}(A-B)}{\tan \frac{1}{2}(A+B)}$$

and the group

$$a^2 = b^2 + c^2 - 2bc \cos A$$

$$b^2 = a^2 + c^2 - 2ac \cos B$$

$$c^2 = a^2 + b^2 - 2ab \cos C$$

Where A, B, and C are the angles and a, b, and c are the sides opposite to these angles, respectively.

b. *Fundamental relations.*

$$\sin A = \frac{1}{\csc A}; \cos A = \frac{1}{\sec A}; \tan A = \frac{1}{\cot A} = \frac{\sin A}{\cos A}$$

$$\csc A = \frac{1}{\sin A}; \sec A = \frac{1}{\cos A}; \cot A = \frac{1}{\tan A} = \frac{\cos A}{\sin A}$$

$$\sin^2 A + \cos^2 A = 1; \sec^2 A - \tan^2 A = 1; \csc^2 A - \cot^2 A = 1$$

c. *Functions of multiple angles.*

$$\sin 2A = 2 \sin A \cos A$$

$$\cos 2A = 2 \cos^2 A - 1 = 1 - 2 \sin^2 A = \cos^2 A - \sin^2 A$$

$$\sin 3A = 3 \sin A - 4 \sin^3 A;$$

$$\cos 3A = 4 \cos^3 A - 3 \cos A$$

45.838

BEST COPY AVAILABLE

d. *Functions of half angles.*

$$\sin \frac{A}{2} = \pm \sqrt{\frac{1 - \cos A}{2}} \quad \cos \frac{A}{2} = \pm \sqrt{\frac{1 + \cos A}{2}}$$

$$\tan \frac{A}{2} = \pm \frac{1 - \cos A}{\sin A} = \frac{\sin A}{1 + \cos A} = \pm \sqrt{\frac{1 - \cos A}{1 + \cos A}}$$

Powers of functions.

$$\sin^2 A = \frac{1}{2}(1 - \cos 2A); \quad \cos^2 A = \frac{1}{2}(1 + \cos 2A)$$

$$\sin^3 A = \frac{1}{4}(3 \sin A - \sin 3A); \quad \cos^3 A = \frac{1}{4}(\cos 3A + 3 \cos A)$$

e. *Sum and difference of angles.*

$$\sin(A \pm B) = \sin A \cos B \pm \cos A \sin B$$

$$\cos(A \pm B) = \cos A \cos B \mp \sin A \sin B$$

$$\tan(A \pm B) = \frac{\tan A \pm \tan B}{1 \mp \tan A \tan B}$$

f. *Sums, differences, and products of functions.*

$$\sin A \pm \sin B = 2 \sin \frac{1}{2}(A \pm B) \cos \frac{1}{2}(A \mp B)$$

$$\cos A + \cos B = 2 \cos \frac{1}{2}(A + B) \cos \frac{1}{2}(A - B)$$

$$\cos A - \cos B = -2 \sin \frac{1}{2}(A + B) \sin \frac{1}{2}(A - B)$$

$$\tan A \pm \tan B = \frac{\sin(A \pm B)}{\cos A \cos B}$$

$$\sin^2 A - \sin^2 B = \sin(A + B) \sin(A - B)$$

$$\cos^2 A - \cos^2 B = -\sin(A + B) \sin(A - B)$$

$$\cos^2 A - \sin^2 B = \cos(A + B) \cos(A - B)$$

$$\sin A \sin B = \frac{1}{2} \cos(A - B) - \frac{1}{2} \cos(A + B)$$

$$\cos A \cos B = \frac{1}{2} \cos(A - B) + \frac{1}{2} \cos(A + B)$$

$$\sin A \cos B = \frac{1}{2} \sin(A + B) + \frac{1}{2} \sin(A - B)$$

The relations for angles greater than 90° are shown in the following tabulation where x represents an angle in the first quadrant where all the functions are positive.

angle	sine	cosine	tangent	cotangent
x	+ sin x	+ cos x	+ tan x	+ cot x
90° + x	+ cos x	- sin x	- cot x	- tan x
180° + x	- sin x	- cos x	+ tan x	+ cot x
270° + x	- cos x	+ sin x	- cot x	- tan x

2. General formulas

24. $\sin A = 2 \sin \frac{1}{2} A \cos \frac{1}{2} A = \sqrt{1 - \cos^2 A} = \tan A \cos A$
25. $\cos A = 2 \cos^2 \frac{1}{2} A - 1 = 1 - 2 \sin^2 \frac{1}{2} A = \cos^2 \frac{1}{2} A - \sin^2 \frac{1}{2} A$
26. $\tan A = \frac{\sin A}{\cos A} = \frac{\sin 2 A}{1 + \cos 2 A}$
27. $\cot A = \frac{\cos A}{\sin A} = \frac{\sin 2 A}{1 - \cos 2 A} = \frac{\sin 2 A}{\text{vers } 2 A}$
28. $\text{vers } A = 1 - \cos A = \sin A \tan \frac{1}{2} A = 2 \sin^2 \frac{1}{2} A$
29. $\text{exsec } A = \sec A - 1 = \tan A \tan \frac{1}{2} A = \frac{\text{vers } A}{\cos A}$
30. $\sin 2 A = 2 \sin A \cos A$
31. $\cos 2 A = 2 \cos^2 A - 1 = \cos^2 A - \sin^2 A = 1 - 2 \sin^2 A$
32. $\tan 2 A = \frac{2 \tan A}{1 - \tan^2 A}$
33. $\cot 2 A = \frac{\cot^2 A - 1}{2 \cot A}$
34. $\text{vers } 2 A = 2 \sin^2 A = 2 \sin A \cos A \tan A$
35. $\text{exsec } 2 A = \frac{2 \tan^2 A}{1 - \tan^2 A}$
36. $\sin^2 A + \cos^2 A = 1$
37. $\sin (A \pm B) = \sin A \cdot \cos B \pm \sin B \cdot \cos A$
38. $\cos (A \pm B) = \cos A \cdot \cos B \mp \sin A \cdot \sin B$
39. $\sin A + \sin B = 2 \sin \frac{1}{2} (A + B) \cos \frac{1}{2} (A - B)$
40. $\sin A - \sin B = 2 \cos \frac{1}{2} (A + B) \sin \frac{1}{2} (A - B)$
41. $\cos A + \cos B = 2 \cos \frac{1}{2} (A + B) \cos \frac{1}{2} (A - B)$
42. $\cos B - \cos A = 2 \sin \frac{1}{2} (A + B) \sin \frac{1}{2} (A - B)$
43. $\sin^2 A - \sin^2 B = \cos^2 B - \cos^2 A = \sin (A + B) \sin (A - B)$
44. $\cos^2 A - \sin^2 B = \cos (A + B) \cos (A - B)$
45. $\tan A + \tan B = \frac{\sin (A + B)}{\cos A \cdot \cos B}$
46. $\tan A - \tan B = \frac{\sin (A - B)}{\cos A \cdot \cos B}$
47. $\sin 3 A = 3 \sin A - 4 \sin^3 A$
48. $\cos 3 A = 4 \cos^3 A - 3 \cos A$
49. $\sin \frac{A}{2} = \pm \sqrt{\frac{1 - \cos A}{2}}$
50. $\cos \frac{A}{2} = \pm \sqrt{\frac{1 + \cos A}{2}}$
51. $\tan \frac{A}{2} = \pm \frac{1 - \cos A}{\sin A} = \frac{\sin A}{1 + \cos A} = \pm \sqrt{\frac{1 - \cos A}{1 + \cos A}}$
52. $\sin^2 A = \frac{1}{2} (1 - \cos 2 A)$
53. $\cos^2 A = \frac{1}{2} (1 + \cos 2 A)$
54. $\sin^3 A = \frac{1}{4} (3 \sin A - \sin 3 A)$
55. $\cos^3 A = \frac{1}{4} (\cos 3 A + 3 \cos A)$
56. $\sin A \sin B = \frac{1}{2} \cos (A - B) - \frac{1}{2} \cos (A + B)$
57. $\cos A \cos B = \frac{1}{2} \cos (A - B) + \frac{1}{2} \cos (A + B)$
58. $\sin A \cos B = \frac{1}{2} \sin (A + B) + \frac{1}{2} \sin A - B$

G. NATURAL SINES AND COSINES

N.	0°		1°		2°		3°		4°		N.
	Sin.	Cos.	Sin.	Cos.	Sin.	Cos.	Sin.	Cos.	Sin.	Cos.	
0	0.0000	1.0000	0.0174	0.9998	0.0349	0.9993	0.0523	0.9986	0.0700	0.9975	40
1	029	000	774	984	519	938	283	861	0700	754	39
2	058	000	803	984	548	937	292	860	031	752	38
3	087	000	832	983	577	936	321	858	063	750	37
4	116	000	862	983	606	935	350	857	092	748	36
5	.00145	1.0000	.01891	.99982	.03635	.99934	.05379	.99855	.07121	.99760	35
6	175	000	920	982	664	933	408	854	150	744	34
7	204	000	949	981	693	932	437	852	179	742	33
8	233	000	978	980	723	931	466	851	208	740	32
9	263	000	.03007	.980	752	930	495	849	237	738	31
10	.00291	1.0000	.02036	.99979	.03781	.99929	.05524	.99847	.07266	.99738	30
11	320	.99999	015	979	810	927	553	846	265	734	29
12	349	999	089	978	839	926	582	844	294	731	28
13	378	999	123	977	868	925	611	842	323	729	27
14	407	999	157	977	897	924	640	841	352	727	26
15	.00430	.99999	.02181	.99976	.03926	.99927	.05669	.99839	.07411	.99725	25
16	463	999	211	976	925	922	669	836	440	723	24
17	493	999	240	975	954	921	727	836	469	721	23
18	524	999	269	974	.04013	.919	756	834	498	719	22
19	553	998	298	974	042	918	785	833	527	716	21
20	.00582	.99998	.02327	.99973	.04071	.99917	.05814	.99831	.07556	.99714	20
21	611	998	356	973	100	916	844	829	565	712	19
22	640	998	385	972	129	915	873	827	614	710	18
23	669	998	414	971	158	913	902	826	643	708	17
24	698	998	443	970	188	912	931	824	672	705	16
25	.00727	.99997	.02472	.99969	.04217	.99911	.05960	.99822	.07701	.99703	15
26	756	997	501	969	246	910	959	821	730	701	14
27	785	997	530	968	275	909	.06018	819	759	699	13
28	814	997	559	967	304	907	047	817	788	696	12
29	844	996	588	966	333	906	076	815	817	694	11
30	.00873	.99996	.02618	.99966	.04362	.99903	.06106	.99813	.07846	.99692	10
31	902	996	647	965	361	904	134	812	875	692	9
32	931	996	676	964	390	903	163	810	904	689	8
33	960	996	705	963	419	901	192	808	933	685	7
34	989	995	734	963	448	900	221	806	962	683	6
35	.01018	.99995	.02763	.99962	.04507	.99898	.06250	.99804	.07991	.99680	5
36	017	995	792	961	477	897	279	803	.08020	678	24
37	076	994	821	960	506	896	308	801	049	676	23
38	105	994	850	959	535	894	337	799	078	673	22
39	134	994	879	958	564	893	366	797	107	671	21
40	.01164	.99993	.02908	.99958	.04653	.99892	.06394	.99795	.08136	.99668	20
41	163	993	918	957	592	890	424	793	145	668	19
42	192	993	947	956	621	889	453	792	194	664	18
43	221	992	976	955	650	888	482	790	223	661	17
44	250	992	.03023	954	679	886	511	788	252	659	16
45	.01309	.99991	.03054	.99953	.04798	.99885	.06540	.99786	.08281	.99657	15
46	338	991	083	953	707	883	569	784	310	654	14
47	367	991	112	952	736	882	598	782	339	652	13
48	396	990	141	951	765	881	627	780	368	649	12
49	425	990	170	950	794	879	656	778	397	647	11
50	.01454	.99989	.03199	.99949	.04943	.99878	.06685	.99776	.08426	.99644	10
51	483	989	228	948	823	876	714	774	435	642	9
52	512	989	257	947	.05071	875	743	772	464	639	8
53	541	988	286	946	030	873	772	770	513	637	7
54	571	988	315	945	059	872	802	768	542	635	6
55	.01600	.99987	.03345	.99944	.05088	.99870	.06831	.99766	.08571	.99632	5
56	629	987	374	943	117	869	860	764	600	630	4
57	658	986	403	942	146	867	889	762	629	627	3
58	687	986	432	941	175	866	918	760	658	625	2
59	716	985	461	940	204	864	947	758	687	622	1
60	.01744	.99985	.03490	.99939	.05234	.99863	.06976	.99756	.08716	.99619	0
	Cos.	Sin.	Cos.	Sin.	Cos.	Sin.	Cos.	Sin.	Cos.	Sin.	N.
	90°	0°	89°	1°	88°	2°	87°	3°	86°	4°	

Appendix II—MATHEMATICS

M.	6°		7°		8°		9°		10°		M.
	Sin.	Cos.	Sin.	Cos.	Sin.	Cos.	Sin.	Cos.	Sin.	Cos.	
0	0.0000	1.0000	0.1218	0.9935	0.2171	0.9781	0.3420	0.9357	0.5000	0.8660	60
1	0.0174	0.9998	0.1231	0.9934	0.2185	0.9780	0.3434	0.9356	0.5009	0.8661	59
2	0.0349	0.9996	0.1244	0.9933	0.2199	0.9779	0.3448	0.9355	0.5018	0.8662	58
3	0.0523	0.9994	0.1257	0.9932	0.2213	0.9778	0.3462	0.9354	0.5027	0.8663	57
4	0.0697	0.9992	0.1270	0.9931	0.2227	0.9777	0.3476	0.9353	0.5036	0.8664	56
5	0.0872	0.9990	0.1283	0.9930	0.2241	0.9776	0.3490	0.9352	0.5045	0.8665	55
6	0.1047	0.9988	0.1296	0.9929	0.2255	0.9775	0.3504	0.9351	0.5054	0.8666	54
7	0.1222	0.9986	0.1309	0.9928	0.2269	0.9774	0.3518	0.9350	0.5063	0.8667	53
8	0.1397	0.9984	0.1322	0.9927	0.2283	0.9773	0.3532	0.9349	0.5072	0.8668	52
9	0.1572	0.9982	0.1335	0.9926	0.2297	0.9772	0.3546	0.9348	0.5081	0.8669	51
10	0.1747	0.9980	0.1348	0.9925	0.2311	0.9771	0.3560	0.9347	0.5090	0.8670	50
11	0.1922	0.9978	0.1361	0.9924	0.2325	0.9770	0.3574	0.9346	0.5099	0.8671	49
12	0.2097	0.9976	0.1374	0.9923	0.2339	0.9769	0.3588	0.9345	0.5108	0.8672	48
13	0.2272	0.9974	0.1387	0.9922	0.2353	0.9768	0.3602	0.9344	0.5117	0.8673	47
14	0.2447	0.9972	0.1400	0.9921	0.2367	0.9767	0.3616	0.9343	0.5126	0.8674	46
15	0.2622	0.9970	0.1413	0.9920	0.2381	0.9766	0.3630	0.9342	0.5135	0.8675	45
16	0.2797	0.9968	0.1426	0.9919	0.2395	0.9765	0.3644	0.9341	0.5144	0.8676	44
17	0.2972	0.9966	0.1439	0.9918	0.2409	0.9764	0.3658	0.9340	0.5153	0.8677	43
18	0.3147	0.9964	0.1452	0.9917	0.2423	0.9763	0.3672	0.9339	0.5162	0.8678	42
19	0.3322	0.9962	0.1465	0.9916	0.2437	0.9762	0.3686	0.9338	0.5171	0.8679	41
20	0.3497	0.9960	0.1478	0.9915	0.2451	0.9761	0.3700	0.9337	0.5180	0.8680	40
21	0.3672	0.9958	0.1491	0.9914	0.2465	0.9760	0.3714	0.9336	0.5189	0.8681	39
22	0.3847	0.9956	0.1504	0.9913	0.2479	0.9759	0.3728	0.9335	0.5198	0.8682	38
23	0.4022	0.9954	0.1517	0.9912	0.2493	0.9758	0.3742	0.9334	0.5207	0.8683	37
24	0.4197	0.9952	0.1530	0.9911	0.2507	0.9757	0.3756	0.9333	0.5216	0.8684	36
25	0.4372	0.9950	0.1543	0.9910	0.2521	0.9756	0.3770	0.9332	0.5225	0.8685	35
26	0.4547	0.9948	0.1556	0.9909	0.2535	0.9755	0.3784	0.9331	0.5234	0.8686	34
27	0.4722	0.9946	0.1569	0.9908	0.2549	0.9754	0.3798	0.9330	0.5243	0.8687	33
28	0.4897	0.9944	0.1582	0.9907	0.2563	0.9753	0.3812	0.9329	0.5252	0.8688	32
29	0.5072	0.9942	0.1595	0.9906	0.2577	0.9752	0.3826	0.9328	0.5261	0.8689	31
30	0.5247	0.9940	0.1608	0.9905	0.2591	0.9751	0.3840	0.9327	0.5270	0.8690	30
31	0.5422	0.9938	0.1621	0.9904	0.2605	0.9750	0.3854	0.9326	0.5279	0.8691	29
32	0.5597	0.9936	0.1634	0.9903	0.2619	0.9749	0.3868	0.9325	0.5288	0.8692	28
33	0.5772	0.9934	0.1647	0.9902	0.2633	0.9748	0.3882	0.9324	0.5297	0.8693	27
34	0.5947	0.9932	0.1660	0.9901	0.2647	0.9747	0.3896	0.9323	0.5306	0.8694	26
35	0.6122	0.9930	0.1673	0.9900	0.2661	0.9746	0.3910	0.9322	0.5315	0.8695	25
36	0.6297	0.9928	0.1686	0.9899	0.2675	0.9745	0.3924	0.9321	0.5324	0.8696	24
37	0.6472	0.9926	0.1699	0.9898	0.2689	0.9744	0.3938	0.9320	0.5333	0.8697	23
38	0.6647	0.9924	0.1712	0.9897	0.2703	0.9743	0.3952	0.9319	0.5342	0.8698	22
39	0.6822	0.9922	0.1725	0.9896	0.2717	0.9742	0.3966	0.9318	0.5351	0.8699	21
40	0.6997	0.9920	0.1738	0.9895	0.2731	0.9741	0.3980	0.9317	0.5360	0.8700	20
41	0.7172	0.9918	0.1751	0.9894	0.2745	0.9740	0.3994	0.9316	0.5369	0.8701	19
42	0.7347	0.9916	0.1764	0.9893	0.2759	0.9739	0.4008	0.9315	0.5378	0.8702	18
43	0.7522	0.9914	0.1777	0.9892	0.2773	0.9738	0.4022	0.9314	0.5387	0.8703	17
44	0.7697	0.9912	0.1790	0.9891	0.2787	0.9737	0.4036	0.9313	0.5396	0.8704	16
45	0.7872	0.9910	0.1803	0.9890	0.2801	0.9736	0.4050	0.9312	0.5405	0.8705	15
46	0.8047	0.9908	0.1816	0.9889	0.2815	0.9735	0.4064	0.9311	0.5414	0.8706	14
47	0.8222	0.9906	0.1829	0.9888	0.2829	0.9734	0.4078	0.9310	0.5423	0.8707	13
48	0.8397	0.9904	0.1842	0.9887	0.2843	0.9733	0.4092	0.9309	0.5432	0.8708	12
49	0.8572	0.9902	0.1855	0.9886	0.2857	0.9732	0.4106	0.9308	0.5441	0.8709	11
50	0.8747	0.9900	0.1868	0.9885	0.2871	0.9731	0.4120	0.9307	0.5450	0.8710	10
51	0.8922	0.9898	0.1881	0.9884	0.2885	0.9730	0.4134	0.9306	0.5459	0.8711	9
52	0.9097	0.9896	0.1894	0.9883	0.2899	0.9729	0.4148	0.9305	0.5468	0.8712	8
53	0.9272	0.9894	0.1907	0.9882	0.2913	0.9728	0.4162	0.9304	0.5477	0.8713	7
54	0.9447	0.9892	0.1920	0.9881	0.2927	0.9727	0.4176	0.9303	0.5486	0.8714	6
55	0.9622	0.9890	0.1933	0.9880	0.2941	0.9726	0.4190	0.9302	0.5495	0.8715	5
56	0.9797	0.9888	0.1946	0.9879	0.2955	0.9725	0.4204	0.9301	0.5504	0.8716	4
57	0.9972	0.9886	0.1959	0.9878	0.2969	0.9724	0.4218	0.9300	0.5513	0.8717	3
58	1.0147	0.9884	0.1972	0.9877	0.2983	0.9723	0.4232	0.9299	0.5522	0.8718	2
59	1.0322	0.9882	0.1985	0.9876	0.2997	0.9722	0.4246	0.9298	0.5531	0.8719	1
60	1.0497	0.9880	0.1998	0.9875	0.3011	0.9721	0.4260	0.9297	0.5540	0.8720	0

BEST COPY AVAILABLE

45.841

ENGINEERING AID 3 & 2, VOLUME 1

M	10°		11°		12°		13°		14°		M
	Sin.	Cos.	Sin.	Cos.	Sin.	Cos.	Sin.	Cos.	Sin.	Cos.	
0	0.17365	0.96481	0.19081	0.98163	0.20791	0.97815	0.22493	0.97437	0.24192	0.97030	60
1	323	476	109	157	820	809	523	430	220	023	59
2	422	471	138	152	818	803	532	424	249	015	58
3	451	466	167	146	877	797	880	417	277	008	57
4	479	461	195	140	903	791	908	411	303	001	56
5	.17598	.96455	.19224	.98135	.20933	.97784	.22637	.97404	.24333	.96994	55
6	537	450	222	129	972	778	915	398	382	987	54
7	565	445	251	124	990	772	923	391	390	980	53
8	594	440	309	118	.21019	768	722	384	418	973	52
9	623	435	338	112	047	760	750	378	446	966	51
10	.17651	.96430	.19366	.98107	.21076	.97754	.22778	.97371	.24474	.96959	50
11	650	427	395	101	104	748	807	365	501	952	49
12	708	420	423	990	132	742	835	358	531	945	48
13	737	414	452	990	161	735	863	351	559	937	47
14	766	409	481	984	189	729	892	345	587	930	46
15	.17704	.96404	.19509	.98079	.21218	.97723	.22920	.97338	.24615	.96923	45
16	823	399	518	873	246	717	948	331	644	916	44
17	872	394	566	867	275	711	977	325	672	909	43
18	880	389	605	861	303	706	.23005	318	700	902	42
19	900	383	623	856	331	698	933	311	728	894	41
20	.17937	.96378	.19652	.98030	.21360	.97692	.23062	.97304	.24756	.96887	40
21	946	373	680	844	358	686	960	298	784	890	39
22	992	368	709	839	417	680	118	291	813	873	38
23	.18023	362	737	833	445	673	146	284	841	866	37
24	052	357	766	827	474	667	175	278	869	858	36
25	.18081	.96352	.19794	.98021	.21502	.97661	.23203	.97271	.24897	.96851	35
26	109	347	823	816	536	655	231	264	925	844	34
27	138	341	851	810	559	648	260	257	954	837	33
28	168	336	880	804	587	642	288	251	982	829	32
29	195	331	908	.97998	616	636	316	244	.23010	822	31
30	.18224	.96325	.19937	.97992	.21644	.97630	.23345	.97237	.25038	.96815	30
31	272	320	905	807	672	623	373	230	988	807	29
32	281	315	924	801	701	617	401	223	994	800	28
33	309	310	.20122	875	729	611	429	217	122	783	27
34	338	304	951	869	758	604	458	210	151	786	26
35	.18307	.96299	.20079	.97963	.21786	.97598	.23486	.97203	.25179	.96778	25
36	395	294	108	858	814	592	514	198	207	771	24
37	424	288	136	852	843	585	542	189	235	784	23
38	452	283	165	846	871	579	571	182	263	786	22
39	481	277	193	840	899	573	599	176	291	749	21
40	.18509	.96272	.20222	.97934	.21928	.97566	.23627	.97189	.25320	.96742	20
41	538	267	250	828	956	560	656	162	349	731	19
42	567	261	279	822	985	553	684	155	378	727	18
43	595	256	307	816	.22013	547	712	148	404	719	17
44	624	250	336	810	611	541	740	141	432	712	16
45	.18652	.96245	.20364	.97905	.22070	.97534	.23769	.97134	.25460	.96703	15
46	681	240	393	809	998	528	797	127	488	697	14
47	710	234	421	803	158	521	825	120	516	690	13
48	738	229	450	807	155	515	853	113	545	683	12
49	767	223	478	801	183	508	882	108	573	675	11
50	.18793	.96218	.20507	.97875	.22212	.97502	.23910	.97100	.25601	.96667	10
51	834	212	535	809	210	496	935	993	629	660	9
52	853	207	563	803	268	489	966	986	657	653	8
53	881	201	592	807	297	483	995	979	685	645	7
54	910	196	620	801	325	476	.24023	972	713	638	6
55	.18939	.96190	.20649	.97845	.22351	.97470	.24051	.97065	.25741	.96630	5
56	967	185	677	839	352	463	979	958	709	633	4
57	995	179	706	833	410	457	108	951	795	615	3
58	.19074	174	734	827	438	450	136	944	828	608	2
59	052	168	763	821	467	444	164	937	854	600	1
60	.19081	.96163	.20791	.97815	.22495	.97437	.24192	.97030	.25882	.96593	0
	Cos.	Sin.	Cos.	Sin.	Cos.	Sin.	Cos.	Sin.	Cos.	Sin.	M.

252

45.842

Appendix II—MATHEMATICS

M.	15°		16°		17°		18°		19°		M.
	Sin.	Cos.	Sin.	Cos.	Sin.	Cos.	Sin.	Cos.	Sin.	Cos.	
0	0.25982	0.96593	0.27364	0.96126	0.28737	0.95634	0.30102	0.95100	0.32557	0.94532	60
1	910	562	592	118	265	622	929	027	584	542	59
2	935	575	620	110	293	643	957	082	612	533	58
3	966	570	645	102	321	665	985	079	639	523	57
4	994	562	676	094	348	686	.31012	070	667	514	56
5	.26022	.96355	.27704	.96096	.29376	.95834	.31040	.95571	.32704	.94504	55
6	050	547	731	075	404	579	086	052	722	485	54
7	079	540	759	070	432	571	091	043	749	483	53
8	107	532	787	062	459	562	121	033	777	476	52
9	135	524	815	054	487	554	151	024	804	469	51
10	.26163	.96517	.27847	.96316	.29515	.95515	.31178	.95315	.32832	.94457	50
11	191	509	871	037	543	536	207	016	828	447	49
12	219	502	899	029	571	528	233	.94217	847	438	48
13	247	494	927	021	599	519	261	085	914	427	47
14	276	486	955	013	626	511	289	079	942	419	46
15	.26309	.96479	.27983	.96103	.29651	.95292	.31316	.94970	.32969	.94409	45
16	331	471	.29111	.95997	682	493	314	081	927	392	44
17	359	463	019	989	710	485	342	052	.33124	391	43
18	387	456	047	981	737	476	369	043	051	381	42
19	415	448	075	972	765	467	427	033	079	370	41
20	.26443	.96440	.28123	.95944	.29793	.95440	.31454	.94924	.33108	.94361	40
21	471	433	120	956	821	459	482	013	134	351	39
22	500	425	175	948	848	441	510	006	161	342	38
23	528	417	206	940	876	433	537	007	189	333	37
24	556	410	234	931	904	424	565	058	216	322	36
25	.26584	.96402	.28262	.95923	.29932	.95415	.31593	.94878	.33244	.94313	35
26	612	394	280	915	920	407	630	069	271	313	34
27	640	387	318	907	947	398	649	060	298	293	33
28	668	379	346	898	.30115	389	675	051	326	284	32
29	696	371	374	890	043	380	703	042	353	274	31
30	.26724	.96363	.28402	.95902	.30071	.95372	.31731	.94832	.33381	.94264	30
31	752	355	429	874	098	363	735	033	408	254	29
32	780	347	457	865	126	354	760	014	436	245	28
33	808	340	485	857	154	345	813	005	463	235	27
34	836	332	513	849	182	337	841	009	490	226	26
35	.26864	.96324	.28542	.95881	.30209	.95325	.31871	.94791	.33518	.94215	25
36	872	316	549	832	237	319	894	777	545	206	24
37	920	308	607	824	265	310	923	768	573	196	23
38	949	301	625	816	292	301	911	758	601	186	22
39	978	293	652	807	320	293	979	749	627	176	21
40	.27004	.96285	.28680	.95860	.30349	.95281	.32009	.94740	.33655	.94167	20
41	032	277	708	791	376	275	034	730	652	157	19
42	060	269	736	782	403	266	061	721	710	147	18
43	088	261	764	774	431	257	089	712	737	137	17
44	116	253	792	766	459	248	116	702	764	127	16
45	.27144	.96246	.28820	.95841	.30486	.95240	.32144	.94693	.33792	.94118	15
46	172	238	847	749	514	231	171	684	819	109	14
47	200	230	875	740	542	222	199	674	846	094	13
48	228	222	903	732	570	213	227	665	874	088	12
49	256	214	931	724	607	204	254	656	901	076	11
50	.27284	.96206	.28959	.95821	.30625	.95195	.32282	.94646	.33929	.94063	10
51	312	198	987	707	633	196	309	637	956	058	9
52	340	190	.79115	698	690	177	337	627	983	049	8
53	368	182	042	690	709	168	364	618	.34011	039	7
54	396	174	079	681	736	159	392	609	034	029	6
55	.27424	.96166	.29098	.95801	.30763	.95150	.32419	.94599	.34093	.94019	5
56	432	158	126	674	791	142	447	590	023	009	4
57	480	150	154	666	819	133	474	580	120	.93999	3
58	508	142	182	647	846	124	502	571	147	989	2
59	536	134	209	639	874	115	529	561	175	979	1
60	.27564	.96126	.29237	.95830	.30902	.95106	.32557	.94552	.34202	.93960	0
	Cos.	Sin.	Cos.	Sin.	Cos.	Sin.	Cos.	Sin.	Cos.	Sin.	M.
		16°		15°		14°		13°		12°	

REST COPY AVAILABLE

ENGINEERING AID 3 & 2, VOLUME 1

M.	30°		31°		32°		33°		34°		M.
	Sin.	Cos.	Sin.	Cos.	Sin.	Cos.	Sin.	Cos.	Sin.	Cos.	
0	0.34202	0.93969	0.35837	0.93358	0.37461	0.92718	0.39073	0.92050	0.40674	0.91355	60
1	229	979	804	748	486	707	100	039	700	343	59
2	237	949	591	337	515	697	127	028	777	331	58
3	284	939	915	327	542	686	133	016	753	319	57
4	311	929	945	316	569	675	180	005	780	307	56
5	.34339	.93819	.35973	.93208	.37585	.92664	.39207	.91994	.40808	.91295	55
6	366	909	.38000	795	622	653	224	982	833	283	54
7	393	899	027	285	649	642	280	971	800	272	53
8	421	869	054	274	676	631	287	959	886	260	52
9	448	879	081	264	703	620	314	948	913	248	51
10	.34475	.93669	.36108	.93253	.37730	.92609	.39341	.91926	.40939	.91256	50
11	503	859	133	243	757	596	367	925	966	224	49
12	530	849	162	232	784	587	394	914	992	212	48
13	557	839	190	222	811	576	421	902	.41019	200	47
14	584	829	217	211	838	565	448	891	045	188	46
15	.34612	.93519	.36244	.93201	.37865	.92554	.39474	.91879	.41072	.91176	45
16	639	809	271	190	892	543	501	868	098	164	44
17	666	799	298	180	919	532	528	856	125	152	43
18	694	789	325	169	946	521	555	845	151	140	42
19	721	779	352	159	973	510	581	833	178	128	41
20	.34748	.93369	.36379	.93148	.37999	.92499	.39608	.91822	.41204	.91116	40
21	775	759	408	137	.38026	488	635	810	231	104	39
22	803	748	434	127	053	477	661	799	257	022	38
23	830	738	461	116	080	468	688	787	284	080	37
24	857	728	488	106	107	455	715	775	310	068	36
25	.34884	.93219	.36515	.93095	.38134	.92444	.39741	.91764	.41337	.91056	35
26	912	708	542	084	161	432	768	752	343	044	34
27	939	698	569	074	188	421	795	741	390	032	33
28	966	688	596	063	215	410	822	729	416	020	32
29	993	677	623	052	241	399	848	718	443	008	31
30	.35021	.93069	.36650	.93042	.38268	.92388	.39875	.91708	.41469	.90996	30
31	048	657	677	031	295	377	902	694	496	084	29
32	075	647	704	020	322	366	929	683	522	072	28
33	102	637	731	010	349	355	955	671	549	060	27
34	130	626	758	.92999	376	343	982	660	575	948	26
35	.35157	.92919	.36785	.92988	.38403	.92332	.40008	.91648	.41602	.90936	25
36	154	606	785	078	430	321	035	636	628	924	24
37	211	596	839	967	456	310	062	625	655	911	23
38	239	585	867	956	483	299	088	613	681	899	22
39	266	575	894	945	510	287	115	601	707	887	21
40	.35293	.92769	.36921	.92935	.38537	.92276	.40141	.91590	.41734	.90875	20
41	320	555	948	924	544	265	168	578	760	863	19
42	347	544	975	913	591	254	195	566	787	851	18
43	375	534	.37002	902	617	243	221	555	813	839	17
44	402	524	029	892	644	231	248	543	840	826	16
45	.35429	.92619	.37056	.92881	.38671	.92220	.40275	.91531	.41866	.90814	15
46	456	503	083	870	698	200	301	519	892	802	14
47	484	493	110	859	725	198	328	508	919	790	13
48	511	483	137	849	752	186	355	496	945	778	12
49	538	472	164	838	778	175	381	484	972	766	11
50	.35565	.92469	.37191	.92837	.38805	.92164	.40408	.91472	.41998	.90753	10
51	592	452	218	816	832	152	434	461	.42024	741	9
52	619	441	245	805	859	141	461	449	051	729	8
53	647	431	272	794	886	130	488	437	077	717	7
54	674	420	299	784	912	119	514	425	104	704	6
55	.35701	.92319	.37326	.92773	.38939	.92107	.40541	.91414	.42130	.90692	5
56	728	400	353	762	960	096	567	402	156	680	4
57	755	389	380	751	983	085	594	390	183	668	3
58	782	379	407	740	.39020	073	621	378	209	655	2
59	810	368	434	729	046	062	647	366	235	643	1
60	.35837	.92169	.37461	.92718	.39073	.92050	.40674	.91355	.42262	.90631	0
	Cos.	Sin.	Cos.	Sin.	Cos.	Sin.	Cos.	Sin.	Cos.	Sin.	M.
	60°		59°		60°		60°		60°		

Appendix II—MATHEMATICS

M.	25°		26°		27°		28°		29°		M.
	Sin.	Cos.	Sin.	Cos.	Sin.	Cos.	Sin.	Cos.	Sin.	Cos.	
0	0.42262	0.90631	0.43837	0.89979	0.45399	0.89101	0.46947	0.88293	0.48481	0.87462	60
1	259	018	853	897	425	057	973	291	506	448	59
2	315	006	869	854	451	074	999	267	532	434	58
3	341	591	916	841	477	061	.47024	254	557	420	57
4	367	552	942	828	503	049	050	240	583	406	56
5	.42394	.90569	.43965	.89916	.45529	.89035	.47076	.88220	.48608	.87391	55
6	430	557	904	803	511	021	101	213	634	377	54
7	446	545	.44030	790	530	008	127	199	659	363	53
8	473	512	010	777	606	.88995	153	181	684	349	52
9	499	520	072	764	632	931	179	172	710	335	51
10	.42525	.90407	.44098	.89752	.45658	.88908	.47204	.88158	.48718	.87211	50
11	532	495	124	739	654	955	229	141	701	346	49
12	578	453	151	726	710	942	210	120	726	292	48
13	601	470	177	713	736	925	201	117	811	278	47
14	611	458	203	700	762	915	306	103	837	264	46
15	.42657	.90248	.44229	.89607	.45797	.88802	.47332	.88069	.48862	.87200	45
16	683	433	235	674	813	888	358	075	888	248	44
17	709	421	261	662	839	875	343	062	913	221	43
18	734	408	307	649	865	862	409	049	938	207	42
19	762	396	333	636	891	848	431	031	964	193	41
20	.42788	.90089	.44359	.89453	.45917	.88635	.47460	.88200	.48989	.87178	40
21	815	371	355	610	942	822	456	066	.49016	164	39
22	811	358	411	597	969	805	511	.87973	040	150	38
23	867	346	437	584	994	795	537	278	015	136	37
24	894	334	464	571	.46030	782	562	905	000	121	36
25	.42920	.90121	.44490	.89358	.46166	.88568	.47588	.88051	.49116	.87107	35
26	945	319	516	545	072	755	614	937	141	093	34
27	972	296	542	532	097	741	639	921	166	079	33
28	999	294	568	519	123	728	665	909	192	064	32
29	.43055	.9025	594	506	149	715	690	896	217	050	31
30	.43051	.90259	.44620	.89493	.46175	.88701	.47716	.88002	.49212	.87098	30
31	077	246	640	480	201	685	741	878	268	021	29
32	104	233	672	467	226	674	765	854	287	007	28
33	130	221	698	454	252	661	793	840	318	.87089	27
34	156	208	724	441	278	647	818	826	344	976	26
35	.43182	.90196	.44750	.89429	.46304	.88634	.47844	.88012	.49369	.87084	25
36	209	183	776	415	340	620	819	796	394	949	24
37	215	171	802	402	315	607	807	784	419	935	23
38	261	158	828	389	351	593	920	770	445	921	22
39	287	146	854	376	407	580	946	756	470	909	21
40	.43313	.90133	.44880	.89373	.46433	.88556	.47971	.88003	.49495	.87079	20
41	340	131	900	350	458	553	997	729	521	878	19
42	366	108	932	337	484	539	.49029	718	546	863	18
43	392	095	958	324	510	526	015	701	571	849	17
44	418	082	984	311	535	512	073	687	598	834	16
45	.43445	.90070	.45010	.89298	.46561	.88499	.48099	.88008	.49622	.87070	15
46	471	057	036	285	587	485	124	679	647	805	14
47	497	045	062	272	613	472	150	645	672	791	13
48	523	032	088	259	639	458	175	631	697	777	12
49	549	019	114	245	664	445	201	617	723	762	11
50	.43575	.90007	.45140	.89232	.46690	.88431	.48226	.88003	.49748	.87061	10
51	602	.89994	166	219	716	417	252	589	773	743	9
52	628	981	192	206	742	404	277	575	798	719	8
53	654	968	218	193	767	390	303	561	821	704	7
54	680	956	243	180	793	377	328	546	849	690	6
55	.43706	.89943	.45260	.89167	.46819	.88363	.48414	.88002	.49874	.87055	5
56	733	930	295	153	844	349	379	518	890	661	4
57	759	918	321	140	870	336	405	504	924	646	3
58	785	905	347	127	896	322	430	490	950	632	2
59	811	892	373	114	921	308	456	476	975	617	1
60	.43837	.89879	.45399	.89101	.46947	.88295	.48481	.88002	.50000	.87003	0
	Cos.	Sin.	Cos.	Sin.	Cos.	Sin.	Cos.	Sin.	Cos.	Sin.	M.
		60°		65°		65°		61°		60°	

BEST COPY AVAILABLE

45.845

ENGINEERING AID 3 & 2, VOLUME 1

M.	30°		31°		32°		33°		34°		M.
	Sin.	Cos.	Sin.	Cos.	Sin.	Cos.	Sin.	Cos.	Sin.	Cos.	
0	0.50000	0.86603	0.51504	0.85717	0.52992	0.84805	0.54404	0.83887	0.55919	0.82804	60
1	025	988	529	702	53017	789	488	851	943	887	59
2	060	973	554	687	041	774	813	835	928	871	58
3	078	959	579	672	066	759	837	819	902	855	57
4	101	944	604	657	091	743	861	804	88016	839	56
5	.30126	.86530	.51628	.85642	.53115	.84728	.54586	.83788	.56040	.82822	55
6	151	815	633	627	140	712	610	772	064	806	54
7	178	801	678	612	164	697	635	756	088	790	53
8	201	485	708	597	188	681	659	740	113	773	52
9	227	471	738	582	214	666	683	724	138	757	51
10	.30262	.86457	.51753	.85567	.53238	.84630	.54708	.83708	.56100	.82741	50
11	277	442	778	551	263	655	722	682	184	734	49
12	302	427	803	536	288	619	736	676	208	708	48
13	327	413	828	521	312	604	781	660	232	682	47
14	352	398	852	506	337	588	805	645	256	675	46
15	.30377	.86384	.51877	.85491	.53361	.84573	.54829	.83629	.56280	.82690	45
16	403	366	902	478	366	557	854	613	303	643	44
17	428	354	927	461	411	542	878	597	328	628	43
18	453	340	952	446	435	526	902	581	353	610	42
19	478	325	977	431	460	511	927	565	377	593	41
20	.30503	.86310	.52002	.85416	.53484	.84495	.54951	.83549	.56401	.82577	40
21	528	285	026	401	509	480	975	533	425	561	39
22	553	281	051	385	534	464	999	517	449	544	38
23	578	268	076	370	558	448	.85024	501	473	528	37
24	603	251	101	353	583	433	048	485	497	511	36
25	.30628	.86237	.52126	.85340	.53607	.84417	.55072	.83469	.56521	.82485	35
26	654	222	151	323	632	402	097	453	545	478	34
27	679	207	175	310	656	386	121	437	569	462	33
28	704	192	200	294	681	370	145	421	593	440	32
29	729	178	225	279	705	355	169	405	617	429	31
30	.30754	.86163	.52250	.85264	.53730	.84339	.55194	.83389	.56641	.82413	30
31	779	148	275	249	754	324	218	373	645	395	29
32	804	133	299	234	779	308	242	356	669	380	28
33	829	119	324	218	804	292	266	340	713	363	27
34	854	104	349	203	828	277	291	324	736	347	26
35	.30879	.86089	.52374	.85188	.53853	.84261	.55315	.83308	.56760	.82330	25
36	904	074	399	173	877	215	339	292	784	314	24
37	929	059	423	157	902	200	363	276	808	297	23
38	954	045	448	142	926	184	388	260	832	281	22
39	979	030	473	127	951	168	412	244	856	264	21
40	.31004	.86015	.52498	.85112	.53975	.84182	.55436	.83228	.56880	.82248	20
41	029	000	522	096	.94000	167	460	212	904	231	19
42	054	.85963	547	081	024	151	484	195	928	214	18
43	079	970	572	066	049	135	509	179	952	198	17
44	104	956	597	051	073	120	533	163	976	181	16
45	.31129	.85941	.52621	.85035	.54097	.84104	.55557	.83147	.57000	.82165	15
46	154	926	646	020	122	068	581	131	024	148	14
47	179	911	671	005	146	072	605	115	047	132	13
48	204	896	696	.84969	171	057	630	098	071	115	12
49	229	881	720	974	195	041	654	082	096	098	11
50	.31254	.85866	.52745	.84959	.54220	.84025	.55678	.83066	.57119	.82082	10
51	279	851	770	943	244	009	702	050	143	063	9
52	304	836	794	928	269	.83994	726	034	167	048	8
53	329	821	819	913	293	978	750	017	191	032	7
54	354	806	844	897	317	962	775	001	215	015	6
55	.31379	.85792	.52869	.84882	.54342	.83946	.55799	.82985	.57238	.81999	5
56	404	777	893	866	366	930	823	969	262	982	4
57	429	762	918	851	391	915	847	953	286	965	3
58	454	747	943	836	415	899	871	936	310	949	2
59	479	732	967	820	440	883	895	920	334	932	1
60	.31504	.85717	.52992	.84805	.54464	.83867	.55919	.82904	.57358	.81915	0
	Cos.	Sin.	Cos.	Sin.	Cos.	Sin.	Cos.	Sin.	Cos.	Sin.	M.
	59°		58°		57°		56°		55°		

45.846

256



Appendix II—MATHEMATICS

M.	34°		35°		36°		37°		38°		M.
	Sin.	Cos.	Sin.	Cos.	Sin.	Cos.	Sin.	Cos.	Sin.	Cos.	
0	.57357	.81915	.58778	.80902	.60182	.79864	.61568	.78807	.63032	.67715	60
1	381	889	892	888	878	868	852	838	823	808	59
2	484	882	826	857	228	829	612	765	977	678	58
3	439	885	849	830	251	811	634	747	63000	660	57
4	439	888	873	823	274	793	658	729	622	641	56
5	.57477	.81823	.59894	.80816	.60388	.79776	.61681	.78711	.63045	.67623	55
6	801	818	930	798	221	788	704	694	618	605	54
7	894	788	943	782	344	741	728	678	620	588	53
8	898	782	967	768	367	723	749	658	613	582	52
9	872	768	989	748	390	704	778	640	635	550	51
10	.57598	.81729	.60914	.80728	.60414	.79688	.61784	.78622	.63136	.67531	50
11	619	731	937	713	437	671	818	634	610	513	49
12	643	714	961	692	460	653	841	606	593	494	48
13	667	698	984	678	483	635	864	588	575	476	47
14	691	681	100	662	506	618	887	570	560	458	46
15	.57719	.81634	.60931	.80644	.60537	.79600	.61900	.78532	.63271	.67439	45
16	728	647	134	627	532	593	922	514	293	421	44
17	762	631	178	610	576	563	956	496	316	402	43
18	786	614	201	593	619	547	979	478	338	384	42
19	810	597	226	576	662	530	1001	460	361	366	41
20	.57840	.81539	.60948	.80558	.60645	.79512	.62004	.78442	.63383	.67347	40
21	857	583	272	541	698	494	1046	424	406	349	39
22	881	566	296	524	741	477	1079	406	429	310	38
23	904	550	318	507	784	459	1092	387	451	272	37
24	928	533	342	490	828	441	1115	369	473	233	36
25	.57961	.81444	.60965	.80472	.60761	.79424	.62108	.78351	.63494	.67255	35
26	976	479	389	455	874	424	1160	353	513	210	34
27	999	462	412	438	907	407	1183	335	540	218	33
28	1023	445	436	420	950	371	1206	317	563	199	32
29	1047	428	459	403	993	353	1229	299	585	181	31
30	.58082	.81349	.60982	.80388	.60874	.79324	.62211	.78251	.63608	.67162	30
31	1094	412	506	388	1039	318	1274	283	630	141	29
32	1118	395	529	371	1082	300	1297	265	653	122	28
33	1141	378	552	354	1125	282	1320	247	675	103	27
34	1164	361	576	336	1168	264	1342	229	698	84	26
35	.58203	.81254	.61000	.80298	.60981	.79247	.62315	.78151	.63720	.67070	25
36	1212	310	622	320	1212	229	1388	213	742	631	24
37	1235	293	646	304	1255	211	1411	195	765	633	23
38	1259	276	669	287	1298	193	1433	177	787	614	22
39	1283	259	693	270	1341	176	1456	159	809	616	21
40	.58324	.81159	.61017	.80217	.61107	.79168	.62419	.78059	.63832	.66977	20
41	1330	242	730	253	1385	159	1499	143	831	608	19
42	1354	225	753	236	1428	141	1521	125	853	610	18
43	1378	208	776	219	1471	123	1543	107	875	611	17
44	1401	174	800	203	1514	105	1565	89	897	612	16
45	.58445	.81064	.61034	.80135	.61222	.79070	.62523	.77968	.63944	.66884	15
46	1449	149	826	186	1557	87	1587	71	919	613	14
47	1472	132	849	169	1600	69	1609	53	941	614	13
48	1495	115	872	152	1643	51	1631	35	963	615	12
49	1519	98	896	135	1686	34	1653	17	985	616	11
50	.58566	.80969	.61051	.80054	.61337	.78980	.62627	.77877	.64056	.66791	10
51	1567	81	920	118	1729	17	1675	0	1007	772	9
52	1590	64	943	101	1772	0	1697	0	1029	754	8
53	1614	47	967	84	1815	0	1719	0	1051	735	7
54	1637	30	990	67	1858	0	1741	0	1073	717	6
55	.58687	.80874	.61068	.79951	.61451	.78891	.62731	.77786	.64167	.66700	5
56	1684	13	1014	50	1901	0	1763	0	1095	699	4
57	1708	0	1037	33	1944	0	1785	0	1117	681	3
58	1731	0	1060	16	1987	0	1807	0	1139	662	2
59	1755	0	1083	0	2030	0	1829	0	1161	643	1
60	.58779	.80802	.61082	.79864	.61509	.78801	.62832	.77715	.64279	.66604	0

BEST COPY AVAILABLE

45.847

ENGINEERING AID 3 & 2, VOLUME 1

M.	40°		41°		42°		43°		44°		M.
	Sin.	Cos.	Sin.	Cos.	Sin.	Cos.	Sin.	Cos.	Sin.	Cos.	
0	0.64279	0.76604	0.65606	0.75471	0.66913	0.74314	0.68200	0.73135	0.69488	0.71904	60
1	301	386	628	432	833	283	221	116	487	914	59
2	323	467	630	433	856	278	242	98	508	894	58
3	346	548	672	414	978	236	284	676	528	873	57
4	368	630	694	393	999	227	286	656	549	853	56
5	.64390	.76311	.65716	.75373	.67021	.74217	.68308	.73036	.69570	.71833	55
6	412	492	738	356	943	198	327	916	601	813	54
7	435	473	739	337	964	178	349	.73886	612	792	53
8	457	455	731	318	986	158	370	676	633	772	52
9	479	436	723	299	107	138	391	657	654	753	51
10	.64501	.76112	.64823	.75280	.67129	.74120	.68412	.73907	.69673	.71732	50
11	534	398	847	281	131	100	434	917	686	711	49
12	546	380	869	241	172	980	455	897	717	691	48
13	568	361	891	222	194	961	476	877	737	671	47
14	590	342	913	203	215	941	497	857	758	650	46
15	.64612	.76323	.65935	.75184	.67237	.74022	.68518	.73837	.69779	.71630	45
16	633	304	956	163	258	902	539	817	.800	610	44
17	657	286	978	146	280	.73983	561	797	821	590	43
18	679	267	.68000	128	301	963	582	777	842	569	42
19	701	248	972	107	323	944	603	757	863	549	41
20	.64723	.76229	.66044	.75086	.67344	.73924	.68824	.73737	.69983	.71529	40
21	746	210	966	92	366	904	613	717	804	528	39
22	768	192	988	630	387	885	636	697	825	488	38
23	790	173	109	430	409	865	658	677	846	458	37
24	812	154	131	011	430	846	709	657	868	447	36
25	.64834	.76133	.66153	.74992	.67452	.73826	.68930	.73637	.69987	.71427	35
26	858	116	175	973	473	806	731	617	.70008	407	34
27	878	97	197	953	493	787	772	597	628	386	33
28	901	78	218	934	516	767	793	577	649	366	32
29	923	639	240	913	538	747	814	557	670	345	31
30	.64945	.76041	.66272	.74896	.67559	.73728	.69035	.73437	.70091	.71226	30
31	967	922	264	876	560	728	837	517	698	325	29
32	989	693	306	857	602	688	878	497	737	284	28
33	.65011	.75984	.66327	.74808	.67623	.73599	.69149	.73237	.70143	.71077	27
34	933	663	349	818	643	649	920	457	774	243	26
35	.65033	.75946	.66371	.74799	.67666	.73629	.69141	.73137	.70183	.71023	25
36	977	927	393	780	685	610	962	417	815	203	24
37	100	908	414	760	709	590	983	397	836	182	23
38	122	889	436	741	730	570	.69004	377	857	162	22
39	144	870	458	722	752	551	923	357	877	141	21
40	.65166	.75831	.66480	.74703	.67773	.73531	.69046	.72937	.70288	.71121	20
41	156	832	501	683	795	511	987	317	898	100	19
42	210	813	523	664	816	491	988	297	919	880	18
43	232	794	545	644	837	472	109	277	940	769	17
44	254	775	566	625	859	452	130	257	961	658	16
45	.65276	.75736	.66588	.74606	.67880	.73432	.69131	.72736	.70401	.71019	15
46	298	738	610	586	901	413	172	216	922	.70896	14
47	330	719	632	567	923	393	193	196	943	874	13
48	342	700	653	548	944	373	214	176	964	767	12
49	364	680	675	528	965	353	235	156	984	667	11
50	.65386	.75661	.66697	.74509	.67987	.73333	.69236	.72136	.70306	.70916	10
51	408	612	718	489	.68008	314	277	116	936	564	9
52	430	623	740	470	979	294	298	988	846	453	8
53	452	604	762	451	931	274	319	973	867	346	7
54	474	585	783	431	972	254	340	958	887	246	6
55	.65498	.75566	.66803	.74412	.68031	.73234	.69361	.72034	.70508	.70813	5
56	518	547	827	397	113	213	382	913	838	143	4
57	540	528	848	373	136	193	403	.71963	849	72	3
58	562	509	870	353	157	173	424	974	870	732	2
59	584	490	891	334	179	153	445	964	890	731	1
60	.65606	.75471	.66913	.74314	.68200	.73135	.69466	.71834	.70711	.70711	0
	Cos.	Sin.	Cos.	Sin.	Cos.	Sin.	Cos.	Sin.	Cos.	Sin.	M.
	40°	40°	41°	41°	42°	42°	43°	43°	44°	44°	

45.848

258

250

BEST COPY AVAILABLE

H. NATURAL TANGENTS AND COTANGENTS

M	0°		1°		2°		3°		M.
	Tan.	Cot.	Tan.	Cot.	Tan.	Cot.	Tan.	Cot.	
0	0.00000	0	0.01746	57.2900	0.03492	28.6363	0.05241	19.0811	60
1	029	3437.75	775	56.3506	321	.3794	270	18.9755	59
2	058	1718.87	804	55.4415	350	.1664	299	.8711	58
3	087	1145.92	833	54.5613	379	27.9372	328	.7678	57
4	116	888.436	862	53.7086	409	.7117	357	.6656	56
5									
6	.00145	687.549	.01891	52.8821	.00638	27.4809	.05347	18.8645	55
7	173	572.957	920	52.0877	667	.2715	416	.5645	54
8	304	491.108	949	51.3032	696	.0566	445	.4655	53
9	333	429.718	978	50.5485	725	28.8450	474	.3877	52
10	362	381.971	.02007	49.8157	754	.6367	503	.3108	51
11									
12	.00291	343.774	.02006	49.1099	.03783	28.4316	.05533	18.0790	50
13	320	312.521	066	48.4121	812	.2296	532	17.9802	49
14	349	286.478	095	47.7305	842	.0307	561	.8853	48
15	378	264.441	124	47.0653	871	25.8348	590	.7934	47
16	407	245.532	153	46.4489	900	.6418	619	.7015	46
17									
18	.00436	229.182	.01182	45.8794	.03729	25.4517	.05678	17.6108	45
19	455	214.856	211	45.2361	936	.2644	708	.6205	44
20	495	202.219	240	44.6388	967	.0798	737	.5314	43
21	534	190.984	269	44.0861	.04016	24.8978	766	.4432	42
22	553	180.932	298	43.5681	046	.7185	795	.3556	41
23									
24	.00582	171.885	.02328	42.9841	.04075	24.5418	.05824	17.1888	40
25	611	163.700	357	42.4335	104	.3675	854	.2837	39
26	640	156.259	386	41.9158	133	.1857	883	16.9990	38
27	669	149.463	415	41.4106	162	.0283	912	.8150	37
28	698	143.237	444	40.9174	191	22.8568	941	.7319	36
29									
30	.00727	137.507	.02473	40.4356	.04220	23.6845	.05970	16.7496	35
31	736	132.219	502	39.9655	250	.5321	989	.6681	34
32	785	127.321	531	39.5059	279	.3718	.06029	.5874	33
33	815	122.774	560	39.0568	308	.2137	068	.5075	32
34	844	118.540	589	38.6177	337	.0577	087	.4283	31
35									
36	.00873	114.589	.02619	38.1885	.04368	22.9038	.06116	16.3499	30
37	902	110.892	648	37.7680	365	.7519	145	.3722	29
38	931	107.426	677	37.3578	424	.6020	175	.2952	28
39	960	104.171	706	36.9560	454	.4541	204	.2190	27
40	989	101.107	735	36.5627	483	.3081	233	.1435	26
41									
42	.01018	98.2179	.02764	36.1778	.04512	22.1640	.06262	15.9887	25
43	047	95.4895	793	35.8008	541	.0217	291	.8945	24
44	076	92.9085	822	35.4313	570	21.8813	321	.8211	23
45	105	90.4633	851	35.0805	599	.7426	350	.7483	22
46	135	88.1436	881	34.7451	628	.6056	379	.6782	21
47									
48	.01164	85.9398	.02910	34.3678	.04658	21.4704	.06408	15.6048	20
49	183	83.8435	939	34.0273	657	.3509	438	.5340	19
50	222	81.8470	968	33.6935	716	.2049	467	.4638	18
51	251	79.9434	997	33.3662	745	.0747	496	.3943	17
52	280	78.1263	.03076	33.0452	774	20.0460	525	.3254	16
53									
54	.01309	76.3900	.03055	32.7309	.04803	20.8188	.06554	15.2571	15
55	338	74.7292	084	32.4213	833	.6632	584	.2893	14
56	367	73.1390	114	32.1181	862	.5691	613	.2222	13
57	396	71.6151	143	31.8205	891	.4465	642	.1657	12
58	425	70.1533	172	31.5284	920	.3253	671	.1098	11
59									
60	.01455	68.7501	.03201	31.2416	.04949	20.2056	.06700	14.9244	10
61	484	67.4019	230	30.9599	978	.0872	730	.8596	9
62	513	66.1055	259	30.6883	.05007	19.9702	759	.7954	8
63	542	64.8580	288	30.4116	037	.8546	788	.7317	7
64	571	63.6567	317	30.1446	066	.7403	817	.6685	6
65									
66	.01600	62.4992	.03346	29.8923	.05095	19.6273	.06847	14.6059	5
67	629	61.3829	376	29.6245	124	.6156	876	.6038	4
68	658	60.3058	405	29.3711	153	.4051	905	.5423	3
69	687	59.2659	434	29.1220	182	.2989	934	.4812	2
70	716	58.2612	463	28.8771	212	.1879	963	.4207	1
71									
72	.01746	57.2900	.03492	28.6363	.05241	19.0811	.06993	14.3007	0
73									
74									
75									
76									
77									
78									
79									
80									
81									
82									
83									
84									
85									
86									
87									
88									
89									
90									
91									
92									
93									
94									
95									
96									
97									
98									
99									
100									



ENGINEERING AID 3 & 2, VOLUME I

M.	4°		5°		6°		7°		M.
	Tan.	Cot.	Tan.	Cot.	Tan.	Cot.	Tan.	Cot.	
0	0.06993	14.3007	0.06740	11.4301	0.10510	9.51436	0.12278	8.14435	60
1	.07072	.2411	.778	.3919	.540	.45781	.308	.12481	59
2	.051	.1821	.807	.3510	.599	.46141	.318	.10336	58
3	.060	.1235	.837	.3163	.599	.43515	.367	.08000	57
4	.110	.0655	.866	.2789	.628	.40004	.397	.06674	56
5	.07139	14.0079	.06895	11.2417	.10637	9.38307	.12426	8.04756	55
6	.168	13.9507	.925	.2048	.687	.35724	.456	.02848	54
7	.197	.8940	.954	.1681	.716	.33135	.485	.00948	53
8	.277	.8775	.983	.1316	.746	.30399	.515	.7.99058	52
9	.286	.7821	.09013	.0954	.775	.28058	.544	.07176	51
10	.07285	13.7267	.09042	11.0594	.10805	9.25530	.12574	7.95302	50
11	.314	.6719	.071	.0237	.814	.23016	.603	.9.1438	49
12	.344	.6174	.101	10.9882	.863	.20516	.633	.91582	48
13	.373	.5634	.130	.9529	.893	.19028	.662	.89734	47
14	.402	.5098	.159	.9179	.922	.15554	.692	.87895	46
15	.07431	13.4566	.09189	10.8829	.10952	9.13093	.12722	7.86064	45
16	.461	.4039	.218	.8483	.941	.10646	.751	.81242	44
17	.490	.3515	.247	.8139	.11011	.08211	.781	.82428	43
18	.519	.2996	.277	.7797	.040	.05789	.810	.80622	42
19	.548	.2480	.306	.7457	.070	.03379	.840	.78825	41
20	.07578	13.1969	.09335	10.7119	.11099	9.00983	.12909	7.77035	40
21	.607	.1461	.365	.6783	.128	8.85598	.809	.75254	39
22	.636	.0938	.394	.6430	.158	.86227	.839	.73480	38
23	.665	.0458	.423	.6118	.187	.93867	.868	.71715	37
24	.695	12.9962	.453	.5789	.217	.91520	.898	.69957	36
25	.07724	12.9469	.09482	10.5462	.11246	8.89195	.13017	7.68208	35
26	.753	.8981	.511	.5136	.276	.86462	.047	.66406	34
27	.782	.8496	.541	.4813	.305	.84551	.076	.64732	33
28	.812	.8014	.570	.4491	.335	.82252	.106	.63005	32
29	.841	.7536	.600	.4172	.364	.79904	.136	.61287	31
30	.07870	12.7082	.09629	10.3854	.11394	8.77689	.13185	7.59573	30
31	.899	.6591	.658	.3538	.423	.75425	.195	.57872	29
32	.929	.6124	.688	.3224	.452	.73172	.224	.56176	28
33	.958	.5670	.717	.2913	.482	.70931	.254	.54487	27
34	.987	.5199	.746	.2602	.511	.68701	.284	.52806	26
35	.08017	12.4742	.09776	10.2294	.11541	8.66482	.13313	7.51132	25
36	.046	.4288	.805	.1988	.570	.64275	.343	.49465	24
37	.075	.3838	.834	.1683	.600	.62076	.372	.47806	23
38	.104	.3390	.864	.1381	.629	.59893	.402	.46154	22
39	.134	.2946	.893	.1080	.659	.57718	.432	.44509	21
40	.08163	12.2505	.09923	10.0789	.11688	8.55555	.13461	7.42871	20
41	.192	.2067	.952	.0493	.718	.53402	.491	.41240	19
42	.221	.1632	.981	.0187	.747	.51259	.521	.39616	18
43	.251	.1201	.10011	9.96931	.777	.49128	.550	.37999	17
44	.280	.0772	.040	.98007	.806	.47007	.580	.36389	16
45	.08309	12.0346	.10069	9.91101	.11836	8.44896	.13609	7.34786	15
46	.339	11.9923	.099	.90211	.865	.42795	.639	.33190	14
47	.368	.8504	.128	.87338	.895	.40705	.669	.31600	13
48	.397	.8087	.158	.84482	.924	.38625	.698	.30018	12
49	.427	.8673	.187	.81641	.954	.36555	.728	.28442	11
50	.08456	11.8262	.10216	9.78817	.11983	8.34496	.13758	7.26873	10
51	.485	.7853	.246	.76009	.12013	.32446	.787	.25310	9
52	.514	.7448	.275	.73217	.042	.30406	.817	.23754	8
53	.544	.7045	.305	.70441	.072	.28376	.846	.22204	7
54	.573	.6645	.334	.67680	.101	.26356	.876	.20661	6
55	.08602	11.6248	.10363	9.64935	.12131	8.24345	.13906	7.19125	5
56	.632	.5853	.393	.62205	.160	.22344	.935	.17594	4
57	.661	.5481	.422	.59490	.190	.20352	.965	.16071	3
58	.690	.5072	.452	.56791	.219	.18370	.995	.14553	2
59	.720	.4685	.481	.54106	.249	.16398	.14024	.13042	1
60	.08749	11.4301	.10510	9.51436	.12278	8.14435	.14034	7.11537	0

Cot. Tan. Cot. Tan. Cot. Tan. Cot. Tan. M.

85° 84° 83° 82°

45.850

260
252

BEST COPY AVAILABLE



Appendix II—MATHEMATICS

M.	8°		9°		10°		11°		M.
	Tan.	Cot.	Tan.	Cot.	Tan.	Cot.	Tan.	Cot.	
0	0.14054	7.11537	0.15838	6.31375	0.17633	5.67128	0.19479	5.14455	60
1	.084	.16038	.868	.30189	.862	.66185	.468	.13658	59
2	.113	.08546	.998	.29007	.893	.65205	.498	.12862	58
3	.143	.07059	.928	.27829	.723	.64249	.529	.12079	57
4	.173	.05579	.858	.26653	.753	.63295	.559	.11279	56
5	.14202	7.04105	.19988	6.25486	.17783	5.62344	.19589	5.10490	55
6	.232	.02837	.16017	.24321	.813	.61397	.619	.09704	54
7	.262	.01174	.047	.23160	.843	.60452	.649	.08921	53
8	.291	6.99718	.077	.22003	.873	.59511	.680	.08139	52
9	.321	.98268	.107	.20851	.903	.58573	.710	.07350	51
10	.14351	6.98823	.16137	6.19703	.17933	5.57638	.19740	5.08484	50
11	.281	.85383	.167	.18559	.903	.56706	.770	.06809	49
12	.410	.93952	.196	.17419	.993	.55777	.801	.06037	48
13	.440	.92525	.226	.16283	.18023	.54851	.831	.05267	47
14	.470	.91104	.256	.15151	.053	.53927	.861	.04499	46
15	.14409	6.89268	.16286	6.14023	.18083	5.53007	.19891	5.02734	45
16	.529	.88278	.316	.12899	.113	.52090	.921	.01971	44
17	.559	.86974	.346	.11779	.143	.51176	.952	.01210	43
18	.588	.85475	.376	.10664	.173	.50264	.982	.00451	42
19	.618	.84082	.405	.09552	.203	.49356	.20012	4.96995	41
20	.14648	6.82694	.16435	6.08444	.18233	5.48451	.20042	4.90940	40
21	.678	.81312	.465	.07340	.263	.47548	.073	.98188	39
22	.707	.79936	.495	.06240	.293	.46648	.103	.97478	38
23	.737	.78564	.525	.05143	.323	.45751	.133	.96690	37
24	.767	.77199	.555	.04051	.353	.44857	.164	.95945	36
25	.14796	6.75838	.16585	6.02962	.18384	5.43966	.20194	4.85201	35
26	.826	.74483	.615	.01578	.414	.43077	.224	.94470	34
27	.856	.73133	.645	.00797	.444	.42192	.254	.93721	33
28	.886	.71789	.674	5.91720	.474	.41309	.285	.92984	32
29	.915	.70450	.704	.88046	.504	.40429	.315	.92249	31
30	.14945	6.69116	.16734	5.97576	.18534	5.39552	.20345	4.81516	30
31	.975	.67787	.764	.06510	.564	.38677	.376	.90765	29
32	.15005	.66463	.794	.05448	.594	.37805	.406	.90056	28
33	.034	.65144	.824	.04360	.624	.36936	.436	.89330	27
34	.064	.63831	.854	.03335	.654	.36070	.466	.88605	26
35	.15094	6.63523	.16884	5.92283	.18684	5.35206	.20497	4.78792	25
36	.124	.62129	.914	.01236	.714	.34345	.527	.87162	24
37	.153	.59921	.944	.00191	.745	.33487	.557	.86444	23
38	.183	.58627	.974	.89151	.775	.32631	.588	.85721	22
39	.213	.57339	.17004	.88114	.805	.31778	.618	.85013	21
40	.15243	6.56055	.17033	5.87080	.18835	5.30928	.20648	4.84300	20
41	.272	.54777	.003	.86051	.865	.30040	.679	.83590	19
42	.302	.53503	.093	.85024	.895	.29235	.709	.82892	18
43	.332	.52234	.123	.84001	.925	.28395	.739	.82175	17
44	.362	.50970	.153	.82982	.955	.27553	.770	.81471	16
45	.15391	6.49710	.17183	5.81966	.18986	5.26715	.20800	4.80769	15
46	.421	.48456	.213	.80953	.19016	.25980	.830	.80068	14
47	.451	.47206	.243	.79944	.046	.25044	.861	.79370	13
48	.481	.45961	.273	.78938	.076	.24218	.891	.78673	12
49	.511	.44720	.303	.77936	.106	.23391	.921	.77978	11
50	.15540	6.43484	.17333	5.76937	.19136	5.22566	.20951	4.77286	10
51	.670	.42253	.363	.75941	.166	.21744	.982	.76595	9
52	.600	.41026	.333	.74919	.197	.20925	.21013	.75906	8
53	.630	.39804	.423	.73900	.227	.20107	.043	.75219	7
54	.660	.38567	.453	.72874	.257	.19293	.073	.74534	6
55	.15689	6.37374	.17483	5.71992	.19287	5.18480	.21104	4.73851	5
56	.719	.36168	.513	.71013	.317	.17671	.134	.73170	4
57	.749	.34961	.543	.70037	.347	.16843	.164	.72490	3
58	.779	.33761	.573	.69084	.378	.16038	.195	.71813	2
59	.809	.32566	.603	.68004	.408	.15256	.225	.71137	1
60	.15838	6.31375	.17633	5.67128	.19436	5.14455	.21256	4.70463	0



ENGINEERING AID 3 & 2, VOLUME 1

M.	12°		13°		14°		15°		M.
	Tan.	Cot.	Tan.	Cot.	Tan.	Cot.	Tan.	Cot.	
0	0.21250	4.70463	0.23097	4.33156	0.24933	4.01079	0.26795	3.73205	60
1	.296	.69791	.117	.32573	.064	.00582	.426	.72771	59
2	.316	.69121	.148	.32001	.095	.00660	.557	.72338	58
3	.347	.68452	.179	.31430	.23026	3.99592	.883	.71907	57
4	.377	.67785	.209	.30860	.003	.00099	.920	.71476	56
5	.21408	4.67121	.23240	4.30291	.23087	3.98607	.26951	3.71046	55
6	.438	.66458	.271	.29724	.118	.09117	.982	.70610	54
7	.469	.65797	.301	.29159	.149	.09227	.87013	.70188	53
8	.499	.65138	.332	.28595	.180	.09139	.044	.69761	52
9	.529	.64480	.363	.28032	.211	.09051	.076	.69335	51
10	.21560	4.63825	.23193	4.27471	.23242	3.96165	.27107	3.68909	50
11	.590	.63171	.424	.26911	.273	.09080	.139	.68485	49
12	.621	.62518	.455	.26352	.304	.09108	.169	.68061	48
13	.651	.61868	.485	.25795	.335	.09173	.201	.67639	47
14	.682	.61219	.516	.25239	.366	.09232	.232	.67217	46
15	.21712	4.60572	.23547	4.24685	.23597	3.93751	.27263	3.66796	45
16	.743	.60927	.579	.24132	.428	.09321	.294	.66376	44
17	.773	.60283	.608	.23580	.479	.09273	.326	.65957	43
18	.804	.59641	.639	.23030	.490	.09216	.357	.65539	42
19	.834	.59001	.670	.22481	.521	.09189	.388	.65121	41
20	.21864	4.57363	.23700	4.21933	.23552	3.91364	.27419	3.64705	40
21	.895	.56726	.731	.21387	.583	.09090	.451	.64289	39
22	.925	.56091	.762	.20842	.614	.09117	.482	.63874	38
23	.956	.55458	.793	.20298	.645	.09045	.513	.63461	37
24	.986	.54826	.823	.19756	.676	.09074	.545	.63048	36
25	.22017	4.54196	.23854	4.19215	.23707	3.89004	.27576	3.62636	35
26	.047	.53568	.885	.18675	.738	.09536	.607	.62224	34
27	.078	.52941	.916	.18137	.769	.09068	.638	.61814	33
28	.108	.52316	.946	.17600	.800	.09001	.670	.61405	32
29	.139	.51693	.977	.17064	.831	.08936	.701	.60996	31
30	.22169	4.51071	.24008	4.16530	.23862	3.86671	.27732	3.60588	30
31	.200	.50451	.019	.15997	.893	.08908	.764	.60181	29
32	.231	.49832	.69	.15465	.924	.08945	.795	.59775	28
33	.261	.49215	.100	.14934	.955	.08974	.826	.59370	27
34	.292	.48600	.171	.14405	.986	.08924	.858	.58966	26
35	.22322	4.47986	.24162	4.13877	.23917	3.84364	.27889	3.58562	25
36	.353	.47374	.103	.13350	.048	.08906	.921	.58160	24
37	.383	.46764	.223	.12825	.079	.08949	.952	.57758	23
38	.414	.46155	.254	.12301	.110	.08992	.983	.57357	22
39	.444	.45548	.285	.11778	.141	.08937	.28015	.56957	21
40	.22475	4.44942	.24316	4.11256	.23972	3.82083	.28046	3.56557	20
41	.505	.44378	.347	.10736	.203	.08930	.077	.56159	19
42	.536	.43735	.377	.10216	.235	.08977	.109	.55761	18
43	.567	.43134	.408	.09699	.266	.08926	.140	.55364	17
44	.597	.42534	.439	.09182	.297	.08976	.172	.54968	16
45	.22628	4.41936	.24470	4.08666	.23928	3.79827	.28203	3.54573	15
46	.658	.41340	.501	.08152	.359	.08978	.234	.54179	14
47	.689	.40745	.532	.07639	.390	.08931	.266	.53785	13
48	.719	.40152	.562	.07127	.421	.08985	.297	.53393	12
49	.750	.39560	.593	.06616	.452	.08940	.329	.53001	11
50	.22781	4.38969	.24624	4.06107	.23983	3.77595	.28360	3.52609	10
51	.811	.38781	.635	.05599	.515	.08952	.391	.52219	9
52	.842	.38193	.666	.05092	.546	.08909	.423	.51829	8
53	.872	.37607	.717	.04586	.577	.08968	.454	.51441	7
54	.903	.37023	.747	.04081	.608	.08928	.486	.51053	6
55	.22934	4.36046	.24778	4.03578	.23939	3.75388	.28517	3.50666	5
56	.964	.35450	.909	.03076	.670	.08950	.549	.50279	4
57	.995	.34879	.840	.02574	.701	.08912	.580	.49894	3
58	.23026	.34300	.871	.02074	.733	.08975	.612	.49509	2
59	.066	.33723	.902	.01576	.764	.08940	.643	.49126	1
60	.23087	4.33148	.24933	4.01078	.23796	3.73205	.28676	3.48741	0
	Cot.	Tan.	Cot.	Tan.	Cot.	Tan.	Cot.	Tan.	M.
	77°		76°		75°		74°		

77 AVAILABLE

45.852

262



Appendix II—MATHEMATICS

M.	16°		17°		18°		19°		M.
	Tan.	Cot.	Tan.	Cot.	Tan.	Cot.	Tan.	Cot.	
0	0.28675	3.45741	0.30573	3.27065	0.32492	3.07768	0.34433	2.90421	60
1	.706	.48359	.605	.27145	.524	.07164	.465	.80147	59
2	.734	.47927	.637	.26106	.536	.07160	.498	.89873	58
3	.769	.47596	.669	.25067	.558	.06857	.530	.89600	57
4	.801	.47216	.700	.25729	.621	.06554	.563	.89327	56
5	.28832	3.46237	.30732	3.25392	.32653	3.06253	.34596	2.89055	55
6	.864	.46458	.764	.24055	.685	.05950	.628	.88783	54
7	.895	.46080	.796	.24719	.717	.05649	.661	.88511	53
8	.927	.45705	.828	.24383	.749	.05349	.693	.88240	52
9	.958	.45327	.860	.24049	.782	.05049	.726	.87970	51
10	.28990	3.44951	.30891	3.23714	.32814	3.04719	.34758	2.87700	50
11	.29021	.44576	.923	.23381	.846	.04450	.751	.87430	49
12	.053	.44202	.955	.24048	.878	.04152	.824	.87161	48
13	.084	.43829	.987	.22715	.911	.03854	.856	.86892	47
14	.116	.43456	.31019	.22384	.943	.03556	.889	.86624	46
15	.29147	3.43084	.31051	3.22051	.32975	3.03260	.34922	2.86356	45
16	.179	.42713	.083	.21722	.33007	.02963	.954	.86089	44
17	.210	.42343	.115	.21392	.010	.02607	.987	.85822	43
18	.242	.41973	.147	.21063	.072	.02372	.35020	.85555	42
19	.274	.41604	.178	.20734	.104	.02077	.052	.85289	41
20	.29206	3.41236	.31210	3.20106	.33136	3.01783	.35085	2.85023	40
21	.337	.40860	.242	.20379	.169	.01499	.118	.84758	39
22	.368	.40502	.274	.19752	.201	.01196	.150	.84491	38
23	.400	.40136	.300	.19426	.233	.00903	.183	.84229	37
24	.432	.39771	.338	.19100	.266	.00611	.216	.83965	36
25	.29463	3.39406	.31370	3.18775	.33298	3.00319	.35248	2.83702	35
26	.495	.39042	.402	.18451	.330	.00028	.281	.83439	34
27	.626	.38679	.434	.18127	.363	2.99738	.314	.83176	33
28	.858	.38317	.466	.17804	.395	.99447	.346	.82914	32
29	.690	.37955	.498	.17481	.427	.99158	.379	.82653	31
30	.29621	3.37594	.31530	3.17159	.33460	2.98868	.35412	2.82391	30
31	.653	.37234	.562	.16838	.492	.98560	.445	.82130	29
32	.685	.36875	.594	.16517	.524	.98292	.477	.81870	28
33	.716	.36516	.626	.16197	.557	.98004	.510	.81610	27
34	.748	.36158	.658	.15877	.589	.97717	.543	.81350	26
35	.29780	3.35800	.31690	3.15558	.33621	2.97430	.35576	2.81091	25
36	.811	.35443	.722	.15140	.654	.97144	.608	.80833	24
37	.843	.35087	.754	.14822	.686	.96858	.641	.80574	23
38	.876	.34732	.786	.14505	.718	.96573	.674	.80316	22
39	.908	.34377	.818	.14288	.761	.96288	.707	.80059	21
40	.29938	3.34023	.31850	3.13972	.33783	2.96004	.35740	2.79802	20
41	.970	.33670	.882	.13658	.816	.95721	.772	.79545	19
42	.30001	.33317	.914	.13341	.848	.95437	.805	.79289	18
43	.033	.32965	.946	.13027	.881	.95155	.838	.79033	17
44	.065	.32614	.978	.12713	.913	.94872	.871	.78778	16
45	.30097	3.32264	.32010	3.12400	.33945	2.94591	.35904	2.78523	15
46	.128	.31914	.042	.12087	.978	.94309	.937	.78269	14
47	.160	.31565	.074	.11775	.34010	.94028	.969	.78014	13
48	.192	.31216	.106	.11464	.043	.93748	.36002	.77761	12
49	.224	.30868	.139	.11153	.076	.93468	.035	.77507	11
50	.30255	3.30521	.32171	3.10842	.34108	2.93189	.36068	2.77254	10
51	.287	.30174	.203	.10532	.140	.92910	.101	.77002	9
52	.319	.29829	.235	.10223	.173	.92632	.134	.76750	8
53	.351	.29483	.267	.09914	.205	.92354	.167	.76498	7
54	.382	.29139	.299	.09606	.238	.92076	.199	.76247	6
55	.30414	3.28795	.32331	3.09298	.34270	2.91799	.36232	2.76996	5
56	.446	.28452	.363	.08991	.303	.91523	.265	.75746	4
57	.478	.28109	.396	.08685	.335	.91246	.298	.75496	3
58	.509	.27767	.428	.08379	.368	.90971	.331	.75246	2
59	.541	.27426	.460	.08073	.400	.90696	.364	.74997	1
60	.30673	2.27086	.32492	2.07768	.34438	2.90421	.36397	2.74748	0
	Cot.	Tan.	Cot.	Tan.	Cot.	Tan.	Cot.	Tan.	M.

COPY AVAILABLE



ENGINEERING AID 3 & 2, VOLUME 1

M.	20°		21°		22°		23°		M.
	Tan.	Cot.	Tan.	Cot.	Tan.	Cot.	Tan.	Cot.	
0	0.36397	2.74748	0.38356	2.60509	0.40403	2.47509	0.42447	2.35585	60
1	.430	.74499	.420	.60283	.436	.47302	.482	.35395	59
2	.364	.74251	.453	.60057	.470	.47095	.516	.35205	58
3	.496	.74004	.487	.59831	.504	.46868	.551	.35015	57
4	.629	.73756	.520	.59606	.538	.46682	.585	.34825	56
5	.36562	2.73509	.38553	2.58381	.40572	2.46476	.42619	2.34636	55
6	.895	.73263	.557	.59156	.606	.46270	.654	.34447	54
7	.628	.73017	.620	.58932	.640	.46065	.688	.34258	53
8	.661	.72771	.654	.58708	.674	.45860	.722	.34069	52
9	.694	.72526	.687	.58484	.707	.45655	.757	.33881	51
10	.36727	2.72281	.38721	2.58291	.40741	2.45451	.42791	2.33693	50
11	.760	.72036	.754	.58038	.776	.45246	.826	.33505	49
12	.793	.71792	.787	.57815	.809	.45043	.860	.33317	48
13	.826	.71548	.821	.57593	.843	.44839	.894	.33130	47
14	.859	.71305	.854	.57371	.877	.44636	.929	.32943	46
15	.36892	2.71062	.38888	2.57150	.40911	2.44433	.42963	2.32756	45
16	.925	.70819	.921	.56928	.945	.44230	.998	.32570	44
17	.958	.70577	.955	.56707	.979	.44027	.43032	.32383	43
18	.991	.70335	.988	.56487	.41013	.43825	.067	.32197	42
19	.87024	.70094	.39022	.56266	.047	.43623	.101	.32012	41
20	.37057	2.69853	.39055	2.56046	.41081	2.43422	.43136	2.31826	40
21	.090	.69612	.089	.55827	.115	.43220	.170	.31641	39
22	.123	.69371	.122	.55608	.149	.43019	.205	.31456	38
23	.157	.69131	.156	.55389	.183	.42819	.239	.31271	37
24	.190	.68892	.190	.55170	.217	.42618	.274	.31086	36
25	.37223	2.68653	.39223	2.54952	.41251	2.42416	.43308	2.30902	35
26	.256	.68414	.257	.54734	.285	.42218	.343	.30718	34
27	.289	.68175	.290	.54516	.319	.42019	.378	.30534	33
28	.322	.67937	.324	.54299	.353	.41819	.412	.30351	32
29	.355	.67700	.357	.54082	.387	.41620	.447	.30167	31
30	.37388	2.67462	.39391	2.53865	.41421	2.41421	.43481	2.29984	30
31	.422	.67225	.425	.53648	.455	.41223	.516	.29801	29
32	.455	.66989	.458	.53432	.490	.41025	.550	.29619	28
33	.489	.66752	.492	.53217	.524	.40827	.585	.29437	27
34	.521	.66516	.526	.53001	.558	.40629	.620	.29254	26
35	.37654	2.66281	.39559	2.52786	.41592	2.40432	.43654	2.29073	25
36	.588	.66046	.593	.52571	.626	.40235	.689	.28891	24
37	.621	.65811	.626	.52357	.660	.40038	.724	.28710	23
38	.654	.65576	.660	.52142	.694	.39841	.758	.28528	22
39	.687	.65342	.694	.51929	.728	.39645	.793	.28346	21
40	.37720	2.65109	.39727	2.51715	.41763	2.39449	.43828	2.28167	20
41	.764	.64875	.761	.51502	.797	.39253	.862	.27987	19
42	.787	.64642	.795	.51289	.831	.39058	.897	.27806	18
43	.820	.64410	.829	.51076	.865	.38863	.932	.27626	17
44	.853	.64177	.862	.50864	.899	.38668	.966	.27447	16
45	.37887	2.63945	.39896	2.50652	.41933	2.38473	.44001	2.27267	15
46	.920	.63714	.930	.50440	.968	.38279	.036	.27088	14
47	.953	.63483	.963	.50229	.42072	.38084	.071	.26909	13
48	.986	.63252	.997	.50018	.036	.37891	.105	.26730	12
49	.38020	.63021	.40031	.49807	.070	.37697	.140	.26552	11
50	.38053	2.62791	.40065	2.49597	.42105	2.37594	.44175	2.26374	10
51	.086	.62561	.098	.49386	.119	.37311	.210	.26196	9
52	.120	.62332	.132	.49177	.173	.37118	.244	.26018	8
53	.153	.62103	.166	.48967	.207	.36925	.279	.25840	7
54	.186	.61874	.200	.48758	.242	.36733	.314	.25663	6
55	.38220	2.61644	.40234	2.48549	.42276	2.36541	.44349	2.25486	5
56	.253	.61418	.267	.48340	.310	.36349	.384	.25309	4
57	.286	.61190	.301	.48132	.345	.36158	.418	.25132	3
58	.320	.60963	.335	.47924	.379	.35967	.453	.24956	2
59	.353	.60736	.369	.47716	.413	.35776	.488	.24780	1
60	.38386	2.60609	.40403	2.47509	.42447	2.35585	.44823	2.24804	0
	Cot.	Tan.	Cot.	Tan.	Cot.	Tan.	Cot.	Tan.	M.
	60°		60°		60°		60°		

45.854

Appendix II—MATHEMATICS

M.	24°		25°		26°		27°		M.
	Tan.	Cot.	Tan.	Cot.	Tan.	Cot.	Tan.	Cot.	
0	0.44523	2.21604	0.46631	2.14451	0.48773	2.05030	0.50933	1.98261	60
1	.558	.24128	.676	.14288	.809	.04379	.989	.06120	59
2	.693	.21252	.812	.11125	.945	.04728	1.1026	.05079	58
3	.827	.20077	.937	.09663	1.081	.04577	1.263	.05335	57
4	.962	.20002	1.062	.08801	1.217	.04426	1.429	.05598	56
5	1.097	.20727	1.188	.08008	1.353	.04276	1.601	.05857	55
6	1.232	.21553	1.313	.07277	1.487	.04125	1.779	.06112	54
7	1.367	.22378	1.438	.06606	1.623	.03975	1.963	.06363	53
8	1.502	.23204	1.563	.06001	1.759	.03825	2.153	.06610	52
9	1.637	.23030	1.688	.05463	1.895	.03675	2.349	.06853	51
10	1.772	.23857	1.813	.04992	2.031	.03526	2.551	.07092	50
11	1.907	.24683	1.938	.04587	2.167	.03376	2.759	.07327	49
12	2.042	.25510	2.063	.04248	2.303	.03227	2.973	.07558	48
13	2.177	.26337	2.188	.03975	2.439	.03078	3.193	.07785	47
14	2.312	.27164	2.313	.03767	2.575	.02929	3.419	.08008	46
15	2.447	.27992	2.438	.03618	2.711	.02780	3.651	.08227	45
16	2.582	.28819	2.563	.03519	2.847	.02631	3.889	.08442	44
17	2.717	.29646	2.688	.03460	2.983	.02483	4.133	.08653	43
18	2.852	.30473	2.813	.03441	3.119	.02335	4.385	.08860	42
19	2.987	.31300	2.938	.03482	3.255	.02187	4.643	.09063	41
20	3.122	.32127	3.063	.03583	3.391	.02039	4.907	.09262	40
21	3.257	.32954	3.188	.03744	3.527	.01891	5.177	.09457	39
22	3.392	.33781	3.313	.03965	3.663	.01743	5.453	.09648	38
23	3.527	.34608	3.438	.04248	3.800	.01596	5.735	.09835	37
24	3.662	.35435	3.563	.04592	3.936	.01450	6.023	.10018	36
25	3.797	.36262	3.688	.04997	4.072	.01302	6.317	.10197	35
26	3.932	.37089	3.813	.05472	4.208	.01155	6.617	.10372	34
27	4.067	.37916	3.938	.06017	4.344	.01008	6.923	.10543	33
28	4.202	.38743	4.063	.06632	4.480	.00862	7.235	.10710	32
29	4.337	.39570	4.188	.07317	4.616	.00715	7.553	.10872	31
30	4.472	.40397	4.313	.08072	4.752	.00569	7.877	.11030	30
31	4.607	.41224	4.438	.08907	4.888	.00423	8.207	.11183	29
32	4.742	.42051	4.563	.09822	5.024	.00277	8.543	.11332	28
33	4.877	.42878	4.688	.10817	5.160	.00131	8.885	.11477	27
34	5.012	.43705	4.813	.11892	5.296	1.99986	9.233	.11618	26
35	5.147	.44532	4.938	.13047	5.432	1.99841	9.587	.11755	25
36	5.282	.45359	5.063	.14282	5.568	.09695	9.947	.11888	24
37	5.417	.46186	5.188	.15597	5.704	.09550	10.313	.12017	23
38	5.552	.47013	5.313	.16992	5.840	.09408	10.685	.12142	22
39	5.687	.47840	5.438	.18467	5.976	.09261	11.063	.12263	21
40	5.822	.48667	5.563	.20022	6.112	1.99116	11.447	.12380	20
41	5.957	.49494	5.688	.21657	6.248	.08972	11.837	.12493	19
42	6.092	.50321	5.813	.23372	6.384	.08828	12.233	.12602	18
43	6.227	.51148	5.938	.25167	6.520	.08684	12.635	.12707	17
44	6.362	.51975	6.063	.27042	6.656	.08540	13.043	.12808	16
45	6.497	.52802	6.188	.28997	6.792	1.98396	13.457	.12905	15
46	6.632	.53629	6.313	.31032	6.928	.08253	13.877	.13000	14
47	6.767	.54456	6.438	.33147	7.064	.08110	14.303	.13091	13
48	6.902	.55283	6.563	.35342	7.200	.07966	14.735	.13178	12
49	7.037	.56110	6.688	.37617	7.336	.07823	15.173	.13261	11
50	7.172	.56937	6.813	.40072	7.472	1.97681	15.617	.13340	10
51	7.307	.57764	6.938	.42707	7.608	.07538	16.067	.13415	9
52	7.442	.58591	7.063	.45432	7.744	.07395	16.523	.13487	8
53	7.577	.59418	7.188	.48247	7.880	.07253	16.985	.13555	7
54	7.712	.60245	7.313	.51152	8.016	.07111	17.453	.13620	6
55	7.847	.61072	7.438	.54147	8.152	1.96969	17.927	.13681	5
56	7.982	.61899	7.563	.57232	8.288	.06827	18.407	.13738	4
57	8.117	.62726	7.688	.60407	8.424	.06685	18.893	.13791	3
58	8.252	.63553	7.813	.63672	8.560	.06544	19.385	.13840	2
59	8.387	.64380	7.938	.67027	8.696	.06402	19.883	.13885	1
60	8.522	.65207	8.063	.70472	8.832	1.96281	20.387	.13927	0
	Cot.	Tan.	Cot.	Tan.	Cot.	Tan.	Cot.	Tan.	M.

45.855

BEST COPY AVAILABLE



ENGINEERING AID 3 & 2, VOLUME 1

M.	28°		29°		30°		31°		M.
	Tan.	Cot.	Tan.	Cot.	Tan.	Cot.	Tan.	Cot.	
0	0.53171	1.88073	0.55431	1.80405	0.57735	1.73205	0.60086	1.66428	60
1	208	.87941	469	.80281	774	.73089	126	.66318	59
2	246	.87809	507	.80158	813	.72973	165	.66209	58
3	283	.87677	545	.80034	851	.72857	205	.66099	57
4	320	.87546	583	.79911	890	.72741	245	.65990	56
5	.53358	1.87415	.55621	1.79758	.57929	1.73025	.60284	1.65881	55
6	395	.87283	659	.79665	968	.72509	324	.65772	54
7	432	.87152	697	.79542	.89007	.72393	364	.65663	53
8	470	.87021	736	.79419	046	.72278	403	.65554	52
9	507	.86891	774	.79296	085	.72163	443	.65445	51
10	.53545	1.86760	.55802	1.79174	.58124	1.72947	.60483	1.65337	50
11	582	.86630	860	.79051	162	.71932	522	.65228	49
12	620	.86499	898	.78929	201	.71817	562	.65120	48
13	657	.86369	926	.78807	240	.71702	602	.65011	47
14	694	.86239	964	.78685	279	.71588	642	.64903	46
15	.53732	1.86109	.56003	1.78563	.58318	1.71747	.60681	1.64795	45
16	769	.85979	041	.78441	357	.71558	721	.64687	44
17	807	.85850	079	.78319	396	.71444	761	.64579	43
18	844	.85720	117	.78198	435	.71329	801	.64471	42
19	882	.85591	156	.78077	474	.71215	841	.64363	41
20	.53920	1.85462	.56194	1.77955	.58513	1.70901	.60881	1.64256	40
21	957	.85333	212	.77834	532	.70787	921	.64148	39
22	995	.85204	270	.77713	591	.70673	960	.64041	38
23	.54032	.85075	309	.77592	631	.70560	.61000	.63934	37
24	070	.84946	347	.77471	670	.70446	040	.63826	36
25	.54107	1.84818	.56385	1.77351	.58709	1.70332	.61200	1.63719	35
26	145	.84689	424	.77230	748	.70219	120	.63612	34
27	183	.84561	462	.77110	787	.70106	160	.63505	33
28	220	.84433	501	.76990	826	.69992	200	.63398	32
29	258	.84305	539	.76869	865	.69879	240	.63292	31
30	.54296	1.84177	.56577	1.76749	.58905	1.69766	.61280	1.63185	30
31	333	.84049	616	.76629	944	.69653	320	.63079	29
32	371	.83922	654	.76510	983	.69541	360	.62972	28
33	409	.83794	693	.76390	.89022	.69428	400	.62866	27
34	446	.83667	731	.76271	061	.69316	440	.62760	26
35	.54484	1.83540	.56769	1.76151	.59101	1.69203	.61480	1.62654	25
36	522	.83413	808	.76032	140	.69091	520	.62548	24
37	560	.83286	846	.75913	179	.68979	561	.62442	23
38	597	.83159	885	.75794	218	.68866	601	.62336	22
39	635	.83033	923	.75675	258	.68754	641	.62230	21
40	.54673	1.82908	.56962	1.75556	.59297	1.69043	.61681	1.62125	20
41	711	.82780	.87000	.75437	334	.68931	721	.62019	19
42	748	.82654	039	.75319	376	.68819	761	.61914	18
43	786	.82528	078	.75200	415	.68708	801	.61808	17
44	824	.82402	116	.75082	454	.68596	842	.61703	16
45	.54862	1.82276	.57155	1.74964	.59494	1.68985	.61882	1.61598	15
46	900	.82150	193	.74846	533	.68974	922	.61493	14
47	938	.82025	232	.74728	573	.68863	962	.61388	13
48	975	.81899	271	.74610	612	.68752	.62003	.61283	12
49	.55013	.81774	309	.74492	651	.68641	043	.61178	11
50	.55051	1.81649	.57348	1.74375	.59691	1.67530	.62063	1.61074	10
51	089	.81524	386	.74257	730	.67419	124	.60970	9
52	127	.81399	425	.74140	770	.67309	164	.60865	8
53	165	.81274	464	.74022	809	.67198	204	.60761	7
54	203	.81150	503	.73905	849	.67088	244	.60657	6
55	.55241	1.81025	.57541	1.73788	.59888	1.66978	.62285	1.60553	5
56	279	.80901	580	.73671	928	.66867	325	.60449	4
57	317	.80777	619	.73555	967	.66757	366	.60345	3
58	355	.80653	657	.73438	.60007	.66647	406	.60241	2
59	393	.80528	696	.73321	046	.66538	446	.60137	1
60	.55431	1.80405	.57735	1.73205	.60086	1.66428	.62487	1.60033	0
	Cot.	Tan.	Cot.	Tan.	Cot.	Tan.	Cot.	Tan.	M.
	61°		60°		59°		58°		

45.856

Appendix II—MATHEMATICS

M.	32°		33°		34°		35°		M.
	Tan.	Cot.	Tan.	Cot.	Tan.	Cot.	Tan.	Cot.	
0	0.62187	1.60033	0.64941	1.53984	0.67451	1.48256	0.70021	1.42815	60
1	.527	.59970	.982	.53588	.493	.48163	.064	.42728	59
2	.658	.59826	.65024	.53791	.536	.48070	.107	.42638	58
3	.608	.59723	.063	.53693	.578	.47977	.151	.42550	57
4	.649	.59620	.106	.53595	.620	.47883	.194	.42462	56
5	.62659	1.59517	.65148	1.53497	.67643	1.47792	.70238	1.42374	55
6	.730	.59414	.189	.53400	.705	.47699	.251	.42286	54
7	.770	.59311	.231	.53202	.748	.47607	.325	.42198	53
8	.811	.59208	.272	.53205	.790	.47514	.368	.42110	52
9	.852	.59105	.314	.53107	.832	.47422	.412	.42022	51
10	.62892	1.59002	.65355	1.53010	.67875	1.47330	.70455	1.41934	50
11	.933	.58900	.307	.52913	.917	.47238	.499	.41847	49
12	.973	.58797	.439	.52816	.960	.47146	.542	.41759	48
13	.63044	.58695	.480	.52719	.68002	.47053	.586	.41672	47
14	.055	.58593	.521	.52622	.045	.46962	.629	.41584	46
15	.63095	1.59100	.65543	1.52525	.68058	1.46870	.70673	1.41497	45
16	.136	.58388	.044	.52429	.130	.46778	.717	.41409	44
17	.177	.58286	.646	.52332	.173	.46686	.760	.41322	43
18	.217	.58184	.688	.52235	.215	.46595	.804	.41235	42
19	.258	.58083	.729	.52139	.258	.46503	.848	.41148	41
20	.63799	1.57981	.65771	1.52043	.68301	1.46411	.70891	1.41061	40
21	.340	.57879	.813	.51946	.343	.46320	.935	.40974	39
22	.390	.57778	.854	.51850	.386	.46229	.979	.40887	38
23	.421	.57676	.896	.51754	.429	.46137	.71023	.40800	37
24	.462	.57575	.938	.51658	.471	.46046	.066	.40714	36
25	.63503	1.57474	.65930	1.51562	.68514	1.45955	.71110	1.40827	35
26	.544	.57372	.66021	.51466	.537	.45864	.154	.40540	34
27	.584	.57271	.063	.51370	.600	.45773	.198	.40454	33
28	.625	.57170	.105	.51275	.642	.45682	.242	.40367	32
29	.666	.57069	.147	.51179	.685	.45592	.285	.40281	31
30	.63707	1.56969	.66189	1.51084	.68728	1.45501	.71329	1.40195	30
31	.748	.56868	.230	.50988	.771	.45410	.373	.40109	29
32	.789	.56767	.272	.50893	.814	.45320	.417	.40022	28
33	.830	.56667	.314	.50797	.857	.45229	.461	.39936	27
34	.871	.56566	.356	.50702	.900	.45139	.505	.39850	26
35	.63912	1.56466	.66398	1.50607	.68942	1.45049	.71549	1.39764	25
36	.953	.56366	.440	.50512	.955	.44958	.593	.39679	24
37	.994	.56265	.482	.50417	.0023	.44868	.637	.39593	23
38	.64035	.56165	.524	.50322	.071	.44778	.681	.39507	22
39	.076	.56065	.566	.50228	.114	.44688	.725	.39421	21
40	.64117	1.55966	.66606	1.50133	.69157	1.44598	.71769	1.39336	20
41	.158	.55866	.650	.50038	.200	.44508	.813	.39250	19
42	.199	.55766	.692	.49944	.243	.44418	.857	.39165	18
43	.240	.55666	.734	.49849	.286	.44329	.901	.39079	17
44	.281	.55567	.776	.49755	.329	.44239	.946	.38994	16
45	.64322	1.55467	.66816	1.49661	.69372	1.44149	.71990	1.38909	15
46	.363	.55368	.800	.49566	.416	.44060	.72034	.38824	14
47	.404	.55269	.902	.49472	.459	.43970	.078	.38738	13
48	.446	.55170	.944	.49378	.502	.43881	.122	.38653	12
49	.487	.55071	.986	.49284	.545	.43792	.167	.38568	11
50	.64528	1.54972	.67028	1.49190	.69588	1.43703	.72211	1.38484	10
51	.569	.54873	.071	.49097	.631	.43614	.255	.38399	9
52	.610	.54774	.113	.49003	.675	.43525	.299	.38314	8
53	.652	.54675	.155	.48909	.718	.43436	.344	.38229	7
54	.693	.54576	.197	.48816	.761	.43347	.388	.38145	6
55	.64734	1.54478	.67239	1.48722	.69804	1.43258	.72432	1.38060	5
56	.775	.54379	.282	.48629	.847	.43169	.477	.37976	4
57	.817	.54281	.324	.48536	.891	.43080	.521	.37891	3
58	.858	.54183	.366	.48442	.934	.42992	.565	.37807	2
59	.899	.54085	.408	.48349	.977	.42903	.610	.37722	1
60	.64941	1.53986	.67451	1.48256	.70021	1.42815	.72654	1.37638	0
	Cot.	Tan.	Cot.	Tan.	Cot.	Tan.	Cot.	Tan.	M.

BEST COPY AVAILABLE

ENGINEERING AID 3 & 2, VOLUME 1

M.	36°		37°		38°		39°		M.
	Tan.	Cot.	Tan.	Cot.	Tan.	Cot.	Tan.	Cot.	
0	0.72654	1.37638	0.75355	1.32704	0.78129	1.2794	0.80978	1.21490	60
1	699	.37354	401	.32624	175	.27917	.81027	.23416	59
2	743	.37470	447	.32544	222	.27841	075	.23343	58
3	788	.37526	492	.32464	269	.27764	123	.23270	57
4	832	.37582	538	.32384	316	.27688	171	.23196	56
5	.72877	1.37218	.75584	1.32304	.78363	1.27611	.81220	1.23123	55
6	921	.37134	629	.32224	410	.27535	263	.23050	54
7	966	.37250	675	.32144	457	.27458	316	.22977	53
8	.73010	.36957	721	.32064	504	.27382	361	.22904	52
9	055	.36883	767	.31984	551	.27306	413	.22831	51
10	.73100	1.36800	.75812	1.31904	.78598	1.27230	.81461	1.22758	50
11	144	.36716	858	.31825	645	.27153	510	.22685	49
12	189	.36633	904	.31745	692	.27077	558	.22612	48
13	234	.36549	950	.31666	739	.27001	606	.22539	47
14	278	.36466	996	.31586	786	.26925	655	.22467	46
15	.73323	1.36383	.76042	1.31507	.78834	1.26849	.81703	1.22394	45
16	368	.36300	098	.31427	831	.26774	732	.22321	44
17	413	.36217	134	.31348	978	.26698	800	.22249	43
18	457	.36134	180	.31259	975	.26622	819	.22176	42
19	502	.36051	226	.31190	.79022	.26546	838	.22104	41
20	.73547	1.35968	.76272	1.31110	.79070	1.26471	.81916	1.22031	40
21	592	.35885	318	.31031	117	.26395	995	.21959	39
22	637	.35802	364	.30952	164	.26319	.82014	.21886	38
23	681	.35719	410	.30873	212	.26244	072	.21814	37
24	726	.35637	456	.30795	259	.26169	141	.21742	36
25	.73771	1.3554	.76502	1.30716	.79306	1.26093	.82190	1.21670	35
26	816	.35472	518	.30637	354	.26018	268	.21598	34
27	861	.35389	594	.30558	401	.25943	227	.21526	33
28	906	.35307	640	.30480	449	.25867	386	.21454	32
29	951	.35244	686	.30401	496	.25792	385	.21382	31
30	.73996	1.35142	.76731	1.30232	.79544	1.25717	.82434	1.21310	30
31	74041	.35060	779	.30214	501	.25642	463	.21238	29
32	086	.34978	825	.30166	689	.25567	531	.21166	28
33	131	.34896	871	.30057	626	.25492	580	.21094	27
34	176	.34814	918	.30009	734	.25417	629	.21023	26
35	.74221	1.34732	.76964	1.29921	.79781	1.25343	.82678	1.20951	25
36	267	.34650	.77010	.29853	829	.25268	727	.20879	24
37	312	.34568	057	.29775	877	.25193	776	.20806	23
38	357	.34487	103	.29696	974	.25118	825	.20736	22
39	402	.34405	149	.29618	972	.25044	874	.20665	21
40	.74447	1.34323	.77196	1.29541	.80020	1.24969	.82923	1.20903	20
41	492	.34242	242	.29463	067	.24895	972	.20832	19
42	538	.34160	289	.29385	115	.24820	.83022	.20761	18
43	533	.34079	335	.29307	163	.24746	071	.20690	17
44	628	.33998	382	.29229	211	.24672	120	.20618	16
45	.74674	1.33918	.77428	1.29158	.80258	1.24597	.83169	1.20237	15
46	719	.33836	475	.29074	306	.24523	218	.20166	14
47	764	.33754	521	.28997	354	.24449	268	.20095	13
48	810	.33673	568	.28919	402	.24375	317	.20024	12
49	858	.33592	615	.28842	450	.24301	366	.19953	11
50	.74900	1.33511	.77661	1.28764	.80498	1.24327	.83416	1.19882	10
51	946	.33430	708	.28687	516	.24253	465	.19811	9
52	991	.33349	754	.28610	564	.24179	514	.19740	8
53	.75037	.33268	801	.28533	642	.24105	564	.19669	7
54	083	.33187	848	.28456	690	.24031	613	.19598	6
55	.75128	1.33107	.77895	1.28379	.80738	1.23858	.83662	1.19528	5
56	173	.33026	941	.28302	786	.23784	712	.19457	4
57	219	.32946	988	.28225	834	.23710	761	.19387	3
58	264	.32865	.78035	.28148	882	.23637	811	.19316	2
59	310	.32785	082	.28071	930	.23563	860	.19246	1
60	.75355	1.32704	.78129	1.27994	.80978	1.23490	.83910	1.19178	0
	Cot.	Tan.	Cot.	Tan.	Cot.	Tan.	Cot.	Tan.	M.

45.858

268

Appendix II—MATHEMATICS

M.	40°		41°		42°		43°		M.
	Tan.	Cot.	Tan.	Cot.	Tan.	Cot.	Tan.	Cot.	
0	0.83910	1.19178	0.89279	1.18037	0.90040	1.11081	0.93282	1.07237	60
1	980	.19105	980	.14989	093	.10996	308	.07174	59
2	.84080	.19035	.87031	.14902	146	.10931	360	.07112	58
3	059	.18964	.82	.14834	199	.10867	415	.07049	57
4	108	.18894	133	.14767	251	.10802	469	.06987	56
5	.84136	1.18324	.87184	1.14689	.90304	1.10737	.93524	1.06925	55
6	206	.18754	236	.14632	357	.10672	578	.06862	54
7	258	.18684	287	.14565	410	.10607	633	.06800	53
8	307	.18614	338	.14498	463	.10543	688	.06738	52
9	357	.18544	389	.14430	516	.10478	742	.06676	51
10	.84407	1.18474	.87441	1.14363	.90569	1.10414	.93797	1.06613	50
11	457	.18404	492	.14296	621	.10349	852	.06551	49
12	507	.18334	543	.14229	674	.10285	906	.06489	48
13	556	.18264	595	.14163	727	.10220	961	.06427	47
14	606	.18194	646	.14095	781	.10156	.94016	.06365	46
15	.84658	1.18125	.87698	1.14028	.90834	1.10091	.94071	1.06303	45
16	706	.18055	779	.13961	837	.10027	125	.06241	44
17	756	.17986	801	.13894	890	.09963	180	.06179	43
18	806	.17916	852	.13828	943	.09899	235	.06117	42
19	856	.17846	904	.13761	.91046	.09834	290	.06056	41
20	.84908	1.17777	.87955	1.13694	.91099	1.09770	.94345	1.05994	40
21	956	.17708	.84727	.13627	153	.09708	400	.05932	39
22	.85006	.17638	059	.13561	206	.09642	455	.05870	38
23	057	.17569	110	.13494	259	.09578	510	.05809	37
24	107	.17500	162	.13428	313	.09514	565	.05747	36
25	.85157	1.17430	.88214	1.13361	.91366	1.09450	.94620	1.05685	35
26	207	.17361	265	.13295	419	.09386	676	.05624	34
27	257	.17292	317	.13228	473	.09322	731	.05562	33
28	308	.17223	369	.13162	526	.09258	786	.05501	32
29	358	.17154	431	.13096	580	.09195	841	.05439	31
30	.85498	1.17085	.88473	1.13029	.91633	1.09131	.94896	1.05378	30
31	458	.17016	524	.12963	637	.09067	952	.05317	29
32	509	.16947	576	.12897	740	.09003	.93077	.05255	28
33	559	.16878	628	.12831	794	.08940	052	.05194	27
34	609	.16809	680	.12765	847	.08876	118	.05133	26
35	.85660	1.16741	.88732	1.12699	.91901	1.08813	.95173	1.05072	25
36	710	.16672	784	.12633	955	.08749	229	.05010	24
37	761	.16603	836	.12567	.92008	.08686	284	.04949	23
38	811	.16535	888	.12501	062	.08622	340	.04889	22
39	862	.16466	940	.12435	116	.08559	395	.04827	21
40	.85912	1.16398	.88992	1.12369	.92170	1.08496	.95451	1.04766	20
41	963	.16329	.89215	.12303	224	.08432	508	.04705	19
42	.86014	.16261	097	.12238	277	.08368	562	.04644	18
43	064	.16192	149	.12172	331	.08306	618	.04583	17
44	115	.16124	201	.12106	385	.08243	673	.04522	16
45	.86166	1.16056	.89253	1.12041	.92439	1.08179	.95729	1.04461	15
46	216	.15987	306	.11975	493	.08116	735	.04401	14
47	267	.15919	358	.11909	547	.08053	811	.04340	13
48	318	.15851	410	.11844	601	.07990	897	.04279	12
49	368	.15783	463	.11778	655	.07927	952	.04218	11
50	.86419	1.15715	.89515	1.11713	.92709	1.07864	.96008	1.04158	10
51	470	.15647	567	.11648	703	.07801	064	.04097	9
52	521	.15579	629	.11582	817	.07738	120	.04036	8
53	572	.15511	672	.11517	872	.07676	176	.03976	7
54	623	.15443	725	.11452	926	.07613	232	.03915	6
55	.86674	1.15375	.89777	1.11387	.92990	1.07550	.96285	1.03855	5
56	725	.15308	880	.11321	.93034	.07487	344	.03794	4
57	776	.15240	933	.11256	088	.07425	400	.03734	3
58	827	.15172	985	.11191	143	.07362	457	.03674	2
59	878	.15104	938	.11126	197	.07299	513	.03613	1
60	.86929	1.15037	.90040	1.11061	.93352	1.07237	.96569	1.03553	0
	Cot.	Tan.	Cot.	Tan.	Cot.	Tan.	Cot.	Tan.	M.
		40°		41°		42°		43°	

BEST COPY AVAILABLE

ENGINEERING AID 3 & 2, VOLUME 1

M.	44°		M.	M.	44°		M.	M.	44°		M.
	Tan.	Cot.			Tan.	Cot.			Tan.	Cot.	
0	0.96569	1.03553	60	20	0.97700	1.02355	40	40	0.99843	1.01170	20
1	625	.03493	59	21	756	.02295	39	41	901	.01112	19
2	681	.03433	58	22	813	.02216	38	42	958	.01053	18
3	738	.03372	57	23	870	.02176	37	43	.99016	.00994	17
4	794	.03312	56	24	927	.02117	36	44	073	.00935	16
5	.96850	1.03252	55	25	.97984	1.02057	35	45	.99131	1.00876	15
6	907	.03192	54	26	.98041	.01998	34	46	189	.00918	14
7	963	.03132	53	27	098	.01939	33	47	247	.00759	13
8	.97020	.03072	52	28	155	.01879	32	48	304	.00701	12
9	076	.03012	51	29	213	.01820	31	49	362	.00642	11
10	.97133	1.02952	50	30	.98270	1.01761	30	50	.99420	1.00593	10
11	189	.02892	49	31	327	.01702	29	51	478	.00525	9
12	246	.02832	48	32	384	.01642	28	52	536	.00467	8
13	.302	.02772	47	33	441	.01583	27	53	594	.00408	7
14	359	.02713	46	34	499	.01524	26	54	652	.00350	6
15	.97416	1.02653	45	35	.98556	1.01463	25	55	.99710	1.00291	5
16	472	.02593	44	36	613	.01406	24	56	708	.00233	4
17	529	.02533	43	37	671	.01347	23	57	826	.00175	3
18	586	.02474	42	38	728	.01288	22	58	884	.00116	2
19	643	.02414	41	39	786	.01229	21	59	942	.00058	1
20	.97700	1.02355	40	40	.98843	1.01170	20	60	1.00000	1.00000	0
	Cot.	Tan.	M.		Cot.	Tan.	M.		Cot.	Tan.	M.
		45°				45°				45°	

45.860

270

APPENDIX III

THE METRIC SYSTEM

The metric system was developed by French scientists in 1790 and was specifically designed to be an easily used system of weights and measures to benefit science, industry, and commerce. The metric system is calculated entirely in powers of 10, so one need not work with the various mathematical bases used with the English system, such as 12 inches to a foot, 3 feet to a yard, and 5280 feet to a mile.

The system is based on the "meter" which is one ten-millionth of the distance from the Equator to the North Pole. It is possible to develop worldwide standards from this base of measurement. The metric system of weights is based on the gram, which is the weight of a specific quantity of water.

Soon after the system was developed scientists over the world adopted it and were able to deal with the mathematics of their experiments more easily. The data and particulars of their work could be understood by other scientists anywhere in the world. During the early 19th century many European nations adopted the new system for engineering and commerce. It was possible for these countries to trade manufactured goods with one another without worrying whether it would be possible to repair machinery from another country without also buying special wrenches and measuring tools. Countries could buy and sell machine tools and other sophisticated and precision machinery without troublesome modifications or alterations. It was much easier to teach the metric system, since meters can be changed to kilometers or centimeters with the movement of a decimal point, which is roughly like being able to convert yards to miles or inches by adding zeros and a decimal instead of multiplying by 1760 or dividing by 36.

With the exception of the United States, all the industrialized nations of the world have adopted the metric system. Even England and Canada are changing from their traditional systems of measure, and the metric system will be almost universal by 1980.

Although the metric system has not been officially legislated by the Congress, the metric system is becoming more prominent in this country. Most automobile mechanics own some metric wrenches to work on foreign cars or foreign components in American cars. Almost all photographic equipment is built to metric standards. Chemicals and drugs are usually sold in metric quantities, and "calorie counters" are using a metric unit of thermal energy.

Because we are allied with countries who use the metric system, much of our military information is in metric terms. Military maps use meters and kilometers instead of miles, and many weapons are in metric sizes, such as 7.62 mm, 20 mm, 40 mm, 75 mm, and 155 mm. Interchange of military equipment has caused a mixture of metric and English measure equipment since World War I when the army adopted the French 75 mm field gun, and World War II when the Navy procured the Swedish 40 mm Bofors and the Swiss 20 mm Oerlikon heavy machine guns.

It is inevitable that the United States will officially adopt the metric system. Exactly when this happens and how rapidly the changeover will depend on economics, since the expense of retooling our industry and commerce to new measurements will be very great. The cost of conversion will be offset by increased earnings from selling machinery and products overseas. Another benefit is that scientists use the metric system, but their calculations now have to be

translated into English measure to be used by industry. With adoption of the metric system ideas can go directly from the drawing board to the assembly line.

The Navy will be using the metric system more during the next few years. Although you will find it easier to solve problems using this system, at first you will find it difficult to visualize or to estimate quantities in unfamiliar units of measure.

Fortunately, many metric units can be related to equivalent units in the English system.

The meter which is the basic unit is approximately one-tenth longer than a yard.

The basic unit of volume, the liter, is approximately one quart. The gram is the weight of a cubic centimeter, or milliliter, of pure water and is the basic unit of weight. As a common weight though, the kilogram, or kilo, which equals the weight of a liter of water, weighs 2.2 pounds. The cubic centimeter (cc) is used where we would use the square inch, and where we measure by the fluid ounce, the metric system employs the milliliter (ml). For power measure the metric system uses the kilowatt (kW), which is approximately 1.3 horsepower.

In terms of distance, a land mile is eight-fifths of a kilometer and a nautical mile is 1.852 kilometers, or nearly 2 kilometers.

A basic metric expression of pressure is the kilogram per square centimeter, which is 14.2 psi, nearly 1 atmosphere of pressure.

When working on foreign machinery, you may notice that your half-inch, three-quarter inch, and one-inch wrenches will fit many of the bolts. These sizes correspond to 13 mm, 19 mm, and 26 mm respectively in the metric system, and are very popular because they are interchangeable. The 13/16-inch spark plug wrench, which is standard in this country, is intended to fit a 20 mm nut.

The basic quantities of the metric system are multiplied or divided by powers of 10 to give other workable values. We cannot easily measure machine parts in terms of a meter, so the millimeter, or one-thousandth of a meter is used. For very fine measure the micron, also called the micrometer, can be used. It is one-millionth part of a meter, or one-thousandth of a millimeter. For small weights the milligram, one-thousandth of a gram is used. All of these multiples are expressed with standard prefixes taken from Latin:

micro	= 1/1,000,000
milli	= 1/1,000
centi	= 1/100
*deci	= 1/10
*deca	= 10
*hecto	= 100
kilo	= 1,000
*myria	= 10,000
mega	= 1,000,000

*Rarely used

Over the next few years the metric system will become more used by the Navy as well as by the civilian world. You will find it easy to work with once you have mastered the basic terms. It will be difficult to translate values from our present system to the metric system, but this operation will become unnecessary once the new measurements are totally adopted.

Tables of equivalent English measure and metric equivalents are essential when you work simultaneously with both systems. The table which follows shows the equivalent measures of the two systems. The columns on the left have the equivalent values which are accurate enough for most work, and on the right are the multiples used to convert the values with a high degree of accuracy.

APPENDIX IV

GLOSSARY

Many terms have different meanings when used in relation to different subjects. The definitions in this glossary of terms are meant to be utilized in conjunction with the subject matter within this text.

ACUTE ANGLE—An angle of less than 90° .

ALGEBRA—That branch of mathematics which treats of the relations and properties of numbers by means of letters, signs of operation, and other symbols. Algebra includes solution of equations, polynomials, verbal problems, graphs, and so on.

ANGLE—A figure formed by two lines or planes extending from or diverging at the same point.

ANTILOG—The result when a logarithm is converted to a number.

ARC—A portion of the circumference of a circle.

ARCHITECT'S SCALE—Scale used when dimensions or measurements are to be expressed in feet and inches.

ARITHMETIC—The art of computation by the use of positive real numbers.

AUXILIARY PLANE—A plane (NOT one of the normal planes) from which the auxiliary view is projected.

AUXILIARY VIEW—A view which is not on one of the normal planes of projection. It is used to show features of an object which do not appear in their true size and shape in the normal views.

AXONOMETRIC—A single view of an object depicting all three dimensions. The projection lines are parallel to each other and perpendicular to the plane of projection. The object is inclined to the plane of projection, thereby allowing the viewer to see three dimensions.

BILL OF MATERIALS—List of materials needed for a given project placed directly above the title block; not normally found on construction drawings.

BISECT—To divide into two equal parts.

BORDER LINES—Dark lines defining the inside edge of the margin on a drawing.

BREAK LINES—Lines used to reduce graphic size of an object generally to conserve paper space. There are two types:

Long—Thin ruled line with freehand zigzag.
Short—Thick wavy freehand line.

BROKEN SECTION—See partial section.

CABINET PROJECTION—A single view of an object having one face in orthographic projection and depicting all three dimensions (length, width, and height). The projection lines are parallel and at an oblique angle with the plane of projection (generally 45°). The lengths of the receding lines are foreshortened to make the object appear optically correct.

CAVALIER PROJECTION—A single view of an object having one face in orthographic projection and showing all three dimensions. The projection lines are parallel and at an

oblique angle with the plane of projection (generally 45°). The lengths of all object lines are drawn to scale and do not appear optically correct.

CENTERLINES—Lines that indicate the center of a circle, arc, or any symmetrical object; consist of alternate long and short dashes evenly spaced.

CHARACTERISTIC—The whole number part of a logarithm; indicates position of the decimal point.

CIRCLE—A plane closed figure having every point on its circumference (perimeter) equidistant from its center.

CIRCUMFERENCE—The length of a line which forms a circle.

CIRCUMSCRIBED—A figure that completely encloses another figure.

COMMON LOGARITHMS—Logarithms with 10 as a base.

COMPASS—PIVOT JOINT, BOW, DROP BOW, BEAM—Instrument used to draw circles or arcs of circles.

COMPOUND CURVE—A curve composed of a series of successive tangent circular arcs.

CONE—A solid figure that tapers uniformly from a circular base to a point.

CONSTRUCTION LINES—Lightly drawn lines used in the preliminary layout of a drawing.

COSECANT—The ratio between the hypotenuse and the side opposite an angle in a right triangle:
 $\text{csc} = \text{hyp}/\text{opp}$

COSINE—The ratio between the side adjacent to an angle and the hypotenuse of a right triangle:
 $\text{cos} = \text{adj}/\text{hyp}$

COTANGENT—The ratio between the side adjacent and the side opposite an angle in a right triangle:
 $\text{cot} = \text{opp}/\text{adj}$

CUBE—Rectangular solid figure in which all six faces are square.

CUTTING PLANE LINES—Thick heavy lines used to indicate a plane or planes in which a sectional view is taken.

CYLINDER—A solid figure with two equal circular bases.

DATUM LINES—Dark medium lines consisting of one long and two short dashes evenly spaced; used to define a line or plane of reference.

DECIMAL—The result of dividing the dividend of a fraction by the divisor; for example, $1/2 = .5$, $3/8 = .375$, $17/100 = .17$.

DEGREE—A 360th part of the circumference of a circle; also, a 360th part of a revolution about a point; used to define the size of an angle.

DESIGN MANUALS (DM's)—Publications containing guidelines set forth by the Naval Facilities Engineering Command.

DETAIL PAPER—Heavy opaque, buff, or neutral green drawing paper that takes pencil well.

DIAGONAL—A line which connects any two nonadjacent corners of a plane figure.

DIAMETER—A straight line passing through the center of a circle or sphere whose ends terminate at the circumference or surface.

DIMENSION LINE—A thin, unbroken line (except in the case of structural drafting) with each end terminating with an arrowhead; used to define the dimensions of an object. Dimensions are placed above line except in structural drafting where line is broken and dimension placed in break.

DISPLAY CHART—Chart used to convey data to nontechnical audiences.

DIVIDERS—Instrument used to transfer distances.

Appendix IV—GLOSSARY

DRAFTING MEDIA—Materials used to draw on. Basically, three types are used: paper, cloth, and film.

ELLIPSE—A plane closed curve having the sum of the distances from any point on the curve to two fixed points a constant.

ENGINEER'S SCALE—A scale used whenever dimensions are in feet and decimal parts of a foot, or when the scale ratio is a multiple of 10.

EQUILATERAL—A polygon with sides of equal length.

EXPONENT—A small number or symbol placed above and to the right of a mathematical quantity to indicate the number of times the quantity is to be multiplied by itself; for example, $3^3 = 3 \cdot 3 \cdot 3 = 27$.

EXTENSION LINES—Thin, unbroken lines used to extend dimensions beyond the outline of a view so they can be more easily read.

FINITE DISTANCE—A defining measurable distance.

FIRST ANGLE PROJECTION—Multiview projection commonly used in Europe in which the top view is below the front view and the right side of the object is toward the left side of the object.

FORESHORTENING—The reduction in length of receding lines in an oblique projection allowing the object to appear to be optically correct.

FORMAT—The systematic arrangement of drawing sheet space to standardize the location of required information.

FRACTION—A division indicated by placing the dividend over the divisor with a line between them.

Proper Fraction - $\frac{3}{4}$

Improper Fraction - $\frac{3}{2} = 1 \frac{1}{2}$

Mixed Fraction - $1 \frac{7}{8}$

FRENCH CURVE—Instrument used to draw smooth irregular curves.

FREEHAND DRAFTING—Any drawing in which the pen or pencil is guided solely by hand.

FRUSTRUM OF A CONE—The portion of a cone which remains after cutting off the upper part by a plane parallel to the base.

FRUSTRUM OF A PYRAMID—This portion of a pyramid which remains after cutting off the top by a plane parallel to the base.

FULL SECTION—A sectional view which passes entirely through the object.

GEOMETRY—That branch of mathematics which investigates the relations, properties, and measurement of solids, surfaces, lines, and angles; it also deals with the theory of space and of figures in space.

GRAPH PAPER—Gridded paper in a variety of scales and patterns utilized for plotting, sketching, and drawing.

HALF SECTION—A sectional view which passes halfway through the object; used when the shape of one half is identical to the other half.

HATCHING—Lines which are drawn on the internal surface of sectional views; used to define the kind or type of material of which the sectioned surface consists.

HEPTAGON—A polygon bounded by seven sides.

HEXAGON—A polygon bounded by six sides.

HIDDEN LINES—Thick, short, dashed lines indicating the hidden features of an object being drawn.

HORN CENTER—Device used to prevent the compass needle from making holes in a drawing.

ILLUSTRATION BOARD—Smooth white paper with a cardboard backing, used for signs, charts, mounting of maps, photos or drawings that require a strong backing.

275

IMAGE PLANE—See plane of projection.

INDIA INK—Drawing ink consisting of a pigment (usually powdered carbon) suspended in an ammonia-water solution.

INFINITE DISTANCE—An indefinite unmeasurable distance; i.e., parallel lines are said to converge at infinity.

INSCRIBED FIGURE—A figure that is completely enclosed by another figure.

IRRATIONAL NUMBER—Real number which cannot be expressed in the ratio of two integers; for example, $\sqrt{3}$, π .

IRREGULAR POLYGON—A nonequilateral polygon.

ISOMETRIC AXIS—Axis used in isometric projections and drawings. Each line in the axis forms an angle of 120° with the adjacent line, easily constructed with a straightedge and a 30-60 degree triangle.

ISOMETRIC DRAWING—Same as an isometric projection except that the dimensions of the object drawn are scaled and not projected.

ISOMETRIC PROJECTION—A single view projection of an object showing three dimensions. The object is inclined so all faces make the same angle with the plane of projection making all lines and surfaces foreshortened in the same ratio. This allows one scale to be used throughout.

ISOSCELES TRIANGLE—A triangle having two equal sides.

LATERAL FACES—Faces or surfaces forming the sides of a solid figure; also known as lateral surfaces.

LATERAL SURFACES—See lateral faces.

LAW OF COSINES—A law of mathematics that states that, in any triangle, the square of one side is equal to the sum of the squares of the other two sides minus twice the product of these

two sides multiplied by the cosine of the angle between them. This statement may be expressed in formula form as follows:

$$a^2 = b^2 + c^2 - 2bc \cos A$$

$$b^2 = a^2 + c^2 - 2ac \cos B$$

$$c^2 = a^2 + b^2 - 2ab \cos C$$

LAW OF SINES—A law of mathematics that states that the lengths of the sides of any triangle are proportional to the sines of their opposite angles. It is expressed in formula form as follows:

$$\frac{a}{\sin A} = \frac{b}{\sin B} = \frac{c}{\sin C}$$

LAW OF TANGENTS—A law of mathematics that states that, in any triangle, the difference between two sides is to their sum as the tangent of half the difference of the opposite angles is to the tangent of half their sum. For any pair of sides— a , side a and side b —the law may be expressed as follows:

$$\frac{a - b}{a + b} = \frac{\tan 1/2(A - B)}{\tan 1/2(A + B)}$$

LEADER LINES—Thin unbroken lines used to connect numbers, references or notes to appropriate surfaces or lines.

LINE OF SYMMETRY—A line which divides an object into two equal identical parts; used only when both halves of an object are identical.

LINES OF SIGHT—See projection lines.

LOGARITHM—The exponent of the power to which a fixed number, called the base, must be raised to produce a given number; for example, common log $.3979 = 10^{-.3979} = 2.5$

MANTISSA—The decimal part of a logarithm; indicates a sequence of numbers without regard to the decimal point.

MAP MEASURE—Instrument used when lengths of irregular outlines are measured.

Appendix IV—GLOSSARY

MATCH LINES—Lines used when an object is too large to fit on a single drawing sheet and must be continued on another sheet. The points where the object stops on one sheet and continues on the next sheet must be identified with corresponding match lines. They are medium weight lines indicated with the words **MATCH LINE** and referenced to the sheet which has the corresponding match line.

MATHEMATICS—The science which deals with the relationships which exist between quantities and operations, and with methods by which these relationships can be applied to determine unknown quantities from given or measured data.

MECHANICAL DRAFTING—Any drawing in which the pen or pencil is guided by a mechanical device.

MILITARY STANDARDS (MIL-STD's)—Instructions set forth by the Department of Defense that all armed services are required to follow. Only a few of these standards refer directly to drafting.

MINUTE—A 60th part of a degree used to define the size of an angle.

NATURAL LOGARITHMS—Logarithms with e (2.17828) as a base.

NONCIRCULAR CURVE—A curve composed of a series of extremely small circular arcs of varying radii.

NON-NORMAL LINE—A line which is oblique to one or more of the planes of projection.

NORMAL LINE—A line which is parallel to two planes or projection and perpendicular to the third. A line or plane which forms a 90° angle with another line or plane is normal to that line or plane.

OBLIQUE PROJECTION—A single view of an object showing three dimensions (length, width, and height).

OBLONG—A nonequilateral rectangle.

OBTUSE ANGLE—An angle greater than 90° .

OCTAGON—A polygon bounded by eight sides.

OGEE CURVE—Any curve composed of two consecutive tangent circular arcs which curve in opposite directions; also known as reverse curve.

ORTHOGRAPHIC PROJECTION—The projection of height, width, and depth of an object into various single planes so as to depict the true size and shape of the object as seen from each individual plane, each plane showing only two dimensions, thereby necessitating a minimum of two planes to show all three dimensions.

PARALLELEPIPED—A solid figure whose base is a parallelogram.

PARALLELOGRAM—A quadrilateral with both pairs of opposite sides parallel.

PARTIAL AUXILIARY VIEW—An auxiliary view in which only the features of an object which are specifically desired are shown.

PARTIAL SECTION—A sectional view consisting of less than a half section; used to show the internal structure of a small portion of an object; also known as broken section.

PENTAGON—A polygon bounded by five sides.

PERCENT—Portion in one hundred parts.

PERIMETER—The sum of the sides of a polygon.

PERSPECTIVE—A single view drawing of an object showing three dimensions. Lines and surfaces are foreshortened to make it appear optically correct. Perspective drawing is used when the end product is to be of an illustrative nature.

PHANTOM LINE—Thin broken line consisting of one long and two short evenly spaced dashes; used to indicate the alternate position of a moving part.

PICTORIAL PROJECTION—Any projection which shows three dimensions in a single view as it would be seen by the eye.

PLAN/PROFILE PAPER—Upper half (plan) is plain white paper used to draw the plan view; lower half is gridded and used to draw profiles.

PLANE OF PROJECTION—The theoretical transparent plane placed between the point of sight and the object in any type of projection. The observer sees the features of an object as they lie on the plane of projection; also known as image plane.

POINT OF SIGHT—The position of the observer in relation to the object and the plane of projection in any type of projection; also known as station point.

POLYGON—A plane figure which is bounded by straightline sides.

POWER—The number of times as indicated by an exponent a number occurs as a factor; for example, $2^4 = 2 \cdot 2 \cdot 2 \cdot 2 = 2$ to the 4th power = 16.

PROJECTION CHART—Chart showing the comparison of scheduled progress and actual progress.

PROJECTION LINES—The imaginary lines from the eye of the viewer to the points on the object in any type of projection; also known as lines of sight.

PROPORTION—An equation in which two ratios are set equal to each other; for example, $3/4 = 9/12$, $3:4::9:12$.

PROTRACTOR—Instrument used for measuring and laying off angles.

PYRAMID—A figure having a plane polygon for its base and triangles meeting at a common vertex for its sides.

PYTHAGOREAN THEOREM—A law of mathematics which states that the square of the hypotenuse of a right triangle equals the sum of the squares of the other two sides.

QUADRILATERAL—A polygon bounded by four sides.

QUALITATIVE CHART OR GRAPH—Any chart which emphasizes the relationships of facts.

QUANTITATIVE CHART OR GRAPH—A chart or graph which emphasizes numerical values.

QUILL PENS—Pens similar to ordinary writing pens with a split point; used for freehand inking of sketches and lettering. Width of the line produced by a quill pen is dependent on the pressure applied to the pen.

RADIAN—System for measuring angles where 2π radians equals 360° ; 1 radian = 57.3° .

RADICAL—A symbol placed on a mathematical quantity to indicate the root of the quantity; for example,

$$\sqrt{4} = \text{square root} = 2 \text{ or } 2 \cdot 2 = 4$$

$$\sqrt[3]{8} = \text{cube root} = 2 \text{ or } 2 \cdot 2 \cdot 2 = 8$$

$$\sqrt[4]{16} = \text{4th root} = 2 \text{ or } 2 \cdot 2 \cdot 2 \cdot 2 = 16$$

RADIUS—A straight line from the center of a circle or sphere to its circumference or surface.

RATIO—A comparison of two like quantities; for example, $2/3$, $2:3$.

RATIONAL NUMBER—A number which can be expressed as the quotient or ratio of two whole numbers: Fractions $2/7$, Integers $3/1 = 3$. A radical is a rational number if the radical is removable, for example $\sqrt{4} = 2$, $\sqrt[3]{27} = 3$.

REAL NUMBERS—All positive and negative numbers.

RECIPROCAL—Reciprocal of a number equals 1 divided by the number.

RECTANGLE—A parallelogram in which adjacent sides join at right angles.

RECTANGULAR PRISM—A solid figure whose base is a rectangle.

Appendix IV—GLOSSARY

REFERENCE PLANE—The normal plane from which all information is referenced.

REGULAR POLYGON—An equilateral polygon.

REVERSE CURVE—See ogee curve.

REVISION BLOCK—Drawn in the upper right corner of construction drawings; contains chronological list of all changes or revisions to the drawing.

REVOLUTION—Object is projected on one or more of the planes of projection but rather than being in the normal position, it is revolved on an axis perpendicular to one of the regular planes; used when it can show the features of an object more clearly than a normal orthographic projection.

REVOLVED SECTION—A sectional view used to show the internal structure of an item within the normal orthographic view.

RHOMBOID—A nonequilateral parallelogram in which adjacent sides join at oblique angles.

RHOMBUS—An equilateral parallelogram in which adjacent sides join at oblique (other than right) angles.

RIGHT ANGLE—An angle of 90° .

ROOT—The number of times a quantity is found as an equal factor within another quantity; for example,

$$\sqrt[4]{16} = 4\text{th root of } 16 = 2$$

$$2 \cdot 2 \cdot 2 \cdot 2 = 16$$

2 is the 4th root of 16

SCALE—The ratio between the dimensions of the graphic representation of an object and the corresponding dimensions of the object itself.

SCALED TRIANGLE—A triangle in which no sides or angles are equal.

SECANT—The ratio between the hypotenuse and the side adjacent an angle in a right triangle:
 $\sec = \text{hyp}/\text{adj}$

SECONDARY AUXILIARY VIEW—An auxiliary view which is used when neither the normal views nor the primary auxiliary view show the features of an object in their true size and shape.

SECTION LINES—Thin diagonal lines used to indicate the surface of an imaginary cut in an object.

SECTION VIEW—A view used to show the internal structure of an object utilized when hidden lines in the normal orthographic views do not amply describe the object.

SECTOR OF A CIRCLE—The part of a circle bounded by two radii and their intercepted arc.

SEGMENT OF A CIRCLE—The part of a circle bounded by a chord and its arc.

SINE—The ratio between the side opposite an angle and the hypotenuse of right triangle:
 $\sin = \text{opp}/\text{hyp}$

SKETCH—A quick freehand drawing, usually pictorial, used to convey information or an idea.

SPACE BLOCKS—Strips placed under the edges of triangles, french curves, and like instruments to prevent ink from running under the edge.

SPEEDBALL PENS—Pens with special points of various sizes and shapes; used for freehand inking and lettering when letters exceed $1/2$ in. in height. Main advantage is a consistent line thickness.

SPHERE—A solid figure having every point on its surface equidistant from its center.

SQUARE—An equilateral rectangle.

STATION POINT—See point of sight.

STITCH LINE—Dark medium line consisting of very short dashes closely spaced; used to indicate stitching or sewing lines on an article.

TANGENT—The ratio between the side opposite and the side adjacent an angle in a right triangle:
 $\tan = \text{opp}/\text{adj}$

TANGENT LINE—Any line which is perpendicular to the radius of a circle which touches the circumference of the circle.

TECHNICAL ENGINEERING CHARTS—Charts based on a series of measurements of laboratory experiments or work activities.

TEMPLATES—Timesaving devices used to draw various shapes and symbols. Templates are available for all types or drawings.

THIRD ANGLE PROJECTION—Multiview projection commonly used in the US. The top view projects above the front view and each side and bottom automatically project into their proper positions.

TITLE BLOCK—Drawn in the lower right corner of a drawing; should contain all information necessary to identify the drawing.

TRACING PAPER—High grade, white, transparent paper which takes pencil well; used when reproductions are to be made of drawings; also known as tracing vellum.

TRACING VELLUM—See tracing paper.

TRIANGLE—A polygon bounded by three sides.

TRIANGULAR PRISM—A solid figure whose base is a triangle.

TRIGONOMETRY—That branch of mathematics which deals with certain constant relationships which exist in triangles, and with methods by which they are applied to compute unknown values from known values.

TRAPEZOID—A quadrilateral with only one pair of opposite sides parallel, the other pair being not parallel.

TRAPEZIUM—A quadrilateral with no sides parallel.

TRIM LINES—Lightly drawn lines used as guides to trim a drawing to standard size.

VIEWING PLANE LINES—Thick heavy lines used to indicate the plane or planes from which a surface or several surfaces are viewed.

VISIBLE LINES—Solid thick lines indicating the edges of the object being drawn.

INDEX

A

- Administration and organization, 11-37
 - assignment as team/party or crew leader, 11
 - cooperation, 13.
 - planning work assignments, 11
 - preparing requisitions, 13
 - supervising, 12
- Adjustable triangle, 101
- Algebraic notation and algebraic operations, 46
- Angles, 59-63
 - cofunctions and functions of, 62
 - functions of, 61
 - functions of angles in a right triangle, 63
 - measuring, 59-61
 - obtuse angle functions, 62
- Angular measurement units, 85
- Appendix I, engineering technical library, 225
- Appendix II, mathematics, 226-262
- Appendix III, the metric system, 263-264
- Appendix IV, glossary, 265-272
- Area measurement units, 84
- Arithmetic, 46
- Axonometric projection, 210-214
 - isometric drawing, 211-214
 - isometric projection, 210

B

- Basic drafting techniques, 123-126
 - attaching paper to the board, 123
 - horizontal lines, 124
 - inclined lines, 124
 - protracting angles, 124-126
 - vertical lines, 124

- Battalion safety organization, 17-20
- Board, drawing, 97

C

- Cabinet projection, 207
- Calculating machine, 79
- Career development, 4-8
 - how to prepare for advancement, 5-8
 - qualifying for advancement, 4
 - who will be advanced?, 4
- Cavalier projection, 206
- Common logarithms, 46-51
- Computations, hints on, 80-82
 - reading the slide rule, 81
 - rounding off, 80
 - using tables, 81
- Construction of curves, 179-185
 - compound curve, 183
 - reverse or ogee curves, 184
- Constructions involving angles, 169
 - bisecting an angle, 169
 - transferring an angle, 169
- Constructions involving noncircular curves, 185-187
 - ellipse by concentric circle method, 187
 - ellipse by four center method, 185-187
 - ellipse by pin-and-string method, 185
- Constructions involving plane figures, 173-179
- Constructions involving straight lines, 170-173
 - bisecting a line, 171
 - dividing a line into any number of equal parts, 171
 - parts according to a given ratio, 173
 - proportional parts, 172
- Conventions, line, 144-153
- Conversion of units, 90

D

- Decimals, percentage, and fractions, 40
- Drafting: basic techniques, format, and conventions, 120-154
- Drafting: equipment and supplies, 92-119
- Drafting equipment and supplies, 94-119
 - adjustable triangle, 101
 - drafting media, 95
 - drafting templates, 114-116
 - drawing board, 97
 - drawing ink, 119
 - drawing instrument set, 102-108
 - drawing pencils, 96
 - erasers and erasing accessories, 96
 - freehand lettering pens, 116-119
 - french curves, 101
 - lighting, 99
 - map measures, 114
 - NMCB standard draftsman kit, 95
 - parallel straightedge, 99
 - proportional dividers, 108
 - protractors, 100
 - scales, 108-114
 - steel straightedge, 99
 - T-squares, 97-99
 - triangles, 99
- Drafting: geometric constructions, 169-187
- Drafting: projections and sketching, 185-224
- Drafting techniques, basic, 123-135
 - curved lines, 126-130
 - parallel and perpendicular lines, 126-135
 - use of drafting templates, 130
 - using the dividers, 130
 - using the ruling pen, 132-135
 - using the scale, 131
- Drafting, types of, 92-94
 - engineering drafting, 93
 - mechanical and freehand drafting, 92
 - technical and illustrative drafting, 92
- Drawing formats, 135-144
 - basic format, 137-144
 - sheet layout, 136
 - sheet sizes, 135

E

- Engineering aid rating, 2
- Engineering division, 28-32

- Engineering drafting, 93
- Engineering technical library, appendix I, 225
- Enlisted rating structure, 1
- Equipment and supplies, drafting, 94-119
- Erasers and erasing accessories, 96
- Exponents, radicals, powers and roots, 40-45

F

- Freehand lettering, 155-165
 - composition of lettering, 163-165
 - guidelines, 155-157
 - inclined lettering, 162
 - vertical single-stroke gothic lettering, 157-162
- Freehand lettering pens, 116-119
- Freehand and mechanical drafting, 92
- French curves, 101
- Fundamentals of mathematics, 38-46
 - algebraic notation and algebraic operations, 46
 - arithmetic, 46
 - fractions, decimals and percentage, 40
 - powers, roots, exponents and radicals, 40-45
 - ratio and proportion, 45
 - reciprocals, 45
 - study guides, 39
 - types of numbers, 39

G

- Geometry, 51-59
 - determining areas, 52-58
 - determining volumes, 58
 - polygons, 51
 - surfaces and figures, 51
- Glossary, appendix IV, 265-272
- Gothic lettering, vertical single-stroke, 157-162

H

- Hints on computations, 80-82

I

- Illustrative and technical drafting, 92
- Inclined lettering, 162

INDEX

Information sources, 8-10
 commercial publications, 9
 government publications, 8
 training films, 9

Ink, drawing, 119
Inking, order of, 153
Isometric drawing, 211-214
Isometric projection, 210

J

Job ahead, 1-10

K

Keeping time, 14-21

L

Lettering, 155-168
Lighting, 99
Line conventions, 144-153
 breaklines, 149
 centerlines, 144
 construction lines, 144
 datum lines, 152
 dimension lines, 148
 extension lines, 148
 leaders, 149
 match lines, 152
 phantom lines, 150
 section lines, 150
 stitch lines, 152
 viewing or cutting plane lines, 151
 visible lines, 144-148
Linear measure units, 83
Logarithms, 46-51
 common logarithms, 46-51
 natural logarithms, 46
Logarithms of trigonometric functions, 63
Log scale, use of, 74

M

Management division, 27
Map measures, 114
Mathematics, appendix II, 226-262

Mathematics fundamentals, 38-46
Mathematics and units of measurement, 38-91
Measurement, units of 82-91
Mechanical and freehand drafting, 92
Mechanical lettering, 165-168
 line weight, 166
 maintenance of mechanical lettering
 equipment, 168
 operating procedure, 166-168
 spacing and centering, 168
Metric system, the, appendix III, 263-264

N

Natural logarithms, 46
NAVFAC engineering field divisions, 36
Navy enlisted classification codes, 2
NMCB standard draftsman kit, 95
Numbers, types of, 39

O

Oblique single-plane projection, 205-210
 cabinet projection, 207
 cavalier projection, 206
 oblique drawing techniques, 208-210
Occupational standards, 2-4
 navy enlisted classification codes, 2
 typical EA billets, 3
Operations department (S-3), 21-32
 engineering division, 28-32
 management division, 27
 operations chief, 27
 operations officer, 21-26
 safety chief, 26
Order of inking, 153
Order of penciling, 153
Organization and administration, 11-37
Orthographic projection, 189-205
 first-angle projection, 190
 third-angle projection, 190-205

P

Parallel straightedge, 99
Penciling, order of, 153
Pencils, drawing, 96
Percentage, fractions and decimals, 40

ENGINEERING AID 3 & 2, VOLUME 1

Personnel readiness capability program, 37
Perspective drawings, 214
Polygons, 51
Powers, roots, exponents, and radicals, 40-45
Projection drawing theory, 188
Proportional dividers, 108
Protracting angles, 124-126
Protractors, 100
Public works department, 32-37
 NAVFAC engineering field divisions, 36
 public works organization and function,
 33-36

R

Radicals, powers, roots, and exponents, 40-45
Ratio and proportion, 45
Reciprocals, 45
Reverse or ogee curve, 184

S

Safety chief, 26
Scales, 108-114
Sketching, 215-224
 sketching materials, 215
 techniques of sketching, 216-224
Slide rule, 72-79
 shifting the index, 72-74
 slide rule solutions of proportional
 equations, 74
 use of the CI (reciprocal) scale, 74
 use of the folded scales, 74
 use of the log scale, 74
 use of the trigonometric scales,
 75-79
Spherical trigonometry, 71
Steel straightedge, 99
Study guides, 39
Supplies and equipment, drafting, 94-119

T

Technical and illustrative drafting, 92
Templates, drafting, 114-116
Theory of projection drawing, 188
Timekeeping, 14-21
 battalion safety organization, 17-20
 safety duties of a supervisor, 20
 safety duties of supervisory personnel, 16
Triangles, 99
Trigonometry, 59-71
 functions of angles, 61
 functions of angles in a right triangle,
 63
 functions and cofunctions, 62
 functions of obtuse angles, 62
 logarithms of trigonometric functions, 63
 measuring angles, 59-61
 solutions of triangles, 64-71
Trigonometry, spherical, 71
T-squares, 97-99

U

Units of measurement, 82-91
 conversion of units, 90
 more units of measurement, 86-90
 units of angular measurement, 85
 units of area measurement, 84
 units of linear measure, 83
 units of volume measurement, 84
 units of weight, 85
Units of measurement and mathematics, 38-91

V

Vertical single-stroke gothic lettering, 157-162
Volume measurement units, 84

W

Weight units, 85

ENGINEERING AID 3 & 2, VOLUME 1

NAVEDTRA 10634-C

Prepared by the Naval Education and Training Program Development Center, Pensacola, Florida

Your NRCC contains a set of assignments and self-scoring answer sheets (packaged separately). The Rate Training Manual, Engineering Aid 3&2, Volume 1, NAVEDTRA 10634-C, is your textbook for the NRCC. If an errata sheet comes with the NRCC, make all indicated changes or corrections. Do not change or correct the textbook or assignments in any other way.

HOW TO COMPLETE THIS COURSE SUCCESSFULLY

Study the textbook pages given at the beginning of each assignment before trying to answer the items. Pay attention to tables and illustrations as they contain a lot of information. Making your own drawings can help you understand the subject matter. Also, read the learning objectives that precede the sets of items. The learning objectives and items are based on the subject matter or study material in the textbook. The objectives tell you what you should be able to do by studying assigned textual material and answering the items.

At this point you should be ready to answer the items in the assignment. Read each item carefully. Select the BEST ANSWER for each item, consulting your textbook when necessary. Be sure to select the BEST ANSWER from the subject matter in the textbook. You may discuss difficult points in the course with others. However, the answer you select must be your own. Use only the self-scoring answer sheet designated for your assignment. Follow the scoring directions given on the answer sheet itself and elsewhere in this course.

Your NRCC will be administered by your command or, in the case of small commands, by the Naval Education and Training Program Development Center. No matter who administers your course you can complete it successfully by earning grades that average 3.2 or higher. If you are on active duty, the average of

your grades in all assignments must be at least 3.2. If you are NOT on active duty, the average of your grades in all assignments of each creditable unit must be at least 3.2. The unit breakdown of the course, if any, is shown later under Naval Reserve Retirement Credit.

WHEN YOUR COURSE IS ADMINISTERED BY LOCAL COMMAND

As soon as you have finished an assignment, submit the completed self-scoring answer sheet to the officer designated to administer it. He will check the accuracy of your score and discuss with you the items that you do not understand. You may wish to record your score on the assignment itself since the self-scoring answer sheet is not returned.

If you are completing this NRCC to become eligible to take the fleetwide advancement examination, follow a schedule that will enable you to complete all assignments in time. Your schedule should call for the completion of at least one assignment per month.

Although you complete the course successfully, the Naval Education and Training Program Development Center will not issue you a letter of satisfactory completion. Your command will make a note in your service record, giving you credit for your work.

WHEN YOUR COURSE IS ADMINISTERED BY THE NAVAL EDUCATION AND TRAINING PROGRAM DEVELOPMENT CENTER

After finishing an assignment, go on to the next. Retain each completed self-scoring answer sheet until you finish all the assignments in a unit (or in the course if it is not divided into units). Using the envelopes provided, mail your self-scored answer sheets to the Naval Education and Training Program Development Center

BEST COPY AVAILABLE

where the scores will be verified and recorded. Make sure all blanks at the top of each answer sheet are filled in. Unless you furnish all the information required, it will be impossible to give you credit for your work. You may wish to record your scores on the assignments since the self-scoring answer sheets are not returned.

The Naval Education and Training Program Development Center will issue a letter of satisfactory completion to certify successful completion of the course (or a creditable unit of the course). To receive a course-completion letter, follow the directions given on the course-completion form in the back of this NRCC.

You may keep the textbook and assignments for this course. Return them only in the event you disenroll from the course or otherwise fail to complete the course. Directions for returning the textbook and assignments are given on the book-return form in the back of this NRCC.

PREPARING FOR YOUR ADVANCEMENT EXAMINATION

Your examination for advancement is based on the Manual of Navy Enlisted Manpower and Personnel Classification and Occupational Standards (NAVPERS 18068-D). The sources of questions in this examination are given in the Bibliography for Advancement Study (NAVEDTRA 10052). Since your NRCC and textbook are among the sources listed in this bibliography, be sure to study both in preparing to take your advancement examination. The standards for your rating may have changed since your course and textbook were printed, so refer to the latest editions of NAVPERS 18068-D and NAVEDTRA 10052.

NAVAL RESERVE RETIREMENT CREDIT

This course is evaluated at 12 Naval Reserve Retirement points, which will be credited upon satisfactory completion of the entire course. These points are creditable to personnel eligible to receive them under current directives governing retirement of Naval Reserve personnel. Credit cannot be given again for this course if the student has previously received credit for completing another Engineering Aid 3&2 NRCC or ECC.

COURSE OBJECTIVE

In completing your nonresident career course you will demonstrate a knowledge of the subject matter by correctly answering items on the following: practical aspects of mathematics; use and maintenance of drafting equipment and instruments; basic techniques of drawing lines; use and meaning of line conventions; sizes of drawings, title blocks, revision blocks, bills of material, and format standards; methods and sizes of the lettering on engineering drawings; methods of bisecting lines and angles; construction of geometric forms and figures; types of projections; pictorial, orthographic and auxiliary views; and methods of drawing a freehand, engineering sketch.

While working on this nonresident career course, you may refer freely to the text. You may seek advice and instruction from others on problems arising in the course, but the solutions submitted must be the result of your own work and decisions. You are prohibited from referring to or copying the solutions of others, or giving completed solutions to anyone else taking the same course.

Naval nonresident career courses may include a variety of items -- multiple-choice, true-false, matching, etc. The items are not grouped by type; regardless of type, they are presented in the same general sequence as the textbook material upon which they are based. This presentation is designed to preserve continuity of thought, permitting step-by-step development of ideas. Some courses use many types of items, others only a few. The student can readily identify the type of each item (and the action required of him) through inspection of the samples given below.

MULTIPLE-CHOICE ITEMS

Each item contains several alternatives, one of which provides the best answer to the item. Select the best alternative and erase the appropriate box on the answer sheet.

SAMPLE

- s-1. The first person to be appointed Secretary of Defense under the National Security Act of 1947 was
1. George Marshall
 2. James Forrestal
 3. Chester Nimitz
 4. William Halsey

The erasure of a correct answer is indicated in this way on the answer sheet:

	1	2	3	4	
	T	F			
s-1		C			

TRUE-FALSE ITEMS

Determine if the statement is true or false. If any part of the statement is false the statement is to be considered false. Erase the appropriate box on the answer sheet as indicated below.

SAMPLE

- s-2. Any naval officer is authorized to correspond officially with a bureau of the Navy Department without his commanding officer's endorsement.

The erasure of a correct answer is also indicated in this way on the answer sheet:

	1	2	3	4	
	T	F			
s-2		CC			

MATCHING ITEMS

Each set of items consists of two columns, each listing words, phrases or sentences. The task is to select the item in column B which is the best match for the item in column A that is being considered. Specific instructions are given with each set of items. Select the numbers identifying the answers and erase the appropriate boxes on the answer sheet.

SAMPLE

In items s-3 through s-6, match the name of the shipboard officer in column A by selecting from column B the name of the department in which the officer functions.

A. Officers

B. Departments

- | | |
|-------------------------------|---------------------------|
| s-3. Damage Control Assistant | 1. Operations Department |
| s-4. CIC Officer | 2. Engineering Department |
| s-5. Assistant for Disbursing | 3. Supply Department |
| s-6. Communications Officer | |

The erasure of a correct answer is indicated in this way on the answer sheet:

	1	2	3	4	
	T	F			
s-3		C			
s-4	C				
s-5			C		
s-6	C				

How To Score Your Immediate Knowledge of Results (IKOR) Answer Sheets

	1	2	3	4	
	T	F			
1		C	6		1
2	C	9		9	2
3			C		
4	CC	12			1

Total the number of incorrect erasures (those that show page numbers) for each item and place in the blank space at the end of each item.

Sample only

Number of boxes erased incorrectly	0-2	3-7	8-
Your score	4.0	3.9	3.8

Now TOTAL the column(s) of incorrect erasures and find your score in the Table at the bottom of EACH answer sheet.

NOTICE: If, on erasing, a page number appears, review text (starting on that page) and erase again until "C", "CC", or "CCC" appears. For courses administered by the Center, the maximum number of points (or incorrect erasures) will be deducted from each item which does NOT have a "C", "CC", or "CCC" uncovered (i.e., 3 pts. for four choice items, 2 pts. for three choice items, and 1 pt. for T/F items).

Assignment 1

The Job Ahead: Administration and Organization

Textbook NAVEDTRA 10634-C: Pages 1-32

In this course you will demonstrate that learning has taken place by correctly answering training items. The mere physical act of indicating a choice on an answer sheet is not in itself important; it is the mental achievement, in whatever form it may take, prior to the physical act that is important and toward which nonresident career course learning objectives are directed. The selection of the correct choice for a course training item indicates that you have fulfilled, at least in part, the stated objective(s).

The accomplishment of certain objectives, for example, a physical act such as drafting a memo, cannot readily be determined by means of objective type course items; however, you can demonstrate by means of answers to training items that you have acquired the requisite knowledge to perform the physical act. The accomplishment of certain other learning objectives, for example, the mental acts of comparing, recognizing, evaluating, choosing, selecting, etc., may be readily demonstrated in a course by indicating the correct answers to training items.

The comprehensive objective for this course has already been given. It states the purpose of the course in terms of what you will be able to do as you complete the course.

The detailed objectives in each assignment state what you should accomplish as you progress through the course. They may appear singly or in clusters of closely related objectives, as appropriate; they are followed by items which will enable you to indicate your accomplishment.

All objectives in this course are learning objectives and items are teaching items. They point out important things, they assist in learning, and they should enable you to do a better job for the Navy.

This self-study course is only one part of the total Navy training program; by its very nature it can take you only part of the way to a training goal. Practical experience, schools, selected reading, and the desire to accomplish are also necessary to round out a fully meaningful training program.

Learning Objective: Indicate fundamentals of the enlisted rating structure, principles of qualifying and preparing for advancement, and useful sources of information.

- 1-1. Why are Navy Enlisted Classifications assigned to certain personnel of the Engineering Aid rating?
1. To facilitate the detailing of skilled personnel
 2. To determine which personnel require training for specific duty assignments
 3. To identify personnel who have been advanced
 4. To identify all personnel who have successfully completed Engineering Aid Class "A" School

- 1-2. Which of the following skills in the EA rating is reflected by the NEC Construction Inspector?
1. Identifying soils
 2. Testing bituminous paving mixes
 3. Scheduling tests on electrical and mechanical systems
 4. Designing a concrete mix
- 1-3. Which of the following is a Special Series NEC?
1. Safety Inspector
 2. Advanced Underwater Construction Technician
 3. SEABEE Team Technician
- 1-4. The majority of EA3's and EA2's are assigned to
1. SEABEE teams
 2. Public Works activities
 3. Naval Mobile Construction Battalions
 4. Naval Construction Regiments
- 1-5. Normally the duties and responsibilities of EA's are related to
1. an entire construction project
 2. only those efforts which are measurable in terms of work-in-place
 3. only particular work phases of a construction project
 4. indirect work efforts only
- 1-6. How does the EA contribute toward ensuring that project work schedules do not lag behind schedule?
1. Adjusting timetables
 2. Readjusting project priorities
 3. Compiling actual man-hours expended
 4. All of the above
- 1-7. As you develop your career, which of the following advantages do you personally gain with each step forward?
1. Greater prestige
 2. More interesting and challenging jobs
 3. Increased pay
 4. All of the above
- 1-8. To qualify for advancement during your Navy career, which of the following actions must you take?
1. Complete required military and professional training courses
 2. Fulfill the requirements of the PAR Program
 3. Be recommended by your commanding officer
 4. All of the above
- 1-9. When the number of men passing a Navywide examination exceeds the number of vacancies, what means is used to determine which men may be advanced?
1. Merit rating
 2. Final multiple score
 3. Longevity
 4. Personnel testing
- 1-10. In addition to the information contained in this Rate Training Manual, with which of the following must you be familiar when preparing for advancement?
1. Bibliography for Advancement Study
 2. Manual of Navy Enlisted Manpower and Personnel Classification and Occupational Standards
 3. Personnel Advancement Requirements
 4. All of the above
- 1-11. The naval standards contained in the Manual of Navy Enlisted Manpower and Personnel Classification and Occupational Standards represent basic things which should be known, and not necessarily done as a matter of routine.
- 1-12. In what section of the Personnel Advancement Requirements pamphlet for Engineering Aids is there an entry that indicates completion of the military requirements RTM?
1. I
 2. II
 3. III

In items 1-13 through 1-15, select from column B the publication that is the source of the information in column A.

A. Information

B. Publications

1-13. Military and occupational knowledge needed to perform the duties of a rating

1. Military Requirements for PO 3 and 2

1-14. Required and recommended references that concern military qualification standards

2. List of Training Manuals and Correspondence Courses

3. Bibliography for Advancement Study

1-15. Current edition of the rate training manuals

4. Manual of Navy Enlisted Manpower and Personnel Classifications and Occupational Standards

1-19. A reliable indication that you have mastered the subject matter in a Rate Training Manual is your ability to

1. express in your own words the main points of the subject
2. quote word for word passages from the manual
3. memorize pertinent dates, tables of weights and measures, and other facts
4. ask intelligent questions about the subject

1-20. When you are preparing construction drawings, which of the following Rate Training manuals may serve as valuable reference material?

1. Builder 3 & 2
2. Utilitiesmar 3 & 2
3. Construction Electrician 3 & 2
4. All of the above

1-21. When training your crew on certain technical procedures, you discover that the only training film available is partially obsolete. What should you do in order to utilize the film?

1. Request the film librarian to cut out the obsolete portions
2. Request permission from the film librarian to cut out the obsolete portions yourself
3. After showing the entire film, point out to the trainees what specific procedures have changed
4. Point out to the trainees, either before or during the time of showing, what specific procedures have changed

1-16. Which of the Rate Training Manuals listed in the Bibliography for Advancement Study, NAVEDTRA 10052, for your rating must you complete before you are eligible to take the Navywide examination for advancement?

1. All courses listed for the EA rating
2. All courses listed for the next higher rate
3. Courses marked with an asterisk listed for the next higher rate
4. Unmarked courses for the next higher rate

1-17. Source materials for Navywide written examination at the appropriate rate level may include any reference listed in the Bibliography for Advancement Study.

1-18. Which of the following hints for studying should help you get the most from a Rate Training Manual?

1. Devote your time exclusively to important military topics
2. Try not to cover a complete unit in any one study period
3. Omit easy material; study only the most difficult and the unfamiliar
4. Make notes as you study, particularly of main ideas, then review your notes

1-22. Acting as survey crew leader, the Engineering Chief briefs you on the tasks which your crew must accomplish for the day. What is the first thing you must do before trying to plan your crew's work?

1. Consider alternate methods for doing the work
2. Establish goals for the workday
3. Understand clearly the scope of each task
4. Select the proper equipment for doing each task

Learning Objective: Recognize factors to be considered in planning and supervising the work of an Engineering Aid crew.

1-23. Under which of the following working conditions are crewmembers likely to become discontented?

1. Working during an emergency
2. Being idle between tasks
3. Working at two or more tasks at the same time

1-24. The Engineering Chief informs you that your survey crew is not being efficient in performing assigned survey tasks. What may be the cause of its inefficiency?

1. Crewmembers were not properly briefed as to the scope of their assigned tasks
2. Each crewmember did not understand his assigned responsibilities
3. The importance of assigned tasks in relation to the unit's overall mission was not emphasized
4. All of the above

1-25. A draftsman with limited experience is tasked with the preparation of a drawing. How should you supervise his work?

1. Criticize his work only when he makes avoidable mistakes
2. Compare his work to the work of more experienced draftsmen
3. If time permits, allow him to complete the drawing before it is checked so that he learns from his own mistakes
4. Check his work periodically to ensure that mistakes and incorrect procedures are not compounded

Learning Objective: Identify principles and techniques of material requisitioning and labor reporting.

1-26. Who is responsible for a survey kit checked out from the battalion central toolroom by the crew leader?

1. Crew leader
2. Engineering Division Supply Petty Officer
3. Engineering Chief or leading Petty Officer of the Survey Section
4. Engineering Officer

1-27. To minimize storage space of consumable items in standard NMCE Table of Allowance kits, replenishment requisitions are normally submitted subsequent to item depletion.

1-28. Coordination of battalion labor utilization data is the responsibility of the

1. Engineering Division
2. Planning and Estimating Section
3. Battalion Planning Team
4. Management Division of the Operations Department

1-29. Labor utilization data for projects assigned an activity must include man-hours expended by which of the following personnel?

1. Military personnel of the activity
2. Military personnel of other activities
3. Civilian personnel
4. All of the above when applicable

1-30. All labor reported for a SEABEE unit is of which type?

1. Direct or indirect labor
2. Direct or overhead labor
3. Productive or overhead labor
4. Productive or indirect labor

1-31. Indirect labor includes man-hours spent in support of construction operations without producing an end product.

1-32. Direct labor for each project phase is reported how often and by whom?

1. Daily by the crew supervisor
2. Daily by the project supervisor
3. Weekly by the crew supervisor
4. Weekly by the project supervisor

1-33. Labor performed on each phase of a project is reported by code numbers that are assigned to each category of labor.

When answering items 1-34 through 1-36, refer to textbook figures 2-2 and 2-3.

1-34. According to the crew leader's daily labor report, how many hours were spent attending to personal affairs?

1. One
2. Two
3. Three
4. Four

1-35. On the crew leader's daily labor report, how many total hours, if any, of productive labor were reported?

1. 31
2. 36
3. 40
4. None

- 1-36. How many hours, if any, were reported as contributing directly to the end product of the unit's assigned construction task?
1. 31
 2. 36
 3. 40
 4. None

Learning Objective: Indicate principles of forming a battalion safety organization, responsibilities of its crew leaders and supervisor, and techniques of accident reporting.

- 1-37. Implementation of a formal safety organization in every NMCB is required according to instructions promulgated by
1. NAVFAC
 2. COMCBLANT/COMCBPAC
 3. CNO
 4. the appropriate Regimental Commander

In items 1-38 through 1-40, select from column B the organization that has the responsibility in column A.

	<u>A. Responsibilities</u>	<u>B. Organization</u>
1-38.	Implementing a safety training program	1. Safety Policy Committee
1-39.	Exchanging safety information and work procedures among project crews	2. Safety Division
1-40.	Determining battalion safety doctrine	3. Supervisor's Safety Committee

- 1-41. Throughout a battalion, who is responsible for conducting standup safety meetings?
1. Each crew leader
 2. Project Officers
 3. Safety Officer and Safety Chief
- 1-42. Achieving safety within a crew is essentially a matter of
1. teamwork
 2. understanding your subordinates
 3. leadership
 4. understanding the job to be done

- 1-43. Assume you are a Crew Petty Officer trying to get your men to maintain a certain standard of safety. You can best accomplish this by
1. being a living example of safety awareness
 2. teaching safety on the job
 3. displaying eye-catching posters
 4. constantly using reminders of safety violations

- 1-44. How long can a man who is injured on the job remain off the job before a formal investigation and report must be filed?
1. 1 day
 2. 2 days
 3. 3 days
 4. 5 days

- 1-45. Minor accidents which do not require formal reporting should be investigated because they tend to
1. be ignored and go unnoticed
 2. reoccur with serious consequences
 3. waste time, causing job delays
 4. be demoralizing

- 1-45. Who is responsible for conducting a formal investigation and submitting a written report when a crewmember is disabled in a work-related accident?
1. Safety Chief
 2. Project Safety Supervisor
 3. Project Officer
 4. His crew leader

- 1-47. The purpose of completing blocks 22 and 24 of the Accidental Injury/Death Report (OPNAV 5100/1), shown in textbook figure 2-6, is to
1. recommend corrective action
 2. identify the principal unsafe act or hazardous condition which contributed to the accident
 3. provide a detailed description of the accident
 4. determine whether or not a formal investigation of the accident is required

- 1-48. What information should you provide in completing block 27 of the Accidental Injury/Death Report (OPNAV 5100/1) shown in textbook figure 2-7?
1. Your description of the accident
 2. Your opinion as to whether or not the accident was caused by an unsafe act
 3. Your opinion as to whether or not the accident was caused by an unsafe condition
 4. The specific remedial actions which have been, or should be, taken to prevent a recurrence of a similar accident

Learning Objective: Indicate the functions of an NMCB's Operations Department and describe the duties and responsibilities of its personnel.

1-49. By whose authority may the basic organization of an NMCB'S Operations Department, shown in textbook figure 2-10, be changed to fit a certain battalion?

1. NAVFAC
2. COMCBLANT or COMCBPAC
3. Battalion Commanding Officer
4. Battalion Operations Officer

1-50. The battalion's Operations Officer has the specific responsibility of managing the

1. mission oriented technical training
2. construction program for the Commanding Officer
3. entire construction mission under the direction of the Executive Officer

1-51. The battalion deployment Operations Order does NOT specify the

1. projects which are to be accomplished
2. methods for accomplishing the projects
3. time frame in which projects are to be accomplished
4. date of deployment

1-52. The Operations Officer is usually assigned the collateral responsibilities of the

1. Battalion Training Officer
2. Project Officer
3. Safety Officer
4. Material Liaison Officer

1-53. Which of the following is NOT normally the responsibility of the Operations Chief?

1. Assisting with the coordination of battalion technical training
2. Ensuring that tool kits are inventoried periodically
3. Approving, by direction, minor changes to work in progress
4. Providing a communications link between customer and command, concerning construction projects

1-54. Of the following, who may be in charge of the division which normally consists of the battalion timekeeper and the Operations Yeomen?

1. Engineering Officer
2. Operations Officer
3. Administrative Officer
4. Operations Chief

1-55. The information that the Operations Department's Management Division collects and analyzes for each construction project is used for

1. preparing project completion letters
2. maintaining project status boards
3. preparing reports
4. preparing project turnover files

1-56. Suppose that, while deployed at Guam, NMCB 1 is preparing its seventh monthly Operations report. Which of the following items of information should NOT be included in the report?

1. Number of Captain's Masts held
2. Method of travel
3. Morale of the men
4. Church attendance

1-57. Of the following battalion visual status boards, which is NOT normally maintained by the Operations Department?

1. Labor analysis
2. Projected job completion
3. Technical training schedule
4. Company personnel strength

1-58. Normal responsibilities of the Engineering Division include

1. resolving field problems related to project design and engineering
2. recommending accepted construction methods to company commanders for new projects
3. Supervising the Deployment Planning Team
4. scheduling concrete and asphalt requirements for all projects

1-59. Who is responsible for project quality control in an NMCB?

1. Engineering Officer only
2. Operations Chief only
3. Project Crew Leader only
4. Each man in the battalion

1-60. As surveying crew leader and leader of the squad which includes the men in your survey crew, you are responsible for the actions of your men at all times.

1-61. Which of the following is a task for the personnel of the Drafting and Reproduction Section?

1. Reflecting as-built information on original drawings
2. Ordering reproduction supplies
3. Interpreting survey notes for map preparation
4. Each of the above

- 1-62. When first assigned to the NMCB Drafting Section, an EA who has only basic drafting skills will probably be tasked with
1. low priority work
 2. simple design sketches
 3. preparing sketches from which the experienced draftsmen will prepare the final drawings
 4. revising existing drawings
- 1-63. What must a new EA who has civilian drafting experience learn to become an efficient SEABEE draftsman?
1. Military Standards
 2. New specialized drafting skills
 3. Operation and maintenance of reproduction machines
- 1-64. Which of the following is true concerning the duties and responsibilities of the Engineering Division Supply Petty Officer?
1. He must inventory all division supplies and equipment periodically
 2. He maintains liaison between the Engineering Division and the Supply Department
 3. He approves all routine supply requisitions for the division
 4. His assignment as division Supply Petty Officer is a full-time position
- 1-65. The duties of the Operations Department Embarkation Representative include
1. ensuring that the cost of each item included in shipping containers is included on the packing lists
 2. ensuring that all department mount-out containers are painted gray and properly coded
 3. maintaining a complete embarkation file of pertinent guidelines and mount-out container packing lists
 4. maintaining a complete inventory of the contents of each surveying, drafting, and material testing kit
- 1-66. Minimum battalion technical library requirements are determined in accordance with
1. instructions from higher authority
 2. the overall mission of the battalion
 3. the availability of administrative funds
 4. the location of deployments and types of projects
- 1-67. The number of EA's assigned to the Engineering Division Surveying Section is governed by the
1. organization of a typical Engineering Division in the Naval Construction Force Manual, NAVFAC P-315
 2. organization specified in the battalion Operations Order
 3. amount of surveying experience of all EA's assigned to the Engineering Division
 4. amount and type of surveying operations required
- 1-68. Normally the tasks assigned to the Surveying Section of the NMCB Engineering Division include all of the following EXCEPT
1. preparing topographic maps from survey data
 2. measuring structures after they are built for preparation of as-built drawings
 3. conducting layout surveys for buildings and sidewalks
 4. conducting stakeout surveys for bridges
- 1-69. To support battalion construction, survey crews are organized into which of the following types of parties?
1. Layout and stakeout
 2. Level and transit
 3. Preliminary survey and final location survey
 4. Vertical layout and horizontal layout
- 1-70. The main function of the Quality Control Section is to inspect structures for evidence of poor workmanship.
- 1-71. An EA with limited quality control experience may be tasked with
1. conducting routine construction inspections
 2. testing mixtures of concrete
 3. interpreting soil compaction test results
 4. writing quality control inspection reports
- 1-72. Recommendations included in an inspector's quality control report are based mainly on quality criteria given in
1. NAVFAC specifications and standards
 2. manufacturers' specifications and standards
 3. COMCBLANT and COMCBPAC quality control guidelines
 4. project specifications and drawings

1-73. Which of the following is NOT normally a responsibility of the Planners and Estimators?

1. Determine material quantities
2. Help to update progress schedules
3. Help determine special tool requirements
4. Reflect as-built information on original drawings

Assignment 2

Administration and Organization (continued); Mathematics

Textbook: NAVEDTRA 10634-C: Pages 33 - 60

Learning Objective: Recognize the basic organization of a standard Public Works Department and the functions of its divisions.

- 2-1. An EA2 assigned to the Engineering Division of a Public Works Department (PWD) will generally come under the supervision of
1. a civilian engineer for all duties and responsibilities
 2. the Engineering Officer for all duties and responsibilities
 3. a civilian engineer for professional matters and a military supervisor for all military related matters

In items 2-2 through 2-5, select from column B the branch of the PWD Administrative Division which is responsible for the function in column A.

A. Function	B. Branch
2-2. Maintains department central files	1. Management Analysis
2-3. Handles department timecards	2. Office Services
2-4. Conducts studies involving personnel utilization	3. Financial
	4. Personnel
2-5. Compiles real property data	

- 2-6. What branch of the PWD Engineering Division is responsible for surveying operations?
1. Operations
 2. Support
 3. Civil
 4. Architectural and Structural

- 2-7. What is the primary function of a PWD Engineering Division?
1. Design the major public works and public utilities of the PWD
 2. Conduct extensive specialized engineering investigations
 3. Do only routine engineering work

- 2-8. Which of the following PWD divisions initiates, for approval, requests for work to be performed under contract?
1. Maintenance
 2. Maintenance Control
 3. Engineering
 4. Administrative

- 2-9. In a standard PWD, who directs and coordinates all matters pertaining to the operations of the Maintenance, Utilities, and Transportation Divisions?
1. Shops Engineer
 2. Maintenance Control Director
 3. Operations Officer
 4. Assistant Public Works Officer

- 2-10. What PWD branch performs work that is primarily unscheduled?
1. Electrical
 2. Emergency Service
 3. General Services
 4. Inspection

- 2-11. Which PWD division or branch does maintenance work on weight-handling and materials-handling equipment?
1. Inspection Branch
 2. Maintenance Division
 3. General Services Branch
 4. Transportation Division

Learning Objective: Explain the purposes and functions of the Personnel Readiness Capability Program (PRCP) at unit and headquarters levels.

Learning Objective: Identify various types of numbers, fractions, and expressions associated with basic mathematics; and compute square roots and reciprocals arithmetically.

- 2-12. What information does the Personnel Readiness Capability Program provide?
1. Information of skills of each crew-member
 2. Detailed personnel skill information to all levels of the Naval Construction Forces
 3. Information to be used for better command and planning in matters of readiness, capability, training, and logistical support at all levels
 4. All of the above
- 2-13. The Personnel Readiness Capability Program (PRCP) sets standards of the collection, processing, identification, and utilization of information, exclusively for members of the active duty Naval Construction Force.
- 2-14. Most PRC information consists of an inventory of
1. individual skills
 2. special technical training
 3. technical skills
 4. military training
- 2-15. The initial PRCP skill inventory information is obtained from
1. your personnel record
 2. your immediate supervisor or the Engineering Chief
 3. personal interviews with your crew leader or other senior EA
 4. filled-out questionnaires
- 2-16. Who is responsible for keeping your PRCP record up to date?
1. The Engineering Chief or division leading petty officer
 2. The battalion or unit Training Chief
 3. The battalion or unit PRCP coordinator
 4. You
- 2-17. The effectiveness of the Personnel Readiness Capability Program depends largely on the
1. manner in which interviewers analyze collected personnel data
 2. accuracy of the data supplied by the persons interviewed
 3. completeness of information obtained from personnel service records

- 2-18. Which of the following is an irrational number?
1. $1/4$
 2. $\sqrt{4}$
 3. 7
 4. $3\sqrt{2}$
- 2-19. Which of the following is a rational number?
1. $\sqrt{25}$
 2. $2\sqrt{2}$
 3. $\sqrt{7}$
 4. $\frac{\sqrt{5}}{2}$
- 2-20. Integers such as 6, 8, and 9 are classed as composite numbers.
- 2-21. An example of an improper fraction is
1. $3/4$
 2. $4/3$
 3. $12/83$
 4. $844/1103$
- 2-22. Which of the following, if any, is an equivalent fraction of $3/4$?
1. $4/3$
 2. $13/24$
 3. $18/24$
 4. None of the above
- 2-23. Written as a decimal fraction, $3/8$ is equal to
1. .0375
 2. $\frac{.375}{100}$
 3. $\frac{375}{100}$
 4. $\frac{375}{1000}$

2-24. Written in the form of an exponent, the product of three 4's equals

1. 3^4
2. $\sqrt[3]{4}$
3. 4^3
4. 64^3

2-25. The expression, $\sqrt[3]{9}$ means

1. the third power of 9
2. $1/3$ the square root of 9
3. the cube root of 9
4. the square root of 9^3

2-26. The decimal equivalent of a radical expression in which the radicand is irrational is always an approximation.

For items 2-27 through 2-29, apply the arithmetic method of extracting square roots to find the square root of 529.

2-27. The initial step is to divide the digits into groups as follows: 5 29. The second step is to find the

1. largest factor of 5
2. largest number whose square is contained in 5
3. largest number whose square is contained in 29
4. square root of 5

2-28. The second step yields the first digit of your answer: This digit is squared, the square is subtracted from 5, and the remainder brought down along with the second group, 29, to become the dividend, 129, for the next step. What is the divisor (at the left in the computation) used to determine the second digit of your answer?

1. 20
2. 23
3. 40
4. 43

2-29. What is the square root of 529?

1. 23
2. 23.1
3. 43
4. 53.1

2-30. If the square root of 0.89 is 0.93808, the square root of 890,000 is

1. 9.3808
2. 93.808
3. 938.08
4. 9380.8

2-31. If the cube root of 38,000 is 33.620, the cube root of 0.38 is 0.03362.

2-32. What is the relationship between $\sqrt{8}$ and $8^{1/2}$?

1. They are rational numbers
2. They are equivalent
3. They are composite numbers
4. They are reciprocals of each other

2-33. What is the decimal equivalent of

- $\sqrt{1 \frac{3}{4}}$
1. 0.662
 2. 0.867
 3. 1.323
 4. 1.732

2-34. To simplify computations, 0.01031 may be expressed as

1. 10.31×10^{-3}
2. 1031×10^{-6}
3. 1.031×10^{-3}
4. 103.1×10^{-5}

2-35. What is the reciprocal of $.00000025 \times .000002 \times .00004$?

1. 5×10^{-16}
2. 5×10^{16}
3. 5×10^{-17}
4. 5×10^{17}

2-36. Which of the following is a ratio expressed correctly in its final form?

1. $\frac{9.03 \text{ meters}}{2.61 \text{ meters}}$
2. 2.5 feet: 17.5 feet
3. 9.03: 2.61
4. $\frac{60 \text{ miles}}{1 \text{ hour}}$

2-37. Which of the following expressions is a correctly written proportion?

1. 9:15::5:3
2. 9:15=3:5
3. $\frac{9:15}{3:5}$
4. $\frac{9}{15} = \frac{5}{3}$

2-38. Which of the following is a linear equation?

1. $x = 3 - y^2$
2. $x^2 + 5 = 1/3$
3. $c^2 = a^2 + b^2$
4. $13y = 26/3$

Learning Objective: Recognize practices associated with the use of logarithms.

2-39. Which of the following statements concerning common logarithms is true?

1. The fractional portion of a logarithm is the mantissa
2. The decimal part of a logarithm is the characteristic
3. The mantissa of a logarithm indicates the position of the decimal point in the antilog
4. Each of the above

2-40. Which of the following can NOT be simplified by the use of common logarithms?

1. Addition or subtraction of large numbers
2. Determining powers of large numbers
3. Multiplication or division of large numbers
4. Determining roots of numbers

2-41. If the mantissa for the number sequence 17,700 is .247973, what is the log of 17.7?

1. 0.247973-1
2. 0.247973
3. 1.247973
4. 2.247973

2-42. If the log of 132 is 2.12057, what is the log of 0.132?

1. 1.12057
2. 1.12057-1
3. -1+0.12057
4. Each of the above

2-43. What is the logarithm of 17.345?

1. 1.239149
2. 2.239149
3. 1.239174
4. 2.239174

2-44. What is the antilogarithm of 4.264464?

1. 18380
2. 18385
3. 18388
4. 18389

2-45. The antilog of the sum of the logarithms of two numbers is equal to the

1. product of the numbers
2. cologarithm of the numbers
3. quotient of the numbers
4. reciprocal of the cologarithm

2-46. If the mantissa for the number sequence 12 is .07918, what may the third power of 120 equal?

1. 1,728,000
2. The antilog of 6.23754
3. The antilog of 3 log 120
4. All of the above

2-47. The use of cologarithms permits you to perform the operation of division logarithmically by extracting a root.

Learning Objective: Compute the area of various plane geometric figures and identify the formulae used to determine the volume of solid geometric figures.

When answering items 2-48 through 2-50, refer to the following characteristics of plane geometric figures:

- A. Five sides of equal length
- B. Both pairs of opposite sides are parallel
- C. Adjacent sides form equal oblique angles
- D. Only one pair of opposite sides is parallel

2-48. Which of the characteristics do trapezoids have?

1. A and C
2. B and C
3. C and D
4. D only

2-49. Which characteristics belong to irregular polygons?

1. B and D
2. A, B, C, and D
3. A, B, and C
4. A, C, and D

2-50. Which of the characteristics do equilateral heptagons have?

1. A, B, and C
2. A, C, and D
3. B and C
4. C only

- 2-51. What is the total area of a rectangular parking lot which measures 310 feet and 784 feet on two adjacent sides?
1. 299,209 sq ft
 2. 243,040 sq ft
 3. 121,520 sq ft
 4. 24,304 sq ft

- 2-52. What is the area of a right triangle whose sides making the right angle measure 5 and 8 feet long?
1. 13 sq ft
 2. 20 sq ft
 3. 26 sq ft
 4. 40 sq ft

- 2-53. Assume that the triangle ABC in figure 3-10 of your textbook has the following dimensions:
- AC = 5 1/2 in.
 AD = 4 1/2 in.
 BD = 2 1/2 in.
 CD = 3 in.

What is the area of the triangle?

1. 5 1/2 sq in.
2. 7 sq in.
3. 10 sq in.
4. 10 1/2 sq in.

- 2-54. Assume that the rhomboid ABCD in textbook figure 3-11 has the following measurements:
- AD = 7 1/2 in.
 CD = 4 3/4 in.
 EC = 6 in.
 AE = 4 1/2 in.

What is the area of the rhomboid?

1. 27 sq in.
2. 30 1/2 sq in.
3. 33 3/4 sq in.
4. 37 1/2 sq in.

- 2-55. Assume that the trapezoid in figure 3-12 of your textbook has the following dimensions:
- AD = 5 in.
 BC = 3 in.
 CF = 3 in.

What is the area of the trapezoid?

1. 8 sq in.
2. 12 sq in.
3. 16 sq in.
4. 24 sq in.

- 2-56. A circle with a diameter of 5 inches will occupy an area of about
1. 12.6 sq in.
 2. 15.7 sq in.
 3. 19.6 sq in.
 4. 31.4 sq in.

- 2-57. A circle with a circumference of 12 inches will occupy an area of about
1. 11.45 sq in.
 2. 11.56 sq in.
 3. 12.45 sq in.
 4. 12.46 sq in.

- 2-58. If the diameter of the circle in textbook figure 3-15 is 4 inches and the central angle of the sector portion is 60 degrees, what is the area of the sector?
1. 1.0944 sq in.
 2. 2.0944 sq in.
 3. 2.1416 sq in.
 4. 3.1416 sq in.

- 2-59. What is the area of an equilateral octagon whose 1 1/2-inch sides are tangent to an inscribed circle with a diameter of 3 1/2 inches?
1. 10 sq in.
 2. 10 1/4 sq in.
 3. 10 1/2 sq in.
 4. 10 3/4 sq in.

- 2-60. What is the approximate area of an ellipse whose major axis is 8 feet long and whose minor axis is 4 feet long?
1. 12 sq ft
 2. 16 sq ft
 3. 25 sq ft
 4. 32 sq ft

In items 2-61 through 2-66 select from column B the formula used to determine the volume of the solid geometric figure in column A.

A. Geometric Figures	B. Formulas
2-61. Cylinder	1. $V = Bh$
2-62. Frustum of a cone	2. $V = 1/3h(B_1 + \sqrt{B_1B_2} + B_2)$
2-63. Frustum of a pyramid	3. $V = 1/3wh(r_1^2 + r_1r_2 + r_2^2)$
2-64. Parallelepiped	4. $V = 4/3\pi r^3$
2-65. Sphere	
2-66. Triangular prism	

Assignment 3

Mathematics (continued)

Textbook NAVEDTRA 10634-C: Pages 61 - 91

Learning Objective: Solve various trigonometric problems using functions of angles, logarithms, and basic laws or theorems.

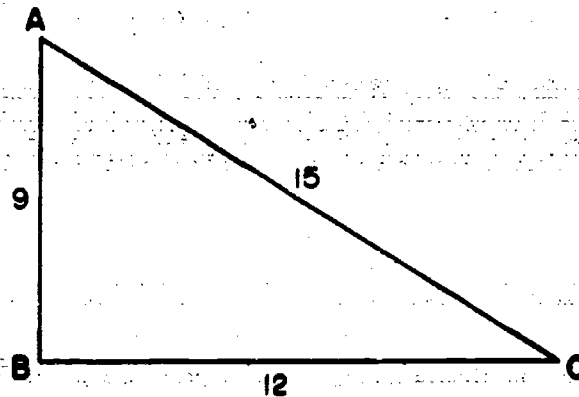

Figure 3A

3-1. What is the reciprocal function of $\cos 25^\circ$?

1. $\csc 25^\circ$
2. $\cot 25^\circ$
3. $\sec 25^\circ$
4. $\sin 25^\circ$

3-2. Which function of the 45 degree angle in textbook figure 3-23 is represented by the line DB?

1. ~~Coversed~~ sine
2. Cosine
3. Cotangent
4. Cosecant

3-3. What angle is the complement of 75° ?

1. 15°
2. 75°
3. 90°
4. 105°

3-4. When expressed as a function of another angle, $\cos 40^\circ$ equals

1. $\sec 140^\circ$
2. $\sin 140^\circ$
3. $\sec 50^\circ$
4. $\sin 50^\circ$

3-5. What angle is the supplement of 145° ?

1. 10°
2. 35°
3. 45°
4. 55°

3-6. The value of $-\cos 118^\circ$ is equal to the value of

1. $\cos 62^\circ$
2. $\sin 62^\circ$
3. $\sin 118^\circ$
4. $\cos 180^\circ$

3-7. The cosine of angle A in figure 3A is

1. 0.60000
2. 0.75000
3. 0.80000
4. 1.33333

3-8. What is the tangent of angle C in figure 3A?

1. 0.60000
2. 0.75000
3. 0.80000
4. 1.44444

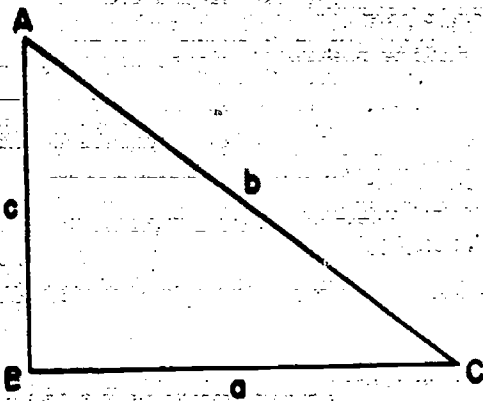

Figure 3B

The following alternatives are for items 3-9 through 3-11.

1. Sine
2. Cosine
3. Tangent
4. Cotangent

- 3-9. Which function should be used to determine the size of angle A in figure 3B if the length of sides a and b are known?
- 3-10. Which function should be used to determine the size of angle C in figure 3B if the length of sides a and b are known?
- 3-11. Which function should be used to determine the size of angle C in figure 3B if the length of sides b and c are known?
- 3-12. Which function of the angle at which the ground slopes is the ratio of the horizontal distance to the slope distance?
1. Sine
 2. Cosine
 3. Tangent
 4. Versed sine

When answering items 3-13 through 3-15, consider the problem of multiplying the sine of $38^{\circ}40'17''$ by 181.5 feet, using figure 3-4 and table 3-1 in your textbook.

- 3-13. What is the log sin of $38^{\circ}40'17''$?
1. 9.795417-10
 2. 9.795462-10
 3. 9.795733-10
 4. 9.795778-10
- 3-14. What arithmetic operation is performed in finding the product of $\sin 38^{\circ}40'17''$ and 181.5 feet by using their logs?
1. $\log 181.5 - \log \sin 38^{\circ}40'17''$
 2. $\log 181.5 + \log \sin 38^{\circ}40'17''$
 3. $\log 181.5 \times \log \sin 38^{\circ}40'17''$
 4. $\log 181.5 \div \log \sin 38^{\circ}40'17''$

- 3-15. The product of $\sin 38^{\circ}40'17''$ and 181.5 feet is represented by the antilog of
1. 2.054610
 2. 2.054655
 3. 3.054610
 4. 3.054655

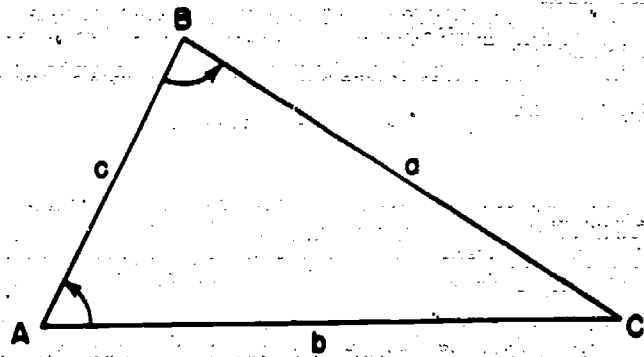

Figure 3C

When answering items 3-16 through 3-20, select from column B the trigonometric law to be used to solve the oblique triangle shown in figure 3C, based on the given and required information in column A.

A. Information	B. Laws
3-16. Given: sides b & c, angle ϕ Required: solve for all unknowns	1. Law of sines 2. Law of cosines 3. Law of tangents
3-17. Given: sides b & c, angle θ Required: solve for side a	
3-18. Given: sides b & c, angle θ Required: solve for unknown angles	
3-19. Given: side a, angles θ & ϕ Required: solve for all unknowns	
3-20. Given: sides a, b, and c Required: solve for all unknowns	

When answering items 3-21 through 3-23, refer to the trigonometric tables following the last assignment of this NRCC.

- 3-21. If in triangle DEF, $d=7$, $e=4$, and angle $F = 44^\circ 25'$, what is the length of side f ?
1. 4.12
 2. 4.38
 3. 5.00
 4. 6.33

- 3-22. If in triangle LMN, $l=5$, $m=8$, and angle $N = 45^\circ 00'$, what are the measures of angles L and M?
1. $\angle L = 55^\circ 00'$, $\angle M = 80^\circ 00'$
 2. $\angle L = 52^\circ 31'$, $\angle M = 82^\circ 29'$
 3. $\angle L = 44^\circ 40'$, $\angle M = 91^\circ 20'$
 4. $\angle L = 38^\circ 22'$, $\angle M = 96^\circ 38'$

- 3-23. If in triangle PQR, $p=8$, $q=7$, and angle $P = 42^\circ 00'$, what is the measure of angle Q?
1. $34^\circ 28'$
 2. $35^\circ 50'$
 3. $36^\circ 14'$
 4. $39^\circ 00'$

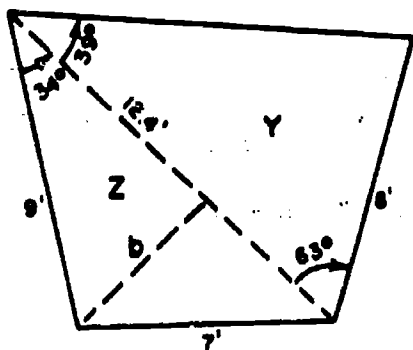

Figure 3D

When answering items 3-24 and 3-25, refer to figure 3D.

- 3-24. The area of triangle Z is approximately equal to the square root of
1. 14
 2. 67
 3. 781
 4. 957
- 3-25. The area of triangle Y is equal to
1. $49.6 \sin 63^\circ$
 2. $49.6 \cos 63^\circ$
 3. $99.2 \sin 39^\circ$
 4. $99.2 \cos 39^\circ$

Learning Objective: Recognize fundamentals of reading a slide rule and of using it to solve problems.

- 3-26. What slide rule operation is sometimes eliminated when you use the folded scales of a 10-inch Mannheim-type slide rule?
1. Reading the C scale
 2. Setting the left index
 3. Setting the right index
 4. Shifting the index

When answering items 3-27 through 3-40, assume that you are using a 10-inch Mannheim-type slide rule. Refer to figures 3-34 and 3-35 of your textbook.

- 3-27. If you place 6 on the C scale over 7 on the D scale, when 3 on the C scale will appear over what number on the D scale?
1. 1.5
 2. 2.57
 3. 3.5
 4. 4.0
- 3-28. Ten centimeters is approximately equal to 3.9 inches. What is the procedure for converting a measurement of 7 centimeters to the equivalent measurement in inches by means of a slide rule and an equation of proportions?
1. Set 3.9 on the C scale over 10 on the D scale and read the figure on the D scale which is under 7 on the C scale
 2. Set 3.9 on the C scale over 7 on the D scale and read the figure on the C scale which is over 10 on the D scale
 3. Set 7 on the C scale over 10 on the D scale and read the figure on the D scale which is under 3.9 on the C scale
 4. Set 10 on the C scale over 3.9 on the D scale and read the figure on the D scale which is under 7 on the C scale.

- 3-29. What number on the CI scale matches 4 on the C scale?
1. 11
 2. 22
 3. 25
 4. 34

- 3-30. Using the right-slanted numerals on the S scale, what value is represented by the third graduation to the right of 12° ?
1. 12.5°
 2. 12.10°
 3. 12.15°
 4. 12.30°
- 3-31. Sine functions are read on what scale of the slide rule?
1. C
 2. S
 3. ST
 4. T
- 3-32. The tangent of 35° is approximately
1. 0.572
 2. 0.700
 3. 0.819
 4. 1.428
- 3-33. In what manner does the ST scale serve to indicate both sine and tangent functions?
1. Left-slanted numerals represent sine functions and right-slanted numerals represent tangent functions
 2. Left-slanted numerals represent tangent functions and right-slanted numerals represent sine functions
 3. The left half of the scale indicates sine functions and the right half of the scale indicates tangent functions
 4. For angles indicated on the ST scale, sine and tangent functions are considered to be the same
- 3-34. The inscription, "10.0 to 1.0", at the right end of the T scale means that for tangent functions of angles greater than 45° the decimal point goes
1. in front of the first digit
 2. behind the first digit
 3. behind the second digit
 4. behind the third digit
- 3-35. The slide rule reading of $\sin 15^\circ$ is 259. This value is written as
1. 0.0259
 2. 0.259
 3. 2.59
 4. 25.9
- 3-36. To determine the tangent of 87° , you should set the hairline at
1. 1 on the D scale, bring 3 on the ST scale under the hairline, and read the number as indicated by the C scale index on the D scale.
 2. 1 on the D scale, bring 3 on the T scale under the hairline, and read the number as indicated by the C scale index on the D scale
 3. 3 on the D scale, bring 87° on the T scale under the hairline, and read the number as indicated by the C scale index on the D scale
 4. 1 on the D scale, bring 87° on the ST scale under the hairline, and read the number as indicated by the D scale index on the C scale
- 3-37. The representation of sine and tangent functions of angles smaller than those found on the ST scale is based on the principle that the sine and tangent functions of an angle smaller than 0.58° are approximately equal to
1. zero
 2. 0.0003
 3. the cosine and cotangent functions of an angle greater than 89.43°
 4. The size of the angle in radians
- 3-38. A preliminary step in finding the sine of $00^\circ 10' 24''$ is to set the hairline on the D scale at
1. 10
 2. 24
 3. 624
 4. 1024
- 3-39. To find the sine of $00^\circ 10' 24''$, the hairline setting on the scale is multiplied by approximately
1. 0.000005
 2. 0.000010
 3. 0.240000
 4. 10.400000
- 3-40. Sides a and b of a triangle are 4 inches and 7 inches, respectively, and angle A, opposite side a, is 24° . Angle B, opposite side b, may be determined by
1. $4/24^\circ = 7/B$
 2. $\sin 24^\circ/4 :: \sin B/7$
 3. $\sin 24^\circ \times 4 = \sin B \times 7$
 4. $4:7 :: \sin B: \sin A$

Learning Objective: Recognize general rules and helpful hints used by the EA in mathematical computations.

Learning Objective: Determine equivalents of weights and measures; compute areas and volumes; and convert English units of measure to metric units and vice versa.

- 3-41. The sides of a triangle are 82.705, 186.01, and 70.5 feet long. How should these dimensions be expressed for computation purposes?
1. 82.70, 186.01, 70.5
 2. 82.71, 186.0, 71.0
 3. 82.705, 186.01, 70.5
 4. 82.705, 186.010, 70.500
- 3-42. For balanced computation results, how should the sides of the triangle of item 3-41 be expressed after they are rounded off to the hundredth digit?
1. 82.71, 186.00, 70.50
 2. 82.70, 186.01, 70.50
 3. 82.70, 186.00, 70.50
 4. 82.705, 186.010, 70.500
- 3-43. Which of the following statements concerning the use of trigonometric tables is generally true?
1. When reading from top down in a table of natural sines and cosines, columns under angles usually list sine to the left and cosine to the right
 2. When reading from bottom up in a table of natural tangents and cotangents, columns under angles usually list tangents to the left and cotangents to the right
 3. When reading an angle of $45^{\circ}20'$ in a table of natural functions, which reads both top down and bottom up, the left-hand minutes column is used
 4. Each of the above
- 3-44. Refer to scales C and D on the slide rule of textbook figure 3-34. Which of the following scale readings represents the correct value?
1. 7 graduations to the right of the large numeral 3 = 312
 2. 2 graduations to the right of the small numeral 6 = 162
 3. 4 graduations to the left of the large numeral 4 = 391
 4. 3 graduations to the right of the large numeral 9 = 906

- 3-45. Universally, the most practical unit of measurement is the English system because computations of measurements are much easier.
- 3-46. The basic standard for linear measurement is the
1. foot
 2. yard
 3. centimeter
 4. meter
- 3-47. Old survey records indicated that most measurements were frequently made with Gunter's chains instead of modern survey tapes. If you were to lay out a Gunter's chain 7 times, how many total links would be involved?
1. 300
 2. 500
 3. 700
 4. 900
- 3-48. Based on the correct number of links in item 3-47, how many feet are represented?
1. 594
 2. 462
 3. 330
 4. 198
- 3-49. Compared with a US statute mile, an international nautical mile is approximately
1. 400 feet shorter
 2. 800 feet shorter
 3. 400 feet longer
 4. 800 feet longer
- 3-50. If town A is 75 kilometers from town B, how many meters is town A from town B?
1. 750
 2. 7,500
 3. 75,000
 4. 750,000
- 3-51. What is the area of a road 1,200 yards long and 22 feet wide?
1. 8,000 sq yd
 2. 8,600 sq yd
 3. 8,640 sq yd
 4. 8,800 sq yd

- 3-52. How many acres are there in 4 square miles?
 1. 2,520
 2. 2,540
 3. 2,560
 4. 2,580
- 3-53. How many cubic yards of concrete are required for the footing of a retaining wall 50 feet long, 15 feet wide, and 5 feet high?
 1. 128
 2. 130
 3. 136
 4. 139
- 3-54. What tension in pounds must be applied to a tape tension scale, if you are required to apply 8 to 10 kg tension to an unsupported tape?
 1. 8.6 to 10.0
 2. 11.6 to 15.0
 3. 17.6 to 22.0
 4. 20.6 to 25.0
- 3-55. How many seconds are there in 0.44 minute of an arc?
 1. 16.4
 2. 26.4
 3. 36.4
 4. 46.4
- 3-56. How many degrees are there in 1.38 minutes?
 1. 0.023
 2. 0.033
 3. 0.038
 4. 0.041
- 3-57. Converted into degrees, minutes, and seconds, 72.73 grads equal
 1. $57^{\circ}17'25''$
 2. $59^{\circ}27'17''$
 3. $65^{\circ}27'25''$
 4. $68^{\circ}39'17''$
- 3-58. About how many degrees are there in 4,300 mils?
 1. 242
 2. 245
 3. 250
 4. 255
- 3-59. Convert 95°F to degrees C.
 1. 35°C
 2. 34°C
 3. 32°C
 4. 30°C
- 3-60. Convert 45°C to degrees F.
 1. 49°F
 2. 57°F
 3. 113°F
 4. 158°F
- 3-61. It was determined that 435 linear feet of 2 x 4 lumber are required for form work. How many board feet of lumber should be ordered for this job?
 1. 278
 2. 280
 3. 286
 4. 290
- 3-62. How many pints are there in 2,564 gallons?
 1. 20,012
 2. 20,112
 3. 20,212
 4. 20,512
- 3-63. How many liters are there in 100,000 US gallons?
 1. 368,500
 2. 378,500
 3. 388,500
 4. 398,500
- 3-64. How many liters are there in 301 kiloliters?
 1. 3,010
 2. 30,100
 3. 301,000
 4. 3,010,000
- 3-65. Convert 135 horsepower to watts.
 1. 100,710
 2. 110,710
 3. 120,610
 4. 120,710
- 3-66. Convert 15.85 feet to the nearest $\frac{1}{8}$ inch in carpenter's measure.
 1. $15' 8 \frac{1}{2}''$
 2. $15' 10 \frac{1}{4}''$
 3. $15' 10 \frac{1}{2}''$
 4. $15' 11''$
- 3-67. Approximately how many cubic yards of concrete are required for a 6-inch layer on a 3.5-acre parking lot?
 1. 1,415
 2. 2,830
 3. 5,650
 4. 16,950

Assignment 4

Drafting Equipment and Supplies

Textbook NAVEDTRA 10634-C: Pages 92 - 119

Learning Objective: Identify various types of drawings that will concern the EA in his work.

Learning Objective: Indicate sources of information used as guidelines by Navy draftsmen.

- 4-1. A drawing is identified as technical or illustrative, depending on its
1. purpose
 2. character
 3. type
 4. quality
- 4-2. The graphic representation of a utility system prepared by an EA is called
1. an industrial drawing
 2. a mechanical drawing
 3. an engineering survey
 4. a qualitative graph
- 4-3. The drawing of quantitative or qualitative display charts and graphs is characteristic of which of the following types of engineering drafting?
1. Construction
 2. Topographic
 3. Administrative
 4. Each of the above
- 4-4. An engineering chart which shows relationships rather than numerical values is called
1. quantitative
 2. qualitative
 3. visual
 4. statistical
- 4-5. What type of engineering display chart is prepared to show the relationship between planned work and actual work accomplished?
1. Management information
 2. Network analysis
 3. Time-and-work
 4. Progress

- 4-6. To provide interpretation, all SEABEE construction drawings are prepared in accordance with what publication(s)?
1. Military Standards
 2. NAVFAC Design Manuals
 3. Both 1 and 2 above
 4. Architectural Graphic Standard
- 4-7. References to obsolete drawing symbols and unusual drawing features are normally found in the
1. Architectural Graphic Standard
 2. explanatory notes and legend of symbols
 3. Military Standards
 4. NAVFAC guidelines

When answering items 4-8 through 4-13, select from column B the publication to consult for engineering drafting practices associated with the subject matter in column A.

	<u>A. Subject Matter</u>	<u>B. Publications</u>
4-8.	Mechanical symbols	1. NAVFAC DM-6
4-9.	Dimensioning and tolerancing	2. AWS A3.0-61
4-10.	Welding symbols	3. MIL-STD-12C
4-11.	Survey-based utilities plans	4. MIL-STD-17B
4-12.	Construction and shop drawings	
4-13.	Technical publication abbreviations	

Learning Objective: Identify types and uses of, and working practices for, drafting equipment and supplies.

- 4-14. A standard NMCB Draftsman Kit contains sufficient drafting supplies and equipment to outfit how many draftsmen?
1. Ten
 2. Two
 3. Three
 4. Five
- 4-15. To retain drafting supplies left over from a deployment, you should place them in the standard kit box and list them on the kit inventory.
- 4-16. What types of drafting media are used by SEABEE draftsmen?
1. Tracing paper, tracing cloth, and detail paper
 2. Tracing paper, graph paper, and profile paper
 3. Tracing cloth, film, and tracing paper
 4. Tracing cloth, tracing paper, and graph paper
- 4-17. Why is it preferable to use tracing vellum rather than detail paper for preparation of original drawings?
1. Drawings are more permanent
 2. Mistakes are easier to erase
 3. Pencil lines are clearer and easier to read
 4. Texture of the paper is heavier
- 4-18. Compared with bristol board, illustration board differs in what respect?
1. It has only one white drawing surface
 2. It is thinner and less rigid
 3. It comes in a smaller size
 4. It cannot be used for making small signs and charts

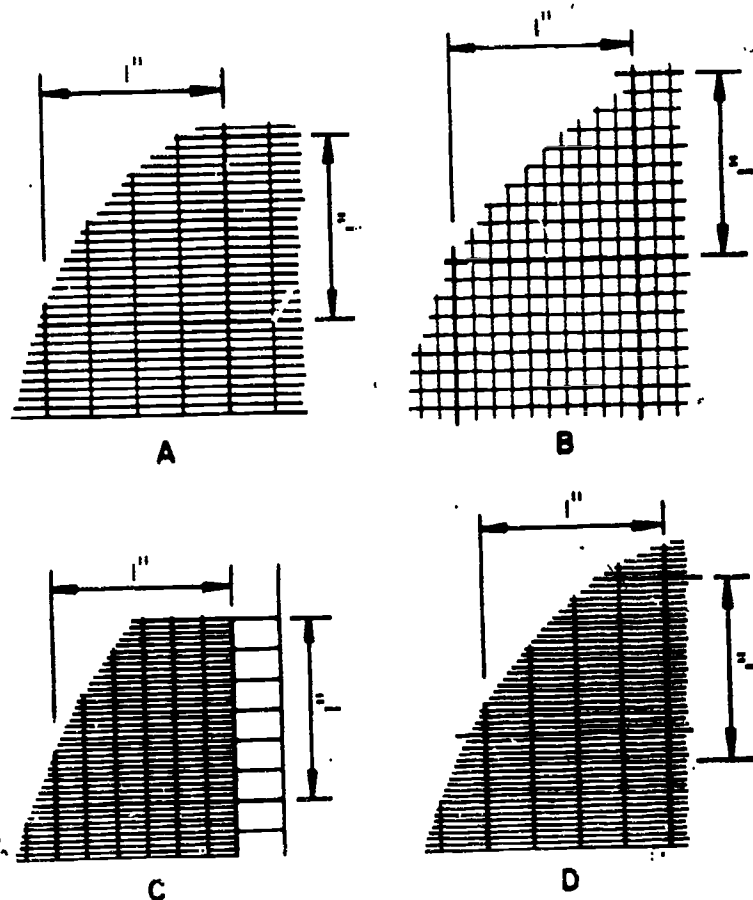

Figure 4A

● When answering items 4-19 through 4-22, refer to the samples of gridded media shown in figure 4A.

- 4-19. Cross section paper is illustrated in
1. A and D
 2. B
 3. C and D
 4. D only
- 4-20. Plan profile gridded paper is illustrated in
1. A
 2. B
 3. C
 4. D
- 4-21. Road profile design is usually drawn on paper gridded as shown in
1. A and D
 2. B
 3. A, C, and D
 4. A, B, C, and D
- 4-22. On what gridded medium would you probably plot road cross sectional areas?
1. A
 2. B
 3. C
 4. D

- 4-23. Which of the following grades of pencil leads is the hardest?
1. F
 2. HB
 3. 2H
 4. 4B
- 4-24. Which of the following types of erasers should be used to erase pencil lines on tracing vellum?
1. Art gum
 2. Vinyl
 3. Ruby red
 4. Pink pearl
- 4-25. When erasing with an electric eraser, what should you avoid doing because of the damage that may occur?
1. Erasing lightly penciled lines
 2. Erasing heavily inked lines
 3. Erasing closely spaced lines
 4. Holding the eraser steady in one spot
- 4-26. To prevent fresh ink lines from spreading, what should be done to the surface of the drafting media?
1. Cover with a film of specially prepared chemical
 2. Rub with fine bone dust
 3. Rub with pulverized art gum particles
 4. Scrape lightly with a steel eraser
- 4-27. Concerning the use of drawing boards, which of the following statements is true?
1. For a right-handed draftsman, the working edge is the left vertical edge
 2. For any draftsman the preferred working edge is the lower horizontal edge
 3. It is assumed all edges are perfectly square
 4. The drawing surface is leveled by adjusting the hinged attachments
- 4-28. Which of the following statements concerning the use of the T-square is true?
1. To draw a long continuous vertical line, set the head of the T-square against the upper edge of the drawing board
 2. To prevent warpage of the T-square when not in use, hang it vertically by the hole in its blade
 3. To test a T-square, draw coinciding lines with both the top and bottom blade edges
 4. To test a T-square draw a continuous line utilizing both vertical edges of the drawing board

- 4-29. Instead of using a T-square, some draftsmen prefer a parallel straightedge because it enables them to
1. produce cleaner drawings
 2. prevent ink blots on small drawings
 3. work more accurately on large drawings
 4. keep drawings from sliding off an inclined drawing board
- 4-30. What is the most desirable source of illumination for drafting work?
1. Indirect sunlight
 2. Direct natural light
 3. Overhead ceiling light
 4. Adjustable fluorescent table lamp
- 4-31. Assuming that a draftsman is right-handed, from what direction should the light come?
1. Left-front
 2. Right-front
 3. Over the right shoulder
 4. Over the left shoulder

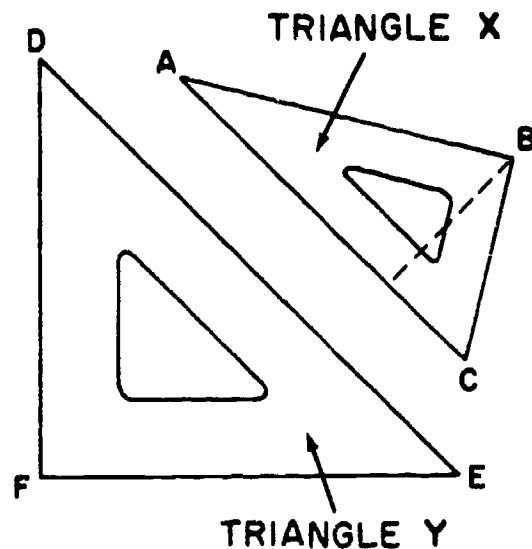

Figure 4B

- When answering item 4-32 and 4-33, refer to triangles X and Y in figure 4B.
- 4-32. The size of a 30-60 degree triangle (X) is designated by the
1. length of AB
 2. length of BC
 3. length of AC
 4. perimeter of the triangle
- 4-33. The size of a 45 degree triangle (Y) is designated by the
1. length of DE
 2. length of DF or EF
 3. perimeter of the triangle

- 4-34. In which of the following ways are circular protractors graduated?
1. Clockwise from 0 to 90 and 180 to 270 and counterclockwise from 360 to 270 and 180 to 90
 2. Clockwise and counterclockwise from 0 to 180
 3. Clockwise and counterclockwise from 0 to 360
 4. Clockwise in quadrants from 0 to 90
- 4-35. What is the minimum angle that can be set on the adjustable triangle shown in textbook figure 4-9, without estimating?
1. 30 seconds
 2. 15 minutes
 3. 30 minutes
 4. 1 degree
- 4-36. With a complete assortment of french curves, smooth arcs for practically any circle may be drawn.
- When answering items 4-37 through 4-40, refer to the instruments in textbook figure 4-11 which are identified alphabetically.
- 4-37. Which instrument is held in a set position by friction?
1. C
 2. F
 3. J
 4. L
- 4-38. A series of eight circles with a diameter of $1/2''$ to $10''$ are drawn from a single center. What instruments should be used to ink the circles?
1. B and C
 2. B, C, and D
 3. B, C, and I
 4. B, C, I, and K
- 4-39. In which of the following groups do all the instruments require setscrew adjustment of the nibs?
1. B, C, F, G
 2. B, F, G, K
 3. B, C, K, L
 4. F, G, K, L
- 4-40. Which instrument should be used to divide a $7\ 1/2''$ line into 20 equal segments?
1. A
 2. C
 3. J
- 4-41. Bringing together the points of dividers by bending the leg joints is a means of testing for
1. sharpness of the points
 2. correct length of points
 3. alinement of the dividers
 4. correct adjustment of the friction joints
- 4-42. When divider points become slightly uneven in length, what should you do?
1. Grind the points separately, in a horizontal position by rubbing on a whetstone
 2. Hold the points vertically together, grind them lightly by drawing them back and forth against a whetstone
 3. Grind the points separately, in a horizontal position by twirling against a whetstone
 4. Replace the needle points
- 4-43. How should the needles of compasses and dividers compare in point size?
1. Those of the compass should be slightly larger
 2. Those of the compass should be slightly smaller
 3. They should be the same size
- 4-44. Drawing instruments should be protected against corrosion by
1. cleaning them with a soft cloth and covering with a light film of oil
 2. polishing them occasionally with metal polish
 3. cleaning them often with a chemical provided by the manufacturer of the instrument
 4. rubbing them lightly with emery paper and applying a light film of oil
- 4-45. The drop bow pen is used primarily for inking of
1. circles which have radii of $1/8''$ or less
 2. circles with broken or dashed lines
 3. circles with radii of more than $1/4''$
 4. circular arcs

When answering items 4-46 through 4-49, select from column B the type of ruling which is best used in column A.

<u>A. Use</u>	<u>B. Type of Ruling Pen</u>
4-46. Inking of lines which are the same width	1. Detail
4-47. Inking of freehand curves	2. Hinged-blade
4-48. Inking of parallel straight lines	3. Railroad
4-49. Inking of very heavy lines	4. Contour

4-50. Which of the following conditions of the nibs of a ruling pen is likely to cause the ink to flow from the pen too fast?

1. Unequal nib length
2. Nibs set too close together
3. Nibs too sharp
4. Nibs too round

4-51. The nibs of ruling pens are sharpened correctly by

1. grinding the inner faces of the nibs with a back-and-forth motion on a whetstone
2. rubbing the backs of the nibs lightly with emery paper
3. grinding the back of each nib with a rocking motion on a whetstone
4. rubbing the inner faces of the nibs with fine sandpaper

4-52. Though damaged points of proportional dividers require sharpening, the instrument scale will still be usable but not the manufacturer's table of settings.

4-53. The scale of 1/6000 is expressed as the equation of

1. 1 in. = 300 ft
2. 1 in. = 500 ft
3. 1 in. = 600 ft
4. 1 in. = 1000 ft

4-54. In order to show details of an object drawn to full scale on a drawing, the details should be

1. scaled up
2. scaled down
3. drawn to half-scale

4-55. Scales made of which of the following materials are the most accurate?

1. Plastic
2. Yellow hardwood
3. Boxwood

4-56. Which of the following scale shapes provides the most scale faces?

1. Two-bevel
2. Opposite-bevel
3. Four-bevel
4. Triangular

4-57. On the face of an architect's scale which has a fractional equivalent of 1/16, what distance is represented between each graduation on the extra interval?

1. 1/8 inch
2. 1/4 inch
3. 1/2 inch
4. 1 inch

When answering items 4-58 through 4-61, select from column B the measuring instrument which best matches the use in column A.

<u>A. Uses</u>	<u>B. Measuring Instruments</u>
4-58. Laying out dimensions given in feet and inches	1. Metric scale
4-59. Laying out dimensions in tenths of a foot	2. Engineer's scale
4-60. Measuring given dimensions to a scale of 1cm = 50m	3. Architect's scale
4-61. Measuring given dimensions to a scale of 1in = 200 ft	
4-62. What must you do before using the engineer's scale for scaling to a scale that is expressed as a fraction?	
	1. Determine the fractional equivalent of the scale on the engineer's scale
	2. Multiply the scale numbers by 10
	3. Multiply the scale numbers by 100
	4. Multiply all measurements by 10
4-63. Which scale on the engineer's scale is used to determine that a line on a drawing 5 inches long is equivalent to 2400 inches, or 200 feet?	
	1. 10 scale
	2. 20 scale
	3. 40 scale
	4. 50 scale

- 4-64. You want to draw the outline of a 200- by 250-foot rectangular area on an 8- by 10 1/2-inch sheet of paper. Which scale should you use to get the largest drawing that will fit on the paper?
1. 10 scale
 2. 30 scale
 3. 50 scale
 4. 60 scale
- 4-65. Before using a map measure to determine the length of a pipeline on a SEABEE drawing, you should first
1. adjust the tracing wheel with an odometer
 2. trace over the line to be measured
 3. set the scale indicator to the numerical scale indicated on the drawing
 4. trace over the graphical scale to insure the accuracy of the reading
- 4-66. Which of the following pens is especially suitable for fine lettering?
1. No. 12 quill pen
 2. No. 1 quill pen
 3. Speedball style A pen
 4. Speedball style B pen
- 4-67. What is a disadvantage of using a quill pen for drawing freehand lines?
1. It holds only small amount of ink
 2. It produces only one uniform line thickness
 3. It is hard to clean
 4. It is hard to control
- 4-68. Which of the following speedball pens will produce the thinnest uniform lines for single-stroke lettering?
1. A-1
 2. B-5
 3. C-6
 4. D-0
- 4-69. What is the probable cause when a large felt tip pen produces ungraded fuzzy lines?
1. The ink reservoir is nearly empty
 2. The tip is too saturated with ink
 3. The tip has been damaged by too much pressure
- 4-70. What should be done to remedy the problem of item 4-69?
1. Refill the ink reservoir
 2. Allow the tip of the pen to dryout
 3. Reshape the tip with a sharp knife
 4. Replace the pen
- 4-71. Which of the following is an advantage of a technical fountain pen over a standard ruling pen?
1. It produces thicker lines
 2. It is easier to maintain and clean
 3. It has a larger ink capacity
 4. It produces uniformly graded lines
- 4-72. In what position should you hold the technical fountain pen when drawing a straight line?
1. Perpendicular to the drawing surface
 2. Tilted slightly toward you
 3. Tilted in the direction the line is drawn
 4. Tilted in the opposite direction the line is drawn

Assignment 5

Drafting: Basic Techniques, Format and Conventions

Textbook NAVEDTRA-10634-C: Pages 120 - 154

Learning Objective: Recognize factors to consider in the arrangement of a suitable drafting work area and in the selection and use of drafting equipment and materials.

- 5-1. Under ideal conditions, how many square feet of working area should be allowed for each draftsman?
1. 25
 2. 50
 3. 75
 4. 100
- 5-2. To be positioned comfortably at your drawing board, your line of sight in relation to the drawing surface should be at what approximate angle?
1. 30°
 2. 45°
 3. 60°
 4. 90°
- 5-3. If a drawing board has a severely marred drawing surface, you should cover the surface with
1. a large sheet of butcher's paper
 2. two thicknesses of drawing paper
 3. laminated vinyl material
 4. self-adhesive linoleum
- 5-4. A sheet of smooth, white paper placed under an original pencil drawing on tracing paper is called a
1. detail sheet
 2. platen sheet
 3. smooth sheet
 4. work sheet
- 5-5. When a pencil drawing is to be inked, what type of eraser should be used on the tracing paper?
1. Electric
 2. Steel
 3. Ruby red or pink pearl
 4. Art gum
- 5-6. What should be done to the surface of drawing paper which has become scratched from excessive erasing?
1. Rub the area smooth with your thumbnail
 2. Rub the area lightly with pounce
 3. Cover the damaged area with transparent tape
 4. Apply a thin coating of clear acrylic spray
- 5-7. Why is it advantageous to use tracing paper for the preparation of original pencil drawings?
1. The surface of the paper is resistant to pencil smudges
 2. Moisture will not shrink or damage the paper
 3. The surface of the paper is resistant to damage by repeated erasures
 4. Transparency of the paper provides excellent reproduction qualities
- 5-8. Of the following drawing pencils, which should be selected for the initial layout of a drawing?
1. 2B
 2. F
 3. H
 4. 4H

- 5-9. A pencil should always be sharpened on its unlettered end to
1. avoid breaking the lead
 2. retain the grade symbol
 3. retain the manufacturer's name
 4. permit easier dressing of the point

- 5-10. The mechanical pencil pointer produces a/an
1. chisel point
 2. elliptical point
 3. conical point
 4. wedge point

- 5-11. When drawing, a draftsman should keep a cloth or tissue handy to
1. wipe graphite particles from his pencil
 2. clean the drawings
 3. remove erasure particles

- 5-12. An advantage of a mechanical pencil over a wooden pencil is that a mechanical pencil
1. is more comfortable to use
 2. does not need to be sharpened as frequently
 3. stays at a constant length
 4. utilizes leads which do not break as readily

Learning Objective: Indicate tools and techniques used for constructing basic lines.

- 5-13. When drawing a horizontal line, you should hold the pencil at an incline of
1. 30°
 2. 45°
 3. 60°
 4. 75°

- 5-14. When you are drawing vertical lines, the pencil should be inclined toward the
1. top of the board and the line drawn from bottom to top
 2. top of the board and the line drawn from top to bottom
 3. bottom of the board and the line drawn from bottom to top
 4. bottom of the board and the line drawn from top to bottom

- 5-15. With a T-square used as a base, 30° x 60° and 45° triangles will produce lines at intervals of
1. 15°
 2. 30°
 3. 45°
 4. 75°

- 5-16. In using a compass to draw a circle, the draftsman should do which of the following?

1. Rotate the compass clockwise
2. Lean the compass slightly forward
3. Apply even pressure
4. All of the above

- 5-17. A french curve is used to draw
1. smooth circular lines
 2. smooth noncircular lines
 3. circular parallel lines
 4. arcs of nonconcentric circles

- 5-18. The first step in using a french curve to draw a line is to
1. lightly sketch in the line between the plotted points
 2. avoid abrupt changes in curvature
 3. place the french curve so that it intersects at least two plotted points
 4. stop short of the last plotted point

- 5-19. When possible, you should use drafting templates because they are
1. as accurate as any other drawing method and usually much faster
 2. not as accurate as other drawing methods but usually faster
 3. more accurate than other drawing methods and usually faster
 4. more accurate than other drawing methods although slower

Learning Objective: Indicate requirements of drawing materials and the standard drawing format used in the preparation of Navy drawings.

- 5-20. Standard drawing sheet sizes are used to
1. standardize the size of all drawings
 2. eliminate the waste of expensive tracing paper
 3. insure that the supply department orders the correct sizes of tracing paper
 4. facilitate filing

- 5-21. The dimensions of a size "C" sheet of drawing paper are
1. 11 x 17 in.
 2. 17 x 22 in.
 3. 22 x 44 in.
 4. 34 x 44 in.

5-22. The actual dimensions inside the borderlines on a size "D" sheet of drawing paper are

1. 16 5/8 x 21 5/8 in.
2. 16 1/2 x 21 1/2 in.
3. 21 1/2 x 33 1/2 in.
4. 21 3/8 x 33 3/8 in.

5-23. When tracing paper is to be used for roll size drawings, you should add

1. 2 inches to all margins
2. 2 inches to the left margin and 4 inches to the right margin
3. 2 inches to the right margin and 4 inches to the left margin
4. 4 inches to both the right and left margins

5-24. The dimensions between the trim lines on a piece of "F" size drawing paper should be

1. 28 x 40 in.
2. 27 1/2 x 39 1/2 in.
3. 34 x 44 in.
4. 33 1/2 x 43 1/2 in.

5-25. If blueprints of a drawing are to be made on paper that is not precut, the trim lines on the drawing should be

1. omitted
2. darkened
3. drawn as hidden lines
4. drawn normally

5-26. The basic format for all drawings which are assigned NAVFAC drawing numbers can be found in MIL-STD-100A and

1. NAVFAC DM-5
2. NAVFAC DM-6
3. NAVFAC P-315
4. NAVFAC P-405

5-27. The primary purpose of the title block on a drawing is to

1. describe the drawing
2. tell who drew the drawing
3. specify who is ultimately responsible for the drawing
4. identify the drawing

5-28. All title blocks must be mechanically lettered.

5-29. The title block of a drawing is always located in the

1. lower right corner
2. lower left corner
3. lower center
4. upper right corner

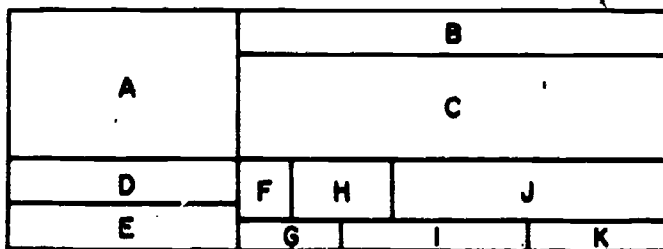

Figure 5A

● When answering items 5-30 through 5-35, refer to figure 5A

5-30. Which of the spaces is reserved for the name and location of the activity preparing the drawing?

1. A
2. B
3. C
4. D

5-31. In which of the spaces could the terms "as shown," "as noted," or "none" be correctly entered?

1. J
2. I
3. G
4. E

5-32. The five-digit number used to identify the Government activity responsible for the design of the item is entered in space

1. D
2. E
3. F
4. H

5-33. The drawing size is entered in space

1. /
2. G
3. I
4. K

5-34. Which space holds the name of the draftsman preparing the drawing?

1. A
2. D
3. E
4. J

5-35. When a set of drawings pertains to a complete project, where should the sheet number and total number of sheets be indicated?

1. E
2. G
3. I
4. K

5-36. On a construction drawing, the revision block is placed at which corner of the drawing?

1. Lower right
2. Lower left
3. Upper right
4. Upper left

5-37. The symbol $\triangle B3$ in the revision of a drawing block indicates the

1. third change incorporated in the second revision
2. third change incorporated in the third revision
3. second change incorporated in the second revision
4. second change incorporated in the third revision

5-38. In which of the following ways is revision information entered in the revision block of a drawing?

1. Chronologically, starting at the bottom of the block
2. Chronologically, starting at the top of the block
3. Alphabetically, starting at the bottom of the block
4. Alphabetically, starting at the top of the block

Learning Objective: Recognize standard line conventions required on Navy drawings.

5-39. What feature do all the lines in the system of line conventions have in common?

1. They convey information
2. They are drawn with a pen guided by a straightedge
3. They are drawn with a compass
4. They are drawn freehand

5-40. In accordance with MIL-STD-100A, how many different thicknesses of lines could be used on a drawing?

1. 1
2. 2
3. 3
4. 4





5-41. How should construction lines be drawn?

1. Thick and dark
2. Dark enough to see, but light enough to erase easily
3. Thin and dark
4. With a soft pencil

5-42. To indicate the travel of a moving center, which of the following lines are used?

1. Phantom lines
2. Centerlines
3. Reference lines
4. Visible lines

5-43. An example of a centerline is

1. 
2. 
3. 
4. 





5-44. The thick, solid lines which define the outlines of an object in a drawing are

1. datum lines
2. dimension lines
3. extension lines
4. visible lines

5-45. Lines drawn to define features of an object which are NOT visible are called

1. invisible lines
2. indefinite lines
3. hidden lines
4. phantom lines

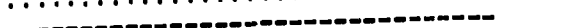



5-46. In a drawing of a certain view of an object, the features of the object that CANNOT be seen are indicated by

1. 
2. 
3. 
4. 

5-47. Thin continuous lines which represent extension lines are used to

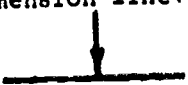



1. facilitate the reading of dimensions
2. indicate dimensions
3. extend the edges of one view to the next
4. extend the dimensions of one view to the next

5-48. Which of the following symbols represents a dimension line?

1. 
2. 
3. 
4. 

- 5-49. How should arrowheads be drawn?
1. Between 1/4 and 1/2 in. long, the length twice the spread and filled in
 2. Between 1/4 and 1/2 in. long, the length twice the spread, and not filled in
 3. Between 1/8 and 1/4 in. long, the length three times the spread, and filled in
 4. Between 1/8 and 1/4 in. long, the length three times the spread, and not filled in

5-50. An explanatory note about a view is indicated on a drawing by means of



1. 
2. 
3. 
4. 

5-51. Leaders must always terminate with an arrowhead if they reference a line.

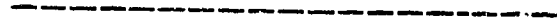
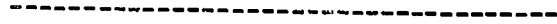

5-52. Drawing space is saved in certain large-scale detailed drawings by omitting unimportant parts that are continuous and have the same size and shape. The omitted parts of the drawing are indicated by means of

1. sectioning
2. leaders
3. breaklines
4. cutting planes

5-53. The alternate positions of a switch handle can be indicated on a drawing by the use of

1. 
2. 
3. 
4. 

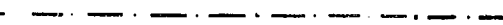
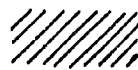
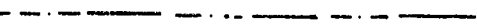
5-54. A section of an object is indicated on a drawing by the use of

1. 
2. 
3. 
4. 

5-55. If an interval section of an object is needed, which of the following would indicate the plane from which the sectional view was taken?

1. The cutting plane line
2. The sectional plane line
3. The datum plane line
4. The reference plane line

In items 5-56 through 5-58, select from column B the description which most closely fits the line in column A.

		<u>A. Types of Lines</u>	<u>B. Descriptions</u>
5-56.	Stitch line		1. Plane from which an elevation is measured
5-57.	Datum line		2. Connects corresponding points on different sheets of the same drawing
5-58.	Match line		3. Indicates sewing lines on an article
5-59.	In a pencil drawing, when should you draw the nonhorizontal and nonvertical lines?		1. After drawing the extension and dimension lines 2. After drawing the horizontal and vertical lines 3. Before drawing the horizontal and vertical lines 4. Before drawing any circles or arcs
5-60.	On a drawing, which of the following lines are last to be inked?		1. Horizontal lines 2. Vertical lines 3. Irregular curves 4. Border lines

Assignment 6

Drafting: Lettering

Drafting: Geometric Construction

Textbook NAVEDTRA 10634-C Pages 155 - 174

Learning Objective: Describe techniques of freehand vertical and inclined single-stroke lettering, and point out methods for lettering composition.

- 6-1. As you practice freehand lettering, you develop "writer's cramp". What is the probable cause?
1. Applying excessive downward pressure on the pencil
 2. Applying too little downward pressure on the pencil
 3. Resting only the ball of the hand on the drawing board
 4. Gripping the pencil too tightly
- 6-2. Which of the following pencil grades is most commonly used for freehand lettering on construction drawings?
1. 2B or 3B
 2. B or H
 3. F or H
 4. H or 2H
- 6-3. What guidelines are used for lettering that requires only capitals?
1. Capline, waistline, and baseline
 2. Capline, baseline, and dropline
 3. Capline and baseline
 4. Capline and dropline

In answering items 6-4 through 6-7, select from column B the name of the guideline which is described in column A.

- | | <u>A. Descriptions</u> | <u>B. Names of Guidelines</u> |
|------|--|---|
| 6-4. | Upper limit of lowercase letters without ascenders | 1. Capline
2. Waistline
3. Baseline |
| 6-5. | Lower limit of lowercase letters with descenders | 4. Dropline |
| 6-6. | Lower limit of capital letters | |
| 6-7. | Upper limit of lowercase letters with ascenders | |
| 6-8. | If vertical guidelines are used to keep letters vertical, how should they be spaced along the horizontal guidelines? | |
| | 1. Approximately every fifth letter | |
| | 2. Approximately every two words | |
| | 3. At the beginning, at the middle, and at the end of each line of lettering | |
| | 4. At random | |

- 6-9. For appearance of inclined lettering, what is the maximum angle between direction lines and horizontal guidelines?
1. 60°
 2. 68°
 3. 70°
 4. 78°
- 6-10. What is the proportion of lowercase to capital letters when the center row of guideline holes of the Ames lettering instrument is used?
1. 1:1
 2. 2:3
 3. 3:5
 4. 1:2
- 6-11. The number 6 on the inner circle of the Ames lettering instrument is aligned with the index on the outer circle. What is the distance between capline and baseline produced by this setting?
1. 3/32 in.
 2. 3/16 in.
 3. 1/4 in.
 4. 3/8 in.
- 6-12. What is the distance between the baseline and waistline when guidelines are drawn with the Ames lettering instrument set on 5, using the left row guideline holes?
1. 1/32 in.
 2. 1/16 in.
 3. 3/32 in.
 4. 5/32 in.
- 6-13. What is the normal spacing between continuous lines of lettering?
1. One-half the distance between the capline and dropline
 2. Two-thirds the distance between the capline and baseline
 3. Three times the distance between the capline and waistline
 4. Equal to the distance between the capline and the baseline
- 6-14. Which of the following statements concerning the formation of single-stroke Gothic letters is NOT true?
1. Each letter is drawn by one single continuous stroke
 2. All inclined strokes are drawn from the top down
 3. All horizontal strokes are drawn from left to right
 4. All curved strokes are drawn from above downward
- 6-15. Single-stroke Gothic lettering is usually used on construction drawings because it is the easiest to read and the simplest to draw.
- 6-16. Which of the following groups of letters includes letters which are all formed with the same number of strokes?
1. O, J, U, S
 2. J, C, O, D
 3. S, Q, U, F
 4. R, B, D, G
- Items 6-17 through 6-23 are statements concerning the formation of vertical single-stroke Gothic letters. Each statement is either TRUE or FALSE.
- 6-17. The strokes of V and W intersect slightly below the baseline.
- 6-18. The central horizontal bar of H, F, and E is normally placed midway between the capline and baseline.
- 6-19. The horizontal strokes of Z are equal in length
- 6-20. The two inclined strokes of A intersect slightly above the capline.
- 6-21. The inclined strokes of X intersect slightly above center.
- 6-22. The straight horizontal stroke of G begins at the center of the circle.
- 6-23. The upper and lower portion of S are connecting semicircles.
- 6-24. In order to balance letters in words, which of the following should be done?
1. Extend the horizontal stroke of T when it precedes A
 2. Compress the O to a narrower elliptical shape when it is between letters that have vertical strokes
 3. The letter H should be slightly compressed
 4. Place the central horizontal bar of H, F, and E slightly below center to create an optical illusion of widening
- 6-25. If the Ames lettering instrument is set on 8 to make capital letter guidelines for drawing notes, what number should be set on the instrument to produce guidelines for numerals that will be used in the same drawing notes?
1. 5
 2. 6
 3. 7
 4. 8

To interpret drawings clearly, it is essential that numerals and fractions be drawn properly. In items 6-26 through 6-30, determine whether each statement is:

1. Good lettering practice
 2. Poor lettering practice
- 6-26. The 9 should be drawn as an inverted 6.
- 6-27. The horizontal bar of the 4 should be drawn midway between the top and bottom of the number.
- 6-28. The closed portion of 6 and 9 should be drawn as circles.
- 6-29. The height of a fraction is 1 1/2 times that of a whole number.
- 6-30. The numbers of a fraction are 3/4 the height of a whole number.
- 6-31. Lowercase letters should NEVER be used
1. on construction drawings
 2. in combination with capitals on Navy drawings
 3. on Navy drawings where the required size of lettering is more than 1/4 in. high
 4. on construction drawing title blocks
- 6-32. In the following lowercase letter groups, select one group in which all letters are formed with the same number of strokes. Refer to textbook figure 6-10.
1. c, o, r, u
 2. d, k, r, n
 3. y, w, a, g
 4. t, u, y, z
- 6-33. Referring to textbook figure 6-10, determine which of the following lowercase letter groups has properly formed letters.

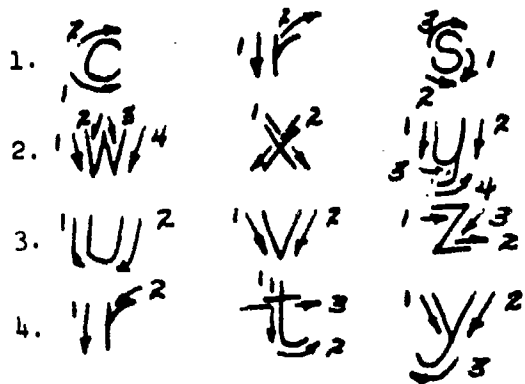

- 6-34. Which of the following statements concerning inclined single-stroke Gothic lettering is NOT true?
1. Rules of balance, proportion and stability are similar to those of vertical lettering
 2. The major axes of the letter O is a minimum of 68° with the horizontal
 3. Horizontal guidelines are the same as for vertical lettering
 4. All circles and circular arcs used in forming vertical letters become elliptical for inclined letters

- 6-35. A block of general notes on a drawing consists of several lines of lettering. What contributes the most to the appearance of the notes?
1. Spacing between letters and words
 2. Formation of each letter
 3. Size of the lettering
 4. Spacing between the lines

When answering items 6-36 through 6-39, select from column B the recommended solution to the letter spacing problem in column A.

- | A. | A. <u>Spacing Problems</u> | B. <u>Recommended Solutions</u> |
|-------|---|--|
| 6-36. | A next to V as in HAVE | 1. Move the letters farther apart |
| 6-37. | M next to N as in COLUMN | 2. Move the letters closer together |
| 6-38. | H next to O as in HOLF | |
| 6-39. | W next to O as in WORK | |
| 6-40. | For good appearance, the spacing between words should be equal to | <ol style="list-style-type: none"> 1. 1 1/2 times the space occupied by N 2. 1 1/2 times the height of the capitals 3. the distance between the capline and the dropline 4. the space occupied by the letter O |
| 6-41. | Generally, what is considered a good distance between lines of lettering? | <ol style="list-style-type: none"> 1. 1/2 the letter height 2. 2/3 the letter height 3. equal to the letter height 4. 1 1/2 the letter height |

- 6-42. What is meant by the term JUSTIFYING as applied to lettering?
1. Adjusting words or letterspacing to make a line of lettering fit a given length
 2. Spacing of letters for good appearance of words
 3. Centering a line or lines of lettering about the center of a given area
 4. Using sample lettering as a guide for centering

Learning Objective: Explain the proper use and care of Leroy lettering equipment, and indicate methods for spacing and centering of mechanical lettering.

- 6-43. Mechanical lettering is the type of lettering used on most drawings, freehand lettering being confined to sketches and special uses.

- 6-44. What is the maximum height of letter which can be made using the templates in a standard Leroy lettering set?
1. 1 1/2 in.
 2. 1 1/4 in.
 3. 1 in.
 4. 1/2 in.

- 6-45. How many different line weights can be made with the pens contained in a standard Leroy lettering set?
1. 8
 2. 9
 3. 11
 4. 12

- 6-46. What part of the Leroy lettering set establishes line thickness of letters?
1. Ink reservoir
 2. Tracing pin
 3. Cleaning pin
 4. Templates

- 6-47. What advantage does the adjustable scribe have over the standard fixed scribe?
1. Templates with larger lettering may be used
 2. Larger pens may be inserted in the scribe to produce thicker lines
 3. Templates with special types of lettering may be used
 4. Inclined lettering may be produced with standard templates

- 6-48. What is the largest size template that should be used with the sharpest point of a reversible tracing pin?
1. 100
 2. 120
 3. 140
 4. 175

- 6-49. To maintain lettering in a straight line, hold the scribe tail pin firmly against the edge of a T-square or straightedge at all times.

- 6-50. What is the maximum that the thickness of lettering may be varied without changing templates?
1. One size under recommended size
 2. One size over recommended size
 3. Two sizes under recommended size
 4. Two sizes over recommended size

- 6-51. Which of the following statements is TRUE concerning the adjustment of the scribe?
1. Rough adjustment of the scribe adjustment screw is made after the pen has been filled
 2. The cleaning pin must be removed for proper rough adjustment
 3. Rough adjustment is made when the cleaning pin barely touches the paper, before the pen is filled
 4. Final adjustment is made after the locknut has been tightened

- 6-52. What can you do when you stop lettering for short intervals to make the ink flow properly again?
1. Remove the cleaning pin and place the tip of the pen flat on a piece of scratch paper
 2. Place the pen tip, with the cleaning pin in the pen, on a small piece of moistened cotton
 3. Remove the cleaning pin and elevate the scribe so that the pin tip does not touch any surface
 4. With the cleaning pin in the pen, elevate the scribe so that the pen tip does not touch any surface

- 6-53. The same general rules for spacing free-hand letters, words, and lines of lettering also apply for mechanical lettering.

- 6-54. Using the Leroy template to center the title, ENGINEERING AID 3 & 2, how many graduations to the left of the zero graduation will the first word of the title begin?
1. 8
 2. 9
 3. 10
 4. 11

Learning Objectives: Recognize techniques and methods of constructing geometric figures.

- 6-55. When transferring an angle, you should determine the angle size by using a
1. compass
 2. scale
 3. protractor
 4. straightedge
- 6-56. From what point should you carry out the first step of procedure to bisect or transfer angle XYZ? (Always use the middle letter as the apex.)
1. A random point on XY
 2. A random point on YZ
 3. The apex Y
- 6-57. To draw a parallel line at a given distance from another, set the compass to the given distance, strike two arcs from random points on the existing line, and draw a line tangent to the arcs.
- 6-58. What is the first step in drawing a line through a given point P parallel to line XY?
1. Place compass needlepoint on P; strike an arc intersecting XY at any point
 2. Place compass needlepoint on P; strike an arc intersecting the approximate midpoint of line XY
 3. Place compass needlepoint on any point along line XY; strike an arc through point P and line XY
 4. Place compass needlepoint on X; strike an arc through Y and near point P
- 6-59. To construct a perpendicular from a given point P on line XY, the compass needle is first placed at
1. P
 2. X or Y
 3. a point near the midpoint of PX and PY
 4. any convenient point along XY
- 6-60. What points on a line should be used as centers for the intersecting arcs drawn to bisect the line?
1. The center and one end
 2. A random point and one end
 3. A random point and the center
 4. The two ends
- 6-61. Line XY is to be divided into 12 equal parts by geometric construction. Which of the following statements concerning this procedure is true?
1. Ray line PY, drawn from Y, is the same length as XY
 2. Ray line PY is divided into 12 equal parts with the compass
 3. A line is drawn from X to the 12th interval on ray line PY
 4. The acute angle formed by XY and ray line PY should be 30° or less
- 6-62. In the procedure for dividing a line into parts which are proportional as 3:4:5, you draw first the ray line as required. The next step of procedure is to lay off
1. 9 equal segments on the ray line
 2. 12 equal segments on the ray line
 3. 9 equal segments on the existing line
 4. 12 equal segments on the existing line
- 6-63. Given the three lengths of a triangle, the triangle cannot be geometrically constructed unless the size of at least one of the angles is known.
- 6-64. In which of the following constructions, if any, is it necessary to draw an angle by using a protractor?
1. Constructing an equilateral triangle on a given inscribed circle
 2. Constructing a right triangle for which the hypotenuse and one side are given
 3. Constructing an equilateral triangle for which the length of one side is given
 4. None

Assignment 7

Drafting: Geometric Construction (Continued)

Drafting: Projections and Sketching

Textbook NAVEDTRA 10634-C Vol. I: Pages 174 - 224

Learning Objective: Recognize techniques and methods of constructing geometric figures

When answering items 7-4 through 7-6, select the geometric figure construction in column B which matches the construction procedure in column A.

	<u>A. Construction Procedures</u>	<u>B. Geometric Figure Constructions</u>
<p>7-1. To inscribe, within a given circle, an equilateral triangle with apex pointing to the right, the essential steps of procedure include drawing a</p> <ol style="list-style-type: none"> 1. horizontal diameter and striking arcs from the left point of intersection of diameter and circumference 2. horizontal diameter and striking arcs from the right point of intersection of diameter and circumference 3. vertical diameter and striking arcs from the lower point of intersection of diameter and circumference 4. vertical diameter and striking arcs from the higher point of intersection of diameter and circumference 	<p>7-4. Connect the points where they intersect the circumference</p>	<ol style="list-style-type: none"> 1. Square on a given inscribed circle 2. Regular polygon on a given inscribed circle
<p>7-2. To construct a square having sides of given length, draw a horizontal line with the T-square equal to the given length; using the T-square and triangle erect perpendicular from both ends of the line, each equal to the given length, and draw a line connecting the perpendiculars</p>	<p>7-5. After dividing the circumference into equal segments, construct tangents perpendicular to the radii</p>	<ol style="list-style-type: none"> 3. Square in a given circumscribed circle
<p>7-3. What is the first step in constructing a square geometrically when given only the length of its diagonal?</p> <ol style="list-style-type: none"> 1. Lay out a vertical line equal to the given length 2. Lay out a vertical line equal to one half the given length 3. Lay out a horizontal line equal to the given length 4. Lay out a horizontal line equal to one half the given length 	<p>7-6. Construct tangents perpendicular to diameters at points of intersection on the circumference</p>	
	<p>7-7. Which of the following regular polygons may be constructed with only the length of one side given?</p> <ol style="list-style-type: none"> 1. 5-sided polygon 2. 7-sided polygon 3. 9-sided polygon 4. All the above 	
	<p>7-8. Assume that you have drawn a hexagonal bolt head from the given distance between its opposite corners. On the drawing, this distance is equal to the</p> <ol style="list-style-type: none"> 1. diameter of the circle inscribed in the hexagon 2. diameter of the circle circumscribing the hexagon 3. diagonal of the square circumscribing the hexagon 4. side of the square circumscribing the hexagon 	

- 7-9. When geometrically constructing a regular octagon from the given distance between two opposite sides, you draw the last four sides tangent to the circle at 45 degrees to the horizontal.
- 7-10. In the construction of a circle that is to pass through three given points, the center of the circle is determined by the intersection of
1. the perpendicular bisector of the longest line and the perpendicular line drawn from the end of the shortest line
 2. the perpendicular bisector of the shortest line and the perpendicular line drawn from the end of the longest line
 3. perpendicular bisectors of the lines that connect the points
 4. tangents drawn through each point
- 7-11. To construct a line tangent to a circle at a given point on the circle, first set a compass
1. equal to the diameter of the circle
 2. equal to the radius of the circle
 3. to a distance less than the radius of the circle
 4. to a distance greater than the radius and less than the diameter of the circle
- 7-12. To draw an arc of a given radius tangent to the sides of any angle, one of the essential steps of procedure is to construct
1. two nonparallel lines at right angles to the sides of the angle
 2. two lines which are parallel to the sides of the angle at a distance equal to $1/2$ the given radius
 3. two lines which are parallel to the sides of the angle at a distance equal to the given radius
 4. two parallel lines at right angles to the sides of the angle
- 7-13. In textbook figure 7-39, the radius $O'P$ is equal to
1. double the radius OP
 2. the radius OP plus the radii of arcs CD and EF
 3. the radius of arc CD plus AB
 4. the radius of arc EF plus AB
- 7-14. In textbook figure 7-37, the compass spread $O'P$ is equal to
1. AB
 2. radius OP minus AB
 3. radius of arc EF minus AB
 4. radius OP minus the radius of arc CD
- 7-15. In figure 7-38 of the textbook, the radius OP is equal to
1. $O'P$
 2. line AB less the radius of arc CD
 3. line AB less the radius of arc EF
 4. the sum of the radii of arcs CD and EF
- 7-16. The first step of procedure for constructing a compound curve, as illustrated in figure 7-40 of the textbook, is to
1. draw the chords connecting AB , BC , CD , and DE
 2. erect a perpendicular bisector from A to B
 3. establish the random distance O_1A
 4. draw arc AB
- 7-17. Assume that you just constructed the ogee curve illustrated in figure 7-42 of the textbook. Which of the following points was not established by geometric construction?
1. C
 2. D
 3. E
 4. O_1
- 7-18. When the pin-and-string method is used to construct an ellipse, which points are used to determine the length of the string before the perimeter of the ellipse is drawn?
1. Both end points of the minor axis and one focus point
 2. Both end points of the major axis and one focus point
 3. Both foci points and one end point of the minor axis
 4. Both foci points and one end point of the major axis
- 7-19. You are constructing an ellipse by the concentric circle method. The ellipse must pass through the intersecting points of the
1. horizontal diameter with both circles
 2. horizontal diameter with the larger circle and the vertical diameter with smaller circle
 3. vertical diameter with both circles

Learning Objective: Recognize various projection methods and their characteristics.

In items 7-20 through 7-23, select from column B the type of projection having the characteristic in column A.

A. Characteristics	B. Types of Projection
7-20. Lines of sight converge	1. Orthographic
7-21. Plane of projection is between point of sight and object	2. Perspective pictorial
7-22. Shows only two dimensions	3. Orthographic and perspective pictorial
7-23. Point of sight is at infinity	

Learning Objective: Describe the principles of orthographic projection and techniques of making multiview orthographic drawings.

- 7-24. In an orthographic projection, which of the following views are the principal planes of projection?
1. Top, bottom, and side views
 2. Front, rear, and top views
 3. Front, bottom, and side views
 4. Front, top, and side views
- 7-25. The most common orthographic projection used in the United States is
1. first-angle
 2. second-angle
 3. third-angle
 4. fourth-angle
- 7-26. Which of the following planes in the third-angle projection is considered to be in the plane of the drawing paper?
1. Horizontal plane
 2. Vertical plane
 3. Profile plane
 4. Third-angle plane

● In answering item 7-27, refer to figures 8-7 and 8-8 in the textbook.

- 7-27. The intersection of lines AB and CD (point O) represents the intersection of the
1. horizontal and vertical planes
 2. horizontal and profile planes
 3. vertical and profile planes
 4. profile, vertical and horizontal planes
- 7-28. How should views be placed on tracing paper?
1. So they give the appearance of a balanced drawing
 2. So they conserve as much paper as possible
 3. In a manner that depicts a clear and concise picture of the object being drawn
 4. In a manner that facilitates the projecting of the views

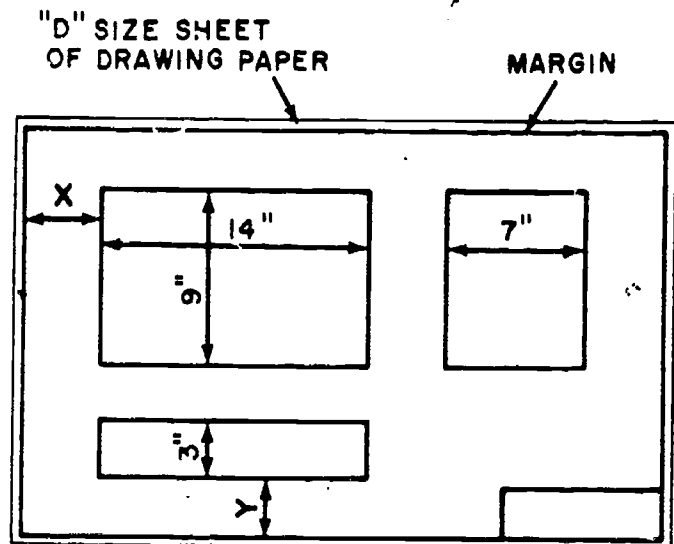

Figure 7A

● In answering items 7-29 and 7-30, refer to figure 7A.

- 7-29. The distance X is equal to
1. $3 \frac{1}{3}$ "
 2. 5"
 3. $4 \frac{1}{3}$ "
 4. 4"
- 7-30. The distance Y is equal to
1. 2"
 2. $2 \frac{1}{3}$ "
 3. 3"
 4. $3 \frac{1}{3}$ "

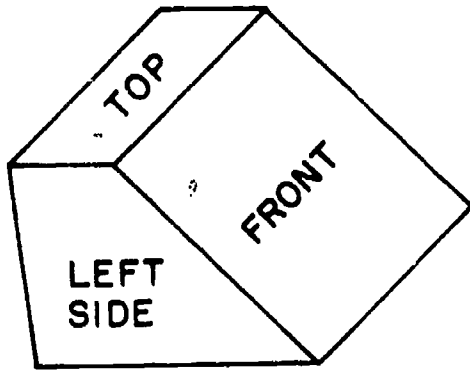

Figure 7B

7-31. Which of the following is the proper view arrangement for figure 7B?

- 1.
- 2.
- 3.
- 4.

7-32. A non-normal line is a line that is

1. curved
2. perpendicular to a plane of projection
3. oblique to one or more of the planes of projection
4. always shown at its true length

7-33. In multiview orthographic projection, how should circles appear?

1. In their true size and shape
2. As circles or ellipses depending on the view
3. As ellipses only
4. In their true shape, but their size may be distorted

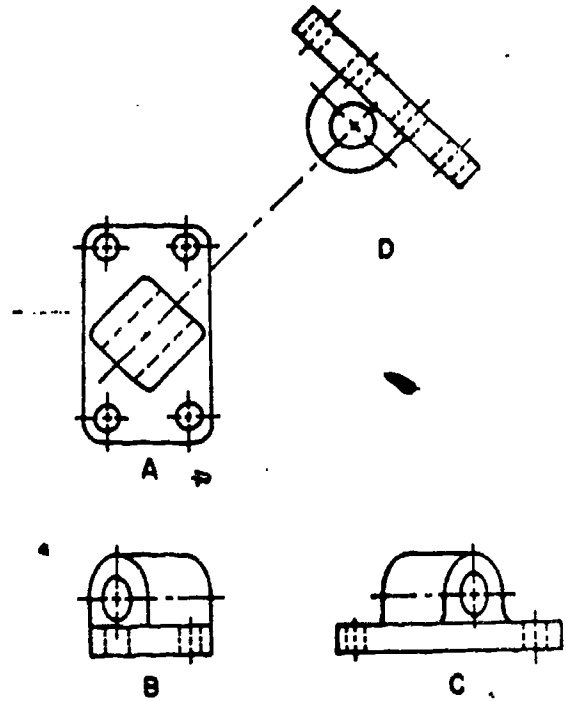

Figure 7C

7-34. Which drawing in figure 7-C shows an auxiliary view of the object?

1. A
2. B
3. C
4. D

7-35. An auxiliary view to a 3-view drawing is required if the object has

1. more than four sides
2. no symmetrical sides
3. a detail that is on a plane parallel to a regular plane of projection
4. an inclined surface not parallel to a regular plane of projection

In items 7-36 through 7-38, select from column B the characteristic that identifies the auxiliary view in column A.

	<u>A. Auxiliary Views</u>	<u>B. Characteristics</u>
7-36.	Front	1. Projected from the front view
7-37.	Right side	2. Projected from the side view
7-38.	Elevation	3. Shows true height and width of an object 4. Shows true height of an object

In answering items 7-39 through 7-41, refer to figure 8-22 in the textbook.

- 7-39. The rear auxiliary view could also have been projected from the
1. top view
 2. front view
 3. rear view
 4. left side view
- 7-40. Where does the line BD appear in its true length?
1. In the rear auxiliary view and the right side view
 2. In the rear auxiliary view and the top view
 3. In the rear auxiliary view and the front view
 4. In the rear auxiliary view only
- 7-41. The distances of points A and E from the auxiliary plane are equal to the length of line DE or line AC in the top view.
- 7-42. A revolved section is represented in a drawing as a
1. projection on a plane parallel to the plane of the drawing
 2. projection on a plane perpendicular to the plane of the drawing
 3. detail of a moving part
 4. detail revealed by revolving the object
- 7-43. A section view may be required in a 3-view drawing if the object has
1. only curved surfaces
 2. a feature not represented on one of the plane views
 3. a feature that is not on a plane parallel to one of the given views
 4. an inclined surface not parallel to one of the given views

- 7-44. A section view that gives a complete cross section view of an object is known as a
1. complete section
 2. full section
 3. full plane section
 4. plane section
- 7-45. In half-sectioning a cylinder, how far do you extend the cutting plane?
1. Half the diameter of the cylinder
 2. Half the radius of the cylinder
 3. Half the circumference of the cylinder
 4. A quarter of the circumference of the cylinder
- 7-46. A section consisting of less than a half-section is called a
1. partial section
 2. detail section
 3. offset section
 4. broken or partial section
- 7-47. If only one type of material is represented in cross section in a drawing, at what angle from the horizontal should diagonal hatching be drawn in orthographic projection?
1. 15 degrees
 2. 30 degrees
 3. 45 degrees
 4. 60 degrees

Learning Objective: Describe techniques used in preparing oblique and isometric drawings.

- 7-48. When an object is to be drawn in oblique projection, how is the front surface placed?
1. Perpendicular to the plane of projection
 2. Parallel to the plane of projection
 3. At an angle of 45° to the plane of projection
 4. At an angle of either 30° or 60° to the plane of projection

In answering items 7-49 through 7-52, select from column B the oblique projection having the characteristic in column A.

A. Characteristics	B. Oblique Projections
7-49. Front surface drawn in orthographic projection	1. Cabinet
7-50. Oblique projections drawn to actual or dimensional length	2. Cavalier
7-51. Oblique projections foreshortened	3. Cabinet and cavalier
7-52. Single view showing length, width and thickness of an object	

7-53. What is the angle between the axis of an isometric drawing?

1. 45 degrees
2. 60 degrees
3. 90 degrees
4. 120 degrees

7-54. In an isometric projection, the object is inclined so that

1. all surfaces make the same angle with the plane of projection
2. the face makes an angle of 30° with the plane of projection
3. the face makes an angle of 60° with the plane of projection
4. each edge forms an angle of 45° with the plane of projection

7-55. The lines of projection in an isometric drawing are

1. converging
2. diverging
3. parallel
4. perpendicular to the plane of projection

7-56. What method is used for drawing nonisometric lines whose ends do not fall on isometric lines or planes?

1. Corresponding end points
2. Conjugate axis
3. Orthographic
4. Section lining

7-57. One rule to follow when transferring an angle to an isometric view is to

1. represent the angle in its true size in the isometric view
2. use the same method as when transferring a nonisometric line
3. label the angle with its actual size as appearing on the isometric drawing
4. reduce the angle's size by one-fifth

7-58. What shape will a figure, appearing as a circle in a regular multiview view, take in an isometric view?

1. Line
2. Circle
3. Oval
4. Ellipse

Learning Objective: Describe methods and techniques of drawing clear, concise sketches.

7-59. To save time, sketching to scale is commonly done with the aid of

1. an engineer's scale
2. cross section paper
3. dividers
4. draftsman's triangles

7-60. In freehand sketching, how should you hold the pencil?

1. Between your middle and index finger
2. With your index finger as close to the point as possible
3. Below your hand and between thumb and fingers
4. With a relaxed grip about an inch from the point

7-61. In the freehand sketching of an object, each line should be drawn with

1. one complete stroke of the pencil
2. the arm held in one position
3. a series of short strokes of the pencil
4. a wrist movement rather than an arm movement

7-62. When sketching a long straight line, you should place a dot at each end of the line and

1. connect them with a series of short pencil strokes
2. connect them with one long pencil stroke
3. at intermediate points in the line, then connect them with a series of short pencil strokes
4. at intermediate points in the line, then connect them with one long pencil stroke

- 7-63. To divide lines and areas into equal parts, you should use a process of
1. dividing and redividing
 2. arbitrary estimation
 3. geometric construction
 4. visual approximation
- 7-64. The basic angle you use when sketching is
1. 30°
 2. 60°
 3. 45°
 4. 90°
- 7-65. In what way, if any, does the technique of sketching a small circle differ from the technique of sketching a large circle?
1. In sketching a small circle, the pencil is gripped so that the tip of the second finger is nearer the pencil point than when the large circle is sketched
 2. In sketching a small circle, a soft-lead pencil is used; in sketching a large circle, a hard-lead pencil is used
 3. In sketching a small circle, a compass is required; a compass is not necessary when a large circle is sketched
 4. None; the techniques is the same for sketching large and small circles

- 7-66. Which items will serve as a substitute for a pencil compass?
1. Pencil, piece of string, and a thumbtack
 2. Pencil, rubberband, and thumbtack
 3. Two pencils and a rubberband
 4. Two pencils and a piece of paper

- 7-67. In one method of freehand sketching of a circle, you rotate the paper with one hand, using as a pivot
1. the side of your hand
 2. your index finger
 3. your second finger
 4. either your index or second finger

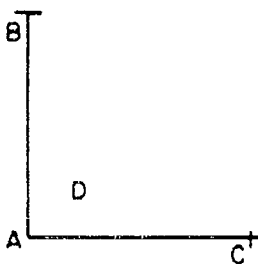

Figure 7D

In answering items 7-68 and 7-69, assume you are to draw a curve connecting straight lines and have proceeded as far as illustrated in figure 7D.

- 7-68. What is your next step?
1. Placing a dot at D
 2. Sketching a light curve through D between B and C
 3. Drawing a straight line between B and C
 4. Drawing a straight line from A through D midway between B and C
- 7-69. What is the preferred way to sketch the curve after you place the dot or X through which the curve is to pass?
1. Start at B, and proceed through the dot or X, and end at C
 2. Start at C, proceed through the dot or X, and end at D
 3. Start at the dot or X and sketch to C, return to the dot or X, and then sketch to B
 4. Start at D, proceed to C, back to D, and then to B

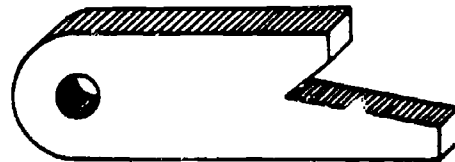

Figure 7E

- 7-70. What is your first step in sketching the object in figure 7E?
1. Drawing the circle
 2. Drawing a rectangular block
 3. Drawing light guidelines to represent the outlines of the object
 4. Drawing the details
- 7-71. Pictorial sketches differ from orthographic sketches in that they
1. are normally drawn to scale while orthographic sketches are not
 2. deal with volumes rather than planes
 3. are usually less detailed than the orthographic sketches
 4. require the use of mechanical aids in their preparation
- 7-72. The primary use of overlay sketches is for
1. preliminary design
 2. changes in design
 3. planning purposes
 4. supplementing previously drawn sketches

COURSE DISENROLLMENT

All study materials must be returned. On disenrolling, fill out only the upper part of this page and attach it to the inside front cover of the textbook for this course. Mail your study materials to the Naval Education and Training Program Development Center.

PRINT CLEARLY

NAVEDTRA Number	COURSE TITLE
10634-C	NRCC ENGINEERING AID 3 & 2, VOLUME 1

Name	Last	First	Middle
Rank/Rate		Designator	Social Security Number

COURSE COMPLETION

Letters of satisfactory completion are issued only to personnel whose courses are administered by the Naval Education and Training Program Development Center. On completing the course, fill out the lower part of this page and enclose it with your last set of self-scored answer sheets. Be sure mailing addresses are complete. Mail to the Naval Education and Training Program Development Center.

NAME

ZIP CODE

MY SERVICE RECORD IS HELD BY:

Activity

Address

ZIP CODE

Signature of enrollee



A FINAL QUESTION: What did you think of this course? Of the text material used with the course? Comments and recommendations received from enrollees have been a major source of course improvement. You and your command are urged to submit your constructive criticisms and your recommendations. This tear-out form letter is provided for your convenience. Typewrite if possible, but legible handwriting is acceptable.

Date _____

From: _____
(RANK, RATE, CIVILIAN)

ZIP CODE _____

To: Naval Education and Training Program Development Center (PD 8)
Pensacola, Florida 32509

Subj: NRCC Engineering Aid 3 & 2, Volume 1, NAVEDTRA 10634-C

1. The following comments are hereby submitted:

(Fold along dotted line and staple or tape)

(Fold along dotted line and staple or tape)

DEPARTMENT OF THE NAVY
NAVAL EDUCATION AND TRAINING PROGRAM
DEVELOPMENT CENTER (PD 8)
PENSACOLA, FLORIDA 32509

OFFICIAL BUSINESS
PENALTY FOR PRIVATE USE, \$300

POSTAGE AND FEES PAID
NAVY DEPARTMENT
DoD-316



NAVAL EDUCATION AND TRAINING PROGRAM DEVELOPMENT CENTER
BUILDING 2435 (PD 8)
PENSACOLA, FLORIDA 32509

332