

DOCUMENT RESUME

ED 247 436

CE 039 509

AUTHOR Courson, Roger; And Others  
 TITLE Core IV Materials for Rural Agriculture Programs. Units A-G.  
 INSTITUTION Illinois Univ.; Urbana. Dept. of Vocational and Technical Education.  
 SPONS AGENCY Illinois State Board of Education, Springfield. Dept. of Adult, Vocational and Technical Education.  
 PUB DATE Jun 84  
 NOTE 542p.; Printed on colored paper. For related documents, see ED 208 148-153, ED 220 689-690, ED 222 663-664, ED 233 228-231, and CE 039 508-511.  
 PUB TYPE Guides - Classroom Use - Guides (For Teachers) (052)

EDRS PRICE MF02 Plus Postage. PC Not Available from EDRS.  
 DESCRIPTORS \*Agricultural Education; Agricultural Production; \*Agronomy; Animal Husbandry; Behavioral Objectives; Citizenship; Classroom Techniques; Conservation (Environment); Conservation Education; Core Curriculum; Educational Opportunities; Field Crops; Guidelines; High Schools; \*Horticulture; Instructional Materials; Job Skills; Job Training; Leadership; Learning Activities; Livestock; Natural Resources; Rural Areas; \*Rural Education; Soil Science; State Curriculum Guides; \*Supervised Farm Practice; Teaching Methods; \*Vocational Education  
 IDENTIFIERS Illinois

ABSTRACT

This curriculum guide, the first part of a core curriculum for a rural agriculture program, consists of materials for use in presenting the first seven units of a nine-unit course for high school vocational agriculture students living in rural areas. Addressed in the individual units of the guide are the following topics: educational and employment opportunities in the field of agriculture, leadership and citizenship, supervised occupational experience, livestock science, crop science, soil science and conservation of natural resources, and horticulture. Each unit contains some or all of the following: suggestions to the teacher, a teacher's guide, a competency inventory, information sheets, student worksheets or assignment sheets and a key, demonstrations, job sheets, transparencies, a discussion guide for the transparencies, and sample test questions along with a teacher's key. (MN)

\*\*\*\*\*  
 \* Reproductions supplied by EDRS are the best that can be made \*  
 \* from the original document. \*  
 \*\*\*\*\*

**U.S. DEPARTMENT OF EDUCATION  
NATIONAL INSTITUTE OF EDUCATION  
EDUCATIONAL RESOURCES INFORMATION  
CENTER (ERIC)**

- 1. This document has been reproduced as received from the person or organization originating it.
- 2. Minor changes have been made to improve reproduction quality.
- 3. Points of view or opinions stated in this document do not necessarily represent official NIE position or policy.

"PERMISSION TO REPRODUCE THIS  
MATERIAL HAS BEEN GRANTED BY

*D. G. M.*

TO THE EDUCATIONAL RESOURCES  
INFORMATION CENTER (ERIC)."

CORE IV MATERIALS  
FOR RURAL  
AGRICULTURE  
PROGRAMS  
UNITS A-G  
Project Staff

Sponsored by  
ILLINOIS  
STATE BOARD  
OF EDUCATION

DEPARTMENT OF  
ADULT,  
VOCATIONAL AND  
TECHNICAL EDUCATION

Walter W. Naumer, Jr.  
Chairman

Research and  
Development Section

Co-directors:  
Earl B. Russell  
Roger L. Courson

Donald G. Gill  
State Superintendent  
of Education

June, 1984

Developers:  
Roger Courson  
Paul Hemp  
Jerry Pepple  
Barbara Koch  
Michael Rauch

Department of  
Vocational and  
Technical Education  
and Vocational  
Agriculture Service,  
University of Illinois  
at Urbana-Champaign

An Equal Opportunity  
Affirmative Action Employer

ILLINOIS STATE BOARD OF EDUCATION

Department of Adult, Vocational and Technical Education  
Research and Development Section

Product Abstract

1. Title of material Core IV Materials for Rural Agriculture Programs

2. Date material was completed June, 1984

3. Please check one: New material  Revised

4. Originating agency University of Illinois

Address Urbana, Illinois Zip Code 61801

5. Name(s) of developer(s) Roger Courson, Paul Hemp, Jerry Pepple,  
Barbara Koch, Michael Rauch, Susie Osborne

Address 1310 S. Sixth St., Champaign, IL Zip Code 61820

6. Developed pursuant to Contract Number R-33-24-D-0362-466

7. Subject Matter (Check only one according to USOE Code):

USOE Code

- |   |  |
|---|--|
| <input checked="" type="checkbox"/> 01 Agricultural Education | <input type="checkbox"/> 10 Industrial Art Education       |
| <input type="checkbox"/> 03 Business and Office Education     | <input type="checkbox"/> 16 Technical Education            |
| <input type="checkbox"/> 04 Distributive Education            | <input type="checkbox"/> 17 Trade and Industrial Education |
| <input type="checkbox"/> 07 Health Occupations Education      | <input type="checkbox"/> Career Education                  |
| <input type="checkbox"/> 09 Home Economics Education          | <input type="checkbox"/> Other (Specify) _____             |

8. Education Level:  
 Pre-K Thru 6       7-8       9-10       11-12  
 Post-Secondary       Adult       Teacher (Pre-service)  
 Administrator (Pre-Service)       Other (Specify) \_\_\_\_\_

9. Intended for Use By:  
 Student       Classroom Teacher       Local Administrator  
 Teacher Educator       Guidance Staff       State Personnel  
 Other (Specify) \_\_\_\_\_

10. Student Type:  
 Regular       Disadvantaged       Handicapped  
 Limited English Proficiency       Other (Specify) \_\_\_\_\_



11. Medium and Format of Materials:

HARDCOPY       VIDEOTAPE       FILM       MICROFICHE

No. of pages \_\_\_\_\_ Minutes \_\_\_\_\_ Minutes \_\_\_\_\_ B & W \_\_\_\_\_  
    Paper bound \_\_\_\_\_ B & W \_\_\_\_\_ B & W \_\_\_\_\_ Color \_\_\_\_\_  
    Hard bond \_\_\_\_\_ Color \_\_\_\_\_ Color \_\_\_\_\_  
     Loose-leaf \_\_\_\_\_ inches \_\_\_\_\_ mm  
Photos: Yes  No \_\_\_\_\_  
Diagrams: Yes  No \_\_\_\_\_

SLIDES       FILM STRIPS       AUDIO       OTHER

No. of frames \_\_\_\_\_ No. of frames \_\_\_\_\_ Automatic synch Specify:  
    B & W \_\_\_\_\_ B & W \_\_\_\_\_ HZ \_\_\_\_\_  
    Color  Color \_\_\_\_\_ Manual cue \_\_\_\_\_  
    Audio \_\_\_\_\_ Audio \_\_\_\_\_ Reel \_\_\_\_\_  
    Carousel provided  Cassette \_\_\_\_\_  
    Other packaging used \_\_\_\_\_ Cartridge \_\_\_\_\_  
    (Specify) \_\_\_\_\_

12. Availability:

\_\_\_\_\_ One copy free      For sale @ \$ \_\_\_\_\_ per copy      \_\_\_\_\_ Not available  
    In ERIC system (No. \_\_\_\_\_)      \_\_\_\_\_ Loan copy available

Contact: Roger Courson      Phone (217)333-3870

Address 1401 South Maryland Drive, Urbana, IL      Zip Code 61801

13. Copyright Restrictions:

Contact: Name \_\_\_\_\_ Phone ( ) \_\_\_\_\_  
    Address \_\_\_\_\_ Zip Code \_\_\_\_\_

14. Is Training Required for Optimum Use of These Materials      Yes  No \_\_\_\_\_

15. Are Consultive/Training Services Available?      Yes  No \_\_\_\_\_

Contact: Illinois Board of Education  
    Department of Adult, Vocational and Technical Education  
    Research and Development Section, E-426  
    100 North First Street  
    Springfield, IL 62777  
    (217)782-4620

16. General Description:

This curriculum/guide includes teaching packets for 24 problem areas selected as suggested areas of study to be included in a core curriculum for twelfth-grade or fourth-year students enrolled in a rural agriculture program.

17: Person Completing this Abstract: Earl B. Russell

Full Address: 357 Education Bldg.  
1310 S. Sixth St.  
Champaign, IL 61820

## SUGGESTIONS FOR USING CORE MATERIALS

These instructional materials and teaching aids have been designed to improve instruction and increase student learning. Each problem area includes some or all of the following components.

1. Suggestions to the teacher
2. Teacher's guide
3. Competency inventory
4. Information sheets
5. Student worksheets or assignment sheets and key
6. Demonstrations
7. Job sheets
8. Transparencies
9. Discussion guide for transparencies
10. Sample test questions and teacher's key

This combination of instructional materials should be utilized as a source unit. This means that teachers should selectively choose those components and those parts which they need to achieve their teaching objectives. The project staff does not recommend that teachers "teach" the core program as it is presented. Instead, the teacher should personalize and localize the materials for the particular group taught and, wherever possible, add other materials and teaching techniques to enrich the core program.

Teachers could teach everything included in the core curriculum but this would not be advisable considering the variations which exist in vocational agriculture programs, students' needs and interests, and program objectives. Instead, teachers should select problem areas for a "local core" and supplement them with other problem areas important in the local area. Another suggestion is that the entire problem area need not be taught to a given group during a given year. For example, teachers may want to teach part of the parliamentary procedure problem area to a beginning class and teach the remaining part to an advanced class.

Specific suggestions for using the different components of a problem area packet are presented in the following section.

1. Suggestions to the teacher. These suggestions are included on the first page of each problem area. Teachers should read these suggestions before problem areas are scheduled for the year. Decisions need to be made regarding which problem areas will be taught, when they will be taught and the approximate number of days to be devoted to each problem area. On the basis of these decisions, teachers can construct a course calendar.  
In some cases, the suggestions also indicate the preplanning that needs to be accomplished before instruction begins. Instructional materials not included in the core need to be ordered in advance.
2. Teacher's guide. The teacher's guide is not a lesson plan. It is a source of teaching ideas which may be implemented by the agriculture teacher to conduct an effective instructional program. Each guide includes more material than most teachers would use. Teachers should select from the several interest approaches and teaching activities those suggestions which seem most appropriate for the local situation. The teacher's guide emphasizes a problem solving method and a student-centered, activity approach. Lecture-presentation, rote memorization of facts and subject matter mastery should be kept to a minimum. The teacher's guides include suggestions for carrying learning to the "doing" level. Application of classroom learning to S.O.E.P.'s and FFA activities is an important part of the teaching process.
3. Competency inventory. A listing of job competencies for most problem areas has been included in the Core IV materials. These listings are included to help teachers focus on skill development in the instructional program for advanced students. The competency inventories can be used to make students aware of the skills important on the job. By including them in the Core IV program, the developers intend to emphasize the importance of competency based instruction for students who are preparing for entry level employment.
4. Information sheet. These sheets have been prepared for those problem areas where subject matter may be difficult to locate. If reference materials are not available, the teacher may want to duplicate copies of the information sheets for class use.
5. Student worksheets or assignment sheets and keys. These exercises are designed as classroom activities for student use. They may provide a change of pace for students when they have grown tired of other activities which may be overused. Most exercises include a teacher's key with suggested answers.
6. Demonstrations. The teaching of certain problem areas often calls for demonstrations of manipulative skills or projects. The demonstration outline may be used by the teacher or students to conduct demonstrations of manipulative skills. Teachers may want to change some of the student activities included in the Teacher's Guide into student demonstrations.
7. Job sheets. In some problem areas, such as the agricultural mechanics areas, job sheets have been provided which include a step-by-step procedure for performing agricultural jobs. These sheets may be used

to guide students engaged in individualized learning and to take a load off the busy teacher who has a large class involved in a variety of learning activities.

8. Transparencies. Some of the problem areas include transparency masters which can be used to prepare overlays and others include small reproductions of transparencies developed for the Core Project which are available from Vocational Agriculture Service, University of Illinois.
9. Discussion guide for transparencies. Most of the transparencies included in the core materials do not include on the overlay any narration or explanation. The discussion guide provides teachers with some suggested points to bring out in the discussion of a transparency including explanations, descriptions and discussion questions related to the transparency.
10. Sample test questions and key. The sample test questions are not intended to be used as a test. The teacher can select questions from those included in the problem area if they are appropriate and add others as needed. Some teachers may choose not to administer a test at the close of each problem area and to prepare a comprehensive test at the end of a unit.

The numbering system found at the bottom of each page includes four digits or letters. The first number is a Roman numeral IV which stands for Core IV. The letters which run from A-I designate the unit. The third character is a numeral which indicates the problem area within the unit (1 means first, 2 for second, etc.). The last digit is the page number. All pages are numbered consecutively and the page in each problem area starts with "one."

The color scheme used in the Illinois Core Curriculum is as follows:

Salmon--Suggestions to the Teacher  
Tan--Teacher's Guide  
Light Blue--Information Sheets  
Ivory--Student Worksheets  
Pink--Job Sheets  
Lime--Teacher's Key to Student Worksheets  
White--Transparencies and Transparency Discussion Guides  
Yellow--Sample Test Questions  
Green--Teacher's Key to Sample Test Questions  
Gold--Competency Inventories  
Gray--Project Plans  
Raspberry--Introductory Sheets

LIST OF UNITS AND PROBLEM AREAS  
RURAL AGRICULTURE PROGRAM  
CORE IV

UNIT A: Orientation to Agricultural Occupations

PROBLEM AREAS:

1. Exploring Educational Opportunities Beyond High School
2. Developing Employment Skills

UNIT B: Leadership and Citizenship

PROBLEM AREA:

1. Utilizing Local, State and Federal Agricultural Agencies and Resources

UNIT C: Supervised Occupational Experience

PROBLEM AREAS:

1. Developing S.O.E Programs for Non-traditional Students
2. Evaluating S.O.E. Programs and Setting Future Directions

UNIT D: Livestock Science

PROBLEM AREAS:

1. Developing Livestock Management Skills
2. Understanding and Using Artificial Insemination
3. Understanding Basic Genetics and Reproduction.

UNIT E: Crop Science

PROBLEM AREAS:

1. Drying and Storing Grain
2. Growing Timber and Trees as an Agricultural Crop
3. Harvesting Forage Crops

UNIT F: Soil Science and Conservation of Natural Resources

PROBLEM AREA:

1. Utilizing Energy Effectively

**UNIT G: Horticulture**

**PROBLEM AREA:**

1. Establishing and Maintaining Turf

**UNIT H: Agricultural Mechanics**

**PROBLEM AREAS:**

1. Selecting and Using Electric Motors
2. Adjusting and Maintaining Spraying Equipment
3. Maintaining and Servicing Tractors

**UNIT I: Agricultural Business Management**

**PROBLEM AREAS:**

1. Understanding and Using Basic Economic Principles of Production
2. Managing Credit in Agriculture
3. Planning an Insurance Program
4. Using Illinois' Farm Record Book
5. Understanding Agricultural Taxes
6. Using Microcomputers in Agricultural Business Management
7. Understanding Basic Agricultural Law
8. Planning an Agricultural Production Business



CORE CURRICULUM ADVISORY COMMITTEE, 1980-1983

RURAL AGRICULTURE PROGRAM

1. High School Vocational Agriculture Teachers

- District One - Russell Leman  
Roanoke-Benson High School
- District Two - Richard Dunn  
Seneca High School
- District Three - Charles Ferguson  
Pittsfield High School
- District Four - Allen Hornbrook  
Paris High School
- District Five - Larry Keyser  
Clay City High School

2. Area Vocational Center Representative

Donald Kaufmann  
Grundy County Area Vocational Center

3. Community College Representative

William Martinie  
Illinois Central College

4. Agricultural Business/Industry Representative

- a. Agricultural Service and Supply  
Louis Wagner, Sommer Bros. Seed Co.
- b. Agricultural Mechanics  
Roger Neitfeld  
Pfister Implement Co.
- c. Horticulture  
Frank Louis Setmi

5. Governmental Agency Representatives

John Rowley, Assistant Director  
Illinois Department of Agriculture

6. Joint Staff Representatives

Dr. Len Harzman, Western Illinois University  
Dr. Joe Townsend, Illinois State University  
Mr. Tom Wiles, DAVTE, Illinois State Board of Education



## ACKNOWLEDGEMENTS

Appreciation is expressed to the many vocational agriculture teachers who shared their time, knowledge, and instructional aids for the preparation of this core curriculum. Without their cooperation and input, this printing would not have been possible.

Some of the material included in the Rural Core IV was written and/or reviewed by the following vocational agriculture instructors. The asterisk (\*) identifies teachers who wrote selected problem area drafts.

### 1. Exploring Educational Opportunities Beyond High School

Jim Guilinger  
Delmar Owens  
Al Tieken  
Clarence Benard  
Brian Cirks

### 2. Developing Employment Skills

Jim Craft  
Al Tieken  
\* Kent Johnson

### 3. Utilizing Local, State and Federal Agricultural Agencies and Resources

Jim Guilinger  
Reggie Grandt  
Richard Watson

### 4. Developing S.O.E. Programs for Non-traditional Students

Jim Craft  
Doug Schwartzkopf

### 5. Evaluating S.O.E. Programs and Setting Future Directions

Charles Harn  
Reggie Grandt  
Clarence Tipton

### 6. Developing Livestock Management Skills

Earl Lindsey  
Donald Miller  
Floyd W Ehrley  
Jim Craft  
Steve Myers  
Richard Watson  
\* Alan Pickens

7. Understanding and Using Artificial Insemination

Paul Mealiff  
Earl Lindsey  
Chris Roegge  
Floyd Wohrley  
Bill Bree  
Dennis Sorenson  
\*Betsy Pech

8. Understanding Basic Genetics and Reproduction

Donald Miller  
Paul Mealiff  
Floyd Wohrley  
Bill Bree  
Steve Myers  
\*Kent Johnson  
\*Tom Faulkner

9. Drying and Storing Grain

Charles Harn  
Eldon Chapman  
Darrell Scherer  
Donald Miller  
\*Richard Schertz

10. Utilizing Energy Effectively

Carl Burkybile  
William Fortschneider

11. Establishing and Maintaining Turf

Robert Brown  
Dick Petrowich  
Al Ticken

12. Selecting and Using Electric Motors

Glenn Sims  
Tom Faulkner  
Eldon Chapman  
Everett Moeller  
Clarence Benard

13. Adjusting and Maintaining Spraying Equipment

John Bangert  
Eldon Chapman  
Tom Faulkner  
Charles Ferguson  
Dave Wilson  
Dave Trent

14. Maintaining and Servicing Tractors

Darrell Scherer  
Tom Faulkner  
Donald Miller  
Paul Mealiff  
Frank Dry  
Clarence Benard  
Dave Wilson  
\*Allen Ritter

15. Understanding and Using Basic Economic Principles of Production

Everett Moeller  
Glenn Sims  
Donald Miller  
C. Eugene McGrew  
John Rentfrow  
John Abell

16. Managing Credit in Agriculture

Donald Miller  
Tom Hand  
David Erickson  
Steve Launius  
John Rentfrow

17. Planning an Insurance Program

Cedric Gowler  
Mike Robertson  
David Erickson  
Mark Streit  
Lee West

18. Using the Illinois Farm Record Book

Mike Robertson  
Robert Brown  
Reggie Grandt  
Tom Hand  
Charles Ferguson  
Dave Wilson

19. Understanding Agricultural Taxes

Charles Harn  
C. Eugene McGrew  
Cedric Gowler  
Tom Hand

20. Using Microcomputers in Agricultural Business Management

Chris Roegge  
Frank Dry  
Richard Schertz  
\*Steve Myers  
Dale Teel  
James Huffman

21. Understanding Basic Agricultural Law

Cedric Gowler  
Frank Dry  
Al Ticken  
C. Eugene McGrew  
Clarence Tipton  
John Rentfrow  
\*Dave Erickson

22. Planning an Agricultural Production Business

Clarence Tipton  
Floyd Wohrley  
Everett Moeller

# **UNIT A: Orientation to Agricultural Occupations**

## **PROBLEM AREAS:**

- 1. Exploring Educational Opportunities Beyond High School**
- 2. Developing Employment Skills**

## UNIT A: ORIENTATION TO AGRICULTURAL OCCUPATIONS

### PROBLEM AREA: EXPLORING EDUCATIONAL OPPORTUNITIES BEYOND HIGH SCHOOL

#### SUGGESTIONS TO THE TEACHER:

This problem area is designed for use with advanced students in vocational agriculture programs. The recommended time for teaching this problem area is during early September.

The estimated instructional time for this problem area is 2 to 4 days depending on how far the teacher wishes to go in exploring continuing education opportunities with the students. If the students are to be involved in other activity exercises, the instructional time will need to be increased.

This problem area was developed to aid the vocational agriculture instructor in assisting senior agriculture students in planning and preparing for post-secondary education. The instructor should encourage all students to work closely with the high school guidance counselor.

Due to the wide variety of educational opportunities available to students, the materials in this problem area are for reference or modification as the instructor adapts these materials to the students' needs. The terms "agency" and "institution" have been used interchangeably to refer to all sponsors of educational opportunities. The instructor is encouraged to conduct a local search to locate other supplementary materials for use with this problem area.

#### CREDIT SOURCES:

These materials were developed through a funding agreement, R-83-24-D-0362-466 with the Illinois State Board of Education, Department of Adult, Vocational and Technical Education, Research and Development Section, 100 North First Street, Springfield, Illinois 62777. Opinions expressed in these materials do not reflect, nor should they be construed as policy or opinion of the State Board of Education or its staff.

The teacher's guide, student worksheets, transparency discussion guide, and information sheets were developed by Barbara Clayton Koch.

The artwork in this problem area was prepared by the Vocational Agriculture Service, University of Illinois. Suggestions and guidance in the development of these materials were provided by the following vocational agriculture teachers:

Clarence Bernard - Enfield High School  
Delmar Owens - Bradford High School  
Brian Cirks - Alexis High School  
Jim Guilinger - Sycamore High School



## TEACHER'S GUIDE

- I. Unit: Orientation to agricultural occupations
- II. Problem area: Exploring educational opportunities beyond high school
- III. Objectives: At the end of the problem area students will be able to:
  1. Identify the various types of continuing education available.
  2. Assess their educational needs and goals.
  3. Select the type of continuing education most suited to meeting their needs and goals.
  4. Gather information concerning educational institutions of interest.
  5. Select their top three choices of continuing education and agencies that best meet their needs and goals.
  6. Identify the steps involved in gaining access to their desired educational agencies.
  7. Identify sources that can provide assistance in selecting and obtaining continuing education.
  8. Explain the importance of lifelong education in career planning.
- IV. Suggested interest approaches:
  1. Ask student when they will be done with school. Then lead into a discussion on when they will be finished learning. Emphasize the importance of education as a lifelong process due to many changes in people's lives.
  2. After gathering information on various local agriculturalists, ask the students to guess the occupation of the person given their educational background. Emphasize that although the type of education may vary they all have worked to acquire new skills and knowledge.
  3. Ask the students if they have made plans for after graduation. Ask those that have how they came to that decision. With those students still undecided discuss the reasons for their uncertainty.
  4. Show a film related to the topic to stimulate discussion on the importance of continuing education.
  5. Utilizing the information on Transparency #1, discuss reasons for education being a life long process.
  6. At the beginning of the problem area distribute Worksheet #1, "Planning for the Future," for students to complete. In class discuss the information gathered and its relevance to the students.

V. Anticipated problems and concerns of students:

1. Why should I continue my education?
2. What educational opportunities are available?
3. If I choose not to continue my education at this time, will I be able to later?
4. What criteria should I use in selecting the best type of continuing education for me?
5. What skills and education are required for my occupational choice?
6. What costs, if any, are involved in continuing education?
7. How can I pay for the education I want?
8. What criteria should I use in selecting the agencies I would most like to attend?
9. How can I gather information on institutes I am interested in?
10. What tests, scores, grades and information will an agency require of me when I apply?
11. How do I apply for admission and/or register for class?
12. Where can I go to get help in applying to and selecting an institute?
13. Does our school provide career days for me to visit a school or business of my choice?
14. What agricultural programs and courses are available locally?

VI. Suggested learning activities:

1. Conduct an interest approach and have students develop a list of problems and concerns related to available educational opportunities.
2. Discuss the transparency provided comparing the planning process involved in continuing education and the planning process involved in going on a trip.
3. Have the students complete Worksheet #1, "Planning for the Future". Refer to Rural Core III, Unit A - Problem Area 1, "Exploring Agricultural Occupations and Careers" if further development is needed by students in career selection.
4. Ask the class to "brainstorm" all the possible sources of continuing education opportunities available to them. The appropriate transparencies can provide an overview after the exercise is completed. Discuss the different needs each type of agency meets.



5. Show slide set "Uniting the World with Agriculture - WEA", Illinois FFA Alumni, and/or other available visuals concerning various types of educational experiences of interest to the student.
6. Using the information obtained in Worksheet #1 have student select the type of agencies that best meet their educational needs. Discuss the criterion they used to reach their conclusions.
7. Using the included transparency ask students to "brainstorm" how they might go about obtaining information on the different educational opportunities available to them. Assign class members one local agricultural organization listed on the transparency "Available Organization Sponsored Programs in Agriculture" and have them obtain information on the organization's current programs. Discuss information gathered.
8. Gather data on current costs of different educational institutions including such items as housing, transportation, books, out-of-state/district charges, tuition, fees, etc. Use the information to lead into a discussion of the economic aspect of education. Encourage student creativity in "brainstorming" ways to aid the financing of their education. Utilize the appropriate transparencies in discussing available financial assistance.
9. Arrange for the school guidance counselor to speak to the class. Ask him/her to explain the information and assistance s/he has available to the students in selecting and planning for post-secondary educational experiences.
10. Distribute Information Sheet #1, "Sample Letter: Information Request", to students that need to obtain further information from an educational agency. Ask students to prepare appropriate letters for mailing.
11. Distribute Student Worksheet #2, "A Choice Comparison Form," to the students. Ask the students to rank in numerical form from 1 to 15, one being the most important, the characteristics of educational agencies they feel are most important in making their educational choice. In the next column entitled "student's idea" have the student briefly explain what they feel would be the ideal for each of the characteristics listed. To complete the form the students must then select the three institutions they are most interested in attending, place one of the names, in each of the three remaining columns and insert the information on each agency concerning each of the characteristics. Space is provided for the student to rank the three institutions from 1 to 3 on their ability to meet the student's desired ideal for each characteristic. (One being the agency that is closest to the desired traits and three, the agency least desirable for that trait.)

After the worksheet is completed discuss the process involved in making decisions. Indicate the importance of weighing the options and selecting according to the important characteristics. Students need to realize that there may be many good options but rarely

will anyone fit the "ideals" exactly. Therefore, one must select the best alternative.

12. Invite recruiters from various agencies to speak on opportunities they have available in agricultural education, examples include the county cooperative extension agent, community college representatives, leaders of local agricultural organizations, college representatives, etc. If class time is not available an "agriculture education night" could be organized in conjunction with a section FFA meeting.
13. Distribute Information Sheet #2 and #3 as appropriate to students. These are included to provide additional assistance to students as they continue to explore educational opportunities.
14. Distribute Worksheet #3 to be used by students as a checklist of the necessary steps involved in the application procedure. They will need one checklist for each institution they intend to apply to.
15. The instructor is highly encouraged to conduct informal follow-up with all students to assist them in obtaining necessary continuing education.

#### VII. Application procedure:

1. This problem area should assist agriculture students in exploring and evaluating possible educational opportunities.
2. Students will be able to apply the knowledge gained through educational exploration to assist them in meeting their occupational goals.
3. This problem area will introduce students to the educational opportunities available through the FFA in WEA and FFA Alumni or Young Farmers Programs.

#### VIII. Evaluation:

1. Evaluate the students' worksheets and their effort to obtain necessary information.
2. Evaluate the students' entrance applications for neatness and completeness.
3. Evaluate the students' progress in gathering necessary information and developing a plan for their continuing education.

IX. References and aids:

1. Occupational Outlook Handbook, 1982-83 Edition, U.S. Department of Labor, Bureau of Labor Statistics.
2. The following audio-visual material may be obtained through the Illinois Association FFA Office, 204 Husseman Street, Box 466, Roanoke, IL 61561.
  - A. Uniting the World with Agriculture - WEA
  - B. Illinois FFA Alumni
3. The following films are available from the University of Illinois Film Center, 1325 S. Oak Street, Champaign, IL 61820. Toll free call 800-252-1357.
  - A. People at Work: How Jobs Change, #55283
  - B. Career Education, #82487
  - C. Today's Culture: Options after High School, #55290

X. Additional resources:

1. Lovejoy's Career and Vocational School Guide by Clarence E. Lovejoy available from Simon and Schuster. Simon and Schuster Building, Rockefeller Center - 1230 Ave. of America's, N.Y., NY 10020.
2. Peterson's Guide to College Admissions; Getting into the College of Your Choice by R. Fred Zuker and Karen Collier Hegener. Available from Peterson's Press, P.O. Box 978, Edison, NJ 08817.
3. The Career Education and Financial Guide by Robert L. Bailey. Available from Apco Publishing, 215 Park Avenue South, N.Y., NY 10003.

INFORMATION SHEET #1

SAMPLE LETTER:

INFORMATION REQUEST

Your street address  
Your town, state zip code  
Date

Director of Admissions  
Name of Institution  
City, State Zip Code

Dear Director,

I am currently a senior at \_\_\_\_\_ High School and expect to graduate June 19\_\_ . I would appreciate your sending me a catalog, application and information on admission, financial aid, and housing.

Any information you might have on my major field of interest, \_\_\_\_\_, would also be greatly appreciated.

Thank you for your assistance.

Sincerely,

Your Signature

INFORMATION SHEET #2  
MONTH-BY-MONTH PLANNING GUIDE  
FOR CONTINUING EDUCATION

September

1. Determine the education and training you will need to begin your career.
2. Select the most appropriate type of continuing education programs to meet your educational and training needs.
3. Narrow your choices down to three or four institutions you are most interested in learning more about.
4. Gather as much information as possible on the institutes of your choice. Visit the agency, talk to counselors, write away for catalogs, check material in library, talk with alumni, students and recruiters.
5. Check with the school counselor for additional information and arrange to take any tests that might be needed for admission.
6. Discuss your ideas with parents and other mature adults who can assist you.
7. Be certain to acquire and complete appropriate application forms by application deadline dates. Mail as soon as possible.

October

1. Attend "college fairs" or "open houses" and talk with recruiters to be certain you have considered all possibilities.
2. Check with your school counselor about the mailing of transcripts and high school reports.
3. Contact any teachers or administrators whom you would like to write recommendations if needed.

## November

1. Double check on deadlines for applications to be certain to apply on time.
2. Make certain all previous scores from the testing services are forwarded to the agencies requiring them.

## December

1. With the assistance of your school counselor, start gathering and filling out financial aid forms and investigating available sources of scholarships.
2. Use your Christmas break to begin looking for that summer job that will help cover the costs of schooling and provide an opportunity to obtain work experience. The experience gained in any job will be valuable in your future profession.

## January

1. Keep your grades up! Those final grades will be on your transcripts for life!

## February

1. Continue to work on financial aid, scholarships, loans, or grants that are available. Be sure to keep copies of all applications. They could save you time later.

## March

1. Check on that summer job. Any job will be beneficial in establishing a good reputation as an employee.

## April

1. As you receive admission information from the various institutes begin to reach a final decision.

## May

1. Contact the institutions to let them know if you have accepted their offers.
2. Arrange for advance placement exams and obtain information on advanced registration and registration.



## INFORMATION SHEET #3

### VISITING EDUCATIONAL INSTITUTIONS

Once you have narrowed your choices to three or four institutions which are of strong interest to you, it is advisable to arrange to visit each agency. You will want to be certain that the time and money spent furthering your education will be well invested. By visiting the educational agencies you are considering attending you will be able to gather first hand information on the school atmosphere, quality of instruction, housing conditions, class size, and instructional facilities to name but a few.

#### Preparing for the Visit

1. Try to find a day to visit that your high school is not in session but the agency you wish to visit does have class. If this is not possible speak with your school counselor to make other arrangements. Visit the agency on a normal class day. Open-House days do not provide a true picture of the actual routine day although an open house can provide additional information.
2. Make an appointment at least two weeks in advance with the admissions office. Explain to them your major interests so that they can assist you in locating all the information you are seeking. Ask them to send a map of the area if necessary. When visiting a large university it is helpful to contact the department you are interested in. They will provide more specific information in your area of study.
3. Prepare questions that will help you gain the information you need from the institution. Your school guidance counselor may have material to help you with this.

#### Touring the Facility

1. Be sure to be prompt and courteous when meeting with representatives of the agency.
2. While touring an educational institution try to visit some classes. Most instructors will be happy to accommodate visitors but be sure to introduce yourself before class and check that you are not taking a student's seat.
3. Take any organized tours that are provided by the institution. It is a good way to become orientated to the campus and obtain additional information. Many agencies provide student guides who can help explain what it is like being a student at the agency.
4. Read announcement boards for information on athletic, social and cultural events. School newspapers, if available, may also give insight to the nature of the school.

5. Ask to tour the student housing facilities if they are agency owned.
6. Visit the student union or commons area. Speak with students if possible.
7. Before leaving be certain to thank those that were of assistance to you.



## STUDENT WORKSHEET #1

### PLANNING FOR THE FUTURE

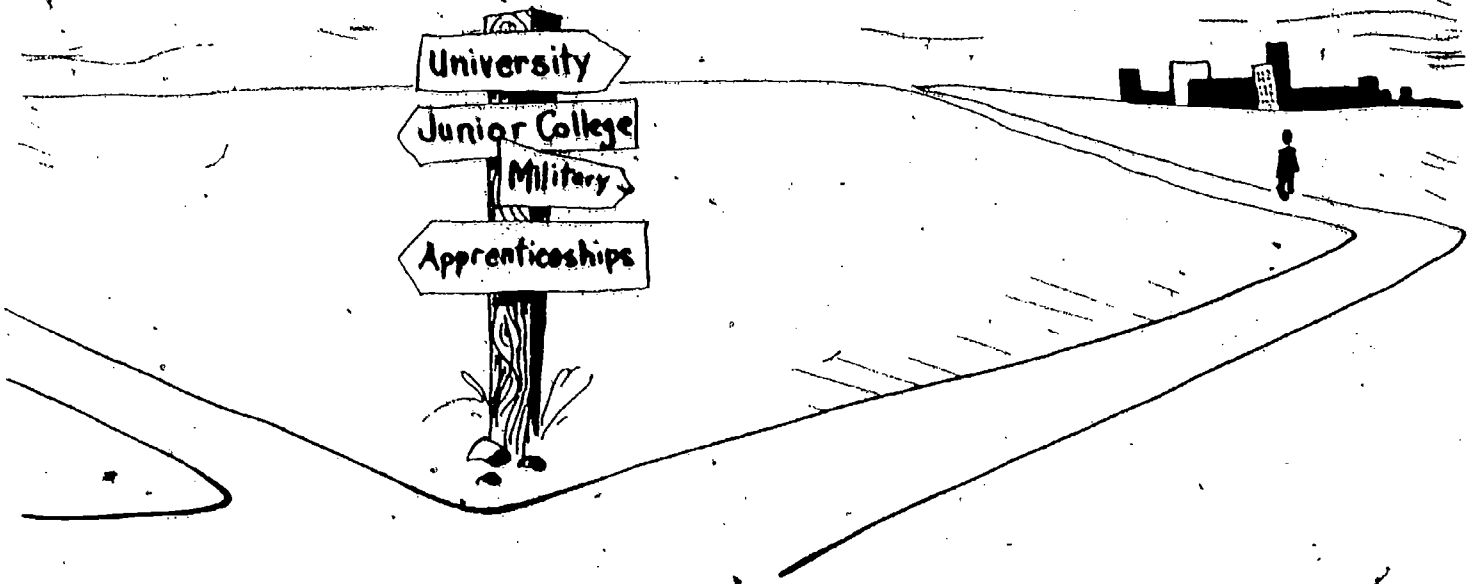

To plan for your journey into the future you will need to decide upon the general destination of your life.

Imagine for a moment that you are 25 years old, what type of job would you like to hold? Where would you like to live? What type of lifestyle would you like to have?

2. Now imagine yourself at 55, what job position would you want to occupy at this point in your life? Where would you be living? Do you have a spouse and any children? Describe the lifestyle you would have.

3. Questions one and two should reflect your short term and long term occupational goals. To achieve these goals, you will need to determine and develop the necessary skills and select from alternatives the most appropriate route to your destination.

4. Using the occupational outlook handbook and other available references list the skills and education recommended for your;

a. short-term occupational goals

b. long-term occupational goals

5. Interview a person in each of the above positions.

a. What skills did each have when they first took the job?

b. How and where did they obtain these skills?

c. Did they receive any training when they began their job? If "yes" what training was provided by their employer?

d. Have they learned new skills since their initial training? If "yes" how did they obtain these skills?

6. From the information obtained, what experiences, training and education would be most beneficial in preparing you for your short-term occupational goal?

7. What experiences, training and education will you need to proceed from your short-term occupational goal to your long-term career goal?

STUDENT WORKSHEET #2  
A CHOICE COMPARISON FORM

	Student Ranking	Student's Ideal	Agency A		Agency B		Agency C	
			Characteristics	Rank	Characteristics	Rank	Characteristics	Rank
Type of Institution								
Curriculum Offered in Area of Interest								
Degree of Certification Available								
Flexibility to Change Area of Study								
Time to Complete Program								
Flexibility of Scheduling (night classes, required course load)								



	Student Ranking	Student's Ideal	Agency A Name		Agency B Name		Agency C Name	
			Charac- teristics	Rank	Charac- teristics	Rank	Charac- teristics	Rank
Size of Institution								
Type of Housing Available								
Distance From Home								
Type of Community (suburban, urban, rural)								
Estimated Yearly Cost or Salary (tuition, housing, fees, books, transportation)								
Availability of Financial Assistance (grants, scholarships, loans)								

	Student Ranking	Student's Ideal	Agency A Name		Agency B Name		Agency C Name	
			Charac- teristics	Rank	Charac- teristics	Rank	Charac- teristics	Rank
Program's Placement Record								
Placement Services Offered								
Availability of Internships or Work Experience								
Accreditation								
Entrance Requirements (grade point, class rank, test scores)								
Transportation								

	Student Ranking	Student's Ideal	Agency A Name		Agency B Name		Agency C Name	
			Charac-teristics	Rank	Charac-teristics	Rank	Charac-teristics	Rank
Extra-Curricular Activities								
Type of Instruction (lab, lecture, discussion)								
Educational Emphasis (vocational, general education research)								
Diversity of Student								
Faculty Quality								
Climatic: Geographic Conditions								
Length of time required to complete program								
Other								

STUDENT WORKSHEET #3  
SAMPLE APPLICATION CHECKLIST

Information Needed

School or Program

Application Deadline

Tests Required

Entrance Requirements  
GPA, test scores

Application Fee

References Needed

Other

Date Completed

Test Completed

Scores and Transcripts Sent

References Sent

Application Completed

Application Mailed

Notification From Agency Received

Verification Sent

Other



# HOW IS PLANNING FOR CONTINUING EDUCATION SIMILAR TO PLANNING TRAVEL?

WHERE TO GO?

Near friends  
Illinois      Hawaii  
Near family

HOW WILL I GET THERE?

Car  
Plane      Train  
Bus

CAN I AFFORD IT?

\$

WHAT SHOULD I TAKE?

Spouse      Supplies  
Clothes

WHAT IF I DON'T LIKE IT  
ONCE I GET THERE?



# **SOURCES OF CONTINUING EDUCATION OPPORTUNITIES**

1. Vocational-technical/trade schools

2. Colleges and universities

3. Military

4. Organization sponsored programs

5. Community/junior colleges

6. Apprenticeships, on-the-job training,  
and volunteer work

7. Correspondence study

---

## AVAILABLE ORGANIZATION SPONSORED PROGRAMS IN AGRICULTURE

1. FFA -- Work Experience Abroad Program
2. 4-H -- International Youth Exchange
3. Illinois Young Farmers
4. Farm Bureau Young Farmers
5. FFA Alumni
6. County cooperative extension programs  
(seminars, field days, telenet courses)
7. ASCS programs
8. Special interest group sponsored activities  
(pork producers, breed associations, Farm Bureau,  
etc.)
9. Agriculture industry and business promotional  
programs  
(computers, welding, machinery; chemicals, etc.)

# **SOURCES OF INFORMATION ON POST-SECONDARY EDUCATIONAL AGENCIES**

1. School counselor
2. Reference material (books, catalogs, lists, brochures)
3. Agency recruiters
4. Visiting the institute
5. College nights/college fairs
6. Other students
7. Alumni

# SOURCES OF FINANCIAL ASSISTANCE FOR CONTINUING EDUCATION

1. Federal government
  - A. Pell grants
  - B. Supplemental educational opportunity grants
  - C. National direct student loans
  - D. Guaranteed student loans
  - E. College work-study
  
2. Civic/special interest organizations
  
3. Private companies
  
4. Educational institutions
  
5. Military

# WHO'S GOT THE FACTS ON FINANCIAL ASSISTANCE?

1. High school guidance counselor
2. Post-secondary institution's financial aid office
3. Library
4. Local Banks

## TRANSPARENCY GUIDE

### EXPLORING EDUCATIONAL OPPORTUNITIES BEYOND HIGH SCHOOL

#### I. Transparency -- HOW IS PLANNING FOR CONTINUING EDUCATION SIMILAR TO PLANNING TRAVEL?

A. Discuss the 5 major questions which relate to taking a vacation then apply the same questions to planning for further education.

1. Where to go?

- a. Life - What are my long- and short-term career goals?  
Where will I feel that I am a "success"?  
What kind of lifestyle do I wish to have?
- b. Education - What educational opportunities are available to me?

2. How will I get there?

- a. Life - What will I need to do to reach my long- and short-term goals?
- b. Education - What education and work experience will I need to meet my life goals?  
When should I obtain that experience?  
What educational opportunities best fit my needs?  
What educational agencies provide my needed opportunities?  
What educational agency is best for my needs and desires?

3. Can I afford it?

What costs are involved in education? (include both direct; indirect, e.g. forgoing income)  
How do different agencies compare in price?  
What are the paybacks for educational investment?  
What financial assistance is available?  
Will I be able to work while obtaining my desired education?

4. What should I take along?

What previous knowledge attitudes and background will I need to acquire my desired education?  
How might a family effect my ability to obtain my goals?  
What other responsibilities do I have?

5. What if I don't like it once I get there?

How able will I be to change educational agencies?  
Will I be able to change careers without starting all over?  
If I don't use my education for my career, will I have wasted time and money?

## II. Transparency--SOURCE OF CONTINUING EDUCATION OPPORTUNITIES

- A. Discuss the seven areas listing cover information concerning costs, living conditions, time required or duration, types of courses provided, role of the student, available pay (military, work experience), type of instruction.
- B. Be certain to explain that each is good and student must consider what is best for them as an individual.

## III. Transparency--AVAILABLE ORGANIZATION SPONSORED PROGRAMS IN AGRICULTURE

Ask students to find examples of each type listed and discuss its educational benefit.

## IV. Transparency--SOURCES OF INFORMATION ON POST-SECONDARY EDUCATIONAL AGENCIES

- A. Use this transparency to assist students in locating further information on educational opportunities.
- B. Encourage students to utilize as many of the sources as possible.

## V. Transparencies --SOURCES OF FINANCIAL ASSISTANCE --WHO'S GOT THE FACTS ON FINANCIAL ASSISTANCE

- A. Use these transparencies to generate discussion on the types and sources of available financial assistance.
- B. Have the students gather additional information on the various types of financial assistance available by utilizing the suggested sources of financial assistance information provided.
- C. Discuss the different criteria used to determine eligibility for financial assistance. Include such criteria as need, achievement and special circumstances.



## UNIT A: ORIENTATION TO AGRICULTURAL OCCUPATIONS

### PROBLEM AREA: DEVELOPING EMPLOYMENT SKILLS

#### SUGGESTIONS TO THE TEACHER:

This problem area is designed for use with advanced students in vocational agriculture programs. The recommended time for teaching this problem area is during early spring.

The estimated instructional time for this problem area is 3 to 7 days, depending on how far the teacher wishes to go in developing employment skills. If the students are to be involved in other activity exercises, the instructional time will need to be increased.

The material provided represents an overview of the skills needed to begin employment. It is not to be an exhaustive listing of ideas and materials. The instructor is encouraged to conduct a local search to locate other supplementary materials for use with this problem area. The items in this problem area are for reference or modification as instructors adapt these materials to their local situation.

#### CREDIT SOURCES:

These materials were developed through a funding agreement, R-33-24-D-0362-466 with the Illinois State Board of Education, Department of Adult, Vocational and Technical Education, Research and Development Section, 100 North First Street, Springfield, Illinois 62777. Opinions expressed in these materials do not reflect, nor should they be construed as policy or opinion of the State Board of Education or its staff.

The teacher's guide, student worksheets, transparency discussion guide, and sample test questions were developed by Barbara Clayton Koch with selected materials adopted from Metropolitan Core Curriculum III.

The artwork in this problem area was prepared by the Vocational Agriculture Service, University of Illinois. Suggestions and guidance in the development of these materials were provided by the following vocational agriculture teachers:

Al Tiecken	- Dixon High School
Kent Johnson	- Galva High School
Jim Craft	- Bluffs High School

## TEACHER'S GUIDE

^

- I. Unit: Orientation to agricultural occupations
- II. Problem area: Developing employment skills
- III. Objectives: At the end of this problem area students will be able to:
  1. Identify personal traits necessary for gaining and maintaining employment.
  2. Identify the value derived from work.
  3. Locate and obtain information concerning job openings.
  4. Develop a resume.
  5. Apply for a job.
  6. Interview for a job.
- IV. Suggested interest approaches:
  1. Begin the class session by asking the students if they would like to not have class today; the rest of the semester. What if we didn't have to work for a month, a year, or a lifetime? How would they feel? Lead into a discussion of the value of work.
  2. Have students identify a particular job they would like to hold. Then have students write down the reason why an employer should hire them for that job, including information on past experiences, education, personality traits, etc. Discuss how this information could be organized into a resume.
  3. Conduct a role-play session on a poor job interview. Have students discuss how they would feel if they were the employer.
  4. Invite a resource person (business owner, personnel manager, or principal) to discuss "What do I look for on resumes, application letters and forms, and during interviews?"
- V. Anticipated problems and concerns of students:
  1. Why do people work?
  2. What personal traits does an employer look for when hiring employees? How can I improve on these?
  3. How can I locate available jobs?
  4. How do I develop a resume?

5. How do I apply for a job?
6. How do I interview for a job?
7. What questions will I be asked during a job interview?
8. What questions should I ask a prospective employer during a job interview?
9. How should I follow up a job interview?
10. How should I decide if I should take a job that is offered to me?
11. What if I get rejected?
12. Once I have a job, how do I keep it?
13. Why should I have to sell myself to a prospective employer?
14. What is a letter of application?
15. What is a personal inventory?
16. How important is a first meeting with a prospective employer?

VI. Suggested learning activities and experiences:

1. Conduct an appropriate interest approach.
2. Ask students to brainstorm reasons why people work. Utilize selected transparencies and the discussion guide included in this unit to discuss work and its value.
3. Discuss the included transparency on lifestyle. Ask students to diagram their ideal lifestyle. Discuss some of the sacrifices they must make in one area of their life to allow for another.
4. Have students read VAS Subject Matter Unit 6003--Human Relations in Agricultural Business. Have students select one of the six topic areas and prepare a five-minute report. Use VAS Slidefilm 392--Human Relations in Agricultural Business to summarize essential facts.
5. Follow up the slidefilm on the importance of human relations by having students evaluate their own personal characteristics. Distribute Student Worksheet #1, "Evaluating My Personal Appearance, Feelings, and Habits." The teacher may also have students answer additional questions regarding personality and responsibility traits located in VAS Subject Matter Unit 6003--Human Relations in Agricultural Business. Have students discuss methods of improving personal characteristics to make them more employable. Ask students to describe the self-improvement plan they have decided to follow (Part IV--Student Worksheet #1).

6. Distribute Student Worksheet #2, "Self-Improvement: Do You See Yourself as Others See You?" for students to complete. Discuss the characteristics listed. Have students ask a friend or relative to complete the worksheet also. Compare both sets of answers to assess personality strengths and weaknesses and make changes accordingly.
7. To assist students in becoming aware of their skills, distribute Student Worksheet #3, "Job Skills and Attitude Survey." Students may need individual help in realizing sources of their own experience and the skills they have acquired. Have students work on Student Worksheet #3a, "Employability Word Search," as they complete Student Worksheet #3.

The instructor may refer to transparencies included on pages III-A-1-17, III-A-1-18 of the Rural Core III materials for additional discussion material on skills employers want their employees to possess.

8. Distribute VAS Subject Matter Unit 6001A--Applying for a Job. Divide the class into groups to present panel discussions on the topic areas presented in the VAS unit. Use VAS Slidefilm 390--Applying for a Job to summarize essential facts.
9. Utilize the included transparency to review sources for locating jobs.
10. Organize and execute a field trip to a public or private placement office. Following the field trip, discuss the office's policies and how they affect job searchers and employers. Alternatively, invite a representative from a state employment agency to explain how employment agencies can help students gain employment.
11. Ask the local school counselor or school placement officer to explain the school's placement program if one is available.
12. Distribute Information Sheet #1, "Want Ads." Following a discussion of each item listed, provide students with a copy of Student Worksheet #4, "Want Ad Abbreviations," to complete.
13. Provide students with agricultural magazines and various newspapers to enable them to locate a job of personal interest. Distribute Worksheet #5, "Researching a Job Opening," for the students to complete. Scissors and tape will be necessary for this activity.
14. Gather additional sample resumes from local sources to share with the students. Distribute and discuss Information Sheet #2, "Guidelines for Developing a Resume or Data Sheet," utilizing Information Sheet #3, "Sample Resume" and Information Sheet #4, "Sample Personal Data Sheet" as examples. Have students complete Student Worksheet #6, "Personal Data Sheet." Have students develop their own resume or data sheet for the job selected in Activity #13 utilizing this material. Provide additional examples if possible:

15. Distribute and discuss Information Sheet #5, "Guidelines for Writing Letters of Job Inquiry and Application." Have students write a letter of job inquiry and a letter of job application for their selected job using this information and Student Worksheet #7, "Letter of Application Worksheet."
16. Using Student Worksheet 8--"Completing a Job Application Form," have students fill out the job application form. Student Worksheet #8a, "Application Words" may be used as a supplementary activity.
17. Divide the class into groups of three students providing each with two copies of Student Worksheet #9, "Job Application Evaluation." Have each student evaluate their own application, then, as a group, evaluate the others.
18. Distribute and discuss Information Sheet #6, "Making Appointments by Telephone." Have students practice the correct procedures using play phones or unplugged telephones.
19. Use Applying For A Job--A Self-Study Guide for Students Including the Job Application Game in one or more of the following ways:
  - a. Individual study for students preparing for actual job interviews;
  - b. Motivational device to help the students realize how their actions affect their lives;
  - c. Supervised study with other texts and instructional devices such as role-playing job interviews and completing job applications;
  - d. Interest approach by playing the Job Application Game; and
  - e. As a source of ideas for test questions and role-play demonstrations.
20. Distribute VAS Subject Matter Unit 6001a--Applying for A Job. A list of 94 questions frequently asked during a job interview is given on pages #10 and #11. Ask each student in class how they would answer some of these questions. The questions could also be used when role-playing job interviews.
21. Ask students what they would want to ask a prospective employer about their selected job. Discuss which questions would be appropriate to ask during a job interview. After the discussion distribute Information Sheet #7, "Questions I Should Ask During My Job Interview."
22. Distribute and discuss Information Sheet #8, "The Do's and Don'ts of Interviewing for Jobs." Point out how both verbal and non-verbal forms of communication affect the job interviewing process.

23. After discussing the transparency--"Handshaking," have the class practice the correct method of handshaking.
24. Have a student read aloud Information Sheet #9, "Letter to Job Applicants." Discuss what the prospective employer meant by the letter.
25. Distribute Information Sheet #10, "The Interview from the Other Side" and discuss as a class.
26. Invite a resource person (business owner, personnel manager, or principal) to discuss "What do I look for on resumes, application letters and forms, and during interviews?"
27. Utilizing the materials the students have developed for their personally selected job including their letter of application, resume or data sheet, job research sheet, and interviewer questions, have the students interview for their job in a role-play situation. If possible, arrange to have the students interviewed by an adult that has been briefed on the student's selected job. Local administrators, teachers, alumni members or agribusiness people may be selected as the interviewers. Arrange to have the interview videotaped. Provide each interviewer in advance any materials included in this problem area that would be of assistance to the interviewer in preparing for the interview as well as a copy of the student's letter of application and resume or data sheet. Arrange the available facility to resemble an actual interview situation. After the interview collect the interviewer's evaluation on Student Worksheet #10. Replay the interview videotape allowing the student to complete the evaluation form and discuss ways to improve the student's interviewing skills.
28. Distribute and discuss Information Sheet #11, "Guidelines for Writing a Follow-Up Letter." Have students write a follow-up letter.
29. Distribute Student Worksheet #11, "Evaluating the Job Offer," and discuss the importance of making a sound job choice.
30. After distributing Information Sheet #12, "Rejection Shock," discuss as a group.
31. Distribute Information Sheet #13, "How to Keep Your Future Job." Discuss good work habits. Ask students to consider their role as a student as an employee. What type of work habits have they developed? What might they wish to improve on? Discuss the appropriate transparency.
32. Invite a panel of local agribusiness people to discuss the importance of employee work habits and attitudes and how they affect the entire business.



VII. Application procedures:

1. This problem area will enable students to evaluate and change personal habits and characteristics, which will help make them more employable.
2. This problem area will help prepare students for the job application and interviewing process.
3. This problem area will assist students in identifying and understanding proper work habits and attitudes.

VIII. Evaluation:

1. Evaluate student reports, resumes, application forms and letters.
2. Grade student worksheets.
3. Evaluate student's ability to cooperate and work in groups.
4. Evaluate student's efforts to collect essential information when job searching.
5. Prepare and administer a written test using the sample test questions included in this problem area.
6. Evaluate student's participation in role-playing sessions.

IX. References and aids:

1. Vocational Agriculture Service, 1401 Maryland Drive, Urbana, IL 61801.
  - a. VAS Subject Matter Unit 6003 - Human Relations in Agricultural Business
  - b. VAS Subject Matter Unit 6001a - Applying for a Job
  - c. VAS Slidefilm 392 - Human Relations in Agricultural Business
  - d. VAS Slidefilm 390 - Applying for a Job
2. Applying For A Job--A Self-Study Guide for Students Including the Job Application Game, by P. M. Rath, R. E. Mason, and L. J. Phipps, available from the Interstate Printers and Publishers, Inc. Danville, Illinois 61832.
3. Rural Core Curriculum III, Unit A.



## INFORMATION SHEET #1

### WANT-ADS

1. Read want-ads every day, all of them--especially on Sundays (usually longer listing); get local papers and those from areas in which you are interested in working. Also check the journals and literature of the area you're interested in for want ads.
2. Circle the ones you are interested in.
3. Note all the particulars, so you are prepared when you call for an interview.
4. If the telephone number is listed, call right away. Have a note pad handy to write down names, addresses, details, and appointment dates.
5. If an address is given, go in person. Personal interviewing techniques will be covered in a later chapter. Don't interview over the telephone; the purpose for calling is to arrange for an interview.
6. If a letter is requested, write immediately. Include your name, address, phone number, and resume.
7. Be quick; others are looking, too!
8. Apply in person for jobs that are closely related to those you are looking for since employers may have other openings not advertised.
9. The more concrete and specific facts it mentions, the more the job offers.
10. Legitimate ads will give specific requirements jobseekers must meet in order to be considered; training, education, experience, physical demands, minimum age.

11. Avoid "Attractive Phrasing":

- "Public Contact" or "Public Relations" - usually means soliciting door to door or by phone.
- "Sales Promotion" - direct selling.
- "Outside order taking" - house to house canvassing.
- "Supervisory Position or Management Candidate" - if no specific requirements refers to gathering your friends and neighbors into sales team.
- "Earnings" - "Opportunity to Earn" - not what you will earn.

12. A BLIND AD is one put in by an employment agency but doesn't say so in the advertisement. You must pay a fee to get a job through a private employment agency, although some fees may be paid by the employer. Check First!

13. When you call about the ad, don't sound hesitant, nervous, bored, or unassured. Be clear, pleasant, and have answers to the questions you may be asked. But remember, your purpose is to get an interview. The less you say over the phone, the better. Be sure to get the person's name ~~right~~ (you may ask to have it spelled for you), the date and time of the interview, and the address. If you'll need directions on how to get there, ask.

14. Don't forget the yellow pages--they have advertisements telling location and type of possible employers.

---

Reprinted from Job-Link: A Career Development Manual For Counselors. Developed by Southeastern Illinois Career Center, Flora, Illinois, and the Illinois State Board of Education, Department of Adult, Vocational, and Technical Education, 1978.

## INFORMATION SHEET #2

### GUIDELINES FOR DEVELOPING A RESUME AND DATA SHEET.

A resume is a brief, typed statement or summary of your qualifications and experience used in applying for a job. A resume or data sheet can be sent along with a letter of inquiry or application to provide the employer with additional information in regard to your background and experience. The information given below should be considered when writing a resume or data sheet.

- I. Information to include in a resume:
  - A. Name, address, and phone number.
  - B. Resume should include a career object which should be a short, one to two sentence statement. Be brief and specific.
  - C. Educational background - name of schools attended (listed in reverse chronological order), dates attended, major field of study, subjects studied relating to job, degrees or diplomas earned.
  - D. Leadership/student activities, honors and accomplishments.
  - E. Work experience - list (in reverse chronological order) both full and part-time jobs, the name and address of company, length of time worked, brief description of duties and responsibilities, and special training programs or courses, involvement in supervised occupational experience programs.
  - F. Special technical skills and interests related to the job.
  - G. References - usually three nonrelatives. (Be sure to obtain permission before naming someone as a reference.) Include one or two former teachers plus one or more individuals who have been an employer or supervisor in the past. Send thank-you notes to those that provide your references.

II. Standards to follow for a resume:

- A. Tailor information to fit position desired.
- B. Limited to one page if possible.
- C. Neatly typed and error free.
- D. Logically organized in outline form.
- E. Honest listings of qualifications and experiences.
- F. Emphasizes your best qualifications by how they are placed and organized on the resume.
- G. No unexplained blank periods of time in resume.

CAUTION Employers are looking for a quick overview of who you are and how you fit into their business. The employer will spend less than 10 seconds reading a resume. Be sure to present relevant information clearly and concisely in an eye catching format.

INFORMATION SHEET #3

SAMPLE RESUME

TIMOTHY ERIC JOHNS

ADDRESS

204 Ripley  
Brown, Illinois 62353  
(217) 773-1018

CAREER OBJECTIVE

A position in sales with an established agribusiness firm that supplies resources to farmers.

EDUCATION

High School Diploma, Tamarack High School, Brown, Illinois, anticipated June, 1985.

COURSES RELATED TO CAREER OBJECTIVE

Vocational Agriculture, Cooperative Vocational Education, Bookkeeping, Computer Science, Power Mechanics.

HONORS

DeKalb Award for Agricultural Leadership  
John Phillip Sousa Award  
Outstanding Senior Award

EMPLOYMENT HISTORY

Assistant, Shiffer's Feed Company, Bucyrus, Illinois, August, 1984 - present.

RELATED ACTIVITIES AND ACHIEVEMENTS

Responsible for the total operation of Shiffer's Feed Company in the absence of the owner.

Developed public relations, salesmanship, and employment skills through the Cooperative Vocational Education Program.

Developed leadership skills as president of the Brown Chapter of Future Farmers of America and National Honor Society and as captain of the Tamarack Wrestling Team.

## INTERESTS

Showing cattle, skiing, fishing, reading.

## REFERENCES

Ms. Jane Martin, Instructor  
Vocational Education  
Tamarack High School  
2102 Paddock Drive  
Brown, Illinois 62353

Ms. Becky Zabel  
English Teacher  
Tamarack High School  
2102 Paddock Drive  
Brown, Illinois 62353

Mr. Fred Fisher  
Shiffer Feed Company  
Rural Route 2  
Bucyrus, Illinois 64820

INFORMATION SHEET #4

SAMPLE PERSONAL DATA SHEET

NAME: Tim Johns

ADDRESS: 204 Ripley  
Brown, Illinois 62353

TELEPHONE: (217) 777-1018

EDUCATION: High School Diploma - Anticipated June, 1985 from Tamarack High School

SUBJECTS STUDIED:

Vocational Agriculture: 8 semesters  
Cooperative Education: 2 semesters  
Bookkeeping: 2 semesters

Computer Science: 2 semesters  
Power Mechanics: 2 semesters

WORK EXPERIENCE:

Assistant, Shiffer's Feed Company, Bucyrus, Illinois, August 1984 - present.

TECHNICAL SKILLS:

Trained in the operation of electronic cash registers and promotion and sales of agricultural products.

LEADERSHIP ACTIVITIES:

President, Future Farmers of America  
Vice President, Senior Class

National Honor Society  
Captain, Wrestling Team

HONORS AND OTHER ACCOMPLISHMENTS

DeKalb Award for Agricultural Leadership  
John Philip Sousa Award  
Outstanding Senior Award

REFERENCES:

Ms. Jane Martin, Instructor  
Vocational Agriculture  
Tamarack High School  
2102 Paddock Drive  
Brown, Illinois 62353

Mr. Fred Fisher, Manager  
Shiffer's Feed Company  
Rural Route 2  
Bucyrus, Illinois 64820

Ms. Becky Zabel  
English Teacher  
Tamarack High School  
2102 Paddock Drive  
Brown, Illinois 62353



INFORMATION SHEET #5  
GUIDELINES FOR WRITING LETTERS OF  
JOB INQUIRY AND APPLICATION

The purpose of a letter of inquiry is to obtain information about possible job vacancies. The purpose of a letter of application is to apply for a specific position that has been publicly advertised. Both letters indicate your interest in working for a particular company, acquaint employers with your qualifications, and encourage the employer to invite you for a job interview.

Letters of inquiry and application represent YOU. Therefore, they should be accurate, informative, and attractive. Your written communications should present a strong, positive, professional image both as a job seeker and future employee. The following list should be used as a guide when writing letters of inquiry and application.

I. Standards to follow for letters of inquiry and application:

- A. Short and specific, one to two pages (details left to resume)  
Use 8½ x 11" white typing paper, not personal or fancy paper.
- B. Neatly typed and error free.
- C. Attractive form, free from smudges
- D. Write to a specific person. Use "To Whom It May Concern" if answering a blind ad.
- E. Logical organized paragraphs which are to the point
- F. Carefully constructed sentences free from spelling or grammatical errors
- G. Positive in tone
- H. Ideas expressed in a clear, concise direct manner
- I. Avoid slang words and expressions.
- J. Avoid excessive use of the word "I".
- K. Avoid mentioning salary and fringe benefits.
- L. Write a first draft, then make revisions.
- M. Proofread final letter yourself, and also have someone else proofread.
- N. Address and sign correctly. Type envelope addresses.

II. Information to include in a letter of inquiry:

- A. Specify the reasons why you are interested in working for the company and ask if there are any positions available now or in the near future.
- B. Express your interest in being considered a candidate for a position when one becomes available.
- C. Since you are not applying for a particular position, you cannot relate your qualifications directly to job requirements. (However, you can explain how your personal qualifications and work experience would help meet the needs of the company.)
- D. Make mention of and include your resume.
- E. State your willingness to meet with a company representative to discuss your background and qualifications. (Include your address and phone number where you can be reached.)
- F. Address letters of inquiry to the personal manager unless you know his/her name.

III. Information to include in a letter of application:

- A. Source of job lead.
- B. Specify the particular job you are applying for and your reason for interest in the position and company.
- C. Explain how your personal qualifications meet the needs of the employer.
- D. Explain how your work experience relates to the job requirements.
- E. Make mention of and include your resume.
- F. Request for an interview and state your willingness. (Include your address and phone number where you can be reached.)

INFORMATION SHEET #5 (continued)

SAMPLE LETTER OF INQUIRY

204 Ripley  
Brown, Illinois 62353  
February 26, 1985

Mr. Dan Blentlinger, Manager  
Eddington Farm Service  
200 Curtis Road  
Barfield, Illinois 61874

Dear Mr. Blentlinger:

I am currently in the process of exploring career opportunities available in agribusiness following my June graduation from Tamarack High School.

During my high school career I have strived to increase my employability in agribusiness. My grade point average is 4.15 on a 5 point scale. I have enrolled in vocational agriculture during my last three years of high school. My occupational experience program during junior and senior year consisted of working as an assistant at Shiffer's Feeds in Bucyrus, Illinois.

I will appreciate any information you can give regarding vacancies at Eddington Farm Service. Thank you for your assistance.

Sincerely,

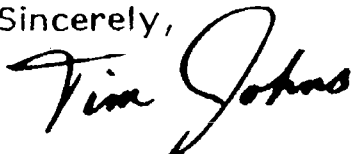

Tim Johns

INFORMATION SHEET #5 (continued)

SAMPLE LETTER OF APPLICATION

204 Ripley  
Brown, Illinois 62353  
May 1, 1985

Clint Sieben  
Personnel Manager  
Eichelburger Ag Supply Company  
923 Wagner Street  
Bucyrus, Illinois 64820

Dear Mr. Sieben:

Please consider me for the sales person position at Eichelburger Ag Supply Company which you advertised in the Bucyrus News Press.

In June I will graduate from Tamarack High School, where my program included three years of vocational agriculture and two semesters of cooperative vocational education. While enrolled in the cooperative vocational course I was employed by Shiffer's Feeds in Bucyrus, Illinois. The skills and knowledge gained through these experiences would help me to be a valuable addition to your firm. A more complete description of my qualifications is provided in the enclosed resume.

My work experience for Shiffer's Feeds was enjoyable, and it is my ambition to continue work in agribusiness. May I come for an interview at your convenience anytime after school? I can be reached by phone at 773-2287 after 3:30 pm, or by mail at 204 Ripley Avenue, Brown, Illinois 62353.

Thank you for your consideration.

Sincerely,

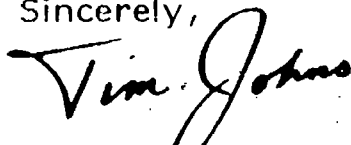
  
Tim Johns

Enclosure

## INFORMATION SHEET #6

### MAKING APPOINTMENTS BY TELEPHONE

There will often be times when you will have to arrange an appointment to interview for a job by telephone. Certain procedures should be followed when making appointments. This call may be the first contact you have with the company. It is important to be polite and courteous, so that you make a good first impression. Remember that the receptionist is there to help you, so it is important to keep him/her on your side. Also, remember that it is not appropriate to ask about salary over the phone. Use the checklist below to help you properly make an appointment by telephone.

#### CHECKLIST FOR MAKING APPOINTMENTS BY TELEPHONE

- |  |     |    |
|--|-----|----|
| 1. Did you prepare a rough outline of what you wanted to cover before making the call? | YES | NO |
| 2. Were you prepared before calling?   | YES | NO |
| 3. Did you have to pause and stammer to find the right words?                          | YES | NO |
| 4. Did you immediately identify yourself?  | YES | NO |
| 5. Did you immediately state your reason for calling?                                  | YES | NO |
| 6. Did you ask when would be the best time for the employer to interview you?          | YES | NO |
| 7. Did you record the exact day, time, and place of the interview?                     | YES | NO |
| 8. Were you courteous and friendly?  | YES | NO |
| 9. Did you thank the receptionist for his/her help?                                    | YES | NO |

## INFORMATION SHEET #7

### QUESTIONS I SHOULD ASK DURING MY JOB INTERVIEW

When interviewing for a job you will probably have several questions to ask the interviewer. However, interviewers will often eliminate the need for asking some questions, due to the information they provide during the interview. While it is important to be prepared to ask questions yourself, you should wait to see how many questions are answered during the course of the interview. A list of appropriate questions to ask the interviewer is given below:

1. What are the typical working hours?
2. What will be the actual starting date for the job?
3. What are the specific job responsibilities?
4. Does the company offer a training program to allow employees to learn new skills?
5. Do employees specialize in a particular aspect of work for the business?
6. What is the established line of authority? Who would be my immediate supervisor?
7. Where exactly would I be working? What are the general working conditions?
8. What types of machinery, tools, and equipment would I be operating?
9. Am I expected to supply any of my own tools? If so, what do I need to supply?
10. How much overtime is generally needed and expected?
11. What is the policy for promotions and raises?
12. What is the policy for vacation and sick leave? (Note: Be careful not to give the impression your main concern is not working!)
13. What type of salary and fringe benefits can be expected? (Note: this question should be asked only toward the end of an interview. Many interviewers prefer to discuss salary and benefits only after you have been offered the job. Let the employer take the lead to introduce this topic.)
14. When will I be contacted regarding your decision on filling the position?
15. Is this position filled on a year-round or seasonal basis?

## INFORMATION SHEET #8

### THE DO'S AND DON'TS OF INTERVIEWING FOR JOBS

#### DO:

1. Find out about the company before you interview (its products, who its customers are, etc.).
2. Be neat and well-groomed, dress conservatively.
3. Be punctual (15-20 minutes early).
4. Have your resume and examples of your work available for quick reference.
5. Have a pen and note pad to take notes.
6. Have a prepared list of questions you are interested in regarding the job. (These may be answered by the interviewer during the course of the interview.)
7. When meeting the receptionist, smile, introduce yourself, state you have an appointment, follow the receptionist's instructions, and wait patiently.
8. Greet the interviewer with a smile and by name.
9. If the interviewer offers his/her hand, shake it firmly.
10. Introduce yourself and state the purpose of your appointment.
11. Be seated only after the interviewer has asked you to do so.
12. Sit and stand erect.
13. Be polite and courteous.
14. Be sincere, enthusiastic, friendly, and honest.
15. Let the interviewer take the lead in the conversation.
16. Be alert (sit slightly forward in the chair to give an alert appearance).
17. Be confident, look directly at the interviewer.
18. Make an effort to express yourself clearly and distinctly.
19. Speak correctly, use proper grammar, speak in clear moderate tones.
20. Take time to think about your answer, choose words carefully.
21. Answer questions completely, but give only essential facts.



22. Convey positive answers.
23. Speak positively of former employers and associates.
24. Watch for signs that the interview is over such as interviewer shuffling papers, moving around in chair, etc.
25. Thank the interviewer for his/her time.
26. Shake hands with the interviewer and leave promptly at the completion of the interview.
27. Write a follow-up letter to express your interest in the job and your appreciation for the opportunity to interview.

DON'T:

1. Take others with you to the interview (parents, friends, etc.)
2. Put your hat or coat on the interviewer's desk.
3. Use a limp or overpowering handshake.
4. Lean against a wall, chair, or desk.
5. Interrupt the interviewer.
6. Chew gum, smoke, eat candy, etc.
7. Giggle, squirm in your chair, tap your fingers, swing a crossed leg, etc.
8. Use slang or swear.
9. Talk too long.
10. Try to flatter the interviewer.
11. Give all yes or no answers.
12. Talk about personal problems.
13. Press for a decision on being hired.

INFORMATION SHEET #9  
LETTER TO JOB APPLICANTS

Dear Job Applicant:

Today you asked me for a job. From the look of your shoulders as you walked out, I suspect you've been turned down before, and maybe you believe by now that people just out of high school can't find work.

But I did hire a teen-ager today. You saw him. He was the one with the polished shoes and a necktie. What was so special about him? Not experience; neither of you had any. It was his attitude. Yes, attitude! He wanted that job badly enough to look neat, and to look in the phone book to find out what this company does. He did his best to impress me. That's how he edged you out.

You see, people who hire people aren't "with" a lot of things. Some of us have what you may call Stone Age ideas about who owes whom a living. But there's nothing wrong with the checks we sign, and if you want one, you'd better tune in to our wave-length, too.

Ever hear of "empathy"? It's the trick of seeing the other fellow's side of things. I couldn't have cared less that you're behind in your car payments. That's your problem. What I needed was someone who'd go out into the plant, keep his eyes open, and work for me as if he were working for himself. If you have even the slightest idea of what I'm trying to say, let it show the next time you ask for a job. You'll be head and shoulders over the rest.

Look, the only time jobs grew on trees was while most of the manpower was wearing GI's and pulling KP. Maybe jobs aren't as plentiful right now as you'd like but a lot of us can remember when master craftsmen were walking the streets. By comparison, you don't know the meaning of "scarce."

You may not believe it, but all around you are employers looking for young men and women smart enough to go after a job in the old-fashioned way. When they find one, they can't wait to unload some of their worries on him or her.

For both our sakes, get eager, will you?

Sincerely yours,

Prospective Employer

The New Mexico Horticultural Core Curriculum was the source of the above letter.

## INFORMATION SHEET #10

### THE INTERVIEW FROM THE OTHER SIDE

The interview from the other side of the desk isn't so easy, either. Interviewing people for jobs frequently involves seeing and evaluating a great many applicants in one day, and it is often a trying task. The most common reasons for not being able to place applicants in a job are:

1. Poor attitude
2. Unstable work record
3. Bad references
4. Lack of self-selling ability
5. Lack of skill and experience
6. Not really anxious to work
7. "Bad mouthing" former employers
8. Too demanding (wanting too much money, or to work only under certain conditions)
9. Unable to be available for interviews or cancelling out

Are any of these qualities pertinent to you? If so, you should consciously and constructively work to improve upon them. You may want to "slant" your resume and overall job hunting approach to minimize certain of the qualities you can't actively control, such as being too specialized in a low demand area.

It is generally agreed that most employers are apt to evaluate you in an interview according to the following general criteria:

1. Appearance
2. Personality, "people" skills, attitudes, poise
3. Knowledge of job, education, and experience
4. Drive, enthusiasm, interest, attitudes
5. Good references
6. Complete, well-organized application or resume
7. Stable work record reflecting growth

From this list, which isn't necessarily in the order of importance, you can nonetheless see that while skills, education, and experience are areas in which you will be evaluated, other qualities may be equally if not more important. From the employer's point of view, skills may always be taught, thereby providing education, and experience can always be developed. The other things--like character, personality, attitudes, enthusiasm--can't be taught or provided by the employer.

Here are some of the things commonly encountered by interviewers that tend to "turn them off":

1. Poor appearance
2. Poor attitude
3. Lack of manners and personal courtesy
4. Chewing gum, smoking, fidgeting
5. No attempt to establish rapport; not looking the interviewer in the eye
6. Being interested only in the salary and benefits of the job
7. Lack of confidence; being evasive
8. Poor grammar, use of slang
9. Immaturity
10. Not having any direction or goals

NOTE: Interviewers prefer people who are interested in the job, the company, and the company's goals rather than persons who seemingly are interested only in what they have to do to receive a certain amount of money. Interviewers prefer persons that can skillfully uphold their part of the interview process, so that the result of the interview is a give-and-take of meaningful dialogue, and not just a bunch of rambling, disorganized conversation.

---

Adapted from Job-Link: A Career Development Manual for Counselors. Developed by Southeastern Illinois Career Center, Flora, Illinois, and the Illinois State Board of Education, Department of Adult, Vocational and Technical Education, 1978.

## INFORMATION SHEET #11

### GUIDELINES FOR WRITING A FOLLOW-UP LETTER

Follow-up letters are sent immediately after you have had an interview. The follow-up letter demonstrates your knowledge of business etiquette and protocol. Always send a follow-up letter regardless of whether or not you had a good interviewing experience and regardless of whether you are no longer interested in this position. When employers do not receive follow-up letters from job candidates, they often assume the candidate is not aware of professional protocol they will need to demonstrate on the job.

The major purpose of a follow-up letter is to thank those individuals who participated in your interview. In addition, a follow-up letter reinforces your name, application, and qualifications to the employer, and indicates whether you are still interested in the job position. The following list should be used as a guide when writing a follow-up letter:

1. Letters should include an expression of appreciation for the interviewer's time and interest in you as a candidate.
2. If you are no longer interested in the position indicate this as clearly and politely as you can. You may wish to indicate why you are no longer interested in the position (accepted a job elsewhere, decision to continue education). You are not required to provide a reason. However, it is polite and often helpful to employers to do so.
3. If you are interested in the position indicate this as clearly as you can. Summarize your qualifications. Reemphasize your strengths as shown on your application letter and resume, plus any other strengths overlooked previously.
4. Letters should include your name, address, and phone number to make it easier for the employer to contact you.
5. Letters should be typed and error free.
6. Letters should be clean, neat, and arranged attractively on the paper.
7. Letters should be free from spelling, punctuation, and grammatical errors.
8. Letters should be proofread by you and another person before mailing.
9. Letters should be sent within a day or two after the interview.
10. A follow-up letter serves as a last bid for a job position. Make it a prime example of your excellent work habits. Be sure it is as clean, neat, and well-groomed as possible.

INFORMATION SHEET #11 (continued)

SAMPLE FOLLOW-UP LETTER

204 Ripley Street  
Brown, Illinois 62353  
May 10, 1985

Mr. Clint Sieben  
Personnel Manager  
Eichelburger Ag Supply Company  
923 Wagner Street  
Bucyrus, Illinois 64820

Dear Mr. Sieben:

Thank you for the interesting and informative interview for the position of sales person with Eichelburger Ag Supply Company.

The interview enabled me to learn more about Eichelburger Ag Supply, and about the duties and responsibilities of a salesperson in your company. I am confident that my abilities, experience, and interests would be valuable as a agriculture supply salesperson.

I am most appreciative of your interest in me as a candidate for this position and am looking forward to hearing from you. Please contact me for any additional information that would be of assistance in your evaluation of me as a possible employee of Eichelburger Ag Supply Company. You may contact me at the above address or by phone after 3:30 at 773-2287.

Sincerely,

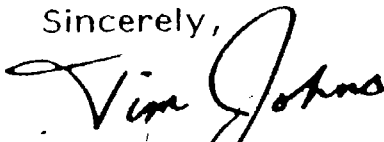

Tim Johns

73

## INFORMATION SHEET #12

### REJECTION SHOCK

As a job-hunter, be forewarned of a common ailment particular to the species: "Rejection Shock."

What exactly is this? And when does it occur? These questions might come to mind. Let me clarify further.

"Rejection Shock"--let's break it down technically:

Rejection--the action of rejecting; the state of being rejected: something rejected. Synonymous with exclusion, denial, dismissal, veto, repudiation, renunciation. Antonymous with acceptance, admission, being chosen, selection.

Shock-- a violent shock or jar, concussion, an effect of violent disturbance, state of profound depression of the vital processes. Synonymous with impact, onset, attack, clash, jolt, outrage, violence, fury, outburst, agitation. Antonymous with soothe, calm, lull, quiet, comfort, console, relieve, humor, compose.

There are more strict definitions of terms. In the context of job-hunting "Rejection Shock," as described by Richard Bolles in his book, "What Color Is Your Parachute?", occurs when a person sets out to look for a job, confidently follows all instructions that are given . . . only to discover that none of that works for him/her. And after a lengthy time is still unemployed. Then goes into Shock, "characterized by slow and rapid erosion of self-esteem, a conviction that there is something wrong with him/her, leading to lower expectations, depression, desparation, and/or apathy. This assumes, consequently, all the proportions of a major crisis in life, personal relations and family, leading to loneliness, irritability, withdrawal, where divorce is a consequence and even suicide is possible.

Sound pretty bleak? It's the pits and it happens, is happening and will continue to happen to countless job-hunters, even to you.

However, because everybody looks for jobs and everybody gets rejected from time to time, cures to this ill have been developed.

Prescribed cures are: (1) Preparation: prepare to avoid the obvious adversity that each job-hunter is likely to encounter. Prepare yourself with the resources at hand, mainly you. (2) Caution: It is easy to slip into the quicksand of rejection shock, especially while embarked on the not-so-easy task of job-hunting. The hardest job you may ever have is that of looking for a job. (3) Consolation: console yourself, there's nothing wrong with you--everyone feels similar despair. (4) Determination: determine to help yourself and others by sharing your better understanding of the blight of "Rejection Shock" . . . as we hope you will be better prepared by our explanation of this pitfall in the job-hunting process.

Reprinted from Job-Link: A Career Development Manual for Counselors. Developed by Southeastern Illinois Career Center, Flora, Illinois, and the Illinois State Board of Education, Department of Adult, Vocational and Technical Education, 1978.



## INFORMATION SHEET #13

### HOW TO KEEP YOUR FUTURE JOB

1. Rest at night so that you will be able to do your job well and be able to do your job cheerfully.
2. Try to be early arriving to work and late to leave work.
3. Work while you are on the job; you are being paid, so stay busy.
4. Try hard to do what you know how to do and then do your best to learn what you can to do your job better.
5. Give a little more than is expected for the salary you get.
6. Learn the names of your supervisors and your fellow employees.
7. Give yourself a chance to learn your work; don't give up; be patient.
8. Learn to do the job you were hired for before you seek the job your supervisor has.
9. Be agreeable and try to get along with your co-workers.
10. Ask questions when you do not understand; your boss had rather you ask than do a job wrong all day.
11. Listen to all directions carefully.
12. Watch your fellow employee's method of doing things and ask them for suggestions and help when needed.
13. Maintain a good personal appearance.
14. Return from lunch and breaks promptly.
15. Stay cool on the job site; control your temper.
16. Be courteous and tactful on the job.
17. Develop a positive attitude toward all your business contacts.
18. Report to your immediate supervisor regarding your current duties.
19. Have a plan for what you have to do before you get to the job site. Make your plans on the way to work.
20. Learn the rules and regulations which relate to your job. Ask for a copy of the company's policies if there is one available.
21. Report mistakes you have made and try to learn from them.



22. It is best to keep business and personal relationships separate.
23. Try not to be a chronic complainer or one who quickly finds fault with others. Don't criticize your boss or co-workers.
24. Smile and try to contribute to a good work environment.
25. Let your co-workers do their job; the worksite is not a place to visit or gossip.
26. When you become successful, keep following the rules; they are what helped make you successful.
27. Check company policy before you eat, drink, smoke, or chew gum on the job.
28. Make yourself aware of the overall goals of the company and support those goals in your everyday working. If the employees of a company do not care how well they do their work, the company will suffer and you may be out of a job.
29. Welcome constructive criticism.
30. Don't make excuses about the work you should have done.
31. Do your personal business at home on your own time.
32. Be loyal to the firm and people that employ you and pay your salary.
33. Use the established line of authority. Don't go over your supervisor's head.
34. Share the credit for accomplishments with co-workers.
35. Discuss problems with your supervisor when they occur. Don't complain to others.
36. Keep confidential business matters to yourself.
37. Don't step on others to get where you are going.
38. Don't ask for favors or exceptions unless it's a real emergency.
39. Continue to show interest in your job and maintain quality performance even after the excitement and newness wears off.

REMEMBER, if you later wish to seek different employment, your supervisors will be contacted concerning your job performance!

---

Reprinted from Job-Link: A Career Development Manual for Counselors.  
Developed by Southeastern Illinois Career Center, Flora, Illinois and the  
Illinois State Board of Education, Department of Adult, Vocational and  
Technical Education, 1978.

## STUDENT WORKSHEET #1

### EVALUATING MY PERSONAL APPEARANCE, FEELINGS AND HABITS

DIRECTIONS: Answer the following questions by circling "A" for Always, "U" for Usually, "S" for Sometimes, or "N" for Never. Review your answers to determine which areas you need to improve.

#### PART I: PERSONAL APPEARANCE

- |   |   |   |   |   |
|---|---|---|---|---|
| 1. Are you aware that personal cleanliness and neatness have an effect on those around you? | A | U | S | N |
| 2. Do you shower or bathe at least once daily and after strenuous exercise?                 | A | U | S | N |
| 3. Do you use an effective deodorant daily?   | A | U | S | N |
| 4. Do you brush your teeth at least twice daily?  | A | U | S | N |
| 5. Do you keep your hair clean and well-groomed?  | A | U | S | N |
| 6. Do you wear clothes that are becoming to you and appropriate to the occasion?            | A | U | S | N |
| 7. Are your clothes neat and clean?   | A | U | S | N |
| 8. Do you keep your weight at the pound recommendation for your height and body frame?      | A | U | S | N |
| 9. Do you eat a well-balanced diet each day?  | A | U | S | N |
| 10. Do you exercise regularly?  | A | U | S | N |
| 11. Do you get enough sleep each night?   | A | U | S | N |
| 12. Do you maintain straight, correct posture when sitting, standing and walking?           | A | U | S | N |

#### PART II: WORKING WITH OTHERS

- |   |   |   |   |   |
|---|---|---|---|---|
| 1. If someone asks you for help, do you give it cheerfully? | A | U | S | N |
| 2. Do you laugh at the mistakes of others?                  | A | U | S | N |

- |   |   |   |   |   |
|---|---|---|---|---|
| 3. Is it easy for you to praise and compliment other people?  | A | U | S | N |
| 4. Do you enjoy gossip?                                       | A | U | S | N |
| 5. Do you feel awkward around strangers?                      | A | U | S | N |
| 6. Are you able to ask others for help when you need it?      | A | U | S | N |
| 7. Do you try to see the other person's point of view?        | A | U | S | N |
| 8. Do others enjoy being around you?                          | A | U | S | N |
| 9. Do you take a sincere interest in those around you?        | A | U | S | N |
| 10. Can you offer constructive criticism in a polite manner?  | A | U | S | N |
| 11. Do you congratulate your friends upon their achievements? | A | U | S | N |
| 12. Do you enjoy being part of a group?                       | A | U | S | N |
| 13. Do you make friends easily?                               | A | U | S | N |
| 14. Are you thoughtful of the feelings of others?             | A | U | S | N |
| 15. Do you get along well with others?                        | A | U | S | N |
| 16. Do people ask for your advice?                            | A | U | S | N |
| 17. Does conversation stop when you join a group?             | A | U | S | N |
| 18. Do you sense that others feel uncomfortable around you?   | A | U | S | N |
| 19. Do you keep the promises you make to others?              | A | U | S | N |
| 20. Do you easily become jealous of others?                   | A | U | S | N |

PART III: COMMUNICATION SKILLS

- |  |   |   |   |   |
|--|---|---|---|---|
| 1. Do you organize your thoughts and ideas before you speak?   | A | U | S | N |
| 2. Do you concentrate on the meaning you are trying to convey? | A | U | S | N |

- |   |   |   |   |   |
|---|---|---|---|---|
| 3. Do you make grammatical and spelling errors when speaking or writing?                      | A | U | S | N |
| 4. When you are listening to someone, are you easily distracted by outside sights and sounds? | A | U | S | N |
| 5. Do you use clear, distinct speech?   | A | U | S | N |
| 6. Do you have a pleasant speaking voice?   | A | U | S | N |

PART IV: PERSONAL FEELINGS AND ATTITUDES

- |   |   |   |   |   |
|---|---|---|---|---|
| 1. Do you try to have a positive attitude?                      | A | U | S | N |
| 2. Do you approach your work confidently?                       | A | U | S | N |
| 3. Are you willing to accept responsibility?                    | A | U | S | N |
| 4. Are you able to act naturally under all circumstances?       | A | U | S | N |
| 5. Do you worry about past mistakes and failures?               | A | U | S | N |
| 6. Do you control your temper?                                  | A | U | S | N |
| 7. Are you able to make decisions about everyday things easily? | A | U | S | N |
| 8. Are you able to keep your personal troubles to yourself?     | A | U | S | N |
| 9. Do you react constructively to criticism?                    | A | U | S | N |
| 10. Do you accept blame for things that are your fault?         | A | U | S | N |
| 11. Do you tell the truth and are you honest?                   | A | U | S | N |
| 12. Are you easily discouraged?                                 | A | U | S | N |
| 13. Can you adapt to all situations?                            | A | U | S | N |
| 14. Do you persevere until you achieve success?                 | A | U | S | N |
| 15. Can you make decisions quickly and accurately?              | A | U | S | N |
| 16. Are you afraid to express your opinions and ideas?          | A | U | S | N |

- |     |  |   |   |   |   |
|-----|--|---|---|---|---|
| 17. | Are you ambitious?                                       | A | U | S | N |
| 18. | Do you complain when things don't go the way you'd like? | A | U | S | N |
| 19. | Do you become impatient with yourself and others?        | A | U | S | N |
| 20. | Do you feel you are a unique and valuable person?        | A | U | S | N |

PART V: PLANS FOR IMPROVEMENT

1. What do you feel are your strengths regarding personal appearance, feelings, and habits?

---



---



---



---

2. What do you feel are your weaknesses regarding personal appearance, feelings, and habits?

---



---



---



---

3. In what ways do you want to change or improve your personal appearance, feelings, and habits?

---



---



---



---

4. Now that you have decided what to improve about yourself, you must decide how you can make the improvements. One way is to develop a self-improvement plan of action with a reward/penalty system. For example, you may decide you need to spend more time studying. Your plan of action may be to study 2 hours each day after school. If you study for 2 hours, reward yourself with a pleasurable activity such as watching TV, playing a game of basketball, eating a piece of cake, etc. If you do not study, you

must give up one of the pleasurable activities you had planned to do. Complete the section below to begin your self-improvement plan.

### SELF-IMPROVEMENT PLAN

NAME \_\_\_\_\_ DATE \_\_\_\_\_

I do hereby agree to \_\_\_\_\_

(activity or behavior)

for a period of \_\_\_\_\_ (number) days. In return I will receive the rewards listed below.

REWARD \_\_\_\_\_  
\_\_\_\_\_

7

If I fail to live up to this self-improvement plan, the following penalties will take effect:

PENALTIES \_\_\_\_\_  
\_\_\_\_\_

SIGNATURE \_\_\_\_\_

## STUDENT WORKSHEET #2

### SELF-IMPROVEMENT: DO YOU SEE YOURSELF AS OTHERS SEE YOU?

**DIRECTIONS:** Before you can project personal characteristics necessary for gaining employment, you must determine if you possess them. It is important that you evaluate yourself truthfully so you can improve your personality. Rate yourself on the following scale by marking either "A" for Always, "U" for Usually, "S" for Sometimes, or "N" for Never. Have a friend or relative rate you as they see you. Compare your answers to determine those areas needing improvement.

#### DESIRABLE CHARACTERISTICS

1. Accurate	A	U	S	N
2. Agreeable	A	U	S	N
3. Ambitious	A	U	S	N
4. Appreciative	A	U	S	N
5. Attentive	A	U	S	N
6. Broadminded	A	U	S	N
7. Cheerful	A	U	S	N
8. Confident	A	U	S	N
9. Conscientious	A	U	S	N
10. Considerate	A	U	S	N
11. Cooperative	A	U	S	N
12. Courteous	A	U	S	N
13. Creative	A	U	S	N
14. Dependable	A	U	S	N
15. Efficient	A	U	S	N
16. Enthusiastic	A	U	S	N
17. Friendly	A	U	S	N
18. Good Natured	A	U	S	N
19. Honest	A	U	S	N
20. Leadership Qualities	A	U	S	N
21. Loyal	A	U	S	N
22. Mature	A	U	S	N
23. Modest	A	U	S	N
24. Obedient	A	U	S	N
25. Optimistic	A	U	S	N
26. Patient	A	U	S	N
27. Perseverant	A	U	S	N
28. Poised	A	U	S	N
29. Positive	A	U	S	N
30. Practical	A	U	S	N
31. Punctual	A	U	S	N
32. Realistic	A	U	S	N
33. Reasonable	A	U	S	N
34. Resourceful	A	U	S	N
35. Self-conscious	A	U	S	N
36. Self-control	A	U	S	N
37. Self-starting	A	U	S	N

38.	Sense of humor	A	U	S	N
39.	Sensible	A	U	S	N
40.	Sincere	A	U	S	N
41.	Sympathetic	A	U	S	N
42.	Tactful	A	U	S	N
43.	Thoughtful	A	U	S	N
44.	Tolerant	A	U	S	N
45.	Trustworthy	A	U	S	N

UNDESIRABLE CHARACTERISTICS

1.	Apathetic	A	U	S	N
2.	Argumentative	A	U	S	N
3.	Artificial	A	U	S	N
4.	Boastful	A	U	S	N
5.	Conceited	A	U	S	N
6.	Critical	A	U	S	N
7.	Deceitful	A	U	S	N
8.	Defensive	A	U	S	N
9.	Domineering	A	U	S	N
10.	Emotional	A	U	S	N
11.	Forgetful	A	U	S	N
12.	Greedy	A	U	S	N
13.	Impulsive	A	U	S	N
14.	Inferiority Complex	A	U	S	N
15.	Inhibited	A	U	S	N
16.	Irritable	A	U	S	N
17.	Jealous	A	U	S	N
18.	Militant	A	U	S	N
19.	Moody	A	U	S	N
20.	Pessimistic	A	U	S	N
21.	Rebellious	A	U	S	N
22.	Restless	A	U	S	N
23.	Rude	A	U	S	N
24.	Sarcastic	A	U	S	N
25.	Selfish	A	U	S	N
26.	Shrewd	A	U	S	N
27.	Stubborn	A	U	S	N
28.	Sulky	A	U	S	N
29.	Timid	A	U	S	N
30.	Vicious	A	U	S	N



## STUDENT WORKSHEET #3

### JOB SKILLS AND ATTITUDE SURVEY

Complete the following questions.

1. Do I like to be alone or with other people?
2. Am I mechanical or artistic?
3. Would I rather sell or work under supervision?
4. Would I like to think, or be active?
5. Could I take authority and responsibility for others?
6. Must I have freedom to express creativity?
7. What things do I like to do?
  - a.
  - b.
  - c.
  - d.
  - e.
8. What time of day can I work best?
9. Can I work under pressure, stress?
10. Make a list of your strong points. Consider skills you can offer an employer. (Also, hobbies, leisure time, and skills.)
  - a.
  - b.
  - c.
  - d.
  - e.
11. Now make a list of school subjects, evening classes, lessons, etc., that have given you job abilities.
  - a.
  - b.
  - c.
  - d.
  - e.

---

Reprinted from Job-Link: A Career Development Manual for Counselors. Developed by Southeastern Illinois Career Center, Flora, Illinois, and the Illinois State Board of Education, Department of Adult, Vocational and Technical Education, 1978.

STUDENT WORKSHEET #3a

EMPLOYABILITY WORD SEARCH

Locate and circle 30 words describing desirable characteristics for gaining and maintaining employment. List the words in the space provided.

1. \_\_\_\_\_
2. \_\_\_\_\_
3. \_\_\_\_\_
4. \_\_\_\_\_
5. \_\_\_\_\_
6. \_\_\_\_\_
7. \_\_\_\_\_
8. \_\_\_\_\_
9. \_\_\_\_\_
10. \_\_\_\_\_
11. \_\_\_\_\_
12. \_\_\_\_\_
13. \_\_\_\_\_
14. \_\_\_\_\_
15. \_\_\_\_\_
16. \_\_\_\_\_
17. \_\_\_\_\_
18. \_\_\_\_\_
19. \_\_\_\_\_
20. \_\_\_\_\_
21. \_\_\_\_\_
22. \_\_\_\_\_
23. \_\_\_\_\_
24. \_\_\_\_\_
25. \_\_\_\_\_
26. \_\_\_\_\_
27. \_\_\_\_\_
28. \_\_\_\_\_
29. \_\_\_\_\_
30. \_\_\_\_\_

BACTCOPJISSTIVELOKCORV  
HOTELRSUNDULUEMROHEERK  
ACCURATENZOLVDAEKUGROP  
TTLI PHOSCCIITNEDIFNOCA  
KIADGQBEIRRTQUOBRELOGAG  
SONOEUORTIIUQSHAEEBODZ  
GDORRSDNSRBDADAETAVITOM  
TRIGLEEOALMHCLAKBITART  
OBSAOI PSIXAUOECLWTWLAB  
LISNCAETSOKMUTBHTAODOO  
UKEIDTNLUFECRUOSERGROR  
NBFZIEDJHBLTTLETIEABLG  
DFOEADAPTABLENUDOPRAID  
ELRDEGBRNUAT,OEPFLOYFLA  
REPDZNLRENIHUOUETOEQUF  
SMATURETFHLMSTABLCEBOL  
TATROBQRTNEATSGRBEAFLU  
ANFEUTIEGIRPATIENTDTUD  
NTOJMETLKELENOOSRUTTRJR  
DRSUNKRACJTEHTAPMEDELS  
IEMDIROOHSALIJMAETORSB  
NZLOEAHRJATPCETOLGUENR  
GYEKNOWLEDGEABLERQLTBA

STUDENT WORKSHEET #4

WANT AD ABBREVIATIONS

The price of a want ad in most newspapers is figured on the number of lines in the ad. Therefore, in order to use as few lines as possible and save money, people who put want ads in newspapers generally use as many abbreviations as they can. Find the abbreviations in the want ads for the words that are listed; and then write them in the empty spaces.

- a. manufacturing company  
\_\_\_\_\_
- b. doctor's office  
\_\_\_\_\_
- c. chemistry aptitude  
\_\_\_\_\_
- d. including Saturday  
\_\_\_\_\_
- e. license required  
\_\_\_\_\_
- f. excellent opportunity  
\_\_\_\_\_
- g. hospital and insurance  
\_\_\_\_\_
- h. light typing  
\_\_\_\_\_
- i. laboratory technician  
\_\_\_\_\_
- j. experience necessary  
\_\_\_\_\_
- k. television and advertising  
\_\_\_\_\_

HELP WANTED  
Routemen  
Linen & Towel Supply  
No exp nec... Good sal  
Hosp & Ins Benefits  
11 Cascade Road See Mr. Lund  
MORNINGS ONLY  
CLERICAL LITE TYP \$100  
TV/ADV FEE PD  
5 days incl Sat. Apply  
VALOR AGENCY  
370 Bellrose Ave

MACHINE SHOP TRNEES  
Exo oppty for high school grads.  
State approved apprentice program  
Patton Mfg Co 5 Janse Ave  
Lab tech-F/T-Chem apt  
Beginner O.K. Call/apply  
Personnel Office  
Mount Royal Hospital

BOYS-AIRPORT ---\$90 week  
Driver lic req  
Phone 763-8245 X21.

P/T Receptionist Dr's ofc  
Hrs 9-1 or 3-7 \$2.25 hr  
Y7645 Times-Herald

Factory Helpers-No exp nec  
\$1.87 to start plus benefits  
& overtime...at least 2 years HS.  
Apply 83 Main 5th flrg

- l. extension  
\_\_\_\_\_
- m. salary  
\_\_\_\_\_
- n. full-time  
\_\_\_\_\_
- o. floor  
\_\_\_\_\_
- p. opportunity  
\_\_\_\_\_
- q. avenue  
\_\_\_\_\_
- r. hours  
\_\_\_\_\_
- s. trainees  
\_\_\_\_\_
- t. high school  
\_\_\_\_\_
- u. paid  
\_\_\_\_\_
- v. part-time  
\_\_\_\_\_
- w. graduates  
\_\_\_\_\_



WANT AD ABBREVIATIONS (con't)

a. east

---

b. major medical

---

c. telephone clerk

---

d. bookkeeper assistant

---

e. good speaking

---

f. boulevard

---

g. corporation

---

h. Bachelor of Science or  
Master of Science

---

i. hotel room clerk

---

j. night

---

k. incorporated

---

l. references required

---

m. manager trainee

---



---

HELP WANTED

---

Exp checker needed by leading  
corp. Resp for million dollar  
shipments.

Good salary and maj med  
PLEASE CALL Miss Strang  
627-4400

---

Htl Rm Clk Nite shift  
R. Melling Agency 18 E. Davis

---

BKPR ASST to \$120  
exp/inexp Downtown

Must spk Span  
Mr. Hernandez RE 7-2231

---

LABORATORY TECHS

BS/MS degree Liberal Salary  
and Benefits-Refs Req

Hempstead Laboratories Inc.  
58 East 11th Street

---

Tel clk gd spkg voice  
\$90 Freed Agency 10 Harris

---

Med receipt Plastic Surgeon  
\$100 Carroll Agency

9 Pudding Lane

---

STORE MGR TRNEE \$5400

Contact emp div Harper  
Employment Agency  
14 Rutgers Bld

---

n. responsible

---

o. speak Spanish

---

p. technicians

---

q. medical receptionist

---

r. employment division

---

Reprinted from Job-Link: A Career Development Manual for Counselors. De-  
veloped by Southeastern Illinois Career Center, Flora, Illinois, and the Illinois  
State Board of Education, Department of Adult, Vocational, and Technical  
Education, 1978.

STUDENT WORKSHEET #5

RESEARCHING A JOB OPENING

1. Look through the help wanted ads in a newspaper or professional magazine for an employment ad of personal interest. Affix it to the space below.

2. Locate the following information concerning the potential employer in the above advertisement.

a. Name of company

---

b. Name of personnel manager

---

c. Company address

---

d. Position available

---

e. Requirements for the position

---

f. Geographic scope of the company (local, county, state, region, national)

---

g. Company's output product(s)

---

h. Recent company developments

---

i. Responsibilities of position

---

j. Demand for the company's product(s)

---

---

STUDENT WORKSHEET #6

PERSONAL DATA SHEET

NAME \_\_\_\_\_

ADDRESS \_\_\_\_\_

PHONE NUMBER \_\_\_\_\_

EDUCATION:

HIGH SCHOOL \_\_\_\_\_

MAJOR COURSES \_\_\_\_\_

TECHNICAL SKILLS \_\_\_\_\_

LEADERSHIP ACTIVITIES \_\_\_\_\_

HONORS AND OTHER ACCOMPLISHMENTS \_\_\_\_\_

WORK EXPERIENCE: (Briefly list jobs held, employers' names and addresses, and length of service for each. Begin with present or last job first.)

\_\_\_\_\_  
\_\_\_\_\_  
\_\_\_\_\_  
\_\_\_\_\_  
\_\_\_\_\_

REFERENCES: (Include complete name, title, address, and phone numbers.)

\_\_\_\_\_  
\_\_\_\_\_  
\_\_\_\_\_  
\_\_\_\_\_



STUDENT WORKSHEET #7  
LETTER OF APPLICATION WORKSHEET

HEADING  
(Your complete address and date)

INSIDE ADDRESS (name, title and complete  
address of employer)

SALUTATION

(name job and where you learned of opening)

(education, training, and related experience)

(request for interview, where, when, how you may be reached)

COMPLIMENTARY CLOSING

SIGNATURE

(Enclosure)

## STUDENT WORKSHEET #8

### COMPLETING A JOB APPLICATION FORM

When completing a job application, remember you are trying to sell yourself by the information given. Review the entire application form before you begin. Pay particular attention to any special instructions to print or write in your own handwriting.

When answering ads that require potential employees to apply in person, be prepared to complete an application form on the spot. Take two good ink pens and two sharpened pencils. Prepare a list of information you will need to complete the application form. The information may include: your social security number; the addresses of schools you have attended, names, phone numbers, and addresses of previous employers and supervisors; names, phone numbers and addresses of references.

The following guidelines will provide you some direction when completing application forms. After you review these guidelines, complete the sample application form attached.

1. Follow all instructions carefully and exactly.
2. If hand-written, rather than typed, write neatly and legibly. Hand-written answers should be printed unless otherwise directed.
3. Application forms should be written in ink unless otherwise requested. If you make a mistake, mark through it with one neat line.
4. Be honest and realistic.
5. Give all the facts for each question.
6. Keep answers brief.
7. Fill in all blanks. If the question does not pertain to you, write "not applicable" or "N/A". If there is no answer, write "none" or draw a short line through the blank.
8. Many application forms ask what salary you expect. If you are not sure what is appropriate, write "negotiable," "open," or "scale" in the blank. Before applying, try to find out what the going rate for similar work is at other locations. Give a salary range rather than an exact figure.
9. Write the complete names, titles, addresses, and phone numbers of all references and former employees when completing the application form.
10. Make sure you have included any of your special abilities and accomplishments.
11. Upon completing the application form, check for completeness, accuracy, and correct spelling.
12. Have another person proofread the form before submitting it.



# APPLICATION FOR EMPLOYMENT

**PERSONAL INFORMATION**

Date \_\_\_\_\_

NAME: Last \_\_\_\_\_ First \_\_\_\_\_ Middle \_\_\_\_\_

PRESENT ADDRESS: Street \_\_\_\_\_ City \_\_\_\_\_ State \_\_\_\_\_ Zip \_\_\_\_\_

PERMANENT ADDRESS: Street \_\_\_\_\_ City \_\_\_\_\_ State \_\_\_\_\_ Zip \_\_\_\_\_

PHONE NO. \_\_\_\_\_ SOCIAL SECURITY NUMBER \_\_\_\_\_

REFERRED BY \_\_\_\_\_

**EMPLOYMENT DESIRED**

POSITION \_\_\_\_\_ DATE YOU CAN START \_\_\_\_\_ SALARY DESIRED \_\_\_\_\_

ARE YOU EMPLOYED NOW? \_\_\_\_\_ IF SO MAY WE INQUIRE OF YOUR PRESENT EMPLOYER \_\_\_\_\_

EVER APPLIED TO THIS COMPANY BEFORE? \_\_\_\_\_ WHERE \_\_\_\_\_ WHEN \_\_\_\_\_

EDUCATION	NAME AND LOCATION OF SCHOOL	YEARS ATTENDED	DATE GRADUATED	SUBJECTS STUDIED
GRAMMAR SCHOOL				
HIGH SCHOOL				
COLLEGE				
TRADE, BUSINESS OR CORRESPONDENCE SCHOOL				

SUBJECTS OF SPECIAL STUDY OR RESEARCH WORK \_\_\_\_\_

U.S. MILITARY OR NAVAL SERVICE \_\_\_\_\_ RANK \_\_\_\_\_ PRESENT MEMBERSHIP IN NATIONAL GUARD OR RESERVES \_\_\_\_\_

ACTIVITIES OTHER THAN RELIGIOUS (CIVIC, ATHLETIC, FRATERNAL, ETC.) \_\_\_\_\_  
Exclude organizations, the name or character of which indicates the race, creed, color or national origin of its members

(CONTINUED ON OTHER SIDE)

**FORMER EMPLOYERS** (List below last four employers, starting with last one first)

DATE MONTH AND YEAR	NAME AND ADDRESS OF EMPLOYER	SALARY	POSITION	REASON FOR LEAVING
From				
To				
From				
To				
From				
To				
From				
To				

**REFERENCES:** Give below the names of two persons not related to you whom you have known at least one year

	NAME	ADDRESS	BUSINESS	YEARS ACQUAINTED
1				
2				

**PHYSICAL RECORD:**

List any physical defects

WERE YOU EVER INJURED? \_\_\_\_\_ GIVE DETAILS \_\_\_\_\_

HAVE YOU ANY DEFECTS IN HEARING? \_\_\_\_\_ IN VISION? \_\_\_\_\_ IN SPEECH? \_\_\_\_\_

IN CASE OF EMERGENCY NOTIFY \_\_\_\_\_

Name \_\_\_\_\_ Address \_\_\_\_\_ Phone No \_\_\_\_\_

I AUTHORIZE INVESTIGATION OF ALL STATEMENTS CONTAINED IN THIS APPLICATION. I UNDERSTAND THAT MISREPRESENTATION OR OMISSION OF FACTS CALLED FOR IS CAUSE FOR DISMISSAL. FURTHER, I UNDERSTAND AND AGREE THAT MY EMPLOYMENT IS FOR NO DEFINITE PERIOD AND MAY, REGARDLESS OF THE DATE OF PAYMENT OF MY WAGES AND SALARY BE TERMINATED AT ANY TIME WITHOUT ANY PREVIOUS NOTICE.

DATE \_\_\_\_\_ SIGNATURE \_\_\_\_\_

DO NOT WRITE BELOW THIS LINE

**TO BE COMPLETED DAY EMPLOYMENT BEGINS** DATE \_\_\_\_\_

HEIGHT \_\_\_\_\_ WEIGHT \_\_\_\_\_ AGE \_\_\_\_\_ DATE OF BIRTH \_\_\_\_\_

SINGLE \_\_\_\_\_ MARRIED \_\_\_\_\_ WIDOWED \_\_\_\_\_ CITIZEN U.S.A. \_\_\_\_\_ SEX \_\_\_\_\_

The above information needed for pension, hospitalization insurance, etc., and not for hiring purposes

INTERVIEWED BY \_\_\_\_\_ DATE \_\_\_\_\_ REMARKS \_\_\_\_\_

NEATNESS		CHARACTER	
PERSONALITY		ABILITY	

HIRED \_\_\_\_\_ FOR DEPT. \_\_\_\_\_ POSITION \_\_\_\_\_ WILL REPORT \_\_\_\_\_ SALARY WAGES \_\_\_\_\_

APPROVED 1. \_\_\_\_\_ 2. \_\_\_\_\_ 3. \_\_\_\_\_

Employment Manager Dept Head General Manager



## STUDENT WORKSHEET #9

### JOB APPLICATION EVALUATION

When filling out a job application form, you are making an impression on paper to your prospective employer. Application forms are a very important part of the hiring process, thus care should be taken when filling one out.

Directions: Here are some points to consider when filling out a job application form. Check the appropriate column indicating your evaluation of the application form.

	YES	NO
*Has the applicant followed instructions carefully?	_____	_____
- Printed where required?	_____	_____
- Circled a response when called for?	_____	_____
- Underlined a response when called for?	_____	_____
- Placed an X where appropriate?	_____	_____
- Has not filled in spaces where it says "do not write in space?"	_____	_____
*Have all the blanks been filled in?	_____	_____
If the question does not apply, is the appropriate response given (not applicable, N/A, a line drawn through the blank, or a diagonal line (/) drawn through a whole section that does not apply)?	_____	_____
*Is the application neat--printed, typed, or written clearly?	_____	_____
*Is the application filled in accurately--spelling correct?	_____	_____
*Are the answers brief?	_____	_____
*Is the work experience listed from most recent to earliest?	_____	_____
*Are the complete names and address of all references and previous employers given?	_____	_____
*Are references appropriate?	_____	_____
*Are dates correct for work experience?	_____	_____

Reprinted from Job-Link: A Career Development Manual for Counselors. Developed by Southeastern Illinois Center, Flora, Illinois, and the Illinois State Board of Education, Department of Adult, Vocational, and Technical Education, 1978.

STUDENT WORKSHEET #10

Interview Evaluation

Person Interviewed \_\_\_\_\_

Please Check the Appropriate Response:

	<u>Lacking</u>	<u>Adequate</u>	<u>Average</u>	<u>Good</u>	<u>Excellent</u>
First impression and handshake					
Overall appearance					
Ability to express himself/herself					
Courtesy and politeness					
Self-confidence and poise					
Personality					
Enthusiasm and interest in the interview					
Intelligence and knowledge of the situation					
Eye contact					
Asked appropriate questions					

Additional Comments: \_\_\_\_\_

Recommend Employment

YES / /

NO / /

\_\_\_\_\_  
Evaluator's Signature

STUDENT WORKSHEET #11  
EVALUATING THE JOB OFFER

How do you feel about the following aspects of the position?

<u>Positive</u>	<u>Negative</u>	<u>Item</u>
_____	_____	Immediate Supervisor
_____	_____	Co-workers
_____	_____	Company
_____	_____	How your friends view the position
_____	_____	Amount of job responsibility
_____	_____	Contribution to society
_____	_____	Advancement potential
_____	_____	Training program
_____	_____	Value of experience for your career
_____	_____	Overtime
_____	_____	Travel
_____	_____	Job location
_____	_____	Job security
_____	_____	Work environment (safe, clean, pleasant, etc.)
_____	_____	Personnel turnover
_____	_____	Promotion policies
_____	_____	Salary (amount and method of payment)
_____	_____	Benefit plan (insurance, sick leave, vacation, savings plans, etc.)
_____	_____	Firm's financial position
_____	_____	Raise policies
_____	_____	Retirement plan
_____	_____	Required working hours and scheduling
_____	_____	Lifestyle
_____	_____	Union membership

TEACHER'S KEY  
STUDENT WORKSHEET #3a  
EMPLOYABILITY WORD SEARCH

Locate and circle 30 words describing desirable characteristics for gaining and maintaining employment. List the words in the space provided.

1. Patient \_\_\_\_\_
2. Mature \_\_\_\_\_
3. Motivated \_\_\_\_\_
4. Adaptable \_\_\_\_\_
5. Knowledgeable \_\_\_\_\_
6. Understanding \_\_\_\_\_
7. Confident \_\_\_\_\_
8. Empathetic \_\_\_\_\_
9. Professional \_\_\_\_\_
10. Organized \_\_\_\_\_
11. Positive \_\_\_\_\_
12. Reliable \_\_\_\_\_
13. Efficient \_\_\_\_\_
14. Honest \_\_\_\_\_
15. Pleasant \_\_\_\_\_
16. Loyal \_\_\_\_\_
17. Tactful \_\_\_\_\_
18. Punctual \_\_\_\_\_
19. Ambitious \_\_\_\_\_
20. Enthusiastic \_\_\_\_\_
21. Cooperative \_\_\_\_\_
22. Resourceful \_\_\_\_\_
23. Dependable \_\_\_\_\_
24. Courteous \_\_\_\_\_
25. Cheerful \_\_\_\_\_
26. Energetic \_\_\_\_\_
27. Friendly \_\_\_\_\_
28. Neat \_\_\_\_\_
29. Alert \_\_\_\_\_
30. Accurate \_\_\_\_\_

BACTCOPJISSITIVELOKCORV  
 HOTELRSUNDULUEMROHEERK  
 ACCURATENZOLYDAEKUGROP  
 TTLIPHOSCCITNEDIENOCA  
 KIADCOBEIRTOUOBRELOGAG  
 SONOEUORTIUSHAEEBODZ  
 GDORRS DNSRBDADETA VITOM  
 TRIGLEEQALMHCLAKBITART  
 OBSAQIPPSIXAUOECLWTWLAB  
 LISNCAETSOKMUTBHFAODOO  
 UKEIDDTNLUFE CRUOSERGROR  
 NBFZIEDJHBLTTLETTEABDG  
 DFOEADAPTABLENDDOPRAID  
 ELRDEGBRNUATOPEPELOYFLA  
 REP DZNLRENIHUOUEEQUEQUE  
 SMATURETFHLMSTABLOEBOL  
 TATROBORTNEATS GRBEAFLU  
 ANFEUTIEGIRPATIENTDTUD  
 NTOJMETLKEINOOSRUTTRJR  
 DR SUNKRACTOEH TAPMEDELS  
 IEMDI ROOHSANJMAETORSB  
 NZLOEAHRJATPOETOLGUENR  
 GYEKNOWLEDGEABLERQLTBA

TEACHER'S KEY  
STUDENT WORKSHEET #4  
WANT AD ABBREVIATIONS

The price of a want ad in most newspapers is figured on the number of lines in the ad. Therefore, in order to use as few lines as possible and save money, people who put want ads in newspapers generally use as many abbreviations as they can. Find the abbreviations in the want ads for the words that are listed, and then write them in the empty spaces.

- a. manufacturing company  
Mfg Co
- b. doctor's office  
Dr's Ofc
- c. chemistry aptitude  
Chem apt
- d. including Saturday  
Incl Sat
- e. license required  
lic req
- f. excellent opportunity  
Exc oppty
- g. hospital and insurance  
Hosp & Ins
- h. light typing  
Lite typ
- i. laboratory technician  
Lab tech
- j. experience necessary  
exp nec
- k. television and advertising  
TV/ADV

HELP WANTED

Routemen  
Linen & Towel Supply  
No exp nec... Good sal  
Hosp & Ins Benefits  
11 Cascade Road See Mr. Lund  
MORNINGS ONLY

---

CLERICAL LITE TYP \$100  
TV/ADV FEE PD  
5 days incl Sat Oppty  
VALOR AGENCY  
370 Bellrose Ave

---

MACHINE SHOP TRNEES.  
Exc oppty for high school grads.  
State approved apprentice program  
Patton Mfg Co 5 Janse Ave  
Lab tech-F/T-Chem apt  
Beginner O.K. Call/apply  
Personnel Office  
Mount Royal Hospital

---

BOYS-AIRPORT---\$90 week  
Driver lic req  
Phone 763-8245 X21

---

P/T Receptionist Dr's ofc  
Hrs 9-1 or 3-7 \$2.25 hr  
Y7645 Times-Herald

---

Factory Helpers-No exp nec  
\$1.87 to start plus benefits  
& overtime... at least 2 years HS.  
Apply 83 Main 5th flr

l. extension  
X

p. opportunity  
oppty

t. high school  
HS

m. salary  
Sal

q. avenue  
ave

u. paid  
PD

n. full-time  
F/T

r. hours  
hrs

v. part-time  
P/T

o. floor  
flr

s. trainees  
trnees

w. graduates  
grads



WANT AD ABBREVIATIONS (con't)

- a. east  
E.

---

- b. major medical  
maj med

---

- c. telephone clerk  
Tel clk

---

- d. bookkeeper assistant  
BKPR ASST

---

- e. good speaking  
gd spkg

---

- f. boulevard  
Bld

---

- g. corporation  
corp.

---

- h. Bachelor of Science or  
Master of Science  
BS/MS

---

- i. hotel room clerk  
Htl Rm Clk

---

- j. night 14 Rutgers Bld  
Nite

---

- k. incorporated  
Inc.

---

- l. references required  
Refs Req

---

- m. manager trainee  
MRG TRNEE

---

HELP WANTED

Exp checker needed by leading corp., Resp for million dollar shipments.

Good salary and maj med  
PLEASE CALL Miss Strang  
627-4400

Htl Rm Clk Nite shift  
R. Melling Agency 18 E. Davis  
BKPR ASST to \$120  
exp/inexp Downtown  
Must spk Span  
Mr. Hernandez RE 7-2231.

LABORATORY TECHS  
BS/MS degree Liberal Salary  
and Benefits-Refs Req  
Hempstead Laboratories Inc.  
58 East 11th Street

Tel clk gd spkg voice  
\$90 Freed Agency 10 Harris  
Med receipt Plastic Surgeon  
\$100 Carroll Agency  
9 Pudding Lane

STORE MGR TRNEE \$5400  
Contact emp div - Harper  
Employment Agency

n. responsible  
resp.

o. speak Spanish  
Spk Span

p. technicians  
techs

q. medical receptionist  
Med receipt

r. employment division  
emp div

Reprinted from Job-Link: A Career Development Manual for Counselors. Developed by Southeastern Illinois Career Center, Flora, Illinois, and the Illinois State Board of Education, Department of Adult, Vocational, and Technical Education, 1978.



# PEOPLE WORK TO FULFILL HUMAN NEEDS

## 5. SELF REALIZATION NEEDS

Learning                      Achieving goals  
Developing talents          Personal growth  
Improving skills

## 4. SELF-RESPECT AND SELF ESTEEM NEEDS

Recognition                  Service  
Responsibility                Independance  
Self-confidence

## 3. SOCIAL NEEDS

Love                      Acceptance                  Belonging  
Friendship                Family

## 2 SECURITY NEEDS

Economic certainty          Prevention of injury  
Safety

## 1. PHYSICAL NEEDS

Food                      Water                      Air                      Shelter

---

**WORK is done when you consciously try to satisfy your own needs and to satisfy other people's needs**

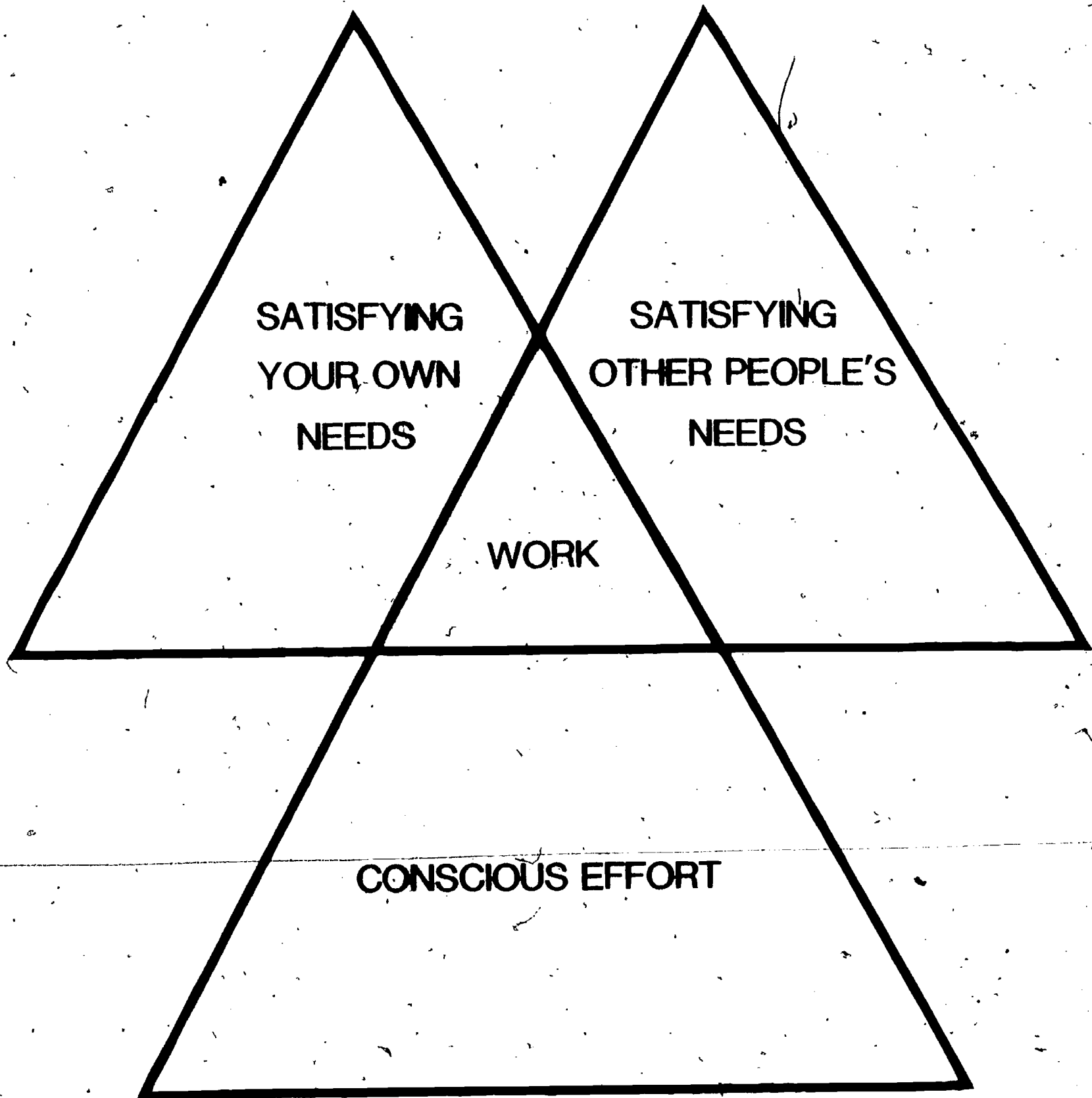

# IS THIS WORK?

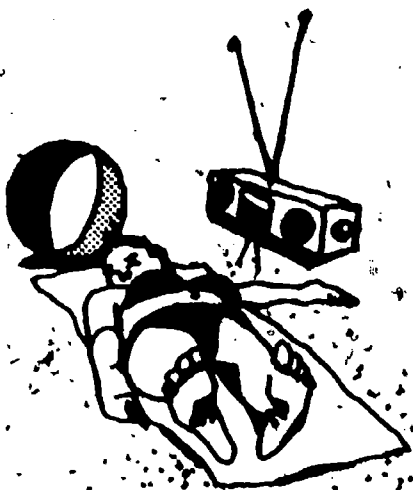

# LIFESTYLE

Leisure activities



Family



Spiritual well-being



Friends



Profession



# THE CHANGING PATTERN OF ADULT CONCERNS AND TIME ALLOTMENT

AGE 18-25

35-45

55-65

80

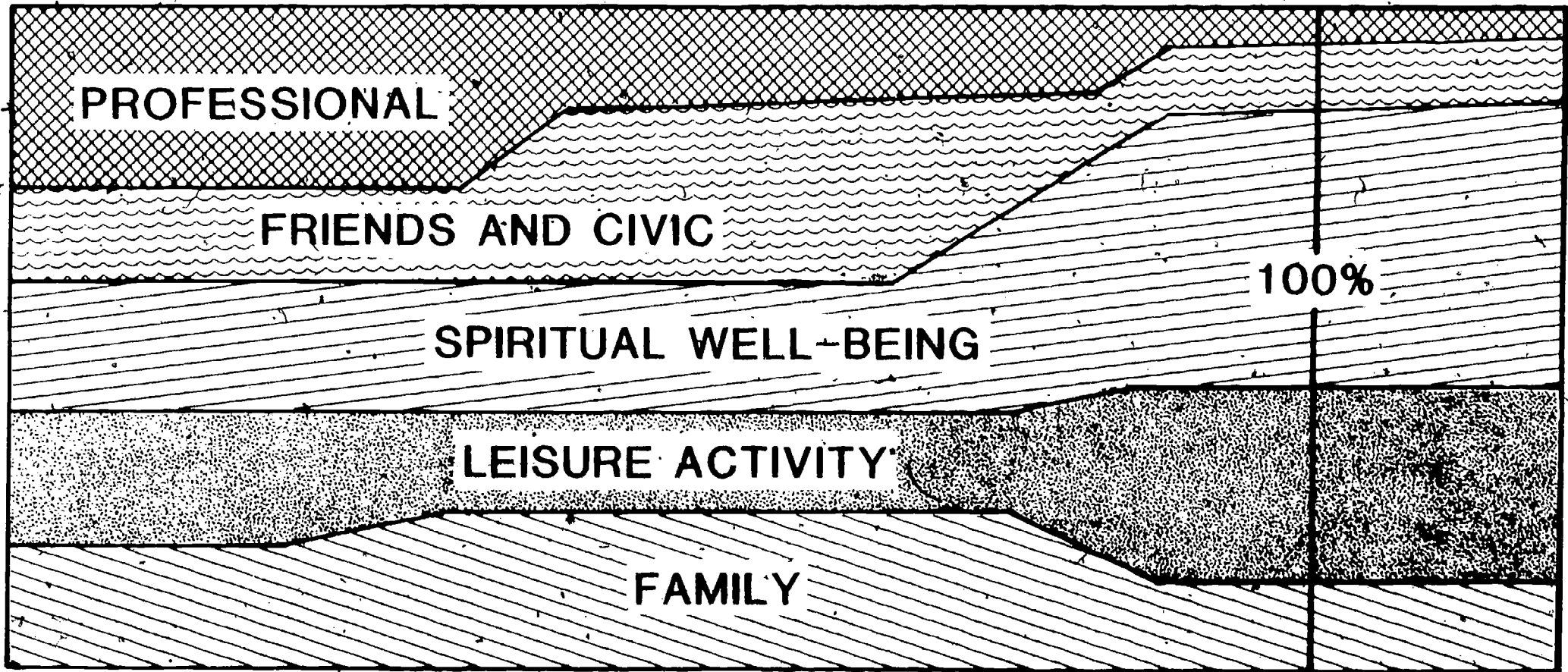

---

## Sources for Locating Jobs

1. Newspapers – classified advertisement section
2. Magazines or trade journals and publications
3. Local labor union business offices
4. Personal contacts
  - A. Friends
  - B. Relatives
  - C. Teachers
  - D. School guidance counselors
  - E. Employees of a company you are interested in
5. Placement offices
  - A. Public
  - B. Private
  - C. School
6. Employment or personnel office of company
7. Public notices – window signs in business

# HANDSHAKING

## CORRECT

1. Look the person in the eye
2. Firm grip
3. Two short up-down shakes

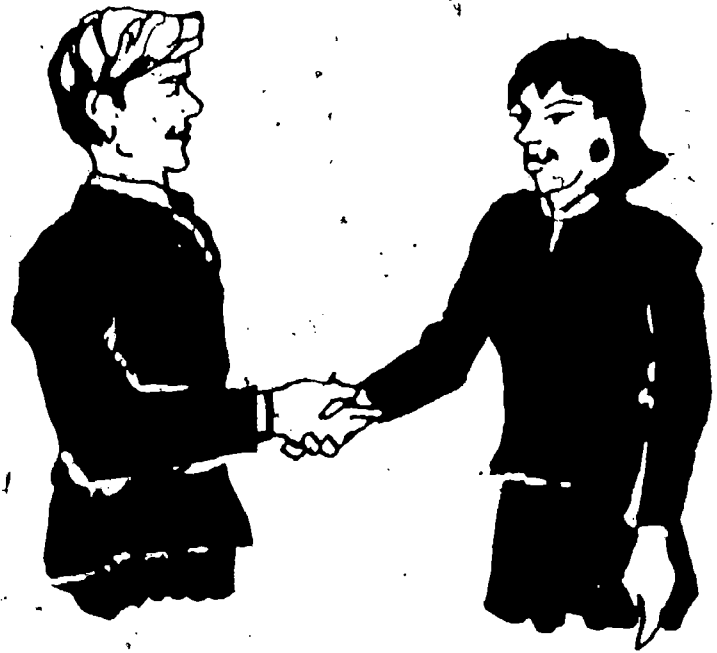

## INCORRECT



◀ The Ring-squeezer  
Bone-crusher

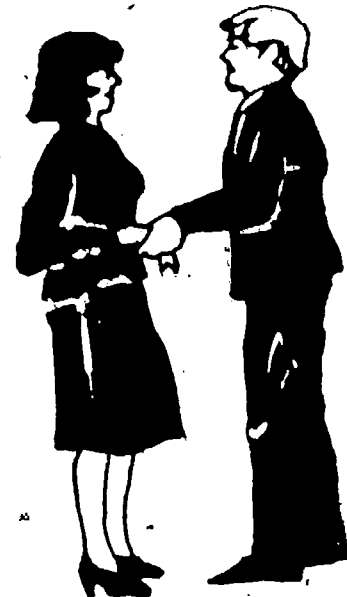

Limp- Dead-fish hand ▶



◀ Won't-let-go glued shake

Hand pump and jerker ▶





# OUT OF EVERY 10 WORKERS WHO LOSE THEIR JOBS



Do you like this arrangement of roses?

ONLY 1 LACKS TECHNICAL  
KNOWLEDGE AND SKILLS

BUT 9 DO NOT KNOW HOW  
TO GET ALONG WITH PEOPLE





TRANSPARENCY GUIDE  
DEVELOPING EMPLOYMENT SKILLS

1. Transparency--MASLOW'S Hierarchy OF HUMAN NEEDS

- A. Describe how the lower level need must be met before the individual will seek to satisfy the next level of need.
- B. Discuss the effect the hierarchy has on a person's behavior.
- C. Have students discuss how different jobs meet these needs.
- D. Read the following story to the class. Ask the class for their reaction to the story.

Smith dies and regained consciousness in the next world. He looked out over pleasant country. After resting comfortably for a while in a delightful spot, he began to get a little bored. He called out, "Is there anybody here?"

An attendant, appropriately dressed in white, appeared and said gravely, "What do you want?"

"What can I have?" asked Smith.

"Whatever you want."

"May I have something to eat?"

They brought him delicious dishes, even the things he liked best on earth. Smith was having a wonderful time eating, sleeping, and calling for more good things.

But soon he wanted something more. He called for games, and the attendants brought a huge number of them. Then he called for books and read with excitement and pleasure. He called for and received anything that struck his fancy. But at last the final boredom caught up with him, and he shouted, "I want something to DO!"

The attendant appeared and said, "I am sorry, but that is the only thing we cannot give you here."

By this time Smith was frantic for something to do and, in his terrible frustration, cried out, "I'm sick and tired of everything here, I'd rather go to the devil!"

"Where do you think you are?" asked the attendant.

\*Gregory, Marvin G. (Ed.) Bits & Pieces. Fairfield, New Jersey: The Economic Press, Inc., June 1975, Vol. 8, No. 6.

- E. As a group, consider the personal problems that can develop from unemployment.

2. Transparency--WORK

- A. Discuss each area of work illustrated in the transparency.
- B. Ask students to identify a non-work activity and describe why it does not fit into the definition of work.
- C. Have students discuss how the job of an agriculture instructor classifies as work.

3. Transparency--IS THIS WORK?

- A. Using the definition of "work" from transparency--Work, have the class determine which pictures illustrate work. Work is being done by the bell ringer, floor mopper and sales person.
- B. Discuss how each picture defines work.

4. Transparency--LIFESTYLE

- A. The people we share our activities with and the amount of time spent on each activity make up our lifestyle.
- B. Discuss each area of a person's lifestyle illustrated in the transparency. Each part of lifestyle effects the others. Careers are the central activity around which we plan our daily lives.
- C. Ask students to discuss why people have different lifestyles. Lifestyle patterns develop because of different sets of values. Each person determines their own lifestyle although some people are highly influenced by others. It is important to emphasize the students role in determining their own lifestyle.
- D. Have students sketch the lifestyle diagram on a sheet of paper making the size of each box represent the relative importance of each part of their life in their lifestyle. This activity is for their own personal development and should not be collected. After the students have completed the activity discuss how the dominance of one activity requires a sacrifice on importance of another since our time and resources are limited.

5. Transparency--THE CHANGING PATTERNS OF ADULT CONCERNS

This transparency can be used to stimulate a discussion of the affect of a person's age on their lifestyle.

6. Transparency--SOURCES FOR LOCATING JOBS

- A. Discuss the various methods that can be used to locate jobs such as personal contacts, newspaper ads, etc.

1. Local labor union business offices can provide information on apprenticeship programs.
2. Interviewing several groups of people already working for a company you are interested in helps provide information about the company.
3. Public notices located in post offices can provide information such as federal civil service jobs.

B. Placement offices provide vocational counseling, give aptitude and ability/interest tests, locate jobs, and arrange job interviews. There are three types of placement offices - public, private and school.

1. Public - supported by federal and state funds, services are free, contact State Employment Commission.
2. Private - charge for services provided usually a percentage of your beginning salary, must sign a contract before they they provide services, many specialize in only one occupational area.
3. School - high schools, trade schools, and colleges provide vocational services for their students.

#### 7. Transparency--HANDSHAKING

- A. Discuss the importance of a handshake in creating a positive first impression.
- B. Illustrate proper handshaking techniques.

#### 8. Transparency--OUT OF EVERY TEN WORKERS THAT LOSE THEIR JOBS

- A. Discuss how these factors can be improved or changed.
- B. Explain the importance of interpersonal relationships with co-workers.

TEACHER'S KEY  
SAMPLE TEST QUESTIONS  
DEVELOPING JOB SKILLS

1. Match the correct word best describing each item. Place the corresponding letter in the blank provided.

- |          |   |                          |
|----------|---|--------------------------|
| <u>D</u> | 1. Being able to say the right thing at the right time  | A. Letter of Application |
| <u>H</u> | 2. Extended feelings of depression and loss of self-esteem following unsuccessful job searching | B. Letter of Inquiry     |
| <u>C</u> | 3. Doing what one has said will be done and completing duties and assignments                   | C. Dependability         |
| <u>B</u> | 4. A correspondence to an employer asking for information concerning job openings               | D. Tact                  |
| <u>J</u> | 5. Doing things without being told  | E. Punctual              |
| <u>I</u> | 6. The combination of the five main areas of our lives  | F. Enthusiasm            |
| <u>F</u> | 7. Being eager to help or take part in something  | G. Cooperation           |
|          |   | H. Rejection Shock       |
|          |   | I. Lifestyle             |
|          |   | J. Initiative            |

2. Select five personal attributes or attitudes that employers look for.

- |          |    |                                 |
|----------|----|---------------------------------|
| <u>A</u> | 1. | A. Alertness                    |
| <u>C</u> | 2. | B. Long wavy hair               |
| <u>D</u> | 3. | C. Dedication and dependability |
| <u>F</u> | 4. | D. Enthusiasm and interest      |
| <u>G</u> | 5. | E. New car                      |
|          |    | F. Honesty and integrity        |
|          |    | G. Desire to work               |
|          |    | H. Beard                        |
|          |    | I. Flashy clothes               |

3. List four sources of job leads.

- a. newspapers and magazines
- b. state employment office
- c. personal contacts
- d. teacher, school counselor

4. List two reasons why people work.

a. to fulfill needs for physical survival

safety; security

social contact

develop self-respect and self-esteem

self realization

5. Who determines a person's lifestyle?

each person

6. List the complete word for the want ad abbreviation in the blank provided.

a. exp = experience

b. incl = including

c. nec = necessary

d. exc = excellent

e. req = required

f. trnees = trainees

g. emp div = employment division

7. List 3 mechanical characteristics of a good resume or data sheet.

a. \_\_\_\_\_

b. see Information Sheet #2

c. \_\_\_\_\_

8. List 4 items of information to include in a resume or data sheet.

a. name and address

b. career objective

c. education and related course work

d. work experience and technical skills

activities and awards

references

9. List two questions you might ask at a job interview.

- a. see Information Sheet #1
- b. \_\_\_\_\_

10. List three items of information you should learn about a company before an interview.

- a. name and address of the company
- b. name of personnel manager  
company's product  
company demand or future  
recent company growth

11. Circle the correct response to each item.

- True    False    a. All resumes are the same, regardless of the job they are intended for.
- True    False    b. You should take an extra resume to an interview even if you have already sent one to the employer.
- True    False    c. You should send an employer a letter following an interview if you are no longer interested in the position.
- True    False    d. You should explain to the interviewer that your last employer was terrible to work for and expected too much of the employees.

12. Why do most people get fired from a job?

They do not know how to get along with others.

13. Who would you list for references (3).

\_\_\_\_\_  
\_\_\_\_\_  
\_\_\_\_\_

14. How might your behavior at school affect your employability and performance in the world of work?

15. Briefly explain the difference between a letter of inquiry and a letter of application.

A letter of inquiry is sent to obtain information concerning the company's employment needs while a letter of application is sent in specific response to a notice of a position opening.

# **UNIT B: Leadership and Citizenship**

## **PROBLEM AREA:**

- 1. Utilizing Local, State, and Federal Agricultural Agencies and Resources**

UNIT B



## UNIT B: LEADERSHIP AND CITIZENSHIP

### PROBLEM AREA: UTILIZING LOCAL, STATE, AND FEDERAL AGRICULTURAL AGENCIES AND RESOURCES

#### SUGGESTIONS TO THE TEACHER:

This problem area is designed to provide students with a brief overview and exposure to some of the local, state and federal agencies which serve or influence agriculture. A problem area on rural agricultural organizations was included in the Rural Core III program as a part of Unit B. This problem area covers governmental agencies which impact on farming and other agricultural enterprises.

Many people are not aware of or do not fully utilize agricultural agencies and resources. Teachers should help high school students and adults gain an understanding of the resources available to them and how these resources affect their businesses and their daily lives.

This problem area should be taught to seniors as an introductory lesson lasting 2-3 days. Young farmers and adults should be interested in a more in-depth treatment of governmental resources and agencies because they can utilize them in their daily operations. Therefore, the in-depth instruction may well be saved for postsecondary students.

Up-to-date reference materials for this problem area can be obtained best by contacting local representatives of the agencies to be studied. This might involve students visiting the agencies which is probably the best way for them to learn about them.

#### CREDIT SOURCES:

These materials were developed through a funding agreement, R-33-24-D-0362-466, with the Illinois State Board of Education, Department of Adult, Vocational and Technical Education, Research and Development Section, 100 North First Street, Springfield, Illinois 62777. Opinions expressed in these materials do not reflect, nor should they be construed as policy or opinion of the State Board of Education or its staff.

The materials included in this problem area were prepared by Paul E. Hemp, Department of Vocational and Technical Education, University of Illinois. The following Illinois teachers of vocational agriculture reviewed the original draft and made valuable suggestions:

Jim Guilinger - Sycamore  
Reggie Grandt - Amboy  
Richard Watson - Lincolnwood

## TEACHER'S GUIDE

- I. Unit: Leadership and citizenship
- II. Problem area: Utilizing local, state, and federal agricultural agencies and resources.
- III. Objectives: At the close of this problem area students will be able to:
  1. Identify the important agricultural agencies which operate in Illinois.
  2. Classify the important agricultural agencies as local, state, federal or a combination of two or more of these levels.
  3. Describe and explain the general purposes of these agencies.
  4. Classify these agencies as a regulatory, educational, or service agency.
- IV. Suggested interest approaches:
  1. Duplicate and distribute the Student Worksheet, "What's My Name?" and have students write in names of abbreviations. Use as a pre-test. Exchange papers and see who gets the highest number correct.
  2. Ask class to name agricultural agencies they know about. List them on the chalkboard and add others which were not identified by students.
  3. Present a brief overview of the problem area. Inform class in a general way what will be discussed and explain the importance of the problem area to (a) farmers, (b) non-farm agriculturalists, and (c) citizens in general.
- V. Anticipated problems and concerns of students:
  1. What are the agricultural agencies that affect farmers and others?
  2. How do these agencies affect farmers and agribusiness groups?
  3. What are the purposes of these agencies?
  4. Which agencies operate at the federal, state, and local level?
  5. Which agencies are regulatory?
  6. Where can I get additional information about these agencies?
  7. How do these agencies affect or help non-farm people?
  8. Where are local offices located?
  9. What are the employment opportunities in these agencies and what do workers in these agencies do?

## VI. Suggested learning activities and experiences:

1. Involve the class in developing a list of questions (what they need to know) about these agencies. Presumably, this list could apply to all agencies to be studied.
2. Involve the class in the selection of those agencies which are most important to the agricultural industry in the local area. Restrict instruction to those agencies which are most important.
3. Conduct supervised study to research the study questions identified earlier. An alternative approach would be to have each student assume responsibility for learning about an agency using the Agency Report Worksheet and report back to class. If group supervised study is used, instructor must obtain reference materials from these agencies and/or other sources.
4. Take a field trip to agencies which are located nearby to have a representative of the agency talk to the class. Have students review the yellow pages of the telephone directory to identify agencies with local offices.
5. Have students read information sheets included with this problem area as a part of their supervised study.
6. Use Student Worksheets "Federal Agencies-Rules and Regulations" and "Sources of Help" as part of supervised study or for review purposes.
7. Enumerate and discuss agricultural occupations represented in the agricultural agencies studied.
8. Obtain a film from agency offices, if available, to use as a source of information.

## VII. Application procedures:

1. Some students will not be able to apply what they learn in this problem area to their own lives; however, they may pass information on to their parents who might apply it.
2. Some students may use selected agricultural organizations to get help with their S.O.E. program or FFA community service projects.
3. Check on availability of loan funds for SOE projects. If available, encourage students to consider these funds to expand their SOEP.

## VIII. Evaluation:

1. Teachers could use one or two of the student worksheets as tests or written assignments to be graded.
2. If student reports are written, they can be evaluated and graded.

3. No sample test questions were prepared for this problem area because the required subject matter content was not clearly delineated and identified.

IX. References and aids:

1. VAS Unit 2027b "Sources of Farm Credit" has some information on Federal Land Banks, Production Credit Association and Farmers Home Administration.
2. Directory of Services, Illinois Department of Agriculture, Springfield, Illinois.
3. Reference material and films can be obtained from local or branch offices of some of the agricultural agencies. Since these agencies are predominantly governmental bodies designed to serve the public, representatives are usually very willing to meet with school groups or furnish informational material.
4. Utilize ASCS office personnel and other agency representatives as resource people to speak to the class or to assist with contests such as land-use, public speaking or farm management.

INFORMATION SHEET #1

PRODUCTION CREDIT ASSOCIATION

Program Title

Production Credit Association (PCA).

Purpose

Provides short- and intermediate-term credit for qualified farmers.

Description

Production Credit Associations were created by Congress in 1933. They are cooperative organizations designed to provide short-term or intermediate-term credit for qualified farmers. Farmers who obtain credit must own \$5 worth of Class B capital stock for each \$100 borrowed. This ownership of stock qualifies members to vote on business of the association including the election of a board of directors.

Loans are approved by a committee consisting of two directors and the manager or president. Loan money is obtained from the Federal Intermediate Credit Bank through the sale of farmers' notes. The Federal Intermediate Credit Bank acts as a wholesaler of credit, using farmers' notes as collateral for debentures which are sold to investors in the money markets throughout the country. This enables farmers to obtain credit on reasonable terms.

Information Contacts

Production Credit Association has both central and branch offices in Illinois. Central offices are located in the following cities or towns:

Northwest Illinois PCA - Freeport  
Northeast Illinois PCA - Woodstock  
Fox Valley PCA - Morris  
Kewanee PCA - Kewanee  
Western Illinois PCA - Monmouth  
Bloomington PCA - Bloomington  
First PCA - Champaign  
Vermilion County PCA - Danville  
Prairie PCA - Decatur  
Illini PCA - Carlinville  
Mississippi Valley PCA - Pittsfield  
Charleston PCA - Charleston  
Wabash PCA - Lawrenceville  
Southern Illinois PCA - Harrisburg

In addition, branch PCA offices are located in most, but not all, counties. Local telephone directories can be used to identify these branch offices.

## INFORMATION SHEET #2

### AGRICULTURAL STABILIZATION AND CONSERVATION SERVICE

#### Program Title

Agricultural Stabilization and Conservation Service (ASCS), Department of Agriculture

#### Purposes

1. To improve and stabilize farm income.
2. To assist in bringing about a better balance between supply and demand of commodities.
3. To assist farmers in the orderly marketing of their crops.

#### Description

The ASCS administers specified commodity and related land use programs designed for voluntary production adjustment, resource protection, and price, market, and farm income stabilization. Price support loans are offered to producers. If market prices fail to rise above support prices, producers can pay off the loan through forfeiture of collateral. If market prices rise above support, producers can pay off their loan and market their commodity. Eligible commodities are feed grains, wheat, rice, rye, soybeans, honey, upland cotton, extra-long staple cotton, dairy products, peanuts, and tobacco. Landlords, owners, tenants, or sharecroppers who meet program requirements are eligible to apply for support. In 1983, the payment-in-kind (PIK) program was offered to producers who participated in crop acreage reduction.

In addition to commodity loans and purchases, ASCS offers programs in areas such as emergency conservation of farmlands and water, storage facilities and equipment loans, agricultural conservation programs (ACP), grain reserve programs, and rural clean water program.

#### Information Contacts

ASCS is a federal agency in the United States Department of Agriculture. An Illinois state office is located in Springfield and county offices are located in each county of the state.



## INFORMATION SHEET #3

### FEDERAL LAND BANK\*

#### Program Title

Federal Land Bank Association

#### Purpose

To provide farm families with financing tailored to meet their unique credit needs at the best possible terms and the lowest cost consistent with sound business practices.

#### Description

The Federal Land Bank System was established in 1917. Originally funded by the federal government, the Land Bank System, which is comprised of 12 district Federal Land Banks and over 500 local Federal Land Bank Associations, has repaid all government monies and is not part of the federal government. It is a cooperative, entirely owned and controlled by those who borrow from it.

The Land Bank offers long-term credit to finance the purchase of land, construction and repair of buildings, improvement of farm property, or the purchase or construction of rural homes. Owners of farm related businesses may also be eligible for loans to finance business sites or structures.

Land bank loans are made for terms ranging from 5 to 40 years. The Land Bank obtains the money it loans through the sale of securities to investors in the nation's money market. Each farm loan requires a stock purchase in the association equal to 5% of the loan. This stock purchase provides membership in the association and voting rights in the election of the association's directors.

#### Information Contacts

The St. Louis Farm Credit District serves Arkansas, Illinois, and Missouri. Illinois is divided into 17 districts or associations. Central offices for these associations are located in the following towns:

Belleville  
Bloomington  
Carrollton  
Champaign  
Danville  
Decatur  
DeKalb  
Dixon  
Effingham

Hillsboro  
Kewanee  
Macomb  
Monmouth  
Morris  
Mt. Vernon  
Pittsfield  
Springfield

In addition branch offices and outlying offices are located in most counties which do not have a central office.

\*Information has been taken from brochures furnished by the Champaign Office of the Federal Land Bank.

## INFORMATION SHEET #4

### FARMERS HOME ADMINISTRATION

#### Program Title

Farmers Home Administration (FmHA), Department of Agriculture.

#### Purpose

Provides credit for farm and non-farm enterprises for those rural Americans who are unable to obtain credit from other sources at reasonable rates and terms.

#### Description

Examples of federal loans or grants offered by the Farmers Home Administration include emergency loans to farm operators, housing loans and grants to provide low-rent housing to domestic farm laborers, loans to operators of not larger than family farms, farm ownership loans, and resource conservation and development loans. The Catalog of Federal Domestic Assistance lists 13 other areas or programs which are eligible for assistance from the Farmers Home Administration. In order to obtain FmHA loans, borrowers must submit a farm and home plan acceptable to the FmHA and agree to operate under the supervision of the FmHA.

#### Information Contacts

The FmHA is a federal agency located in the United States Department of Agriculture. State FmHA offices are located in each state and county offices are located in each county as a general rule. The state office for Illinois is located in Champaign. Consult the local telephone directory or contact the state office for location of the county offices.



## INFORMATION SHEET #5

### COOPERATIVE EXTENSION SERVICE

#### Program Title

Cooperative Extension Service, Department of Agriculture

#### Purposes

1. To help people and communities identify and solve their farm, home, and community problems through the practical application of research findings of USDA and the Land-Grant Colleges and Universities.
2. To provide educational programs based upon local needs in the broad fields of (a) agricultural production and marketing, (b) rural development, (c) home economics, and (d) youth development.

#### Description

Funding is provided for land-grant institutions which, through state and county extension service personnel, provide educational and technical assistance to (1) farmers, producers, and marketing firms on how to apply new technical developments emanating from agricultural research; (2) community organizations to develop natural, economic, and human resources; (3) homemakers and youth in the areas of food and nutrition, home management, family economics, child development, and parent education; and (4) 4-H youth in the areas of leadership development and career guidance through work projects, demonstration projects, camping, and achievement programs.

#### Information Contacts

The Cooperative Extension Service is administered at the federal level in the Department of Agriculture. At the state level, it is administered through the land-grant university (University of Illinois). Extension personnel are located in each county; for the most part, usually in the county seat. County extension offices have a supply of extension circulars and leaflets which can be obtained for instructional purposes.

## INFORMATION SHEET #6

### FEDERAL CROP INSURANCE CORPORATION

#### Program Title

Federal Crop Insurance Corporation, Department of Agriculture.

#### Purpose

To improve economic stability of agriculture through a sound system of crop insurance by providing all-risk insurance for individual farmers to assure a basic income against droughts, freezes, insects, and other natural causes of disastrous crop losses.

#### Description

Insurance is available on crops in 3000 agricultural counties in 49 states. The following Illinois crops may be covered: apples, beans, combined crops, corn, forage crops, oats, soybeans, sweetcorn, and wheat. To encourage participation, the Federal Crop Insurance Corporation will pay up to 30% of each producer's premium.

#### Information Contacts

The FCIC is a federal agency in the United States Department of Agriculture. Regional offices are located in 18 states. One of the regional offices is located at 320 W. Washington Street, Springfield, Illinois.

## INFORMATION SHEET #7

### SOIL CONSERVATION SERVICE

#### Program Title

Soil Conservation Service, Department of Agriculture

#### Purpose

Develops and carries out a national soil and water conservation program in cooperation with landowners, operators, and other land users and developers, community planning agencies, and regional resource groups, federal, state and local government agencies; also assists in agricultural pollution control, environmental improvement, and rural community development.

#### Description

The Soil Conservation Service operates 11 programs in the conservation area. Technical assistance is provided to individuals and groups in planning and applying soil and water conservation practices and treatment; and furnishing technical soil and water conservation resource information to units of government. Other program areas include soil surveys, watershed protection and flood prevention, river basin surveys, and rural abandoned mine program.

#### Information Contacts

In addition to the headquarters office in Washington, D.C., state offices are located in all states. The SCS state office for Illinois is located in Champaign.

## INFORMATION SHEET #8

### ILLINOIS DEPARTMENT OF AGRICULTURE

The Illinois Department of Agriculture was established in 1855. Its responsibilities, functions and services are in the areas of marketing, transportation, food quality, animal health, research, industry regulation, soil and water conservation, farm energy development, and information/education. The Department headquarters are located at the Illinois State Fairgrounds in Springfield.

The Department is organized with the following divisions:

- Division of Administrative Services
- Division of Marketing
- Division of Agricultural Industry Regulation
- Division of Meat, Poultry and Livestock Inspection
- Division of Natural Resources
- Division of Fairs and Horse Racing

Services, responsibilities, and functions of the last five divisions listed above are outlined in this Information Sheet and taken from the "Directory of Services" printed by the Illinois Department of Agriculture.

### DIVISION OF MARKETING

#### Bureau of Agricultural Statistics

\*Responsible for the Agricultural Statistics Act, the Dairy Statistics Act and U.S. laws relating to crop reporting and agricultural statistics.

\*Services include disseminating information on crops, livestock, prices and related agricultural items.

#### Bureau of Market Development and Information

\*Market News Section is responsible for gathering and dissemination of grain and livestock market prices.

\*Market Services Section provides assistance in the areas of direct marketing, promotion, research, and works with commodity and farm groups.

\*International Trade Section assists Illinois firms in developing international markets for Illinois agricultural products.

\*Alternate Fuels Section disseminates information, assists in development of research, and promotes the development of alcohol and alternate fuels.

### DIVISION OF AGRICULTURAL INDUSTRY REGULATION

#### Bureau of Warehouses

\*Responsible for the Public Grain Warehouse and Warehouse Stores for Food Act; Alcoholic Liquors, Drug and Cosmetics Act; Personal Property Warehouse Act; Agricultural Cooperative Act; and the Grain Dealer's Act.

\*Services include grain dealer's licensing, grain warehouse licensing, personal property warehouse licensing, grain dealers and grain warehouse examination.

#### Bureau of Plant and Apiary Protection

\*Responsible for Insect Pest and Plant Disease Act; Bees and Apiaries Act; Noxious Weed Law; Economic Poison Act, and Acts dealing with pesticide use and licensing users.

\*Services include the registration and inspection of apiaries, certification and inspection of all nurseries and greenhouses, registration of nursery stock dealers, licensing of pesticide users, inspection and certification of plant material destined for markets outside Illinois, response to pesticide incidents and complaints, and coordination of state responsibilities relative to Federal Insecticide, Fungicide and Rodenticide Act. (FIFRA).

#### Bureau of Products Inspection and Standards

\*Responsible for the Weights and Measures Act; Fair Package and Labeling Act; Commercial Feed Law; Commercial Fertilizer Act; Seed Law; Egg and Egg Products Act; and Rules and Regulations relating to the Storage and Handling of Anhydrous Ammonia.

\*Services include the testing of all meters that dispense petroleum products, issuing seed permits, and granting egg licenses.

#### Bureau of Laboratories

\*Provides analytical services in the administration of the Weights and Measures Act; Commercial Feed Law; Commercial Fertilizer Act; State Economic Poison Law; and the Seed Law.

\*Provides chemical analysis of feeds, fertilizers, and some pesticides.

\*Performs seed purity and germination analysis.

\*Responsible for calibration of weights and measures.

### DIVISION OF MEAT, POULTRY, AND LIVESTOCK INSPECTION

#### Bureau of Animal Health

\*Responsible for programs aimed at control or eradication of swine and bovine brucellosis, bovine tuberculosis, cattle scabies, scrapie in sheep, pseudorabies, equine viral encephalitides, various poultry diseases, etc.

\*Administers these Acts: Livestock Dealer and Feeder Swine Dealer Licensing, Diseased Animals, Bull Leasing, Livestock Auction Market, Bovine Tuberculosis Eradication, Swine Disease Control and Eradication, Bovine and Swine Brucellosis Eradication, Hatcheries, Poultry Flocks, etc., Milk and Cream Testers, and Slaughter Livestock Buyers.

\*Services include registration of slaughter livestock buyers, licensing of bull lessors, feeder swine dealers, livestock dealers, livestock auction markets, swine herd validation as brucellosis-free and qualification as pseudorabies negative, bovine brucellosis-free herd certification, goat brucellosis-free herd certification, and tuberculosis-free herd accreditation, and technical advice on animal health problems.

### Bureau of Animal Welfare

\*Administers these Acts: Animal Welfare, Humane Care for Animals, Dead Animal Disposal, Loading Platforms for Collection of Dead Animals, Law Relative to Slaughter and Use of Horse Meat, Brand Act, Domestic Animals Running at Large, Act to Prohibit the Keeping of Certain Animals and Reptiles, Refrigerated Warehouses and Act to Prohibit the Feeding of Garbage to Swine, other Animals or Poultry.

\*Services include general supervision of the administration of the animal control act and county animal programs, licensing of pet shop operators, dog dealers, kennel operators, cattery operators, pounds, and animal shelters, supervision of the slaughtering of horses and sale or use of horse meat, licensing of inedible rendering plants and issuance of permits for trucks which transport dead animals and/or inedible products and permits to remove inedible meat products, and to provide technical advice.

### Bureau of Diagnostic Laboratories

\*Responsible for laboratory services in support of animal health, animal welfare, and meat and poultry inspection programs.

\*Serves to assist the animal owner, via his or her veterinarian, with disease diagnosis.

\*Monitors incidence of animal diseases.

### Bureau of Meat and Poultry Inspection

\*Administers the Meat and Poultry Inspection Act and the Humane Slaughter of Livestock Act.

\*Services include inspection of meat and poultry slaughtered and/or processed in Illinois and sold to restaurants, hotels, retailers, and consumers, development of standards for new products, provide laboratory analysis of meat and/or poultry products from licensed establishments.

## DIVISION OF NATURAL RESOURCES

### Bureau of Farmland Protection

\*Maintains responsibility for working with state agencies in implementing the Governor's Executive Order on Farmland Protection.

\*Provides technical assistance to local units of government in developing programs for farmland protection.

\*Reviews state development projects for compliance with the Governor's Executive Order on Farmland Protection.

\*Conducts a public information program on the importance of and the need for farmland protection.



### Bureau of Mine Reclamation and Water Resources

- \*Works with the U.S. Army Corps of Engineers and various state and federal agencies in developing and implementing effective land treatment programs to protect existing water resources.
- \*Works with the Illinois Department of Mines and Minerals in developing the State's surface mine reclamation program.
- \*Assists the IDMM in reviewing permit applications, permits, and mining operations to insure that mined farmland is returned to its pre-mined level of productivity and to minimize the impacts of mining on agricultural resources.
- \*Develops revegetation, standards and methodologies for assessing levels of productivity.

### Bureau of Soil Conservation

- \*Coordinates a State erosion and sediment control program.
- \*Assists private and public organizations and agencies in the development of soil erosion and water quality programs.
- \*Represents the State in all matters arising from the provisions of the Soil and Water Conservation Districts Act.
- \*Assists the Soil and Water Conservation District Directors in carrying out their duties and programs.
- \*Establishes rules and procedures for district referendums, hearings, and supervising district director elections.
- \*Evaluates Soil and Water Conservation District proposed budgets and special project proposals.
- \*Provides training sessions, information, and exchange of ideas between districts.

## DIVISION OF FAIRS AND HORSE RACING

### Illinois State Fair

- \*Schedules and coordinates non-fair activities on the fairgrounds.
- \*Schedules all space rental activity for fair and non-fair events.
- \*Supervises all horse related activities on fairgrounds.
- \*Responsible for all competitive events activity for the Illinois State Fair, including livestock, arts, crafts, produce, etc.
- \*Responsible for premium payment and budgetary information related to all competitive events.

\*Responsible for all entertainment functions at the Illinois State Fair, including grandstand, free stages, and all special events.

\*Responsible for supervising all publicity and promotion for the Illinois State Fair.

\*Responsible for all administrative rules pertaining to all fair and non-fair activity at the fairgrounds.

\*Responsible for preparing and supervising all contractual activity relating to the fair.

#### Bureau of County Fairs

\*Responsible for rules, regulations and procedures governing state financial assistance to agricultural and industrial fairs.

\*Services include financial assistance to County Fairs, 4-H Clubs, Exposition Authorities, Mid-Continent Livestock Exposition, and Vocational Agricultural Section Fairs.

#### Bureau of Horse Racing

\*Responsible for administration of the Horse Racing Act, qualifying stallions for Illinois breeding, registering foals, establishing conditions and minimum purses for State Fair Colt Stake races.

\*Services include breeders awards, state fair races, pari-mutual races, county fair races for standardbreds and breeder awards, purse supplements, stallion owner awards, stake races and "race-a-day" for thoroughbreds.



STUDENT WORKSHEET #1

WHAT'S MY NAME?

Agricultural agencies and legislation are commonly referred to by an abbreviation of their correct title. List the name of each of the following.

SCS \_\_\_\_\_

ASCS \_\_\_\_\_

FHA \_\_\_\_\_

OSHA \_\_\_\_\_

FDA \_\_\_\_\_

USDA \_\_\_\_\_

EPA \_\_\_\_\_

FCC \_\_\_\_\_

ICC \_\_\_\_\_

FT \_\_\_\_\_

CES \_\_\_\_\_

PCA \_\_\_\_\_

FLB \_\_\_\_\_

REA \_\_\_\_\_

CCC \_\_\_\_\_

## STUDENT WORKSHEET #2

### AGENCY REPORT

Each student should select an agency or resource which affects agriculture or provides services to agriculture and do an in-depth study of that agency or resource. Visit the agency or write for information if necessary. Answer the following questions.

1. Name of agency \_\_\_\_\_

2. Does agency operate at national, state or local level? \_\_\_\_\_

3. Does it function as a regulatory agency, a service agency or an educational resource? \_\_\_\_\_

4. What does the agency do? \_\_\_\_\_

5. What groups or individuals are affected or benefitted by this agency? \_\_\_\_\_

STUDENT WORKSHEET #3

FEDERAL AGENCIES--RULES AND REGULATIONS

Government agencies enforce rules and regulations which affect farmers and agribusiness firms. Through library research and/or class discussions, identify and record three rules and regulations which each of the following agencies enforce.

<u>Agency</u>	<u>Rules and Regulations</u>
Food and Drug Administration	1. _____ 2. _____ 3. _____
Environmental Protection Agency	1. _____ 2. _____ 3. _____
National Labor Relations Board	1. _____ 2. _____ 3. _____
Federal Communications Commission	1. _____ 2. _____ 3. _____
Interstate Commerce Commission	1. _____ 2. _____ 3. _____
Bureau of Animal Welfare in Illinois Department of Agriculture	1. _____ 2. _____ 3. _____

Division of Agricultural Industry  
Regulation in Illinois Department  
of Agriculture

1. \_\_\_\_\_
2. \_\_\_\_\_
3. \_\_\_\_\_

## STUDENT WORKSHEET #4

### SOURCES OF HELP

<u>Problem or Need</u>	<u>Agency to Contact</u>
1. Farmer needs a short-term loan to finance a feeding operation.	_____
2. Member of adult class wants more information on price support loans.	_____
3. Vocational agriculture student wants a free bulletin or circular on grain marketing	_____
4. Credit is needed to build housing for domestic farm workers	_____
5. Students want information about organizing a 4-H club	_____
6. Farm operator needs crop insurance	_____
7. Young farmer needs help in implementing soil conserving practices	_____
8. Ag. business person needs information on using two-way radios in business	_____
9. Livestock feeder suspects contamination in feed he has purchased	_____
10. Pesticide applicator needs more information on regulations regarding disposal of chemical containers	_____
11. Elevator operator needs someone to check grain scales	_____
12. Union suspects violations of federal minimum wage laws	_____
13. Local citizen wants to contact agency responsible for Noxious Weed Law	_____
14. Need information on conduct of county fairs	_____
15. Agency in charge of horse racing	_____

TEACHER'S KEY

STUDENT WORKSHEET #1

WHAT'S MY NAME?

Agricultural agencies and legislation are commonly referred to by an abbreviation of their correct title. List the name of each of the following.

- SCS Soil Conservation Services
- ASCS Agricultural Stabilization and Conservation Service
- FHA Farmers Home Administration
- OSHA Occupational Safety Health Act
- FDA Food and Drug Administration
- USDA United States Department of Agriculture
- EPA Environmental Protection Agency
- FCC Federal Communications Commission
- ICC Interstate Commerce Commission
- FTC Federal Trade Commission
- CES Cooperative Extension Service
- PCA Production Credit Association
- FLB Federal Land Bank
- REA Rural Electrification Administration
- CCC Commodity Credit Corporation

TEACHER'S KEY (SAMPLE)

STUDENT WORKSHEET #2

AGENCY REPORT

Each student should select an agency or resource which affects agriculture or provides services to agriculture and do an in-depth study of that agency or resource. Visit the agency or write for information if necessary. Answer the following questions.

1. Name of agency Cooperative Extension Service
2. Does agency operate at national, state or local level? all three levels
3. Does it function as a regulatory agency, a service agency or an educational resource? educational agency
4. What does the agency do? Helps people and communities identify and solve their farm, home and community problems. Helps people apply and implement research findings from land grant university research stations and experiment farms. Provides educational programs and services to youth and adults in agriculture, home economics, youth development and rural living. Sponsors 4-H programs.
5. What groups or individuals are affected or benefitted by this agency? All persons could benefit. Farmers are often the main group of clients; however, city people can use these services too. Both youth and adults are served.



## TEACHER'S KEY

### STUDENT WORKSHEET #3

#### FEDERAL AGENCIES--RULES AND REGULATIONS

Government agencies enforce rules and regulations which affect farmers and agribusiness firms. Through library research and/or class discussions, identify and record three rules and regulations which each of the following agencies enforce.

<u>Agency</u>	<u>Rules and Regulations</u>
Food and Drug Administration	1. <u>Labeling of animal drug products</u> 2. <u>Correct mixing of drugs in feed</u> 3. <u>License to sell certain drugs</u>
Environmental Protection Agency	1. <u>Disposal of chemical containers</u> 2. <u>Record of sales of chemicals</u> 3. <u>Runoff control</u>
National Labor Relations Board	1. <u>Compliance with minimum wage</u> 2. <u>Workmen's Compensation insurance</u> 3. <u>Grievance procedures-employees</u>
Federal Communications Commission	1. <u>Use of two-way radios</u> 2. <u>Clearance to use channels</u> 3. <u>Licensing of employees for two-way radio use</u>
Interstate Commerce Commission	1. <u>Permits to haul through states</u> 2. <u>Licensing of grain-hauling units</u> 3. <u>Bonded to protect shippers</u>
Bureau of Animal Welfare in Illinois Department of Agriculture	1. <u>Licensing of pet shop operators</u> 2. <u>Supervising slaughter of horses</u> 3. <u>Issue permits for truckers hauling dead animals</u>

Division of Agricultural Industry  
Regulation in Illinois Department  
of Agriculture

1. Test all meters that dispense petroleum products
2. Seed purity and germination analysis
3. Certification of nurseries

TEACHER'S KEY  
STUDENT WORKSHEET #4  
SOURCES OF HELP

<u>Problem or Need</u>	<u>Agency to Contact</u>
1. Farmer needs a short-term loan to finance a feeding operation	<u>Production Credit Association</u>
2. Member of adult class wants more information on price support loans.	<u>ASCS</u>
3. Vocational agriculture student wants a free bulletin or circular on grain marketing	<u>Cooperative Extension Service</u>
4. Credit is needed to build housing for domestic farm workers	<u>Farmers Home Administration</u>
5. Students want information about organizing a 4-H club	<u>Cooperative Extension Service</u>
6. Farm operator needs crop insurance	<u>Federal Crop Insurance Corp.</u>
7. Young farmer needs help in implementing soil conserving practices	<u>Soil Conservation Service</u>
8. Ag. business person needs information on using two-way radios in business	<u>Illinois Dept. of Agr.</u>
9. Livestock feeder suspects contamination in feed he has purchased	<u>Illinois Dept. of Agr.</u>
10. Pesticide applicator needs more information on regulations regarding disposal of chemical containers	<u>Environmental Protection Agency</u>
11. Elevator operator needs someone to check grain scales	<u>Illinois Dept. of Agr.</u>
12. Union suspects violations of federal minimum wage laws	<u>National Labor Relations Board</u>
13. Local citizen wants to contact agency responsible for Noxious Weed Law	<u>Illinois Dept. of Agr.</u>
14. Need information on conduct of county fairs	<u>Illinois Dept. of Agr.</u>
15. Agency in charge of horse racing	<u>Illinois Dept. of Agr.</u>

# **UNIT C: Supervised Occupational Experience**

## **PROBLEM AREAS:**

- 1. Developing S.O.E. Programs for Non-traditional Students**
- 2. Evaluating S.O.E. Programs and Setting Future Directions**

## UNIT C: SUPERVISED OCCUPATIONAL EXPERIENCE

### PROBLEM AREA: DEVELOPING S.O.E. PROGRAMS FOR NON-TRADITIONAL STUDENTS

#### SUGGESTIONS TO THE TEACHER:

This problem area is designed to provide assistance to teachers who are teaching non-traditional or non-farm students about opportunities for S.O.E. programs. The S.O.E. problem areas included in Core I, II, and III were based primarily on traditional S.O.E. programs which students who had available land or livestock production facilities could conduct. An increasing number of vocational agriculture students do not have access to the physical resources required for traditional S.O.E. programs or are interested in conducting programs which are more closely related to their non-farm occupational goals. This problem area includes some basic information for the following S.O.E. areas:

1. Placement programs
2. Non-traditional projects
3. School-based projects
4. Group projects.

The primary purpose of this problem area is to broaden students' vision of what an S.O.E. program can be. In this way the S.O.E. concept can better serve the diverse student groups currently enrolled in high school vocational agriculture programs.

The recommended time for teaching Core IV problem areas is the senior year; however, this problem area may be more timely during the junior year or earlier for some classes. If non-traditional S.O.E. programs are seen as an addition to a basic, traditional S.O.E. program, then, instruction could be given at the junior or senior level. The problem area should be scheduled for 3-4 days in early September. Teachers should order the film "Bridging the Gap" a month or more ahead of the time it is to be used.

#### CREDIT SOURCES:

These materials were developed through a funding agreement, R-33-24-D-0362-466, with the Illinois State Board of Education, Department of Adult, Vocational and Technical Education, Research and Development Section, 100 North First Street, Springfield, Illinois 62777. Opinions expressed in these materials do not reflect, nor should they be construed as policy or opinion of the State Board of Education or its staff.

The materials included in this problem area were prepared by Paul E. Hemp, Department of Vocational and Technical Education, University of Illinois. Some of the materials were adapted from the Handbook-Supervised Occupational Experience developed by the National FFA Foundation through a special grant from the DeKalb Ag Research, Inc. of DeKalb, Illinois. Information sheets describing non-traditional projects were prepared from information furnished by vocational agriculture students enrolled in Illinois schools. Students were identified through a teacher survey conducted in 1983.

..The following teachers reviewed the original draft of this problem area and made valuable suggestions:

James Craft  
Douglas Schwartzkopf

## TEACHER'S GUIDE

- I. Unit: Supervised occupational experience
- II. Problem area: Developing S.O.E. programs for non-traditional students
- III. Objectives: At the close of this problem area students will:
  1. Be aware of the S.O.E. program opportunities available to them.
  2. Understand how non-traditional S.O.E. projects can be used to supplement traditional S.O.E. projects.
  3. Be able to select and plan an S.O.E. program which is related to their occupational and educational goals.
- IV. Suggested interest approaches:
  1. Have students briefly summarize the status of their S.O.E. programs with oral reports.
  2. Review definition and purposes of S.O.E. programs using transparencies included on pp. 17-22 in Core I.
  3. Survey class to find out how many students have a part-time job or are interested in working in an agricultural business.
  4. Help students to evaluate their progress in developing a strong S.O.E. program by raising the following questions:
    - a. Why haven't the S.O.E. programs in our school been expanded more?
    - b. What are some ways to expand our S.O.E. programs?
  5. Define a non-traditional S.O.E. program or project. Explain why such projects or programs should be considered.
- V. Anticipated problems and concerns of students:
  1. What are some examples of non-traditional production projects?
  2. What are some group projects that could be carried out by the class or through the FFA?
  3. What are some S.O.E. projects that could be carried out on school grounds or in the greenhouse?
  4. Does a part-time job qualify as an S.O.E. program? Why or under what conditions?
  5. Where can I get help in starting a non-traditional project?



6. How can a record book be modified to fit a non-traditional project?
7. How do you decide what project to have?
8. Does the FFA do anything to promote S.O.E. programs that are new or different? If so, what does the local chapter do?
9. Should a senior start a new project if he or she is planning to leave home next year?
10. What requirements must be met in order for a placement program to qualify for credit?
11. What do the following terms mean?
  - a. entrepreneurship
  - b. school-based S.O.E.P.
  - c. placement experience
  - d. training station
  - e. training agreement
  - f. training plan
  - g. group project
  - h. production project
  - i. improvement project
  - j. supplementary agricultural skills
12. What steps should be followed in starting a new enterprise or ownership project?

VI. Suggested learning activities and experiences:

1. Define the problem area by giving students a brief description of what is involved. Explain that the problem area will be useful to all students even though it is directed primarily towards the non-farm group.
2. Relate the experiences you have had as a teacher in trying to develop and promote broad S.O.E. programs. Mention problems some of your former students had in developing S.O.E. programs.
3. Lead class in a discussion to identify objectives for this problem area. Use the lead question "What should we try to accomplish by discussing this problem area?" or "What goals should we set for this problem area?"
4. Lead class in a problem identification exercise. Write students' problems and concerns on the chalkboard or on a transparency.
5. Show the film "Bridging the Gap" available from Venard Films Ltd. Use the film order card included with this problem area to schedule the film.



6. After viewing the film, have students complete the Student Worksheet on "Bridging the Gap." Summarize their responses and present a summary later in the week.
7. Use problem list developed by students and add additional problems as needed (see Section V). Re-order and group problems into the following four main areas to be covered in this problem area:
  - a. Placement programs
  - b. Non-traditional projects
  - c. School-based projects
  - d. Group projects.
8. Use Information Sheets included with this problem area as a source of information to work out solutions to problems.
9. Have each student read one or more of the Student Information Sheets on non-traditional projects and present a brief summary report to the class.
10. Explain school requirements for placement programs. Review forms included with this problem area and explain how students might be involved in this type of S.O.E.
11. Have students read and discuss S.O.E. Case Studies on pp. 14-16 of the Handbook--Supervised Occupational Experience.
12. Have each student develop one or more plans for becoming involved in a non-traditional project, a placement program, a group project sponsored by the FFA or a school-based S.O.E. program.
13. Distribute copies of Illinois Supervised Employment Experience Record Book in Agricultural Occupations available from Interstate Printers and Publishers, Inc., Danville, Illinois. Review training agreement and training plan forms with class.
14. Use Slidefilm 1112, Supervised Occupational Experience Programs to bring out main points or answer questions raised in this problem area.

VII. Application procedures:

1. Use this problem area to stimulate expansion of S.O.E. programs and to encourage students to become involved in new and different projects or activities.
2. Have a class representative meet with the FFA executive committee and/or with the agriculture advisory committee to explore ways that these groups might help students expand their S.O.E. programs.

3. Have each student develop an implementation plan to apply what was learned in this problem area to his or her S.O.E.P.

#### VIII. Evaluation

1. No pencil and paper tests are recommended for this problem area.
2. Evaluation of student progress should be based on an assessment of changes in S.O.E.P.'s.

#### IX. References and aids:

1. Handbook--Supervised Occupational Experience available from the National Supply Service, National FFA Center, 5632 Mt. Vernon Memorial Highway, P.O. Box 15160, Alexandria, Virginia 22309.
2. Illinois +Supervised Employment Experience Record Book in Agricultural Occupations available from Interstate Printers and Publishers, Danville, Illinois 61832.
3. Slidefilm 1112, Supervised Occupational Experience available from Vocational Agriculture Service, 1401 South Maryland Drive, Urbana, Illinois 61801.
4. Film, Bridging the Gap, available on a loan basis from Venard Films Ltd., Box 132, Peoria, Illinois 61654.
5. Materials provided with this problem area include transparency sheets, information sheets, and student worksheets.

INFORMATION SHEET #1

DIRECTIONS FOR ORDERING FILM

"Bridging The Gap" is a 16mm film designed for use in orienting students of vocational agriculture and their parents to the development of effective supervised occupational experience programs.

The film is available on a free-loan basis courtesy of the Agricultural Division of CIBA-Geigy, the Special Project Sponsor of the National FFA Foundation who also funded the development of the S.O.E. film. To reserve a copy of the film, write:

Venard Films Ltd.  
Box 1332  
Peoria, IL 61654

Film Order Card

"Bridging The Gap"

Supervised Occupational Experience

Please send our chapter a copy of the 16 mm film "Bridging The Gap." We plan to use the S.O.E. film on: \_\_\_\_\_ Our alternative date is: \_\_\_\_\_ Please ship the film to: (Please Print)

\_\_\_\_\_ c/o \_\_\_\_\_  
(Chapter Name) (Advisor)

\_\_\_\_\_ (School)

\_\_\_\_\_ (Address)

\_\_\_\_\_ (City or Town) \_\_\_\_\_ (State) \_\_\_\_\_ (Zip)

-----

"Bridging The Gap"

Supervised Occupational Experience

Please send our chapter a copy of the 16 mm film "Bridging The Gap." We plan to use the S.O.E. film on: \_\_\_\_\_ Our alternative date is: \_\_\_\_\_ Please ship the film to: (Please Print)

\_\_\_\_\_ c/o \_\_\_\_\_  
(Chapter Name) (Advisor)

\_\_\_\_\_ (School)

\_\_\_\_\_ (Address)

\_\_\_\_\_ (City or Town) (State) (Zip)

## INFORMATION SHEET #2

### S.O.E. GLOSSARY

1. Entrepreneurship - the act of organizing, managing and assuming the risks of a business or enterprise.
2. School-based S.O.E.P. - a supervised occupational experience project or activity conducted at school or on school grounds under the supervision of the teacher.
3. Placement experience - a type of S.O.E. in which students work for other people, typically on farms or ranches, or in agribusinesses.
4. Training station - the location where a student carries out a placement program, as in a farm machinery dealership.
5. Training agreement - a written S.O.E. agreement involving the student, parent and employer giving the responsibilities of each.
6. Training plan - a written document involving the student, teacher and employer describing the competencies to be developed and duration of the experience.
7. Group project - a S.O.E. project operated and managed by two or more students.
8. Production project - the common crops or livestock produced on farms. An example is beef cattle. The term also applies to production of plants or animals in other settings, such as laboratory animals and bedding plants.
9. Improvement project - a series of learning activities that improves the value or appearance of the place of employment, home, school or community; the efficiency of an enterprise or agribusiness; or the living conditions of the family.
10. Supplementary agricultural skills - jobs or practices performed to improve the student's occupational competence.

## INFORMATION SHEET #3

### S.O.E.P. POINT AWARD SYSTEM\*

**Objective** To encourage and recognize students who conducted successful supervised occupational experience programs as part of their vocational agriculture instructional program.

**Rules:** The selection is based on a point system which measures the relative value of each S.O.E. related achievement.

**Recognition:** All students completing a planned supervised occupational experience program earning 500 points or more will receive a framed certificate. In addition, the following individual awards will be presented:

- Top Freshman--FFA Ring
- Top Sophomore--FFA Belt Buckle
- Top Junior--FFA Certificate & Tie Bar
- Top Senior--FFA Desk Pen Set

All awards will be presented at the annual parent/member banquet.

ITEM	POINTS	AWARDED
1. For each enterprise completed		
a. Ownership (Production and/or Agribusiness) (Maximum of 6)	100	_____
b. Placement (Production and/or Agribusiness) (Maximum of 2)	300	_____
c. School-Based (Maximum of 2)	300	_____
2. For each \$50 invested in an enterprise	2	_____
3. For each \$100 labor income (student's)	2	_____
4. For each 10 hours of labor	2	_____
5. For each improvement project completed (Maximum of 6)	50	_____
6. For each supplementary agricultural skill (Maximum of 6)	25	_____
7. For each continuation enterprise 1st year (Maximum of 6)	10	_____
8. For each continuation enterprise 2nd year (Maximum of 6)	15	_____

ITEM	POINTS	AWARDED
9. For each continuation enterprise 3rd year (Maximum of 6)	20	_____
10. For each continuation enterprise 4th year (Maximum of 6)	25	_____
11. For each exhibit at FFA Sectional Fair (Maximum of 3)	10	_____
12. For participating in any Proficiency award at the chapter level (Maximum of 2)	10	_____
13. For participating in a local judging contest (Maximum of 2)	2	_____
14. For each piece of farm equipment repaired or agricultural items completed in the vo-ag shop (Maximum of 4)	3	_____
TOTAL POINTS EARNED:		_____

\*Adapted from material in the Handbook--Supervised Occupational Experience, National FFA Foundation.



## INFORMATION SHEET #4

### PLACEMENT PROGRAMS

What is a placement program?

A placement program is a type of S.O.E. which involves the placement of a student in a job situation usually as a paid employee. In rural communities, students may be placed in jobs for pay after school, on weekends, and during the summer. In some schools, school-released time for a total of 15 hours per week is used for placement. Such programs are often referred to as cooperative vocational education.

Which type of placement program is best?

Neither type is best for all students or all situations. Agricultural students cannot always meet the time requirements for cooperative vocational education or may not have access to such a program in their school. Placement programs which are not subject to cooperative education requirements offer more flexibility to the student and the teacher.

What are some examples of placement programs?

1. Small engine and equipment repairer
2. Agricultural mechanic's helper
3. Set-up person
4. Fertilizer and seed worker
5. Feed and seed business employee
6. Landscape aide
7. Groundskeeper
8. Florist's aide
9. Lumberyard or hardware store employee
10. Produce worker

How can a student get started with a placement program?

If cooperative vocational education is offered, a student can enroll in this course and follow the procedures outlined by the cooperative education coordinator.

Another way to get started is for the student to plan a placement program through his or her regular vocational agriculture class. Such a program would not have to meet cooperative vocational education requirements but could serve as the student's S.O.E.P.



## INFORMATION SHEET #5

### NON-TRADITIONAL PROJECTS

What is a non-traditional project?

A non-traditional project is different from the typical S.O.E. projects commonly conducted by vocational agriculture students. Traditional projects usually involve the production of crops and/or livestock popular in the state. For example, in Illinois, corn, soybeans, swine, and beef cattle are common, traditional projects.

Why should non-traditional projects be considered as possible S.O.E. projects?

Some students do not have the land or facilities to grow corn or soybeans or to raise swine or beef cattle. Some students are interested in areas of agriculture which do not involve these traditional areas of production.

What are some examples of non-traditional projects conducted by vocational agriculture students?

#### Strawberries

Ross McCullough of the Windsor FFA Chapter has a half acre of strawberries for his S.O.E. project. His grandfather helped him get started with 1000 Guardian plants. The project now includes Earliglow, Redchief and Guardian plants. Customers may pick their own fruit or buy directly from the owners. Ross keeps records in the Fruit or Vegetable Production Record Book available from Vocational Agriculture Service, University of Illinois. Mr. Glenn Sims is the vocational agriculture teacher at Windsor High School.

#### Pheasants

Aaron Gigl goes to Central High School, Clifton, Illinois. His vocational agriculture teacher is Mr. Dennis Sorenson. Aaron raises pheasants to turn loose to add to the pheasant population in his area. In other words, his project is conducted to benefit wildlife rather than to make a profit. Aaron has plans to build three cages to start quail in during the coming year. His S.O.E. project records are kept in the Fish and Wildlife Record Book.

#### Italian Bees

Rodney Neuendorf goes to Lewistown High School where he studies vocational agriculture under Mr. Steve Myers. Rodney has 14 hives of honey bees and sells honey to local customers. He estimates that the cost of getting started in this type of S.O.E. project would be approximately \$200 for one hive of bees.

#### Bird Dogs

Chuck Cooper, Windsor FFA Chapter, has a dog project. He and his family breed, raise, train and sell about 150 dogs per year. Chuck spends approximately 35 hours per week on this project and keeps records in the regular Production Record Book.

### Placement at a Marina

Kirk Devore lives in Oquawka, Illinois and works at a marina doing mechanical work, boat cleaning and test driving. His S.O.E. project is classified as Outdoor Recreation and his records are kept in the Outdoor Recreation Record Book. Kirk spends approximately 15 hours per week on his project during the school year and works full-time at the marina in the summer. His vocational agriculture teacher is Mr. Tom Faulkner.

### Trapping

Travis Gass, Windsor High School, has an S.O.E. project which involves hunting and trapping fur-bearing animals. He has 18 traps and sells furs to the Shelbyville Fur Market. Records are kept in the Fish and Wildlife Management Record Book.

### Carpentry

Scott Pritchard goes to Erie High School where Mr. Alan Pickens is the vocational agriculture teacher. Scott's S.O.E. project is primarily refinishing work; however, he also builds projects for people. Scott has approximately \$1000 invested in tools and keeps his records in the Agricultural Mechanics Record Book.

### Draft Horses

Brian Maxwell, Farmer City-Mansfield High School, has five Belgian mares for his S.O.E. project. He sells young stock at horse sales and keeps part of the foals to increase the size of his enterprise. Mr. Gene Elliott is the vocational agriculture teacher at Farmer City-Mansfield High School.

### Pet and Plant Care

Krista Warren has an S.O.E. project which involves taking care of other people's pets and plants while they are on vacation. She keeps records in the Illinois Supervised Employment Experience record book. Krista goes to Windsor High School and her vocational agriculture teacher is Mr. Glenn Sims.

### Quail

Doug Thompson is involved in a quail project with his father. He has 115 live birds at the present time. Doug sells eggs and birds to his friends and relatives and releases birds to restock areas where he hunts. He keeps records in the Fish and Wildlife Management Book but is considering the Live-stock Specialty record book as a possible alternative. Doug is a vocational agriculture student at Windsor High School.

### Auctioneering

John Wieseman is a student at Bismarck High School. His agriculture teacher is Mr. Earl Lindsey. In 1983, John took an Auctioneer Course at the Reppert School of Auctioneering in Decatur, Indiana. He works for other auctioneers and also conducts auctions of his own. His project is classified as a self-employment project. John spends 8-10 hours per week on

his S.O.E. project and plans to open an auction barn and obtain a real estate license when he finishes high school.

## INFORMATION SHEET #6

### SCHOOL-BASED PROJECTS

What is a school-based project?

A school-based S.O.E. project is one that is conducted at school or on the school grounds under the supervision of the vocational agriculture teacher. These projects may be group projects or they may be conducted by individual students.

What are some examples of school-based projects?

#### Group Projects

1. Growing and selling horticultural crops on school grounds.
2. Broiler production
3. Feeding steers or market hogs and marketing them.
4. Growing and selling a crop of lilies, mums or bedding plants.

#### Individual Projects

1. Employing a student as a teacher's aide or as a worker on the school farm.
2. Dividing school land into small plots for students to use in growing a garden.
3. Dividing benches in the greenhouse to enable students to manage and control their own growing space.
4. Employing students during summer months to maintain the land laboratory or school greenhouse.

Why are school-based projects important and necessary?

An increasing number of students do not have facilities to conduct an S.O.E. program at home. Schools need to have facilities available to accommodate these students.

## INFORMATION SHEET #7

### GROUP PROJECTS

What is a group project?

A group project is a supervised occupational experience project conducted by a group such as a vocational agriculture class or the FFA chapter. Usually, group projects are conducted as a supplement to individual projects and not as a substitute for them.

What are some examples of group projects?

Examples of group projects which might be conducted by high school students are as follows:

1. Production of a crop such as corn, soybeans, vegetables, poinsettias, or bedding plants.
2. Operation of a school farm, land laboratory, school nursery, or greenhouse on a cooperative basis.
3. Operation of a cooperative to mix and sell livestock feed, construct and sell agricultural equipment or product, or produce and sell an agriculture crop.
4. Operation of an agricultural business such as a produce stand.
5. Operation of a plant rental service.

What are some advantages of group projects?

1. Provide additional learning opportunities.
2. Help students to learn how to work with others.
3. Provide opportunities for earning money.
4. Enable students to conduct certain S.O.E. activities which they could not do on their own.
5. Provide problems for instruction.
6. Serve as community demonstration or as a public relations project.

INFORMATION SHEET #8

TRAINING AGREEMENT

The training agreement reproduced below is taken from the Handbook-- Supervised Occupational Experience published by the National FFA Center. Another version of a training agreement commonly used in Illinois is included in the Illinois Supervised Employment Experience Record Book available from Interstate Printers and Publishers, Danville, Illinois.

To provide a basis of understanding and to promote sound business relationships, this agreement is established on \_\_\_\_\_, 19\_\_\_\_\_. Placement will begin on \_\_\_\_\_, 19\_\_\_\_ and will end on or about \_\_\_\_\_, 19\_\_\_\_\_ unless the arrangement becomes unsatisfactory to either party.

Name of agribusiness/farm \_\_\_\_\_

Name of supervisor \_\_\_\_\_

The usual working hours will be as follows:

While attending school \_\_\_\_\_

When not attending school \_\_\_\_\_

Provision for overtime \_\_\_\_\_

Liability insurance coverage (type and amount) \_\_\_\_\_

Length of trial period and wage rate \_\_\_\_\_

Wage rate for the remainder of agreement period \_\_\_\_\_

Frequency of payment \_\_\_\_\_

It is understood that the employer will:

Provide the student with opportunities to learn how to do well as many jobs as possible, with particular reference to those contained in their placement plans.

Instruct the student in ways of doing his/her work and handling his/her management problems.

Help the teacher make an honest appraisal of the student's performance.

Avoid subjecting the student to unnecessary hazards.

Notify the parent and the teacher immediately in case of accident of sickness and if any other serious problem arises.

Assign the student new responsibilities in keeping with his/her progress.

Cooperate with the teacher in arranging a conference with the student on supervisory visits.

Other (Include all other points that the employer will have the responsibility to provide on a separate sheet).

The student agrees to:

Do an honest day's work.

Keep the employer's interest in mind; be punctual, dependable and loyal.

Follow instructions, avoid unsafe acts and be alert to unsafe conditions.

Be courteous and considerate of the employer.

Keep records of occupational experience and make required reports.

Achieve competencies indicated in placement plan.

Other (in case there are additional student responsibilities, they should be included on a separate sheet).

The teacher, in behalf of the school, agrees to:

Check and approve the placement center.

Provide a copy of the agreement to the school and employer.

Schedule class instruction to prepare students for occupational experience.

Visit the student on the job at frequent intervals for the purpose of instruction and to insure that the student gets the most education out of the experience.

Show discretion at the time and circumstances of these visits, especially when the work is pressing.

Assist the student in obtaining a work permit and developing a placement plan.

Other (Additional teacher responsibilities should be added on a separate sheet).

The parents agree to:

Assist in promoting the value of the student's experience by cooperating with the employer and teacher.

Satisfy themselves in regard to the living and working conditions made available to the student.



Assist in providing transportation to and from the placement center according to work schedule.

Other (Additional items agreed to by the parents should be included on a separate sheet).

All parties agree to:

An initial trial period of \_\_\_\_\_ working days to allow the student to adjust to the job.

Discuss the issues with the teacher before ending employment.

Other (list on separate sheet).

STUDENT \_\_\_\_\_  
(Signature)

Address \_\_\_\_\_

Social Security No. \_\_\_\_\_

Tel. No. \_\_\_\_\_

Date of Birth \_\_\_\_\_ Age \_\_\_\_\_

EMPLOYER \_\_\_\_\_  
(Signature)

Address \_\_\_\_\_

Tel. No. \_\_\_\_\_

TEACHER \_\_\_\_\_  
(Signature)

Address \_\_\_\_\_

Tel. No. \_\_\_\_\_ School Tel. No. \_\_\_\_\_

PARENT \_\_\_\_\_  
(Signature)

Address \_\_\_\_\_

Tel. No. \_\_\_\_\_



INFORMATION SHEET #9

SAMPLE TRAINING PLAN

Name of Student: \_\_\_\_\_ Teacher's Name: \_\_\_\_\_

Student's Occupational Objective: \_\_\_\_\_

Beginning Date: \_\_\_\_\_ Ending Date: \_\_\_\_\_

S.O.E. Training Station: \_\_\_\_\_

Experiences/Competencies	Date Accomplished	School-Related Instruction	Check When Done

## STUDENT WORKSHEET #1

### BRIDGING THE GAP\*

Part I. I have just reviewed the film "Bridging The Gap." Here are my thoughts about an S.O.E. program as it involves me.

1. Right now I'm interested in a career in: (Rank 1-2-3 Choice)  
 a. Production Agriculture  
 b. Ag Sales and/or Service  
 c. Ag Mechanics  
 d. Ag Processing  
 e. Horticulture  
 f. Forestry  
 g. Natural Resources  
 h. Professional Agriculture
2. I think my best opportunities for a career might be in \_\_\_\_\_  
(a-b-c etc. above)
3. At this time I am in this stage of development of my own SOE program.  
 a. Exploring  
 b. Planning  
 c. Getting started  
 d. Conducting my program  
 e. Replanning my program  
 f. Expanding my program
4. I expect benefits from my S.O.E. program to be mostly in terms of: (Rank 1-2-3 etc.)  
 a. New skills & abilities learned  
 b. Money earned  
 c. Ability to plan, make decisions and keep records  
 d. Personal satisfaction  
 e. Receiving recognition and awards provided by FFA
5. I believe that my S.O.E. program will be of help to me because I will: (Check any of the following with which you agree.)  
 a. Learn to work with others  
 b. Develop leadership skills  
 c. Earn money to make a start  
 d. Learn about money management  
 e. Experience decision making  
 f. Become informed about possible careers
6. While I know that the responsibility for my S.O.E. program rests with me, I feel that I will need help from (check one or more)  
 a. My parents  
 b. My ag teacher  
 c. School counselor  
 d. My employer  
 e. Brothers, sisters, other relatives  
 f. Others, identify \_\_\_\_\_

Part II. My implementation plans are as follows:

7. Two years from now this is what I hope to have going in my S.O.E. program:  
\_\_\_\_\_  
\_\_\_\_\_  
\_\_\_\_\_

8. In the film "Bridging the Gap" I saw students in S.O.E. programs that interested me. They include: (Example: Person working in greenhouse)

---

---

---

---

9. How can your S.O.E. program be used to receive recognition provided by the FFA?

---

---

---

---

\*Taken from Handbook--Supervised Occupational Experience, National FFA Foundation.

## **CHARACTERISTICS OF A GOOD PLACEMENT PROGRAM**

- 1. Prepares student for an occupation.**
- 2. Develops human relations skills.**
- 3. Develops job skills**
- 4. Includes a variety of tasks.**
- 5. Promotes growth on the job.**
- 6. Meets legal requirements**
- 7. Relates to instruction at school.**
- 8. Properly supervised.**
- 9. Provides record-keeping experience.**
- 10. Utilizes cooperative arrangements.**

## UNIT C: SUPERVISED OCCUPATIONAL EXPERIENCE

### PROBLEM AREA: EVALUATING S.O.E. PROGRAMS AND SETTING FUTURE DIRECTIONS

#### SUGGESTIONS TO THE TEACHER:

This problem area is designed primarily for seniors and should be taught early in the school year. Instruction in this area can be limited to 3-4 days; however, the inclusion of at least one S.O.E. problem area in each year of vocational agriculture is important and necessary to maintain student interest in S.O.E. programs and to reinforce the concept that S.O.E. is an integral part of vocational agriculture.

The problem area can be divided into the following parts:

1. Evaluation of S.O.E. programs
2. Expansion of S.O.E. programs
3. Savings and investment of money earned in S.O.E. programs.
4. Record keeping review

This instructional area should be related to and taught immediately after the problems areas in the Orientation Unit of Core IV.

#### CREDIT SOURCES:

The materials included in this problem area were developed through a funding agreement, R-33-24-D-0362-466, with the Illinois State Board of Education, Department of Adult, Vocational and Technical Education, Research and Development Section, 100 North First Street, Springfield, Illinois 62777. Opinions expressed in these materials do not reflect, nor should they be construed as policy or opinion of the State Board of Education or its staff.

The teacher's guide, student worksheets, information sheets, transparency discussion guide, and test questions were developed by Paul E. Hemp, Department of Vocational and Technical Education, University of Illinois. Transparency masters were prepared by Vocational Agriculture Service, University of Illinois. Suggestions and guidance in the development of these materials were provided by the following vocational Agriculture teachers:

Charles Harn - Spoon River Valley High School  
Reggie Grandt - Amboy High School  
Clarence Tipton - Serena High School

## TEACHER'S GUIDE

- I. Unit: Supervised occupational experience.
- II. Problem area: Evaluating S.O.E. programs and setting future directions.
- III. Objectives: At the close of this problem area students will be able to:
  1. Evaluate their S.O.E. programs using the eight factors listed in this problem area.
  2. Identify the factors to consider in deciding whether or not to expand an S.O.E. programs during the senior year.
  3. Present to the class a proposed plan for what they want to do after high school.
  4. Replan their S.O.E. programs based on their post-high school plans.
  5. Identify five investment opportunities and two advantages of each opportunity.
  6. Define terms included in the Investment Glossary.
- IV. Suggested interest approaches:
  1. Ask students to report on their plans for expanding their S.O.E. programs during (a) the senior year and (b) after high school.
  2. Conduct a discussion of students' plans after high school and raise questions about how these plans might affect their S.O.E. programs.
  3. Review FFA awards and degrees which call for an active S.O.E. program after high school.
  4. Define the problem area and describe, in a general way, what you plan to cover.
- V. Anticipated problems and concerns of students:
  1. What kind of S.O.E. program should I have during the senior year?
  2. Should I expand my S.O.E. program?
  3. How should I handle or manage my S.O.E. program if I go to college next year?

4. Should I retain my membership in FFA and continue my S.O.E. program after high school ?
5. Should I diversify my S.O.E. program by starting some new projects? How can this be done?
6. If I expand my S.O.E. program what records need to be kept? Should I use a different record book?
7. When will my projects end during the senior year?
8. How can I invest earnings for maximum return?
9. How is simple and compound interest calculated?
10. How do various investment opportunities differ and which type would be best for me?

VI. Suggested learning activities and experiences:

1. Conduct an interest approach using one or more of the suggested activities included in Section IV.
2. Have class members set goals for what they intend to do after high school. Anticipated goals might include the following:
  - a. Go to college
  - b. Stay home and work on the farm or in the family business
  - c. Get a job
  - d. Go to military service
3. Show and discuss the transparency on post-high school alternatives. Mark on the transparency the number of students or the names of students fitting each alternative.
4. Have students complete Student Worksheet #2 on S.O.E.P. Plans after High School.
5. Use Student Worksheet #3 on Replanning my S.O.E. Program to identify more specific plans of students:
6. Before worksheets are handed out review information on transparencies entitled "Ways to Expand or Improve a Farming Program" and "Factors to Consider in Deciding whether to Expand an S.O.E. Program."
7. Discuss the evaluation of S.O.E. programs using the transparencies included with this problem area. Point out to class that these factors can also be used to guide them in replanning their S.O.E. programs.
8. Refer to the Transparency Discussion Guide for ideas or points to discuss with each transparency.

171



9. Shift discussion to investments and savings. Explain to the class that this area is especially important to students who have surplus funds or need to save money for future use.
10. Conduct a short interest approach for this part of the problem area to shift students' attention from S.O.E. programs to savings and investments. Survey class to see how many have a savings program and what kinds of savings programs are being used.
11. Ask class to define terms included in the Investment Glossary. Correct their responses or add to them as needed.
12. Have class identify the investment opportunities available to them. Ask them to find out the rate of return, minimum investment required, and length of required investment period for each investment opportunity. This could be a out-of-class assignment.
13. Explain and discuss The Rule of 72.
14. Explain the difference between simple and compound interest and have students work sample problems.
15. Review with class the kinds of records they need to keep and review the reasons why records should be kept.

VII. Application procedures:

1. Students should be required to develop and turn in an S.O.E. program plan for the senior year or beyond.
2. As a result of this instruction students should begin a savings program or adjust their present program to maximize earnings.

VIII. Evaluation:

1. Construct and administer a test using sample questions included with this problem area.
2. Confer with each student on a home visit or at school to discuss their revised S.O.E. program plan.

IX. References and aids:

No reference material other than the items included with this problem area are needed; however, teachers may want to use materials from local banks or savings institutions for the investment area.



INFORMATION SHEET #1

INVESTMENT GLOSSARY

- INTEREST: "Rent" paid for the use of money.
- COMPOUND INTEREST: Interest paid on the interest as well as on the principal.
- YIELD: The percentage return on the original purchase price. Yield can be calculated by dividing the annual interest or dividend by the amount of the loan or purchase price of the stock.
- COMMON STOCK: Security issued by corporations representing ownership in a company. Rights to assets and dividends are subordinate to the rights of bonds and preferred stock but it has unlimited interest in profits and assets once all prior claims are met.
- PREFERRED STOCK: Stock which has prior claim on a company's earnings before the common stock. Dividends are paid at a specified rate.
- BOND: A certificate which represents money loaned to a corporation, government or municipality on which interest is paid until it becomes due at which time the face value is paid in full.
- SAVINGS BONDS: Bonds sold by the federal government. They are considered to be the safest of all bonds.
- MUNICIPAL BOND: An IOU of a town, city, county or municipal authority. These bonds pay interest which is exempt from federal income taxes.
- CERTIFICATES OF DEPOSIT: Interest bearing time deposits.

## INFORMATION SHEET #2

### INVESTMENT OPPORTUNITIES

Most vocational agriculture students earn money from ownership (production) projects or from placement-employment programs. Students who are employed through a cooperative education program or farm placement will receive wages for their work. Part of these earnings should be saved and invested in interest or dividend bearing programs. Students who have production projects may wish to "plow back" or invest their profits in the project. Others may wish to invest surplus funds in interest-bearing investments.

Even though earnings or wages received during high school years may be small, students should develop a savings program which can be used to help finance a college education or for other productive purposes. Savings and investment opportunities commonly available in most communities include the following:

- Now Account:** A checking account which pays interest of 5-5½ on money in the account. Some banks require a minimum balance of \$300 or more.
- Passbook Savings:** An account which pays interest on money deposited to it. Withdrawals and deposits can be made at any time.
- Savings Bonds:** Savings bonds issued by the United States Government which mature in 5 or more years. Interest earned on these bonds is paid when the bond is redeemed.
- Money Market Account:** An account which combines characteristics of both checking and savings accounts. The account pays a higher rate of interest than a savings account and the interest rate varies with market conditions. A limited number of checks (usually 3) can be written each month.
- Certificate of Deposit:** Interest bearing time deposits. These certificates mature in 6, 12, 18, 24, or 32 months and pay a rate which is guaranteed until maturity.
- Stocks:** Common stocks represent a share of ownership in a corporation or business. Shares of stocks may be bought and sold through a stock exchange. Prices vary and dividends, if paid, are subject to fluctuation.

### INFORMATION SHEET #3

#### THE RULE OF 72

The Rule of 72 can be used to find out how long it takes to double your initial investment at various levels of interest providing that the interest is left to accumulate. If you divide the interest rate into 72 you will have the number of years required to double your money at that rate. Conversely, if you divide the number of years you want your money to double into 72, you will get the rate that must be charged or received.

1. How long will it take my money to double if it earns 8%?

$$8\% \quad \frac{72}{9 \text{ yrs}}$$

Money will double in 9 years  
if it earns 8%

in 7.2 years if it earns 10%

in 6 years if it earns 12%

2. What interest rate must I earn if I want my money to double in 9 years?

$$9 \text{ yrs} \quad \frac{72}{8\%}$$

If money must double in 9  
years it must earn 8%.

in 7.2 years it must earn 10%

in 6 years it must earn 12%



STUDENT WORKSHEET #2

S.O.E.P. PLANS AFTER HIGH SCHOOL

1. Occupational plans after high-school graduation.

First Year

Five Years after Graduation

---

---

---

---

---

---

---

---

2. Plans for my S.O.E. program. Check one or more of the following:

---

---

---

---

---

---

Sell it.

Continue program as is.

Expand it.

Continue program in a partnership.

Continue program on a reduced scale.

Other, specify \_\_\_\_\_

3. Reasons for your plans. Why did you choose the plan checked in Item 2?

---

---

---

---

4. How will you carry out the plan checked in Item 2?

---

---

---

---

---

---

## STUDENT WORKSHEET #3

### REPLANNING MY S.O.E. PROGRAM

This worksheet is designed for senior students who need to replan or revise their S.O.E. program plans for the last year of high school and beyond. Because students needs and goals change frequently during high school, S.O.E. program plans need to be reviewed and revised at the beginning of each school year. This worksheet can be used by students to record changes in their S.O.E. program plans.

<u>S.O.E. Program</u>	<u>Senior Year</u> <u>Scope</u>	<u>After High School</u> <u>Scope</u>
1. Production Projects (list)		
2. Improvement Projects (list)		
3. Agriculture Skills (list)		
4. School Projects (list)		

S.O.E. Program

Senior Year  
Scope

After High School  
Scope

Place of Employment  
and Expected Hours

Place of Employment  
and Expected Hours

5. Coop Program

6. Major Plans and Proposed Activities

---

---

---

---

---

---

---

---

Other Plans

---

---

---

---





# **FACTORS TO CONSIDER IN DECIDING WHETHER TO EXPAND AN S.O.E. PROGRAM**

1. Occupational goals
2. Plans for year after high school
  - a. Work
  - b. College
  - c. Farm
  - d. Other
3. Opportunities to expand
4. Parental support to expand
5. Need to expand or broaden the S.O.E.P.
6. Alternative uses of time

# **WAYS TO EXPAND OR IMPROVE A FARMING PROGRAM**

- 1. Increase the size of your projects**
  - a. Number of animals**
  - b. Number of acres**
  
- 2. Diversify by adding new projects**
  
- 3. Do a better job**
  - a. Become more efficient**
  - b. Use better production practices**

# **EVALUATION OF PLACEMENT PROGRAMS**

## **FACTORS TO CONSIDER**

- 1. Hours of experience**
- 2. Variety of experiences**
- 3. Wages earned**
- 4. Knowledge learned**
- 5. Skills developed**
- 6. Personal development**
- 7. Adequate records**
- 8. Relevant to occupational goal**

# **EVALUATION OF PRODUCTION PROJECTS**

## **FACTORS TO CONSIDER**

- 1. Size of the project**
- 2. Growth and expansion**
- 3. Profit**
- 4. Adapted to home farm or community**
- 5. Relevant to occupational goal**
- 6. Approved practices used**
- 7. Learning experience**
- 8. Adequate records**

---

# POST-HIGH SCHOOL ALTERNATIVES

1. Full-time student
2. Part-time student and part-time work
3. Full-time off farm job in agriculture
4. Full-time non-agricultural job
5. Self-employed farmer
6. Farming in partnership
7. Working on a farm
8. Operating an agricultural business

# **REASONS FOR KEEPING AGRICULTURAL BUSINESS RECORDS**

- 1. To determine profit or loss**
- 2. To observe financial progress over a period of years**
- 3. To determine which enterprises are profitable**
- 4. To provide a basis for sound management decisions**
- 5. To furnish information for income tax returns**
- 6. To provide information for FFA degree advancement  
and FFA award programs**

## TRANSPARENCY DISCUSSION GUIDE

### EVALUATING S.O.E. PROGRAMS AND SETTING FUTURE DIRECTIONS

#### I. Transparency -- FACTORS TO CONSIDER IN DECIDING WHETHER TO EXPAND AN S.O.E. PROGRAM

A. Occupational Goals - S.O.E. programs are intended to serve as learning activities to help students learn those occupational skills and knowledge which cannot be learned in the classroom. If your S.O.E. program is closely related to your occupational goal it should be expanded or at least continued. If your S.O.E. program is not related to your occupational goal it should be modified or expanded to make it more relevant.

1. "How many of you feel that your S.O.E. program is closely related to your occupational goal?"
2. "How can the rest of you adjust your S.O.E. program to bring it in line with your occupational goals?"

B. Plans for Year after High School - Work, College, Farm, Other.

1. "How many of you fit into each category?"
2. "Will your plans for next year affect the kind of S.O.E. program you will have this year?" "How?"

C. Opportunities to Expand - Some students may not be able to expand their S.O.E. programs because they lack facilities, capital or time to conduct a larger program.

D. Parental Support to Expand - Most successful S.O.E. programs have developed with the full support of parents or guardians. Before you go too far in your expansion plans, you should discuss these plans with your parents.

E. Need to Expand or Broaden the S.O.E.P. - An S.O.E. project can be so small that it is not economically sound.

1. "How efficient is a project that includes only one or two animals?"
2. "What are some other reasons why S.O.E. programs should be expanded or broadened?"

F. Alternative Uses of Time - The bottom line is a decision about how you want to use your time.

1. "What would you be doing if you didn't have a S.O.E. program?"
2. "Could you make more money or learn more by doing something else?"



II. Transparency: WAYS TO EXPAND OR IMPROVE A FARMING PROGRAM.

- A. Increase The Size Of Your Projects - One way to expand the size of your projects is to raise more animals or grow more acres of crops. This is known as increasing your volume. It usually calls for an increase in labor input, capital or land.
- B. Diversify By Adding New Projects - Another way to expand is to start some new projects and to keep the ones you already have. This calls for more inputs but should result in increasing your experience and learning. Diversification is important if you feel that your present S.O.E. program is not preparing you for your future occupation.
- C. Do A Better Job - It is possible to improve the quality of your S.O.E. program by doing a better job. By using more approved practices or spending more time on preparing products for the market you can expand or improve your productive enterprises.

III. Transparency: EVALUATION OF PLACEMENT PROGRAMS - FACTORS TO CONSIDER

- A. Before this transparency is shown and discussed, the teacher could have the class identify the factors to consider in the evaluation of placement programs.
- B. After students have identified some factors, show them the eight items listed in this transparency and discuss each one.
- C. Focus the discussion on those placement programs which class members are currently involved in or have completed.

IV. Transparency: EVALUATION OF PRODUCTION PROJECTS - FACTORS TO CONSIDER.

- A. Size of the Project - The largest project is not always the best project but in order to be economically efficient, it needs to be a minimum size. With some enterprises, an increase in volume will mean lower costs of production and increased profits.
- B. Growth and Expansion - An ideal production program is one that shows some growth and expansion each year. As you become more experienced and skillful, you need to assume more responsibility and increase the challenges which go along with a production enterprise.
- C. Profit - Making a profit will not ensure learning but the goal of every production project should be to realize a reasonable profit. Sometimes, we learn from our mistakes but a business which loses money year after year will not survive.

- D. Adapted to Home Farm or Community - Most production projects should involve animals or crops that are commonly grown in the community. If you produce crops not commonly grown in the community you may have trouble marketing what you raise. On the other hand, there is a place for innovation in S.O.E. programs and someone has to lead the way in trying new things.
- E. Relevant to Occupational Goal - A production project should be related to your occupational goal. If it isn't, then why does it exist as a part of your vocational agriculture course of study?
- F. Approved Practices Used - A production project should involve the use of recommended and approved practices of production and marketing. The only way we learn how to do something successfully is to practice the right way.
- G. Learning Experiences - Sometimes the profit motive interferes with the accomplishment of the real objective of an S.O.E. project, which is, to learn. The more learning value a project has the better it is.
- H. Adequate Records - All production projects should be closely monitored by a good record keeping system. Records are a required part of an S.O.E. project and are needed to support applications for FFA awards.

V. Transparency: POST-HIGH SCHOOL ALTERNATIVES

- A. Show students the transparency and ask them to add additional alternatives.
- B. Have each student or volunteers to (a) indicate which alternative they plan to follow and (2) how this plan might affect what they do with their S.O.E. programs after high school.

VI. Transparency: REASONS FOR KEEPING AGRICULTURAL BUSINESS RECORDS

- A. This transparency is taken from the Core I problem area on "Starting and Keeping S.O.E.P. Records"
- B. These reasons should be discussed in connection with a discussion of the kinds of records students need to keep during the senior year and thereafter.

## TEACHER'S KEY

### SAMPLE TEST QUESTIONS

#### EVALUATING S.O.E. PROGRAMS AND SETTING FUTURE DIRECTIONS

##### PART I. True (+) False (o)

- + 1. As a general rule, a student's S.O.E. program should increase in size or scope each year.
- + 2. A student's S.O.E. program should be related to his or her occupational goal.
- o 3. Seniors do not have to keep records on their S.O.E. program.
- + 4. Students who plan to apply for the American Farmer Degree in the future should continue their S.O.E. program.
- o 5. Money loaned on a simple interest basis will earn more than an equal amount loaned on a compound interest basis.
- o 6. Money which is loaned out at 6% compound interest will double in six years.
- + 7. Preferred stock has prior claim on company earnings before common stock.
- o 8. Passbook savings accounts usually pay a higher rate of interest than CD's.
- + 9. Yield is calculated by dividing the interest or dividends paid in one year by the amount of money invested.
- + 10. Compound interest means that interest is paid on interest as well as the principal.

##### PART II. Essay Questions

1. Name 5 factors to consider in evaluating a production project.
  - a. Size of project
  - b. Growth and expansion each year.
  - c. Profit
  - d. Adapted to home farm or community
  - e. Relevant to occupational goal.
  - f. Approved practices used
  - g. Learning experiences
  - h. Adequate records.
2. Evaluate one of your S.O.E. projects using factors listed in Question 1.
  1. Indicate how your project rates on each factor.

# **UNIT D: Livestock Science**

## **PROBLEM AREAS:**

- 1. Developing Livestock Management Skills**
- 2. Understanding and Using Artificial Insemination**
- 3. Understanding Basic Genetics and Reproduction**

## UNIT D: LIVESTOCK SCIENCE

### PROBLEM AREA: DEVELOPING LIVESTOCK MANAGEMENT SKILLS

#### SUGGESTIONS TO THE TEACHER:

This problem area is designed for use with advanced students in vocational agriculture programs. The recommended time for teaching this problem area is when students have the opportunity to practice these skills on their S.O.E. livestock program.

The estimated instructional time for this problem area is 7 to 10 days depending on how far the teacher wishes to go in developing livestock management skills. If the students are to be involved in other activity exercises, the instructional time will need to be increased.

The instructor is encouraged to conduct a local search to locate other supplementary materials for use with this problem area. The items in this problem area are for reference or modification as instructors adapt these materials to their local situation.

#### CREDIT SOURCES:

These materials were developed through a funding agreement, R-33-24-D-0362-466 with the Illinois State Board of Education, Department of Adult, Vocational and Technical Education, Research and Development Section, 100 North First Street, Springfield, Illinois 62777. Opinions expressed in these materials do not reflect, nor should they be construed as policy or opinion of the State Board of Education or its staff.

The teacher's guide, student worksheets, transparency discussion guide, and sample test questions were developed by Jerry Pepple, Department of Vocational and Technical Education, University of Illinois. The student job sheets were adapted from materials prepared by Gary Varner, Champaign County Extension Advisor and James Dickson, graduate student, University of Illinois for Votec 359A, Teaching Livestock Skills and Practices.

The artwork in this problem area was prepared by the Vocational Agriculture Service, University of Illinois. Suggestions and guidance in the development of these materials were provided by the following vocational agriculture teachers:

Earl Lindsey - Bismark High School  
Donald Miller - New Holland-Middletown High School  
Floyd Wohrley - Kewanee High School  
Jim Craft - Bluffs High School  
Steve Myers - Lewistown High School  
Richard Watson - Raymond-Lincolnwood High School  
Alan Pickens - Erie High School

## TEACHER'S GUIDE

- I. Unit: Livestock science
- II. Problem area: Developing livestock management skills
- III. Objectives: At the close of this problem area students will be able to:
  1. Perform management tasks necessary to increase the animal's chances of survival as identified through class instruction.
  2. Perform the following tasks using accepted procedures as defined through class discussion on selected animal species:
    - a. Castration
    - b. Dehorning
    - c. Intramuscular injections
    - d. Docking tails
  3. Identify and discuss the importance of performing selecting livestock management skills.
- IV. Suggested interest approaches:
  1. Have students give a definition of "Livestock Management" and name some examples of management skills which are needed when caring for cattle, swine, and/or sheep. After some lists have been developed, promote class interest by asking students to share experiences they have had in performing any of the identified skills.
  2. Have a sack or box containing tools used in performing management skills (can use pictures of large items or equipment) on your desk when students arrive for class. Avoid telling the students why the sack is there or what it contains. Begin this problem area by emphasizing the importance of proper livestock care for both economic and consumer reasons. Ask students if they know what is done to livestock to obtain the type of product consumers want. List their key points and skills as they identify them.
  3. After students have become aware that they know something about caring for livestock, have students come forward one at a time and reach in the sack and get one item. Have the student name the item and give a brief explanation of its proper use.
  4. Compile a series of slides or pictures depicting livestock which have and have not had selected management practices performed on them. Promote class discussion and questions as students view each animal. Try to identify the reason each practice is performed, such as economics, safety, or to change the characteristics of the animal.



5. As soon as students arrive in class, tell them a local livestock producer had called you and needs a selected management skill performed. Call out three students by name and tell them to gather up all the essential equipment and supplies needed to perform this skill. You should select students that are not experienced livestock producers. This should create a need or concern with the class members.
6. Have students identify possible occupations available to people who have training and knowledge in livestock management.

V. Anticipated problems and concerns of students:

1. What are some common livestock management skills for beef, swine, and sheep?
2. Why are market animals castrated?
3. What is the best age for animals to be for castration?
4. How should I prepare animals and equipment for castration?
5. What tools are used for castration?
6. What are some common methods of castration?
7. What post-operative care should I give to newly castrated animals?
8. What is "docking lambs" and why is it done?
9. Is it necessary to dock all lambs?
10. What are some common docking techniques?
11. Why are cattle dehorned?
12. What are some common methods of dehorning?
13. What factors determine which dehorning method to use?
14. Why are baby pigs given iron shots?
15. How can I tell if a baby pig needs iron injections?
16. What is meant by bolusing cattle?
17. How can I properly administer a bolus tablet to an animal?

VI. Suggested learning activities and experiences:

1. Conduct an interest approach to start students considering the types of skills necessary for proper management of livestock. Your interest approach should raise some questions and concerns about livestock management skills.

2. Have students identify the management skills they need to be able to perform to properly manage their S.O.E.P.'s. Identify selected skills the class will study and/or practice to improve their proficiency.
3. Review and select the livestock management skills which are essential for people employed by a livestock producer in the local area. Discuss some of the local techniques used to perform these skills.
4. Use filmstrips or slides to identify several of the skills needed for proper livestock management if students do not have a strong background in livestock. Briefly discuss each skill as it is identified.
5. Have students identify and select one or more management skills. Have them research and present a report to the class on their findings and conclusions. Refer to Section IX for suggested references and aids.
6. Organize and conduct management skill demonstrations using one or more of the following approaches:
  - a. Use the students' S.O.E. livestock.
  - b. Video tape the demonstration for future use.
  - c. Visit an area producer to observe the skills being performed by a professional livestock manager.
  - d. Have students perform each skill after it has been discussed and properly demonstrated.
7. Invite a resource person to class to speak on the importance of using approved procedures in performing selected management skills.
8. Use the Student Worksheets included in this problem area to assist students during their supervised study time.
9. Use the Job Sheets included in this problem area as a reference when performing management skill demonstrations.

#### VII. Application procedures:

1. Students should apply the livestock management skills studied in class to their livestock S.O.E.P.
2. Students should apply the livestock management skills to the school based livestock laboratory.



VIII. Evaluation:

1. Select appropriate questions from the sample test included with this problem area and administer to students.
2. Evaluate student reports on livestock management skills.
3. Evaluate student competency in performing assigned management skills.

IX. Reference and aids:

1. Vocational Agriculture Service, College of Agriculture, 1401 Maryland Drive, University of Illinois 61801:
  - a. VAS Unit 1032, "Castrating, Docking, and Dehorning."
  - b. VAS Unit 1037b, "Caring for the Sow and Litter at Farrowing Time."
  - c. VAS 1054, "Health Problems with the Beef Cow Herd."
  - d. Slidefilm 141a, "Shearing Sheep."
  - e. Slidefilm 144, "Blocking and Trimming Sheep."
2. Handbook of Livestock Management Techniques, by R. A. Battaglia and V. B. Mayrose, Burgess Publishing Company, 7108 Ohms Lane, Minneapolis, Minnesota 55435.
3. Livestock and Poultry Production, fifth edition, Clarence Bundy, Ronald Diggins, Virgil Christensen. Prentice-Hall, Inc. Englewood Cliffs, New Jersey.

## LIVESTOCK MANAGEMENT SKILLS

### COMPETENCY INVENTORY

1. Student has no knowledge of competency.
2. Student has read about competency.
3. Student has seen competency performed.
4. Student has performed competency.
5. Student has performed competency without supervision.
6. Student does possess skill.
7. Student does not possess skill.

Competency	Circle One				
1. Castrate calves.	1	2	3	4	5
2. Dehorn calves.	1	2	3	4	5
3. Implant calves.	1	2	3	4	5
4. Castrate pigs.	1	2	3	4	5
5. Clip needle teeth on pigs.	1	2	3	4	5
6. Give iron injections to pigs.	1	2	3	4	5
7. Castrate lambs.	1	2	3	4	5
8. Dock lambs.	1	2	3	4	5
9. Explain proper use and care of selected livestock management equipment.					6 7
10. Organize a task sheet for performing essential livestock management jobs.					6 7

These competencies are outlined in the National Ag Occupations Competency Study, 1978, for entry level positions in agriculture.

Name \_\_\_\_\_

Date \_\_\_\_\_

## STUDENT WORKSHEET #1

### CASTRATING HOGS, CATTLE, AND SHEEP

(Refer to VAS Unit 1032)

1. Why are market animals castrated?
2. Why should animals be castrated at an early age?
3. When should male hogs be castrated?
4. Why is it not necessary or advisable to apply a dressing of any kind to the wounds of pigs?
5. At what age should bull calves be castrated?
6. What seasons of the year are generally best for castration?

7. What are the commonly used methods for castrating bull calves?
8. Which method is most commonly used in this area? Why?
9. At what age should ram lambs be castrated?
10. What 2 methods are generally practiced in lamb castration?

## STUDENT WORKSHEET #2

### DOCKING LAMBS

(Refer to VAS Units 1032 and 1060)

1. What is docking lambs and why is it practiced?
2. What kinds of equipment can be used for docking?
3. How close to the body should the tail be cut?
4. How can bleeding be reduced after docking?
5. How can the wound be treated to prevent infection?

## STUDENT WORKSHEET #3

### DEHORNING CATTLE

(Refer to VAS Unit 1032 and 1010b)

1. Why are horns objectional on commercial cattle?
  
2. What are some methods cattle producers use to dehorn?
  
3. What dehorning practices are commonly used in your local area by commercial producers?
  
4. What dehorning methods are recommended on cattle in the following age groups?
  - a. 3-10 days of age -
  - b. 1-2 months of age -
  - c. over 3 months of age -
  
5. How should the wounds be treated to reduce bleeding and chances of infection?

STUDENT JOB SHEET #1  
CASTRATING BABY PIGS

Objective:

The student will be able to castrate one to three week old pigs successfully following the procedures as identified in class.

Material:

Confined pigs which are 1 to 21 days of age.  
Scalpel or razor blade.  
Disinfectant and applicator.  
Warm water and soap.

Procedure:

1. Secure the baby pig in a mechanical device, or by having one person hold the pig while a second performs the operation.



2. Wash the scrotum and surrounding area with water and a mild antiseptic solution.
3. Make the incision parallel to and about  $\frac{1}{2}$  inch from the line or raphe. The incision should pass through the testicular covering into the body of the testicle itself. Cut as low as possible on the scrotum to aid in drainage.

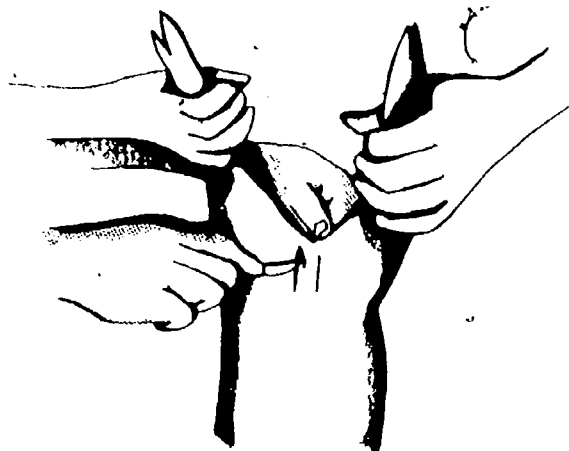

4. Slip the testicle out through its membranes and cut the attachments except the cord.
5. Turn each testicle two or three revolutions and pull the cord until it breaks and comes out.
6. Remove the second testicle in a similar manner.
7. Apply wound dressing or antiseptic to the wound. Return the pig to a clean dry pen.

Questions:

1. What kind of knife was used for this operation? \_\_\_\_\_  
What other types could be used? \_\_\_\_\_
2. Why is it best to castrate pigs before they are weaned? \_\_\_\_\_  
\_\_\_\_\_  
\_\_\_\_\_
3. Why should you not perform this operation in the same room as the sows? \_\_\_\_\_  
\_\_\_\_\_  
\_\_\_\_\_

Application:

Briefly explain how this skill can be used to benefit your S.O.E.P.



## STUDENT JOB SHEET #2

### DOCKING LAMBS

#### Objective:

The student will be able to dock one to two week old lambs successfully following the procedures as identified in class.

#### Material:

Confined lambs between one and fourteen days of age.

Docking tool (pocketknife, burdizzo, elastrator, emasculator, "all-in-one" pliers, or pruning shears).

Antiseptic solution (7% iodine solution).

Fly repellent spray.

Syringe (vaccinate for tetanus, if horses have been on farm).

Assistant or equipment to hold lamb.

#### Procedure:

##### A. Using Sharp Knife With Assistance in Holding Lamb

1. Position animal so the part of the tail where the cut is to be made is on a secure, solid foundation.
2. Push the loose skin of the tail toward the animal.
3. Locate the junction or end of the caudal folds on the underside of the tail.
4. Cut off the tail between the vertebrae using a firm slice. The stub should be between 1 and 1½ inches long.

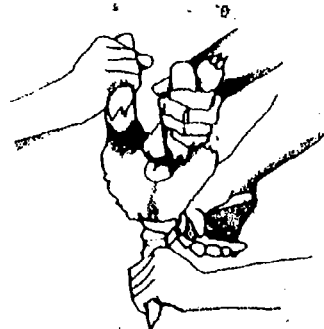
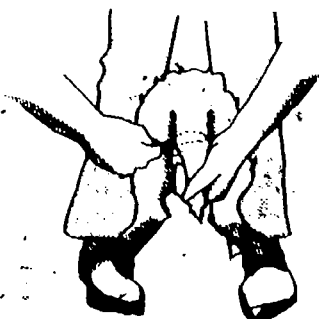

5. Apply antiseptic solution to the wound. Pull skin over end of cut so the bone is not exposed.

B. Using Emasculator With Assistance in Holding Lamb

1. Put tail through the emasculator. Have the crushing surface of the instrument toward the lamb so the blood vessels are crushed and bleeding is reduced.
2. The remaining stub should be 1 to 1½ inches long.
3. Slowly and firmly squeeze the handles of the instrument until the tail is severed. Hold instrument on dock for a few seconds till the blood starts to clot.

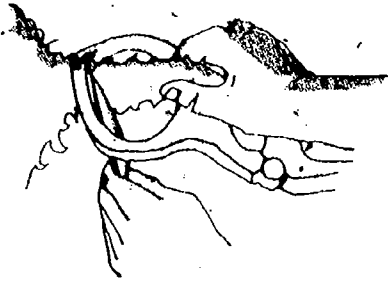

4. Apply antiseptic solution to the wound.

Questions:

1. Why are lamb tails docked? \_\_\_\_\_  
\_\_\_\_\_
2. What problems did you have in performing this skill? \_\_\_\_\_  
Why? \_\_\_\_\_
3. Which method of docking do you like best? \_\_\_\_\_ Why? \_\_\_\_\_  
\_\_\_\_\_

Conclusions: Briefly explain how these skills can be used to improve your livestock S.O.E.P.

## STUDENT JOB SHEET #3

### CLIPPING NEEDLE TEETH

#### Objective:

The student will be able to properly clip needle teeth and use the equipment described during class discussion.

#### Material:

Pen of one to three day old pigs.  
Side-cutter pliers (sharp and clean).  
Pan of disinfectant.

#### Procedure:

1. Put side-cutters in pan of disinfectant. Remove pigs from farrowing area so the sows are not excited by the pigs' squeals.
2. Hold the pig with one hand and force the mouth open with your fingers.

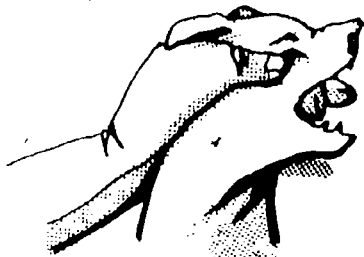

3. Position the clippers over one pair of needle teeth and remove about one-half of each tooth. Take care so you do not cut the pig's lips, gums, tongue, or your own fingers.

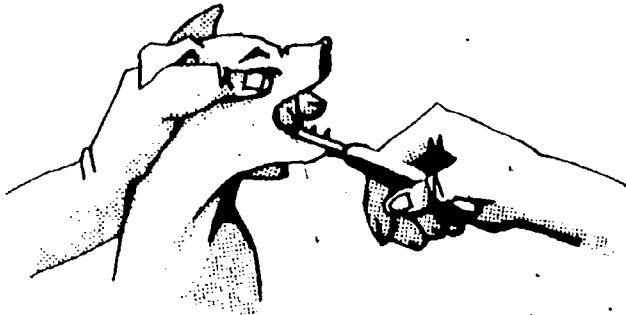

4. Clip the remaining six teeth using the same procedure.

Questions:

1. Why are needle teeth clipped on baby pigs? \_\_\_\_\_  
\_\_\_\_\_  
\_\_\_\_\_
2. How is the procedure different on the amount of tooth removed if the pigs are less than two days old as compared to more than two days of age? \_\_\_\_\_  
\_\_\_\_\_  
\_\_\_\_\_

Conclusions: Briefly explain how having this skill can improve your livestock S.O.E.P. profits.

## STUDENT JOB SHEET #4

### ADMINISTERING IRON SHOTS TO BABY PIGS

#### Objective:

The student will be able to properly demonstrate how to hold a baby pig, fill a syringe, and administer an iron injection in either the ham or neck muscle.

#### Equipment:

Pen of two to four day old pigs.  
Syringes.  
14-16 gauge needle.  
20 gauge needle,  $\frac{1}{2}$  inch long.  
Injectable iron product.  
Disinfectant and cotton balls.

#### Procedure:

1. Assemble sterilized equipment. Remove baby pigs from farrowing area so the squealing pigs will not excite the sows.
2. Read the label and product of the solution you are using. Determine the amount to inject per pig and how much solution will be loaded into the syringe. One load will generally inject a number of pigs, depending on the type of syringe you are using.
3. Warm the iron solution to body temperature because many iron solutions are thick and a warm solution would cause less discomfort to the pigs.
4. Attach 14 or 16 gauge needle to syringe. Inject small volume of air into bottle and then fill syringe by slowly pulling back on plunger.

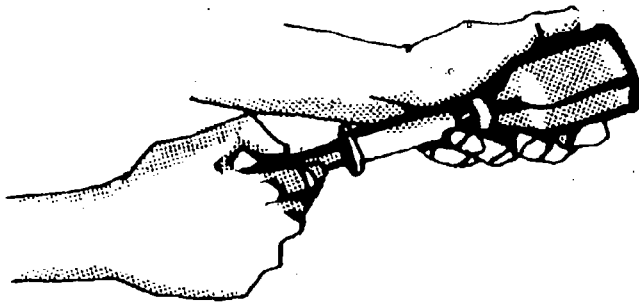

5. Leave 14 or 16 gauge needle in bottle and attach a smaller 20 gauge needle to syringe. Remove air from syringe.
6. Select an injection site and clean it with a cotton ball and disinfectant, such as denatured alcohol.

7. Insert needle into muscle and slowly inject the pre-determined amount of solution. To prevent the solution from bleeding out after the needle is removed from the muscle, pull the skin to one side before you insert the needle into the animal.

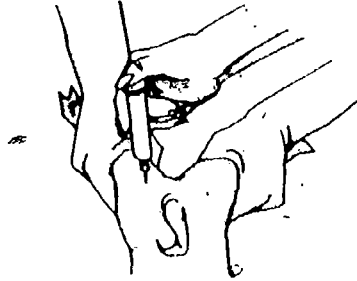

8. After a few refills, the plunger may become hard to move. If this happens, take it apart and wash it, or get a new syringe if you're using disposable plastic syringes.
9. Return the pigs to their farrowing area. Clean and sanitize all reusable equipment before storing.

Questions:

1. Why do newborn pigs need iron injections? \_\_\_\_\_  
\_\_\_\_\_  
\_\_\_\_\_
2. What criteria should you consider when deciding if you are going to inject in the ham or neck muscle? \_\_\_\_\_  
\_\_\_\_\_  
\_\_\_\_\_
3. What are the results and symptoms if confined, newborn pigs are not given iron injections? \_\_\_\_\_  
\_\_\_\_\_  
\_\_\_\_\_

Conclusions: Briefly explain how this skill can be used to benefit your livestock S.O.E.P.

TEACHER'S KEY  
STUDENT WORKSHEET #1

CASTRATING HOGS, CATTLE, AND SHEEP

(Refer to VAS Unit 1032)

1. Why are market animals castrated?

- a. To improve quality of meat.
- b. To prevent indiscriminate breeding.
- c. To prevent the development of sexual odors and flavors, which occur in the meat of the uncastrated male hog or sheep.

2. Why should animals be castrated at an early age?

- a. Less shock will be experienced by the animal.
- b. Less of the animal's development will be interrupted.
- c. The male characteristics will fail to develop and the animal will become more refined or feminine in nature.

3. When should male hogs be castrated?

Any time between a few days and a few months of age. Most breeders want the wounds entirely healed before weaning time.

4. Why is it not necessary or advisable to apply a dressing of any kind to the wounds of pigs?

It interferes with the quick healing process which usually results. The lymph and blood serum which escape at the edges of the wound contain sufficient germicidal properties to take care of ordinary exposure. Animals should be kept in a clean, dry lot or pen to watch for possible infection.

5. At what age should bull calves be castrated?

Many breeders recommend that the operation be performed when the calf is only a few days old. Generally, castration is best done when calves are from 1 to 4 months of age.

6. What seasons of the year are generally best for castration?

Spring and fall months are most favorable because of less insect and temperature stresses on the animal.

7. What are the commonly used methods for castrating bull calves?
  - a. Knife, surgical removal.
  - b. Emasculator, crushing cords.
  - c. Elastrator, banding to cut off circulation.
8. Which method is most commonly used in this area? Why?
9. At what age should ram lambs be castrated?  
Generally, when they are between 1 and 2 weeks of age.
10. What 2 methods are generally practiced in lamb castration?
  - a. Removal by operation.
  - b. Pinching the cords.



TEACHER'S KEY  
STUDENT WORKSHEET #2  
DOCKING LAMBS

(Refer to VAS Units 1032 and 1060)

1. What is docking lambs and why is it practiced?

Docking is removing a lamb's tail. It is practiced because the tail is of no benefit to the animal and its presence is injurious because of the filth that accumulates around and beneath it. Also, lambs are more attractive if the tails are docked.

2. What kinds of equipment can be used for docking?

Pocket-knife, burdizzo, elastrator, emasculator, electric docker, and "all-in-one."

3. How close to the body should the tail be cut?

The tail should be cut off 1-1½ inches from the body.

4. How can bleeding be reduced after docking?

- Push the skin toward the body before cutting to allow coverage of the stub and not expose the bone.
- Searing the cut with a red-hot iron will seal the blood vessels.
- Tying a cord around the stub for a few hours until the blood clots.

5. How can the wound be treated to prevent infection?

- Vaccinate lambs for tetanus if there are or ever have been horses on the property.
- Use tincture of iodine as a disinfectant on the stub.
- Use fly repellent in warm weather to decrease chances of maggot infestation.

TEACHER'S KEY



STUDENT WORKSHEET #3

DEHORNING CATTLE

(Refer to VAS Unit 1032 and 1010b)

1. Why are horns objectional on commercial cattle?
  - a. Reduced quality of cattle due to damaged hides.
  - b. Reduced quality of carcasses due to bruises and cuts.
  - c. Excessive injuries in feedlots, at feed bunks, in shelters, and to herdsmen.
2. What are some methods cattle producers use to dehorn?
  - a. Use a pure polled bull.
  - b. Chemicals, such as caustic soda or caustic potash.
  - c. Electrical dehorner.
  - d. Mechanical dehorner, such as gouges, dehoring tubes, dehoring spoons, Barnes dehorner, Leavitt dehorner, and saws.
3. What dehoring practices are commonly used in our local area by commercial producers?
  
  
  
  
  
  
  
  
  
  
4. What dehoring methods are recommended on cattle in the following age groups?
  - a. 3-10 days of age - chemical dehorner
  - b. 1-2 months of age - electrical dehorner
  - c. over 3 months of age - mechanical dehorner
5. How should the wounds be treated to reduce bleeding and chances of infection?
  - a. If the operation is conducted during the fly season, use a good fly repellent to reduce maggot infestations.

- b. Dehorn at an early age and avoid cold, damp weather if mechanical methods are used, as the open sinuses can cause health problems.
- c. If bleeding is excessive pick up the squirting arteries with forceps and pull them straight out till they break back in the head.
- d. Keep calves in clean, dry pasture for a few days.

# KEYS TO GOOD LIVESTOCK MANAGEMENT

Know what to do



Know how to do it

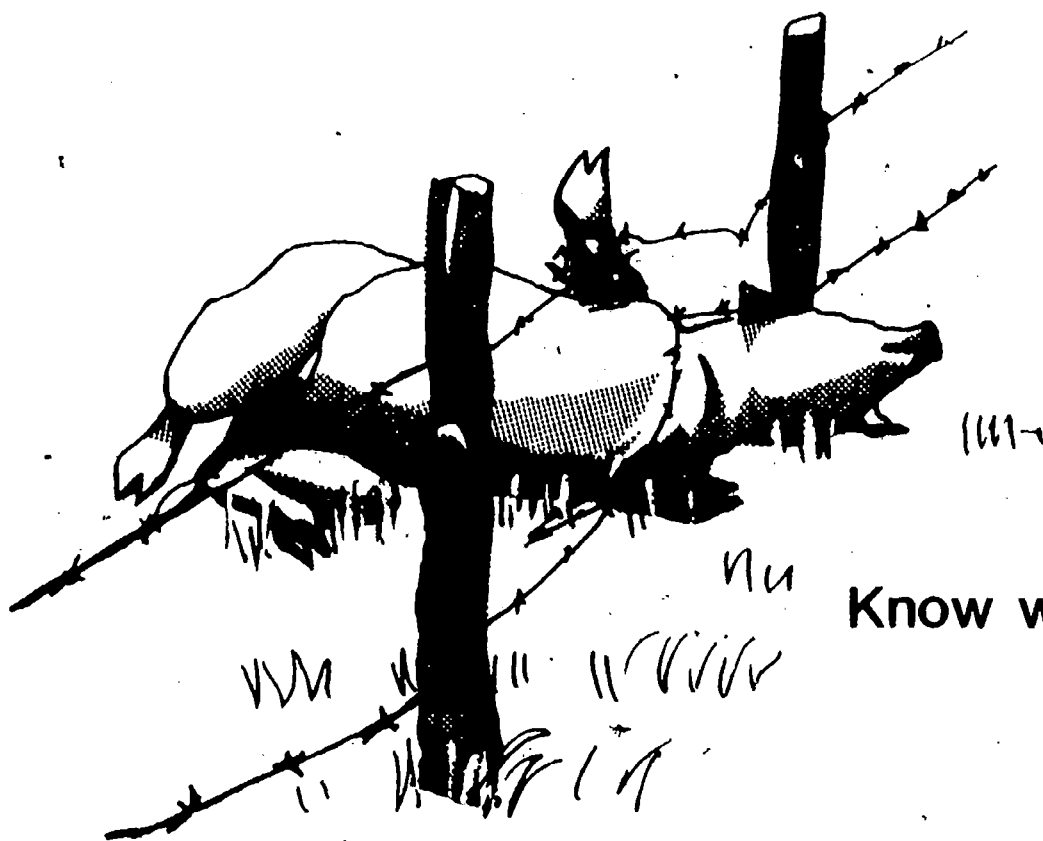

Know when to do it

---

## **LIVESTOCK MANAGEMENT TASKS**

**Requires controlling an animal's movement or activity by one or more of the following methods:**

**PHYSICAL CONTROLS**---ropes, snares, leg hooks,  
nose rings

**SENSORY CONTROLS**---blindfolds, ear plugs

**PSYCHOLOGICAL CONTROLS**---coercion, human  
voice, mannerisms

**EQUIPMENT CONTROLS**---confining alleys, chutes,  
barriers, gate panels

**CHEMICAL CONTROLS**--- drugs

---

## **MATCH THE MANAGEMENT TECHNIQUE WITH AN ANIMAL'S CHARACTERISTICS**

### **Beef cattle**

reasonably gentle  
strong maternal instinct  
panoramic vision  
color blind and poor depth perception  
good sense of smell  
group oriented  
follow a leader

### **Swine**

hear, see, and smell very well  
learns routines quickly  
maintain constant body temperature  
prone to panic if rushed  
persistently active, easily bored

### **Sheep**

flock together  
follow a leader  
timid and unaggressive  
not eat or drink from contaminated containers  
good sense of smell  
prefer grazing in early morning and late evenings  
good foragers

# **SELECTING RESTRAINING METHODS**

**The proper restraint will:**

**Minimize danger to the handler**

**Minimize danger to the animal**

**Minimize the animal's pain and fright**

**Allow the management task to be properly completed**

## **MANAGEMENT AT CALVING TIME**

Have cows available for easy observation

Keep cows in clean, dry area

Watch for difficulty in calving

Disinfect navel

Check for claiming of calf by cow

Have available a pen for cow and calf

Contact veterinarian if cow does not clean properly

Keep cows with calves separated from those that have not calved

Watch for mastitis and other infections

Properly identify calf and record information



## **MANAGEMENT AT FARROWING TIME**

**Provide clean, comfortable quarters**

**Provide properly controlled environment**

**Worm sow 2-3 weeks before farrowing**

**Wash sow before farrowing time**

**Provide proper feed rations**

**Stabilize new born pigs**

**Disinfect navel**

**Clip needle teeth**

**Give iron injections**

**Clip tails**

**Properly identify pigs and record information**

## **MANAGEMENT AT LAMBING TIME**

Have ewes available for easy observation

Prepare lambing quarters

Shear ewes several weeks before lambing

Watch for difficulty in lambing

Place animal in lambing pen

Check udder for colostrum

Check for claiming of lamb by ewe

Help weak lambs nurse

Provide for controlled environment

Disinfect navel

Dock lambs

Properly identify lambs and record information

---

# **USING PRODUCTION RECORDS AS A MANAGEMENT TOOL**

**Measure productivity**

**Evaluate performance**

**Identify high producing animals**

**Identify low producing animals**

**Identify differences in gaining ability**

**Provide permanent records of business**

**Select replacement animals**

**Supplement memory and observations of manager**

TRANSPARENCY DISCUSSION GUIDE  
DEVELOPING LIVESTOCK MANAGEMENT SKILLS

Transparency - KEYS TO GOOD LIVESTOCK MANAGEMENT

- A. Point out that a good livestock manager is aware of what tasks are essential for proper livestock care.
- B. Explain that a good livestock manager is aware of how tasks should be properly performed. They keep up on the latest improvements in livestock management.
- C. Emphasize that a good livestock manager is aware of when tasks should be performed for proper care of livestock. Livestock require almost constant supervision in order to minimize losses.
- D. Provide other examples of these three areas of good livestock management.

Transparency - LIVESTOCK MANAGEMENT TASKS

- A. Point out that livestock management is much more than looking at livestock or writing information in a record book.
- B. Discuss the fact that almost all livestock management tasks will require controlling an animal in some form.
- C. Ask students to identify ways or methods of controlling livestock. Compare their list with those on the transparency.
- D. Have students share some of their personal experiences in controlling livestock.

Transparencies - MATCH THE MANAGEMENT TECHNIQUE WITH AN ANIMAL'S CHARACTERISTICS AND SELECTING RESTRAINING METHODS

- A. Point out that a good livestock manager is also a good animal psychologist. They know and understand what generally causes certain livestock species to behave as they do.
- B. Have students identify some general physical and psychological characteristics of beef, swine, and sheep. Match their list with those on the transparency.
- C. Discuss how a good livestock manager will use these characteristics for an advantage and not a disadvantage when controlling livestock.

- D. Discuss the measures of good restraining methods for controlling livestock. Point out that a livestock manager evaluates all these criteria when selecting a restraining method.
- E. Give examples of good and poor restraining methods which can help clarify the five characteristics of a proper restraint.

Transparencies - MANAGEMENT AT CALVING TIME, MANAGEMENT AT FARROWING TIME, AND MANAGEMENT AT LAMBING TIME

- A. Use these transparencies to supplement discussion on some tasks a good livestock manager may perform.
- B. Have students identify possible restraining methods which could be used to control livestock so selected management tasks could be performed.
- C. Have students supplement these tasks with other tasks they have seen done.
- D. Select certain management tasks for students to report on or demonstrate.

Transparency - USING PRODUCTION RECORDS AS A MANAGEMENT TOOL

- A. Ask students to identify some management uses of good livestock records. Add their ideas to those on the transparency.
- B. Use students livestock S.O.E. program records to identify where and how this information would be recorded.
- C. Discuss how and when a livestock manager would obtain this type of record information.

TEACHER'S KEY

DEVELOPING LIVESTOCK MANAGEMENT SKILLS

SAMPLE TEST QUESTIONS

PART I. True (+) - False (0)

- + 1. The object of castration is to improve the quality of meat.
- + 2. Castration of pigs may be performed successfully at any season of the year.
- 0 3. When castrating pigs, it is necessary to apply dressings to the wounds for purposes of disinfection.
- + 4. An instrument used for castrating calves, without loss of blood, is the elastrator.
- 0 5. The most common method of castrating lambs is by pinching the cords.
- 0 6. It is not necessary to apply any disinfectant to tail stubs of lambs after the tails are removed.
- + 7. Horns on commercial cattle are extremely objectionable.
- + 8. A pure polled bull will sire nothing but hornless calves even when used on horned cows.
- 0 9. A polled cow will give birth to nothing but hornless calves even when used on horned bulls.
- + 10. Chemicals are often used for dehorning young calves.

PART II. Multiple Choice--(Make appropriate choice of A, B, C, or D)

- A 1. The removal of the testicles from the male is referred to as:
- A. Castrating
  - B. Dehorning
  - C. Docking
  - D. Spaying
- C 2. Undesirable sexual odors and flavors can occur in the meat of uncastrated:
- A. Cattle and hogs
  - B. Cattle and sheep
  - C. Hogs and sheep
  - D. Only cattle

- B 3. Ram lambs should be castrated when they are:
- A. One to three days old
  - B. Seven to fourteen days old
  - C. Ten to twenty days old
  - D. Weaned
- C 4. The removal of the tail from lambs is referred to as:
- A. Castrating
  - B. Dehorning
  - C. Docking
  - D. Spaying
- B 5. The instrument used to place a strong rubber band around the top of the scrotum is:
- A. Burdizzo
  - B. Elastrator
  - C. Emasculator
  - D. Scalpel
- D 6. The pouch of skin containing the testicles is the:
- A. Cord
  - B. Raphe
  - C. Ridgeling
  - D. Scrotum
- D 7. The surest method of successful castration is to use a:
- A. Burdizzo
  - B. Elastrator
  - C. Emasculator
  - D. Scalpel
- A 8. For dehorning young calves (3 to 10 days old) it is best to use:
- A. Chemicals
  - B. Gouge
  - C. Leavitt dehorner
  - D. Saws
- C 9. For dehorning calves which are about three to ten months of age, the type of dehorner which has proven best is:
- A. Chemicals
  - B. Gouge
  - C. Leavitt dehorner
  - D. Saws

C

10. One of the most satisfactory methods of docking is with the:

- A. Burdizzo
- B. Elastrator
- C. Emasculator
- D. Scalpel

PART III. Identify the following livestock management tools:

A. Emasculator



B. Dehorning tube

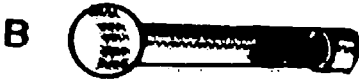

C. Leavitt dehorner

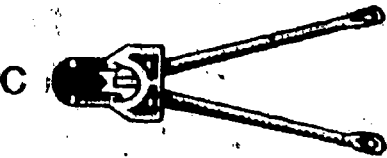

D. Burdizzo

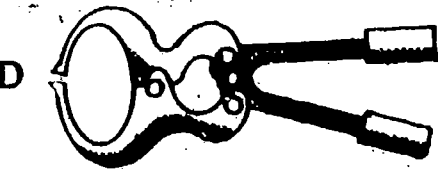

E. Barnes dehorner

F. Electric dehorner

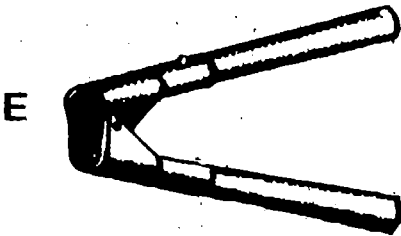

G. Dehorning spoon

H. Elastrator

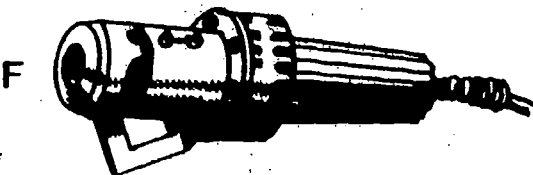

I. Pruning shears

J. Scalpel

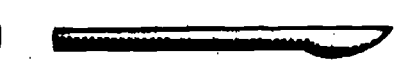
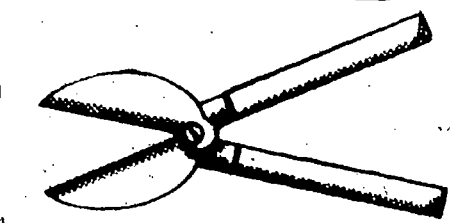
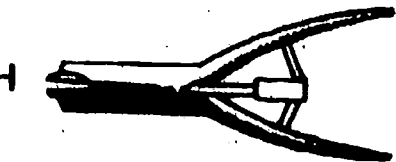



PART IV--Completion (Write appropriate information or words to complete statements.)

1. As a result of castration, the characteristic sex features fail to develop.
2. A common mistake in castrating pigs is to cut too high on the scrotum.
3. The lymph and blood serum which escape at the edges of a wound contain germicidal properties.
4. Castration is best done when calves are from 1 to 4 months of age.
5. A redgeling has one or both testicles remaining in the body cavity.
6. A rupture occurs when part of the intestine slips into the scrotum.
7. When castrating older lambs the cord should be scraped rather than pulled to prevent excessive bleeding.
8. It should be a uniform practice to dock lambs when they are 7 to 14 days old.
9. The docked stub should be about 1 to 1½ inches long.
10. A polled bull out of a polled sire and horned dam will produce about 50 percent hornless calves when mated to horned cows.

PART V-- Essay Questions

1. Briefly discuss the reasons for castrating commercial market animals. (See VAS Unit 1032, part 1)
2. Horns on commercial cattle are extremely objectionable. Briefly identify and discuss these objections. (See VAS Unit 1032, part 3)

## UNIT D: LIVESTOCK SCIENCE

### PROBLEM AREA: UNDERSTANDING AND USING ARTIFICIAL INSEMINATION

#### SUGGESTIONS TO THE TEACHER:

This problem area is designed for use with advanced students in vocational agriculture programs. The recommended time for teaching this problem area is when students would have the opportunity to observe or practice this skill on their S.O.E. livestock program.

The estimated instructional time for this problem area is 5 to 7 days depending on how far the teacher wishes to go in developing knowledge and skills in artificial insemination of livestock.

If students are to be involved in other exercises, the instructional time will need to be increased.

The instructor is encouraged to conduct a local search to locate other supplementary materials for use with this problem area. The items in this problem area are for reference or modification as instructors adapt these materials to their local situation.

#### CREDIT SOURCES:

These materials were developed through a funding agreement, R-33-24-D-0362-466 with the Illinois State Board of Education, Department of Adult, Vocational and Technical Education, Research and Development Section, 100 North First Street, Springfield, Illinois 62777. Opinions expressed in these materials do not reflect, nor should they be construed as policy or opinion of the State Board of Education or its staff.

The teacher's guide, student worksheets, job sheets, transparency discussion guide, and sample test questions were developed by Betsy Pech, Vocational Agriculture Instructor, Wapella High School, Wapella, Illinois, and Jerry Pepple, Department of Vocational and Technical Education, University of Illinois.

The artwork in this problem area was prepared by the Vocational Agriculture Service, University of Illinois. Suggestions and guidance in the development of these materials were provided by the following vocational agriculture teachers:

Betsy Pech	-	Wapella High School
Dennis Sorenson	-	Central High School
Paul Mealiff	-	Carthage High School
Earl Lindsey	-	Bismark High School
Chris Roegge	-	Geneseo High School
Floyd Wohrley	-	Kewanee High School
Bill Bree	-	Lincoln High School

## TEACHER'S GUIDE

- I. Unit: Livestock science
- II. Problem area: Understanding and using artificial insemination
- III. Objectives: At the close of this problem area students will be able to:
  1. Define artificial insemination.
  2. Identify and discuss advantages and disadvantages of artificial insemination.
  3. Explain the functions of the major parts of the male and female reproductive systems in livestock.
  4. Identify the advantages and disadvantages of the most commonly used methods of collecting sperm.
  5. Explain the techniques used to extend and store semen.
  6. Describe the commonly used artificial insemination procedures for livestock.
  7. Discuss how to prepare and perform an artificial insemination procedure on selected species of livestock.
- IV. Suggested interest approaches:
  1. Develop student interest in this problem area by identifying a sample problem on how a livestock manager can upgrade the quality of livestock offspring. Record the students ideas on the chalkboard. Direct the students discussion toward the idea of using artificial insemination as one possible solution.
  2. Ask several lead questions concerning the local practice of using artificial insemination by some livestock producers in the area. Encourage students to share their knowledge or experiences with artificial insemination of livestock.
  3. Show a few selected slides or use actual pieces of equipment needed for artificial insemination and ask students to name and/or identify what the equipment does.
- V. Problems and concerns of students:
  1. What is artificial insemination?

2. When was artificial insemination first developed?
3. What type of livestock can be artificially inseminated?
4. What are some advantages and disadvantages of artificial insemination?
5. What are the major reproductive organs of female mammals and the functions of each?
6. What are the major reproductive organs of male mammals and the functions of each?
7. How are sperm cells collected and stored?
8. How are females artificially inseminated?
9. What type of equipment is needed for artificial insemination?
10. When can a female be artificially inseminated?
11. How does a livestock manager detect heat in female livestock?
12. Where can semen be obtained?
13. What information is needed before a livestock manager can purchase semen?
14. What are some reputable breeding organizations which supply semen for artificial insemination of livestock?

VI. Suggested learning activities and experiences:

1. Identify student problems and concerns relating to this problem area and attempt a trial solution. Conduct supervised study on the questions students could not satisfactorily solve.
2. Distribute Student Worksheet #1, "Parts of the Male and Female Reproductive System of Cattle" and have students identify the selected organs. Discuss the functions of each organ.
3. Use construction board to develop an estrus cycle chart for selected livestock species.
4. Use buzz groups to develop a list of why artificial insemination is becoming more popular as a method of breeding livestock. Have students orally report their findings and conclusions to the class.
5. Have students write and present a 3-5 minute speech on artificial insemination for an FFA Public Speaking Contest.

6. Show the slidefilm "Artificial Insemination" to illustrate selected artificial insemination techniques.
7. Develop a chart to show the different ages in which species of livestock reach sexual maturity and can be bred for the first time.
8. Obtain a female reproductive tract from a local slaughter house and have an artificial inseminator identify the reproductive organs and demonstrate the technique of artificial insemination.
9. Arrange a field trip to a local livestock farm or sale barn and have an artificial inseminator demonstrate the technique of artificial insemination on a live animal.
10. Use selected transparencies included in this problem area to illustrate various artificial insemination procedures.
11. Use Student Worksheets #2 & #3 on artificial insemination and VAS Unit 1002b, "Artificially Inseminating Livestock", to introduce students to artificial insemination.
12. Use Student Job Sheets #1 and #2 to give student an opportunity to examine semen quality and planning an estrous or heat cycle chart.

#### VII. Application procedures:

1. Students having an ownership or placement S.O.E.P. with livestock breeding programs should develop the ability to use artificial insemination for herd improvement.
2. Students should identify employment opportunities available in the area of artificial insemination.

#### VIII. Evaluation:

1. Prepare and administer a pencil and paper test on reproduction and artificial insemination.
2. Grade students' written and oral reports.
3. Have students artificially inseminate a cull cow, heifer, or female reproductive tract obtained from a local slaughter house.

IX. References and aids:

1. Vocational Agriculture Service, University of Illinois, Urbana, Illinois 61801.
  - a. VAS Unit 1002b, "Artificially Inseminating Livestock."
  - b. Transparency Packet, "Livestock Breeding and Genetics"
  - c. "The Bovine Estrous Cycle", Cooperative Extension Service, Circular 1205, University of Illinois.
2. Slidefilm, "Artificial Insemination", California Polytechnic State University, Vocational Education Production, San Luis Obispo, California 93401
3. Addresses of A.I. Services and Information:
  - a. Illini Sire Service  
201 Park St.  
Cornell, IL 61319  
(815) 358-2291
  - b. Tri-State Breeders Cooperative  
Route 3, Box 50  
Baraboo, Wisconsin 53913
  - c. American Breeders Service  
De Forest, Wisconsin 53532
  - d. Select Sires, Inc.  
11740-U.S. 42  
Plain City, Ohio 43064
  - e. International Boar Semen  
P.O. Box 538  
Eldora, Iowa 50627
4. Dr. Phil Reeser (veterinarian specializing in embryo transfers)  
Route 2, Box 44  
Monticello, IL 61856  
(217) 669-2125
5. University of Illinois Film Center  
1325 South Oak Street  
Champaign, Illinois 61820  
(217) 333-1360 or  
(800) 252-1357



## COMPETENCY INVENTORY

### UNDERSTANDING AND USING ARTIFICIAL INSEMINATION

1. Student has no knowledge of competency.
2. Student has read about competency.
3. Student has seen competency performed.
4. Student has performed competency.
5. Student has performed competency without supervision.
6. Student does possess skill.
7. Student does not possess skill.

Competency	Circle One				
1. Detect cattle in heat.	1	2	3	4	5
2. Perform pregnancy checks on cattle.	1	2	3	4	5
3. Keep cattle breeding records.	1	2	3	4	5
4. Operate breeding chutes.	1	2	3	4	5
5. Identify symptoms of reproductive diseases in cattle.	1	2	3	4	5
6. Handle semen samples without exposing samples to adverse environment.	1	2	3	4	5
7. Identify the reproductive tract by prerectal palpation and locate cervix quickly.	1	2	3	4	5
8. Properly insert pipette into the vagina.	1	2	3	4	5
9. Deposit semen into body of uterus properly.	1	2	3	4	5
10. Discuss advantages and disadvantages of A.I.					6 7
11. Select semen donors by reviewing records and reports from A.I. representatives.					6 7

These competencies are outlined in the National Ag Occupations Competency Study, 1978, for entry level positions in agriculture.

Name \_\_\_\_\_

Date \_\_\_\_\_

STUDENT WORKSHEET #1

MALE AND FEMALE REPRODUCTIVE ORGANS

(Refer to VAS Unit 1002b, part 2)

1. Label the identified parts of the female reproductive organs of the cow.

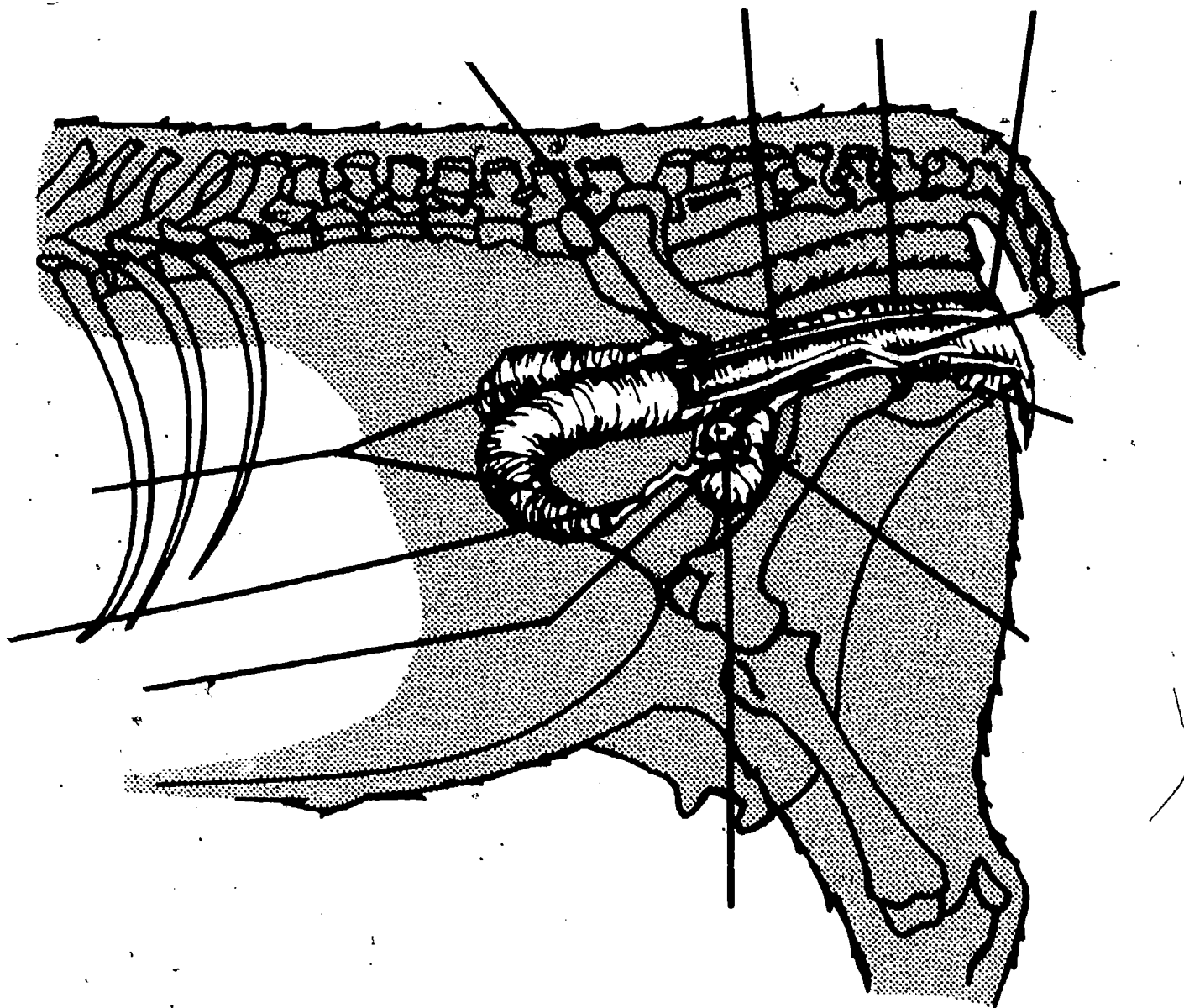



2. Label the identified parts of the male reproductive organs of the bull.

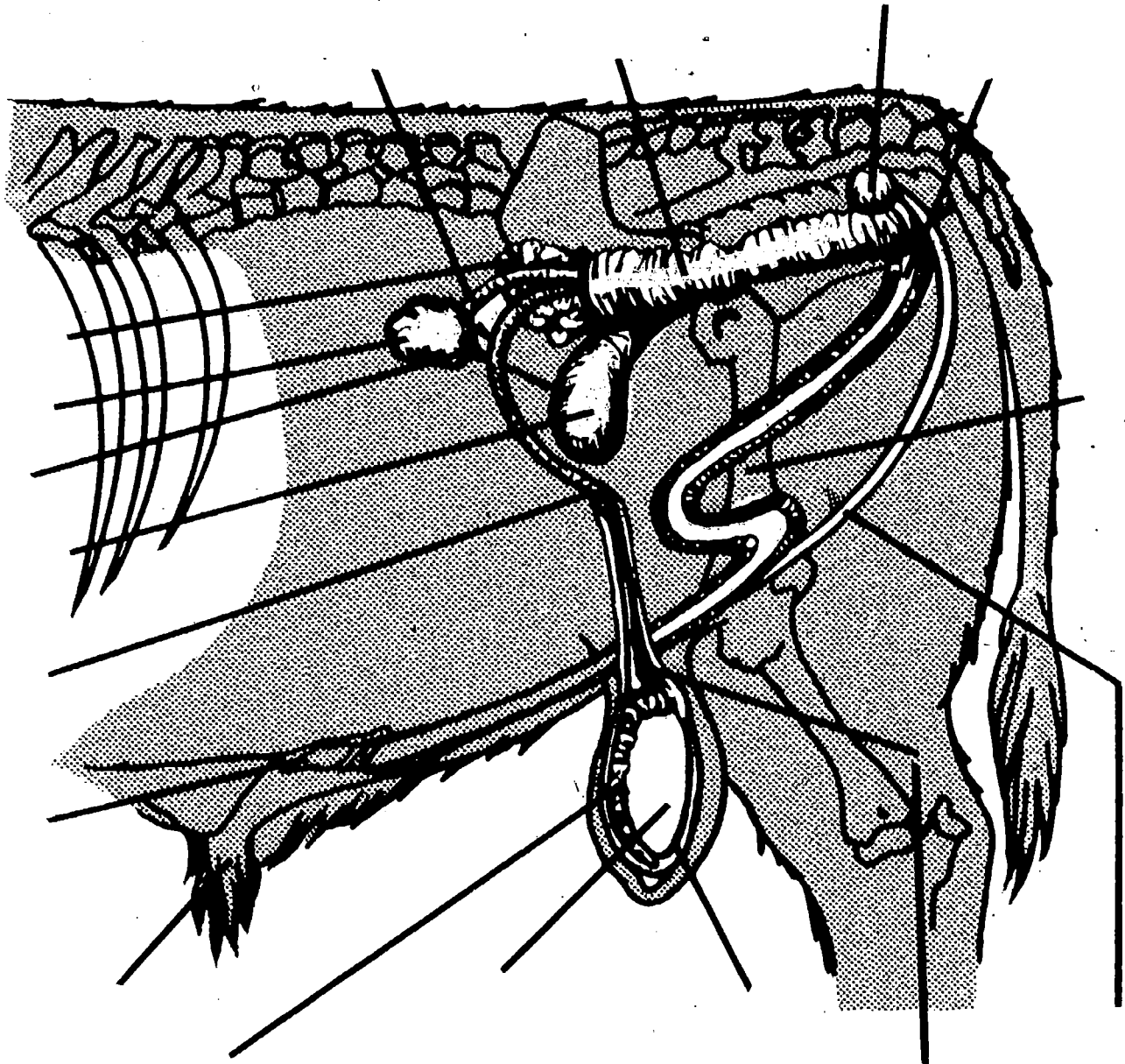

236

## STUDENT WORKSHEET #2

### ARTIFICIAL INSEMINATION AND REPRODUCTIVE ORGANS OF MAMMALS

(Refer to VAS Unit 1002b, Artificially Inseminating Livestock, parts 1 and 2)

1. Define artificial insemination.
2. What are some advantages of artificial insemination?
3. What are some disadvantages of artificial insemination?

4. The \_\_\_\_\_ mammal produces gametes or eggs and if they are \_\_\_\_\_, they can grow and develop into young offspring.
5. The two \_\_\_\_\_ produce the ova.
6. Usually in the cow and mare only one \_\_\_\_\_ is released during each \_\_\_\_\_ or \_\_\_\_\_.
7. It is in the \_\_\_\_\_ that sperm cells meet and fertilize the ova.
8. The oviducts join with the horns of the \_\_\_\_\_.
9. The embryo develops and grows in the \_\_\_\_\_ until time of birth.
10. During pregnancy, the \_\_\_\_\_ becomes sealed to prevent bacteria or other harmful materials from entering the uterus.
11. The \_\_\_\_\_ and \_\_\_\_\_ serve also to receive the \_\_\_\_\_ of the male at the time of mating.
12. The main function of the male in reproduction is the production of \_\_\_\_\_ cells.
13. The \_\_\_\_\_ produce the sperm cells.
14. The process of sperm cell formation requires a temperature \_\_\_\_\_ that of the body and that is why the testes are suspended in the \_\_\_\_\_.
15. The \_\_\_\_\_ is the primary storehouse for millions of sperm.
16. The \_\_\_\_\_ connect the epididymis from each testes with an \_\_\_\_\_.
17. Why are fluids added to the sperm?
18. The sperm follows the urethra through the \_\_\_\_\_ to the exterior.
19. The penis of the bull, ram, and boar straightens by relaxation of the \_\_\_\_\_ allowing the penis to be extended to deposit semen in the vagina of the female.
20. The penis of the stallion contains more \_\_\_\_\_ tissue which becomes engorged with \_\_\_\_\_ under proper stimulation causing erection for insertion into the vagina of the mare.

### STUDENT WORKSHEET #3

#### COLLECTING SPERM AND ARTIFICIALLY INSEMINATING FEMALES

(Refer to VAS Unit 1002b, Artificially Inseminating Livestock, parts 3 and 4)

1. Male semen consists of two parts, a \_\_\_\_\_ part and a \_\_\_\_\_ part.
2. A cow egg has a diameter approximately 20 times \_\_\_\_\_ than the length and \_\_\_\_\_ times \_\_\_\_\_ than the width of the head of a bull sperm cell.
3. Identify some methods which are used for collecting semen for artificial insemination.
4. Which of the identified methods has been shown to be more satisfactory? Why?
5. What is meant by extending semen and why is it done?
6. What method is most widely used for preserving semen today?
7. What are some things that can harm sperm cells?

8. What technique of artificial insemination is most widely used for cattle? Why?
9. As a general rule, the \_\_\_\_\_ of the heat period is the most satisfactory breeding time.
10. Studies have shown that at least \_\_\_\_\_ days should be allowed after calving before rebreeding cows.
11. Why is it not a good practice to rebreed on the first heat after giving birth?
12. What sanitary precautions should one observe when using artificial insemination.

240

## STUDENT JOB SHEET #1

### EXAMINING SEMEN

Objective: To observe and check sperm for mobility and abnormality.

Materials: Microscope and slides  
semen sample

- Procedure:
1. Prepare a slide with semen sample for microscope.
  2. Check the sample for mobility.
    - a. Progressive \_\_\_\_\_
    - b. Oscillatory \_\_\_\_\_
    - c. Rotary \_\_\_\_\_
    - d. No movement \_\_\_\_\_
  3. Check sample for abnormality.
    - a. Tailless head \_\_\_\_\_
    - b. Two tails \_\_\_\_\_
    - c. Two heads \_\_\_\_\_
    - d. Pear-shaped head \_\_\_\_\_
    - e. other \_\_\_\_\_
  4. Draw and label a normal sperm cell.

- Questions:
1. At what temperature should semen be refrigerated?
  2. What is the color of the sperm?
  3. Can an abnormal sperm fertilize an egg?
  4. How and why do the sperm move?

Conclusions: Briefly explain how this knowledge can be used to benefit your livestock S.O.E.P.

JOB SHEET #2

ESTROUS CYCLE CHART

Objective: To be able to identify different points in time that estrus occurs in a cow.

Materials: VAS Unit 1002b, page 7.

Procedure: 1. On the chart below label the breeding times, estrus, and ovulation.

STAGES OF ESTROUS CYCLE

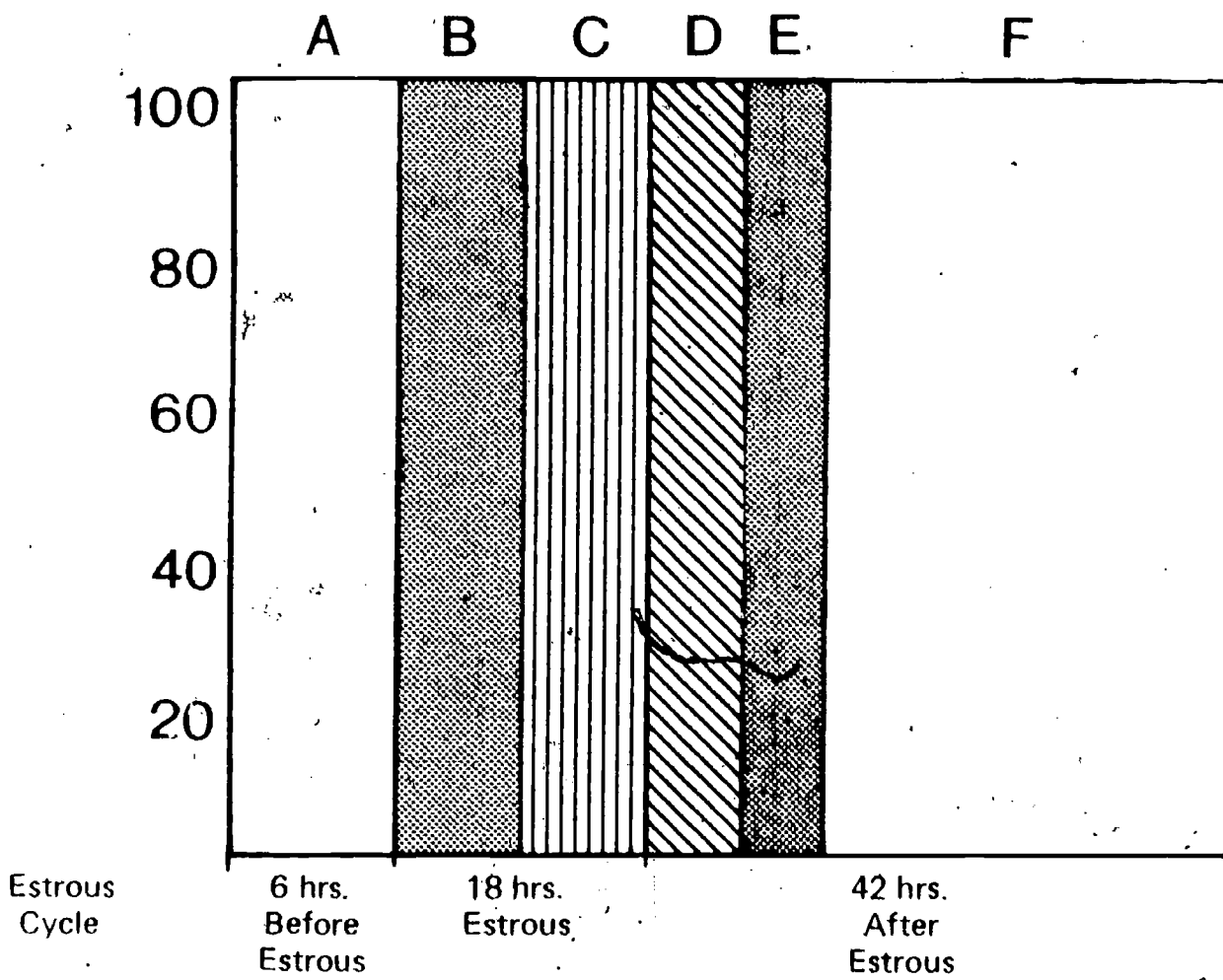

1. Label the stages of the estrous cycles as best, good, fair, etc.

A. \_\_\_\_\_ D. \_\_\_\_\_  
B. \_\_\_\_\_ E. \_\_\_\_\_  
C. \_\_\_\_\_ F. \_\_\_\_\_

2. Draw in a percent conception rate curve.



Questions:

1. When is it too early for artificial insemination?
2. When is the optimum time for artificial insemination?
3. When is the egg released from the ovary?
4. At what stage in the estrous cycle, will a cow be in standing heat?
5. What is the heat interval for cows?

Conclusions:

Briefly list some approved practices which can be applied to livestock S.O.E.P.s which relate to livestock breeding.

TEACHER'S KEY

STUDENT WORKSHEET #1

MALE AND FEMALE REPRODUCTIVE ORGANS

(Refer to VAS Unit 1002b, part 2)

1. Label the identified parts of the female reproductive organs of the cow.

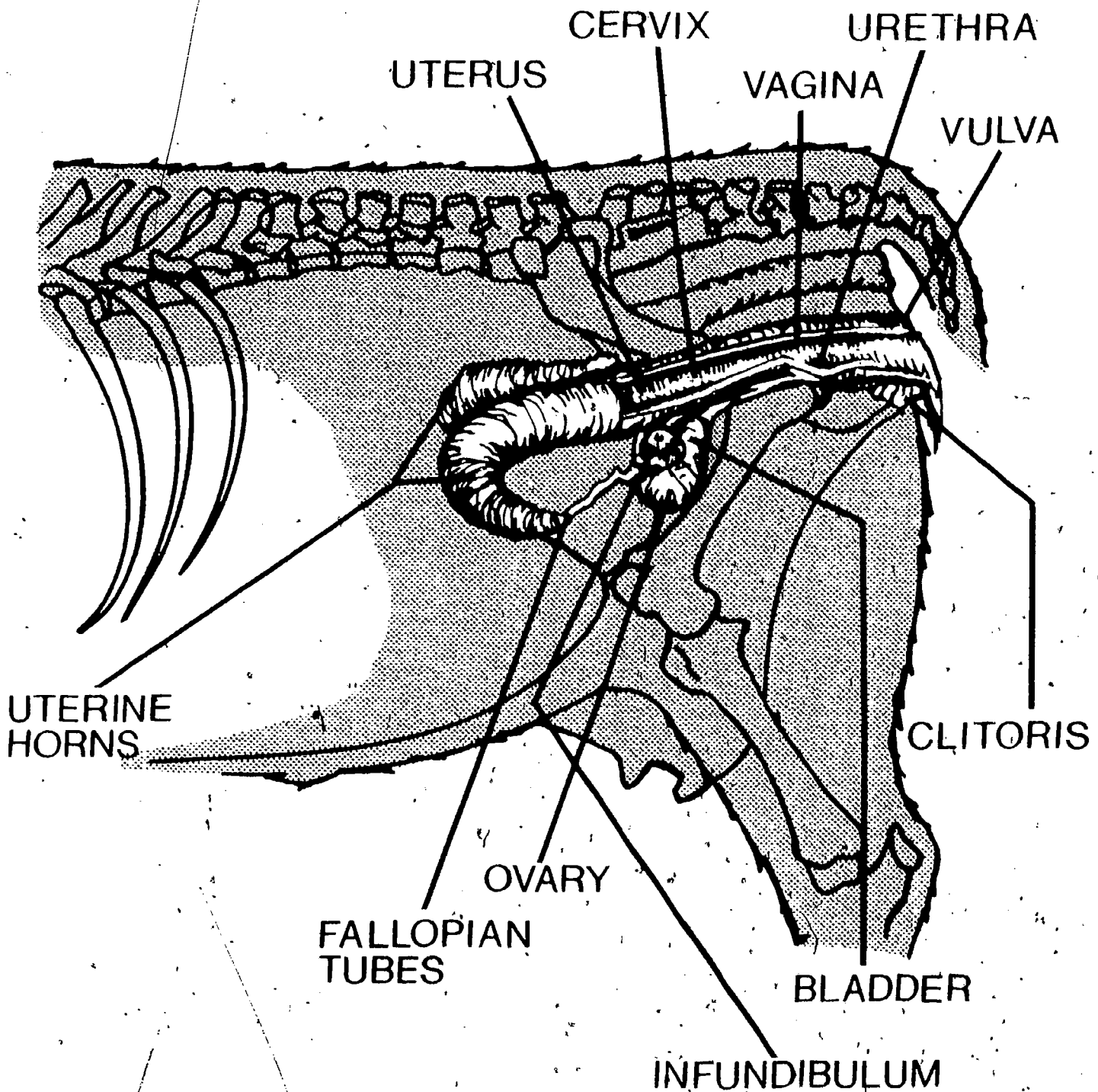

2. Label the identified parts of the male reproductive organs of the bull.

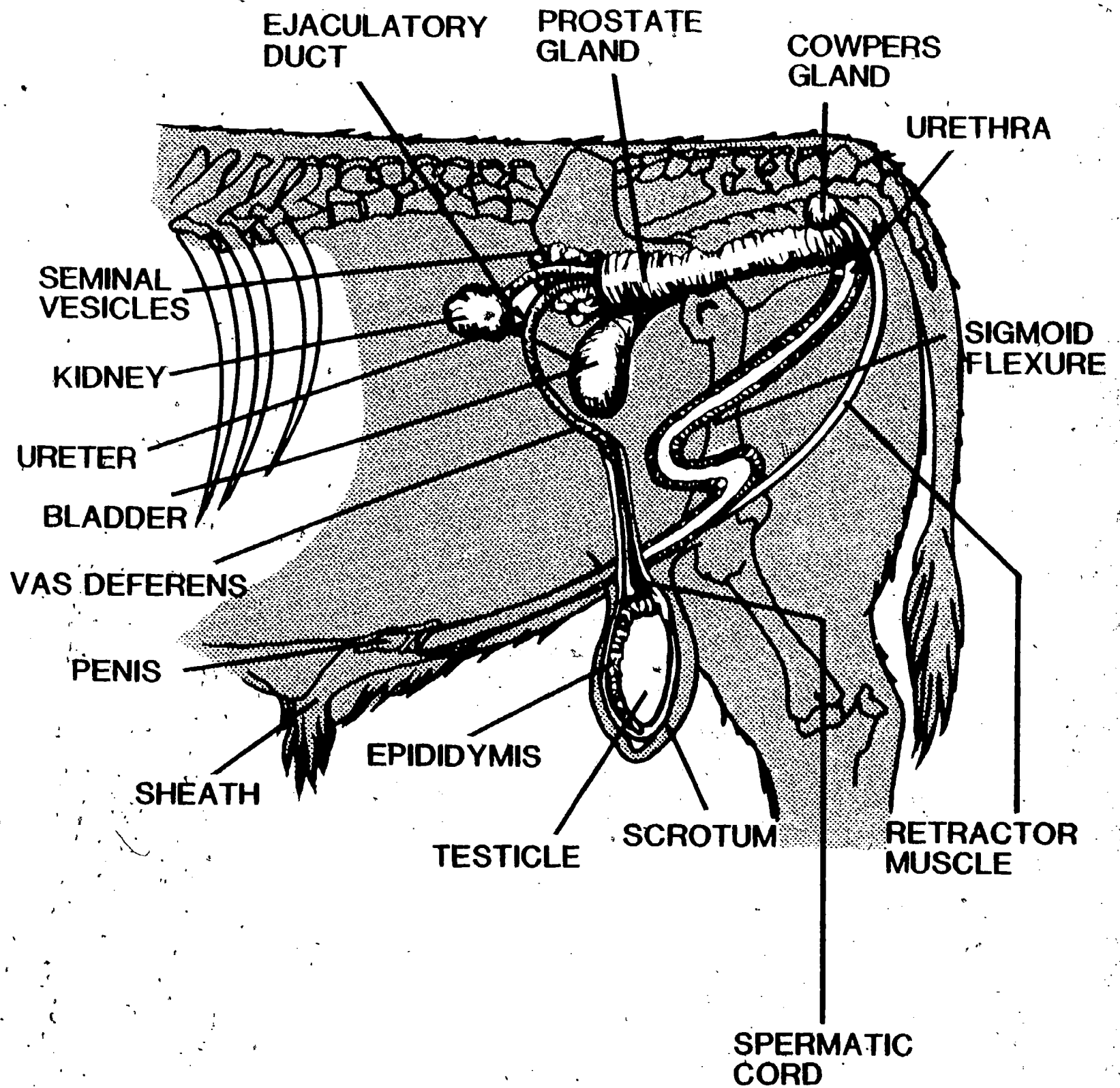

## TEACHER'S KEY

### STUDENT WORKSHEET #2

#### ARTIFICIAL INSEMINATION AND REPRODUCTIVE ORGANS OF MAMMALS

(Refer to VAS Unit 1002b, Artificially Inseminating Livestock, parts 1 and 2)

1. Define artificial insemination.

It is the placing of male reproductive cells in the female reproductive tract by using an inseminating tube rather than using direct service by the male.

2. What are some advantages of artificial insemination?

- a. The use of outstanding sires can be increased.
- b. Eliminate the cost and expense of buying and keeping a sire.
- c. Mating of animals who are physically hundreds or thousands of miles apart.
- d. Can test or prove an animal on a few females on a farm.
- e. Valuable sires can be used even if they cannot mate naturally due to injury, age, size, or other physical handicap.
- f. Danger of spreading genital diseases is greatly reduced.
- g. Encourages better breeding and birth records.
- h. Risk and labor of keeping a sire can be eliminated.
- i. Cooperative study of breeding problems should result in a more rapid advancement of the livestock industry.

3. What are some disadvantages of artificial insemination?

- a. Requires a well-trained operator and special equipment.
- b. Requires more time and supervision and better records than if the sire is running with the females.
- c. All equipment and instruments used must be clean or infection may be spread.
- d. The demand for a large number of sires could be reduced.

4. The female mammal produces gametes or eggs and if they are fertilized, they can grow and develop into young off-spring.
5. The two ovaries produce the ova.
6. Usually in the cow and mare only one ovum is released during each estrous or heat cycle.
7. It is in the oviducts that sperm cells meet and fertilize the ova.
8. The oviducts join with the horns of the uterus.
9. The embryo develops and grows in the uterine horns until time of birth.
10. During pregnancy, the cervix becomes sealed to prevent bacteria or other harmful materials from entering the uterus.
11. The vagina and vulva serve also to receive the penis of the male at the time of mating.
12. The main function of the male in reproduction is the production of sperm cells.
13. The testes produce the sperm cells.
14. The process of sperm cell formation requires a temperature below that of the body and that is why the testes are suspended in the scrotum.
15. The epididymis is the primary storehouse for millions of sperm.
16. The vas deferens connect the epididymis from each testes with an ampulla.
17. Why are fluids added to the sperm?
  - a. Helps transport sperm.
  - b. Supplies proper environment to keep the sperm alive.
  - c. Cleanses the urethra passageway.
18. The sperm follows the urethra through the penis to the exterior.
19. The penis of the bull, ram, and boar straightens by relaxation of the retractor muscle allowing the penis to be extended to deposit semen in the vagina of the female.
20. The penis of the stallion contains more erectile tissue which becomes engorged with blood under proper stimulation, causing erection for insertion into the vagina of the mare.

## TEACHER'S KEY

### STUDENT WORKSHEET #3

#### COLLECTING SPERM AND ARTIFICIALLY INSEMINATING FEMALES

(Refer to VAS Unit 1002b, Artificially Inseminating Livestock, parts 3 and 4)

1. Male semen consists of two parts, a fluid part and a cellular part.
2. A cow egg has a diameter approximately 20 times greater than the length and 30 times greater than the width of the head of a bull sperm cell.
3. Identify some methods which are used for collecting semen for artificial insemination.
  - a. Recovering semen from the vagina of the female after mating.
  - b. Collecting by massaging of the ampullae and seminal vesicles by rectal palpation.
  - c. Artificial vagina.
  - d. Electrical stimulation or electroejaculation.
4. Which of the identified methods has been shown to be more satisfactory? Why?

Artificial vagina. The semen can be collected under controlled, sterile conditions. The animal is allowed to mount another animal or constructed dummy. The male ejaculates into an artificial vagina.

5. What is meant by extending semen and why is it done?

It is adding materials to the collected semen to keep the sperm alive and increase the volume of the sample. It is extended so one sample can be used to breed many females.

6. What method is most widely used for preserving semen today?

Freezing - slow and fast methods

7. What are some things that can harm sperm cells?

Water, acids, soaps, metals, cold shock, and high temperature.



8. What technique of artificial insemination is most widely used for cattle? Why?

Rectovaginal technique. The results have been just as good as with natural mating and the equipment is plastic and disposable.

9. As a general rule, the middle of the heat period is the most satisfactory breeding time.
10. Studies have shown that at least 60 days should be allowed after calving before rebreeding cows.
11. Why is it not a good practice to rebreed on the first heat after giving birth?

Conception rates can be lower. The uterus has not returned to normal and it is more susceptible to infection at this time.

12. What sanitary precautions should one observe when using artificial insemination.
- Use only healthy animals.
  - Use only clean, sterile equipment.
  - Disinfect all clothing if the same material is used on different animals and farms.
  - Observe general cleanliness around the area and facilities where the work is being performed.

250

---

# WHY BREED ARTIFICIALLY ?

- A. MAXIMUM USE OF OUTSTANDING SIRE
- B. GREATLY INCREASED UNIFORMITY
- C. POSSIBLE TO OVERCOME CERTAIN PHYSICAL HANDICAPS TO MATING
- D. LESSENS SIRE COST
- E. ALLEVIATES DANGER AND BOTHER OF KEEPING A SIRE
- F. REDUCES THE COST AND DELAYS OF USING INFERTILE SIRE
- G. BETTER HEALTH PROTECTION
- H. IMPROVED HERD RECORDS
- I. INCREASES PROFITS
- J. INCREASES PRIDE OF OWNERSHIP



---

# LIMITATIONS OF ARTIFICIAL INSEMINATION

- A. REQUIRE SKILLED TECHNICIAN
- B. MUST CONFORM TO PHYSIOLOGICAL PRINCIPLES
- C. MAY RESTRICT THE SIRE MARKET
- D. MAY INCREASE THE SPREAD OF DISEASE
- E. MAY BE SUBJECT TO CERTAIN ABUSES
- F. MAY ACCENTUATE THE DAMAGE OF A POOR SIRE
- G. CONSIDERABLE CAPITAL AND COMPETENT MANAGERIAL ABILITY ARE NECESSARY TO INITIATE AND OPERATE AN ARTIFICIAL BREEDING ORGANIZATION

# THE REPRODUCTION CYCLE IN FARM ANIMALS

Species	Length of Estrus Cycle (days)		Length of Estrus		Usual Time of Ovulation	Length of Gestation (days)		Age at Puberty (months)
	av.	range	av.	range		av.	range	
mare	21	10-37	5-6 days	1-14 days	24-48 hrs. before end of estrus	336	310-350	10-12
cow	19-21	16-24	16-20 hrs.	8-30 hrs.	10-14 hrs. after end of estrus	281	274-291	4-8
ewe	16	14-20	30 hrs.	20-42 hrs.	1 hr. before end of estrus	150	140-160	4-8
sow	21	18-24	1-5 days	1-5 days	18-60 hrs. after estrus begins	112	111-115	5-7

# TIME OF BREEDING AND CONCEPTION RATE IN CATTLE

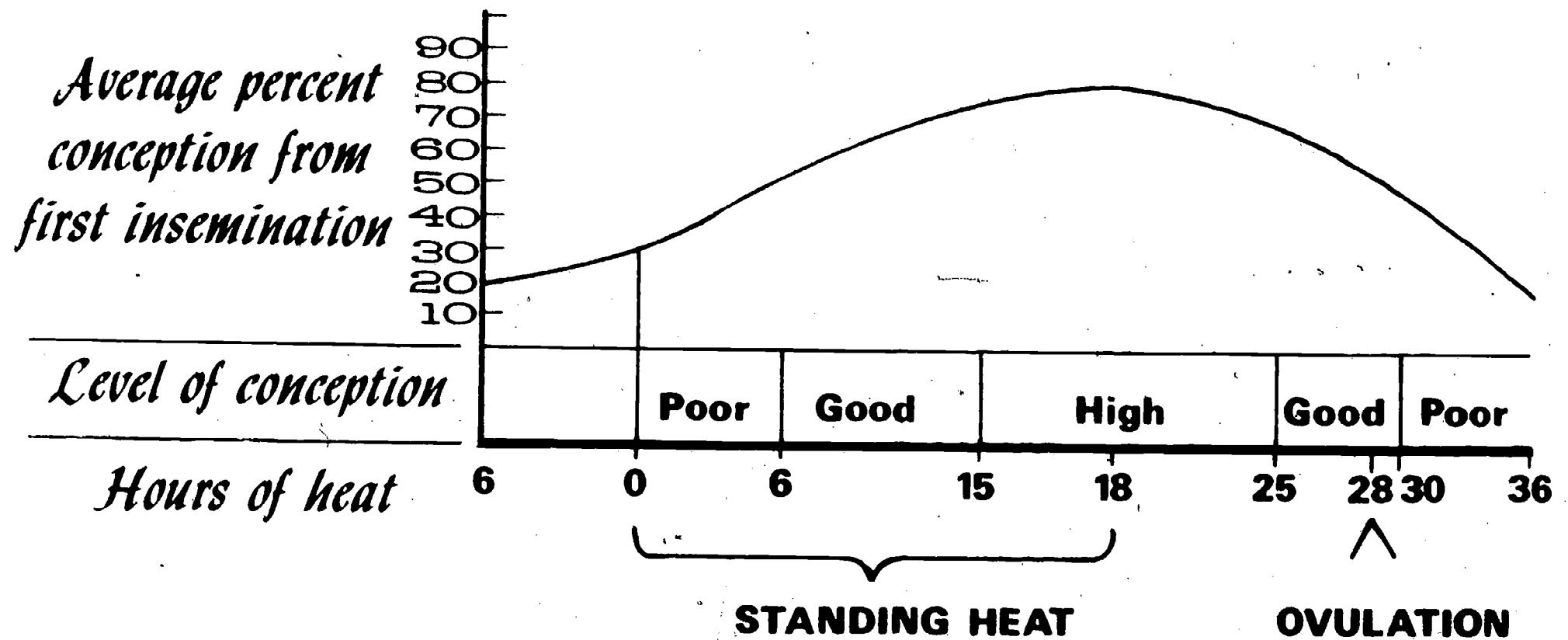

255

256

# GOOD SEMEN

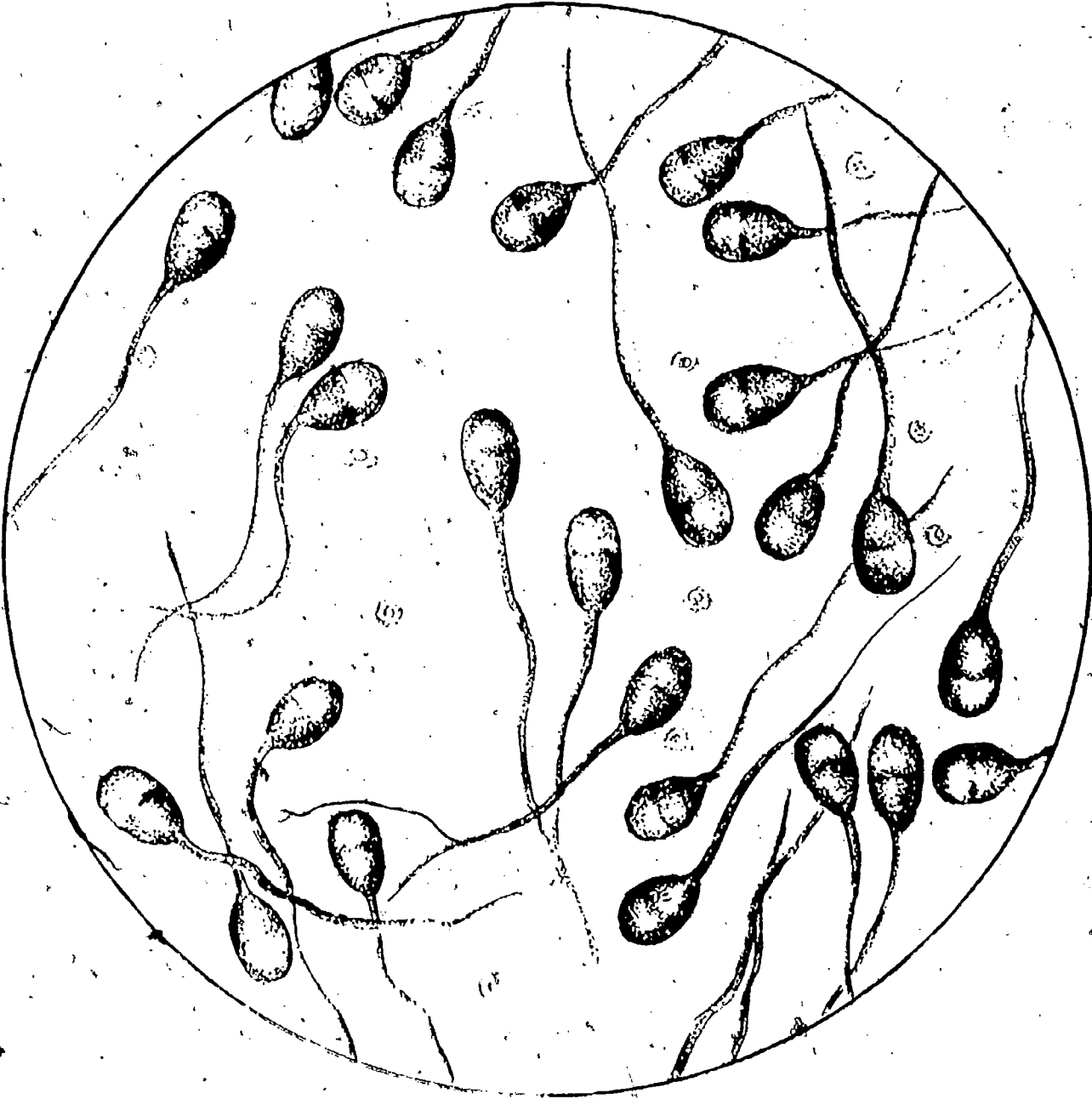

257

# QUESTIONABLE SEMEN

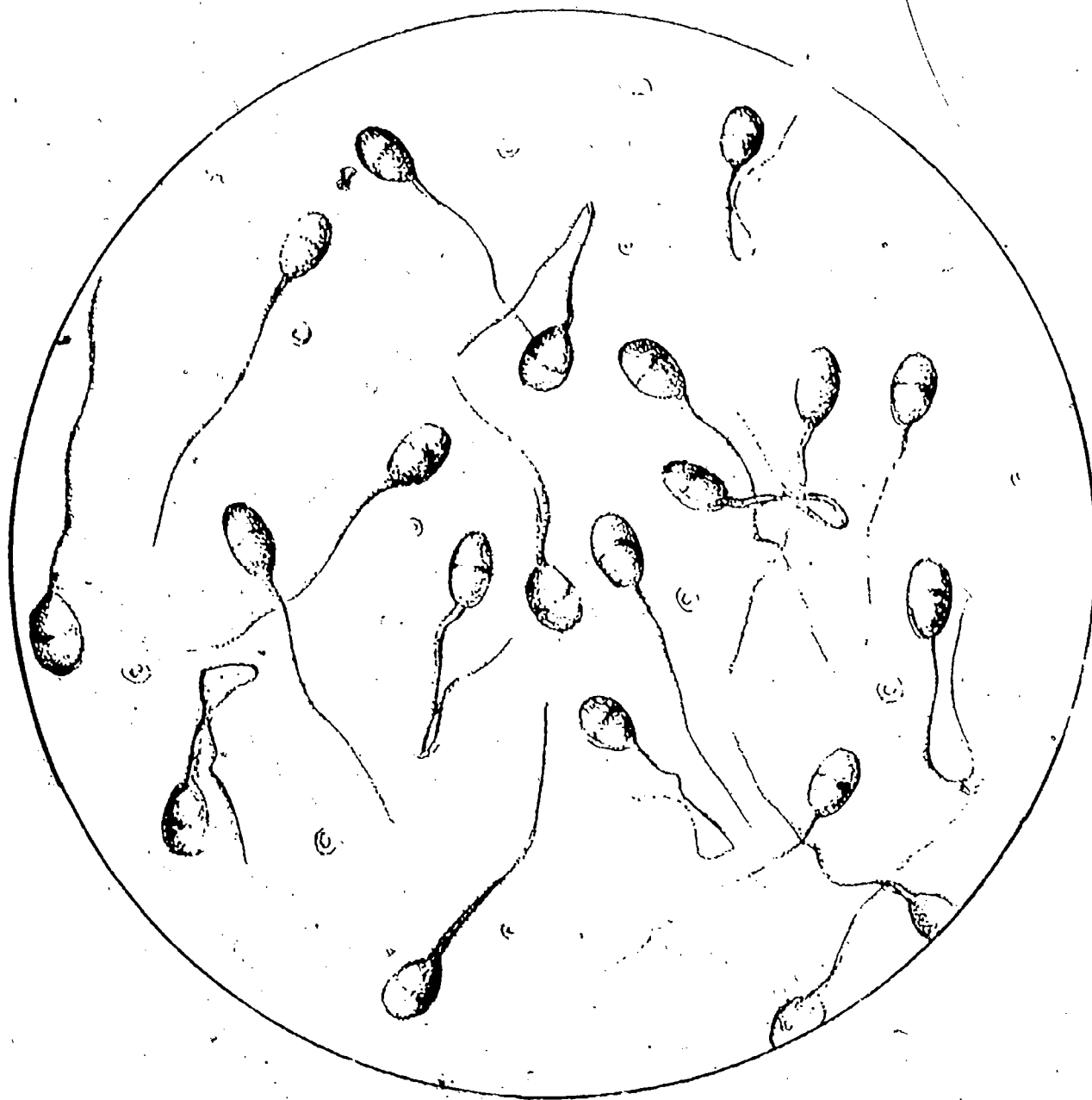

258

# POOR SEMEN

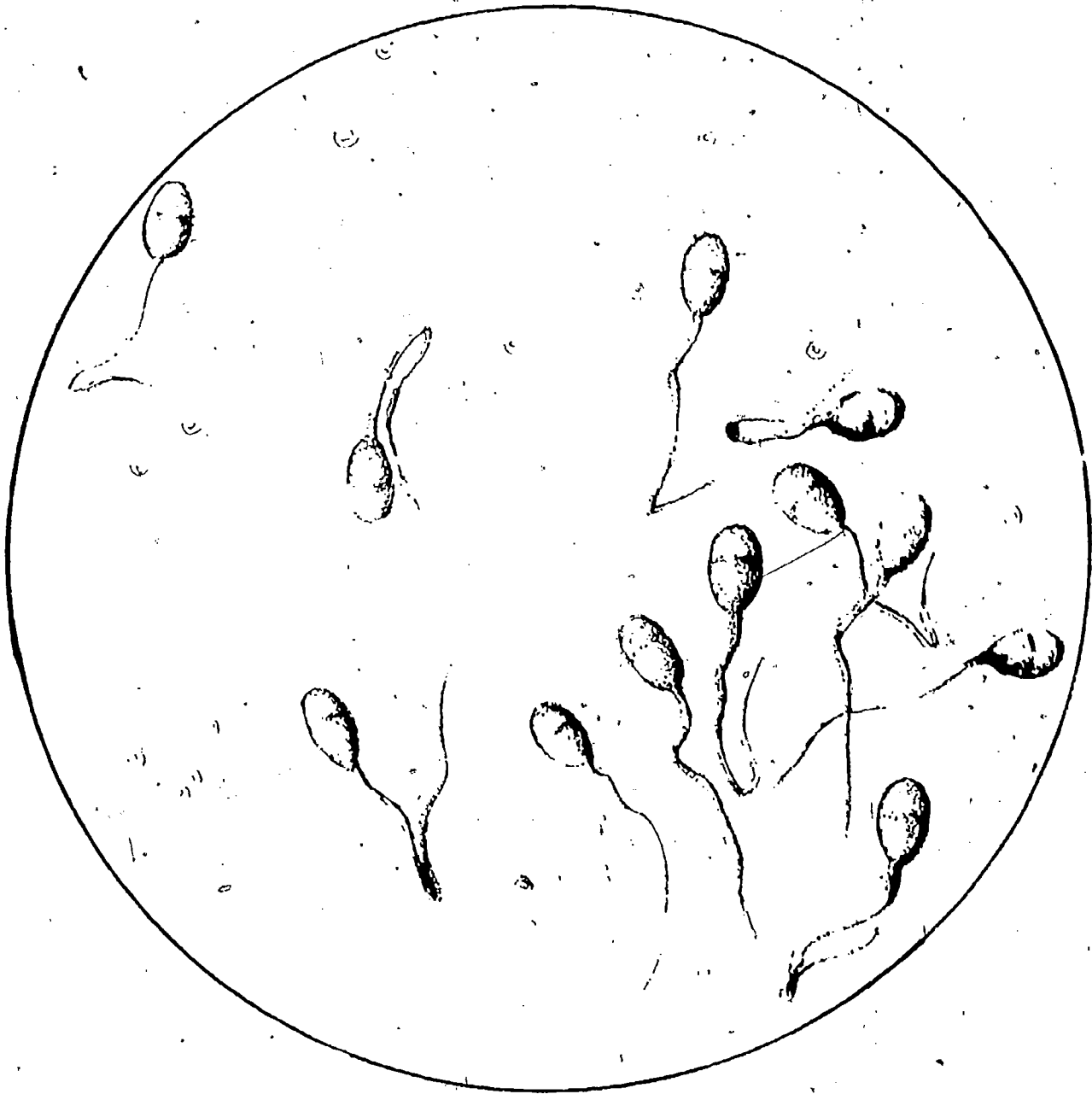

## TRANSPARENCY DISCUSSION GUIDE

### UNDERSTANDING AND USING ARTIFICIAL INSEMINATION

#### Transparencies - WHY BREED ARTIFICIALLY, AND LIMITATIONS OF ARTIFICIAL INSEMINATION

- A. Use these transparencies to supplement and summarize class discussion on artificial insemination.
- B. Supplement items listed on transparencies by providing examples of situations which help clarify the lists.
- C. Have students share their experiences as you review these transparencies.

#### Transparencies - THE REPRODUCTION CYCLE IN FARM ANIMALS, AND TIME OF BREEDING AND CONCEPTION RATE IN CATTLE

- A. Use these transparencies to help clarify the optimum time for insemination of various livestock species.
- B. Point out that the optimal time is in advance of the time of ovulation.
- C. Discuss the different estrous cycle lengths among various species.

#### Transparencies - GOOD SEMEN, QUESTIONABLE SEMEN, AND POOR SEMEN

- A. Use these transparencies as an instructional aid to supplement the Student Job Sheet #1, "Examining Semen".
- B. Point out that good semen has a uniformity and fullness in the heads. The tails are primarily normal, permitting vigorous mobility.
- C. Point out that questionable semen could have about 25% abnormal sperm. It has fairly good mobility and fair viability.
- D. Point out that poor semen contains many sperm with coiled tails, and some are tailless. The heads may appear normal in size and shape. Only a slight movement is noted and some may appear to be lifeless.

TEACHER'S KEY

SAMPLE TEST QUESTIONS

ARTIFICIALLY INSEMINATING LIVESTOCK

Part I. True (+) or False (0)

- 0 1. Artificial insemination was introduced in the United States in 1780.
- + 2. It is possible to inseminate almost all types of livestock.
- + 3. The female mammal produces gametes.
- + 4. Using artificial insemination allows a bull to breed more cows than using natural breeding.
- 0 5. Artificial insemination reduces the need for detailed herd records.
- 0 6. There are two ovaries in a male mammal.
- 0 7. The artificial vagina is operated by electricity.
- + 8. If a cow shows signs of heat in the morning, she should be bred that afternoon.
- + 9. The testes produce the sperm cells.
- + 10. Millions of sperm cells are ejaculated by the male at breeding time.

Part II. Multiple choice (select the best answer to complete the statement.)

- D 1. A disadvantage of using artificial insemination is that it:
- A. Decreases the demand for poor bulls.
  - B. Eliminates the risk of keeping a bull.
  - C. Provides for high uniformity in a herd.
  - D. Requires a skilled technician.
- C 2. The male produces:
- A. eggs.
  - B. gametes.
  - C. sperm cells.
  - D. zygotes.



- D 3. A fertilized sex cell is called a:
- A. ampullae.
  - B. gamete.
  - C. teste.
  - D. zygote.
- C 4. The developing embryo grows and develops in the:
- A. epididymis.
  - B. oviduct.
  - C. uterine horns.
  - D. vulva.
- A 5. The most satisfactory method of collecting semen from farm animals involves:
- A. artificial vagina.
  - B. electroejaculation.
  - C. massaging the ampullae.
  - D. recovering semen from the vagina.
- D 6. The most widely used technique for artificially inseminating cows is by:
- A. simply directing the inseminating tube into the vagina.
  - B. using a hollow glass tube to hold the wall of the vagina out so the opening into the cervix can be seen.
  - C. inserting a hand and arm into the vagina.
  - D. inserting a hand and arm into the rectum and grasping the cervix through the wall of the rectum.
- B 7. The cow, sow, and mare come in heat in intervals of about:
- A. 7 days
  - B. 21 days
  - C. 31 days
  - D. 45 days
- B 8. On cows, the best time for breeding is:
- A. just before the estrous cycle
  - B. in the middle of the estrus
  - C. at the time of ovulation
  - D. after the estrus
- A 9. Artificial insemination has been used most often on:
- A. cows.
  - B. ewes.
  - C. mares.
  - D. sows.

- C 10. The number of sperm cells per cc. of semen in bulls is about one:
- A. thousand.
  - B. million.
  - C. billion.
  - D. trillion.

Part III Matching (match the term with the correct definition.)

- |          |                     |                                   |
|----------|---------------------|-----------------------------------|
| <u>A</u> | 1. seminal vesicles | A. accessory glands               |
| <u>E</u> | 2. semen            | B. where fertilization occurs     |
| <u>H</u> | 3. vagina           | C. forms sperm cells              |
| <u>C</u> | 4. testes           | D. receptive period               |
| <u>I</u> | 5. ovaries          | E. contains fluid and sperm cells |
| <u>F</u> | 6. egg              | F. female sex cell                |
| <u>D</u> | 7. estrus           | G. S-shaped in the boar and bull  |
| <u>J</u> | 8. spermatogenesis  | H. receives penis during mating   |
| <u>G</u> | 9. penis            | I. produce ova                    |
| <u>B</u> | 10. oviducts        | J. sperm cell formation           |

Part IV Completion (complete the sentence with an appropriate word or phrase.)

1. Artificial insemination is the placing of male reproductive cells in the female reproductive tract of animals by people.
2. The vagina connects the cervix with the vulva.
3. The rectovaginal technique is most widely used for artificially inseminating cattle.
4. The artificial vagina is the most satisfactory method of collecting semen from farm animals.
5. Using liquid nitrogen, semen can be stored at a temperature around -320°F.
6. The male hormone testosterone causes the development of male characteristics.

7. The epididymis is where sperm are stored and mature.
8. The cervix is a thick-walled fibrous tube which serves as a gateway between the vagina and uterus.
9. The testes are suspended in the scrotum.
10. The female egg is larger in size than the male sperm.

Part V Essay (Briefly answer each question)

1. Compare the advantages and disadvantages of using artificial insemination as compared to natural breeding of livestock.

(Refer to VAS Unit 1002b, part 1)

2. Describe some basic sanitary precautions which need to be followed when using artificial insemination.

(Refer to VAS Unit 1002b, part 4)

## UNIT D: LIVESTOCK SCIENCE

### PROBLEM AREA: UNDERSTANDING BASIC GENETICS AND REPRODUCTION

#### SUGGESTIONS TO THE TEACHER:

This problem area is designed for use with advanced students in vocational agriculture programs. The recommended time for teaching this problem area is during the winter months between seasonal activities in agriculture businesses.

The estimated instructional time for this problem area is 3 to 5 days depending on how far the teacher wishes to go in developing the student's knowledge of genetics.

If the students are to be involved in other activities, the instructional time will need to be increased.

The instructor is encouraged to conduct a local search to locate other supplementary materials for use with this problem area. The items in this problem area are for reference or modification as instructors adapt these materials to their local situation.

#### CREDIT SOURCES:

These materials were developed through a funding agreement, R-33-24-D-0362-466 with the Illinois State Board of Education, Department of Adult, Vocational and Technical Education, Research and Development Section, 100 North First Street, Springfield, Illinois 62777. Opinions expressed in these materials do not reflect, nor should they be construed as policy or opinion of the State Board of Education or its staff.

The teacher's guide, student worksheets, information sheets, transparency discussion guide, and sample test questions were developed by Tom Faulkner, vocational agriculture instructor, Union High School, Biggsville, Illinois and Jerry D. Pepple, Department of Vocational and Technical Education, University of Illinois.

The artwork in this problem area was prepared by the Vocational Agriculture Service, University of Illinois. Suggestions and guidance in the development of these materials were provided by the following vocational agriculture teachers:

Tom Faulkner	-	Union High School
Kent Johnson	-	Galva High School
Donald Miller	-	New Holland - Middletown High School
Paul Mealiff	-	Carthage High School
Floyd W Ehrley	-	Kewanee High School
Bill Bree	-	Lincoln High School
Steve Myers	-	Lewistown High School

## TEACHER'S GUIDE

- I. Unit: Livestock science
- II. Problem area: Understanding basic genetics and reproduction
- III. Objectives: At the end of this problem area students will be able to:
  1. Identify the importance of the cell and cell parts.
  2. Explain the difference between sexual and asexual reproduction.
  3. Explain the transmission of genetic characteristics.
  4. Define terms relating to reproduction and fertilization.
  5. Explain how the sex of an offspring is determined.
  6. Demonstrate with the "checkerboard method" the probable results of crosses when given certain gene characteristics.
- IV. Suggested interest approaches:
  1. Have a purebred breeder make a presentation to the class on the importance of improving the herd through selection.
  2. Show how probable crosses may be derived by the use of the checkerboard method.
  3. Ask lead questions:
    - a. What is the importance of the chromosomes in reproduction?
    - b. What is a dominant characteristic? Recessive characteristics?
    - c. Why should there be concern in improving the herd through breeding?
    - d. How and when is the sex of an animal determined?
  4. Show slides or pictures of livestock and/or plants and ask students if selected characteristics are due to genes or environment. Develop class discussion on the nature vs. nurture issue.
- V. Anticipated problems and concerns of students:
  1. What is sexual reproduction?
  2. How can animals be improved through breeding?
  3. How are the characteristics of an animal determined?
  4. What are chromosomes and genes?
  5. What are cells?

6. What are the parts of a cell?
7. How do cells reproduce?
8. What is asexual reproduction?
9. What are germ-cells?
10. What happens during fertilization?
11. How can I determine offspring characteristics?
12. How is the sex of an offspring determined at time of fertilization.
13. What are sex-linked characters?
14. How can selection be used to improve livestock quality?
15. What is genetics?
16. What are genes? Chromosomes? DNA? RNA?
17. How many chromosomes are in animal cells?
18. What is the difference between homozygous and heterozygous?
19. What is mitosis? Meiosis?
20. What are dominant and recessive genes?
21. What is the relationship between heredity and environment in determining characteristics?
22. What is a mutation? What causes it?
23. What is the difference between phenotype and genotype?
24. What is a purebred? Thoroughbred? Crossbred? Inbred?
25. Which is more important the selection of a boar or sow? Why?

VI. Suggested learning activities and experiences:

1. Conduct an interest approach using one of those suggested in Section IV.
2. Have students identify their problems and concerns by asking them lead questions.
3. Ask a local purebred breeder to explain how to improve a herd through the selection of animals.

4. Secure photographs or slides of mutations and perfect animals for class discussion on how the animals differ and probable causes.
5. Have students complete a probability chart using the reference materials.
6. Discuss and work through sample problems on how the sex of an animal is determined.
7. Distribute information sheets concerning basic genetics and reproduction to provide additional topics of discussion.
8. Distribute student worksheets and have students complete the exercises. Discuss and evaluate their responses.
9. Use chalkboard or overhead projector to explain and illustrate the process of mitosis and meiosis.
10. Have students prepare an oral or written report on a selected topic relating to animal genetics and breeding.

#### VII. Application procedures:

1. Students may use the knowledge acquired in this problem area to improve livestock through breeding and selection.
2. Students may use the knowledge acquired in this problem area to improve their S.O.E.P. by working with a purebred association, or a herdsman to select desirable animals.

#### VIII. Evaluation:

1. Evaluate students' worksheets used with this problem area.
2. Evaluate student reports and other out-of-class assignments.
3. Construct and administer a paper and pencil test using some of the sample test questions included in this problem area.

#### IX. References and aids:

Available from Vocational Agriculture Service, University of Illinois, College of Agriculture, 1401 South Maryland Drive, Urbana, Illinois 61801:

1. VAS Unit 1009a, "Improving Animals Through Breeding".
2. VAS Unit 1039a, "Systems of Swine Breeding".
3. Transparency Set, "Animal Genetics and Breeding".



## COMPETENCY INVENTORY

### UNDERSTANDING BASIC GENETICS AND REPRODUCTION

1. Student has no knowledge of competency.
2. Student has read about competency.
3. Student has seen competency performed.
4. Student has performed competency.
5. Student has performed competency without supervision.
6. Student does possess skill.
7. Student does not possess skill.

Competency

Circle One

1. Compare the maturation process male and female germ-cells.	1	2	3	4	5	
2. Identify dominant and recessive characters of selected livestock species.	1	2	3	4	5	
3. Define terms associated with livestock genetics and breeding.						6 7
4. Discuss how the genetic character of an animal is determined.						6 7
5. Discuss how the sex of an offspring is determined.						6 7
6. Use the "checkerboard method" to estimate possible gene combinations.						6 7
7. Explain how genetics can be used to improve livestock.						6 7
8. Identify and explain the steps in mitosis.						6 7
9. Discuss the influence of nature vs. nurture in causing variations within livestock species.						6 7
10. Explain how selection can be used to improve livestock.						6 7

These competencies are outlined in the National Ag Occupations Competency Study, 1978, for entry level positions in agriculture.

Name \_\_\_\_\_

Date \_\_\_\_\_



INFORMATION SHEET #1

CELL PARTS

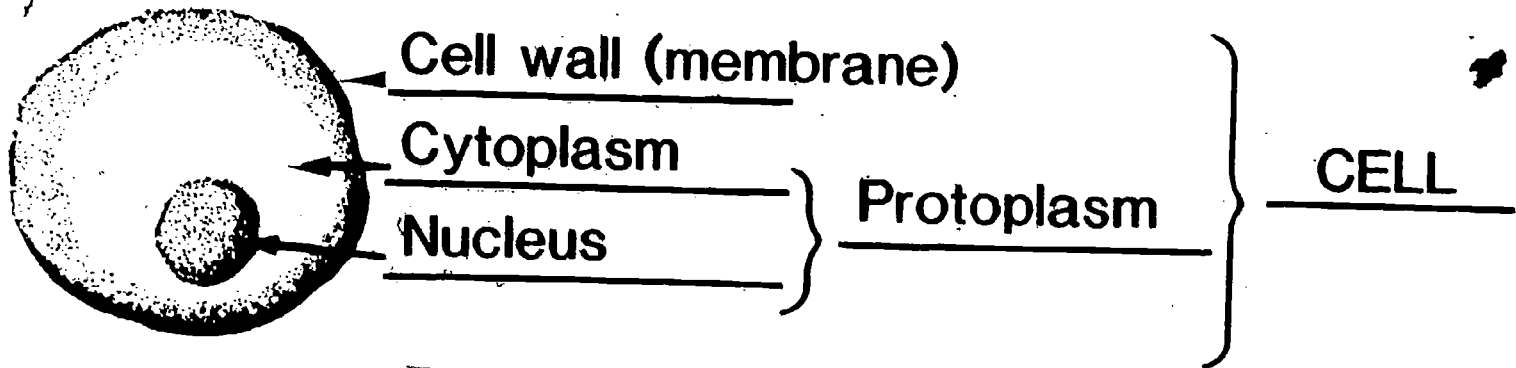

Cell - Small all structural units of an animal body. Also, the basis of improvement since most animals start their life from a single fertilized cell.

Protoplasm - The living material within the cell and often referred to as the physical basis of life.

Cytoplasm - Protoplasm outside the nucleus.

Nucleus - The part of the cell which contains the chromatin material.

Cell Wall - The membranous wall which encloses the cell. May or may not be well defined.

INFORMATION SHEET #2

PARTS OF CELL NUCLEUS

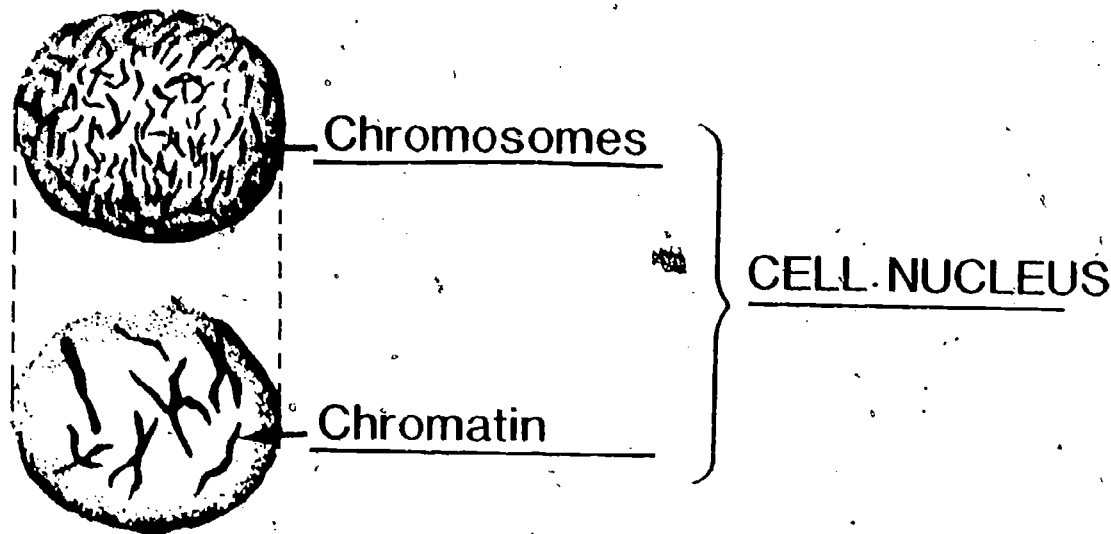

(Chromatin material is located within the nucleus of the cell. In certain stages the chromatin changes into rather definite bodies, called chromosomes.)

Chromatin - Part of the protoplasm material in the cell which carries the genes.

Chromosomes - Organized masses of chromatin that carries the genes. Chromosomes are sometimes referred to as the carriers of the hereditary material.

Gene - That material in the reproductive cell that gives rise to a character. The smallest unit of inheritance.

The numbers of chromosomes possessed by some animals are as follows:

Swine.....	38
Man.....	46
Cattle.....	60
Horse.....	64
Sheep.....	54
Chicken.....	78
Cat.....	38
Donkey.....	62
Mule.....	63
Dog.....	78
Mink.....	30

## INFORMATION SHEET #3

### REPRODUCTION

#### I. Asexual Reproduction -

- a. Occurs without the aid of germ cells.
- b. Simple cell division of a bacteria is one form of asexual reproduction.
- c. Another method is by budding. Yeasts reproduce this way.

#### II. Sexual Reproduction -

- a. Occurs with the start of a fertilized cell.
- b. Gametes - the cells from which a new individual is produced.
- c. Sperms, spermatozoa - the germ cells formed by the male.
- d. Eggs, ova - the germ cells formed by the female.

III. In the maturation process the number of chromosomes in both the male and female germ cells are reduced by one-half the original number. This is known as meiosis in sex cells.

IV. Mutations occur when a gene fails to exactly duplicate itself and a "new gene" is born:

##### a. Lethals:

1. Occur where there is a lack of a chromosome.
2. Causes death of the organism either before or at birth.

##### b. Sub-lethals:

1. Could be more serious than lethals as they can be carried by an animal unnoticed but be visible in offspring.
2. Could eventually cause death of the organism.
3. Could cause changes in phenotype.

INFORMATION SHEET #4

FERTILIZATION

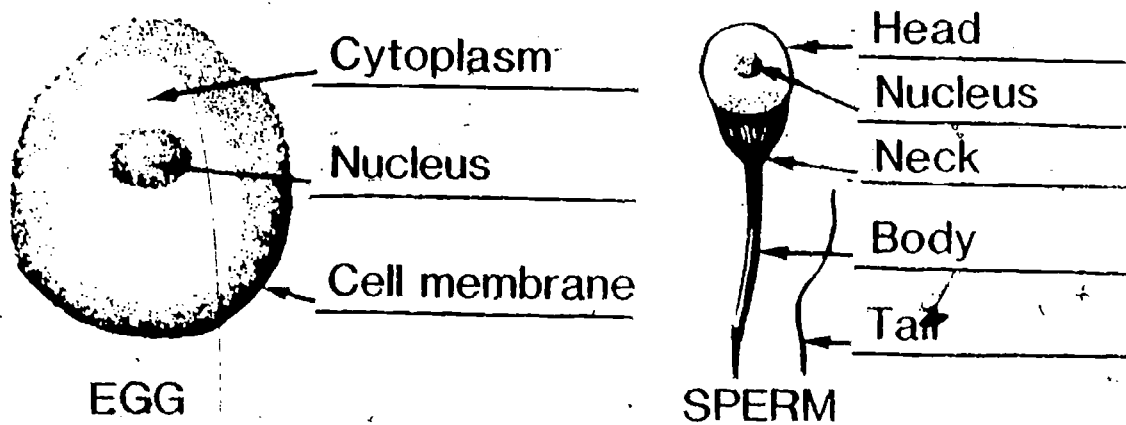

(Eggs are usually much larger than the sperm.  
The tail of the sperm serves as an organ of locomotion.)

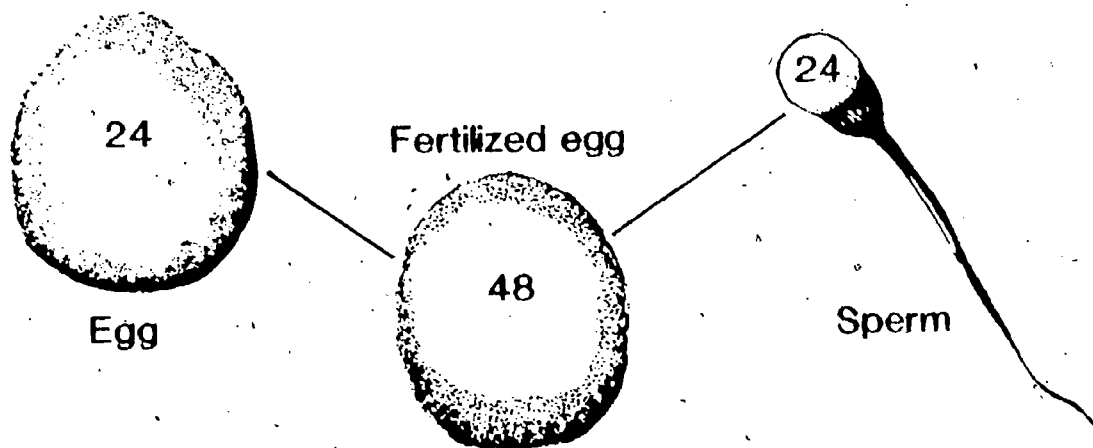

(Fertilization restores the original number of chromosomes, which was reduced during maturation.)

- IV. Fertilization - the union of the nuclei of the male and female reproductive cells restoring the original number of chromosomes which were reduced in maturation.
- a. Zygote - the fertilized egg that contains all of the hereditary material which the developing plant or animal will ever have.
  - b. Identical twins - one fertilized egg will form two separate parts, and from each part an individual is produced.
  - c. Fraternal twins - two individuals produced from two separate fertilized eggs.
  - d. Freemartin - heifer calf born twin with bull calf. The female may be sterile due to an undeveloped reproductive tract.

INFORMATION SHEET #5  
TRANSMISSION OF CHARACTERS

1. A character may be defined as a distinguishing detail of structure or form of an individual.
2. Genes that are located in the reproductive cells are the source of a character.
3. Dominant genes hide or mask the presence of another (usually designated by capital letters).
4. Recessive genes will express their character only in the absence of the dominant character (usually designated by a small letter).
5. Homozygous characteristics have two like genes for the same character.
6. Heterozygous characteristics have two different genes that affect a character.
7. Phenotype is how an animal looks, genotype is the genetic makeup of the cells of the animal.
8. Inbreeding is the mating of closely related animals (such as sire to daughter, sister to brother, dam to son).
9. Sire selection is generally more important than the dam because the sire affects the offspring of the entire herd.
10. The sire determines the sex of the offspring because his reproductive cells contain both X and Y sex chromosomes and the dam has only X sex chromosomes.
11. All chromosomes other than sex chromosomes are called autosomes.

## STUDENT WORKSHEET #1

### BASIC GENETICS AND REPRODUCTION PRE-TEST

Answer the following questions to evaluate your present knowledge of basic genetics and reproduction.

I. True (+) False (o)

1. The sex of an animal is determined at the time of fertilization.
2. An individual that carries two different genes for a character is said to be homozygous.
3. The cell is the basis of improvement since most animals start life from a fertilized cell.
4. Identical twins came from two different fertilized eggs.
5. The egg carries half the genetic material while the sperm carries the other half.
6. Fertilization is the union of the sperm and the egg.
7. Genes that hide or mask the presence of another character is said to be recessive.
8. During fertilization, a sperm carrying an x chromosome units with an egg the resulting offspring will be male (xx).
9. The zygote or fertilized egg contains only half of the genetic material necessary for the animal.
10. A cell is made up largely of material called protoplasm.
11. Chromosomes carry the genes.
12. Asexual reproduction occurs without the aid of germ cells.
13. During the maturation process the number of chromosomes in both the sperm and egg is reduced to half the original number.
14. Character is a distinguishing detail of structure or form of an individual.
15. The nucleus is the denser portion of the cell that contains the chromatin material.

## II. Matching

- |       |                          |  |
|-------|--------------------------|--|
| _____ | 1. Cytoplasm             | A. Carry the genes.  |
| _____ | 2. Chromosomes           | B. Male germ cells.  |
| _____ | 3. Heterozygous          | C. Protoplasm outside the nucleus.                                 |
| _____ | 4. Recessive character   | D. Occurs without the aid of germ cells.                           |
| _____ | 5. Fertilization         | E. Fertilized egg.   |
| _____ | 6. Sexual reproduction   | F. Have two like genes for a character.                            |
| _____ | 7. Fraternal twins       | G. Developed from single fertilized egg.                           |
| _____ | 8. Sperm                 | H. A distinguishing detail of an individual.                       |
| _____ | 9. Character             | I. Developed from two different zygotes.                           |
| _____ | 10. Protoplasm           | J. Female germ cells.  |
| _____ | 11. Asexual reproduction | K. Starts with the single fertilized egg.                          |
| _____ | 12. Identical twins      | L. Union of sperm and egg.   |
| _____ | 13. Ova                  | M. A character that shows only in absence of a dominant character. |
| _____ | 14. Homozygous           | O. Have two different genes for a character.                       |
| _____ | 15. Zygote               |  |

How did you score?

- |       |              |   |
|-------|--------------|---|
| _____ | 28-30        | (excellent, keep up the good work)            |
| _____ | 25-27        | (very good, but you could use some reviewing) |
| _____ | 22-24        | (let's read the reference material)           |
| _____ | 19-21        | (you better be here every day for class)      |
| _____ | less than 19 | (sit in the front row)                        |

273

STUDENT WORKSHEET #2  
TRANSMISSION OF CHARACTERS

1.

Chart 1 Information

Fill out the chart above for the possible characteristics from the following mating:

The bull is homozygous for black (BB) and the cow is homozygous for black (BB). Indicate whether the offspring will be homozygous (pure) or heterozygous (impure).



2.

Chart 2 Information

Fill out the above chart for the possible characteristics from the following mating:

The bull is homozygous for black (BB) and the cow is heterozygous for black (Bb). Indicate whether the offspring will be homozygous (pure) or heterozygous (impure).

3.

Chart 3 Information

Fill out the above chart for the possible characteristics from the following mating:

The bull is heterozygous for black (Bb) and the cow is heterozygous for black (Bb). Indicate whether the offspring will be homozygous (pure) or heterozygous (impure).

STUDENT WORKSHEET #3

PARTS OF ANIMAL CELLS

1. Identify the following parts of the cell.

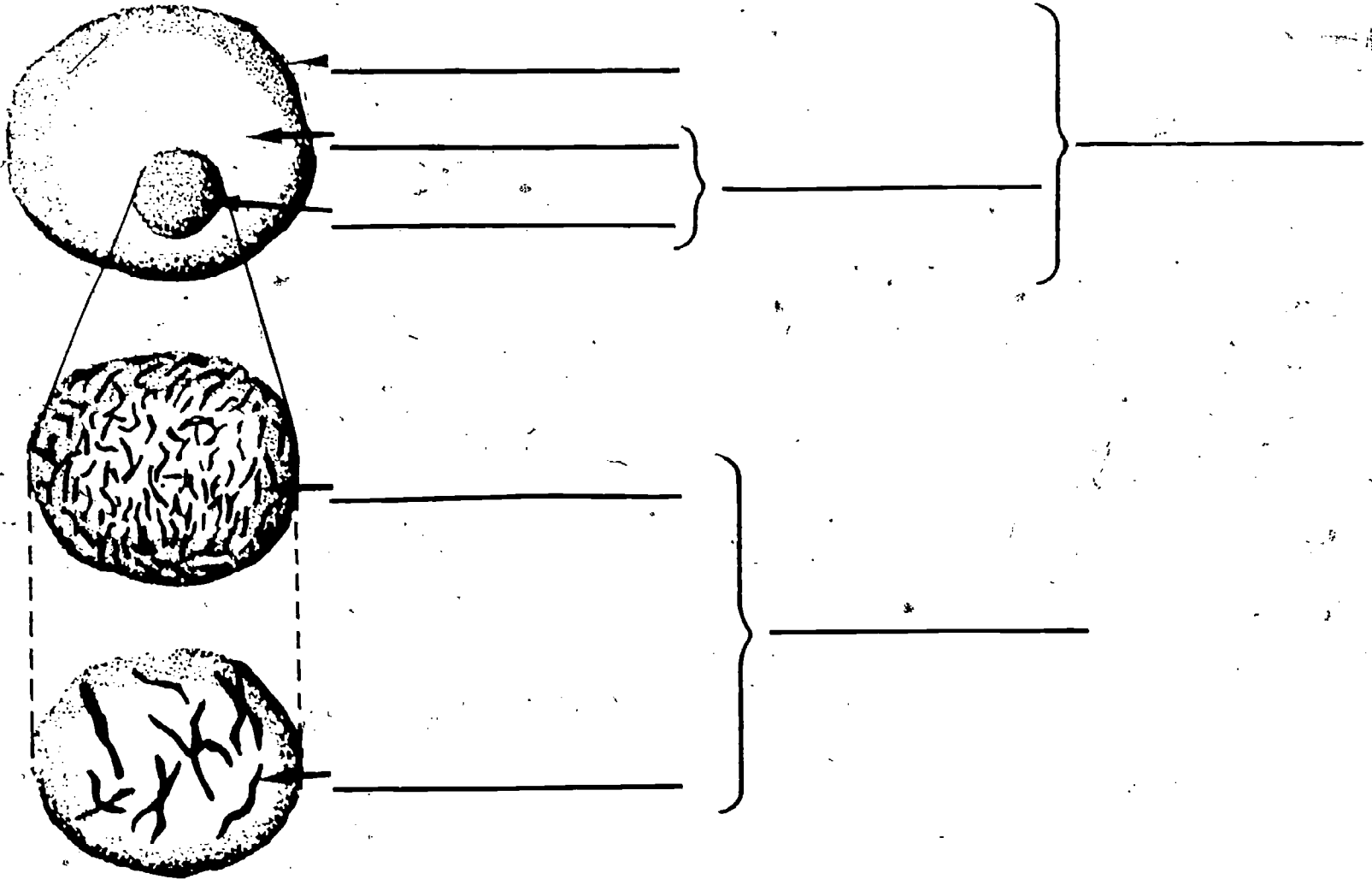

2. Identify the following parts of the egg and sperm cells.

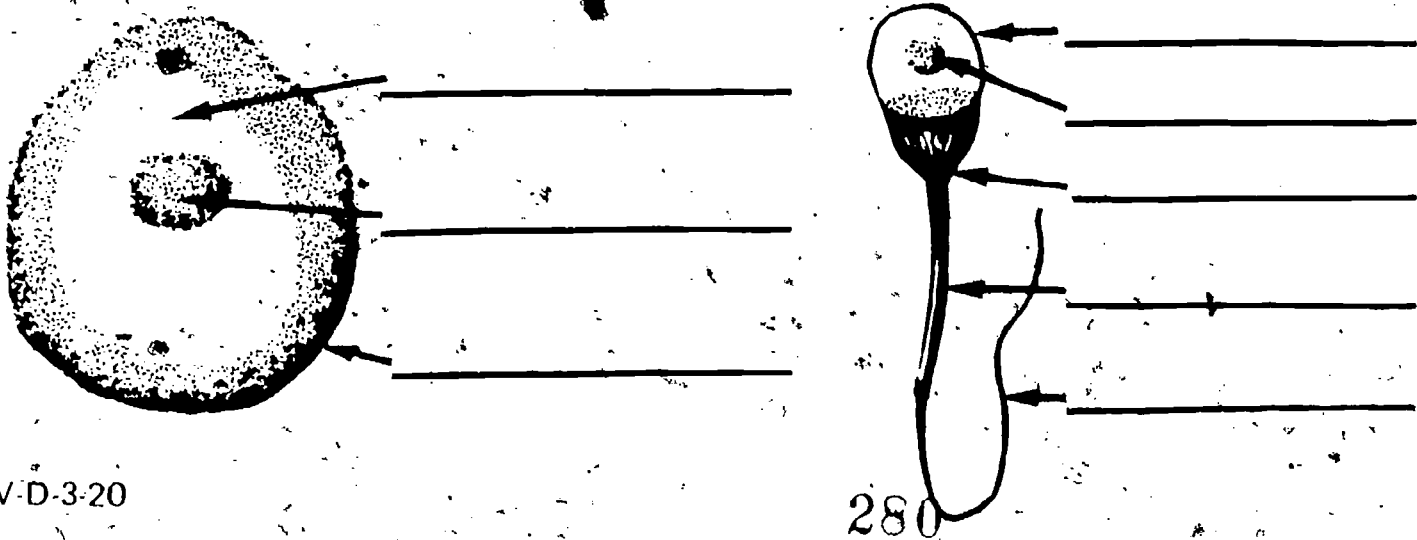

# STEPS IN CELL MITOSIS

3. Correctly label the steps in mitosis.

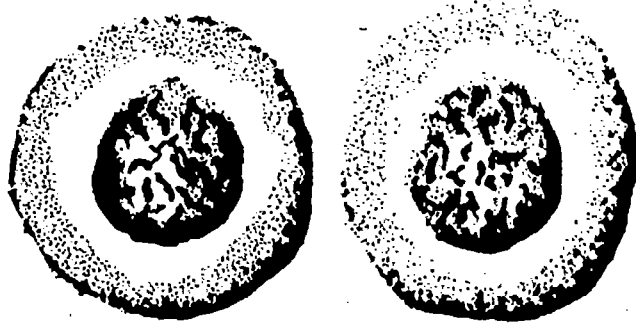
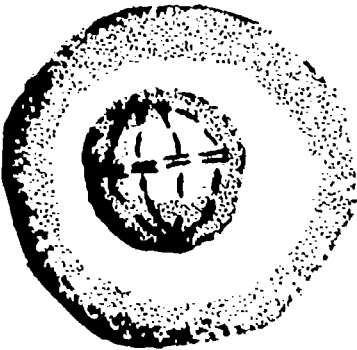
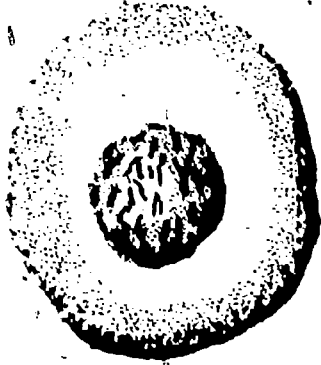

TEACHER'S KEY

STUDENT WORKSHEET #1

BASIC GENETICS AND REPRODUCTION PRE-TEST

Answer the following questions to evaluate your present knowledge of basic genetics and reproduction.

I. True (+) False (o)

- +   1. The sex of an animal is determined at the time of fertilization.
- o   2. An individual that carries two different genes for a character is said to be homozygous.
- +   3. The cell is the basis of improvement since most animals start life from a fertilized cell.
- o   4. Identical twins came from two different fertilized eggs.
- +   5. The egg carries half the genetic material while the sperm carries the other half.
- +   6. Fertilization is the union of the sperm and the egg.
- o   7. Genes that hide or mask the presence of another character is said to be recessive.
- o   8. During fertilization, a sperm carrying an x chromosome units with an egg the resulting offspring will be male (xx).
- o   9. The zygote or fertilized egg contains only half of the genetic material necessary for the animal.
- +   10. A cell is made up largely of material called protoplasm.
- +   11. Chromosomes carry the genes.
- +   12. Asexual reproduction occurs without the aid of germ cells.
- +   13. During the maturation process the number of chromosomes in both the sperm and egg is reduced to half the original number.
- +   14. Character is a distinguishing detail of structure or form of an individual.
- +   15. The nucleus is the denser portion of the cell that contains the chromatin material.

II. Matching

- |           |                          |  |
|-----------|--------------------------|--|
| <u>C.</u> | 1. Cytoplasm             | A. Carry the genes.  |
| <u>A</u>  | 2. Chromosomes           | B. Male germ cells.  |
| <u>O</u>  | 3. Heterozygous          | C. Protoplasm outside the nucleus.                                 |
| <u>M</u>  | 4. Recessive character   | D. Occurs without the aid of germ cells.                           |
| <u>L</u>  | 5. Fertilization         | E. Fertilized egg.   |
| <u>K</u>  | 6. Sexual reproduction   | F. Have two like genes for a character.                            |
| <u>I</u>  | 7. Fraternal twins       | G. Developed from single fertilized egg.                           |
| <u>B</u>  | 8. Sperm                 | H. A distinguishing detail of an individual.                       |
| <u>H</u>  | 9. Character             | I. Developed from two different zygotes.                           |
| <u>N</u>  | 10. Protoplasm           | J. Female germ cells.  |
| <u>D</u>  | 11. Asexual reproduction | K. Starts with the single fertilized egg.                          |
| <u>G</u>  | 12. Identical twins      | L. Union of sperm and egg.   |
| <u>J</u>  | 13. Ova                  | M. A character that shows only in absence of a dominant character. |
| <u>F</u>  | 14. Homozygous           | O. Have two different genes for a character.                       |
| <u>E</u>  | 15. Zygote               |  |

How did you score?

- |       |              |   |
|-------|--------------|---|
| _____ | 28-30        | (excellent, <u>keep up</u> the good work)     |
| _____ | 25-27        | (very good, but you could use some reviewing) |
| _____ | 22-24        | (let's read the reference material)           |
| _____ | 19-21        | (you better be here every day for class)      |
| _____ | less than 19 | (sit in the front row)                        |

TEACHER'S KEY  
STUDENT WORKSHEET #2  
TRANSMISSION OF CHARACTERS

1.

	<b>B</b>	<b>B</b>
<b>B</b>	<b>BB</b> (PURE)	<b>BB</b> (PURE)
<b>B</b>	<b>BB</b> (PURE)	<b>BB</b> (PURE)

Chart 1 Information

Fill out the chart above for the possible characteristics from the following mating:

The bull is homozygous for black (BB) and the cow is homozygous for black (BB). Indicate whether the offspring will be homozygous (pure) or heterozygous (impure).

2.

	<b>B</b>	<b>B</b>
<b>B</b>	<b>BB</b> (PURE)	<b>BB</b> (PURE)
<b>b</b>	<b>Bb</b> (IMPURE)	<b>Bb</b> (IMPURE)

Chart 2 Information

Fill out the above chart for the possible characteristics from the following mating:

The bull is homozygous for black (BB) and the cow is heterozygous for black (Bb). Indicate whether the offspring will be homozygous (pure) or heterozygous (impure).



3.

	<b>B</b>	<b>b</b>
<b>B</b>	<b>BB</b> (PURE)	<b>Bb</b> (IMPURE)
<b>b</b>	<b>Bb</b> (IMPURE)	<b>bb</b> (PURE)

Chart 3. Information

Fill out the above chart for the possible characteristics from the following mating:

The bull is heterozygous for black (Bb) and the cow is heterozygous for black. (Bb). Indicate whether the offspring will be homozygous (pure) or heterozygous (impure).

TEACHER'S KEY

STUDENT WORKSHEET #3

PARTS OF ANIMAL CELLS

1. Identify the following parts of the cell.

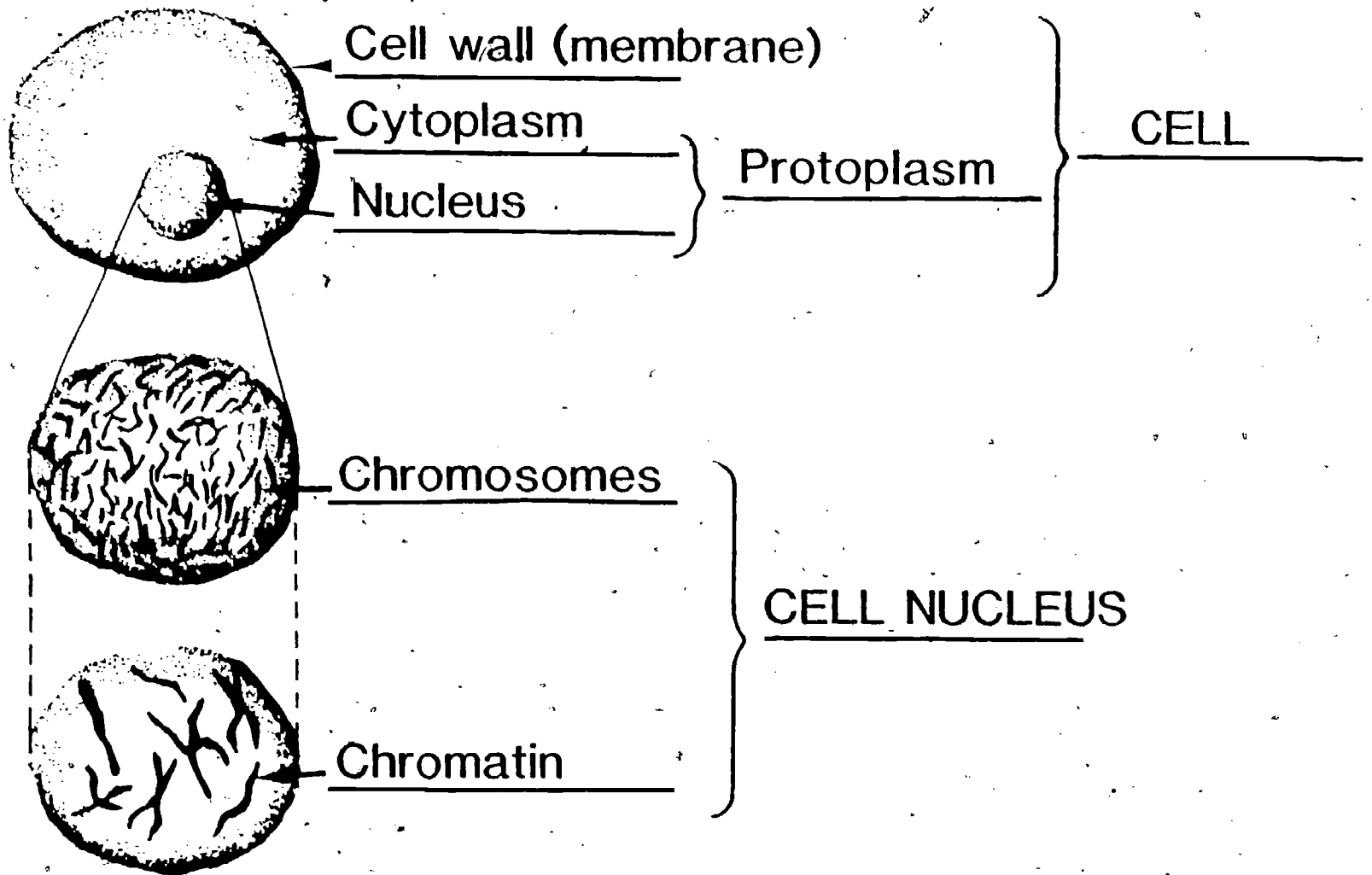

2. Identify the following parts of the egg and sperm cells.

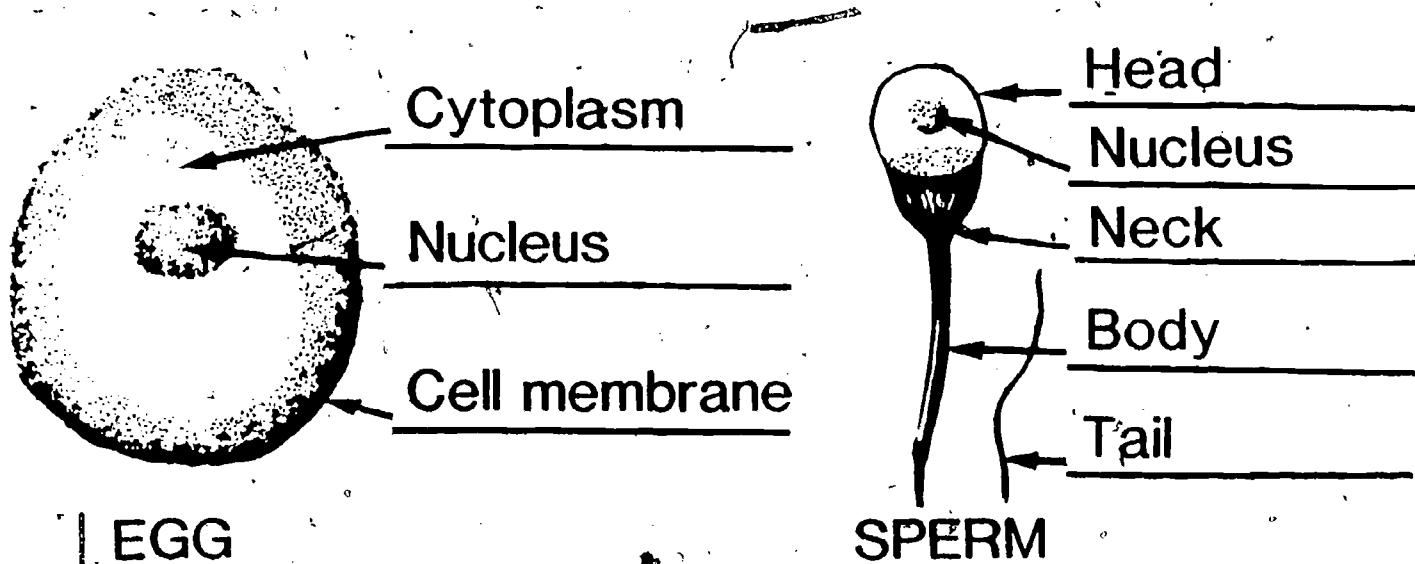

# STEPS IN CELL MITOSIS

3. Correctly label the steps in mitosis.

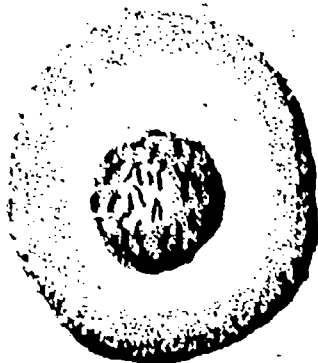

RESTING CELL

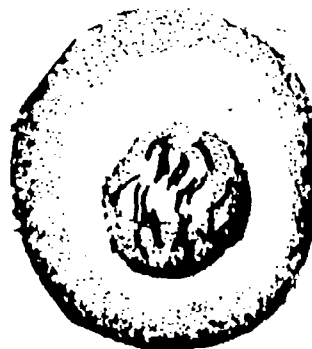

CHROMOSOMES FORMING

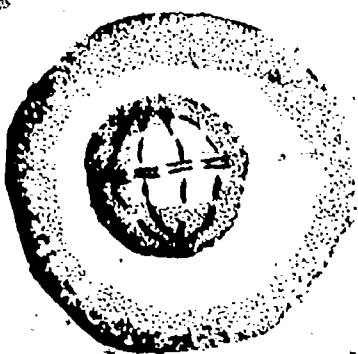

CHROMOSOMES DIVIDING

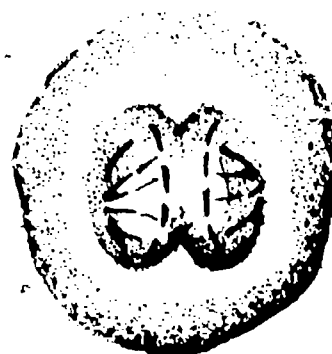

CHROMOSOMES AND NUCLEUS SEPARATING



CELL DIVIDING

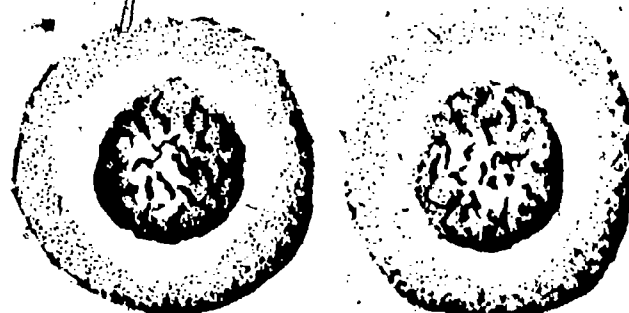

TWO CELLS FORMED

# STEPS IN CELL MITOSIS

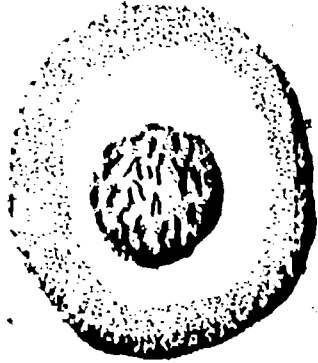

RESTING CELL



CHROMOSOMES FORMING

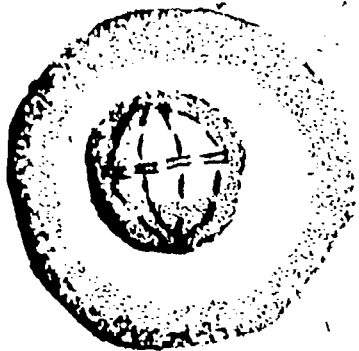

CHROMOSOMES DIVIDING

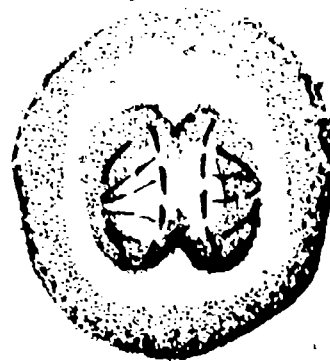

CHROMOSOMES AND NUCLEUS SEPARATING



CELL DIVIDING

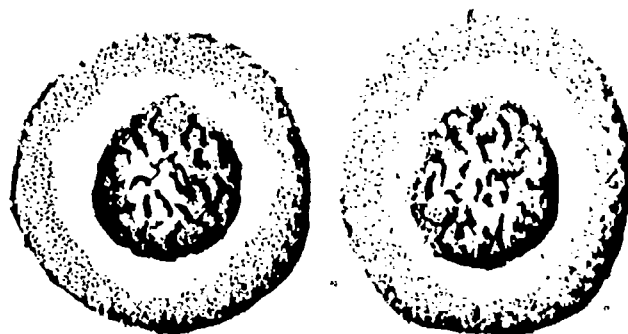

TWO CELLS FORMED

# MATURATION PROCESS (MEIOSIS)

Male Germ Cell

Female Germ Cell

(SPERM)

(EGG)

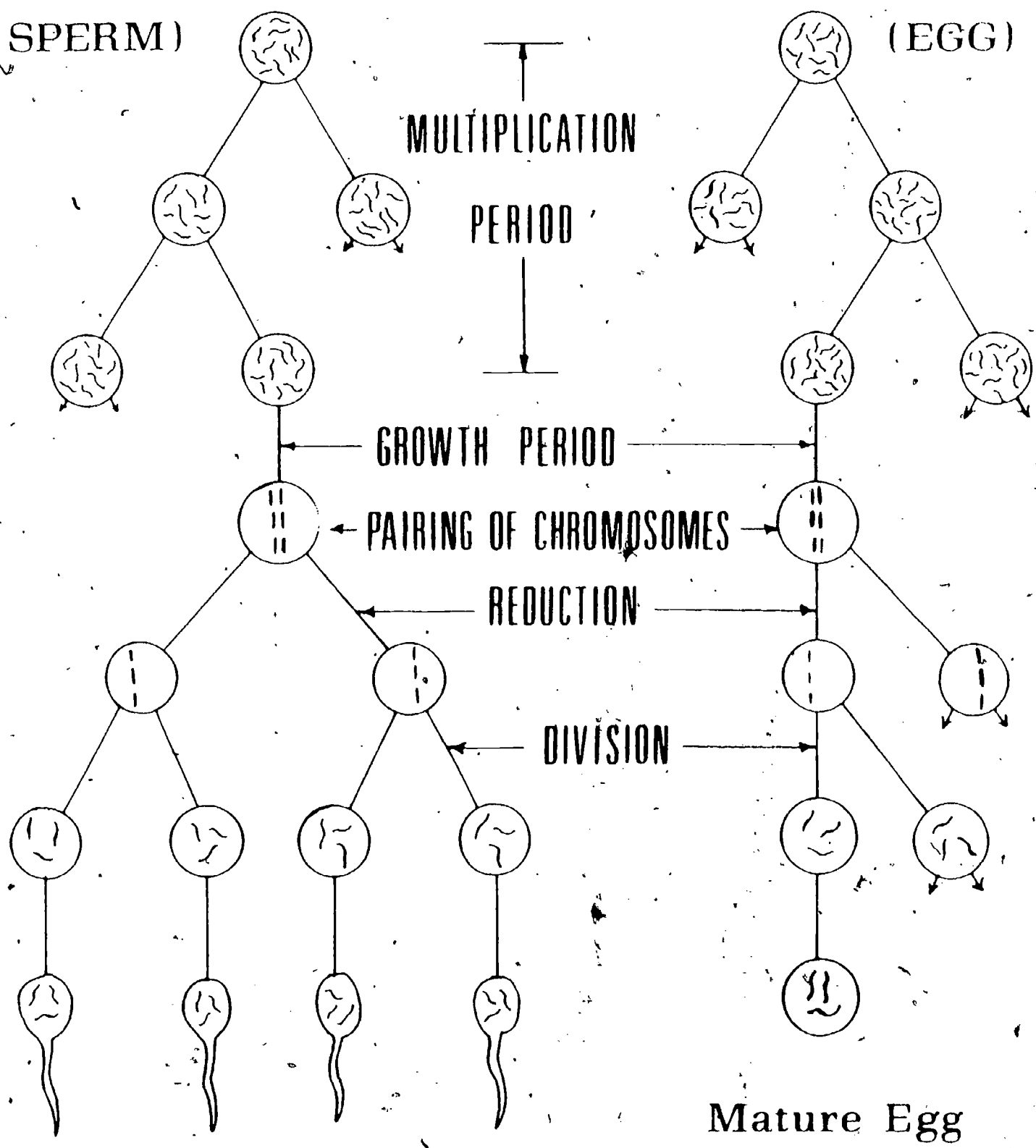

Mature Sperm

Mature Egg

# SEX DETERMINATION IN ANIMALS

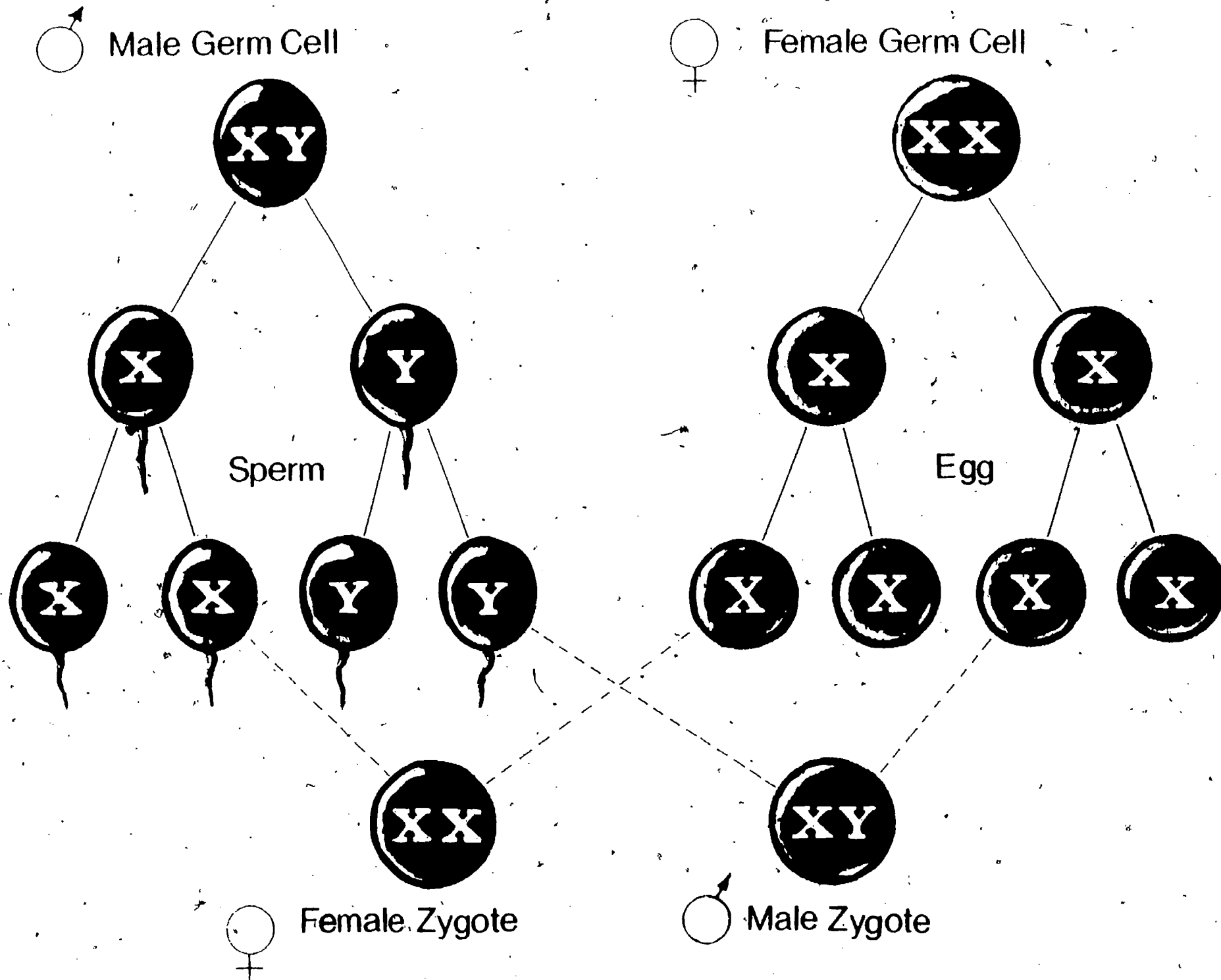

IV-D-3-33

# A DIAGRAM FOR DETERMINING THE PROBABLE RESULTS FROM A DOMINANT AND RECESSIVE CHARACTER

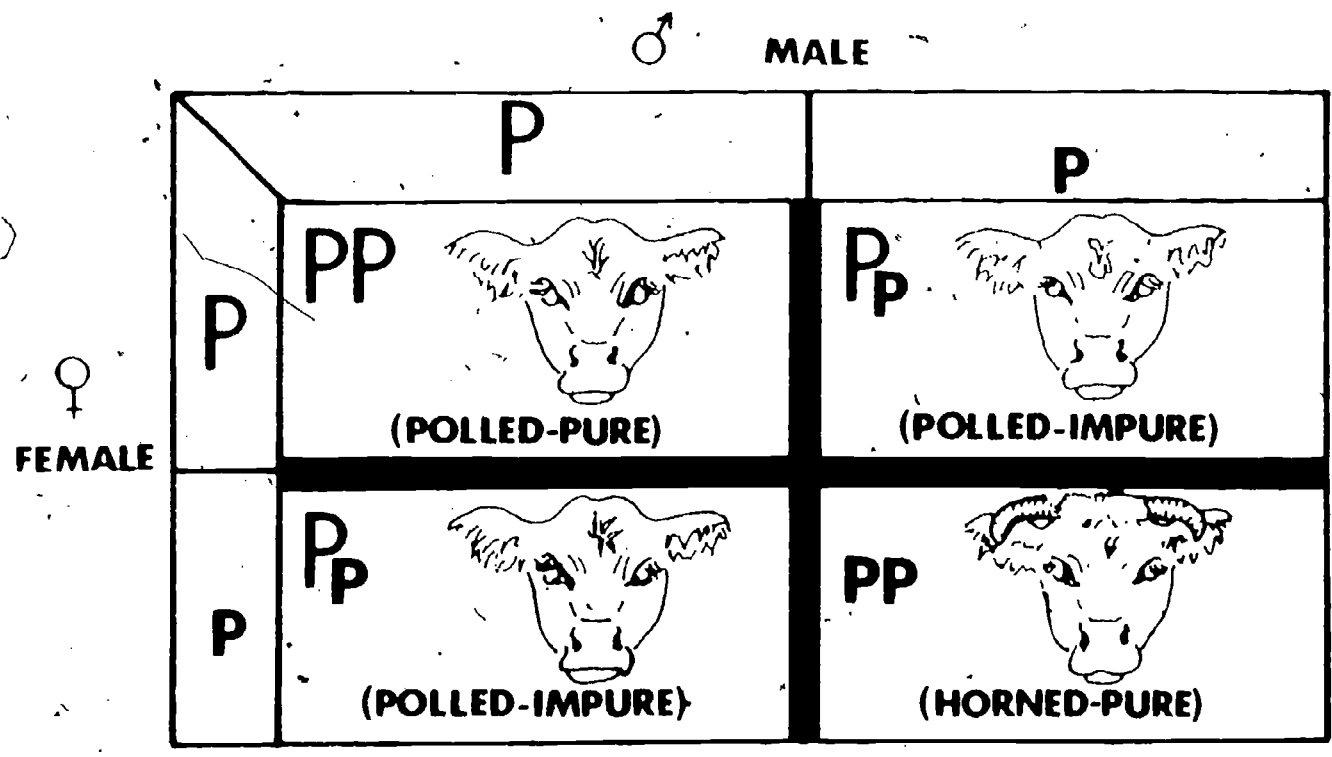
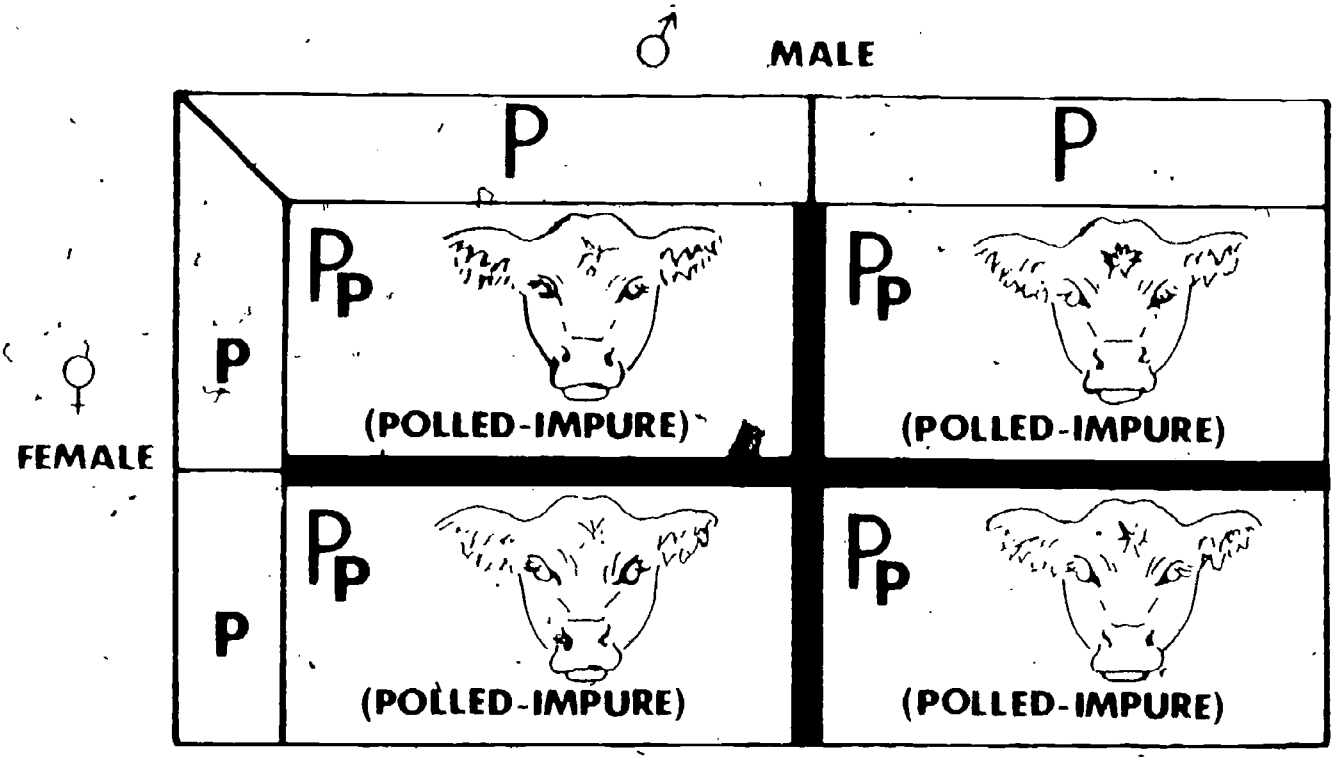

# COLOR DETERMINATION IN SHORTHORNS

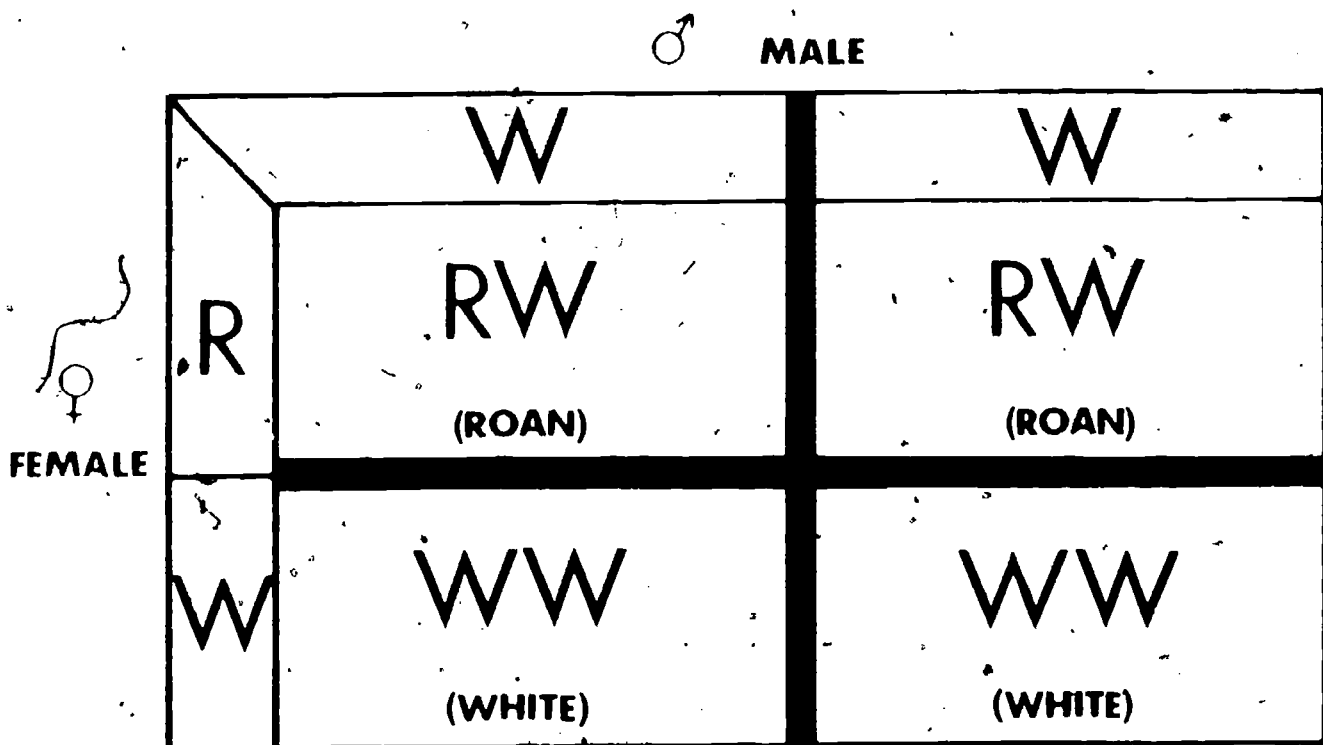
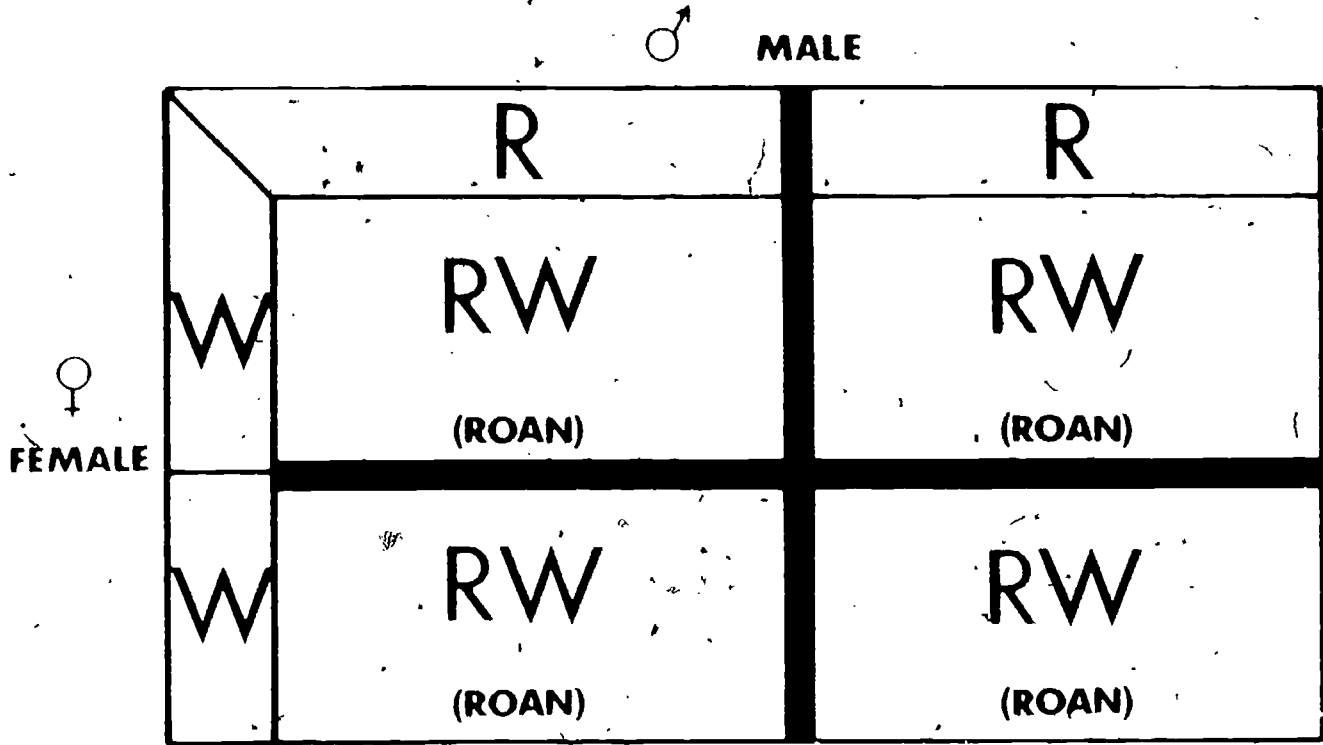



















# A CROSS WITH TWO CHARACTERS

♂ MALE

♀ FEMALE

	PW	Pw	pW	pw
PW	 <b>PPWW</b> (POLLED, WHITEFACED)	 <b>PPWw</b> (POLLED, COLOREDFACED)	 <b>PpWW</b> (POLLED, WHITEFACED)	 <b>PpWw</b> (POLLED, COLOREDFACED)
Pw	 <b>PPWw</b> (POLLED, WHITEFACED)	 <b>PPww</b> (POLLED, COLOREDFACED)	 <b>PpWw</b> (POLLED, WHITEFACED)	 <b>Ppww</b> (POLLED, COLOREDFACED)
pW	 <b>PpWW</b> (POLLED, WHITEFACED)	 <b>PpWw</b> (POLLED, WHITEFACED)	 <b>ppWW</b> (HORNED, WHITEFACED)	 <b>ppWw</b> (HORNED, WHITEFACED)
pw	 <b>PpWw</b> (POLLED, WHITEFACED)	 <b>Ppww</b> (POLLED, COLOREDFACED)	 <b>ppWw</b> (HORNED, WHITEFACED)	 <b>ppww</b> (HORNED, COLOREDFACED)

- ☆ — 9 POLLED, WHITEFACED
- ★ — 3 POLLED, COLOREDFACED
- ☆ in circle — 3 HORNED, WHITEFACED
- — 1 HORNED, COLOREDFACED

# TRAITS AND THEIR LEVEL OF HERITABILITY

TRAIT	LEVEL OF HERITABILITY
REPRODUCTIVE PERFORMANCE.....	LOW to MODERATE
WEANING WEIGHT.....	MODERATE
COW MATERNAL ABILITY.....	MODERATE
FEEDLOT GAIN.....	MODERATE+
CARCASS GRADE.....	MODERATE+
FEED EFFICIENCY.....	MODERATE+
RIBEYE AREA.....	HIGH+
TENDERNESS.....	HIGH
FAT THICKNESS.....	MODERATE
CARCASS YIELD.....	MODERATE
YIELD OF RETAIL CUTS.....	MODERATE
CANCER EYE SUSCEPTIBILITY.....	MODERATE
EYE LID PIGMENTATION.....	HIGH

LOW=less than 30%

MODERATE=30-50%

HIGH=greater than 50%

TRANSPARENCY DISCUSSION GUIDE  
UNDERSTANDING BASIC GENETICS AND REPRODUCTION

Transparencies - STEPS IN CELL DIVISION IN GROWTH (MITOSIS), MATURATION PROCESS (MEIOSIS), AND SEX DETERMINATION IN ANIMALS

- A. Use these transparencies as an instructional aid in helping students distinguish between mitosis and meiosis when completing Student Worksheet #3.
- B. Point out that the sex of an animal is determined at the time of fertilization.
- C. Promote class discussion on sex determination through X and Y chromosomes.

Transparencies - A DIAGRAM FOR DETERMINING THE PROBABLE RESULTS FROM A DOMINANT AND RECESSIVE CHARACTER, COLOR DETERMINATION IN SHORTHORNS, A CROSS WITH TWO CHARACTERS, AND TRAITS AND THEIR LEVEL OF HERITABILITY

- A. Use these transparencies as an instructional aid when students are working on Student Worksheet #2.
- B. Demonstrate how to complete a "checkerboard" diagram to determine the probable results in breeding livestock.
- C. Explain how this type of information is useful to livestock breeders.
- D. Point out the influences of various dominant and recessive characters.
- E. Provide additional examples for students and explain how different traits have various levels of heritability.

TEACHER'S KEY  
SAMPLE TEST QUESTIONS

TRUE (+) - FALSE (0)

- 0 1. Most animals start their life from a fertilized egg and a sperm.
- + 2. The genes are carried on the chromosomes.
- + 3. The nucleus is the most vital part of the cell.
- 0 4. Growth of the body is an increase in the size of the cells.
- 0 5. Man possesses 48 cells in his body.
- + 6. A fertilized egg is referred to as a zygote.
- 0 7. Fertilization is the union of an ovum and an egg.
- + 8. An individual that carries two genes for a character is said to be pure or homozygous for that character.
- + 9. Most mutations are not beneficial and some are even harmful.
- + 10. Color blindness in humans is a sex linked character.

MULTIPLE CHOICE (Make appropriate choice of A, B, C, or D)

- C 1. A cell is made up mostly of:
- A. Cytoplasm
  - B. Nucleus
  - C. Protoplasm
  - D. Cell wall
- B 2. Sexual reproduction occurs with:
- A. Bacteria
  - B. Birds
  - C. Yeast
  - D. Amoeba
- D 3. Asexual reproduction is:
- A. Maturation
  - B. Mitosis
  - C. Homozygous
  - D. Simple cell division

- C 4. A large sexually produced animal (horse) started as a \_\_\_\_\_ number of fertilized cells than a smaller one (chicken).
- A. Larger
  - B. Smaller
  - C. The same
  - D. None of the above
- C 5. In the male, large numbers of spermatozoa are formed - often:
- A. Hundreds
  - B. Thousands
  - C. Millions
  - D. Trillions
- A 6. Identical twins came from:
- A. Same original fertilized egg
  - B. Same fertilized egg but different sperm
  - C. Two similar eggs and two different sperm
  - D. Two fertilized eggs and two sperm
- B 7. A characteristic that masks or hides the presence of others is said to be:
- A. Recessive over the other one
  - B. Dominant over the other one
  - C. Sex linked with the other one
  - D. A mutation
- C 8. Mutations:
- A. Look like both parents
  - B. Has a different character than the parents but will not pass it on to its offspring
  - C. Has a character that is different from that of its parents and will pass it on to its offspring
  - D. Always die at birth
- A 9. Our domesticated animals have been improved primarily by:
- A. Artificial selection
  - B. Natural selection
  - C. Selecting mutations
  - D. Selecting heterozygous individuals
- C 10. The dominant characteristics:
- A. Show only on the larger offspring
  - B. Show only on the smaller offspring
  - C. Show up on the first generation
  - D. Show up only on the F<sub>2</sub> generation

MATCHING (Match the correct terms with the qualities listed.)

- |          |                  |    |   |
|----------|------------------|----|---|
| <u>E</u> | 1. Chromatin     | A. | A reproductive cell, before fertilization   |
| <u>I</u> | 2. Purebred      | B. | A character that shows only when the dominant character is absent                         |
| <u>A</u> | 3. Gamete        | C. | Union of the nuclei of the male and female reproductive cells                             |
| <u>K</u> | 4. Sperm         | D. | Color of hair of many rodents   |
| <u>M</u> | 5. Maturation    | E. | Material in the nucleus of cell. Carries the genes  |
| <u>G</u> | 6. Gene          | F. | Reproductive cell of the female   |
| <u>J</u> | 7. Mutation      | G. | That part of a reproductive cell that produces a character                                |
| <u>C</u> | 8. Fertilization | H. | Cell division by which two identical cells are produced from the parent cell              |
| <u>F</u> | 9. Ovum          | I. | An individual that is eligible for registry   |
| <u>H</u> | 10. Mitosis      | J. | A change in the germ plasm that produces a character different from that of its ancestors |
|          |                  | K. | Male reproductive cell  |
|          |                  | L. | The uniting of the part of one chromosome with a part of another                          |
|          |                  | M. | The formation of germ cells in which the chromosomes are reduced in half                  |

COMPLETION (Write appropriate information or words to complete statements.)

1. In certain stages of cell life, the chromatin material is formed into rather definite bodies called chromosomes.
2. There are two general types of reproduction, sexual and asexual.
3. Germ cells formed by the male are called male germ cells, sperms or spermatozoa.
4. Fertilization is the union of a sperm and an egg.
5. An individual that carries two genes for a character is said to be pure or homozygous for that character.
6. The term purebred refers to animals that are registered, or are eligible for registry by a breed association.
7. If a gene has been changed and an individual is produced with a new character, that change is called a mutation.
8. Causes of variation may be classed under three headings, environment, recombination of characters, and mutation.
9. Some body cells are so small that 250,000 placed side by side would measure only an inch.
10. The protoplasm, outside the nucleus of a cell, is called cytoplasm.

## ESSAY QUESTIONS

1. Explain the various steps in ordinary cell division (mitosis).

(refer to VAS Unit 1009a, part 1)

2. How do the steps in maturation of male and female reproductive cells differ from the mitosis process?

(refer to VAS Unit 1009a, part 2)

301

# **UNIT E: Crop Science**

## **PROBLEM AREAS:**

- 1. Drying and Storing Grain**
- 2. Growing Timber and Trees as an Agricultural Crop**
- 3. Harvesting Forage Crops**



## UNIT E: CROP SCIENCE

### PROBLEM AREA: DRYING AND STORING GRAIN

#### SUGGESTIONS TO THE TEACHER:

This problem area is designed for use with advanced students in vocational agriculture programs. The recommended time for teaching this problem area is during the fall when harvest is in progress and grain samples are available and being dried commercially.

The estimated instructional time for this problem area is 10 to 15 days depending on how far the teacher wishes to go in discussion and development of grain drying skills. If the students are to be involved in other activity exercises, the instructional time will need to be increased.

The instructor is encouraged to conduct a local search to locate other supplementary materials for use with this problem area. The items in this problem area are for reference or modification as instructors adapt these materials to their local situation.

#### CREDIT SOURCES:

These materials were developed through a funding agreement, R-33-24-D-0362-466 with the Illinois State Board of Education, Department of Adult, Vocational and Technical Education, Research and Development Section, 100 North First Street, Springfield, Illinois 62777. Opinions expressed in these materials do not reflect, nor should they be construed as policy or opinion of the State Board of Education or its staff.

The teacher's guide, student worksheets, job sheets, transparency discussion guide, and sample test questions were developed by Michael H. Rauch, Department of Vocational and Technical Education, University of Illinois, and Richard Schertz, Moweaqua Community High School, Moweaqua, IL.

The art work in this problem area was prepared by the Vocational Agriculture Service, University of Illinois. Suggestions and guidance in the development of these materials were provided by the Rural Core Curriculum Field Test Teachers.

Eldon Chapman - Herscher High School  
Darrell Scherer - West Richland High School  
Donald Miller - New Holland-Middletown High School  
Charles Harn - Spoon River Valley High School  
Dave Wilson - St. Joseph High School

## TEACHER'S GUIDE

- I. Unit: Crop science
- II. Problem area: Drying and storing grain
- III. Objectives: Upon completion of this problem area students will be able to:
  1. Identify different grain drying and storage systems.
  2. Properly sample grain and test for moisture content.
  3. Evaluate discounts and costs of drying grain.
  4. List the safety precautions for grain handling and storage.
  5. Estimate the size and capacity of grain systems.
- IV. Suggested interest approaches:
  1. Discuss some of the grain drying and storage systems on the students' home farms or in the community.
  2. Show samples of improperly dried and stored grain.
  3. Invite a guest speaker to discuss drying and storage systems.
  4. Tour a commercial elevator and have them explain their grain handling systems and equipment.
- V. Anticipated problems and concerns of students:
  1. At what moisture should corn, soybeans, and wheat be harvested? Stored?
  2. What problems can occur from high moisture?
  3. How can grain moisture be determined?
  4. What are the different grain drying systems?
  5. How long can a farmer store grain?
  6. What type of storage is best?
  7. What is the cost of drying grain?
  8. How can solar energy be used to dry grain?
  9. Is it cheaper to harvest and handle ear corn or shelled corn? Why?

10. What are the differences between corn and soybean drying systems?
11. What is the best way to handle grain?
12. What safety precautions should be observed in grain handling?

VI. Suggested learning activities and experiences:

1. Use one or more of the suggested interest approaches.
2. Identify student's problems and concerns related to this problem area.
3. Distribute Planning Grain-Feed Handling (MWPS-13) book and Information Sheet #1 and discuss materials handling with the class.
4. Distribute Worksheet #1 for homework and discuss in class.
5. Distribute Information Sheet #2 and #3 and discuss in class.
6. Do some % moisture problems with the class and distribute Worksheet #2 to check their skill.
7. Conduct Job Sheet #1 where students gather grain samples and test them for moisture content.
8. Distribute FS Grain Drying Guide and hand out Information Sheet #4 for additional information.
9. Have students complete Worksheet #3.
10. Distribute Information Sheet #5 and compare advantages and disadvantages of different drying systems.
11. Have students complete the series of Worksheets #4 to #8 as the information is presented and discussed from the FS Grain Drying Guide.
12. Have a resource person from a nearby commercial facility address the class about grain handling, drying, and storage systems.
13. Emphasize safety as an integral part of grain handling systems and distribute Information Sheet #6.
14. Have each student design a handling, drying, and storage system for his/her home farm.
15. Have students observe and record a grain flow outline. (Combining time, unloading time, wagon or truck size, travel time, unloading or dump time, point out any dead time). Use Job Sheet #2.

16. Have students bring in samples of spoiled grain and try to determine the cause of spoilage.

#### VII. Application procedures:

1. Students should apply their knowledge and skills to their home farm systems.
2. Grain handling knowledge could apply to the students' S.O.E. projects.
3. Students may use this knowledge in the FFA crops judging contest.
4. Students should apply these skills to out-of-school situations when evaluating and planning future grain drying and handling systems.

#### VIII. Evaluation:

1. Administer and evaluate student worksheets included with this problem area.
2. Have students complete the Competency Inventory to check their progress in specific areas.
3. Prepare and administer a paper and pencil test on drying and storing grain, utilizing some of the sample questions provided in this unit.

#### IX. References and aids:

1. FS Grain Drying Guide, 1980 Edition (available at local FS dealers)
2. Costs of Drying and Storing Shelled Corn on Illinois Farms. Cooperative Extension Service, Circular 1141 (Worksheet available)
3. Low Temperature and Solar Grain Drying Handbook. Midwest Plan Service, Iowa State University, Ames, Iowa 50011. (\$3.00)
4. Planning Grain-Feed Handling. Midwest Plan Service, Iowa State University, Ames, Iowa 50011. (\$3.00)

## COMPETENCY INVENTORY

### DRYING AND STORING GRAIN

1. Student has no knowledge of competency.
2. Student has read about competency.
3. Student has seen competency performed.
4. Student has performed competency.
5. Student has performed competency without supervision.

Competency	Circle One				
1. Determine moisture content of grain.	1	2	3	4	5
2. Discount the price of small grains for test weight, moisture, and damage.	1	2	3	4	5
3. Select an economic and efficient method of grain storage.	1	2	3	4	5
4. Calculate the cost of drying and storing grain.	1	2	3	4	5
5. Calculate the volume of a structure needed to store a specified number of bushels.	1	2	3	4	5
6. Collect grain samples.	1	2	3	4	5
7. Identify and select storage facilities for various methods of harvest.	1	2	3	4	5
8. Calculate shrinkage of grain.	1	2	3	4	5
9. Calculate the income potential or loss from storing grain.	1	2	3	4	5
10. Identify methods of cleaning grain.	1	2	3	4	5
11. Identify basic drying systems.	1	2	3	4	5
12. Estimate the size of grain handling equipment for selected operations.	1	2	3	4	5

These competencies are outlined in the National Ag Occupations Competency Study, 1978, for entry level positions in agriculture.

Name \_\_\_\_\_

Date \_\_\_\_\_

## INFORMATION SHEET #1

### MATERIALS HANDLING

Sizing your handling system to match dryer and combine capacities is the most important step in reducing bottlenecks or delays in harvest. The major components of the materials-flow process are 1) harvest, 2) transport, 3) unload, 4) receive, 5) elevate, 6) dry, 7) store, 8) unload, 9) elevate, 10) transport or feed, 11) market. A rule of thumb would be to estimate the capacity necessary, then design a system twice that size. Always have room to add on if it ever becomes necessary. Try not to plan a system that can be outdated or closed in a few years. Sketch a layout or flow chart to see how your system should operate. Size all of the system functions to match and compliment each other.

Harvesting usually dictates the size of your system. Combines and corn pickers are rated in bushels capacity per hour by the manufacturer. This figure is valid if the operator never stops to unload or eat lunch. Even so, it is a good practice to use the highest capacity you're capable of harvesting. Wagons and/or trucks need to be able to keep up with the harvester so precious time is not lost in the field. Unloading and receiving has a great deal to do with hauling time. If the truck or wagon takes too long to unload, the harvester will have to wait. Let's begin with an example farm to illustrate grain flow.

Consider a 500 acre farm producing 120 bushels of corn per acre. During the fall, there is an average of 20 days available for harvest. At this rate our system must handle at least 3000 bushels per day or a minimum of 125 bushels per hour. Assuming the farmer works a 10 hour day increases our minimum to 300 bushels per hour. Assume also that the combine harvests 400 bushels of 25% moisture corn per hour, this will be our maximum capacity. If travel and unloading time is 30 minutes, 2 trucks or wagons sized at 200 bushels would be enough to keep the combine going. If travel and unloading time was 60 minutes, the trucks or wagons would need to be twice that size or twice as many (4). Using the first case, consider a 10 minute travel time (one way). The auger or elevator would need to move 200 bushels in 10 minutes. Looking at our approximate auger ratings we would need an 8" auger running at 350 rpm.

From this point we need to size our drying and storage systems. We need a continuous flow dryer of 400 bushels per hour capacity, or a batch or layer bin large enough for 3-4000 bushels per day. According to the FS charts this capacity would require at least 2-24 foot diameter drying bins.

The low temp drying method would require the capacity for the entire crop. According to the FS charts this would be:

- 8-24' bins 20' tall
- 5-30' bins 21' tall
- 4-36' bins 18' tall
- 3-42' bins 18' tall
- 2-48' bins 17' tall

## INFORMATION SHEET #2

### DRYING FANS

The fan is the key to drying capacity for all dryers. Fan capacity is measured by cubic feet of air per minute (cfm). It is common practice to recommend fan capacity in cfm/bu for aeration and drying. Different size and type fans are necessary for various drying systems depending on static pressures. Static pressure is the pressure on a bin wall when air is forced through it. It is measured by inches of water displaced in a tube.

Vanexial fans are commonly used in flat storage or shallow grain depths. They are low pressure fans, usually lower horsepower and more economical to operate. These fans deliver large volumes of air at low pressure and are usually quite noisy. They seldom go over 10 or 12 horsepower and are used for static pressures of 4 or less.

Centrifugal fans on the other hand are quieter and used for high pressure situations. They are available in sizes over 20 horsepower and can move air through grain with static pressures of 10 or more. These fans generally require more energy but they can withstand dusty and dirty conditions better.

Centrifugal fans are characterized by the angle of the blades. If the blades are angled forward, the fan is quiet but it can be overloaded. If the blades are straight, the fan will handle dust and dirt with greater ease. If the blades are angled back, the fan will work at higher pressures and will not overload itself.



## INFORMATION SHEET #3

### SHRINKAGE

The corn kernel is made of 2 basic parts, water and dry matter. As the kernel dries, water is removed and this causes the kernel to shrink. Shrinkage is an important factor in drying grain. Commercial elevators must be able to calculate shrinkage so they don't pay farmers for the moisture or water. 100 pounds of 25% moisture corn contains 75 pounds of corn and 25 pounds of water. Simply removing 10 pounds of water does not result in 15% corn but actually 16 2/3% corn. (15 divided by 90 = 16 2/3) Two methods are used to calculate shrinkage:

$$1. \quad \frac{Ww}{Dm+Ww} = \% \text{ moisture} \quad \begin{array}{l} Ww = \text{Weight of the water} \\ Dm = \text{Dry matter} \end{array}$$

$$2. \quad 100\% - \left( \frac{\% \text{ Dm in wet grain}}{\% \text{ Dm in dry grain}} \times 100 \right)$$

Example: 200 bushels of 25% corn, dried to 15%.

$$1. \quad \frac{50}{150+50} = 25\% \quad \text{replace \% moisture with 15\% and solve for Ww.}$$

$$\frac{Ww}{150+Ww} = 15\%$$

$$Ww = 26.5$$

$$\frac{176.50}{200} = 11.75\% \text{ shrink}$$

$$2. \quad 100\% - \left( \frac{75\%}{85\%} \times 100 \right) = 11.75\% \text{ shrink}$$

In most shrinkage tables one half percent handling shrink is usually added. This .5% accounts for invisible shrink or what is actually a slight loss in dry matter itself.



## INFORMATION SHEET #4

### DRYING SYSTEM MODIFICATION FOR IMPROVED EFFICIENCY

Drying a corn crop often requires as much energy as was used to grow and harvest it. Costs of fossil fuels are likely to continue to increase, and shortages of petroleum fuels should be considered as a possibility. Some drying methods require only half as much energy as other methods, and should be considered in planning expansion or modification of drying systems on the farm. Suggestions for saving energy in harvest and storage of corn and other grains can be summarized as follows:

1. Don't dry it if it will be fed to livestock. Ensiling of early-harvested high moisture grain is a satisfactory method if it will definitely be fed to livestock. Late-harvested corn can be stored in bins at 18 percent moisture or less, if aerated to keep it cool, and fed to livestock during the winter.
2. Harvest at lower moisture. There is twice as much water to be removed in drying corn from 27% moisture to 15½% moisture as in drying from 22% to 15½% moisture. Harvesting at lower moisture to save energy is suggested, provided there is not increased field loss.
3. Don't overdry. Corn that will not be kept over the following summer need not be dried below 15½%. Drying to 15% instead of 13%, from 24% moisture can save about 25% on fuel where a high-speed drying method is used. Also, overdrying causes an excess "shrinkage" in weight that is a loss to the owner.
4. Use a more energy-efficient drying method. Fast drying methods usually exact an energy "penalty" for speed. Slow drying methods use more of the natural drying ability of air. Here are approximate energy requirements for different drying methods: (per pound of water removed)
  - High-speed batch or continuous-flow--2000 to 3000 BTU/lb.
  - Batch-drying in a bin--1500 to 2000 BTU/lb.
  - Low-temperature drying in the bin--1000 to 1500 BTU/lb.
  - a. Use low-temperature drying in the bin. This is a relatively slow (20 to 40 days) but efficient method of drying, using little or no heat. Temperature rise is from 2 degrees (from the fan) up to 5 degrees F. (fan and heater).

Shelled corn of 22% moisture can safely take up to 30 days to dry if kept at 50 degrees F. or less. At 40 degrees; allowable drying time is twice as long. Some recommendations for low-temperature drying are:

\*Provide adequate airflow for the moisture content, as follows:

Initial Moisture	Airflow CFM/BU.	Max. depth, feet	Power, Hp. per 1000 bu.
26%	3	12	3hp
24%	2	16	2hp
22%	1½	28	1½hp
20%	1	20	1hp

\*Screen out trash and use a distributor. This helps get the air through the corn.

\*Level as you fill, for uniform air distribution.

\*Use no more heat than necessary for final moisture content desired. Checking moisture content on the bottom of the bin will reveal whether the right amount of heat is being used. Too dry means too much heat; not dry enough means more heat is needed. Probing bins and checking moisture at different levels will help in keeping track of drying progress.

\*Be very careful about piling up corn that is higher in moisture than the airflow is designed to dry; hold down depths to increase airflow per bushel until it has partly dried. Be careful also about fast-filling in unseasonably warm weather; ten degrees warmer means the allowable drying time is cut in half.

- b. Use solar heat with low-temperature drying. The wall of the drying bin, or the roof or wall of a nearby building can be used to collect solar energy for the small temperature rise required for low-temperature drying.
- c. Use less heat when batch-drying in the bin. Use only enough heat to keep drying on schedule with harvest. Less heat utilizes more of the natural drying ability of the air. A 24-hour cycle per batch is suggested, with time allowed for cooling and moving the corn to final storage.

Stirring will increase airflow, reduce energy required, when drying in 4 to 6 foot depths. Benefits are reduced at shallower depths, questionable at deeper depths.

Solar heat can be used to pre-heat, or temper the drying air for batch-in-bin drying. For instance, if a 50 degree F. temperature rise is being used, pre-heating by 20 degrees with solar energy and providing the rest with the burner will reduce the heat required by about 2/5, or 40% during sunshine hours.

- d. Don't reduce heat on high-speed batch or continuous flow dryers. Reducing the fuel rate will decrease the efficiency rather than increase it on high-speed dryers which use high temperatures and high airflows. Use the highest temperature that will not affect corn quality. For market

corn, a maximum kernel temperature of 140 degrees is recommended.

- e. Use dryeration with high speed dryers. With dryeration, corn is dried with the high-speed dryer to within two percentage points of desired final moisture, transferred without cooling to a special dryeration bin to "soak" all day, then cooled overnight, which removes the two additional "points" of moisture. It is then transferred to final storage. Savings of 20 to 25% are possible when drying from 24% moisture in the high-speed dryer, then moved, warm, to a low-temperature drying bin to finish drying. Fuel savings of 50% or more can be realized when drying from 24% moisture to 15½% moisture.
- f. Recirculate part of the exhaust air from the high-speed dryer. With some dryers, it is possible to recirculate exhaust air from the part of the dryer which holds the driest corn. Fuel savings can be up to 20%. Do not attempt such modifications on a dryer without checking with the manufacturer of the dryer, as performance could be adversely affected.
- g. Soybean drying. Generally, the recommendations given for saving energy in drying corn apply also to soybeans. Low-temperature drying is suitable for soybeans. Soybeans offer about the same resistance of airflow as shelled corn, and systems designed for shelled corn should be suitable for soybeans of 18 or 19% moisture. The temperature rises that will dry shelled corn to 15% moisture will dry soybean to 13% moisture, which is considered satisfactory for storage over winter.
- h. Crib as ear corn. While not lending itself to mechanized handling as well as shelled corn, ear corn will generally dry from 20% moisture in 8-foot cribs which are exposed to the prevailing wind. It can be dried in cribs or piles from 30% moisture with forced air at the rate of 5 cfm per bushel.

## INFORMATION SHEET #5

### CONSIDERATIONS AFFECTING THE CHOICE OF A DRYING AND STORAGE SYSTEM

Besides the cost relationship, there may be operational and managerial requirements that should be considered in selecting a dryer. Some advantages and disadvantages are listed below for each of the systems.

#### BATCH-IN-BIN DRYER

Advantages: The drying bin may be used for grain storage at the end of the drying season.

Disadvantages: After drying, the grain must be transferred to another bin for storage; the grain in the bottom of the dryer may be 3 to 5 percent drier than the grain on top of the batch.

#### STIR DRYER

Advantages: Stir drying increases the capacity over the batch-in-bin dryer; stirring can prevent overdrying of bottom grain and give more uniform grain-moisture content throughout the bin.

Disadvantages: The stirring device takes up about 1 to 1½ rings of the bin, which may not be used for drying or storage; special care must be taken in starting and operating the stir augers--mechanical problems have been encountered.

#### LOW-TEMPERATURE DRYER

Advantages: Low temperatures can result in a high-quality grain with no stress cracks from heating and cooling; the system can be used to supplement current on-farm systems; reliance on restricted supplies of propane or natural gas is eliminated.

Disadvantages: Harvest must be delayed until the average daily temperature is below 50°F.; moisture content of the grain should be 26 percent or less to facilitate proper airflow; all bins are limited to a 16-foot depth because of excessive power requirements for the necessary airflows at greater depths; each bin must have a drying unit since the drying period may extend for a month or more.

#### AUTOMATIC BATCH DRYER AND CONTINUOUS-FLOW DRYER

Advantages: Generally, these systems are automatic and require less attention, although dried grain has to be checked and controls set accordingly; the drying units can be moved from place to place; generally, the units may be powered by an electric motor or a tractor power take-off.

Disadvantages: The investment cost of these units is not competitive with other systems at volumes less than 60,000 bushels; systems are not as adaptable to expanding volume as some of the other drying systems.

#### OXYGEN-FREE STORAGE

Advantages: Grain requires little attention after being put in storage; a high-quality livestock feed is provided; the harvesting rate is not limited by the capacity of conditioning units.

Disadvantages: Grain must be used as livestock feed.

#### EAR-CORN STORAGE

Advantages: No drying equipment required; some elevators pay premiums for ear corn.

Disadvantages: Grain must be near 20 percent moisture before corn can be stored; corn must be shelled before entering market channels; the necessity to delay harvest for lower moisture levels increases field losses and the danger of bad weather and may prevent fall plowing.

#### ELEVATOR DRYING AND STORAGE

Advantages: No capital is required for drying and storage equipment; system is competitive with other systems at volumes of 10,000 bushels or less for grain fed on the farm and up to 20,000 bushels on grain to be marketed.

Disadvantages: Harvesting must be geared to the ability of the elevator to handle the grain in the community at harvest; costs may vary, depending upon the demand for services at the elevator.

## INFORMATION SHEET #6

### HAZARDS OF FLOWING GRAIN\*

#### A. SAFETY HAZARDS AND RECOMMENDATIONS

1. Don't enter a bin of flowing grain.
2. Never enter a bin when unload equipment is running, whether or not grain is flowing.
3. Don't enter a bin that has automatic unload equipment, without locking-out the control circuit.
4. Always be cautious before walking on any surface crust.
5. When entering a questionable bin/storage circumstance, always have three men involved two on the outside and one inside. The man in the bin should be lashed to a safety rope with the two men outside capable of lifting him out without entering the bin. One man outside cannot do this, and cannot go for help and maintain preliminary aid.
6. Never work in obviously dusty-moldy grain without a respirator. Never work in such conditions, no matter what the protection, without a second person on safety, standby. Use a respirator capable of filtering fine dust.
7. Always be cautious when working with grain that has gone out of condition. You can have molds, blocked flow, cavities, cave-offs, crusting--it's a time to be alert.
8. Don't depend on a second person, either on the bin roof, on the ground, or any other remote point to whom you shout instruction on equipment start or stop.
  - a. The equipment noise can block out commands or cries for action or assistance, and
  - b. The second person may fall and/or over-exert themselves in the panic and haste of getting off the bin or running to the control point.

#### B. POSSIBLE CORRECTIVE MEASURES

1. Install ladders inside all bins.
2. If you must enter a bin with evident danger, use a rope and safety harness to support and lift you in the event of trouble.
3. A rope with knots or a chain with stirrups, suspended down the center from the top of the bin, may be a useful safety addition to grain bins. Performance and use of such safety units has not been proven, and the drag on them in flowing grain may pull the roof in.

C. NO SECOND CHANCE

1. The average human body displaces 2.5 cubic feet.
2. A ten inch auger operating at 300 rpm can move 3,600 bushels/hour. (1 bushel/second)
3. The entire body can be buried in grain in 2.5 seconds.

317



INFORMATION SHEET #7  
GRAIN SHRINKAGE TABLE

Initial moisture (percent)	(percent of shrinkage)								
	13.0%	13.5%	14.0%	14.5%	15.0%	15.5%	16.0%	16.5%	17.0%
15.5	3.37	2.81	2.24	1.67	1.09	---	---	---	---
16.0	3.95	3.39	2.83	2.25	1.68	1.09	---	---	---
16.5	4.52	3.97	3.41	2.84	2.26	1.68	1.10	---	---
17.0	5.10	4.55	3.99	3.42	2.85	2.28	1.70	1.10	---
17.5	5.67	5.12	4.57	4.01	3.44	2.87	2.29	1.70	1.11
18.0	6.25	5.70	5.15	4.59	4.03	3.46	2.88	2.30	1.71
18.5	6.82	6.28	5.73	5.18	4.62	4.05	3.48	2.90	2.31
19.0	7.40	6.86	6.31	5.76	5.21	4.64	4.08	3.50	2.91
19.5	7.97	7.44	6.90	6.35	5.79	5.23	4.67	4.10	3.52
20.0	8.55	8.01	7.48	6.93	6.38	5.83	5.27	4.70	4.12
20.5	9.12	8.59	8.06	7.52	6.97	6.42	5.86	5.30	4.72
21.0	9.70	9.17	8.64	8.10	7.56	7.01	6.46	5.89	5.32
21.5	10.27	9.75	9.22	8.69	8.15	7.60	7.05	6.49	5.93
22.0	10.84	10.33	9.80	9.27	8.74	8.19	7.65	7.09	6.53
22.5	11.42	10.90	10.38	9.86	9.32	8.78	8.24	7.69	7.13
23.0	11.99	11.48	10.97	10.44	9.91	9.38	8.84	8.29	7.73
23.5	12.57	12.06	11.55	11.03	10.50	9.97	9.43	8.89	8.34
24.0	13.14	12.64	12.13	11.61	11.09	10.56	10.03	9.49	8.94
24.5	13.72	13.22	12.71	12.20	11.68	11.15	10.62	10.09	9.54
25.0	14.29	13.79	13.29	12.78	12.26	11.74	11.22	10.68	10.14
25.5	14.87	14.37	13.87	13.37	12.85	12.33	11.81	11.28	10.75
26.0	15.44	14.95	14.45	13.95	13.44	12.93	12.41	11.88	11.35
26.5	16.02	15.53	15.03	14.54	14.03	13.52	13.00	12.48	11.95
27.0	16.60	16.11	15.62	15.12	14.62	14.11	13.60	13.08	12.55
27.5	17.17	16.69	16.20	15.71	15.21	14.71	14.20	13.68	13.16

$$\text{Shrinkage} = 100.0\% - \left( \frac{\% \text{ dry matter in wet grain}}{\% \text{ dry matter in dry grain}} \times 100 \right) + 0.5\% \text{ handling shrink}$$



STUDENT WORKSHEET #1  
MATERIALS HANDLING

(Reference: Planning Grain-Feed Handling (MWPS-13))

1. What is meant by closed-loop handling?
  
  
  
  
  
  
  
  
  
  
  
  
  
  
  
  
2. List the major functions of the materials-flow process and at least 2 pieces of equipment for each one.

3. What is the capacity, in bushels of soybeans, of a 6 inch auger turning 400 rpm with an 18" intake at 45°? \_\_\_\_\_
  
4. What is the storage capacity of a common round bin 24 feet in diameter and 16 feet tall? \_\_\_\_\_
  
5. What is the storage capacity of a double ear corn crib with sides 6 feet wide, 20 feet long, and 12 feet high?  
Ear corn \_\_\_\_\_  
shelled corn \_\_\_\_\_

STUDENT WORKSHEET #2

SHRINKAGE

1. Why does grain shrink?
2. Using the formula,  $\frac{Ww}{Dm+Ww}$ , calculate shrinkage on 1000 bushels of 25% corn dried to 15%. (Show your work)

3. Do the same problem with the second formula. (Show your work)

4. Using the grain shrinkage table find % shrink of:

25% corn dried to 15.5% \_\_\_\_\_

27.5% corn dried to 15% \_\_\_\_\_

19% corn dried to 13% \_\_\_\_\_

26.5% corn dried to 14.5% \_\_\_\_\_

5. If you dried 100 bushels of corn to 15.5% and measured a 7% shrink in weight, what could you assume the % H<sub>2</sub>O was initially? \_\_\_\_\_

## STUDENT WORKSHEET #3

### HOW GRAIN DRIES

(Reference: FS Grain Drying Guide)

1. Explain how air and heat is used in the grain drying process.
  
2. Why is overdrying to prevent mold growth, not a good alternative to keep grain in condition?
  
3.
  - a. What level of moisture is considered low enough if corn is to be fed to livestock during the winter. \_\_\_\_\_
  - b. What level of moisture is recommended for corn if it is removed from storage before spring. \_\_\_\_\_
  - c. What level of moisture is recommended for corn stored through spring if it is not closely watched? \_\_\_\_\_
  
4. Define the equilibrium point.
  
5. Define relative humidity.
  
6. \_\_\_\_\_ reduces the relative humidity of the drying air and, in so doing, absorbs more \_\_\_\_\_.
  
7. What does BTU stand for?
  
8. The maximum drying temperature for corn fed to livestock is \_\_\_\_\_.

9. The actual kernel temperature is usually \_\_\_\_\_ than the air temperature.
10. The capacity of a fan is measured in \_\_\_\_\_.
11. A 10,000-cfm. fan can move enough air in one minute to displace the air in an area \_\_\_\_ high, \_\_\_\_ wide, and \_\_\_\_ long.
12. Fans are rated by their ability to move \_\_\_\_ against \_\_\_\_\_.
13. In grain drying, airflow resistance is called \_\_\_\_\_.
14. Static pressure is measured in inches of \_\_\_\_\_.
15. What are 2 types of drying fans? \_\_\_\_\_, \_\_\_\_\_.
16. Define drying zone.
17. The leading edge of the drying zone is called the \_\_\_\_\_.

## STUDENT WORKSHEET #4

### BATCH-IN-BIN DRYING

(Reference: FS Grain Drying Guide)

1. Explain Batch-in-Bin drying.
2. What are the maximum and minimum depths for batch drying and why?
3. List the operating procedure for batch-in-bin drying.

4. A farmer has a 30' diameter bin with a 20 hp fan. The farmer wants to dry 28% moisture corn to 15%. How deep should each batch be and how should the burner be set?

324

## STUDENT WORKSHEET #5

### LAYER FILL DRYING

(Reference: FS Grain Drying Guide)

1. Explain how layer fill drying works.
2. What are the hazards of layer fill drying?
3. List the operating procedures for layer fill drying.

4. If spoilage appears, do not \_\_\_\_\_
5. How can you operate a layer fill system equipped with a 7 hp. fan on a 20' bin drying 20% corn?



STUDENT WORKSHEET #6  
LOW TEMPERATURE AND SOLAR DRYING

(Reference: FS Grain Drying Guide)

1. Explain how low temperature drying works.
2. What is the main advantage of this method?
3. Why is low temperature drying a promising drying method for the future?
4. Low temperature drying depends on what four variables?
5. Problem: Figure 16  
What percent of relative humidity is needed to achieve 15% corn at 40° temperature?

6. Solar drying is considered an involved process of a \_\_\_\_\_  
\_\_\_\_\_
7. What are the three categories of collectors for grain drying?
8. For maximum performance, the collector should be \_\_\_\_\_ to the sun's rays.
9. Why are thermostats and humidistats unnecessary expenses for low temperature drying?
10. Problem: Table 7  
How should a 36' diameter bin with a 20 hp. Long Mfg. centrifugal fan be filled?



## STUDENT WORKSHEET #8

### TEMPERATURE, VAPORIZER, AERATION, & SAFETY

(Reference: FS Grain Drying Guide)

1. How do you raise or lower drying temperature?
2. Lower drying temperatures save \_\_\_\_ (energy) and help improve grain \_\_\_\_\_.
3. \_\_\_\_\_ is the measure of resistance to airflow.
4. List and explain the four controls of a dryer.
5. In what two situations should you not enter the bin?
6. Explain the purpose of a vaporizer.
7. A large tank produces more \_\_\_\_\_ than a \_\_\_\_\_ tank.
8. What other factors affect the rate of vaporization?
9. What are the two types of vaporizers?
10. Explain the purpose of aeration.
11. Into what three categories can aeration be divided?

JOB SHEET #1

MOISTURE TESTING CORN AND SOYBEANS

Equipment: Insto Moisture Tester

Operating Instructions:

1. The Insto Moisture Tester is precalibrated to read-out the moisture content of corn.
2. For maximum precision place the moisture tester in a steady, level position.
3. Pour the sample to be tested into the testing chamber slowly, at a constant rate-approximately 10-12 seconds, using the pouring cup, until a reading appears.
4. Read moisture content of corn directly, refer to chart for other grains.
5. To compensate for difference in temperature of the grain, wait 15 seconds and push the temperature compensation button. Read the temperature compensated moisture content of corn directly; refer to chart for other grains.
6. To empty sample, simply turn over the tester.

Corn Moisture \_\_\_\_\_

Soybean Moisture \_\_\_\_\_

Tester Manufactured by:

Insto Inc.  
P.O. Box 113  
Auburn, IL 62615  
Phone: 217-438-6171

JOB SHEET #2

DETERMINING MATERIALS-FLOW

Instructions: Observe and record the time, at the home farm or any local operator, the circuit covered in a grain harvesting operation.

				<u>Average</u>
1. Combine fill time.	_____	_____	_____	_____
2. Combine unload time.	_____	_____	_____	_____
3. Combine dead time. (Not loading or unloading)	_____	_____	_____	_____
4. Truck or wagon sizes.	_____	_____	_____	_____
5. Travel times to unload.	_____	_____	_____	_____
6. Travel time from unload.	_____	_____	_____	_____
7. Truck or wagon unloading time.	_____	_____	_____	_____
8. Elevator, auger, or leg capacity.	_____			
9. Holding tank capacity (if present)	_____			
10. Type of surge tank (if present)	_____	_____		
11. Size and type of dryer (if present)	_____			
12. Storage capacity on farm _____ elevator _____				

In your opinion, what are the strengths and weaknesses of this flow system?

TEACHER'S KEY  
STUDENT WORKSHEET #1  
MATERIALS HANDLING

(Reference: Planning Grain-Feed Handling (MWPS-13))

1. What is meant by closed-loop handling?

Incoming grain is elevated, stored, and unloaded to the original incoming point thereby constructing a loop.

2. List the major functions of the materials-flow process and at least 2 pieces of equipment for each one. P. 9 (MWPS-13)

3. What is the capacity, in bushels of soybeans, of a 6 inch auger turning 400 rpm with an 18" intake at 45°? 880 Bushels

4. What is the storage capacity of a common round bin 24 feet in diameter and 16 feet tall? 5800 Bushels

5. What is the storage capacity of a double ear corn crib with sides 6 feet wide, 20 feet long, and 12 feet high?

Ear corn 576 Bushels/side (2.5 ft.<sup>3</sup>/bushel)  
shelled corn 1152 Bushels/Side (1.25 ft.<sup>3</sup>/bushel)

TEACHER'S KEY  
STUDENT WORKSHEET #2  
SHRINKAGE

1. Why does grain shrink?

As excess water is removed from grain, its physical size decreases.

2. Using the formula,  $\frac{Ww}{Dm+Ww}$ , calculate shrinkage on 1000 bushels of 25% corn dried to 15%. (Show your work)

$$\frac{Ww}{Dm+Ww} = 25\%$$

$$.25 = \frac{250}{750+250}$$

$$.15 = \frac{Ww}{750+Ww}$$

$$112.50 + .15Ww = Ww$$

$$112.50 = .85Ww$$

$$132.35 = Ww$$

$$\frac{750+132.35}{1000} = .8823 \text{ or } 11.77\% + .5 = 12.27\% \text{ shrink}$$

3. Do the same problem with the second formula. (Show your work)

$$100 - \frac{75}{85} \times 100)$$

$$100 - 88.24 = 11.78 + .5 = 12.26\% \text{ shrink}$$

4. Using the grain shrinkage table find % shrink of:

25% corn dried to 15.5%     11.74%

27.5% corn dried to 15%     15.21%

19% corn dried to 13%     7.4%

26.5% corn dried to 14.5%     14.54%

5. If you dried 100 bushels of corn to 15.5% and measured a 7% shrink in weight, what could you assume the % H<sub>2</sub>O was initially? 21%



TEACHER'S KEY  
STUDENT WORKSHEET #3  
HOW GRAIN DRIES

(Reference: FS Grain Drying Guide)

1. Explain how air and heat is used in the grain drying process.

A fan (1) picks up air (2) carries over an energy source to absorb moisture from grain (3) pushes air through grain to absorb moisture from grain and (4) carries it outside the system.

2. Why is overdrying to prevent mold growth, not a good alternative to keep grain in condition?

The extra moisture removed below the necessary minimum levels will require more energy.

3. a. What level of moisture is considered low enough if corn is to be fed to livestock during the winter? 17%  
b. What moisture is recommended for corn if it is removed from storage before spring? 15%  
c. What level of moisture is recommended for corn stored through spring if it is not closely watched? 13%

4. Define the equilibrium point.

Point when continued contact with the drying air results in no further reduction in moisture.

5. Define relative humidity.

Ratio of the amount of water vapor actually in the air to the maximum amount the air can hold.

6. Heat reduces the relative humidity of the drying air and, in so doing, absorbs more moisture.

7. What does BTU stand for? British Thermal Units

8. The maximum drying temperature for corn fed to livestock is 180°.

9. The actual kernel temperature is usually lower than the air temperature.
10. The capacity of a fan is measured in cubic feet per minute.
11. A 10,000-cfm fan can move enough air in one minute to displace the air in an area 10' high, 20' wide, and 50' long.
12. Fans are rated by their ability to move air against resistance.
13. In grain drying, airflow resistance is called static pressure.
14. Static pressure is measured in inches of water column.
15. What are 2 types of drying fans? vaneaxial, centrifugal
16. Define drying zone.  
The layer being dried.
17. The leading edge of the drying zone is called the drying front.

TEACHER'S KEY  
STUDENT WORKSHEET #4  
BATCH-IN-BIN DRYING

(Reference: FS Grain Drying Guide)

1. Explain Batch-in-Bin drying.

The batch-in-bin system operates on a 24-hour schedule. Drying begins as you fill the bin. Drying continues overnight. The next day, the grain is cooled and transferred to another bin for storage. Batch size should not exceed the amount of grain that can be dried in one day (maximum 4').

Constant heat is used for about 20 hours. The amount of heat varies, depending on the initial moisture content of the grain.

In the actual drying process, the average moisture content is the primary concern. The grain on the bottom will be somewhat overdried, while that on top will be wetter. But as the batch is transferred to storage, the moisture content averages out.

2. What are the maximum and minimum depths for batch drying and why?

The maximum batch depth is 4' since greater depths cause too much variation between the top and bottom. Two feet is a minimum depth since an even distribution of air is difficult to achieve at shallow grain depths.

3. List the operating procedure for batch-in-bin drying.

Operating procedures:

1. Test the moisture content so controls can be properly set.
2. Fill the bin using a grain spreader. If grain piles in one spot, all the air will go up the shallow areas and not be used to its full advantage.
3. Start fan when floor is covered. Open the roof hatches and remove humidistat so the high heat won't damage the sensor. Disconnect humidistat from heater and use a jumper on the control panel.
4. Set burner gas pressure. Use Table 2 for the correct setting, but don't exceed 140°F.
5. Consult Table 2 and continue filling. Don't exceed 4'.
6. Use fan and constant heat for about 20 hours. Sample the grain at several locations before unloading. Actual drying time will vary. Experience will be your best guide.
7. Cool grain for at least an hour. Turn off heater, continue operating fan. Cool to within 10°F of outside air.
8. Unload. Transfer grain into aerated storage to assure grain stays in condition.
9. Layer-fill dry the final fill.

4. A farmer has a 30' diameter bin with a 20 hp fan. The farmer wants to dry 28% moisture corn to 15%. How deep should each batch be and how should the burner be set?

Maximum depth 3.5 feet and set burner to deliver 2,029,000 BTU/hr.

338

TEACHER'S KEY  
STUDENT WORKSHEET #5  
LAYER FILL DRYING

(Reference: FS Grain Drying Guide)

1. Explain how layer fill drying works.

Refer to page 7 of manual.

2. What are the hazards of layer fill drying?

Two possible hazards to remember are (1) the possibility of over-drying the bottom layers and (2) spoilage occurring at the top.

3. List the operating procedures for layer fill drying.

1. Test the moisture content to determine the maximum wet depth allowable.
2. Fill using a grain spreader. A level surface prevents air traveling out the low spots to cause uneven drying.
3. Start drying when floor is covered. Open roof hatches. Leave fan and heater running and hatches open 24 hours a day. Rain, damp evenings or hot dry days won't affect outcome.
4. Adjust humidistat. For 13% corn, set the humidistat at 60% (see Table 3). Adjust the burner gas pressure to give a 20°F temperature rise. The humidistat will turn on the burner when the humidity is high and turn it off after the humidity has been lowered.
5. After 24 hours, sample grain on bottom. Humidistats provide good--but not exact--control. If the grain is still too wet, lower the humidistat setting 10% for each point of moisture too high. If too dry, raise the setting.

For future reference, remember the amount you changed the setting and its effect on the final moisture content. Once adjusted, do not change--or a new drying front may result. This could result in a longer drying time.

6. Continue filling, but don't exceed the maximum wet depth. Spoilage will result if too much wet grain is above the drying front. You can locate the drying front by pushing a  $\frac{1}{2}$ " steel rod into the wet grain. The rod pushes easier or sinks when you reach the drying front.
  7. Inspect grain daily. If crusting appears, you should break and spread grain over the surface.
  8. Turn off burner and cool with fan. Begin cooling when the surface is uniformly dry. Cool to within  $5^{\circ}$ - $10^{\circ}$ F of outside temperature--but not below freezing.
  9. Aerate and sample frequently.
4. If spoilage appears, do not lower the humidistat setting.
  5. How can you operate a layer fill system equipped with a 7 hp. fan on a 20' bin drying 20% corn?

Maximum wet depth 9.5 feet  
Days to fill 16' = 6 days

340

TEACHER'S KEY  
STUDENT WORKSHEET #6

LOW TEMPERATURE AND SOLAR DRYING

(Reference: FS Grain Drying Guide)

1. Explain how low temperature drying works.

Refer to p. 10 of Manual.

2. What is the main advantage of this method?

Enables farmers to fill at any rate and dry full load bins.

3. Why is low temperature drying a promising drying method for the future?

It adapts easily to solar energy.

4. Low temperature drying depends on what four variables?

- |            |                             |
|------------|-----------------------------|
| 1. Weather | 3. Initial moisture content |
| 2. Airflow | 4. Amt. heat used           |

5. Problem: Figure 16

What percent of relative humidity is needed to achieve 15% corn at 40° temperature?

60% to 70%      65%

6. Solar drying is considered an involved process of a collector catching radiant heat from sun. This heat raises the temperature of an absorbing surface which then heats the air.

7. What are the three categories of collectors for grain drying?

1. Bare plate
2. Covered plate
3. Suspended plate

8. For maximum performance, the collector should be perpendicular to the sun's rays.

9. Why are thermostats and humidistats unnecessary expenses for low temperature drying?

Humidistats\* are unreliable at low temperatures. Thermostats are unnecessary since they do not truly indicate the type of air needed for drying.

10. Problem: Table 7

How should a 36' diameter bin with a 20 hp. Long Mfg. centrifugal fan be filled?

22% corn to 19'

26% corn to 8 feet

24% corn to 11 feet



TEACHER'S KEY

STUDENT WORKSHEET #7

STIR DRYING

(Reference: FS Grain Drying Guide)

1. To get maximum benefits of the stirring device, you must properly size the fan.

2. What are the three ways to use a stirring device?

P. 15

3. Problem: Table 8.

What is the expected drying capacity of a 30' stirring bin with a fan delivering 20,000 cfm? (Note based figures).

P. 16

RECIRCULATING BIN DRYERS

1. A recirculating device allows you to use a bin as a continuous flow dryer.

2. The heart of the recirculating bin dryer is the sweep auger which periodically revolves around the bin to remove an even layer of dry grain from the bottom.

3. The three types of recirculating bin dryers discussed in this section are:

1. In-bin recirculating

2. Continuous flow

3. Horizontal discharge

4. How many thermostats are needed with this type of system? 2

5. Problem: Table 9

What is the capacity of a 33' diameter bin with a 20' hp. centrifugal fan drying corn from 25% to 15%.

5,948 bu./day

TEACHER'S KEY

STUDENT WORKSHEET #8

TEMPERATURE, VAPORIZER, AERATION, & SAFETY

(Reference: FS Grain Drying Guide)

1. How do you raise or lower drying temperature?

Raise or lower gas pressure settings.

2. Lower drying temperatures save LP (energy) and help improve grain quality.
3. Static Pressure is the measure of resistance to airflow.
4. List and explain the four controls of a dryer.

P: 21

Constant heat

Modulating valves

Humidistat

Thermostat

5. In what two situations should you not enter the bin?
  1. When the grain is bridged.
  2. When the grain being removed.

6. Explain the purpose of a vaporizer.

Change LP gas from a liquid to a vapor.

7. A large tank produces more vapor than a smaller tank.
8. What other factors affect the rate of vaporization?

Wind, sunshine, shape of tank, and percent of fill.

9. What are the two types of vaporizers?

Internal & external

10. Explain the purpose of aeration:

Ventilating the grain with air to keep grain in its present condition.

11. Into what three categories can aeration be divided?

1. Safe storage of dried grain
2. Cooling of warm grain
3. Holding wet grain

# PARTS OF A GRAIN BIN DRYING SYSTEM

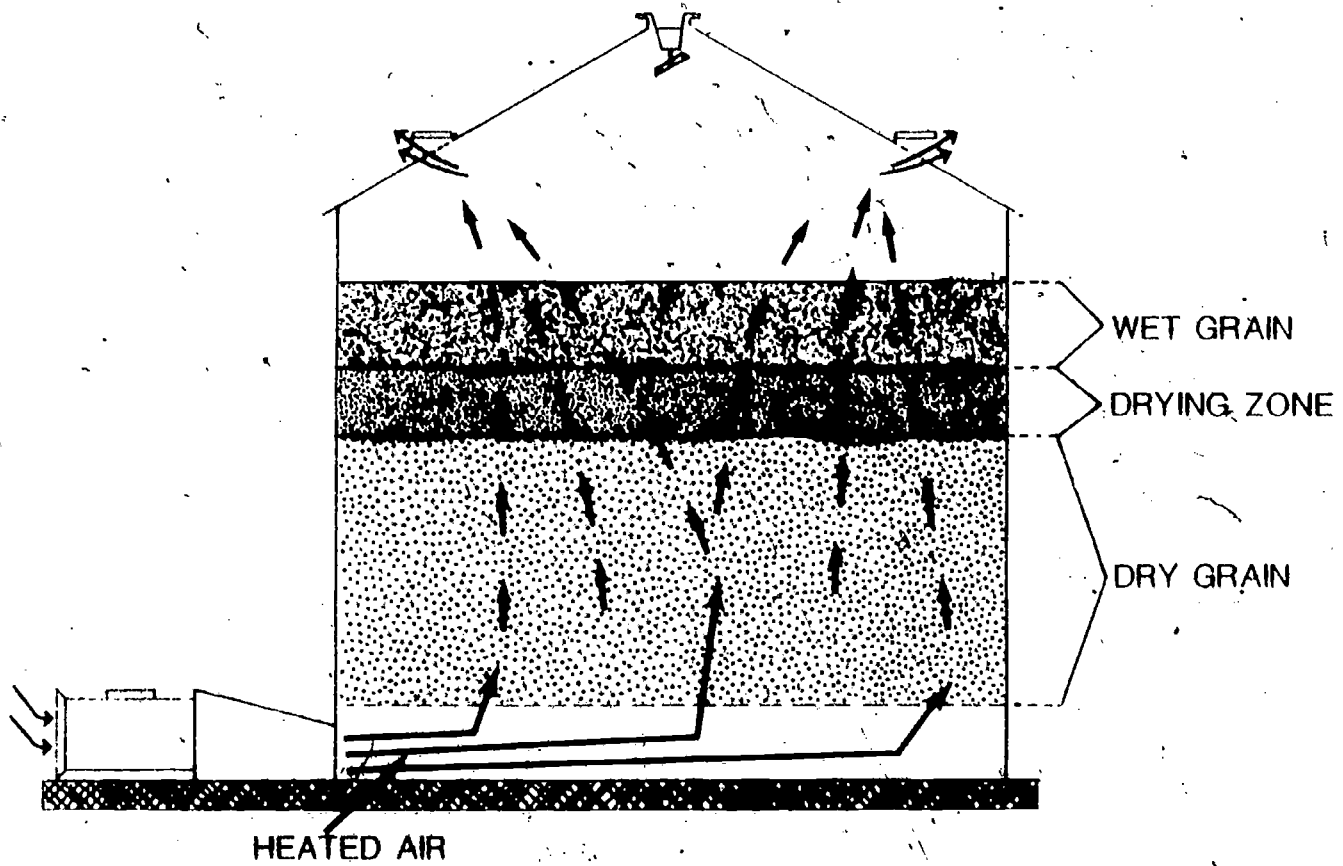
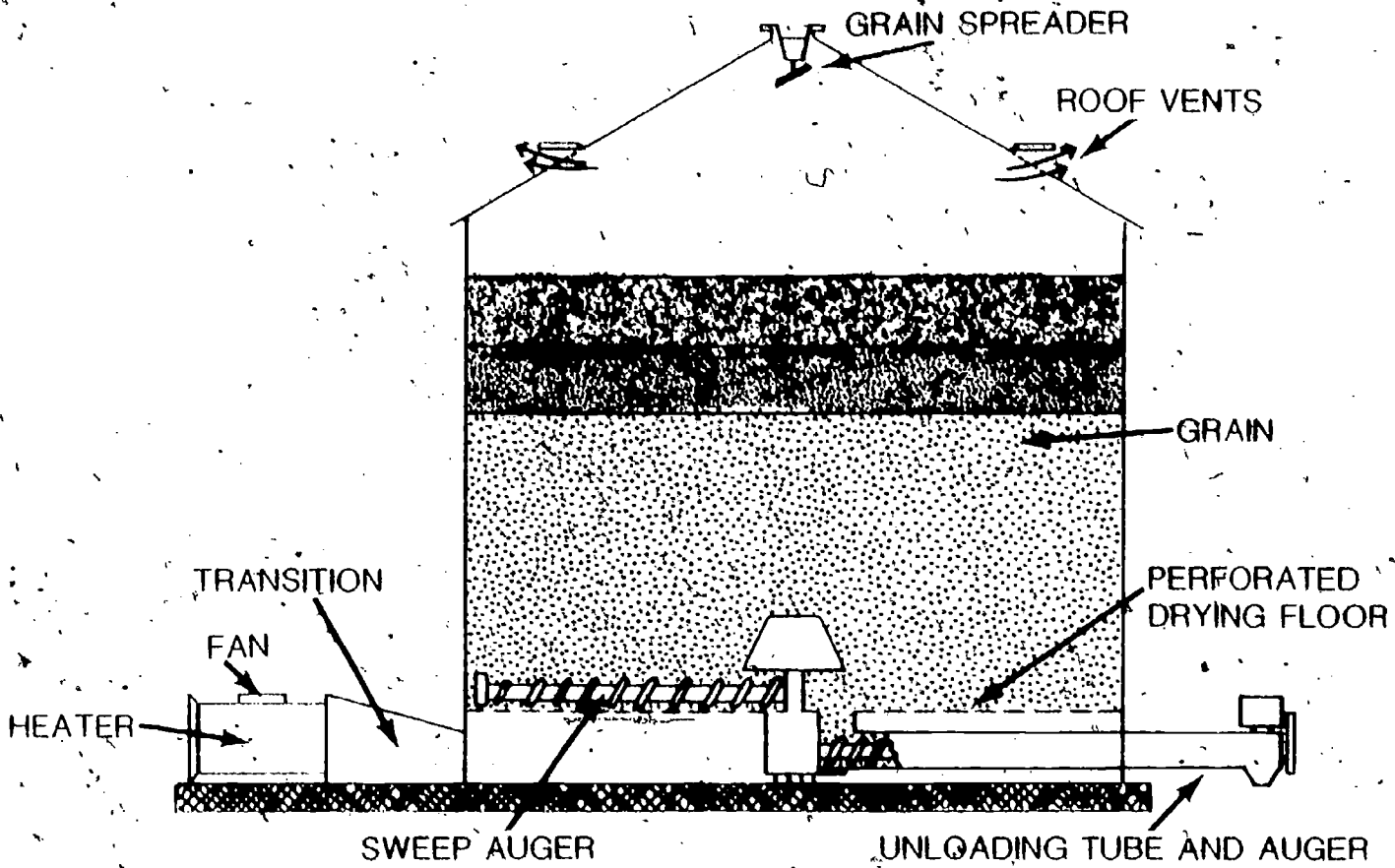

# THINK ABOUT SAFETY BEFORE ENTERING A GRAIN BIN

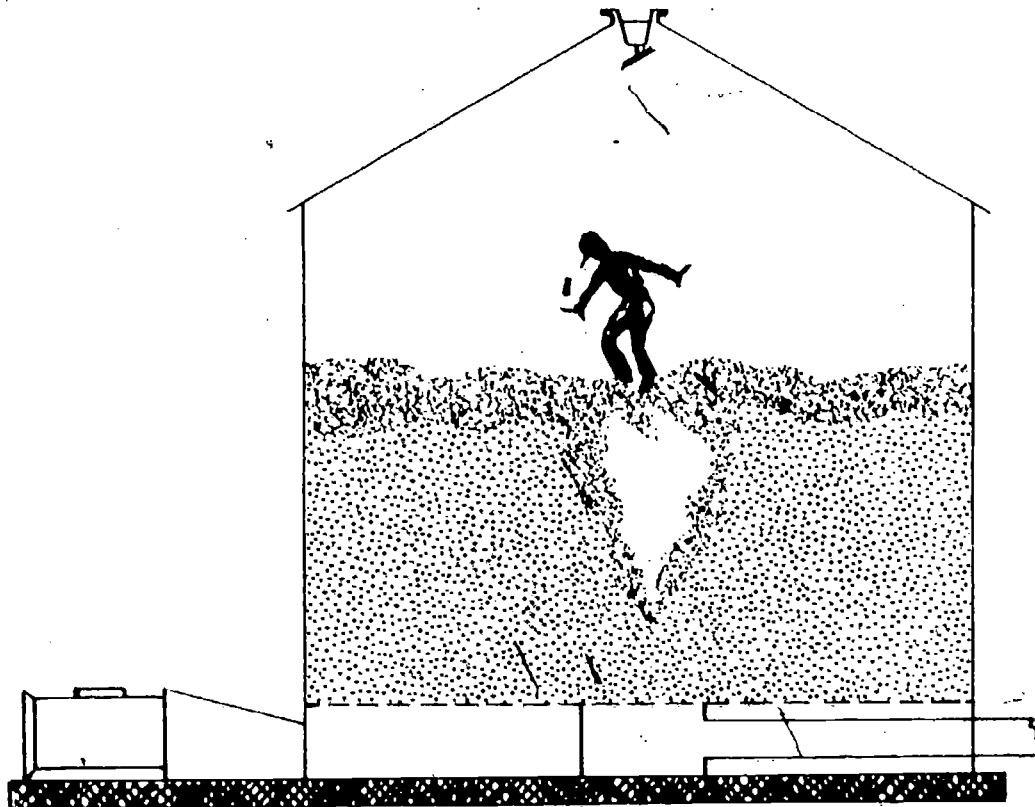

Bridged grain can bury you.

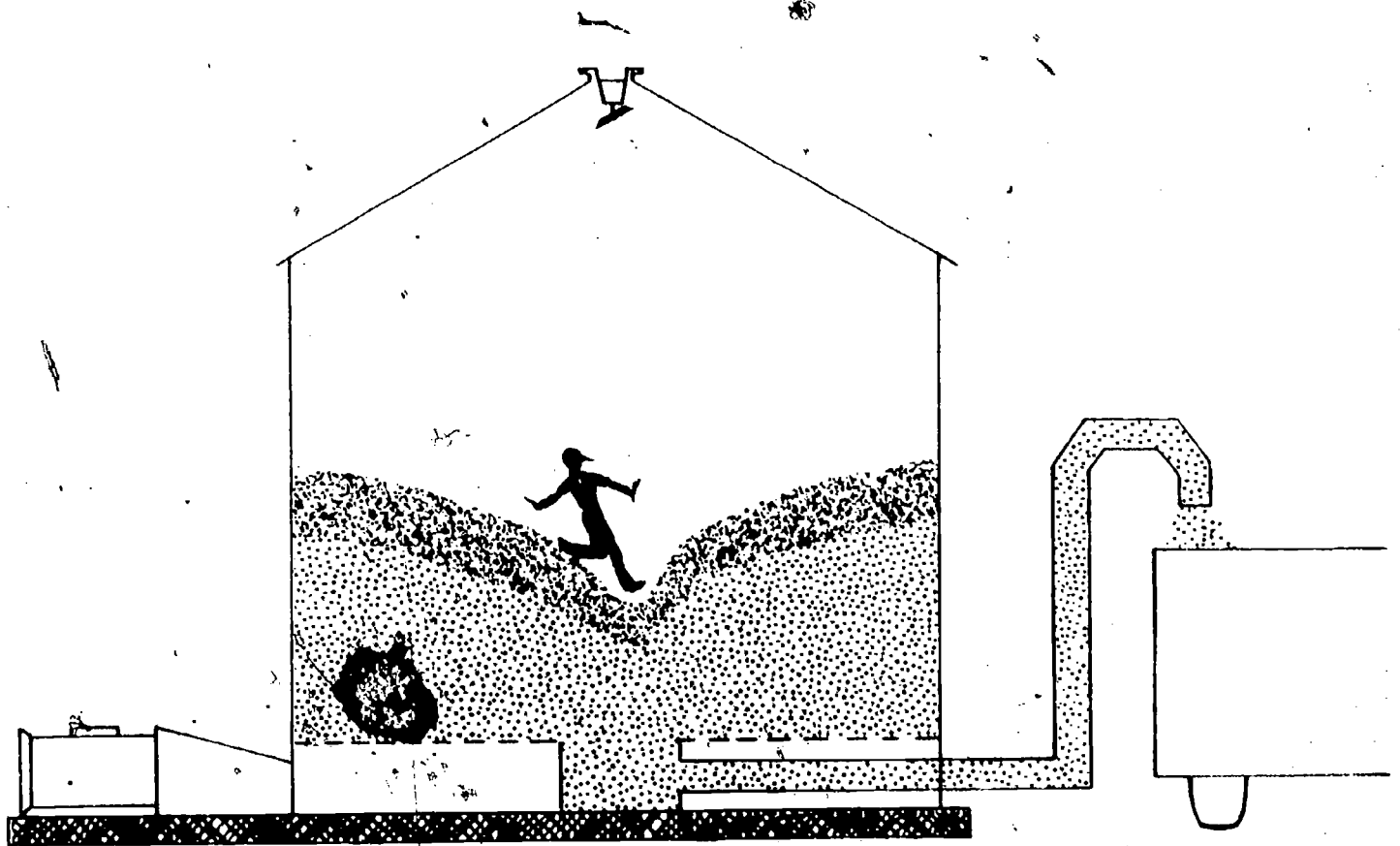

Flowing grain can trap you in seconds.

# GRAIN DRYING FANS

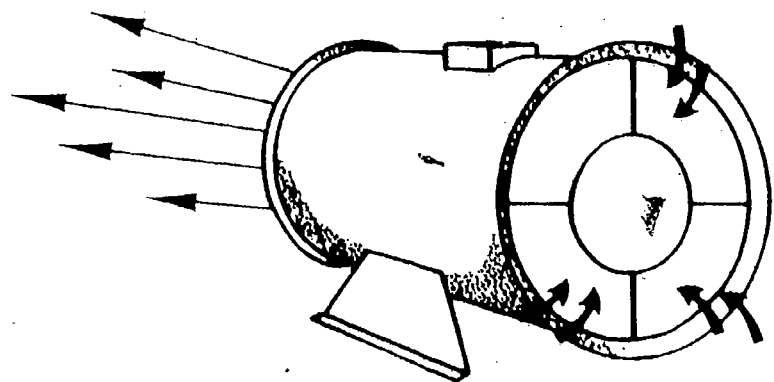

Vaneaxial for lower static pressures

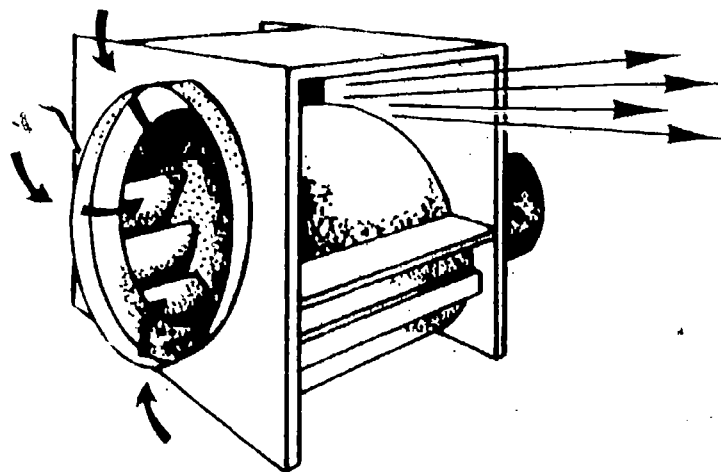

Centrifugal for higher static pressures

# MEASURING STATIC GRAIN BIN PRESSURE

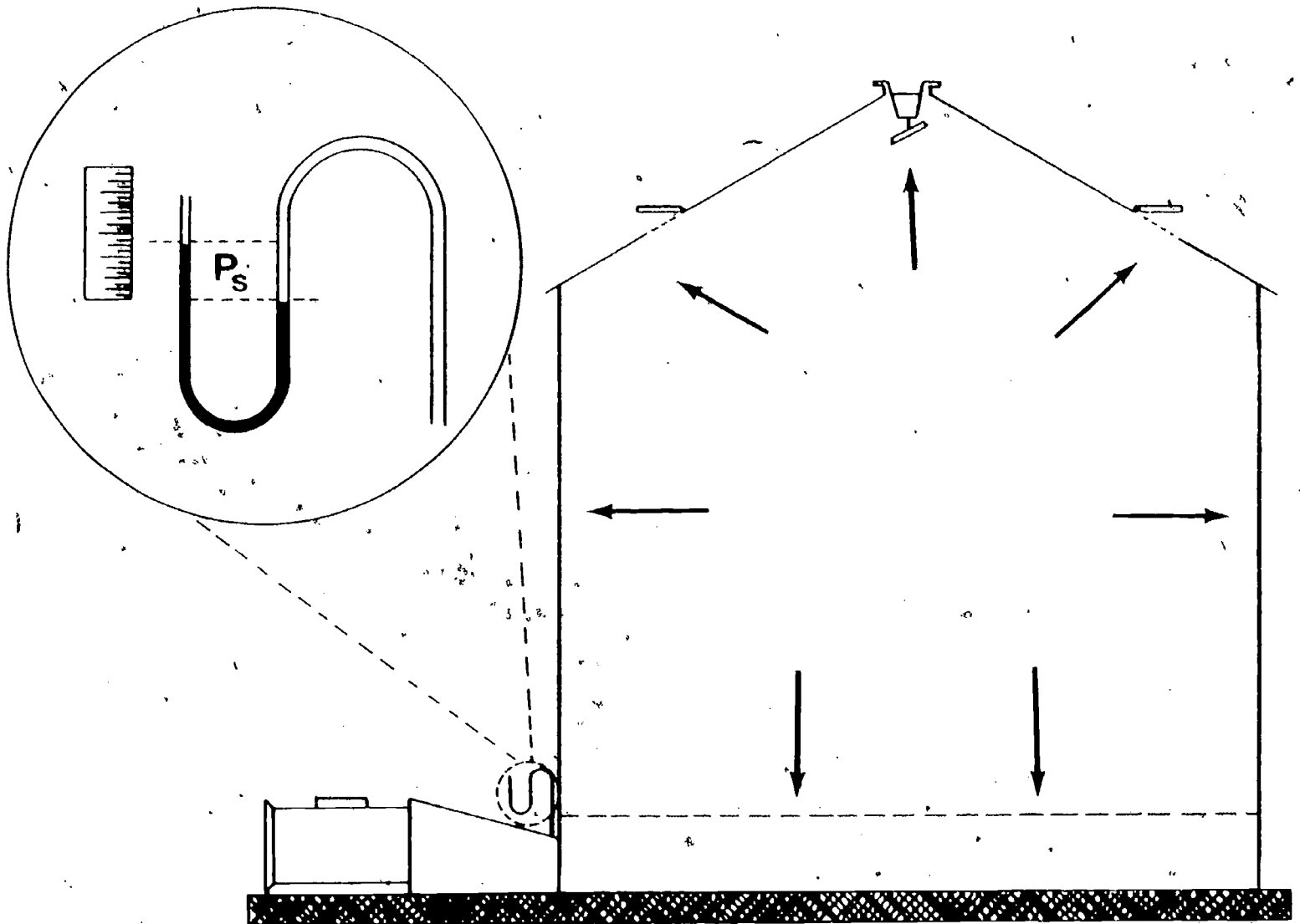

The pressure ~~pushes~~ pushes the water down on one side of the u-tube which, in turn, raises it on the other side. The difference of these two levels is the static pressure (measured in inches).

# LAYER FILL DRYING

A method of drying and storing in the same bin.

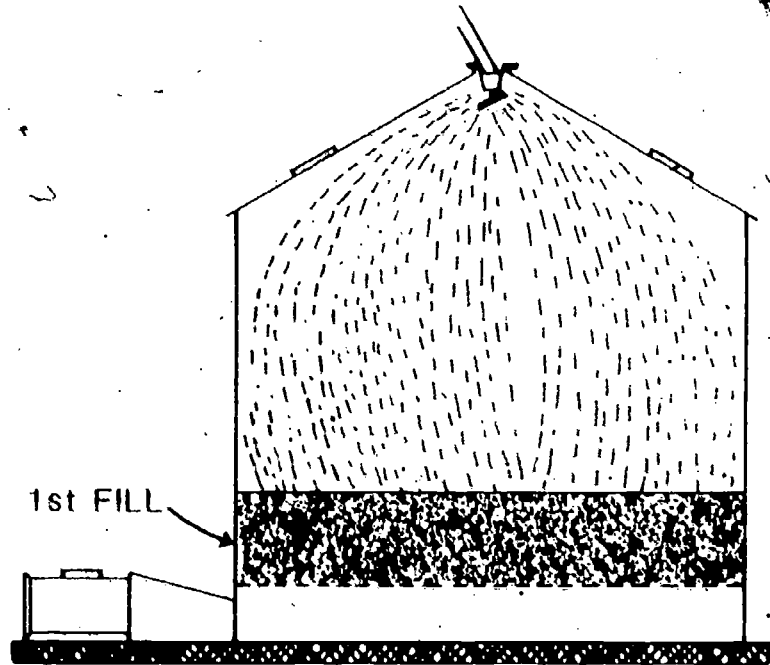

Filling is done a layer at a time.

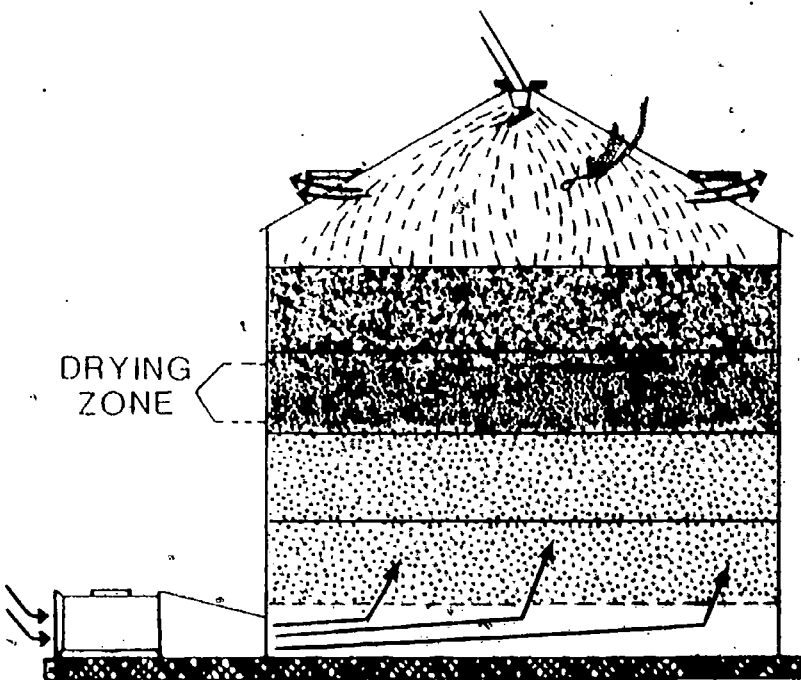

As the drying front progresses up through the grain, you can add additional layers of wet grain.

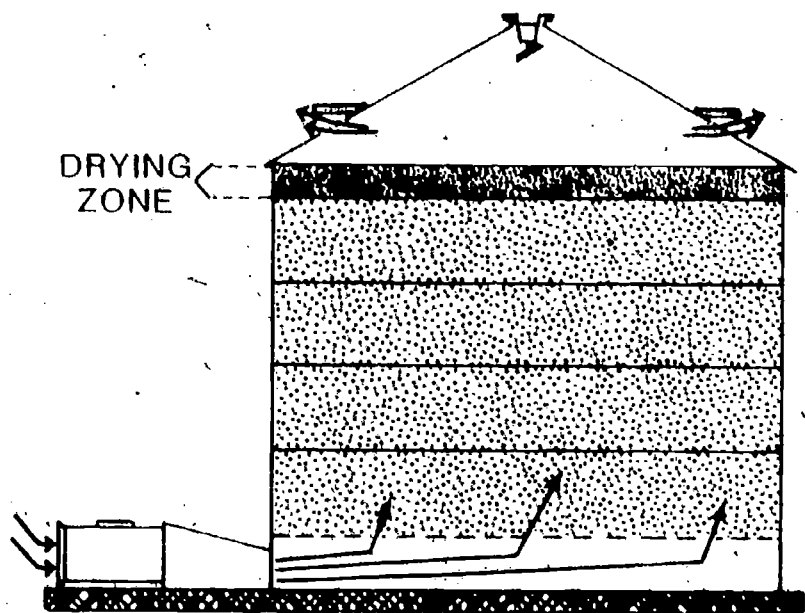

Continue drying until the drying zone reaches the top.



# BATCH-IN-BIN DRYING

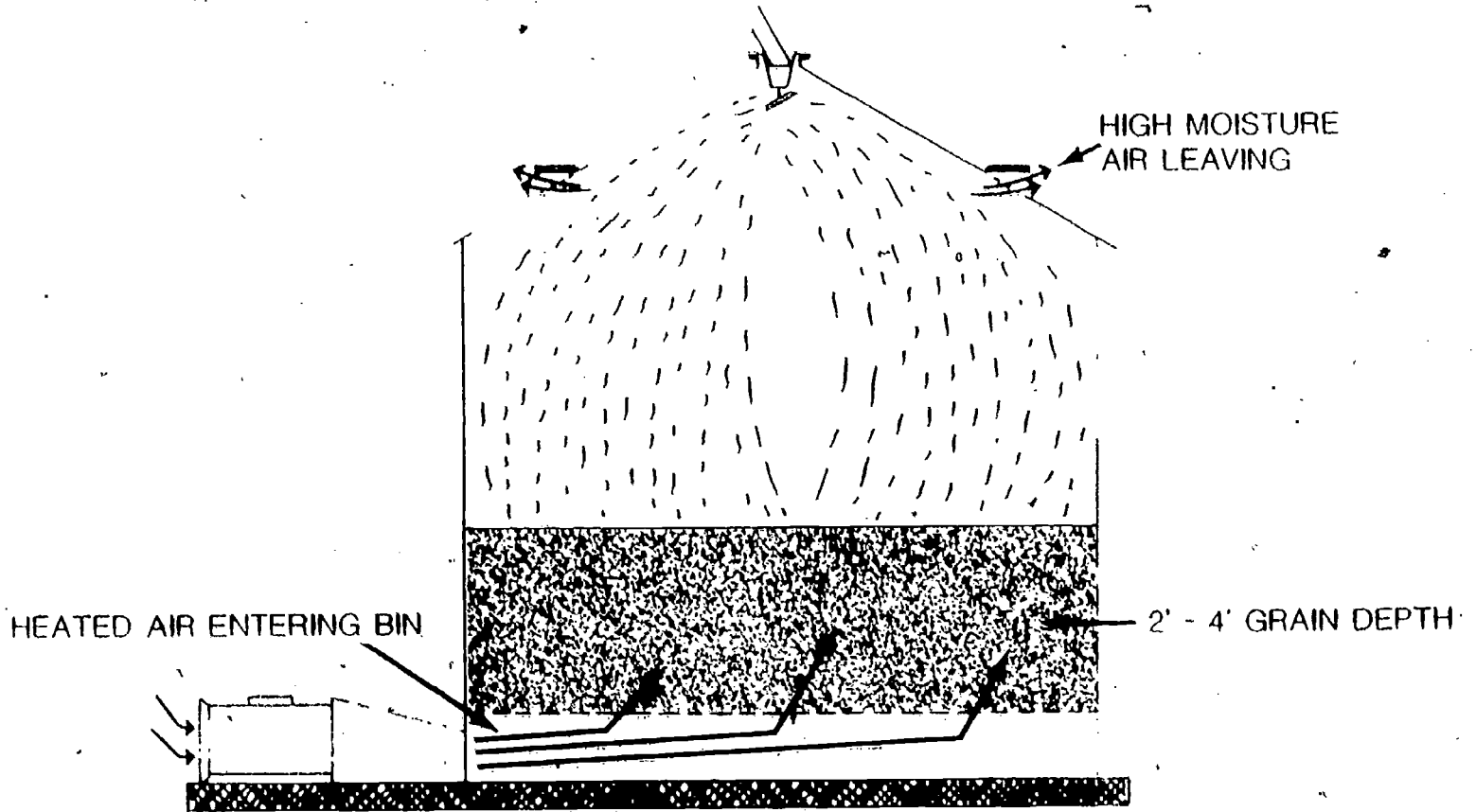

Drying begins as bin fills.

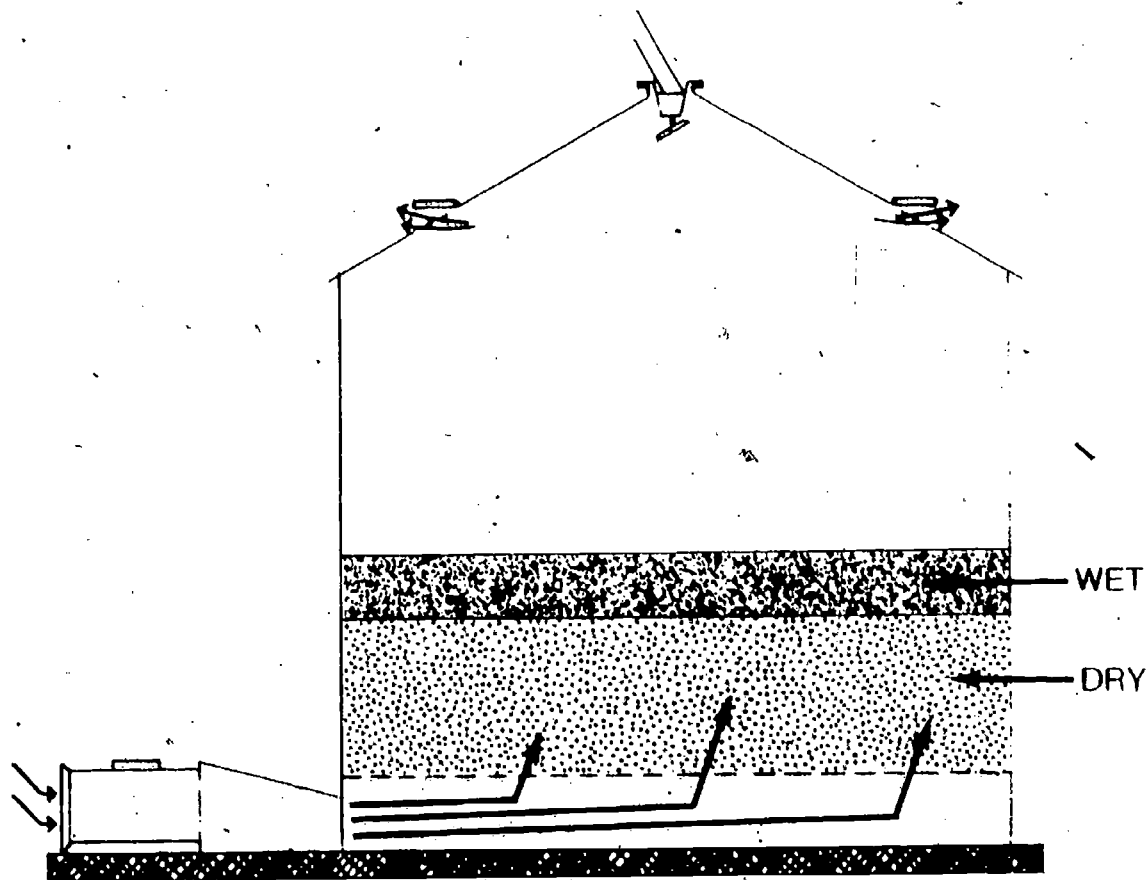



The grain on the bottom is drier than the surface layer.



# TRANSFERRING GRAIN FROM BATCH TO BIN

## KEY

-  wet grain
-  dry grain
-  blended wet and dry grain

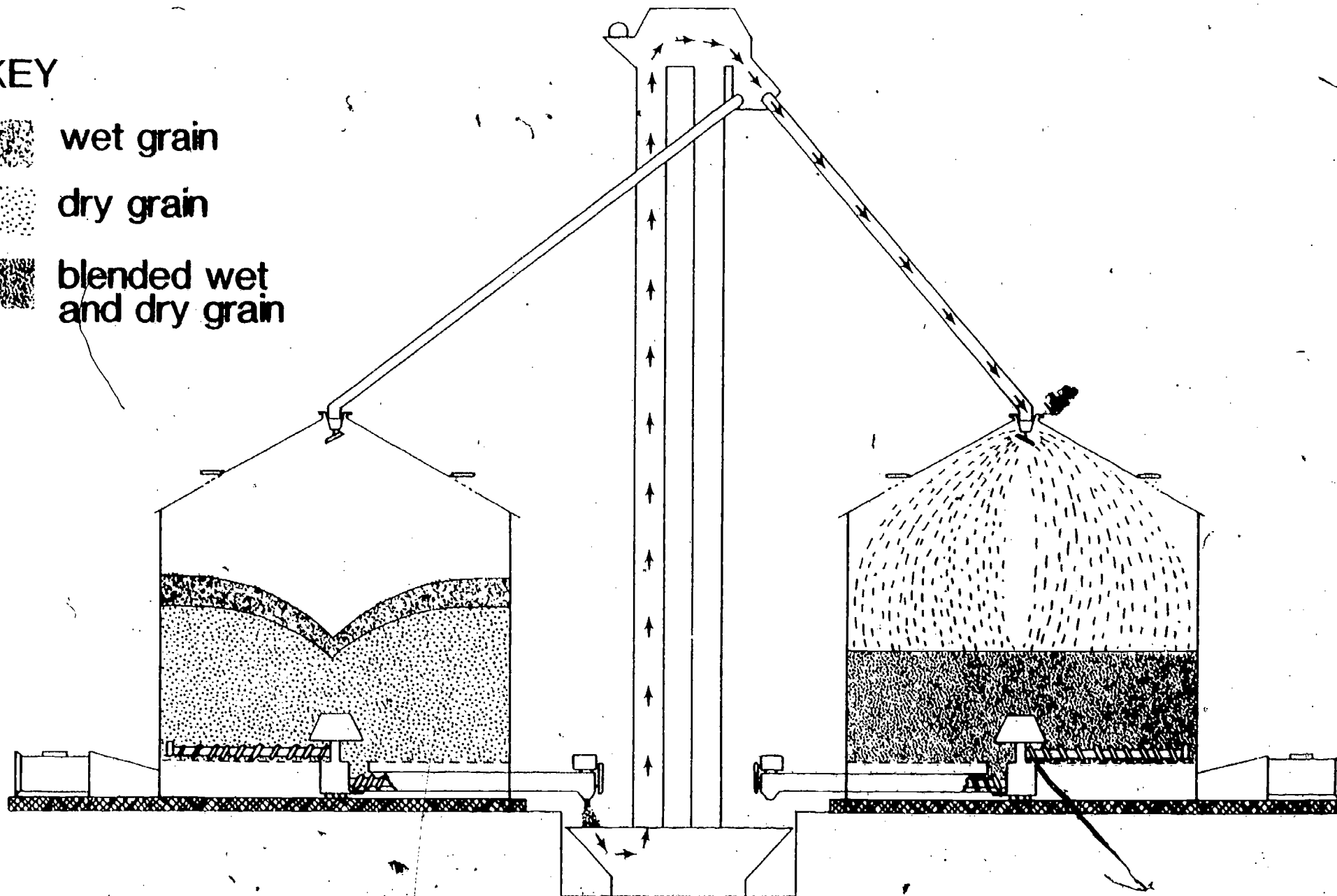

The final moisture content is averaged by mixing during transfer.

# DRYING BIN WITH STIRRING DEVICE

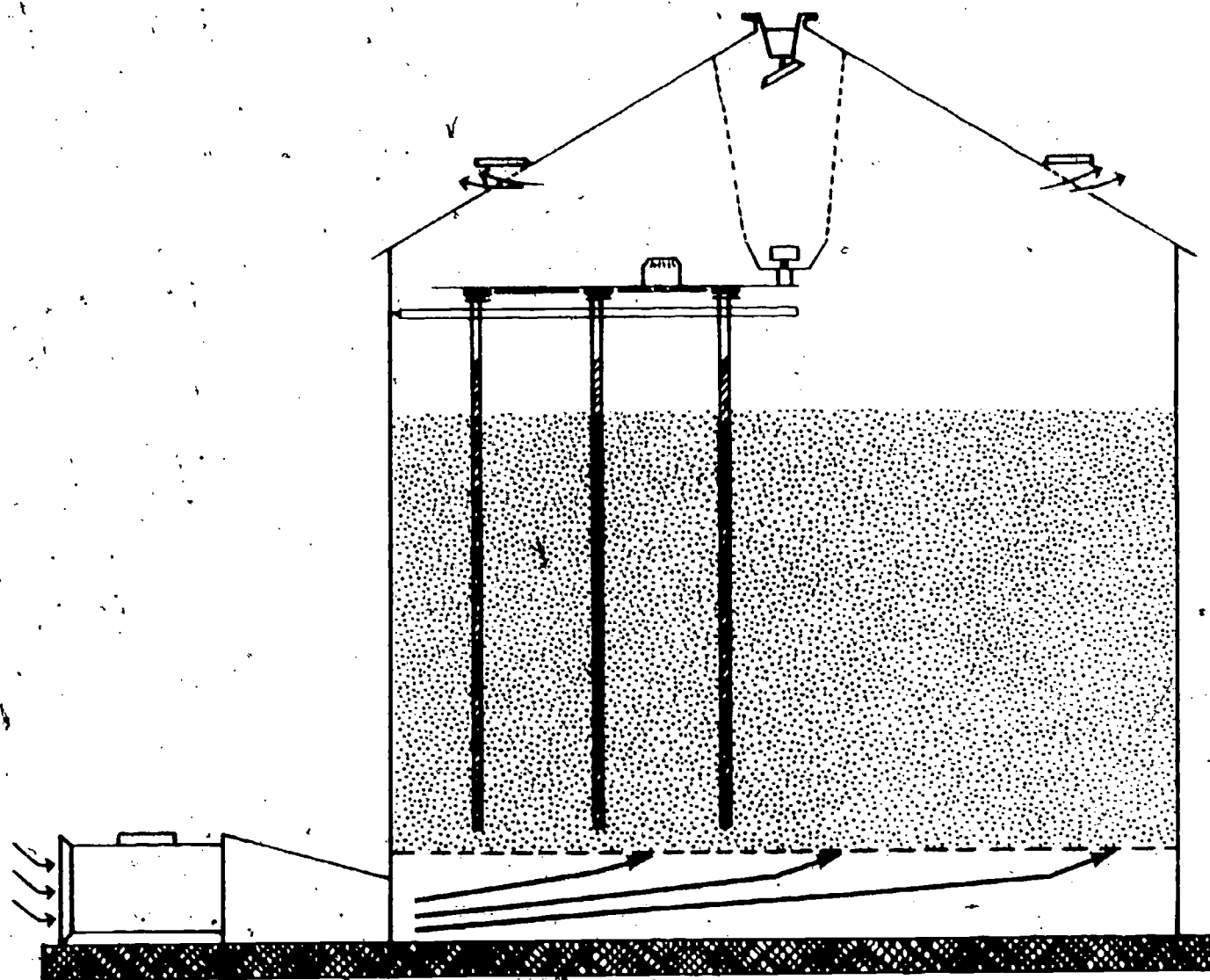

Vertical augers blend grain for more uniform drying.

# MOISTURE CONTENT TO WHICH SOYBEANS WILL DRY

Relative humidity of air entering soybeans, %	Temperature of air entering beans (°F.)				
	30	40	50	60	70

40 .....	9	8.5	8	7.5	7
50 .....	10.5	10	9.5	9	8.5
60 .....	12	11.5	10.5	10	9.5
70 .....	14	13	12	11.5	10.5
80 .....	16	15	14.5	13.5	12.5
90 .....	20	19	18	17	16
100 .....	26	25	24	23	22

## TRANSPARENCY DISCUSSION GUIDE

### DRYING AND STORING GRAIN

Transparencies-- PARTS OF A GRAIN BIN DRYING SYSTEM, and THINK ABOUT SAFETY BEFORE ENTERING A GRAIN BIN

- A. Identify and discuss the major parts of a grain drying system. Explain the functions of each part.
- B. Have students explain how their own grain handling systems differ from those in the illustrations.
- C. Review the important safety rules people should observe when working around and inside grain bins.

Transparencies-- GRAIN DRYING FANS, MEASURING STATIC GRAIN BIN PRESSURE

- A. Review the different types of grain drying fans.
- B. Identify the advantages and disadvantages of each type and when each type should be used.
- C. Explain the importance of measuring the static grain bin pressure.
- D. Identify the types of fans most frequently used in the local area.

Transparencies-- LAYER FILL DRYING, BATCH-IN-BIN DRYING, TRANSFERRING GRAIN FROM BATCH TO BIN, DRYING BIN WITH STIRRING DEVICE, and MOISTURE CONTENT TO WHICH SOYBEANS WILL DRY

- A. Have students identify and explain the type of drying system they have observed or operated.
- B. Point out that layer fill drying is done in 2' to 4' layers.
- C. Explain the movement of the drying zone. It starts at the bottom and a "drying front" moves up the layer.
- D. Explain how some systems use one bin for drying and then transfer the grain to another bin for storage. This technique can blend wet and dry grain.
- E. Point out and discuss how various stirring devices can also blend grain.
- F. Discuss how the humidity and temperature of the air entering the grain bin influences the moisture content to which the soybeans will dry.
- G. Identify some management practices to observe in drying and storing grain.

TEACHER'S KEY  
DRYING AND STORING GRAIN  
SAMPLE TEST QUESTIONS

Part I. True (+) False (0)

- + 1. The maximum depth for corn in a batch drying is 4'.
- + 2. Electric heaters are generally used as a heat source for low temperature drying.
- 0 3. A taller bin needs a less h.p. fan than a short bin to deliver cfm/bu.
- 0 4. Relative humidity is the ratio of the amount of water vapor actually in the grain.
- + 5. To get maximum benefits from a stirring device, one must properly size the fan.
- + 6. One can raise the drying temperature by increasing the pressure setting on the heater.
- + 7. BTU is British Thermal Units.
- + 8. Fans are measured in cubic feet per minute.
- 0 9. Static pressure is a measure of the airflow without resistance.
- 0 10. Vaporizers are internal only.

PART II. Multiple Choice

- B 1. Which of the following answers is not a type of grain drying system?
- A. Batch-in-Bin  
B. Low Bin  
C. Layer Fill  
D. Low Temperature
- D 2. The primary concern in storing grain is the prevention of ?
- A. Insects  
B. Bacteria  
C. Rodents  
D. Mold

- A 3. The point when continued contact with the drying air results in no further moisture reduction is
- A. Equilibrium point
  - B. Humidistat point
  - C. 20% moisture point
  - D. None of the above
- B&D 4&5. Grain drying fans are usually which two of the following.
- A. Roller
  - B. Centrifugal
  - C. Piston
  - D. Vaneaxial
- C 6. Which of the following is not considered when you determine material-flow?
- A. Total grain production
  - B. Size of combine
  - C. Size of tractor
  - D. Future planning
- D 7. What is considered invisible loss?
- A. 5%
  - B. 1%
  - C. 10%
  - D. .5%
- B 8. What should you not do when you enter a bin?
- A. Have 2 men around to help in case of trouble.
  - B. Tie a safety rope around your ankle.
  - C. Be cautious of crusting.
  - D. Use a respirator.
- D 9. What is the maximum drying temperature for seed corn?
- A. 200°
  - B. 100°
  - C. 140°
  - D. 110°
- C 10. Which type of drying keeps corn in one bin?
- A. Batch-in-bin
  - B. Low Bin
  - C. Layer Fill
  - D. Continuous Flow

### PART III. Completion

1. Low temp drying uses natural air, with a small amount of additional heat.
2. Total air temperature is the sum of the outside temperature and the temperature rise.
3. LP Gas must be vaporized before combustion.
- 4&5. Chicago Electric and Long Mfg are two examples of grain dryer manufacturers.
6. The heart of a recirculating bin dryer is the tapered sweep auger.
- 7-10. A centrifugal fan is used for high static pressure and low noise. If you want large volume at low pressure use a vanexial fan. A vanexial fan can overload itself while a centrifugal fan is generally heavy duty and can handle dirt and dust well.

### PART IV. Problems

1. You delivered 1400 bushels of 22% corn to your local elevator. How much actual #2 (15.5%) corn did you deliver?

$$100 - \frac{78}{84.5} \times 100 = 7.69\% \text{ shrink}$$

$$1400 - 107.66 = 1292.34 \text{ bushels}$$

2. How much will the elevator shrink your delivery? 8.19%



PART V. Essay

1. When 100 bushels of 21.5% corn is dried to 15.5% how many bushels of dry corn will be left?

Answer:  $100 \text{ bu.} \times \frac{100-21.5}{100-15.5}$

$$100 \text{ bu.} \times \frac{78.5}{84.5} = 92.89 \text{ bushels}$$

2. Explain the drying process of corn.

Answer on Worksheet #1

3. List and describe the different methods of drying corn.

Answer on Worksheet #2



## UNIT E: CROP SCIENCE

### PROBLEM AREA: GROWING TIMBER AND TREES AS AN AGRICULTURAL CROP

#### SUGGESTIONS TO THE TEACHER:

This problem area is designed for use with advanced students in vocational agriculture programs. The recommended time for teaching this problem area is during the late Spring or Fall, depending upon the outdoor activities which are assigned.

The estimated instructional time for this problem area is 5 to 10 days depending on how far the teacher wishes to go in developing student knowledge and skills in forestry management. If the students are to be involved in other exercises, the instructional time will need to be increased.

The instructor is encouraged to conduct a local search to locate other supplementary materials for use with this problem area. The items in this problem area are for reference or modification as instructors adapt these materials to their local situation.

#### CREDIT SOURCES:

These materials were developed through a funding agreement, R-33-24-0-0362-466 with the Illinois State Board of Education, Department of Adult, Vocational and Technical Education, Research and Development Section, 100 North First Street, Springfield, Illinois 62777. Opinions expressed in these materials do not reflect, nor should they be construed as policy or opinion of the State Board of Education or its staff.

The teacher's guide, student worksheets, student job sheets, transparency discussion guide, and sample test questions were developed by Jerry D. Pepple, Department of Vocational and Technical Education, University of Illinois. The information sheets are reprints of articles from Illinois Research, Agriculture Experiment Research Station, Winter 1983, Volume 25, Number 1, Agricultural Publications Office, 123 Mumford Hall, 1301 West Gregory Drive, Urbana, Illinois 61801.

The artwork in this problem area was prepared by the Vocational Agriculture Service, University of Illinois.

## TEACHER'S GUIDE

- I. Unit: Crop science
- II. Problem area: Growing timber and trees as an agricultural crop
- III. Objectives: At the close of this problem area students will be able to:
  1. Identify and explain the functions of selected parts of a tree.
  2. Understand the environmental and economic factors which influence forestation in Illinois.
  3. Explain how forests can be established.
  4. Recognize and explain the major differences between an unmanaged and a well-managed forest.
  5. Recommend various management practices to improve a given forest area.
  6. Appreciate the value and marketability of various tree species located in a given forest area.
- IV. Suggested interest approaches:
  1. Begin class discussion by raising the following questions with the class:
    - a. What is a productive forest?
    - b. What land should be planted to forests?
    - c. Why should forests be preserved in Illinois?
  2. Ask the class if any of them are interested in working as a forest conservationist.
  3. Pass photographs of unmanaged and well-managed forests around the class. Then ask a series of questions:
    - a. What is wrong with these forests?
    - b. How can forest areas be improved?
  4. Ask students to "brain-storm" and identify the major purposes of forests in Illinois.
  5. Ask students if they know what the value of a selected tree might be if marketed for lumber. Work out a problem with the class.
  6. Demonstrate how to properly use a chain saw to "fell" a tree and cut fire-wood.

V. Anticipated problems and concerns of students:

1. Why is it important to maintain forests in Illinois?
2. What are trees in Illinois used for?
3. What is happening to forest areas of Illinois? Increasing? Decreasing? Why?
- \* 4. What are the characteristics of a good marketable tree?
5. What care should be given to forests?
6. How can we estimate the value of a tree? forest?
7. How can we safely operate a chain saw?
8. How can we safely use an ax?
9. Are forest fires always bad? Why or why not?
10. What are the parts of a tree?
11. How are trees harvested in this area?
12. What land should be planted to forest?
13. What kinds of trees should be planted or maintained?
14. When should trees be planted?
15. What is the potential for Illinois forests?

IV. Suggested learning activities and experiences:

1. Begin the instructional phase of this problem area with the following steps:
  - a. Select and conduct an interest approach.
  - b. Assist students in the identification of goals and objectives.
  - c. Have students identify their problems and concerns about forestry and land use in Illinois.
  - d. Lead students through a trial discussion of problems and concerns.
  - e. Identify those problems which need further study and investigation.
2. Distribute copies of information sheets to students and identify other sources where information on Illinois forestry can be obtained.
3. Have students complete student worksheets using information sheets and VAS Unit 4024, "Planting and Care of Farm Forests."

4. Have students organize a display which promotes a theme on the importance of forestry in Illinois.
5. Organize a field trip to a wooded area and invite a Soil Conservation forester to help demonstrate selected activities such as:
  - a. boring trees to determine age.
  - b. measuring trees to determine volume.
  - c. marking trees and labeling for reasons of removal.
  - d. cruising timber.
6. Have class organize and plant a Christmas tree plot as an FFA or land laboratory exercise.
7. Assist the local Soil Conservation Service or other conservation agency in organizing the distribution of tree seedlings to elementary and junior high students during Arbor Week.
8. Demonstrate the proper use of chain saws for pruning, limbing, cutting fire wood, and felling trees.
9. Have students explore the opportunity for developing supervised occupational experience programs in forestry.
10. Organize a local or sectional FFA forestry contest, invite local 4-H club members to participate.
11. Have students who are interested in forestry make application for Summer Forestry Workshops by contacting Forestry Extension Department, University of Illinois, 110 Mumford Hall, 1301 West Gregory Drive, Urbana, Illinois 61801.

#### VII. Application procedures:

1. Students should be able to critically evaluate trees and forested areas for their economic and environmental values.
2. Have students develop S.O.E. programs in forestry.
3. Skills learned in this problem area will aid students working for park forestry divisions, farmers, and conservation agencies.

#### VIII. Evaluation:

1. Grade written exercises and worksheets assigned with this problem area.
2. Evaluate students ability to identify and suggest approved practices for the improvement of selected forestry areas.

IX. References and aids:

1. Vocational Agriculture Service, College of Agriculture, University of Illinois, 1401 South Maryland Drive, Urbana, Illinois 61801.
  - a. VAS Unit 4024, Planting and Care of Farm Forests.
  - b. VAS Unit 4018, Farmstead Windbreaks.
2. Elements of Forestry with Special Reference to Illinois, Department of Conservation, Division of Forest Resources and Natural Heritage, Northwest Office Plaza, 600 North Grand West, Springfield, Illinois 62706.
3. Chain Saw Safety Tips; by C. S. Walters. Illinois Cooperative Extension Circular 1170. 1979. 11p. Single copies free.

Office of Agricultural Publications  
University of Illinois  
123 Mumford Hall  
1301 West Gregory Drive  
Urbana, Illinois 61801

4. Forest Trees of Illinois; by Robert Mohlenbrock. Department of Conservation. 1972. 328p. \$2.

Division of Forest Resources  
and Natural Heritage  
Northwest Office Plaza  
600 North Grand West  
Springfield, Illinois 62706

5. Department of Forestry  
University of Illinois  
110 Mumford Hall  
1301 West Gregory Drive  
Urbana, Illinois 61801
  - a. Chart for Identifying Some Common Native Forest Trees of Illinois in Summer. 4p.
  - b. Christmas Tree Series. Leaflets 14 through 17.
  - c. Firewood Economics. Leaflet 10. 4p.
  - d. Growing Christmas Trees in Illinois; by A. R. Gilmore. Illinois Cooperative Extension Circular 1171. 1980. 35p.
  - e. Growing Walnut for Profit and Pleasure. Fine Hardwoods/American Walnut Association. 1980. 12p.
  - f. Improve Your Woodlot by Cutting Firewood. USDA-Forest Service. 9p.

## COMPETENCY INVENTORY

### GROWING TIMBER AND TREES AS AN AGRICULTURAL CROP

1. Student has no knowledge of competency.
2. Student has read about competency.
3. Student has seen competency performed.
4. Student has performed competency.
5. Student has performed competency without supervision.
6. Student does possess skill.
7. Student does not possess skill.

Competency	Circle One				
1. Inspect and care for stock before planting.	1	2	3	4	5
2. Obtain good quality seedlings.	1	2	3	4	5
3. Operate safely chain saws, brush kings, etc.	1	2	3	4	5
4. Maintain tools and equipment.	1	2	3	4	5
5. Layout and maintain access roads and firebreaks.	1	2	3	4	5
6. Plant seedlings using hand tools.	1	2	3	4	5
7. Plant seedlings using mechanical equipment.	1	2	3	4	5
8. Remove undesirable species by chemical or mechanical means.	1	2	3	4	5
9. Use harvesting tools and equipment safely.	1	2	3	4	5
10. Maintain harvesting equipment.	1	2	3	4	5
11. Select and mark trees to be cut.	1	2	3	4	5
12. Eliminate cull trees while harvesting.	1	2	3	4	5
13. Evaluate and understand future marketability and management systems for different species.					6 7
14. Recognize needs for and methods of reforestation.					6 7

These competencies are outlined in the National Ag Occupations Competency Study, 1978, for entry level positions in agriculture.

Name \_\_\_\_\_

Date \_\_\_\_\_



INFORMATION SHEET  
FORESTRY IN ILLINOIS

By: Robert A. Herendeen and Gary L. Rolfe, University of Illinois,  
Department of Forestry, Illinois Research Publication, Winter 1983.

Illinois is known as the Prairie State rather than the Sylvan State or the Nation's Woodbox; only 11 percent of the land is forested, compared with 30 percent for the rest of the United States. Despite this disadvantage, we believe that with improved management Illinois forests will become increasingly important to the state in the years ahead.

A century and a half ago forests covered 40 percent of Illinois. Today the remainder comprises 4 million acres, located primarily in southern Illinois and along the Illinois and the Mississippi Rivers. Hardwoods dominate, with 97 percent of the forests being classified as oak-hickory or elm-ash-cottonwood. Silver maple prevails on river bottomlands. Barely one percent of our forest land contains conifers.

Management problems. More than 90 percent of the 4 million acres is privately owned; the only major public holding is the 261,570 acres of the Shawnee National Forest. Private holdings are divided among 110,000 landowners, 37,000 of them farm owners who average 54 wooded acres each. The remaining 73,000 owners average 22 acres. Because of this pattern of many small holdings, improving the management of Illinois forests is extremely difficult.

Regardless of the inherent problems, we are determined to develop the valuable resource found on this poorly managed land. First, however, we must assess the potential of Illinois forests and identify some of the economic issues involved in realizing the potential.

Potential value of Illinois forests. Modern forestry recognizes that forests can serve several purposes. They can be used to produce sawtimber, pulp logs, convertible biomass, and chemical feedstocks; protect soil and water quality; provide windbreaks, grazing lands, and recreational facilities; and offer aesthetic values. Some of these uses are compatible with one another and some are not. The value of any one use can be considerable; taken together, several uses add up to a still greater potential value.

If Illinois were to harvest the wood from its net annual growth, 86 million cubic feet of sawlogs could be produced per year. Converted to lumber, the harvest would amount to 520 million board feet, or enough to build about 50,000 new homes.

Given the quality of the land, this level of production represents only a third of the state's potential, according to data from the U.S. Forest Service. Compared with any of the other central and lake states, Illinois has a greater percentage of its forest land (40 percent) classified as highly productive, with a potential of at least 85 cubic feet per acre per year.

If converted to pulp instead, this output would provide roughly a fifth of the paper used in Illinois. Here again, the output could be tripled. Impressive as these figures are, Illinois is not likely to use valuable hardwoods for pulp in the near future.

Yields for biomass to produce energy can be significantly larger than yields for sawlogs, since rotations can be short and plantings dense. For example, the potential yield for sawlogs is 1.4 dry tons per acre per year (DTA), and 5 DTA for biomass for energy, according to our preliminary findings.

Biomass crops can be fast-growing hardwoods like sycamore, autumn olive, black locust, and hybrid poplar, with rotations as short as 3 years. In some cases, coppicing, or resprouting from the stump, allows for several rotations before the rootstock must be replanted. At yields of 5 DTA, the biomass produced on 4 million acres could provide 9 percent of the total energy Illinois currently uses; even higher yields are possible.

The effect of forests on water quality is more difficult to quantify. To tackle the problem, we have been studying the interrelationship of forest cover, management practices, and water quality. So far our results indicate that the quality of water from forest watersheds is extremely good. We have also found that typical silvicultural and management practices for rotations of several decades have little effect on water quality.

Recreational and aesthetic values are an important area. One, perhaps imperfect, indicator is how often public lands in Illinois are used. People make about 800,000 visits annually to the Shawnee National Forest, 500,000 to state forests, and 32 million to county forest preserves. Most of the visits in this last category are to the Cook County Forest Preserves and include very short as well as longer stays. Measuring the value of amenities provided by private lands is more of a problem because access to them is often restricted. It is safe to say, however, that the value is considerable, especially near urban areas.

Because row crops are so productive on the rich soils of Illinois, the profits from silviculture must be measured against those from traditional agriculture. If environmental factors are included in the comparison, an increase of forested land is clearly needed. Three million acres now in row crops or pasture ought to be under permanent cover or in conservation use because of problems with soil erosion. If forested, these marginal lands--typically slopes or periodically flooded bottomlands--would help conserve topsoil and would roughly double the state's forest lands.

Introducing forestry to prime, rather than marginal, agricultural land is a controversial issue. As a first step, shelterbelts, once common but now quite rare, can be planted to enhance crop production, reduce erosion, and control snowdrifts so that soil moisture is distributed more uniformly. Shelterbelts also protect farm buildings and livestock and provide firewood.

Development of forestry. We feel that the limitations on forestry in Illinois are primarily economic rather than political or biological. A major stumbling block is the landownership pattern. To change the way land is used, we will have to cooperate with roughly 110,000 landowners.



Efforts among all the state and federal organizations involved with forestry in Illinois must be carefully coordinated. The University of Illinois and Southern Illinois University--the two state universities with forestry research and teaching programs--are working with the U.S. Forest Service, the Illinois Division of Forest Resources and Natural Heritage, the Soil Conservation Service, and other related organizations. Our own Department of Forestry in turn is working with other agricultural units in the College of Agriculture to ensure the integration of agriculture and forestry. Only through coordinated efforts will forestry in Illinois be fully developed.

Allan Mickelson of the Illinois Division of Forest Resources and Natural Heritage has pointed out that a typical tree crop, which might take 50 years to mature, annually yields a net of \$10 per acre. In light of this low return coupled with tax increases and mounting pressures to develop land, it is no wonder that landowners either plant their woodlots to corn or leave them to the care of Mother Nature. The decision not to manage forests hinges on two main points: taxation of land and information on the returns from modern silviculture.

Landowners must be educated, but to do so we need a reliable way of predicting individual benefits. The Department of Forestry is planning to develop a user-friendly package of information based on the economics of forest management. This information should eventually help landowners get a vivid picture of the costs and benefits of forestry on their sites.

Some neglected issues to be evaluated in the package include:

- Competing land uses, particularly row cropping. For example, if forests are converted to row crops, we will weigh the costs to producers for meeting the same water quality and soil erosion criteria now satisfied by current forestry practices. This information is especially important for bottomlands.

- Rotation times. Typical timber rotations of 30 years or more are longer than most private investors want to wait. But waiting times are shorter for several forestry options:

pulp	15 to 20 years
Christmas trees	7 to 12 years
woody biomass	3 to 7 years
firewood	10 to 20 years

Another option is integrated farming (interplanting row crops and trees), which offers inherent advantages as well as an early revenue. At the Dixon Springs Agricultural Center, we are experimenting with planting white pine at spacings of 40 to 60 feet within a row crop to assure a revenue for 10 to 12 years until the pine begins to shade the crop. In pastures, we are exploring methods for protecting seedlings and young trees from cattle.

- Amenities provided by forests. Especially in urban forestry, access and privilege need to be considered. Should communities financially sup-

port tree planting on private land, and how does the public view the costs and benefits?

° Markets. To manage their forests effectively, landowners must be well informed of the market situation and methods for marketing timber in Illinois. Part of the management package will show landowners how to exploit existing markets and evaluate possible new ones.

Illinois will probably never be dubbed anything but the Prairie State. But if we increase and coordinate our efforts, we believe that Illinois can dramatically improve its forests and will profit economically, ecologically, and aesthetically from them.

## INFORMATION SHEET

### VIEWS ON ILLINOIS FORESTRY

By: George T. Weaver, chairman, Department of Forestry, Southern Illinois University, Illinois Research Publication, University of Illinois, Winter, 1983.

Overlooked as a renewable natural resource, Illinois forests are an unrealized opportunity. Put in other terms, Illinoisans are losing out on many benefits from the state's forested lands. These benefits include forest recreation, protection of wildlife species, an abundance of wood products and fuel wood, and cost-effective erosion control on much of the state's 900,000 acres of marginal land. Forests can also help protect and improve the quality of water flowing in our streams. Associated with these benefits are many employment and manufacturing opportunities.

Extensive forests still grow in southern and western Illinois and along our major streams and rivers. More than 35 Illinois counties have at least 10,000 acres of forested land. Dozens of native trees and shrubs occur in nearly endless combinations to form numerous forest types. These types vary from bald-cypress swamps in the bottomlands of southern Illinois to upland hardwood forests throughout the state. Whether through privately owned woodlands or the system of public parks and forests, virtually every Illinois resident can have access to forest recreation.

Illinois forests are minor only on a relative scale. In absolute terms they represent a major resource with potentially significant benefits to the state, region, and nation. Why, then, has the potential of these lands remained undeveloped?

The reasons are varied and complex. According to recent information released by the Illinois Division of Forest Resources and Natural Heritage, forested lands are divided into small, isolated tracts interspersed with agricultural land. Woodland owners have few incentives for practicing forestry because they don't know what their woodlots can be used for and don't have specific objectives in view. Furthermore, markets are inadequate, management techniques are unsatisfactory, and attention is usually focused on agricultural production. Ironically, demand for Illinois forest products and services may remain low because residents rely on other states that are better known for their forests.

Likewise, government policies and assistance programs affect the incentive to manage forests. Low utilization can also be blamed on the real estate tax structure for forest and agricultural land, unemployment compensation laws, highway systems and road regulations, and even on the motives for owning land.

What does the future hold for Illinois forests? During the past two years forestry leaders have discussed this question at major conferences held in the state. They believe that Illinois can realize many of the benefits offered by its forests, especially as forest production in the southeast and Pacific northwest falls short of demand. But first we will have to learn more about the status of our forests, increase people's awareness of potential uses, and develop incentives for forest management.

Many individuals and agencies seem willing to take up the challenge, and programs are now being planned. We have good reason to be optimistic. By working together, forest landowners, users, and professional foresters can begin to realize the benefits offered by Illinois forests.

372

## INFORMATION SHEET

### THE TREE

By: Department of Conservation, Division of Forest Resources and Natural Heritage, Elements of Forestry, Springfield, Illinois.

Trees are separated into two groups. One is the conifers or softwoods which include the trees bearing cones and having scale-like or needle-like leaves. Pines, spruces and all of our native evergreen trees are conifers. Cypress and larch are also conifers although these two species are not evergreen and shed their leaves each fall.

The second group is known as deciduous or hardwoods. In species native to Illinois this group contains all the broad-leaved trees that shed their leaves every year. The oaks, hickories and walnuts are hardwoods. Cottonwood is also a hardwood, hence the classification has nothing to do with the actual hardness of the wood, for in a literal sense, the wood of larch is considerably harder than that of cottonwood.

Since the tree itself is the basis of forestry, we must first of all understand how it grows, its parts and their function. Finally we may think of the tree as we think of a human being--an organism that breathes, eats, drinks, develops, reproduces, has certain habits, is subject to diseases and responds to its environment.

#### Roots

The roots of a tree have two principal functions. The large ones near the stem act as a mechanical support for the tree and by their spread and branching through the ground, keep the tree from being blown over by the wind. The millions of small hair-like roots at the ends of the large ones also are an aid in the tree's support, but their chief duty is to absorb water and food in solution from the soil.

The roots of some trees like the spruces and hemlock tend to spread out near the surface of the ground, so the tree is said to have a shallow or flat root system. Other trees like the oaks and hickories have roots that go deep into the ground and generally branch out from a long, underground extension on the stem. Such root systems are called taprooted. The root system of a single species of tree, however, is not always uniform but often develops according to the soil conditions. If a tree grows where there is plenty of surface moisture a shallow root system may develop, but if the same species grows on a deep, dry soil where surface moisture is lacking the roots may be more or less taprooted and penetrate deeper into the ground.

#### Trunk

The trunk, stem or bole of a tree is the second principal part to be considered. From a standpoint of wood products, it is the most valuable one. The trunk may vary in shape and size but this vital structure in all trees is essentially the same and performs the same functions. In a cross section, we can see in the center the pith which is surrounded by the

wood. In the wood, we can usually see series of concentric rings, the number of which tells us how many years were required to develop the tree to that size.

Outside of the wood is the bark which acts as a protection against the loss of water in the stem and against mechanical injuries to that growing tree. Between the wood and the bark is a thin layer of cells known as the cambium. This layer of soft material contains the most active elements of the stem, since here lie the cells that have the power to grow new wood over the wood formed the previous year. Thus each spring when weather warms up, the cambium begins its work of adding wood cells to the trunk and continues until fall, when it remains inactive over winter. About 80 or 90% of the stem's growth occurs in the first two months of the spring. These cells are thin-walled and relatively large, while those developed later are smaller and thick walled. The contrast between these cells is readily visible and shows as a ring when viewed on a stump. These rings are often called annual rings because trees normally produce one of them each year in our temperate climate.

The cambium and the new wood cells near it are the working parts of the trunk. Here the water is transported, the food used by the tree is distributed and, as has been stated, new wood is formed. This explains why a tree will grow even though the inside of it may be completely rotted. It indicates further that the main function of the old wood or "heartwood" is to provide mechanical support.

#### Crown

The crown is made up of branches, twigs, leaves, buds, fruit and flowers. The leaves are the most important organs for they have the power to combine the water and dissolved nutrients that come from the roots with the carbon dioxide from the air to form sugar and starches which can be used as food by the tree. For this reason the leaves have been called the tree's laboratory. This food-making process takes place only in the presence of water, carbon dioxide, a green substance in leaves called chlorophyll and sunlight. Consequently the absence of any of these items means the loss of food and eventual death of the tree. It is quite evident, therefore, why the tree must have water, soil nutrients, air, green leaves and sunlight. Equally evident is the fact that the greater the number of leaves (or the bigger the crown) the more nutrients it will require, the more food the plant will manufacture for its own use and the greater the growth.



## STUDENT WORKSHEET #1

### FORESTRY IN ILLINOIS

(Refer to Information Sheet, Forestry in Illinois)

1. What is the major problem in managing and developing Illinois' forests?
2. Identify some potential value or purposes of Illinois' forests.
3. Illinois has a potential production of about \_\_\_\_\_ cubic feet of sawlogs per year, which could build about \_\_\_\_\_ homes.
4. What are some good hardwood tree species which have potential for biomass crops?
5. What type of Illinois land is suited for forest production?
6. How could timber be used on prime land areas to improve them?

7. What are some Illinois agencies that are currently involved in developing Illinois forests?
8. In some cases, a typical tree crop might take \_\_\_ years to mature and have an annual net yield of about \_\_\_ dollars per acre.
9. What are the two key points which tend to determine if a forest is managed or not managed?
10. What are some current educational issues which landowners need information and assistance?



## STUDENT WORKSHEET #2

### CARING FOR FARM FORESTS

(Refer to VAS Unit 4024, Planting and Care of Farm Forests)

1. What are some major reasons for planting trees in Illinois?
2. What general classes of land seem best suited for forest production in Illinois?
3. Identify, around your local community, land areas which could be put in one or more of the above classes. Mark the areas in a plat book or aerial photo available from your county soil conservation office.
4. What factors need to be considered when determining the kinds of trees to plant?
5. Using the above factors, plan out one or two forestation plans for locally identified land areas.
6. When is the best time to plant seedlings or transplants? Why?
7. Select the type of tree species, which could be planted on your local land areas. Develop a map for your plantings. Explain how to prepare the ground. Organize the planting crew and identify needed equipment.
8. What care will be needed after the seedlings or transplants are planted?

## STUDENT JOB SHEET #1

### CONSTRUCTING A CRUISER'S STICK

#### Objective:

To construct a cruising stick to estimate the volume of lumber in a forest using a Biltmore Stick and Merritt Rule.

#### Materials:

1. A piece of hardwood lumber 1 3/4" x 3/4" x 32"
2. Wood working tools
3. Straight edge and rule
4. Wood burning set or engraving stamps

#### Procedure:

1. Secure a straight piece of hardwood that is free from knots or other defects.
2. Work the stock to the following dimensions 30" long, 1/2" thick, 1 1/2" wide, then bevel one edge so other side is 1 1/4".
3. Sand the sides and edges of the stick smooth.
4. The stick can be marked on the 1 1/2" side for the Biltmore Stick using the graduations below.

Biltmore Rule Graduations

Diameter graduations on stick	Distance in inches from end of stick to diameter graduations	Diameter graduations on stick	Distance in inches from end of stock to diameter graduations
5	4.6	18	13.7
6	5.4	19	14.3
7	6.2	20	14.9
8	7.0	21	15.5
9	7.7	22	16.0
10	8.4	23	16.6
11	9.2	24	17.1
12	9.8	25	17.7
13	10.5	26	18.2
14	11.2	27	18.7
15	11.8	28	19.2
16	12.5	29	19.7
17	13.1	30	20.2

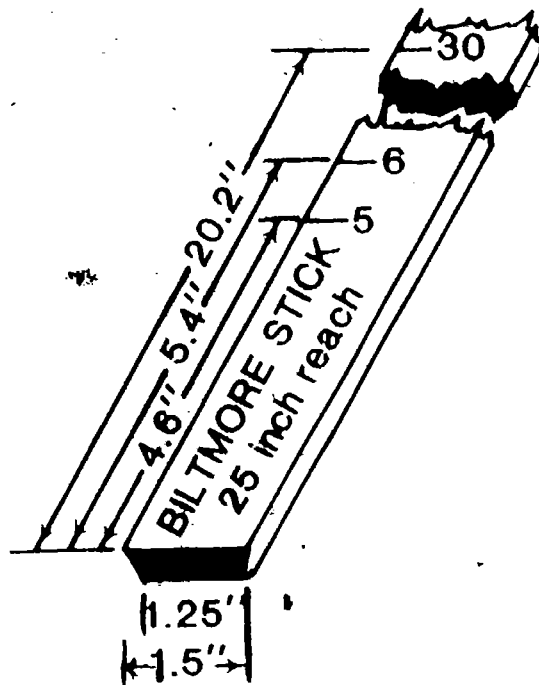

5. The stick can be marked on the 1 1/4" side for the Merritt Rule.
6. Mark off graduations which are 6.1 inches apart starting at the zero end of the stick. Each graduation represents a 16-foot log length.
7. Mark half-log graduations halfway between the 16-foot log marks.
8. Finish the graduations to make them legible. Seal the stick with a weather proof finish to protect the wood from moisture and dirt.

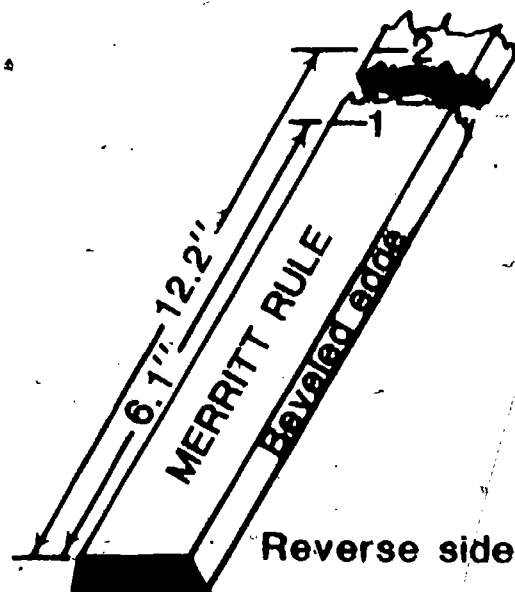

379

STUDENT JOB SHEET #2  
ESTIMATING BOARD FEET

Objective:

At the conclusion of this exercise students should be able to survey a specific woodlot to estimate the volume of product from the trees on the plot.

Materials:

1. Cruiser's stick
2. Note pad and pencil
3. Measured land area

Procedures:

A. Determining diameter breast high

1. Hold cruiser's stick 25" from your eye and horizontally against the tree trunk.
2. Place the stick 4-1/2 feet above the ground to obtain the D.B.H. (diameter breast high.)
3. Place the stick so one end is even with your line of sight at the edge of the trunk.
4. Observe the other edge of the trunk and where this line of sight crosses the cruiser's stick, you read the diameter of the tree.
5. Record your reading in note book.

B. Determining 16-foot saw logs

1. Use the "Merritt Hypsometer" side of cruiser's stick.
2. Measure a distance of 66 feet (1-1/2 chains) from the base of a tree which is the same elevation as the tree base.
3. From the above area, hold the cruiser's stick vertically, 25" from your eye.
4. Line up the bottom end of stick with a point which is about 1' above the ground (stump height).
5. Do not move the stick or your head, locate the highest point of useable log on the trunk.
6. Read the marking on the cruiser's stick which is at your line of sight. Estimate to the nearest full one-half log on the scale.

7. Use the attached International Log Rule Table to estimate the volume of lumber in the tree.
8. Record measure in note book.
9. Repeat the above measures for a representative sample of trees (all trees over 4"D.) in the specified land area (1/4 or 1/2 acre).
10. Determine total number of trees which could be harvested to estimate potential yield.

### TIMBER ESTIMATING RECORD

Tree No.	Species of tree	D.B.H. (inches)	Merch. Height-- No. of 16-ft. logs or 8-ft. bolts	Volume board feet
1				
2				
3				
4				
5				
6				
7				
8				
9				
10				
11				
12				
13				
14				
15				
<b>Total gross volume</b>				
<b>Net volume</b>				

381

Questions:

1. What is a board foot?  
\_\_\_\_\_  
\_\_\_\_\_
2. What tree species were most marketable in the measured plot?  
\_\_\_\_\_  
\_\_\_\_\_
3. Where could you market these logs? Identify a buyer.  
\_\_\_\_\_  
\_\_\_\_\_
4. What has to be done next to get the trees marketed?  
\_\_\_\_\_  
\_\_\_\_\_

Observations:

Explain how this knowledge can be used to improve your community or S.O.E.P.

FARMER'S BULLETIN, No. 1210

MEASURING AND MARKETING FARM TIMBER

Amount of sawtimber in trees, by diameter and merchantable height  
International 1/4-inch rule

Diameter of tree, breast-high (inches)	Cir- cumfer- ence of tree breast high (inches)	Volume (board-feet) according to number of usable 16-foot logs								
		1	1½	2	2½	3	3½	4	5	6
10	31	39	51	63	72	80				
11	35	49	64	80	92	104				
12	38	59	78	98	112	127	136	146		
13	41	71	96	120	138	156	168	181		
14	44	83	112	141	164	186	201	216		
15	47	98	132	166	194	221	240	260		
16	50	112	151	190	223	256	280	305		
17	53	128	174	219	258	296	325	354		
18	57	144	196	248	292	336	369	402		
19	60	162	222	281	332	382	420	457		
20	63	181	248	314	370	427	470	512	580	
21	66	201	276	350	414	478	526	575	656	
22	69	221	304	387	458	528	583	638	732	
23	72	244	336	428	507	586	646	706	816	
24	75	266	368	469	556	644	708	773	899	
25	79	290	402	514	610	706	779	852	992	
26	82	315	436	558	662	767	849	931	1,086	
27	85	341	474	606	721	836	925	1,014	1,185	
28	88	367	510	654	779	904	1,000	1,096	1,284	1,453
29	91	396	551	706	842	977	1,080	1,184	1,394	1,588
30	94	424	591	758	904	1,050	1,161	1,272	1,503	1,723
31	97	454	634	814	973	1,132	1,254	1,376	1,618	1,862
32	101	485	678	870	1,042	1,213	1,346	1,480	1,733	2,001
33	104	518	724	930	1,114	1,298	1,442	1,586	1,858	2,152
34	107	550	770	989	1,186	1,383	1,537	1,691	1,984	2,304
35	110	585	820	1,055	1,266	1,477	1,642	1,806	2,124	2,458
36	113	620	870	1,121	1,346	1,571	1,746	1,922	2,264	2,612
37	116	656	922	1,188	1,430	1,672	1,858	2,044	2,416	2,783
38	119	693	974	1,256	1,514	1,772	1,970	2,167	2,568	2,954
39	123	732	1,031	1,330	1,602	1,874	2,087	2,300	2,714	3,127
40	126	770	1,086	1,403	1,690	1,977	2,204	2,432	2,860	3,300

Data from Mesavage and Girard, tables for estimating board-foot volume of timber.

(Form class 80.)

U.S. Department of Agriculture, Forest Service. 1946.

For exceptionally tall, slender trees add 10 percent.

For exceptionally short, stubby trees deduct 10 percent.

STUDENT JOB SHEET #3  
CUTTING BOARDS FROM A LOG

Objective:

At the conclusion of this exercise students should be able to evaluate a cross section of a log and determine how it should be cut to obtain the maximum board feet.

Procedures:

1. Assume the drawing below is the cross section of the small end of a 16' log.
2. Carefully draw each board that could be cut from the log. Leave allowance for saw kerf.
3. Your instructor will give you the diameter of the log and if it is to be quarter-sawed or plain-sawed.

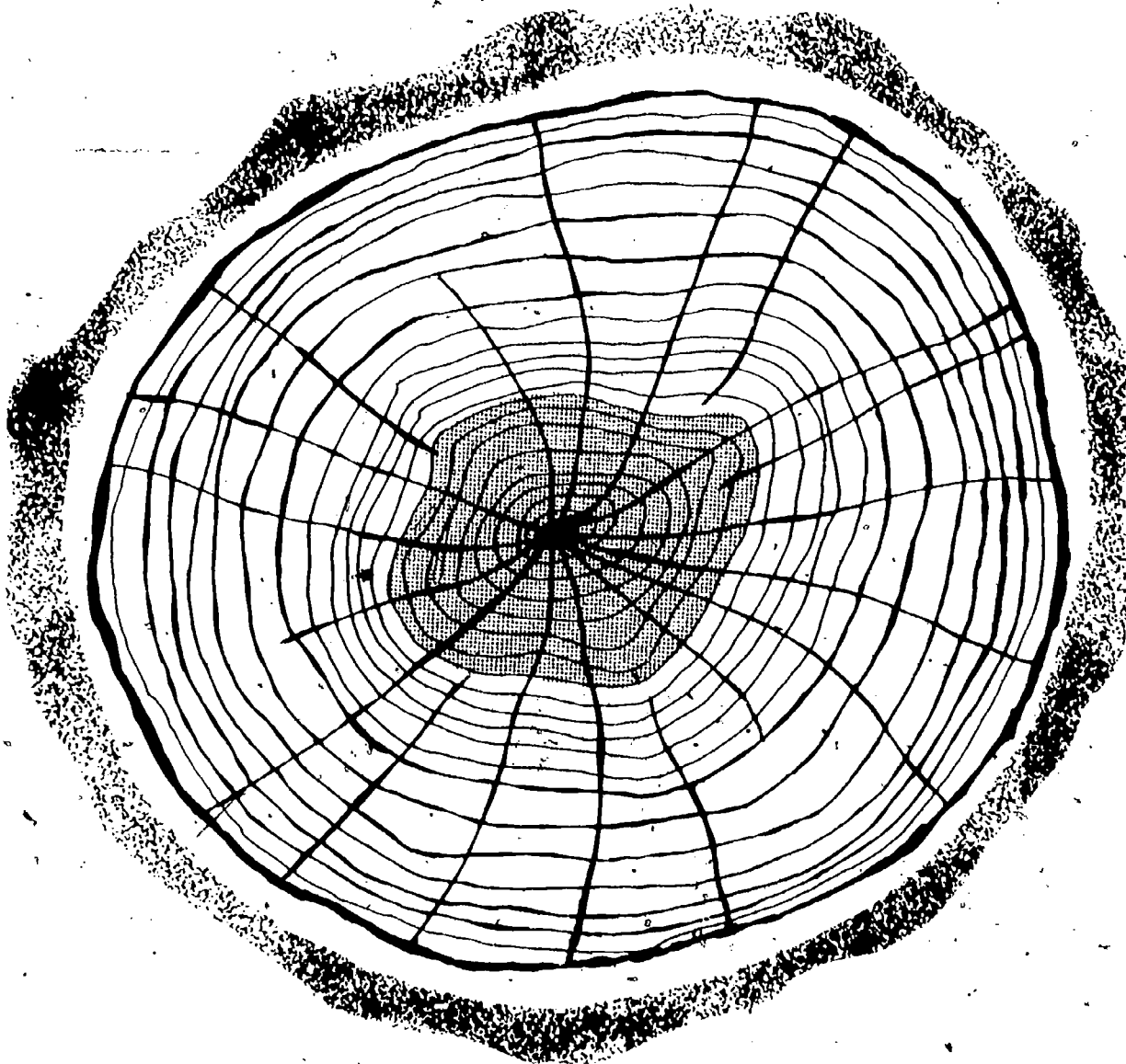



Questions:

1. How many board feet could you cut from the log? \_\_\_\_\_
2. Name the dimensions of the boards you cut.  
\_\_\_\_\_  
\_\_\_\_\_  
\_\_\_\_\_  
\_\_\_\_\_
3. If you were a sawyer at a mill, how would you decide the best way to cut a log as it moves through the mill?  
\_\_\_\_\_  
\_\_\_\_\_  
\_\_\_\_\_  
\_\_\_\_\_

## \* STUDENT JOB SHEET #4

### LIMBING A TREE

#### Objective:

At the conclusion of this exercise students should be able to evaluate the order of limbing to provide for safety and to make appropriate cuts to remove the limbs from the desired log.

#### Materials:

1. Felled tree
2. Safety equipment for operators
3. Chain saw
4. Crosscut saw
5. Bow saw
6. Ax

#### Procedures:

1. Determine where, in what order, and how to make the cuts by considering:
  - a. obstacles
  - b. safety
  - c. desired finished product
2. Clear area of obstacles, brush, people, etc.
3. Become familiar and comfortable with the chainsaw before you start limbing.
4. Start limbing cuts at the crotch or top side of limb and at the base of trunk.
5. Cut as close to the trunk as possible.
6. Cut underneath limbs with care. The tree trunk may have pressure on them and the trunk could fall or roll when you are cutting.
7. Always observe proper chain saw safety when using this power tool.

Questions:

1. What type of chain saw (size, model, etc.) did you use?

---

---

---

2. Make a list of how to check-out a chain-saw before you start limbing.

---

---

---

3. Why is it recommended that you start limbing at the base rather than the top of the trunk?

---

---

---

4. What is the difference between pruning and limbing a tree?

---

---

---

Observations:

How can this be used to benefit your S.O.E.P. or home?

387

## STUDENT JOB SHEET #5

### BUCKING A TREE

#### Objective:

Given a felled tree and appropriate equipment students will measure the desired length of log, determine the correct position to handle the saw, and make appropriate cuts to produce logs of the desired length.

#### Materials:

1. Limbed trunk
2. Chain saw
3. Safety equipment for operators
4. Wedges
5. Sledge
6. Ax
7. Measuring equipment

#### Procedures:

1. Check out the proper operation of all power and hand tools. Become familiar with their use before you start bucking the log.
2. Carefully analyze the situation before any cuts are started so you can anticipate any log movement.
3. Determine and mark the desired length of the log.
4. Observe defects in the log that may need removing or could influence the bucking.
5. Determine the type of cuts necessary. Assume proper operator position and saw position.
6. Use wedges, sledge, ax, and braces if necessary to control log.
7. Make straight cuts, perpendicular to the length of the log.

#### Questions:

1. How many board feet are in this log?  
\_\_\_\_\_  
\_\_\_\_\_  
\_\_\_\_\_

2. What can be done with the removed limbs? branches? brush?

---

---

---

3. What uses can be made of the log? limbs?

---

---

4. What is the value of this log?

---

---

Observation:

How can this knowledge be used for your S.O.E.P. or at home?

339

STUDENT JOB SHEET #6

CONSTRUCTING A TREE PLANTING MACHINE

Objective:

After studying a sample plan of a tree planting machine, the student will be able to design and construct a planting machine by selecting appropriate materials and organizing work crews.

Materials:

1. Fabrication materials
2. Tree planting machine plans
3. Shop tools and equipment

Procedures:

1. Organize class into work crews.
2. Distribute drawings or plans of machine to be constructed.
3. Assign crews to specific section of the machine.
4. Develop a bill of materials for the machine.
5. Develop a plan of activities and make assignments for shop work.

Questions:

1. What modifications were necessary during project construction?  
\_\_\_\_\_  
\_\_\_\_\_  
\_\_\_\_\_
2. What was the total cost incurred with the construction of this machine?  
\_\_\_\_\_  
\_\_\_\_\_
3. Did the machine work when it was first tried? If not, why?  
\_\_\_\_\_  
\_\_\_\_\_  
\_\_\_\_\_

# TREE PLANTING MACHINE AND SCALPER PLANTING SHOE

Plans developed by Illinois Central Railroad

Details shown are furnished by railroad to be used  
in converting Ferguson or Ford Tractor Plow type  
16-AO-28 into tree planting machine.

Where bolts holes are not shown assemble by welding.

Scale 1/8" - 1"

391

# TREE PLANTING MACHINE AND SCALPER PLANTING SHOE

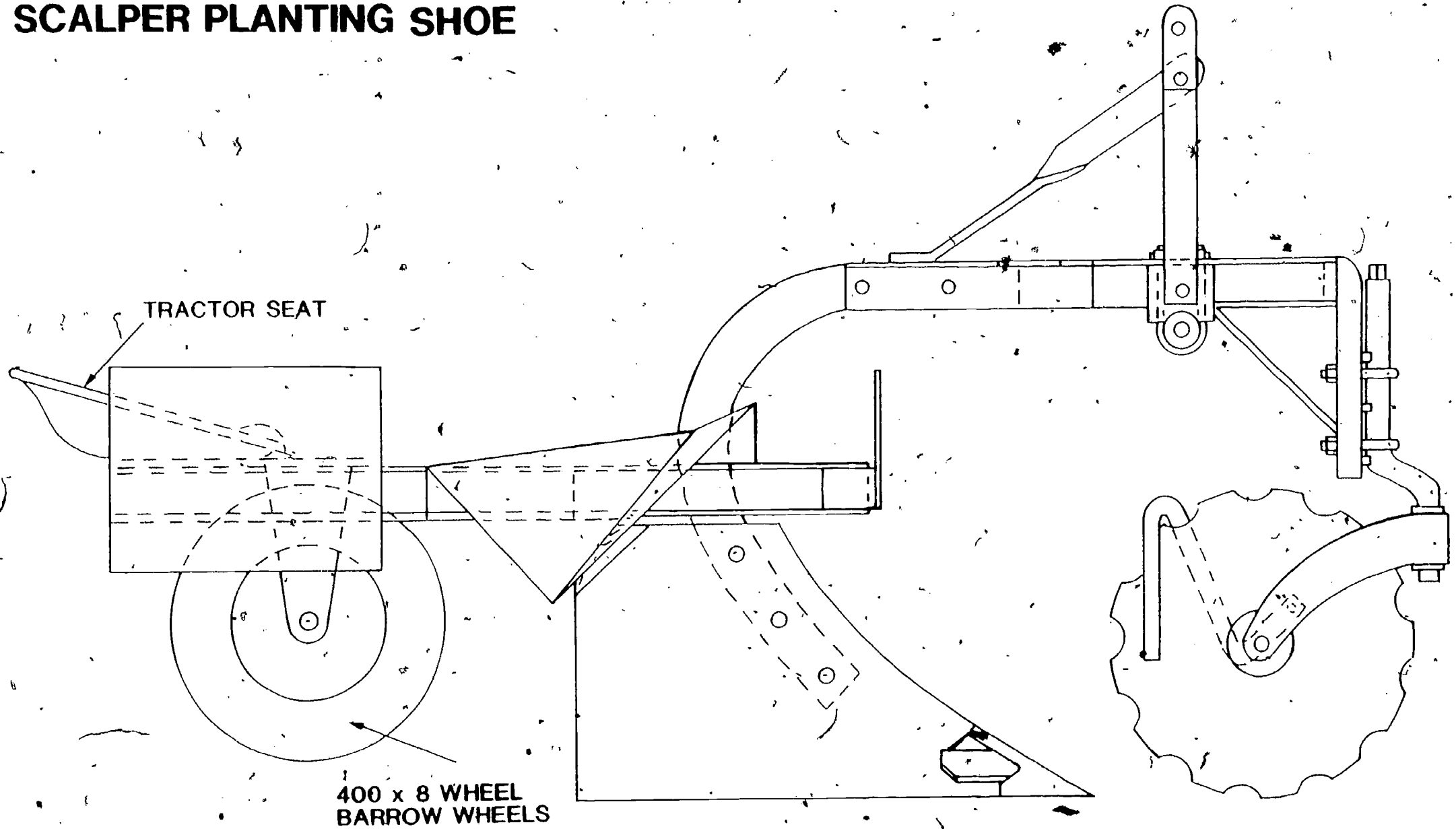



# TREE PLANTING MACHINE AND SCALPER PLANTING SHOE

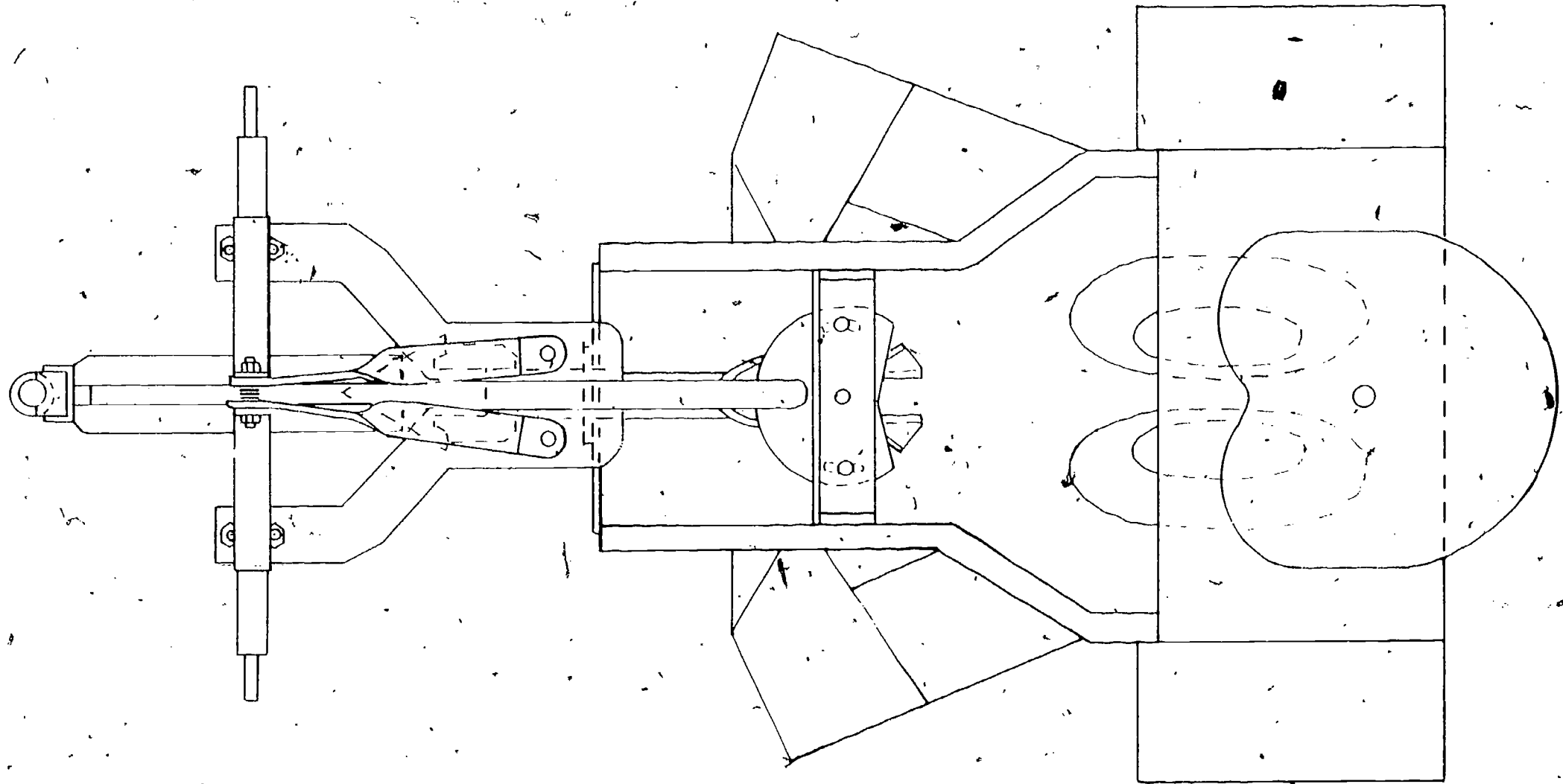

IV-E-2-37

This drawing is not to scale

395

394

# TREE PLANTING MACHINE AND SCALPER PLANTING SHOE

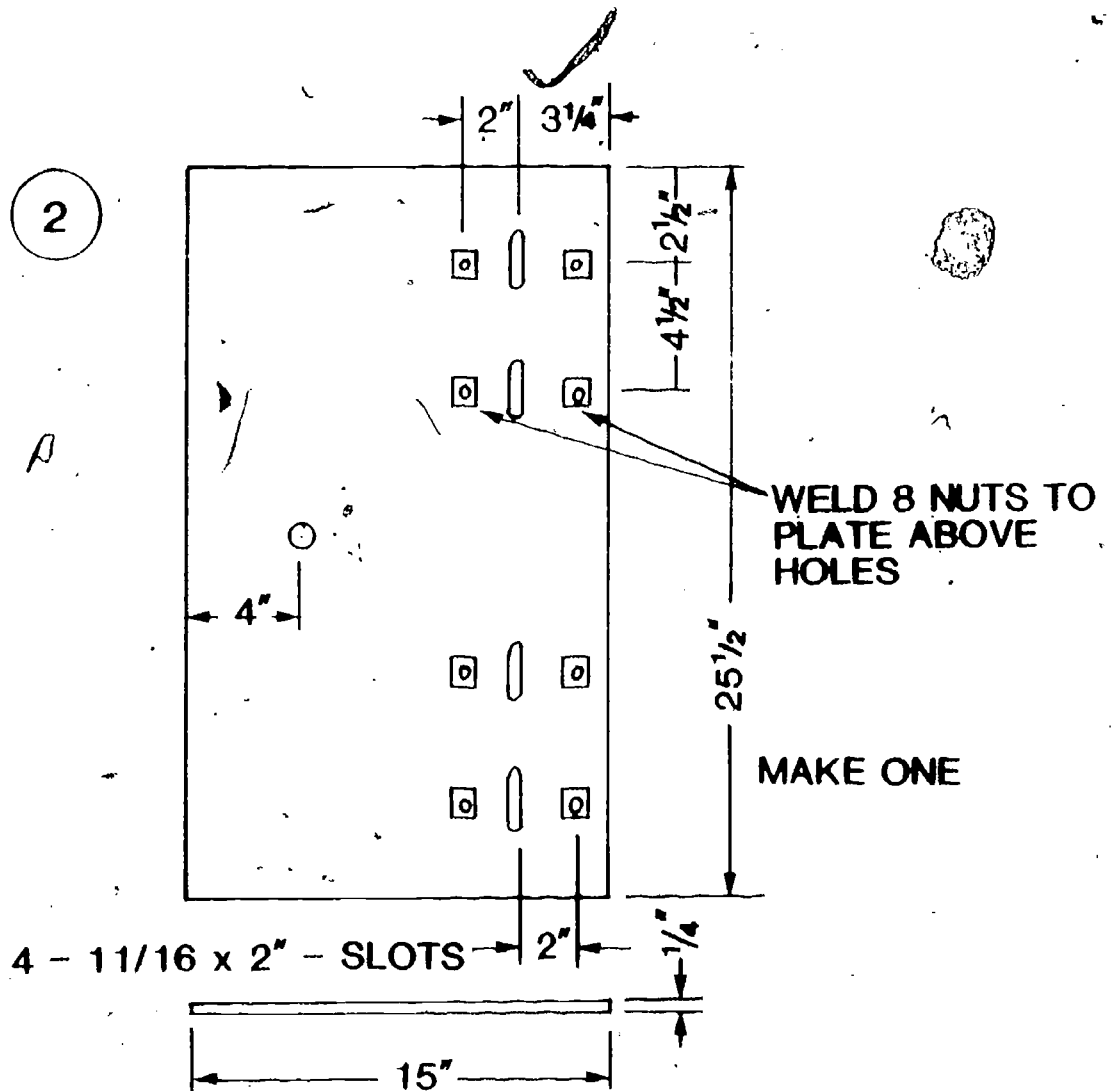
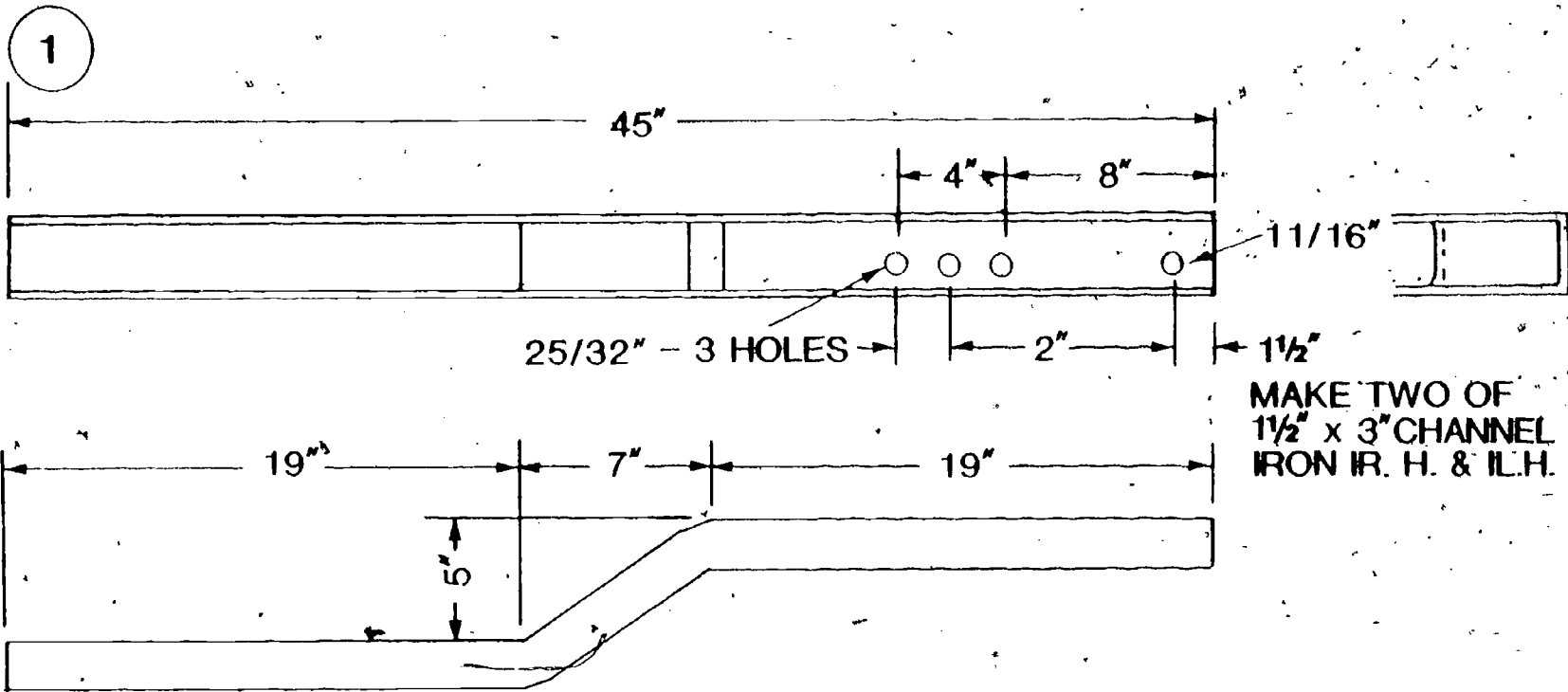

# TREE PLANTING MACHINE AND SCALPER PLANTING SHOE CONTINUED

3

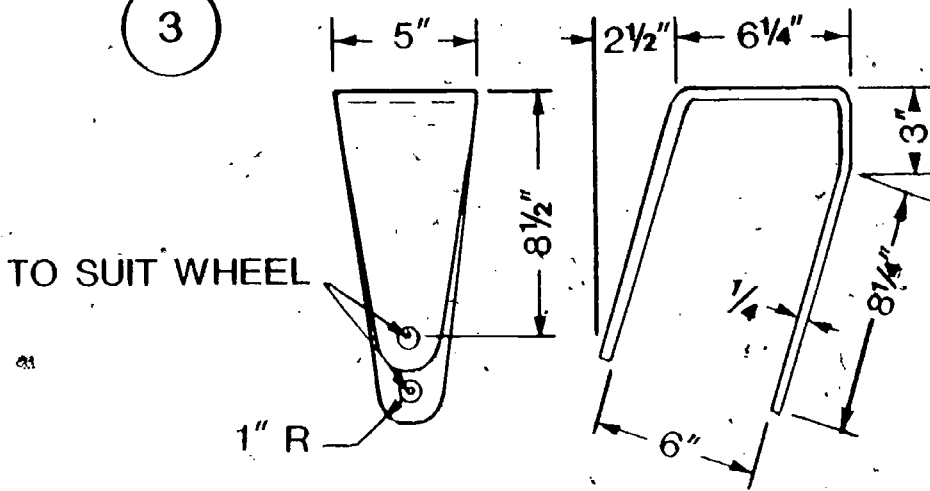

MAKE TWO

11/16" - 2 HOLES

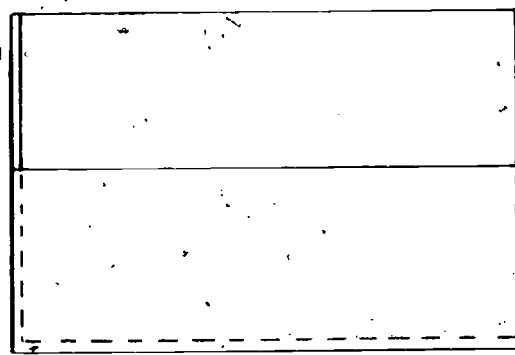
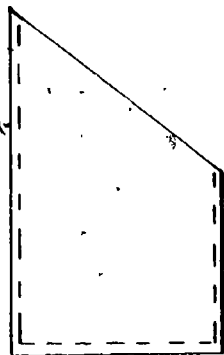
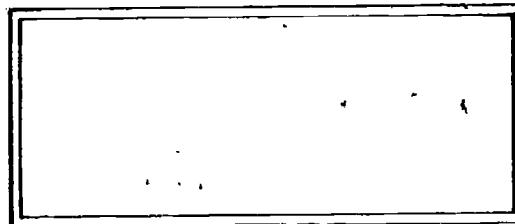
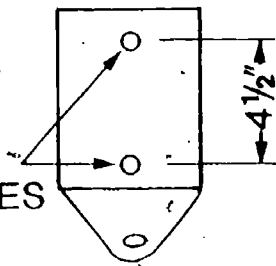

SEEDLING BOXES TWO EACH PER MACHINE  
CUT OUT AND BEND R.H AND L.H. ON DOTTED  
LINES WELD SEAMS

# TREE PLANTING MACHINE AND SCALPER PLANTING SHOE CONTINUED

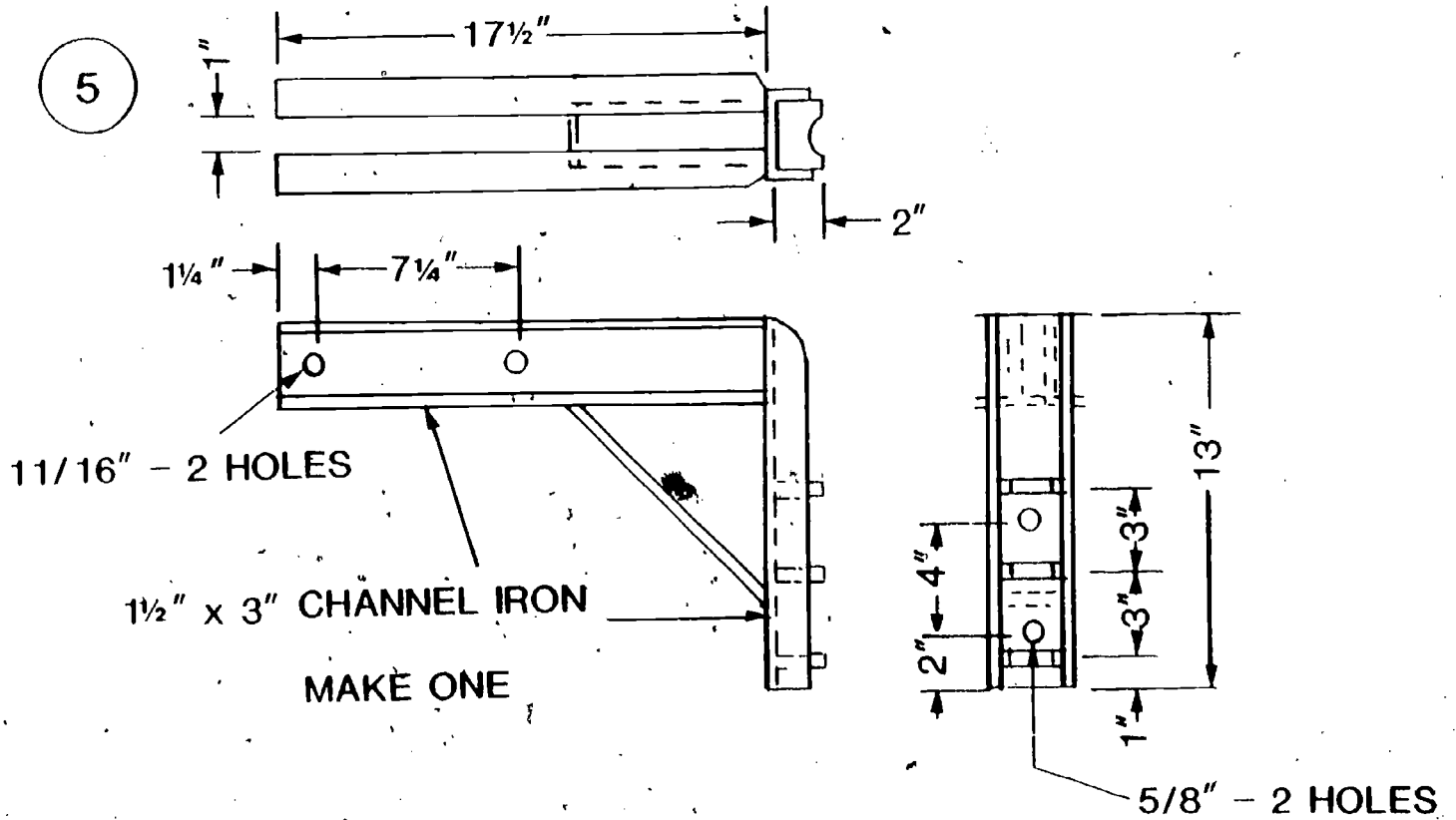
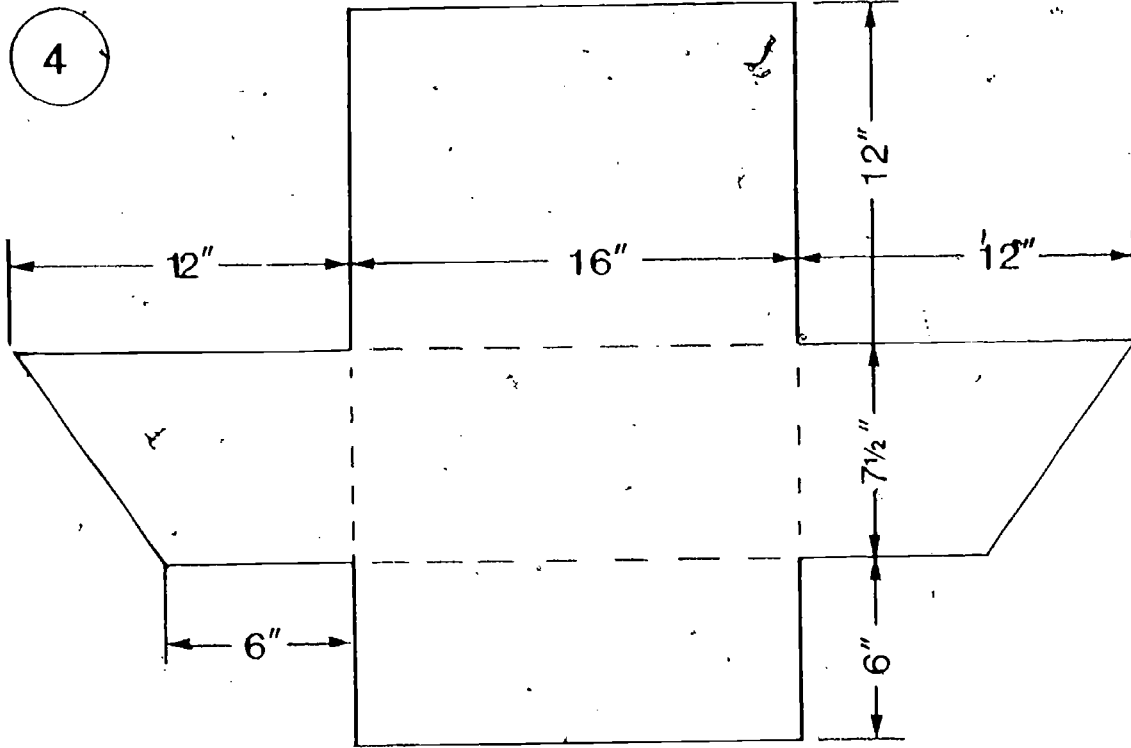

# TREE PLANTING MACHINE AND SCALPER PLANTING SHOE CONTINUED

6

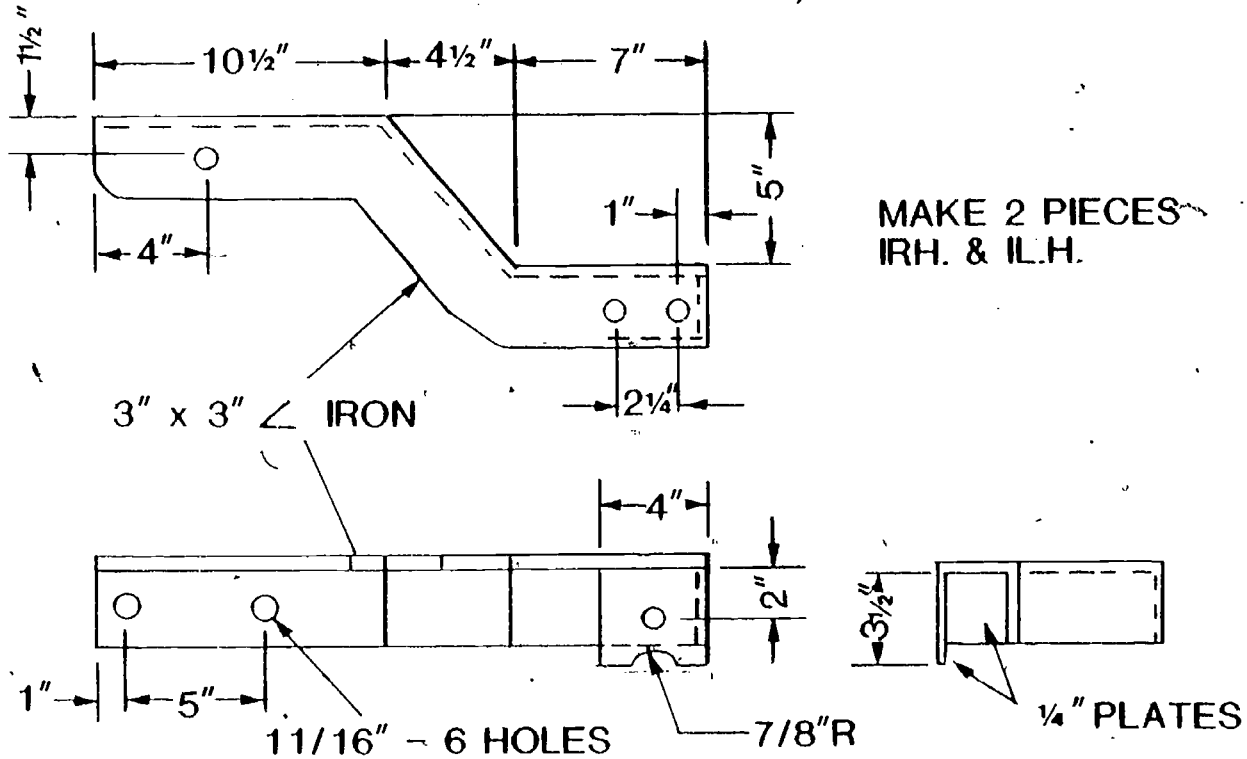

7

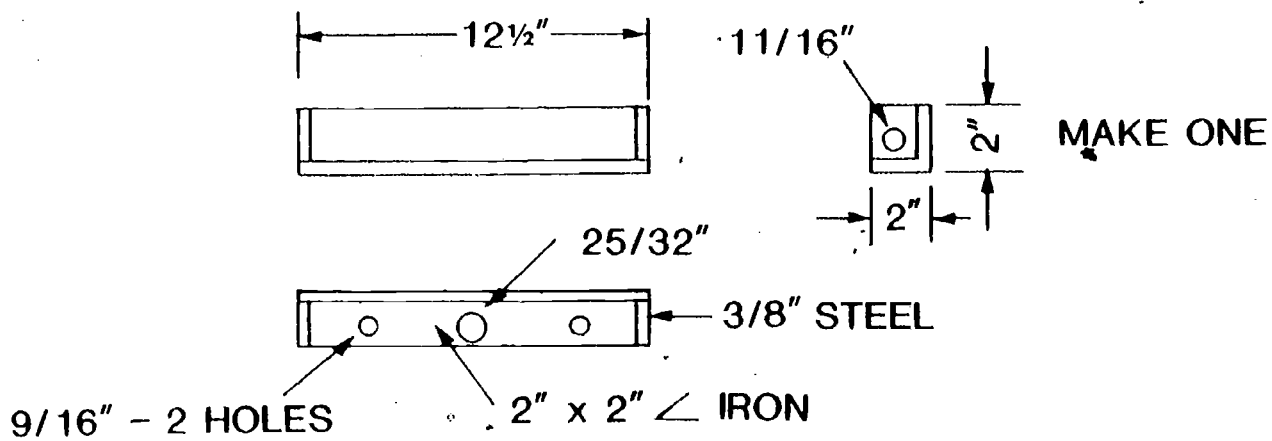

# TREE PLANTING MACHINE AND SCALPER PLANTING SHOE CONTINUED

8

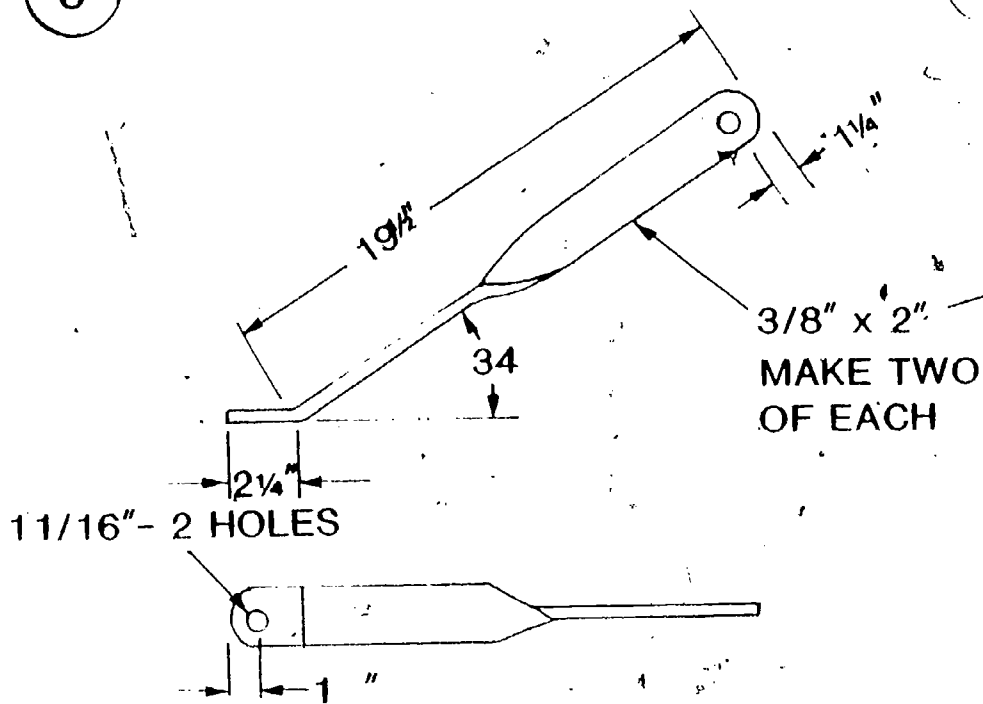

9

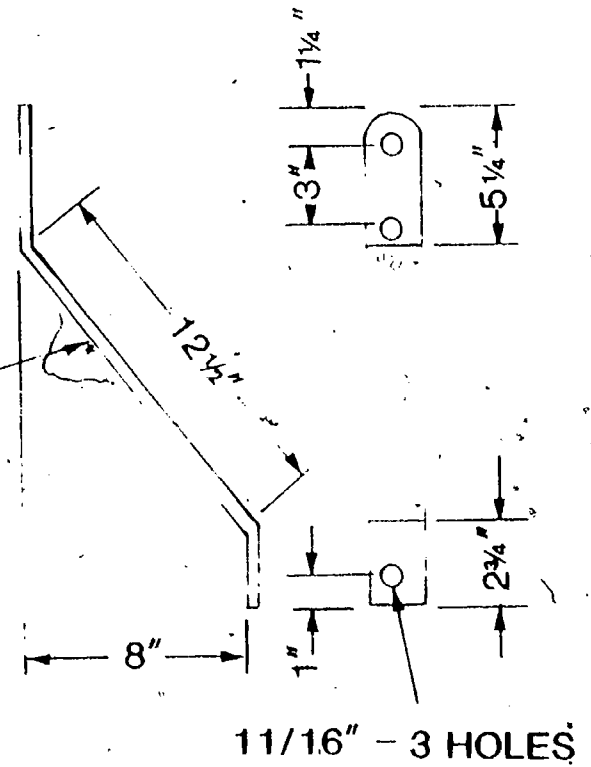

10

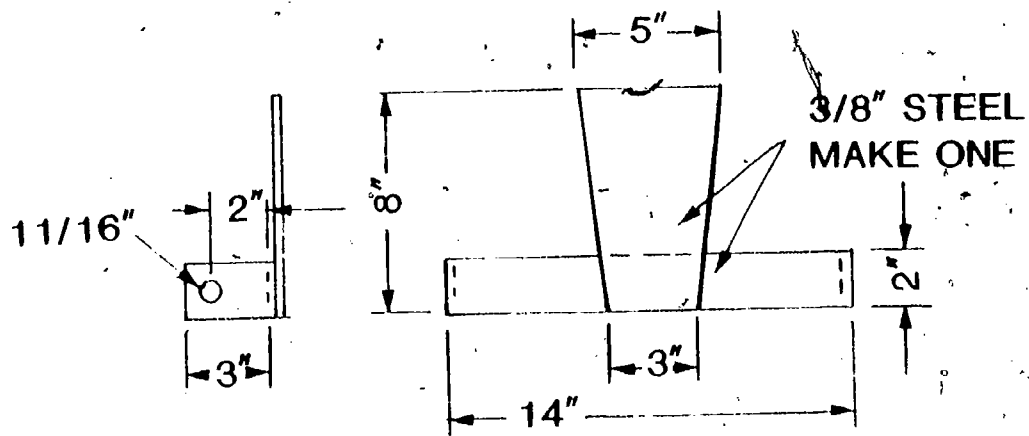

400

# TREE PLANTING MACHINE AND SCALPER PLANTING SHOE CONTINUED

11

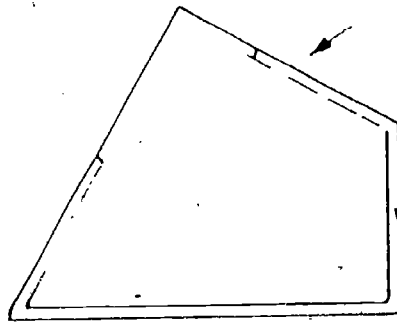
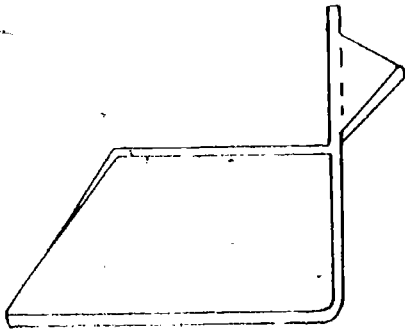

FOOT BOXES 2 EACH PER  
MACHINE. CUT OUT AND  
BEND R & L. H. ON DOTTED  
LINES.

WELD SEAMS

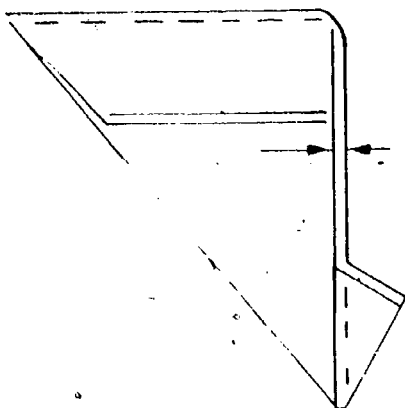

1/8" PLATE

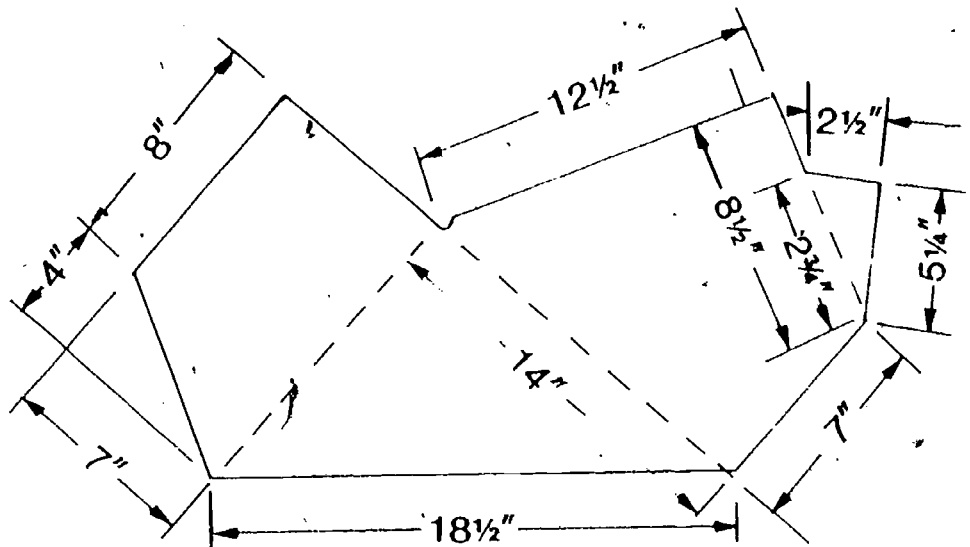

# TREE PLANTING MACHINE AND SCALPER PLANTING SHOE CONTINUED

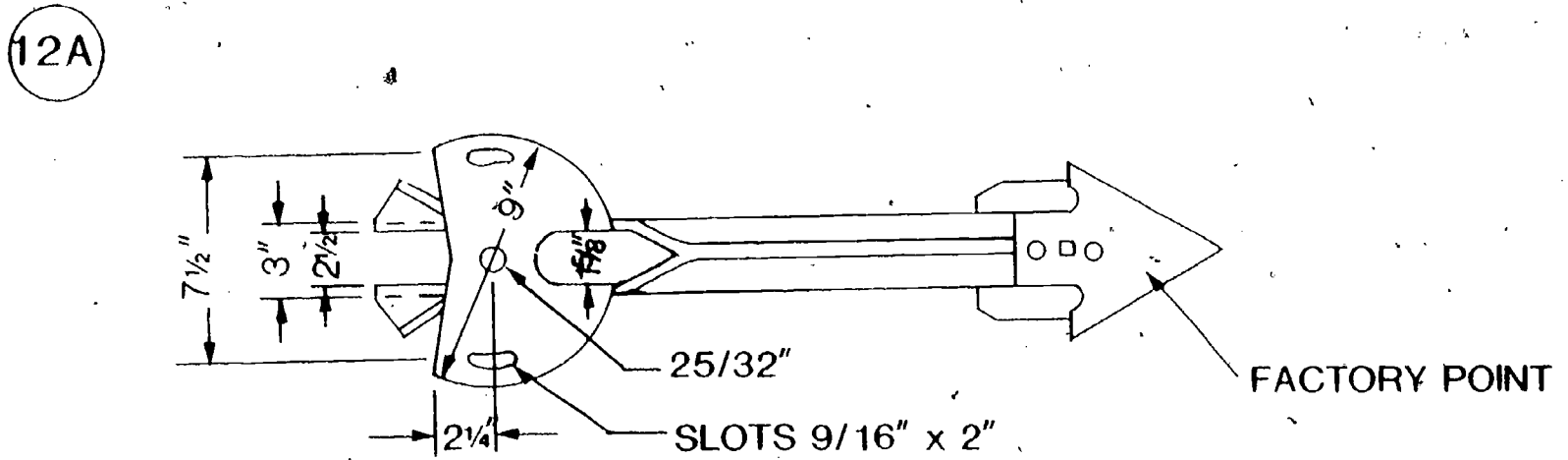
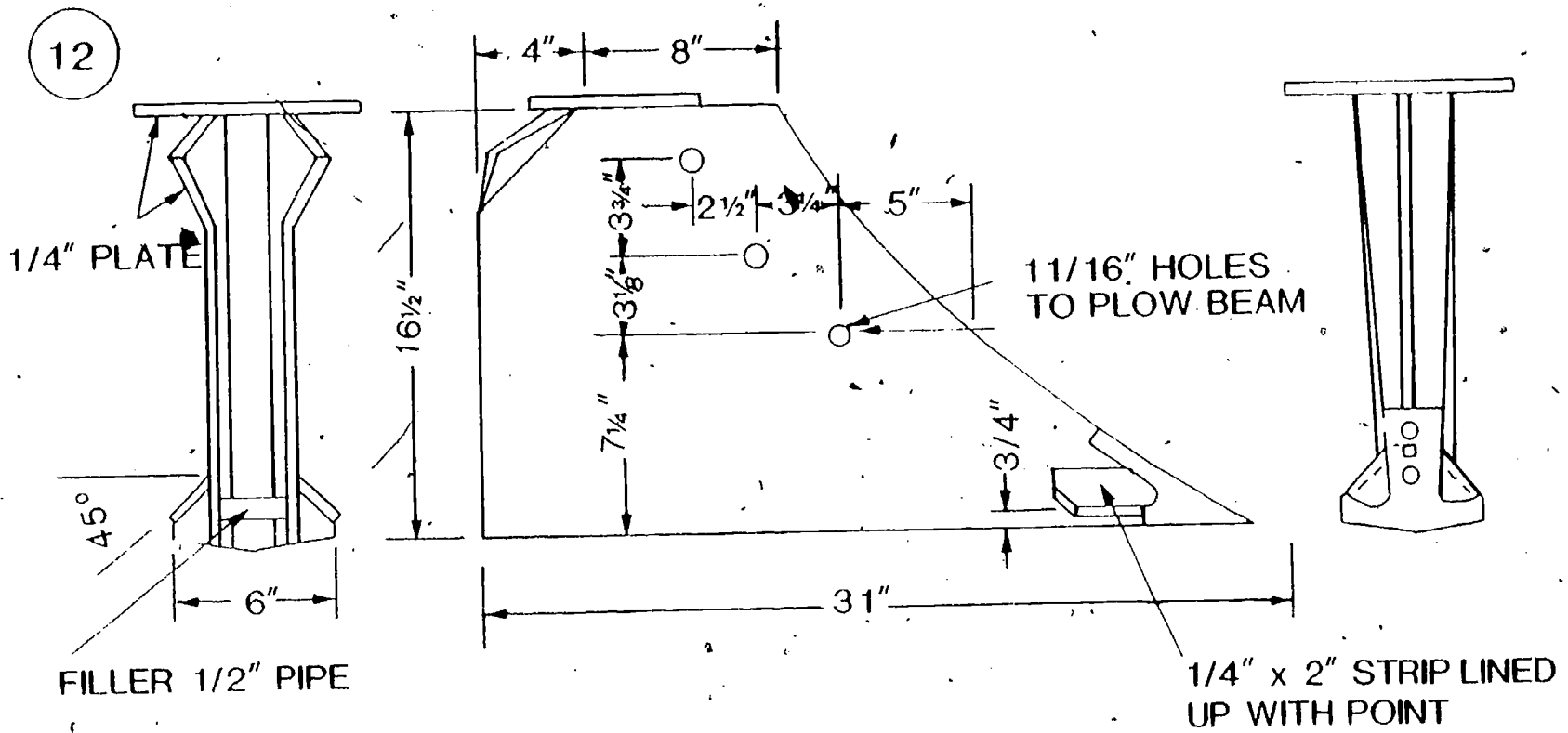



# TREE PLANTING MACHINE AND SCALPER PLANTING SHOE CONTINUED

13A

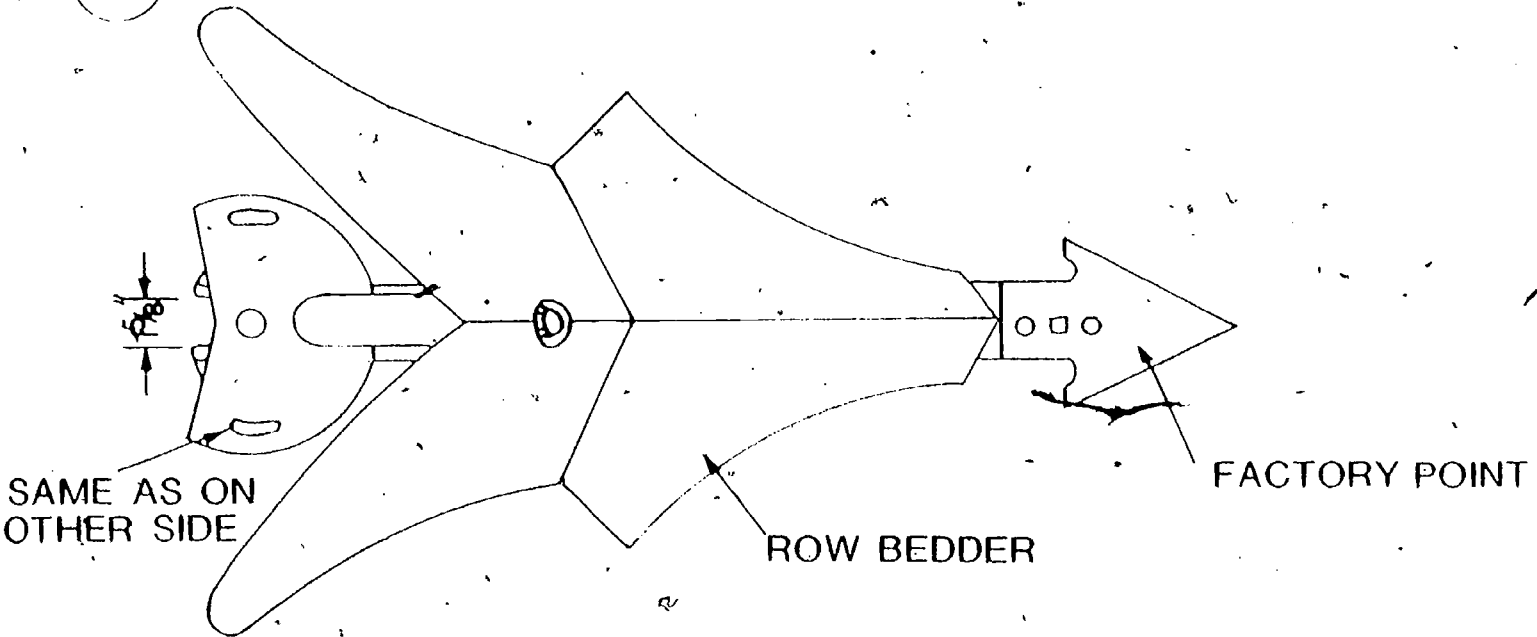

13

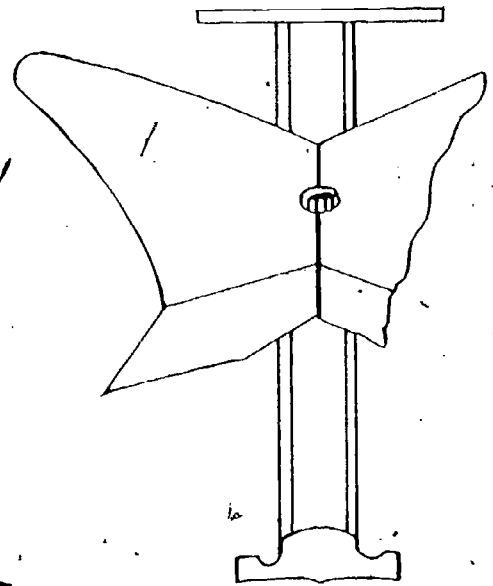
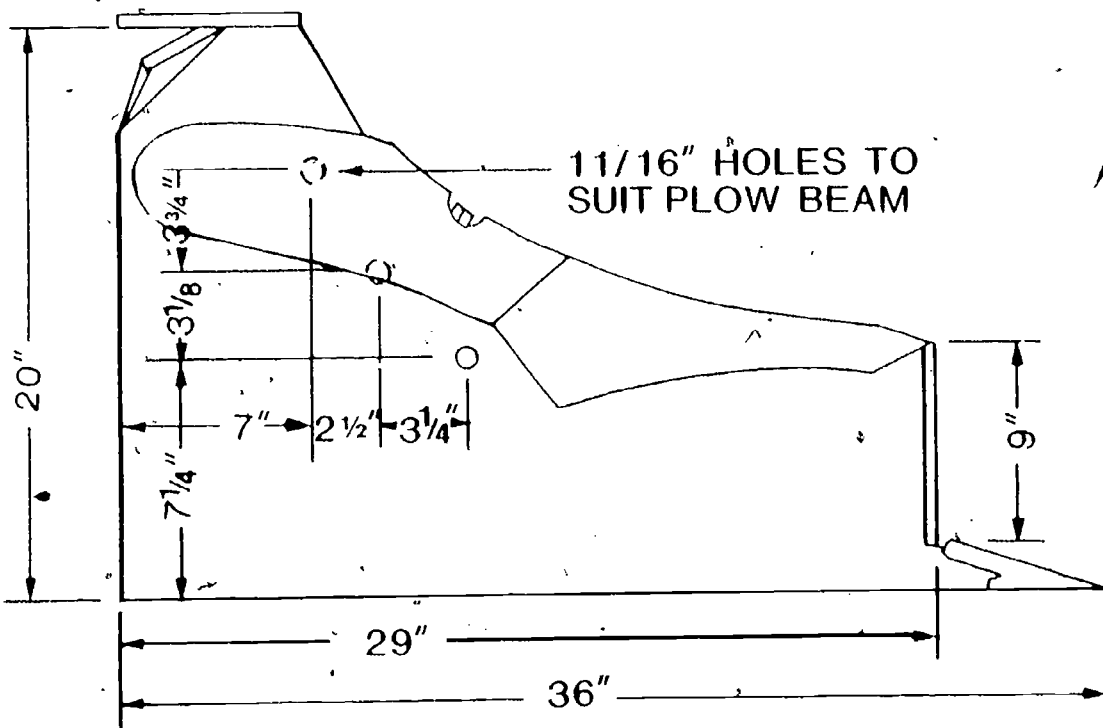

TEACHER'S KEY  
STUDENT WORKSHEET #1  
FORESTRY IN ILLINOIS

(Refer to Information Sheet, Forestry in Illinois)

1. What is the major problem in managing and developing Illinois' forests?

More than 90% of the forest land is privately owned with each owner averaging less than 55 wooded acres.

2. Identify some potential value or purposes of Illinois' forests.

The timber can be used for:

- sawtimber,
- pulp logs,
- convertible biomass,
- chemical feedstocks,
- protect soil and water quality,
- provide windbreaks, grazing lands, and recreational facilities,
- aesthetic values.

3. Illinois has a potential production of about 86 million cubic feet of sawlogs per year, which could build about 50,000 homes.

4. What are some good hardwood tree species which have potential for biomass crops?

- sycamore,
- autumn olive,
- black locust,
- hybrid poplars.

5. What type of Illinois land is suited for forest production?

Marginal lands with steep slopes or flooding problems could benefit and be less controversial than using prime land.

6. How could timber be used on prime land areas to improve them?

Controlled plantings can reduce erosion, control snowdrifts, provide shelterbelts for livestock, and provide a source of firewood.

7. What are some Illinois agencies that are currently involved in developing Illinois forests?
- University of Illinois
  - Southern Illinois University
  - U.S. Forest Service
  - Illinois Division of Forest Resources and Natural Heritage
  - Soil Conservation Service.
8. In some cases, a typical tree crop might take 50 years to mature and have an annual net yield of about ten dollars per acre.
9. What are the two key points which tend to determine if a forest is managed or not managed?
- Taxation of land,
  - Information on the returns from modern silviculture.
10. What are some current educational issues which landowners need information and assistance?
- Evaluating competing land uses.
  - Timber rotation times.
  - Amenities provided by forests.
  - Timber markets.

405

TEACHER'S KEY  
STUDENT WORKSHEET #2

CARING FOR FARM FORESTS

(Refer to VAS Unit 4024, Planting and Care of Farm Forests) Note to teacher: Parts of this worksheet may be used as a group or class activity.

1. What are some major reasons for planting trees in Illinois?
  - a. To prevent and control erosion.
  - b. To make unproductive land more profitable.
  - c. To produce wood crops for sale and use.
2. What general classes of land seem best suited for forest production in Illinois?
  - a. Eroded land.
  - b. Idle land.
  - c. Woodland.
3. Identify, around your local community, land areas which could be put in one or more of the above classes. Mark the areas in a plat book or aerial photo available from your county soil conservation office.
4. What factors need to be considered when determining the kinds of trees to plant?
  - a. Section of Illinois where the land is located.
  - b. Type of soil found in area.
  - c. Purpose or use of tree crop.
  - d. Use of pure or mixed plantings.
  - e. Native or natural range of the specific tree under consideration.
5. Using the above factors, plan out one or two forestation plans for locally identified land areas.
6. When is the best time to plant seedlings or transplants? Why?

In the spring of the year. The new plants can take advantage of the spring rains and get good root growth before the summer drought and winter freezing.
7. Select the type of tree species which could be planted on your local land areas. Develop a map for your plantings. Explain how to prepare the ground. Organize the planting crews and identify needed equipment.

8. What care will be needed after the seedlings or transplants are planted?

- a. Keep livestock clear of the area.
- b. Prevent fires.
- c. Control insects and diseases.
- d. Control rodents.
- e. Control volunteer hardwoods.
- f. Prune at proper growth stage.
- g. Thin for products and market needs.

407

# ILLINOIS FOREST LANDS

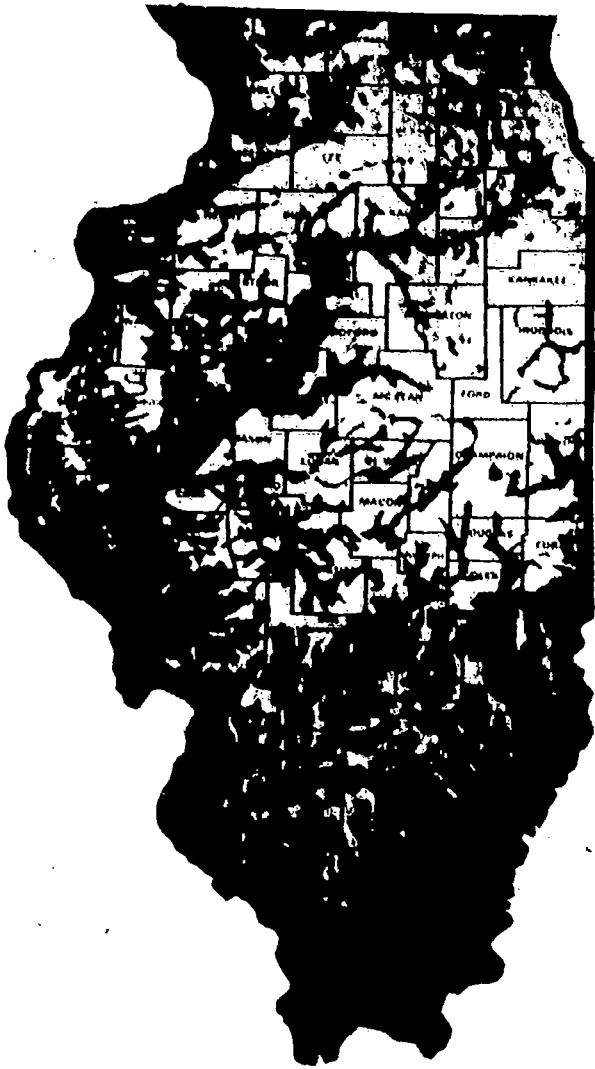

1810

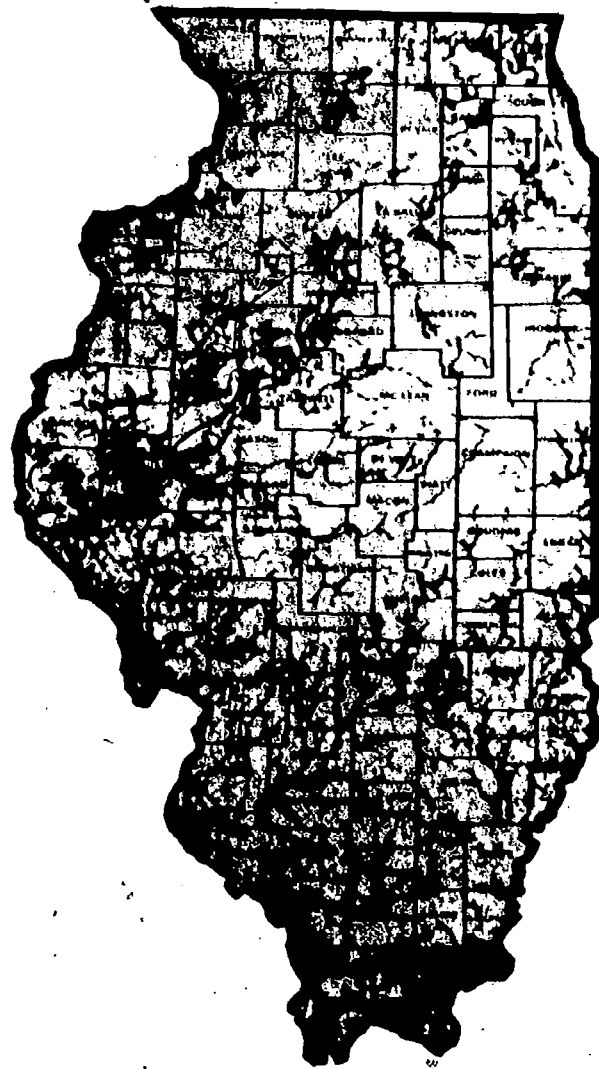

1983

Shaded areas show forest lands today and when Illinois was first settled.

# ADVANTAGES OF FORESTS

- ★ Prevent and control erosion
- ★ Make economic use of unproductive land
- ★ Provide windbreaks
- ★ Improve soil conditions and water quality
- ★ Provide cover and food for wildlife
- ★ Produce wood products for industry

---

- ★ Provide recreational facilities

# MANAGING A FOREST WITH NEW PLANTINGS

- ★ Exclude livestock
- ★ Prevent fires
- ★ Control insects and diseases
- ★ Reduce rodents
- ★ Control volunteer hardwoods
- ★ Prune at proper times
- ★ Thin for products



# FOREST STAND IMPROVEMENT CUTTING

To up-grade the quality of a forest by removing trees with undesirable qualities such as:

- ★ Trees of slight value but having wide spreading crowns.
- ★ Crooked trees which are not usable for 16 foot logs.
- ★ Trees having forked trunks.
- ★ Overmature trees.
- ★ Trees which are dead, damaged or diseased.

# FOREST STAND HARVEST CUTTING

**Primary purpose is economic and not woodland improvement.**

## **Clearcutting**

Final cutting of all trees usually 2" or larger in diameter after desirable species have shed their seeds.

## **Seed-tree cutting**

Similar to clearcutting. Selected trees are left to reseed area.

## **Shelterwood cutting**

Involves three cuttings. Trees to be cut are identified. First to be cut are marked. First cutting removes undesirable trees. Second cutting opens up the stand and leaves seed trees. Third cutting removes the seed trees.

## **Selection cutting**

Removing mature trees in small quantities. Comparable with woodland improvement.

# PARTS OF A TREE

Leaves prepare the food obtained from air and soil and give off moisture by transpiration.

## CROWN

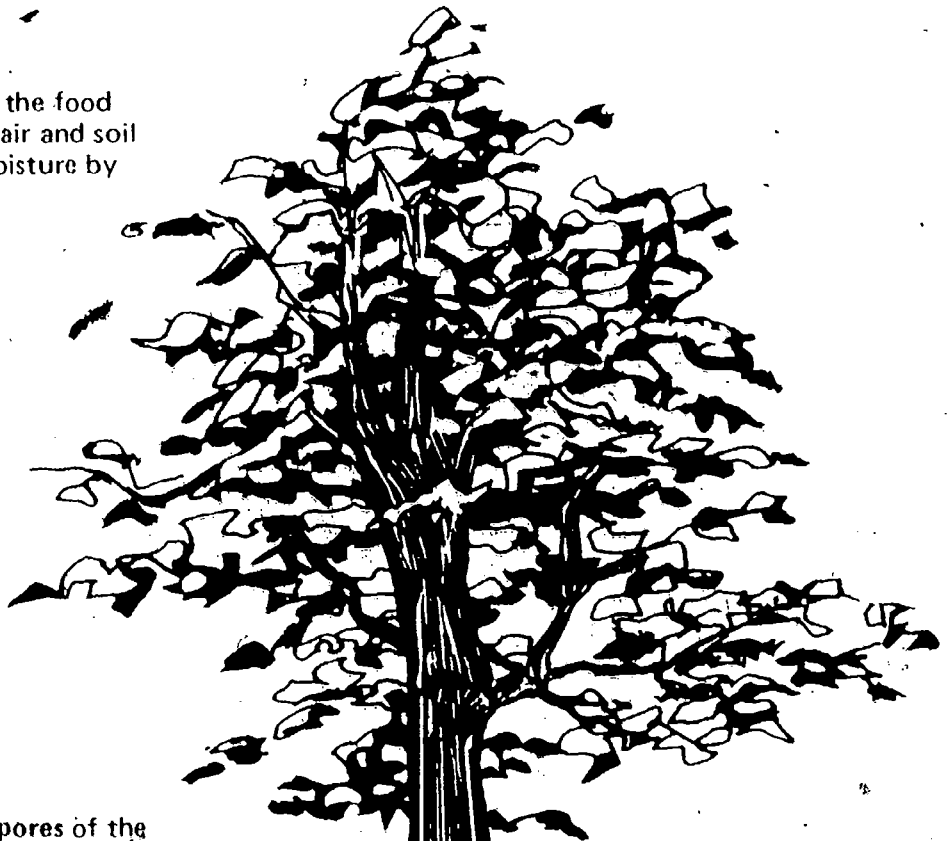

The breathing pores of the entire tree on leaves, twigs, branches, trunk, and roots take in oxygen.

## TRUNK

The buds, root tips, cambium layer are the growing parts of the tree.

Heartwood (inactive) gives strength.

Sapwood carries sap from root to leaves.

Cambium (microscopic) builds the cells.

Inner bark carries prepared food from leaves to cambium layer.

Outer bark protects tree from injuries.

Surface roots.

Taproot.

Root tips or root hairs take up water containing small quantity of minerals in solution.

# CROSS SECTION OF A TREE TRUNK

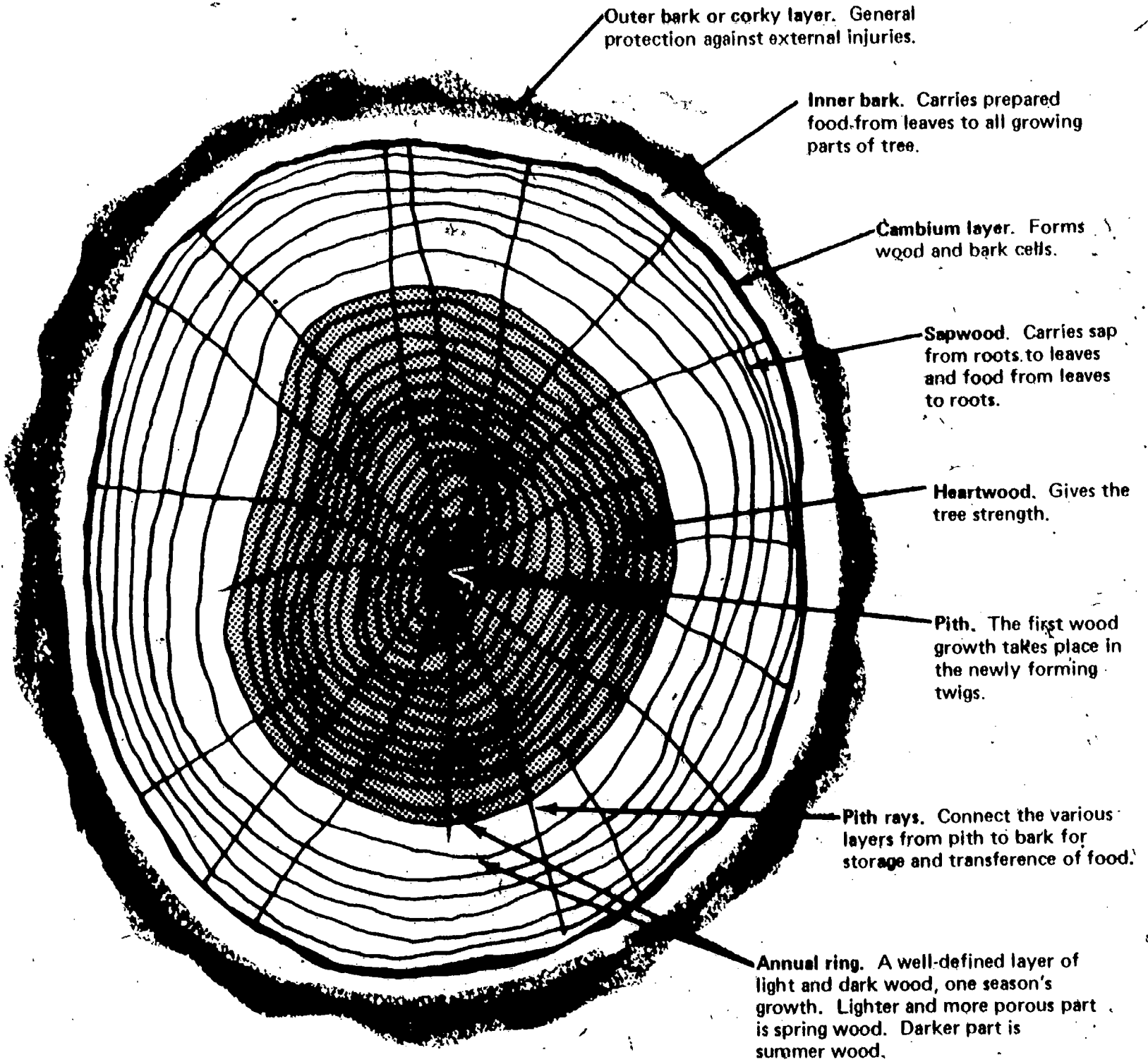

# CRUISER STICK

BILTMORE STICK

MERRITT RULE

reverse side

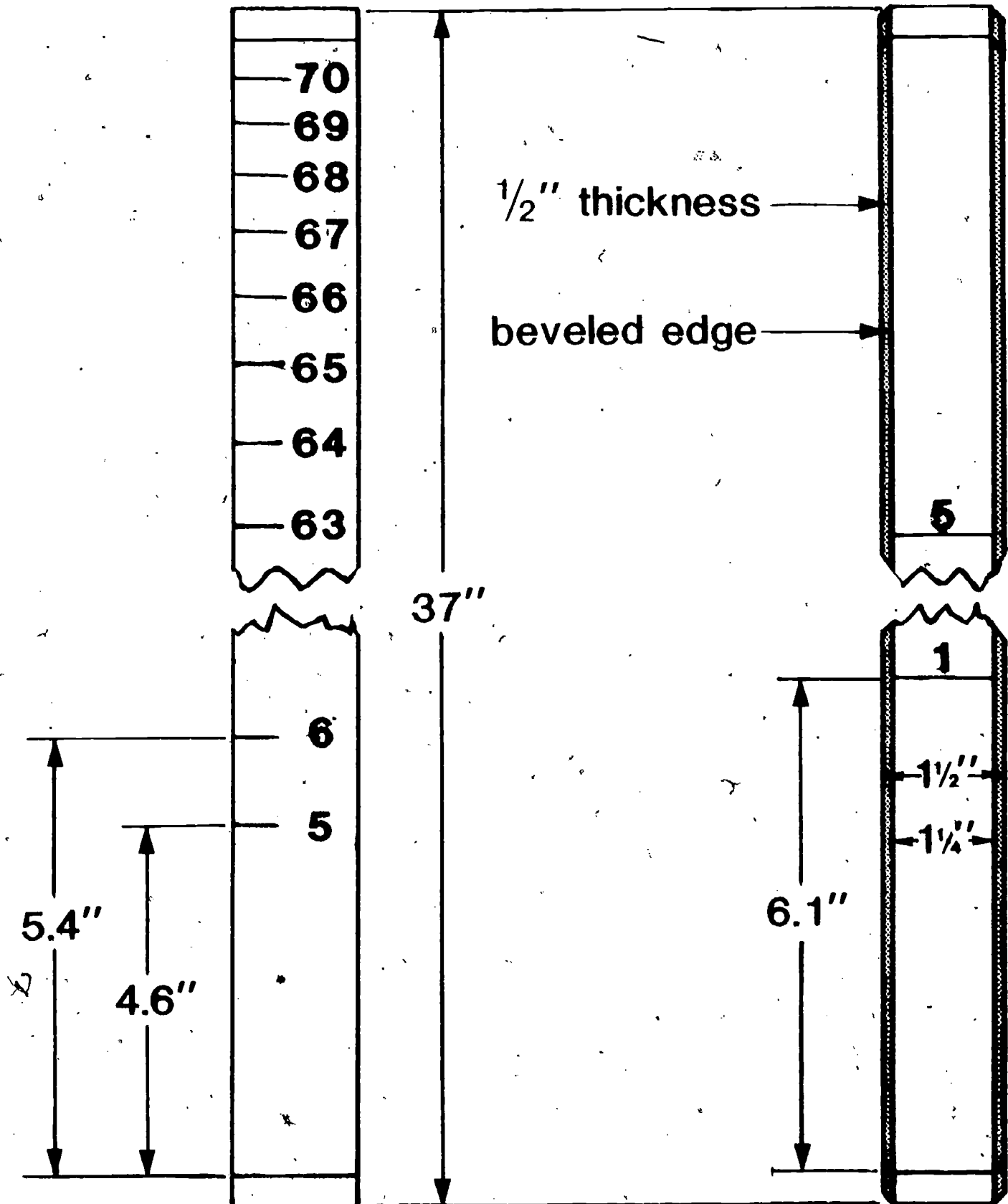

# DETERMINING BREAST HIGH DIAMETER WITH CRUISER'S STICK

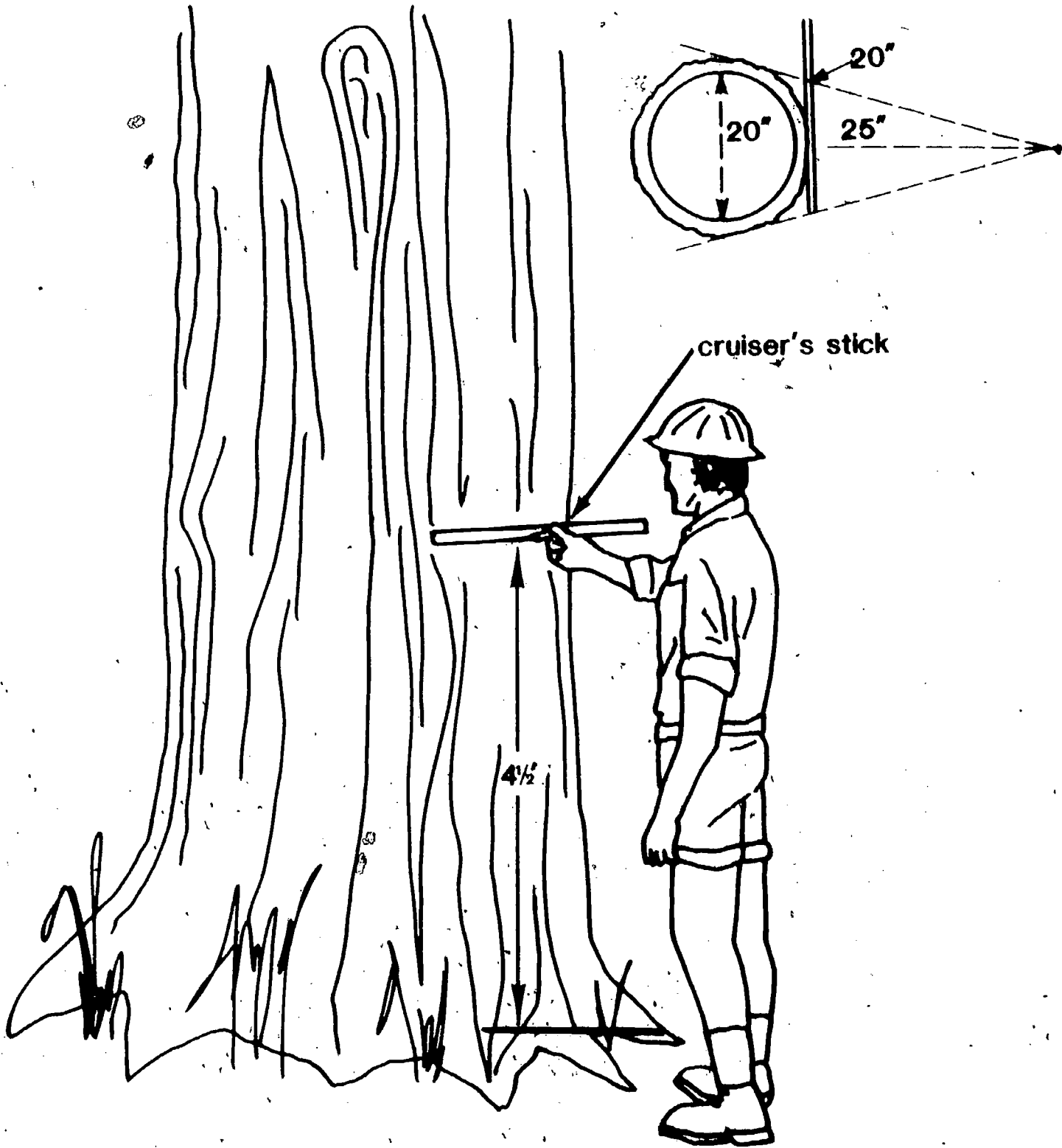

IV-E-2-59

# MEASURING TREE HEIGHT IN 16 FOOT LOG UNITS WITH MERRITT RULE

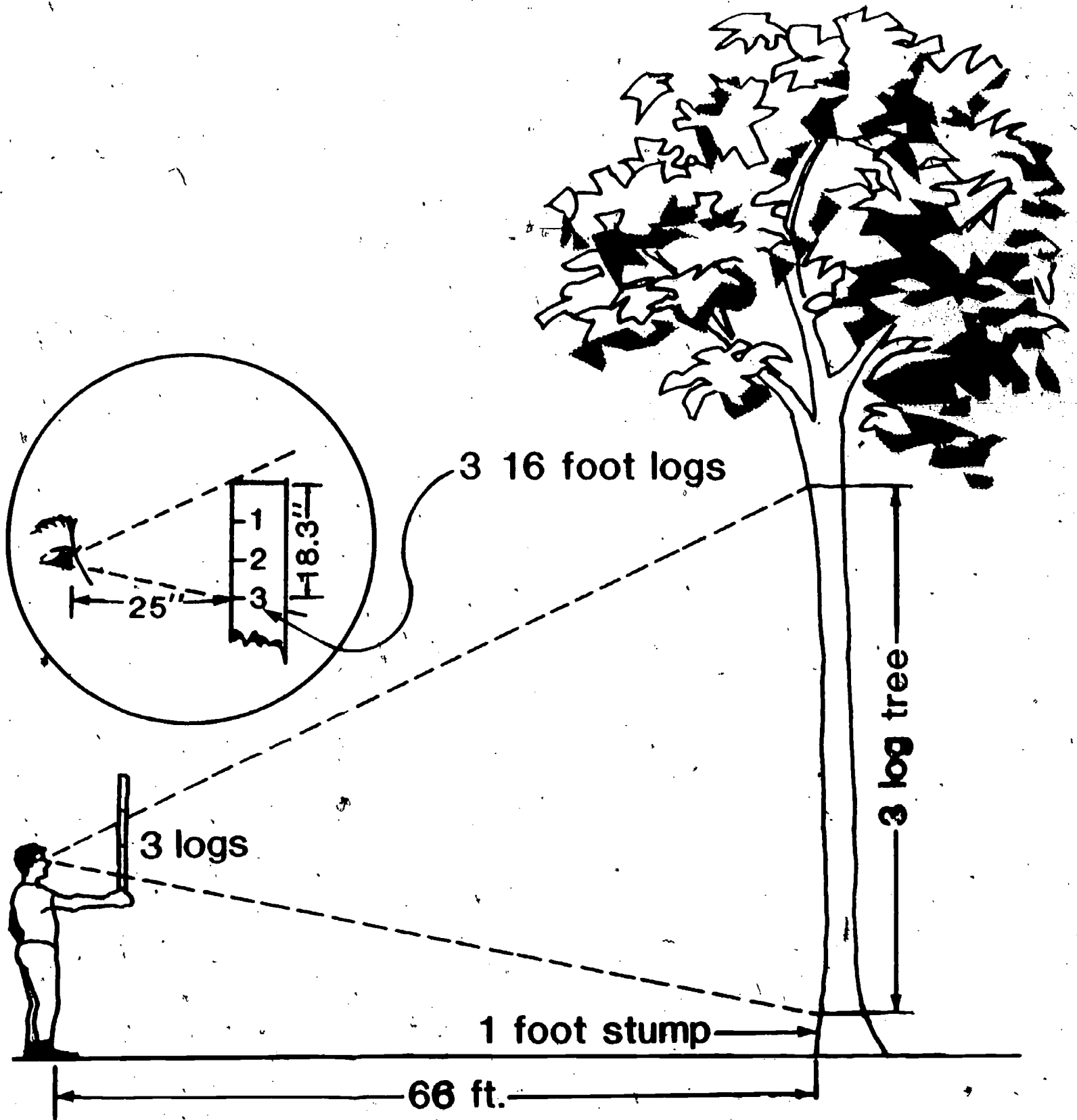



TRANSPARENCY DISCUSSION GUIDE  
GROWING TIMBER AND TREES AS AN  
AGRICULTURAL CROP

Transparencies: ILLINOIS FOREST LANDS, AND ADVANTAGES OF FORESTS

- A. Use these transparencies to promote interest and discussion on the importance of timber and trees in Illinois' economy and to society in general.
- B. Develop class discussion on why the Illinois timber acreage has declined.
- C. Have students try to identify other advantages of timber and tree crops.

Transparencies: MANAGING A FOREST WITH NEW PLANTINGS, FOREST STAND IMPROVEMENT CUTTING, AND FOREST STAND HARVEST CUTTING

- A. Use these transparencies to supplement student conclusions on ways and means of improving forest lands.
- B. Use these transparencies to clarify ways of improving and maintaining existing forest lands.
- C. Have students identify local land areas where each of these techniques could be used.

Transparencies: PARTS OF A TREE, AND CROSS SECTION OF A TREE TRUNK

- A. Use transparencies to supplement class understanding of how trees grow and mature.
- B. Have students identify the parts and functions of a tree.

Transparencies: CRUISER STICK, DETERMINING BREAST HIGH DIAMETER WITH CRUISER'S STICK, AND MEASURING TREE HEIGHT IN 16 FOOT LOG UNITS WITH MERRITT RULE

- A. Use transparencies with Student Job Sheet on constructing a cruiser stick.
- B. Explain how the stick is used to estimate timber volume in a given area.
- C. Have students practice these exercises.



TEACHER'S KEY  
SAMPLE TEST QUESTIONS

GROWING TIMBER AND TREES AS AN AGRICULTURAL CROP

PART I. True (+) - False (0)

- + 1. Illinois has a smaller percentage of its land forested as compared with the percentage for the rest of the United States.
- + 2. A century and a half ago forests covered about 40 percent of Illinois.
- 0 3. Today Illinois forests are found primarily in east-central Illinois.
- + 4. Hardwoods make up over 90 percent of Illinois forests.
- 0 5. Silver maple trees prevail on well-drained, upland soil.
- 0 6. More than 90 percent of Illinois forest land is publicly owned.
- + 7. A primary limitation on forestry development in Illinois is economic.
- 0 8. It is generally believed that the quality of water from forest watersheds is very poor.
- + 9. Recreational and aesthetic values are important considerations for Illinois forest development.
- + 10. Only through coordinated efforts of state and federal organizations will forestry in Illinois be fully developed.

PART II. Multiple Choice - (Make appropriate choice of A, B, C, or D)

- D 1. Land areas which could profitably be planted to forests are:
- A. Eroded land
  - B. Idle land
  - C. Woodland
  - D. All of the above
- A 2. Biomass crops can be fast-growing hardwoods like:
- A. Autumn olive and sycamore
  - B. Black locust and white pine
  - C. Douglas fir and white oak
  - D. Scotch pine and silver maple

- B 3. The most favorable time for planting a forest is:
- A. Fall
  - B. Spring
  - C. Summer
  - D. Winter
- D 4. An example of a weed tree is:
- A. Boxelder
  - B. Sassafras
  - C. Thornapple
  - D. All of the above
- D 5. Today, Illinois has about \_\_\_\_\_ acres of forest lands.
- A. 1 million
  - B. 2 million
  - C. 3 million
  - D. 4 million
- C 6. A good floodplain tree for Southern Illinois is:
- A. Oak
  - B. Ash
  - C. Cottonwood
  - D. Spruce
- C 7. Young trees which have been grown one, two, or three years in seedbeds and have never been moved are called:
- A. Baby stock
  - B. Nursery stock
  - C. Seedlings
  - D. Transplants
- B 8. An example of a conifer is:
- A. Ash
  - B. Red cedar
  - C. White oak
  - D. All of the above
- B 9. Hardwoods are not used for:
- A. Basket veneer
  - B. Christmas trees
  - C. Posts
  - D. Pulp

D 10. Where no undergrowth is present, a good spacing for planting is:

- A. 2' x 2'
- B. 4' x 4'
- C. 6' x 6'
- D. 8' x 8'

PART III. Matching

- |          |                            |    |  |
|----------|----------------------------|----|--|
| <u>F</u> | 1. Eroded land             | A. | The art of tending and treating a forest.          |
| <u>B</u> | 2. Pulp                    | B. | Used in making paper.                              |
| <u>I</u> | 3. Shawnee National Forest | C. | Land areas where timber can be cut.                |
| <u>A</u> | 4. Silviculture            | D. | Illinois.  |
| <u>D</u> | 5. Prairie State           | E. | Interplanting row crops and trees.                 |
| <u>J</u> | 6. Idle land               | F. | Land area where fertile soil has been washed away. |
| <u>G</u> | 7. TDA                     | G. | Dry tons per acre.                                 |
| <u>E</u> | 8. Integrated farming      | H. | Planting one species in an entire area.            |
| <u>H</u> | 9. Pure plantings          | I. | Major public forest in Illinois.                   |
| <u>C</u> | 10. Woodland               | J. | Land areas which have been abandoned.              |

PART IV. Completion (Write appropriate information or words to complete statements.)

1. In general, hardwood species are much more exacting in regard to soil characteristics than evergreens.
2. Mixed plantings tend to reduce damage caused by insects and diseases.
3. Trees such as thornapple, sassafras, and boxelder are commonly called weed trees.
4. The roots of a tree provide mechanical support and absorb water and nutrients from the soil.



5. When considering wood products, the most valuable part of a tree is the trunk.
6. Outside of the wood is the bark which acts as a protection against external mechanical injuries.
7. The active, growing thin layer of cells just outside the wood is the cambium.
8. The crown is made up of branches, twigs, leaves, buds, fruit and flowers.
9. The leaves are commonly called the trees' food-making laboratory.
10. The green substance in leaves which is essential for the food-making process is called chlorophyll.

PART V. Essay Questions

1. Identify and briefly explain two important reasons why forest land is not well managed in Illinois.

(Refer to the Information Sheets included with this problem area.)

2. Briefly discuss the major benefits which could be derived from improving Illinois' forest lands.

(Refer to the Information Sheets included with this problem area.)

## UNIT E: CROP SCIENCE

### PROBLEM AREA: HARVESTING FORAGE CROPS

#### SUGGESTIONS TO THE TEACHER:

This problem area is designed for use with advanced students in vocational agriculture programs. The recommended time for teaching this problem area is during the spring of the year when forage crops are being harvested and in the fall when grain silage is being harvested.

The estimated instructional time for this problem area is 3 to 5 days depending on how far the teacher wishes to go in developing forage harvesting and storing skills. If the students are to be involved in other activity exercises, the instructional time will need to be increased.

The instructor is encouraged to conduct a local search to locate other supplementary materials for use with this problem area. The items in this problem area are for reference or modification as instructors adapt these materials to their local situation.

#### CREDIT SOURCES:

These materials were developed through a funding agreement, R-33-24-D-0362-466 with the Illinois State Board of Education, Department of Adult, Vocational and Technical Education, Research and Development Section, 100 North First Street, Springfield, Illinois 62777. Opinions expressed in these materials do not reflect, nor should they be construed as policy or opinion of the State Board of Education or its staff.

The teacher's guide, student worksheets, student job sheets, transparency discussion guide, and sample test questions were developed by Barb Clayton Koch, Doug Falk, and Jerry Pepple, Department of Vocational and Technical Education, University of Illinois.

The artwork in this problem area was prepared by the Vocational Agriculture Service, University of Illinois.

Suggestions and guidance in the development of these materials were provided by Dr. Darrell A. Miller, Department of Agronomy, University of Illinois.

## TEACHER'S GUIDE

- I. Unit: Crop science
- II. Problem area: Harvesting forage crops
- III. Objectives: At the end of this problem area students will be able to:
  1. Compare and contrast the advantages and disadvantages associated with the production of the various forage products.
  2. Explain the effects of proper harvesting methods on forage product quality.
  3. List the factors affecting the cutting of forages.
  4. List the common steps involved in harvesting a forage crop.
  5. Describe the ensiling process and its possible safety hazards.
  6. Identify different types of forage equipment.
  7. Identify different parts of forage equipment and describe the use of each part.
- IV. Suggested interest approaches:
  1. Identify students who have forage crops as part of their SOEP's. Have them discuss their forage program.
  2. Bring in different forage equipment items. Ask students to identify the items and explain how they are used.
  3. Discuss forages as a cash crop and compare their value to grain crops.
  4. Illustrate how forages fit into the total farm situation. Include soil erosion benefits, feed for animals, marketing, cash flow, and improvement of soil structure.
  5. Prepare and show slides which depict forage harvesting 50 years ago as compared to today's methods.
  6. Bring in sample of different types of forages and have class examine and identify the quality indicators of each forage sample.

V. Anticipated problems and concerns of students:

1. What are forages?
2. What are the proper moisture content levels for forages at harvest?
3. What are the advantages and disadvantages of different types of forage harvesting methods?
4. What are the common forage harvesting methods used in this area?
5. What are some characteristics of high-quality forages?
6. What are some advantages of harvesting hay in the proper stages of maturity?
7. What are some different types of facilities used for storage?
8. What can happen if forage is not properly cured and stored?
9. What equipment is necessary for harvesting forage crops?
10. What adjustments can be made to forage harvesting equipment to reduce field losses.
11. Where can I find information on how to adjust forage harvesting equipment?
12. Where can I find information on harvesting and storage of forage crops?

VI. Suggested learning activities and experiences:

1. Select and conduct an interest approach on harvesting forages.
2. Identify problems and concerns of students and supplement their list with additional problems to adequately cover this problem area.
3. Use the included Information Sheets, Job Sheets and Worksheets to stimulate discussion of various aspects of forage harvesting.
4. Use the transparencies and supplemental references to explain the operation of commonly used forage harvesting equipment.
5. Plan a field trip to see various forage harvesting equipment at a local implement dealer. Have a resource person explain the use and adjustments of various implements.



6. Acquire sales brochures from machinery dealers on various forage harvesting implements. Identify and discuss information concerning the specifications of the implements.
7. Conduct a field trip to observe actual harvesting operations. Identify ways to reduce harvest loss and improve forage quality.
8. Secure a forage harvesting implement to bring to the agriculture mechanics laboratory and have class members get it field ready.
9. Have students prepare reports on the different aspects of harvesting and storage of forages. Use small groups or individual assignments.
10. Develop a safety campaign on harvesting and storing forage crops.

VII. Application:

1. Students should be able to use this information to improve their SOEP forage harvesting techniques.
2. Students will be able to judge forage samples for quality and condition in crop judging contests.

VIII. Evaluation:

1. Collect and grade written assignments.
2. Evaluate student ability to judge forage samples on quality.
3. Administer test at end of problem area.

IX. References and aids:

1. Operators' manuals for selected forage harvesting implements.
2. Sales brochures from local dealers on various items used for forage harvesting and storage.
3. Miller, Darrell A.  
Forage Crops  
McGraw-Hill Book Company  
St. Louis, Missouri. 1984.
4. Deere and Company.  
Fundamentals of Machine Operation: Hay and Forage Harvesting  
Deere and Company  
Moline, Illinois. 1976.



5. Heath, Maurice E., Darrell S. Metcalf and Robert Barnes.  
Forages: The Science of Grassland Agriculture  
Iowa State University Press  
Ames, Iowa. 1974.

**COMPETENCY INVENTORY**  
**HARVESTING FORAGE CROPS**

1. Student has no knowledge of competency.
2. Student has read about competency.
3. Student has seen competency performed.
4. Student has performed competency.
5. Student has performed competency without supervision.

Competency	Circle One				
1. Determine optimum moisture content to insure proper storage.	1	2	3	4	5
2. Adjust machines used in harvesting forages.	1	2	3	4	5
3. Recognize proper stage of maturity to harvest for highest quality.	1	2	3	4	5
4. Identify safety hazards present in harvesting and storing forages.	1	2	3	4	5
5. Determine the relative advantages of producing the different forage products.	1	2	3	4	5
6. Evaluate the costs of different forage harvesting and storing methods.	1	2	3	4	5
7. Identify and explain the criteria for quality forages.	1	2	3	4	5
8. Use weather information to reduce the risk of rain damage in forage harvesting.	1	2	3	4	5
9. Identify and explain the operation principles of forage handling and storage equipment.	1	2	3	4	5

These competencies are outlined in the National Ag Occupations Competency Study, 1978, for entry level position in agriculture.

Name \_\_\_\_\_

Date \_\_\_\_\_

## INFORMATION SHEET #1

### FORAGE PRODUCTS

- A. **Green Chop:** Not less than 70% moisture. The crop is cut, chopped and fed directly without being stored.
- B. **Silage:** A fermented green forage:
1. **Direct Cut Silage:** not less than 70% moisture. The crop is cut, chopped and immediately placed in silo.
  2. **Wilted Silage:** 50-70% moisture. The crop is cut and field dried to the desired moisture content. The crop is chopped and placed in a silo.
  3. **Haylage:** 40-50% moisture. The typical non-grain crop is cut and field dried to the desired moisture content. The crop is chopped and placed in an oxygen limiting silo.
- C. **Hay:** 12-22% moisture. The crop is cut and cured in the field before packaging in one of the following methods.
1. **Small bale:** round or square, generally weight less than 100 pounds.
  2. **Large bales:** round and generally weight 1000 or more pounds.
  3. **Stack:** rectangle with dome top, generally weight one to six tons.
- D. **Cubes and Pellets:** 8-10% moisture. Normally produced by commercial growers after drying the forage with a rotating drum dehydrator.
- E. **Wet Processing:** A commercial process which uses forage to produce a liquid protein component. The by-product can be utilized as a high moisture silage or to make a dry meal.

## INFORMATION SHEET #2

### CUTTING FORAGE CROPS

Proper cutting of a forage crop is essential for maximum harvest yield and utilization. Cutting should be done at the correct forage growth stage, during favorable weather conditions and to the optimum cutting height.

Before harvesting a forage crop it is important to carefully monitor the weather conditions. Unfavorable weather conditions at harvest can significantly decrease the value of the forage crop. Wet conditions may result in moldy and musty hay and reducing the valuable nutrients in the crop. Poor weather can be responsible for a loss of up to 40% of the forage dry matter usually in the form of nutritionally important leaves.

The recommended time and height for cutting a forage crop varies according to the species being harvested. It is important to obtain specific information on the time and height for harvesting a particular forage crop in your area. This information can be obtained by contacting the local county extension agent. Several important facts should be considered when harvesting a forage crop.

1. The forage leaves are high in protein, easily digested and are important in determining the crops palatability.
2. A more mature plant will be less palatable and contain a lower percentage of digestible nutrients than a plant in earlier stages of growth.
3. A plant in the early stages of growth will not lose its leaves after cutting as easily as a more mature plant.
4. The rate of maturity of a forage crop will vary with species and cultivars being harvested as well as the climate.
5. Regardless of the forage species, the recommended time to harvest is at the first flower stage of growth (except for grain crops being ensiled).
6. Generally, when two or more species are grown in combination the earlier maturing species will serve as the harvest time indicator.
7. The total number of harvests per year is dependent on the climate and the number of frost free days.
8. The last pre-frost harvest should be completed at such a time as to allow the forage to produce adequate reserves for the winter before the killing frost, this is usually 35-40 days before a killing frost of 26°F.

9. A final harvest may be taken on an established forage stand after a killing frost provided there is adequate drainage and tall stubble height. This is not recommended for legumes during the year of establishment.
10. The point of regrowth of the plant will determine the recommended height for cutting to ensure regrowth. The suggested cutting height will vary according to species.

Various types of equipment are used to cut forage crops. Frequently these machines combine the cutting process with other necessary operations to reduce the amount of crop handling. When a forage is to be field dried a mower is used to cut the crop. A mower may be combined with a conditioner and a windrower. The conditioner crushes the forage stem to allow for more rapid, uniform drying and greater forage palatability. The windrower gathers the cut forage onto a windrow that can be collected by a baler. The windrow also protects leaves from bleaching by the sun.

When cutting and gathering for green-chop, direct-cut silage or mechanically cured forage, the cutting mechanism is combined with a gathering device. Various heads may be used to harvest silage and green-chop for efficient gathering.

The ultimate quality of a forage crop is highly dependent on the management practices used in selecting the appropriate time, height, and equipment to harvest the forage, as well as the quality of the growing crop itself.

## INFORMATION SHEET #3

### SILAGE

Silage is the product of controlled anaerobic fermentation of green forage. The ensiling process is controlled by the type and makeup of the plant material, amount of available oxygen and the type of bacteria that is present on the plant material. The ensiling process kills weedseeds, increases the forage palatability, preserves the nutritional value of the forage and reduces field losses.

To produce silage the forage crop is cut, chopped into pieces 1½ inches to 2 inches in length, dried to the desired moisture level and placed in a horizontal or vertical silo. The aerobic (oxygen consuming) bacteria present begin producing acetic acid and multiply until the oxygen condition supply is completely depleted. The aerobic condition will last approximately four days. Anaerobic bacteria then begin to grow, producing lactic acid. These bacteria will remain active for approximately two weeks until the pH reaches 4.0. At the completion of this stage the silage is a stable product and will remain preserved indefinitely if no additional oxygen is allowed to contact the silage.

Additives may be used to aid in the ensiling process or to increase the feeding value. Chemical non-nutritive additives may be used to change or maintain the pH level within an acceptable range for proper fermentation. Nutritive additives such as molasses and grains may be added to add food value to the silage. Nutrients may be added to ensure a balanced ration and to ensure enough nutrients for proper fermentation.

Poor silage can result from improper preparation, storage or pre-ensiling, drying. Forages which are too dry before ensiling will typically have a high oxygen content which allows mold and other organisms to grow and spoil the silage. Haylage should always be stored in an oxygen limiting silo. Overly wet forage being ensiled may limit the acetic acid production and consequently increase the development of butyric acid causing the silage to spoil. The length of cut, compaction and distribution of the forage within the silo will effect the amount and distribution of oxygen within the silage.

The ensiling process can create highly hazardous conditions primarily due to the gases being produced. Carbon dioxide gas is given off during the aerobic fermentation process. Although it is a non-poisonous gas, colorless, odorless carbon dioxide prevents oxygen inhalation causing suffocation. Nitrogen dioxide, a reddish-yellow gas with an odor similar to bleach, can also be present near the ensiling area. Weeds being ensiled can create high levels of nitrogen dioxide. This gas being heavier than air will be found at the surface of the silage or in low areas around the silo. Nitrogen dioxide when oxidized produces nitric acid which combined with water is highly corrosive. Breathing nitrogen dioxide will cause lung damage. Silage, not stored properly, has the capacity to burst into flame. Spontaneous combustion is most likely to occur in haylage due to its high oxygen content. The increased temperature of the forage from the aerobic process can allow the forage to burst into flame if an adequate supply of oxygen is present.

To minimize the risks associated with the ensiling process:

1. Stay out of the silo during the ensiling process.
2. Run the silo blower 15-20 minutes before entering the silo.
3. Be alert to signs of the presence of harmful gasses.
4. Ventilate the silo room during the ensiling process.
5. Protect livestock from harmful gasses by closing doors between the silo room and the barn.
6. Get immediate medical attention if exposed to dangerous fumes.
7. Haylage should be stored in an oxygen limiting silo to prevent spontaneous combustion.



## STUDENT WORKSHEET #1

### FORAGE PRODUCTS

(For use with Information Sheet #1)

1. Explain the difference between green-chop and direct-cut silage.
2. What is the difference between silage and haylage?
3. What type of hay packaging is used in this area? Explain why.
4. Why would commercial forage producers cube or pellet their forage crops?
5. What is silage?



6. As a class, complete the following chart by:
  - a. Placing a "√" in each box corresponding to the steps required for harvesting forage to produce the product listed at the top of each verticle column.
  - b. Place a "+" in the box to indicate an optional step.
  - c. Use "H"=high, "M"=medium, and "L"= low to describe the required amounts of labor and facilities necessary for each product.

	GREEN		SILAGE		HAY		
	Chop	Direct Cut	Wilted	Haylage	Large Bale	Small Bale	Stacks
Cutting							
Drying							
Chopping							
Conditioning							
Packaging							
Storing							
Labor (Daily)							
Storage Facilities							

7. List the types of forage drying methods used in this area:
  
8. What type of hay storage facilities do local farms utilize? How do they compare in cost and wastage?
  
9. List the types of silos being used in the local area.

## STUDENT WORKSHEET #2

### SILAGE

(For use with Information Sheet #2)

1. List the three factors which control the ensiling process.

a. \_\_\_\_\_

b. \_\_\_\_\_

c. \_\_\_\_\_

2. What are four benefits of ensiling a forage crop?

a. \_\_\_\_\_

b. \_\_\_\_\_

c. \_\_\_\_\_

d. \_\_\_\_\_

3. Explain the role of aerobic bacteria on the ensiling process.

Aerobic bacteria consume the oxygen in the silo as they produce acetic acid. Once the oxygen is used up the bacteria become dormant.

4. \_\_\_\_\_ bacteria produce lactic acid which acts as a preservative keeping the silage in a stable condition.

5. \_\_\_\_\_ bacteria ferment the forage. Fermentation is the process of turning sugar into carbon dioxide and alcohol.

6. List the three types of silage additives and explain their function.

a. \_\_\_\_\_

b. \_\_\_\_\_

c. \_\_\_\_\_

7. Why would overly wet silage limit acetic acid production? What problem would this cause?
  
8. Why would too much oxygen be detrimental to the ensiling process?
  
9. List six factors which can affect the amount of oxygen present during the ensiling process.
  - a. \_\_\_\_\_
  - b. \_\_\_\_\_
  - c. \_\_\_\_\_
  - d. \_\_\_\_\_
  - e. \_\_\_\_\_
  - f. \_\_\_\_\_
  
10. How could you check to determine if the level of carbon dioxide gas in a silo is dangerous?
  
11. How could you detect the presence of nitrogen dioxide?
  
12. How can spontaneous combustion be prevented in haylage?
  
13. How soon after placing the forage in a silo should you enter the silo?

STUDENT WORKSHEET #3

CUTTING FORAGE CROPS

(For use with Information Sheet #3)

1. T. F. The way in which a forage is cut will not affect the forage's nutritional value.
2. Poor drying weather can reduce the yield of a forage crop by up to \_\_\_\_\_ percent.
3. List three factors which can affect the time for harvesting a forage crop.
  1. \_\_\_\_\_
  2. \_\_\_\_\_
  3. \_\_\_\_\_
4. Regardless of the species, what is the recommended time for harvest?
5. When is it recommended to take a final harvest after a killing frost?
6. Cutting height depends primarily on \_\_\_\_\_
7. Define the following terms.
  - a. Mower
  - b. Conditioning
  - c. Windrow

8. Complete the following chart after identifying the most common forages grown in your area.

Common Forage Name(s)	Scientific Forage Name(s)	Recommended Time For 1st Harvest	Recommended Time For Subsequent Harvest	Recommended Time for Last Pre-killing Frost Harvest	Recommended Cutting Height	Average Annual Number of Harvests

TEACHER'S KEY  
STUDENT WORKSHEET #1  
FORAGE PRODUCTS

(For use with Information Sheet #1)

1. Explain the difference between green-chop and direct-cut silage.

Green chop is fed directly to the livestock. It is not stored while direct-cut silage is placed in a silo where it is fermented and stored for later use.

2. What is the difference between silage and haylage?

Haylage is a type of silage. Haylage is a low (45%) moisture silage which is ensiled in the absence of oxygen.

3. What type of hay packaging is used in this area? Explain why.

4. Why would commercial forage producers cube or pellet their forage crops?

The low (8-10%) moisture content and small size allows for efficient and easy transportation.

5. What is silage?

A fermented green forage.

6. As a class, complete the following chart by:

- Placing a "√" in each box corresponding to the steps required for harvesting forage to produce the product listed at the top of each verticle column.
- Place a "+" in the box to indicate an optional step.
- Use "H"=high, "M"=medium, and "L"= low to describe the required amounts of labor and facilities necessary for each product.

	GREEN		SILAGE		HAY		
	Chop	Direct Cut	Wilted	Haylage	Large Bale	Small Bale	Stacks
Cutting	√	√	√	√	√	√	√
Drying			√	√	√	√	√
Chopping		√	√	√			
Conditioning					+	+	+
Packaging					√	√	√
Storing		√	√	√	√	√	√
Labor (Daily)	L	L	M	M	M	H	M
Storage Facilities	L	M	M	M	L	M	L

7. List the types of forage drying methods used in this area:

8. What type of hay storage facilities do local farms utilize? How do they compare in cost and wastage?

9. List the types of silos being used in the local area.

TEACHER'S KEY  
STUDENT WORKSHEET #2

SILAGE

(For use with Information Sheet #2)

1. List the three factors which control the ensiling process.

- a. type and makeup of the plant material
- b. amount of available oxygen
- c. type of bacteria which is present on the plant material.

2. What are four benefits of ensiling a forage crop?

- a. kills weed seeds
- b. increases the forage palatability
- c. preserves the nutritional value
- d. reduces field losses.

3. Explain the role of aerobic bacteria on the ensiling process.

Aerobic bacteria consume the oxygen in the silo as they produce acetic acid. Once the oxygen is used up the bacteria become dormant.

4. Anaerobic bacteria produce lactic acid which acts as a preservative keeping the silage in a stable condition.

5. Anaerobic bacteria ferment the forage. Fermentation is the process of turning sugar into carbon dioxide and alcohol.

6. List the three types of silage additives and explain their function.

- a. Chemical-non-nutritive additives - aid in controlling the pH level for proper fermentation.
- b. Feed additives - aid in the ensiling process add food value to the silage.
- c. Nutrient additives - helps to ensure a balanced ration when feeding the silage to livestock and insure enough nutrients for proper fermentation.



7. Why would overly wet silage limit acetic acid production? What problem would this cause?

If water takes up a large share of the plant material less oxygen will be able to enter the silo. Aerobic bacteria, requiring oxygen to produce acetic acid, will be unable to function.

Butyric acid will form causing the forage to spoil.

8. Why would too much oxygen be detrimental to the ensiling process?

- mold would be able to grow
- spontaneous combustion may occur

9. List five factors which can affect the amount of oxygen present during the ensiling process:

a. the moisture content of the plant material

b. the length of cut

c. the compaction of the plant material

d. the distribution of the plant material

e. the silo construction

10. How could you check to determine if the level of carbon dioxide gas in a silo is dangerous?

Hold a lit match or candle inside the silo - if it burns, adequate levels of oxygen are present and the carbon dioxide is not at a life threatening level.

11. How could you detect the presence of nitrogen dioxide?

It would appear reddish yellow, smell like bleach and be close to the surface.

12. How can spontaneous combustion be prevented in haylage?

Store the haylage in an oxygen limiting silo.

13. How soon after placing the forage in a silo should you enter the silo?

Three weeks - if sooner. run the silo blower 15-20 minutes in advance of entering - check for hazardous gasses and use the "buddy" system.

TEACHER'S KEY  
STUDENT WORKSHEET #3  
CUTTING FORAGE CROPS

(For use with Information Sheet #3)

1. T. F. The way in which a forage is cut will not affect the forage's nutritional value.
2. Poor drying weather can reduce the yield of a forage crop by up to 40 percent.
3. List three factors which can affect the time for harvesting a forage crop.
  1. the species being harvested
  2. the climate
  3. the condition or stage of growth of the stand.
4. Regardless of the species, what is the recommended time for harvest?

First flower stage. (In large fields it may be necessary to begin slightly sooner.)
5. When is it recommended to take a final harvest after a killing frost?

When there is good drainage, adequate stubble remaining and the stand is in its second or more year.
6. Cutting height depends primarily on the species being harvested.
7. Define the following terms.
  - a. Mower - a piece of equipment used to cut a standing crop.
  - b. Conditioning - a process in which the forage stems are crushed to increase uniformity and speed of drying time and the palatability of the forage.
  - c. Windrow - row of hay formed by a rake, or windrower to be picked up later by a harvesting machine.

## **FACTORS TO CONSIDER WHEN HARVESTING FORAGES**

1. Size of area to be harvested.
2. Type of forage being harvested.
3. Availability, capacity, dependability, and compatability of harvesting equipment.
4. Use of forage after harvest.
5. Storage facilities available.
6. Weather conditions.
7. Availability of labor.
8. Quality of forage product.
9. Marketability.

# FEED EFFICIENCY OF FORAGE HARVESTING METHODS

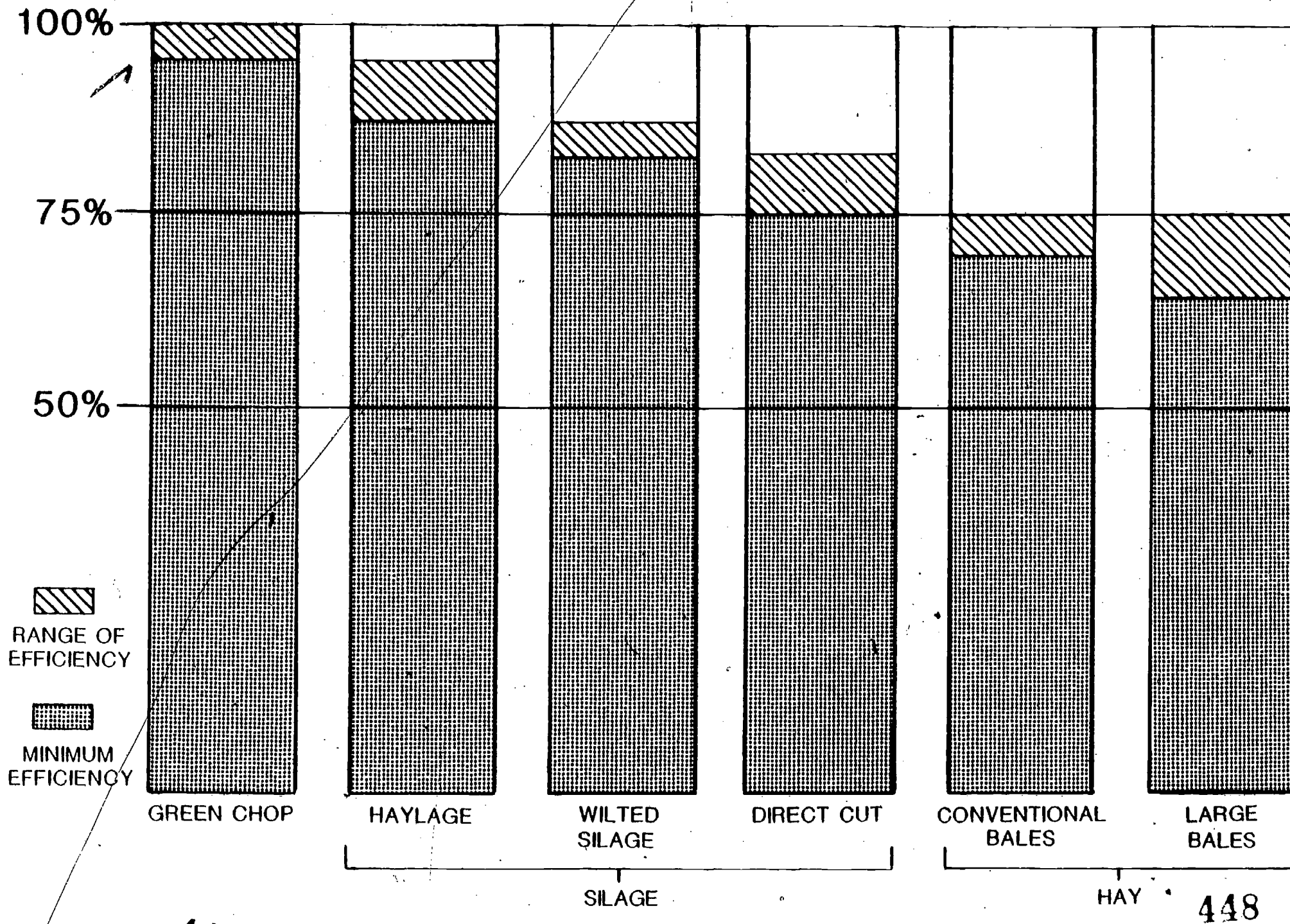

447

448

# MOWER COMPONENTS

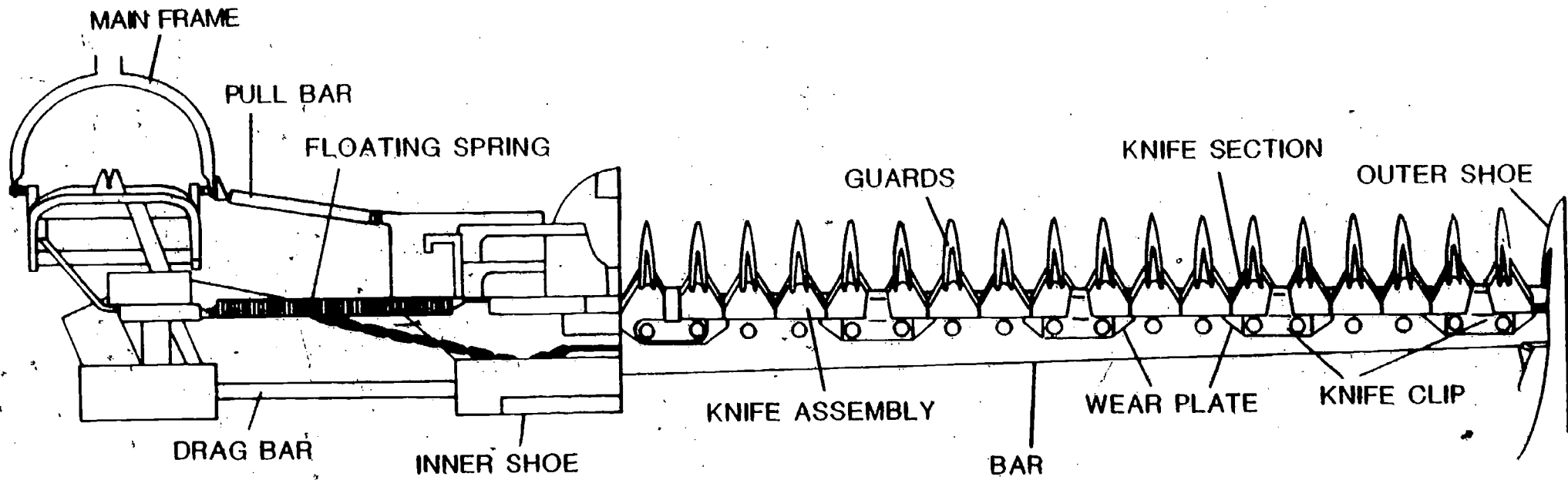

IV-E-3-29

449

450



# HAY CONDITIONER COMPONENTS

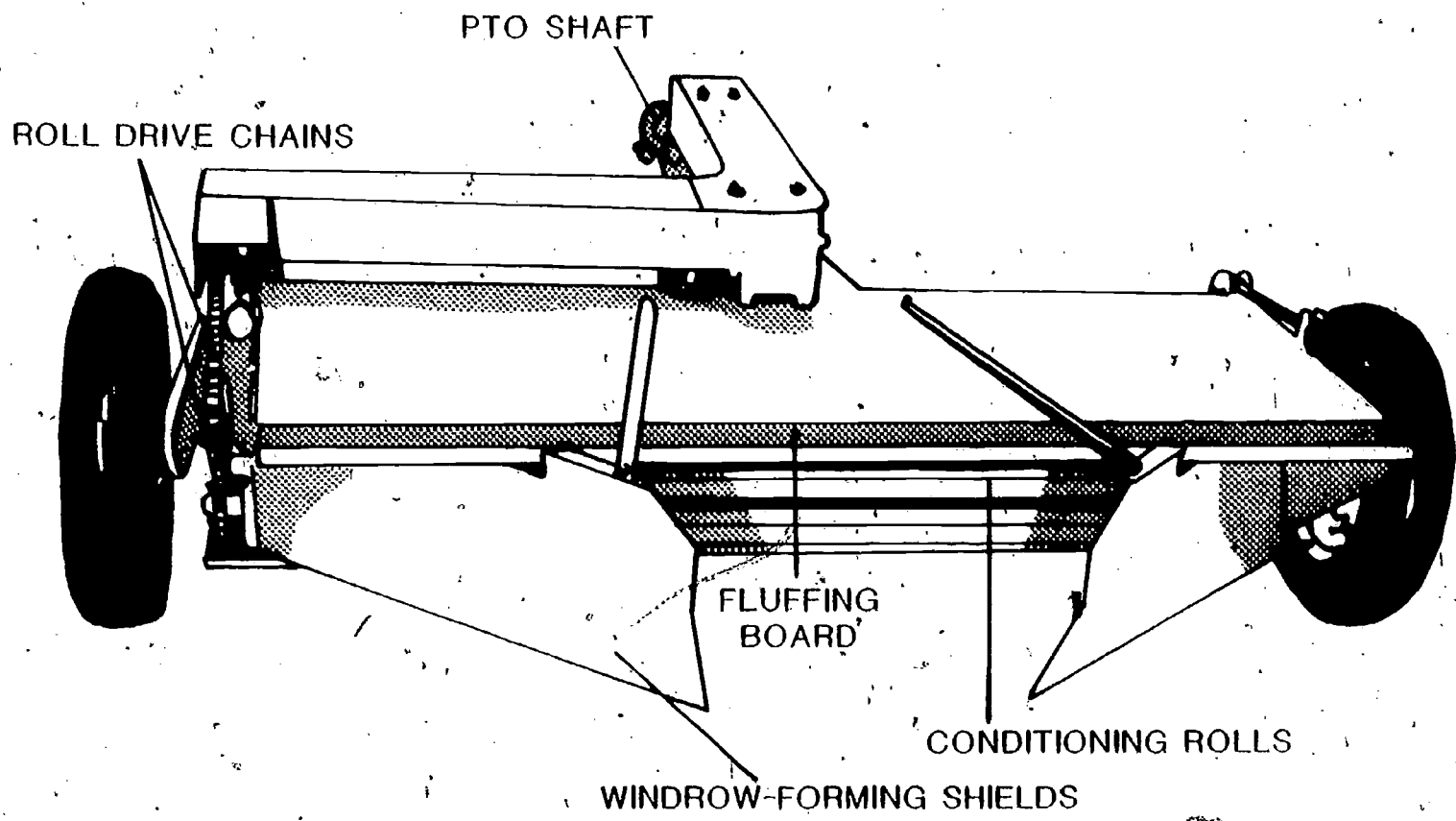

# CONDITIONING ROLLS

## CRIMPER ROLLS

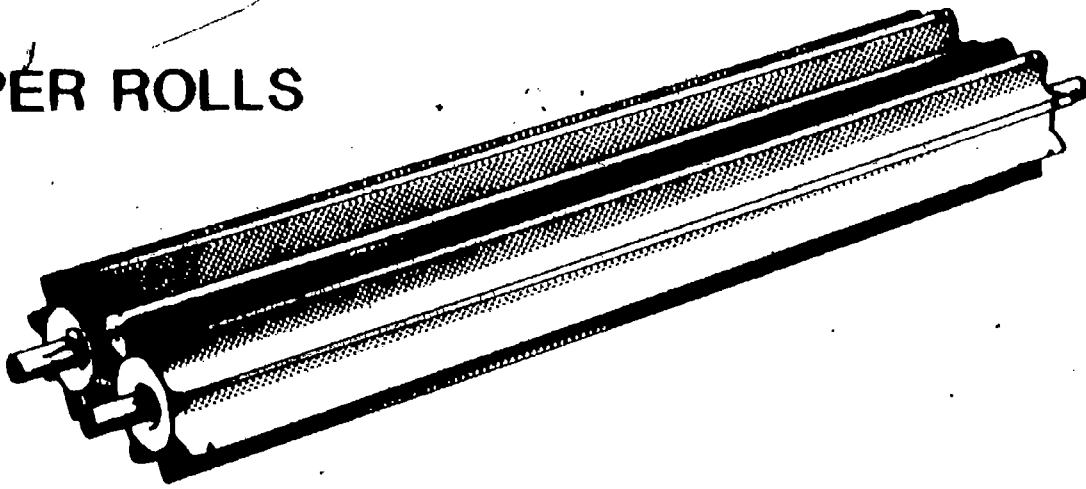

## CRUSHER ROLLS

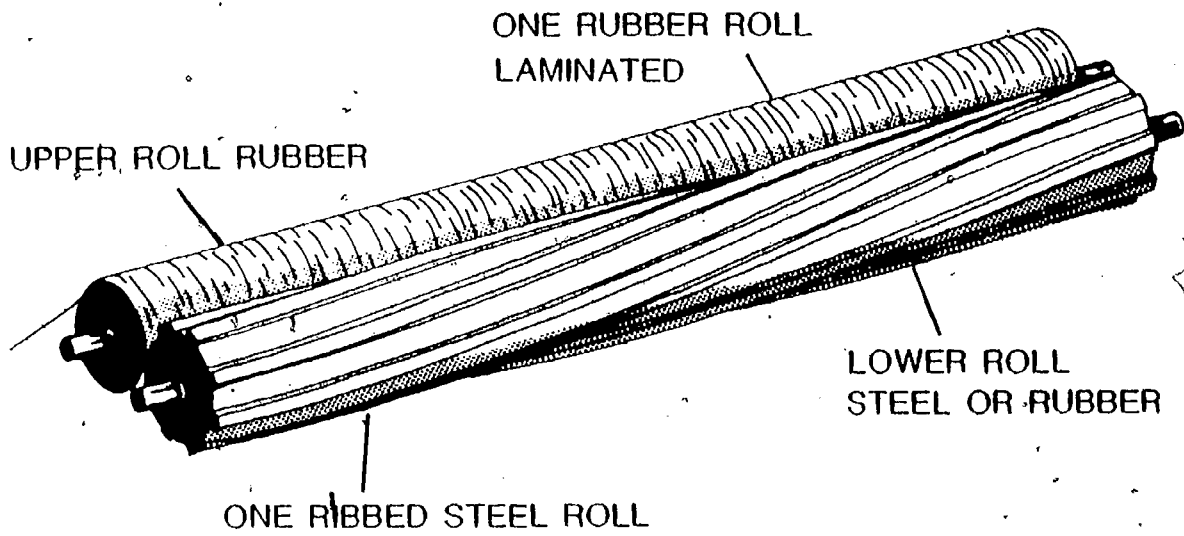

## MOLDED RUBBER CRUSHING/CRIMPING ROLLS

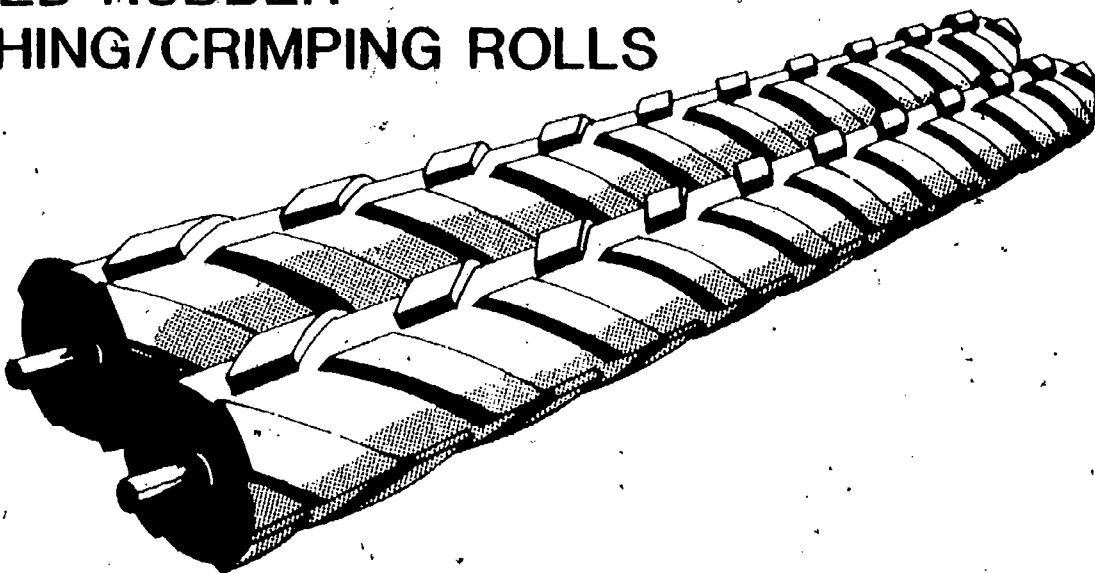

# RAKES

## REAR MOUNTED, PARALLEL BAR RAKE

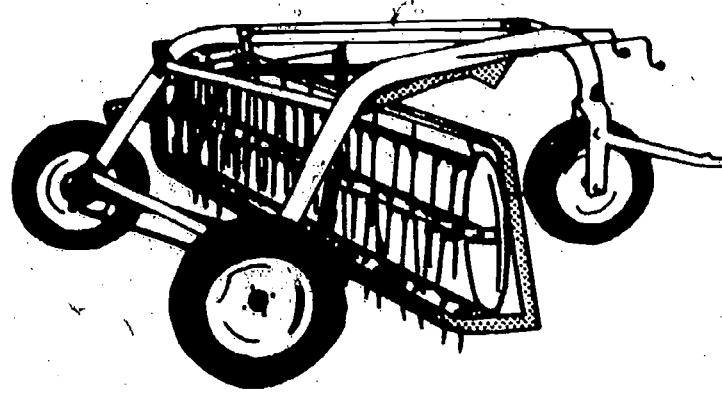

## REAR MOUNTED, WHEEL RAKE

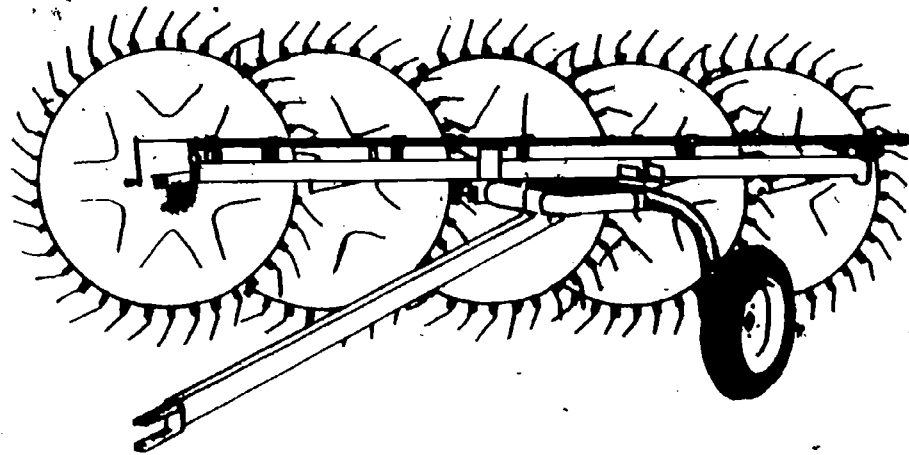

## TWO RAKES WITH TANDEM HITCH

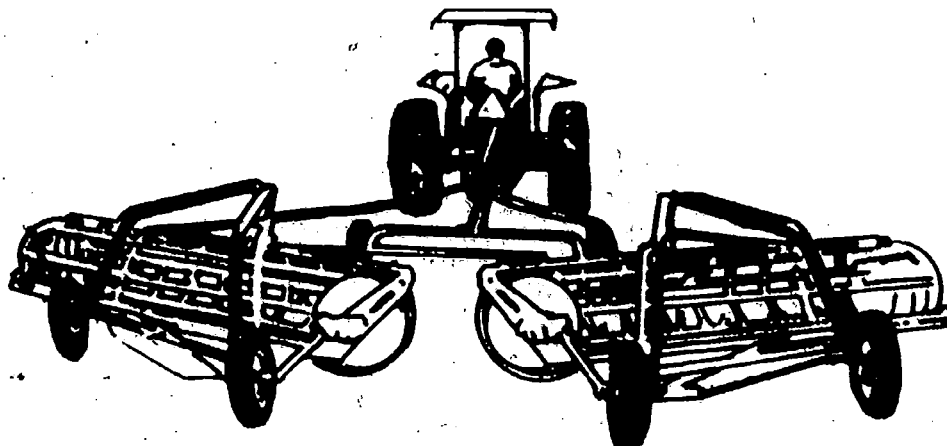



# PARTS OF A RAKE

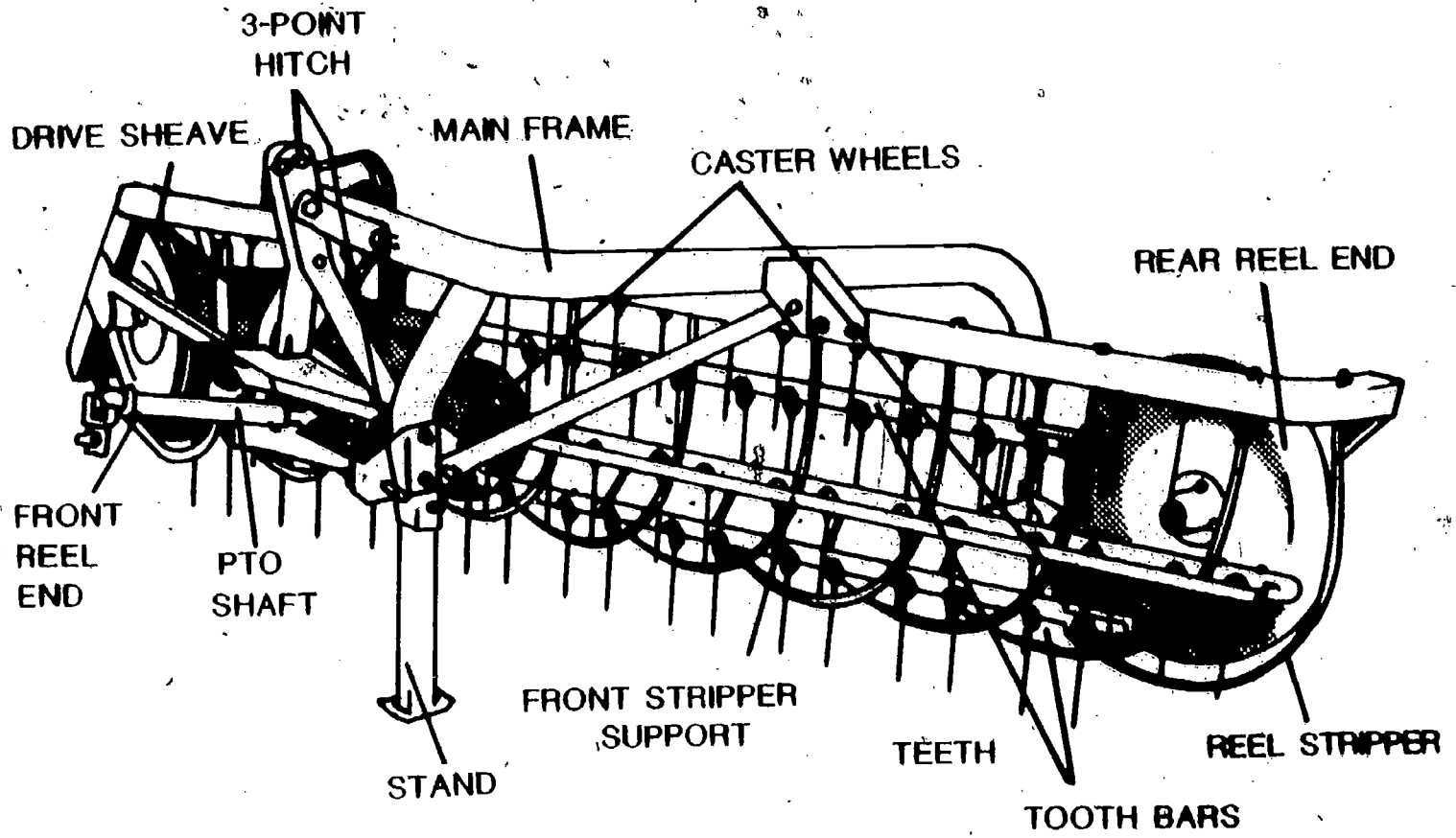

# SQUARE BALER

## FRONT VIEW

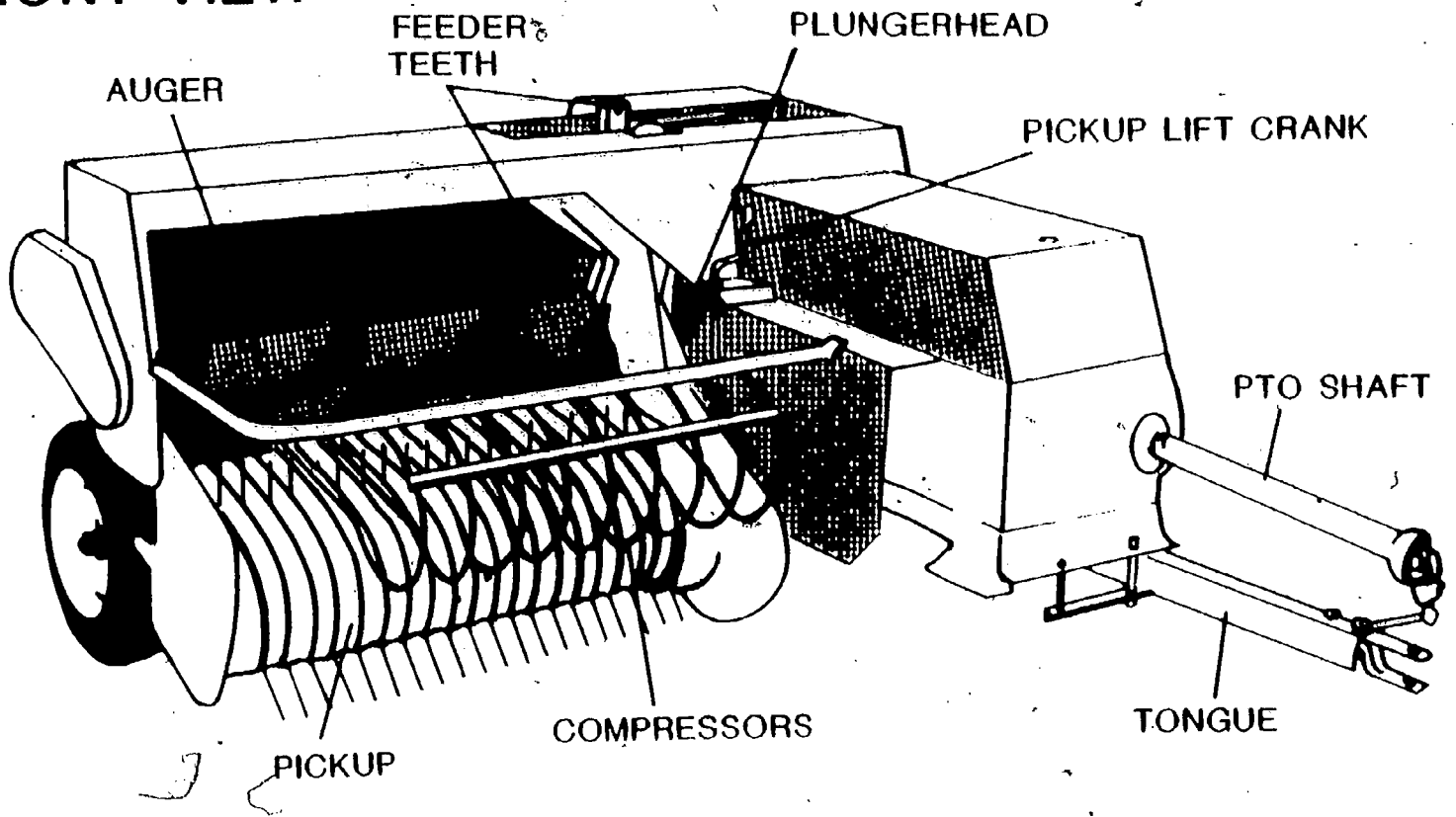

## REAR VIEW

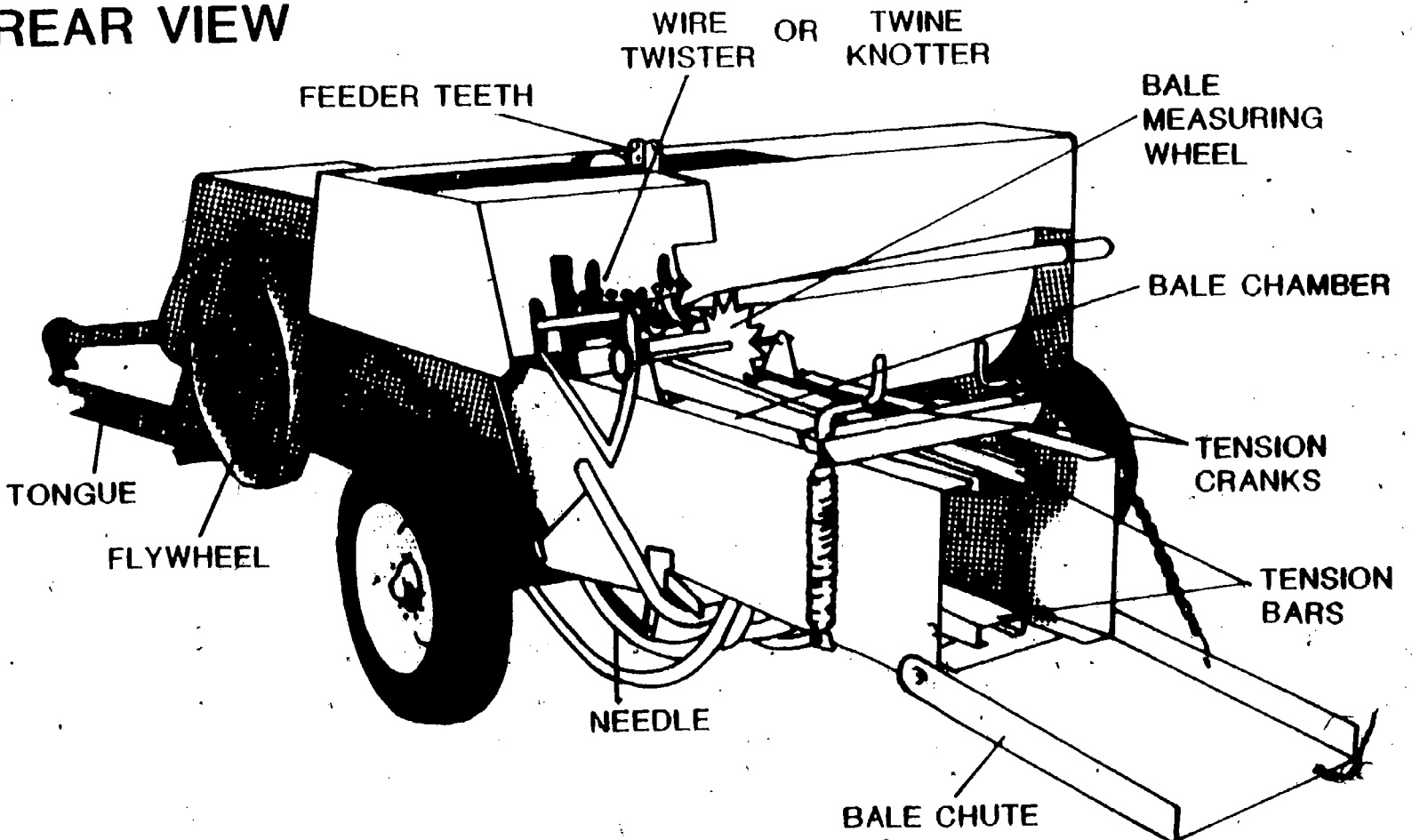

# CHAMBER-ROLLING LARGE ROUND BALER

## CHAMBER-ROLLING BALER COMPONENTS

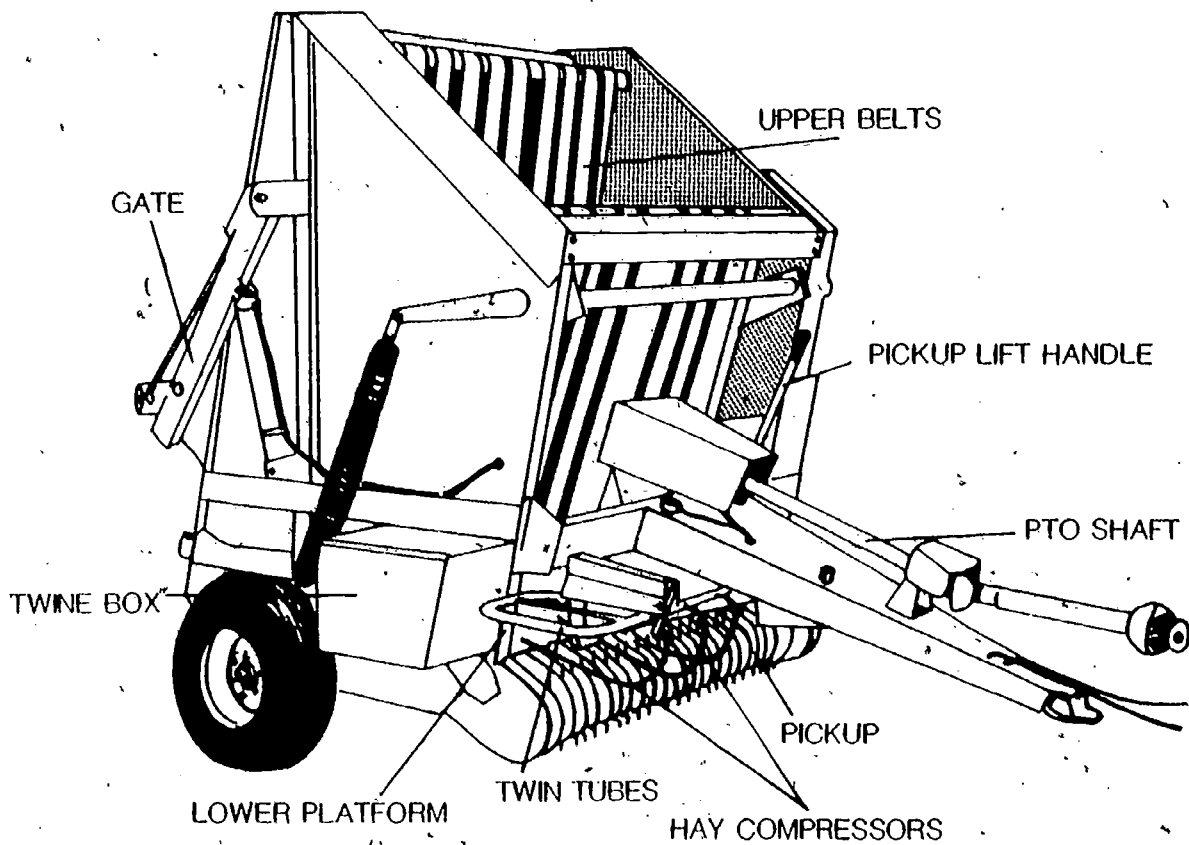

## MAKING A CHAMBER ROLLED BALE

1. The pickup teeth lay the hay on the bottom drum roller which moves the hay toward the back of the machine.

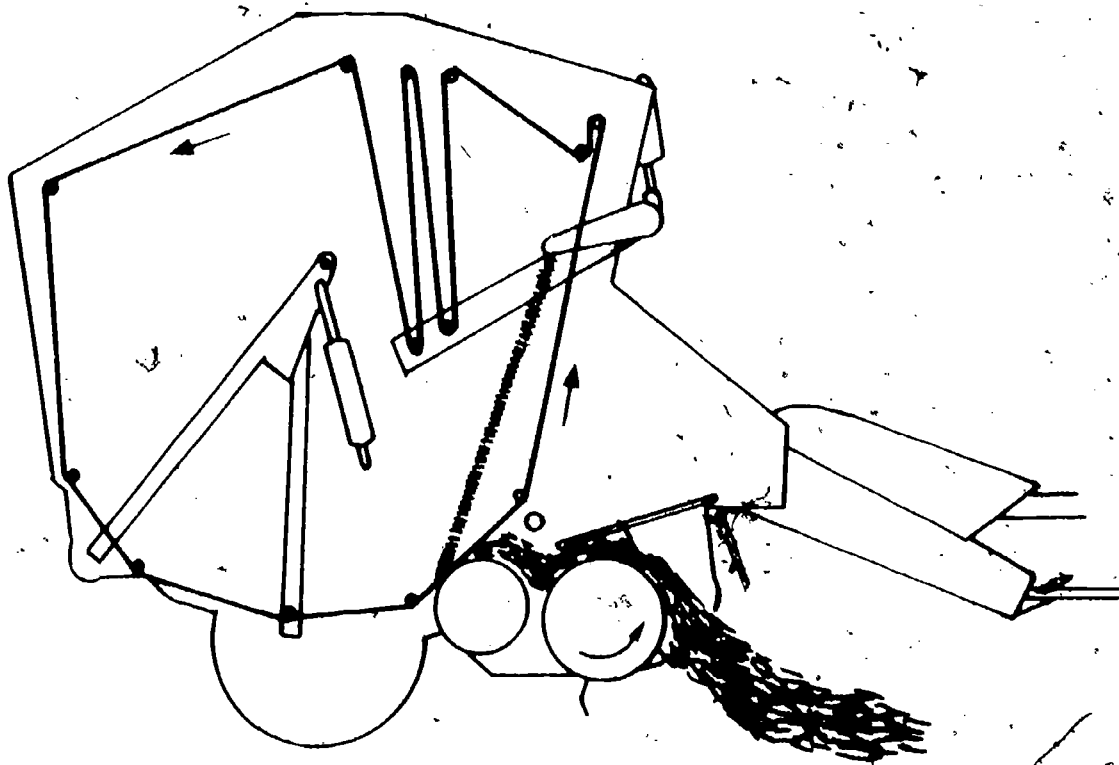

## MAKING A CHAMBER ROLLED BALE, CONT.

2. As the hay moves toward the back of the baler, the upper belts move it toward the front starting roller. When the hay hits the starting roller it is laid on top of the other hay coming into the machine, starting the rolling action.

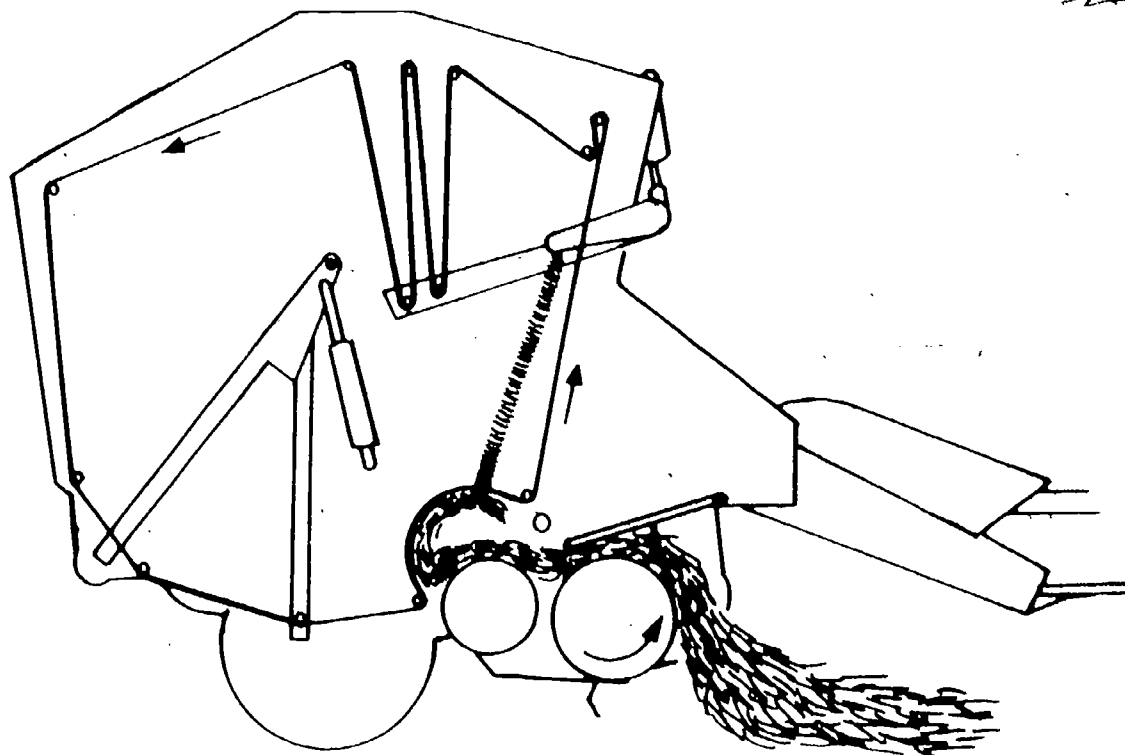

3. The bale grows as more hay is fed into the machine. The belt tightener arms adjust to keep the bale encircled by the belt.

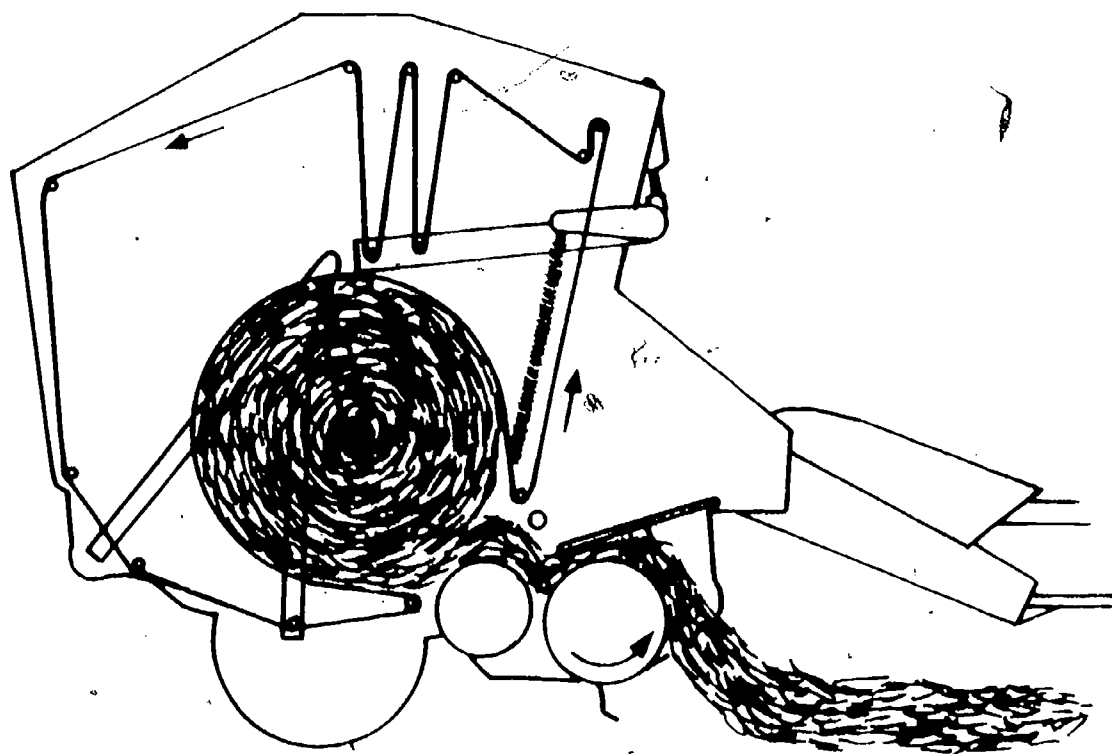

## MAKING A CHAMBER ROLLED BALE, CONT.

4. The bale is wrapped with twine when the bale size indicator shows that the bale has reached full size.

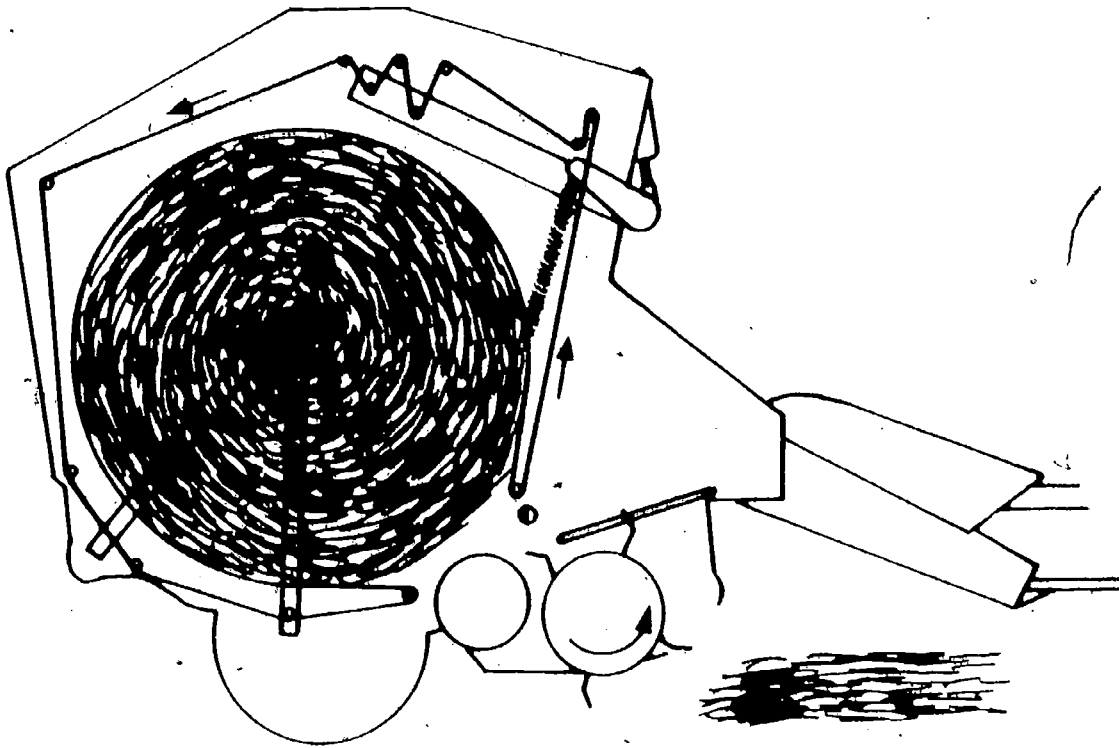

5. After the bale has been wrapped with twine, the rear gate of the machine is opened and the bale leaves the machine.

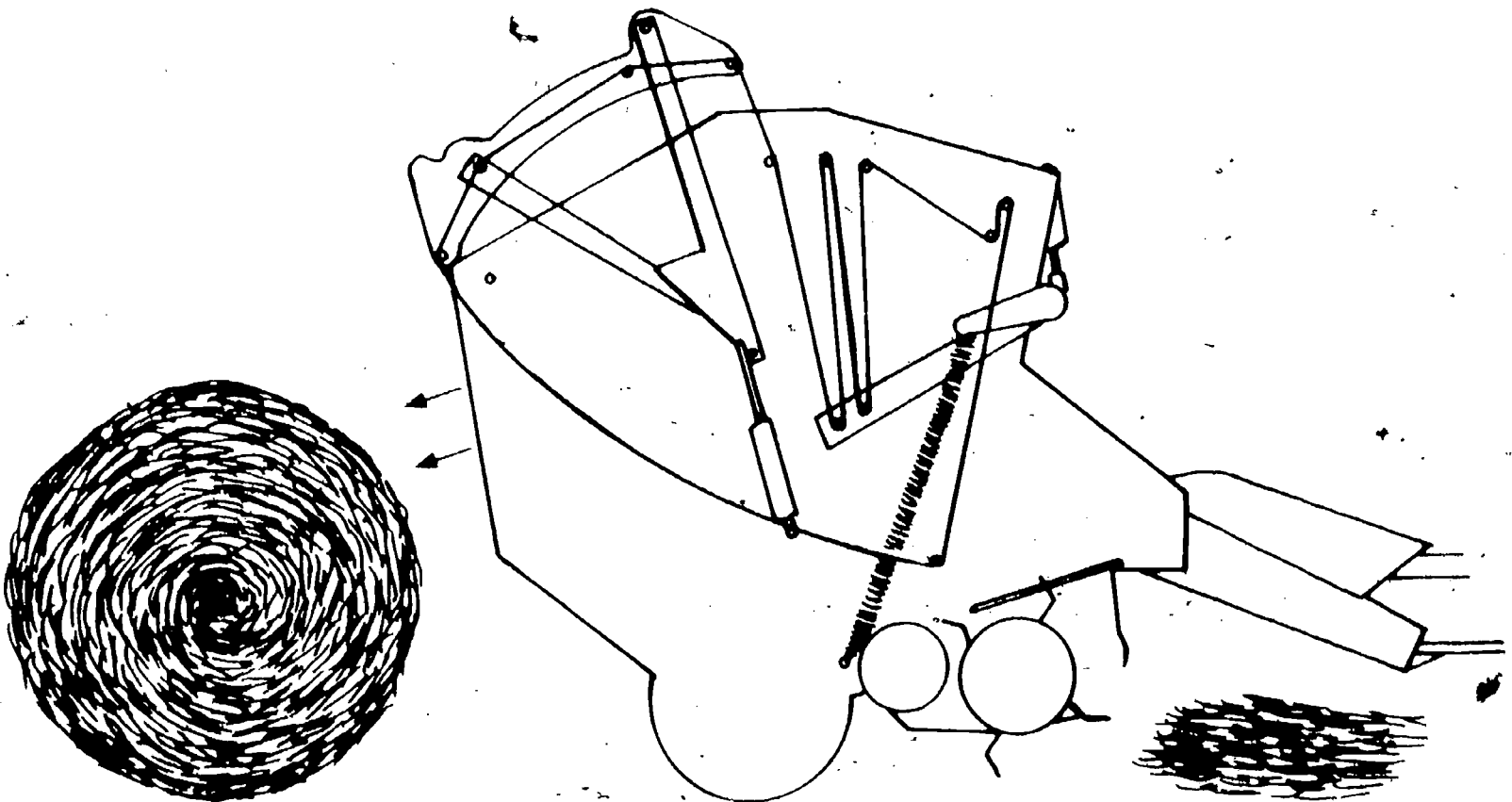

IV-E-3-37

# STACKING WAGON

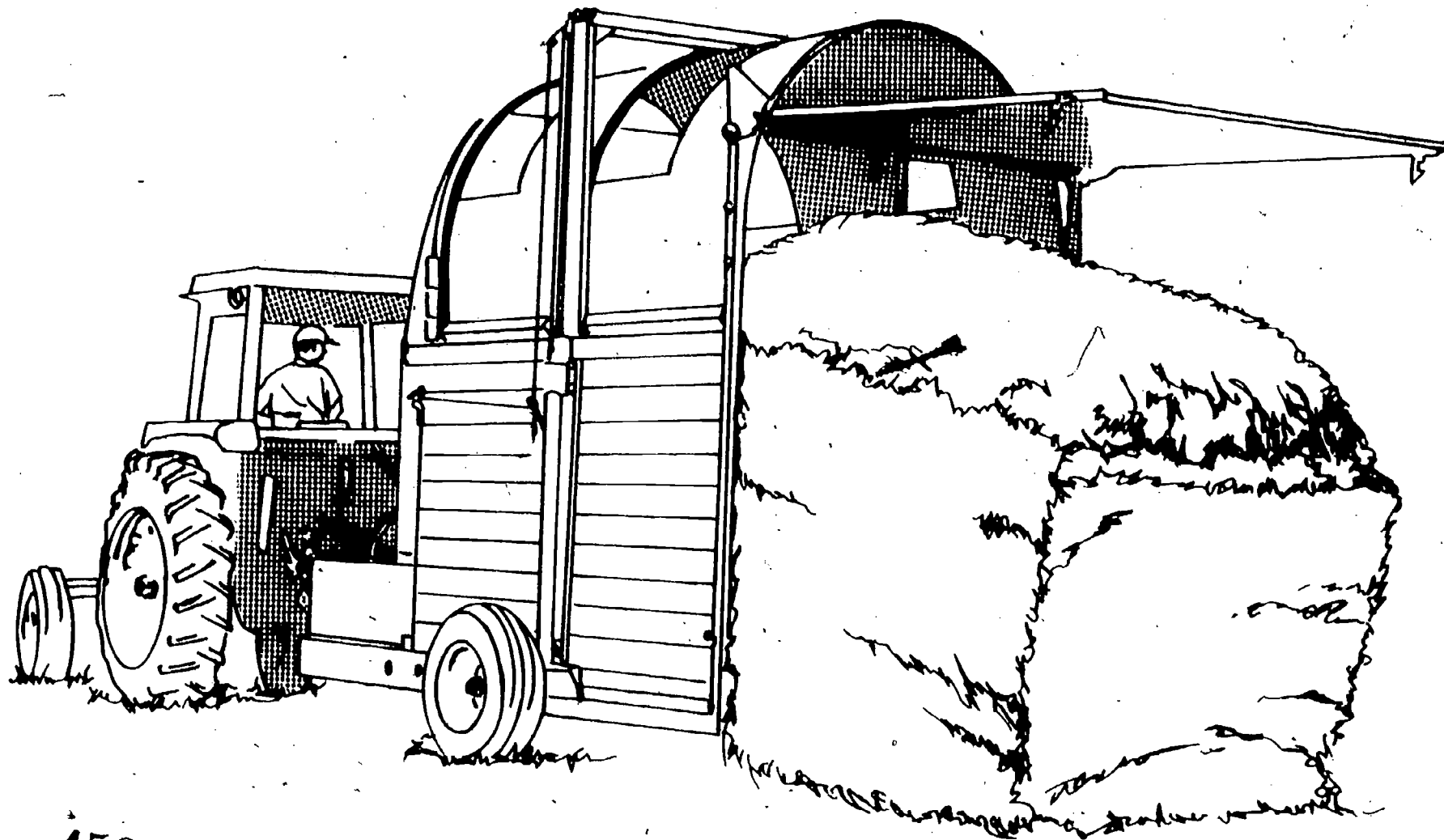

459

460

IV-E-3-38



# SILAGE HARVESTER

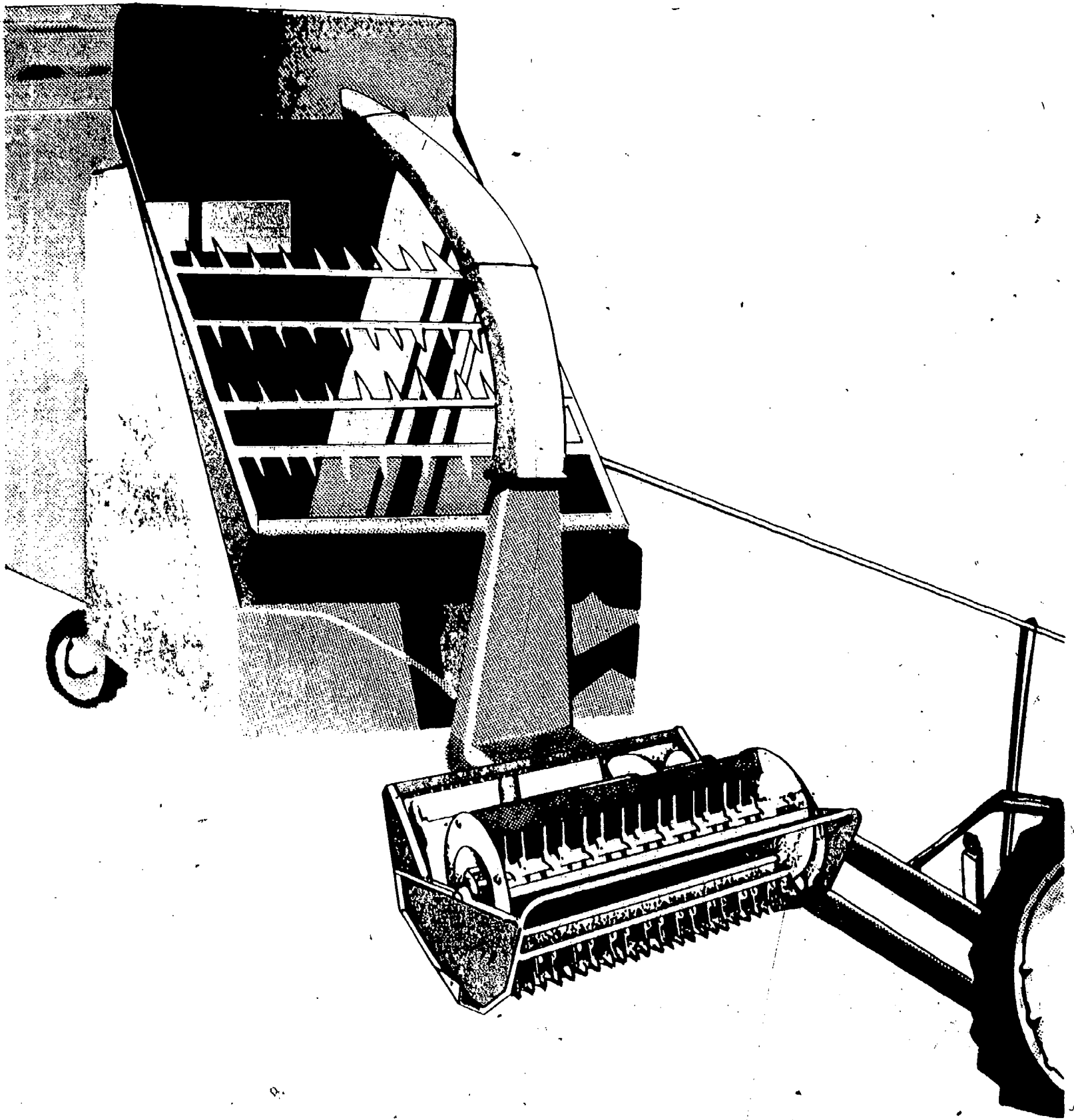

461

IV-E-3-39

# SILAGE HARVESTING HEADS

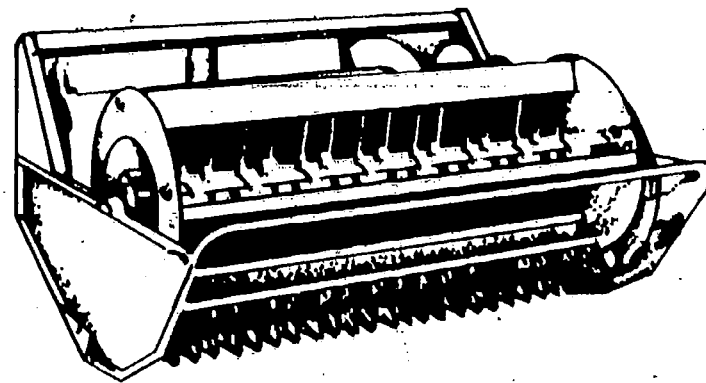

DIRECT-CUT

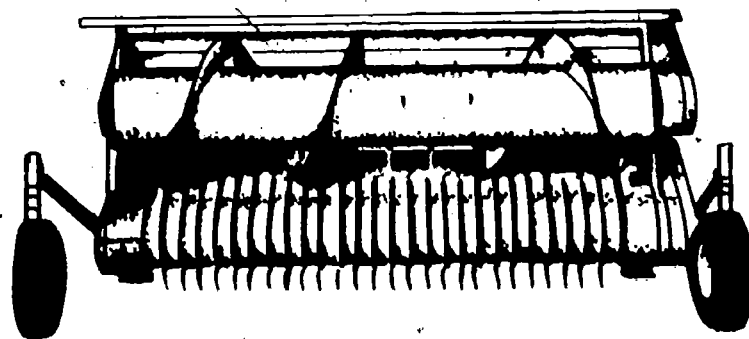

WINDROW PICKUP

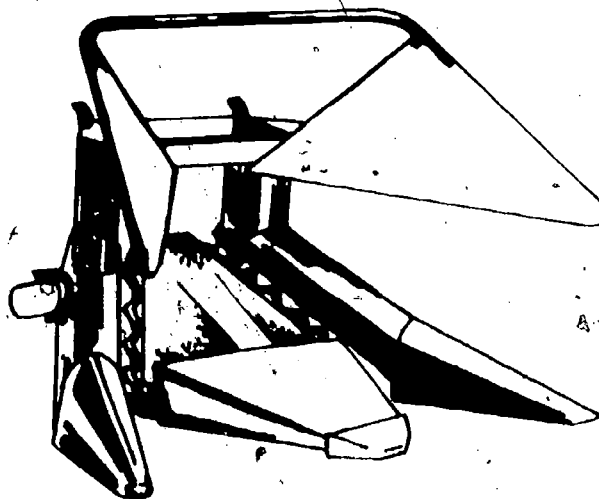

ROW CROP



**TRANSPARENCY GUIDE**  
**HARVESTING FORAGE CROPS**

- I. **Transparencies -- FACTORS TO CONSIDER WHEN HARVESTING FORAGE CROPS--FEED EFFICIENCY OF FORAGE HARVESTING METHODS**
  - A. Discuss the information included on the transparencies and their effect on forage harvesting decisions.
  - B. Have the students discuss how they determine the proper time to harvest forages.
- II. **Transparency--MOWER COMPONENTS**
  - A. Discuss the major components of the mower and their functions.
  - B. Have students list possible hazards of using a mower.
- III. **Transparency--HAY CONDITIONER COMPONENTS**
  - A. Discuss the function of a hay conditioner.
  - B. Locate the major components of the hay conditioner and explain their operation.
- IV. **Transparency--CONDITIONING ROLLS**
  - A. Describe the difference in the structure of the three rolls illustrated.
  - B. Have the students identify the different conditioning treatment each type would produce.
- V. **Transparency--RAKES**
  - A. Discuss the reasons for using a rake. Include recommended times.
  - B. Describe the different actions involved in each type of rake.
  - C. Have the students identify the advantages and disadvantages associated with each type of rake.
- VI. **Transparency--PARTS OF A RAKE**
  - A. Locate the major components of the rake, identifying their functions.

VII. Transparency--SQUARE BALER

- A. Discuss the flow of hay through the baler and the baling process.
- B. Identify the major systems of the baler and their operation.
- C. Have the students identify the advantages and disadvantages of square and round bales.

VIII. Transparencies--CHAMBER-ROLLING LARGE ROUND BALER

- A. Discuss the pros and cons of large vs. small bales.
- B. Locate the major components of the large round baler.
- C. Discuss the process involved in the making of a large round bale.

IX. Transparency--STACKING WAGONS

- A. Discuss the purpose and use of hay stacks and stack wagons.

X. Transparency--SILAGE HARVESTER

- A. Identify the major systems of the silage harvester and discuss their function and operation.
- B. Discuss the importance of chopping silage the proper length. If possible have an implement dealer demonstrate the procedure for adjusting the chopping length of a forage harvester.

XI. Transparency--SILAGE HARVESTING HEADS

- A. Describe the four stage harvesting heads and their function.
- B. Have the students identify the types of silage harvesting heads they have seen.
- C. As a class discuss the differences in mounted, pull-type and self-propelled silage harvesters.

TEACHER'S KEY  
SAMPLE TEST QUESTIONS  
HARVESTING FORAGE CROPS

PART I. True (+) - False (0)

- 0 1. Cubes and pellets have little value to commercial forage producers.
- + 2. Haylage is a form of silage.
- 0 3. Overly wet silage can limit oxygen availability to the point that bacteria will be unable to produce the desired butyric acid.
- 0 4. It is important to take a final harvest 3-6 days before the first killing frost.
- + 5. A harvest may be taken on a well established field with good drainage after the killing frost provided adequate stubble remains.
- + 6. The ensiling process kills weed seeds.

PART II. Match the terms in column 1 with the corresponding phrase in column 2.

- |                                |  |
|--------------------------------|--|
| <u>D</u> 1. Silage             | A. Produce lactic acid during the ensiling process                               |
| <u>F</u> 2. Fermentation       | B. A reddish yellow gas, smelling like bleach                                    |
| <u>A</u> 3. Anaerobic bacteria | C. Increases uniformity and speed of drying while increasing forage palatability |
| <u>G</u> 4. Aerobic bacteria   | D. Fermented forage  |
| <u>E</u> 5. Carbon dioxide     | E. May cause suffocation   |
| <u>B</u> 6. Nitrogen dioxide   | F. Process of producing carbon dioxide and alcohol from sugar                    |
| <u>C</u> 7. Conditoner         | G. Oxygen using bacteria   |
|                                | H. Cuts conditions and windrows the forage                                       |

PART III: Multiple Choice

A 1. Hay is normally

- A. 12-22% moisture
- B. 15-35% moisture
- C. 6-12% moisture
- D. 2-10% moisture

B 2. Silage having a moisture content of 60% is

- A. Haylage
- B. Wilted silage
- C. Direct-cut silage
- D. Hay

B 3. The picture is an example of a

- A. Crimper rolls
- B. Crusher rolls
- C. Crushing-crimping rolls
- D. None of the above

D 4. The arrow indicates the location of the

- A. Tension bar
- B. Feeder
- C. Needle
- D. Twine knotter

A 5. This illustration shows a

- A. Parallel-bar rake
- B. Perpendicular-bar rake
- C. Wheel rake
- D. Finger wheel rake

PART IV. Short Answer

1. List two types of silage additives.

- A. Chemical, non-nutritive
- B. Feed nutrient

2. List three factors which can affect the amount of oxygen present during the ensiling process.

- A. Moisture content of plant material
- B. Length of cut
- C. Compaction  
Distribution  
Silo construction

3. How can you help prevent spontaneous combustion of haylage?  
Store it in an oxygen limiting silo.

4. List the six major possible steps in forage harvesting.

- A. Cutting
- B. Drying
- C. Chopping
- D. Conditioning
- E. Packaging
- F. Storing

5. Regardless of the species the recommended time for harvesting a forage is normally at first flower.

6. Explain the steps involved in the ensiling process.

- The forage enters the silo with the proper moisture content.
- Aerobic bacteria grow and produce acetic acid until the oxygen supply is depleted.
- Anaerobic bacteria then begin to grow producing lactic acid until a pH of 4.0 is reached.

7. Discuss safety precautions you would take in producing silage.

(Refer to Information Sheet #3)

8. List four harvesting factors that can affect the quality of a forage product.

- A. Climate
- B. Stage of growth when cut
- C. Drying methods
- D. Storage methods

9. Compare and contrast the advantages and disadvantages of harvesting large versus small bales in this area.

# **UNIT F: Soil Science and Conservation of Natural Resources**

## **PROBLEM AREA:**

### **1. Utilizing Energy Effectively**

## UNIT F: SOIL SCIENCE AND CONSERVATION OF NATURAL RESOURCES

### PROBLEM AREA: UTILIZING ENERGY EFFECTIVELY

#### SUGGESTIONS TO THE TEACHER:

This problem area is designed for use with advanced students in vocational agriculture programs. The recommended time for teaching this problem area is between the seasonal activities in agriculture, possibly during the winter months.

The estimated instructional time for this problem area is 3 to 5 days, depending on how far the teacher wishes to go in developing students' awareness of energy conservation in the home. If the students are to be involved in other activity exercises, the instructional time will need to be increased.

The instructor is encouraged to conduct a local search to locate other supplementary materials for use with this problem area. The items in this problem area are for reference or modification as instructors adapt these materials to their local situation.

#### CREDIT SOURCES:

These materials were developed through a funding agreement, R-33-24-D-0362-466, with the Illinois State Board of Education, Department of Adult, Vocational and Technical Education, Research and Development Section, 100 North First Street, Springfield, Illinois 62777. Opinions expressed in these materials do not reflect, nor should they be construed as policy or opinion of the State Board of Education or its staff.

The teacher's guide, student worksheets, job sheets, transparency discussion guide, and sample test questions were organized by Jerry Pepple, Department of Vocational and Technical Education, University of Illinois. The student worksheets, "Home Energy Management" and "Farm Energy Management," and job sheets on "Draftometer" and "Insulation Experiment" were originally developed by the Pennsylvania State University Department of Agricultural Education and used with their permission. The worksheets, "Truck and Automobile Program" and "Feed Processing and Handling Program," were developed by the National Food and Energy Council and used with their permission.

The artwork in this problem area was prepared by the Vocational Agriculture Service, University of Illinois. Suggestions and guidance in the development of these materials were provided by the following vocational agriculture instructors:

Carl Burkybile - Rantoul High School  
William Fortschneider - Jacksonville High School



## TEACHER'S GUIDE

- I. Unit: Soil science and conservation of natural resources
- II. Problem area: Utilizing energy effectively
- III. Objectives: At the close of this problem area students will be able to:

1. Identify and measure energy losses in a house using a home energy check list.
2. Identify and explain the proper uses of home insulating materials.
3. List common types of energy used on Illinois farms and homes.
4. Develop an energy conservation program for a selected agribusiness operation.

#### IV. Suggested interest approaches:

1. Promote student interest in energy conservation by having students "brain-storm" energy sources available for Illinois homes and agribusinesses.
2. Collect newspaper articles and magazine articles dealing with environmental and energy concerns before you teach this problem area. Have at least one clipping for each student and let students draw an article from a box and then briefly inform the class about the theme of the article.
3. Identify the major consumers of energy in your community. Determine the types of energy which are used.
4. Administer an energy pre-test to students to measure their Energy Conservation I.Q.
5. Preview and show the film, "The American Experience," available from the Department of Energy. Identify important questions and issues the students should look for when viewing the film. Discuss the film with the class afterwards. This is a 30-minute film.
6. Bring in to class some sample energy conservation items. Put them on a display board and have students identify and explain their use.

#### V. Anticipated problems and concerns of students:

1. What are our major sources of energy in Illinois?
2. How does energy use affect our environment?



3. What are some agencies which are concerned with energy and its conservation?
4. What are the major consumers of energy in the United States?
5. How can I measure energy loss in my home?
6. What are some alternative energy sources available to agriculturalists?
7. What are some energy conservation practices which can be implemented in the home or business?
8. Why should I insulate my home?
9. How do I compare insulating materials?
10. How do you insulate a home?
11. What are some types of home insulation?
12. How can moisture problems be reduced when insulating a home?
13. What is gasohol?
14. How is gasohol produced?
15. To what extent is gasohol being used at the present time?

VI. Suggested learning activities and experiences:

1. Select and conduct an interest approach on energy utilization. Promote class discussion on energy and identify student problems and concerns which need solving.
2. Preview and show a film on energy utilization such as "Energy: The American Experience," 30 minutes in length, "Fuel for the Food Machine," 40 minutes in length, or "Sun Power for Farms," 12 minutes in length. During the viewing of the film, students should identify important concepts and be prepared to discuss some of the issues presented in the film.
3. Identify resources people to come to class and discuss how to determine energy rates from local utility companies, new construction techniques to make buildings more energy efficient.
4. Contact your local power company for booklets on energy conservation. Have class conduct an energy audit of a home. Have them recommend and, if possible, install the conservation materials.
5. Have students calculate their average monthly energy use and cost for their home and car.

6. Identify and define important energy conservation terms.
7. Conduct a demonstration on the proper methods of sealing around doors, windows, and other cracks in the exterior side of a house.
8. Have class construct an "Insulation Demonstration Board" and present the demonstration to various local organizations as a class or FFA activity.
9. Have class build a "Draftometer" and use the instrument to estimate energy loss in selected homes.
10. Make a bulletin board display of various insulating materials and identify them by type, use, and quality.
11. Distribute Student Worksheet, "Insulating My Home," and VAS Unit 3050, How Can I Save Money and Energy By Insulating My Home. Have students use VAS Unit as reference to complete worksheet. Discuss key points on insulating structures and homes.
12. Use selected Job Sheets included in this problem area as possible activities for students to complete on an individual or group basis.
13. Have students develop an energy conservation plan for a selected home in the community or their own home.

VII. Application procedures:

1. Skills learned in energy conservation should be applied in the student's home situation.
2. Skills learned in this problem area will aid students working in an agricultural business.
3. Skills learned in this problem area can be used to develop an FFA energy conservation program.
4. Students should apply the skills learned to complement their S.O.E.P.

VIII. Evaluation:

1. Collect and evaluate students' efforts on completing selected outside energy conservation activities.
2. Evaluate students' skill in installing selected insulation materials.
3. Administer and grade skill and laboratory identification tests.
4. Provide a written test over energy conservation.

IX. References and aids:

1. VAS Unit 3054, Energy Alternatives in Agriculture: Alcohol.  
VAS Unit 3050, How Can I Save Money and Energy By Insulating My Home, Vocational Agriculture Service, College of Agriculture, University of Illinois, 1401 South Maryland Drive, Urbana, Illinois 61801.
2. Farm Energy Analysis Program, National Food and Energy Council, 409 Vandiver West, Suite 202, Columbia, Missouri 65202.
3. Food, Energy, and Your Future, National Food and Energy Council.
4. Films:
  - a. "Energy: The American Experience," and "Sun Power for Farms," available from National Audio Visual Center, Department of Information Services, Attention, Order Section - PQ, Washington, D.C. 20409 (PH #301-763-1896). (Note: rental fee is \$30.00 for 3 days for each film.)
  - b. "Fuel for the Food Machine," Farm Film Foundation, 1425H Street Northwest, Washington, D.C. 20005. (Note: no information about rental fee or telephone number available.)
4. Audio visual materials on energy conservation:

Energy Information Library  
Illinois Department of Energy and Natural Resources  
325 West Adams Street  
Springfield, Illinois 62706  
(217) 785-2389
5. Designing an Energy--Efficient Home Landscape, Circular 1178, University of Illinois, College of Agriculture, Cooperative Extension Service. (Contact county extension office.)

COMPETENCY INVENTORY  
UTILIZING ENERGY EFFECTIVELY

1. Student has no knowledge of competency.
2. Student has read about competency.
3. Student has seen competency performed.
4. Student has performed competency.
5. Student has performed competency without supervision.
6. Student does possess skill.
7. Student does not possess skill.

Competency	Circle One						
1. Use a home energy checklist to determine home energy consumption.	1	2	3	4	5		
2. Define key terms often used with energy conservation.	1	2	3	4	5		
3. Compare R-Values of selected insulation materials.	1	2	3	4	5		
4. Repair leaking faucets and pipes.	1	2	3	4	5		
5. Weatherize doors, windows, and exterior siding.	1	2	3	4	5		
6. Select energy efficient devices for home and farm.	1	2	3	4	5		
7. Identify and discuss energy sources used on the home and farm.						6	7
8. Identify and measure energy loss.						6	7
9. Discuss methods of increasing energy efficiency at home and on the farm.						6	7
10. Lead a group discussion on increasing general energy conservation awareness.						6	7

These competencies are outlined in the National Ag. Occupations Competency Study, 1978, for entry level positions in agriculture.

Name \_\_\_\_\_

Date \_\_\_\_\_

# STUDENT WORKSHEET #1

## INSULATING MY HOME

(Refer to VAS Unit 3050, How Can I Save Money and Energy by Insulating My Home?)

1. List 4 reasons why homeowners should insulate their homes:

- a. \_\_\_\_\_
- b. \_\_\_\_\_
- c. \_\_\_\_\_
- d. \_\_\_\_\_

2. Define "R" value: \_\_\_\_\_

\_\_\_\_\_

3. How should the different insulations be compared to determine which one is the best buy? \_\_\_\_\_

\_\_\_\_\_

4. Before adding insulation first caulk and weatherstrip around \_\_\_\_\_ and \_\_\_\_\_

5. \_\_\_\_\_ air raises so insulating the \_\_\_\_\_ is extremely important.

6. Name the 4 forms of insulation and give an example of each:

Form	Example
a. _____	_____
b. _____	_____
c. _____	_____
d. _____	_____

7. List 8 commonly used insulating materials:

- a. \_\_\_\_\_
- b. \_\_\_\_\_
- c. \_\_\_\_\_
- d. \_\_\_\_\_
- e. \_\_\_\_\_
- f. \_\_\_\_\_
- g. \_\_\_\_\_
- h. \_\_\_\_\_

8. The vapor barrier should always face the side of the wall that is \_\_\_\_\_

9. \_\_\_\_\_ air can hold more water vapor than \_\_\_\_\_ air.

10. Moisture condensation on inside walls or in the insulation can be prevented by using a \_\_\_\_\_ and properly \_\_\_\_\_ your house.

11. What are 3 things that can be done to help prevent heat loss around windows?

- a. \_\_\_\_\_
- b. \_\_\_\_\_
- c. \_\_\_\_\_

12. Name 6 different sources of additional information on insulating your home:

- a. \_\_\_\_\_
- b. \_\_\_\_\_
- c. \_\_\_\_\_
- d. \_\_\_\_\_
- e. \_\_\_\_\_
- f. \_\_\_\_\_

STUDENT WORKSHEET #2  
HOME ENERGY INVENTORY

Complete the information on an assigned home. This inventory will help you evaluate and document the overall energy efficiency of a home. From this inventory you should be able to identify areas which need critical attention plus areas which are better than average.

1. Sketch an outline of the shape of the home. Include landscape features which influence energy use.

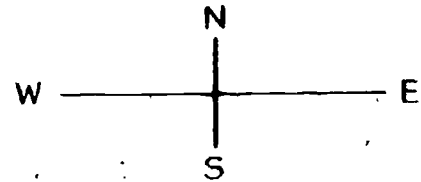

2. Identify the following characteristics of the home.

- a. Type of exterior siding: \_\_\_\_\_
- b. Number of floor levels: \_\_\_\_\_
- c. Type and color of roofing materials: \_\_\_\_\_  
\_\_\_\_\_
- d. Crawl space or basement: \_\_\_\_\_

3. Home Insulation in:

Actual

Recommended Standards

- a. ceiling \_\_\_\_\_
- b. outside walls \_\_\_\_\_
- c. floor \_\_\_\_\_

4. Are storm windows present and in good condition? \_\_\_\_\_

Type of window? \_\_\_\_\_

5. Are storm doors present on outside doorways? \_\_\_\_\_

If yes, are they insulated? \_\_\_\_\_

6. Are windows and doors caulked and weatherstripped? \_\_\_\_\_

7. Hot water heater:

- a. age \_\_\_\_\_
- b. capacity \_\_\_\_\_
- c. efficiency rating \_\_\_\_\_
- d. insulation value \_\_\_\_\_
- e. electric or gas \_\_\_\_\_
- f. recovery time \_\_\_\_\_
- g. temperature setting \_\_\_\_\_

8. Are hot water pipes insulated? \_\_\_\_\_

9. Home heating system:

- a. type of furnace (gas, electric) \_\_\_\_\_
- b. age \_\_\_\_\_
- c. capacity rating \_\_\_\_\_
- d. efficiency rating \_\_\_\_\_
- e. condition of filter \_\_\_\_\_
- f. thermostat setting \_\_\_\_\_
- g. heat ducts insulated \_\_\_\_\_



10. Attic ventilation system \_\_\_\_\_

11. Is fireplace present? \_\_\_\_\_

If yes, describe its condition and type.

\_\_\_\_\_  
\_\_\_\_\_  
\_\_\_\_\_

12. Home cooling system (fans, air-conditioning, etc.) \_\_\_\_\_

a. age \_\_\_\_\_

b. capacity \_\_\_\_\_

c. efficiency rating \_\_\_\_\_

13. Home appliance inventory: Briefly describe each major appliance.

a. refrigerator-freezer \_\_\_\_\_

\_\_\_\_\_  
\_\_\_\_\_

b. Laundry appliances \_\_\_\_\_

\_\_\_\_\_  
\_\_\_\_\_

c. Cooking appliances \_\_\_\_\_

\_\_\_\_\_  
\_\_\_\_\_

d. Other major kitchen appliances \_\_\_\_\_

\_\_\_\_\_  
\_\_\_\_\_

e. Other major home appliances \_\_\_\_\_

\_\_\_\_\_  
\_\_\_\_\_

14. After completing this inventory, review your findings and identify those items which are in most need of improvement to increase the home's energy efficiency.

Results of Survey

Recommended Standards

15. After identifying items which are in need of improvement, rank them in one of the three categories below. Then, number the order in which the improvements will be done (1, 2, 3, . . .).

Little or No  
cost improvement

Moderate  
cost improvement

Major  
cost improvement

480

STUDENT WORKSHEET #3

FARM ENERGY MANAGEMENT PROGRAM\*

Yes	No	Improvement Needed
-----	----	--------------------

FARM TRACTORS AND EQUIPMENT

- |   |                                     |                          |                          |
|---|-------------------------------------|--------------------------|--------------------------|
| 1. Select the proper tractor size to fit the operation.                         | <input checked="" type="checkbox"/> |                          |                          |
| 2. Size the equipment to match the tractor.                                     | <input type="checkbox"/>            | <input type="checkbox"/> | <input type="checkbox"/> |
| 3. Practice minimum tillage where practical.                                    | <input type="checkbox"/>            | <input type="checkbox"/> | <input type="checkbox"/> |
| 4. Follow regular maintenance and tune-ups.                                     | <input type="checkbox"/>            | <input type="checkbox"/> | <input type="checkbox"/> |
| 5. Merge small fields into large fields to reduce turning and have longer rows. | <input type="checkbox"/>            | <input type="checkbox"/> | <input type="checkbox"/> |
| 6. Keep all implements lubricated and properly adjusted.                        | <input type="checkbox"/>            | <input type="checkbox"/> | <input type="checkbox"/> |
| 7. Use tractor weights to distribute load for minimum wheel slippage.           | <input type="checkbox"/>            | <input type="checkbox"/> | <input type="checkbox"/> |
| 8. Check tire pressure.   | <input type="checkbox"/>            | <input type="checkbox"/> | <input type="checkbox"/> |
| 9. Replace faulty radiator thermostats.   | <input type="checkbox"/>            | <input type="checkbox"/> | <input type="checkbox"/> |
| 10. Keep tillage tools sharp and properly lubricated.                           | <input type="checkbox"/>            | <input type="checkbox"/> | <input type="checkbox"/> |
| 11. Avoid excessive idling and engine warm-up time.                             | <input type="checkbox"/>            | <input type="checkbox"/> | <input type="checkbox"/> |
| 12. Remove tractor wheel weights when not needed.                               | <input type="checkbox"/>            | <input type="checkbox"/> | <input type="checkbox"/> |
| 13. Use preventative maintenance.   | <input type="checkbox"/>            | <input type="checkbox"/> | <input type="checkbox"/> |

TILLAGE MANAGEMENT

- |  |                          |                          |                          |
|--|--------------------------|--------------------------|--------------------------|
| 1. Omit plowing, harrowing, disking, or cultivation where good management practices will permit. | <input type="checkbox"/> | <input type="checkbox"/> | <input type="checkbox"/> |
| 2. Don't plow quite as deep unless there is subsurface compaction.                               | <input type="checkbox"/> | <input type="checkbox"/> | <input type="checkbox"/> |
| 3. Keep plow shares sharpened.   | <input type="checkbox"/> | <input type="checkbox"/> | <input type="checkbox"/> |

	Yes	No	Improvement Needed
4. Plow when soil moisture is favorable, if possible.			
5. Plow around fields instead of inlands.			
6. Harrow fields diagonally when two passes are needed.			
7. Work the long way of the field.			
8. Have a good soil and water conservation plan.			
9. Use contour strip cropping.			
10. Combine some field operations into one.			
11. Apply liquid nitrogen and herbicides.			
12. Disk and apply pesticides.			
13. Plant and apply pesticides.			

FERTILITY MANAGEMENT

1. Use high analysis fertilizers.			
2. Use ammoniated starters to enhance early germination and reduce replanting risk.			
3. Plow down all P & K when planting clear seeded alfalfa for 3 year stands.			
4. Handle and store manure in semi-dry form.			
5. Spread manure less frequently.			
6. Plow down manure promptly.			
7. Handle less weight.			
8. Grow forage legumes.			

GRAIN DRYING

1. Use early maturing varieties.			
2. Field dry to the fullest possible extent.			



Improvement  
Needed

Yes	No	Improvement Needed
_____	_____	_____
_____	_____	_____
_____	_____	_____
_____	_____	_____
_____	_____	_____
_____	_____	_____
_____	_____	_____
_____	_____	_____
_____	_____	_____

3. Buy a good moisture tester and use it.
4. Do not overdry.
5. Clean grain to remove fines and reduce power needed to move air through grain.
6. Use as little grain depth as possible and level the top.
7. Operate dryer at optimum levels recommended by manufacturer and keep serviced properly.
8. Use dryeration process.
9. Grain preservation with organic acid.

FARM TRUCKS AND AUTOS

_____	_____	_____
_____	_____	_____
_____	_____	_____
_____	_____	_____
_____	_____	_____
_____	_____	_____

1. Carry loads to vehicle capacity. Do not overload.
2. Plan and schedule trips.
3. Follow regular maintenance programs.
4. Buy the right size vehicle properly equipped to do the job.
5. Inflate all tires to proper pressure peak.
6. Avoid excessive motor idling.

WATER HEATING

_____	_____	_____
_____	_____	_____
_____	_____	_____
_____	_____	_____
_____	_____	_____

1. Preheat incoming water with heat exchanger.
2. Drain water heater and remove lime deposits on a periodic basis.
3. Repair all leaking faucets.
4. Use automatic waterers rather than continuous flow.
5. Insulate around outside of water heater and between its base and the floor.



	Yes	No	Improvement Needed
6. Insulate hot water lines which run through unheated areas.			
7. Keep temperature setting at low level.			
8. Use hot water conservatively.			

### VENTILATION

1. Eliminate mechanical ventilation in animal housing facility wherever practical by using natural ventilation.			
2. When warm animal housing facilities are required, consider a convertible system, closed, warm, and mechanically ventilated during cold months--open and naturally ventilated during summer months.			
3. Reduce ventilation rates (cfm) to minimum levels in animal housing facilities mechanically ventilated year round and increase air circulation within the structure during hot months to compensate.			
4. Turn fans off when ventilation is not required.			
5. Select fans with a high cfm/watt rating.			
6. Clean fans and shutters frequently.			
7. Lubricate fans per manufacturer's recommendation.			
8. Keep belts tight.			
9. Check thermostats.			
10. Controls properly set to prevent over ventilation during cold weather months and wasting supplemental heat.			
11. Temperature-controlled, variable speed fans, 2-speed fans or motor-operated fan shutters to reduce fuel consumption in heated buildings.			

Improvement  
Needed

Yes

No

LIGHTING

1. Switch to lower wattage bulbs.
2. Switch incandescent to lower wattage or to lower wattage reflector bulbs.
3. Use task lighting and reduce whole area lighting.
4. Replace regular fluorescents with new GE Watt Misers.
5. Reduce total light burning hours by turning off when not in use.
6. Light dimmers used where total wattage of bulbs gives more light than needed.
7. Eliminate unnecessary dusk-to-dawn lights.

Yes	No	Improvement Needed
_____	_____	_____
_____	_____	_____
_____	_____	_____
_____	_____	_____
_____	_____	_____
_____	_____	_____
_____	_____	_____

REFRIGERATION

1. A heat exchanger coupled with a refrigerant compressor.
2. Remove half of the heat from fruits or vegetables brought from the field.
3. A multitube pre-cooler, using well water to pre-cool milk.
4. Keep compressor condensers and fans clean.

_____	_____	_____
_____	_____	_____
_____	_____	_____
_____	_____	_____

ELECTRIC MOTORS

1. Load motor with work as near as possible to its related capacity. Size motor to the job.
2. Avoid overheating.
3. Avoid letting motors run idle.
4. Start motors in sequence rather than simultaneously if there are 2 or more large motors.

_____	_____	_____
_____	_____	_____
_____	_____	_____
_____	_____	_____



	Yes	No	Improvement Needed
5. Keep motors and equipment lubricated and clean.			
6. If you are on demand billing, operate as few motors and lights at one time as practical.			
7. Install electric wiring for motors which is heavy enough gauge for minimum voltage drops.			
8. Maintain proper V-belt tension.			
9. Electrical equipment powered by motors of correct type and size.			
10. Distribution pole near center of load.			
11. All equipment supplied with correct voltage.			

\*Originally developed by: Pennsylvania State University Department of Agricultural Education, State College, Pennsylvania.





STUDENT WORKSHEET #4

HOME ENERGY MANAGEMENT PROGRAM\*

TEMPERATURE CONTROL

Do you:	Yes	No	Improvement Needed
1. Reduce daytime home heating in winter, maintaining 65°F (18°C) or lower temperature.	_____	_____	_____
2. Set air-conditioning unit to recirculate cool air instead of pulling in warmer outside air.	_____	_____	_____
3. Increase temperature setting for summer air conditioning to 78°F (26°C) or higher.	_____	_____	_____
4. Reduce nighttime winter temperature 5°-8°F (3°-5°C) or more.	_____	_____	_____
5. Use window and attic fans for cooling during summer when outside temperature is below temperature in home.	_____	_____	_____
6. Maintain heating and cooling equipment in good operating condition.	_____	_____	_____
7. Keep air filters clean to make it easier for heating and cooling system to do its job.	_____	_____	_____
8. Close off unused rooms and closets.	_____	_____	_____
9. Use kitchen and bathroom exhaust fans only when necessary.	_____	_____	_____
10. Install an exhaust fan in the attic to remove hot air in the summer.	_____	_____	_____
11. Shade windows from direct sun in summer with draperies and roll-up shades.	_____	_____	_____
12. Open draperies and raise shades to receive sun's heat in winter.	_____	_____	_____
13. Close door of attached garage in winter.	_____	_____	_____
14. Close damper when fireplace is not in use.	_____	_____	_____

Do you:	Yes	No	Improvement Needed
15. Select an energy efficient airconditioning unit the proper size for space to be cooled. It is better to buy a slightly undersized unit, rather than an oversized one.	_____	_____	_____
16. Repair leaks and insulate heating and cooling ducts in spaces not heated or cooled.	_____	_____	_____
17. Adjust radiator valves, air duct dampers, or heat registers according to activity in area.	_____	_____	_____
18. Reduce heating and cooling temperatures when away from home for long periods of time.	_____	_____	_____

SEAL AIR LEAKS

Do you:	Yes	No	Improvement Needed
1. Weather-strip doors, windows, and all movable joints.	_____	_____	_____
2. Caulk interior and exterior cracks.	_____	_____	_____
3. Seal unused doors.	_____	_____	_____
4. Cap unused flues and (or) chimneys.	_____	_____	_____
5. Install storm windows and storm doors, or	_____	_____	_____
6. Cover windows and doors with plastic.	_____	_____	_____

PROTECT HOME FROM ENVIRONMENT

Do you:	Yes	No	Improvement Needed
1. Plant or build windbreak landscape treatment.	_____	_____	_____
2. Use garage entrance where possible.	_____	_____	_____
3. Protect entrances with double-door arrangement.	_____	_____	_____



Do you:	Yes	No	Improvement Needed
4. Plant deciduous trees.	<input type="checkbox"/>	<input type="checkbox"/>	<input type="checkbox"/>
5. Install a roof overhang to protect windows.	<input type="checkbox"/>	<input type="checkbox"/>	<input type="checkbox"/>
6. Use awnings or other treatment.	<input type="checkbox"/>	<input type="checkbox"/>	<input type="checkbox"/>
7. Close windows during midday.	<input type="checkbox"/>	<input type="checkbox"/>	<input type="checkbox"/>
8. Open windows in evening.	<input type="checkbox"/>	<input checked="" type="checkbox"/>	<input type="checkbox"/>

LIGHTING

Do you:	Yes	No	Improvement Needed
1. Turn off unnecessary lights, indoors and out.	<input type="checkbox"/>	<input type="checkbox"/>	<input type="checkbox"/>
2. Reduce lighting levels to minimum for task to be performed?	<input type="checkbox"/>	<input type="checkbox"/>	<input type="checkbox"/>
3. Use bulbs with lower wattage in halls, stairways, and other areas of general illumination.	<input type="checkbox"/>	<input type="checkbox"/>	<input type="checkbox"/>
4. Use light colors in decorating to improve lighting efficiency.	<input type="checkbox"/>	<input type="checkbox"/>	<input type="checkbox"/>
5. Do tasks that require a high light level during daylight hours when possible.	<input type="checkbox"/>	<input type="checkbox"/>	<input type="checkbox"/>
6. Keep lighting fixtures clean.	<input type="checkbox"/>	<input type="checkbox"/>	<input type="checkbox"/>
7. Use fluorescent lighting for maximum light from electrical energy used.	<input type="checkbox"/>	<input type="checkbox"/>	<input type="checkbox"/>
8. Use timers to turn lights on in the evening rather than leaving lights on all day when no one is home.	<input type="checkbox"/>	<input type="checkbox"/>	<input type="checkbox"/>

HEATING WATER

Do you:	Yes	No	Improvement Needed
1. Reduce amount of hot water used.	<input type="checkbox"/>	<input type="checkbox"/>	<input type="checkbox"/>

Do you:	Yes	No	Improvement Needed
2. Insulate long hot water pipes, especially those under the home or those that go through unheated basements or crawl spaces.			
3. Repair leaky faucets.			
4. Maintain regular temperature setting of 110°-120°F (43°-49°C) on water heater if automatic dishwasher is not used; 140°F (60°C) if automatic dishwasher is used.			

LAUNDRY

Do you:	Yes	No	Needed
1. Wash only full loads of laundry.			
2. Use heated water in only the wash cycle.			
3. Use water no hotter than necessary for adequate soil removal and sanitation.			
4. Use good laundry techniques to obtain satisfactory results in one washing process.			
5. Avoid overdrying in clothes dryer.			
6. Sort dryer loads by weight.			
7. Line-dry garments and household items when practical.			
8. Use dryer efficiently. Avoid drying one or two items at one time.			
9. Vent electric dryer indoors during heating season.			
10. Remove items when dryer stops to avoid unnecessary wrinkling, which will require ironing to remove.			
11. Reduce ironing to a minimum by careful selection of garments and household linens.			

DISHWASHING

Do you:	Yes	No	Improvement Needed
1. Accumulate dishes; hold until dishwasher is filled. If dishes are hand washed, rinse and hold breakfast and lunch dishes until evening.	_____	_____	_____
2. Do not let hot water run continuously while washing or rinsing dishes.	_____	_____	_____
3. Omit dishwasher drying cycle; open the door at end of the rinse cycle.	_____	_____	_____

FOOD PRESERVATION: REFRIGERATOR, FREEZER

Do you:	Yes	No	Improvement Needed
1. Avoid opening door or holding it open unnecessarily.	_____	_____	_____
2. Keep grilles and evaporator coils clean.	_____	_____	_____
3. Locate cooling appliances away from heat sources such as range, hot air register, or direct sunlight.	_____	_____	_____
4. Defrost as needed.	_____	_____	_____
5. If cold air is leaking around door, have door adjusted or gasket replaced.	_____	_____	_____
6. Turn off, empty, clean, and leave refrigerator door open when taking an extended vacation.	_____	_____	_____

FOOD PREPARATION

Do you:	Yes	No	Improvement Needed
1. Use oven to capacity.	_____	_____	_____
2. Use cooking utensils that fit surface unit.	_____	_____	_____
3. Use tight-fitting lids on cooking utensils, when appropriate.	_____	_____	_____
4. Reduce heat to maintain necessary cooking temperature when using surface units.	_____	_____	_____

Do you:	Yes	No	Improvement Needed
5. Use small appliances for cooking if they are more efficient than a range!	_____	_____	_____
6. Preheat oven only for leavened foods. Do not preheat longer than needed to attain required temperature.	_____	_____	_____
7. Turn off oven and surface units when food is cooked.	_____	_____	_____

CLEANING AND MAINTENANCE

Do you:	Yes	No	Improvement Needed
1. Empty or replace vacuum cleaner bag frequently to keep it functioning efficiently.	_____	_____	_____
2. Use hand equipment rather than power tools when practical.	_____	_____	_____
3. Develop preventive maintenance practices. Routine check-up and servicing will prevent greater problems later.	_____	_____	_____

\*Originally developed by: Pennsylvania State University, Agricultural Education Department, State College, Pennsylvania.

STUDENT WORKSHEET #5

TRUCK AND AUTOMOBILE PROGRAM\*

FARM ENERGY ANALYSIS

Trucks and automobiles account for about 20% of all energy used in agriculture. Careful thought and conscientious efforts applied to fuel reduction concepts can pay good dividends.

No Cost Maintenance and Management Practices

Do you:	Yes	No	Improvement Needed
1. Clean out car trunks and truck beds to reduce unnecessary weight? (It takes energy to move any weight.)			
2. Keep records in your vehicles that show trips you make, and their purpose? (Use these to help you decide: "Is this trip necessary?")			
3. Plan trips carefully and combine errands as much as possible?			
4. Call implement dealers before making a trip for parts to reduce both energy and time expenditures? (Use one stop service if and where possible.)			
5. Use the most economical vehicle for errands? (If you have a choice, use an automobile instead of the truck unless you have a large load to carry.)			
6. Drive at modest speeds locally, look ahead and anticipate stops?			
7. Use engines as soon as started and shut-off when visiting? (Most vehicles do not require warm-ups.)			
8. Always load trucks properly? (While slight overloads on short runs may sometimes be justified, keep in mind that a 10% overload increases fuel consumption by about 20%.)			

Do you:	Yes	No	Improvement Needed
9. Check the tire pressure frequently (10% under-inflation can cause a 5% loss, and a 20% under-inflation can cause a 15% loss in fuel efficiency.)			
10. Check regularly for leaks in the engine's vacuum system, carburetor and fuel line?			
11. Drive at reasonably constant speeds and avoid jackrabbit starts and sudden stops?			
12. Purchase properly sized vehicles for jobs to be done?			
13. Open or remove tailgates in pickup trucks, whenever possible, to reduce wind resistance and to increase fuel efficiency?			
14. Use air conditioners only when really necessary?			
15. Consider towing a trailer to reduce number of trips when hauling bulky items?			
16. Use your 4-wheel drive vehicles only when needed for purposes designed?			

Low Cost Maintenance and Management Practices

Do you:	Yes	No	Improvement Needed
1. Replace or clean clogged, dirty air filters so that engines have maximum power and economy?			
2. Tune-up engines regularly and as needed? (A single spark plug misfiring reduces fuel use efficiency 7%; two plugs misfiring can reduce fuel use efficiency 20%. Retiming the ignition can improve fuel efficiency by 5%.)			
3. Check engine thermostat performance frequently replacing, as necessary, to assure good operating efficiency?			



Do you:	Improvement		
	Yes	No	Needed
4. Drain cooling system, flush and replace antifreeze-coolant at manufacturer's recommended intervals?	_____	_____	_____
5. Use radial tires to reduce rolling resistance and to increase fuel efficiency? (Steel belted tires can save up to 10% in fuel use over rayon bias tires.)	_____	_____	_____
6. Change oil, oil filter and lubricate chassis on a regular schedule as prescribed by manufacturer?	_____	_____	_____
7. Service automatic transmissions, including filter change and necessary adjustments, at specified intervals?	_____	_____	_____

Significant Cost Improvements/Investments

Do you or Can you	Improvement		
	Yes	No	Needed
1. Justify a truck or automobile purchase on the basis of fuel efficiency, provided all other requirements are met? (For example, can you use a diesel-fueled instead of a gasoline-fueled vehicle?)	_____	_____	_____
2. For bulky loads, such as hay or straw, build a deck over the (large) truck cab, extending the bed to haul more and reducing the number of trips? (Guard against exceeding permissible weight limits and be sure such extensions are approved in state where used.)	_____	_____	_____
3. Use a small 3-wheel motor bike for short on-farm and/or off-farm trips?	_____	_____	_____
4. Use vehicles with standard transmissions rather than automatic?	_____	_____	_____
5. Use 2-wheel drive instead of 4-wheel drive trucks?	_____	_____	_____
6. Use a smaller, lower-powered pickup than you now use?	_____	_____	_____

\*Originally developed by: National Food and Energy Council, 409 Vandiver West, Suite 202, Columbia, Missouri 65202 (314) 875-7156.

STUDENT WORKSHEET #6

FEED PROCESSING AND HANDLING PROGRAM\*

FARM ENERGY ANALYSIS

Grinding, rolling, proportioning, mixing, and handling feed ingredients are basic to feeding livestock. All require energy in substantial amounts.

No Cost Maintenance Practices

Do you:	Yes	No	Improvement Needed
1. Make certain power units (motor or tractor PTO) and driven machines are correctly aligned for minimum friction and bearing wear?	_____	_____	_____
2. Align and adjust tension on belt drives for least-friction operation?	_____	_____	_____
3. Check for excessive wear and shaft end play on a regular basis?	_____	_____	_____
4. Sharpen knives, rotate hammers, and/or adjust rollers or plates to increase capacity and greatly reduce energy consumption?	_____	_____	_____
5. Process feed to the largest particle size possible consistent with efficient feeding practices? (i.e., larger sizes for cattle than for hogs or poultry.)	_____	_____	_____
6. Practice free choice feeding, where applicable, to save the energy needed to reduce the size of feed particles?	_____	_____	_____
7. Match the correct size tractor with the grinder or hammer mill? (Such systems are most efficient when running under full load.)	_____	_____	_____
8. Empty conveyors before stopping motors to reduce load and energy requirement when restarting?	_____	_____	_____
9. Follow equipment manufacturers' recommendations concerning adjustments, maintenance and operation for minimum energy-use and maximum efficiency?	_____	_____	_____



Low Cost Maintenance Practices

Do you:	Yes	No	Improvement Needed
1. Keep chains, sprockets and bearings on conveyors well lubricated at all times?	_____	_____	_____
2. Lubricate bearings, as needed, in motor drive shafts, pulleys and gear boxes for freely operating components?	_____	_____	_____
3. Re-orient automatic grinding equipment to use gravity flow?	_____	_____	_____
4. Operate automatic equipment during off-peak hours to reduce electrical load and demand? (This is especially important if electricity is demand metered, now or in the future.)	_____	_____	_____
5. Use low capacity, low horsepower conveyors (under 1 hp) to move feed over long periods of time? (This reduces investment and electric demands.)	_____	_____	_____
6. Take steps to assure that motor size and conveyor capacity are matched to operate at rated capacity?	_____	_____	_____
7. Install controls that allow components of feeding systems to operate only when needed?	_____	_____	_____
8. Protect all electric motors against needless burnout?	_____	_____	_____
9. Operate cattle feeding system conveyors only when feed needs to be moved?	_____	_____	_____

Significant Cost Improvements/Investments

Do you or Can you	Yes	No	Improvement Needed
1. Relocate storage to take advantage of gravity flow principle? (Relocation cost can sometimes be large.)	_____	_____	_____
2. Convert present processing system to one requiring lower energy requirements? (Roller mill uses less energy than hammer mill, for instance.)	_____	_____	_____

Do you or Can you			Improvement
	Yes	No	Needed
3. Use vertical bucket elevator to replace inclined or vertical auger conveyors?	_____	_____	_____
4. Alter large, scattered feeding systems so that mobile equipment seldom, if ever, needs to go into muddy lots or through gates? (i.e., use hard surface road in front of fence line bunks.)	_____	_____	_____
5. Have feed processed commercially to avoid large investments in major improvements? (This might be especially applicable to small scale operations.)	_____	_____	_____

Major Cost Improvements/Investments

Can you:			Improvement
	Yes	No	Needed
1. Convert from large mobile feed processing operation to stationary processing facilities, perhaps using small electric motors?	_____	_____	_____
2. Consider use of 3-phase electrical service and equipment when planning new facilities, if 3-phase service is available and rates are favorable?	_____	_____	_____
3. Switch to newer motors with higher efficiency where operated for many hours per day?	_____	_____	_____
4. Use present mobile equipment more efficiently by relocating major storage facilities?	_____	_____	_____
5. Increase size of livestock or poultry operation so that unit cost of energy-conserving feed handling systems can be optimized?	_____	_____	_____

\*Originally developed by: National Food and Energy Council, 409 Vandiver West, Suite 202, Columbia, Missouri 65202 (314) 875-7156.

## STUDENT JOB SHEET

### CONSTRUCT DRAFTOMETER\*

**Objective:** To detect excessive air currents caused by improperly sealed windows and doors.

**Materials:**

1. Piece of wood 1" x 2" x 12"
2. Wood dowel 3/8" x 5"
3. Strip of plastic food wrap 5" x 10"
4. Wood glue
5. Five thumbtacks
6. Flat head wood screws 2 - #6 x 1"

**Procedure:**

1. Mark and cut the 1" x 2" x 12" piece of lumber into two pieces which are approximately 6" long.
2. Measure and drill a 3" hole through one 1" x 2" piece, one inch from the end.
3. Glue the wood dowel into the hole.
4. Fasten the two 1" x 2" pieces together with glue and wood screws.
5. After glue has dried, wrap the plastic strip around the dowel until about 4 inches of plastic wrap remain as a sail. Secure with 4 or 5 thumbtacks.
6. Hold the draftometer near the edges of doors, windows, etc., to detect air currents and areas of excessive heat loss. The lightweight plastic wrap will act like a flag and respond to the slightest air current. Excessive movement indicates poor weatherstripping and sealing.

**Conclusions:** Briefly report your findings from the use of the draftometer and make recommendations for corrections of located problem areas.

---

---

---

---

\*Originally prepared by: Pennsylvania State University - Department of Agricultural Education, State College, Pennsylvania.

# DRAFTOMETER

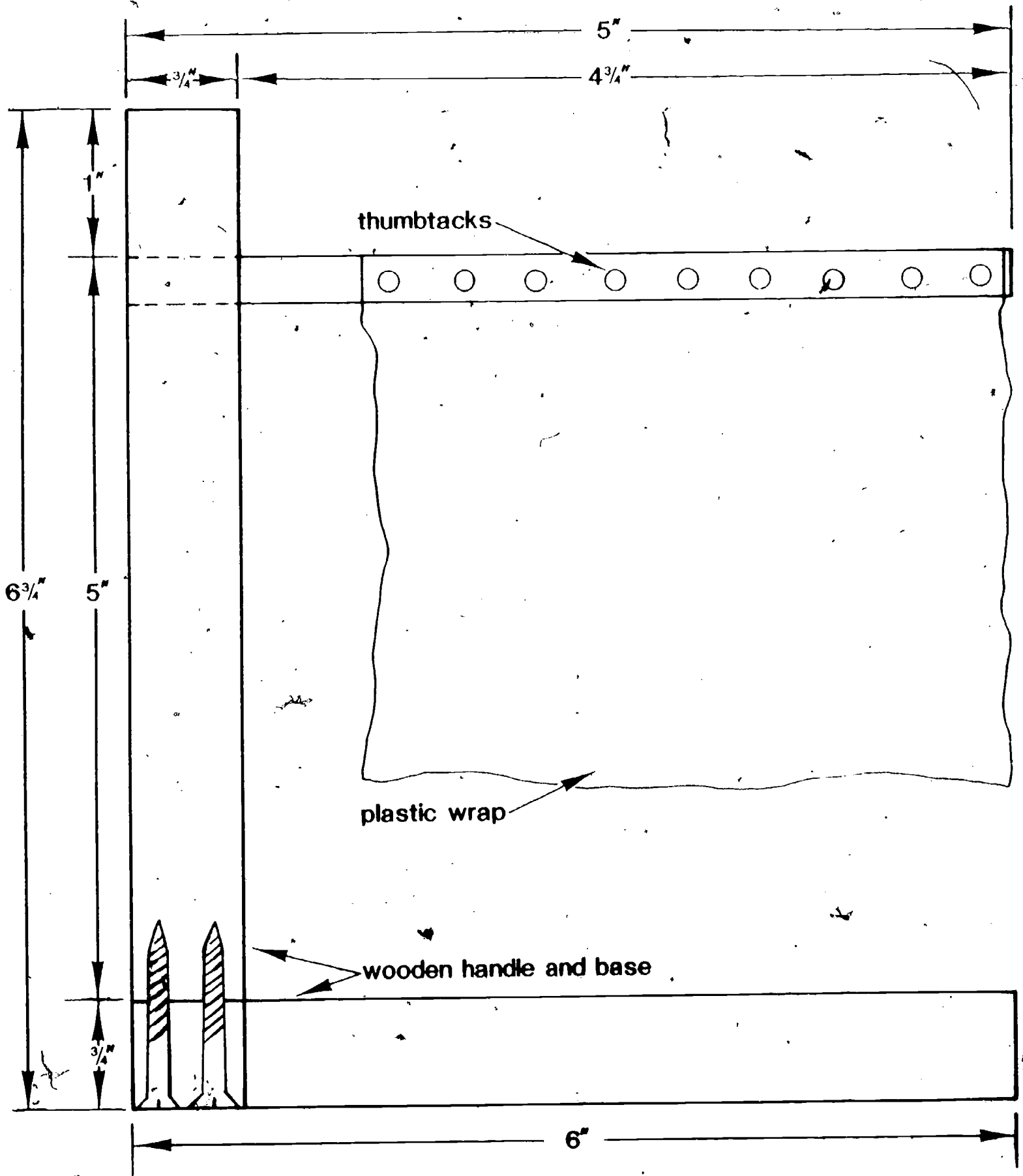

## STUDENT JOB SHEET

### INSULATION COMPARISON EXPERIMENT\*

Objective: To compare the effectiveness of various insulation materials.

- Materials:
1. One piece of plywood 3/4" x 16" x 7' for base
  2. Two pieces of pine 2" x 2" x 6' and two pieces 2" x 2" x 16" for frame of base
  3. 4 - 1/2" x 12" x 5' plywood for cubes
  4. 2 strap hinges
  5. 4 - keyless porcelain receptacles
  6. 14 - 2 NM cable with ground
  7. 1 - male electrical plug
  8. 1 - single pole switch and box
  9. 4 - 100W light bulbs
  10. 4 - corks and thermometers
  11. Various types of insulation materials such as:
    - a. glass wool
    - b. polystyrene extruded
    - c. molded boards (polystyrene)
    - d. expanded urethane

#### Procedures:

1. Measure and cut lumber to proper dimensions for base.
2. Construct base and sand smooth.
3. Cut lumber for cubes and assemble. Leave the bottom of the cubes open. Drill hole for cork and thermometer in top of each cube. Sand smooth.
4. Measure and attach electrical devices to base. Have connections checked by instructor before closing electrical devices.
5. Attach various insulating materials to insides of the cubes. Have one cube without insulation and cracks at the joints for control cube.
6. Measure temperature changes at 30 second time intervals. Caution: Do not leave the lights on for longer than 4 minutes because of the heat buildup and fire hazard.
7. Record your results and conclusions.

Conclusions: Briefly describe the results of your experiment with various insulating materials.

---

---

\*Originally prepared by: Pennsylvania State University Department of Agricultural Education, State College, Pennsylvania.

# INSULATION EXPERIMENT MODEL

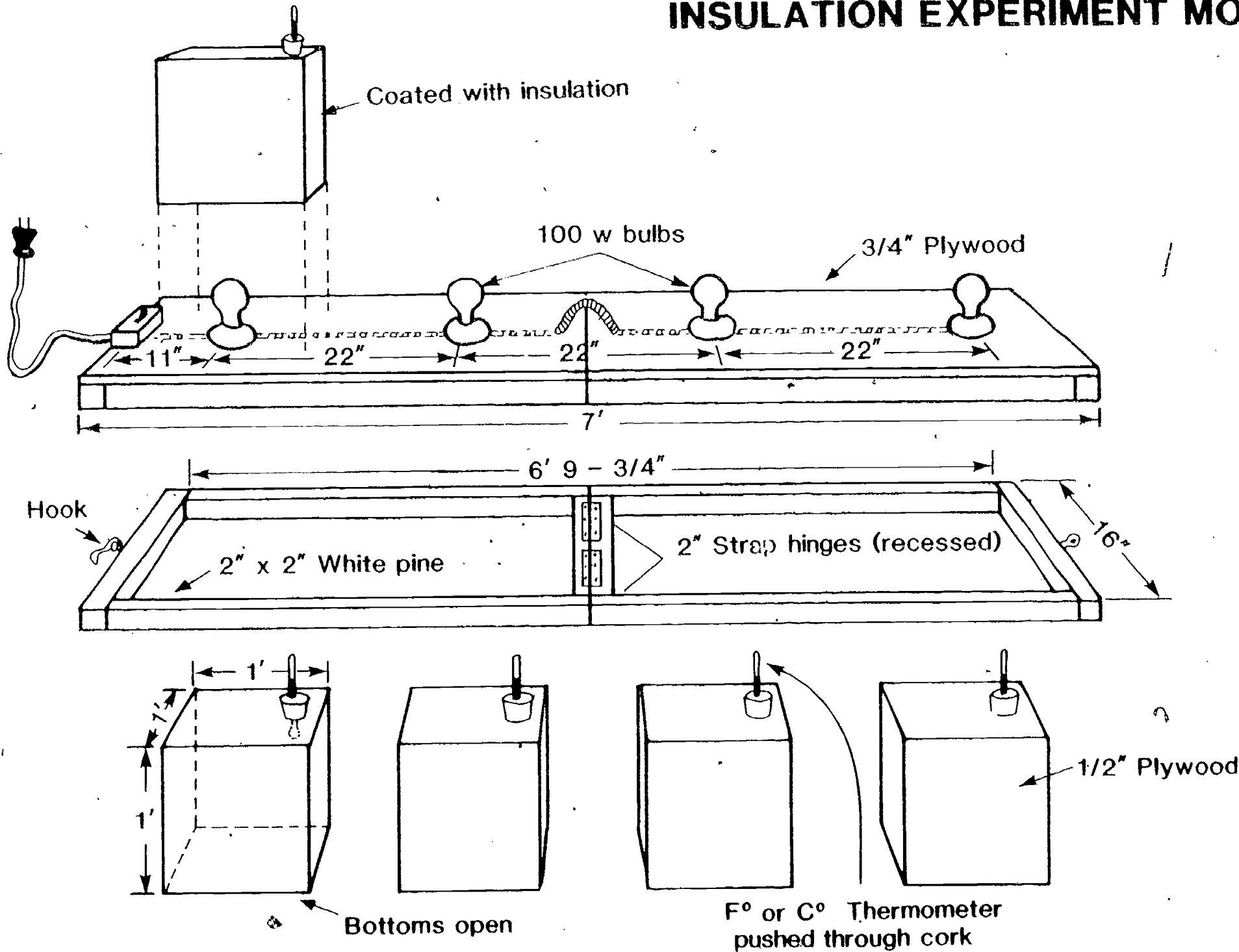

Each 1' cube is coated with different insulating materials



TEACHER'S KEY  
STUDENT WORKSHEET #1  
INSULATING MY HOME

(Refer to VAS Unit 3050, How Can I Save Money and Energy by Insulating My Home?)

1. List 4 reasons why homeowners should insulate their homes:
  - a. to save money
  - b. to increase comfort
  - c. to conserve energy
  - d. to prevent condensation
2. Define "R" value: "R" value is the ability of a material to resist the flow of heat.
3. How should the different insulations be compared to determine which one is the best buy? Compare cost per unit of "R" value.
4. Before adding insulation first caulk and weatherstrip around windows and doors.
5. Warm air rises so insulating the attic (or ceiling area) is extremely important.
6. Name the 4 forms of insulation and give an example of each:

Form	Example
a. <u>blankets (batts or rolls)</u>	<u>fiberglass</u>
b. <u>loose fill</u>	<u>cellulose or rock wool</u>
c. <u>rigid board</u>	<u>blue board, thermax, beadboard</u>
d. <u>foam</u>	<u>urea formaldehyde, polyurethane</u>

7. List 8 commonly used insulating materials:

- a. fiberglass
- b. cellulose
- c. rock wool
- d. molded polystyrene (beadboard)
- e. extruded polystyrene (Styrofoam TG or blue board)
- f. polyurethane
- g. urea formaldehyde
- h. polyisocyanurate (thermax or high-R sheathing)

8. The vapor barrier should always face the side of the wall that is heated in the winter.

9. Warm air can hold more water vapor than cold air.

10. Moisture condensation on inside walls or in the insulation can be prevented by using a vapor barrier and properly ventilating your house.

11. What are 3 things that can be done to help prevent heat loss around windows?

- a. storm windows
- b. caulk
- c. weatherstrip

12. Name 6 different sources of additional information on insulating your home:

- a. cooperative extension service
- b. agriculture teacher
- c. public utility companies
- d. Illinois Institute of Natural Resources
- e. insulation companies
- f. Internal Revenue Bureau (tax credit information)

---

## AVAILABLE FORMS OF ENERGY

**MAJOR** oil  
natural gas  
coal  
nuclear

**MINOR** water  
solar  
wind  
geothermal  
refuse / garbage

Classify the above sources of energy as **exhaustible** or **inexhaustible** and as **renewable** or **non-renewable**.

# HOME ENERGY USE

Heating and cooling dwelling

Hot water heater

Refrigerator and freezer – preserving food

Cooking food

Dishwashers

Cloths washers and dryers

Lighting

Other small appliances

507

# **REDUCING HOME ENERGY CONSUMPTION**

**Insulate home walls and ceiling**

**Weather strip doors and windows**

**Install insulated storm doors and windows**

**Clean furnace filter and service furnace regularly**

**Lower thermostat on hot water heater**

**Reduce home temperature—setting in winter and increase temperature—setting for summer**

**Repair leaking water faucets**

**Use energy efficient lighting**

**Insulate furnace ducts**

**Plan for efficient food preparation and laundering tasks**

**Use energy efficient supplementary heating units**

# RECOMMENDED MINIMUM R-VALUES BY AREA AND CLIMATE

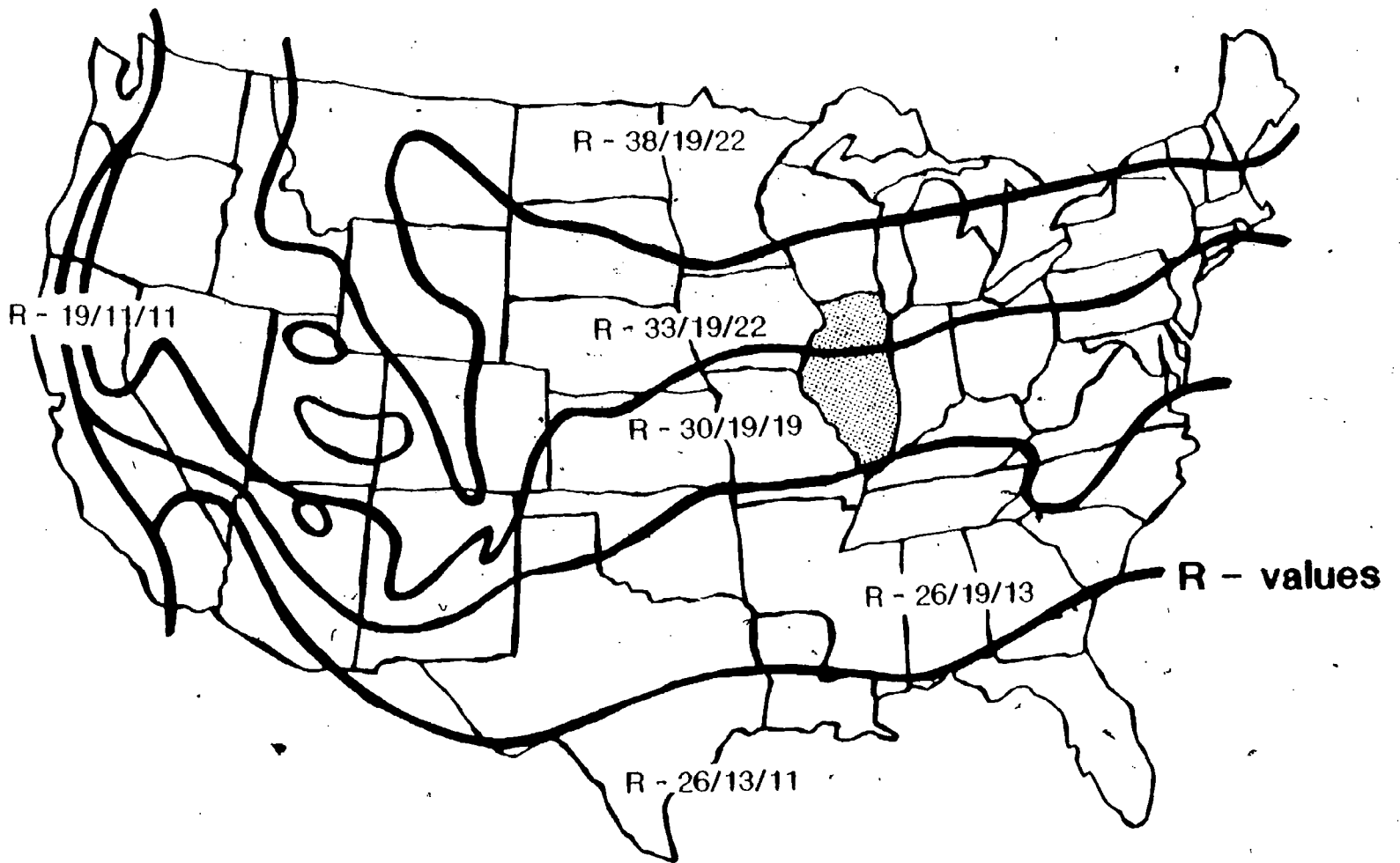

Note: R - 38/19/22  
Ceilings - R-38  
Walls - R-19  
Floor - R-22

509

# POINTS OF HEAT GAINS AND LOSS IN HOMES

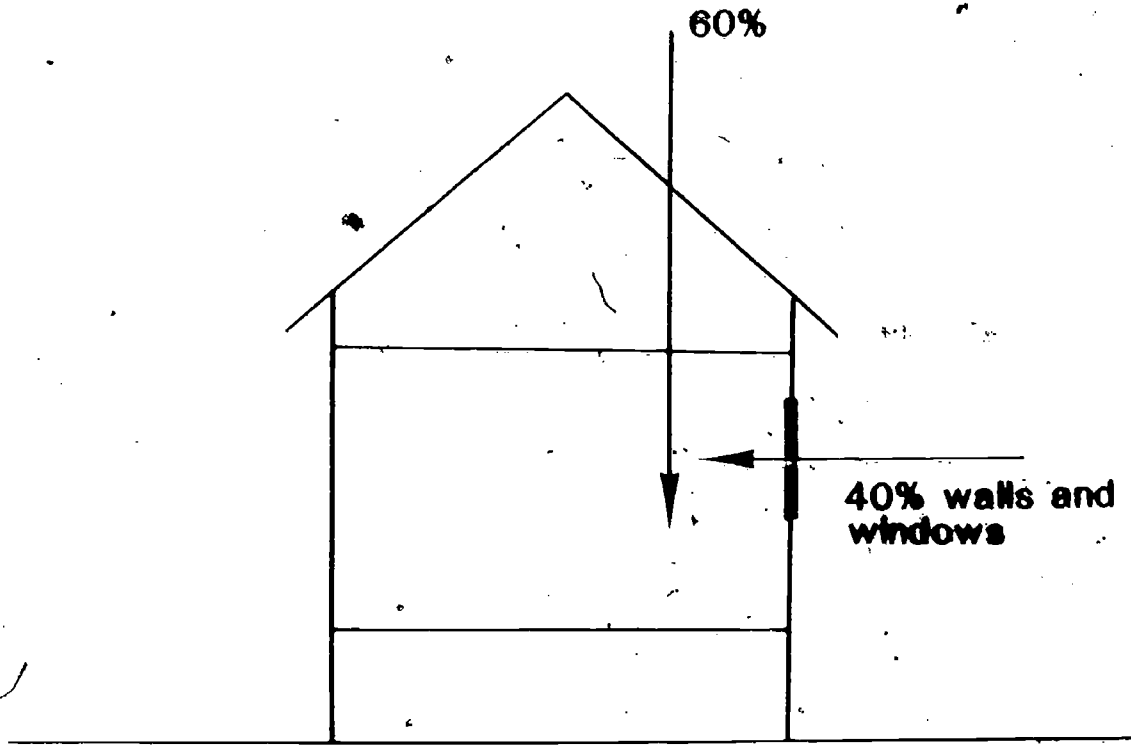

points of  
**HEAT GAIN**  
summer

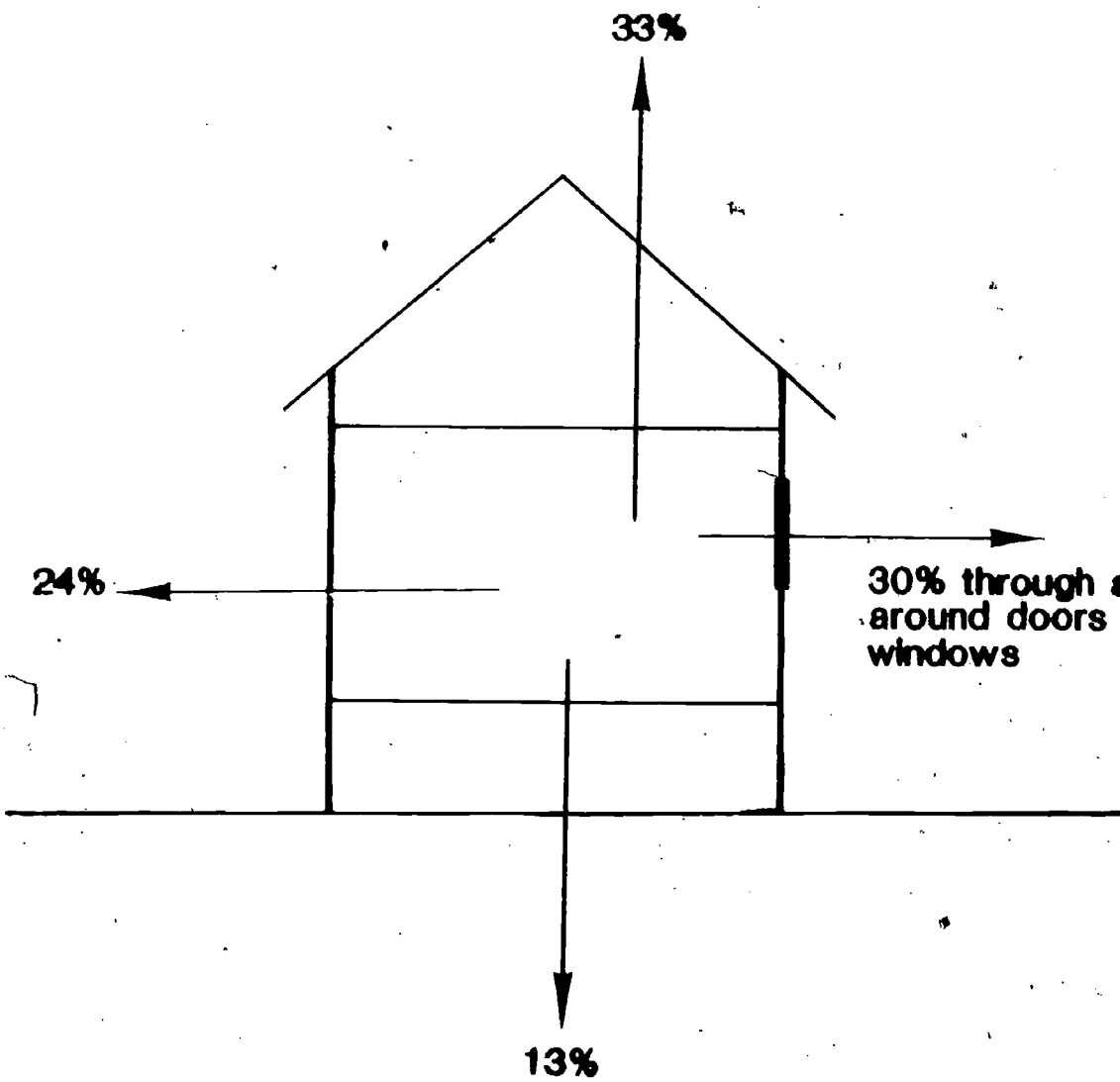

points of  
**HEAT LOSS**  
winter

TRANSPARENCY DISCUSSION GUIDE  
UTILIZING ENERGY EFFECTIVELY

Transparency--AVAILABLE FORMS OF ENERGY

- A. Have students name as many sources of energy as they can think of for home or agriculture uses.
- B. Have students classify these sources as major and minor sources in Illinois.
- C. Classify the named sources as exhaustible or inexhaustible.
- D. Classify the energy sources as renewable or non-renewable.

Transparencies--HOME ENERGY USE, REDUCING HOME ENERGY CONSUMPTION, RECOMMENDED R-VALUES, and HEAT GAINS AND LOSSES IN HOMES

- A. Review the causes or uses of home energy consumption.
- B. Have students identify methods of reducing home energy uses.
- C. Point out the average amounts of heat gain and loss in homes and how these can be controlled.



TEACHER'S KEY  
SAMPLE TEST QUESTIONS

UTILIZING ENERGY EFFECTIVELY

PART I. True (+) - False (0)

- + 1. The greatest cause of energy waste in homes is caused by inadequate insulation.
- + 2. Insulation helps maintain uniform temperatures throughout a house.
- + 3. It has been estimated that 30 percent of all energy used in the U.S. is wasted.
- 0 4. In the winter, about 45 percent of the heat loss in a home is through the walls.
- + 5. Many insulating jobs can be done by the average homeowner.
- 0 6. When installing insulation in an attic, the vapor barrier must be face up.
- 0 7. Installing foam-in-place insulation is an easy do-it-yourself operation.
- 0 8. Cold air can hold more water vapor than warm air.
- + 9. To reduce moisture problems in a home use vapor barriers and ventilation.
- 0 10. Crawl spaces do not need ventilation.

PART II. Multiple Choice (Select the most correct answer A, B, C, or D.)

- A 1. Which fossil fuel is most abundant in Illinois?
- A. coal  
B. gas  
C. geothermal  
D. oil
- D 2. The greatest energy user in the home is:
- A. hot water heater  
B. cooking  
C. electrical appliance  
D. space heating and cooling

- B 3. An important energy source which is not being utilized to a major degree is:
- A. oil
  - B. solar
  - C. coal
  - D. natural gas
- A 4. Usable energy from inside the earth's crust is called:
- A. geothermal
  - B. geometric
  - C. volcanic
  - D. geology
- D 5. According to present consumption rates, which of the following uses the most energy?
- A. transportation
  - B. commercial buildings
  - C. homes
  - D. industry
- C 6. Energy sources available from the sun are called:
- A. geothermal
  - B. nuclear
  - C. solar
  - D. volcanic
- C 7. The recommended insulation R-value for a ceiling in a house in the Central and Southern parts of Illinois is:
- A. 11
  - B. 19
  - C. 30
  - D. 48
- B 8. Most fireplaces can be a source of heat loss when:
- A. dampers are closed when not in use
  - B. using the fireplace during very cold weather
  - C. using well dried hardwoods
  - D. tempered glass doors are closed
- D 9. An attic fan will:
- A. draw out heat in the day
  - B. draw in cool air during the evening
  - C. require one square foot of free area inlet and one square foot of free area outlet for every 600 square feet of ceiling area
  - D. all of the above

D 10. Blinds and drapes can be used to save energy consumption by:

- A. keeping them open to let the sun in during sunny winter days
- B. keeping them closed to keep out the cold on cloudy winter days
- C. keeping them closed on hot summer days
- D. all of the above

PART III. Matching (Match the correct term with its definition.)

- |                                 |  |
|---------------------------------|--|
| <u>D</u> 1. Fossil fuels        | A. Material which prevents or restricts the flow of moisture                           |
| <u>H</u> 2. R-Value             | B. Energy efficient ratio, a number between 4.7 and 12.2                               |
| <u>J</u> 3. BTU                 | C. Material that reduces leakage of heat, sound, electricity                           |
| <u>F</u> 4. Condensation        | D. Fuels formed from plants and animals  |
| <u>B</u> 5. EER                 | E. Capacity for doing work   |
| <u>C</u> 6. Insulation          | F. Gas changing to a liquid as it cools  |
| <u>I</u> 7. Soft coal           | G. Wise use of energy resources  |
| <u>E</u> 8. Energy              | H. Heat resistance of a material   |
| <u>G</u> 9. Energy conservation | I. An energy resource available in Illinois  |
| <u>A</u> 10. Vapor barrier      | J. Heat required to raise the temperature of one pound of water one degree Fahrenheit. |

PART IV. Completion (Complete the statements by inserting the most appropriate word or phrase.)

1. Home insulation can generally pay for itself in 1 to 5 years.
2. Before installing insulation, first caulk and weatherstrip around doors and windows.
3. Moisture buildup can be controlled by using vapor barriers and ventilation.

4. Material used to seal cracks around door and window openings is called weatherstripping.
5. Some insulations cause skin and eye irritation, so protective clothing must be worn when handling it.
6. The roof area can generate about 60 percent of the summer heat gain in a home.
7. Space heating and cooling are the greatest energy-users in the home.
8. The recommended R-value for walls of houses in Illinois is 19.
9. A major concern of burning soft coal for energy is environmental pollution.
10. A major concern of using nuclear fission for energy is safety due to radioactive waste.

PART V. Essay (Briefly answer the following questions.)

1. Identify and discuss why homeowners should insulate their homes.

(Refer to VAS Unit 3050, Part 1)

2. Identify at least 4 sources of information on insulating a home.

(Refer to VAS Unit 3050, Part 8)

515

# **UNIT G: Horticulture**

## **PROBLEM AREA:**

### **1. Establishing and Maintaining Turf**

UNIT G

## UNIT G: HORTICULTURE

### PROBLEM AREA: ESTABLISHING AND MAINTAINING TURF

#### SUGGESTIONS TO THE TEACHER:

This problem area is designed for use with advanced students who have received instruction in basic soil and crop science. Three or more days can be devoted to this problem area in early September or in May when students have an opportunity to apply what they have learned to their home lawns or other turf areas. The amount of time spent on this problem area and the decision of whether or not to include it in a local program of instruction will depend on the needs of students enrolled in vocational agriculture. Enrollments in many schools include 50% or more of the students as non-farm students. This suggests a need for increased emphasis on non-farm problem areas.

Instruction may be divided into three main areas as follows:

1. Identifying and selecting turfgrasses.
2. Establishing a turf by seeding, sodding or through vegetative plantings.
3. Maintaining a turf including fertilizing, controlling pests, mowing, watering and controlling-thatch.

Teachers should order the subject matter units and slidefilms from Vocational Agriculture Service in advance so reference material is available for student use. School and community turf projects should be arranged and improvement projects in the areas of "Turf and Landscape Management" and "Home and Farmstead Beautification" should be encouraged as part of students' S.O.E. programs.

#### CRÉDIT SOURCES:

These materials were developed through a funding agreement, R-33-24-D-0362-466, with the Illinois State Board of Education, Department of Adult, Vocational and Technical Education, Research and Development Section, 100 North First Street, Springfield, Illinois 62777. Opinions expressed in these materials do not reflect, nor should they be construed as policy or opinion of the State Board of Education or its staff.

The teacher's guide, student worksheets, information sheets, and test questions were prepared by Paul E. Hemp, Department of Vocational and Technical Education, University of Illinois. The following teachers reviewed the original draft and made useful suggestions:

Robert Brown - LeRoy High School  
Albert Tieken - Dixon High School  
Richard Petrowich - New Athens High School

## TEACHER'S GUIDE

- I. Unit: Horticulture
- II. Problem area: Establishing and maintaining turf
- III. Objectives: At the end of this problem area students will be able to:
  1. Select the proper type, variety and mixture of grass seed for a given site.
  2. Establish a new lawn by seeding, sodding or vegetative planting.
  3. Maintain and manage an established lawn or turf area.
  4. Renovate a lawn that has deteriorated.
  5. Identify common lawn problems and recommend a treatment to solve these problems.
- IV. Suggested interest approaches:
  1. Review background experiences of students in turf management by asking the following lead questions:
    - a. "How many of you care for the lawn at home?" "What do you do?"
    - b. "Have any of you sodded or seeded a lawn?" "How did you do it?"
    - c. "How many of you take care of neighbor's lawns?" "What do you do that is different?"
  2. Ask students to identify jobs available in the turf industry on businesses which they might wish to consider for future employment. Use Student Worksheet 4 in Core I problem area "Identifying Careers in Agriculture."
  3. Discuss the level of education, training, and experience needed for entrance and advancement in turf occupations.
  4. Take a walking tour of lawns in the community to evaluate them and to identify problems.
  5. Give students a brief overview of the problem area explaining content to be covered and possible class activities to be carried out.
- V. Anticipated problems and concerns of students:
  1. What grasses should I consider for my lawn?
  2. What are some recommended varieties and species and what are their major characteristics?



3. Should I plant a single grass variety or a mixture? Why?
4. How can I use the seed tag information as a buying guide?
5. How should I prepare the soil to establish a new lawn?
6. How and at what rate should lawns be seeded?
7. What are the advantages of sodding?
8. How should sod be laid?
9. What is sprigging? When is it used?
10. When is the best time to start a lawn?
11. How should I care for a new lawn?
12. What insects affect grass and how can they be prevented or controlled?
13. What diseases affect grass and how can they be prevented or controlled?
14. What is "thatch"?
15. How should the following maintenance practices be carried out?
  - a. Mowing
  - b. Fertilizing
  - c. Watering
  - d. Controlling lawn pests
16. What tools and equipment do I need to maintain my lawn?
17. How should these tools and equipment be maintained and used?
18. What is "aeration"? Why is it important?
19. What weeds affect lawns and how can they be controlled?
20. How should the lawn be watered? How often and how much water is needed?
21. What steps should be taken to renovate a poor lawn?

VI. Suggested learning activities and experiences:

1. Conduct an interest approach to review the kinds and types of experiences students have had and to stimulate interest in lawns and turf.
2. Explain to the class that a study of turf can lead to employment training for the turfgrass industry.



3. Relate instruction to possible S.O.E. projects and FFA award programs. Explain to students how they can use this instruction to expand their S.O.E. programs.
4. Establish instructional objectives for the problem area. Have class state these objectives in terms of (a) the characteristics of a good lawn, (b) learning outcomes stated as competencies or skills or as (c) reasons why the study of turf establishment and maintenance is important to students.
5. Lead class in a problem identification exercise. Have students identify problems and concerns in the following areas:
  - a. Seeding a new lawn
  - b. Sodding a lawn
  - c. Maintaining a lawn

Add additional problems on vegetative planting and other areas which students do not identify.

6. Use VAS Units 5008, 5015 and 5016 as references for students to read to find answers and solutions to problems and concerns. Supervised study may be conducted as an individualized activity or as a group effort.
7. Show VAS Slidefilms F650, F651a, and F652 to bring out information needed to answer questions.
8. Have each student bring in a lawn tool or piece of equipment and explain to the class how it should be used and maintained.
9. Bring in seed tags or photocopy an example of a seed tag to use in teaching students how to interpret the information provided.
10. Conduct seed germination tests on different kinds of grasses to illustrate differences in germination period. Use laboratory exercise included with this problem area.
11. Demonstrate weed control on test plots, individual lawns, flats or other demonstration areas using recommended chemical methods in a split-plot design.
12. Plan a school demonstration plot to illustrate the effects of various fertilizer or chemical treatments. Use laboratory exercise included with this problem area.
13. Conduct a walking tour of turf areas in the community to identify turf problems. Have students identify problems and recommend control procedures.
14. Visit a golf course and ask the golf course superintendent to explain how turf is maintained.

15. Have students develop a list of new terms used in this problem area. Review definitions of these terms with the entire class. The new terms might include the following:

- a. aerification
- b. thatch
- c. sprigging
- d. renovation
- e. purity
- f. rhizome
- g. rootbound sod
- h. plugging

VII. Application procedures:

1. Students should be encouraged to start an improvement project using one of the FFA Foundation record books available from Vocational Agriculture Service.
2. Students should survey their lawns at home to identify needs and to develop a plan for lawn improvement.
3. Students who are interested in pursuing turf management as a possible employment area should be encouraged to apply for part-time work and to consider further education in this area at a community college.

VIII. Evaluation:

1. Construct and administer a test using sample questions included with this problem area.
2. Conduct an identification test covering one or more of the following areas:
  - a. Weeds
  - b. Insects
  - c. Diseases
  - d. Lawn tools
  - e. Seeds

IX. References and aids

The following materials are available from Vocational Agriculture Service, University of Illinois, Urbana, Illinois.

1. VAS Unit 5008 "Establishing a Lawn".
2. VAS Unit 5015 "Turfgrass Diseases and their Control".
3. VAS Unit 5016 "Identifying and Controlling Lawn Insects".
4. VAS Slidefilm F650 "Lawn Weeds - Identification and Control".

5. VAS Slidefilm F651a "Steps to a Better Lawn".
6. VAS Slidefilm F652 "Identifying Illinois Turfgrasses.
7. VAS Study Guides G650, G651, and G652 to be used with slidefilms.
8. Illinois Pesticide Applicator Training Manual - Turfgrass, Special Publication 39-1 published by the Cooperative Extension Service, University of Illinois.
9. Turfgrass Pest Control, Circular 1076, Cooperative Extension Service, University of Illinois.
10. Lawn Diseases in the Midwest, North Central Regional Extension Publication No. 12.
11. Illinois Lawn Care and Establishment, Circular 1082, Cooperative Extension Service, University of Illinois.
12. Turfgrasses of Illinois, Circular 1105, Cooperative Extension Service, University of Illinois.

# TURFGRASS DISEASES I

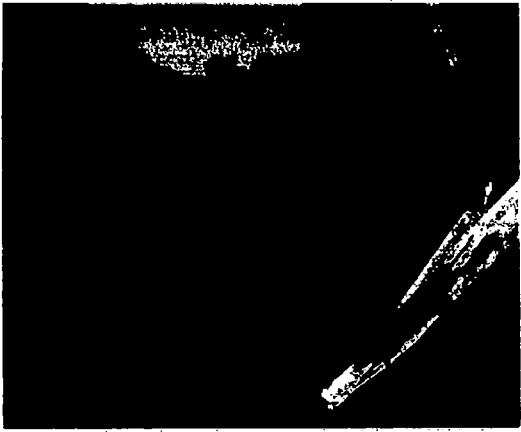

1. Helminthosporium melting-out and leaf spot



2. Stripe Smut

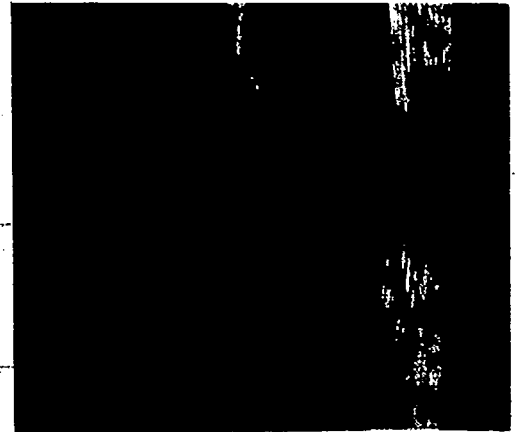

3. Rust



4. Sclerotinia dollar spot



5. Rhizoctonia brown patch, yellow patch, and seedling blight



6. Fusarium blight

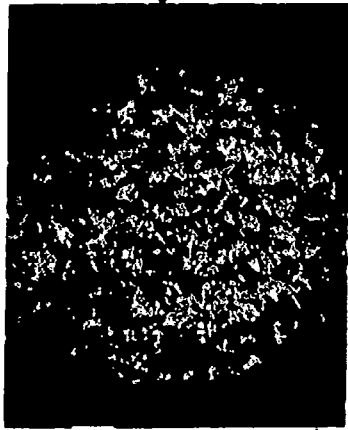

7. Fusarium patch



8. Typhula blight

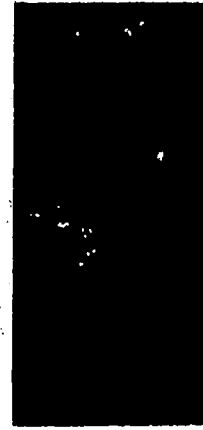

9. Pythium blight



10. Powdery mildew



11. Fairy rings



12. Red thread and pink patch



13. Slime molds



14. Dog injury

## TURFGRASS DISEASES I

- 1. Helminthosporium Melting-out and Leaf Spot** diseases are caused by a dozen or more species of the fungus *Helminthosporium*. Dark brown, reddish brown to purplish black or olive-green spots form in leaves and sheaths. The leaf lesions enlarge and develop white-gray or tan centers with a dark margin. Girdled leaves die and drop off. The turf thins and develops a yellow or brownish cast. Irregular areas may die when the stem and root tissues decay. These diseases are favored by alternating dry and wet periods, close mowing, low or excessive nitrogen fertilization, a thick thatch, frequent light sprinklings, and growing susceptible cultivars.
- 2. Stripe Smut** is caused by the fungus *Ustilago striiformis*. Pale green plants develop long gray streaks that rupture to release masses of black spores. Infected leaves later twist, shred, and die. Patches of smutted plants die during summer droughts. Smut is favored by excess thatch, frequent irrigations, and growing susceptible cultivars.
- 3. Rust** diseases are caused by about a dozen species of the fungus *Puccinia*. Yellow, orange or reddish brown, dusty pustules form in leaves and sheaths of grass that is growing very slowly. Heavily rusted grass appears yellow, thin, weak, and is more susceptible to drought, weed invasion, winter-kill, and other damage.
- 4. Sclerotinia Dollar Spot** is caused by the fungus *Sclerotinia homocarpa*. Roundish, straw-colored spots, up to 2½ inches across, appear on closely cut bentgrass. On lawn-type turf, the spots are 3 to 8 inches in diameter. If unchecked, large, irregular, sunken areas may develop. Tan lesions with a reddish-brown border form on leaves at the margins of affected patches. A white mold grows over leaves in moisture-saturated air. Dollar spot is favored by excess thatch and very low levels of nitrogen and potassium fertilization.
- 5. Rhizoctonia Brown Patch, Yellow Patch, and Seedling Blight** is caused by several species of the fungus *Rhizoctonia*. Roughly circular, light brown patches of thinned grass, up to 2 or 3 feet across, appear in hot, wet weather on closely cut bentgrass. A grayish black ring of blighted grass may border the margin. On most other turfgrasses the roundish patches are up to 2 feet across. The turf is thinned or killed when the crowns and roots decay. Yellow patch appears in cool-to-cold weather as yellow, tan, or straw-colored rings, up to 2 feet across, with "healthy" grass in the center. *Rhizoctonia* and other fungi often cause seedling blight in patches. Seedlings may wilt, collapse, and die (damp-off), resulting in bare areas or thin turf. These diseases are favored by poorly drained soils, excessive moisture, nitrogen fertilization and shade.
- 6. Fusarium Blight** is incited by *Fusarium roseum*, *F. tricinctum* and several stress factors. Straw-colored circles, crescents, or streaks, up to about 2 feet across, usually with healthy grass in the center, attack Kentucky bluegrass during hot, humid, droughty weather. The disease is favored by a thick thatch, close mowing, lack of water, nematode damage to the roots, a heavy compacted soil, excessive nitrogen fertilization in hot weather, and growing susceptible cultivars.
- 7. Fusarium Patch (Pink Snow Mold)**, caused by the fungus *Fusarium nivale* (*Gerlachia nivalis*), usually appears at the edge of melting snow. Round, bleached-tan to whitish gray or reddish brown spots, up to about 8 to 12 inches across, may merge to kill large irregular areas. A dense, white to pale pink mold covers the margin in wet weather. The mold disappears as the grass blades dry. Fusarium patch is favored by excessive shade, poor air circulation, a thick thatch, and a deep snow cover or abundant moisture for prolonged periods.
- 8. Typhula Blight (Gray Snow Mold)**, caused by several species of the fungus *Typhula*, occurs at the edge of melting snow. Roundish, grayish white to straw-colored areas, up to about 2 feet across, may merge to form large, irregular areas. The wet grass is briefly covered with a white-gray mold that may appear as a silvery, membranous crust. Numerous, minute, yellow then dark brown sclerotia form on the grass leaves and crowns. Typhula blight is favored by the same conditions as Fusarium patch.
- 9. Pythium Blight (Grease Spot, Spot Blight and Cottony Blight)**, caused by several species of the fungus *Pythium*, is active during very wet weather in spring, summer and fall. Roundish, dark, "greasy" to slimy patches of matted grass, up to 6 to 12 inches across, suddenly appear. The patches fade from reddish brown to light brown as the grass dries. Pythium blight may appear in golf greens as streaks that follow water drainage or mowing patterns. White to straw-colored spots without a reddish brown border form in the grass blades causing them to twist, collapse, and die. A whitish, cobwebby mold may cover blighted grass in moisture-saturated air. Pythium blight is favored by excessive thatch or shade, lush dense grass, abundant moisture, poor air circulation, and a heavy compacted soil.
- 10. Powdery Mildew** is caused by the fungus *Erysiphe graminis*. Superficial, white to grayish patches of mold develop on leaves and sheaths. The turf appears dull white (as if dusted with flour), thin, and weak. The leaves may later turn yellow, wither, and die. Mildew is most serious on Kentucky bluegrass growing in moderate to dense shade.
- 11. Fairy Rings** are caused by a number of soil-borne fungi. Circles, arcs, or crescents of dark green, fast-growing grass, often with a ring of thin, wilting, or dead turf inside or outside, form in turf. Most rings are up to 15 feet in diameter with some being 50 feet or more across. Mushrooms (toadstools) or puffballs appear in the outer ring of dark green grass of some rings following heavy rains or watering. Fairy rings are favored by buried organic matter and a thick thatch.
- 12. Red Thread and Pink Patch** are caused by several fungi that infect turfgrasses during prolonged, cool-to-warm weather in very humid areas. Round to irregular, light tan to pinkish patches develop that are 2 to 12 inches across. The spots may merge to form large, irregular, bleached-tan or yellowish areas with a reddish brown cast. Bright coral-pink to blood-red "threads," up to ¼ inch or longer, commonly protrude from the leaf tips and sheaths. The threads are gelatinous at first but later dry and become brittle. This disease is favored by slow-growing, nitrogen- and calcium-deficient turfgrass, excessive thatch, lack of water, and weakening by other stresses.
- 13. Slime Molds**, caused by several soil-borne fungi, suddenly appear on grass, other low-lying vegetation or objects during wet weather or following deep watering. The slimy masses, up to about a foot across, are watery-white, gray, cream, or black. They soon dry to form bluish, bluish gray, grayish white, black, creamy yellow, orange, or purple-brown spore masses that are easily wiped off leaving the blades beneath a healthy green or somewhat yellow. Slime molds are favored by dense, lush, well-watered grass and excessive thatch.
- 14. Dog Injury** is seen as roundish, straw-colored or brown areas, up to 2 feet across, usually bordered by a ring of darker green grass.

For chemical and cultural control suggestions, a listing of resistant turfgrass cultivars and other information, consult the Extension Plant Pathologist at your land-grant university, or your county extension office.

Photo credits: D. H. Scott (1L, 5C, 12), Purdue University (1R, 3R, 4R), University of Illinois (2L, 4C, 5L, 5R, 6, 7, 8, 9, 13R, 14), W. A. Meyer (2R), C. T. Schiller (3L), T. M. Sjulin (4L, 10), T. H. Bowyer (11), and Noel Jackson (13L).

The Illinois Vocational Agriculture Service provides equal opportunities in programs and employment.

## INFORMATION SHEET #1

### SUGGESTED TURFGRASSES AND WEEDS FOR IDENTIFICATION

#### Turfgrasses

1. Kentucky Bluegrass
2. Annual Bluegrass
3. Creeping Bentgrass
4. Red Top
5. Perennial Ryegrass
6. Annual Ryegrass
7. Tall Fescue
8. Bermuda Grass
9. Red Fescue
10. Zoysiagrass

#### Weeds

1. Crabgrass
2. Goosegrass
3. Yellow Foxtail
4. Red Sorrel
5. Nimblewill
6. Yellow Rocket
7. Quackgrass
8. Nutsedge
9. Broadleaved Plantain
10. Buckhorn
11. Dandelion
12. Chickory
13. Bull Thistle
14. Prostrate Spurge
15. Curled Dock
16. Henbit
17. Roundleaved Mallow
18. White clover
19. Mouseear Chickweed
20. Common Chickweed
21. Knotweed
22. Purslane
23. Ground Ivy



INFORMATION SHEET #2  
APPROVED PRACTICES FOR LAWN CARE

Mowing

1. Mow in a different direction each time the lawn is mowed to prevent "grain" which is a streaked appearance.
2. Mow bluegrasses to a height of 2 inches or higher.
3. Mow bentgrass and zoysia grass to a height of 1/2 to 3/4 inches.
4. Mow established lawns as soon as grass height is 1/2 inch above the cutting height.
5. Mow lawns when grass is dry and when soil is not subject to excessive compaction.
6. Keep mower blades sharp to produce a clean cut.

Watering

1. Apply enough water to penetrate soil to a depth of 6-8 inches. Frequent, light waterings are not recommended.
2. Use an empty coffee can or other receptacle placed near the sprinkler to measure the amount of water applied. One to two inches of applied water is required to moisten most soils to a depth of six to eight inches.

Fertilizing

1. Fertilize the lawn four times a year in April, June, August and September.
2. Use a "complete" fertilizer for the April and September applications. A nitrogen-only fertilizer such as 33-0-0 can be used in June and August.
3. Avoid early spring fertilization which forces top growth at the expense of root development. Avoid fertilization in mid-fall or later to allow grass to harden-off naturally and reduce the possibility of cold-weather injury.
4. For most varieties of bluegrass apply four to six pounds of nitrogen per 1000 square feet per year.
5. Apply fertilizer uniformly and avoid misses.
6. Avoid applying excessive amounts of fertilizer when starting, stopping or turning the spreader.

7. Apply fertilizer to dry grass, then water in immediately to wash the plant foliage.

### Controlling Pests

1. Follow a sound lawn management program to minimize weed problems.
2. Use a recommended herbicide application program to control broad-leaf weeds and crabgrass.
3. Use a recommended insecticide application program to control sod webworm and white grubs.
4. When thatch develops to a thickness of one-half inch or more, remove with a vertical mower or power rake.



## STUDENT WORKSHEET #1

### INTERPRETING INFORMATION ON FERTILIZER BAG LABELS

#### Fertilizer Bag #1

1. What is the analysis of this fertilizer?
2. This fertilizer has \_\_\_\_\_ percent available nitrogen.
3. What form of phosphorus is represented in the analysis?
4. How many pounds of this fertilizer should be added per 1000 square feet of new lawn?
5. What company produces this fertilizer?

#### Fertilizer Bag #2

1. This fertilizer has \_\_\_\_\_ percent available phosphorus.
2. Name 3 weeds that can be controlled with this Weed and Feed mixture.
3. When are weeds easiest to kill with this product?
4. When would you apply this fertilizer to your lawn?

5. Should you allow this product to drift on to desirable plants, shrubs or flowers?

6. Should you use Weed and Feed on the garden? Why?

Fertilizer Bag, #3

1. This fertilizer has \_\_\_\_\_ percent available potassium.

2. What form of potassium is represented in the analysis of this fertilizer?

3. What is the potential acidity of this fertilizer?

4. What rate of application would you use on a new lawn?

STUDENT WORKSHEET #2  
INTERPRETING GRASS SEED LABELS

A sack of grass seed mixture has a tag attached to the sack with the following information

CONTENTS

51.57%	Kentucky Bluegrass	80% germination
35.23%	Creeping Red Fescue	80% germination
10.22%	Chewings Fescue	85% germination

OTHER INGREDIENTS

2.89%	Inert Matter
.09%	Weeds
	No Noxious Weeds

Net Weight - 100 lbs.

1. How many pounds of each grass would germinate under ideal conditions?
2. Assuming that only 50% of the viable seed will germinate under field conditions, how many lbs. of seed from this 100# sack will actually germinate in your lawn?

STUDENT WORKSHEET #8

LAWN GRASS STUDY

1. Common name \_\_\_\_\_

2. History \_\_\_\_\_

3. Habitat \_\_\_\_\_

4. Distribution \_\_\_\_\_

5. Varieties \_\_\_\_\_

6. Desirable Characteristics

Undesirable Characteristics

\_\_\_\_\_

\_\_\_\_\_

\_\_\_\_\_

\_\_\_\_\_

\_\_\_\_\_

\_\_\_\_\_

\_\_\_\_\_

\_\_\_\_\_

\_\_\_\_\_

\_\_\_\_\_

\_\_\_\_\_

\_\_\_\_\_

\_\_\_\_\_

\_\_\_\_\_

\_\_\_\_\_

\_\_\_\_\_



STUDENT JOB SHEET #1  
GERMINATION OF GRASS SEEDS

Purposes

1. To ascertain the germination period of different grasses.
2. To observe how pre-soaking grass seed affects germination rate.

Materials

1. Seed flats or milk cartons
2. Sterile soil mix
3. Approximately one tablespoon of annual ryegrass, Kentucky bluegrass, red fescue and three tablespoons of Merion bluegrass.

Procedures

1. Soak two samples of Merion bluegrass in water - one for 24 hours and one for 48 hours. Dry on paper towel so seed can be handled.
2. Prepare flats with soil mix and firm the soil for planting.
3. Plant and mark the following specimens:
  - a. Merion bluegrass - no soaking
  - b. Merion bluegrass - 24 hours of soaking
  - c. Merion bluegrass - 48 hours of soaking
  - d. Red fescue - no soaking
  - e. Annual ryegrass - no soaking
4. Place flats in a warm place and keep moist while seeds are germinating.

Observations

1. Which seed germinated first? \_\_\_\_\_
2. Which seed germinated last? \_\_\_\_\_
3. Does pre-soaking promote faster germination of Merion bluegrass?  
\_\_\_\_\_
4. What is the germination time for each of the grasses?  
Merion bluegrass \_\_\_\_\_  
Red fescue \_\_\_\_\_  
Annual ryegrass \_\_\_\_\_

5. Why does pre-soaking hasten the germination of Merion bluegrass?

---

---

---

---

## STUDENT JOB SHEET #2

### ESTABLISHING A TURFGRASS DEMONSTRATION PLOT

#### Purposes

1. To display different turfgrass species.
2. To study the effects of different management practices.
3. To practice turfgrass establishment through seeding, vegetative methods and sodding.
4. To gain experience in soil testing.

#### Materials

1. Land for the demonstration plots. Try to secure a site that is easily accessible to students and the public. A water source should be located near the plot.
2. Signs to mark the turfgrass plots.
3. Seeds and vegetative parts to be used in the establishment of the turfgrass species.
4. Equipment for the establishment and maintenance of turfgrasses (rototiller, rakes, seeder, roller, fertilizer spreader, irrigation equipment, mower).
5. Soil testing equipment to use in determining the lime and fertilizer requirements.
6. Fertilizers, of different analysis to be used for comparative purposes on the turfgrass plots. Lime may be required to correct the pH.

#### Procedures

1. Select an area of land that is easily accessible for students and the public.
2. Conduct soil tests to determine fertilizer and lime needs.
3. Prepare the area for the establishment of the turfgrass species (rough grade, till, smooth grade).
4. Mark off the area into individual plots. The plots should be marked with signs which identify the turfgrass species, the date of planting and any modifications in establishment or maintenance practices.

5. Establish the turfgrass species according to the demonstration plot plan.
6. Perform the maintenance practices that are outlined on the demonstration plot plan.
7. Record the observations that are made for each turfgrass plot.

## EXPERIMENTAL TURFGRASS PLOTS

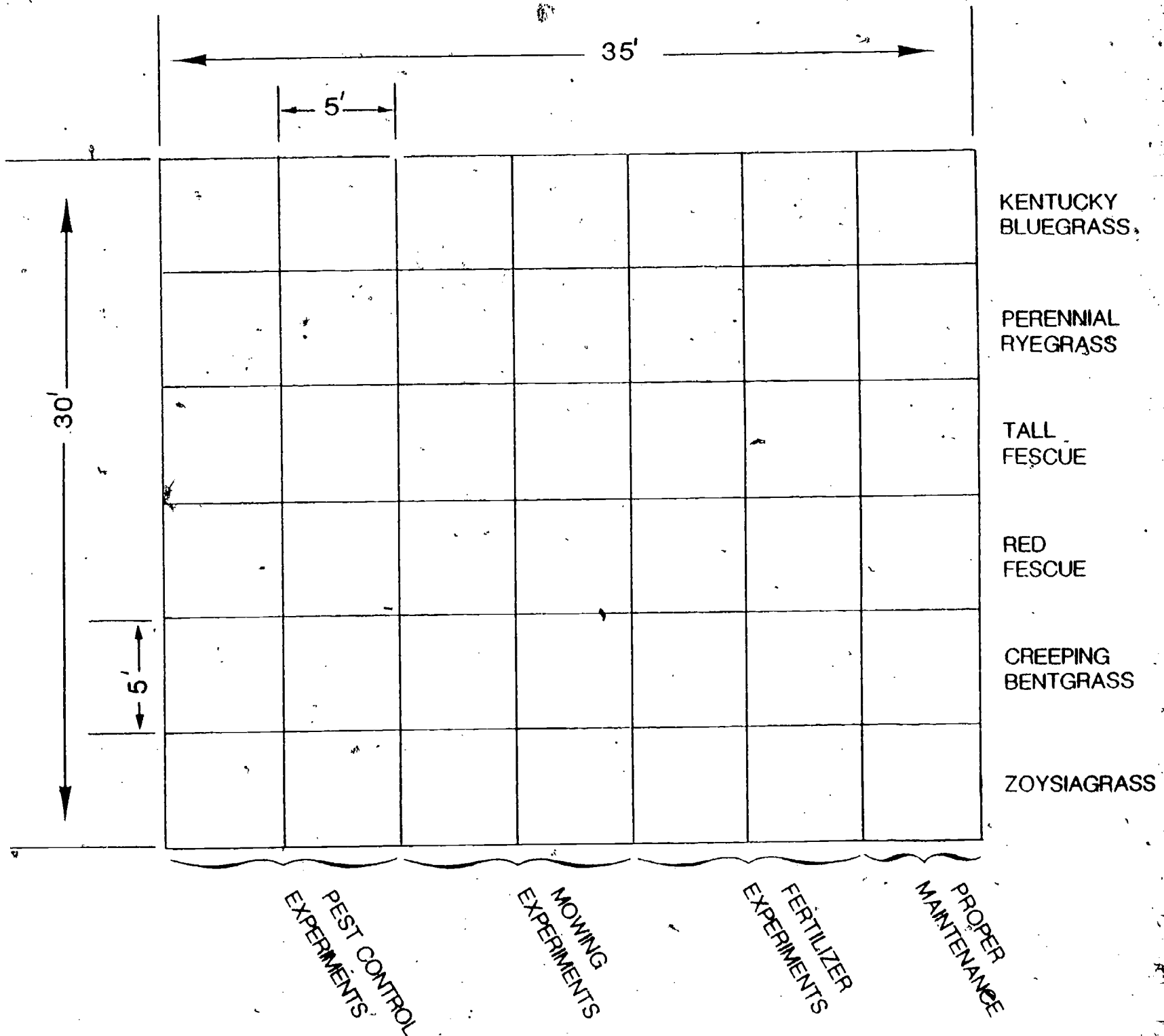



TEACHER'S KEY

STUDENT WORKSHEET #2

INTERPRETING GRASS SEED LABELS

A sack of grass seed mixture has a tag attached to the sack with the following information:

CONTENTS

51.57%	Kentucky Bluegrass	80% germination
35.23%	Creeping Red Fescue	80% germination
10.22%	Chewings Fescue	85% germination

OTHER INGREDIENTS

2.89%	Inert Matter
.09%	Weeds
	No Noxious Weeds

Net Weight - 100 lbs.

1. How many pounds of each grass would germinate under ideal conditions?

$51.57 \times 80\% = 41.256$  lbs. Kentucky Bluegrass  
 $35.23 \times 80\% = 28.184$  lbs. Creeping Red Fescue  
 $10.22 \times 85\% = 8.687$  lbs. Chewings Fescue

2. Assuming that only 50% of the viable seed will germinate under field conditions, how many lbs. of seed from this 100# sack will actually germinate in your lawn?

$78.127 \times 50\% = 39.06$  lbs.

TEACHER'S KEY

SAMPLE TEST QUESTIONS

ESTABLISHING AND MAINTAINING TURF

PART I. True (+)-False (0)

- 0 1. The best time to fertilize a lawn in Illinois is August.
- + 2. To maintain a healthy lawn it is necessary to water deeply every two weeks during periods of drought.
- + 3. Dull lawn mower blades may lead to disease problems in the lawn.
- + 4. Use of herbicides is often necessary to control weeds in the lawn.
- + 5. You should work in (incorporate) phosphorus and potassium nutrients into the soil as it is tilled for seedbed preparation.
- + 6. The procedure used to prepare a seedbed for sodding is the same as that used to prepare an area for seeding.
- 0 7. Bentgrass would be a good choice for a home lawn.
- 0 8. The soil at a new turfgrass site should be tilled to a depth of about 3 inches.
- + 9. A general rule for mowing states that you should not remove more than 1/3 of the total foliage at any one mowing.
- 0 10. Watering a lawn should be done when the grass turns brown.

PART II. Multiple Choice

- D 1. The best time to fertilize a lawn is \_\_\_\_\_.
- A. Spring  
B. Summer  
C. Fall  
D. A and C
- C 2. About \_\_\_\_\_ lbs. of nitrogen should be applied each year to 1000 sq. ft. of lawn.
- A. 50-100  
B. 1  
C. 3-5  
D. 7-9

- B 3. It's beneficial to make \_\_\_\_\_ fertilizer applications a year to the lawn.
- A. 12
  - B. 3-4
  - C. 1
- D 4. Cool season grasses such as Kentucky Bluegrass should be mowed to about \_\_\_\_\_ inches in height.
- A. 1
  - B. 4-5
  - C. 3
  - D. 2
- D 5. Weed control is \_\_\_\_\_.
- A. Possible with herbicides
  - B. Often frustrating
  - C. Possible with good lawn maintenance practices
  - D. All of the above
- B 6. A soil test is useful in determining the \_\_\_\_\_ needs for a given site.
- A. Nitrogen
  - B. Phosphorus, potassium, pH
  - C. Nitrogen, phosphorus, potassium, pH
- C 7. When you set out to establish a lawn, you should begin by \_\_\_\_\_.
- A. Mulching the seedbed.
  - B. Raking the area to cover seed.
  - C. Controlling weedy perennial grasses and grading the site.
- B 8. Grass seed should be distributed uniformly on the seedbed and covered with no more than \_\_\_\_\_ inches of soil.
- A. 2
  - B.  $\frac{1}{4}$
  - C. 1
- A 9. The best time of year for seeding a turfgrass area is \_\_\_\_\_.
- A. Late summer to early fall.
  - B. Middle of the summer.
  - C. Late winter and early spring.

- D 10. Perennial Ryegrass is an example of a bunch-type grass. A bunch grass reproduces by \_\_\_\_\_.
- A. Rhizomes
  - B. Basal Tillers
  - C. Stolons
  - D. None of these
- C 11. Vegetative planting methods such as stolonizing, sprigging and plugging are used when \_\_\_\_\_.
- A. You have a very large site to plant.
  - B. There is a steep slope on the site.
  - C. When seed for a particular turf is scarce.
- C 12. Sod should not be cut more than \_\_\_\_\_ inch(es) thick.
- A. 3
  - B. 1/8
  - C. 1
- D 13. When putting in sod, the slabs should be \_\_\_\_\_.
- A. All laid in the same direction.
  - B. Laid so the edges butt tightly together
  - C. Laid so the ends are staggered as in laying bricks.
  - D. All the above.
- C 14. Cutting height and \_\_\_\_\_ should determine the mowing frequency.
- A. Amount of fertilizer required.
  - B. Slope of the land.
  - C. Rate of growth.
  - D. Time of day.
- B 15. When the turfgrass site is irrigated, enough water should be applied to moisten the soil to a depth of six inches. This is roughly equivalent to applying \_\_\_\_\_ inch(es) of water.
- A. 2
  - B. 1
  - C. 5

PART III. Matching

1. Match the life span group name with the appropriate definition.

- A. Annual
- B. Biennial
- C. Perennial

- C A plant that lives for more than two years.
- A A plant that germinates from seed, grows, matures, and dies in less than 12 months or when killed by frost.
- B A plant that requires two years to complete the life cycle.



2. Match the turfgrass species name with the appropriate characteristic.

<u>Species Name</u>		<u>Characteristics</u>
<u>1</u>	Kentucky Bluegrass	1. Principal turfgrass in Illinois
<u>2</u>	Creeping Bentgrass	2. Requires intensive cultural practices
<u>5</u>	Tall Fescue	3. Warm season grass that forms dense turf
<u>6</u>	Red Fescue	4. Germinates quickly and provides rapid cover
<u>3</u>	Zoysiagrass	5. Coarse textured grass often used for pasture
<u>4</u>	Perennial Ryegrass	6. Fine, wiry, dark green turfgrass that does well on poor or drouthy soils

3. Match the structure name to the numbered plant parts on this diagram of a grass plant.

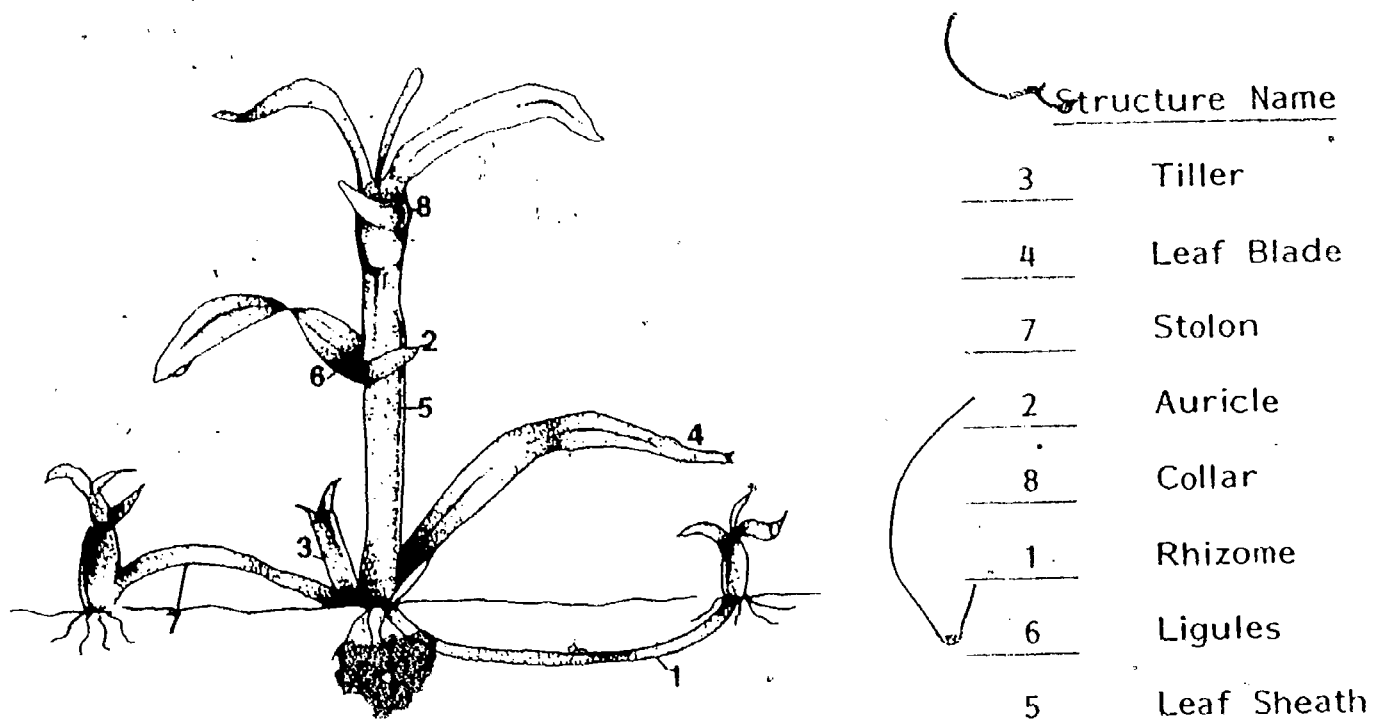

#### PART IV. Essay

1. List the names of six turfgrass species that are commonly used in Illinois:

- |                       |                       |
|-----------------------|-----------------------|
| 1. Kentucky Bluegrass | 4. Tall Fescue        |
| 2. Perennial Ryegrass | 5. Zoysiagrass        |
| 3. Red Fescue         | 6. Creeping Bentgrass |

2. How could you determine the plant nutrient levels on a site where you plan to establish turf grass?

Conduct a soil test.

3. What are the 3 basic nutrients needed by turfgrasses?

Nitrogen, phosphorus, potassium.

4. Briefly describe the procedure of turfgrass establishment through stolonizing, sprigging, and plugging.

Stolonizing - Shredded stolons are spread over the area with mechanized equipment. Spreading is followed by disking or rolling.

Sprigging - The planting of individual plants, runners, cuttings or stolons at spaced intervals.

Plugging - Planting small plugs or blocks (2 or more inches wide) of sod at measured intervals.

5. List two reasons why it is beneficial to till the soil before a turfgrass is established.

1. Improves the movement of water into and through the soil.
2. Improves soil aeration.

6. Briefly explain why it is important to smooth grade a turfgrass seedbed.

Smooth grading removes the high and low spots on a site. The low spots might collect water and damage the grass. High spots tend to dry out faster and may cause wilting.

7. Put the following steps in turfgrass establishment through seeding in the proper order by placing the numbers 1-8 in the blanks next to the steps.

- 5 Place the seed on the area with a mechanical seeder.
- 7 Roll the seeded area lightly to firm the surface.
- 2 Till the soil with a rototiller and apply phosphorus, potassium and lime.
- 1 Rough grade the seedbed.
- 6 Rake the area lightly to cover seed.
- 4 Apply a starter fertilizer.
- 3 Smooth grade the area to achieve a uniform surface.
- 8 Mulch the seeded area with weed-free straw or other material.

8. Choose an appropriate turfgrass species to fit the following environmental and cultural conditions.

A lawn that is open to the sun and level. The soil is moist, well-drained and fertile. The lawn will be maintained under moderate to high levels of fertilization and mowed to moderate heights (1.5 - 2.5").

Turfgrass Species - Kentucky Bluegrass

A putting green on a golf course. The cultural practices for this turfgrass site include close and frequent mowing ( $\frac{1}{4}$ " or less) regular applications of fungicide for disease control, frequent irrigation, and some cultivation or top dressing.

Turfgrass Species - Creeping Bentgrass

A turfgrass species for a roadside area. The species chosen should have a good resistance to heat, drought and wear. This site will receive a low level of maintenance.

Turfgrass Species - Tall Fescue

9. List 2 advantages of mulching a new turfgrass seedbed.

1. Reduces drying of the seedbed.
2. Helps reduce erosion.

10. Describe the disadvantage of using light, frequent irrigations to maintain the turfgrass area.

Often results in the deterioration of the lawn as a result of shallow rooting, increased disease incidence, weed development and insect damage.