

DOCUMENT RESUME

ED 245 659

IR 011 148

TITLE Computers and Education. Hearings before the Subcommittee on Investigations and Oversight of the Committee on Science and Technology. U.S. House of Representatives, Ninety-Eighth Congress, First Session (September 28, 29, 1983).

INSTITUTION Congress of the U.S., Washington, D.C. House Committee on Science and Technology.

PUB DATE Sep 83

NOTE 620p.

PUB TYPE Information Analyses (070) -- Legal/Legislative/Regulatory Materials (090) -- Viewpoints (120)

EDRS PRICE MF03 Plus Postage. PC Not Available from EDRS.
DESCRIPTORS Computer Literacy; *Computer Oriented Programs; *Computers; *Computer Science Education; Educational Change; Elementary Secondary Education; Hearings; Higher Education; *Policy Formation; Public Policy; *Technology Transfer

IDENTIFIERS *Computer Uses in Education; Congress 98th

ABSTRACT

This report considers the current and future impact of technology on schools, solutions to existing problems, and major policy questions concerning computer technology's role in education. Experiences of several universities in integrating computers into their programs are reviewed, as well as those of states and local school districts in developing computer based instruction. Statements and testimony are included from the following individuals: (1) T. H. Bell, U.S. Secretary of Education; (2) Edward Knapp, National Science Foundation; (3) Joe B. Wyatt, Vanderbilt University; (4) Robert P. Taylor, Columbia University; (5) Ludwig Braun, New York Institute of Technology; (6) Maurice Glicksman, Brown University; (7) Bernard P. Sagik, Drexel University; (8) James W. Johnson, University of Iowa; (9) Edmund G. Brown, Jr., National Commission on Industrial Innovation; (10) Sharon P. Robinson, National Education Association; (11) Joan Parent, National School Boards Association; (12) Ronald E. Anderson, Minnesota Center for Social Research; (13) David M. Moore, Memphis City Schools; (14) Patricia Sturdivant, Houston Independent School District; (15) Kyko R. Jhin, Washington, District of Columbia, Public Schools; (16) Jack Gordon, Florida General Assembly, and (17) Curman Gaines, Assistant Commissioner of Education, Minnesota. An appendix includes questions and answers submitted for the record. (LMM)

* Reproductions supplied by EDRS are the best that can be made *
* from the original document. *

COMPUTERS AND EDUCATION

U.S. DEPARTMENT OF EDUCATION
NATIONAL INSTITUTE OF EDUCATION
EDUCATIONAL RESOURCES INFORMATION
CENTER (ERIC)

† This document has been reproduced as received from the person or organization originating it.
Minor changes have been made to improve reproduction quality.

• Points of view or opinions stated in this document do not necessarily represent official NIE position or policy.

HEARINGS

BEFORE THE

SUBCOMMITTEE ON
INVESTIGATIONS AND OVERSIGHT

OF THE

COMMITTEE ON
SCIENCE AND TECHNOLOGY
U.S. HOUSE OF REPRESENTATIVES

NINETY-EIGHTH CONGRESS

FIRST SESSION

SEPTEMBER 28, 29, 1983

[No. 64]

Printed for the use of the
Committee on Science and Technology



U.S. GOVERNMENT PRINTING OFFICE
WASHINGTON : 1984

28-378 O

00 2

ED245659

IR011148

COMMITTEE ON SCIENCE AND TECHNOLOGY

DON FUQUA, Florida, *Chairman*

ROBERT A. ROE, New Jersey
GEORGE E. BROWN, Jr., California
JAMES H. SCHEUER, New York
RICHARD L. OTTINGER, New York
TOM HARKIN, Iowa
MARILYN LLOYD, Tennessee
DOUG WALGREN, Pennsylvania
DAN GLICKMAN, Kansas
ALBERT GORE, Jr., Tennessee
ROBERT A. YOUNG, Missouri
HAROLD L. VOLKMER, Missouri
BILL NELSON, Florida
STAN LUNDINE, New York
RALPH M. HALL, Texas
DAVE McCURDY, Oklahoma
MERVYN M. DYMALLY, California
PAUL SIMON, Illinois
NORMAN Y. MINETA, California
RICHARD J. DURBIN, Illinois
MICHAEL A. ANDREWS, Texas
BUDDY MacKAY, Florida
TIM VALENTINE, North Carolina
HARRY M. REID, Nevada
ROBERT G. TORRICELLI, New Jersey
FREDERICK C. BOUCHER, Virginia

LARRY WINN, Jr., Kansas
MANUEL LUJAN, Jr., New Mexico
ROBERT S. WALKER, Pennsylvania
WILLIAM CARNEY, New York
F. JAMES SENSENBRENNER, Jr.,
Wisconsin
JUDD GREGG, New Hampshire
JOE SKEEN, New Mexico
CLAUDINE SCHNEIDER, Rhode Island
BILL LOWERY, California
ROD CHANDLER, Washington
HERBERT H. BATEMAN, Virginia
SHERWOOD L. BOEHLERT, New York
ALFRED A. (AL) McCANDLESS, California
TOM LEWIS, Florida

J. H. POORE, *Executive Director*
ROBERT C. KETCHAM, *General Counsel*
REGINA A. DAVIS, *Administrator*
DAVID S. JEFFERY, *Minority Staff Director*

SUBCOMMITTEE ON INVESTIGATIONS AND OVERSIGHT

ALBERT GORE, Jr., Tennessee, *Chairman*

HARRY M. REID, Nevada
HAROLD L. VOLKMER, Missouri
ROBERT A. ROE, New Jersey
RICHARD J. DURBIN, Illinois
JAMES H. SCHEUER, New York

JOE SKEEN, New Mexico
ALFRED A. (AL) McCANDLESS, California
CLAUDINE SCHNEIDER, Rhode Island

ROBERT B. NICHOLAS, *Chief Counsel/Staff Director*
STEPHEN A. OWENS, *Counsel*
JAMES E. JENSEN, *Investigator*
ROBERT W. LAMINA, *Minority Technical Consultant*

(17)

CONTENTS

WITNESSES

	Page
September 28, 1983:	
Hon. T. H. Bell, Secretary of Education	9
Dr. Edward A. Knapp, Director, National Science Foundation	36
Dr. Joe B. Wyatt, Chancellor, Vanderbilt University; Dr. Robert P. Taylor, associate professor of computing and education, Teachers College, Columbia University; and Dr. Ludwig Braun, professor of computer science and director of the academic computing laboratory, New York Institute of Technology	53
Dr. Maurice Glicksman, provost and dean of the faculty, Brown University; Dr. Bernard P. Sagik, vice president for academic affairs, Drexel University; and Dr. James W. Johnson, director, office of information technology, University of Iowa	232
September 29, 1983:	
Edmund G. Brown, Jr., Chairman, National Commission on Industrial Innovation	291
Dr. Sharon P. Robinson, director, instruction and professional development, National Education Association, Washington, D.C.	313
Dr. Joan Parent, president, National School Boards Association, Washington, D.C.	326
Dr. Ronald E. Anderson, director, Minnesota Center for Social Research, Minneapolis, Minn.	345
Dr. David M. Moore, director, computer education, Memphis City Schools, Memphis, Tenn.	374
Patricia Sturdivant, associate superintendent for technology, Houston Independent School District, Houston, Tex.	522
Dr. Kyo R. Jhin, assistant superintendent, educational technology, Washington, D.C., public schools	541
Jack Gordon, chairman, senate education committee, Florida General Assembly, Tallahassee, Fla.	556
Curman Gaines, assistant commissioner of education, State of Minnesota ..	568
Appendix: Questions and answers submitted for the record	579

COMPUTERS AND EDUCATION

WEDNESDAY, SEPTEMBER 28, 1983

HOUSE OF REPRESENTATIVES,
COMMITTEE ON SCIENCE AND TECHNOLOGY,
SUBCOMMITTEE ON INVESTIGATIONS AND OVERSIGHT,
Washington, D.C.

The subcommittee met, pursuant to call, at 9:13 a.m., in room 2318, Rayburn House Office Building, Hon. Albert Gore, Jr. (chairman of the subcommittee) presiding.

Mr. GORE. The subcommittee will come to order.

I would like to welcome all of our witnesses and guests. I have a short opening statement, and then I will recognize my colleagues. Then we will go forward with the first witness.

Over the past few years our Nation has developed a love affair with the computer. Thanks to the development of the microcomputer, an increasing number of Americans each year are becoming acquainted with computer technology. Personal computers are now appearing in homes and businesses all over the country, and new applications for the technology are being discovered every day.

As our country has gradually become more familiar with the use of computers in general, attention has now been focused on the role that computer technology can play in educating our children. In increasing numbers, elementary and secondary schools, colleges and universities are making an effort to integrate computers into their educational programs.

Computers are important in the educational process for two reasons. First, the nature of our future economy dictates that our citizenry be familiar with computer technology. In the years ahead, the number of jobs for computer programmers and technicians is going to grow exponentially, and the demand for people to fill these jobs will naturally be great. Additionally, computer technology will influence and affect almost every aspect of our economy. Our individual economic survival will depend on how well we understand that technology and its potential.

Second, computers have the potential to tremendously enhance the quality of education in this country. Not only can computers be used to teach basics in math and science; they can be used for other subjects as well and can enable students to learn more rapidly.

To realize the benefits of the technology, however, our educational institutions must be equipped to utilize it properly. Teachers must be trained to teach with computers. Curriculums must be designed to take advantage of the technology's capabilities. Adequate

(1)

00 5

courseware must be available. And all students must have fair access to the technology.

Unfortunately, although educators are rapidly acquiring computer equipment for their classrooms, few schools are really prepared to use it. As recent studies by the National Science Board, the Carnegie Foundation for the Advancement of Teaching, the Congressional Office of Technology Assessment, and others have shown, our schools are being swept up in this tidal wave of technology without any idea of how to make wise use of it. Many teachers are not trained either to use computers or to teach with them, and many courses that use computers use them in unproductive, sometimes even counterproductive ways. The author of the Carnegie report declared, in fact, that our schools have taken a buy now, pay later approach to computers.

Moreover, serious disparities are beginning to appear in access to computers between economically advantaged and disadvantaged students. A National Science Foundation study recently found that wealthy schools are four times as likely to have computers than poor schools. These findings are, of course, disturbing.

Can computers really enhance the quality of education in this country, and can we take advantage of their educational potential? Of course, most of us believe the answer to these questions is yes. The issue is how do we insure that the desired result is achieved.

That's really the purpose of this hearing. Over the next 2 days we will examine the questions that have arisen as our educational institutions have sought to bring computers into the classroom. We will consider both the impact that the technology has already had on our schools and the ways in which the technology will affect them in the future. And we will explore solutions to the problems that exist.

Today the subcommittee will focus on the major policy questions that face educators and decisionmakers in addressing the role of computer technology in education. We will also review the efforts of several universities to integrate computers into their programs. Tomorrow, the subcommittee will review the experiences of States and local school districts in developing and implementing computer-based instructional programs. We will also hear testimony from several national organizations concerned with American education.

Now, before proceeding, I would like to recognize our ranking minority member, Joe Skeen.

Mr. SKEEN. Thank you, Mr. Chairman.

I think before we begin that it might be useful if we go back a step first and look at some of the issues that were raised when the earliest electronic calculators appeared in the sixties. If you recall, teachers and educationalists argued ferociously at that time against handing such gadgetry over to school pupils on the grounds that they would destroy numeracy and make youngsters into illiterates unable to manipulate figures or develop the basic skills of mathematics. Against this viewpoint, other voices pleaded that silicon-chip calculators would actually encourage students to understand numbers, quantities, and mathematical functions.

A decade later, I believe it is quite clear that the enthusiasts were correct. The use of calculators—assuming it is intelligent rather than blind use—does help children to familiarize themselves

with the nature of arithmetical and algebraic processes. The very simplicity of a pocket keyboard and the speed with which it can be employed to repeat, check, and cross-check calculations makes it a powerful tool for the promotion of basic mathematics skills.

Mr. Chairman, we face a similar situation in the 1980's. While many teachers and educationalists believe the rapid introduction of computers and other information technologies promise to promote and improve the quality of education in America, many others have anxieties about what this may mean for such basic skills as writing and mastery of the English language. And still others are justifiably concerned about the equality of access to computers by different socio-economic groups in this country.

The point is, Mr. Chairman, in every case we can discern two sides of the balance sheet when discussing the roles of computer technology in our Nation's schools. I feel strongly that most of these concerns are manageable given their proper understanding and with the right direction. A decade from now, I am hopeful we can look back and find that today's enthusiasts were correct in their assumptions about the proper role for computers in education. In that regard, I want to commend you for calling these hearings, and I look forward to a lively discussion of these issues, on a very topical issue of today.

Mr. GORE. Thank you very much.

I believe Congressman Reid has an opening statement.

Mr. REID. I wish to thank you, Mr. Chairman, for calling these hearings on computers and education.

I believe that all of us recognize the tremendous impact computer technology has made in all of our lives. Perhaps the most important characteristic of this computer revolution is the speed in which it has permeated our society. However, the very speed of this transfer of technology, especially within our Nation's schools, has asked a serious question: Is man in charge of this revolution and in control of its direction and purpose, or are we simply following a tide of change within our society over which we have little control?

I look forward in the next 2 days to the testimony being a critical analysis of equity of access, financing, teacher training, curriculum development, and classroom utilization of computer technology. My congressional district encompasses the 20th largest school district in the Nation. Using Federal block grant moneys, this district has developed computer classes in every junior high school and in the ninth grade in every school. Currently, the Clark County School District is evaluating student, teacher, and equipment needs and developing a kindergarten-through-12 curriculum for the entire school district.

I wish to thank these distinguished witnesses for agreeing to appear before this committee. I hope that they can provide insight on the impact computer technology has on our Nation's schools, the problems inherent in properly utilizing this new technology, and provide recommendations that will enhance the quality of education in America for all of our students. I look forward to enlightened dialog on these important issues.

Mr. GORE. Thank you.

Congresswoman Claudine Schneider.

Mrs. SCHNEIDER. Thank you, Mr. Chairman.

00 7

I would like to thank you for holding these hearings today. Once again, it shows your enlightened leadership in addressing some of the different issues that are coming before us in a very rapid fashion.

The panelists who have agreed to testify this morning will no doubt represent many of the major institutions that are participating in this entire national debate over computer utilization. We have the Federal Government; we have the States and localities, universities, and primary and secondary schools. Their various recommendations will be extremely helpful in assisting us to determine what type of policy we need to develop in order to facilitate the best and the most equitable use of computers in the Nation's schools.

I think it is interesting, just in my little State of Rhode Island, the seven largest school systems within my district have made major purchases of computer hardware over the last 3 years. For example, in the town of Narragansett, it is now required that all eighth graders have computer literacy. In the town of Coventry, computer instruction is also available for children of kindergarten age. In Providence, an entire high school auditorium has been converted into a computer demonstration and simulation center. I think that the Rhode Island experience pretty clearly mirrors what is happening across the country, which is an explosion in the use of computers at the elementary, secondary, and university levels.

There are right now 500,000 microcomputers in U.S. public schools, and this number, it has been predicted, will surge to 2 million by the year 1988. Some of the panelists that we will be hearing from today I understand will be decrying this explosion as a threat to our schools and a threat to education. I share the opinion, however, of many educators that this boom in computer use, if well managed, can represent an opportunity to substantially improve both the quality and the levels of education in this country.

Like all societal developments, there is potential for great abuse and waste, but also, if the use of computers is developed properly, then we can certainly expect great benefits.

Educators have already succeeded in identifying several potential trouble spots. First, there now exists a severe shortage of qualified computer instructors. In these hearings, we will also be talking about how many of the schools are discovering that computers do not necessarily fit in with their traditional academic curriculum. Adjustments in curriculum no doubt will have to be made to insure that students don't merely learn how to use computers, but that the computers themselves are being utilized for teaching basic skills, such as reading or arithmetic.

Another concern which needs to be addressed is the whole issue of computer equity. The existing research has well documented the growing gap in computer instruction and availability between the rich and the poor. Earlier this year, the National Science Foundation put forward a rather startling—some rather startling figures—saying that youngsters in the 12,000 most affluent schools are 4 times more likely to have access to computers than students in the 12,000 least affluent schools. Futurist Alvin Toffler has warned that "kids who know how to use computers will have an edge over those who don't, and this means that, unless conscious steps are

taken, white middle class children will start, once more, with an edge that the less affluent lack." So insuring equity in computer accessibility certainly needs to be a high priority. And how we accomplish that, hopefully we will have some answers from the panelists today. But some suggestions have been made that perhaps we solve that problem through creative taxes or perhaps through direct Federal subsidies. But each of these problems we have no answers for now. We are looking for those answers.

Just as important, I think we have to evaluate the question of what exactly to expect from computers in educating our children and how computers can best help all of us to adapt to our changing world economy. There is no question but that computers have changed the traditional definition of literacy. Although few of our children may someday work as computer programmers, all of our children, and many of us as adults, will interact every day with computers of some type. Educators at all levels deserve much applause for the work that has already been done in integrating computers into our educational systems, and Congress now must take that opportunity to examine the potential for computers in education, the weaknesses that now exist, and the role which the Federal Government can play in correcting these weaknesses. This task is essential if we are to prevent a waste of human, monetary, and technological resources.

I once again commend my chairman for assisting us in pulling together the valuable human resources that we have gathered for these hearings, and I am hopeful that we will come to some solutions very soon.

Thank you.

Mr. GORE. Thank you very much.

Congressman Volkmer does not have a statement. Congressman Nelson, who wanted to be here and may be able to attend later, has a statement, and, without objection, we will include that for the record.

[The opening statement of Hon. Bill Nelson follows:]

CONGRESSMAN BILL NELSON (D-FL.): OPENING STATEMENT TO THE SCIENCE AND TECHNOLOGY SUBCOMMITTEE ON INVESTIGATIONS AND OVERSIGHT, SEPTEMBER 28, 1983

Thank you, Mr. Chairman, for the opportunity to join you and the Subcommittee for this very important hearing.

I commend you for focusing congressional attention on a matter which has been the subject of my extended personal efforts -- the computer.

Understanding your hearings are to review the status of the computer in our educational system, let me share with you my own experience with the machine.

I am getting an education myself in the use of a computer. On my desk is a cathode ray tube, CRT for short, which is connected to a powerful minicomputer in our office. We have 384 K of core memory and 60 megabytes of disk memory, a tape drive for backups, and an emergency power supply. From the receptionist to the administrative assistant, the computer is a daily working tool in my Washington office. We have also connected our district offices with our in-house computer, so the Florida staff members are able to handle correspondence and casework through the computer. They direct the computer to produce letters, either from standards letters or from the keyboard, and these come out in Washington in the daily stream of the letters that makes up a substantial part of a congressional office's daily work. The computer system also handles messages and memoranda back-and-forth, and allows us to create and modify documents in Washington or Florida.

This experience has provided me with a great appreciation for the usefulness of this electronic tool and a better understanding of the potential for more efficient and effective use of time with the assistance of a computer's speed.

an trying to emphasize that familiarity with computers is becoming the common experience of tens of millions of working Americans. And where people work daily with a powerful tool such as a computer, there will be those who go far beyond normal day-to-day use to overstep the boundaries between legitimate and criminal uses of these powerful devices.

It is estimated that there are more than 2 million computer operators, programmers, and technicians in the country. And I think this figure is far too low. It calculates primarily those who have a good deal of training in computer programming and operation, rather than the general use that is now becoming the norm for business and government offices.

The federal government uses more than 15,000 computers. Some 56,000 large general purpose computers and 213,000 smaller business computers are utilized in the private sector. Approximately 570,000 minicomputers and 2,4 desktop computer are also in use throughout our society.

These computers will increasingly be interfacing with the data-banks of major institutions -- banks, to direct the transfer of funds among customer accounts; department stores, to order merchandise; TV polling operations, to get instant public reaction to public events; and many, many more.

We need a national statute to defend computers from unauthorized entry, to protect the developing electronic funds transfer system, to preserve the integrity of the Federal Reserve and to safeguard business computers in a world where a computer terminal may be on every desk in every home.

Therefore, I have introduced The Federal Computer Systems Protection Act of 1983 to make crime by computer a specific federal offense. H.R. 1092 would make it illegal to tamper with computers of the federal government, the computers of financial institutions guaranteed by the federal government and computers operating in interstate commerce or using a facility thereof.

Prosecutors are currently unable to make effective cases against computer criminals because the 40 or so federal laws that could be applied were designed originally to control other kinds of criminal activity.

My bill provides statutory penalties against "...whenever uses, or attempts to use, a computer with intent to execute a scheme or artifice to defraud, or to obtain property by false or fraudulent pretenses, representations, or promises, or to embezzle, steal, or knowingly convert to his use or the use of another..." It provides fines amounting to twice the value of the gain from the offense, \$50,000, whichever is higher, or imprisonment up to five years, or both. Also contained is a measure to protect designated computer systems from damage and terrorism from unauthorized users.

We currently have 103 cosponsors on H.R. 1092, and Chairman Don Edwards, of the Judiciary Subcommittee on Civil and Constitutional Rights, has expressed he is "finnly committed" to holding hearings on the legislation this fall.

As well as receiving this generous support from my colleagues, H.R. 1092 has been endorsed by many of the major trade industry associations. The Computer Business Equipment Manufacturers Association, American Bankers Association, Data Processing Management Association, EDP Auditors, and the American Society for Industrial Society, are just a few of these organizations supporting the bill.

Mr. Chairman, I applaud your bringing to the forefront this nation's increased reliance on computers -- in education, as well as in government and business.

I extend my appreciation to Dr. Bell for his time in joining us today, and personally welcome my former colleague in the State Legislature, Senator Jack Gordon, to Washington.

I look forward to what I am sure will be excellent testimony today and tomorrow from our distinguished guests.

Mr. GORE. I am really pleased at the lineup of witnesses that we have for these 2 days' worth of hearings. We have the leading experts in the entire country on this subject. There could be no better witness to lead off than our country's Secretary of Education, Dr. T. H. Bell.

We are honored to have you, Dr. Bell. We appreciate your patience and your participation here today, and we look forward to hearing you. Without objection, your prepared statement will be put into the record. You are invited to go ahead with the presentation of it. If you care to summarize any of it, use your own discretion.

STATEMENT OF HON. T. H. BELL, SECRETARY OF EDUCATION

Secretary BELL. Thank you, Mr. Chairman. I am pleased to be here.

I have a 6-page statement and I would prefer to summarize it, just highlight it, and then we can maximize our time, I think, for questions and answers.

It sounds a bit overdone, Mr. Chairman, since others have already commended you for holding hearings on this subject, but as far as American education is concerned, it's a very timely subject. How to best utilize computers is a big problem, and I would hope, just speaking ad lib, Mr. Chairman, that the committee would know that I would welcome your—at the conclusion of these hearings and after you have deliberated—I would welcome your recommendations to the Secretary of Education on what you think from these hearings we ought to be doing administratively, so that we could translate into action administrative matters as well as you looking at the implications for legislation.

I believe strongly that computers do have an important role to play in our schools. There are very few classroom presentations, in my opinion, made by teachers in our schools, even in secondary school subject areas like history and mathematics and science, that we couldn't improve on them by having preprogrammed computer presentation. There is little learning that takes place by students in these subjects that couldn't be assisted by some computer practice of some kind. It may be that computers can also be used to reduce what we have referred to as the labor intensiveness of education that contributes to the continually rising cost and increased expenditures for students with each passing year.

I just might digress from my prepared statement to say that, unlike other industries—if I can call education an industry—we haven't been able to use machines to do our work, and therefore increase the productivity of the workers. I view the computer as having great potential for doing that. I think it does hold potential for providing relief, for example, from the heavy paperwork load that teachers have. The computer may provide assistance in relieving the burdens of countless hours spent by teachers in such things as test scoring, correcting student papers, keeping attendance records, and other routine tasks.

As I talk to teachers—and we have had our major report, the National Commission on Excellence report, which has been on the front page of the newspapers all over the country—and as I talk to

teachers of English, for example, they talk about the workload that they have, and we complain here that students don't write well. An English teacher tells you what a burden that he or she has when you assign an essay. If you meet 150 students in a secondary school in a day, what an enormous burden that is to score and correct and to blue pencil those essays and send them back.

We know from experimental evidence that there is great potential for—with the word processing capability of even inexpensive microcomputers—for much of that to be done, and that burden can be taken off of teachers. So I emphasize that I think that there is a lot of potential in this area. We need to use our resources to help in the development of software that will help make computers what I would call an effective slave mechanism, and by doing that, to free teachers in this regard.

I would like to skip over in my statement and just say a few things about software and the software problems that we have and the compatibility problems, and would like to have that sort of be the highlight of what I might be able to contribute to your hearings, Mr. Chairman.

There is a large number of individual, commercially available software programs available right now: about 500 in reading and writing, 1,650 in mathematics and science education, and from our studies, over 500 titles in 14 major languages for foreign language instruction. I would like to leave with the committee some studies that we have done here, and in these publications that you may want to have your staff review a bit.

But in these subject areas, there are nonetheless many important educational gaps. For example, there is very little software available for elementary school science, as important as that is, and of all things, there isn't what there ought to be in secondary school mathematics, particularly algebra, and critical subjects where we have a real shortage, in the foreign language areas, especially in areas like Russian and Japanese, Chinese and Arabic, where we really ought to be doing much more because of the needs of our international commerce and trade and our diplomatic circumstance. We're finding the computer has great potential in language instruction.

Well, of the software that is found, in addition to that, Mr. Chairman, most of the software is low-level, drill-and-practice programs. They are simple textbook, tutorial-type programs. With the exception of basic arithmetic and reading programs, most of the remainder of the software represents isolated instructional units rather than a total course or a comprehensive approach to the teaching. That makes it difficult for the teacher to integrate the whole program into the course sequence that is being taught, and to do that in a timely and appropriate way. The combined judgment of the directors of the three different contract studies that we have made—and those are the publications that I refer to here—have provided us data on the status of the computer and the available software and some of the problems that are there.

The biggest problem that needs to be solved, in my opinion, if computers are to fully meet the needs of education, is this matter of software compatibility. Our situation, Mr. Chairman, isn't unlike the earliest years of the history of the railroad industry in this

country, when various gages of railroad tracks made millions of dollars of equipment useless on hundreds of miles of expensive track. I have been expressing my concern about this and I would just urge the committee to—if there is any way you can help us—to persuade executives in the industry to do more to solve this problem. You would make a great contribution to American education and I think to everyone that is spending their money on computers these days.

We are currently making grants to educational institutions, trying to assist them in the development of the best software that can be written by the most bright and able and talented people that we can find to write the software. But the benefit of this creative work is often limited to only a few thousand children whose schools happen to have the brand of hardware that the software will work on. So, as I emphasize this and express this concern and criticism, I would also want to emphasize that it isn't a simple problem that can be solved by just a few agreements among computer manufacturers. I know there are some technical difficulties there. But the problem is greatly exaggerated by the competition and the understandable desire on the part of corporate executives and others, after they spend money on software, to sort of see that it is exclusively available for their brand of computer. I think that if we could bring this to the attention of high-level corporate executives—and I don't think it has been brought to their attention like it ought to—that maybe we would have a possibility for solving this problem. So I think others that will be appearing will be highlighting this problem. Some of them I know—and I commend you for your witness list—will be technical experts that will be able to give you a lot more enlightenment than I will on this subject.

But at a time when there is nationwide concern about student achievement—and we're reading about it all over—we need at the earliest possible time to develop much more effective software that will utilize the full potential of the computer's artificial intelligence to interact with the minds of learners.

Now, too much computer software is simply electronic page turning, and it has little advantage over a well-illustrated book. I might just digress to say that I have a 12-year-old son and a microcomputer in my home, and being in education, I have been intensely interested in this. I have been disappointed about the availability of software that is available and the fact that it is electronic page turning, and much of it you might as well go to, as I said, a well-illustrated book.

I have tried to outline here what I think ought to be the criteria for good software. What we need is a major effort to develop some super software packages that will do these six things. And if you think through these with me, you can see how they would really help learners to learn.

First of all, they ought to motivate the students through reaching their interests and concerns and approaching through the mind of the learner a good study of the age and interest of the learner and then develop it around that.

Second, these computer programs ought to have a capability to branch out and present the subject matter again and again to the learners who didn't grasp it the first time that it was presented, so

that they will have an opportunity to go over it in a way that will help them get it. Some bright and quick learning students can go right through; others need the branch-out capability. The computer can detect that the student isn't catching the full significance of the subject matter that is being presented and branch them over and take them through a series so they will get it in a mathematics—say, in an algebra course; then it will be as effective as it ought to be. I find that is very, very deficient right now in many of these software packages.

It also needs to have the capability, as I make here in point three of my testimony, to move ahead rapidly with the gifted and talented learners, so we don't waste their time.

It ought to present the subject matter with the utmost that creative people can present—attractive sound and color and animation that will really turn the students on and hold their attention. We all know that motivation is a big problem in learning, and I think there is much to be desired in much of the software at the present time in that regard.

Then it ought to reinforce the students' desire to learn more by offering prompts, cues and encouragement as the student struggles through some of the more difficult and crucial phases of the lesson.

Then, lastly—and a very important thing and a service to the teacher—the computer software, if it is developed like it ought to, it ought to keep a careful tabulation of the student's progress and correct erroneous responses and print out where responses were erroneous, so that the teacher would have that and the teacher could follow up and utilize it.

I realize it is easy to sit here and outline the criteria for a good software package, but I make that point to emphasize that it takes a big investment and a major effort to develop a good computer software package that will meet all of these requirements. And if we get them so that we would meet those requirements, I think we would begin to meet some of the criticism that we're hearing about computers. So I would emphasize, in concluding, that we have a long way to go in the computer software problem. I would say that the software and the compatibility problem are the two big items that need a lot of attention.

I would just like to touch on a little frustration that we have with respect to this, down adlibbing at the bottom of page 4 of my testimony. We know there is enormous potential to be realized from the computer if we could bring together a coordinated effort, rather than the way it is splintered now. We need to work at this problem in a bigger way, in a more massive way. I have said here that education needs the equivalent of the R&D effort of the famous Manhattan project in World War II, or NASA's space shuttle project of today. This requires leadership and coordination, and in my opinion there is no good reason for the States and local education agencies to be working independently from each other and duplicating their work and doing things in isolation. So if we could help in that regard, we could make a great contribution.

So I would just emphasize, Mr. Chairman, in concluding, that we ought to beware of waste, overlap, and duplication. We need to concentrate on the great potential of the computer. We need to beware of gadgetry and gimmickry. We need to make sure that we concen-

trate on basic subject matter—English and math and science and social studies, foreign languages—some of the basics, and make sure that through the advent of the computer we don't indulge in fads and in gadgetry in our instruction. So there is enormous potential in our opinion, and it's a big challenge to realize that potential.

As I said at the beginning, Mr. Chairman, we would welcome your recommendations and your critique of how we could provide a better effort and a better leadership response to this challenge.

Thank you very much. I would be pleased to respond to questions.

[The prepared statement of Secretary Bell follows:]

STATEMENT OF HON. T. H. BELL, SECRETARY OF EDUCATION

Mr. Chairman, Members of the Subcommittee:

I am pleased to be here today to testify on this important topic of computers in education. I have expressed my views publicly on this subject many times before. I believe strongly that computers have an important role to play in the schools. There are very few classroom presentations by the teacher in such secondary school subjects as history, mathematics and science education that could not be improved with the help of a preprogrammed computer presentation, and there is little learning by the student in these subjects that could not be assisted by computer practice of some kind. It may be that computers can also be used to reduce the labor-intensiveness of education that contributes to the continually rising cost and increased expenditure per student with each passing year. The computer holds great potential for providing relief from the paper work load of teachers. The computer may provide assistance in relieving the burden of countless hours spent by teachers in test scoring, correcting student papers, keeping attendance records, and many other routine tasks. We want to use our resources to help in the development of software that will make the computer an effective slave mechanism that will free teachers to teach.

The schools themselves are demonstrating very strong interest in this subject measured by their acquisition of the personal microcomputers that became available at the beginning of this decade. National Center for Education Statistics data-collection activities report a growth from about 31,000 microcomputers in the schools in Fall, 1980 to about 96,000 in Spring 1982. Estimates from various sources range upwards of 300,000 by the end of this calendar year. Funds available to the States through Chapter II of the Education Consolidation and Improvement Act have contributed to this growth.

Our data on teacher training do not adequately reveal its extent and nature, which are much harder to quantify than installed equipment. Even defining what knowledge skills and understanding are required of teachers in this rapidly changing field is a continuing process. I can say there is much independent activity by teachers to get up-to-speed, as well as sponsored activities by State and local education agencies, and by firms in the private sector.

Business and industry are an important player in this area. Announced programs include donations of equipment to the schools by firms such as International Business Machines and Digital Equipment Corp. and programs of teacher training by firms such as TANDY - Radio Shack. Another very important way that private firms have an effect in this area is by their level of investment in the development and marketing of educational computer software.

Overall, there appear to be a surprisingly large number of individual commercially available software programs: about 500 in reading and writing, 1650 in mathematics and science education, and over 500 titles in 14 languages for foreign language instruction. In these subject areas, there are nonetheless many important educational gaps. For example, there is very little software for elementary science, for secondary mathematics courses such as algebra, and for such critical foreign languages as Russian, Japanese, Chinese and Arabic.

Of the software found, most are low-level, drill-and-practice programs or simple textbook-like tutorials. With the exception of basic arithmetic and reading programs, most of the remainder of the software represents isolated instructional units, which makes it difficult for the teacher to integrate their use into the

course sequence in a timely and appropriate way. The combined judgement of the directors of the three contract studies that provided these data is that of the total amount of presently available software materials, the fraction that uses the unique capabilities of microcomputers presently in the schools to improve teaching and learning in the subject areas examined is very, very small -- less than 5 percent.

The biggest problem that must be solved if computers are to fully meet the needs of education is the matter of software compatibility with the machines. Our circumstance today is not unlike the earliest years in the history of railroads when various gauges of railroad tracks made millions of dollars of equipment useless on hundreds of miles of expensive track. I have been expressing my concern about this, and I would urge this Committee to help us to persuade executives in the industry to do more to solve this problem.

We are currently making grants to educational institutions to assist them in the development of the best software that can be written by the many bright and talented people who work at this very significant task. But the benefit of this creative work is often limited to a few thousand children whose schools own the hardware for which the software was written. This is not a simple problem that can be solved by a few agreements among computer manufacturers. But the problem is not attracting the attention of corporate executives, and it is on this level that we must strive for a solution. I hope this Committee will highlight this problem for us in your hearings.

At a time when there is nationwide concern about student achievement, we need at the earliest possible time much more effective software that utilized the

full potential of the computer's artificial intelligence to interact with the minds of learners. Too much computer software is simply electronic page turning, and it has little advantage over a well-illustrated book. What we need is a major effort to develop some super software packages that will:

- (1) Motivate the students through reaching into the interests and concerns of the minds of the learners;
- (2) Branch out and present the subject matter again and again to the learner who did not grasp the concept the first time it was presented;
- (3) Move ahead rapidly with the gifted and talented learners;
- (4) Present the subject matter with the utmost in attractive sound, color, and animation;
- (5) Reinforce the students' desire to learn more by offering prompts, cues, and encouragement in working through some of the most crucial phases of some lessons; and
- (6) Keep careful tabulation of each student's progress, correct any erroneous responses, and print the same out for use of the teacher.

We have a long way to go to reach a level where our computer software meets the criteria I cited above. But the potential is so promising that we ought to be aggressively pushing an educational software development effort on a much more massive scale.

Let me take a moment to tell you of my frustration in trying to bring the efforts of the Department of Education up to a point where we can begin to realize some of the potential of the computer to help us solve the problems that we face nationwide in our schools. We should work at this problem in a well-coordinated manner so that we are not duplicating, overlapping, and spending unnecessarily and excessively. Education needs the equivalent of the R and D effort of the famous Manhattan Project in World War II or NASA's space shuttle project of today. This requires our leadership on coordination. There is no good reason for each State to work independently on this, duplicating and working in isolation.

Within the Department, I have established a coordinating capacity under the leadership of the Assistant Secretary for Educational Research and Improvement, and have approved four program strategies. These strategies are data-gathering for Federal, state and local policy development; dissemination of information on school practice; school-based demonstrations of advanced practice; and applied research. In fiscal year 1983, I anticipate that in excess of \$5 million will have been obligated in the implementation of these strategies.

Data-gathering activities in fiscal year 1983 focused on school utilization of computers, and will provide information from teachers, principals and superintendents on instructional uses of computers for the school year 1982-83, and on problems and barriers inhibiting success. Studies planned for fiscal year 1984 include a higher education utilization study of computers, with emphasis on colleges of education; and a home utilization study of the use of computers for credentialled and non-credentialled learning at home.

Information on exemplary school practice using computers is disseminated by print materials, teleconferences, and by individual visits of educational practitioners to school sites. Federal funds are used to meet the cost of preparation and distribution of print materials describing and explaining these activities, teleconferences, and for whatever special arrangements may be required at a selected school site to enable the school to host visitors without disturbing regular instructional activities. This year five school site lighthouse technology projects were continued for a second year; and five new projects have been approved for first-year funding. A teleconference on September 7 drew an audience of educational practitioners in excess of 5,000, using 80 downlink-reception sites in 22 states. This program of dissemination activities will be continued in fiscal year 1984.

In an important and rapidly developing area such as this, some schools and school systems must inevitably get out in front of others in their objectives and in their knowledge of what is possible using computers. In a program of school-based demonstrations we selected twelve in fiscal year 1983 for grant awards through a competitive process. These Federal funds will be used by recipients to explore more advanced educational applications of computers than are presently found in schools. Two-year funding is planned for this program. Successful applications will be disseminated to interested school districts around the nation.

Many critics of education and educators look with fully-justified skepticism at the entry of the computer on the education scene. We have had too many "new fangled" ideas and innovations in education. So, critics look at the computer as just another innovative effort at a time when we need solid reform in teaching the basics of English, math, science, and social studies to develop a highly literate and basically well-educated student body. The computer, however, has great potential for accomplishing the best in well-disciplined, rigorous mastery of learning. It can free both teacher and learner to reach new heights of academic attainment. As this is said, a warning must be voiced that the computer also has great potential for harmful waste, for tinkering, and for losing and eroding real disciplined learning in the basics. We must concentrate the great potential of the artificial intelligence of the computer on the priorities that have been identified by the reports and nationwide studies such as our National Commission on Excellence and several other very outstanding studies completed by the Education Commission of the States, the National Science Foundation, the Carnegie Foundation for the Advancement of Teaching, and others. We must not let our determination and our priorities be aborted by chasing another fad in the education scene. To the end that the computer can assist us in the central purposes we should exploit the potential. We must guard against the danger of it doing otherwise.

Mr. GORE. Well, thank you very much.

I appreciate your statement that you would welcome recommendations from this subcommittee. We will have some recommendations for you at the conclusion of these hearings. We hope to learn a great deal over the next 2 days and we will look forward to working closely with you to try to help move the country in the right direction and to make it possible for us to take advantage of this enormous potential which is not being utilized today. So I appreciate your approach to it very much.

Secretary BELL. The reason I emphasize that, Mr. Chairman, if I can just break in for a moment—

Mr. GORE. Sure.

Secretary BELL [continuing]. Is that I know there are many things that we can do administratively, that don't need legislation. I would like to express a willingness to harmonize that with the committee and your findings and efforts that you may find from the hearings that you want to enact into legislation.

Mr. GORE. Well, it wouldn't be fair to describe you as a hostile witness, then.

Secretary BELL. I am very humble about this subject. That's why I am less hostile than usual.

I have said that I'm humble, and I've had some friendly critics say, "Well, you ought to be humble, Ted Bell; you have a lot to be humble about." I recognize that.

Mr. GORE. Well, as are we on this subject and some others.

You mentioned the key role of software development and software compatibility. That has long been recognized as one of the bottlenecks in our movement toward a greater use of computers in education, and we're going to be hearing a great deal about software development and compatibility during these 2 days of hearings.

But I was interested in your statement that you are now subsidizing the development of better educational software; is that correct?

Secretary BELL. Yes. We have three major contracts. I have the titles of them here and I can submit them to you, including the dollar amounts. But even these, I think, Mr. Chairman, won't meet the criteria that I tried to outline, in being as comprehensive and as effective in teaching. I think those contracts will yield a level of software higher than where we are now. But after that, the problem still remains and lingers on the compatibility of software. It's the railroad analogy that I gave.

Mr. GORE. Right. Well, there may be some solutions to that which we will be exploring during these hearings.

What is the total of the three projects that you've mentioned, just a ballpark estimate?

Secretary BELL. Let's see, Mr. Chairman—and I'll submit these for the record. One of them is for \$95,000; another one is for \$101,000; and another is for \$106,000. The principal investigators, one is a university and the others are—here's a teacher education research center. We'll submit that to you, Mr. Chairman.

Mr. GORE. OK, that's fine.

So it is \$300,000 total.

Secretary BELL. That's approximately, yes.

Mr. GORE. Well, I could see where we might not know, and if this is the key to the problem, that's not a Manhattan project—

Secretary BELL [continuing]. By any means.

Mr. GORE [continuing]. Style commitment, is it?

Secretary BELL. It really isn't. That doesn't approach it.

Mr. GORE. Yeah. Well, I can see where if we find out more about which direction to push in and how to go about it, perhaps one of the recommendations we could discuss with you is a heftier commitment to developing this kind of software.

°About 3 years ago an organization that Congresswoman Schneider and I are active in, the Congressional Clearinghouse on the Future, convened a symposium on this subject, and at that time, 3 years ago, software availability for education was identified as the key to the problem. A lot has been done since then by people all over the country. Everybody that has looked at this came to the conclusion some time ago, and we'll be hearing from some of the people who developed software.

One thing that you didn't mention in your testimony that has come up in many of these reports—these national reports that have come out—is the problem of teacher training. A concern has been expressed that many teachers are not trained to utilize computers in the classroom, to make use of them in schools. Do you believe that this is a serious part of the problem as well?

Secretary BELL. Yes, I do. I think as far as the use of the computer, it can be taught quite easily. Based upon my own experience, you can show your wife or your child in just a few hours and a few practice sessions how to load the computer, the disc, and how to use the certain basic commands in the program, to utilize it. So in my opinion, we may have—although I don't want to denigrate it unduly—we may be overblowing this phrase of computer literacy, if that means having a way to operate it, like we learn how to operate a car or some other machine.

Now, it's a bit complex, but it is getting easier all the time as we get more sophisticated machines and easier to operate units.

Mr. GORE. Should there be a Federal role in addressing the teacher training part of the problem?

Secretary BELL. I think so. And we have the math-science legislation that was recommended, and the bill that we recommended is not going to be the one passed, but that isn't as important as the fact that we're going to get a math and science bill. I think in there, if the legislation comes out the way we're looking at it, we would also be able to use it for technology. That would be very helpful for us.

I am pleased that the Director of the National Science Foundation is going to be here, because he is scheduled to receive part of that appropriation and that program responsibility, Mr. Chairman. So we have a responsibility to work closely together and I think also to coordinate with you as well as our Education Committee.

Mr. GORE. Very good. Of course, this committee, under the leadership of Don Fuqua, the full committee chairman, has tried to take a leadership role on that math and science bill, and we're very optimistic about it.

Well, I have a number of other questions, but I have exceeded my time.

Did you want me to yield?

Mrs. SCHNEIDER. I was hoping that you would yield on that point, because it was our committee, as you mentioned, Mr. Chairman, that passed the science and math education bill, and it was with great frustration that we saw the Senate did not take any action on it.

I wondered, Dr. Bell, if you are personally lobbying the Senate so that we could move ahead with this legislation, because many of us who are supportive of it, are frustrated that it hasn't moved.

Secretary BELL. I think they're working on their own math and science bill—

Mrs. SCHNEIDER. And it is somewhat similar to ours.

Secretary BELL. Yes. But then I believe—and I am sort of speculating about the strategy on the Senate side—I think, after they act on theirs, then they would like to come to you in a conference committee mode to get more of the features of what they want versus the features that you want. But I think there are many similarities in both pieces of legislation.

Mrs. SCHNEIDER. Certainly we can reach some compromise. But it was frustrating to see, also, that there was no attachment in one of your priorities which you had mentioned, and also one of mine personally, and that is of the critical languages, Chinese, Japanese, and Russian, being added on as an amendment to that bill. I think it would help all of our purposes if perhaps you could play some role as part of the administration to lobby for its movement in the Senate.

Secretary BELL. I will see what I can do with that.

Mrs. SCHNEIDER. Thank you, Mr. Chairman.

Mr. GORE. Congressman Reid.

Mr. REID. Mr. Chairman, just following up a little bit on some of your questions. Dr. Bell, Chairman Gore indicated that what we're doing to this point certainly isn't comparable to the Manhattan project, and I think that's an understatement.

Your being from the West, and my being from the West, you know out there people talk about schools are supposed to do things on their own and not get help from the Federal Government, that type of thing.

Secretary BELL. Right.

Mr. REID. Now, it seems to me in your statement that you gave to us—and I have read it closely—that this appears to be one of the areas where you feel the Federal Government should assist local school districts; is that right?

Secretary BELL. I think, in research and development, I don't see any good reason for the States to independently develop computer software of the complexity and the expense of developing it, the time required to develop it, that would meet the criteria that I mentioned. So I think in that type of an area that possibly we could play a role. I put it ahead of many other areas where I think that maybe I wouldn't identify that as significant a role as this. I think we need to be very careful, Mr. Reid, that we not determine or in any way dictate the content of the curriculum. I just feel that our coordinating effort and our working with, say, a consortium of State education agencies, and university people, and our funding a major effort to develop software would be helpful.

Just as an example, based on my own experience—and this is a lengthy response, but I think it's significant. In my years in education, I found that more students stumble and fall and become discouraged on algebra than on any other subject. Maybe some of the committee members can get a little tug when they hear that word "algebra." We have students that decide they don't want anything more to do with math and they want nothing more to do with physics and chemistry because it involves math and the use of algebra, because of the bad experience that they have there. I am convinced that we could develop, for the benefit of millions of young people that hit that hurdle and stumble, if we could develop a super software package just for algebra that would meet the criteria that I outlined here. Maybe there are better criteria than that; but I do feel that those principles ought to be incorporated.

Now, that's a very complex job, to do that for a full year program in algebra. I think we would salvage many youngsters, who are very bright and very able, but have felt well, they just don't have mathematic aptitude, when they probably didn't have an instructor with the patience, and the very brightest ones went on, and someone who maybe was a B or a B-plus or a B-minus student, stumbled on algebra and got turned off by it.

I think that's the great potential of this machine. It can repeat endlessly. It can't lose its patience at my slowness in learning. It'll come back and go over it again and again. We get this branching capability here. If I need much, much more detailed explanation, Mr. Reid, and you were quick and bright and went right through it, it would take care of our needs accordingly. Now, that problem, and the teaching of algebra, as basic as algebra is, I think we could do it with one good, well-funded, major super software development project, and we would save the taxpayers a lot of money.

That's a long-winded answer to explain why I think that in this software development that we can play a significant role. But even there, all the time I would be wary about how the Feds start muscling into the content of curriculum.

Mr. REID. Do you think the Federal Government should be involved in assisting school districts in purchasing, through block grants or otherwise, equipment, computer equipment, both hardware and software?

Secretary BELL. I believe that we had ought to make it possible, make it optional, for schools to utilize our Federal resources for that purpose—if they want to do it. Now, some school districts have a lot more money because of the nature of the school finance formula on the State level. Some of them have more money for purchase of equipment than they do for other items, like teachers' salaries and other areas. So I would not want a rigid role so that if in Nevada, for example, the school districts there had ample capital expenditure money and equipment money, that they were hurting in another area, that they wouldn't have the flexibility. That's why I like the block grant.

We know that much of the chapter 2 block grant, the Elementary Secondary Education Act, is going in to equipment purchase. I appreciated what Representative Schneider had to say about—and also Mr. Skeen—about the wealthy school district and the availability of computers in this regard. Maybe our Federal funds can

help a little bit in equalizing that. But I wouldn't want to see a categorical program that would compel you to spend your money on—your Federal money—on computers if you had another priority. I would rather that be decided on the local level.

Mr. REID. But don't we always have a problem there, especially legislatures having the trouble they do negotiating contracts with the teachers? The reason categorical grants have been given in the past is so that the school districts don't have the pressure applied to them to give the money to salaries as compared to programs for computers or other such things.

Secretary BELL. Yes. To be very plain about it, if the money is on the bargaining table, it is harder to get it for this purpose. I'm aware of that. I have felt that the broad purposes for which you can use chapter 2 are still not so broad that it puts it on the bargaining table. So I think it's an area where we can help on it.

I do know of some State legislatures that are making appropriations now to provide computer hardware. I think we're going to be hardware wealthy and software poor. I think we're there now. We really need to develop this software, and we need to solve this problem, if this committee can help us to figure out how to do it, so that when we develop a piece of software, a great program that will really teach youngsters, that we can use it on the IBM and the Apple and the TRS-80 and Texas Instruments and the Atari and all the rest of them.

That's the problem now. They're all buying different computers and we can't utilize them. Imagine the chaos we would have—I know it's a little bit of a yukkie analogy—if you had to find a filling station for Fords if you were driving a Ford. You would have to zip around and find one for a Plymouth if you happened to be driving a Plymouth. I know that's a simplistic statement and it's an unfair comparison in some ways, but in other ways it isn't. We need more compatibility. We can never solve it totally, but there is not enough going on there in my opinion among the computer manufacturers. How we get them together and help it is the big question.

Mr. REID. Thank you, Mr. Chairman.

Mr. VOLKMER [presiding]. The Chair now recognizes the gentleman from New Mexico for 5 minutes.

Mr. SKEEN. Thank you, Mr. Chairman.

Secretary Bell, I think that your statement was a very prudent one and it brings to my mind—and I like your terminology, "yukkie analogy."

You know, we hype ourselves on programs in education because we're probably the most interested nation in the world in the quality and type of education, but we also love to hype ourselves.

Secretary BELL. Right.

Mr. SKEEN. If it gets a lot of publicity, if it gets a lot of recognition, why we go like a herd of turtles off in every direction with the programs.

The yukkie analogy I was talking about is that some years ago we had a great program back in the late fifties, early sixties, that we were going to change the whole educational process with visual aids. We did very well with it, and we spent an awful lot of money on visual aids. We've got warehouses full of visual aid equipment

in and around schools, for the same reasons that you talked about, a lack of prudence on where we're going and compatibility and so on. But we put an awful lot of money in those programs, and I hope that we don't go the same route.

I think that your approach indicates that we are trying to be prudent, that we have learned a lesson. We're not only good about providing for educational systems in most cases, but we also learn from some of the mistakes we made in the past.

You mentioned chapter 2, the Education, Consolidation Improvement Act, and I wonder if you might—and that some of these funds have been used at present at the discretion of the school districts. Is there specific language in there that has to do with reference to purchases of microcomputer equipment, or could you expand on the use of these funds?

Secretary BELL. Yes. The language is broad enough so the school districts can use it for that purpose. Indeed, I think that we're getting—there is probably more money spent, being spent, on the computer area than any other. As Representative Schneider indicated, there is a great deal of momentum in Rhode Island in this direction. So they can use it for that purpose if they want to.

But it is such a broad statutory authority that you could also, if you had a large number of handicapped children that weren't being served, you could take some or all of your chapter 2 money and use it there. It's very broad and flexible. I think that's why the school districts like it.

A lot of Federal money, you have difficulty using it because of the restrictions on it. This particular statute gives a lot of discretion to the school board. Many express concern about that because they feel that the authority is too broad. But I haven't felt that. I think the best wisdom rests on that level.

Mr. SKEEN. What you're saying is, leave the flexibility and the options and the decisionmaking to the local level again, but still have a broad enough umbrella for some kinds of aid programs, such as chapter 2, to allow them that discretion, but also to allow them to expand their program and progress with their program if they want to use it that way. I couldn't agree more with that approach.

I think, as you say, a lot of our Federal programs have so many specific strings to it, and the question is, how specific is the language. So many times around this body, we become so enamored with our own authorship of these things that we write provisions in that are a hindrance rather than a help.

Thank you very much, Mr. Secretary. I have enjoyed the conversation with you.

Mr. VOLKMER. The Chair now recognizes the gentlelady from Rhode Island.

Mrs. SCHNEIDER. I, too, was very interested in your testimony, Dr. Bell, and delighted to hear that you have been very seriously trying to cope with some of the more difficult challenges in developing an appropriate program.

The Carnegie report recently came out—and I don't know if you're familiar with it—

Secretary BELL. Yes, I have read that.

Mrs. SCHNEIDER. But it suggested that Federal funds be used to establish a Technology Resource Center, centers, rather, all around the country, and the purpose would be to demonstrate some of the new technology that is available. I just wondered what you thought of that specific proposal.

Secretary BELL. Yes. That proposal—maybe the author wasn't aware that Congress mandated, under the National Institute of Education—which incidentally, Mr. Skeen, is headed by one of your colleagues, Manual Justiz, a very able NIE director—but we are directed there, Representative Schneider, to fund a Center for Instructional Technology. And since there hasn't been a center in that area, we are also instructed to locate it in the New England part of the country. But it is supposed to be a national center.

Mrs. SCHNEIDER. But there will only be one center?

Secretary BELL. Yes.

Mrs. SCHNEIDER. I see.

Secretary BELL. We have some national centers in our network of laboratories and centers. We have regional laboratories, and then we have centers. This Center on Instructional Technology will be—we're in the process of awarding that contract at the present time. I think that will make a fine contribution, if we can fund it and coordinate its activities, so it will meet the needs that we're so interested in.

Mrs. SCHNEIDER. The Carnegie report also suggested the establishment of a National Commission on Computer Instruction to evaluate some of the software that is being done. This would be something separate and apart from the technology resource centers.

Have you thought about establishing such a commission within the Department of Education, rather than leaving that job to the legislative branch?

Secretary BELL. I have contemplated that. Of course, as you know, I appointed a National Commission on Excellence in Education. We are in the process now of disseminating those results around the country. We are holding 12 regional forums and have—we have held 9 of them and have 3 more to go.

Following that, we're going to have a national conference, and we will be examining this problem along with others at that national conference that we plan to hold in early December. At that time we hope to learn from Governors and State legislators and chief State school officers and local school boards and others what they're planning to do and what initiatives they plan to take, and at that time we're going to do our best to get some central coordination.

It may be that we will want to establish some entity, like this one suggested. We'll be looking at that further and listening to their recommendations in December. Hopefully by then your hearings will be over and we'll have the benefit of what this committee thinks also, which I will welcome very much.

Mrs. SCHNEIDER. I also share your feeling that legislation is not necessarily the best route to solving our problems, and certainly not the speediest, whereas through the administrative angle you could certainly, I would think, pull together some of those solutions. So we'll be happy to be working with you on that.

Secretary BELL. I would emphasize that hearings like that, that highlight the problems, even if you don't mark up and write a bill afterward, you do a great deal of good for the rest of us. That's why I commend the subcommittee for their foresight and leadership on this area.

Mrs. SCHNEIDER. Excuse me. Let me ask one final question.

You did mention that you felt the Federal Government did have a role in funding the R&D insofar as computers were concerned.

Secretary BELL. Yes.

Mrs. SCHNEIDER. The Office of Technology Assessment had made some recommendations recently and they suggested that the Federal funds should be used for the direct acquisition of computers by schools, and also to subsidize some of the software development. I just wondered what your opinion was in those recommendations.

Secretary BELL. If you had flexibility in the legislation—What concerns me is, when we pass legislation on education, that we need to be aware that every year—and you all know this; I just say it for emphasis—every year the legislature meets, they receive a message from the Governor, they receive a proposed budget, and bills are introduced, and each of the 50 States have their own framework of school finance. And many of them will have a lot of emphasis on computers, and others will have no emphasis. So if we have it flexible enough, so that if—and most legislation that is written lets each State have their pro rata share of the funds. And if a State already has, because of State legislation, a very rich and adequate program in the area of acquisition of computer hardware, that then they would have flexibility to use this on inservice training of teachers and acquisition of software. It is that sort of flexibility that I would plead for.

It is hard to fashion 1 Federal shoe to fit 50 different State feet, if I can use that analogy, and all the States are so different and every year they're adding to the school finance formulas. We need to, I believe, respect the autonomy and the major responsibility of the States to meet their needs, at the same time that we try to supplement and encourage and provide leadership and direction on the Federal level.

Mrs. SCHNEIDER. Well, I can certainly relate to that response, because I, too, share the value and importance of local governments making such decisions. But I think we get back to the equity issue, and I think that if there is concern on the national level, and if this administration is dedicated to changing the way things are, then it seems to me that some of those guidelines may have to be mandatory and there may have to be some strings attached in order to provide that kind of equity, almost the same kind of situation that we find with providing equal access to education for the handicapped or something of that sort.

I'm not sure that's the solution, but I think, you know, perhaps there really must be some kind of national role in that decision.

Secretary BELL. I would acknowledge that an equity problem is emerging, and it is going to relate to the have and have-not homes with computers. Some youngsters right now have access to computers at home and some can use them in their studies, and others can't. It is going to continue to aggravate our equality and our equity problems. The low-income neighborhood schools and the low-

income children are going to be disadvantaged in this area. You're touching on a significant point there.

Now, how to formulate legislation in a way so you don't oversupply or almost overkill the problem—in some States where the State legislatures are addressing it, and they, too, are concerned about equity within their States—how you do that on the Federal level takes a lot of careful thought.

Programs with some flexibility, that still can carry out the purpose that Congress intended when you enacted it, that's the real key. I think that that's attainable. But I think you really need to enact your legislation with the maximum amount of awareness of the States' capability in that area.

Mrs. SCHNEIDER. Thank you, Mr. Chairman. I have no further questions.

Mr. GORE [presiding]. Congressman Volkmer.

Mr. VOLKMER. Thank you, Mr. Chairman.

Dr. Bell, as you know, many people in the country, and I think many parents, are concerned today about the still basic skills in our schools, the three R's.

Secretary BELL. Right.

Mr. VOLKMER. I would like to know how you view the impact of the use of computers in educational systems, impacting on those basic skills.

Secretary BELL. I believe that anything that we do, whether it is the use of computers or anything else, that disuades and swerves us away from meeting the enormous need that we have to teach English, a good command of the English language, so we have highly literate and articulate citizens, and social studies, so there is a good grasp of economics, and history, and how our Government functions, and mathematics and science, good, fundamental, basic math and science, the mastery of those basic subjects must be our first priority. Only to the extent that the computer can help in teaching those basics do I think that it also ought to be a top priority.

I don't want to denigrate the arts and the humanities. I know that that's important. But we have slipped so far in our levels of literacy and our mastery of the basics, as evidenced by the decline in the college entrance examination scores—and our National Commission on Excellence study recommends that every student, before they graduate from high school, be required to study mathematics for 3 years, science for 3 years, English for 4 years, and social studies for 3 years, and a foreign language for at least 2 years—and, incidentally, they recommend in their study at least a course, a semester course, in computer and computer literacy and an awareness.

I would just emphasize, in response to your point, that I think that we need to focus on the computer's potential for helping the teacher and strengthening the teacher's role in teaching these basic subjects. We ought to beware of side trips out into esoteric areas when we're hurting so bad for this.

It's like spending your money on dessert when you need the good, basic nutrition in your diet. That's what we need educationally. We need to be aware of any deviation in that regard.

Mr. VOLKMER. In other words, we should make sure that whatever we do in this field in the use of computers in education does not reduce the requirements on those basic skills?

Secretary BELL. My worry is that there is all kinds of software being developed in many areas that isn't fundamental to what you have emphasized and what I believe is so critical to us. Not that we ought to deny that or try to prohibit or discourage it if computer manufacturers and programmers want to do it. But I think our efforts and our focus and our goal ought to be on the basics, because we need it so badly to regain our position where we were.

Mr. VOLKMER. The next thing I would like to follow up on is the gentlelady from Rhode Island's one question, I don't believe we got a—at least I listened and I didn't hear the full answer—as to the possibility of the Federal Government, either through the technology resource centers or through a task force, a funded task force, develop software.

Secretary BELL. I think that research and development is a role that the Federal Government can play. I don't think there's any reason to duplicate that in the 50 States and in all the universities around. But we ought to, in doing that, we ought to harness that talent and those capabilities and coordinate it. So I believe that R&D in education is very important.

Right now I think top priority ought to be to develop the best software we can develop for the computers. The computer is here to stay and it's going to play an increasing part in our lives. That's why we critically need software that just does the job. So much of it isn't doing the job. As I said earlier, it's electronic page turning. You ask what could you get here that you can't get from a book, and the answer, with much of the software, is very little. Although there are exceptions to that, and I want to emphasize that. There is some good software that does a great job and meets the criteria that—some of the criteria that I was talking about in my testimony.

Mr. VOLKMER. Do you see within the Department of Education, within this coming year, a development of a—I don't care—any kind of body, to oversee or try to coordinate the development of software?

Secretary BELL. Yes, I do. I think we have a firm responsibility in that regard. And if the committee feels that way, I'd be interested in your views and your recommendations.

I think what we do ought not to be—ought not to ignore other efforts. I think it needs to be some coordination. I know the National Science Foundation has a great deal of expertise and interest, concern and commitment in this area. We need to work together to get the maximum out of every dollar—

Mr. VOLKMER. Not only development of software, but would all those entail also the possible assistance in developing appropriate courses for a computer-based course?

Secretary BELL. Right. I agree with that. We have the big problem, as I said earlier, of trying to get more compatibility with equipment, so when you get some good software, you can use it on more than one name brand.

Mr. VOLKMER. In closing, I would like to ask you to comment on whether or not you view the present utilization of computers in our

educational system as one where it is mostly just familiarization with the computer—in other words, not really a learning process of educational, except to the extent of what a computer is and how it operates, as against—in other words, learning with the computer or through the computer.

Secretary BELL. I think that much of it is getting familiar with it. There is a great deal of learning how to program the computer. I think computer programming may be important to those that want to do that, but I don't need to know how to program a computer to use it any more than I need to know how to overhaul my automobile to use it. And so I feel that we ought to be spending our resources to the maximum extent we can on developing the software and the equipment compatibility so we have outstanding programmers that will really motivate and turn students on and meet their individual needs.

Mr. VOLKMER. Thank you, Mr. Chairman.

Mr. GORE. Congressman Durbin.

Mr. DURBIN. Dr. Bell, I apologize for being a little late. I read your statement and would like to ask a question that goes back to what Mr. Reid was speaking to you about.

I sense in the last few months—I think we all do—there has been a heightened interest in this country in education, our deficiencies. The very reason we're having this hearing today, I think, is probably grounded in some of the reports that have been released across the country, and I sense what is going on here is the general agreement in reference to the problem and some genuine disagreement as to how we solve it, even though we sound to be a very unanimous group here today.

I, for one—I read with great interest, and I think with great approval, the statement that you made, about undertaking an effort similar to the Manhattan project, or NASA's space shuttle project, when it comes to developing R&D as to computer. And I think it's needed, because I think it's far beyond the proficiency of individual school districts to come up with answers to some of these large questions.

But what I also hear in your testimony is a continued reference, whether it's to funding or to stating objectives, of deferring again to the local unit and not stating national objectives and national goals, not putting our money where our interests are. How long can we afford to sit back and talk about these problems nationally without making a commitment here at the Federal level? If we had left the space program to 50 individual States, I don't know if we would have had our first orbit of the Earth, let alone our space shuttle going on today. When are we going to set these objectives and put our resources at the Federal level, as limited as they are, into some national goals that we need?

Secretary BELL. I think your point is well taken. I think as far as developing software in the R&D effort that we really need to take the lead there. I wonder to what extent we ought to prescribe and mandate by laws passed by the Congress that every student in the United States must study English for 4 years, math for 3, science for 3 and so on. That's—

Mr. DURBIN. Doctor, excuse me for interrupting, but is it not true that when we don't pursue such a mandate and don't make sure

it's done at the local level, that we in Washington bear the burden of illiteracy in the moneys we have to appropriate year after year for various programs to help people who are unable to be trained or skilled and be productive in our society?

Secretary BELL. Yes, I agree with that. But the fundamental question is do we want to reverse our time honored position—and maybe you'd say yes, indeed, it's urgent enough that we need to do that. I just raise the question, do we want to reverse our time honored position that education is primarily a State responsibility? You know, you can say there are 50 States out here going in 50 different directions. I'm aware of that problem. But education is primarily a State responsibility. And I have been meeting with Governors and State legislators and I have been reporting on this report and since then others that we've talked about and I've been saying to the States: "Look, education is to State government what national defense is to the Federal Government. It's your first responsibility." And when this country was established, the Founding Fathers, representing the States, the colonies that came to do it, they reserved for themselves the responsibility for education. So it is the big argument we always have, what's the Federal role, how much Federal direction should we give, and how much should we defer to the States.

I think we have a leadership responsibility, and I feel that I do, as the Secretary of Education. I don't feel that I have a mandate to direct and to set standards and to lay them on from Washington.

I recognize that it's an increasingly frustrating answer to give because of our concern, and I'd say, frankly, because of the failure of some of the States to meet their needs. At the present time I have been compiling an assessment of the 50 States and how they're performing in education. I can tell you—and I know you wouldn't be surprised—that the results are enormously varied. I'm trying to do everything I can.

I met with the Governors in their annual meeting up in Portland, Maine, and I am in correspondence with them and I'm on the telephone with them. There are going to be a large number of recommendations proposed to legislatures in January when the legislatures convene again. I think we're going to see an acceptance of the recommendations of our National Commission on upgrading standards.

But the States have insisted—they are very jealous of their prerogatives in the area of education. They feel that it's their arena and that we ought to help them and supplement them and strengthen them, but we hadn't ought to supplant what they're doing.

Mr. DURBIN. Thank you.

Mr. GORE. Thank you very much.

Let me just close with a couple of brief questions to try to clarify the policy questions that we have been discussing with you.

First, there is general agreement that the use of computers in education, to improve the educational process, represents a vast, unexploited opportunity; that's a given.

Secretary BELL. I should say, Mr. Chairman.

Mr. GORE. Second, perhaps the key part of the problem which must be solved before that potential is realized involves the development of good educational software.

Secretary BELL. Right.

Mr. GORE. Now, we may come to different conclusions as these 2 days of hearings proceed, but that appears to be the case at this point in the hearing.

Perhaps the best opportunity with educational software will involve interactive educational software. OK, so far so good?

Secretary BELL. Yes.

Mr. GORE. Third, you agree—I mean, the talk about Federal role and State role in prescribing standards is one thing—but you agree, if I'm not mistaken, that there should be a large Federal role in solving this bottleneck, in helping us get past this bottleneck of the lack of good educational software; is that right?

Secretary BELL. Yes; if we don't do it, it's not going to be done. So I agree with that.

Mr. GORE. OK.

Fourth, the Federal role in solving that part of the problem should be a massive role. Is that, where the Manhattan project reference is—

Secretary BELL. Yes; if we don't develop software that meets the criteria that I outlined here—and others who are wiser than I that will come before you and maybe add or correct or modify what I have tossed out here—if we don't do that, and if we don't do it by bringing together the best resources we have, we're going to continue to have fragmented effort and we're not going to realize the great potential of this artificial intelligence called a computer.

Mr. GORE. OK. Well, we've made a lot of progress, then.

Now, of course, with the fiscal problems that we have in this country, all such conclusions are subject to revision, both on Capitol Hill and in the executive branch, I know. But at least we're in agreement that that's really what ought to be done.

One of our later witnesses, Dr. Joe Wyatt of Vanderbilt University, will testify and makes an intriguing suggestion about the possibility of a Comsat model for helping private enterprise in conjunction with the Federal coordination to hurdle the high-risk barriers on the front end and set up a massive effort to solve this educational software problem.

If we happen to come back after these hearings and after our deliberations with such a recommendation, that is something you have an open mind about, is it?

Secretary BELL. I do. I would emphasize to you that we have a research arm now, called the National Institute of Education. It's an embattled agency in our Department. Part of the problem is the resources that NIE gets, the funding is already categorized. We have a large number of laboratories and centers that are out there that are autonomous bodies, and we have to fund them first. When we get through, we have precious little left. So I'm not saying that we need—if we could use the money that we have, we'd be a lot—a long ways toward it.

Mr. GORE. Maybe we went two steps forward and then one back—

Secretary BELL. Really, we had ought to use and we had ought to have the authority to use the resources that we have more effectively.

Mr. GORE. Well, I don't want to get into the current controversy about the NIE. I support the NIE. I don't want to get into the controversy about that. I think this is really a different subject.

Secretary BELL. Well, you see, Mr. Chairman, whatever it is, and whatever entity it is—and if it isn't NIE, it ought to be something else—but we ought to have research in education and about teaching and learning. I have had this argument inside and outside the administration, and I've had a lot of it. We ought to have research about teaching and learning just as we have research in the health area for the National Institutes of Health and like we have NASA and their massive R&D efforts.

We can just do a lot more than we're doing to make our teaching and learning more effective—and we spend \$230 billion out there on education. That's the price tag for this year. Three out of every 10 people in the United States are involved in education as their full-time endeavor, either as students or employees. You take kindergarten through graduate school, public and private institutions, 30 percent of the people in this country are involved in that enterprise. It's a \$230 billion enterprise. I have been pleading as fervently as I can for some good R&D effort, and the computer has just highlighted that necessity.

Mr. GORE. One final question from me.

Some of us have supported legislation to allow the computer hardware manufacturers to donate computers to schools around the country in an effort to increase the pace with which school systems acquire computers. Do you support that bill?

Secretary BELL. Yes; I don't have any objection to it.

Mr. GORE. OK, fine. Our fight is really with the Secretary of Treasury on that one, then.

Secretary BELL. Well, I think Don Regan is concerned about all of the—

Mr. GORE. We'll let him speak for himself.

Secretary BELL. Right.

Mr. GORE. I don't want to clutter the record, you know, with—I'm just kidding. You can complete your statement if you want.

Secretary BELL. I've had other debates. I've wanted an equivalent of the Individual Retirement Act for funding access to higher education. I've had debates with Don on that. He says we have all kinds of schemes to invade IRS and then we wonder where the revenue is.

Mr. GORE. Yeah.

Secretary BELL. So I have a little sympathy with his point of view there.

Mr. GORE. Just not on this particular bill.

Secretary BELL. Well, I guess I'm like everyone else. My pet project, you know.

Mr. GORE. Right.

I went out of turn inadvertently and didn't notice Congressman McCandless was here. He is recognized at this time.

Mr. McCANDLESS. Thank you, Mr. Chairman. I apologize to you and Dr. Bell. California's Outer Continental Shelf well drilling

took, unfortunately, priority this morning, and I don't want to be competitive.

The concern I have here—I have read your statement and you talk about the Manhattan project, and then the conversation that I was able to listen to talked about the space program and so forth. I have a little difficulty here in drawing analogies and comparisons to what it is I understand we're talking about as to the intensity or the need to proceed in that direction.

Could you just briefly elaborate on why you feel the intensity of such a program is necessary?

Secretary BELL. Well, I think to develop the kind of software, teach the basics that we talked about, the math, the science, the English and so on, it takes a big effort, not the many efforts that have been going on to develop little software units that might be the equivalent of a chapter or half a chapter in a course, but a big effort to develop a good software package.

Now, the Manhattan project analogy that I used here, I wouldn't want to have that interpreted as a plea that we need to come up with a vast sum of money. My plea is that we have some freedom to use the resources that we do have. And our hands are tied by the way our funds are appropriated to us, or we could come to grips with that.

Now, the NIE budget varies from \$48 to \$53 million. Well, that's enough for a big effort if we had some capability and some authority to coordinate what we have. So I wouldn't want my testimony to be interpreted as just coming up here and asking for a massive, big additional funding proposal. My plea is that.

Now, we have a fund called the Secretary's discretionary fund, and the only thing about the Secretary's discretionary fund is there is no discretion in it. So that's the point I'm making. I could come to grips with some of these problems. I think the committee is saying to me, "why can't you do more than you're doing," or you're implying that, and I'm saying the resources are there, but our inclination—and I sympathize with it; I know what you have to do in the House and the Senate in that regard. By the time you take care of the special interest groups that wants a piece divvied off from this and that, and they all get their hunk of it, there is little left for a large effort. That's where the Manhattan project analogy came from.

I wouldn't want you to interpret from me, Congressman, that I think we need a huge, massive new spending program. I would say, like we're trying to say to the schools now, let's do what we can do with the resources that we have. This is a high enough priority that it ought to come ahead of some of the other kind of trivial effort that's going on out in many of these areas now that we're mandated to fund.

Mr. McCANDLESS. You and I visited a high school in Whittier not too long ago, when we found something rather astounding about the improvement in the basic skills of those students and how that high school was able to arrive at that point in its history. I noted the absence of a lot of computers around and computers were not talked about as a part of the result.

I am wondering here if we're—again, I am probably repetitive— if we're saying that maybe computers are the answer to the problem of our educational system.

Secretary BELL. I think we ought to be careful about that. We have—and the reason we honored Pioneer High School in Whittier is because it's an institution that is 72 percent minority, a huge amount of poverty, and it has gone against the trend and is such a distinguished high school.

Incidentally, Congressman, those schools, 152 of them, of which Pioneer High is one, are in town today, and they are all going to receive awards and are going to be honored at the White House today. You might be interested in that. I know your colleagues from Pioneer High School in Whittier are going to be here.

But I recognize, and we ought to be careful as we emphasize the potential of the computer, that we're not saying that that's going to be the solution to all of our problems. I think it's still going to take a good solid teacher and a heavy commitment, like was at Pioneer High School, the great leadership of that principal, and many of the traditional approaches are still going to be necessary.

I guess the point in this testimony is that the computer is here, and it's going to invade our lives whether we want it to or not, and we'd ought to be bending it to our advantage and utilizing it and exploiting it to the maximum potential. But we hadn't ought to imply, and I hope my testimony hasn't implied, that we can't learn and we can't do better than we are doing with good, solid, fundamental teaching in the traditional way, because I believe that we can and I believe that Pioneer High demonstrated that to many other high schools in the country.

Mr. McCANDLESS. Thank you, Doctor.

Thank you, Mr. Chairman.

Mr. GORE. Mr. Secretary, thank you very much for getting us off to a good start in these 2 days of hearings. And we will communicate with you as time goes on. We're going to have recommendations on this subject, and we are most appreciative of your statement that you will welcome such recommendations—

Secretary BELL. I surely will.

Mr. GORE. And we will consult with you in the future as to what we find out in our exploration here.

Secretary BELL. I'll follow this hearing with great interest, more than normal, and will be interested in the recommendations of the committee.

Thank you for the opportunity to testify.

Mr. GORE. Thank you, Mr. Secretary.

Our next witness is Dr. Edward Knapp, Director of the National Science Foundation. Dr. Knapp, we are honored to have you with us today as well. We look forward to your statement. As I told Secretary Bell, the entire text will be put into the record, without objection, and if you care to summarize any portion of it, please feel free to do so. If you care to present it all, you're welcome to do so.

We are honored to have you, and please proceed.

STATEMENT OF DR. EDWARD A. KNAPP, DIRECTOR, NATIONAL
SCIENCE FOUNDATION

Dr. KNAPP. Thank you, Mr. Chairman, I will present a short summary of the testimony which is entered for the record.

I am really very pleased to be here to discuss with you a topic that has received much publicity lately, and it is also, I think, extremely important for our future—that is, computers in education.

I will describe to you some current NSF activities related to the use of computers in education, and will then present what I see as the major issues before us in the growing use of computers at all levels of education, from elementary schools through graduate school.

NSF's broad mission, as you know, was to monitor and improve the health of American science and engineering. Today, this unavoidably includes the use of computers in science and engineering and in science and mathematics education.

Because computer technology and the uses of computers have grown so rapidly in the past 30 years, we are able to contemplate possibilities for using computers in education that only the most imaginative educator or computer scientist dreamed of 30 years ago. But dreaming and doing are not the same thing. We must realistically appraise these possibilities to determine which ones are worth pursuing and then take what steps we can to incorporate the best of these uses of the computer in the classroom.

How has NSF fostered and supported the use of computers for education? NSF does not mandate the specific uses of computers in education and, in fact, NSF is not the chief source of funding for educational institutions in this or any other area. However, NSF has traditionally leveraged its expertise and money so that it has a significant impact on the way computers are used in education. To do this, NSF has supported innovations in computing equipment and materials. Some of the landmark results of this support have been the computer languages BASIC and LOGO, CONDUIT as a clearinghouse for computer software, PLATO and the software and authoring system, the Huntington II.

NSF continues to provide leadership in this area. Currently, NSF sponsors two programs concerned with computers and precollege education. One, materials development for precollege science and mathematics, is designed to enlist the best scientists and science educators in developing new or improved science and mathematics instruction materials. These new or improved materials might focus on advanced technologies such as computers and telecommunications and computer programs, software and systems, and television-based materials to improve the teaching of science and mathematics.

Much interest has been shown for another program, honors workshops for precollege teachers of science and mathematics, which is aimed at recognizing and honoring excellent precollege mathematics and science teachers and providing renewal and updating for these teachers. It is done by, first, identifying and selecting science and mathematics teachers of proven quality performance and, second, establishing workshops designed to update these teachers in important areas of science, mathematics, and technol-

ogy. Some of these workshops will cover new uses of computers in the classroom.

We will make sure at NSF that these workshops are designed so that participants will be equipped with the materials and skills necessary to teach what they have learned to fellow teachers. Because relatively few teachers can attend these workshops, we must build such a multiplier effect into the workshops we fund. Only in that way can the workshops have a noticeable impact on the quality of science and mathematics instruction in our schools.

In these two areas of precollege education, as in all areas, we call on the community of educators, scientists and engineers, to write proposals to develop materials or to organize workshops that will help improve the way science and mathematics is taught in our country's elementary and secondary schools. Our great strength at NSF is not our ability to come up with great ideas—although we do come up with some. Our strength lies in tapping the talents of people all over the country, recognizing their ideas, and then supporting those ideas with funds.

The skillful and intelligent use of computers at colleges and universities is important in educating prospective scientists and engineers. We support a number of programs that address this need. They, along with a brief summary of seven studies that have affected the way NSF is approaching its leadership in the area of computers in education, are included in the testimony submitted for the record.

I would like to describe to you one especially interesting example of interagency cooperation which serves undergraduate and graduate students in remarkable ways. A joint cooperative agreement has been established between the National Science Foundation and the Defense Advanced Research Projects Agency [DARPA], that will allow qualifying universities to use the DARPA fast turn-around very large scale integration [VLSI] implementation facility at no cost as part of a university-based research and education program. This enables selected students to design semiconductor chips, submit them in digital form over a network at the implementation facility, have them fabricated by DARPA, receive the chip in the mail in 4 to 6 weeks, and test its capabilities. This provides a special opportunity for college and graduate level students to have hands-on learning experiences in these very sophisticated technologies.

Now I would like to present some of my reflections on where we are today regarding computers and education. The use of computers in education is still in its infancy. In looking at the educational uses of computers, we must understand that the computer is only a tool—like the telephone or the typewriter—that does not replace basic thinking or work in the classroom. The computer will never take the place of teachers, whose knowledge of children and how each child learns is essential for successful education.

Even so, all Americans should have an acquaintance with the computer and how it can work for them. This is true of those people who will never write a program, as much as it is true for those who will help design computer architecture for the next generation of supercomputers. Computers are becoming a part of our lives, like the telephone, and those Americans who are not ac-

quainted with them will be as helpless as those who don't know how to dial a telephone.

While the Nation's schools are putting computers in every classroom, several areas need continual investigation. We must better understand instructional computing. We will continue to support scientists, mathematicians, engineers, and educators to develop ways to use computers as a tool in the classroom—developing programs that will actively involve students in building intuition, understanding complex ideas, and improving problem-solving abilities.

We must also continue our research on the effectiveness of computers in education at all levels. NSF supported a study which examined over 400 prototype projects investigating the use of computers in higher education. The study found that using computers to instruct in higher education improves the student performance slightly but significantly, fosters positive attitudes toward the subject being studied, and allows the student to complete specific educational tasks in two-thirds the time required for conventional teaching of the same task. The results are basically the same for instructional computing in secondary schools.

The use of computers in elementary education also promises to improve the performance of students. The degree of improvement, of course, depends upon many factors, including expertise of the teacher using the computer, whether the student is actively or passively involved with the computer, and the appropriateness of the task being performed on the computer in relation to the subject being taught. Today's hardware, including such things as intelligent video discs, uses both the student's and the teacher's time more efficiently, but we need to improve dramatically suitable applications for such hardware and teacher training.

Lack of a critical mass of quality software for computers is a serious issue that must be discussed among educators and scientists and engineers concerned about the use of computers in instruction. To encourage the development of quality software, NSF is presently reexamining its copyright and royalty policies for curriculum development to insure that what we do develop is placed into the system and can be used by schools throughout the country.

The lack of quality software is compounded by a lack of science and mathematics teachers qualified to use computers. Teacher training and retraining is vital to the effective use of this new technology in teaching. How can this best be accomplished? Meeting this challenge must necessarily involve all sectors of government. However, we believe that NSF can make a significant contribution in this area. We can encourage each State and local school district to continuously train and retrain teachers in the use of computers. We also believe the development of new course materials can be combined with teacher training to the benefit of both.

The new development of artificial intelligence techniques in computing may open the door to an entirely new level of computer use in instruction. Computers that can carry on dialog with the student and lead the students to the correct concept could revolutionize instruction in some school subjects. Unfortunately, major changes in hardware design concepts may be required to allow these artificial intelligence concepts to be applied within the classroom.

Another very important and often overlooked use of computers in schools is helping relieve teachers of much of their administrative burden. The use of computers in the classroom should also include teacher use of the computer for such mundane tasks as recordkeeping, word processing, and internal school mail. This will allow teachers to spend more time teaching which will not only improve the quality of science and mathematics instruction, but instruction in all the disciplines.

Of special concern is equity in the use of computers by all segments of society. We must use our influence at NSF to help make computers available for education to all Americans. As a society, we must take steps to insure that all students have the opportunity to learn about and use computers. Price, and the availability of small computers, are such that students should be provided computers as readily as they are provided hand calculators or textbooks in the next few years.

NSF has prime responsibility for supporting basic research in, for example, the cognitive sciences, which will aid the development of more effective materials. And again, NSF has an important role in developing exemplary programs, and in encouraging partnerships among the scientific community, government, industry, and the universities.

I am very encouraged by the grass roots concern for the condition of our system of education in the United States. And I believe NSF can further the enthusiastic and resourceful efforts of teachers, pupils, school administrators, and parents.

The age of computers is here—in our homes, in our business, in our schools, in our government. To derive the greatest benefit from computers and other new information technologies in education, we must continue to ask questions about their usefulness and analyze the ways they can best be used in the education of all of our citizens.

Thank you, Mr. Chairman.

[The prepared statement of Dr. Knapp follows:]

STATEMENT OF
DR. EDWARD A. KNAPP
DIRECTOR
NATIONAL SCIENCE FOUNDATION

BEFORE THE

SUBCOMMITTEE ON INVESTIGATIONS AND OVERSIGHT
COMMITTEE ON SCIENCE AND TECHNOLOGY
HOUSE OF REPRESENTATIVES

SEPTEMBER 28, 1983

Mr. Chairman and Members of the Committee:

I welcome the opportunity to appear before you to discuss the general topic of computers and education. Today I will give you a report on current NSF activities related to this area. I will also describe what I see as the major issues before us in the use of computers at all levels of education -- from elementary schools through graduate school.

When the National Science Foundation was formed in 1950 by an Act of Congress, it was charged with improving the health of U.S. science and engineering. Within this mission, NSF is responsible for fostering and supporting "the development and use of the computer and other scientific methods and technologies, primarily for research and education in the sciences." This broad mandate has been focused and shaped since that time, in response to the evolving needs of research and education in this country. It is especially true in the use of computers in education because computer technology and the uses of computers have grown rapidly, allowing for possibilities that only the most imaginative educator or computer scientist dreamed of in 1950.

How has NSF fostered and supported the use of computers for education? NSF does not mandate the specific uses of computers in education and NSF is not the chief source of funding for educational institutions in this or any other area. However, NSF is able to leverage its expertise and money in such a way that it will have an impact on the way computers are used in education. NSF has done this in the past by supporting educational innovations in computing equipment and materials. Among the educational developments resulting from NSF support are: the computer languages BASIC and LOGO; CONDUIT as a clearinghouse for computer software; the PLATO hardware and software and authoring system; the Huntington II software to supplement existing high school courses; the prototype demonstration of intelligent video discs; and a range of software and courseware options in science and mathematics ranging from the pre-school to college levels.

I would also like to note that many of the following witnesses today have received support from NSF when they first proposed their ideas back in the late 1960's.

NSF continues to provide leadership in this area. Currently, NSF sponsors two programs concerned with computers and precollege education. One, Materials Development for Precollege Science and Mathematics, is designed to enlist the best scientists and science educators in developing new or improved science and mathematics instruction materials. These new or improved materials might focus on advanced technologies such as computers and telecommunications as well as computer programs, software and systems, and television-based materials to improve the teaching of science and mathematics.

Much interest has been shown for another program, Honors Workshops for Precollege Teachers of Science and Mathematics, which is aimed at recognizing and honoring excellent precollege mathematics and science teachers and providing renewal and updating for these teachers. This is done by, first, identifying and selecting science and mathematics

teachers of proven quality performance and, second, establishing workshops designed to update these teachers in important areas of science, mathematics, and technology. Some of these workshops will cover new uses of computers in the classroom.

We will make sure, at NSF, that these workshops are designed so that participants will be equipped with the materials and skills necessary to teach what they have learned to fellow teachers. Because relatively few teachers will be attending these workshops, we must build such a multiplier effect into the workshops we fund. Only in that way can the workshops have a noticeable impact on the quality of science and mathematics instruction in our schools.

In these two areas of precollege education, as in all areas, we call on the community of educators and scientists and engineers to write proposals to develop materials or to organize workshops that will help improve the way science and mathematics is taught in our country's elementary and secondary schools. Our great strength at NSF is not our ability to come up with great ideas -- although we do come up with many such ideas. Our strength lies in tapping the talents of people all over the country, recognizing their excellent ideas, and then supporting those ideas.

Key Studies

Currently we are evaluating several key studies, some sponsored by the NSF, which have recently described the use of computing in education and research, and prescribed ways of using them better at all levels. These reports are affecting the way NSF is approaching its leadership responsibilities in this area. Let me describe them briefly for you.

Large Scale Computing in Science and Engineering, Peter D. Lax, Chairman. Prepared for the Department of Defense and NSF, this report calls for a long-term nationally coordinated program for the development of large scale computing. It also calls for increased

access to such computers by the scientific and engineering research community; increased research in the computational mathematics, software, and algorithms necessary for the effective and efficient use of supercomputer systems; training of personnel in scientific and engineering computing; and government-sponsored research and development necessary to design and build supercomputer systems larger and faster than those likely to arise from commercial sources.

A National Computing Environment for Academic Research, Kent K. Curtis, Chairman, and Marcel Bardou. This NSF report addresses the computational needs of science and engineering research at universities and colleges. Although still in draft stage, the report suggests a role for NSF that includes: increased NSF support for local computing facilities; NSF support for supercomputer services and access of these services for academic scientific and engineering research and education; NSF assistance in the formation and use of appropriate computer communications networks; and NSF support of academic research in advanced computer systems design and the computational mathematics necessary to improve our ability to solve problems beyond the reach of today's supercomputers.

Educating Americans for the 21st Century, The National Science Board Commission on Precollege Education in Mathematics, Science and Technology. This report recommends that NSF should lead in evaluating the progress of new technology applications, and also support prototype demonstrations, disseminate information, and support research on integration of educational technologies with curricula. It also recommends that the states establish regional computer centers for teacher education and encourage the use of computers in the classroom for both teaching and administration. It calls on top executives in the computer, communication, and information retrieval and transfer industries to develop good, economical and quick ways for school systems to use the technology.

A Nation At Risk, The Department of Education. This report concludes that high school graduates should understand the computer as

an information, computation, and communication device; use the computer to study basic school basics and for other work-related purposes; and understand the world of computers, electronics, and related technologies.

Informational Technology and Its Impact on American Education, Office of Technology Assessment. This report defines information technologies to include cable, satellite communication, digital telephone networks, broadcast technologies, computers, storage technology, video technology, video disks, and information services. It also describes the impacts these technologies have had on institutions effected by them. To better use information technologies, the report suggests that new educational technology be designed for easy integration into schools, that teachers be trained to use such technologies, that quality educational software be developed, that the long-term effects of informational technologies on learning be studied and understood, and that the cost of such technologies be analyzed. Several options for Federal action in these areas were discussed, including tax incentives for donations of computers and other information technologies to schools; subsidizing software development; directly funding technology acquisition by the schools; leadership in areas of teacher-training programs, information centers and demonstration projects; and increases in Federal support of research and development in educational technology.

Computing and Higher Education: An Accidental Revolution, Robert G. Gillespie and Deborah A. Dicaro. Funded by NSF, this report discusses the need for national goals in developing new information technologies and the importance of incorporating information technologies in our instruction in higher education. To reach these goals, the report describes actions that can be taken by industry, Federal and state government, institutions of higher education, associations, and societies. The National Science Board, in this plan, would be charged with focusing these activities such as informing the public about issues, stimulating curriculum development, training people, expanding research programs, and coordinating the

development of standards for computing in higher education.

High School: A Report on Secondary Education in America, Ernest L. Boyer. This report, for the Carnegie Foundation for the Advancement of Teaching, outlines steps that should be taken to link computers to school objectives. These steps include asking key questions before buying computers; for example: Is available software as good as the equipment? What educational objectives will be served? It advises buying hardware with an eye on the quality of compatible instructional material available; setting up a Special Instructional Materials Fund, using funds from the computer industry to develop high-quality, school-related software; training teachers to use the equipment effectively; naming a National Commission on Computer Instruction, under the auspices of the Secretary of Education, to evaluate available software; and establishing ten Technology Resource Centers on university campuses with Federal funds to demonstrate the latest technology available.

Current NSF Activities in Higher Education

The skillful and intelligent use of computers at colleges and universities is important in educating prospective scientists and engineers. NSF provides leadership in this area in a number of ways. One, the NSF-Industry/Cooperative Program for Science and Engineering Education Using Computers, is a unique cooperative effort among the Federal government, universities and five of the leading computer companies in this country. It involves 57 research teams conducting experimental programs aimed at improving science and engineering education at the 10th, 11th, and 12th grade, and at early college levels. These research teams, financed by NSF, will use over \$1 million in computer equipment, donated by these computer companies, to explore ways that computers and other information technologies can help students learn science and engineering. Grantee institutions had to provide at least a quarter of the project costs to receive the award. And in many cases local businesses concerned about the future of education donated additional money.

It is also important to note that each company which contributed equipment has also provided technical information about the equipment and expert assistance so that the computers can be used to best advantage in the projects.

NSF has supported the development of consortia to share in the high cost of developing and using innovative technologies. One example is the Computer-Aided Design and Manufacturing (CAD/CAM) Consortium for Engineering Education. This consortium develops instructional materials, case studies, and the computer programming necessary to introduce CAD/CAM into undergraduate and graduate curricula where appropriate in all major engineering disciplines and into continuing education for engineers and applied scientists. This consortium also is exploring a system for evaluating, training, and rewarding faculty for the production of educational materials in the same way faculty is now rewarded for contributions to research. NSF will then phase out its support as the consortium becomes self-sustaining.

We have another example of interagency cooperation which serves undergraduate and graduate students in remarkable ways. A joint cooperative agreement has been established between NSF and Defense Advanced Research Projects Agency (DARPA) that will allow qualifying universities to use the DARPA Fast Turnaround Very Large Scale Integration (VLSI) Implementation Facility at no cost, as part of university-based research and education programs. This enables selected students to design a VLSI chip, submit it in digital form over a network at the implementation facility, have it fabricated by DARPA, receive the chip in the mail in four to six weeks, and test its capabilities. This provides a special opportunity for college and graduate level students to have "hands on" learning experiences in these sophisticated technologies.

It also should be remembered that NSF research grants have an educational impact on the quality of college education through involvement of graduate and undergraduate students. Because of the

strong link between education and research at U.S. colleges and universities, NSF research directorates will continue to greatly influence the level of computer literacy of undergraduate and graduate students. NSF-funded research provides many opportunities for students to learn first-hand about computers and how to use them effectively.

For instance, the Chemistry Division's Instrumentation Program funds computers used by many students and faculty to carry out theoretical calculations, control experiments, and to analyze complex experimental data. Research experiences of this type develop an understanding of the strengths and limitations of computers.

The Computer Science Section has two especially excellent activities underway. One is aimed at significantly increasing the number of colleges and universities that are capable of high-quality research and education in computer science. This program has already dramatically improved the computer science activities at over a dozen schools. The other activity was the establishment of the Computer Science Network (CSNET). CSNET has opened up many new opportunities for communication among computer scientists.

These programs are important and exciting. We need to ensure that U.S. scientists and engineers are provided with as much access to the most advanced computers as their counterparts in Europe and Japan. Several recent studies and workshops have focused on the need to provide faculty and students with enhanced access to supercomputers. For this reason, I have established a special task force to define the role of NSF in improving access to advanced scientific computing resources, especially for institutions of higher learning.

Critical Issues

Now let me present some of my reflections on where we are today regarding computers and education.

The use of computers in education is still in its infancy. In looking at the educational uses of computers, we must understand that the computer is only a tool -- like the telephone and the typewriter -- that does not replace basic thinking or work in the classroom. The computer will never take the place of teachers, whose knowledge of children and how each child learns is essential for successful education.

Even so, all Americans should have an acquaintance with the computer and how it can work for them. This is true of those people who will never write a program as much as it is true for those who will help design computer architecture for the next generation of supercomputers. Computers are becoming a part of our lives, like the telephone, and those Americans who are not acquainted with them will be as helpless as those who don't know how to dial a telephone.

While the Nation's schools are putting computers in every classroom, several areas need continual investigation. We must better understand instructional computing.

We will continue to support scientists, mathematicians, engineers, and educators to develop ways to use computers as a tool in the classroom -- developing programs that will actively involve students in building intuition, understanding complex ideas, and improving problem solving abilities.

We must also continue our research on the effectiveness of computers in education at all levels. NSF supported a study which examined over 400 projects investigating the use of computers in higher education. This study found that using computers to instruct in higher education improves the student performance slightly but significantly, fosters positive attitudes toward the subject being studied, and allows the student to complete specific educational tasks in two-thirds the time required for conventional teaching of the same task. The results are basically the same for instructional computing in secondary schools.

The use of computers in elementary education promises to improve the performance of students also. The degree of improvement, of course, depends on many factors, including expertise of the teacher using the computer, whether the student is actively or passively involved with the computer, and the appropriateness of the task being performed on the computer in relation to the subject being taught. Today's hardware, including such things as intelligent video discs, uses both the student's and the teacher's time more efficiently, but we need to improve dramatically suitable applications for such hardware and teacher training.

Lack of a critical mass of quality software for computers is a serious issue that must be discussed among educators and scientists and engineers concerned about the use of computers in science and mathematics instruction. To encourage the development of quality software, NSF is presently re-examining its copyright and royalty policies for curriculum development.

The lack of quality software is compounded by a lack of science and mathematics teachers qualified to use computers. Teacher training and retraining is vital to the effective use of this new technology in teaching. How can this best be accomplished? Meeting this challenge must necessarily involve all sectors of government. However, we believe that NSF can make significant contributions in this area. We can encourage each state and local school district to continuously train and retrain teachers in the use of computers. We also believe the development of new course materials can be combined with teacher training, to the benefit of both.

Another very important, and often overlooked, use of computers in schools is helping relieve teachers of much of their administrative burden. The use of computers in the classroom should also include teacher use of the computer for such mundane tasks as record keeping, word processing, and internal school mail. This will allow teachers

to spend more time teaching -- which will not only improve the quality of science and mathematics instruction, but instruction in all disciplines.

Of special concern is equity in the use of computers by all segments of society. We must use our influence at NSF to help make computers available for education to all Americans. As a society we must take steps to ensure that all students have the opportunity to learn about and use computers. The prices and availability of small computers are such that students should be provided computers as readily as they are provided hand calculators or textbooks.

NSF has prime responsibility for supporting basic research in, for example, the cognitive sciences, which will aid the development of more effective materials. And again, NSF has an important role in developing exemplary programs, and in encouraging partnerships among the scientific community, government, industry and universities.

I am very encouraged by the grass roots concern for the condition of our system of education in the United States. And I believe NSF can further the enthusiastic and resourceful efforts of teachers, pupils, school administrators, and parents.

The age of computers is here -- in our homes, in our business, in our schools, in our government. To derive the greatest benefit from computers and other new information technologies in education, we must continue to ask questions about their usefulness and analyze the ways they can best be used in the education of all of our citizens.

Mr. GORE. Thank you very much.

I will recognize first Congressman Volkmer.

Mr. VOLKMER. Thank you very much, Mr. Chairman.

Dr. Knapp, it appears to me that NSF is already on its way of at least developing some software, is that correct?

Dr. KNAPP. Yes; we have the program on the development of materials. We have asked for proposals from universities. We are now receiving them for software development. And, of course, our system at the National Science Foundation is to solicit proposals in very broad areas, judge these in a peer review system, choose what we and the peers in that particular field feel are the best proposals, and fund those for the development of the program as outlined in the proposed that we received.

Mr. VOLKMER. So you'll do it basically by contract, not in-house, then?

Dr. KNAPP. No; we do no in-house development. It's all by grant or contract.

Mr. VOLKMER. Has there been any attempt to work with the Department of Education in development of this software?

Dr. KNAPP. We consult with the Department of Education but we have no joint programs that I'm aware of.

Mr. VOLKMER. I heard Dr. Bell mention that one of the areas, of course, in math—it seems to be a stumbling block for many of our students, and I can look back on my own history in math education, and algebra was a little bit of a problem—in development, he said, of a computer software course in algebra. Are you all looking at that in any extent?

Dr. KNAPP. It's sort of amazing. The tests show that 30 percent of the students who have graduated out of 2 years of algebra still cannot solve the simplest algebraic equation in a test. How that can be, I really do not understand that. I think the computer can be of great help in teaching of mathematics, algebra, and even more complex mathematics. I believe that there are some very innovative software programs being developed by some of our grantees and also by some people in the Department of Education to try to help this particular area of mathematics.

Mr. VOLKMER. You're looking not only in higher education levels to help with the teaching part, but also into secondary, high school?

Dr. KNAPP. And in elementary school, too.

Mr. VOLKMER. And elementary.

Thank you, Mr. Chairman.

Mr. GORE. Congressman McCandless.

Mr. MCCANDLESS. Thank you, Mr. Chairman. I have no questions at this time.

Mr. GORE. Dr. Knapp, the National Science Foundation recently released a study which found a disturbing gap in access to computers in schools which is beginning to appear between economically advantaged and disadvantaged students. You also mentioned this issue in your testimony.

How do we get a handle on this problem? First of all, how serious do you believe it is?

Dr. KNAPP. There certainly is a gap. Secretary Bell mentioned the gap in the access to computers in the home, between the afflu-

ent and the less affluent sections of our society. I don't see how we directly approach that particular problem, but as far as the schools are concerned, I feel that the cost of computers and computing equipment is coming down rapidly enough that even relatively poor school districts will be able to afford good computing equipment within the next few years.

I think, as Secretary Bell said, I think the problem in the next few years will not be access. The problem—because the costs for computer equipment has been dropping at an absolutely incredible rate for the last 30 years, and it has shown no sign of changing that drop—the problem will be in having developed the proper software programs for the computer and having access for all people to the software to use on the equipment which will be available.

I think both the Department of Education and the National Science Foundation have a very strong role to play in developing software and getting it disseminated throughout our school systems and to the general public in such a way that it is inexpensive and is available to all people.

Mr. GORE. Do you support the legislation to modify the tax credit given to computer manufacturers in order to speed up the introduction of these computers in the schools? Have you had a chance to look at that?

Dr. KNAPP. I do not have a position on that. I take more or less the position of Secretary Bell. I really am not a fiscal expert and I think the arguments about that are really that of problems of taxation.

I do support the encouragement of the donation of equipment to schools.

Mr. GORE. Now, you heard my summary at the conclusion of Secretary Bell's testimony. Did you disagree with that, No. 1, that the opportunity to be realized here is just enormous—

Dr. KNAPP. I agree with that.

Mr. GORE. No. 2, that the most serious bottleneck involves the availability of excellent educational software?

Dr. KNAPP. Yes, I believe that.

Mr. GORE. A second bottleneck, I guess, would be teacher training problems; you would add that, would you not?

Dr. KNAPP. Yes; I would add that.

Secretary Bell, I think, indicated that he felt that the computer was as a tool and that the teacher training was not as important as the development of quality software. I would say that in certain applications, particularly in science and mathematics, that teacher training is extremely important, too.

Mr. GORE. Yeah.

Third, there should be a Federal role in getting us past this bottleneck, particularly where educational software is concerned; do you agree with that?

Dr. KNAPP. Yes; I think our programs address that.

Mr. GORE. Yes; and do you agree that the opportunity is so great, and the problems to be solved are so serious, that we really should be thinking in terms of a large project approach? We've heard Manhattan project as a phrase used several times. Do you think that we ought to be gearing up for a major effort in this area?

Dr. KNAPP. My own personal opinion is that—I have seen for the last 30-some years the individual grant proposal from universities being funded on the basis of peer review work in the National Science—the way the National Science Foundation does it—and I would hope that we would have an expanded program. But I would like to keep the flexibility that that kind of a funding program has in the system, so that, in fact, new ideas can be responded to, ideas that don't necessarily come from Washington, ideas that come from the people doing research in educational areas, in the cognitive sciences, in mathematics and science, that we can have a response to this problem which is very flexible and which allows both of the agencies who are involved with this, the NSF, the Department of Education, and other agencies, to have the flexibility to do what appears to be the consensus as the best approach at the time.

I would echo Secretary Bell's comments about the problem of restriction to the agencies by legislation of what we can do with the funds that we have.

Mr. GORE. So any Manhattan project should be funneled through the National Science Foundation?

Dr. KNAPP. Not necessarily. I would be very happy to have any Manhattan Project funneled through the Department of Education. I think we have a part to play in it.

Mr. GORE. All right, fine.

Well, let me say this. We have a vote on the floor, which is the rule on the war powers resolution concerning the troops in Lebanon, and, as a result, we are going to have to adjourn very briefly for about 10 minutes. When we return, we will have our panel on policy issues, and with the indulgence of the witnesses, we will get that panel underway in about 10 minutes.

Thank you, Dr. Knapp, for your excellent testimony.

Dr. KNAPP. Thank you, Mr. Chairman.

[Whereupon, the subcommittee was in recess.]

Mr. VOLKMER [presiding]. The subcommittee will come to order. We will now take up our third panel. We have Dr. Joe Wyatt, chancellor of Vanderbilt University; Dr. Robert Taylor, Columbia University Teachers College; and Dr. Ludwig Braun, New York Institute of Technology, Academic Computing Laboratory.

Gentlemen, all of your statements will be made a part of the record and you may review your statement or you may summarize, however you so desire. We will begin and proceed with the way your name was called. So, Dr. Wyatt, you may begin.

STATEMENTS OF DR. JOE B. WYATT, CHANCELLOR, VANDERBILT UNIVERSITY; DR. ROBERT P. TAYLOR, ASSOCIATE PROFESSOR OF COMPUTING AND EDUCATION, TEACHERS COLLEGE, COLUMBIA UNIVERSITY; AND DR. LUDWIG BRAUN, PROFESSOR OF COMPUTER SCIENCE AND DIRECTOR OF THE ACADEMIC COMPUTING LABORATORY, NEW YORK INSTITUTE OF TECHNOLOGY

Dr. WYATT. Thank you, Mr. Chairman. I will attempt to summarize my written statement in a way that I hope will bring more point to the action items that I have referenced in the statement.

I think it's not too strong to say that we are at a crossroads in education today, and that has been brought to our attention in several ways—the reports from various panels.

Only 2 weeks ago the National Science Board Commission on Precollege Education in Mathematics, Science, and Technology presented their report to the National Science Board. They called it an urgent message to parents, decisionmakers and other Americans.

"The Nation that dramatically and boldly led the world into the age of technology is failing to provide its own children with the intellectual tools needed for the 21st century," they said.

Last week, as if to punctuate that finding, the recent issue of *Physics Today* announcing a special issue on "The Crisis in High School Physics Education," stating that barely 3 percent of the high school seniors in this country now take physics, a 60-year low, attributable to a shortage, even an absence, of physics teachers in many secondary school systems.

My statement will focus on teachers and teaching. It will also focus on the role of computer technology and, more broadly, on information technology on teaching.

It is clear that we are involved in a revolution that compares to the industrial revolution and is moving at a pace much more rapid than the industrial revolution. It is also clear that this year's graduates of high schools will spend half a century in the workforce and 33 years of that past the 21st century.

All segments of the work force are affected. Agriculture is not gone. In fact, technology in plant genetics, which uses computer systems for its research and development, is still affected; it is still producing more food than it did a hundred years ago. So what we are seeing is productivity improvements as a result of technology.

The same basic interplay between mind, muscle, and technology that produced gains in the industrial economy is likely to be able, if we treat it properly, to produce equivalent gains in today's society. And perhaps most important, and one development that will affect virtually all technological development, is the computer. The computer, coupled with basic science, mathematics, and engineering, continues to produce a watershed of development that applies to human wants and needs in ways that alter the composition and make up of the American work force, and will continue to do so.

There are many examples of the rate at which the change has come and its pace and its implications. Certainly we have seen research and development move very rapidly from the laboratory to implementation, and biotechnology, where human insulin was produced as a marketable product last fall. The routes of that research can be traced back 25 years to basic research that was authorized by the National Science Foundation and the National Institutes of Health, and it is now a technology that promises to create new business, create new opportunities in health care, and change the society in a variety of ways.

We also have other examples. Nuclear magnetic resonance imaging is a product of computers as well as a discovery in 1946 about the resonance properties of matter, for which Messrs. Purcell and Bloch won a Nobel Prize. But it would not have been possible to produce nuclear magnetic resonance imaging even with the theory developed without the use of computer technology.

I would like to propose four action items for consideration. And let me say the reason I am proposing these specific action items is not as an exhaustive set, for there are many items on which the Congress can and should take actions. Many of these will be explained to you in testimony here and will be articulated in reports that have been and will be presented.

My menu for recommendation of action items is based on personal knowledge of these four areas, after having spent 27 years in the field of computer science, beginning with computer design, and through a plethora of applications of computer technology.

I believe that basic computer technology, along with appropriate software and expert support, must be provided to educate Americans of all ages in the use of information technologies and the application of these technologies to future human endeavor, ranging from manufacturing robots to complex models of physical science. I believe that the Congress should support a major effort in the development and testing of interactive educational software that uses the latest developments in computer, video, audio, and communication technology to provide augmented media for imaginative and innovative teaching.

This may be the most important action that can be taken relative to education, because if it's implemented correctly, it can improve the quality of teaching to individual students, improve the productivity of teaching, and perhaps, above all, add a new dimension of excitement, opportunity, and fulfillment to the profession of teaching.

I have personally developed such material for teaching in computer science, and I have personally participated in the development of such materials for several other disciplines ranging from law to medicine. These efforts and others have encouraged me to believe that the time has come for a major effort involving both public and private participants with support from the Federal Government to prime the pump for what I believe will become a major business opportunity for the next decade as well.

The scale is too large and the risks are too high for the private sector to bear alone now. I suggest a support program in the range of \$100 million per year for 5 years, and I believe that one method of financing could be a Comsat-type format which would provide a framework for public-private venture capital through a public corporation to provide cohesion and binding together the standards issues that we were discussing earlier, to underwrite individual development ventures. Major uses for the funding that I see would be to subsidize efforts by proven teachers teamed with technological experts to develop teaching material, test and refine the material, and train other teachers in its use and development. I believe the Congress should also intervene directly to provide tax incentives for donations of state-of-the-art computers and other technologies, including software, to schools, colleges and universities to support the use of such materials.

Moving to the second recommendation at the other end of the spectrum in education, I propose large-scale super-computer resources be made available to university researchers. You have already heard about this project. The current state of university computing resources for research is inferior to those in private and

Government laboratories and several of our scientists are moving off shore in order to gain access to the kind of facilities they need for their research.

The problem is described and a recommendation has already been submitted to the Office of Management and Budget through the National Science Board, the report and recommendation derived from a panel of working scientists, along with the Director of the National Science Foundation, and a group of experienced NSF research program managers, with whom I have met on a continual basis since May 1983. I suggest that you consider a funding level of \$200 million per year after the startup phases of this work, and for the foreseeable future. One of the key issues in the provision of this kind of resource is staying power, so that science and science researchers can depend on the existence and availability of this technology. These supercomputer resources need to be conveniently located geographically to the major research universities of America that is agreed upon, and they can be linked continuously by electronic communication networks to hundreds of smaller computer systems located directly in university research laboratories.

Third—and I will be brief with the following two recommendations—Congress should use its powers to eliminate unintended regulatory barriers and to encourage improvements in incentives for the development of intellectual property in those numerous areas where education and information technology are likely to yield fruit unless impeded or discouraged.

We have heard discussion this morning about standardization in the development of software, and yet, having observed a number of cases, software entrepreneurs who are willing to risk their time and their funds to develop software, they find that their only protection is trade secret protection, which, in essence, is enhanced by incompatibility and nonstandardization. We simply have to provide a framework in which we have the best of both worlds, and I don't propose to know exactly what that framework is, but I think we can have some standardization and also allow for the kind of entrepreneurial efforts that has clearly produced on an individual basis the best software.

Finally, I believe Congress should encourage and support basic research in the computer and information sciences. There is still a great deal to understand about human cognition and other fundamental aspects of human communication and learning. The paths to understanding these are not clear, but having been involved in a fledgling research program in information science and technology at the National Science Foundation over the past several years, and watched the flow of outstanding proposals from outstanding scientists in this country come to that group, it has convinced me that increased support for research in this area, information science, is both warranted and urgently needed.

I would be happy to answer any questions that you might have.
[The prepared statement of Dr. Wyatt follows:]

JOE B. WYATT
CHANCELLOR
VANDERBILT UNIVERSITY
testimony to
U.S. HOUSE OF REPRESENTATIVES
COMMITTEE ON SCIENCE AND TECHNOLOGY,
SUBCOMMITTEE ON INVESTIGATIVE AND OVERSIGHT
SEPTEMBER 28, 1983

" It is not too strong to say that America stands at a crossroads with respect to education. At this crossroads, our decisions about the direction of education are not just which curricula we choose, how we pursue the development of new knowledge through research, how we educate and motivate our teachers, or how we communicate knowledge to our students. Our decisions at this crossroads are also about which cultural values we will choose for our part of America in the future.

Forty years ago, Will Rogers made the observation that, "Schools are not as good as they used to be...but, then, they never were." Not just wry humor for us today. This Spring, the National Commission on Excellence in Education reported evidence that the average graduate of both our high schools and our colleges is not as well educated as the average graduate of 25 years ago.

Two weeks ago, the National Science Board Commission on Precollege Education in Mathematics, Science and Technology presented their report to the National Science Board. Under the heading "An Urgent Message to Parents, Decision Makers and Other Americans," this Commission's report began with a pointed indictment -- "The Nation that dramatically and boldly led the world into the age of technology is failing to provide its own children with the intellectual tools needed for the 21st Century."

Last week, as if to punctuate the various Commission's findings, the September 1983 issue of Physics Today announced a special issue on its cover with the title "The Crisis in High School Physics Education." Among other perspectives is the finding that barely 3% of high school seniors now take physics - a 60-year low, attributable in large part to a shortage, even an absence, of physics teachers in many secondary school systems.

These findings are relevant far beyond education itself since the recent declines in America's preeminence in the economic marketplaces of the world are attributed with increasing frequency to deficiencies in our education system, particularly to failings in mathematics and science. Whether or not the attributions are appropriate, the U.S. share of companies with world sales over \$1 million declined from 70 to 40 percent from 1965 to 1980. And there is a growing feeling that the

information and service based economy of the future will link in new and important ways to American education at all levels.

The generations just past, or our parents and grandparents, participated in the industrial revolution -- a revolution in which machines powered first by steam and later by electricity and fossil fuels reduced the need and therefore the value of human muscle power. Today we face the beginning of another revolution, brought on by the computer, which promises to alter the need and therefore the value for forms of human endeavor that involve not just muscle power, but also the capabilities of the mind. Our children will live their entire working lives during the computer revolution, an age in which gains are likely to come from higher quality education in an educational system that must continually evolve in response to the value of knowledge at all educational levels.

This year's high school or college graduate will spend half a century in the work force: thirty-three years past the beginning of the 21st century. No one can predict what the work place will be like then, but there is wide recognition that every one of our young people requires solid preparation for life in a high-technology society where the ability to reason and communicate in a vernacular of mathematics, science and technology will constitute the basic skills of a service and information based economy. And this is true of all students --

poor students and average students as well as those who will pursue professional careers in science.

All segments of the work force are affected. The industrial revolution did not spell the end of agriculture. Far from it. The production of food has continued to increase both in the United States and world-wide as the population has increased. The increase has been virtually monotonic over more than two centuries. What has happened over these two centuries is the improvement of productivity in agriculture through the refinement and application of various technologies. The resulting gains in productivity allow orders of magnitude more food to be produced by orders of magnitude fewer people. Future technological refinements in agriculture, perhaps most notably the field of plant genetics, continue to promise even further improvements.

The same basic interplay between mind, muscle, and technology produced similar productivity gains in the industrial economy -- orders of magnitude more production from the efforts of orders of magnitude less workers. In other words, the death of the industrial economy is not a signal of less industry or fewer products -- it is a signal of improvement in the productivity of each worker through education and the ingenious application of technology, as the most important of several factors. Perhaps the most important technological development, the one that has affected and will affect virtually all technological development, is the computer. The computer,

coupled with basic science, mathematics and engineering, continues to produce a watershed of development that applies to human wants and needs in ways that alter the composition and makeup of the American work force at all levels.

Change has been swift. In the 1940's, John Von Neumann, working at Princeton in a context established by several predecessors of prior decades, notably Turing and Babbage, conceived the stored-program digital computer, the concept on which the design of all contemporary digital computers is based. Early applications of the Von Neumann concepts using telephone relays and vacuum tubes to construct the hardware, together with programs that would be primitive by today's standards, demonstrated the feasibility of the concept in several university and industrial laboratories. In the early 1950s, the first commercial digital computers entered the marketplace from two manufacturers, IBM (the IBM 701) and Sperry Rand (the Univac I). The Forester group's invention of magnetic core memory at MIT in the early 1950s, the Shockley group's invention of the transistor at about the same time, the Noyce group's conception of the integrated circuit chip in 1959, the doubling each year of chip complexity which has enabled the microcomputer-on-a-chip; all have accelerated the development of the computer and its application well beyond original projections. Today's microcomputer is tiny, portable and reliable. It can be packaged to withstand virtually any environmental condition. Its storage capacity and its speed continue to rise rapidly and its cost continues to decline. Says

sociologist Daniel Bell of this phenomenon, "I would assume that if people in the twenty-first century look back on our time and ask 'What was the most extraordinary technological development?' the answer will simply have to be miniaturization."

The development of enabling software, the contemporary term for sets of programs for computers, poses occasional delays in the application of computers to specific problems, but the delays are only temporary. And as software is perfected to perform particular functions using a particular computer, copies can be "manufactured" and distributed at low cost.

The computer has played a dual role in the development of new science and new technology: first, as a research instrument through mathematics and engineering; second, as a primary component of implementation for specific devices. The microcomputer is accelerating both roles. As the computer has developed continuously from research and experimentation over the past four decades, it has served to join other threads of research from other disciplines to produce a watershed of technology. Consider one recent example.

At about the time the Von Neumann concepts were being formulated in 1946, Edward Purcell at Harvard and Felix Bloch, at Stanford, working independently, discovered a phenomenon called Nuclear Magnetic Resonance, a technique for probing the properties of atomic nuclei. In using the technique, hydrogen,

phosphorous, and other elements with an odd number of protons or neutrons produce a detectably different electromagnetic response to the monetary application of a strong magnetic field.

Independent developments -- including the design of magnets with stronger and more uniform magnetic fields, work in mathematics by John Tukey at Princeton led to a breakthrough in computer algorithms for Fourier transforms, and Lauterbur's experiments suggested localization of NMR signals by using field gradients, all separate threads of scientific discovery -- have now led to the technology of Nuclear Magnetic Resonance Imaging. And NMR imaging devices could not function without their high-speed, high-capacity microcomputer components.

Some of the potential effects described for NMR imaging technology include:

1. It promises to render obsolete a prior "breakthrough" medical diagnostic technology, namely the x-ray CAT Scanner, that has been deployed for less than a decade and in which billions of dollars have been invested worldwide.
2. The production and widespread application of NMR imaging may affect the job of a variety of skilled workers from physician to technician. It will at least necessitate some re-education of radiologists and will cause the

alteration of medical school curricula. It may also alter the mix of medical services including surgery.

1. The design, development, and production of NMR imaging devices and related equipment will create a multibillion dollar industry with a demand for new job skills, e.g., in the production of large, "pure" magnets and with new demands for existing job skills, and in microcomputer production. The NMR industry will produce another contest between American and foreign manufacturers for market superiority.

NMR imaging is but one example of hundreds of new developments originating in large part from University scientists doing basic research that form the basis for America's new economic development hopes.

Consider another example. A set of seemingly unrelated discoveries in biological research over the past 30 years have recently been combined to produce perhaps the newest form of "technological revolution": Biotechnology. Among its early effects was the release for sale in September, 1982, of human insulin manufactured in a process that uses recombinant DNA technology. Dozens of products from biotechnology are now under clinical or animal tests including interferon, human growth hormone, and a vaccine for foot and mouth disease. The application of recombinant DNA techniques to plant tissue is

underway. Microorganisms can now be used to produce antibiotics as well as special chemical components like amino acids. The field is so new that, aside from the dazzling success of some new business ventures like Genentech and Gigen, the future employment effects are unclear. It is clear, however, that a variety of skills in science and technology will be required of most participants in this new labor market of research, development and manufacture. It seems clear that the biotechnology industry will be a significant contributor to employment. But it is also interesting to note that many of the prototypical manufacturing processes in biotechnology are already highly automated through the use of computer technology. Perhaps more important, the research methodology of biotechnology depends heavily on the availability of sophisticated computer hardware and software technology as well as the criterion that scientist and technician alike are, in the broadest sense, computer literate.

Finally, consider a third example that portrays in historical terms, the implications of error in judgment by government, industry and organized labor about the application and use of computer technology - an education problem of major proportions. In the industrial economy of past decades, particularly prior to 1965, America was dominant in all phases of business:

1. Research and Development

2. Manufacturing
3. Marketing
4. Application and Use

During this period, a substantial part of the American work force was involved in the manufacturing sector. In the decade around 1960, from 1955 to 1965, prototype technology was developed that signaled the end of an era in mass production and many of the jobs associated with the large-scale assembly line methods of manufacturing. The two major ingredients were the computer and the machine tool. The prototype system, developed at MIT in a special project staffed from Aerospace companies and from MIT, was demonstrated in 1958. It allowed mechanical engineering designs to be represented in a new computer programming language called APT. The APT language provided commands for the mathematical definition of part geometry and for directing the path of a cutting tool within the context of the defined geometry.

Over several years' time, the computer programs were developed that would interpret the APT language definitions and instructions to produce ordered sequences of incremental motion commands for a machine tool initially positioned at a precisely defined point on a block of metal to be machined. The use of these "computer-controlled machine tools" spread rapidly throughout the American aerospace industry with the capital cost largely financed by the U.S. Government. Once the representation

of geometric form in a computer language from engineering design was linkable directly to machines that could manufacture the parts, the race to the automatic factory had begun.

In the twenty-five years since 1958, the computer-controlled machine tool methodology has been augmented by a technology called computer-aided design and computer-aided manufacture (CAD/CAM) enabled by better computer hardware and software to become today's acronym for the automated factory, FMS (for Flexible Manufacturing Systems). In March of 1983, almost exactly 25 years after the prototype demonstration of APT at MIT, a new factory employing FMS started production in Japan by the Yamazaki Company. A brief description from Fortune magazine of February 21, 1983:

"The new plant's 65 computer-controlled machine tools and 34 robots will be linked via a fiber-optic cable with the computerized design center back in headquarters. From there the flexible factory can be directed to manufacture the required types of parts -- as well as to make the tools and fixtures to produce the parts -- by entering into the computer's memory the names of various machine tool models scheduled to be produced and pressing a few buttons to get production going. The Yamazaki plant will be the world's first automated factory to be run by telephone from corporate headquarters.

The plant will have workmen, to be sure: 215 men helping produce what would take 2,500 in a conventional factory. At maximum capacity the plant will be able to turn out about \$230 million of machine tools a year. But production is so organized that sales can be reduced to \$80 million a year, if need be, without laying off workers."

The Fortune article goes on to state that such factories can typically produce in three days a number of parts that would require three months with conventional skilled workers and conventional machines. Yamazaki estimates that over five years of operation the plant will produce after-tax profits of \$12 million compared with \$800,000 for a conventional plant. This methodology also enables small volume production runs without retooling -- reprogramming the computer-controlled machines does the trick. And, of course, the products of this FMS factory are parts to produce other machines -- including other robots.

To summarize:

Compared with manufacturing technology of only a decade ago, the automated plant is 15 times more profitable, 30 times more productive and requires 10 times fewer people to operate.

History is repeating itself. Just as the work force was displaced from the farm to the factory, now it promises to be displaced from the factory. And just as technology has continued to improve farm productivity, it promises to improve factory

productivity, perhaps even more and certainly at a more rapid pace.

This time, however, most of the productivity gains can be traced to the computer, the technology that magnifies the power of both human and muscle and mind. With manufacturing employment in decline and with future employment demand in occupations relating to services, information and technology, what is the role for education in America? In considering the supply of college graduates entering the work force over the past seven years, it is interesting to note trends in the major fields of study in the perspective of the "technological age." From the total number of degrees awarded by American universities over the past seven years, the largest major field in absolute number is education; but there has been a rapid decline in this category over the past several years. The next largest category is business and management, a major field that shows a rapid increase over the same period. The next five largest fields in absolute numbers, all declining, are social sciences, letters, biological sciences, psychology and history.

Those fields with the most rapid increases are led by Computer Science (a tripling over seven years) Mechanical and Chemical Engineering (a doubling), and the Electrical Engineering group (an increase of 50 percent).

The rapid growth is in the fields where one might expect it in a "technological age." But, in absolute numbers, the total number of computer science majors in the highest year is less than the number of history majors, about one-third the number of psychology majors and only about 15 percent of the number of education majors.

For the foreseeable future, it is estimated that the demand for computer science graduates will exceed the supply by 50,000 annually. Indeed, two years ago it was estimated that a single American company had needs in excess of the entire graduating classes of computer science major at the B.S. and M.S. levels. Other data also show that in virtually all fields of study, the computer literate job applicant has the advantage in the competition for jobs. This phenomenon is also clear for people in the job market without college degrees or without high school diplomas -- a much larger number.

The problem of future employment in a "technological society" may lie in large part with the capacity of the American educational system to respond. But one measure of an inherent weakness in the capacity is the alarming drop in mathematics and science performance in the secondary schools. In addition, educational opportunities for adults are often limited, of low quality and unimaginatively structured. Curriculum reform is usually slow -- often very slow for lack of resources. The flight of outstanding teachers to better-paying jobs outside

teaching is a large problem in the secondary schools. Universities are beginning to see symptoms of similar danger. In computer science and related fields, fewer students are entering graduate school, graduate students are leaving to take jobs without completing their Ph.D.'s, and more faculty are leaving academia for industry. It is noteworthy that a recent NSF survey of faculty mobility concluded that salary was not the most compelling reason given for leaving academia -- several other "institutional disincentives," particularly relative to research resources, ranked ahead of salary. We need both resources and imagination for our educational system to respond.

Action Items

The Congress of the United States cannot come into the classroom and the laboratory. But the Congress can enable and appropriate, actions that will be necessary if we in education are to be able to succeed. Today's topic is narrowed to the benefits of computers in our educational system. Even within this framework, I cannot provide a complete list of items for Congressional action. I trust that others here will provide, in the aggregate, a rather complete menu of recommendations. I shall concentrate on three matters that I believe to be of very special importance.

1. Basic computer technology along with appropriate software and expert support must be provided to educate Americans of all ages in the use of information

technologies and the application of these technologies to future human endeavor, ranging from manufacturing robots to complex models of physical science. The Congress should support a major effort in the development and testing of interactive educational software that uses the latest developments in computer, video, audio and communication technology to provide augmented media for imaginative and innovative teaching. This may be the most important action that can be taken; because if implemented correctly, it can improve the quality of teaching to individual students, improve the productivity of teaching, and perhaps, above all, add a new dimension of excitement, opportunity, and fulfillment to the profession of teaching. I have personally developed such material for teaching in computer science, and I have personally participated in the development of such materials for several other disciplines ranging from law to medicine. These efforts and others have encouraged me to believe that the time has come for a major effort involving both public and private participants with support from the Federal government to "prime the pump" for what I believe will become a major business opportunity for the next decade. The scale is too large and the risks are too high for the private sector to bear alone. A support program in the neighborhood of \$100 M per year for five years is my recommendation. One method of financing could be

"COMSAT-type" legislation which could provide a framework for public-private venture capital through a public corporation to underwrite individual development ventures. Major uses for the funding would be to subsidize efforts by proven teachers teamed with technological experts to develop teaching material, test and refine the material, and train other teachers in its use and development. The Congress should also intervene directly to provide tax incentives for donations of state-of-the-art computers and other technologies to schools, colleges and universities to support the use of such materials.

2. "Large-scale "supercomputer" resources must be made available to University researchers. The current state of University computing resources for research is sufficiently inferior to those in private and government laboratories to the extent that important research in chemistry, molecular biology, physics, mathematics and engineering - virtually all fields of science, is being debilitated by the lack of resources. The problem is described and a recommendation has been submitted to the Office of Management and Budget through the National Science Board. The report and recommendation derived from a panel of working scientists with whom I met in May of 1983 along with the Director of the National Science Foundation and a group of exper- ed NSF

research program managers. I suggest a funding level of \$200 million per year for the foreseeable future in order to provide for fully configured and fully supported regional supercomputer resources conveniently located geographically to the major research universities of America and linked continuously by electronic communication networks to hundreds of smaller computer systems located directly in University research laboratories. The Congress should support this effort.

3. Congress should use its powers to eliminate unintended regulatory barriers and to encourage improvements in incentives for the development of intellectual property in those numerous areas where education and information technology are likely to yield fruit unless impeded or discouraged.
4. Congress should encourage and support basic research in the computer and information sciences. There is still much to understand about human cognition and other fundamental aspects of human communication and learning. The paths to understanding are not clear, but the fledgeling research program in Information Science and Technology at the National Science Foundation has convinced me that increased support for research in information science is both warranted and urgently needed.

JBW/bjt
9/27/83

Mr. VOLKMER. Thank you very much, Dr. Wyatt.

Dr. Taylor, you may proceed with your statement.

Dr. TAYLOR. I am not going to read my statement. I'm going to summarize it. The people who did not get a copy of this statement can do so after probably. There's a one-page summary on the front. In there I tried to raise the issues that I think are, basically, pertinent for education, not so much at the university level, as Dr. Wyatt was addressing us, but at the school level.

If introduced appropriately into schools, computing will transform many aspects of education. In particular, it will increase the role of graphics, force us to be more aware of the process nature of real learning, and make formal learning environments more richly interactive than books, lectures and traditional classes alone can ever be.

Computers are used in a variety of ways, but a simple classification is helpful for appreciating the implications of computing in schools. The computer can function as a tutor, a tool, a toy and a tutee. Though these uses differ sometimes markedly from each other, to profitably be incorporated in the classroom, all presuppose a teacher appropriately trained in computing. The tutee mode, involving the students in learning to program, is currently—and for some time is likely to remain—and I say that regardless of what people would like to think—the most popular mode of classroom computing. This mode, more than any other, requires a specially trained teacher, one who can function more as a coach than as a font of all knowledge, one who can accept and capitalize on the ways in which youngsters can outperform their teachers in computing.

Finally, there are major problems with using computers in the schools: The lack of really educationally appropriate hardware and software—which has also been touched upon repeatedly this morning—the lack of substantial research about how the computer helps or does not help learning—and I would second what Dr. Wyatt said about more understanding of cognitive processes, and we need research in that area; certainly that's a part of this problem—the lack of teacher training programs and opportunities for experience using computers, the inequity of access to computers and information training in our educational system, and the fact that all too much of our national funding for computing development, both direct and indirect, is focused on developing hardware and software specifically to support warfare and human destruction.

I think it's interesting that one of the examples that was brought up this morning is another defense research project. I think one can have a position about the amount of funding that goes into that kind of development along a whole spectrum, but it is quite clear that technology that is developed primarily to support that sort of thing may not be suitable for educational purposes. I think we need to bear that in mind in terms of thinking about where we want to fund things, because computers, while in some ways they are a spin off from military expenditure, it's not really true that they're completely tied to that or that they don't have a life of their own entirely. I think it's dangerous to continue to think that the spinoff from other purposes, especially those purposes, will be

sufficient to provide us with the kinds of hardware and software we need.

Well, that's a summary of what I want to say. The statement covers those points I think in some little detail. I think it also provides several references which I commend to people who need to know more about this.

I think that what I would like to focus my few remarks on is the concept of teacher training. I think that it's quite remarkable that, though it seemed clear to me and other people 10 years ago that there would have to be a major effort in teacher training in computing and education, and when I founded the program at Teachers College in computing and education in 1975, I believed, you know, that in 2 or 3 years lots of schools of education would be doing something like this.

In fact, few are. If you go around the country, you still don't see very many schools that have coherent programs in computing and education. Arthur Luerhrmann has written a recent paper—in fact, it will be published in November in the AEDS Monitor—in which he discusses some of these problems. I commend that to your attention, too, and I have cited it in there.

As he points out, the person, as I mentioned in my summary, who is going to be teaching computing—and whether we take seriously Commissioner Bell's statement that you don't need to know anything about computers except how to use them or not—I think that the teacher is going to be teaching computing and, as I said, that is the major use of computing in schools right now. That person needs to know far more about the computer than he or she currently does.

If we could draw "yukkie" analogies, I would say a "yukkie" analogy would be you take somebody who has never seen, heard, or knows anything about French, you give him a 2-week crash course, send him to Montreal for a weekend, bring him back and expect him to train people well enough to go to participate in labor negotiations in French in Southern France.

I think the possibilities are astounding in terms of what people expect will come from minimal training. Most of the people who are now teaching computing in schools, most of the thousands of people, are masquerading as something else. They're a resource coordinator or they're a math teacher, or they're something else. But, in fact, if you look at what they're doing, they're teaching computing 5 days a week, three, four, five periods a day. What kind of teaching they are doing is certainly something we ought to be concerned about.

I think that in terms of action issues with respect to teacher training, which I think is the major issue, we heard over and over again today—and you would hear it again if you had a whole series of these hearings—that people are spending the money on hardware. Schools are rushing out and buying hardware, in some cases disastrous, like they're getting cheap pets because pets are cheap, without wondering or worrying about what they're going to do with them. But in all cases, they are getting hardware when they're not really training the teachers. Most teachers are superficially trained.

What can be done about this is something that can only be done on a national level, in a sense, because the problem is too massive, with thousands and thousands of people out there, and a lack of coordination between States. When you try, as I have, to get two States to work together on something, you find that they inevitably split apart on local rivalries. They say, "Well, gee, you know, those people in New Jersey, they don't really understand our problems in New York." And if you go to Trenton, they say "well, you know, up in Albany it's a different climate. The thing that works up there won't work here." So without some sort of national coordination and national impetus in terms of training about computing, I don't think we'll make a great deal of progress.

I think that the kinds of things that need to be done in addition to the obvious ones of helping teacher education schools get on the ball is to help State governments get on the ball with respect to certification about computing. There are only five States in the United States that currently certify teachers in computing, and yet every single State in this country has got people teaching computing full time. Nobody knows what they're doing. Nobody knows if these people are competent or if what they're doing amounts to anything or not.

Moreover, we need to have some coordination with that teacher training, but also some help with States. Those people cannot supervise all that stuff with respect to certification standards and possible use of computing in schools without some help. I think that's something the Federal Government could and should think about.

In addition, I think we need to think about the greater problem of all teachers using computing. It is true, that in some ways you can use a computer without knowing anything about it. But I don't think you can use it very well, at least not in very many purposes. I think that one of the things we need to think about is that the computer is not like a car. I'm so tired of that analogy. I mean, I can drive a car, it's true; but if I get out—and I once knew a lot about cars, as many people probably did when they were youngsters—but I don't think it ever excited me intellectually to know a lot about a car. When you know a lot about a computer, though, you may begin to confront the limitations on your own thinking, and that's a somewhat different proposition. If that isn't the heart of education, I don't know what is.

So I'm a little bit reluctant to think that we want to limit people. I think some people may not want to go as far in learning to program in some classical or some far out language, but I think everybody should have an opportunity to. So one of the things I think we need to think about is how are teachers going to teach people if they haven't had this opportunity to try to do some of this stuff, too.

I don't think it's something we can do on a hit-or-miss basis. I don't think projects that have supercomputers, much though they are needed, speak to that, and I'm not sure some of the other things we've heard mentioned today speak to it, either. We need to have a comprehensive program that addresses teachers.

I don't think the whole question of software is something that we can let slide by. Software is very hard to develop; it takes a lot of

time; it takes a lot of expertise. The average teacher, no matter how well trained he or she is in computing, is not going to develop software to be used except the way they would develop their own instructional aids now in other media. But somebody does have to develop software, and if you've seen good software, whether it's tutorial software or tool software, doesn't matter. You can see that it has great educational implication. But right now, as Dr. Wyatt suggested, there is not the right kind of reward system, there is not the right kind of protection system, and in terms of specifically educational software, there is not even the right kind of impetus system. So the Federal Government needs to be involved in that.

I will stop by saying one of the things that I am always disturbed by when I hear someone from the National Science Foundation is not that they haven't done some good work and not that they haven't supported some very noble projects, but that if you go to them with a project that has nothing to do with science or math, they're not interested in it. Computing is still falling in a strange crack right now. They're interested but they can't support it because of their bylaws and guidelines.

I think we need to think about computing as a science, or as a special discipline, if you want, but also as something that permeates the whole curriculum and think about supporting it in that context as well. Those are somewhat different, just as the kind of teacher training needed to use computing versus to teach computing as a separate subject are different. But they both need to be supported. The real contribution of computing to our society through the intellectual growth of young people will only come if we support both kinds of that training, and the software and so on that's related to it.

[The prepared statement of Dr. Taylor follows:]

United States House of Representatives
Committee on Science and Technology
Testimony on Computing and Education
September 28, 1983

Robert P. Taylor
Associate Professor of Computing and Education
Teachers College, Columbia University

Testimony Summary

If introduced appropriately into schools, computing will transform many aspects of education. In particular, it will increase the role of graphics, force us to be more aware of the process nature of real learning, and make formal learning environments more richly interactive than books, lectures and traditional classes alone can ever be.

Computers are used in a variety of ways, but a simple classification is helpful for appreciating the implications of computing in school: the computer can function as (1) tutor, (2) tool, (3) toy and (4) tutee. Though these uses differ sometimes markedly from each other, to profitably be incorporated in the classroom, all presuppose a teacher appropriately trained in computing. The tutee mode, involving the students in learning to program, is currently (and for some time is likely to remain) the most popular mode of classroom computing. This mode, more than any other requires a specially trained teacher, one who can function more as a coach than as a font of all knowledge, one who can accept and capitalize on the ways in which youngsters can outperform their teachers in computing.

Finally, there are major problems with using computers in the schools: the lack of really educationally appropriate hardware and software, the lack of substantial research about how the computer helps or does not help learning, the lack of teacher training programs and opportunities for experience using computers, the inequity of access to computers and information training in our educational system, and the fact that all too much of our national funding for computing development, both direct and indirect, is focused on developing hardware and software specifically to support warfare and human destruction.

The potential impact of computing on education

In wondering what we should immediately do about computing in education, it is a good idea to consider the impact computing will have on our educational system as it permeates it. Some effects are probably unanticipatable. I would like to mention a couple we can anticipate. Appropriately incorporated into our education system, computing is likely to : (1) raise the graphic representation of ideas and information to a new level of importance relative to text, (2) help us rediscover that education is a process, (3) diminish our misconception of education as being something we can complete in some fixed period of time and then be "educated", and (4) stimulate and increase interactivity in learning.

Computing will raise awareness of understanding of graphics to a new level. Our society is obsessed with textual communication in education, and the graphical symbol manipulation as well as reading and writing. Even our tests for people going on to the next level of school test textual skills and knowledge of textually transmittable information. At Teachers College, we think this obsession with text will lessen, thanks to computers, and that graphics will assume a bigger role. Text is only one way of expressing some of the things we think about and although we have become very adept at using language, it's not always the best way to express everything. Sometimes our ideas can be augmented by expressing them with some sort of still or animated graphic representation. Now drawing, coloring, and so forth can be done so easily on computers, graphic communication will surely become more common.

The computer will help us rediscover that education is a process. Although we talk a lot about education being a process, the way we have organized our educational programs really denies it. We focus learners on the end products they must produce (the papers they must write, the overnight homework assignments they must do, and so on) and prevent them from sensing the unfolding process of learning. In using the computer to write or to program, it becomes routine to create multiple drafts or versions by refinement. The learner loses a sense that creation is simply the one-shot translation of a bright idea into a finished essay or program. He or she begins to see education and creation naturally as a process.

Integrating computers into education may also get rid of another misconception that blocks some of our thinking -- that education is something you can "get" and be done with the getting. Learning does not end, education is not something you have finished when you receive your diploma, certificate, degree or what have you. It is something that goes on and on for life. Those who have worked much with computers realize computers are going to impress the

endlessness of education upon all who use them. When you write programs, you realize that you never really finish a program completely; you sort of stop at some point and decide that this is as far as you really want to go although you can see other possible refinements. When you use the computer as an instrument to write papers, letters, books and so on, you have the same feeling: you could revise a little bit more, but finally you run out of energy or time, you've got the main idea down, and so you just stop there. As you develop successive drafts, you can't escape sensing that writing is a process. (Students also discover that writing is not a magic gift that some people have and some don't. They find they can write, if they work at it.)

At Teachers College, probably because we have put communication and computing in the same department, we see computing as a new medium. Though it has been around for almost 30 years, it has only been around a decade or so in terms of vast numbers of people using it. As the Canadian scholar Marshall McLuhan stressed, the prior medium becomes the content of the new medium. So novels became the content of movies, movies became the content of television, and books and television have become the content of computing. He also suggested that only the artist saw ahead to where a medium was going and tended to use it creatively the way it generally emerged at the end. I think that we have not reached a point in computing where we see too clearly what the final content of computing is going to be. If I were to try to characterize it at this point, I would say that it is going to be interactivity.

Educational use of the computer will feature its interactivity, because that is what makes computing different from TV, books, and lectures. The ability to let the user (and that very term implies more than the term 'reader') interact with the material embodied in the software, especially graphically, makes computers entirely new. The user can bring her or his own interests and will to bear in using the computer, and in doing so, becomes a more active learner. Even the best lecturer can only handle a few questions in a given period and only then can give evaluative responses to only a few of the questions. A book can interact with the reader only at the most general imaginative level and can not prompt and respond accordingly. TV tends to be graphical but can not (without being computer-driven) allow the viewer to navigate backward or forward and sideways through the ideas it embodies at all.

Interactivity provides direct access to information. This too seems to make learning with computers highly interesting. The user of a piece of software can go directly to a set of information he or she is interested in and skip the parts that are not of interest. This is like skipping around in a book, except that the computer can

provide clues to where to skip to, based on previous use or the current user's questions.

For example, this document can not allow you, the reader, to ask it any questions at all. It can only hope to anticipate some of your questions by the format and nature of the information it displays. If it were computer-based, it might ask you several questions and use the answers to decide what to display. Even more significantly, it might allow you to ask questions and use those questions themselves to determine what to display.

This direct access can even be to a piece of graphical information such as an animated sequence of a ball (in physics) rolling down a hill and accelerating, or graphical and aural information such as the display (in traditional musical staff notation) of a tune and the sound of two alternative harmonizations of that tune. By allowing you to interact with and manipulate the process being displayed or demonstrated, it can make learning about it more personal and interesting.

Based on another of McLuhan's ideas, that electronic communication generally is moving us toward a global village, I think interactivity in computing will probably bring back some of the things we recognize anthropologically as characteristic of primitive societies. We will communicate via computing across great distances, but informally, much as our ancestors did face-to-face. This tendency is visible in the way people use electronic mail, computer talk systems, and electronic conferencing. In fact, the informality and immediacy evident strongly suggests that computer communication will significantly alter the way we read and the way we write generally, though it is still too early to predict exactly what alterations will occur. And finally, through interactivity enhanced by interconnecting computers over cables, phone lines and electromagnetic communication channels of various kinds, computers may make our schools places where children cooperate more and realize their interdependence on others.

How computing is used in the school

The computer in the school suggests four ways or modes in which the computer can be used in school: (1) as tutor, (2) as tool, (3) as toy, and as (4) tutee. This framework is a simple and convenient way to summarize the way computers are being used in schools.

First, the computer can be used as a tutor, to teach the learner a specific topic or subject. In tutor mode, the software that the learner uses is designed to guide that learner through a sequence of material much as a human tutor might, by questioning and reacting to the learner's responses to the questions.

Second, the computer can be used as a tool, to help the learner perform some specific task. Commonly available examples are : text-editing software such as that used for word processing, statistical analysis packages, musical synthesizer control software, financial spread-sheet and projection software, energy-use monitoring software, and so on.

Third, the computer can be used as a toy, to simulate or represent a physical situation or the behavior of some people or objects. Using computers in the toy mode, a learner can gain experience analogous to that which could be gained from the real situation, without the potential endangerment, confusing complexity, horrendous expense or inaccessibility associated with that real situation.

Finally, the computer can be used as a tutee, or student for the human learner to teach. Tutee mode presupposes that teaching someone else is a good way to learn and that the learner should therefore act as a teacher. To do so, the human learner must first learn an appropriate computer language and then use it to 'teach' the computer how to do something or to teach the computer how to teach another human to do something.

Because there has not till quite recently been much tutor, tool or toy software available, teachers and administrators have concentrated on using computers to teach programming, in BASIC, LOGO, or some other language. Historically a convenient way to introduce subject matter into the school curriculum has always been to introduce a new course and schedule it as part of the school day or week for some segment of the school population. The result here has been that the dominant way of introducing computing into the curriculum has been as a course (or a mini-course) in programming, at one or more grade levels. The school has evidence it is keeping up with the times, and can meet the demand for introducing computing with minimal disruption to the rest of the curriculum. This has implications for teacher training - it guarantees there will be a lot of untrained (in computing) teachers, manning these courses.

The computing-oriented teacher's role

The dominant concept of the teacher's role in the classroom is illustrated by the arrangement of the typical classroom : the teacher's desk marks the front of the room and faces a roomful of pupil desks, all respectively oriented to face the teacher and ignore or minimize the presence of fellow students. Learning is the private, individualized acquisition of facts dispersed from book and teacher, directly to each child. The teacher is the commander, the leader, the giver of information, and, most significantly, the most knowledgeable individual in the class room. Under this model, teachers are supposed to know

more than their pupils. This is evident in the comments teachers make when teaching a topic for the first time, when they talk about "keeping a day ahead of the kids".

This model does not work in the computer-oriented classroom. There the teacher can't keep a day ahead of even modestly able pupils unless the teacher keeps them away from the computer altogether, an increasingly unlikely option as the number of computers in the home continues to escalate. Instead, it is not unusual for the able teacher to find the children rapidly outpace her or him in every aspect of computer competence, despite heroic efforts to keep up. The teacher is no longer the primary dispenser of facts (at least about computing) and falls to second, third, or even further down the line among the classroom's population in this respect, and pupils begin to cooperate and learn from each other.

By contrast with the situation in other subjects, in computing the children have no doubt about their superiority. Whereas with other subjects the teacher might claim to have some vaguely unspecified but superior experience and background in the subject which the children can't really test, what the teacher knows and doesn't know about the computer is constantly demonstrated in the classroom.

There is another, well-known and accepted model of teaching that fits the computer-oriented classroom much better: the model of the vocal or athletic coach. In that model, the coach never expects to be able to keep up with, let alone outperform, the good students. Instead, the teacher as coach expects to spur them on, suggesting new approaches and warning against excesses, fully expecting the best students to outdo anything he or she could. This is particularly true of the older coach whose voice or athletic powers have long since faded to mediocrity.

This is exactly the model the new computer oriented teacher should emulate. The major reason for the superiority of the children in computing is the superiority of their memories over those of adults. Children learn vast amounts quickly by interacting with the computer and remembering everything, while adults forget vast amounts and try desperately to locate what they've forgotten by thumbing through manual after manual. Here the teacher must be realistic. He or she can only help the children by being a coach, not a font of all knowledge.

The implications for teacher training are significant. The teacher must know enough about computing to be secure with the knowledge that he or she will not keep pace with his or her students, in many respects. And the teacher must know how to function in this relatively new, coach role, and must know when that role is appropriate and when it is not.

Major problems with computer use in school

There are major problems confronting computer use in schools in 1983 and the years immediately ahead. First, and most critical, there is a need, across the country, for teachers to be provided with training on computers and in being a good coach. Second, research is desperately needed either to support or refute some of the claims and counterclaims now being propounded about the benefits and dangers of using computing extensively in schools. Third, hardware and software that are especially appropriate for children and education are still very scarce. Fourth, there is a very great need to minimize inequity with respect to computing in schools. Fifth, too much of our national funding for computing development is focused on developing hardware and software specifically to support warfare and human destruction.

The first major problem in using computers in education is that most teachers are not computerate (computer literate). Most were trained before computers were seen as significant to education, so most never had any formal training in computing. Those who do know something either taught themselves or took a single course or workshop on either (1) computer literacy, (2) BASIC, or (3) LOGO, typically from someone who herself or himself was only minimally competent in computing.

Research as yet indicates very little about what computers should be doing or what they are capable of encouraging or preventing in the learner. More research is certainly needed on the longer range effects of computing on the learning of other skills, both positively and negatively. Most important of all, research is needed to see how learning might be structured differently when principle communication and interaction is with a dynamic medium like a computer rather than a static one like a book.

Hardware now available is not particularly well designed in terms of the needs of human users, especially young ones. Screens are too small and often too hard to read, keyboards are the dominant input means supported even though other devices are far easier for most people to use, memory is still so limited as to preclude the design of really supportive software, and so on. Software typically lacks imagination and often aims at what is easiest to produce rather than at what is most needed by the learner.

Fourth, there is likely to be an unequal distribution of teacher training, of being studied and of profiting from research in various ways, and of getting hardware and software, appropriate or not. Nowhere is the pattern clearer than with what we already see about who gets and uses computers. Those buying and filling their schools with computers are those who in our society are already

relatively wealthy and powerful.

Finally, many of our brightest minds in computer science are being paid directly or indirectly by the federal government to develop systems tailored not to discover and nourish human intellectual development and critical reasoning power, but to annihilate them. The kinds of interfaces, peripheral devices and software needed for these two so opposite purposes are quite different. What is developed can not, and will not ever be interchangeably useful.

Immediate implications

There is no ideal solution to the problem of getting computing most usefully into our schools. Any solution though will involve money, a reordering of national priorities, and a massive teacher training effort. Developing coherent training for teacher education faculty in all our colleges and universities, public and private, certainly would be an excellent place to begin. Supporting and implementing efforts that develop more appropriate software and hardware for educating all our young people would be an important correlative. I urge you to press forward in support of both tasks, as swiftly as you can.

Selected references

Luehrmann, Arthur and H. Peckham. Computer Literacy. New York: McGraw-Hill, 1982.

Luehrmann, Arthur. "A Nation at Risk - Implications for computer science education." AEDS Monitor, Nov 83.

McLuhan, Marshall. Understanding Media: The Extensions of Man. New York: McGraw-Hill, 1964.

Papert, Seymour. Mindstorms. New York: Basic Books, 1980.

Poirot, James, James Powell and Robert Taylor. "Computing competencies for teachers." Proceedings of the Second National Educational Computing Conference, Norfolk, Va, June 1980.

Taylor, Robert P. (editor) The Computer in the School. New York: Teachers College Press, 1980.

Elementary and Secondary Schools Subcommittee/ ACM Curriculum Committee, Interim Report. Topics in Instructional Computing. New York: ACM SIGCUE and ACM SIGCSE, 1983.

Mr. VOLKMER. Thank you very much, Dr. Taylor.
Dr. Braun.

Dr. BRAUN. Thank you very much.

I would like to make some remarks that supplement my formal testimony. In the first place, I would like to underscore the importance of the Federal role in this field.

There are several reasons that I think the Federal role is an important one. In the first place, the States individually have not developed the leadership in this area which is necessary. With the exception of perhaps Minnesota and Rhode Island, the States have not provided leadership. The leadership has come, in fact, from local school districts rather than States.

Another reason I think the Federal role is essential is that private industry has so far been unwilling to put up the money that's required to do the research and development, for software development of the sort that's needed in education. I think that there is a need for a large amount of venture capital in developing these kinds of things. I'm thinking about capital which identifies high risk but potentially highly innovative and highly effective programs. The National Science Foundation science education directorate is largely, I think, responsible for the fact that we are all here today. In the decade of the sixties and the early seventies, the science education directorate at NSF was the principal vehicle for providing support for research and development into the applications of computers in education, and yet that science education directorate was almost wiped out 2 years ago. It's now being revived, but it was almost wiped out. I find that incredible that it happened.

All of the major developments in science education that one could point to emanated in one way or another from that kind of activity, and I think a Federal role in that is a critical one and will continue to be a critical one until there is enough profit in it for the private sector to take it over. We're not at that stage yet.

Another critical issue I think is the equity issue. There are districts which are sufficiently well to do, that they have lots of computers in their schools. There are also in the same communities lots of computers in the homes of children, so those children get a great deal of exposure to computers. In poorer districts, there isn't enough money in the district to provide computers in the schools, and there isn't enough money in the homes to provide computers in the homes. So those children are doubly cheated.

We are moving very rapidly into what people are calling the information age, and if we don't provide access for children in less well to do communities, at a significant level, then we're going to be robbing these kids of their futures and robbing the Nation of an important natural resource.

A central issue I think in this whole business is teacher training. I would like to disagree slightly with what Secretary Bell said this morning. It certainly is possible to train someone in a couple of hours how to turn a computer on and how to stick a disc in the drive, but it is not possible in a couple of hours to teach a teacher how to take effective pedagogical advantage of the computer within the learning environments of that teacher's students. That's a critical issue. If within the next 5 years, as many people are predicting, that there will be millions of computers in schools, we will have

millions of computers in schools sitting on tables with nobody using them because teachers won't know how to use them. In my opinion, within that 5-year period, we need to train the 3 million teachers who are out there in the precollege schools how to take effective advantage pedagogically of those computers.

I think there are two problems here. In the first place, in the conventional mode of training teachers at the level we're talking about, it costs about \$5,000 per teacher. So we're talking about investing \$15 billion in the conventional mode to train teachers. A second dimension of that that disturbs me is that there probably are somewhere on the order of 1,000 to 5,000 people in this country who are qualified to train teachers to use computers pedagogically. If you divide 3 million by 5,000, you come up with something like a 60-year period for doing the training in summer institutes.

In my opinion, neither \$15 billion expended nor 60 years to do the training is acceptable to us. We must do the training within 5 years, in my opinion, and we must do it in a way which is cost effective.

I think—I have done a little bit of thinking about this—actually Bob Talyor and I go back a long way together, and the two of us have thought a great deal about teacher training. My feeling is that for something in the order of \$300 million within a period of 5 years we can train 3 million teachers, if we take intelligent advantage of all of the high technology we've got. We have broadcast television, we have video cassettes and video discs; we have computers; we have print medium; we have telecommunications. If we effectively integrate all of those technologies, and pull together the best brains in this country in teacher training, we can, for a modest sum, train all of the teachers to make effective use of those computers that they will have available.

I would like to make a few comments about high-quality software. There were comments by essentially everyone this morning about the problems of high-quality software. I would like to make the discussion a little bit more concrete.

It seems to me that we need in the K through 12 domain of our educational system, over all of the disciplines we teach in schools, we need something in the order of tens of thousands of high-quality software packages. Secretary Bell pointed out this morning that there were perhaps 2,000 or 3,000 software packages. He mentioned that not many of them are high quality. I would like to make that a little bit more quantitative. The percentage of high-quality materials from among all the educational materials that exist has been estimated to be 3 or 4 percent of all of that which exists. That means we are orders of magnitude away from the numbers of materials that we need to have available.

In my opinion, it will take something on the order of an investment of \$50 to \$100 million to break the logjam that currently exists. Private publishers are beginning to look at development of educational software, but they go with the flow. They develop material that they think will sell. The material that they think will sell, unfortunately, is the kind of drill-and-practice material that Secretary Bell denegated this morning. The kind of high quality, good learning experience that many of us are looking for does not exist in a large enough quantity at the moment by a long shot, and we

need to invest—I think we don't need a Manhattan project. Manhattan projects conjure up billions of dollars in my mind. I think that we need something on the order of a \$50 to \$100 million investment in this area.

I would like to make a comment about a few pieces of legislation that I'm aware of that are currently being considered. One of them is H.R. 701 and H.R. 2417. One was introduced by Congressman Stark and the other by Congressman Wright. My feeling is that those two bills are inappropriate. They essentially propose making it possible for a manufacturer to put one computer in each school in the United States. One computer in a school is not an adequate number. In some schools, one computer just makes it 101 or 201 computers; in other schools it will change the number from zero computers to one computer. In neither case is that computer likely to have an important impact.

I personally—although I'm not an expert on legislation and have not looked in detail at it—I think that H.R. 91, which was submitted by Congressman Donnelly, looks much better to me because it addresses the equity issue. It suggests placing computers according to the economic status of the school system. That makes much more sense to me.

There are two bills in the Senate, S. 1194, introduced by Senator Danforth, and S. 1195, submitted by Senator Bentsen, and also there is H.R. 3098, submitted by Congressman Stark, which address the issue of teacher training. Again, I don't know in detail what they contain, but those are pieces of legislation that I think need to be looked at very seriously.

There was some conversation earlier today about the concept of establishing centers in various places in the United States. H.R. 1134, which was introduced by Congressman Downey, addresses that issue and proposes the establishment of centers for computers in education in various parts of the United States. Those centers in the proposed legislation would address teacher training, software development, research into the applications of computers, the paying of attention to special audiences, handicapped people, minority people and so on.

It seems to me that in some way a coalescence of H.R. 91, H.R. 1134, and H.R. 3098 and the two Senate equivalents of that makes a lot of sense for us nationally.

Thank you very much.

[The prepared statement of Dr. Braun and attachment follow:]

COMPUTERS IN EDUCATION--L. Braun, September 26, 1983

Thank you Mr. Chairman and members of the Subcommittee on Investigations and Oversight for this opportunity to express my views on the importance of computers to education and to address key issues facing our country as computers are introduced into our classrooms. I should like to start by introducing myself.

I. My Background

I am a Professor of Computer Science and Director of the Academic Computing Laboratory at the New York Institute of Technology on Long Island. For the past twenty years, I have devoted most of my energy to advising, guiding, and supporting school people in exploring applications of computers to enhance the learning environments of their students. Most of my graduate students during that period have been classroom teachers. In this effort, I have come to sense the potential of this tool, and the needs of teachers and students.

II. Are Computers Useful in Education?

This question has been debated actively for all the time that I have been involved. Until recent years, the answer was based on faith; however, more recently, solid evidence has been accumulating. That evidence is overwhelmingly positive.

Last Spring, in my capacity as a member of a Task Group of the NSB Commission on Precollege Education in Mathematics, Science, and Technology, I was asked to prepare a report on the potential of technology to improve the education of our children. I have attached that report as an appendix to this statement because it is a summary of the opinions of a group of experts in the field, because it defines educational technology, and because it identifies the research verifying the impact of computers in enhancement of learning. (The findings of Drs. Gerard Bracey and James Kulik are summarized in that report.) Finally, the Report describes a vision of the future of this new field and makes a number of recommendations regarding it. Many of these recommendations require Federal intervention.

I shall not restate the findings of the Report here. Rather, I wish to address three issues whose solutions must be found urgently, if the enormous potential that technology offers is to be realized for the benefit of our children and, ultimately, for the Nation.

III. Three Issues

I could give many examples of exciting projects involving computers in schools in the United States. In each of these examples, exciting things happened because a set of important

factors came together. There are many such factors; however, there are three which are central to the success of this tool if this success is to be widespread. These factors are: equality of access to this technology across the spectrum of children; training of teachers; and availability of large amounts of high-quality educational software. I shall address each of these factors briefly below.

A. Equality of Access

We all know that there is a large range of levels of quality in our existing educational system. Frequently, these variations are related to ethnic background, socio-economic status, or geographic location of the children involved. All of our children are part of our precious National resource. We cannot afford to waste the lives of any of these children. Yet, we are doing so every year that we permit inequality of access to technology to exist in our classrooms.

There are two dimensions of this inequality:

1. Students in economically-deprived areas do not have easy access to computers in schools, because the schools cannot afford them, nor do they have access at home because their parents cannot afford them; while students in well-off areas have many computers in school, and, frequently, have computers at home as well.

2. Students in economically-deprived areas frequently are exposed to computers only in the drill-and-practice mode, in which the student is controlled by the computer; while those in well-off communities use computers in many ways in which the student controls the computer (e.g., in programming, simulations, and the development of higher-level skills).

Taken together, these circumstances widen the gulf between the "have" and "have-not" children, which squanders a valuable National resource, and which threatens the peace and stability of our Nation as the disadvantaged are further disadvantaged by lack of exposure to the most important tool of our National future and the consequent lack of access to the new Information Age.

B. Teacher Training

The most important ingredient in a successful educational program is its enthusiastic acceptance by the teachers who must implement it. We have approximately three million pre-college teachers in the United States, almost none of whom has any understanding of the potential of computers to assist them in providing rich learning experiences for all their students. To a large extent, these teachers are fearful of computers because they don't understand them, and because they perceive them as a threat to their jobs. From present trends, it appears to be clear that, within the next five years, schools will have large numbers of computers available. It also is clear that, unless there is some large-scale intervention, most teachers will remain unprepared to use computers effectively.

The magnitude of the training involved here is staggering. The National Foundation estimates that it costs about \$50 per participant in a conventional Summer training institute. At that rate, the training bill for our teachers is about \$15 Billion, an amount we as a Nation are unlikely to commit to this endeavor, especially in the present economic climate. Further, since there are, at most, a few thousand people nationally who are qualified by training and experience to conduct such training programs, the training effort is likely to take several decades to accomplish--an unacceptably-long period.

These two simple calculations together suggest that conventional training methods are totally inadequate to address this critical problem.

Fortunately, there is a solution imbedded in the very technology which we are considering. Educational technology (computers, video, print, and telecommunications), properly used, offers us the opportunity to provide training at a financial level which we can support as a Nation, and within a time frame which is acceptably short. I would estimate that a well-designed program could be mounted for about \$300 Million (\$100 per participant) which could be delivered to teachers in every corner of our Nation, whether urban or rural, whether in a population center where there are many colleges or in a remote community hundreds of miles from the nearest college.

After years of running and participating in conventional Summer institutes and in-service programs, I am convinced that their pace is too slow.

and their cost is too high to provide a satisfactory solution to the need identified here. We must employ technology in the most innovative ways to accomplish the task within a time frame which is acceptable for our children and affordable by our adults.

C. High-Quality Software

Once we have schools equipped with large numbers of computers, and have trained the teachers to use them, we still will not have accomplished our goal of improving the education of our children, if the development of educational software continues at the present pace and level of quality. Estimates of the fraction of commercially-available software which is of good quality vary from three percent to twenty percent. This issue aside, the numbers of packages available to teachers is woefully inadequate. An elementary-school teacher should be able to choose from among hundreds of programs during a school year in order to take account of the range of topics to be presented and the range of abilities among the students in a class. There may be ten actually available--of dubious quality! If this need is multiplied by the number of years that a child is in school and by the numbers of disciplines to which s/he is exposed, the discrepancy between need and availability looms very large. We need, as a Nation, to mount a serious attack on this problem.

Conventional publishers are only now beginning to enter this field, and, in most cases, are producing products which are of inadequate quality, and which focus on drill-and-practice, rather than on the exciting applications described in Appendix B of the attached Report. It is these newer applications which offer the real promise of technology for the education of children.

We must find ways of training software developers, identifying and rewarding those who do exist, and of exploring new avenues of application of the technology as it continues its evolution.

IV. Elements of the National Solution

The Congress has begun to respond to the needs which I have outlined above, and I wish to take the liberty of commenting on some pending legislation; however, there is one important point which I must make first. The Science Education Directorate of the National Science Foundation has supported the research and development of most of the important work which has been done in this area. Some of the Staff at NSF are among the leaders, internationally, in educational computing. The NSF programs in

this area should be revitalized and strengthened. A careful review of the history of the development of educational computing would show that the role of NSF was crucial to the establishment of the United States as the world-wide leader; however, severe cutbacks of funds for these programs in recent years has caused us to lose the edge which we have had. Other nations are catching up to us, and, in some cases, are beginning to pass us.

The Congress has many bills currently before it which deal with issues related to computers in education. Although I am not competent to judge the relative merits of all these Bills, I shall comment briefly on some of these from the perspective of the remarks which I have made above.

H.R. 701 (the so-called Apple Bill) and H.R. 2417 appear to me to be inappropriate, because, although they address the critical issue of access to computers, they address this issue in a way which does not go to the heart of the equity issue. When we wish to address the problem of hunger in the United States, we do not send a steak to every family in the Nation. We identify those in need and provide food for them. Similarly, it makes sense to identify those schools which cannot afford to provide computers in the numbers needed, and to assist them in acquiring computers. The well-to-do schools will get computers without Federal assistance. It is the economically-deprived ones which need help. H.R. 91, on the other hand, appears to address this specific issue. It is the only Bill of which I am aware which does. The concept of corporate contributions is a good one. We need to enlist the support of industry, but it must be directed to the heart of the matter, rather than being dissipated in an unfocused application.

S. 1194, H.R. 3098, and S. 1195 all address the critical issue of teacher training, and, in addition, provide some tax incentives to manufacturers who donate equipment to schools. These Bills, combined with a Bill such as H.R. 91, make a serious attempt to address two of the three issues I have identified.

The only Bill of which I am aware which addresses the issue of software development is H.R. 1134 which has been introduced by Congressman Downey each year since 1980. This Bill also addresses the issues of teacher training, assistance for the handicapped and minorities, and proposes evaluation of hardware and software.



REPORT ON
EDUCATIONAL TECHNOLOGY

SUBMITTED TO
COMMISSION ON PRE-COLLEGE
EDUCATION IN MATHEMATICS,
SCIENCE AND TECHNOLOGY
JUNE 27, 1983

BY LUDWIG BRAUN

**NEW
YORK
INSTITUTE OF
TECHNOLOGY**

ACKNOWLEDGMENTS

It is impossible for me to identify, and to acknowledge all of the people who helped me to prepare this report. Clearly, all of the participants in the conference who are listed in Appendix A made important contributions.

Certain individuals made contributions far beyond what any reasonable person might expect. Among these are : Carl Berger, Karl Zinn, Norman Kurland, and James St. Lawrence, all of whom continued making comments and suggestions weeks after the conference ended; Ward Deutschman, who arranged the teleconference and kept us all going on the system; and Barbara Zengage and Lisa Sancho, who helped me a great deal in organizing the conference and in putting the report together.

I wish also to thank Dr. Matthew Schura, the President of New York Institute of Technology, who made the NYIT teleconferencing system available to our conferees at no charge. The availability of this system helped very much to keep us in contact during the formative parts of the report preparation.

Finally, I wish to thank Dr. Cecily Selby and The Commission on Precollege Education in Mathematics, Science and Technology for the opportunity to prepare this report.

Ludwig Braun

TABLE OF CONTENTS

EXECUTIVE SUMMARY

I.	INTRODUCTION	1-1
II.	EDUCATIONAL TECHNOLOGY - DEFINITION AND DOMAIN	2-1
	A. DEFINITION	2-1
	B. THE COMPUTER	2-2
	C. EDUCATIONAL TELEVISION	2-8
	E. VIDEOTEX/DATABASES/COMPUTER-BASED TELECOMMUNICATION	2-11
	F. VIDEO-DISC SYSTEMS	2-13
	G. INTELLIGENT VIDEO-DISC SYSTEMS	2-15
	H. ROBOTICS	2-16
	I. CONCLUSION	2-18
III.	EVIDENCE OF EFFECTIVENESS	
	A. EVALUATIONS OF COMPUTER APPLICATIONS	3-1
	B. EVALUATIONS OF TELEVISION APPLICATIONS	3-6
	C. EVALUATION OF AN INTERACTIVE VIDEO-DISC SYSTEM	3-8
	D. CONCLUSION	3-9
IV.	QUALITY COURSEWARE	4-1
V.	MICROCOMPUTERS IN INFORMAL LEARNING CENTERS	5-1
VI.	PROMISING FUTURE DIRECTIONS	5-1
VII.	GENERAL RECOMMENDATIONS	7-1
	APPENDIX A : Conference Attendees	A-1
	APPENDIX B : Examples of Quality Courseware	B-1
	APPENDIX C : "Effectiveness of Technology" by James Kulik	C-1

EXECUTIVE SUMMARY

The attached document reports on a conference held at the New York Institute of Technology on April 24 and 25, 1983, the purpose of which was to clarify the issues relating to applications of technology to education. These issues and the recommendations of the conferees are summarized in the paragraphs below.

EDUCATIONAL TECHNOLOGY-DEFINITION AND DOMAIN

The conferees identified six major technologies which have great potential for education in mathematics, science, and technology. These are: computers; educational television; videotex, data bases, and computer-based telecommunications; video discs; intelligent video discs; and robotics. In addition, the conferees suggested exploration of combinations of these technologies, and vigilant attention to new technologies as they emerge, to identify educational applications.

Computers are the most widely-considered technology in the current educational scene. They are used in three separate modes: learning about computers, the most-widely used application in education; learning through computers (i.e., drill-and-practice, and tutorial), the most-widely researched area; and learning with computers, the area with the most exciting potential for computer impact on learning.

Television has a great deal of potential for contributing to learning as demonstrated in the Nova series, Sesame Street, and 3-2-1 Contact, as well as the many college

courses offered on TV by colleges.

The remaining technologies considered (as well as others which just are emerging, but which were not considered in detail) have great potential for contribution to learning; however, they all are in exploratory phases of their development and have not yet had great impact on education.

EVIDENCE OF EFFECTIVENESS

Before we as a Nation bring technology into learning environments on a large scale, we must determine that there is some real value in so doing. The conferees considered that issue at some length, and found very strong evidence that computers, used in the "learning-through" mode, make significant contributions to the learning experiences of children in a variety of disciplines, and that, even though there is much less evidence in these areas of application, computers used in the "learning-about", and "learning-with" modes have a great deal to offer educators and students as well.

The published evidence on educational impact of television also is very strongly favorable, especially when it is accompanied by well-developed support documentation for teachers and students.

Unfortunately, the other technologies considered are so new, at least in education, that there is no published evidence of effectiveness. There only is anecdotal evidence in these areas.

QUALITY COURSEWARE

The conferees identified several problems related to courseware. These are:

1. The overall quality of existing courseware is very low. There are outstanding materials, but their proportions are small.
2. There is a serious problem of identifying, training, and rewarding people with talent in this area.
3. The investment cost to develop an adequate base of quality computer courseware in mathematics, science, and technology for the Nation's K-12 schools is about \$60 million, an amount beyond the levels publishers can justify.
4. There is a serious problem of obtaining reviews of courseware (computer programs, films, and video tapes and discs).

MICROCOMPUTERS IN INFORMAL LEARNING ENVIRONMENTS

Informal learning environments have several advantages over schools, including access by everyone in the community, and creation of a non-judgmental climate without the time constraints of more formal environments.

Informal learning environments include participatory museums like the Capital Children's Museum in Washington, community-based centers like Playing To Win in New York and ComputerTown USA in Menlo Park, California, and people's homes. The home may be the most powerful influence of all

these. It will be necessary for educators to develop ways of taking advantage of home computers and of developing cooperative relationships with parents in acquisition of hardware and courseware.

Home computers raise another important issue for the Nation--that of equity. Not every home will have computers. We must develop ways of ensuring equality of access across socio-economic boundaries.

PROMISING FUTURE DIRECTIONS

The conferees identified several application areas for computers, including: "intelligent" drill-and-practice; simulations as developers of procedural skills; embedded and adaptive testing; computer-controlled video discs; and computers as intellectual tools.

Problem areas identified included: identification of new school structures to accommodate the new technologies; development of incentives for creative developers; and recruitment of courseware authors.

MAJOR RECOMMENDATIONS

The conferees compiled a list of 28 recommendations for the Commission. Of these, the following are the most important:

1. Overall, the conferees see an important role for technology in enriching the educational experiences of all children, and urge the Commission to endorse vigorous pursuit of its application to the improvement of education at all levels.
2. The most critical need is to train teachers, administrators, and parents in the uses of technology in the education of children.
3. The conferees urge the Commission to support the

Downey Bill (H.R. 1134) to provide the support structures educators need.

4. The Nation must find ways of providing equality of access to the advantages of technology to all children.
5. The Federal Government has a crucial role in establishing educational technology. This includes investing venture capital in development, coordination among the states, and establishing long-term evaluation programs.
6. Business and the Military benefit from the products of our educational system, but must invest in overcoming its deficiencies when they exist. Ways must be found to bring these two groups into the development program along with the Federal and State Governments, and the educational system.

I. INTRODUCTION

At the request of the Commission on Precollege Instruction in Mathematics, Science, and Technology, a conference was held at New York Institute of Technology on April 24 and 25, 1983. The broad purpose of the conference was to prepare a set of recommendations for the Commission that would contribute to the achievement of its goals. The list of attendees and others who contributed to the development of the conference are listed in Appendix A.

The conferees considered six major topics during the meeting:

1. Definition of educational technology (in the broadest terms) and its sphere of application in education in mathematics, science, and technology.
2. Gathering of evidence of the effectiveness of educational technology.
3. Identification of examples of high-quality courseware.
4. Promising future directions for the development of applications of technology in education.
5. Identification of non-school environments in which educational technology can contribute to the education of children in mathematics, science, and technology.
6. Identification of the responsibilities of the several elements of our society in developing the potential of educational technology.

Before we consider specific recommendations, there are several general observations that should be made:

1. Educational technology is not considered by the conferees to be a panacea for all the problems of our educational system, but it can contribute significantly to its improvements.

2. The book was born in the fifteenth century, but did not impact the education of the masses until the nineteenth century. Even then, it penetrated very slowly. We had a great deal of time to develop a structure within which to use the book.

Technology, on the other hand, has played a serious role in education only within the past three decades, and the computer only for the past two. The pace of development has been breath-taking and has occurred so rapidly that there has been little time to assimilate technology into the system. This pace (an accelerating one) must be considered in any plans to take advantage of educational technology. Toffler's Future Shock is nowhere more evident than in education.

3. Computers are entering our homes at a rapid rate. For good or ill, their existence there will have an impact on our educational system.
4. There is an increasing gulf between the "haves" and the "have nots" in access to technology. This gulf must be minimized in any comprehensive plan for improving our educational system.
5. Many people still think of computers in the same way now as they did in 1968. New capabilities require new thinking!
6. The educational establishment (teachers and administrators alike) resist change with great vigor. Waterman, for example, developed the fountain pen in 1880--yet, in the late 1950s, there still were schools which used ink wells and dip pens! Such conservatism must be overcome if innovative techniques are to survive in the system.

II. EDUCATIONAL TECHNOLOGY - DEFINITION AND DOMAIN

A. Definition

Educational technology, as a term, must be defined if we are to discuss how educational technology can help our students to improve their understanding of mathematics, science and technology.

We propose the following definition:

"Educational technology is any technology that is used to create or improve learning environments."

There are a number of technologies that have been used within this context. They include:

1. Computers which are the currently dominant technology in education. We include here both microcomputers and main-frame computers--although, as the capabilities of microcomputers increase, the distinctions between the two will blur.
2. Television. Even though it has been characterized as a "wasteland," it has been used effectively in many circumstances.
3. Satellite communication systems that permit delivery of educational materials to large numbers of people over widely scattered areas. It is especially important in sparsely settled regions.
4. Telecommunications is a relative newcomer to educational technology, but holds a great deal of promise, especially in distance-learning situations.
5. The video disc is a relatively new, but potentially very valuable technology in education. It has similarities to television, but there also are important distinctions between the two that must be made.
6. Intelligent video-disc systems, the term coined by Dr. Alfred Bork, is used to identify systems in which microcomputers and video-disc systems are combined to create powerful learning environments.
7. Videotex and database systems are also important technologies.

B. The Computer

The computer is the most versatile of the technologies identified in Section A. It has the distinction compared to other technologies that it is a highly interactive medium. We shall describe briefly here the ways in which computers have been used to create learning environments:

1. Learning About Computers

Probably the widest use of the computer in our schools is in teaching programming. This application is important for several reasons:

- a. Programming ability is a marketable skill. Many jobs in the future will require some level of skill at programming.
- b. It encourages students to think algorithmically and develops problem-solving skills.
- c. It strengthens intellectual development of the learner.
- d. The process has been likened to teaching. Many teachers are aware that to really learn a subject one must teach it. Programming a computer is similar to "teaching" the computer how to solve the problem being addressed. The process requires that the student (i.e., the "teacher") understand the subject and the solution technique.
- e. Learning programming develops procedural thinking skills--skills that are important in our society, but that are poorly developed in most school settings.

2. Learning Through Computers

The major focus of research and development in educational computing (measured in effort and dollars spent) has been on drill-and-practice, diagnostic testing, and question-and-answer tutorials. This mode of computer use has several attractions:

- a. There is a body of research attesting to the effectiveness of this mode of learning compared to conventional instruction.
- b. Its familiarity to teachers, administrators, and the public make it easy to assimilate into the system.
- c. With authoring languages like PILOT, teachers are able to develop their own learning materials with relative ease, permitting them to tailor the material to the needs of their students and giving them the feeling of control and "ownership."
- d. The cost of developing materials in this mode is moderate.
- e. Because it involves a one-on-one relation between the student and the computer and because there is little need for teacher intervention during a lesson, this mode is well-suited to home-based learning.
- f. It permits each student to learn at her/his own pace.

One caution is in order at this point. Learning through the computer is a computer-controlled learning mode as compared with learning with the computer as described in the next section. Concerns have been expressed that, in our pluralistic society, poor children will learn under the control of the computer, while those in well-to-do areas will learn to control computers. This does not mean that this mode is not useful in fostering learning; however, it must be used carefully as a part of a total approach in every school system.

111

3. Learning with Computers

The most promising use of computers in learning environments, both formal and informal, is the use of the computer as a tool of instruction and an environment within which learning can occur.

This mode is the least developed of the three because it is the most sophisticated and, hence, the most difficult to implement, but it appears likely that it will be the most important area in the future.

Materials generated for this mode generally are more expensive to produce because they require a wide range of talents and expertise not found in a single individual; however, they offer rich opportunities for learning of concepts and procedural skills, as well as development of the student's intellect.

This mode has several components, including:

- a. Microworlds are cybernetic environments within which elements may be combined according to given rules. These environments permit students free rein to experiment with the environment, building a "microworld" and learning about the consequences of the rules, and developing problem-solving skills.
- b. Educational games take advantage of the interest most of us have in games to generate exciting learning environments. Sometimes games are an environment for a drill-and-practice session, which makes that session more interesting for the student, and, thus, increases student motivation to learn. Sometimes the game creates learning environments that are difficult or impossible to create otherwise.

A largely unexplored example of the latter case is the adventure game in which the student is placed in a situation that requires exploration of the environment (frequently, a cave, a castle, or forest), experimentation, problem solving, and decision making. In addition, the student develops reading and comprehension skills. Few currently available adventure games are designed with learning as the principal objective. Once their potential is uncovered, they will provide rich learning

experiences for students. Even the ones that currently are available provide such experiences, even though they were not designed with that purpose in the mind of the designer.

- c. Microcomputer-based instrumentation (in which the computer is connected to the real world through any one of a variety of transducers and serves as a data gatherer and processor and as a display generator) permits students to explore real-world phenomena without being overwhelmed by the drudgery often associated with laboratory experiments. Students in these situations will be better able to discover underlying principles. Such an approach permits students to conduct experiments at a much earlier age than usually is the case.
- d. Databases that may be accessed by the student through a computer and manipulated by the student with the assistance of the computer provide a totally new resource to learning. Already, hundreds of databases exist for professionals in many fields. Once students are given access to these databases, as well as to others especially designed with students in mind, they will be able to carry out powerful investigations in many disciplines.
- e. The computer is a powerful tool for the teacher and for the student in the study of a variety of disciplines. There are software packages, for example, that plot graphs of functions specified by the user so that relationships and properties of these functions may be visualized easily. Because of its computational power and speed, the computer allows on-line, interactive displays to be generated without the drudgery usually involved in such activities. With these tools, it is possible to ask students to explore much larger numbers of functions than is reasonable by hand.

Other exciting tools available to educators and students include:

- I. Word processing, which has been found to generate dramatic improvements in students' writing skills and attitudes toward writing, is being used by

innovative science teachers who require their students to write laboratory reports and to produce science newsletters.

II. Spread-sheet programs, which were designed originally for accounting and business-projection purposes, but which are useful also as general-purpose simulation tools for the study of population-dynamics, economic systems, and a wide variety of other dynamic systems.

III. General-purpose problem-solvers, which permit students to study phenomena for which they are ready intellectually, but for which they do not have adequate mathematical preparation.

f. Newer, special-purpose computer languages are becoming available that permit students to develop their skill in many ways not previously available. Among these are: LOGO, which is a learning environment as well as a language; TUTSIM and Dynamo, which are simulation languages that make it easy for the user to create her/his own simulations; and GrafORTE.

We can expect the introduction of many additional special-purpose languages to address needs that we perceive only dimly.

g. One of the most versatile applications of the computer is as a simulator of real-world phenomena. In this mode, the computer serves as a flexible universe within which any environment the teacher desires can be created. Systems that are inaccessible to the student because of danger, equipment cost, complexity, time scale, or experimental skill requirements become accessible.

b. Discovery learning in mathematics is a potentially fruitful, but largely unexplored application of computers. In this mode, the computer serves as a laboratory environment within which the learner can discover the concepts in mathematics that are important. Concepts like limiting processes, slope, maximum and minimum, functions, addition, and subtraction of positive and negative numbers, roots of equations (to cite just a few) are understandable to students over a wide range of mathematical abilities.

C. Educational Television

When most people think of using television for education, they think in terms of commercial TV and are appalled by the thought. This is the commonly-held view that TV is a "wasteland". In fact, viewed correctly, TV can make significant contributions to the education of our children.

Sesame Street, 3-2-1-CONTACT, and the NOVA series on PBS are just a few examples of outstanding TV-based materials which are available to educators.

Many colleges and universities in the US are offering courses via TV (either broadcast or using video tape) to groups of adults who for one reason or another, do not take courses in the normal classroom mode. According to a recently-quoted Roper study, "30 million adults say they can't find the time for formal studies and are willing to take college credit courses on television and to pay for them." As a result, PBS has formed an organization called Adult Learning Service to address this need.

TV Ontario has conducted extensive research and development on educational applications of TV. Among the applications they have identified are:

1. The development of "lots of good stories to develop a wide range of comprehension skills."
2. Development of problem-solving skills in three-to-six-year-olds through a series called Today's Special.
3. Development of vocabulary and reading skills in fourth

and fifth graders through a series called Read All About It.

4. Teaching of concepts of physics to middle-school children through a program entitled Eureka!
5. Teaching of geography in the middle schools using a series called North America: Growth of a Continent.
6. Captioned TV programs for deaf and hearing-impaired students.
7. Improving skill in a foreign language.

All of these courses were designed to be used in the classroom as well as in the broadcast mode at home. In each case, the TV series was supplemented by teacher and student booklets.

During the Summer of 1983, PBS will be running a series called "Reading Rainbow" using well-known TV personalities reading some of the best books in literature for children. The series is aimed at six-to-nine-year-olds.

Television has been used successfully since 1964 (when the University of Florida started delivering graduate electrical-engineering course work to engineers at Cape Kennedy) to deliver graduate instruction in engineering. Successful live microwave delivery of instruction is being carried out at, e.g., Stanford University, Purdue University, and Illinois Institute of Technology; while video-tape is being used at, e.g., Colorado State University, University of Arizona, Georgia Institute of Technology, and the University of Idaho.

It is clear that production of a high-quality educational TV-series is expensive, and requires spreading the cost over large groups of students; however there is no doubt that TV, properly applied, can provide a rich variety of learning experiences which are unavailable to students through more conventional means (textbooks and lectures). This is especially true in elementary-school and middle-school science courses.

E. Videotex, Databases, and Computer-Based Telecommunication

Videotex and computer-based telecommunication are techniques that use the same technology, but in very different ways. Both consist essentially of a large central computer that may be accessed from any one of a large number of remotely located microcomputers or computer terminals. In both cases, the user at her/his terminal interacts with the central computer--this interaction is a central feature of the system, in both cases. The two systems differ significantly in the character of the interaction between users and the central computer. Both systems have great potential for education, and both will be described briefly in the paragraphs below:

1. Videotex

The essential features of a videotex system are the availability to the user of a wide variety of databases and the intimacy of the interaction between the user and those databases.

Typical of commercially-available videotex systems are CompuServe and The Source. In these systems, the user may access databases containing information on: financial matters; current news items in great depth; legislative matters at state and federal levels; demographic data; consumer-oriented "catalogs"; and on a great variety of scientific disciplines. One can imagine that the videotex system will replace the encyclopedia as the information source of the future for students at all levels. It has the enormous advantage, over printed encyclopedias, that it can be kept current on a moment-by-moment basis.

2. Computer-Based Telecommunication

Computer-based telecommunication, although similar to videotex in the hardware that it uses, is very different conceptually from videotex. In this mode, the computer serves principally as a communications channel between two people, or among the members of a group (a class of students, members of a company, members of professional organizations, teachers, administrators, etc.).

The power and storage capacity of the computer are used to facilitate and enhance the intercommunication that goes on among the participants. The power of the computer is used to permit the users to do on-line editing through resident word processors and to do filing and retrieving of information in complex and flexible ways.

The storage capacity of modern computers permits intercommunication among the members of a group in an asynchronous manner--i.e., two people who wish to discuss some matter may do so even if they are not at the communication system at the same time. In that sense, telecommunication is similar to communication by mail, although the transmission time of a message is measured in seconds rather than in days, and access and retrieval of information is dramatically easier.

Telecommunication systems are potentially useful in education because they permit "education at a distance." New York Institute of Technology, for example, offers several courses in which telecommunication is an important component to students whose schedules do not permit them to come to the campus for conventional classes. The students and instructor are linked together through the school's telecommunication system and discuss points that need clarification, as well as administrative aspects of the course. In addition, the instructor is able to transmit new information to the class as it is generated, as well as to share with the entire class the work of a student who has done a noteworthy paper.

Such a vehicle has clear implications for educational situations wherever students cannot attend classes in a central location. There are at least two classes of circumstances where this is the case: in sparsely populated areas of the

United States where it is economically difficult to bring students to the teacher; and in disciplines where there are few experts. In the latter application, the expertise that exists can be made available to people over an unlimited geographical region. The training of teachers in uses of the various educational technologies and in modern aspects of their disciplines is one important example of remote instruction by telecommunication at a cost that is within reason.

An example of this approach to teacher education was cited in a recent issue (April 25, 1983) of the Department of Education Weekly. A university professor in Iowa is conducting a course for high-school physics teachers who participate in their own school laboratories. The professor communicates with the teachers through a telecommunication system. The implementation is costing the State of Iowa \$30,000 this year for all hardware and materials costs for 45 schools. Next year it is expected that every high school in the State will be connected to the system.

F. Video-Disc Systems

A video disc usually is thought of as a new medium for presenting television programs, and it certainly is that; however, it is much more. A single video disc contains 54,000 frames. These frames can consist of half an hour of motion sequences, over 54,000 individual still frames (e.g., 54,000 slides of biological specimens), or any combination of motion and still frames. It also is possible to run frames in slow or fast motion, if that is desirable pedagogically. In addition, it is possible to access any frame at random within a few seconds.

The combination of these properties provides the instructional designer with the opportunity to create a rich environment for the learner.

Despite this potential, the video disc has not yet

penetrated into the educational system because video-disc players still are relatively expensive and because the production of video-disc programs still is quite difficult.

Fortunately, these things are changing. As video-disc players become more popular with the consumer, their price will drop to the point where they will be affordable by schools, and we can expect that, soon, writeable video discs and inexpensive disc recorders will become available. In the interim, several groups in the United States are developing demonstration discs to explore the medium.

C. Intelligent Video-Disc Systems

Intelligent video-disc systems involve the combination of the strengths of video-disc systems and those of microcomputers, and, in this combination, they overcome some of the weaknesses of each.

Video-disc systems permit the display of high-resolution graphic images at moderate cost, but have the drawback that the available images are fixed in the medium (the available images have been preselected by the producer of the disc). The computer, on the other hand, can produce images that respond to the needs and wishes of the user, but those images have only limited resolution. In addition, video-disc images are available almost instantaneously, whereas computer-generated ones take a significant, and sometimes educationally-intolerable, time to generate.

Computers have very powerful decision-making abilities inherent in their structure, whereas video-disc systems have no decision-making ability. By combining these technologies, the strengths of each can compensate for the weaknesses of the other to provide an educational environment for the student which is very rich.

A learning environment that combines the capabilities of both computers and video-disc systems has been called by Dr. Bork of UC Irvine an intelligent video-disc system. Such systems can provide students with simulations of enormous power and flexibility. It is possible to conceive of an environment where a student carries out, for example, a

simulation of an ecological study in which the video-disc component provides images of the flora and fauna at many locations in a river whose pollution is being studied. The student can look at pictures of a species of organism under a microscope and compare those from one location with those from another. By transferring to a computer simulation, the student can investigate the level of pollution as a function of dumping levels and treatment technique, and, then, with the help of the computer, can go to the section of the video disc on which images of flora and fauna are shown that exist under the circumstances the simulation has generated.

Little work has been done yet to exploit the potential of intelligent video-disc systems, principally because video-disc systems themselves have not yet become widely available to schools; however, a few examples of what has been generated are:

1. The Minnesota Educational Computing Consortium (MECC) economics course produced by Dr. Richard Pollak.
2. The WICAT biology disc produced for McGraw-Hill.
3. The package produced by Quentin Carr at the Herkimer, New York BOCES on weather instruction.
4. The cardiopulmonary resuscitation program developed by David Hon, which may help to solve the problem of woefully-inadequate numbers of CPR instructors which currently exists.

B. Robotics

Robotics is a field usually associated with industry and automation. We suggest here that there are circumstances in which robots may be useful in educational settings.

One such application of robots which has gained in popularity along with the increasing popularity of the LOGO language is the Milton Bradley Big Trak "toy". In its conception, Big Trak was indeed a toy; however, imaginative teachers looking for a way to make the LOGO screen and its turtle graphics more concrete, and, hence, more comprehensible to their young students, saw in Big Trak a real-world implementation of the LOGO turtle. Big Trak is a tank with a built-in microcomputer which can be programmed by young children to maneuver over a pre-defined course--in other words, it is a simple robot, programmable by children!

Advertisements are beginning to appear offering robots which cost only about \$1,000--not cheap, but beginning to approach the range of affordability of schools. Such robots, in the hands of imaginative teachers, can provide strongly-motivating experiences for high-school students, and can prepare them for exciting industrial careers.

I. Conclusion

The technologies described in the foregoing paragraphs represent only those which currently are in use. They are only the leading edge of the technological revolution which we are about to witness. Among the technologies which we now can predict are:

1. Cellular radio in which local radio stations are linked together to cover large geographic areas.
2. Fiber-optic based communications links which will cut communication costs dramatically.
3. Enormously increased information storage and retrieval capabilities. NASA expects, by June 1984, to have available an optical disc storage-and-retrieval system with a capacity of 10 million million bits (10,000 times that of most current computer systems). With this system, it is expected that users will be able to access all the information on line.
4. Within two decades, we can expect satellite firms to provide 22,00-48,000 channels for video, voice, and other communications.
5. There have been predictions that within a decade, most homes will be wired for two-way communications.

in much the way of many homes in Columbus, Ohio with its Qube System.

6. Low-power TV stations will serve specialized audiences.

7. It has been estimated that the cost of storage of information on disc dropped below that of paper storage in 1980, and that, by 1990, it will be only one percent of the cost of paper storage. Such cost figures suggest dramatic changes in our perceptions of publications, in general. Electronic publishing surely will follow such cost reductions.

Each of these technologies and others which have not yet emerged from the research laboratories will contribute to the improvement of education in ways we cannot yet perceive.

Yet another dimension of this picture of educational technology which must be considered is the design of systems which integrate several of the individual technologies into information systems which take advantage of the capabilities of each to create a whole which is much greater than the sum of its parts.

One exciting example of this (in addition to the intelligent video disc described above) is the major series on the human brain now in development at WNET/Thirteen, in which the producers are creating a college-level psychology course to be offered in association with airing, in 1984, of

eight one-hour programs. The programs will be supplemented by a textbook being written by a group of leading scientists. In addition, a museum exhibit is planned for major cities that features an interactive video disc that will enable visitors to explore regions of the brain. Excerpts from the series, including animated simulations of neural transmission, will be distributed to high schools along with associated explanatory materials and microcomputer software.

Clearly, the extent to which technology can contribute to the education of our children is limited only by our imaginations and our willingness to commit resources.

III. EVIDENCE OF EFFECTIVENESS

It is clear to many of the practitioners in the field that educational technology has exciting potential for creating learning environments for children. Statements to that effect, however, are of no use to educational planners unless there is supporting evidence that, indeed, there is improvement in learning when the technologies described in Section II are applied. In this section, we shall look at some of the evidence that supports these contentions.

A. Evaluations of Computer Applications

Unfortunately, many of the applications of computers described in Section II have been developed only recently, and we do not have adequate data on their effectiveness. There have, however, been substantial numbers of evaluative studies of the impact of computers in drill-and-practice applications. Dr. Gerald Bracey of the Virginia Department of Education recently has issued a report entitled "Computer Assisted Instruction: What the Research Says and Doesn't Say and Can't Say About its Effectiveness" which surveys the literature on evaluation of CAI. Bracey divides the research studies into three categories: achievement; affective and motivational; and social.

This report is summarized in the paragraphs below.

1. Achievement Outcomes

Bracey cites the work of James Kulik* and his colleagues at the University of Michigan. In 51 soundly conducted studies of students in Grades 6-12,

*See Appendix C for recent paper on "Effectiveness" by Kulik

they found that CAI improved retention as well as initial results on objective tests. Students using CAI also learned to the same criteria faster than non-CAI students (with up to 88 percent time savings). An interesting observation is that later studies show a greater impact of computers than earlier ones even though research methods didn't change over the observation period.

Bracey makes the point that, in Kulik's study, the average student who received CAI would have scored at the 63d percentile, while those who did not would have scored in the 50th.

Kulik's analysis covers the academic waterfront including composition, counseling, biology, chemistry, and history.

Kulik found that the impact of CAI was greater on secondary students than on college students.

ETS conducted a four-year study of the impact of drill-and-practice on students in Grades 1-6 in the Los Angeles Unified School District. In this study, students with access 10 minutes a day scored significantly higher than those without access, and those who spent 20 minutes a day had double the gain. This study focussed on mathematics; in reading and language arts, they found consistent, if smaller, gains.

In this ETS study, drill and practice seemed to be more effective with slow learners than with average or above average learners.

2. Affective/Motivational Outcomes

Students generally report positive attitudes toward computer-based learning and enjoy the ability to move at their own pace, the lack of embarrassment about mistakes, and the absence of a teacher-to-yell at them.

Students find the computer's unending patience is important. This is especially so for slow learners and those with learning disabilities.

Bracey identifies teacher attitudes as a problem. He points out that most teachers do not participate in development of computer-based material and that a well-known management principle suggests that feeling of "ownership" is very important. Teachers, of course, do not "own" textbooks either, but this is a problem worth exploring because of the difficulty of developing courseware compared to developing a book.

3. Social Outcomes

Bracey points out that there is no "hard" research here, but that many observers have found a great deal of cooperative problem solving surrounding programming activities.

An interesting observation by Bracey is that some schools with computers have reported higher attendance and even reduced levels of vandalism since acquiring computers.

Terry Rosegrant of Arizona State University is doing research that tends to confirm the assertion that children using computers feel more in control of things.

Richard Bowman of Moorehead State University has identified 14 characteristics of video games that could be incorporated profitably into the classroom. His work is reported in:
 "A 'Pac-Man' Theory of Motivation: Tactical Implications for Classroom Instruction," Richard F. Bowman, Jr., Educational Technology, September 1982.

Thomas Malone of Xerox PARC recently has reported on the effectiveness of games on learning in a report entitled "What Makes Things Fun to Learn? A Study of Intrinsically Motivating Computer Games".

4. Cost Effectiveness

Bracey addresses the issue of cost effectiveness. He identifies the difficulty of developing good numbers in this area.

He cites flexibility, interactivity, improvement of student motivation to learn, delivery of instruction by computer that cannot be delivered otherwise, and the development of new knowledge and skills not available without computers as elements in the cost/effectiveness equation that are impossible to evaluate numerically.

Bracey cites simulation as one of the ways of providing experiences by computer that are not available otherwise. He suggests simulations involving intelligent video-disc-based systems as an exciting area for development.

Bracey mentions that 81 percent of educators in Montana say that getting and using computers is their number-one priority. He observes that: "You can't find a group of parents who would stand for their children being left out of the computer group (in any experiment)."

5. Other Observations by Bracey

Bracey ends his paper with some interesting observations including:

- a. William Cole, in a Wayne State dissertation, found that use of computers in instruction in whole numbers, percents, fractions, and decimals had increased scores in the Stanford Achievement Test.
- b. John Boblick, a curriculum specialist for the Montgomery County Schools in Maryland, found that students learned more from a simulation of conservation of momentum than those who learned in a traditional laboratory.
- c. Thomas Foster, in a dissertation at the University of Wisconsin, found that students who learned flowcharting did better in the Problem Solving Abilities Test than those who did not learn flowcharting, and that those who learned programming did still better.

In a paper entitled "Computers in Learning Environments--An Imperative for the 1980s", Dr. Ludwig Braun cites studies which show that attendance increases significantly in schools which install computers. He describes other studies which show significant learning gains as well as reductions in time needed to learn mathematics.

Finally, he cites a large number of studies of the effect of simulations on learning in which there were savings in learner time, greater efficiency in terms of achievement per unit time, improved skills, and provision of instruction not previously available by conventional means.

One of the findings of the National Assessment of Educational Progress is that problem-solving skills are poorly developed among our students. Typically, students find algebra word problems difficult to solve.

In a recent report funded by the National Science Foundation, Dr. Elliot Soloway and his colleagues at Yale University describe a research study on the effect of computer-programming experience on students' ability to solve such problems. The research is preliminary, but it shows that students who have taken a one-semester course in programming are able correctly to solve algebra word problems more reliably than are students without that experience. In some cases, the difference in correct solutions was different by a factor of two.

These results are supported by similar studies conducted by Lochhead and Clement and their colleagues at the University of Connecticut.

An important, but little-known application of computers in education is exemplified by the work of Mrs. Antonia Stone who has created Playing To Win--a non-profit organization which focusses on convicts, ex-convicts, and juvenile delinquents.

In her work, Mrs. Stone has demonstrated the value of computers with such populations. To cite just one example, she has found that 94% of internees at the Spofford Juvenile Detention Center who participate in a computer-based education program are active participants; while only 20% of those enrolled in conventional programs are active.

Playing To Win recently has established a community center in East Harlem in New York City which will have the principal objective of impacting the young people in that community through computers in positive ways so that they will continue their educations in useful ways. It is too early to tell about the success of this program; however, on the basis of her past successes, this program bears watching.

Attention must be paid to such unconventional learning environments, because they address an audience which frequently exists outside the conventional educational system. A significant segment of our population is in this group, and usually is lost to society--in fact it costs society a great deal in funds which are misdirected (into prisons, etc.), rather than being used to strengthen society.

B. Evaluations of Television Applications

There is a long tradition of application of television

to the teaching of young children by television in the well-known Sesame Street, 3-2-1 Contact, and Electric Company. The results of those efforts have been documented carefully and will not be elaborated here. We shall, however, look at a set of studies on several recently-developed TV series by TV Ontario (TVO).

TVO staff looked at programs aimed at widely-varying audiences ranging from pre-school through adult levels, and focussing on language arts, geography, science, cognitive development, and an application for handicapped children.

In this section, we shall review briefly the findings of these studies.

1. READ ALL ABOUT IT aims at fourth- and fifth-grade students, and focusses on development of reading and vocabulary skills. In this study, students in experimental classes had pre/post-test gains which were at least double those of students in the control groups.

Ninety percent of the experimental students stated that they liked the programs very much, and two thirds said they would watch the programs at home.

2. EUREKA! is a series aimed at grades 7-11 and focusses on physics. The average gain in the experimental group was 3.3, while that in the control group was 1.4. The teachers using the series in their courses were positive about the effectiveness of the materials with their students: two thirds felt that their students learned more with the TV series; while the rest felt that their students learned at least as much.
3. READALONG has as its principal objective, the development of a basic vocabulary in primary readers. The first grade students in the experimental group were found to score significantly higher on each of three tests than did the control group.
4. SUMMER ACADEMY: BRUSH UP YOUR FRENCH was a series aimed at improving the skills of adults with French.

The participants reported that the experience was worthwhile (97%); relevant to their needs (88%); informative (87%); and exciting (86%). The participation rate among enrollees was 97%.

5. CAPTIONED TV PROGRAMS FOR DEAF AND HEARING-IMPAIRED CHILDREN is a program aimed at exploring the relative effectiveness of captioned and non-captioned TV programs. The research reported dealt with 10-14 year old deaf or hearing-impaired children. The experimental group had a correct response rate of 81% compared to 59% for the control group. Further, 80% of the experimental group reported understanding all or most of the time, while only 43% of those who did not use captioning had similar responses.
6. NORTH AMERICA: GROWTH OF A CONTINENT is intended for geography classes. All the teachers using the materials agreed that the programs would be very effective if used during the teaching of a topic, when used with other support materials. The large majority of the participating students wanted to use the materials.
7. TODAY'S SPECIAL is a series whose purpose is to enhance cognitive development in 3-6 year-olds. The evaluation was a formative one, and, hence, preliminary; however, ninety percent of the test subjects focussed on the screen during quizzes when the subjects were interacting with the screen, while only half were paying attention during passive puppet-show sequences.

All of these studies show very positive effects of TV programs when they are well designed and used correctly. The audiences, in general, found the programs to be useful and interesting.

These programs were developed by a public agency of a Canadian Province. It is unlikely that such programs would be produced by private funds. This experience has been similar in the United States.

C. Evaluation of an Interactive Video-Disc System

WICAT Systems, Inc. recently reported on the results of a study of the effectiveness of an interactive video-disc

system which they designed for the U.S. Army. The system used consisted of a microcomputer controlling a video-disc player. Its purpose was to train people in the repair of missile systems.

The student population was divided into three groups: a control group receiving instruction in the normal manner; a group which received its instruction through CAI; and a group which used CAI plus video-disc-based simulations. The results were:

1. Only one quarter of the control group finished the training program before the prescribed time limit was reached.
2. Every member of both experimental groups completed the task within the prescribed time limit.
3. The group which received instruction using both CAI and simulation completed the assigned task in half the time of the CAI-only group.

The conclusion one reaches from such a study is that CAI is beneficial in instruction and that the video-disc-based simulation provides a dramatic improvement in performance of students.

D. Conclusion

The evidence cited in this section is very positive about applications of technology in learning environments over a wide spectrum of ages and subject matter. The reader must be cautioned, however, that much of the technology described in Section II has not been scrutinized adequately; indeed some forms have not received any evaluations which have been reported in the literature. Even with the computer, which has been explored as an instructional tool for about

two decades, most of the exciting applications have been conceived only recently, and have not been evaluated in even a preliminary manner.

This situation suggests an important national priority. We must evaluate carefully all of the technological applications suggested here, and to be developed in the future by innovative educators and technologists to determine which are effective and which are not. We are very likely, as a nation, to invest a great deal of money in educational technology. It is imperative that this investment be made wisely.

IV. QUALITY COURSEWARE

A serious problem faces the educator who wishes to apply computers in her/his classroom. The quality of available courseware leaves a great deal to be desired. Dr. Gerald Bracey of the Virginia State Education Department cites a recent study of some 4000 courseware packages in which it was found that only 3-4 percent were of acceptable quality. Mr. Stanley Silverman of the Hempstead School System on Long Island expresses concern because even with a careful screening process before purchase, they still wind up with "30-45 percent junk."

Clearly these problems need solution, or they will cause discouragement, and the predictions of the Luddites that computers are a fad and will soon be hidden in closets will indeed come true, even though the evidence of effectiveness of this vehicle is overwhelmingly favorable. The Commission must develop recommendations to address these problems.

One of the principal reasons for the poor quality of much of the available courseware is the lack of understanding among educators, publishers, and developers alike of the elements that go into the creation of a high-quality piece of courseware. Courseware development is a creative act which requires a wide range of talents, including:

1. Subject-matter expertise in order that there is assurance that the content of the material is correct.
2. Experience with the grade level and ability level of the target audience to ensure that the material is appropriate for the target audience.

3. Ability to design the graphics in the program and to design the screen images (e.g., proportion of the screen occupied by text, the graphic images displayed, etc.).

4. Understanding of the pedagogy needed to convey the intended concept.

5. Programming the computer to take maximum advantage of the capabilities of the target computer.

6. The system-engineering ability to integrate the several parts of the design into a coherent whole.

Rarely does this combination of talents reside in a single individual, so that courseware creation, generally, is a team endeavor. The required set of individuals plus the needed support structure is expensive and tends to discourage publishers, because there still is the perception among publishers that the education market for software is diffuse, hard to define, and unprofitable.

A simple calculation demonstrates the level of this funding problem. We shall make the following assumptions:

1. A single courseware unit costs \$15,000 to develop. This amount makes no allowance for profit--only reasonable overhead is included.
2. Each teacher needs a total of 100 separate packages to provide support for all of her/his students for one school year. This number allows for the varying needs of the curriculum and of the student population with its range of ability levels.
3. Accounting only for mathematics, language arts, and the natural and social sciences over the K-12 grade range, there are approximately forty separate subject areas which need support.

Based on these assumptions, the development cost of the courseware which is needed by an adequate K-12 application of

computers in our educational program is \$60 Million. This is a very large investment, but is necessary nationally over the next several years, if we are to achieve the potential of educational computing. The publishing industry seems to be unwilling to make this level of investment in as nebulous an area as educational computing, so supplemental funding must be obtained from other sources.

Educators face other problems with introduction of educational technology into their programs. In the case of films, video tapes, and video discs, so many materials exist that the educator is overwhelmed by the choices. It is impossible to tell from a title or even a catalog description (seldom written objectively) whether the product is appropriate for the students in a course. Since little has been done to provide objective reviews of such materials for educators, it is necessary for the teacher to review each program to determine its suitability. This is a time-consuming task, and suggests a remedy. If there were a central agency to provide objective reviews of such material, including computer-based material, educators could refer to these reviews when making decisions about educational materials.

Several efforts have been undertaken to review computer-based material, including the work of MicroSift in Oregon, Dresden Associates in Maine, and reviews in some of the computer magazines. These efforts are being supplemented in recent months by the EPIE group; however, all the efforts

of these groups combined are inadequate to the task at hand. Reviews are published at rates of tens-per-month, while programs are being introduced at rates of hundreds-per-month. We are falling behind at an alarming rate!

Unfortunately, no organized efforts exist for review of courseware using other kinds of educational technology. Such reviews are essential if the overburdened classroom teacher is to use these technologies.

The conferees felt that it is important to cite some courseware that they feel are good examples of the kinds of materials toward which authors and publishers should strive. As a result, a list of high-quality courseware was compiled and is included as Appendix B.

V. MICROCOMPUTERS IN INFORMAL LEARNING CENTERS

(Prepared by Ann Lewin, Capitol Children's Museum)

Since 1975 we have seen the birth of a phenomenon in the United States called the participatory museum. It represents a dramatic change from a museum that is organized to collect, preserve, and exhibit artifacts to a museum in which exhibits are large-scale props designed to elicit the same joy and exploration that children find when they play outside. These museums provide a sense of wonder, participation, and involvement. They are places where children and adults handle abstract ideas in exhibits made to use rather than look at--exhibits that integrate art, humanities, science, and technology.

During this same period, incredible developments have taken place in the world of computing. The formidable array of tubes and wires that 25 years ago could only be approached by the highly initiated, is today friendly, even whimsical, and accessible to young children. But the general public is not thoroughly aware of these changes. To many, the mere word "computer" conjures up images that are frightening and overwhelming.

In 1976 Capital Children's Museum surveyed the United States for examples of educational use of computers in public settings. In defining a public computer center, we included places where the public that is not acquainted with computers can walk in without reservation, six or seven days a week, and for no more than the general admission cost, use several

computers with programs designed to educate.

The best two examples were the Boston Children's Museum where on four terminals you could play tic-tac-toe or hang-the-man, existing software culled from other sources that ran on a DEC PDP/11; and, the Lawrence Hall of Science with a program to compose simple tunes and Weizenbaum's Eliza on half a dozen terminal connected to the University's mainframe computer. The Hall had developed classes, and for \$1/hour you could reserve time on a teletype connected to the computer or learn how to program. Then, that was the state-of-the-art in public computing.

In 1980, we took another look and found a significant increase in the amount of access to computers used for educational purposes in public settings--and a range of applications. In the five years since our first survey, the Boston Children's Museum had expanded to a dozen DEC VT05 terminals with an assortment of popular games--word games, number guessing, hunting/coordinate systems. Every effort had been made to design a supportive environment, out of the traffic flow and with warm wood and carpeting around the computer.

The Lawrence Hall of Science had increased its computer courses and added an Apple van to take to schools. It was also designing computer programs to enhance its exhibits.

The Oregon Museum of Science and Industry in Portland, Oregon, had three or four computers with a database game about the city, a machine to make words from phonemes, and a

database about local industry. They were building an exhibit with wooden models to explain how different parts of the computer work.

The Exploratorium in San Francisco had two exhibits that used microcomputers: the game of life and a simulation about population growth.

North of San Francisco in Marin County, the Marin County Computer Center had recently opened in a vacant school. Here you signed up to use one of about 20 computers; you brought your own floppy or rented one of the Center's. You could charge the time--between \$3 and \$5 an hour--with a credit card. Computers were also taken into schools. A local computer club had designed "tomorrow's space ship," an elaborate simulation for six people to role play captain, bridge commander, lieutenant, navigator, and try to fend off attacks by aliens using a sophisticated program and linked computer system. The design was never implemented.

One of the nicest uses of computers in a public setting was in the public library in Menlo Park. Here Bob Albrecht and Ramon Zamora were running an experiment to teach everyone in the town to use a computer. Teenagers, age 12 and 13, were trained to check others out on a few basic points and then give newcomers a button that said, "I like my computer." They used whatever hardware they could get donated and selected what they considered the best programs from available software. As many as 20 kids came in a night: The one rule--they could not ask the librarian for help. She did

One of the most ambitious undertakings to get computers into a public setting is Sesame Place. It has made an enormous commitment to the design of the user interface and to software development. Sesame Place is an investment of the Children's Television Workshop, which produces "Sesame Street," and Busch Gardens, which designs and runs theme parks and outdoor amusement centers. They plan to have Sesame Places all over the United States. The second Sesame Place opened in Dallas in the spring of 1982.

One dollar buys three Big Bird tokens, and each token buys four minutes on a computer. Even parents who complain about the high price of admission are still buying tokens 30 minutes later to try each of the 20 or so games (designed to teach something to a child of age four to ten). Programs, which run on about 50 Apples, are stored centrally on three Nectar hard disks; one Apple controls the system. Two different cards control, respectively, a coin mechanism and a touch sensitive soft keyboard. The letters are in alphabetical order; there is a nice big erase space and a "go" space that flashes if you need prompting. Software ranges from educational (a game to learn about the physics of light refraction) to trivial (matching body parts of muppet figures).

In the National Museum of Ethnology near Osaka, Japan, there is an application that uses a huge robot arm. The Museum's main thrust is ethnological research, and it makes extensive use of computers in all aspects of its work. The

public sees a bit of that research in the form of tapes documenting how different peoples in the world live. There are sophisticated "space age" carrels where you enter your own private film viewing area, activate a terminal by inserting a card, type your selection onto a console, and in less than 60 seconds see any one of 1600 films. A computer-operated robot pulls and loads selections in full view of fascinated visitors.

That represented what was out there three years ago. We designed the computer activities at the Capital Children's Museum in Washington, D.C., after assessing what we had seen.

We currently have four areas of computer activity:

1. The integration of computer games into existing exhibits where each game will enhance the experience. Example: We have an exhibit called Metricville, where you learn about weight at the shipping docks and green grocer, length in the shoe parlor and lumber yard, liters at the chemist, and so on. In the gaming parlor, you play Centimeter Eater, a computer game designed to help you learn to measure in centimeters.
2. A demonstration of a variety of applications. One exhibition in the COMMUNICATION wing is on the computer. Visitors can try their hand at "painting," at using a database, playing simulation games, exploring CompuServe, playing music, and trying some sound educational games.
3. FUTURE CENTER. With micros provided by Atari, the Museum teaches classes that run the gamut from an overview of today's applications to programming. Students range from age 3 to age 83 and include school groups, groups of Congressmen, and business executives.
4. SuperBoots, a lab in which we write software like PAINT, a graphic utility for the Atari 800 that uses the machine's full graphic potential in natural English, easily mastered commands.

Today, in the spring of 1983, there has been such

widespread proliferation of computers in public settings, it would be impossible to maintain a current index. Most museums and science centers have at least some computers available for their audiences. There are computers in community centers, libraries, store fronts, restaurants, grocery stores, and shopping malls. The best centers in terms of quantity and quality are Sesame Place, the Ontario Science Center, ComputerTown, USA, and Capital Children's Museum in Washington, D.C. Arcades abound. Computer shows attract larger and larger crowds. Attendance at computer clubs continually increases, and summer computer camps are common. Courses in basic computer literacy are given in shopping malls, at museums, and at hotels.

But, what does it all mean? What is the role that public access computing centers can serve in expanding the usefulness of computers in society and especially in education?

The expectations for public computer centers are high. So is the risk of disappointment. A public computer center cannot help people get to know everything about computers. It may always be vulnerable to charges of superficiality.

Studies show that the average museum exhibit commands attention for only 20 to 30 seconds. Computer exhibits, even when they are tree search databases with text and no graphics, can command attention for much longer than the average exhibit. But, do they educate? Often the games are trivial, the equipment outdated. Further, it is difficult to

reduce as complex a machine as the computer to pictures and words in exhibits. And how do you tell the whole story to an audience standing on one foot.

However, well-designed public computer centers can provide information. They can give classes about computers and programming--they can give people a chance to use computers.

Public computer centers can present issues. They can be catalysts for changing impressions. They have the chance to explode the myth that computers are monstrously large machines which will only function when attended by priests in white coats. They can open for consideration some of the hard issues that we face in today's information society: Who has the access to information? What is the individual's right to privacy? What are the future modes of employment? Public computer centers can let people form conclusions as a result of actually using computers. Public computer centers have the potential to play a vital role in overcoming the further disenfranchisement of the poor by putting them in touch with new skills and new directions. They also have the potential to demonstrate the difference between worthwhile and trivial software. Moreover, there are characteristics that the public computer center has in common with all informal learning centers which offer possibilities for learning that are not found in formal systems of education.

One characteristic that is unique to the informal learning environment is that time is not structured; that is,

you are free to engage in an activity for as long as it sustains your interest. That may be a few seconds. With computers it is often many minutes, as long as an hour, or even more. In contrast, time on computers in classrooms is often metered out in minutes: ten minutes per student per week. If you accept the premise that learning is more likely to occur when you are interested in what you do, then it follows that arbitrary time limits may cut off interest at the time you are most stimulated, most involved, and most likely to learn something. Thus, an environment that you control encourages the likelihood that you will learn something.

Another characteristic is that informal learning environments are nonjudgmental. Early on, schools become associated with evaluation in the minds of even the youngest students. Thus, grades, papers hung on walls, being a "red bird" not a "blue bird," praise from a teacher, a satisfied look from the principal become rewards for which students work. The rewards replace the intrinsic satisfaction of learning for its own sake. For the student who is a nontraditional learner, whose patterns of acquiring information do not fit the modalities of the formal classroom, the judgmental environment becomes synonymous with failure. An informal learning environment may be a haven from failure for this student.

In assessing the uniqueness of informal learning centers in the use of computers, there are a number of significant factors:

1. Overcome Fear. "I can't use anything technical" is a prevalent attitude that can be overcome through actual use of a computer in an informal setting.
2. Familiarize with Today's Computer. Large numbers of people have an image of a computer as the machine existed 25-30 years ago. They have no notion of mainframe, mini, and micro, of computer generations, or of the enormous changes in power, size, reliability, approachability, and cost of today's computers, nor of the exciting new capabilities for graphics and sound generation of the new micros.
3. Provide "Hands-On" Exposure. Some people learn only by direct involvement, by manipulating, turning the buttons, and creating effects themselves. These people may see ads and articles about computers, but they won't understand until they actually use the computer themselves.
4. Broaden the Audience. More than half the work force in the United States is involved in some facet of the information revolution. Public computer centers can increase awareness of computers among the half who are not involved.
5. Broaden Understanding of the Real Nature of the Computer. If you ask most people what a computer is, they'll name one or two applications: "A computer sends me my phone bill!" The public access center can demonstrate the very wide range of computer applications.
6. Make the Computer Relevant Personally. By letting a person new to computers experience some application that is really important or exciting to him or her, the public access setting can demonstrate the place for a computer in everyone's life.

7. Remove Commercialization. The computer center can provide side-by-side access to a number of different machines outside of a sales environment.
8. Bridge the Gap Between the Layperson and Technologist. Among many there still exists distrust of those who use computers--or those who don't. Familiarity gained in public settings can foster understanding of one another.
9. Diffusion of Computer into Everyday Life. The public center may be the only place where the public can have "hands on" access to today's computers, to a range of computer applications, and to a staff trained to answer questions and facilities.
10. Hook Parents and Teachers. Then they may want a computer to use at home or a computer in the classroom.
11. Hook Children. For lots of important reasons, among them:
 - a. Preclude their ever forming misconceptions or fearing computers.
 - b. Provide effective competition for television.
 - c. Develop hand/eye coordination.
 - d. Build vocabulary.
 - e. Replace dull, rote learning with games with immediate and personal feedback.
 - f. Stimulate development of logical thought processes.
 - g. Increase their ability to make deductions.
 - h. Help them learn to program.
 - i. Develop advocates for computers in school.
12. Increase Awareness of What Software is Worthwhile. Public centers could do a real service by providing examples of good educational software. The software crisis is real. Look at the programs filling the racks in computer stores. Most is trivial or worse. The best of today's software is repackaged editions of Hamurabi, Lemonade, and Animal games originally developed in university research labs.

One of the best pieces of educational software is the algebra lessons called TRIP developed at Xerox PARC. In this program, highly interactive graphics display word problems, many an eighth grader's nemesis, and literally coach a user through the problem like the most highly skilled teacher, giving only as many clues and hints as the person needs, keeping track of blocks, letting the user discover his/her own way around the blocks. But the program runs on the ALTO, a developmental machine in Smalltalk, a language not yet available. It has just become available on a commercial machine--costing \$60,000!

Dusty Reuaton, founder and chairman of WICAT, concluded, after investing over \$1 million in educational software for an 8-bit machine, that he had to build a 16-bit machine and double disk drive. So, the hardware to support good software may have to become more powerful than the popularly priced machines of 1983.

Seymour Papert remains the master of the computer as an open-ended tool and the creator of software that survives through the changing generations of computers. In 1975 he "wowed" us with the turtle, a computer-operated robot that was intrinsically fascinating to children and that compelled their attention. It required the robot itself, a terminal, control box, a prearranged telephone connection, and a minicomputer. Today's micros have brought LOGO a very long way from the total hardware dependence of early turtle use--but you cannot find LOGO in public centers, and it is

even hard to find it in classrooms. Moreover, it too requires at least extra graphic chips in order to implement some of its more powerful features.

We have a little time, I do not know how much, in which to develop good computer programs, in which to use the best educators, designers, subject specialists, and programmers to create software for the micros. But no one is funding it. The textbook publishers are not convinced there is a market. The micro manufacturers have found there is more profit in games. NSF and the Department of Education apparently do not have the funds. My greatest fear is that the computer will go the way of TV, that it will drop in cost more than it already has, and that tomorrow's generation of kids who "have" everything will grow up as "space invaders" addicts, proving, in the words of Judah Schwartz, that the computer is an "insurmountable opportunity" in its educational options.

Public demonstrations of good software could go a long way toward educating parents and teachers about the difference between sound educational programs and trash, especially in conjunction with explanatory text, side-by-side comparisons, and public programs of lectures and workshops. Valhalla? Not necessarily, especially as more people become knowledgeable and capable of pointing out the difference, and as better software is written.

13. Address Disparities Among Rich and Poor. It is projected that computers will enter our lives through home and business more readily than through schools. For this reason, children in poor families may be the last to have access to computers. A frightening implication is that computer illiteracy among this segment of the population will widen the disparity that already exists between middle and lower economic groups.

The issue of disparity is real. It is hard to make it immediate to middle Americans who live outside of urban ghettos or away from isolated tenant farmhouses. But not so many blocks away from your house and mine are kids who may, if they are lucky or if they are tracked right, get to take a computer course sometime in the 11th grade--many years after other members of their age group may have had frequent, intense, and rewarding computer experiences.

In our Museum in Washington, which is located at the edge of a slum burned during the 1968 riots and not put back together yet, we have daily proof that there is greater disparity between rich and poor than is described in the most somber accounts. We have seen third graders who have never held a paint brush. The middle-class child is weaned from the bottle to a big fat crayon or marker. Middle-class parents know the value of such activity and prime their children from the minute they are born, taking advantage of every kind of experience that will enhance cognitive development. We have seen children, third-generation Washingtonians, who do not know the name of the Washington Monument, who do not recognize the Lincoln Memorial, who have never been to even one of the Smithsonian Institution's 13 museums. For these children, there is only Washington, the blocks immediately around their house and between their house and the nearby elementary school. Yet, our

Washington "have nots" are lucky by comparison because the slums in the nation's capital do not look like slums. They do not close in on you like the towering apartments of larger cities. They occur mainly in two-story row houses, most with a patch of dirt or grass out front. They do not match the bleak horror of sections of Brooklyn or Bedford Stuyvesant.

But the have not children, wherever they live, face a danger today that is potentially more damaging than anything they have faced in the past. As the computer revolution spreads, and as information takes on more economic value, these children could become more and more cut off from mainstream America. And the computer, the very tool that could do so much to alleviate disparity, may become a very powerful instrument in increasing disparity. For, as documented in the study conducted for the Department of Health, Education and Welfare by Larson, Thomas and Walling, the computer will probably find its way into the home and office before it is widely used in schools. Yet, it is the school, not the office or home, which preserves and fosters commitment to educational equality.

If public schools cannot afford computers, the parents who want them for their children may seek alternatives to public education that will once again remove from the public schools the very parents who are the strongest proponents of quality education. Thus, the computer could be the instrument that hastens the establishment of what is called in current Washington jargon the "permanent underclass." And no one has come up with a viable solution or even a list of partial alternatives. Public computer

centers, strategically located, could be one part of the answer.

The home may, after all, be the best informal learning environment. A century ago the one-room schoolhouse incorporated many of the best aspects of the home: peer teaching by children of one another; mixed age groups; siblings learning together. The home still retains these features. It also offers uninterrupted blocks of time--longer than the five minutes per student per week school time. And, it offers parent and child a chance to learn together.

Two centuries ago, children learned at home how to carry out adults' work by playing with toys that were miniature tools. In fact, the word toy is derived from the word tool. As the work shifted from farm to factory, the home was replaced by schools as the primary learning center. Parents ceased to be teachers as mothers and fathers moved into offices and as grandparents were moved into nursing homes. However, the electronic cottage and office in the home may again make the home the primary center for education especially as the better educational software is written for cheap computers or as cheap computers become more powerful.

There are several advantages to the home as an informal education center. It provides a new form of evaluation: Atari heavily promoted ET software based on the popularity of the movie "ET" and failed. Word spread quickly from child to child that the game was no fun. Apparently, there is an evaluation network among kids who use software at home that can counter the effects of advertising.

The home allows easiest access--you can use the computer

whenever you want, dressed in pajamas, a bowl of popcorn nearby, and continue until your cycle of interest is exhausted. The use of computers at home may not restore the role of the home as the primary education center, but it adds a dimension to learning that may be effective competition for the increasing amounts of time which youth have spent over the past decade watching television and hanging out in shopping centers.

In summary, there is increasing use of computers in informal learning situations, both public spaces and the home. Some aspects of an informal center enhance the likelihood that learning will take place. The questions are whether there will be powerful enough machines and worthwhile software, whether homes at the low end of the economic scale will get computers, and whether public centers can meet the challenge of presenting up-to-date equipment, educationally worthwhile software, and address questions of ethics and access. If computers proliferate to all homes, if there is good software, and if public centers fulfill their potential, then we indeed have two places outside of school where we could turn to meet educational challenges such as the need for improved math and science education. However, those are big "ifs", and the verdict may not be in until the end of the decade, if then.

VI. PROMISING FUTURE DIRECTIONS

(prepared by Joseph Lipson, WICAT Systems, Inc.)

The purpose of this paper is to identify (1) promising directions for the development of educational technology, and (2) who should be called on to carry out the needed research and development.

Educational technology includes all the techniques for promoting learning, not simply the hardware and courseware of computers and other media. The point of this comment is that, especially with the new information technologies, there is much that we do not know. We do not know, for example, what the long-term effects of using computers will be on the psychological development of children. We do not know the best combination of human conversation and ritual, computer work, and laboratory activities to propose. Curriculum decisions (what should be taught and when it should be taught--what knowledge is most worth having) are a major determinant of the quality of results. But we do not yet know how the curriculum should be modified to teach new knowledge and skills that can be economically taught by using the new technologies.

School organization will influence whether equipment such as computers will fall into disuse or be used (properly or improperly). But we do not know how the organizational structure of the school should be redesigned to help people to be productive with the new technologies. The social and psychological characteristics of teachers and students will determine whether they find the learning situation satisfying

or alienating. Certification regulations and the characteristics of education departments will influence the kind of talent that is recruited to teaching and those who successfully enter the teaching profession. Pay, promotion, and working conditions will influence who stays in teaching and whether they will sustain a commitment to service and excellence. The design of school buildings and the relation of the school to the community helps to determine whether the school is looked upon as an attractive and desirable place or as a jail. In sum, the school is almost as complex as society. We should not expect that educational technology will compensate for all the failings of society and schools. If we understand society and schools better, we can use the technology to further our visions even as the technology changes us and thereby changes our visions.

Directions (independent versus interrelated). Some steps can be taken that do not strongly depend on other parts of the system. For example, a program for home computers can be used by a student at home regardless of the conditions in his/her school. Note, however, that such developments may place additional strains on the schools by increasing student variability and by creating "have" and "have not" classes of students. Other directions for development are so woven into the system that, unless a restructuring of the entire system is undertaken, it is unlikely that separate, unrelated modifications will do much good.

Emotion. There is considerable evidence that emotion (affect, aesthetic preference) is an essential part of

learning. New materials should be developed that are emotionally and aesthetically satisfying without trying to compete with the emotional "fix" of computer games and TV games.

Mass Media. The mass media (TV, newspapers, popular music) have been shown to be a powerful influence on people's priorities. We are all faced with messages that compete for our attention, and what we pay attention to partially determines how resources are allocated. Therefore, a continuing high priority for development should be mass media programs such as Cosmos. Further, programs that examine the crisis in science education should be pursued. I attribute much of the surge of interest in science education over the past years to efforts in the mass media by such people as Dr. Izaak Wirszup, Dr. James Rutherford, Dr. Bill Aldridge, Dr. Carl Sagan, and many others whom I have seen interviewed on TV and quoted in news articles.

Incentives. Our society works well on the basis of monetary and prestige incentives. Thought should be given to economic and status incentives to encourage individuals to create significant amounts of instructional materials for the new educational technologies and for commercial firms to market them. There should be incentives for computer firms to make donations of equipment and expertise to schools.

Development Centers. The Downey Bill (H.R. 1134) has been introduced in Congress for each of the last four years in an attempt to support the systematic development of new materials and to provide the support which educators need in this

relatively new field. These efforts have failed because of the lack of leadership in this country and because the public had not focussed its concern. It is time to support this concept to see if we can make further progress in the current climate. California and Minnesota (and perhaps other states) have invested in science education development centers. A serious national effort is needed.

Development Funds. The Information Tax. Education is a bootstrap operation. As the world becomes more technologically advanced we will need to devote a greater and greater fraction of our resources to excellence in education. We have a measure of the activity and complexity of the new information society. It can be measured in terms of the number of bits that are encoded on various media (floppy discs, hard discs, RAM, PROM) and the number of bits that flow over our communication systems. I propose that a tax for the development of educational technology materials be passed that takes a tiny fraction of the value of each bit. The money would fund curriculum development centers such as the ones proposed by the Downey Bill and research into how people learn science and mathematics.

I would now like to discuss specific directions for development. We have had many years of prototype funding. I believe that for the well-established technology of the home computer, and even for the not-so-well established video disc we should have development projects that will create coherent materials for courses that will (a) span the entire public school years, and (b) have the property that they can be shaped

by the individual school and the individual teacher. There is one warning. Since it will take five years from authorization to availability of any course, development should be aimed at the properties of popular computers of five years from now, not those of today.

Intelligent Drill and Practice. Many people speak with a sneer of "Drill and Practice." I believe this is an error. As long as we provide drill and practice in skills worth having (instead of skills being rendered obsolete by the computer), there is no sin in developing student competence on computers through drill and practice. However, we should use the enhanced power becoming available to have interesting and intelligent drill and practice.

As one example, Xerox Research developed an arithmetic drill program that created a car driving along a path. For every arithmetic problem there was a rectangular hole in the path. The size of the hole was exactly in proportion to the solution to the problem; the answer the student gives fills up the hole in proportion to the answer given. If the student's answer is too small, the car falls into the hole. If the student's answer is too great, the car slams into the barrier created by the graphic representation of the answer. The program is intelligent in the sense that the program keeps track of the percentage of correct answers. As the student improves, the car begins to go faster and faster so that the student has less time to compute the answers. Further, the program can adjust the difficulty and type of problems to keep the student most actively involved. Intelligent drill and

practice in reading, math, and science concepts can go a long way to freeing time in the classroom for discussion, exploration, and applied problem solving.

Procedural Skills: Simulations. Computers are logical devices. As a result, they can simulate and monitor logical operations (procedures). Until recently, it was not easy or economical to teach procedures except in arithmetic and English. At least these could be attempted because of the low cost of printed symbols. Any procedures requiring diagrams, pictures, or complex arrays of data became extremely difficult for most teachers and students--partly because of the cost of visual and laboratory materials. For example, most people do not have the chance to fly an airplane because of the cost of the equipment. However, computers allow us to simulate airplane flying so effectively and at such low cost that pilot training is increasingly dependent on computer-simulated flying. The same thing could be true in many areas of science. In fact, the Huntington Computer Project (an 'old' project in these fast moving times) demonstrated the power of the computer as a simulator of scientific event, and science teachers are naturally drawn to using computers for this purpose. It is obligatory to point out that a simulation is not the same as the real thing. However, practice with a simulation can free the student to gain much more from "real" field studies and laboratory experiments.

Materials for Libraries and Science and Technology Museums--the generic video disc. Much of science, technology, and even math learning depends upon photographically realistic

pictures. Understanding of processes and concepts is greatly enhanced by pictured examples that define the concepts and provide mental images (runnable models) of processes such as the rainfall cycle. In addition, there is evidence that learning is facilitated by the chance to observe models of skilled performance of scientific activity. In some cases, the computer alone cannot simulate a process without the kind of images that a video disc can provide. Concepts, abstract constructs, processes, simulations requiring detailed images, and skilled performance--learning of all of these can be aided by a rich supply of images under computer control, i.e., the intelligent or computer-controlled video disc.

However, at the present time, the equipment for a computer-controlled video disc station is too expensive for the classroom. This suggests a role for libraries and museums. Their large flow-through of people allows the community to share their resources to make knowledge available that no individual can afford. Thus, every library and museum should have at least one well-maintained computer/video disc station.

The next step would be for libraries and museums to form a consortium to commission educational video discs and computer-programs. If this organizational feat could be accomplished, we would have a demand base to get the educational video disc market off the ground.

Of particular appeal to science teachers is the generic video disc. A generic video disc is a collection of valuable images on a video disc. For example, watch a biology teacher's eyes light up if you ask if she/he would like to have 100,000

biology pictures (including motion sequences) from which she/he could select for each class with the aid of a friendly computer program. In almost every subject taught, a collection of images under computer control would be a great aid to exciting and effective teaching. Of course, the video discs would be greatly enhanced by a variety of computer programs to facilitate different kinds of activity and discussion (e.g., the relation of fertility to a country's demographic profile and impact on social institutions).

Embedded and Adaptive Testing. Computers can provide more effective ongoing monitoring of student performance than periodic pencil and paper tests. By giving students a map of their knowledge, the student can become involved in his/her own strategy for advancing his/her frontier of knowledge and skill. The NIE had a fairly impressive conference a few years ago on testing. Many of their concerns and recommendations dealt with the use of computers to improve the quality of tests and to make them less onerous to the student and less burdensome to the teacher. I would strongly recommend the development of a full series of computer adaptive tests for the school curriculum. Tests can provide a clear standard for all students to relate to while permitting tolerance of diversity in both style of learning and what is learned.

Programs for Teachers. Many teachers feel inadequate to deal with the vast amount of scientific knowledge. I believe that they would welcome excellent computer-based materials (it is hoped with video discs) for in-service and pre-service enhancement of teacher's knowledge of science and math. This

page 6-8

use of the technology may be the most cost-effective way to upgrade the quality of science education in our elementary, middle, and junior high schools.

Programs for Parents. Many parents have home computers (the number is likely to be in the millions within a year) and are eager to give their children assistance in preparing for the information and knowledge-based society. Although there is an equity question, the development of home education programs should be aided in ways that can also provide benefits to the disadvantaged students. For example, although generally the wealthy are the ones who buy books, many poor people have been able to get their start with library books that would not have been available had we as a society not subsidized books in various ways (e.g., mailing rates). This is a sticky problem, but if equitable ways of mounting a development program can be worked out, it would provide large benefits in enhanced knowledge of science.

Programs in Technology. We should develop computer-based programs that teach: (a) how things work, (b) how machines and technologies exquisitely exemplify the truth and accuracy of scientific laws, and (c) the role of technologies in society. Who benefits; who pays; what are the economics of the technology; what are the economic effects of the technology; what are the social and psychological effects of the technology? Even when we do not know the answers, we should raise the questions.

Creativity. Everything should not be cut and dried. Computers can be wonderful intellectual tools for creative

effort of all kinds. We should develop computer aids for such activities as: (1) handling real data from large data bases used to answer a student's question; (2) handling data generated by the student; (3) design of laboratory experiments; (4) analysis and solution of real problems.

Networks. Education is, I believe, improved by conversation among interested learners and between mentors and students. We should develop an affordable electronic computer network that would enable the educational system to reach out to the isolated and also to permit conversation among dispersed students who share an unusual interest or commitment.

Summary. In conclusion, there is a tremendous amount of work to be done. The relatively small amount of empirical data suggests: (1) that computer based learning can be cost effective and satisfying to the learner; (2) that although the computer can be used to teach old skills more effectively, the most important use will be to introduce more procedural learning into the curriculum; (3) that the computer will not succeed except where there is a commitment to learning. This commitment cannot be provided by the new technologies, but must come from the parents, teachers, and leaders of our society.

A Mixed Strategy to Recruit Talent. Since talent is so important and so unpredictable, I would recommend a mixed strategy. On the one hand, we should have programs and incentives for untried and/or economically minded people to develop their own programs and materials in the hope of wealth through royalties. There should be programs of small seed grants to help such people. In California, Ms. Ann Piestrup

exemplifies the value of this approach. The Apple Education Foundation gave Ann a small grant (about \$5,000 in equipment). She used this to develop a small but interesting program for young children and then used the product to give credibility to a proposal to the NSF. Because she received an NSF grant, she was able to expand her program. Eventually her talent and ambition to the point attracted investment capital, and she now runs a sizeable educational software firm. The moral is that we need small-scale awards and recognition for the beginner, intermediate awards for people who have shown talent and commitment, and large-scale development projects to give our students the full benefit of the new educational technologies.

Education of Authors for the New Technologies. In a previous paper (Lipson and Fisher, in press), Dr. Fisher and I argued that we should educate individuals who are knowledgeable in all the domains of creating materials for educational technology systems. At the present time the production process relies upon teams of science experts, teachers, media professionals, programmers, etc. Teams whose members know little or nothing of the problems and expertise of the others are expensive and not very imaginative. Even for large products that require teams, we believe that team leaders who are the products of an education program at the doctoral level would improve the quality of computer-based and computer-controlled materials.

Centers for Authoring and Development. Many groups and individuals who have examined the question of development of instructional materials have recommended establishment of

centers for that purpose. I concur in that recommendation. Excellent work in the use of media and computers seems to arise from a combination of equipment, leadership, permanent personnel to provide continuity, and teachers and temporary personnel to provide new ideas and energy. The British Open University is one model; scientific research centers are another. Centers do not guarantee quality; often poor centers are difficult to phase out. However, the record suggests that we will do better by having centers as part of our mixed strategy.

Combination of Development and Research. Centers and other development organizations should strive to have basic research linked to the development process. Each can improve the vitality and quality of the other. Development generates new kinds of events and effects for the basic research worker, and people who are knowledgeable in what we know about the learning process can avoid certain classes of errors in the development process.

Facilitation of Commercialization. Most of what students use is sold to schools or parents by some profit-seeking business. Yet the government and academic people often act as if commercialization of materials is against one of the ten commandments. I would like to propose that teachers and scientists work closely with both traditional and electronic publishers to help get good products to market. Government contracts and grants should be written to facilitate the process and to help both individuals and firms gain financially. There are many ways to waste the taxpayers'

money, but, in my judgment, one of the worst ways is to ask taxpayers to pay for development that never reaches students. In addition, the potential of making royalties and a profit will bring more talent and competition. I believe that the danger of poor products being foisted on the schools can be better handled by extensive review and criticism in magazines and journals than by trying to make sure that no one who ever gets government funds ever makes a profit.

VII. GENERAL RECOMMENDATIONS

Because of the variety of needs, backgrounds, and expectations of students and parents, improvement of our educational system will require a variety of approaches if we are to take maximum advantage of the resources available. In the specific recommendations listed below, the contributions of governmental agencies, professional associations, industry, the publishers, the educational support groups (e.g., PTAs, school boards, etc.), and the military are not always explicated; however, their contributions in intelligent integrated ways are assumed. The Federal Government is assumed to take the lead in providing this integration and guidance at the National level and is expected to provide the leadership, coordination, and attention to equity required.

Within this broad perspective, the conferees wish to offer the following set of recommendations to the Commission for its consideration:

1. Probably the most critical need here is for trained teachers, administrators, and parents (each in an appropriate role); hence, the Commission should recommend the establishment of training programs for each of them with the background they need to assist students in useful applications of educational technology. Acceptance of this concept requires the realization that the magnitude of the numbers of people in these groups is so large that new approaches to training must be developed--probably using the same technologies that will be used by students. The ratio of potential trainees to available trainers is staggering (there are about three million teachers alone and only a few thousand people who have the background needed to provide training). This ratio will require the application of some

of the same technologies which we have considered for children to these populations.

2. In order to provide the support that is needed by the academic community (support which is largely lacking currently) and to provide an environment within which applications of educational technology may be explored, the conferees recommend that the Commission support passage of H.R. 1134 (the Downey Bill), which proposes establishing a number of centers for educational technology nationally. These centers can serve as focal points for research, development, and dissemination of information, as well as gathering places for researchers in the field.
3. The Commission should make a strong recommendation that equal access to the new technologies is not only a desirable goal in a democracy, but that it is essential as we move into the Information Age. Means must be found to ensure that all students have adequate access to the best vehicles for learning which we can provide without regard to ability of students to pay. This is especially important as the new information utilities emerge. Ways must be found to absorb the costs of accessing these utilities (as we have done with books by establishing libraries--perhaps libraries are an appropriate vehicle for access to the newer technologies as they have been for books and films in the past) so that access is not based on ability to pay.
4. New technologies will require new school structures (financing, reporting, organizational, etc.) if they are to succeed. We cannot expect that structures designed to optimize the "chalk-and-talk" mode of instruction will be adequate to support the learning environments of the future. Support and encouragement must be provided for the development and strengthening of these new structures.
5. Most current applications of technology in education were developed in the immediate post-Sputnik era. The technology of today is related to the technology of that period in only the most remote sense. An entirely new effort similar to that of the period from 1960 to 1970 must be mounted. Major Federally-funded projects such as PLATO, TICCI, the Huntington Project, Project SOLO, and similar efforts made important contributions to our understanding of the technology and established the United States as

the world leader in the field, even though only the crudest technology was available to them. With current technology, things are possible that couldn't even be dreamed of then. A national effort of similar scope and magnitude as that of the post-Sputnik era is essential and can be expected to provide similar benefits nationally.

6. The Commission should recommend that longitudinal studies be conducted on the impacts of educational technology. Very few such studies ever have been done. They are essential to the establishment of educational technology in its proper place in our educational system.
7. Schools of education must be encouraged strongly to include significant components of educational technology in their own instructional programs and in their curricula. There is a great deal of truth in the saying, "Teachers teach the way in which they were taught."
8. The work of the Commission must go on long after the Commission itself is terminated. Major curricular reform is essential to meet the objectives set out for the Commission. Significant changes must be made in the content of curricula, courses, and methods if the potential of educational technology is to be realized. The Commission will only scratch the surface of this facet of the overall problem.
9. The military establishment and industry must be brought into the process of exploring, training, and implementation involved in bringing technology to our students. Both of these groups benefit from a good educational system, and both are required to spend large sums to overcome deficiencies in it. They should be encouraged to invest some fraction of their current training funds in support of education. One model of such cooperation is the recent joint NSF-computer industry grant program (of Fiscal 1982).
Although we cannot anticipate the opportunities which will be most significant, the door must be left open to, e.g., a program of donations of equipment, funds, and other valuable resources available to the private sector.
10. The Commission should encourage development of materials to support informal learning in the home, libraries, museums, and in other social institutions.

11. Federal and state grants for development of courseware materials should include provision for financial rewards for individuals and institutions to encourage creative people to carry on the activities which we need to take advantage of educational technology.
12. The Commission must recognize that there is a five-year lag between development of educational materials and their acceptance in the system. This lag means that plans must be developed carefully and with full realization that efforts must be long term. It is essential to realize that this lag is inconsistent with the traditional ten-year textbook adoption cycle in school systems.
It has been estimated that the United States will spend \$1 billion per year on educational technology in the future. If we were given that much money starting tomorrow, we would be unprepared to spend it wisely!
13. An information tax (similar to the British entertainment tax to support the BBC TV programs) be considered for curriculum development funds.
14. Training programs are needed for the staffs of publishing houses to prepare them for their new roles in materials development.
15. Teachers must be convinced of the importance of their new roles as information managers, rather than the traditional role as dispenser of information. Until teachers recognize and accept this change, there can be no widespread impact of technology on the learning experiences of children.
16. Research on games as educational vehicles appears to be very important, because of their strong motivational appeal.
17. There is a serious lack of understanding of means for integrating educational technology into existing curricula. This lack must be overcome. Appropriate support structures for this integration must be developed.
18. Although the Federal role is unclear in detail, it is evident to the attendees at the Conference that the Federal Government has a crucial role to play in the establishment of educational technology in our schools. At least, the venture capital needed for short-term development must come from the Federal Government, since the

private sector (with its need to see a return on investment in the short range) is unwilling to provide such capital at the necessary levels.

19. We are building a social time bomb by ignoring (or excluding) those in the lower half of our high schools and those who are disadvantaged socially, economically, or by reason of handicaps. This time bomb must be defused by intelligent programs. In a democracy, we must expect equity (hence, equal access), both because it is just, and because it is a waste of valuable human resources if equity does not exist in our educational system.
20. An early start on the programs recommended here is essential because of the hardening of positions which occurs inevitably, and because we are losing children to society every day that there is inaction.
21. We recommend that Federal subsidies for publishers be considered as one means of overcoming reluctance to enter this new field.
22. There is a need to educate the public about the potential of educational technology so that they will support its introduction into the schools. A publicity campaign should be mounted to convince the public of this need.
23. There is a serious social imperative to bring handicapped people into the mainstream of our society. Technology has provided a wide variety of means for assisting the handicapped to lead fuller lives--there is the Kurzweil Reading Machine, which enables the blind to read, word processing to enable physically-handicapped people to write, computers which assist the paralyzed to speak and to type on a keyboard, and simulations to permit concept development in those who cannot work in a laboratory. We, as a nation, must address these possibilities, and provide the opportunities for the handicapped individual which technology now makes possible at reasonable cost.
24. A study should be made of the value of establishing "MECC"-like organizations in each State in the Union, with coordination at the Federal level.

25. ... must find ways of funding, developing, and rewarding those who have the talent to create courseware materials.

26. In all the developments suggested here, it is important that one ingredient of the design is to make learning exciting as well as more effective.
27. Our schools must be prepared to respond to the proliferation of computers in the home. Will these computers be a threat to the existing educational system, as some predict, or will the schools be prepared to take advantage of this new dimension? Will the schools be able to act as guides for parents in the acquisition of computers, or will they sit on the sidelines as salespeople dictate the equipment and software that parents buy? The answers to these questions, and many similar ones depend strongly on the extent to which the schools and educators are trained to respond to public inquiry.
28. It is essential that we attempt to anticipate the impact of the new technologies, as they become available. We must conduct a continuing research program, based as that program is on the technology of the future.

APPENDIX A
CONFERENCE ATTENDEES

Dr. Thomas Althius Pfizer, Inc.	Ann White Lewin Capital Children's Museum
Dr. Carl Berger University of Michigan	Dr. Thomas Liao SUNY at Stony Brook
Dr. Ludwig Braun New York Institute of Technology	Doris K. Lidtke Towson State University
Rugh Burkhardt, Director Shell Centre for Mathematical Education University of Nottingham	Dr. Joseph Lipson
Dr. Ward Deutschman New York Institute of Technology	Dr. William J. Lnenicka Georgia Institute of Technology
Dr. Thomas Dwyer University of Pittsburgh,	Dr. Henry Pollak Bell Laboratories
Doris R. Ensminger Milbrook Elementary School	Stephen L. Salyer WNET / Thirteen
Rosemary Fraser Shell Centre for Mathematical Education University of Nottingham	James St Lawrence New York Institute of Technology
Samuel Y. Gibbon Jr. Bank Street College	Dr. Robert Seidel HUMRRO
Gerald J. Heing Chicago Public Schools	Cecily C. Selby
Dr. Joseph Kanner	Stan Silverman Hempstead High School
Dr. Kent T. Kehrberg MECC	James R. Squire Ginn and Co.
Mary Kohlerman NSB Commission	Antonia Stone Playing to Win, Inc.
Dr. Norman D. Kurland State Education Department	Robert F. Tinker TERC
Dr. G. D. Laubach Pfizer, Inc.	Barbara Zengage SUNY at Stony Brook
Katherine P. Layton Beverly Hills High School	Dr. Karl Zinn U-M CRLT

APPENDIX B: EXAMPLES OF QUALITY COURSEWARE

The conferees felt that they had the responsibility to compile at least a brief list of examples of quality courseware materials to support the discussion in Section IV. The list below is not, in any sense, an exhaustive one; rather, it is illustrative of the kinds of quality courseware which currently are available.

Among these are:

1. Computer-based tools are often overlooked by educators. Such tools include:
 - a. Plotting of data is a simple, but powerful example (e.g., the plotting program by Cactus Software which labels and colors graphs, in addition to plotting them).
 - b. Word processing is a very powerful tool for developing writing skills. Although writing is not within the purview of the Commission directly, it is an important tool for learning about the sciences. Some science teachers, for example, require their students to prepare a weekly science newsletter, with exciting results in the learning of science as well as in developing writing skills.
 - c. Special-purpose simulation languages, like TUTSIM and DYNAMO (both of which are available on micros), which permit students to create their own models of phenomena which they are studying.
 - d. Programs for computation and for data collection and retrieval, which simplify the experimental process by letting the student focus on the interpretation of data, rather than its collection.
 - e. Spread sheets which permit the exploration of "what if" questions in systems characterized by sets of algebraic equations. This tool was developed originally for application in financial analysis; however, because it is structured as a

tool for solution of sets of algebraic equations, it is useful also for the simulation of systems represented by sets of difference equations. Such systems include population dynamics, epidemics, and drug administration.

The best-known spreadsheet program (and one of the best-selling programs all time) is VisiCalc by VisiCorp.

2. Simulations which provide important opportunities to learn about processes, models, and systems which cannot be manipulated directly because of cost, danger, complexity, time scale, or inaccessibility. To be used, however, simulations need support materials which include advice to the teacher, materials for the student, and background materials for the subject. The Huntington Computer Project was the first to provide complete support materials, and some of the 23 simulations in biology, physics, and social sciences still are models for this mode of computer use.

Simulations must have an appropriate balance between realism and abstraction. Whenever possible, they should include role playing. "Debriefing" should be done after a simulation exercise in complete detail whenever possible.

Three Mile Island from Muse Software and SCRAM from Atari's Program Exchange are impressive tools for exploring the design of nuclear reactors and serve as strong motivators for discussions; however, they are set up to make system failure likely, even unavoidable, in order to make the play of the "game" challenging.

3. Microworlds are a cross between simulations and tools; in fact, they are fanciful "worlds" with built-in tools, within which the learner is given an environment to explore, and the opportunity to discover the rules of the microworld which s/he is exploring.

In a world of sensors, logic gates, connecting wires, and actuators, a child is able to implement logic circuits and to discover their implications in Rocky's Boots, a product of The Learning Company. Such programs demonstrate how science concepts can be learned at an early age, with aesthetics as well as power.

4. Discovery learning in mathematics is an exciting approach to the development of understanding of mathematical concepts which is analogous to simulation in the sciences. In this mode, a student "discovers" important mathematical concepts by experimentation rather than by the traditional didactic methods. Students using BALANCE (produced by New York Institute of Technology) to discover the basic properties of an equation, are able to develop solution techniques rather than merely to apply those presented in a lecture.

5. Games are strong motivators of young people, as is evident from even a short visit to a video arcade or a store which sells video games.

Perhaps the best example of such games (and one of the best mathematics learning materials ever developed) is GREEN GLOBS by Sharon Dugdale and her colleagues at the University of Illinois. In GREEN GLOBS, the student must pass a beam through as many globs as possible--the more globs per beam, the higher the score. Using this program, students develop the ability to visualize the shapes of high-order polynomials and their intercepts on the independent axis (i.e., the roots).

6. Data bases that provide students with easy access to large amounts of information offer a totally new resource for students and teachers. A good example is DEMOGRAPHICS, a program that contains world wide demographic data, and a set of graphing and projection tools. With this program, a student can explore population trends, study the effects of new policies, and can follow major sub-groups (such as retirees).

There already are many special-purpose data bases aimed at chemists, medical professionals, political scientists, and others. Such data bases are likely to replace the encyclopedia as the students information support system.

7. Microcomputer-based instrumentation (MBI) turns the computer into a powerful laboratory instrument. In such systems, the student is able to study real-world systems, recording, analyzing, displaying, and saving data from experiments. Well-done MBI systems (e.g., the Pendulum program of Bruce Ford) remove most of the drudgery which is a major part of most laboratory investigations, and allow the student to focus on data interpretation--the principal intellectual component of experimentation.

8. Special computer languages provide teachers and students with new dimensions in learning. Perhaps the best example of this is LOGO, developed by Seymour Papert and his colleagues. Students using LOGO are able to develop an understanding of mathematics that goes far beyond the graphics for which LOGO is best known.
9. Adventure games like Spinnaker Software's Snoopier Troops, and Deadline and the Zork Series by Infocom represent a new approach to learning which is especially exciting. In these games, the student learns reading and comprehension skills, and, in addition, develops higher-level problem-solving and decision-making skills.

Another special-purpose language which has interesting potential is GraFORTH, which includes the capabilities of most general-purpose programming languages, and, in addition, supports three-dimensional graphics, animation, and sound generation that are spectacular, and strongly motivational.

Most of the programs described above have been released within the past two years. They represent the creation of learning environments which are new and exciting. They demonstrate what creative minds working without the constraints of the past are able to accomplish. On the basis of our experience with these and other courseware materials, we may expect that other new approaches to learning will emerge, and that student learning will become more interesting, more exciting, and, most important, more effective.

179

Effectiveness of Technology
In Precollege Mathematics and Science Teaching

by

James A. Kulik

Center for Research on Learning and Teaching
The University of Michigan

June, 1983

183
181

Effectiveness of Technology in Precollege Mathematics
And Science Teaching

It is easy to recognize the use of instructional technology in a classroom, but the term itself is not easy to define. To some, instructional technology is the use of machines, tools, and equipment in teaching. To others, instructional technology is the application of certain specific technological processes, such as automation, quality control, and so on. But most of those who have considered the matter deeply emphasize the conscious application of scientific principles as the key defining feature of instructional technology. According to Hawkrige (1970), for example, educational technology is "the practical art of using scientific or other organized knowledge about education."

Saettler (1968) has traced the roots of instructional technology back 2500 years to 5th century Athens when the Sophists first provided systematic instruction to groups of learners and when Socrates began teaching his followers through carefully structured dialogues. More critical to the development of modern instructional technology, however, were contributions made during the last century: Lancaster's manuals of instruction and organization of classrooms for mass instruction under monitors; Montessori's self-motivating materials that young learners could use to increase their perceptual and motor capacities; Burk and Washburn's self-instructional bulletins that learners

mastered individually at their own rates. Such contributions set the stage for the explosive development of instructional technology that has occurred in the last three decades.

The event that marks the start of the modern period in instructional technology was the publication of B. F. Skinner's 1954 article "The Science of Learning and the Art of Teaching." The article described a forthcoming revolution in education:

We are on the threshold of an exciting and revolutionary period, in which the scientific study of man will be put to work in man's best interest. Education must play its part. It must accept the fact that a sweeping revision of educational practices is possible and inevitable.

Skinner was not the first to call for an "industrial revolution" in education, but he was the first prophet of educational revolution to reach a wide and receptive audience.

Skinner's argument was that the teaching methods in use at the time were ineffective and that mechanical devices could make teaching more effective. The design of the devices, Skinner noted, would have to be consistent with established laws of learning, namely:

- a) the learner must respond actively while learning;
- b) appropriate learner responses must be reinforced immediately and frequently;
- c) the learner must follow a coherent, controlled sequence through material; and

- d) the learner must be in control of his or her learning rate.

Skinner pointed out in his 1954 article that programmed machines already developed by himself and his students at Harvard incorporated these learning principles. These machines could present lessons in a series of small, simple steps and could provide learners with immediate reinforcement after each successful step.

Skinner's programmed machines at first seemed destined to transform education. Articles on teaching machines and programmed instruction appeared in journals with great frequency in the early 1960s, and instructional programs were soon available in every subject and for every grade level. But by the mid-sixties, excitement about programmed instruction began to die down. One problem was that the premises of programmed instruction did not always hold up well in experimental studies. Another was that results from field studies were not as dramatic as supporters of programmed instruction hoped they would be.

The hopes for an instructional revolution that Skinner aroused did not die immediately. In the mid-sixties a new focus was found for the revolution: the technology of individualized instruction. In individualized teaching systems, students work at their own rates through carefully designed units of course material with the help of study guides and diagnostic tests (J. Kulik, 1983). This teaching technology was originally developed by Burk and Washburn in

the early years of the century, but the method was almost forgotten until the 1960s. At that time, individualized systems of instruction began to be used at all levels of schools: Keller's Personalized System of Instruction and Postlethwaite's audio-tutorial approach at the college level; Individually Prescribed Instruction, Project Plan, Individually Guided Education, and Bloom's Learning For Mastery at the lower levels of instruction. Such systems continued to attract attention for a decade, but in recent years a decline in interest in them has also become evident.

More recently, talk about a technological revolution in education has focused on the computer. To many, the computer seems the perfect vehicle to deliver instruction. It can require the student to respond actively; it can reinforce correct responses immediately; it can work at the student's rate; and it can follow a systematic plan of instruction. The computer can also do other things that good teachers do. It can be an infinitely patient tutor, a scrupulous examiner, an engaging performer, and a tireless scheduler of instruction. With the development of the microcomputer in recent years, talk of a computer revolution in teaching has intensified.

Will the computer succeed, however, where programmed instruction and individualized instruction failed? Will it be used widely in schools throughout the country and change the nature of teaching and learning? Will the computer bring learners better, more comfortable, and faster

learning? Will it reduce drudgery and repetition for teachers? Will the computer give teachers more time for meaningful contact with learners?

For more than two decades now, educational evaluators have been trying to assess the effects of instructional technology. This report draws together results reported in the various evaluations to show what is known about the effectiveness of instructional technology. No review can cover all implementations of instructional technology, and like others, this report is selective. Its coverage is restricted to the major technologies developed during the last three decades: programmed instruction, individualized systems of instruction, and computer-based instruction. Another focus of this report is mathematics and science teaching at the precollege level--areas where educational needs have been shown to be especially great. College level and non-science findings are included occasionally, however, to provide background for the major points.

Programmed Instruction

Reviews of findings on the effectiveness of programmed instruction can be classified into two basic types: box-score reviews and meta-analyses. Box-score reviews provide frequency counts of studies favorable and unfavorable to a certain method. Meta-analyses provide statistical syntheses of accumulated findings (Glass, McGaw, & Smith, 1981).

Box-Score Reviews

Typical of the box-score reviews written in the first wave of excitement about programmed instruction are those by Silberman (1962) and Schramm (1964). Silberman reported results from 15 comparisons of programmed and conventional instruction. Nine of the comparisons reported superior learning from programmed instruction, and 6 reported no difference in the results of the two teaching methods. Schramm's report was based on 36 comparisons of programmed and conventional instruction. Eighteen of the comparisons reported no significant difference in achievement of programmed and conventionally taught classes, but 17 studies showed a significant superiority for the students that worked with programs, and only 1 study showed a final superiority for the classroom students. Eight of the experimenters reported a time advantage for the students using programs, and one experimenter mentioned a cost advantage.

Box-score reviews from the fields of mathematics and science education reported results that were less favorable to programmed instruction. Briggs and Angell (1966) reported that only 2 of 14 studies in science and mathematics classes found significantly higher examination scores for students taught with programs; the other studies found no significant differences in results of the competing instructional methods. Zoll's review (1969) reported even less favorable results from the field of mathematics

education. Of the studies he reviewed in which programmed instruction was compared to a traditional method, three reported significant learning gains in mathematics in favor of programmed instruction, three reported significant learning gains in favor of the traditional course, and seven found no statistically significant difference.

Box-score reviews of research on programmed instruction continued to appear during the 1970s. Nash, Muczyk, and Vettori (1971), for example, summarized results from 213 comparisons of programmed and conventional teaching or training. Of 138 studies using a criterion of immediate learning, 49 found a significant difference in favor of programs, 18 found a significant difference in favor of conventional instruction, and 71 found no significant difference between methods. The pattern of findings was similar in studies using a retention criterion of learning. In contrast, however, Nash et al. reported that 90% of the studies using a criterion of training time reported a significant difference in favor of programmed instruction.

Although these box-score reviews reported a variety of results from studies of programmed instruction, some generalizations are still possible. First, about half the studies reported no significant difference in student achievement due to teaching method. No significant differences were found in 51% of the studies reviewed by Nash et al. (1971); in 50% of the studies reviewed by Schramm (1964); and in 40% of the studies reviewed by

Silberman (1962). Second, a majority of the studies reporting significant differences favored programmed instruction: 73% of the studies with significant differences located by Nash, Muczyk, and Vettori; 94% of the studies with significant differences located by Schramm; and all of the studies reporting significance located by Silberman. A third point on which there was general reviewer agreement was that programmed teaching reduces the time spent in learning.

Meta-Analyses

Although box scores yield a general overview of effects of programmed instruction, they have serious limitations. Dichotomous classifications of studies as favorable or unfavorable are not completely reliable. Reviewers do not always apply the same standards in making such classifications. Second, although box scores may tell how often programmed instruction is better or poorer than conventional teaching, they do not say how much better or poorer. Third, box-score reviewers, with their dichotomous classification of study outcomes, are seldom able to explain why some studies report substantial effects and others report negligible results. Trying to discern relationships between study characteristics and outcomes without parametric statistics is like trying to grasp the sense of hundreds of test scores without using statistical methods to organize the data.

Hartley (1977) and J. Kulik and his colleagues (C.-L. Kulik, Shwalb, & Kulik, 1982; J. Kulik, Cohen, & Ebeling, 1980) have used such statistical methods to integrate evaluation findings on effectiveness of programmed instruction. Like other meta-analysts, these researchers located studies by clearly specified and objective procedures. They then characterized the outcomes and features of the studies in quantitative or quasi-quantitative terms. Finally, they used multivariate techniques to describe the overall findings and to relate characteristics of studies to these outcomes.

Achievement results. Hartley (1977) located a total of 40 separate reports written between 1962 and 1974 on the effects of programmed instruction in elementary and secondary mathematics class. These 40 reports described results from a total of 89 comparisons of programmed and conventional teaching. In the typical comparison conventional and programmed classes differed by only .11 standard deviations on examinations. The performance levels of the programmed and conventional groups were therefore virtually indistinguishable: at the 50th percentile for the conventional group and the 54th percentile for the programmed group.

C.-L. Kulik et al.'s meta-analysis (1982) covered 48 independent evaluations of programmed instruction in secondary schools. About half of the studies examined applications of programmed instruction in mathematics, and

more than two-thirds of all studies covered applications in mathematics or the physical sciences. A few studies evaluated programmed teaching in the social sciences, and a few focused on programmed teaching in the humanities. A total of 47 of the 48 studies contained results from achievement examinations. The average effect of programmed instruction in these studies was to raise achievement test results by .08 standard deviations, or from the 50th percentile to the 53rd percentile.

Finally, J. Kulik et al. (1980) located 57 studies comparing effects of programmed and conventional instruction at the college level. This meta-analysis covered many applications of programmed instruction to mathematics teaching and also covered applications of programmed teaching to the physical sciences, life sciences, and social sciences. Relatively few of the studies covered programmed teaching in the humanities. A total of 56 of the 57 studies contained results from achievement examinations. In the typical study, programmed instruction raised student examination scores by approximately .25 standard deviations, or from the 50th to the 60th percentile.

Study features and examination results. The studies located for these meta-analyses took place in a variety of settings and used a variety of methodological designs. Each of the meta-analyses therefore classified studies according to their features. Such a classification helps the meta-

analyst to determine how properties of studies affect the principal findings.

One factor that appears to affect study results has already been mentioned. The average effect of programmed instruction was to increase student achievement by approximately one-quarter standard deviation at the college level and by one-tenth standard deviation at the precollege level. Effects of programmed instruction thus appear to be stronger at the college level than at lower levels of instruction. Another factor that has influenced size of effect is the time when the study was performed. Hartley (1977) reported a correlation of .39 between study year and size of study effect; J. Kulik et al. (1980) reported a correlation of .31; and C.-L. Kulik et al. (1982) reported a correlation of .28. In each of the meta-analyses, later studies reported significantly larger effects than did earlier studies.

Relationships between size of effect and other study features were smaller and less consistent from meta-analysis to meta-analysis. Hartley (1977), for example, found some evidence that evaluator involvement in the design of teaching and testing materials led to stronger effects. C.-L. Kulik et al. (1980) also found some evidence that average effects were larger in the social sciences than in the physical sciences and mathematics, although this finding was based on a relatively small number of studies of programmed instruction in the social sciences.

Figure 1 summarizes the most dependable findings on study features and their effects on the outcomes of programmed instruction. First, it shows that larger effects are associated with studies carried out at the college level. Second, it shows that at each level of instruction, effects are larger in studies that were carried out in more recent years.

Other study outcomes. Only a few studies located for these meta-analyses contained results on nonintellective outcomes of programmed instruction. The nonintellective outcomes investigated most often were student satisfaction and student study time.

C.-L. Kulik et al. (1982) found that only 9 out of 48 studies of programmed instruction at the secondary level contained findings from attitude measures. In 4 of these 9 studies, the programmed class rated the subject being taught more positively than did the conventional class; in the other 5 studies the conventional class gave the higher ratings. The average size of effect was $-.14$. This implies that in the typical study, students in the programmed class gave slightly lower ratings to the subject being taught than did students in the conventional class.

Only 4 of the 57 college-level studies located by J. Kulik et al. (1980) contained student rating data. Ratings from programmed classes were higher than conventional ratings in 2 of the 4 studies that secured ratings of overall quality, and conventional ratings were

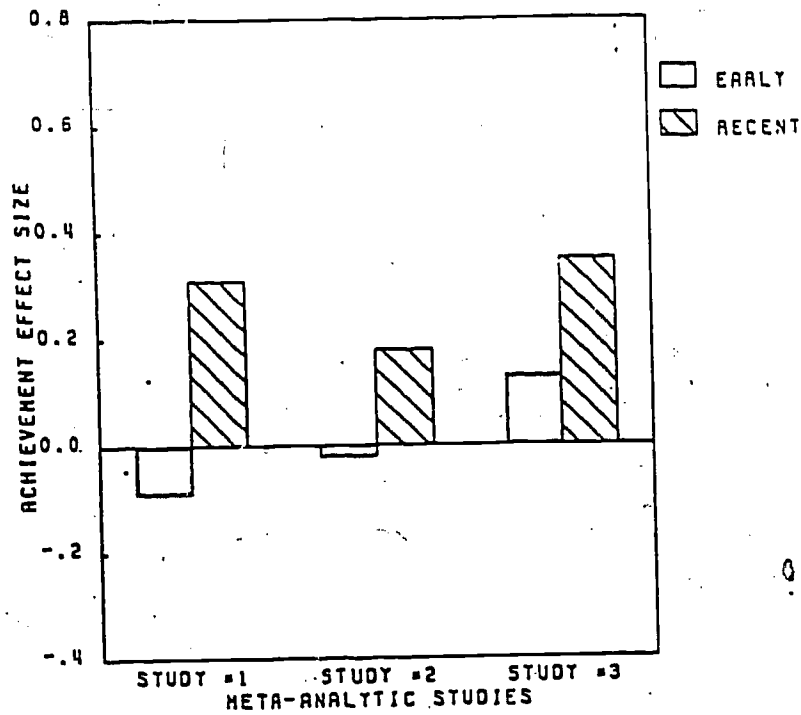

Figure 1. Effects of programmed instruction, as reported in early and recent studies. (Note: Study #1 is Hartley's meta-analysis (1977) of results from precollege studies; Study #2 is J. Kulik, Cohen, and Ebeling's meta-analysis (1980) of findings from grades 6 through 12; Study #3 is C.-L. Kulik, Shwalb, and Kulik's meta-analysis (1982) of college-level findings.)

higher in the remaining 2 cases. On a 5-point scale going from 1 (lowest rating) to 5 (highest rating), the average rating of course quality was 3.41 in the typical programmed class, whereas the average rating was 3.49 in the typical conventional class.

J. Kulik et al. (1980) also reported that nine investigators collected weekly reports of study hours from students taught by programmed and conventional methods. Six of the investigators found that programmed materials resulted in a time saving, and three reported a time saving with conventional teaching. On the average, the conventional approach required six hours per week of student time, and the programmed required about five hours. In general, we can conclude that programmed instruction makes no extra demand on student time and sometimes results in a significant time saving for students.

Conclusions

Given the expectations once held for programmed instruction, its record of effectiveness seems disappointing. Skinner and his followers expected programmed instruction to bring about a revolution in education. They expected it to make learning more efficient and joyful. The most thorough reviews of findings on programmed instruction showed that this method does not typically produce such results.

The most positive findings on programmed instruction came from college-level studies. Here, programmed

instruction produced at least moderate positive effects on student learning, and programmed teaching also tended to reduce time spent in learning. College results from recent studies of programmed instruction were especially impressive. It is possible that the stronger results from recent studies are attributable to use of different research designs in recent years. It seems more likely to us, however, that programmed instruction has been used more discriminatingly in recent years. No longer viewed as a panacea, programmed instruction is now used where it can contribute most. In addition, the art or science of programming may have improved so that recent studies may involve better programs than the older studies did.

The outlook for programmed instruction in elementary and secondary school mathematics and science teaching looks far less promising, however. Learning effects were especially weak at this level of instruction and in these content areas. Another negative point is the reactions of students to classes taught with programmed instruction. Programmed instruction does not produce enthusiastic acceptance of course content. This limits its application in the elementary and secondary schools. If our search, therefore, is for an instructional technology that will contribute to precollege science and math education, we have to look beyond programmed texts and programmed workbooks to such contemporary offshoots of programmed teaching as individualized and computer-based instruction.

Individualized Systems of Instruction

The earliest reviews of findings on the effectiveness of individualized systems of instruction were box-score reviews from the field of mathematics education. More recent reviews in this area have used meta-analytic methodology and have covered education in mathematics, science, and other areas. Findings from both the earlier and later reviews are included here.

Early reviews

Individualized systems of teaching usually require learners to demonstrate mastery of lower level skills before they move on to higher order skills. Mathematics is therefore considered by many to be an ideal subject for individualization since it is a hierarchically ordered field in which concepts generally build on the foundation provided by prior concepts. The early reviews of the effectiveness of individualization in precollege mathematics teaching, however, did not give a positive picture of the effects of individualization.

Schoen (1976) concluded that elementary school results were overwhelmingly against individualized instruction as measured by mathematics achievement. At the secondary level, only 1 out of 12 studies reviewed by Schoen reported improved mathematics achievement in individualized classes, whereas 3 researchers reported greater achievement in traditional classes. No study at the secondary level showed improvement in the affective areas attributable to

individualization. Schoen's conclusions were almost entirely negative:

Over 50 studies in all grade levels aimed at showing the effectiveness of this approach demonstrate no consistent objective evidence that there will be student improvement of any sort. The most consistent result is less mathematics achievement with an individualizing approach. (p. 356)

Hirsch's (1976) findings were similar. Of the 33 studies that he reviewed in which individualized instruction was compared to group-based teaching, 5 reported significant learning in mathematics in favor of individualized instruction; 4 reported significant gains in favor of group-based instruction; and 24 found no statistically significant differences. Nineteen of the studies reviewed by Hirsch also included results from scales measuring attitude towards mathematics. Of the 19 comparisons, only 3 reported significant differences between the treatments. In each case, individualized instruction was found to be superior to conventional instruction.

Miller (1976) located 145 studies dealing with various aspects of individualized instruction in mathematics. Approximately 90% of these studies came from elementary and secondary schools; about 10% of the studies came from college classes. In 48% of the 88 achievement studies examination performance was about equal in individualized and control groups; in 36% of the studies achievement was

better in the individualized group, and in 16% of the studies it was worse. Approximately 76% of the 33 studies of student attitudes towards mathematics showed equivalent attitudes in individualized and control groups; 21% showed better attitudes in the individualized group and 3% showed poorer attitudes there.

Given the lack of positive findings at the precollege level, the college-level findings on individualized instruction seem almost startling. The individualized method studied most frequently at the college level is Keller's Personalized System of Instruction, or PSI. Researchers have carried out a large number of outcome studies comparing results from PSI classes with results from conventional classes, and both narrative and box-score reviewers have concluded that results from these studies are highly positive (e.g., Block & Burns, 1976; Johnson & Ruskin, 1977; J. Kulik, 1976; Robin, 1976). A typical box-score review found, for example, that more than 95% of the studies reported better achievement results in PSI classes, and more than 80% of the studies reported significantly better achievement results (J. Kulik, 1976). Box-score and narrative reviewers also pointed out that student ratings tend to be favorable in PSI classes, but some reviewers cautioned that course withdrawal rates may be higher in PSI classes.

Meta-analyses

Quantitative syntheses of evaluation findings on individualized instruction bring into clearer focus the picture presented in the box-score reviews. The major meta-analyses on individualized instruction were carried out by Bangert, Kulik, and Kulik (in press); Hartley (1977); and J. Kulik, Kulik, and Cohen (1979).

Achievement outcomes. Hartley's (1977) meta-analysis on innovative approaches in mathematics instruction in the elementary and secondary school included 51 studies on individualized systems. These 51 papers reported results from a total of 139 separate comparisons. Hartley found that the average effect reported in these studies was small. In the typical case, use of an individualized system of teaching raised examination performance by .16 standard deviations. This effect was only slightly larger than the average effect of programmed instruction in the studies examined by Hartley.

Bangert et al. (in press) located 51 separate studies on the effects of individualized systems of instruction at the secondary-school level. A total of 49 studies reported results from achievement tests, and all but 5 of these studies were in the areas of math and science. The average effect of individualization in the 49 studies was to raise achievement test performance by .10 standard deviations, or from the 50th percentile to the 54th percentile.

J. Kulik et al.'s meta-analysis (1979) of research on PSI in college classes presented a strikingly different picture of the effectiveness of individualized teaching. The data for this meta-analysis came from 75 courses, taught both conventionally and by PSI, described in 72 different papers. A total of 62 of the 75 studies reported final examination averages in PSI and conventional classes. In the typical study, the average examination score in the PSI class was .5 standard deviations higher than was the average score in the conventional class. This means that in the typical college-level study PSI raised the final examination score of a typical student from the 50th to the 70th percentile.

Study features and examination results. The results of the three meta-analyses--when looked at together--suggest that individualized instruction has different effects at different instructional levels. To summarize, the average effect of individualized systems was to raise examination scores by about one-eighth standard deviation at the elementary and secondary levels and by about one-half standard deviation at the college level. The elementary and secondary effects are small; the college effect seems large enough to be important.

Meta-analysts working in a number of different areas have reported a significant relationship between study source and effect sizes. Studies located in dissertations often contain weaker findings; studies located in journal

AOS 203

J. Kulik et al.'s meta-analysis (1979) of research on PSI in college classes presented a strikingly different picture of the effectiveness of individualized teaching. The data for this meta-analysis came from 75 courses, taught both conventionally and by PSI, described in 72 different papers. A total of 62 of the 75 studies reported final examination averages in PSI and conventional classes. In the typical study, the average examination score in the PSI class was .5 standard deviations higher than was the average score in the conventional class. This means that in the typical college-level study PSI raised the final examination score of a typical student from the 50th to the 70th percentile.

Study features and examination results. The results of the three meta-analyses--when looked at together--suggest that individualized instruction has different effects at different instructional levels. To summarize, the average effect of individualized systems was to raise examination scores by about one-eighth standard deviation at the elementary and secondary levels and by about one-half standard deviation at the college level. The elementary and secondary effects are small; the college effect seems large enough to be important.

Meta-analysts working in a number of different areas have reported a significant relationship between study source and effect sizes. Studies located in dissertations often contain weaker findings; studies located in journal

J. Kulik et al.'s meta-analysis (1979) of research on PSI in college classes presented a strikingly different picture of the effectiveness of individualized teaching. The data for this meta-analysis came from 75 courses, taught both conventionally and by PSI, described in 72 different papers. A total of 62 of the 75 studies reported final examination averages in PSI and conventional classes. In the typical study, the average examination score in the PSI class was .5 standard deviations higher than was the average score in the conventional class. This means that in the typical college-level study PSI raised the final examination score of a typical student from the 50th to the 70th percentile.

Study features and examination results. The results of the three meta-analyses--when looked at together--suggest that individualized instruction has different effects at different instructional levels. To summarize, the average effect of individualized systems was to raise examination scores by about one-eighth standard deviation at the elementary and secondary levels and by about one-half standard deviation at the college level. The elementary and secondary effects are small; the college effect seems large enough to be important.

Meta-analysts working in a number of different areas have reported a significant relationship between study source and effect sizes. Studies located in dissertations often contain weaker findings; studies located in journal

articles often contain stronger findings. Smith (1980) has reported on the consistency of this result in numerous meta-analyses carried out at the University of Colorado. J. Kulik (1981) has discussed the consistency of this finding in University of Michigan meta-analyses. In the typical meta-analysis, according to Kulik, the average effect reported in journal articles is .16 standard deviations higher than the average effect reported in dissertations.

The difference in dissertation and journal results is particularly striking in studies of individualized instruction. Figure 2 presents the result graphically. In Hartley's meta-analysis (1977) of individualized instruction in precollege mathematics education, the average of 6 effects described in journal articles was .59; the average of 85 dissertation effects was .12. In Bangert et al.'s meta-analysis (1983) of individualized secondary-school teaching, the average of 10 effects described in journal articles was .29; the average of 36 dissertation effects was .06. In J. Kulik et al.'s meta-analysis (1979) of PSI in college teaching, the average of 46 effects described in journal articles was .57; the average of 3 dissertation effects was .15. If precollege and college studies of individualized instruction had been found in the same sources, conclusions about effectiveness might be more similar for different instructional levels.

Other findings on study features are less strong and less consistent from meta-analysis to meta-analysis.

205206

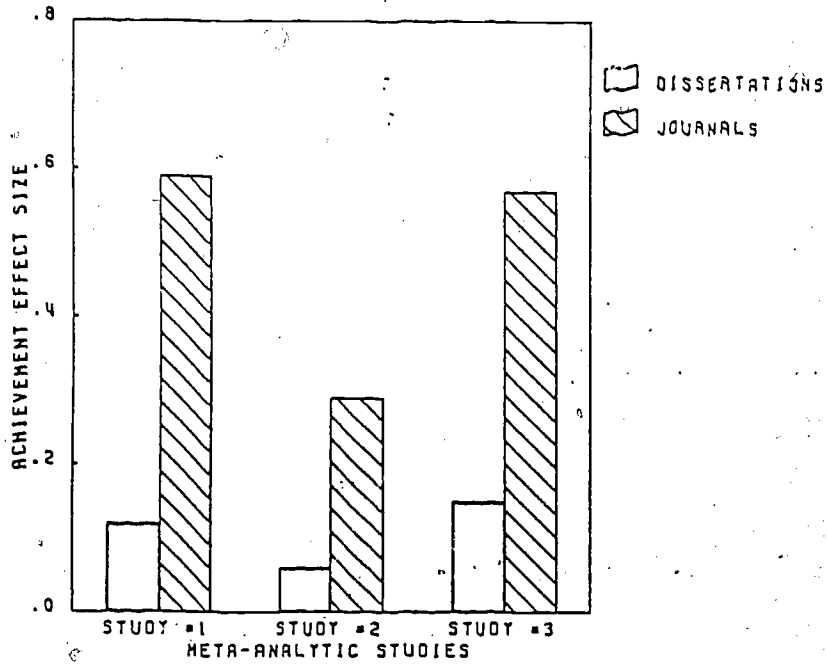

Figure 2. Effects of individualized instruction on achievement examinations, as reported in studies located in journals and dissertations. (Note: Study #1 is Hartley's meta-analysis (1977) of results from elementary and secondary schools; Study #2 is Bangert, Kulik, and Kulik's meta-analysis (in press) of findings from grades 6 through 12; Study #3 is J. Kulik, Kulik, and Cohen's meta-analysis (1979) on college-level findings.

Hartley (1977) found that studies using new, evaluator-designed teaching and testing materials showed stronger results than did studies using field-tested commercial materials. Evaluator involvement in instruction thus seemed to influence evaluation results. J. Kulik et al. (1979) reported that PSI effects were stronger when different teachers were in charge of PSI and control classes and weaker when the same teacher taught both experimental and control sections of a course. Kulik and his colleagues also found this relationship in other meta-analyses of college-level findings. A similar effect has not been established in meta-analyses of precollege findings.

Other outcomes. Bangert et al.'s meta-analysis (in press) also examined nonintellective outcomes of individualization in secondary school classes. In general, these nonintellective effects were small. Fourteen studies, for example, contained results on student attitudes toward the subject matter being taught. The average effect of individualization in the 14 studies was to raise attitude ratings by only .14 standard deviations.

As one might expect, results from individualized college teaching were strikingly different from these secondary school results. J. Kulik et al. (1979) reported that differences in student ratings of PSI and control classes were pronounced. Students rated PSI classes as more enjoyable, more demanding, and higher in overall quality and contribution to student learning. Kulik and his associates

208

also reported that PSI and conventional classes apparently make equal demands on student time. The difference in time spent in PSI and conventional sections of a course seldom amounted to as much as an hour or two for a complete semester.

Conclusions

Individualized systems of instruction have apparently made only limited contributions to precollege math and science teaching in the past. Such teaching systems have raised examination scores and improved student attitudes by only a small amount. The prospects for major contributions from this teaching technology in the future seem remote.

It is possible, of course, that individualized systems have not been expertly evaluated. The vast majority of evaluations at the elementary and secondary level have been carried out as dissertation research. The discrepancy in results from the dissertation studies and from journal studies is considerable. If we were to disregard the dissertation findings and rely entirely on journal results for our conclusions, we would have to conclude that individualization shows some promise for improving instruction at the elementary and secondary level.

Some researchers (e.g., Glass et al., 1981) have suggested, however, that dissertation effects are more dependable than are journal effects. They attribute the difference in results from the two sources to selective publication. Experimenters tend to submit papers with

significant results to journals, they point out, and editors tend to select for publication those papers with the strongest effects. Journal results therefore reflect more than simple experimental effects. They also reflect the added effects of multiple selection decisions.

It is possible, however, that educational research carried out by dissertation writers may be different from the research carried out by journal authors. The producers of the two types of research are different in experience, goals, and resources. The two types of researchers are usually working under different pressures to complete an evaluation, and they are usually involved to different degrees in the innovative programs they are evaluating. Journal research--produced by more experienced workers with greater resources--may be the more reliable research.

The way we interpret the difference between the two is important because it will determine how we look at the record of effectiveness of PSI at the college level. This record has long been regarded as unusually strong, and it has also been interpreted as showing that individualization is appropriate for mature learners working in the unconstrained environment of a college campus. PSI's unique record of effectiveness comes from an evaluation literature that has a unique characteristic: it is almost entirely lacking in dissertation evaluations. Are the producers of PSI evaluations different in other respects? Would PSI's record of effectiveness be less impressive if this college

level teaching innovation had been evaluated in the same way that other teaching innovations were?

Computer-Based Instruction

Reviews of evaluations of CBI have followed the same cycle as reviews of evaluations of other instructional technologies. Early reviews provided box-score tallies of positive and negative findings; later reviewers have used sophisticated meta-analytic techniques to determine the size of effect in different computer applications.

Box-Score Reviews

Major reviews that used box-score methods of synthesizing findings concluded that CBI is effective in raising student achievement, especially in elementary schools. Vinsonhaler and Bass's review (1972), for example, reported on results from 10 independent studies, 3 covering instruction in language arts and 3 covering mathematics teaching. These reviewers found a substantial advantage for CBI augmentation of traditional classroom instruction. Generally, children who received CBI drill and practice plus conventional instruction showed performance gains of 1 to 8 months over children who received only conventional teaching.

Edwards, Norton, Taylor, Weiss, and Dusseldorp (1975) reviewed studies at various educational levels and in various subjects, and they also reached positive conclusions about the effectiveness of CBI. Findings were especially clear when CBI was used to supplement conventional teaching.

Nine studies showed that normal instruction supplemented by CBI was more effective than was normal instruction alone. Findings were less clear when CBI was substituted, in whole or in part, for traditional instruction: nine studies showed that the CBI students achieved more than non-CBI students, whereas eight studies found little or no difference and three studies showed mixed results. Finally, all studies of instructional time showed that it took less time for students to learn through CBI than through other methods.

Meta-Analyses

The major meta-analytic syntheses are by Burns and Bozeman (1981); Hartley (1977); J. Kulik, Bangert, and Williams (1983); and J. Kulik, Kulik, and Cohen (1980). The meta-analysis by Hartley and the one by Burns and Bozeman examined CBI effects on mathematics achievement; the meta-analyses by Kulik and his colleagues examined effects in a wider variety of areas.

Achievement results. Hartley (1977), who was the first to apply meta-analysis to findings on CBI, focused on mathematics education in elementary and secondary schools. She reported that the average effect of CBI, was to raise student achievement by .41 standard deviations, or from the 50th percentile to the 66th percentile. Hartley also reported that the effects produced by computer-based teaching were not quite so large as those produced by programs of peer and cross-age tutoring, but they were far

larger than effects produced by programmed instruction or the use of individual learning packets.

Burns and Bozeman (1981), like Hartley, used meta-analysis to integrate findings on computer-assisted mathematics instruction in elementary and secondary schools. In all, these reviewers located 40 studies in which CBI drill and practice or tutorials supplemented traditional classroom instruction. They found overall effect sizes of .45 for computer-based tutorial instruction and .34 for drill and practice.

The meta-analysis by J. Kulik et al. (1983) examined studies of CBI in grades 6 through 12. A total of 48 of the 51 studies that they located reported achievement test results. More than 50% of these studies examined CBI effects on mathematics teaching; nearly 25% of the studies examined CBI effects in other science areas. The studies covered a variety of uses of the computer: drill and practice, tutorials, management of instruction, simulation exercises, and practice in programming as a means of increasing cognitive skills. The average effect of CBI in the 48 studies was to raise achievement scores by .32 standard deviations, or from the 50th to the 63rd percentile.

J. Kulik et al.'s meta-analysis (1980) examined applications of CBI in college classes. A total of 54 of the 59 studies located for this meta-analysis looked at achievement test results. Nearly two-thirds of these

studies came from courses in mathematics, science, and engineering; many of the remaining studies came from psychology and the social sciences. The effect of CBI in a typical class was to raise student achievement by approximately .25 standard deviations, or from the 50th to the 60th percencile.

Study features and achievement results. It is hard to find any study feature that relates consistently or strongly to CBI study outcome. On the basis of findings on mathematics teaching, J. Kulik (1981) has suggested that CBI results may be a function of instructional level. Computer-based teaching appears to raise examination scores in mathematics by approximately .4 standard deviations at the elementary level, by .3 standard deviations at the secondary level, and by only .1 standard deviation at the college level. Kulik suggested that at the lower levels of instruction, learners might benefit more from the stimulation and guidance provided by a highly reactive teaching medium. It is not yet clear, however, that this relationship between CBI results and instructional level holds true in all content areas. Until more evidence is available, Kulik's suggestion should be treated as tentative.

Short-term studies of CBI have sometimes reported stronger effects than have long-term studies, although results have not been especially strong or consistent from meta-analysis to meta-analysis. The difference in results

from long and short studies reached borderline significance in J. Kulik et al.'s meta-analysis (1983) of secondary school results; the superiority of short-term over long-term results was less pronounced and did not reach statistical significance in meta-analyses by Hartley (1977) and J. Kulik et al. (1980).

Meta-analyses have also suggested other relationships between CBI results and study features, but these relationships have not yet been firmly established. Hartley (1977) found that CBI was relatively ineffective in the few studies where it was used as a complete replacement for conventional teaching. Other meta-analysts have not calculated effects separately for studies in which CBI substituted completely for conventional teaching, and so Hartley's finding still needs to be confirmed. Finally, J. Kulik et al.'s meta-analysis (1983) on secondary school applications of CBI found somewhat greater effectiveness in more recent implementations of CBI. Other meta-analysts have not reported a time trend in study outcomes, but they also have not included so many recent reports in their analyses.

Other study features seem unrelated to CBI results. CBI results from both journal articles and dissertations are basically similar; studies from both sources show moderate achievement gains for students using computers in classrooms. Evaluator involvement in the computer-based teaching programs also appears to have little effect on.

215
315

from long and short studies reached borderline significance in J. Kulik et al.'s meta-analysis (1983) of secondary school results; the superiority of short-term over long-term results was less pronounced and did not reach statistical significance in meta-analyses by Hartley (1977) and J. Kulik et al. (1980).

Meta-analyses have also suggested other relationships between CBI results and study features, but these relationships have not yet been firmly established. Hartley (1977) found that CBI was relatively ineffective in the few studies where it was used as a complete replacement for conventional teaching. Other meta-analysts have not calculated effects separately for studies in which CBI substituted completely for conventional teaching, and so Hartley's finding still needs to be confirmed. Finally, J. Kulik et al.'s meta-analysis (1983) on secondary school applications of CBI found somewhat greater effectiveness in more recent implementations of CBI. Other meta-analysts have not reported a time trend in study outcomes, but they also have not included so many recent reports in their analyses.

Other study features seem unrelated to CBI results. CBI results from both journal articles and dissertations are basically similar; studies from both sources show moderate achievement gains for students using computers in classrooms. Evaluator involvement in the computer-based teaching programs also appears to have little effect on

to a size of effect of .78 standard deviations. In the other study, students spent 90 minutes on instruction and study when taught with computers and 745 minutes when taught conventionally. The 88% savings in time is obviously great and of practical importance for teaching.

J. Kulik et al. (1980) also located college-level studies that examined CBI effects on attitudes and instructional time. Results in these areas were consistent with J. Kulik et al.'s results (1983) at the secondary level. The average effect of CBI at the college-level was to improve attitudes toward instruction by .24 standard deviations and to improve attitudes towards subject matter by .18 standard deviations. J. Kulik et al. (1980) also reported that in each of eight studies, the computer produced a substantial savings in instructional time. In all of the cases in which investigators performed statistical tests, the difference in instructional time between CBI and conventional classes was statistically significant. On the average the conventional approach required 3.5 hours of instructional time per week, and the computer-based approach required about 2.25 hours. This is a substantial and highly significant difference between methods. There appears to be little doubt that students can be taught with computers in less time than with conventional methods of college teaching.

Conclusions

Evaluative studies show that CBI has real potential as a tool in improving precollege mathematics and science teaching. The first criterion on which CBI excelled was student achievement. The average effect of CBI on precollege mathematics and science instruction was to raise student achievement by .4 standard deviations, or from the 50th to the 66th percentile. This compares favorably to the effects produced by other technologies. Both programmed instruction and individualized instruction raised student achievement in precollege mathematics and science by only .1 standard deviations.

CBI also showed good results when measured by the criterion of instructional time. Several studies have shown that students can learn more quickly with computer assistance than with conventional teaching methods. Although the claim of quicker learning has been made for programmed instruction, findings for programmed instruction are far less dramatic than are CBI findings. A third important effect of CBI was to foster positive attitudes toward the computer. Students who learned with computer assistance felt more positively about computers than did students who received all their instruction by conventional means. Use of the computer in instruction may therefore help prepare students for the computer society in which they will live and work.

One of the remarkable things about CBI studies at the precollege level is how robust their findings are. CBI findings were similar for different groups of studies carried out under different conditions. The worrisome complications found in studies of programmed and individualized instruction were absent from the CBI literature. Journal and dissertation studies of CBI reported similar results. Evaluator involvement in the development of teaching material did not seem to be necessary for positive results. CBI effect were acceptably strong in both early and recent studies of CBI.

One of the few things that may weaken seriously the effectiveness of CBI is its use as a complete replacement for conventional teaching. Not many studies were located in which CBI was so used, but Hartley (1977) managed to locate a few such studies, and she found that their results were unimpressive. Total reliance on the computer as teacher therefore seems to be one thing that school systems should avoid. The effectiveness of CBI appears to be enhanced, on the other hand, by the use of up-to-date programs and computers. J. Kulik et al.'s meta-analysis (1983) covered a number of studies carried out in the period from 1976 to 1980, when programs and computers had increased in sophistication, and results from these studies seemed to be especially positive.

CBI results also appeared to be somewhat stronger at the lower level of instruction than at the higher levels.

That is perhaps because programs developed so far exploit capacities of the machine most adapted to lower level learning: its patience in drilling and tutoring students and its capacity to respond immediately and appropriately to student answers. A major evaluation of CBI whose results were published too recently for inclusion in the meta-analytic studies shows what can be accomplished by an infinitely patient computer in an elementary school classroom. The study was a 4-year project conducted by the Educational Testing Service (ETS). Evaluators from ETS teamed up with the Los Angeles Unified School District in 1976 to install computer-assisted instruction labs using Computer Curriculum Corporation's hardware and software in four elementary schools. In each of the schools half of the first through sixth graders were given access to 20 minutes of computer-assisted drill and practice in mathematics, reading, and language arts; the other half of the students did not receive this computer assistance. At the end of the first year, the CBI mathematics students were at the 64th percentile compared to the 50th percentile for the non-CBI students. At the end of the second year the CBI students were in the 71st percentile; at the end of the third year they were in the 76th percentile.

Although these findings are impressive, they are findings of the past, not necessarily of the future. This is an important point to keep in mind in the rapidly changing field of CBI. Evaluations seldom reflect the

newest applications of the computer in teaching. Meta-analyses lag especially far behind the leading edge in development. They provide at best a summary of the major themes in reported evaluation findings. With developments in computer technology occurring so swiftly, no one can predict with confidence what the next year, much less the next decade, will bring in computer-based teaching.

Summary

This evaluative review of the effects of instructional technology on learners made several major points:

- 1) The major instructional technologies developed for classroom use in the past three decades show different degrees of promise as aids in precollege mathematics and science classrooms.
- 2) Programmed instruction raised student achievement test results by only a small amount (.1 standard deviation), did not have positive attitudinal effects on students, and did not produce dramatic effects on student time to learn. Recent studies of programmed instruction and studies of its use in college teaching, however, presented a somewhat more positive picture of its results.
- 3) Individualized systems of instruction also raised student achievement in precollege mathematics and science classrooms by about .1 standard deviations and had very small effects on student attitudes. Like programmed instruction, individualized instruction seems

to be more effective at the college level, but the picture of effectiveness is clouded by the difference in results from journal articles and dissertations and by the different sources for college and precollege studies of individualized instruction.

- 4) CBI shows far more promise than the other technologies as an aid in improving precollege mathematics and science teaching. It raised student achievement by approximately .4 standard deviations in the typical study, dramatically affected the amount of time needed for teaching and learning, and significantly altered student attitudes toward computers. Recent studies have reported stronger effects than have older studies. The few available evaluations in which CBI was used as a complete replacement for conventional teaching rather than as a supplement, however, showed small effects.

- Hirsch, C. R. A review of research on individualized instruction in secondary mathematics. School Science and Mathematics, 1976, 76, 499-507.
- Johnson, K. K., & Ruskin, R. S. Behavioral instruction: An evaluative review. Washington, D.C.: American Psychological Association, 1977.
- Kulik, C.-L. C., Shwalb, B. J., & Kulik, J. A. Programmed instruction in secondary education: A metaanalysis of evaluation findings. Journal of Educational Research, 1982, 75, 133-138.
- Kulik, J. A. PSI: A formative evaluation. In B. A. Green, Jr. (Ed.), Personalized instruction in higher education: Proceedings of the Second National Conference. Washington, D.C.: Center for Personalized Instruction, 1976.
- Kulik, J. A. Integrating findings from different levels of instruction. Paper presented at the American Educational Research Association, Los Angeles, April 1981. (ERIC Document Reproduction Service No. ED 208 040)
- Kulik, J. A. Individualized systems of instruction. In H. E. Mitzel (Ed.), The encyclopedia of educational research (Fifth edition). New York: MacMillan, 1983.
- Kulik, J. A., Bangert, R. L., & Williams, G. W. Effects of computer-based teaching on secondary school students. Journal of Educational Psychology, 1983, 75, 19-26.

- Kulik, J. A., Cohen, P. A., & Ebeling, B. J. Effectiveness of programmed instruction in higher education: A meta-analysis of findings. Educational Evaluation and Policy Analysis, 1980, 2, 51-64.
- Kulik, J. A., Kulik, C.-L. C., & Cohen, P. A. A meta-analysis of outcome studies of Keller's Personalized System of Instruction. American Psychologist, 1979, 34, 307-318.
- Kulik, J. A., Kulik, C.-L. C., & Cohen, P. A. Effectiveness of computer-based college teaching: A meta-analysis of findings. Review of Educational Research, 1980, 50, 525-544.
- Miller, R. L. Individualized instruction in mathematics: A review of research. Mathematics Teacher, 1976, 69, 345-351.
- Nash, A. N., Muczyk, J. P., & Vettori, F. L. The relative practical effectiveness of programmed instruction. Personnel Psychology, 1971, 24, 397-418.
- Robin, A. R. Behavioral instruction in the college classroom. Review of Educational Research. 1976, 46, 313-354.
- Saettler, P. A history of instructional technology. New York: McGraw-Hill, 1968.
- Schoen, H. L. Self-paced instruction: How effective has it been in secondary and post-secondary schools. The Mathematics Teacher, 1976, 69, 352-357.

- Schramm, W. The Research on Programmed Instruction: An annotated bibliography. Washington, D.C.: U. S. Department of Health, Education, and Welfare, 1964.
- Silberman, H. F. Characteristics of some more recent studies of instructional methods. In J. E. Coulson (Ed.), Programmed learning and computer-based instruction. New York: Wiley, 1962.
- Skinner, B. F. The Science of learning and the art of teaching. Harvard Educational Review, 1954, 24, 86-97.
- Smith, M. L. Publications bias and meta-analysis. Evaluation in Education: An International Review Series. 1980, 4(1), 22-24.
- Vinsonhaler, J. F., & Bass, R. K. A summary of ten major studies on CAI drill and practice. Educational Technology, 1972, 12, 29-32.
- Zoll, E. J. Research in programmed instruction in mathematics. The Mathematics Teacher, 1969, 62, 103-110.

Mr. GORE [presiding]. Thank you very much.
Congressman Volkmer.

Mr. VOLKMER. Yes. I would like to ask Dr. Taylor and Dr. Wyatt if they agree with Dr. Braun's basic premise on the need for involvement of teacher education in computing.

Dr. WYATT. Let me answer, if I may, in the following way.

As I said in my statement, I have had some experience in developing materials of this sort. And as I was thinking—I had concluded about this statement—that it really depends on the individual. That is, Robert Keaton, one of the best teachers at the Harvard Law School, developed some interactive computer exercises that are now used in probably 50 law schools. In fact, other law teachers are also using the same methodology to develop these materials. I don't think Professor Keaton ever really learned what a computer did.

What he did do was to look at the capacity of the computer system to deal with interactive material, to pose questions to students, to network the different responses, depending on the answers of the student.

On the other hand, there are examples—Prof. Richard Sidman at the Harvard Medical School is now developing some material for teaching neuroanatomy. Professor Sidman is not a computer expert, either, but I believe he is going further than Professor Keaton did in learning about computers. So I think it depends on the material, I think it depends on the individual. But in both cases I believe it requires a support cast, very much like a book requires an editor or a television production requires a producer-director. The successful efforts that I know have a supporting cast for the teacher-innovator in order to produce this material.

Mr. VOLKMER. That's the same as I view it.

What about the teacher that's going to be a math teacher, let's say in a high school; do they need to have the utilization of the knowledge of what makes that computer actually work, or do they need only good software to use with hardware?

Dr. WYATT. My personal opinion, having mathematics training, is that it's one of the most exciting things that can happen to them. That is, I believe it would stimulate them, their interest, their curiosity, because of the inherent nature of logic and almost a mathematical context that a computer presents. So rather than say it's necessary, I think it's enormously helpful, and I suspect that it might even be necessary.

Dr. BRAUN. Excuse me for interrupting, but I think my proposal is being misinterpreted. I did not mean to suggest that I want to train teachers about the innards of computers.

"Yukkie" analogies seem to be the fashion of the day. It seems to me that if I were to take an automobile and drop it in the Outback in Australia in a tribe of Aborigines, they wouldn't know what to do with it. If I told them what an automobile is used for, they would figure out what to do with it. They may not know there is gasoline burning in the chambers or any of that sort of thing, and they wouldn't have to. But they would need to know that an automobile is used to carry people and things from place to place.

In the same way, it seems to me, teachers don't necessarily need to know how to program a computer, nor do they need to know

what the insides of a computer are like. But they absolutely must know how to use a computer to increase the level of understanding of their students in mathematics, in language arts, in science, in the social studies, in shop, and in every discipline that students study in school.

Dr. WYATT. May I respond once more to that question?

Mr. VOLKMER. Yes.

Dr. WYATT. For quite a number of years I have taught in executive programs, that is, teaching people past the age of 30 about management systems that use computers. For the first 2 years I did that, I did not teach these people anything about computers. And there was obviously a very deep insecurity in their own minds about not knowing about computers. And they insisted—later students insisted—that I put in a module that did 1 week's worth of description of programing a computer and understanding how its innards worked.

Now, in 1 week one can't do a whole lot, but one of the things I did accomplish in that was to give a lot of people a lot of peace of mind so that then they could get on with the business of learning how a computer is used.

Mr. VOLKMER. Dr. Taylor.

Dr. TAYLOR. I think that I would rather put the issue this way, that is, I believe people should be given the opportunity to learn as much about computers as they can comfortably take. What I grow uncomfortable with is a person who says you don't need to know anything about computers except how to use them. I think that is true, that to use it you don't need to know anything about it except how to use it. But if there is intellectual growth to be achieved by messing around with it, and by learning to program it to whatever extent a person is able, then I think that should not be denied to somebody, particularly a young person.

I think perhaps you raised the issue about algebra. Did you make the comment about algebra?

Mr. VOLKMER. Yes.

Dr. TAYLOR. Some interesting research has been done at the Universities of Massachusetts and Yale through Elliott Soloway and some of the people who have been looking at cognitive structures and programing. And one of the things they seem to have found out is that a group of students, a large sample of students, could conceptualize a problem better, a simple algebraic problem, if they had studied programing than those students who hadn't. I think that maybe what Dr. Wyatt was talking about bears on that.

One of the things that Seymour Papert, who unfortunately is not here today, likes to talk about is that mathematics has been robbed of its tangibility in order to make it pure, and many people lose interest and lose touch with it. One of the things that the computer can do is provide a tangibility again to some of the things that otherwise seem to allude people mathematically. But in terms of teacher training, I think that I would argue that teachers should be given as much training as we can afford to. Certainly to use the computer in something like teaching writing, they do need some kind of at least minimal idea of what a computer is and how it works, apart from just using the text editor, so they feel more com-

fortable with it. Whether they'll write software is a totally different issue, I think.

But my main issue today was that everybody needs some teacher training, and those people that are going to teach computing desperately need a lot more than they're getting now. There are a lot of those people out there.

Mr. VOLKMER. Then that gets me back to Dr. Braun. I believe you're the only one that has made a proposal as to the cost of doing this, the cost of actually teaching teachers, right?

Dr. BRAUN. Yes.

Mr. VOLKMER. And you say that—you're talking about \$15 billion if you do it one way, and you could possibly come up with \$300 or \$400 million?

Dr. BRAUN. I think \$300—well, I said \$300 million. Yes; I think that using technology intelligently to deliver this educational program to teachers would require something on the order of \$300 million.

Mr. VOLKMER. Could you give us—you don't have to do it right now, but perhaps if you do have some time you could submit it in writing—the methodology on being able to do that?

Dr. BRAUN. Sure.

Mr. VOLKMER. I would be interested in it.

Dr. BRAUN. I would be glad to do that.

Mr. VOLKMER. Thank you.

Thank you, Mr. Chairman.

Mr. GORE. Thank you very much.

I have some questions, but first let me say I, too, am sorry that Dr. Papert couldn't join us today. I felt he could make a contribution here. I'm real sorry that he couldn't come. A sister subcommittee also sought his testimony some weeks ago and he was unavoidably detained on that occasion.

I also wanted to be here at the beginning of this panel, so I could make some complimentary remarks about my fellow Tennessean, Dr. Joe Wyatt; and I apologize to all of you for being out of the room at the beginning of this panel. Right across the hall we have what is called a markup on legislation affecting telephone rates, and that is another top priority issue for my constituents. I had to join in that briefly.

Dr. Wyatt, help me to envision what the role of computers in education can become. You and I have talked about inter-active computers. I know that you've done a lot of pioneering work on this. And I also know that we don't really know where it will go. But do some dreaming with me for a moment, if you would.

What kind of role can they play? In a practical way, what's a child going to school going to be able to look forward to if we resolve the policy issues and the financial issues and the access issues and all of the other issues that these hearings are supposed to help us get a grip on? What are we really talking about in practical terms?

Dr. WYATT. You don't mind tough questions, do you?

Let me start at the other end of the spectrum at, say, the graduate school level. In many fields of science, and social science, it is now really impossible to do graduate research without the use of models, computer-based models, that simulate a large system for

investigation, whether it is an aerodynamic body, as those represented in the very earliest days of computers to study flight, flight characteristics of aircraft, to other kinds of models, social models—

Mr. GORE. A national economy.

Dr. WYATT. A national economy. Economic models are used to teach economics very, very effectively. If we can visualize those models, which took years to develop, being mapped downward in the school system, so that we extract from them the kinds of concepts, the kinds of models that we wish to deliver to high school students on various topics—like we allow high school students to perhaps play some of the games that exist now have been taught at the college level. After all, we're pushing and have pushed calculus from the college level down into high schools, and other subjects as well. I think if we take that as a concept, we begin to see that we consider the student and the computer and the teacher in possibly different roles.

As it was put earlier, perhaps the teacher does not have to become the sole source of information. The teacher can become an inspiration, a leader, a solver of problems, a deliverer of information in a very provocative way, so that the student's knowledge against various kinds of models is tested. I think that's probably one of the most powerful things that we can do with these systems.

The Keaton model was the model of a courtroom, in which a student played the role as a judge, and the computer would raise issues in the case that the student had read. The person who was being interacted with by the computer would be asked by the computer system, through the material he had developed, given this model, one counsel raises an objection, "Do you sustain the objection—"

Mr. GORE. No, no—

Dr. WYATT [continuing]. A network of kind of interactive model of all sorts of topical areas.

Mr. GORE. If I can interject just briefly—and I apologize for breaking your train of thought—that interaction would be through a keyboard?

Dr. WYATT. Well, that is one of the major constraints of computers. In fact, it is probably the thing, when we got down to it, that many people disliked the most, the problem of keying information.

We now are close to vocabularies that allow a person to speak to a computer, very close to workable vocabularies, so perhaps in the near future one of the major manufacturers will announce a marketable computer that can be programmed with 50 commands or so that could be spoken to the system.

Touch pads, that is, a way to break the kind of routinized keying, that is good for some kinds of information, word processors and other things, not very convenient at all for certain other kinds of information.

Mr. GORE. Well, go ahead, or were you—

Dr. WYATT. Well, I was just going to say that as the technology has developed, the ability to present models now can take the form of graphics, through the integration of video discs into these systems, that can take the form of either moving pictures or still pictures, all blended together in a way that will allow the teacher,

through the computer system, to place the student in this simulation, this model of an environment, and in which the teacher can provoke the student to be responsive in a Socratic dialog, to test knowledge of a model, or to exercise the model with the student's own, more or less, free hypotheses.

Mr. GORE. The development of speech recognition circuits sophisticated enough to respond to elementary and high school students would be a major breakthrough in interactive computer instruction, would it not?

Dr. WYATT. I think it might. I think the range of the vocabulary is the subject of much debate; that is, how much of a vocabulary would it take to be useful in that context. There are widely differing opinions on that.

I personally believe that once that problem is overcome, that is, the fundamental problem of translation—and a mass of technology can be brought through large-scale integrated circuits to the algorithms that do that—then the vocabulary can probably be expanded fairly rapidly to the point that it will become useful.

Mr. GORE. Dr. Taylor, do you have any thoughts on this general, too general, question of what do students have to look forward to in the future if we could envision what the role is likely to be for computers in education?

Dr. TAYLOR. Yeah. I think that we would see a change in the classroom. As I said, I think the teacher has—one of the problems of teacher training is that the teacher has to see himself or herself in a new role, more as a coach and coordinator, and less as someone who is going to be superior to all the students in terms of the amount of knowledge he has or she has.

The real underlying idea there is that we have long since passed the idea in science that we're going to know everything there is to know. In your lifetime, much more turns up than people knew for centuries before that.

What people have to learn now is how to navigate through information and have to accept that what they learned in school is going to be a sort of subset of what they maybe ought to know in any given context and no longer a total set of information. So it might be this example or it might be that one.

What people have to do is formulate a new way of intellectually dealing with reality because they can't know it all any more. Our educational systems really posit the idea that there's a certain set of things to learn, and once you learn those, you're educated. We now know that's no longer possible. You can't learn all the things you ought to learn, and whether you take any one subject or all subjects, what you are really trying to do is teach people how to think and how to behave in a certain way, so they can come to terms with the future which we don't yet perceive.

Mr. GORE. And how to learn.

Dr. TAYLOR. Yes. That's another reason why I think, and why I think Seymour Papert always talks about people learning how to make the computer do what they want in something like a programming language, because in a way that gives them practice with themselves wrestling with the whole process of navigating through intellectual growth.

I think, as Dr. Wyatt said again, models right down to the elementary school can be very useful for learning, too. We can do all that sort of thing. But I think one of the things we would expect to find is more cooperation between children, the demise probably of the old idea of cheating, which is really based on the old idea of print technology, where each person has his own private knowledge right here on a piece of paper, and instead, you learn to work cooperatively to produce things. That's what you see when children get around computers often, especially if they're developing their own stuff, rather than doing somebody else's drill and practice. So the concept of cheating, which was really based on—Why do we worry about cheating? Because we really want to make sure the kid learned that body of stuff that we said he had to learn.

If we're really more concerned with the child developing a sense of process and a sense of being able to do something, then the idea of cheating becomes rather hard to pin down. It's not a matter of I copy your answers; it's can I do it, and can you do it. It's not something you can just cheat on, whatever we mean by that. So I think we will see a lot of changes in the classroom.

I think we would also see more independence, that is, we might have classes, as, indeed, we do at good universities now, where there is some lecture, there is some computer work in a lab environment, there's a lot of work back in the dormitory or somewhere else where the person goes and works on whatever he or she is working on.

In the school you still have the constraint that these are youngsters, and that you have to supervise them is a basic tenet of American education, with the school as a babysitting agency. But even with those tenets, and with that basic structure, you're still going to have a change in the way the classroom looks and the way things take place there I think we'll have more freedom. When children are occupied with something useful, you don't have to watch them very closely, so it is possible for them to work on something on their own. It's when you're forcing them to do something that they're not the least bit interested in, that they're going to go off and cause you a lot of trouble. So I think we'll see a more fluid classroom... in some cases, and possibly other structures of younger children helping, being helped by older children, to learn this process, because the teacher can't do it all.

Mr. GORE. Dr. Braun.

Dr. BRAUN. Yeah. Let me for starters make it very personal. I have a granddaughter named Katharine, with a "K," who is 14 months old. If we are at all intelligent in the way we use computers in education in the next 5 to 10 years, that child is going to be an intellectual giant. I think all children will, compared to us adults—

Mr. GORE. Well, she's likely to be in any event, isn't she? [Laughter.]

Dr. BRAUN. Of course. How could I disagree with that?

My feeling is that all children are going to be intellectual giants compared to any of us adults, or most of us. I mean, Seymour Papert aside, there always are a few of those. But the large majority of us don't come anywhere near achieving our intellectual potential.

I think that in developing higher level reasoning skills, computers will be very important. Dr. Wyatt's comments about simulation is one dimension of that. We do a terrible job in this country of teaching children problem-solving skills. Dr. Taylor mentioned the work at University of Massachusetts, where people are able to develop better problem-solving skills after they learn programming. Those are all higher level skills than just the reading, writing, arithmetic that our forefathers thought was all there was to education. All of those things are enhanced enormously if we use computers in intelligent ways.

There are people all over the United States using computers in intelligent ways, but in isolation from one another. We need to merge all of those separate activities together and build those into an educational system that provides my granddaughter and all the other children in this country with the opportunity they have a right to expect.

Mr. GORE. Well, now, you, Dr. Braun, and you, Dr. Wyatt, agree that the shortage of high-quality educational software is the critical bottleneck at the present time; is that correct?

Dr. WYATT. I think if you use the term software quite generally, yes—I mean, methodology implemented in software that can cause collection of technology to function independently and interactively.

Dr. BRAUN. I think there are two bottlenecks which are equally critical. One of them is the lack of adequate amounts of educational materials, and the other is the absolute lack of teachers trained to use those materials. If we, tomorrow, were able in some way to erect an enormous mound of really high quality educational software, we wouldn't have anybody in the United States who would know how to use it. So that's as important a problem, I think.

Mr. GORE. Dr. Taylor, you take the position that that's even more important than the lack of educational software; is that correct?

Dr. TAYLOR. I think so, though I would agree with what Dr. Wyatt said. In working on software, you do have to have a team of people and the teacher—if you're producing educational material to be used at a kindergarten-to-12 level, functional, adequate, insightful teachers are a critical part of that team.

Mr. GORE. Yeah.

Dr. TAYLOR. But I think they cannot develop the expertise in actually coding and implementing the ideas on to computers that allows them to do it fast enough to make it worthwhile. That takes another kind of expertise. But if they know something about software, they can perform that role.

I think we do need software, definitely, but I would agree with what Lud said, too.

Mr. GORE. Dr. Wyatt, what about the compatibility problem that Secretary Bell focused on so intensely. There are so many software writers out there working feverishly right now to come up with high-quality programs, if we had fungibility or compatibility between the different systems, then perhaps we could use that creative energy to better advantage.

Is there any hope of a technological fix for that compatibility problem, or is it just tougher than that?

Dr. WYATT. Well, it's been a problem that has existed as long as the technology has itself. A large part of the problem that originally existed has been solved. We have an American standard code for information interchange in terms of coding, alphabets, and special characters, that all computers use—the so-called ASCII code. But there is still a significant problem that exists in standardization, and chipping away at that problem without damaging—

Mr. GORE. Is that a pun, Dr. Wyatt?

Dr. WYATT. I hadn't intended it to be, but I'll accept it, I'll accept it. [Laughter.]

Mr. WYATT [continuing]. Is something that we probably should worry a good deal about, because on the one hand, this business of uniqueness, individuality, is a form of protection for the software and hardware that people develop, trade secret protection. If everything is equally compatible, I think it will be very difficult—and somehow forced to be compatible. We will have to devise a new means to protect the uniqueness of the things that are developed.

But I think we really must press for some forms of standardization on some key issues of interface and communication. Very often we find that that happens de facto by virtue of people making their product compatible with one of the large manufacturers of products just succumbing to whatever it is that manufacturer does. But there is still some room for improvement.

Mr. GORE. The way the market pressures are going, there is at least a chance that all of it is going to be IBM compatible within the next—

Dr. WYATT. Well, there is certainly a lot of evidence to suggest that the thing that has made the IBM personal computer most successful is that the software industry, so to speak, has judged it to be a good investment to risk their software development in IBM's technology, and that has had a feedback effect on the technology itself, and so it continues to spread.

Mr. GORE. And all the best programs are appearing in their first versions for IBM because they perceive the market moving in that direction; is that—

Dr. WYATT. Oh, I think if a person is developing a program, and in order to make any money from it has to multiply by a large number, one looks for where likely that person is likely to find a large number, and the IBM PC, of course, is a growing and large number.

Mr. GORE. Yeah. Dr. Braun.

Dr. BRAUN. I think your comment about the software for IBM is correct, if you're talking about business software, but it's not at all correct if you're talking about educational software. Machines like the IBM machine are much too expensive for schools to afford. So the people who are developing educational software by and large are focusing on the Apples and Ataris and Commodores and machines like those.

I have only been in the computing business for 20 years, but during that period I have heard the word standardization mentioned enough times that it makes me nauseous to hear it, frankly. I think it's a fiction that we keep running after. Because each time we develop a standard, in the American free enterprise system every manufacturer wants his or her product to be better than the

competitor's product, and so everybody meets the standard and exceeds it in some unique way, so that that product is different from any other and can be sold on the basis of the uniqueness. So, unless we're willing to do in the American free enterprise system, I think we're not likely to have standardization.

I personally am happy with that because with the lack of standardization we've got an evolution of the hardware capabilities that we would not have had we decided at any time—in the 25 years I've been in this business—had we decided at any time to standardize, we would have strangled future development. We now have computers that can speak, that can hear, that can draw pictures, that can make music. Each machine does it in a unique way and each machine has capabilities that are different than any others. Each generation of machine is evolved from the preceding generation and would not be as far advanced if we had standardization as it is with the lack of standardization. So I don't—I hope that standardization doesn't come for another 20 years.

Mr. GORE. Well—

Dr. BRAUN. At which time I won't have to worry about it anymore.

Mr. GORE. I bet there'll be a lot of people here who disagree with that. I mean, standardization worked well for television signals, radio waves, long-playing records, FM stereo, cassette tapes. The next generation of video tape recorders are all going to be standardized. I mean, surely we reach a point where it becomes good sound judgment to get everybody playing in the same stadium so that we can maximize the benefits of what has been developed through the trial-and-error process.

Dr. BRAUN. What you say is a very powerful argument. I accept that argument, and it grieves me to say what I said a minute ago. But computers are different from TV and stereo and all of the things you mentioned as benefiting from standardization. The generation of music and generation of TV images and so on are things which are relatively simple. The computer is an enormously complex environment which we don't yet really understand. I don't think that we're in a position yet to standardize, to specify standards, because we don't understand the educational impact of this medium to the same extent that we did the movie film and records and all of the things that have been standardized. When we do, then I will be in favor of standardization.

Mr. GORE. Does somebody want to speak out in disagreement?

Dr. TAYLOR. I'm not sure how moot the argument is; that is, I don't know what this committee or Congress could necessarily do about standardization. But I believe it is necessary. I think it's like getting married. You lose something and you gain something, and you can't have it both ways. The creativity that comes from being able to endlessly extend your horizons in all possible directions leads to chaos if you don't harness it down some channel sooner or later.

I find in writing software myself that it is very frustrating to have to worry about whether I'm going to be able to put it on another computer without messing around with it an awful lot. I would be willing to give up some of the flexibility I have in order to

be able to guarantee that it could be put down some channel. I think, in general, that's just a necessary compromise.

I don't know whether the committee or whether Congress can really do much about that. I would sort of be in favor of—maybe I'm getting old—of making a compromise so I could have some standardization. So I think that is an important issue, although I'm not sure what you can do about it.

Mr. GORE. Dr. Wyatt.

Dr. WYATT. Let me offer another perspective to support Dr. Taylor's statement, although I respect what Dr. Braun is saying. Many school systems—If we had our ways, as we have described it here, many school systems would invest to some extent in a series of computers, say a personal computer—for example, supposed they invested in the IBM PC. And people would develop software for it, teaching materials and the like, and we have seen that this technology is very unpredictable, that it cycles on about a 3- to 5-year basis, and it is very likely that that school system would face in a relatively short time a very attractive possibility of using, say, an Apple configuration for one reason or another.

The conversion costs of software have stopped many a fine venture from happening, just the cost of trying to keep the status quo and move it to something new and innovative. And that's, indeed, unfortunate. I do think we need to make some compromises there, and I believe they can be made in areas that perhaps are less important and still allow the kind of innovation and creativity that we have to have.

Mr. GORE. Well, it may be that our recommendations will include the recommendation that any Federal role to stimulate the development of educational software include incentives for those who provide such software to come within a range of—to come within parameters of compatibility. But we'll take your views into consideration, Dr. Braun.

I would also look forward to working with you, Dr. Wyatt, on your very intriguing suggestion that we consider a COMSAT model for accomplishing this task. I think that's a very innovative idea, one that you recognize requires some work and thinking through. I want to work with you to flesh out that idea because I think that proposal has a lot of promise.

I could ask a lot more questions, but we've got another panel and we need to get to it. Let me thank the three of you very much for your help here. It's really been a good panel, and I appreciate it very much.

We will go to the next panel after a 2-minute recess, 2 minutes only.

[Whereupon, the subcommittee was in short recess.]

Mr. GORE. The subcommittee will come to order.

I would like to invite to the witness table our panel on universities: Dr. Maurice Glicksman, provost, Brown University; Dr. Bernard Sagik, vice president for academic affairs, at Drexel University; and Dr. James Johnson, director of the office of information technology, University of Iowa in Iowa City, Iowa.

Gentlemen, I really appreciate your appearance here today. I appreciate your patience, too. I'm sorry the hearing has gone as long as it has, but it's an intriguing subject and one which inspires a lot

of curiosity and questions. It's going to be hard to get a grip on it, but we look forward to your help in getting a grip on this problem.

Without objection, the entire text of your prepared statements will be included in the record in full. If you care to summarize any of your statements, feel free to do so. Dr. Maurice Glicksman, provost of Brown, we will begin with you.

STATEMENTS OF DR. MAURICE GLICKSMAN, PROVOST AND DEAN OF THE FACULTY, BROWN UNIVERSITY; DR. BERNARD P. SAGIK, VICE PRESIDENT FOR ACADEMIC AFFAIRS, DREXEL UNIVERSITY; AND DR. JAMES W. JOHNSON, DIRECTOR, OFFICE OF INFORMATION TECHNOLOGY, UNIVERSITY OF IOWA

Dr. GLICKSMAN. Thank you very much, Mr. Gore. Mr. Chairman, I appreciate the opportunity to come before the subcommittee and discuss the questions that you've asked us to deal with.

In your letter to me you noted that you were interested in my discussing the program at Brown University and the philosophy and reasoning behind that program. Let me just briefly start by saying something about the background and philosophy and reasoning and then say a little bit more about the program. The details of what we have underway are in the written testimony which has been submitted to the committee.

Computing is part of the life on the university campus and has been such for many years. I was involved and used computing in my own work over 30 years ago—computers, I should say—in my own work over 30 years ago. But what has happened in the last decade, and particularly in the last 5 years, are some important changes in technology which have opened up the use of computers much more broadly to people generally and for various purposes on university campuses.

In terms of Brown's own involvement in this—

Mr. GORE. We're going to get those doors closed, Doctor. The telephone hearing just—

Dr. GLICKSMAN [continuing]. Broke up.

Mr. GORE [continuing]. Broke up, and three-quarters of the lobbyists in town are coming out into the hallway there.

There we go.

Dr. GLICKSMAN. I would like to say that, in terms of Brown's role in this, first I think I should like to say something about Brown as an institution and the way it in a certain sense may differ from some other institutions but has much in common with many institutions.

At Brown we integrate the notion of scholarship and teaching and undergraduates and graduate students in research get comparable attention. Hence, we try to make sure that our programs are open to all segments and not restricted to any one particular group.

Another point is, in fact, that the sciences and the humanities are of comparable strength and comparable faculty size. Broad use of computer needs and a concern for the use of computers in work on the humanities and social sciences is as important to us as its traditional use in the sciences. I think this has to be understood.

There is a statement of goals and objectives that is in the appendix of material I sent to you which I would like to quote, because I think it epitomizes the approach we have taken:

Augmenting knowledge and the techniques for furthering that knowledge has been a quest for centuries. We believe that the computer provides an opportunity to augment man's creativity and productivity by providing processes and functions heretofore unavailable. Our long-range goal is to find new ways through which computers and information systems can enhance people's thinking and learning, and help them in their daily work, which we call knowledge work, and remove or at least ameliorate inefficiencies in the processes which have hampered that use in the past.

The improvements we seek through interdisciplinary experimentation will use computer work stations and an electronic communications environment, and include integrated methods for creating, accessing, filtering, synthesizing and manipulating information. It will also include more efficient processes and tools for learning, teaching, research, and the routine daily tasks that often impede or take valuable time away from those.

Finally, I think importantly, they will enhance the group interactions with more sharing of work and more joint exploration of ideas. What computers do is open up our environment, basically our horizons, to a much more effective way of sharing resources and sharing knowledge.

Brown has tried to be an experimenter in this field, but with a flexible and nonauthoritarian approach. We have been involved in experiments in the curriculum, experiments in computer-aided courses, as another example of our experimentation, and we were successful in moving forward with providing a broad band network for communication among all the buildings on the campus several years ago, which has been operating quite successfully now for over 2 years, approximately 2 years, has carried out all the functions that we expected of it and more, and will be challenged in the next 5 years with much greater use. We have over 1,200 users on it at the present time.

Important to us in being involved in such a program is our feeling that as an innovator in this field we have an opportunity to play a part in influencing those forces which are affecting society and the way people work. In other words, we do not want to be, and we don't want to feel that we have to be, carried basically on the wave that is washing over all of society, but rather play a role in the way that those wave directions will move in the future years.

By being involved in this experimentation in an early stage, and presenting our ideas for exploration, it also gives us an opportunity to carry them out. I make this point because support from institutions—and we have been talking here about the Federal and State Governments, but here I want to go to the private sector—foundations and corporations are interested in supporting innovation and interested in supporting successful ideas which have portability. They rarely will be able to help pay for emulation of what other people have shown to be successful. Those institutions of higher education which do not essentially put themselves forward and offer to participate in exploring this whole revolution, as it has been called, are going to find it much more expensive and find sup-

port for it very difficult to come up with in future years. I, therefore, do have concern, and I think this committee should be concerned, about many institutions which will be in that position in years to come.

We also see an opportunity in this whole business of experimenting with higher education itself—and I remind you of Secretary Bell's comments that, in fact, education is a process, and higher education in particular, is a process that has been subject to very little in the way of experimentation or study, research on education itself. This is a place and this is an area where that education process can be examined, can be looked at, for changes and new directions guided through research which can feed back into the processes of change which are going on in our institutions. And we have to look, in fact, at the way that we carry on our responsibilities to society to see if we can do them better, and if we can do them better, in fact, the society will benefit as well as our own institutions.

Now let me say a little bit about the program which we embarked on. We have taken as our goal the notion that all of the members of our Brown community—and that includes students, staff, faculty, individuals in the hospitals who are affiliated with Brown—Brown has a medical school with eight hospitals affiliated—should have available to them what we call work stations, and hopefully as they develop we will call scholars work stations, which will be basically responsible for two major sort of general functions. I have described those two functions as those things that the individual needs to do himself or herself, and those things an individual does together with other people or other sources; that is, the communications aspect of those work stations is really as important as the functionality of the station itself in what that station can do.

Those devices would be tools which would be connected to things like large data bases, which may be storage machines and devices, the whole gamut of knowledge which can be and will be available to Dr. Braun's granddaughter as well as us, I hope, in the future, high-quality, high-speed printing devices, storage devices for filing of information. It is very convenient for me to be able not only to file documents, communicate documents, but also to erase them. I think that is a helpful process that is much more quickly done on the computer.

The storage of video and other—

Mr. GORE. Hopefully not accidentally.

Dr. GLICKSMAN. Not accidentally.

The storage of video and other media, both storage and also live communications media, and an area which we have not discussed as yet but I think is important to higher education and education generally, and that is the large storage of information that is now contained in our libraries and which it is important to remove basically from seclusion and make available much more broadly. Libraries have faced a major economic problem over the last decade because of the large growth in printed material and the inability of any of the libraries to keep up with that growth, especially in institutions of higher education and large eminent public libraries such as the New York Public Library.

The move among libraries has been to try to share information cooperatively, which is obviously the answer to the economic concerns, but the sharing of that information is only made feasible because of the communication and computer technology about which we're talking. Groups like the Research Libraries Group, which is a private group of approximately 26 institutions, have been pioneering in investing their funds in order to provide facilities which can be used by libraries generally, so that a faculty member or student at Brown, for example, should be able to find out where any one of some hundred or hundred million or billion items of discrete information—books, pamphlets, and so on, which are stored in various places around the country—where it is, and hopefully at some future time even easy access to it through the communication medium.

I noted that the connections of the work stations and the network are very important. These connections raise another aspect, and that is that connecting is not restricted to the campus. I agree with the speakers who have noted earlier that education will not—I do not see in the future, let's say, that education will continue without the teacher. I think the teacher and the person interaction is an important aspect of the learning process and the communication of learning and excitement that the student has. But the aids that can be provided to that I think will make the teacher a much more effective teacher in the classroom and in the universities.

Now, Rhode Island is a small State, one of the smallest, as everyone says. It is small in area; it's not one of the smallest in population, but it is small. But it also has some unitary character. Our State has been going through the process, as many States have, of cabling for cable TV. We are fortunate in that the Public Utilities Commission in Rhode Island has made as a requirement for the cable companies that come into Rhode Island, that they carry a second cable accessible to institutions of higher education, public institutions, nonprofit institutions. Although there has been some challenge to that, apparently the challenge has been beaten off, the challenge in the courts. Hopefully that will provide a medium which will enable us to communicate from the university to other colleges and universities and also to other schools—high schools and elementary schools throughout the State—and assist those schools in making use of what we learned from what we're doing.

An important aspect and a major aspect of investment and time is the development and utilization of development elsewhere of the appropriate software, and we have talked about that already this morning. I don't have to emphasize that again. That software, which will enable us hopefully to make use of developments of current hardware, as well as some of the current hardware, into what we call scholars work stations which will enable the student and faculty member to use those devices to assist her or him in their acquisition of knowledge and their understanding and in the development of new knowledge.

An important area which has not been emphasized and discussed much this morning as yet is that concurrent with all this, what is happening to the people and to the social interactions, the psychological health and behavior of the groups that are making use of the new computer technology are of importance.

We have—For example, we have been teaching a course in what we call an interactive classroom. It's been operating—We started with something like that back in 1976, with the help of private sources, the Exxon Education Foundation, and also with the National Endowment of the Humanities. The course was a course in poetry. It involved interaction among all of the students and students with the instructor through the medium of a special, fairly-expensive computer device at that time, using a light pen for interaction. What was interesting there was that the basic software underlying this has to do with a system called hypertext—it's mentioned in my presentation—and what that does is it allows you to make a network of connections, so that you can connect from a point in a document or a point—it doesn't have to be a document—a point in the computer, to other pieces of information. We found that our students, that the shy students took more advantage of this than the ebullient ones. They spoke up a lot through the medium of the computer. We also found that in writing, improvement of basic skills in writing as an example, that our students wrote considerably more, three times as much, in the course given this way as compared to another version of the same course that was offered in the traditional way.

In the courses that we have been offering in the last year and a half in the interactive classroom, which consists of right now a network of 60 very powerful microcomputer work stations, that those are all hooked together so that the students using one can communicate with the students using next door or across the classroom, but also connected with the instructor and with teaching assistants in groups of about 10 each. There is an instructor or teaching assistant who supervises groups of 10.

The material being presented by the instructors is presented right on the face of that machine, and the students are asked to work through problems at the time their concepts are being explained, so that it's fresh in their mind. While they work through the problems, the instructor is basically, in a sense, looking over their shoulder, but through the medium of the communications network, and can provide guidance to the student: "Oh, you're—" you know, "how about trying it with a plus sign instead of a minus sign," et cetera, or use a different kind of character in the program.

We found that this approach ended up with completing—doing a little bit better than the survey that the National Science Foundation indicated for all courses. We cover about the standard material of one semester in about half the semester. We also found the students' work was somewhat better, the programs they worked in this was better. Very demanding. It's hard to keep the students away from those machines when they don't have to be there. We are now running a class with 250 students in that interactive classroom.

At the same time as we started that class, we had one of our faculty, an educational psychologist, working with that class and with the students in it to see if he could determine, by interviews and by questionnaires to students, what changes were occurring in the way the students communicated with each other and the way the students understood the material, and the way the students per-

ceived the instruction, and the way the students perceived life generally as a result of immersion in this very intensive course and this intensive learning experience. The results of that are still being worked on, but I give this as an example to point out our concern that the social sciences and the changes in people and in group interactions not be neglected in concern about the changes, about the introduction in the work with introduction of computer technology.

We have embarked on this with a continued openness to questions as they arise. Flexibility is very important in this field, and the use of conclusions from our studies we hope to embrace in modifying the program as we develop it.

There is a possibility which I mentioned, expanded on in my written testimony as well, which I would like to point out and then conclude this part of the testimony, and that is that as we develop more instructional modes, using computers in the college, in the 4 years undergraduate, that we open up the very real possibility that universities or places of higher education will basically not be restricted to a 4-year—think of themselves as a 4-year educational experience, providing that for their students, but rather, a long term, lifetime perhaps, commitment to individuals to come which will be intensive for 4 years, can continue because of the communications, and the very broad spread of personal computers and work stations in the future in the homes can continue on an indefinite basis, with periodic, perhaps, touching of hands or a meeting of eyes by coming back to campus for some weekends, but perhaps with a prescribed series of continuing courses—

Mr. GORE. They could pay tuition for 50 or 60 years.

Dr. GLICKSMAN. It might be less expensive to do so, but obviously that's a possibility. We have our alumni do that now. [Laughter.]

They do that for the children and grandchildren as well.

The opportunities provided by the availability of very powerful microcomputers and efficient ways of providing communication among large numbers of these work stations, special computers, and large informational data bases, seem to augur for major changes in higher education which are being explored at Brown. We embark on this study with some vision of a possible future, but with an openness to possible modifications as human ingenuity develops a better understanding of the uses of the new technology. We are, in a real sense, dealing with an experiment in and with higher education. We expect that what we learn will have value beyond the gates of the university, and welcome the interest and support of various segments of our society in moving forward with our exploration.

Thank you.

[The prepared statement of Dr. Glicksman follows:]

The Use of Computers and Communication Technology**at Brown University**

by

Maurice Glicksman**Provost and Dean of the Faculty****Brown University****(Testimony to the House Committee on Science and Technology****28 September 1983)****ABSTRACT**

Rapid changes in the character and usage of computers and communications technology have a major impact on institutions of higher education, and will have a greater influence on educational methods and styles in the coming decade. Several years ago, Brown University embarked on a program to provide support for computing by all of its students, faculty and staff through a distributed group of facilities, which would include sophisticated microcomputers ("scholar's workstations") available to all who wished to use them. These workstations would have sufficient capability to satisfy the computer needs of most of the individuals using them, and would be in a network communicating with other workstations, more powerful or special purpose computers, and devices containing large collections of data. The user could thus have available the information and computing resources to work more effectively. Brown calls this a system of "Networks of Scholar's Workstations". It will require large capital investment and increased operational expenses for full implementation. Brown intends to participate in the development of the system, through cooperative activities with vendors of equipment and software. Brown also believes that the implementation of such a system has broad applicability in society, and can have a profound influence on the way in which people work and communicate with each other; Brown intends to participate in an active research program to study these social and psychological phenomena. In the long run, the possible broad availability of workstations in the homes of alumni and their utilization in teaching in universities offers a new educational opportunity. We may see a commitment by the universities and their students/alumni to a continuing, lifetime agreement for the use of educational, scholarly and informational services provided by and through their university.

INTRODUCTION

Brown University has provided instruction in computing to its students, computing resources for its faculty for their research, and computational support for its administrative functions as part of its program for many years. In doing so, it has had to be economical in the use of its scarce resources. Brown noted that the demand for all of these has outstripped both the projections of their growth and the resources Brown has been able to provide for at least a decade.

Until the mid-1970's, the pattern followed at Brown was one which had a central computing center to provide basic support for the instructional needs of its students, and the general research needs of many of its faculty. Separate facilities provided computing support for specialized research needs, mainly in the sciences, and some specialized administrative needs. As demands increased (at rates which approached a doubling each year at the beginning of the 1980's), the facilities were expanded, but were never quite adequate for the demands at any one time. Because of limitations in resources, usage was kept below needed levels and computing resources were allocated on a priority basis.

As a result of planning studies begun in the 1977-78 year, it was recognized that a different approach was required to provide the best possible service for a growing, large population of users, for two fairly obvious reasons. The first is that centralized facilities that would satisfy research needs as well as educational and administrative needs appear to be cost-ineffective. Many of the users require a quite simple type of supporting facility, yet the size has to be large enough to satisfy the demand, and the sophistication sufficiently high for the more demanding users. Too expensive a set of large machines are being used for the job. It would be better to provide facilities of high sophistication and appropriate (smaller) size for the few demanding users, and greater computing power of simple type for the large body of users having more modest requirements. This clearly calls for a variety of computers, tailored for the needs of the individual users. The second problem is the communication complexity of thousands of users connected to a central facility, and the very heavy load on central facilities involved in handling the demands of such a large number of individuals working on one or a group of paralleled machines at one time.

We decided that computing resources on the campus and in affiliated hospitals should be distributed geographically. The individual user would have a computer

suitable for most of his or her requirements, and access through communications networks to nearby sophisticated computational services for the rest of them. All users should also be able to use the facilities for communication with others with equipment attached to the networks. Whatever the actual items of equipment used by individuals and the system, we concluded that it would operate through a high quality basic communications network. Late in 1981 Brown installed a cable network capable of handling up to 15,000 input stations and linking all of its campus buildings (126 in number, distributed over an area of several square miles). This network (called "BRUNET") was designed also to handle video transmission, the signals of our energy management system, fire and safety signals, etc. It has been operating very reliably; in 1983 it had some 1200 computer terminals and computers connected to it, carried video signals, and was transmitting energy management and fire and safety signals.

By mid-1982 it became clear that the kinds of computers for individual use which were envisaged in our plans were going to become available from manufacturers at an affordable cost within the coming several years. A great deal of development would be required to make these devices suitable for the system we envisaged. Discussions with manufacturers encouraged us in the belief that such developments would have wide applicability, and hence that the manufacturers could justify providing some support for our efforts in this direction, through their own activities as well as activities on our campus for which they could provide support.

Although much of the use of computers at Brown in the past several decades has been for research, mostly in the sciences, a number of other major uses have developed. One that has been very rapidly growing in use by students, faculty and staff is the writing of books, papers and correspondence with the aid of word/text processors. A second important example is the integral use of computers in teaching. In the mid-1970's a team of faculty from the English Department and Computer Science at Brown taught courses in poetry which made use of special computer equipment and a software system called "hypertext". The courses were educationally successful, but too expensive at the time to continue to offer. In the past year the Computer Science Department has been teaching sections (in 1983-84 the full course) of one of its programming courses using networks of sophisticated computers (workstations) in an "interactive classroom" with great success. A third important new use arises as the result of the development of large files of information, called databases, useful for scholars. One such database consists of bibliographic descriptions of printed material available in libraries or other large collections. Another database of great interest would

include abbreviated or full text of scholarly works. Both kinds of databases are stored in such a way as to be quickly accessible to desiring users having communicating computers. In addition to these important general uses, musical scholars and composers use the computer in analyzing musical works, and artists use computers as tools in the creation of their artistic products. These applications, and others developing, give clear signals to us of the importance of moving forward with plans for much broader use of computers by members of the Brown community.

BASIC CONSIDERATIONS

Brown University is a small, liberal-arts institution committed to undergraduate and graduate education and research. Its faculty are proud of their commitment to the educational as well as research aspects of Brown's mission. The governing body (the Brown Corporation) and the alumni strongly support this mission. The governing body made a decision in the early 1970's that Brown should remain small in size (approximately 5200 undergraduates and 1500 graduate and professional students) to maintain its atmosphere of good communication among all of its community members. The faculty of the University is unitary, i.e., not divided into faculty of different schools, and the number of faculty engaged in teaching and research in the humanities and the social sciences is about the same as the number of faculty in the physical and life sciences.

We feel that the computer and associated communications technology present opportunities to members of the educational community that can have profound effects on their activities in the years to come. As a matter of principle, we feel an obligation to explore these with our fellow faculty and students, and to provide whatever guidance we can both to the development of the technology and its use, and to a thorough exploration and evaluation of its value and its impact on the community and individuals. In exploring the use of the new technology, we follow a number of guiding principles:

1. We intend to have the campus open to technology. We will be able to provide support from our resources only for a limited variety of equipment and software that satisfy what appear to be the most broadly useful criteria, but such devices and software will be provided from a number of different sources. Individuals wishing to

use other equipment can do so.

2. We intend to make equipment which is necessary for academic functions available to all who need to use it. Our finite resources will limit the types of equipment and the pace of their introduction to the institution.

3. We plan to engage in studies of the use of the technology, including its optimization, and to make the results of these studies available to society at large. These investigations should include an increased level of research on the fundamental processes (including the relationship between people and information they acquire, the interactions among people making use of computer technology, and the interactions between people and computers) as well as the specific applications studies related to the computing environment at Brown and other institutions.

4. In approaching the use by students, faculty and staff of computational resources, one governing principle is related to our educational philosophy. We require that undergraduates choose a subject or subjects in which to concentrate their studies, but we do not mandate a particular set of subjects or areas for all students. The students are expected to be able to choose, with the close guidance of faculty advisors, the most appropriate program of study for them. Studies we have made of the results of this educational philosophy give us confidence that the students who come to Brown are able to make their choices responsibly. We also feel that, in the area of computing, we should provide students with the best advice we can give, and the best possible programs for them to choose among.

PRESENT DIRECTIONS

Brown University has established an Institute for Research in Information and Scholarship (IRIS) to carry out research, to encourage research and to have general responsibility for the development of our plan, in accord with faculty, student and administrative needs. Our plan is basically to provide, on the campus, computers which we have labelled as "scholar's workstations", for every faculty and staff member who has a need to use them. Students who require devices in their work will have them available, either through purchase at low cost or through the use and loan of University machines. The scholar's workstations will have certain requirements to satisfy, among them being: a large memory, a user-friendly interface requiring no computer language to learn to use for most applications, a display system of high

resolution and amenable to individual modification (a 'bit-map' display satisfies this), easy communication of signals and files to and from other workstations and computers, a variety of sophisticated computer languages available for use, and excellent database systems. Although the cost of making equipment available to all members of the Brown community will be large, it is important to define an acceptable limit. We envisage that the level of requirements will not be the same for all groups of users, and that there may be as many as three different types of workstations, from the moderately simple one used by most students and faculty, costing less than \$3000, to the most sophisticated one needed only by a few of the faculty members in the sciences, costing up to \$20,000. At the present time there is no workstation which satisfies all of our needs, even at several times our cost limit, but there are several available and under development which show promise of doing so in the next several years.

If the major part of the Brown community makes use of workstations, we will have to support a communication network with as many as 10,000 workstations linked to it. Many of them will be in smaller-size local networks, attached to BRUNET. There will be links to computers with large storage capacity, for use by the workstations, as well as computers with special functions in printing, high speed computation, specialized databases, etc. A vital part of the network system involves rapid and satisfactory access to library information: availability of books, ordering of material from the Library and other libraries linked through external networks with our own and eventually transmission of text files through the network to the individual workstation user.

We are in the process of developing the details of a proposed program of research on the social and psychological aspects of the use of the new technology. A group of Brown faculty - humanists, social scientists, physical scientists - together with administrative and professional staff and a number of outside consultants, has been discussing plans for research on the impact of the computing technology on scholarship, teaching and learning, and the social experiences of members of the Brown community. The IRIS will develop support for this program of research.

If our projections of these developments prove realistic, the picture sketched above will come to fruition during the 1980's. A description of the system has been recently published and is attached as Appendix A. Brown is receiving substantial support for our program from manufacturers such as the IBM Corporation, Apple Computer

and Apollo Computer, and from the System Development Foundation. We are continuing to seek additional support and commitment from industry and foundation sources, as well as the appropriate Federal agencies.

QUESTIONS FOR STUDY

There are two major aspects of our proposals which involve serious questions of research, both basic and applied in character. We believe these should be studied in a parallel fashion: work on the development of the components of the system should involve, in intimate fashion, continuing studies of the influence of the technology on the way it is used and its effect on the people and their work. It is for this reason that we have established the Institute for Research in Information and Scholarship with two parallel and intimately connected internal sub-units, one dealing with the technical development, and the other with the analysis and research on social and psychological aspects.

Research on the technical aspects of the system will include a study of the kinds of workstations which suit best the different kinds of work for which they will be used: writing and editing, calculating, planning, communicating ideas and text to others, course work, storing collections of information (e.g., lists of references), referring to large collections of information for specific items, working with collections of data, drawing, musical studies, analyzing art and photographs, etc. The research effort will also involve the development of the appropriate technology to enable easy communication among the various workstations, and the transfer of files of information (text, data, etc.) from computer to computer. In the University, the access to library information is a vital part of this effort. It is very important, in the research program, to have a group of users having diverse interests, who are also cooperating in the research. Faculty and staff at Brown, as well as students, will be key contributors to the research effort.

Research on the social and psychological aspects of the effect of the new technology requires a suitable basis for comparison of the changes. It is obvious that there have already been substantial changes for many faculty and students, and that the base for studies is thus a constantly changing one. Nonetheless, the state of affairs has to be periodically sampled to show us the changes, and this is an important prerequisite in a sound research program.

The program of research in these areas will focus on a number of subjects. The question whether such a system will improve the products of the work of members of the university community, and their lives, will depend on the actual applications adopted and the attitudes of both users and non-users toward the changes in their work and life-patterns which may be involved. We have identified three major and inter-related areas of university activity in which such questions need to be studied: education, scholarship and campus life. In addition, we have to try to understand general uses of workstations by individuals which may fall outside those general areas.

In education, we deal with teaching and learning. The process is not restricted to the classroom, and ranges in character from formal structured coursework to very informal exchanges of information. We have experimented with a number of new ways of teaching (the "hypertext" poetry course and the computer science course in the "interactive classroom" described in the Appendix are examples), and a number of courses making use of personal computers are scheduled for this academic year. Experimental protocols for studying the impact of the course on the students, and the result of the course are to be used with each course offered, as was done in our earlier experiments. As the system develops more fully, the role of electronic communication in the education of the students -- enhanced individual communication, and communication between students and instructors, as well as access to information sources like the library collections -- are to be studied. It is important to repeat courses and to try to assess the persistence of positive attitudes (which we have observed in our earlier examples), since the involvement in experimental programs in and by itself has positive results (the "Hawthorne" effect).

There are many aspects of the program which have potential impact on the work and resulting scholarship of faculty and students. Information is an essential ingredient in the work of any scholar; its generation and utilization will be affected by the network of scholar's workstations. The availability of on-line library catalogues, library data bases, and personal data bases is one aspect of change. Another is the ease of communication of written work among scholars and an enhanced capability for close collaboration in joint research. Studies of the way in which these new techniques and enhanced tools affect the pace and style of scholarship will be important in answering our basic questions.

The way that workstations will affect the daily life of the individuals in the university, particularly students and staff, is the third important major topic of

study. For staff it may be a question of replacement of normal jobs, or components of jobs; for students it involves the question of the types of activities in which the individual is engaged, and the overall impact on the social interaction with others on the campus. Questions of privacy and of fairness to the individual student who shows no interest in participating in the program will need to be addressed.

As the use of workstations in the educational program becomes widespread, the opportunity to make courses available to individuals not on campus becomes practical. As can be seen in the extension of the "hypertext" poetry course, study of material and discussion of its meaning need not be restricted to people in the same place at the same time. Many graduates leave Brown feeling that they would like to have studied other subjects and with other faculty, but for lack of time. And of course the need for continuing to maintain contact with developing knowledge is keenly felt by graduates, particularly those in professional fields. This opens up the possibility that future students coming to Brown will be offered a continuing commitment from the University: four years of on-campus education, followed by the availability of courses and information services to graduates, which can be structured in a number of different ways. The opportunity could be taken advantage of by the alumna or alumnus, wherever that person chose to settle. The change in the traditional view of a higher education can be major, since programs could be developed which would be partially open-ended, with the educational services offered after 'graduation' meshed with the undergraduate part of the programs.

CONCLUSIONS

The opportunities provided by the availability of very powerful microcomputers and efficient ways of providing communication among large numbers of these workstations, special computers and large informational data bases seem to augur for major changes in higher education which are being explored at Brown University. We embark on this study with some vision of a possible future, but with an openness to possible modifications as human ingenuity develops a better understanding of the uses of the new technology. We are, in a real sense, dealing with an experiment in and with higher education. We expect that what we learn will have value beyond the gates of the University, and welcome the interest and support of various segments of our society in moving forward with our exploration.

ACKNOWLEDGMENTS

Many individual members of the Brown University community have been involved in developing the ideas which are discussed here, and in carrying them forward. Key among them are: Andries van Dam, Professor and Chairman of Computer Science, William Shipp, Associate Provost, and Norman Heyrowitz, staff member in Computer Science. The active support and commitment of Howard Szwed, President of Brown University, has been vital to the development of our program.

We are grateful for the support provided by the System Development Foundation, Apple Computer, the IBM Corporation and Apollo Computer in the development of our plans and the beginning phases of their testing.

APPENDIX A

Networks of Scholar's Participations in a University Community, by William S. Shipp, Norman Heyrowitz and Andries van Dam, published in COMPCON '83, by the IEEE.

Mr. GORE. Thank you very much. I appreciate your statement. We'll hold off on questions.

Dr. Sagik.

Dr. SAGIK. There is a certain advantage in going this late in the program. You can edit out all the things that would be totally repetitive, but then you would be left with nothing to say so you'll go ahead with part of it anyway.

Although Drexel has built its reputation as a cooperative education school, with strong engineering, science, and business programs, we do have other programs of great strength in areas ranging from the humanities, to fashion, and interior design. However, all of our students share a common track for their first year. They have, therefore, an essentially prescribed curricular sequence in that year. That gives us an advantage or a perspective certainly on the challenge of computer-enhanced education that may differ from other colleges and universities that have instituted similar computer requirements.

In Drexel's case, our requirement that all freshmen in all academic disciplines have their own self-contained microcomputers is consistent with a long-term commitment to computer-enhanced education. Our proposal for teaching technical writing through interactive computing won the support of FLISE several years ago. We have had NEH support for a Milton concordance done via computer by faculty and students. Over 1,000 freshmen take a course in problem solving using FORTRAN and interactive computing each year. In addition, students have access, and have had for some time, to a campus network of nearly 300 terminals linked to our mini-mainframe and to other off-campus computers, all of which are used for a wide variety of academic purposes. We think these computer applications will increase dramatically, both in number and variety, when students have their own personal computers to be used whenever and wherever they want. More important, we feel it gives them, as Dr. Glicksman pointed out, an opportunity to spend time that is not a course requirement working at the computer—a very critical issue.

The Drexel program is not intended to produce a generation of programmers or computer scientists. Rather, its academic purpose is to help students become more creative, more knowledgeable about their areas of study, more skillful in the handling of information, and, above all, more excited about learning what it is they came to college to learn.

Consistent with these objectives, Drexel has selected a microcomputer featuring a high degree, an unparalleled degree, of user accessibility. With all due respect to the comments made by the previous panel, with this machine the student novice can minimize the time-consuming process of learning some of the complex and specialized command instructions, and the concentration now is on testing concepts and exploring creative approaches to problem solving.

The wording of the committee which selected this computer indicates as its first task that we were charged with exploring "the present needs and possible uses of a student-owned personal microcomputer in the undergraduate curriculum." The purpose here was to enhance the education of the undergraduate students, not to fa-

facilitate graduate student or faculty research. Our primary goal in the program is to enable undergraduates to have computer access whenever they need it, and not require that they tie into the network which exists and is intended to serve the university's research interests and needs.

The selection committee was faced with finding a computer that would fulfill the teaching needs of all faculty in all undergraduate programs. That, by the way, turned out to be one more reason why we didn't want to see everything standardized too fast. We needed a microcomputer that would be useful whether we were teaching FORTRAN, whether we were teaching composition, or clothing design.

The task now underway is to prepare the entire faculty to take advantage of this powerful teaching tool. Success in that endeavor is the key to success for the entire program. Before we can educate what clearly we believe is a computer-competent student body, we need an enthusiastic, cooperative, computer-competent faculty. We have been fortunate in obtaining outside money from the Pew Memorial Trusts which have provided support for a 3-year effort to create what we would like to think will be the first 100 percent computer-competent faculty around.

The major components of this critically important development program include:

A seminar series for faculty, taught by faculty. That's a hands-on program that goes on week after week. Its objectives are to introduce the microcomputer as a useful tool, to help overcome anxiety about computers, to introduce applications and educational software while stimulating thought about uses of that software in specific subject areas, and to introduce the rudiments of programming.

We have a large software review center. It provides a place where faculty can use several microcomputer systems, other than our standard, to review a growing collection of educational software in many disciplines.

We have a process for the internal funding of proposals from faculty for support of such activities as courseware development and design, implementation, and attendance at seminars or workshops on advanced topics in educational computing.

We put out a widely read campus newsletter containing information about the computer program, articles of general interest in computing, a glossary, which turns out to be critical for us, and an occasional controversial opinion—I note occasional.

The newly formed instructional support group within academic services has come into being, consisting of computer professionals and students who help faculty in software development or in the use of application packages.

We think our faculty development program is simply one possible model. We are convinced, however, that a total commitment to faculty development and renewal is essential to the success of any large-scale attempt to introduce computers into the curriculum.

The enormous effort required to assist the faculty should cause any institution considering a program of computer-enhanced education to consider carefully its available resources. Another concern is the paucity of sophisticated educational software, referred to earlier. With the help of the trust moneys that we have been given,

we are compiling an enormous storeroom of educational software. But we find it inadequate. Most of it tends to use computers as little more than electronic flashcards. The whole area of software development, cited before, for academic purposes is one that needs to be supported selectively. We urge that be looked at. We have started to do some of that. We have also started to develop a very few of the kinds of specific and subtle teaching aids that we envision are needed. But it is a difficult job, and places great demands on faculty.

One concern we have is that expectations of students and parents not outrun the pace at which we, as educators, learn to make truly effective use of the computer.

We rely on faculty and students for something else. Just as we expect them to identify academic areas where the computer can be an effective tool, we also look to them to determine what areas are not appropriate for computer-enhanced education. We don't know all the answers to that yet, nor do we know all the psychological and sociological ramifications of our program. Dr. Joan McCord, a nationally respected sociologist, has begun a longitudinal study, both of students and of faculty, by age cohort, by discipline and other variables, which will cover the next decade and we hope give us some answers:

We believe that Drexel University and other private institutions are perhaps in the best position to determine the value of the microcomputer to higher education. Whereas the required purchase and vast investment in microcomputers may be unrealistic at publicly supported colleges and universities, it is possible at private institutions.

I hope that support will be made available so that institutions that have undertaken such a venture can study all aspects of computer-enhanced education and permit them to make valid, documented recommendations to the rest of higher education, as well as to assist in all innovative approaches to the development of educational software.

As appendices to these remarks, I have attached for inclusion an abridged report of the Drexel Microcomputer Selection Committee, and a number of comments made by faculty after they have begun playing with it.

Thank you.

[The prepared statement of Dr. Sagik follows:]

MICROCOMPUTING AT DREXEL

Bernard P. Sagik

Although no one could be more excited by the educational potential of microcomputers, I offer some words of caution: the microcomputer may not be appropriate for every student in every discipline in every college or university in the country. Sometimes, reading the weeklies and newspapers, one almost feels political leaders and parents pushing us to conclude that computers must become a way of life for all students -- and as quickly as possible. This probably seems a surprising admonishment from an officer of Drexel University, which requires every member of the 1983-84 freshman class, regardless of academic major or career plan, to own a personal computer.

Although Drexel has built its reputation in engineering, science and business, we have extensive programs in humanities, communications, music, political science, history, psychology, dietetics, early childhood development, fashion and interior design. However, our students share a common track for their first year, with an essentially prescribed curricular sequence. That gives us a perspective on the challenge of computer-enhanced education that differs from other colleges and universities that have instituted similar computer requirements. While we are stimulated by the challenge, we see some signs that while this program may be right for us now, it may not be right for everyone.

In Drexel's case, our requirement that all freshmen in all academic disciplines have their own self-contained microcomputers is consistent with a long-term commitment to computer enhanced education. Our proposal for teaching technical writing through interactive computing won the support of the Fund for the Improvement of Post-Secondary Education (FIPSE). Over 1000 freshmen have taken a course in problem solving using FORTRAN and interactive computing for several years. In addition, students have had access to a campus network of nearly 300 computer terminals linked to our mini-main frame and to other computers off-campus, which are used for a wide variety of academic purposes, including structural analysis assignments in engineering; remediation and drill in foreign languages; textual studies and criticism in literature courses; reviewing records and documents in history courses; developing management game plans in business courses; and facilitating the development of language and cognitive skills in early childhood studies. Such computer applications will increase dramatically -- in number and variety -- when students have their own personal computers to be used whenever and wherever they want.

The Drexel program is not intended to produce a generation of computer programmers or computer scientists. Rather, its academic purpose is to help students become more creative, more knowledgeable about their areas of study, more skillful in the handling of information, and more excited about learning. For some students, this may mean understanding no more about how a computer works than they do about how a calculator or typewriter works.

Consistent with these objectives, Drexel has selected a microcomputer that features an unparalleled degree of user accessibility. With this machine, a student-malice can avoid the time-consuming process of learning complex and specialized command instructions, and concentrate instead on testing concepts and exploring creative approaches to problem solving.

The authorized model -- which we at Drexel call the "Apple III" -- will be available to students during the winter term. Its selection was made by a special faculty committee representing all areas of the university. The wording of that committee's first task says a great deal about the emphasis of Drexel's project. The group was charged with exploring "the present needs and possible uses of a student-owned personal microcomputer in the undergraduate curriculum". Drexel University's purpose is to enhance the education of the undergraduate students, not facilitate graduate student or faculty research. Our primary goal in this program is to enable undergraduates to have computer access whenever they need it and not require that they tie into a network that is intended to serve the university's research interests and needs.

The selection committee was faced with finding a computer that would fulfill the teaching needs of all faculty in all undergraduate programs -- a microcomputer that could be used to teach freshman composition, clothing design, or the basics of computer-aided design and manufacturing. The machine we chose will serve faculty as well as their students.

The task now underway is to prepare the entire faculty to take advantage of this powerful teaching tool. Success in that endeavor is the key to success for the entire program. Before we can educate what may be a computer-competent student body, we need an enthusiastic, cooperative, computer-competent faculty. The Pew Memorial Trusts have provided \$2.8 million to support a three-year effort to create what we think would be the first 100 percent computer-competent faculty in the country.

The major components of this critically important faculty development program include:

- A 20-hour seminar for faculty taught by faculty. Its objectives are to introduce the microcomputer as a useful tool, to help overcome anxiety about computers, to introduce applications and educational software, while stimulating thought about uses of that software in specific subject areas, and to introduce the rudiments of programming.
- A Software Review Center. Established in the university's library, the Center provides a place where faculty can use several microcomputer systems to review a growing collection of educational software in many disciplines.
- A process for the internal funding of proposals from faculty for support of such activities as courseware design and implementation, and attendance at seminars or workshops on advanced topics in educational computing.

- A widely-read campus newsletter containing information about the computer program, articles of general interest, a glossary, and an occasional controversial opinion.
- A newly formed Instructional Support Group within Academic Services in the Drexel Computer Center. This group of computer professionals and students helps faculty in software development or the use of application packages.

We think Drexel's faculty development program is one possible model. We are convinced that a total commitment to faculty development is essential to the success of any large-scale attempt to introduce computers into the curriculum. Our efforts are paying off already. We have one professor who has taught introductory accounting more than 35 years. This year he will teach it with the use of computers thanks to special software he has helped develop. Another professor spent much of the summer plugging variables into an economic model so that his students can see how decisions affecting government spending might affect such conditions as unemployment and inflation. Neither professor had any previous experience with computers as teaching tools. Now they're at the forefront of an exciting change in education.

The enormous effort required to assist the faculty should cause any institution considering a program of computer-enhanced education to consider its resources. Another possible concern is the paucity of sophisticated educational software. With the help of the Pew Memorial Trust, we're compiling an enormous storeroom of educational software. But it's not adequate. Most commercially available software tends to use computers as little more than electronic flashcards. The whole area of software development for academic purposes is one that needs to be supported. We have started to do that at Drexel. We have also started developing a very few of the kinds of specific, sophisticated and subtle teaching aids that we envision. But it's a difficult job -- and one that places even greater demands on our faculty. We are concerned that expectations of students and their parents not outrun the pace at which we as educators learn to make effective use of the computer.

We are relying on our faculty and on students for something else. Just as we expect them to identify academic areas where the computer can be an effective tool, we also look to them to determine what areas are not appropriate for computer-enhanced education. We don't know the answers to that yet. We also don't know all the psychological and sociological ramifications of our program. Drexel's Dr. Joan McCord, a nationally-respected sociologist, has begun a longitudinal study that will provide some of those answers.

We think Drexel University and other private institutions are in the best position to determine the value of the microcomputer to higher education. Whereas the required purchase of microcomputers may be unrealistic at publicly-supported colleges and universities, it is possible at private institutions. We have demonstrated that by enrolling for 1983-84 the largest freshman class in Drexel's history.

I hope that support will be made available so that institutions that have undertaken such a venture can study all aspects of computer-enhanced education, and permit them to make valid, documented recommendations to the rest of higher education, as well as to assist in all innovative approaches to the development of educational software.

I have attached as appendices to these comments for inclusion in the printed record an abridged report of the Drexel Microcomputer Selection Committee as well as comments by individual faculty members which were printed in the newsletter referred to in my remarks.

B



SEP

258



The role of the computer as an educational tool

By Dr. Bernard Sagik, Vice President for Academic Affairs

Universities have preserved, enhanced and passed on knowledge for centuries. Naming the computer "Man of the Year," as Time magazine recently did, doesn't change those tasks, but it does suggest that we in higher education must use today's technology in order to do the job better.

Drexel University has mandated that all 1983 incoming freshmen own or have access to a microcomputer, and it is likely that many other colleges will follow this lead. Elementary and secondary schools are already introducing students to microcomputing, and it's reasonable to assume that by the end of this decade virtually all students will bring some computer skills with them when entering college.

Perhaps because cost and user-accessibility have made them readily available, the focus today seems to be on microcomputers, not microcomputing. At Drexel, we feel this emphasis on the machine is distorted. The computer is but one of several means by which to achieve our academic goals and the computer, per se, is not about to become the purpose of a university education.

It is also important to note that Drexel's intent is not to produce a campus full of computer programmers; it is, rather, to help students become more creative, skillful and knowledgeable through their use of the most powerful information-handling tool yet devised. Some have expressed concern that student use of microcomputers will erode basic skills. On the contrary, key skills will be enhanced as the student is freed from routine and rote tasks and encouraged to concentrate on understanding concepts. An example is the computer's word-processing capability. Students report that it helps them focus on developing ideas, not simply typing clean copy.

At Drexel, a conscious decision was made to use microcomputers to enhance the teaching of curricula now in place. The intent is to make the student's study of traditional subject matter more sophisticated by using this technology. Students in cognitive psychology, for example, can work with computer programs that simulate well-known experiments and then compare their results with findings recorded in the professional literature. Students can transcend the boundaries of textbooks and journals to corroborate what they have read with their own simulated experiments. We believe that the use of microcomputers can permit the student to respond to existing course material with greater creativity.

A problem universities face as students become more active users of microcomputers is the need to support a massive faculty development effort so that teachers can fully assist their students. We already expect the faculty to

keep up-to-date in their separate disciplines. Now we are asking them to integrate teaching methods which simultaneously teach that subject matter while imparting disciplined computer competency to students.

Fortunately, hardware and software developments have brought us all to the point where we can be effective computer users without being highly trained computer specialists. There was a time when any computer application required the direct and extensive involvement of programmers and other esoteric specialists. Through a program of in-house courses, Drexel is now able to develop its present faculty, not as computer scientists, but as knowledgeable professionals who are competent computer users in their own fields of expertise.

As our faculty—and students—become more sophisticated in their use of microcomputers, the machines themselves must have the potential to grow along with the user's capabilities. Expandability is one of several factors we have considered during a methodical search for the equipment that best suits our needs.

The decision to require every freshman to have access to his or her own microcomputer was a surprisingly easy one, despite our concern over the financial implications to prospective students. At Drexel—as at most other universities—the demand for almost unlimited access to computers far outstrips the ability to provide it. And the cost—as are all costs—is passed on to students through additional tuition and fee increases. To allow students to gain more access time for their money, the decision to require microcomputers was a logical one. This is especially true at Drexel where students spend up to 18 months at cooperative education jobs, usually at sites away from campus.

At the end of their Drexel career, our graduates will be able to take their microcomputers and enter the working world as highly marketable professionals. Parents who are concerned about adding the cost of a microcomputer to the cost of college must consider the importance of computer competency as a career asset, enhancing the value of the education received no matter what the field of study.

It is Drexel's goal to educate professionals to be prepared for the world in which they will spend their working lives. At an approximate cost equivalent to one extra textbook per course, Drexel will be able to improve the educational process markedly, prepare the graduating student for a career which will be fulfilled largely in the 21st Century, and contribute even more than we already do toward providing the talented individuals who will help revitalize this region's economy.

APPENDIX II

Faculty perspectives on creative computer applications in education

In response to Drexel's computerization program, Dr. Thomas Hewett, associate professor of psychology, and Dr. Donald Perkey, associate professor of physics and atmospheric sciences, founded last fall a newsletter that serves the Drexel community as an informal information exchange on microcomputers. The following series of excerpts from the newsletter feature faculty suggestions for applications of microcomputers in the Drexel curriculum.

Electronic spreadsheet versatility

Although the electronic spreadsheet was described in earlier issues as a large paper worksheet used in accounting and financial planning, it is quite versatile and can be used in other ways. For example, in a physics class it is necessary that students learn and understand what is meant by "directly proportional to." The spreadsheet can be used to do several calculations of a physical relationship, e.g., velocity is directly proportional to distance traveled in a given time. The results of these calculations can then be plotted, revealing that the plot of velocity versus distance traveled in a given time results in a straight line. In addition, once the formulas and relationships have been set up, the data can be changed with new results being calculated automatically. Thus the spreadsheet, along with associated plotting software, provides a numerical and graphic method of illustrating and revealing relational concepts which may occur in any discipline.

— Dr. Donald J. Perkey,
Associate Professor of Physics and Atmospheric Sciences

Computers and student presentations

This winter term in my Business Policy course I had a chance to observe some of the benefits which personal computers will open up to faculty and students. In the course teams of students do a case study presentation. The students in one team used an Apple II to program, control, and present their visual aids on monitors. On the several occasions that I have taught this course, I have had a number of imaginative student presentations, but this one was unique. Not only were the visual aids uniform, colorful, and precise, but the use of a personal computer significantly enhanced the use of visual aids in the presentation. There was a dimension of flexibility which cannot be achieved with slides, posters, or static drawings.

— Dr. Andrew G. Verzilli,
Professor of Economics

The importance of creativity

The world is overpopulated with programmers who can get the computer to do anything, but who don't know what they want it to do. The greatest limitation of the use of computers in education is the creativity of the people trying to use them.

— Dr. Stan Smith
University of Illinois, Guest Lecturer at Drexel

Published by the Office of University Relations, John R. McCullough, vice president; Philip Teramona, director of publications; Catherine Albert, Eugene Stoller, Joe B. Naugle, assistant editors; Sally Lynn Breen, Gertrude Keenan, graphics; Martin Ratzig, photography. April, 1981.

Writing with word processors

Using a computer in a writing course can excite students about something they regard usually as a chore. Students are fascinated by computer games. They accept the necessity of following a logical set of commands. In doing their own programming, students accept the fact that they will not write an error-free program on the first try. Even those who haven't had programming know, all programs have to be debugged. Why not revise? All writing has to be revised. Any professional writer expects to revise; many students expect to write it once, hand it in, and get an A. Revising means a big confusing mess of words (many misspelled). If we could make revision as integral to writing as debugging is to programming, we could improve the quality of student writing. And using the computer offers the advantage of recapturing the excitement of learning by also stimulating invention.

We must still teach the fundamentals of writing, but we have added a word processing lab at Drexel University to encourage and facilitate student writing. The student response has been overwhelmingly positive. I have found their enthusiasm generates an excitement about writing that is genuine albeit unusual. I use the lecture time to cover the traditional course content and the lab time to introduce AICAD which is our word processing software, and to confer individually with students at their terminals.

But the computer does more than make revision easy, or actually enjoyable. Freeing students from the drudgery of recopying, the computer also frees them from the horror of the blank page. They have found they are less inhibited to begin writing.

In a traditional class, students find themselves spending so much time recopying some parts of their papers that they have little motivation to spend time at the important task of critically planning, reading and then revising what they have written. The traditional approach to writing teaches students rhetoric which they have been learning since grade school; if knowledge of rhetoric were all students needed to write well, their writing should have improved years ago. The computer can offer students in writing the kind of tool that they can appreciate.

— Dr. Valerie Arms,
Assistant Professor of Humanities and Communications

Analyzing "real world" data

Some members of the history-politics department are doing research which leads to the creation of data sets. For example, my own work in public opinion research generates a variety of questionnaire responses which allow the study of relationships between attitudes on certain political issues and demographic variables. The data sets we are establishing will provide an excellent opportunity for the analysis of "real world" data. One example might be the use of the computer to examine and re-examine the effects on electoral outcomes of various possible changes in voting district boundaries. Both numerical and graphical presentations can be used to illustrate the effect.

— William Rosenberg,
Lecturer in Political Science

APPENDIX III

REPORT OF THE MICROCOMPUTER SELECTION COMMITTEE

Members:

- Dr. Jonathan Burton, Management
- Dr. Frank Carmone, Marketing
- Dr. Bruce Eisenstein, Electrical and Computer Engineering
- Dr. Hakhtier Farouk, Mechanical Engineering and Mechanics
- Dr. William Gordon, Mathematical Sciences
- Professor Al Herr, Mathematical Sciences
- Dr. Thomas Hewett, Psychology/Sociology
- Dr. Donald Perkey, Physics and Atmospheric Science
- Mr. Robb Russell, Academic Services, Computer Center
- Dr. Allan Smith, Chemistry (chairman)
- Dr. Gary Strong, School of Library and Information Science

The full version of this report was submitted to Vice President Bernard P. Sagik on November 22, 1982. In the present version, intended for internal Drexel circulation, all references to specific microcomputer vendors and products have been omitted.

I. CONSTITUTION AND CHARGE OF THE SELECTION COMMITTEE

The Microcomputer Selection Committee was constituted by Vice President Bernard P. Sagik in a letter dated October 28, 1982. At the same time Dr. Sagik appointed the Microcomputer User Committee, chaired by Prof. Robert Gilmore. Dr. Sagik spoke with both committees on November 2, at which time he charged the Selection Committee with the following tasks:

- (1) Explore, with the help of the User Committee, the present needs and possible uses of a student-owned personal microcomputer in the undergraduate curriculum, with particular reference to the needs of the incoming freshman class of the fall of 1983;
- (2) Develop a set of specifications for the personal microcomputer based on these needs and uses;
- (3) Identify commercially available microcomputers which meet or exceed these specifications.

II. GOALS TO ACHIEVE BY STUDENT OWNERSHIP OF A PERSONAL MICROCOMPUTER

From the results of meetings of both the Selection Committee and the User Committee, a list of goals for student ownership of the microcomputer emerged. This report attempts to describe the assumptions and rationale underlying the recommendations that the Microcomputer Selection Committee is making, to present and justify the specifications, and to identify a list of candidate

systems and evaluate them against the specifications.

The goals which the committee believes should be achieved are as follows:

1. Provide stand-alone computational power;
2. Provide access to larger computer systems;
3. Enable the introduction of computer-based instruction into the curriculum;
4. Provide a useful collection of software and hardware tools to be carried by the student into co-op and post-graduate employment.

III. REQUIREMENTS FOR THE MICROCOMPUTER SYSTEM

Given these goals, an assessment of needs was independently conducted by both the Microcomputer Selection Committee and the Microcomputer Users' Committee in order to identify the functional capabilities which the Drexel microcomputer should have. This needs assessment identified the following capabilities:

A. Applications Software.

Three utilities have been identified as being particularly important: (1) a word-processing package; (2) a spreadsheet simulator, and (3) a database management system. The word-processing function affects all curricula from the freshman humanities sequence through upper-level courses and senior projects. Students are required to prepare written products for evaluation at all levels. The capability represented by a spreadsheet package is traditionally

thought of as a business-oriented application, but it is, in a more general sense, a useful tool for studying the functional relationships among many parameters and as such could be used by many disciplines. The capability represented by database management systems is the representation and manipulation of large lists of numeric and non-numeric records.

B. Language Capability.

Obviously some higher level language capability is required to enable the students to access easily the computational power of the hardware. It is also necessary to have a variety of languages available to provide for teaching logical analysis of problem structure and to accommodate the variety of problem-solving methods employed by different disciplines.

C. Graphics Capability.

This capability provides the means to present information visually as graphs, charts, and animated simulations. This is a necessary component of the system if it is to be used for teaching concepts best presented visually. It is also required for computer-aided design in such diverse fields as engineering and fashion.

D. Communications with Other Computers.

The personal microcomputer must be able to communicate with computationally more powerful computers having large-scale sources of information, large software systems, and more sophisticated peripherals.

E. Growth.

The selected microcomputer should be able to grow in capability as the student

matures. The capability to attach multiple disk drives is a requirement. In addition, students may need at some later time to add peripheral devices such as printers, plotters, digitizing pads, tone generation hardware, color graphics capability, and analog-to-digital convertors. Furthermore, growth does not depend upon hardware alone; it is essential that the student be able to build and/or acquire a library of special purpose software tailored to his needs both as a student and as a professional.

IV. SOFTWARE SPECIFICATIONS FOR THE MICROCOMPUTER SYSTEM

Specifications are grouped into two categories:

AVAILABLE NOW - available for installation in the microcomputer when purchased by freshmen for the fall of 1983

DESIRED CAPABILITY - useful capability but of lower priority than above

A. Software Available Now

1. Word processing. This software is required for the development, refinement, and final formatting of all forms of written materials to be required of students throughout their curriculum. In addition, the students, as professionals, will always need to prepare written material in the most effective and efficient manner possible.
2. Spreadsheet simulator. In addition to obvious business-oriented applications, this tool can be used in fields as diverse as

physics, psychology, sociology, nutrition, etc., to study and investigate relationships among variables.

3. FORTRAN. FORTRAN represents a fundamental capability both for the kind of programming required in science and engineering freshman courses, and for the needs expressed by co-op and post-graduate employers.
4. Pascal. Pascal is a language developed to promote good habits of problem-solving embodied in structured programming. In addition, the constructs of the language facilitate applications in non-numeric computational environments.
5. BASIC. BASIC is an important capability in that the bulk of available solutions to many programming problems for microcomputers have been expressed in some dialect of this language.
6. Graphics software. Both business graphics applications packages and graphics routines accessible through some supported programming language other than assembler are required. This software makes it possible for the student and the teacher to most effectively and efficiently make use of the full range of graphics display capabilities.
7. Large base of applications packages. Pre-existing applications packages can help to reduce the time and costs required to develop programs for instructional use. (They also help to avoid the re-invention of the wheel.)
8. Terminal emulation software. The capability to use the personal microcomputer as a terminal to communicate with some larger host in the future is a major goal of student ownership of

microcomputers.

9. Database management package. A database management package is important because students as they learn and work are required to organize and manipulate such information as names, reference citations, and large data sets.

B. Desired Software Capability

1. Additional High-level languages. Mentioned in this category were LISP, LOGO, APL, FORTH, and COBOL.
2. Executable computer-based learning material. If a high-level authoring language facility could be installed on a larger machine used by faculty for courseware development, the executable results of that facility should be able to be run on the personal microcomputer. However, the microcomputer itself does not need to be able to support the high-level authoring language itself.

V. HARDWARE SPECIFICATIONS FOR THE MICROCOMPUTER SYSTEM

Specifications are grouped into three categories:

- REQUIRED NOW - installed in the microcomputer when delivered
- REQUIRED CAPABILITY - must be able to be added
at a later date
- DESIRABLE CAPABILITY - useful, but of lower priority than the
required capability

A. Hardware Required Now.

1. A minimum of 48Kbytes RAM user workspace. This amount of memory is required if the user is to perform significant tasks. It can not be preempted by the operating system or its utilities since this could preclude the use of an applications package or language.
2. One disk drive, 160 Kbytes minimum storage. Reasonable word processing capability necessitates a minimum of one disk drive. Cassette storage and retrieval of files is unacceptably slow.
3. 80 character display with upper and lower case. For word processing, one of the major uses the microcomputer will have, the ability to display a full-width page and produce upper and lower case type is considered to be essential by the faculty teaching composition courses.
4. High resolution monitor, not a T.V.. A video monitor which has been designed for computer use provides a high level of clarity which enhances the ease of readability of both textual and graphical images. This reduces fatigue which can build up during periods of extended usage.
5. Bit-mapped graphics, 192 x 280 pixel minimum. The capability provided by bit-mapped graphics allows the display of graphical images with a high degree of clarity and detail. This opens up a variety of applications not available with character graphics, applications which are often associated with specialized equipment. With this capability students and faculty would be free to explore the use of quality graphics

in all aspects of the teaching and learning process.

6. RS-232 interface. This interface is the most commonly used standard for communication with peripheral devices and main-frame computers. Without the ability to communicate, the machine can not be used to send and receive information produced on other machines, or to serve as a terminal.
7. High reliability and durability. Since the machine will be used by students in all areas of their academic environment, the machine must be characterized by a high degree of reliability and durability. This is necessary to enable students to complete their various assignments in a timely fashion. Constant or repeated malfunctions will create nothing but frustration in both students and faculty.
8. All basic hardware from one vendor. With the possible exception of the monitor, the basic system should be provided by a single vendor. Given the wide availability of integrated systems already in existence it is not necessary to introduce the complications of procurement and maintenance that would arise with multiple vendors.

B. Required Hardware Capability

1. Additional RAM. The ability to have 128KB or even 256 KB of memory available at a later date is deemed important, even though most applications required of students may not use this much memory.
2. Second disk drive. For the purpose of backing up files a second drive is needed.

3. Communication hardware. A modem/acoustic coupler for telephone communication to larger host computers both at Drexel and elsewhere, as well as for access to remotely-based services (Dow-Jones, EDUNET, etc.) makes this a requirement.
4. Laboratory equipment interface. The machine should have the capability to acquire data and control equipment in the laboratory.

C. Desired Hardware Capability

1. Color graphics. While the cost of individual student ownership of this capability may be prohibitive, color capability is quite important for a number of departments, and could be added to the microcomputers in departmental laboratories or for classroom displays.
2. Sound generation. Both the music and electrical engineering departments are presently using microcomputer-generated sound, and other uses are anticipated in instruction.

VI. COMMITTEE CONCERNS

Several concerns the Selection Committee discussed at length are posed for consideration.

A. Simplicity of Operation - the Human Interface.

While harder to quantify than the specifications presented above, this requirement is no less important. The User Committee ranks this item of equal

importance to such requirements as reliability, high level languages, word processing software, and ease of service. There is a great need for education not only of incoming students but of faculty in the uses of the personal microcomputer, and a system requiring a large amount of "up-front" learning before basic applications can be used is undesirable. This is not just an issue of good documentation, although that is important. Students and faculty must not be detracted by computer methodology or esoteric command languages from the essential aspects of learning how the microcomputer can help them in their studies and careers.

B. Reputation of the Manufacturer.

The company providing the microcomputer must be fully capable of producing the necessary units Drexel will purchase next fall and also to provide development units for faculty this winter. The company should provide an acceptable level of hardware and software support and should aid in establishing service arrangements. There is also the more intangible but equally important "image issue." Drexel has already received national attention with its decision to require personal microcomputers of all freshmen. A poor choice of company would be detrimental to our reputation whereas an identification with a technological leader and innovator could be of substantial benefit in enhancing Drexel's reputation.

C. Expandability.

Next year's freshmen will be making a substantial investment in a piece of equipment they will be using here at Drexel, on their co-op jobs, and in the early stage of their careers. The system must be capable of growing as the students needs and capabilities grows. It would be very unfortunate to choose

a unit based on well-proven but limited technology which will become obsolete in a year or two. Even the most advanced units being considered will be nearing obsolescence when the freshman class of 1983 graduates.

D. Cost to the Student.

There was unanimous agreement that for Drexel to specify the purchase of a "toy" or "video game" machine would be an utter disaster even if the cost were favorable. Furthermore, there is the additional concern about purchasing a machine with too little capability even if it does not fall into the "toy" category. It is no savings to the student to purchase a machine which must be discarded or replaced within a few years. If, after one year's use, the needs of our students exceed the capabilities of the system then a **SERIOUS MISTAKE** has been made!

In addition to the initial cost of the system, the continuing cost of software, maintenance, insurance, and system upgrades must be considered. This committee believes that the total annual cost (both initial system cost and continuing operating costs) should not exceed \$400 to \$500 per year for the five-year period in which a student is at Drexel.

E. Maintenance.

An on-site service arrangement with at most a one-day repair turnaround time and/or provisions for loaner machines is essential in order for the student to keep current with his academic demands.

F. Cost to the University

Another type of cost not directly considered by the committee is the cost to

Drexel. Certain machines may require that Drexel's investment be larger than would be required if some other system were selected. For example, print stations compatible with one system may be more expensive than for an alternate system.

VII. CONCLUSIONS

The findings and recommendations presented in this report represent a mixture of the committee members' (1) prior experience with computers; (2) information gained from talks with vendors and from vendor presentations; (3) information from published microcomputer evaluations; (4) input from colleagues, most importantly being the Users' Committee, and (5) intangible factors that cannot be identified or eliminated.

Given the time available to conduct our analysis, we believe that the report is as complete and as accurate as possible.

APPENDIX: OPERATION OF THE SELECTION COMMITTEE

The Selection Committee began by asking, "What will the personal microcomputer be used for, both next year in the freshman curriculum and in the following years by upperclassmen?" The same question was asked at the first meeting of the User Committee. Contributions by departments and by individual faculty members including those responsible for the large-enrollment freshman courses, were solicited. A list of courses which are prime candidates for use of the

ITS 273

microcomputer in the fall of 1983 was compiled.

The Selection Committee began its deliberations on Wednesday evening, November 3. Subsequent meetings of the full committee were held on Friday afternoon, November 5, Monday afternoon November 8, Wednesday afternoon November 10, Friday afternoon November 12, Wednesday evening, November 17, and Friday afternoon, November 19. Throughout this period presentations were given at Drexel by a number of personal microcomputer vendors, with the first scheduled November 8 and the last November 17.

During this time the User Committee and the Selection Committee worked closely together, primarily by means of the joint members of both committees and by consultation of the chairmen. For example, a "global and technical check list" handed out by Dr. Gilmore at the November 9 User Committee meeting and discussed more fully at that committee's November 12 morning meeting was integrated into the Selection Committee's work that afternoon.

The final report of the committee went through many drafts, worked on by many small subgroups of the committee over a period of a week.

ETS 274

Mr. REID [presiding]. That will be made a part of the record, Doctor.

Dr. JOHNSON.

Dr. JOHNSON. It is a pleasure to be here, Mr. Chairman. I wish to augment my remarks that are in the record. It is also a pleasure to sit here next to Brown and Drexel because we, being a public institution, fully intend to not repeat their mistakes and build on what they find out in the future.

I want to give a little bit of background about how the University of Iowa is attempting to come to grips with or wrestle with what I like to call information technology. I think it is instructive, when one thinks about computers, one should not just think of computers, but I don't think you can think of computers as divorced from communications, nor divorced from ideas such as artificial intelligence. Therefore, it's of almost as much interest to me as to what's happening here as to what's happening across the hall, for instance, with the telephone rate changes.

A few comments about the University of Iowa. It is a State-supported university, similar to probably what most of you have in your States. We are fairly large. We have 30,000 students. Our student body, surprisingly, is growing. Our enrollment was up 5.2 percent this year, and we suffer with the other problems of having very high enrollments of computer science, engineering, and the like, to the extent we have capped enrollments in engineering.

We are fairly research-oriented. Our research budget last year was about \$17 million in grants and contracts. That placed us in the thirties of colleges and universities throughout the country, both public and private. Similarly, our library is the 26th largest library in the United States.

We have a philosophy at the University of Iowa of a low tuition rate; therefore, our tuition is near the bottom of the Big 10. It also is approximately \$1,200 a year. That represents a State interest in access to education that we intend to follow in the future.

The University of Iowa is not an engineering or technical oriented institution. There is another university in the State, which is a land grant college, and has the engineering school. Our orientation, despite recent results, is not football, either, but rather our orientation is toward the arts, medicine. We have some pockets of excellence in areas like speech pathology, theater arts, and so on down the line.

The last comment I would make about the university, before we start talking specifically about computing and our strategy for the future, is that our university, like most universities, is highly decentralized. I think it was Hutchins, when he was chancellor at the University of Chicago, who said that "the university was a fiefdom of departments tied together by the central heating system."

What that means, to a lot of people that would seem to represent chaos. What it means is we make the important decisions at a level where we think they ought to be made, in the academic departments and in the colleges, not universitywide.

The reason why that is important for our discussions today is it's highly unusual that a large university of the size of Iowa, or even Stanford, would make a decision universitywide to require all their students to have computers. On the other hand, it is fairly likely

that those institutions may require all students in business administration to acquire a computer, or all students in engineering and the like, because that's where those decisions were made.

Now, a few things about computing. To put computing where it really stands, and communications, on our campuses in perspective, I think we have to talk a little bit about dollars. I would estimate that the University of Iowa's position is in the top 25 percent in providing instructional and research computing among our peer institutions or other State universities throughout the country. Our total expenditure in academic computing is about \$4 million a year, with probably another \$4 million a year embedded in departmental budgets. That represents, at best, about 1.5 to 2 percent of our total institutional budget. Our expenditures for computing are about half our expenditures for libraries, so you get some idea of the balance taking place here or what's really involved.

In addition to being in the top 25 percent, which I don't think is just shilling—I think that that's really true—that we have been pioneering in the use of instruction in computing going back to 1973. We started to put instructional computing clusters of the kind we're talking about today throughout the campus.

I would observe, in doing that, we followed the lead of another institution that was pioneering in a different day, and that was Dartmouth College. The one result we found of those clusters early on was that the use of computers was not diffused at all across the curriculum but the heavy use occurred in areas like business, engineering, and computer science. It was only with the advent of word processing that suddenly—and microcomputers—that we overcame what I thought were significant barriers to use by people in all disciplines across the university, including English, art, music, and the like.

In 1981-82 I was asked by the president to review our situation with respect to information technology on campus. I did this through a very large task force and we came to some significant, I think, conclusions, only one of which I'll mention here, and then I'll talk about our strategy.

We conclude that, although the appropriate role to be a leading edge in a university—in other words, we expect our departments to be a leading edge, but not the university as a whole to be a leading edge in any particular area—that the time to expand leading edge activity to the rest of the university was when a technology or idea became so pervasive that no discipline, no area of the university could escape it. I think in about 1982 we made the conclusion that this technology was so pervasive, so important to the lifeblood of the university, that we could not escape its consequences.

I would like to point out that universities are in the information business, and we're talking about an information technology, and anyone that doesn't think that's important is as foolish as someone who is in the horse business and didn't consider the impact of the automobile. I think that analogy is not a clutzy analogy at all.

We talk about our program where we're at, and talking about the meager sums of money we're talking about, and what I think the barriers are.

What essentially we provided was, in addition to the funds we were now providing for computing and information technology, es-

essentially a \$1 million Superfund which should expand over 2 years to be a \$2 million Superfund. Essentially, that fund was targeted to providing an increased terminal base for students or work station base or microcomputer base, if you care—I use those terms fairly loosely—and providing the underlying resources to make effective use of computing at the university work. And let me get to what I mean by effective use and sort of underlying resources.

That we think that over time we will want most of our students to acquire computers. We do not necessarily want them to acquire computers because we want to avoid cost to the university. But we think they are significant enough that they should be used and, on the other hand, like calculators, we think that students will, in fact, acquire them whether we recommend them or whether we require them or not.

I do not think, even at a public university, that student acquisition of computers is a major problem—if the following conditions hold: If we can provide adequate financing, in other words, if we can attract capital to purchase equipment, that we could lease to students, I think that's barrier No. 1 that we have to overcome, but I think that's a solvable problem. We think we will do that by bonding.

The second point is we do not think it's a major problem if we can receive significant discounts from manufacturers. If we can receive discounts of the like of Drexel and other early pioneers in the area, then we think we can handle the situation.

The third major "if" is that we think we could do this if we have sufficient financial aid from other sources to help those students that don't have funds to acquire their own equipment, and last, we think we can do it if we can enter into flexible software agreements with vendors so that we don't have to buy one piece of software for every piece of equipment. I think that's an important point.

Our target is roughly a charge—so you get some order of magnitude—we think we can do this, when we get equipment that's capable, where we can charge students essentially \$250 to \$500 per student per year with a buyback capability. Equipment available at that price today I think is extremely limiting and we're perhaps 1 or 2 years away from gaining equipment that is not so limiting. I speak about limitations from long experience in software development, particularly on commonly available microcomputers and a love-hate relationship that says we can do all these neat sorts of things, but on the other hand there are also some things we should be able to do but can't because of the limitations of the resources. That's particularly true in the whole ease-of-use area and using artificial intelligence techniques and so on down the line. The good news is I think we're getting there. So that's strategic consideration No. 1.

But we do not think that simply going out and requiring or recommending that students acquire computers is sufficient without a very important underlying structure, and that's, I think, where the problems really start in terms of cost. If we think we're going to get into this area and simply pass costs along to students, we're all in for big surprises or insufficient and insignificant results.

That is not to say a student couldn't buy a piece of equipment and put it in their home and use it for word processing, preparation of papers, access to data bases and the like, but I don't think it's going to be significant in terms of their total educational process, in terms of doing that.

Let me talk about a couple of things in terms of underlying structure. The first one is curriculum development. We think that the major use of computer technology and related information technology is the use of the computer as a tool to solve problems. Literacy is being able to use the computer to solve problems, to explore universes; it is not necessarily being able to program.

The other point I will make about curriculum development is what is taught is very important. It is my contention that the technology, as used by students, is going to change what is taught in mathematics, what is taught in writing, and what is taught in numerous other areas. And so what essentially one has to ask is departments review their entire curriculum in terms of what courses do you offer and what is the content of those courses.

To put that in more concrete terms, there are some people who contend, with the age of calculators, we ought not teach long division any more. I think that's a bit extreme. But there are some other things, even at that level, I think we can do instead of long division. My favorite example is statistics, where I think to be literate in even reading a newspaper one ought to have a modicum of understanding of statistics. My kids at fourth and fifth grade are fully capable of statistics; yet, if they go according to the way things are now, they might take statistics the last year in college—if they're lucky. So there are significant changes I think in what we teach, in addition to how we teach, resulting from the technology.

When you talk about that type of reivew, the costs are massive. In institutions alone they're probably in the range of tens of millions of dollars to do that per year over a 5-year period of time.

Our approach toward that development, or curriculum development, is one that was probably fairly controversial, and that's an attempt to put the technology, if you wish, in the hands of all faculty members, because we feel in that way they will then start to understand the technology and can start to think about ways in which that's going to change what they teach and what's important in their disciplines. We think that for the most part sufficient technology is available today, and sufficient software in the form of tools is available to start people along that road.

The other underlying development is sufficient communication. I won't say much more than that. I think a lot of communication is talked about in the Braun report. We're looking at a few million dollars a year to provide a sufficient communication base to access university resources.

I offer one sidelight on that as to why I'm interested in telephones, however. We have a student body of 30,000 students. Only 6,000 of those students reside on campus. The rest live, what we used to say in the Army, on the economy in town. They live in the town. Now, when they all walk home with their computers and want to access university resources, like the library catalog, they're going to use the telephone system. Now, does our telephone system

have sufficient capacity to handle that? Probably not. Are there alternatives available? Yeah. For instance, we're looking at using our local cable system for two-way communication, as was suggested earlier. There is certainly a lot of regulations in that whole area that may or may not preclude that capability. But that's an important dimension of what we're doing.

The other underlying resource I would mention, and the last one I would like to mention here, is the whole idea of information resources. I think as critical as computing is how we deal in an information-rich society. As more than just a library catalog as a resource, it's having our basic information in a form that can be accessed in an easy way.

Let me give you an example. I subscribe to a service called Newsnet. I was looking at the technology Brown uses in terms of providing communication in our campus, so I went to Newsnet, which has about 200 publications and bulletins and reports, and I simply gave the name of the technology I was interested in and the firm I was interested in, and I got 10 articles describing what this firm was doing in other parts of the country and what the successes and failures were. So it isn't just the catalog that's important; it's also having the information in a form in which it's retrievable and, beyond that, it's teaching students how to use that sort of capability.

I don't have to go too far into the whole area than we start talking about information resources. There is good news and bad news. One result of the information age is we all realize information is important, and it's a valuable commodity. So we are going to have and are beginning to have various clashes between private rights and public rights. There is the first amendment, there is free access to museums, libraries, free education on the one hand, and those people that view information as a commodity to be sold on the other, and that's going to be a long, hard tussle and the Federal role is going to be significant in it.

In closing, I would like to make one observation, because I was asked by the chairman to say something about the haves versus have nots, or private versus public institutions.

I don't think the problem is public versus private. The only difference I really see there is the capability of private institutions to be somewhat more flexible and somewhat more readily engaged in joint ventures with the commercial sector of the economy. There are few areas where the flexibility helps. For example, I tried instituting a program that allowed our faculty and staff to buy equipment for their personal use but professional use through the university. That probably took about 2 man-years' worth of attorney action in terms of dealing with State regulations and the capability of a public institution to resell to its staff and so on down the line. That's one area where I think there's a big impact.

I think the real issue, though, is the haves or have nots. At Iowa I estimate that we spend about four times per capita on computing as numerous other public universities that I would call the have nots. On the other hand, we probably spend four times less than the pioneers, such as the Carnegie-Mellons and others. I don't think that Carnegie-Mellon spends four times more than Iowa is necessarily bad because I think we need to have pioneers and lead-

ing edge people, particularly since I think the jury is still out on all this area, and I think we need to encourage variety and, if you wish, natural selection. I hope you're not victims of the process.

But I think it is a problem where the University of Iowa, providing what I know myself is very inadequate level of support, spends four times more per capita than numerous other State institutions. So I think what we're looking at here is providing a basic level across most universities and then letting pioneers and others go off somewhat differently, perhaps in many cases with private support, but not necessarily, you know, limited to that.

I would be glad to answer questions about software development and standardization, but I have more than taken enough time already, so thank you for your bearing with me.

[The prepared statement of Dr. Johnson follows:]

Statement to
U.S. House of Representatives
Committee on Science and Technology

COMPUTERS AND EDUCATION AT THE UNIVERSITY OF IOWA

James W. Johnson

The University of Iowa

The University of Iowa is a single-campus, state-supported university, located in one of the most literate states in the Union. State support covers about one-half of the educational budget, and because of a large hospital, about one-third of the total institutional budget. The University enrolls about 30,000 students, including over 20,000 undergraduates. It has programs in medicine, liberal arts, law and engineering, but its major emphases are medicine and the arts.

The University is a major research institution earning about \$70 million a year in grants and contracts, placing it about 35th among the nation's colleges and universities. Its library is the 26th largest in the United States.

Computing has evolved from being largely research grant and contract supported in the 1960s to become deeply ingrained in the fabric of the institution. In 1973, the University formally recognized the importance of instructional computing by establishing several groups of instructional terminals, providing free access for student computing (for course work), and setting up a computer-assisted instruction laboratory. Computing has evolved to become an institutionally supported activity, only about 10% of the clearly identified research and teaching computing budget is supported by grants and contracts. Today annual expenditures for academic computing of \$4 million are about one-half of the expenditures for libraries.

Computing and Information Technology Goals

In 1981, the President of the University, noting that "The new information technology (computers, communications and information science) may be embraced by education or examined and cast aside; but it cannot be ignored," commissioned a year-long study of the impact of information technology on the University of Iowa. The resulting report

argued that information technology was having a dramatic impact on education since creating, storing, retrieving, processing, shaping and disseminating information is the essence of academic effort. It also laid out a long-term program for supporting wide scale adoption of information technology for research, teaching and public service.

The plan for information technology recognized the decentralized nature of university decision making about research directions and curriculum requirements. It also recognized that although certain departments must be at the cutting edge and rapidly embrace new ideas, the University as a whole should only adopt those ideas that have become so pervasive that no area of the University can escape their importance. The majority, but not unanimous, view was that information technology was such a force. Thus the plan called for a University approach that was highly supportive of departmental plans for using information technology and that provided basic University-wide resources, particularly instructional computing, communications systems and data bases such as the library catalog.

Specific goals included:

1. Increasing the number of terminals (or microcomputers) available for students from 1 per 75, to 1 per 3 students.
2. Exploring ways of facilitating student purchases of computing equipment and allowing this equipment to be tied into the University computer system.
3. Strengthening University programs for curriculum and course development to encourage faculty to integrate information technology in their teaching and research.
4. Providing one computer station for every faculty member to enhance scholarly productivity.
5. Developing a high-speed communications network both on and off campus for computer, telephone and television communication.
6. Facilitating the move to place major information resources such as census data, bibliographic indices in accessible, machine-readable form.

These goals support an objective of providing a computer-rich, information-rich environment for students and other researchers. They recognize that without large investments in equipment, curricular development and adoption of new research techniques are meaningless. Goals, however, require specific programs to back them up.

Implementation of Information Technology

To date the University of Iowa has implemented several programs to achieve information technology goals. These programs represent an initial incremental University expenditure of \$1 million a year and as they evolve will reach \$2 million a year. This expenditure is in addition to funds supporting normal growth in academic computing and providing for equipment acquisition. The programs are:

1. Terminals (or microcomputers) for student access. An increase of 1 per 75 students to 1 per 25 students in two years.
2. Microcomputers for liberal arts. Microcomputers used mainly for word processing for liberal arts faculty who are productive scholars and teachers but do not have access to external funds.
3. Broad-based cable network. A cable facility for data and television communications across the campus.
4. Microcomputers for students pilot project. Students are being provided with microcomputers and their use is being monitored.
5. Library automation. A large scale project for automating the University library is being planned.
6. Faculty and staff purchase. A program providing faculty and staff with significant discounts for purchasing equipment has been implemented.

To date resources devoted to computing at the University of Iowa have placed it among the top 20% of public colleges and universities in providing students with computing and related support. Yet efforts fall far short of what is required, and those of more pioneering private institutions.

Barriers and Problems

Experience in attempting to provide first-rate computing and related resources at a public institution leads to several observations about the problems we face.

1. Providing adequate computing resources is a significant additional expenditure. Iowa expenditures for instructional computing are about \$100 per undergraduate student per year. This is double the amount usually quoted as adequate, yet is woefully inadequate despite demonstrably low costs. An amount ranging from \$500 to \$2,000 per

Student Per Year is a more reasonable estimate. These expenditures, for the most part, do not result in other reduced costs. The economics of computing in education is less analogous to using technology to reduce costs to produce a fine commodity such as an automobile than it is analogous to using technology to provide improved quality service such as medical care.

The area of computing for specialized research use is also crucial. Researchers' needs for development and access to supercomputers is well documented. Also needed is a wide range of equipment from artificial intelligence machines to data gathering equipment. Faculty members were recently asked to identify urgent equipment needs where the lack was seriously harming research and teaching. Over \$20 million of equipment needs were identified, a large portion of which was computing equipment. This deficiency is likely to grow as existing equipment becomes obsolete.

2. There is a growing gap between colleges and universities in their ability to keep up with information technology. The University of Iowa's expenditures for information technology are four to five times per student that of poorer institutions, while Iowa's per capita expenditures are four times less than pioneering institutions. With the large infusion of private funds into a few select institutions, the gap is likely to increase. While pioneering institutions are necessary risk-takers in an area where numerous questions need to be answered, a certain minimum level of resources is required by all colleges and universities.

From a societal viewpoint, asking students to bear the entire burden of these costs is a debatable policy. Again, the medical care analogy is instructive: basic care for all citizens, slightly augmented care for those capable of providing for added service, and high-cost experimental care for those with a high level of financial support.

3. Information resource development, curriculum revision and research support are crucial to effective use of information technology. Providing students with microcomputers without guidance is not sound educational policy. True computer literacy is the ability to use the computer as a tool for solving problems and exploring the universe. This requires curriculum change. Related to computer technology is the vast amount of information that is available for education and

decision making. Knowledge is becoming less what one knows and more where one finds it and how one uses it. Information resources must be made available to students and researchers. Increasingly effective learning will require a rene and use of information resources ranging from bibliographies to research articles. Work needs to be accelerated in putting resources such as library catalogs and current literature on-line. Also appropriate protections for intellectual property rights need to be balanced against rights to free access to information. In some ways, increasing dependence on the private sector and the military for research support exasperates the problem of free flow of information.

Computing and information science is in an infant state. Similarly much needs to be discovered about human learning! This suggests continued support of basic science as well as research. Finding funds to attract and retain people to do this research is an increasingly difficult problem. The University of Iowa, for example, has experienced a 4% state appropriations cut and a 5% loss of federal contract support over the last year.

The message I wish to convey is threefold. One, significant things can be done as the result of local initiative. Second, serious problems remain that could be partly overcome by federal assistance for faculty and information resource development. Third, there are, as of yet, no clear cut answers, and this variety must be encouraged. One is reminded of Peters and Waterman's recent book In Pursuit of Excellence, and John Gardner's earlier work Excellence, both suggest in their own way that "Creative organizations are rarely tidy. Some tolerance for inconsistencies, for profusion of purpose and strategies, and for conflict is the price of freedom and vitality."

Mr. Rem. Gentlemen, thank you very much.

This morning, Dr. Bell, the Secretary of Education, appeared before us and testified for some time. He said a number of things, but as I understood most of his testimony was directed toward the elementary and high school levels. However, one of the things he said I would like to have a comment from any of you that feel you would like to comment on it, and that is, he basically said we have lots of hardware all over; the problem is the software, and a lot of young people could get as much out of reading a good illustrated book as they could out of programs they have on many of the computers.

Dr. JOHNSON. OK. First, I think the notion that we have a lot of hardware is only relative. To me—for example, I live in what would have to be called a relatively wealthy community, and we would obviously be in one of the top area that the NSF looked at. The local elementary school where my kids go to school has two computers in it, and those were bought by the parent-teacher organization—a part of the haves versus the have nots, I guess.

While I agree there's a dearth of software, I don't think that there's an overabundance of computers, No. 1. No. 2 is, I get very upset about the analogy between computers and AV equipment. That analogy is totally inappropriate, because I don't use AV equipment in my work, I don't use AV equipment as an intellectual tool, and AV equipment is not interactive. I think all those things argue quite differently, and I defy anyone to find any computers seen in any school that is gathering dust.

Now, it's true, they may not be being used for computer-aided instruction because a lot of it is page turning, but they are used in gaming situations, some of which are worthwhile, some of which develop the ability of people to fantasize, and I think that's very important in terms of dreaming and fantasizing.

In terms of software development itself, I would much rather see kids have tools like LOGO, with the ability to control the machine, or even, at the elementary level, once you get the manual dexterity down, to use the computer for word processing, for writing one's papers. I think that's much more significant than some drill and practice program in mathematics.

Dr. GLICKSMAN. Let me make a comment on that from the higher education perspective. We do not yet see available to us the kind of hardware and software—and I wouldn't want to distinguish those too much—that we think we will need to carry out some of the things we're looking forward to at the university, in terms of providing them a device and a system which would enable the scholar, the faculty member, the staff member, the student, to really enhance his ability to deal with information, to enhance his ability to carry out his work more effectively and, in fact, more deeply.

The two are related in a very real sense because we see the broad usability of computers as dependent upon a very good level of software which doesn't require the individual using a computer to basically learn languages in order to do so. In fact, when the person uses a different disc or a different tape for one program and the other, you have to learn a new set of meanings for the same words, which is what goes on now.

The advent of what really came as development out of Xerox PARC, the Xerox Palo Alto Research Center, and which is starting to show up in devices being produced by manufacturers, enables—because the devices can have a large memory capacity at low cost, because of the improvements in electronic devices—the sophistication of the software can be built into those devices by using some of that memory so that the user can use it as—in a certain sense, the analogy of the driver of the automobile, without having to learn, going through a learning process every time he rents a different car. In a certain sense, that's what we have with much of the hardware we are talking about in the schools right now.

The software is the most difficult, very labor intensive. I don't think there are enough software engineers, people doing software right now, to be able to do what we would like to see done in the next 3 to 5 years.

Mr. REM. Also, one of the complaints that he made about software is that—and I'm paraphrasing, of course—that there wasn't much of it that was interchangeable, a lot of problems with one company coming up with something that was not usable someplace else.

Do you have that same problem?

Dr. GLUCKSMAN. There is some of that problem. We—at Brown, we do not—we haven't designated one manufacturer's equipment as standard, and therefore, we have to develop the software that we are developing to be able to use several different systems together.

What I feel is going to be the answer to that is basically the result of the market, and manufacturers getting together and using common operating systems. There are a number of common operating systems that have been mentioned, CPM and even more so, the UNIX system, which was developed basically out of a research community but is being implemented on a number of microprocessors as well as minicomputers, and which provides a base that enables the individual using the machine, in whatever, say, in "C" in language called "C," to quite simply manipulate the machine and make use of it for various purposes.

Mr. REM. The example that Dr. Bell gave was the railroad, when we had so many different gage tracks, and it was very expensive, and before those problems were all solved we came up with a regular gage railroad track.

A couple of other questions. Do you believe that private institutions—and you, Dr. JOHNSON, talked about this a little bit—do you believe that private institutions should take the lead in using computers for educational purposes, because of some of the problems you mentioned in the public institution?

Dr. JOHNSON. What I was commenting was they de facto had an institutional basis. What I was suggesting was in our universities we certainly should expect and must have I think certainly leading edge departments. But I would make that distinction between what you do in a department or even a college as opposed to across-the-hall institution. I think private institutions have a lot of roles to play in our society, and I think, being a product of a private institution, I think they're quite important. But I would not want us to simply sit back and rely on private institutions to provide all our

pioneering work, and I certainly would be very concerned about relying totally on combinations of private institutions and private enterprise firms to control the destiny of this technology.

One example of that is—the thing of real concern to university administrators—and that is the relationship of faculty members who have private firms essentially on the side. Every time I talk to some people, or every time that someone that does that gives a talk, I sort of wonder whether they're telling me 10 years ago information and they're keeping the latest information to themselves to use in their private enterprise. I could name names and places, but I don't think I have to. One can understand again—

Mr. REID. I understand.

Dr. JOHNSON [continuing]. That conflict between free access to information on the one hand and proprietary information on the other, and there certainly are values to our society to both. It's just a delicate balance.

Mr. REID. Dr. Sagik, let me ask you, what do you see as the potential benefits of computer technology to education at the university level? What are you talking about? What's the benefit to the student?

Dr. SAGIK. I think the first thing we've seen is in writing. It is something that Dr. Glicksman mentioned. A 3-pound snowpaque [phonetic] job can be delayed until you're ready to go with final copy, hard copy, and revised and wonderful pieces of phraseology that you wanted to save can be stored away and used for another occasion.

We find that in graphics it's a terrific tool. Our architects use it, engineers are using it. In clothing design and fashion, interior layout, good computer graphics are a superb tool. Because we're a co-op institution, our students are away from campus for as much as 18 months in three 6-month periods. Under those conditions, they continue both a tie-in to us as well as to continue certain types of work via computer.

So we see that we extend the boundaries of the campus, in a sense, which is what Dr. Glicksman referred to. We also extend students' horizons in terms of how they think about problems.

Let me give you one example that was used by Dr. Johnson on statistics. Statistics is taught in our university, largely in the business college. It is taught—I don't think I'm saying anything which would offend by the surprising nature of it—it is taught traditionally, probably abominably. It's largely rote, and there isn't much thinking that goes into it. The hurdle is not making too many stupid, bonehead errors. These are calculation errors.

What do you do for an encore if you have some good algorithms, you've talked about which ones you're going to use, why you use a particular distribution, why you use a particular statistical mode rather than any other, what do you do for an encore for the rest of the quarter if you can do all that on the computer? Suddenly you've got 9 more weeks to go and you can't depend on grading a student on errors. Instead, you now need to develop conceptually how you approach statistics, what they mean philosophically. There's an awful lot that I see happening to the faculty.

And, by the way, from my viewpoint, in the Northeast, where you are not having a growing demographic base, one of the most

important things that this program has done is given us faculty renewal, and faculty renewal, inevitably, is reflected in more excitement in the classroom and, therefore, better learning.

Mr. REID. Interesting.

What do you think, other than money—or maybe that is the problem—is the greatest problem facing universities wishing to bring computers into their programs?

Dr. SAGIK. We did not, to our surprise, find money as big an obstacle as we thought it would be. The second thing that I worried about was faculty resistance, and that's where the money became useful. [Laughter.]

You give them a little time, release time, the freedom to not have to teach as much as they were, the opportunity to attend some seminars which open their eyes to things that they wished they could have done and someone has already begun to do, now they want to be part of it.

Joan McCord used the term—which sounded to me almost like a penal institution, but she doesn't mean it that way; sociologists have another apparently private jargon—she said, "You create by sponsoring these programs an atmosphere of forced compliance, whether you mean to or not." That's where renewal comes from. So it was the resistance which I feared most on the part of faculty because those faculty who are uncomfortable with machines are threatened both by the machine and by students coming in who are comfortable with the machine, so it became important to create teams of students, faculty, programers, so that everyone was learning something, everyone was teaching something, and I think those were the obstacles we had to overcome.

Money helps, but it's not the only answer. Attitudinal things turned out to be bigger than just money.

Mr. REID. Do either of you two other gentlemen have anything to add?

Dr. GLICKSMAN. I would not downplay the concern for cost as much as Bernie—Dr. Sagik has. We estimate that the investment we would require over the next—the rest of the decade would run a minimum of \$50 to \$70 million. That is not a very small amount of money. It is more than we invested in the previous half decade in facilities. It will also increase the costs of education, the operations, because of the increased cost of maintaining as well as the training for students and faculty.

So money is of concern to us, particularly because we see our launching, the launching of the program that we have embarked on, as an experiment. We recognize that it may not, in fact, solve all the problems or be the panacea that a number of us have layed out before you. And if that, in fact, is the case, we don't want to be in the position that Dr. Johnson doesn't want us to be in, but is happy that he wouldn't be in, and that is of trying things out and finding that you've overstepped the situation.

We also do not require and will not require all students to purchase computers, just like we don't require all students to take any given courses. We have a practice of that at Brown and we feel that our student body benefits greatly from the advice we give them, and they seem to end up with an excellent education—at least the evidence we have of that is pretty strong. But the cost to

the students then will not be so great compared to the cost of private education.

Cost to the institution is one aspect which is important, although not the overriding one. I think the overriding one, in my view, is the means of developing understanding of the way the society is changing and our microcosm of it is changing in the process of change. Our rate of change is more rapid than probably any previous generation has seen, in this area in particular, and that generation probably said the same thing comparing previous generations. It's been an exponential, almost an exponential process. And here we are talking about experimenting with something and trying to understand something while it is going forward and while, at a time when we do not have a well-drawn picture of what the world will be like, our world will be like, say, 10 years from now, in terms of use.

Therefore, that always gives one pause for conservatism, cause for conservatism, in commitment, yet willingness to take risks if those can have possibly a strong payoff. We think that the willingness to take risk is there.

The attitude of the institution is important in leadership, too. I would like to see more public institutions take the same stand that Drexel or Brown or Carnegie-Mellon, MIT, and Stanford have taken. There are a number that have tried, but the problem right now for most institutions of higher education is financial, and the allocation of resources that Dr. Johnson talked about is of real concern to them.

I know the planning study, for example, at the University of Minnesota, an institution somewhat larger than the University of Iowa, which has tried to and decided it cannot afford to be at the leading edge, but be just one step behind it, because it's a massive institution with a massive investment involved.

The other aspect besides the experimentation is people. The process is not an automatic one. You cannot write a prescription which says "X" is going to be done 2 years from now and have it done unless there are the individuals who will make the commitment—you've trained them or induced them to be involved in that process. The number of people is a problem. A shortage of individuals who are competent to write the 3 or 4 percent high-quality programs that we talked about earlier, there is a shortage of those people and it will take time for the people involved now to carry out the functions we're looking for them to do, to carry out, and as well to train more people to be able to solve the problems down the line. So we have a people problem; we have a resource problem; and we have a continuing concern about are we on the right road; and we had better keep looking to make sure that the future is as solid as we can make it in a moving environment, where everything is changing very rapidly from year to year.

Dr. JOHNSON. I want to make one attitudinal point and then two points where we should make investments.

One thing we have to confront in education, particularly in relationship to allocations, is the whole idea of increased capitalization of the academies. The investment today per instructor or per student is very, very low. Our educational institutions are labor intensive. As Dr. Bell said, something like 65 percent of our budget at the

university is for labor, and what happens is the day the budgets are cut the first thing that goes is equipment, in the first place, and in the second place there is no concept that the equipment becomes obsolete. We treat equipment like it's a building and like it's going to last from 50 to 100 years, not that it's going to be obsolete in 5 years. So there is this sort of attitudinal thing that I think is quite important.

I was asked by a friend when the first Commodore PET came out as to whether they ought to buy one for \$795, knowing it was going to become obsolete. I said, "Well, even if it becomes obsolete in 2 years, you ought to just take it and throw it in the river because you've learned more than the \$795 worth." I'm sure the president of the university would have probably killed me for saying that; yet the same person will gladly spend \$795 to fly to San Francisco for a 2-day meeting—in fact, far in excess of that. So we have this attitude of kinds of funds and commingling funds that is a serious problem in terms of allocation.

In terms of barriers for development, where I would put emphasis, I would focus on two: first is faculty development and curriculum development, and I would go a step further. There are some very interesting areas where we do not have enough people trained today where we ought to be taking people that are existing on our campuses and essentially reeducating them. There have been some pilot projects in this and taking areas where we have declining enrollments and declining intellectual interest, and in a sense reeducating these people in many cases as a renaissance in terms of their interest in new areas.

One that strikes me as very important is that the knowledge base of this country in artificial intelligence is abysmally small. Probably in four centers in the country is there any real sound knowledge of what artificial intelligence is all about. I believe that the whole idea of working smart and knowledge base systems and expert systems and artificial intelligence in general is exceedingly important to our futures, and any university that does not have some emphasis in this area is going to be in bad trouble.

Well, how do we then develop those sorts of people? Well, I was very impressed, being out at Research PARC last week, where Research Park in Palo Alto, a part of Xerox, has developed instruction for people, teaching them how to develop expert systems. I would like to see more of those institutes be carried on nationwide, if you wish, in centers, and have us provide opportunities for people to go there.

The third area I would mention in terms of development is this whole area of putting information on line and making those resources available. I think that's something again that doesn't have to be replicated on every campus, but can be done in cooperative ventures like Ireland and hopefully get more Federal support from that. Most of that support has been from private foundations, and although we're a part of Ireland, I think it's safe to say these very often are self-select groups of universities that view themselves as being elite.

Mr. REID. Gentlemen, we appreciate very much your time here today. I would, on behalf of Chairman Gore, reiterate the fact that today was a bad day for us, even though the schedule had been set

some time ago. We had the War Powers Resolution that we're going over to vote on in just a minute; we have Radio Marti and a lot of things that have taken some of the members away.

You should each know, of course, that a complete record is taken of all the hearings. These will be given to our members and to the staffs, and we'll come up with a report, hopefully giving a real insight during these hearings in the next couple of days, as to some of the things we can do to help the computer crave that's sweeping the Nation.

Thank you very much for your time.

Dr. GLICKSMAN. Thank you.

Dr. SAGIK. Thank you, sir.

[Whereupon, at 1:45 p.m., the subcommittee was adjourned.]

COMPUTERS AND EDUCATION

THURSDAY, SEPTEMBER 29, 1983

HOUSE OF REPRESENTATIVES,
COMMITTEE ON SCIENCE AND TECHNOLOGY,
SUBCOMMITTEE ON INVESTIGATIONS AND OVERSIGHT,
Washington, D.C.

The subcommittee met, pursuant to recess, at 9:09 a.m., in room 2318, Rayburn House Office Building, Hon. Albert Gore, Jr. (chairman of the subcommittee) presiding.

Present: Representatives Gore, Schneider, Nelson, Skeen, Volkmer, Reid, McCandless, and Carney.

Mr. GORE. The subcommittee will come to order.

I'd like to welcome all of our witnesses and guests. We appreciate your attendance. We look forward to today's hearing.

This is the second day of the subcommittee's hearings on computers and education. Yesterday we heard some fascinating testimony from a number of eminently qualified witnesses, including Dr. T. H. Bell, the Secretary of Education, about the promise and problems of computers and education. There was unanimous agreement among the witnesses that computers can significantly enhance the quality of education in this country. There was also agreement, however, that several obstacles currently prevent realization of the potential of computer technology.

We heard, for example, that the available educational software is now inadequate to meet the instructional needs of schools and universities. One witness stated, in fact, that only 3 percent of the available educational software was of good quality. For another thing, we heard that the vast majority of teachers in this country are not trained to utilize computer technology in the schools. It was estimated that unless our present rate of progress in training is accelerated, it will take 60 years before all teachers are trained.

We also heard testimony that few courses are really designed to take advantage of this technology. And all the witnesses expressed concern about a growing gap in access to computers between the "haves" and the "have nots" in our society.

Today the subcommittee will consider the experiences of States and localities in implementing computer-based educational programs. We will hear testimony from State and local officials, and we will discuss with them the extent to which they have encountered the difficulties cited by yesterday's participants. We will also hear testimony from several national organizations concerned with the quality of education in America.

Before we begin, however, I would like to point out for the record that initially we had considered hearing from the computer compa-

(289)

ES 293

nies during these hearings, and we tried to set that up. They obviously play an important role in this matter, and many of them have made laudable efforts in establishing training and curriculum development programs for schools, as well as in donating money and equipment. Unfortunately, however, scheduling problems in working out appearances by all of the companies on the same day prevented us from taking testimony from them on this occasion. We have, however, invited them to submit written statements for the hearing record, and, without objection, these statements will appear in the printed hearing transcript. I know that some of them have already prepared statements, and we're delighted to include them in the hearing transcript.

Before going to our witnesses, I'd like to recognize the ranking minority member, Mr. Skeen.

Mr. SKEEN. Thank you very much, Mr. Chairman.

And I'll just have my statement entered in the record.

I just want to welcome Governor Brown. We're glad to have you here this morning.

I think we're making good progress with this hearing. I commend you once again for having them. I'd like to get on with it. [The prepared statement of Mr. Skeen follows:]

PREPARED STATEMENT OF HON. JOE SKEEN, SEPTEMBER 29, 1983

Thank you, Mr. Chairman. I want to join with you in welcoming our witnesses to Washington this morning to discuss the proper and multiple roles of computers and education in America.

I believe there is an inherent challenge in managing the rapid introduction of computers and other information technologies in our Nation's schools. Yesterday, we learned that computers promise to greatly enhance the quality of education in this country given their proper use, and with the right direction. We also learned, however, that serious concerns must be addressed if we are to achieve this laudable goal. Chief among these were the questions of software compatibility, and the question of equality of access among the various socio-economic groups.

I am convinced that State education councils and local school boards are in the best position to address a majority of these fundamental questions. It is critically important that these groups work with local school districts and individual schools in formulating goals and plans for properly integrating computers and other information technologies in the schools. These groups might also make a special effort to utilize the expertise of the computer and communications industry, and appropriate professional societies.

In this manner, I feel computers and other information technologies can be directly applied to achieving the educational goals and objectives of the 1980's and beyond.

Mr. GORE. Thank you very much.

And our first witness, indeed, is Hon. Edmund Brown, Jr., chairman of the National Commission on Industrial Innovation and a well-known leader in this particular field. There could be no more appropriate witness to lead off this second day, because of the efforts that took place in California while you were Governor. We're delighted to welcome you here.

Without objection, we'll put the prepared text of what you have in your statement in the record. If you want to present all of it, that's fine. We'd be delighted to hear it. If you want to summarize any portion of it—you just use your own discretion.

We're very interested in your views and invite you to proceed.

STATEMENT OF EDMUND G. BROWN, JR., CHAIRMAN, NATIONAL
COMMISSION ON INDUSTRIAL INNOVATION

Mr. BROWN. OK. Thank you, Congressman.

This hearing goes right to the heart of one of the most important developments in American education today, and that is the introduction of computers in an instructional setting. I'm happy to give you some of the initial results of what has occurred in California.

There's no doubt that young people like computers, work with them, play with them, and can certainly learn from them in very exciting ways. In order to make this a positive educational experience, there is a great deal that Government can and should do.

Speaking of what has occurred in California, there are three significant aspects to any solid program introducing computers in schools.

The first is to insure the teachers are adequately trained, understand the problems and the potentials of the use of computers. In order to achieve that goal, in California we set up 15 regional TECC centers, and that is a teacher education computer center. The State was divided up into these 15 regions, and in each of these centers teachers from the various surrounding school districts could be instructed on the use of computers for instructional learning.

The result after a year is that thousands and thousands of teachers have signed up for these courses. There are literally waiting lists, and a tremendous level of excitement and interest in this new educational development. So that's the first step—develop a network of instructional forums whereby teachers can learn how to make these computers a positive experience.

Second, as you alluded to in your opening statement, there is a need for the evaluation of educational software. So that at 1 of the 15 centers a software clearinghouse has been established to evaluate the educational software that's available, so that teachers who are interested in finding out what program is good for arithmetic or English or science is able to find out the specific courses and programs that would be available and appropriate for his or her particular class. So that's the second point—a statewide clearinghouse for software evaluation.

The third component of this computers in schools program is a tax credit that gives a very strong incentive to the manufacturers to donate computers to the schools. It is a credit given to the manufacturers of 25 percent of the retail value of the computer, and in practice that works out to much greater than 25 percent, given the markup between manufacturing and actual retail sales.

If you put the three together—a tax credit, teacher education computer centers, and software evaluation—you get a three-part program that really does accelerate in an intelligent way the introduction of computers into schools.

The centerpiece, which is the tax credit, will be in effect until July 1984, and I would recommend to this committee that you consider a Federal tax credit of a limited time duration, probably 3 years, wherein manufacturers are given strong incentives to donate computers to schools, and link with that a program of regional TECC centers, teacher education computer centers, so that it isn't

just hardware, but it is in the context of teacher training. And if this is enacted, I would think a 3-year program would be quite sufficient. I'm confident that all 50 States will pick up from there and continue on their own funding.

The reason why I am confident when I say that is because of the tremendous grassroots activity. In California an organization was begun in 1977 called CUE [computer-using educators]. And without any help from Government, thousands of teachers joined together in an informal organization to promote the use of personal computers in the classroom.

What has really happened to the technology is that individual teachers can make their own decisions, can have computers introduced into their classroom, and this can occur without the school board or without some major appropriation of \$1 million or a half a million dollars being debated and finally approved. The earlier technology, 10 years ago, required a central computer operation, required a very large sum of money, and therefore was a top-down, centralized decisionmaking situation. Now you have a situation where, for \$1,000 or \$2,000, a local school, or even a classroom, can begin the use of computers in a school. And that gave rise to this organization called computer-using educators.

And it was on that that we built our State program. This was not something developed by experts. It didn't come out of a school of education. It came from classroom teachers who already started the ball rolling. They had already started their own software clearinghouse, and the State merely built on that and provided financial help.

And I would note in passing that the program which was started in 1982 was increased under the present Governor of California, and actually the funding was expanded by \$1 million. So it's a bipartisan issue. It's of growing interest, and not only is it schools, administrators, and the State legislature, but you find a growing partnership between the industries and the teachers themselves.

We have involved, in a program which I call California computers in schools, the school administrators, the school teachers, and the equipment manufacturers. In some material I've handed out I've mentioned some of the programs that are working under this effort. Apple Computer is giving several thousand computers in what they call a "Kids Can't Wait" project. Hewlett-Packard has been following a slightly different route, but also working with 14 selected high schools in the State. Kaypro, which is a computer company from southern California, is working in the San Diego area, and then IBM has a particular model that they're working on.

It's very important to point out that this is not just gimmickery, it's not just another technological toy here. IBM has found out in one of their projects, which I visited here in Washington, that young children, particularly in inner-urban schools, can actually learn to read through the use of computers, and they actually teach them how to write before they read by using a phonetic alphabet, using tape recorders, computers, and typewriters. It's a very effective—it's an integrated program. It's very imaginative.

And I think that we have to take the leadership and not leave computers just to the games producers and to the war games that

you see in the arcades, but to take a technology that does have the excitement, does have the interest of young people, and apply it in an educational setting. If we do that, I think that you're going to see not only heightened learning, not just in the sciences, but across the spectrum of educational experience, but you're also going to see a renewed interest on the part of teachers.

This group which I referred to earlier—computer-using educators—has reported that in the face of burnout, in the face of a lot of problems in the teaching profession, the introduction of computers has brought a new excitement to the classroom, has proven effective in terms of outright achievement, but also in improving the quality of the classroom and the level of motivation, and that's why I can recommend wholeheartedly this three-point approach of teacher training centers, of a tax credit, and a software clearinghouse.

And I'm confident that if you can put in place a Federal tax credit for 3 years, then all 50 States will have the kind of educational technology excellence that a nation such as ours has a right to expect.

Thank you.

[Material supplied by Mr. Brown follows:]



NATIONAL COMMISSION ON INDUSTRIAL INNOVATION

1125 WEST SIXTH STREET • SUITE 100 • LOS ANGELES, CALIFORNIA 90017 • (213) 401-2230

California Computers In School Project

MODEL DONATION PLANS

Since the Computers in Schools tax credit became law in the State of California, national computer corporations have shown a great deal of creativity and imagination in responding to the law's opportunity.

APPLE COMPUTER initiated its "Kids Can't Wait" project with donations of up to 10,000 Apple IIe systems to every public and private school in California. In addition, the APPLE EDUCATION FOUNDATION aids in teacher-training and basic research.

HEWLETT-PACKARD launched its "Grants for Instruction in Future Technologies" (GIFT) initiative which placed full personal computer systems (value, \$50,000 each), teacher-training sessions and technical liaison support in 14 selected California high schools.

IBM through the EDUCATIONAL TESTING SERVICE has developed a "Model Secondary School Project" which targeted a diverse group of 28 public and private high schools for donations of 15 IBM PC's, extensive teacher-training and \$5,000 worth of software.

KAYPRO donated 300 computers with complete software packages (value, \$1,600 each) to almost every middle and junior high school in the San Diego area. A follow-up program for Kern County is under way.

Other companies including ATARI, COMMODORE, NCR and TEXAS INSTRUMENTS have donation plans in the development stage.

RADIO SHACK is offering free teacher-training classes to every school in the United States. The training is called "America's Educational Challenge" and would normally be valued at about \$200 per teacher.

COMPUSERVE INFORMATION SERVICES is providing low-cost, discounted accounts to California educators and participants in the Electronic Learning Exchange (TELE). TELE is an electronic network managed by the California Computers in Schools Project which will provide descriptions of donation programs, new educational product announcements, legislative updates and a directory of software evaluations.

NATIONAL COMMISSION ON INDUSTRIAL INNOVATION
 CALIFORNIA COMPUTERS IN SCHOOLS PROJECT

...the Commission's report on the California Computers in Schools Project...
 ...the Commission's report on the California Computers in Schools Project...
 ...the Commission's report on the California Computers in Schools Project...

...the Commission's report on the California Computers in Schools Project...
 ...the Commission's report on the California Computers in Schools Project...
 ...the Commission's report on the California Computers in Schools Project...

THE CALIFORNIA COMPUTERS IN SCHOOLS PROJECT

The Commission's report on the California Computers in Schools Project...
 ...the Commission's report on the California Computers in Schools Project...

The Commission's report on the California Computers in Schools Project...
 ...the Commission's report on the California Computers in Schools Project...

The Commission's report on the California Computers in Schools Project...
 ...the Commission's report on the California Computers in Schools Project...

PERCENTAGE OF SCHOOLS IN CALIFORNIA WITH AT LEAST ONE MICROCOMPUTER

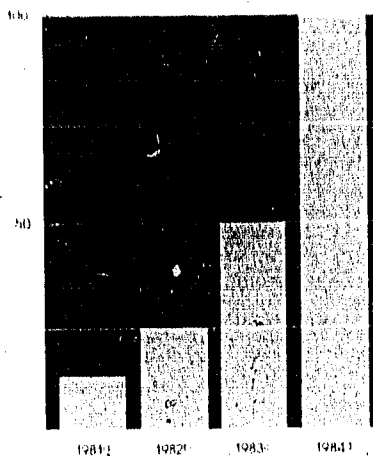

- a. Source: Market Data Retrieval, 1981
- b. Source: Market Data Retrieval, 1982
- c. 1983 estimate based on 1981-1982 growth rate of 1981
- d. 1984 estimate based on projected growth rate

ERS

NATIONAL COMMISSION ON INDUSTRIAL INNOVATION

CALIFORNIA COMPUTERS IN SCHOOLS PROJECT

Strategic Plans

The California Computers in Schools Project helps individual corporations develop strategic plans for donating computers to schools.

- state-wide distribution or geographic focus
- entire school or an entire school district
- reading, writing, math, science, business education, computer science, music, art, social studies.

Donation Prospects

The California Computers in Schools Project helps corporations find schools which are ready to use computers.

- enthusiastic teachers, principals, parents
- bilingual students, gifted students, handicapped students
- inner city schools, private schools, rural schools

The Electronic Learning Exchange

The California Computers in Schools Project manages The Electronic Learning Exchange (ELEX).

- ELEX is California's only statewide, public access, electronic information exchange on computer education.
- ELEX can disseminate information on corporate members plans to subscribing members.

Advisory Forum

The California Computers in Schools Consortium serves as an informal educational advisory group to the CICS.

- Monthly meetings from September through June serve as a forum where corporations can discuss their donation plans with representatives of California's major educational organizations.
- Corporate representatives are invited to attend as observers, to seek assistance in the development of a donations program and to announce fully formulated plans.
- During the first half of 1983 the Consortium met with representatives from Apple, Atari, Hewlett Packard, Kayako, Teledyne Spink, Texas Instruments and ETS/IBM.
- Information on corporations' plans and activities is disseminated to educators throughout California via newsletters, statewide conferences and local seminars.



NATIONAL COMMISSION ON INDUSTRIAL INNOVATION

CALIFORNIA COMPUTERS IN SCHOOLS PROJECT

The following groups are regularly represented on the CCIS Advisory Board:

Teacher Education/Computer Centers (TECCs)
 Far West Laboratory for Educational Research and Development
 California State Parent Teacher Association (PTA)
 State Department of Education
 Computer Using Educators (CUE)
 Industry Education Council of California (IECC)
 Association of California School Administrators (ACSA)
 California Association of Bilingual Educators (CABE)
 California Association of Private Schools Organizations (CAPSO)
 California Federation of Teachers (CFT)
 California School Boards Association (CSBA)
 California Association of Compensatory Educators (CAACE)
 California Teachers Association (CTA)
 United Teachers of Los Angeles (UTLA)
 California Association for the Education of Young Children (CAEYC)
 Math, Engineering, Science Achievement (MESA)
 Educational Products Information Exchange (EPIE)

NATIONAL COMMISSION ON INDUSTRIAL INNOVATION

The California Computers in Schools Project is a demonstration project of the National Commission on Industrial Innovation, a nonprofit, tax-exempt foundation. The NCI is developing a national strategy to promote industrial innovation based on a new partnership of business, labor, government and education. One component of this strategy is commitment to excellence in the education of our youth.

For further information, please contact:

Judith Johns Hubner, Director
 California Computers in Schools Project
 1125 West 6th Street, Suite 300
 Los Angeles, CA 90017
 (213) 481-0205

NCII

INVESTMENT IN PEOPLE

A California Agenda for Education and Training in the 80's

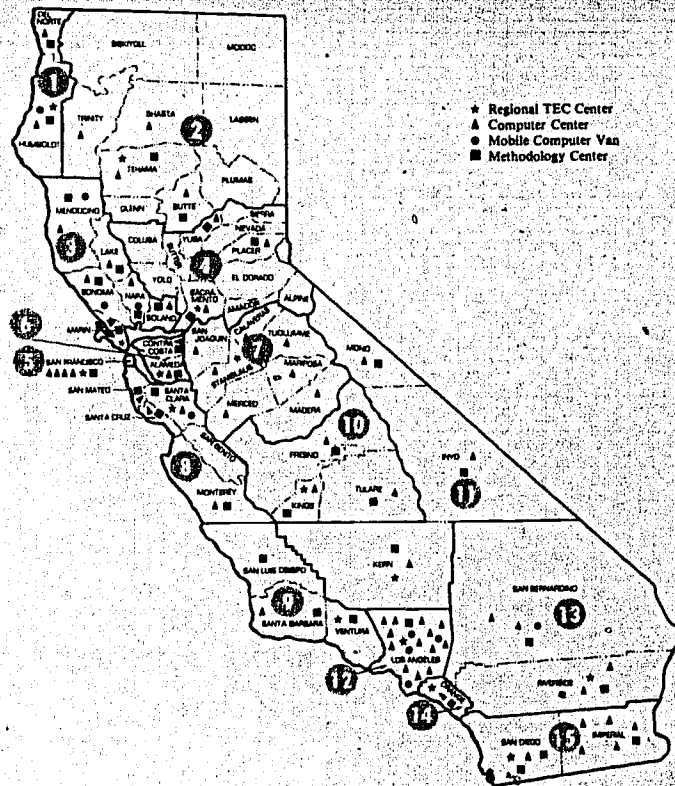

303 303

INVESTMENT IN PEOPLE

A California Agenda for Education and Training in the 80's

Introduction

We are now in the midst of a revolution that will surpass in its magnitude the industrial revolution of the 19th century. Driven by advances in microelectronics and telecommunications, our society is transforming itself and fundamentally changing the way it works and organizes itself.

In this new age of information, wealth will not derive from a mere abundance of resources but from people—from human intelligence. Accordingly, we must nurture that intelligence through education, research and training in both the private and public sectors and thereby ensure that the people of California will remain up among the best for years to come.

During 1982, Governor Edmund G. Brown Jr. initiated a series of programs designed to meet the challenge of the information age as he forged new relationships between government, industry, education, labor, colleges and universities.

California Commission on Industrial Innovation

To forge a new alliance to promote sustainable economic growth, Governor Brown created the California Commission on Industrial Innovation. Composed of a broad range of outstanding citizens and chaired by Governor Brown, the Commission formulated an economic blueprint to strengthen California for the rest of this century. The Commission's fifty specific proposals chart a clear path to renewed productivity, educational excellence and competitiveness in world trade.

Investment in People in Our Elementary and High Schools

Governor Brown called for higher standards, including requiring at least three years of math and two years of science—with a minimum of one semester of computer study—for all high school graduates and even more math and science for college bound students.

The State Board of Education included Governor Brown's call for a "three year math, two year science" requirement, with a

semester of computer studies, in its model high school curriculum issued on December 10, 1982.

On January 26, 1982, the California State University Board of Trustees passed a resolution raising entrance requirements in English

"If we think clearly and act correctly, we can make the tools to lift millions out of poverty and ignorance and we can pioneer the new technologies that emphasize quality over quantity."

FROM THE STATE OF THE STATE MESSAGE
GOVERNOR EDMUND G. BROWN JR.
JANUARY 7, 1982

and mathematics. Subsequently, the Board authorized a study group to consider adding additional requirements.

At their June, 1982 meeting, the University of California Regents raised the entrance requirement for mathematics from two to three years. In addition, the Regents initiated a study at the Governor's urging to consider requiring additional math and science for all incoming students.

In the 1982-83 Budget, \$9.7 million was provided to upgrade math, science, computer and related education in our public schools. This money has been spent to fund:

- School-site staff development in mathematics, science, computer education, and other curriculum areas for twenty-five percent of the state's secondary schools (grades 7-12).
- Retraining of 270 teachers to become eligible for an additional credential authorization in mathematics to address the immediate shortage of qualified math teachers.
- Fifteen regional *Teacher Education/Computer Centers* to provide training in teaching methodology and to broker staff development services with major focus on math, science and computer studies. The decentralized structure of these TEC Centers has resulted in a statewide network of 114 local training facilities.

- In addition, each TECC region contains one or more computer demonstration center. Also eleven mobile computer vans are in operation providing in-service training in computer-aided instruction.
- A series of statewide *Computer Institutes* to guide teachers and administrators in establishing and operating the computer demonstration centers.
- A statewide *Software Library and Clearinghouse* located in the San Mateo County Office of Education, to purchase, evaluate and disseminate information on educational software.
- A *Council on Technology Education* to solicit, review and fund proposals for teacher training in math, science and computer studies.
- The *Institute for Computer Technology*, a new, high-technology magnet school for students from three school districts in California's "Silicon Valley".
- Support for exemplary projects such as the *Mathematics Engineering Science Achievement (MES-A)* program geared to motivating and supporting minority and women high school students and to help these students complete their college degrees in math, engineering and science-based disciplines.

Lastly, Governor Brown signed legislation to encourage the integration of computers into schools:

- A tax credit for companies which donate computers to elementary and secondary schools for instruction.
- An "Educational Technology Committee" to provide matching grants to school districts for the bulk purchase of computer equipment.

Investment in People in the California Conservation Corps

\$35 million funds the maintenance of 25 centers serving 1,700 young Californians, aged 18-23 years. Corps members learn the work ethic by engaging in arduous, often dangerous work.

Investment in People in California Worksite Education and Training Act (CWETA) Program

Since Governor Brown signed CWETA into law on September 29, 1979, \$35 million has been allocated to put more than 12,000 people to work in the skilled jobs that increasingly power our economy. More than 2,500 employers have become involved. CWETA is different because it is based on the real life demands of specific businesses. Moreover, training starts only when an employer decides to participate and agrees to hire or upgrade all graduates. The program is recognized as the most innovative job effort in the nation.

Investment in People in Our Community Colleges

\$2.0 million was provided to community colleges to establish employment-based high technology training. This was supplemented by an additional \$2.3 million of matching funds from labor, state and federal government. Twenty-seven campuses now have "CWETA model" programs, with priority given to projects in new and emerging technologies.

Investment in People in Our Universities

\$3.3 million was provided to the California State University and the University of California to support engineering and computer science education through instructional research grants, joint appointments with industry, retraining opportunities, the purchase of modern equipment, and programs for the recruitment and retention of women and under-represented minority students. For example, "Investment in People" funds helped establish a *Computer-Aided Productivity Laboratory* at Cal State San Luis Obispo which attracted an additional \$1.5 million in private donations.

In addition to these funds, the University of California has received \$3 million for MICRO (Microelectronics Innovation and Computer Research Opportunities). This provides industry/university matching grants for research in basic microelectronics and an engineering and computer science scholarship program.

Governor Brown also allocated \$2.3 million to equip Cory Hall at U.C. Berkeley with a state-of-the-art microelectronic fabrication facility.

Investment in People in Employment Development

\$9.2 million was provided for training displaced workers and employment services to welfare clients. This has funded:

- More than 20 Displaced Workers Reemployment Centers around the state. These centers are set up on a temporary basis to respond to immediate local needs. The largest project serves 10,000 displaced workers at a total cost of \$8 million including additional funding from State of California, General Motors, United Auto Workers and the federal government.
- Expansion of the Employment Preparation Program by \$7.2 million to assist welfare applicants find jobs rather than going on welfare.

On September 10, 1982, Governor Brown signed legislation initiating a landmark training program. Under the new law, \$55 million a year will be allocated from the Unemployment Insurance Fund to prepare Californians for jobs in growth industries. A seven-member panel will contract directly with employers and schools for necessary services. Like CWETA, emphasis is on employer commitment to hire after training.

Investment in People in Private Industry

\$5.9 million funded four *Business/Labor Councils* in Orange County, Los Angeles, Ventura and Alameda Counties. Composed of top business, labor, education and local government leaders, the Councils are working to see that vocational training programs in educational institutions in fact prepare students for jobs that exist in the marketplace.

INVESTMENT IN PEOPLE, 1982-83

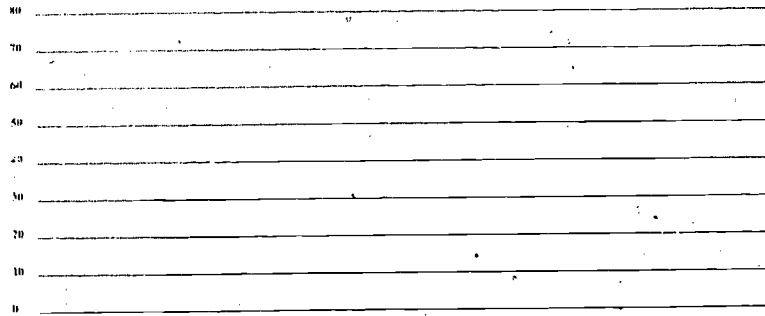

1. Public School Math, Science and Computer Instruction	\$ 9.7 million
2. California Conservation Corps	\$35.0 million
3. California Worksite Education and Training Act (CWETA)	\$12.0 million
4. Community College Employment-based Job Training	\$ 4.3 million
5. University Engineering and Computer Science Education	\$10.1 million
6. Training and Retraining Programs	\$64.2 million
7. Business/Labor Partnerships in Job Training	\$ 9 million

*Includes private sector matching funds

708

Mr. GORE. Thank you very much. We appreciate that.

I have a number of questions.

First, on the tax credit, I'm one of the cosponsors of that. Pete Stark is the principal sponsor from California, and I have pushed that idea hard for the last couple of years. And we came close last year. The Senate has been unwilling to go along so far.

But you have, of course, an income tax in California, and that is—you've done it at the State level; is that correct?

Mr. BROWN. Yes, it's a tax against the corporate income tax.

Mr. GORE. Yeah.

Mr. BROWN. The corporate income tax in California is over 10 percent, and a number of the computer manufacturers pay a very significant tax to the State. So it is a very effective incentive for California. That probably would not apply to all States, and that's why a credit on the Federal tax would be very effective and probably the only effective tool that you could use in States, for example, that don't have a corporate tax.

Mr. GORE. That's my feeling, and I was pleased that yesterday Secretary Bell endorsed that idea as well. Secretary Regan at the Treasury Department hasn't endorsed it yet. And, as a result, the administration is still, I think, formally opposed to it; but we are making a little progress.

One criticism that you often hear is that a pledge by a computer company to put one computer in every school, for example, wouldn't do that much because if you just have one computer in each school, what do you really have?

Mr. BROWN. You've got a computer in each school, which is more than you had before.

Mr. GORE. Well, correct, but how do you respond more fully to that?

Mr. BROWN. Well, in this brochure that I believe we passed out—it's called "California Computers in Schools Project"—there's a graph which indicates the growth in the number of schools in California that have at least one microcomputer.

In 1981, only 20 percent of the schools had even just one computer. By 1984, principally as a result of the California tax credit, we expect 100 percent of the schools to have at least one.

Mr. GORE. Yeah.

Mr. BROWN. Now when you get one, you begin to get the interest. It operates as a magnet. It's exciting. And, as a matter of fact, as more companies get into it, you're going to get considerably more than one computer per school.

Mr. GORE. Sure.

Mr. BROWN. The program was initiated by just one or two companies, but we found as more companies learn about this they're prepared to contribute, also.

In addition, if you would in some way give a credit for software, that could enable other computer companies to join in the effort. The way the credit was written, some companies appear to have more of an advantage than others, and I would like to see a tax credit that would give an incentive to all computer companies, whatever their markup is, to contribute to schools. Now if that happens, you will find many, many computers going to every school in the United States.

And if the program is done right and phased in properly, with the proper teacher training and the software evaluation, this would have a very significant impact. In fact, I can't think of any one single thing we could do for American schools in a 3-year time-frame that would have more impact than putting this three-point program into effect throughout the United States. It doesn't mean that everything's going to be solved at the end of that, but it is a major, concrete step that you can take, and it will not necessitate a big bureaucracy. You won't need any more people over at the Department of Education, because the tax credit is something that is worked out between the IRS and the individual corporation.

The use of the computers is developed and monitored by teachers, by administrators, and the manufacturers in the local school districts. So this is decentralized, nonbureaucratic, one-time-only introduction of some hardware with a permanent, ongoing expansion of educational excellence.

So I think from every point of view there really are no objections; other than the fact that there is going to be some revenue loss, far less than you would get if you had to go out and buy the computers.

Mr. GORE. Right.

Mr. BROWN. And they're going to buy at least as many computers as you would, "incentivize" with the tax credit anyway, and you're going to get a better deal. You're going to get them cheaper. You're going to have almost no bureaucracy in the process, and you will create the partnerships between industry, the teachers' groups, and I would point out that both teachers' unions in California are active participants in this effort, and then you have the participation with the administrators and other school personnel.

So it's a very interesting—it's a creative approach, and it does not necessitate a permanent government program. Because I believe that after the use of computers has been—has reached a certain level, then I think the normal budgetary process is going to take place, and the tax credit ought to be eliminated.

Mr. GORE. Well, I agree with all of that, and I think we ought to have a national program modeled on the California experience.

I'd like to ask you a couple of questions about how this software clearinghouse operates. One of the problems stressed yesterday by several witnesses, including Secretary Bell, was the problem of software compatibility. The picture painted is that it's almost as if you have little groups of software developers making products for a small slice of the market, and they're not interchangeable. It would be like the record industry having not just 33 revolutions per minute and 78 and 45, but 100 different categories and record manufacturers making records for each, and if you don't have the right record player, you can't play the records that are on the market.

Similarly, with computers now, you have software for Texas Instruments that can't be used on Apple, and Apple's software that can't be used on Radio Shack, and Commodore, all the rest. And I'm wondering how your clearinghouse in California has approached this terrible problem of compatibility.

Mr. BROWN. Well, obviously if something isn't compatible, then it isn't compatible. The principal problem that the software clearing-

houses deal with is the fact that much of the software is no good, that it is educationally defective and not worth anything.

So you asked what do the software clearinghouses do. Well, there's one in San Mateo, Calif., and they literally read, use, and evaluate each item of educational software and then rate it and make that information available to teachers. So if the software is no good, that word is communicated. As a matter of fact, it's communicated by computers through a telecommunications network.

The computers are compatible to the extent that you can plug them into a telephone.

Mr. GORE. Yeah.

Mr. BROWN. But the main function is to identify the good software and stigmatize the bad software.

Mr. GORE. Yeah.

Mr. BROWN. And one of the—some of the funding that we did have available was made available for a 3-day workshop, and the teachers who were interested came on their own time and actually used and evaluated the software and came up with a report to say, "These are the good programs. These are the bad ones." And then that was disseminated.

So that's the most important point—is to separate the wheat from the chaff in terms of quality.

As far as incompatibility, that is just a technological fact of life, and that is being reduced by the fact that standardization is occurring because certain manufacturers are doing better than other manufacturers. And, as a matter of fact, the software creators are working for those companies that have the largest part of the market.

So I would think the incompatibility problem is being reduced, and within a matter of a couple years will not be a significant barrier.

Mr. GORE. I hope that's the case. We heard some testimony yesterday that that movement is taking place much more rapidly in the business computer end of the market, where you have the IBM PC, which is in a price range that most schools are not getting into. You get a lot of IBM compatibility, but in the—on the lower end of the market it's still so scattered that it's moving very slowly.

But separating the wheat from the chaff is a necessary first step.

I'm wondering whether or not the clearinghouse ever seeks to identify needs for the development of new software and communicate that to people who—

Mr. BROWN. Well, I think there ought to be a parallel effort on the part of government to create software. That is occurring in Minnesota. It is occurring in some ways in California, and there's no reason why this can't also occur along with the private sector, at least in these initial stages. The teachers can write software, and they do.

And to the extent—I think that ought to be part of the program and see how that works. It doesn't have to be a permanent effort, but some funding in this effort could well go to the creation of software by teachers themselves. Probably this will be done—not probably; certainly it will be done principally in the private sector, but there are some public sector efforts, and I think they should be given some initial encouragement to see how they work out.

Mr. GORE. Now at your 15 TECC centers, when a teacher goes for training, how long does that teacher stay there?

Mr. BROWN. Sometimes a weekend, sometimes it's in the evening, and sometimes there's inservice training during the summer. There's really—there are stipends that are given to the teachers.

There are—for example, in these TECC centers there will be two or three employees employed by a county board of education. They will be in a county building. They will have computers. Teachers will come on a Saturday or after school, and they will get the training.

These are very—generally very brief periods of instruction.

Mr. GORE. I see. Now is—are there different kinds of computers at the TECC centers?

Mr. BROWN. Sure. There are different computers in fact. I mean, that's the nature of the business.

Mr. GORE. So which computer a teacher was trained on would depend on which TECC center and—

Mr. BROWN. Well, presumably, people are learning general principals and can learn to use a variety of computers. Since that's the way the world is, certainly teachers have to be given that opportunity and not be limited to one manufacturer. And, in fact, they are learning on different computers.

Mr. GORE. Let me recognize my colleague, Mr. Skeen.

Mr. SKEEN. Thank you, Mr. Chairman.

I want to commend you, Governor Brown, and also commend California, for the initiative that they've taken in this particular program, and I think that a State whose employment base is so dependent on the use of computers and the understanding of computers—it's a very far-reaching and a very advanced outlook and initiative that was taken by the State.

I wanted to ask you, though, in carrying on with what the chairman started talking about in these teacher training centers—what's the frequency of this? Is there a mandatory type of requirement?

Mr. BROWN. No, it's voluntary.

Mr. SKEEN. It's voluntary?

Mr. BROWN. And, in fact, thousands, tens of thousands, of teachers have already taken advantage of this.

Mr. SKEEN. So it's left up to the teacher to decide when they need to go back and either—

Mr. BROWN. It is.

Mr. SKEEN [continuing]. Take a refresher or—

Mr. BROWN. It's voluntary, but because of the general level of interest and excitement in computers by the students and by the teachers who are already using them in the classroom, there has been no lack of interest. So here you have not only a nonbureaucratic, decentralized program, but it's a voluntary effort. It is not coercive or mandatory in any way.

Mr. SKEEN. With the rapid advancement that we've had in computer technology, I was just curious from that aspect of it, just how often the teachers themselves felt the need to refresh themselves or to upgrade their training in that area. But it's left strictly up to them, which I think is admirable.

Mr. BROWN. It's left up to the teacher.

Mr. SKEEN. The next question I'd like to ask—in the news it's been a topical interest of late about the question of the "haves" and the "have nots." Does California have any problem in that particular area, and how have you dealt with it?

Mr. BROWN. The donations, of course, go to schools irrespective of the wealth of the school district, and in that sense it's perfectly equitable. But, in fact, there are certain areas—for example, in the Santa Clara Valley area where Silicon Valley is—there are many more computers than there are out in the boondocks. That's just a fact. Because there are affluent parents where they have computers at home and are working in the industry, so they're going to be much more sophisticated and they're going to have more computers. That's just—it's like they have more cars; they're going to have more computers. I think that's unfortunate, and that's the reason why there should be some positive Government effort to make sure that we don't create a second class of citizens, which could well be the case. I think it's a real risk.

Mr. SKEEN. But you haven't had what you would call an overriding problem, or one that's been all that apparent, because of the disparity between the so-called haves and—

Mr. BROWN. Well, there's obviously going to be a difference in a family where there's very low income people and a high income family. Every educational study shows that the more wealth in a neighborhood, the higher the educational scores. So I don't think there's going to be any different outcome with respect to computers.

Mr. SKEEN. It's more of a sociological concern than maybe a technical one?

Mr. BROWN. It's strictly a—yes, it's a political-sociological problem.

Mr. SKEEN. I want to join the chairman in talking about these tax credits. I like tax credits. If you leave the money in the local area, it turns over many more times than it does when it's taken up in taxes and sent to Washington or to Sacramento or Santa Fe, N. Mex. And I think it's a good approach, and I don't think you lose one dime when you leave money or give tax credits for this kind of a purpose, so long as it's well defined and you know where you're going with it.

So I wanted to endorse that with you, Mr. Chairman.

So thank you very much. I enjoyed the conversation with you, Governor Brown. I'm glad you were here today.

Mr. BROWN. Thank you very much. So have I.

Mr. GORE. Congressman McCandless.

Mr. McCANDLESS. Thank you.

Welcome to Washington, Governor.

I have some concerns about the computer age and the fact that we're overlooking one of the basic deficiencies of our educational system and we're going off in a direction of making everyone a keyboard genius, when we haven't even been able to accomplish, to a satisfactory level, the teaching of the three "R's."

Now from your experience and your present association, and within your discussions here, you talk about the teachers and the programs they're involved in. Are we going to be able to accomplish something meaningful in teaching the three "R's" and giving

these young children, young people, the tools to function in society by using these computers?

Mr. BROWN. I think you can, if it's done properly. The computer is different from other educational technologies in the sense that it's interactive. The student gets a response. There's a feedback.

For example, in one of the computer systems, the words will be written on a computer, on a computer screen, and there will be a little box that will say, "dog," "tree," "jump," and the student would just touch the corresponding word, and then there would be an animated picture of a dog jumping over a tree. So you get an immediate feedback from the sight of the word, its proper spelling, and an animation of the concepts that are represented by those words.

So I believe that basic reading, writing, and arithmetic can very much be enhanced by the computer. The teacher has a classroom of 25, 30, sometimes a larger number, of students, and students learn at different rates. Some students pick it up very fast, and some are way at the bottom.

If there is a computer, it is moving at the particular rate of speed of the individual student. And in that sense, it is a real, solid advance in the educational context. So I don't think we ought to look at computers as part of science or part of math. It is a tool that the individual student can use that will relate directly to that individual student's needs. And eventually every student will have a computer just like today they have to have a pencil and a textbook. But unlike a pencil and a textbook, this computer talks back. It interacts.

And the program can be drawn and tailored in such a way that whatever the given student problem, whether it be because the student wants to go too fast or too slow in terms of a common average, the computer can take that into account.

So I don't think we have any fear of that as long as we do test and maintain the basic standards. There has to be some accountability, it's very clear, and it is not enough to learn how to work a machine. I believe in the teaching of literature, of art, of math and science, and the capacity to write. And all of that has to be part of a curriculum. I don't think we ought to view this as a cure-all for the total program. It is just a very important, exciting tool that can help, but it isn't the whole show.

Mr. McCANDLESS. In those areas where computers have become an integral part of the educational process, who determines the standards necessary for the teacher to actually be the computer instructor?

Mr. BROWN. That is really very informal at this point. There's no licensing of—if I understand the question correctly—of teachers in their competence to work with computers. That's just part of the—the teacher has a credential. From there on, it really depends on the person to develop the proper experience and qualification to work with the computers. There's no formalized testing that I know of.

Mr. McCANDLESS. So it—for all intents and purposes—it comes down to the school board or the administration, as to whether or not this person has competent background and training to be able to utilize this instrument?

Mr. BROWN. And I don't see anything so bad about that. I mean, there is a limited capacity on the part of the State to insure quality at the classroom level, and that ultimately depends on the school board, the principal, and the interest of the parents.

Mr. McCANDLESS. I'm somewhat reminded of the fact that part of the educational process for becoming a certified teacher is so many hours of education in the field of working motion picture projectors and slide machines, and that kind of thing, which many teachers find somewhat ridiculous, but it is a requirement; at least it used to be. And I somewhat liken this to it. Only it's certainly a more sophisticated instrument by which to teach. That's why I asked the question.

Mr. BROWN. Well, in many ways the students are more advanced than the teachers. They're growing up with these machines. They're seeing them in the arcades. They feel comfortable with them, and many times the problem is the teacher is behind the students and has to catch up. That really is one of the psychological barriers here—that you have an instrument that is individualized, and that really creates a different kind of learning environment. But I don't know if teachers need to have this added into their curriculum in a mandatory way, in the manner that you describe.

Mr. McCANDLESS. Now we've talked about all of the good points of a computer system as a teaching instrument. What do you see as the possible negative effects of such an introduction into the system?

Mr. BROWN. Well, the—I'd say the No. 1 negative potential would be that the teachers and the school is not prepared to use the hardware in an intelligent way. So that it's just not used, or not used properly. So I'd say that teacher training and the teacher involvement would be the No. 1 problem or risk.

I'd say No. 2 would be, as you suggest, an emphasis—well, not an emphasis, but a neglect of the basic skills. For example, writing—you're probably not going to learn how to write an essay on a computer, although you might. You can type it into it, but I would say that the liberal education, the arts, have to be kept at the forefront because, after all, it's not just machinery; it's values and basic critical reasoning powers that are the object of education.

So I believe the computer can help in that, and you don't have to have this dichotomy between technology and the arts or between a machine and a human being. That all can be integrated together, if the hardware is introduced in the context of a rigorous, intelligent curriculum; and I believe that's the way it can be done.

Mr. McCANDLESS. Is there a parallel between the State board of education approving certain textbooks for use in the school system and approving certain types of computers or computer programs?

Mr. BROWN. Well, I think you can find some parallel, but the difficulty is there are thousands and thousands of computer programs. And if you empower a State authority to block, by way of some approval process, you're going to compact the process in a way that it will break down.

Mr. McCANDLESS. Don't we have thousands of different types of books that say, "Run, Jane, run" with different kinds of pictures that have to be approved by the State superintendent—

Mr. BROWN. And that's a big controversy as to how you deal with that, even now. Seventy years after the State printing plant was built, people are still arguing exactly who ought to be approving it.

But in the case of software, the technology is so young and so rapid in its development that I believe it would be very premature to empower a State authority to approve or disapprove the individual software.

The beauty of the microcomputer is the empowerment of the individual teacher in the classroom, as opposed to some central authority several hundred miles away dictating the terms of the teaching.

Mr. McCANDLESS. I'm not advocating a central authority as—

Mr. BROWN. Oh, I know you wouldn't be.

Mr. McCANDLESS [continuing]. As our historical background would point out.

Mr. BROWN. It's a real problem. It's not a—that's not a trivial problem, the bad software and the proliferation of different machines. I would just say that, given the state of where we are today, it wouldn't be very practical to bog the process down with some complicated approval procedure in the State capital—

Mr. McCANDLESS. Thank you, Governor.

Mr. BROWN [continuing]. Much less in Washington.

Mr. McCANDLESS. Thank you, Mr. Chairman.

Mr. GORE. Congressman Volkmer.

Mr. VOLKMER. I'd like to continue on with that and maybe take a little time to point out that yesterday, Governor, we had testimony by persons who are very knowledgeable in this field that felt that we did need some development on software, on specific courses, et cetera; that the present software available was not really sufficient as far as using the computer as a learning aid.

In other words, the difference between a piece of hardware and learning to use a piece of hardware, than using it as a learning tool.

Mr. BROWN. People use the term that 90 percent of the software is no good.

Mr. VOLKMER. Well, I'm not saying 90 percent, and I don't think—

Mr. BROWN. Well, I've heard that term used quite commonly.

Mr. GORE. One witness said 97 percent, yesterday.

Mr. BROWN. I was just being conservative.

Mr. VOLKMER. But some of us look to this as—you know, if the computer is being used, but only being used to learn how to use the computer, and not being used to learn with a computer, then I think we need to look very seriously at maybe changing that.

Mr. BROWN. Well, it's—you've put your finger on the problem, that the software is not so good right now, and, therefore, there has to be a careful evaluation of the programs that are bought for use by given schools. But as teachers develop the sophistication of use of computers, I think that can be done. I have confidence that people can learn to make these decisions in local schools. And as the competition goes forward and as people read the literature and go to the conferences, they will buy better software than not.

And the important point now is to have the adequate funding to train the teachers and to make sure we get an adequate amount of

hardware in the schools. And from there on, it really is up to the school boards and local schools to insure the excellence that we all would like.

Mr. VOLKMER. Well, do you disagree that the Federal Government has a part in providing good software?

Mr. BROWN. Well, the Federal Government has a research and development responsibility, and so in that respect I believe that the Department of Education could develop—play some role in all that. But I think most importantly the Federal Government has a role of being the catalyst, being the innovator, and here we have an opportunity to plant some seeds and to stimulate a movement that would otherwise occur anyway over a longer term, and can be accelerated through tax credits, through some block grants for teacher training, and some money for the evaluation, and perhaps even the creation of some software in the appropriate context.

Mr. VOLKMER. NSF testified yesterday they are already in a process of putting out basic contracts, evaluation contracts, right now and later on, for development of software. So I'd say right now, as far as I know, they're the first movement in it.

Mr. BROWN. Well—

Mr. VOLKMER. The Department of Education hasn't moved yet—

Mr. BROWN. Well, maybe at the NSF level, but actual teachers are coming together to use software, put it into the machines, look at it, and talk among themselves, and give it some evaluation. So I believe people are smart enough to figure out what's good and what's bad, and teachers, as part of their responsibility, will join together and communicate among themselves what works and what doesn't.

Mr. VOLKMER. We also had testimony yesterday talking about teachers, that we've got a—I wasn't going to use the word "massive," but I'd say a major effort yet to have teachers taught in the use of computers throughout the Nation, and at a great cost.

Mr. BROWN. I don't think the cost is very high at all. I mean, the amount of money that's going into this program is a few million dollars, and the educational budget of California is \$12 billion. So this is pennies compared to the overall amount of money that we're spending on kindergarten through 12th grade. This whole program is \$5 million, and then when you add local money, I mean, I'm sure it isn't any more than \$10 million, out of \$12 billion. So this is very cheap in terms of the payoff that you get from it.

Mr. VOLKMER. Can I ask you one last question, Mr. Chairman?

In the instruction of the teachers in California, does that instruction include why the computer does what it does—in other words, how it operates—or is it just how you operate a computer?

Mr. BROWN. They have—it's a short course. They go for, like, a Saturday. Sometimes they go for longer, but they give the—try to teach some basic principles, but they're not learning how to use the computer any more than most of us know how to work the television set.

Mr. VOLKMER. But they're not learning what makes the computer work. It's just like—

Mr. BROWN. No; they learn certain program—certain basic principles.

Mr. VOLKMER. It's just like the automobile, you know. When you learn, you learn basically you turn the key on and you have to put gasoline in it, but a lot of people don't know how it actually works.

Mr. BROWN. Well, no, there are basic principles that are taught. And, also, the computer courses themselves teach the work—how a computer functions, what the principles are, and how it all operates. Those are—that's part of the course, depending upon how much a teacher wants to learn.

You can use a computer just like you can use a phonograph, without understanding the basic—

Mr. VOLKMER. That's correct.

Mr. BROWN [continuing]. Underlying workings.

Mr. VOLKMER. Thank you, Mr. Chairman.

Mr. GORE. Congresswoman Schneider.

Mrs. SCHNEIDER. Thank you. I regret I was not here to listen to the beginning of your testimony, Governor Brown.

I was at a Clearinghouse on the Future meeting where we had the opportunity to listen to Nobel Prize Winner Bryan Josephson, who was talking about the link between computers and the paranormal. And I thought that I might be able to add something to the hearings here this morning as a result of these discussions.

But I certainly commend California for their leadership in the United States insofar as pursuing the development of the computer, but let me mention that it looks like what we're going to be seeing very soon is molecular electronics where we're replacing the silicon chip with biological materials. So this is the word for the future, gentlemen. Tune in to it, and we'll see where we end up.

I also understand that most all of the questions that could possibly be asked of you have already been asked. So, for fear of being redundant, I have no questions to ask but will read over the material you've submitted, and, once again, commend you for your leadership.

Mr. BROWN. Thank you very much.

I'm glad we didn't get into the paranormal. We have enough of that already in California. [Laughter.]

Mr. GORE. We have a hard enough time with the normal.

Thank you very much for getting us off to a good start today. We appreciate it.

Mr. BROWN. Thank you.

Mr. GORE. And congratulations on California's program in this area.

I'd like to call now our first panel of witnesses: Dr. Sharon Robinson, director for instruction and professional development with the National Education Association; Dr. Joan Parent, president of the National School Boards Association; and Dr. Ronald Anderson, director of the Minnesota Center for Social Research in Minneapolis.

If you all would join us at the witness table.

You might want to shift over one there, so you can line up with the microphones a little bit.

Let me welcome you to this hearing. We appreciate your willingness to attend.

Without objection, the prepared statements you've submitted will be included in full in the record. If you want to summarize any portions of your statement, feel free to do so.

I believe we will start with Dr. Sharon Robinson, director of instruction and professional development with the National Education Association.

Dr. Robinson, we're glad to have you here, and we invite you to proceed.

You might bend the microphone down a little so that we can—there you go.

STATEMENT OF DR. SHARON P. ROBINSON, DIRECTOR, INSTRUCTION AND PROFESSIONAL DEVELOPMENT, NATIONAL EDUCATION ASSOCIATION, WASHINGTON, D.C.

Dr. ROBINSON. It really is exciting to have an opportunity to discuss this very important instructional issue, absent the constraints of pending legislation even, because it does allow us a chance to explore some aspects of this topic that might not be so apparent in the context of pending legislation.

Our major concern in terms of this technology and all instructional technology could be characterized as a concern for equity and the concern for equality. The written testimony takes some time to explore some of the issues relative to equity and equal access.

Fortunately, the recent various reports on education have highlighted that the question of equal access has to be accompanied with the equally compelling question of access to what and the quality of the instructional environment to which we expose all of our students.

The prospect of introducing the microcomputer, the personal computer, into the classroom and making that technology available in an equitable way, so that we afford all of our young people a chance to be computer literate, whatever that turns out to mean, but we afford them a chance to be participants in our growing technological society is exciting.

We have also been concerned with what we would call a glorious marketing strategy, a strategy which is represented by the prospect of introducing the technology as perhaps a little less than a panacea but something that compels our interest, and yet knowing that there are many questions relative to the use of the technology in the classroom to do that, and keeping a handle on, the process of its introduction.

I know that you've heard much already in the course of these hearings about the process of introducing the computer into the classroom, the involvement of the classroom teacher and why that is so important, but we also have to recognize that we are dealing with one aspect of our economic community that has a profit interest that might not be always compatible with our interest of quality.

I'd like to introduce you to a new program that the NEA is now supporting. It is a program that we have designed in collaboration with Core Datum Corp. That is a computer consulting organization in this area. It is called the NEA Educational Computer Service.

The first objective of this project was to design standards of quality for computer hardware and computer software. That objective has been achieved, and we have now published this "Guide to Evaluation of Software." The guide looks at three different areas: the technical areas, the educational considerations, and the management considerations—in other words, how the teacher can use the technology for instruction and how the technology addresses the management and assessment and student progress considerations.

We are now trying to identify a network of teacher evaluators and teacher producers of software to apply these standards so that we can collect that data and put it into a manual or a catalog. The catalog will be offered for consideration to librarians, school media specialists, and classroom teachers for their consideration as they make selection decisions about courseware and hardware for purchase.

Another document, which I will also submit for the committee's consideration, is a survey of classroom teachers conducted in 1982. It is a survey depending on a scientifically drawn sample of all teachers, and the results of the survey are rather interesting.

First, we find that teachers are overwhelmingly enthusiastic and intrigued about the prospects of computers in the classroom. They are also very keenly aware of the factors that require caution. They insist on being involved at the front end in the decisionmaking process regarding introduction of the technology into the classroom. They will insist on adequate training, so that they may use the technology effectively, and they will insist that there be some process for the appropriate research questions to be placed into the appropriate form, so that the technology will continue to serve education, and that education will not become a market for a product that may or may not be as useful as it might.

With that, I will close my remarks and await the interaction through questions with the panel.

[The prepared statement of Dr. Robinson follows:]



NATIONAL EDUCATION ASSOCIATION • 1201 16th St. N.W., Washington, D.C. 20036 • (202) 833-4000
MARY PATRICK FUTRELL, President
KEITH DEWLER, Vice President
ROSEMARY E. BRADSHAW, Secretary-Treasurer
DON CARTER, Executive Director

Statement

By

The National Education Association

On

Computers In School

Before The

Subcommittee on Investigations and Oversight

Of The

Committee on Science and Technology

U. S. House of Representatives

Presented By

Sharon P. Robinson, Director

Instruction and Professional Development

September 29, 1983

Mr Chairman and Members of the Committee:

My name is Sharon Robinson. I am on the staff of the National Education Association (NEA) here in Washington. The NEA, as you may know, is made up of 1.7 million classroom teachers. I serve as director of an NEA headquarters unit called Instruction and Professional Development (IPD).

During the past three years our IPD unit has provided staff support for several ad hoc committees established by the NEA to consider various educational aspects of the computer and the broader technology that has produced this pervasive and phenomenal machine.

I am very pleased to have this opportunity to give you some of the conclusions and recommendations from classroom teachers who made up these committees. I sincerely hope that this will be useful to you as you consider the complex matter of federal policy in relation to new technology and the public interest.

First, however, I would like to comment on a long-standing problem in the public education sector -- the problem of providing equal access to a quality education for all of our children.

It is a problem, incidentally, that has been dangerously enlarged over the past few years by technology. It seems to me, Mr. Chairman, that the question of "equity of access" to school computers is a microcosm -- in some ways, an electronic red herring -- of the growing need for increased federal support of public education.

This is a fundamental problem since we all know that some schools are more equal than others; we all know that -- because all school districts have not won the demographic sweepstakes -- their schools are far from equal in many measurable and important ways. Of course school districts with modest resources do not get microcomputers -- at least they don't get as many high quality microcomputers with good software and numerous peripherals. But then, these less affluent schools get less of just about everything that money can buy: science equipment, good libraries, books, field trips, advanced courses, and on and on.

The responsibility of the federal government was put in perspective by one of the many recent task force studies to reform American education. I refer to the Twentieth Century Fund's report earlier this year called Making the Grade: Report of the Twentieth Century Fund Task Force On Federal Elementary and Secondary Education Policy where we read (on page four) that "the fed-

EST321

eral government, after all, is charged with providing for the security and well-being of our democratic society, which rests largely on a strong and competent system of public education." A number of other recent studies of American education reflect this technological rationale for more federal support.

In a report two months ago on educational programs for computers (i. e., courseware or software) an NEA committee used a quote from a high placed government official. I would like to read the quote first; then give you the facts behind it:

LIKE THE DRUG FOR WHICH THERE IS AS YET NO
DISEASE, WE NOW HAVE SOME MACHINES THAT CAN
TALK BUT HAVE NOTHING TO SAY. I WOULD
CAUTION THE BUSINESSMAN NOT TO VENTURE INTO
HARDWARE UNLESS HE IS PREPARED TO GO ALL THE
WAY INTO PRINTED MATERIALS AND PROGRAMMING.
OTHERWISE, HE WILL HAVE CREATED AN EMPTY VES-
SEL OR SIMPLY A GLORIFIED PAGE TURNER.

Although this could easily be taken as something from an education meeting last week on the problems of computers in school, it is in fact a 1966 statement by then U. S. Commissioner of Edu-

S0322

cation Harold Howe II. Dr. Howe was speaking to the First Practicum on Educational Technology sponsored by the American Management Association. This, of course, was during the golden days of the Elementary and Secondary Education Act. As far as educational technology is concerned, have we been condemned to repeating the past? In those days, American business and industry dominated what was passed off on the schools as educational technology. In those days, black boxes (teaching machines) were sold to school administrators with a warranty that they were teacher proof and that somehow this would make possible an electronic learning bypass -- a bypass that would move the "education" directly from the salesman to the child.

We have clear evidence from a recent membership survey that teachers today are neither anti-computer nor anti-technology. Nearly all teachers in our survey (95.8 percent) stated that in their opinion computers do have a positive effect on student learning. Teacher attitudes toward computers in school for instruction is almost as positive since, 82.6 percent of them "expressed an interest in taking an instructionally related computer course." And within this group of teachers, 56.6 percent wanted to write computer programs for use in their classes.

Here are the NEA committee recommendations which I believe will be of most interest to members of this committee:

1. Professional development activities which make it possible for teachers to learn what they need to know about computers are seldom available when they are needed. All teachers whose professional practice and responsibility will be affected by a new technology must be provided with adequate continuing education.
2. The NEA encourages properly controlled research and the empirical development of all aspects of a new technology of instruction before its wide spread use in schools. School children and their teachers must not serve American industry as guinea pigs.
3. It is essential that Classroom teachers in each school district be involved directly in the planning, introduction, and use of such new technology in their schools. Microcomputers, for example, should not be introduced as a surprise for teachers when they return to the classroom in September.

I would like to conclude my comments this morning. Mr. Chairman, by calling attention once again to the hardware-software dilemma raised by Harold Howe II 16 years ago. Software, in the jargon of the computer people, means programs that tell computers what to do. Other interesting words such as courseware and firmware are sometimes used, but for our purposes it is sufficient to understand that a computer without software is like a motion picture projector without film, or a book with blank pages. Ralph W. Tyler recently observed that the computer is metaphorically a printing press, but that the invention of printing has not prevented bad books.

The 16-year-old remark by Howe was brought up to date earlier this month by Ernest L. Boyer, president of the Carnegie Foundation for the Advancement of Teaching. On page 192 of his new book, High School (Harper & Row), Boyer says:

HARDWARE MANUFACTURERS VIEW SCHOOLS AS A SMALL
PORTION OF THE TOTAL COMPUTER MARKET. ONE
ESTIMATE PLACES THE SHARE AT ONLY 3 PERCENT BY
1985. FIRMS ARE CAUTIOUS ABOUT DEVELOPING
SOFTWARE FOR THE MODEST SCHOOL MARKET, AND YET,
IRONICALLY, THEY ARE PUSHING COMPUTERS ON SCHOOLS
WITH FULL-SCALE ADS AND TAX-WRITEOFF PROPOSALS
TO CONGRESS.

Mr. Chairman, the National Education Association firmly believes that the federal government has a clear and substantial responsibility in helping schools meet the needs created by advancing technology and limited local and state resources. Indeed, the NEA-supported American Defense Education Act (H.R. 881 and S. 553) grew out of a recognition of this need--to revitalize local curricula, to train and retrain teachers, and to provide resources at the local level so that our schools can better meet the challenges of the 1980's and beyond.

At the same time we understand and support the call for additional, more targeted initiatives to bring technology--particularly microcomputers and educational courseware--directly and immediately into the classroom. It appears to us that there are only three basic approaches to federal support for such an endeavor. These are 1) to stimulate the donation of such equipment by private industry and individuals; 2) to provide assistance to states and local school districts for the direct purchase of this equipment and software; or 3) to promote cooperative arrangements by which schools utilize equipment which is (and remains) in the possession of private industry.

Our preference is clear. It is for the provision of direct federal grants to local school districts for planning, curriculum development, teacher training, and acquisition of computer hardware and software. This approach would allow for a sufficiently comprehensive and appropriate federal program--a program which would place resources, purchase options and educational decisionmaking squarely in the hands of the schools themselves. We are therefore encouraged by legislation such

326

As the Computer Literacy Act of 1983 (H.R. 3760 and S. 1069). Although we have some additional recommendations and proposed legislative language which we have been discussing with the authors of these measures, we support the concept which underlies these bills and are prepared to endorse them.

During the last Congress, legislation (then numbered H.R. 5673) utilizing a differing approach passed the House of Representatives. If enacted, this measure would have encouraged the donation of computers and other technological equipment to primary and secondary schools by liberalizing the charitable deduction allowable to a corporation for making such contributions. As you will recall, the inspiration for this bill was a proposal by the Apple Computer Company of Cupertino, California, to provide free of charge, a computer to every elementary, middle and secondary school in the country in return for more favorable federal tax treatment of such donations. This legislation has been reintroduced in the 98th Congress as H.R. 701, the Computer Contribution Act, and other legislation utilizing this approach in varying forms is currently pending in both Houses of Congress (including such bills as H.R. 91, H.R. 2417, S. 1194, and S. 1195).

Several concerns have been raised in regard to the donation approach. These are that it would leave the selection of computer equipment (or software if included) with the donor rather than with the educational institution; that it would be virtually impossible and perhaps inappropriate to attempt to develop a comprehensive federal program within the confines of the Internal Revenue Code; that it could

entangle a new federal bureaucracy (the Internal Revenue Service and the Department of the Treasury) in education matters; that it could be viewed as backdoor financing; and that it could well set precedents for other--unacceptable--types of educational tax credits or deductions such as those for tuition.

NEA has considered these arguments most carefully and while we have always and continue to prefer the direct purchase assistance approach, we recognize the reality of the support such legislation has gained in the Congress. Moreover, we can see circumstances under which such donation legislation could be helpful in a limited way--but only if it is constructed and implemented in such a manner as to assure a beneficial and appropriate educational use in the classroom environment. To gain NEA support, any such tax incentive legislation would have to meet several tests. First, the primary utilization of the donated computer would have to be in the direct education of students. Second, there would have to be proper assurances of geographic and economic diversity in the donation pattern of these computers. Third, the donation must be treated identically to a direct purchase of the same equipment--that is, all the same guarantees and warranties must apply, the same manuals and ancillary materials provided, the same service agreements honored. Fourth, it is essential that the donor provide sufficient training with each donated computer at no charge to the school or operator to assure that classroom users have access to the knowledge and operating tools necessary to utilize this equipment in the education of elementary and secondary school children. And fifth, such a program must also mandate the provision of sufficient operational and

educational software so that these computers can function in a meaningful manner. We believe that H.R. 2417, the Computer Contribution and Teacher Training Act comes closest to meeting these standards.

In addition to tax incentives and federal grants as means to help move technological equipment into the classroom, there remains a final--albeit less satisfactory--approach: the increased use of cooperative arrangements. Under this last alternative, private industry would make its equipment available to educational institutions either at the worksite or, if possible, at school during non-work hours. The federal government could stimulate such cooperation through either tax or non-tax incentives. While such an approach has been gaining more popular discussion and, in fact, has been beneficial in a few instances (particularly at the community college level), it simply does not provide the kind of comprehensive solution to the problem that is required. Limited by the availability of equipment, by distances between school and the workplace, and by time constraints on students, teachers, and private industry, it simply is not an effective means to increase the use of computers among school children.

Mr. Chairman, we are confident that the Congress can fashion a meaningful program of assistance to help our schools and communities meet the challenges and opportunities of the coming decade. We look forward to working with you in that effort.

Thank you.

Mr. GORE. Very good. Thank you very much.

We'll hold all our questions until the panel has been completed.

Our next witness is Dr. Joan Parent, president of the National School Boards Association.

And, Dr. Parent, we're delighted to have you here and look forward to your testimony.

STATEMENT OF DR. JOAN PARENT, PRESIDENT, NATIONAL SCHOOL BOARDS ASSOCIATION, WASHINGTON, D.C.

Dr. PARENT. Thank you, Congressman. We are very pleased to represent the School Boards Association testifying before this committee on computers.

We are, as the other speakers have mentioned, concerned with the equity issues and with the curricular integration of computers into our school system.

Stated in a broad context, computer education symbolizes what is probably the most significant reexamination of American education that has occurred in this part of the 20th century. The policy decisions which are going to be made over the next few years will not only significantly influence the education of our people, but will shape the direction of our economy, our position in international markets, and the overall American culture.

Our testimony starts with the premise that the computer is here and will become increasingly significant in America's future. Accordingly, we will focus on how we plan to deal with the underlying issues, such as teacher training, curriculum development, equity of access, and cost, rather than whether or not we should have computers.

The public schools are caught up in the computer rush, and we're being judged not only by test scores, but also how many computers each school building holds. There's an assumed connection between the two, but that connection is the school curriculum.

Rather than say how many computers are in what schools and being used by what students, I'd like to turn my attention to curricular aspects, using computers in our schools. We believe that this spreads through every other educational concern about the computer, assuming that the school district has the funds to buy them in the first place.

Throughout the computer instruction literature inadequate software is cited as the single greatest impediment for successful use of technology in the schools. Most manufacturers are content to produce software as inexpensively as possible, and anyone who surveys a representative sample will be struck about how very unimaginative and disappointing most of it is.

We also fault the software for being mainly drill-and-practice and tutorial routines. The capacity of the machine is not being tapped for use of its unique properties such as elaborate simulations and demonstrations, extensive hypothesis testing and variable manipulation, text editing of all sorts, and responsive languages such as LOGO and complex educational games.

We believe that a major component of the curricular issue is the nature of the instructional tasks that the computer performs in the classroom. Here's the first equity issue which the National School

Boards Association is concerned: Increasingly, studies are echoing last November's *Time* report that teachers in poor rural and inner-city schools elect to spend their limited funds using computers as electronic flash cards for simple drill and practice. And, by contrast, "specially trained teachers at more sophisticated schools are introducing ever younger children to the art of programming."

The instructional and curricular issues which structure the use to which the computer is put in the classroom compounds the better understood problem of providing student opportunity to machine access.

We find that the equity issue has at least two multidimensional problems for which solution needs fashioning. The first problem is how to provide all students comparable access to the technology. An NIE study of four Los Angeles schools demonstrates a direct relationship between the time students use the computers in remedial mathematics and their improvement in math skills. Disadvantaged students spending 10 minutes a day on the computer for remedial math show only half the achievement than those who spend 20 minutes a day on the computer.

And access is not only considered in relation to whether the child has the opportunity to use the computer, but the amount of time he has to use it.

Who gets the computer for how long is obviously a fundamental equity concern. It may be even more important when computer instruction is oriented to the more complex cognitive comprehensive tasks addressed by reading and language arts. These tasks require the student to understand the complexity of concepts that can only be constructed through experience. Well-designed courseware can provide the student with structured experiences that he would otherwise not have available. For an inner-city child, what is the concept of a house if he's never seen anything but apartment buildings?

In addition to being relative to the student, it's important that the machine is also used so that what is taught when the student is using the computer will fit into the total curricular plan.

If it does not fit into the teacher's instructional strategy for achieving the school district curriculum, it becomes a classroom toy.

For 30 minutes a day at a computer for every elementary and secondary child, not including research and development activities, we estimate the startup cost to the schools of America to be in 1980 dollars—to be \$1.8 million.

For policymakers, such as school board members, the issue is how to avoid spending billions of dollars on computers only to see them turned into classroom plant stands. The school districts which can least afford to gamble are our poor school districts, and it's critical that their scarce dollars be used correctly.

To avoid serious errors, attention must be given to the curricular aspect of computers. This view is supported by Henry Jay Becker's analysis, which was hailed by the experts as the most judicious and comprehensive examination of the educational impact of microcomputers. He recommends that school districts should develop policies regarding the optimal educational use of computers. Equipment investments should not be made until educational strategies can be

implemented properly, and we agree with that philosophy. We believe preparation includes teacher in-service training; parental involvement, including the option of permitting parents to purchase or borrow equipment for their child's use at home; policies that guard the copyrights of producers; provisions for hardware for teacher class preparation usage and integration of technology into the total curriculum, rather than just math and science programs.

We would urge Congress to look at the issue comprehensively and not encourage only the purchase of equipment.

To the extent that the curriculum of a school district is a local determination, we'll need resources to have our staff do some of the work themselves. Certainly existing coursework can be sequenced into a local curriculum program, and that which is available now is often unrelated to curricular sequence of the school district, and it's often produced to show more the capability of the computer than to fit our curriculum scheme. There's very little available that will provide school districts with a place to begin.

The outstanding selling point of the computer for serious educators is its individualized interactive nature. The textbook author depends on the teacher to add the interactive element of instruction to the content. Courseware must be developed not only by persons knowledgeable in subject matter, but they must also have a fundamental understanding of the learning process.

The courseware must be congruent with the school district's curriculum and with the individual teacher's instructional plan.

Help is needed to make the technology work at the local school district level. In addition to the initial cost of the hardware, school districts that do not have funds to integrate their hardware with their courseware needs in-service their teachers continuously on the use of courseware with the district curriculum, evaluate the congruence of computer construction for all students with their educational goals, and provide computer practice for all students outside of school hours, and upgrade their curriculum on a continuous basis, will not be able to provide instructional services to their students equivalent to that received by students in the most affluent school districts.

Our recommendations are divided according to the two aspects of the equity issue addressed in our testimony. The first addresses access to the computer.

Aid needs to be provided on some determination of financial need at the school district level. H.R. 3750, titled "The Computer Literacy Act of 1983," introduced by Mr. Wirth, confronts the access issue. Such legislation is a valuable beginning. It would help place a computer for every 30 students in the schools and help school districts train their staff in computer usage.

Help is needed for economically disadvantaged communities where families cannot afford home computers. The computer is rapidly becoming the homework textbook of our information age.

The equipment becomes obsolete very quickly, and two things are needed to help address this problem. First, information about the market is needed by school districts to avoid inefficient use of public dollars. NSBA is working on this problem by a formation of a computer alliance with our school districts. Second, friends are

needed to help—funds are needed to help replace outdated machines.

With respect to curriculum, our recommendations are:

First, response to the need for curriculum relative to the new technology has come in math and science subject areas. We have developed a far-reaching bill by NSBA which has been introduced in the Labor and Education Committee by Chairman Perkins and 47 cosponsoring colleagues. Our bill, called the National Education and Economic Development Act, the NEED bill, would involve a Federal commitment of \$1 billion in the first year and \$2 billion in the second year. This would provide the capability for local school districts to meet their own unique needs.

Currently, there's another bill, H.R. 1310, which has cleared the House and which was developed under the joint jurisdiction of the committee. That bill, which represents a great beginning, primarily addresses the in-service training of teachers and would provide less than \$2 million [sic] for each of 2 years to local school systems. Overall, H.R. 1310 cannot be taken as a total solution to the Nation's math, science, and technological needs, and will only tangentially influence computer education.

In conclusion, I would like to state funds and leadership are needed at the Federal level to insure access for all students to a high quality instructional product that permits a degree of individualization for the teacher and for the student.

[The prepared statement of Dr. Parent follows.]

18333



TESTIMONY
on behalf of the
NATIONAL SCHOOL BOARDS ASSOCIATION
on
COMPUTERS AND EDUCATION: The Equity Issue
before the
INVESTIGATIONS AND OVERSIGHT SUBCOMMITTEE
of the
SCIENCE AND TECHNOLOGY COMMITTEE
U. S. House of Representatives
2318 Rayburn House Office Building
September 29, 1983
M. Joan Parent
President, NSBA

Also present for NSBA:

Thomas A. Shannon
Executive Director

August W. Steinhilber
Associate Executive Director

Michael A. Resnick
Assistant Executive Director

Dena G. Stoner
Director, Legislative Liaison

NATIONAL SCHOOL BOARDS ASSOCIATION

A. INTRODUCTION

As President of the National School Boards Association, and as a member of the National Science Board's Commission on Precollege Education, I appreciate the opportunity to testify before the Subcommittee on Investigations and Oversight on the matter of computers and education. The National School Boards Association is the only major education organization representing school board members who govern the nation's public school districts. Throughout the nation, approximately 90,000 of these individuals are Association members. These people, in turn, are responsible for the education of more than 95 percent of the nation's public school children.

Currently marking its forty-fourth year of service, NSBA is a federation of state school board associations, with direct local school board affiliates, constituted to strengthen local lay control of education and to work for the improvement of education. Most of these school board members are elected public officials. Accordingly, they are politically accountable to their constituents for both education policy and fiscal management. As lay unsalaried individuals, school board members are in the rather unique position of being able to judge legislative programs purely from the standpoint of public education, without consideration to their professional interests.

Stated in its broadest context, computer education symbolizes what is probably the most significant re-examination of American Education that has

occurred since the early part of the Twentieth Century. The policy decisions which are made over the next few years will not only significantly influence the education of our people, but will shape the direction of our economy, our position in international markets, and the overall American culture, as well.

The NSF study, like the President's Commission on Educational Excellence, the Carnegie Report, and other similar efforts, are clear that America's educational needs will require a variety of complex and costly solutions--including a role for the computer.

By way of introduction, our testimony starts with the premise that the computer is here and will become increasingly significant in America's future. Accordingly, our testimony today will focus on how we plan to deal with a number of underlying issues, such as teacher training, curriculum development, equity of access, and costs--rather than whether or not we should have computers.

8. THE CURRICULUM AND THE COMPUTER: EQUITY ISSUES

Recently the Wall Street Journal published a series of articles on the current status of the bevy of computer companies that are stampeding for the micro-computer market. What caught my eye was a cartoon illustrating the disillusionment of the public with the home computer which has translated into some business failures. The computer was pictured in a affluent middle-class home being used as a plant stand. The articles reported that the early machines were toys and not large enough to do anything useful around the house. Consequently, the home market has cooled a bit as consumers become more knowledgeable

The public schools are now caught up in the computer rush. School districts are being judged not only by test scores but also by how many computers each school building holds. There is an assumed connection between the two. That link is the school curriculum.

Rather than address the statistics of how many computers are in what schools being used by what students, I want to turn our attention to the curricular aspects of using computers in our schools. We believe that this issue threads through every other educational concern about computer assuming the school district has the funds to buy them in the first place.

Throughout the computer instruction literature, inadequate software is

cited as the single greatest impediment for the successful use of computer technology in the schools. According to the Education Testing Service, "most manufacturers are content to produce software as inexpensively as possible. And anyone who surveys a representative sample will be struck by how unimaginative and disappointing most of it is. Critics also fault existing software for consisting mainly of drill-and-practice and tutorial routines. The capacity of the machine is not being tapped for the use of its unique properties such as elaborate simulations and demonstrations, extensive hypothesis testing and variable manipulation, text editing of all sorts, responsive languages (such as LOGO) and complex educational games.

The Southeastern Regional Council for Educational Improvement in a July report provides some explanation for the lack of educationally sound courseware. The contribution of educators to the development process of education software, they assert, is almost entirely at the discretion of commercial producers. The commonly held opinion, according to the report is that "the presence of educators is minimal." In August, the Department of Education underscored the need for a unique blend of skills if the potential of computer use in education is to be realized. "The successful application of computers to education will require expertise in subject matter, in teaching, in computer technology, in cognitive science, and in design," they say.

A major component of the curricular issue is the nature of the instructional tasks that the computer performs in the classroom. Herein lays the first equity issue about which the National School Boards Association is concerned. Increasingly studies are echoing last November's Time report that

teachers in poor rural and inner-city schools elect to spend their limited funds using computers as electronic flash cards for simple drill and practice. By contrast, "specially trained teachers at more sophisticated schools are introducing ever younger children to the art of programming."

The instructional and curricular issues which structure the use to which the computer is put in the classroom compounds the better understood problem of providing student opportunity to machine access. Student access to the machine is the second equity issue about which NSBA is concerned. Dr. Ron Anderson at the University of Minnesota's Center for Social Research concludes that "the 12,000 wealthiest schools are four times as likely to have micro-computers as are the 12,000 poorest". Anderson's findings are based upon research carried out at the University of Minnesota in collaboration with the National Assessment of Educational Progress, a periodic testing of 18,000 students across the United States.

C. THE EQUITY ISSUE: TWO PROBLEMS

The equity issue must be seen as at least two multidimensional problems for which solutions need fashioning. The first problem is how to provide all students comparable access to the technology. A NIE funded study of four Los Angeles schools demonstrates a direct relationship between the time students use Computer Assisted Instruction (CAI) in remedial mathematics and their improvement in math skills. Disadvantaged students spending 10 minutes a day using the computer for math, show only one-half the achievement results of those who use it 20 minutes a day.

Access, however, not only must be considered in relation to whether the child has the opportunity to use the computer, but the amount of time he can use it is also important.

Who gets access and for how long is obviously a fundamental equity concern. It may be even more important when the computer instruction is oriented to the more complex cognitive comprehension tasks addressed by reading and language arts. These tasks require the students to understand the complexity of concepts that can only be constructed through experience. Well designed courseware can provide the student with structured experiences that he otherwise would not have available. For an inner-city child, what is the concept of "house" if he has seen only apartment buildings? Comprehension skills form the capacity to make the judgements and generalizations that provide the foundation for advanced learning. Intellectual achievement in subjects (history, literature, economics, etc.) language arts as fundamental skills is more difficult to determine in short term studies of the computer usefulness. We believe, however, that the computer could be invaluable in these areas as well as in areas of remediation. It is important that the machine is used so that, what is taught when the student is using the computer will fit into the total curricular plan.

If it does not fit into the teacher's instructional strategy for achieving the school district curriculum, then it becomes a classroom toy. Karon Sheingold of the Bank Street College of Education in New York City, concludes after examining the use of micro-computers at several diverse sites that "... micro-computers on their own will not promote any particular outcomes. Their impact will depend, not only on hardware and software but to a large extent, on the educational context within which they are embedded." Access to the machine is a necessary step toward the achievement of educational equity, but it is not in itself sufficient to achieve it.

Providing access is not easy. But the problem can be at least partially solved by a equitable distribution of money. Arthur Melmed, a NIE consultant, reported in January of 1982 a breakdown of costs in 1980 dollars of providing 30 minutes a day at a computer for every elementary and secondary child. It would cost, he estimates approximately \$30 per year per child. Using his figures, the national cost for 39 million school children would total about \$1.8 billion in 1980 dollars. This figure would pay for "equipment, maintenance, courseware and materials other than courseware." This is a lot of money right now when most school districts are strapped for funds. This amount does not take into account the additional funds needed at all levels, federal, state and local, for the research and development activities that I will address next.

D. ASSURING EQUITABLE INSTRUCTIONAL OUTCOMES:

For policy makers, such as school board members, the issue is how to avoid spending billions of dollars on computers only to see them turned into

classroom plantstands. The school districts who can least afford to gamble are our poor school districts. It is critical that their scarce dollars be used correctly.

To avoid serious errors, the second aspect of the equity issue must be given attention. Overwhelmingly the focus has been on the first. But

attention must be given to the curricular aspects of the computer. The problem is fundamentally more complex than is the access problem. Experts are warning that the microcomputer innovation is being fueled by a great deal of enthusiasm, with the conviction that the micro-computer is a good thing. Yet no one knows for sure if it is, how it is, or, really, what it's good for, in terms of educational outcomes. Dr. Sheingold indicated that "We need to begin acquiring such knowledge very quickly, in order to help guide an innovation which is bound to grow even in the absence of guidance."

This view is supported by Henry Jay Becker's analysis which is hailed by the experts as the most judicious and comprehensive examination of the educational impact of micro-computers.¹ He recommends that schools districts should carefully develop policies regarding the optimal educational use of computers. Equipment investments, he advises, should not be made until such educational strategies can be implemented properly. We agree. Preparation includes teacher inservice training, parental involvement including the option of permitting parents to purchase or loan equipment for their child's use at home, policies that guard the copyrights of producers, provision of hardware for teacher class preparation usage and a integration of

¹Micro-computers in the Classroom -- Dreams and Realities: Center for Social Organization of Schools, John Hopkins University, 1983.

the technology into the total curriculum rather than just the math and science program. Computer purchases, should not precede policy and should not be based on an emotional response to the market place. We would urge Congress to look at the issue comprehensively and not encourage only the purchase of equipment.

Becker points to one aspect of for which solutions have yet to be developed: which is the harnessing of this technology to the curricular objectives and goals of the school district. To the extent that the

curriculum of a school district is a local determination, we will need resources to have our staff do some of the work themselves. Certainly existing courseware can be sequenced into a local curricular program.

But the job will have to be done largely at the local level. Even at the local level the job will be not be done entirely by the guy in the central office because our best innovative teachers will personalize the courseware for their own teaching style and their student's needs. At this point, however, even the sophisticated courseware now available is written in short, disconnected modules that are unrelated to each other. Current available courseware is often unrelated to the curricular sequence of the school district and is often produced more to show the capability of the computer than to fit into a larger curriculum scheme. There is very little available that will provide school districts with a place to begin. Robert Kershaw, the ETS area systems director agrees. "The software is just not there" he says.

The unique selling point of the computer for serious educators is its

individualized interactive nature. Courseware creation is a very different process from that of writing a textbook. The textbook author depends upon the teacher to add the interactive element of instruction to the content. Courseware must not only be developed by persons knowledgeable in subject matter but they must also have a fundamental understanding of the learning process. In addition to that basic requirement, the courseware must be congruent with the school district's curriculum and with the individual

teacher's instructional plan. The need for a national program oriented to quality courseware is important from another viewpoint as well. In this case, I am concerned about keeping the student interested in the computer as a learning tool. It is vital that students view their use of the computer as exciting and directly oriented to their coursework. The only way to assure this is the direct involvement of our educators who preside over our classrooms. Teachers must feel comfortable with the computer as they will see them at best as a nuisance or at worst a job threat. The response to the curricular aspect of the equity issue cannot just be from the state and federal government. We believe the response must also come with much involvement from the local school districts.

Help is much needed to make the technology work at the local school district level. In addition to the initial cost of the hardware, school districts that do not have the funds to integrate their hardware with their courseware needs, inservice their teachers continuously on the use of courseware with the district curriculum, evaluate the congruence of computer construction for all students with their educational goals, provide computer

practice for all students outside of school hours and upgrade their curriculum on a continuous basis will not be able to provide instructional services to their students to the degree that more affluent school districts will be able to provide.

While there has been much discussion of the federal governments role in providing student access to the equipment, there has not been as much discussion on the second area which is essentially curricular, NSBA supports the federal effort to help provide equipment. However, we would also urge serious consideration of the second area as well.

E. RECOMMENDATIONS: ACCESS AND CURRICULAR INTEGRATION

The following recommendations are divided according to the two aspects of the equity issue addressed in this testimony. The first set addresses the access problem.

- o Aid needs to be provided on some determination of financial need at the school district level. The House bill H.R. 3750 titled the Computer Literacy Act of 1983 introduced by Mr. Wirth (D-CO) confronts the access issue. Such legislation is a valuable beginning. It would help place a computer for every 30 students in the schools and help school districts train their staff in computer usage. H.R. 3750 bill is preferred by NSBA to some other bill because it would be funded through the appropriation process rather than through the tax expenditure process.

- o Help is needed for economically disadvantaged communities where families cannot afford home computers. The computer is rapidly becoming the homework textbook of the information age. Funds are needed to establish a loan system or after school use center so that access to the equipment does not inhibit academic growth.

The equipment becomes obsolete very quickly. Two things are needed to help address this problem. First, information about the market is needed by school districts to avoid inefficient use of public dollars. NSBA is working on this problem by the formation of a computer alliance with our school districts. For your information I have attached our publication: Computerwise. Second, funds are needed to help replace outdated machines so that sophisticated courseware can be utilized.

The following recommendations address the second aspect of the equity issue which is the curricular development needs.

- o The first response to the need for curriculum relative to the new technology has come in the math and science subject areas. NSBA has developed a far-reaching bill which has been introduced in the Education and Labor Committee by Chairman Perkins and 47 co-sponsoring colleagues. Our bill, the National Education and

Economic Development Act (the NEED Bill) would involve a federal commitment of \$ 1 billion in the first year and \$2 billion in the second year. This bill would provide the capability for school districts to use the funds.

Currently, there is another bill, H.R. 1310, which has cleared the House and which was developed under the joint jurisdiction of the Committee. That bill, which represents a great beginning, primarily addresses the in-service training of teachers, and would provide less than \$200 million for each of two years to local school systems. Overall, H.R. 1310 cannot be taken as a total solution to the nation's math, science and technological needs, and will only tangentially influence computer education.

New technological innovations that increase the interactive aspects of the courseware with the student should be encouraged. At this point, the laser videodisk provides the optimum capability. Existing courseware picks up a student at a particular achievement level and moves them along at a individualized pace. The laser video disk permits a student at any achievement level to enter into a subject area and then move at an individualized pace. The addition, the technology permits the teacher to enter additional courseware components that will further individualize the curriculum.

The manufacturing cost of one video disk is \$98,000 with copies costing \$15 each. While high, these costs if distributed will make individualized instruction accessible. The federal government can aid in that distribution process.

The real cost, however, is for development of the content and its sequencing to be placed on the video disk. The technology will do graphics that can be manipulated, show film and track a student's progress. Initially, development cost will be high. A major federal contribution is needed here to finance and guide these efforts. Existing resources already funded by the federal government should be tapped. We would suggest close coordination of the National Institute of Education with the Corporation for Public Broadcasting. NIE could bring together the educational process expertise with content produced by the experts Corporation for Public Broadcasting. There are probably other public-financed resources also available that could also be utilized as subject matter in the Department of Defense and Energy just to name a few obvious examples.

F. SUMMARY

In summary, the use of the most highly interactive processes should be encouraged by the federal government for their classroom use. Funds and leadership are needed at the federal level to assure a high quality instructional product that permits a degree of individualization for the teacher and the student not yet available.

Mr. GORE. Thank you very much.

I'd like to call on the third member of the panel, Dr. Ronald E. Anderson, who, in addition to being the director of the Minnesota Center for Social Research, is chairman of the Association for Computing Machinery, Special Interest Group for Computer Uses in Education; also, an associate professor at the University of Minnesota.

We're delighted to have you here, wearing all three hats, and we look forward to learning from you in each capacity.

Please proceed.

STATEMENT OF DR. RONALD ANDERSON, DIRECTOR, MINNESOTA CENTER FOR SOCIAL RESEARCH, MINNEAPOLIS, MINN.

Dr. ANDERSON. Thank you, Mr. Gore. Thank you for the opportunity to appear before you to discuss the current problems and challenges in the field of computers in education.

First, I want to summarize some findings from current studies and, second, I wish to summarize the outcome and recommendations of a task group meeting earlier this month which was convened by ACM/SIGCUE to address policy alternatives for educational computing.

Very few research studies are done to assess how schools and colleges are actually using computers for instruction, but even fewer are done on computer learning outside of the educational system. Consequently, it is difficult to have a high degree of confidence in what we currently know. However, I will do the best to summarize existing trends and use them as guideposts for planning additional research. I summarize the results of research around particular issues.

The first issue is the computer literacy curriculum chaos. Computer literacy has become a household word meaning the ability to communicate with computers, but widely diverse viewpoints exist on what it means to communicate with computers. The prevailing educational ideology is that every student needs or eventually will need to be computer literate to function productively in the computer society. Attempting to address this need, courses and curricular programs are being developed from preschool through college as well as in programs for continuing education and employee training.

What is disturbing about this development is not the rapidity with which it is developing, but the diversity, the nonuniformity, and the confusion which has been created. Institutions are seeking to plan, but they do not know how to plan, and not only is the educational system confused on how to plan computer literacy instruction, but the publishing industry is also at a loss to predict profitable directions for publishing books, materials, and software.

The sector of the publishing industry devoted to educational computing is extremely small. Unfortunately, most of the research which this industry does to study relevant markets is generally proprietary and also unavailable for policy analysis.

The second issue is instructor demand for instructional materials and training. All of the studies which have been done over the past few years show that the teachers view the lack of training opportu-

nities and the lack of resources as the two major areas of greatest concern, and they're most often cited as barriers to instructional computing.

The third issue is minimal utilization of facilities. A recent study by Dr. Becker found that the average elementary school computer is used slightly over 2 hours per day, and the average microcomputer in high school is used about 2½ hours per day. It should be noted that some schools use their computers constantly, while others use them very minimally. But about one-fourth of the elementary schools and one-fifth of the secondary schools use their computers less than 1 hour per day.

Effective utilization of computers and instruction requires experience, it would seem from the existing research, because those schools where the teachers have been involved with computers for a long period of time are using them in general more comprehensively throughout their teaching and throughout the curriculum.

The fourth issue is minimal penetration of instructional computing into the schools. There are lots and lots of schools, lots and lots of school districts throughout the United States that have purchased microcomputers and are using them, but it is still the case that, as of this school year, probably less than 15-50 percent of all the school children in the United States have had a chance to ever use a computer in school.

In the national assessment of the science study, which was released earlier this year, we found that of the schools with five or more computers only 61 percent of age 13 students had ever used a computer in school. So even in the schools that are getting computers, and in some cases many of them, still only a small segment of the student body is getting to use them.

Becker's study also found that most teachers do not use their school computers. He reports that in about half the schools with micros only one or two teachers, at most, are regular users, regular users meaning teachers using instructional software packages or teaching computer classes.

Next I wish to switch to the equity-inequity issues. Findings on the inequity with respect to socioeconomic groups have been mentioned several times already in the hearing. I will not repeat the evidence, but to point out that we did find in the recent report, which I was principal author of and was released by the National Science Foundation on the national assessment of science data, that a growing gap between the students who are in poor schools versus those who are in rich schools is continuing, and in the area particularly of computer programming course enrollments.

It turns out that the actual number of accesses is beginning to be fairly similar between the richer and the poorer schools, in that poorer schools are tending to begin to buy more computers, but the infusion of the computer into the curriculum is much slower in the poorer schools, and the likelihood of students in the poorer schools getting the opportunity to take computer classes is still very low and, in fact, the gap is increasing, at least has been increasing over the past 5 years.

Next I wish to mention the issue of inequity and size of community. In Minnesota we did a study several years ago and found that schools in the rural areas are about as likely to be using computers

as in the central urban areas, but that probably is because of the fact that Minnesota for about 7 or 8 years has had a free telecommunication system for use by students across the State. Now that has actually been discontinued within the last year. So the inequity may increase with respect to size of community.

Because when we look at the national data, the rural students, students in small towns, are much less likely to get access to computers and also much less likely to be enrolling in computer programming classes than are the students in the urban areas, and it stands to reason because there is much more emphasis on computer—retail computer outlets in the cities. It's much easier to get information on repair and maintenance, and so forth, in these areas than it is in remote areas.

Furthermore, it appears from the data from the national assessment that the gap between the city and the rural areas appears to be widening.

Next I wish to mention geographic region. From the national assessment of science data, we found that age 13 students in the South had only 12 percent with school computer experience. However, twice that number of the students in the West had received such experience. Now this was 1 year ago in the assessment of that year. The Central and Northeast areas are roughly comparable to the West in terms of access.

Over and over again the inequities that have been found by region show that the southern schools are the lowest with respect to computer access and computer opportunities.

Finally, I wish to mention the gender inequity. Studies report that young women in secondary schools are less likely than young men to spend time with computers and to enroll in computer classes. Now this, in part, is a result of their own choice, but it is also probably, in part, a result of structural factors in the school that inhibit females from taking advantage of computer opportunities. For example, counselors may not recommend computer courses for the girls, and very often the computer programming course is an advanced math elective that requires prior mathematics courses.

One thing that would help to reduce the gender gap is to have more broad base courses in computers and computer literacy in the schools at all levels.

While it is true that the issues raised by this summary list of research findings do not constitute a very large proportion of the list of actual problems in the educational computing, they point, and very concretely, to a substantial set of issues that cannot be ignored. If nothing else, they identify an agenda for ongoing assessments of what is taking place in the educational system.

These results also reveal many unanswered questions concerning the direction and impact of existing educational computer policies.

Next I wish to switch to some specific recommendations for computer uses in education, and I will point out that in stating these priorities and recommendations I speak for myself and not the Association of Computing Machinery, nor the University of Minnesota. However, these recommendations do benefit greatly from the work we have done within ACM in trying to develop a consensus on what the needs and recommendations are with respect to educa-

tional computing, and they also reflect the discussions we had 3 weeks ago at a task group meeting on educational computing policy, where approximately 20 specialists in this area were brought together, representing a number of organizations, including the American Federation of Information Processing Societies, the International Council on Computers in Education, and the National Council for Teachers of Mathematics, as well as a number of other institutions at various levels of the educational system.

Coming out of this group was a general consensus about what the value premises or goals were that were key to keep in mind in analyzing these problems, and I wish to read at least a part of the list that is in my prepared statement.

First of all, within the area of general education, it is felt that the education, training, and retraining will continue to be more and more necessary for individuals as well as the society as a whole.

Access to information resources and skill in retrieval from large data bases are increasingly a major requirement for individuals as well as organizations. Education must shift priorities to insure that students are taught the necessary information-related skills.

Today's educational curriculums must be reassessed and restructured to take into account the skills and knowledge needed in an information-base society. These skills include formulating problems and problem-solving algorithms, using data and analytic tools to solve these problems, and communicating and collaborating with others in solving problems.

With respect to the use of computers in education, while all major modes of educational computing have value in certain situations, research is needed to determine relative and conditional effectiveness of each mode. While it is true that much research has been done on the effectiveness of drill and practice and tutorials in the learning process, relatively little research has told us about the effectiveness of other modes of using computers in the classroom process.

The computer as a tool for word processing, data analysis, planning, modeling, et cetera, is an educational approach that should be infused throughout the entire educational system, including every discipline.

Much more attention should be given to techniques for using computers to teach higher order thinking skills and to extend cognitive functioning.

The role of computer science and information science must be given more attention in the curriculum, and more emphasis should be given to the potential role of computing to motivate and hold learner attention.

I've organized action items that I wish to recommend in five different areas, with the approximate following order of priority.

One, research.

Two, policy analysis and leadership.

Three, public education.

Four, educator education.

And, five, curriculum analysis and development.

First of all, research, which I've already mentioned, holds the highest priority for action to initiate and continue several different

kinds of research. Current difficulties in planning and decisionmaking result from a void of knowledge which could be supplied by research.

I've listed a number of areas where research needs to be done, and I will not repeat this, but I would like to point out that the actual amount of research going into the computing area is relatively minimal. It's almost nonexistent at the present time.

It is true, however, as we heard from the speakers yesterday, that both the National Science Foundation and the Department of Education do have plans for spending more money next year, but it would appear that still the plans that they have for doing research in this area still would constitute less than \$3 or \$4 million, and it would appear to me that, on the basis of the kinds of things that need to be addressed and need to be studied, that we need an order of magnitude of about 100 times more than that; that is, we need in the area of 250 to 400 million dollars' worth of research to begin the kinds of short-term as well as long-term projects to assess what is happening in the schools and to assess what we will be doing with respect to experimenting and trying out new policies.

This research agenda cannot be treated as a luxury, but it is true the cost will be substantial. Projects in all the areas should be initiated as soon as possible, and some can be completed in the short run, but others require long-term focus and emphasis.

The second category is policy analysis and leadership. Many educational computer policies have been written and implemented without careful evaluation of the consequences, and that should not continue. We need to invest in think tanks and study groups to continuously assess goals and needs and effects, as well as alternative policies and possible scenarios for impact.

Broad goals should be addressed as well as very specific problems, such as how to support thin educational markets that the publishers will not address. Investigation should be made into such problems as existing Federal and State regulations which inhibit computer purchase and use.

The third area, public education, exists because of the need for dissemination of accurate information in a number of areas. For example, there are a number of myths that seem to be prevalent that should be dispelled, myths about computers in education.

For example, the belief that computers are a panacea for all social, economic, and educational problems. Another myth is that everybody should be a programmer. Another is that all computing costs are dropping. Another is that teachers are the best courseware developers. Another is that if you can leave a child alone with a computer, she or he will become computer literate.

These kinds of misconceptions need to be identified and the necessary programs implemented to remove some of the misconceptions about what is currently going on and what will be going on in the future.

Fourth, educator education, which colleges call faculty development and precolleges call teacher education or teacher training. Such computer education requires that schools and colleges have computers for teacher education, but computers should not be purchased without software and training programs to complement them. Special consideration should be given to producing and pro-

viding courseware packages for teacher training with the purchase of any new computer.

Training programs for teachers should be designed to address inequity problems. Special support should be given for training and associated equipment for schools and colleges in low income and remote locations.

Next is computer analysis and development—curriculum analysis and development, which is proposed in two arenas. First of all, the general curriculum and, second, the computer curriculum. Because new thinking and information tasks will become necessary in the information-based society, content should be reexamined in all subjects. A wide selection of specialists in various disciplines must be involved in assessing where shifts may be useful and where computer-assisted activity may enhance the learning process.

In addition to initiating this implicit revolution, the curriculum in computer literacy and computer science should be reexamined. One sign of the need for activity in this area is the frenzied growth of short basic courses under the banner of "computer literacy." Such courses address only a small portion of the actual knowledge and skills that students need to function effectively as computer citizens in the next few decades.

By now you may have noticed that no recommendations have been offered to install large numbers of computers in the educational system. It is true that research and demonstration projects require hardware and teacher education requires computer access, but it is too early to create a wired educational system with computer stations at every desk. First, we must conduct the research, the policy analysis, the planning, and in other ways prepare the educational system for the transition.

We should seriously consider such proposals as we have heard throughout the hearings and also such proposals as Tucker's proposal to spend \$13 billion to give every four students an intelligent workstation linked to an interstate data system, but first we should conduct the research and planning and install the mechanisms to conduct this research and planning on an ongoing basis that would enable us to use such systems wisely.

We have serious problems of inequity, computer misuse, mislearning, but these cannot be solved by unrestricted donations of computer equipment. Unless the infusion of computers is accompanied or preceded by software tools and the training of teachers in these tools, we will find it difficult to achieve a symbiosis between computer technology and our educational system.

[The prepared statement of Dr. Anderson follows:]

STATEMENT OF DR. RONALD E. ANDERSON
 CHAIRMAN, ACM/SIGCUE (Association for Computing Machinery/Special
 Interest Group for Computer Users in Education)
 and
 ASSOCIATE PROFESSOR AND DIRECTOR, CENTER FOR SOCIAL RESEARCH
 UNIVERSITY OF MINNESOTA

BEFORE THE
 SUBCOMMITTEE ON INVESTIGATIONS AND OVERSIGHT
 OF THE
 HOUSE SCIENCE AND TECHNOLOGY COMMITTEE

SEPTEMBER 29, 1983

Thank you for the opportunity to appear before you today to discuss the current problems and challenges in the field of Computers and Education.

First, I want to summarize the findings from current studies which assess the state of computers and education. After which I will summarize the outcome and recommendations of a Task Group meeting earlier this month, convened by ACM/SIGCUE to address "Educational Computing Policy Alternatives."

PERTINENT FINDINGS FROM STUDIES OF COMPUTERS AND EDUCATION

Very few research studies are done to assess how schools and colleges are using computers for instruction, but even fewer are done on computer learning outside of the educational system. Consequently it is very difficult to have a high degree of confidence in the stability of the conclusions that are drawn from these studies. The findings should be viewed primarily as suggestive of existing trends and as guideposts for planning further research. The results are summarized by the problem or issue identified; in each case the issue is worthy of careful policy analysis.

1. The Computer Literacy Curriculum Chaos

Computer literacy has become a household word meaning the ability to communicate with computers. Widely diverse viewpoints exist on what it means to "communicate" with computers, but the prevailing educational ideology is that every student needs or eventually will need to be computer literate to function productively in the computer age. Attempting to address this need, courses and curricular programs are being developed from preschool through college as well as in programs for continuing education and employee training.

A 1982 nationwide survey by Instructional Computing, Inc.(1) found that over half of the precollege schools with instructional computers claimed to have a "course that can be construed to be a computer literacy course." However, these courses varied from a one-week unit in BASIC programming to a year-long course covering a broad range of computer topics. The diversity of software utilized is most revealing. Even though about 200 different software packages were reported in use by the 600 schools surveyed, only one package was reported by as many as 5% of the schools.

Another Instructional Computing, Inc.(2) survey, where 100 randomly selected colleges were contacted, found similar diversity and nonuniformity. Ninety percent of the identified "computer literacy" courses used a textbook not used by any of the other courses in other institutions.

The EDUCOM Computer Literacy Project (EDUCOM, Princeton, NJ) from its college survey has identified hundreds of institutions seeking direction in planning computer literacy programs.

Not only is the educational system confused on how to plan computer literacy instruction, but the publishing industry is also at a loss to predict profitable directions for publishing books, materials, and software. The sector of the publishing industry devoted to educational computing is extremely small. Unfortunately most of the research with regard to this industry and relevant markets is generally proprietary and unavailable for policy analysis.

2. Unfulfilled Instructor Demand for Instructional Materials and Training

The Instructional Computing survey (1) of elementary and secondary computer-using schools found that teacher training and instructional courseware were the two needs most often cited by microcomputer coordinators and computer teachers.

Apparently a similar need exists in higher education. A CONDUIT survey of college instructors (3) asked for reasons for lack of computer utilization. Lack of training and lack of resources were the first and second most often cited barriers to instructional computing.

3. Minimal Utilization of Facilities

A very recent national survey of school computing by Dr. Henry Jay Becker (4) found that schools vary a great deal in the amount of computer use. The average elementary school computer is used slightly over 2 hours per day; and the average microcomputer in high school is used about 2 and a half hours per day. It should be noted that some schools use their computer continuously while others very minimally. About one fourth of the elementary schools and one-fifth of the secondary schools use their computer(s) less than one hour per day.

Effective and extensive instructional computer utilization requires not only skill but experience. This is one conclusion of a Minnesota study of high school teachers(5). The number of years of experience with instructional computing was found to significantly predict stable involvement in computerwork. It may be that the many schools under-using their computer

equipment are relatively new to educational computing.

4. Minimal Penetration of Instructional Computing into the Schools

Statistics showing rapid penetration of computers into the schools are often quoted, e.g., 85% of the school districts are expected to have microcomputers by the end of this school year. However, relatively few students get any computer experience to say nothing of an extensive, productive experience. National Assessment results from the 1981-82 school year show that only 33% of all 17-year-olds and 23% of 13-year-olds had ever used a computer in school. If we examine only those schools which have 5 or more computers, then only 39% of the 13-year-old students have had any computer use. More significantly, 61% of the age 13 students in schools with 5 or more computers have never used a computer in school. Obviously computer installation does not guarantee access.

Becker's study (4) shows that it is also true that most teachers do not use their school computer(s). He reports that "in about half of the schools with micros, only 1 or 2 teachers, at most, are regular users." And in some schools with microcomputers, none of teachers are regular users, i.e., teachers using instructional software packages or teaching computer classes.

5. Inequity in Socio-economic Groups

According to a survey of all schools in 1983, Quality Education Data, Inc., reports that the 12,000 wealthiest schools are four times as likely to have microcomputers as are the 12,000 poorest schools. Recently reported findings from the 1982 assessment(7,8) show that the number of students enrolling in computer programming is much lower in schools that qualify for Title I assistance than those that don't. (Schools qualify for Title I assistance by having a large percent of the parents with income below the poverty line.) Age 17 students were asked if they had studied computer programming, 11% said they had done so for a semester or more, which is up slightly from 1978 when only 7% said they had. Figure 1 gives the enrollment trend line from 1978 to 1982 showing that while the number of students taking computer programming classes is on the rise, in 1982 only 7% of students in Title I schools had taken programming while 14% of students in other schools had taken such classes. The graph depicts a widening in the trend lines indicating a growing gap between the schools in wealthier as opposed to poorer communities. This increased disparity results from the fact that during the past four years the poorer schools have had only a negligible rise in enrollment in computer programming classes.

As already mentioned, students were asked in they had ever used computers or computer terminals in school. If we look only at rural and disadvantaged-urban communities, the number of students getting to use computers is much lower than those from other types of communities. "Rural" is defined as farms or towns with under 10,000 population. "Disadvantaged-urban" consists of high-unemployment areas within cities of at least 200,000 population. As shown in Figure 2, among students at age 13 less than 17% of the students from rural and ghetto areas report use of school computer equipment. In contrast 32% of the 13-year-olds living in "urban/rich" areas, those areas in large cities of at least 200,000 which

have an unusually high proportion of residents who are employed in professional or managerial jobs, report use of computers in schools.

Figure 1

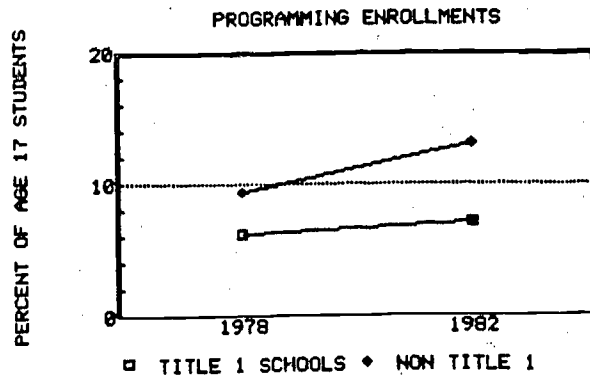
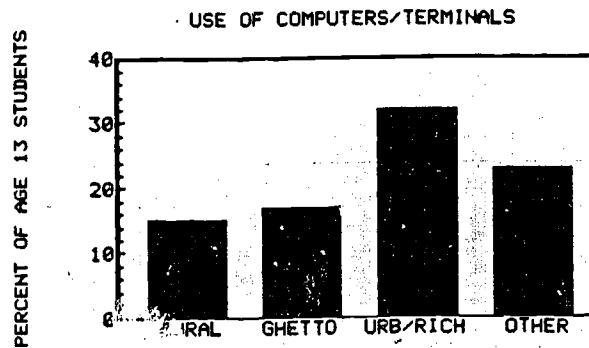

Figure 2



6. Inequity by Size of Community

A large, statewide computer literacy assessment in Minnesota failed to find any large, substantial differences in school computer utilization when comparing students living in different size cities and towns(9). Minnesota may be unique however, since at that time the State provided free telecommunications for all schools that wanted to use the central, time-sharing computer system. Such support for instructional computing makes student access to computers for learning much more feasible.

The 1981-82 national science assessment data reveal that nationwide the smaller communities do not provide as many opportunities for computer education as the larger ones. For example, only 18% of junior high school students in small towns report school computer use, but 26% of the junior high students in large cities have such access.

Inequity in rural areas is much more noteworthy in the area of programming enrollment and these data are given in Figure 3. This graph shows that the growing computer inequity in computer instruction affects mostly the big, inner cities and the rural areas. The trend lines for these two parts of the country are mostly flat, but the trends for the suburbs and small cities rise sharply. As of 1982 17% of the suburban high school students had enrolled in computer programming for at least one term, but only 6% (less than 1/2) of the rural students had done so. The gap between the city and the rural areas appears to be widening, although the evidence for this is not very large.

Figure 3

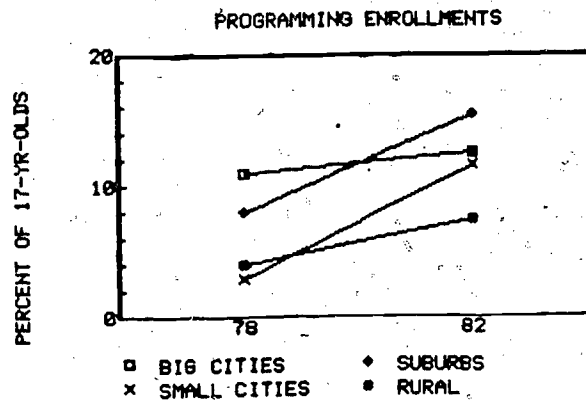

7. Inequity by Geographic Region

Student computer experiences were examined separately for each of four major regional divisions of the United States. These regions were defined as follows: the West included all states west of Montana, Colorado, Oklahoma and Texas; the Central region included those states bounded by North Dakota, Kansas, and Ohio; The South contained all states southeast of Arkansas, Kentucky, and West Virginia; the North included all states northeast of Pennsylvania.

The students living in the South are much less likely to have used computers in school than the students living in other parts of the country. This is especially true for junior high school students but also true for age 17 high school students. The magnitude of the regional differences is shown in Figure 4. Age 13 students in the South had only 12% with school computer experience, however twice that number (24%) of the students in the West had received such experience. For 13-year-olds the Central and North are roughly comparable to the Central region with respect to opportunities to use computers in the schools.

Figure 4

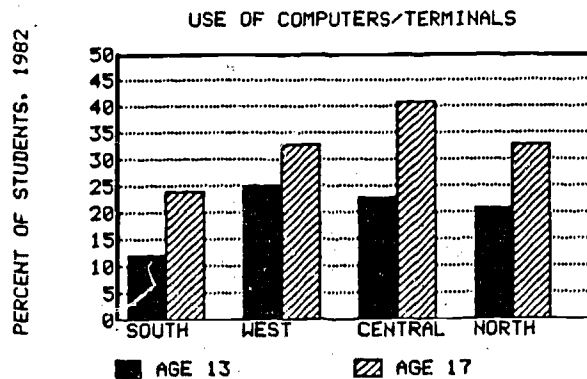

8. Inequity and Gender

Gender differences in computer education have received considerable attention but little systematic research. Two exceptions to this are an experiment by Lockheed, Nielsen, and Stone (10) and a statewide assessment (9), and these studies report that young women in secondary schools are less likely than young men to spend time with computers and to enroll in computer classes.

The 1981-82 national assessment in science provides additional data on gender differences. While no significant differences are found in the number of males and females reporting any use of computers in school, a substantial gap remains in signing up for computer programming classes. As shown in Figure 5 females are less likely to take these courses than are males; 8% of the females and 14% of the males have enrolled in a programming course for at least one semester. This difference has remained constant since 1978 as depicted in the trend lines (Figure 5).

Undoubtedly some portion of this difference between the two genders results from cultural socialization, however there may be structural factors in the schools that inhibit females from taking advantage from computer opportunities. For example, counselors may not recommend computer courses for the girls, and very often the computer programming course is an advanced math elective that requires prior mathematics courses.

Figure 5

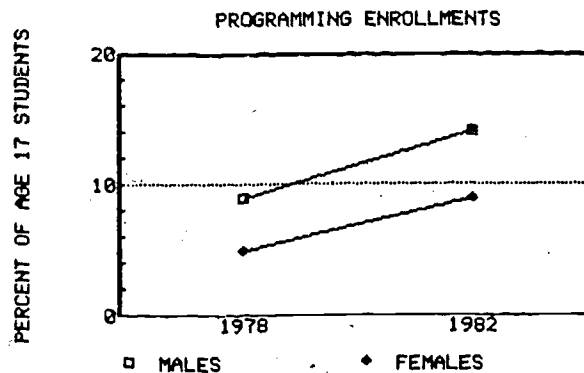

9. Summary

While it is true that the issues raised by this summary list of research findings do not constitute a very large portion of the list of actual problems in educational computing, they point very concretely to a substantial set of issues that can not be ignored. If nothing else, they identify an agenda for ongoing assessments of what is taking place in the educational system. These results also reveal many unanswered questions concerning the direction and impact of existing educational computing policies.

RECOMMENDATIONS FOR COMPUTER USES IN EDUCATION

I would point out that in stating priorities and recommendations I speak for myself and not the Association of Computing Machinery nor the University of Minnesota.

The Association of Computing Machinery with over 60,000 members is dedicated to three basic purposes: 1) to advance the sciences and arts of information processing, 2) to promote the free interchange of relevant information, and 3) to develop and maintain the integrity and competence of individuals engaged in the practice of information processing.

The ACM Special Interest Group on Computer Uses in Education, of which I am Chairman, has a membership of over 1,700 and is organized to facilitate the goals and needs of those specializing in computers and education. One of our activities during this past year has been to encourage discussion of policy issues and identification of the problem areas of instructional computing. On June 7, 1983 we held an informal working group meeting at the National Educational Computer Conference in Baltimore. From this we established a small network of concerned persons willing to work on clarifying the issues. On September 7 and 8 we held a Task Group meeting in Washington D.C. to explore ideas and consensus on specifying the issues and priorities of computers in education. At this meeting were representatives not only from ACM but from most of the large organizations dealing with educational computing. Representation included the AFIPS (American Federation of Information Processing Societies), the ICCE (International Council on Computers in Education), and the NCTM (National Council on Teachers of Mathematics) as well as a variety of institutions at all levels of the educational system.

The conclusions and recommendations which follow are my own personal beliefs and claims, however they are primarily a summary of the collective judgments and opinions stated at the September 7-8, 1983 task group meeting on educational computing policy alternatives.

Before stating policy recommendations the underlying values or goals have been specified. The value premises for education generally, and for the role of computers in particular, are listed below and provide the rationale for the action items which follow.

VALUE PREMISES: EDUCATION

1. Education, training, and retraining will continue to be more and more necessary for individuals as well as the society as a whole.
2. The productivity of our future society is critical and students must be taught creative skills to insure adequate productivity.
3. Access to information resources and skill in retrieval from large databases are increasingly a major requirement for individuals as well as organizations. Education must shift priorities to insure that students are taught the necessary information-related skills.
4. Today's educational curricula must be reassessed and restructured to take into account the skills and knowledge needed in an information-based society. These skills include formulating problems and problem-solving algorithms, using data and analytic tools to solve problems, and communicating and collaborating with others in solving problems.
5. Educational systems and programs must become more responsive to change. But more attention must be given to defining the new goals of education, so that change is not without direction.
6. Affective as well as cognitive learning goals must be pursued. Learning environments should be created which have autotelic (intrinsically motivating) properties.
7. Mechanisms must be established to insure equity in educational opportunities for all social groups as well as special populations such as the handicapped.

VALUE PREMISES: COMPUTER USES IN EDUCATION

1. While all the major modes of educational computing have value in certain situations, research is needed to determine the relative and conditional effectiveness of each mode.
2. The "computer as tool" for word processing, data analysis, planning, modeling, etc., is an educational approach that should be infused throughout the entire educational system including every discipline.
3. The computer should be used for individualized instruction, particularly for special populations.
4. Much more attention should be given to techniques for using computers to teach high-order thinking skills and to extend cognitive functioning.
5. The role of computer science and information science should be given more attention in the curriculum.
6. More emphasis should be given to the potential role of computing to motivate and hold learner attention.

7. The computer can be an agent of progress in the educational system. It can also be an agent of control and repression. Decisions must be made to insure that computers only become agents of progress.

RECOMMENDATIONS/ACTION ITEMS

Actions are recommended in five areas with the following order of priority: 1) research, 2) policy analysis, 3) public education, 4) educator education, and 5) curriculum analysis and development.

1. Research

By far the highest priority for action is to initiate and continue several different kinds of research. Current difficulties in planning and decision-making result from a void of knowledge which could be supplied by research. All of the following types of research have high priority:

- a. tracking (monitoring) the impact of computers on schools, society, and progress in learning;
- b. needs and changes in the labor force;
- c. new matches between new technology and learning activities (symbiosis between computer and learner);
- d. delivery systems, markets, publisher-consumer interaction;
- e. curriculum reorganization and redesign;
- f. high-risk, long-term basic research on possible uses of computers and related technology in education;
- g. Artificial intelligence (knowledge-based systems and coaching) applied to learning and education;
- h. different modes (e.g. LOGO) of computer access/work/use and their impact on different types of learning;
- i. how to effectively teach computer literacy and programming;
- j. research on how to use existing tools to improve inquiry, IQ, and logical reasoning process;
- k. demonstration projects which experiment with procedures for providing low income students (and parents) with access to computers, software, and training.

This research agenda can not be treated as a luxury, and the cost to initiate it will be substantial. Projects in all of the areas identified should be initiated immediately. Some can be completed in the short run,

while other types of projects require both a short run commitment as well as long-term support.

2. Policy Analysis and Leadership

Many education computer policies have been written (and implemented) without systematic analysis and careful evaluation of the possible consequences. What we need instead is a new commitment to policy analysis such as the work of Pogrow (12) and Tucker(13). "Think tanks" and study groups should be funded to continuously assess goals, needs, effects, as well as alternative policies and possible scenarios of impact. Research findings are a critical source of guidance to this process and essential to its success.

Policy analysis should address many different levels from individual classrooms up through national levels of activity. Broad goals should be addressed as well as very specific problems such as how to support "thin" educational markets. Investigation should be made into such problems as existing federal and state regulations which inhibit computer purchase and use.

The results of concerted attention to these issues could lead to a new consensus among the specialists in educational computing. Such a consensus would provide the leadership which this field needs so badly. This type of effort is needed right now, but must be implemented on an ongoing basis as well.

3. Public Education

A major need exists to improve the dissemination of information in several areas. These areas include

- a. resources (e.g. software, materials, etc.)
- b. advances in technology
- c. results of research.

Projects which centralize, condense, and organize such information into databases are needed. Less expensive, easier telecommunications accesses through a system of interstate "data highways" are needed also.

Public information programs are needed to dispel myths about computer uses in education. Such myths include beliefs that

- a. Computers are a panacea for our social, economic, and educational problems.
- b. Everyone should be a programmer.
- c. All computing costs are dropping.
- d. Teachers are the best courseware developers.
- e. Leave any child alone with a computer and s/he will become computer literate.

Other misconceptions should be identified and the clarifications channeled into media and developer information networks.

4. Educator Education

New opportunities for the training of teachers (kindergarten up through the university) should be provided. A most critical need is for instructors to learn how to use computers as tools in their respective disciplines. Such training and retraining is urgently needed now and will be required on an ongoing basis.

Special attention should be given to educating computer teachers in current developments in computer science and information science.

Such computer education requires that schools and colleges have computers for teacher education, but computers should not be purchased without software and training programs. Special consideration should be given to producing and providing courseware packages for teacher training with the purchase of any new computer.

Training programs for teachers should be designed to address inequity problems. Special support should be given for training and associated equipment for schools and colleges in low income and remote locations.

5. Curriculum Analysis and Development

Curriculum projects are proposed in two arenas: the general curriculum and the computer curriculum. Because new thinking and information tasks will become necessary in the information-based society, content should be re-examined in all subjects. A wide selection of specialists in various disciplines must be involved in assessing where shifts may be useful and where computer-assisted activity may enhance the learning process.

In addition to initiating this implicit revolution, the curriculum in computer literacy and computer science should be re-examined. Curriculum development projects are needed to identify and implement the best approaches to teaching in these areas at all grade levels. One sign of the need for activity is the frenzied growth of short BASIC courses under the banner of "computer literacy." Such courses address only a small portion of the knowledge and skills that students need to function effectively as computer literate citizens.

CONCLUSION

By now you may have noticed that no recommendations have been offered to install large numbers of computers in the educational system. It is true that research and demonstration projects require hardware and teacher education requires computer access, but it is too early to create a wired educational system with computer stations at every desk. First we must conduct the research, the policy analysis, the planning, and, in other ways, prepare the educational system for the transition. We should seriously consider proposals such as Tucker's (13) to spend \$13 billion to give every four students an intelligent workstation linked into an interstate data system. But first we should conduct the research and planning that would enable us to use such systems wisely. We have serious problems

of inequity, computer misuse, and mislearning, but these can not be solved by unrestricted donations of computer equipment. Unless the infusion of computers is accompanied or preceded by software tools and the training of teachers in these tools, we will find it difficult to achieve a symbiosis between computer technology and our educational system.

REFERENCES

1. Instructional Computing, Inc., (1982) Microcomputers and Computer Literacy Instruction In Pre-College Schools: A National Survey, Minneapolis, MN: Instructional Computing, Inc.
2. Instructional Computing, Inc., (1982) Trends in College Computer Literacy Courses, Minneapolis, MN: Instructional Computing, Inc.
3. Johnson, James W., (1979) The State of the Art of Instructional Computing, Proceedings of the National Educational Computer Conference.
4. Center for Social Organization of Schools, (1983) School Uses of Microcomputers, Baltimore, MD: Johns Hopkins University.
5. Anderson, R.E.; Hansen, Thomas; Johnson, David C.; Klassen, D., (1979) Instructional Computing: Acceptance and Rejection, SOCIOLOGY OF WORK AND OCCUPATIONS, Vol. 6 No. 2.
6. Quality Education Data, Inc., (1983) Microcomputer Data, Denver, CO.
7. Anderson, R.E.; Welch, W.; Harris, L. J., (1983) Computer Inequities in Opportunities for Computer Literacy, Minneapolis, MN: University of Minnesota Center for Social Research.
8. Hueftle, S.J., Rakow, S.J., Welch, W.W. (1983) Images of Science - A Summary of Results from the 1981-82 National Assessment in Science, Minneapolis, MN: Minnesota Research and Evaluation Center, University of Minnesota.
9. Anderson, R.E., Klassen, D. L., Krohn, K.R., Smith-Cunnien, P (1982) Assessing Computer Literacy, (Publication #503), St. Paul, MN: Minnesota Educational Computing Consortium.
10. Lockheed, M., Nielsen, A., Stone, M. (1983) "Sex Differences in Microcomputer Literacy," Pp 372-5 in Proceedings of the National Educational Computer Conference, Baltimore, MN, 1983.
11. Seidel, R. J., Anderson, R.E., Hunter, B. (1982) Computer Literacy, New York, NY: Academic Press.
12. Pogrow, S. (1983) Education in the Computer Age. Beverly Hills, CA: Sage Publications.
13. Tucker, M. S. "Computers in the Schools: The Federal Role," Project on Information Technology and Education, Washington DC, September, 1983.

Ronald E. Anderson

BIOGRAPHICAL SKETCH

Dr. Ronald E. Anderson is Director of the Minnesota Center for Social Research, University of Minnesota, where he is also an Associate Professor of Sociology. He completed his Ph.D. at Stanford University in 1970. For the past fifteen years he has taught courses in sociological research methods, social psychology, computer use, and computer programming. Dr. Anderson has directed numerous research, evaluation, and development projects including several large research projects funded by the National Science Foundation. Several studies involved analysis of data from the National Assessment for Educational Progress. Currently he is Director of the ongoing Twin Cities Area Survey, an annual social survey of adults in the seven county Metropolitan area.

Currently the elected Chairperson of ACM/SIGCUE (Association for Computing Machinery/Special Interest Group on Computer Uses in Education), Professor Anderson has been active in the Association for many years. He is also a member of the steering committee of the National Educational Computer Conference. Over the past 10 years he has served as advisor and consultant to many projects and organizations including the National School Boards Association, the Modern Language Association, and EDUCOM.

Author of over 50 articles and several books on computers and education, he is also a Series Editor for CONDUIT. Dr. Anderson serves as the principle subject matter expert and Editorial Consultant for the Control Data Computer Literacy Series.

Dr. Anderson is founder and president of Instructional Computing, Inc. which develops instructional software and courseware. Through this role he also has served as special consultant to the Educational Testing Service and the National Institute of Education's computer literacy project. He often conducts computer literacy workshops for teachers and school administrators.

For several years he was associated with the Minnesota Educational Computer Consortium (MECC). At MECC he directed two large projects funded by the National Science Foundation. The first was "Computer Awareness and Literacy: An Empirical Assessment," the first large-scale computer literacy assessment, which involved the testing of over 6,000 Minnesota students. The second project was "Computer Literacy Instructional Modules," which produces 26 instructional packages for junior high school classrooms.

Mr. GORE. Thank you very much, Dr. Anderson.
Congressman Volkmer.

Mr. VOLKMER. Yes. Thank you, Mr. Chairman.
I appreciate all the testimony we received.

It appears we possibly will have a question of equity in the distribution of not only computers, but information systems, the software, and teachers' training, unless something is done. Do you agree with that?

Dr. ANDERSON. Yes.

Mr. VOLKMER. Everybody agree with that? If there's no unified effort on anybody's part and we just let things develop as it has been developing, then there will end up 5 or 10 years down the line a gross inequity—poor districts, rich districts, et cetera. Agree with that?

Dr. PARENT. Yes, very much.

Dr. ROBINSON. And, in fact, that's the very prospect that suggests some appropriate governmental involvement at both the Federal and the State level. It is, indeed, in all our interests to see that we have a uniformly educated populace, at least to a certain level.

Mr. VOLKMER. At least the opportunities for that education.

Dr. ROBINSON. At least the opportunity for that education, yes.

Mr. VOLKMER. All right. Then the next thing, do we have any agreement among the panel that the Federal Government should be involved at least into this effort to make sure there's some equity?

Dr. PARENT. Yes, we believe there is a Federal role.

Mr. VOLKMER. Dr. Anderson.

Dr. ANDERSON. Very definitely, especially in the research and planning area.

Dr. ROBINSON. In the testimony we did comment on a number of specific bills being considered at various stages now in the Congress, but there is definitely a Federal role, and we urge you to consider several possibilities for that role.

Mr. VOLKMER. Some of that legislation leads me to ask the next question. One computer in a school district or in a high school, maybe one in a junior high and one in the elementary schools, does that satisfy a requirement?

Dr. PARENT. That's not very useful, not very useful.

Mr. VOLKMER. That, in itself, is not a way to achieve equity, is it?

Dr. PARENT. No. One of the reasons that the National School Boards Association is supporting the bill that we call the NEED bill is the fact that this would put approximately—the cost of the bill is \$1 billion, and that is approximately \$25 for every student in the whole United States between the ages of 4 and 17. This money largely would go to the local school district.

Now some school districts are already somewhat geared up in hardware. They may need it for some other facet of improvement of math, science, or technology or foreign languages in their district, but we feel that the local district, indeed, knows best what its unique needs are and that our NEED bill addresses that. It's not just a computer per school or per so many children, but, as we pointed out earlier, that if we are to have sufficient computers in the school for each child to have 30 minutes a day on a computer,

it would cost in the nature of \$1.8 billion to gear up to that possibility.

Mr. VOLKMER. That would be over a period of time, of course?

Dr. PARENT. No. That is the cost of putting the hardware and gearing up to that. Now to continue and keep the equipment up to date, and to keep current with software, would cost far more than that.

Mr. VOLKMER. On teacher education in the use of computers, do you all have an opinion as to whether or not that should go into just how to use the computer, but also into how that computer, in other words, works, so that a teacher knows more than just how to use it?

In other words, the same thing—in an automobile, you know people know that you put gasoline in it and you change the oil and you turn the key, but many people don't know the intricacies of it. Any little thing goes wrong, they have to have somebody, you know, fix it.

But I'm talking about actually how to program it and develop their own material for it. Do you think they should be taught that, too?

Dr. PARENT. I would think not all teachers necessarily would learn that. I think those that were specifically interested in that aspect of use of the computer. However, it's very definitely necessary that every school district and every teacher have inservice training in the use of a computer, because obviously if it comes into the classroom, if the teacher is not—has not had inservice learning to use it and working with it, it will, in fact, become a dustcollector in the corner of the classroom, because if you give anyone a kind of a tool and do not teach them how to use it, then that—they're going to put that tool aside. They're not going to use it. They're going to go back to their familiar hammer and nails and screwdriver that they've always used, and it will be money not well spent.

Mr. VOLKMER. Dr. Robinson.

Dr. ROBINSON. We have a concern, also, for those entering the profession, that the teacher preparation programs at the university level become sensitive to the needs for teachers to be skilled consumers and users of various types of technology, computers certainly being one of them.

Those programs are very slow to change, unfortunately, and they will encounter the same kind of financial constraints in bringing the computer and that kind of knowledge into their programs as the elementary and secondary schools will experience in utilizing the computer in the instructional environment that they control.

We are concerned that we do not place an unrealistic requirement or expectation on everybody, that everybody will be required to do exactly the same thing. We feel that experience to date suggests that there are a number of teachers who are, indeed, interested becoming programmers and producers of courseware. It presents a number of very interesting and challenging copyright and ownership issues. These issues are beginning to emerge.

And we know there's a lot of activity in the area of teacher-developed courseware.

The project that I mentioned is one which now requires that we identify a network of those teachers throughout the country, so that we can help inform the courseware development industry in a more influential and significant way, so that they can understand that we're going to be very well educated and sensitive consumers of the product, whether it's teacher developed or commercially developed.

As to whether we need to all know how to operate or fix our cars, I suspect that a number of automobile mechanics would get real nervous if we said we were all going to learn how to do that. I know that the corps of repairmen who work for IBM and Xerox take great pains to cloak all of that in some mystique, so that we don't bother to open up their machines and tamper with them.

I don't know that we need to go quite that far. But certainly, as we learn to operate the film projector, we had to know how to change the bulb. Sometimes that wasn't real easy to do and sometimes you had to do it very often, but to avoid the frustration of having the equipment sitting there useless, you did take the pains to know how to at least maintain the equipment in a responsible way and to effect minimal repairs, superficial repairs.

Mr. VOLKMER. Then one last question, Mr. Chairman, with your indulgence.

Talking again about—and, Dr. Robinson, you talked about it very briefly. I'd like to get more in detail. On—eventually should we have a requirement for teacher certification, that they be familiar with the computer?

Dr. ROBINSON. We have developed some specifications for teacher education. It's in a document we call "Profiles of Excellence: Teacher Education."

Being very competent users of all the technology of instruction is cited in that document, and computer—working with the computer is specifically mentioned.

We don't want the document to be doomed—to be archaic before it's even out and within the realm of discussion, so we haven't said just what all that means, because the technology is in the process of being developed all the time.

But the teacher certainly should be a competent lifelong learner, and that means the teacher should have the capacity to learn how to use emerging technologies as they become available.

Mr. VOLKMER. Dr. Parent, do you have any comment to make on the question of certification for teachers, familiarization at least with computers?

Dr. PARENT. I would hope that it would become part of teacher certification in the future. However, because of declining enrollment in many of our school districts, that is not a primary issue at this time. What is of more concern to us in school boards is having training for the teachers that we now have in our school districts, so that they will be very comfortable in using what has become a marvelous tool for teaching, we believe, in the past few years. And many of our teachers have not had that kind of training or have no opportunity to get it, unless we do it inservice in our districts.

Mr. VOLKMER. Dr. Parent, have you run your all's proposal, the School Boards' proposal, by Dr. Bell; the Department of Education?

Dr. PARENT. I believe that Mr. Bell is very aware of our bill.

Mr. VOLKMER. Has he made a comment on it, to your knowledge?

Dr. PARENT. Oh, I'm sure that he has. [Laughter.]

Mr. VOLKMER. Has it been favorable or unfavorable?

Dr. PARENT. Well, I believe that he is in favor of anything that would be good for education in the Nation. However, he does have a distinct preference for everything being done by the State and the local districts.

Mr. VOLKMER. That—

Dr. PARENT. When it comes to money—he's in favor of education, but when it comes to money—

Mr. VOLKMER. This goes back to the money yesterday—

Dr. PARENT [continuing]. He wants to do it ourselves.

Mr. VOLKMER. Right, and I didn't see your proposal yesterday. Maybe I'd had a better shot at him yesterday on it.

But I'm one of those who I think realizes, as one who comes from a State legislature, and one time I believed firmly, as he did, that it would be better if we'd do everything on a local level and on a State level for education, and keep the Federal Government out of it. For a while, on the State level, in the State legislature, that you do it on the local level and not even on the State level, until you start to find out that there are school districts that just do not have any economic base at all. And if you relegate them totally to that local level, you're going to have a group of children brought up in this society without a qualified education, unless we do—well, if you want to say it—redistribute the wealth so that they can participate.

Dr. PARENT. Perhaps if we lived in a climate or a world in which there were fences around every community and you didn't ever go from that community into the world at large, this would be a more significant argument. But, however, if we fail to educate children in Foley, Minn., they will not stay there. They may become a charge on the State of New Mexico, or California, or anywhere else they may happen to migrate to in the future.

Mr. VOLKMER. Thank you very much.

Thank you, Mr. Chairman.

Mr. GORE. Thank you.

Congressman Skeen.

Mr. SKEEN. We thank you, Dr. Parent, for sending us any help that we might need in New Mexico.

Dr. PARENT. Snow refugees, you know.

Mr. SKEEN. Snow refugees. We get a lot of you folks down there. We're also exporting a lot of our youngsters out of our State because we don't have an employment base, and I think it's a very cogent comment that you make. You don't educate children for just a local situation.

And I'm not trying to get in an argument with Dr. Bell about financing. Our State commits over 75 percent of its total resource to one area, education, because we've got no local base from which to raise the necessary funds to support a statewide educational system, so we do it from State funds; 75 percent are committed to education. I think it's one of the highest in the United States, but it takes a mix of Federal commitment, and we recognize that.

I wanted to talk to you about equity. It's been the thread that's gone through this whole conversation from this panel. And I notice

that even amongst the three of you there's a slight bias in determining what we're talking about in equity toward each one of your particular interest, and I think that's what happens when we talk about education in general.

I see that the researcher over there, he was very much interested in, if we're going to have equity, let's be sure that we take care of the equity first in the research area, and then the school boards, and the administration, and the teaching profession. And that's just natural, but it is puzzling for us.

If we're going to talk about a new technology in education today, and one that's going to have such a profound impact on education as the computer sciences and so forth, it's how do we really define when we're going to reach an optimum equity, who is going to define it, who is going to assure that we have it, who is going to enforce this so-called idealistic goal of reaching some kind of equity?

And I'd like to start with—I was amazed, Dr. Anderson, from your reports, the citations that you made from studies, of the low usage that we have today, when we're considering the equipment that we have available throughout the school systems in the United States, it's that low. That was somewhat startling to me, because even at this point, you think we're trying to reach some kind of equity.

For instance, 61 percent, I think you said, nationwide—of the students that have computers available to them, only 61 percent of the students use them. And I would have thought it would have been somewhat higher than that.

What would you consider an optimum computer-student ratio for a school, if you were just setting out parameters of what we're going to do when we reach this equity?

Dr. ANDERSON. Well, an optimum student-computer ratio would be one computer per desk, and I think probably 25 years from now that will be a given. But, in the meantime, you need at least a computer lab in a school. In an elementary school you need at least a computer in a classroom.

Mr. SKEEN. Per class?

Dr. ANDERSON. Per class. And I guess a good optimum or interim structure would be to have one computer for every three or four students.

Mr. SKEEN. What about you, Dr. Parent?

Dr. PARENT. Well, we are attempting to gear up in my local school district. It's not easy. They are expensive.

We spent—before we did—put in our computer room, we had in-service training for our teachers in the use of the computer, any who wished to take it. Right now we have a ratio of 35 students per computer, but we are hoping to have that within the next year or—

Mr. SKEEN. You wouldn't consider that an optimum level, would you?

Dr. PARENT. No. That's very—it's sparse. We have 35 students per computer, and we just do not have a good ratio. But my State is—and I believe Rhode Island, Minnesota, and Rhode Island are the two States that have a greater ratio—but the ratio is smaller of

computers. We have fewer students per computer than any other—I'm not saying this right.

Mr. SKEEN. I know where you're going.

Dr. PARENT. Yes. I'm just not getting there very easily.

Mr. SKEEN. We share that kind of a problem around here.

But that's interesting. What did you think of the low usage that the studies indicated, such as in many schools, elementary schools, 2 hours a day, 2½ hours for high school? I thought it was kind of shocking.

Dr. PARENT. I was not surprised.

Mr. SKEEN. You were not surprised?

Dr. PARENT. No, I was not surprised, no.

Mr. SKEEN. I was.

Dr. PARENT. I've seen some figures before in conjunction with the National Science Foundation Commission, and it really is very sad. A lot of the computers that have gone into schools are in one area. They're very, very necessary in the handicapped classrooms because it's the most amazing thing if you see a child—the computer does wonderful things. You see a child that cannot use their hands or their legs, and only can work with a headband, and work with that computer. And just to see that child sparkle because they're learning—

Mr. SKEEN. It's an enlargement of their ability.

Dr. PARENT. Pardon?

Mr. SKEEN. It's an enlargement of their ability.

Dr. PARENT. Oh, yes.

Mr. SKEEN. Almost instantaneous.

Dr. PARENT. Yes. It gives them what they couldn't do any other way, and I think this is what's happened throughout the United States. If you have been able to buy a computer or so, it has been in your handicapped classroom and available only to those people, because they need it the most.

Mr. SKEEN. Dr. Robinson, could you comment?

Dr. ROBINSON. The survey presented that same kind of startling finding, in that there's enormous enthusiasm. There are very few computers in the classroom, and where the computers are there, they're available to a very small percentage of the student population. And it has to do with a number of things.

Some of it is inadequate planning because there has not been time made available or resources made available for the teacher to use the technology in a number of important ways. So it becomes a reward for the students who finish their work to get time on the computer. Sometimes it is used to perform certain classroom management functions, and that's a great benefit to the teacher and to the student as well, but it is not direct instruction through the computer and the student interacting.

So I did not find that so startling this time. We were surprised when we saw it in the survey, because there's a lot of—there's a lot of enthusiasm for learning more about how to use it, and a great deal of receptivity to have a computer come into the classroom, but not without the attending support, so that it can be used properly.

Mr. SKEEN. That's what's bothering me in the equity. There are so many elements to consider and so many parameters to decide on in approaching this question of how do you do an equitable job of

presenting this kind of technology to students, and do you get the most effective—and how do you get the most effective use from it? It's certainly been helpful listening to you, the three phases of this problem aired today. You did an exceptionally good job, and I appreciate it very much. And I have learned a lot by it, and I thank you.

Mr. GORE. Thank you very much.

Dr. Anderson, how is it that the South has such low figures? Your study indicated that students living in the Southern United States are much less likely to have used computers in school than students living in other parts of the country. Why is that?

Dr. ANDERSON. Well, it's because there's fewer computers there, which is probably mostly related to the expenditures per student, the lack of resources to purchase computers and to pay for teacher training programs, and so forth.

Mr. GORE. Yeah. All right.

What about the problem of software compatibility? Dr. Robinson, do you have any thoughts on how we might begin to solve that problem?

Dr. ROBINSON. Well, I think that the market is going to help us solve that problem, just some of those dimensions, though I don't like saying things like that. I don't want to be taken for a rabid free enterpriser.

But certainly if we establish certain elements, certain standards of quality that will drive the marketplace, those standards will become more important than compatibility. And I suspect that unless we do something to generate a more attractive market within educational software, we're not going to get the attention that we really need from the industry, because the education software market is a very small part of the total market that the computer industry will have to consider.

I believe that we have to make it less profitable to maintain the unique features of program and machine compatibility, and we'll only make that happen through use of the technology and establishing standards that are really operative standards, that drive the marketplace.

Mr. GORE. Do either of the other witnesses have any thoughts on that question?

Dr. PARENT. I would agree with Dr. Robinson that eventually the marketplace will even out by itself, so that software will become compatibility, because there will be the hardware companies that fit it, and then the ones that are remaining, the software companies will provide stuff that fits their computers, and that's the way it will just work in the marketplace.

Mr. GORE. Well, I hope you're right.

On the tax credit idea that was discussed with our first witness today, help me understand NEA's position on that, Dr. Robinson. Are you for it or against it?

Dr. ROBINSON. Well, we're for it with qualifications.

Mr. GORE. OK.

Dr. ROBINSON. We have some standards that we use as a guide for evaluating proposals that relate to tax incentives or tax credits, whatever.

In this instance, the first standard or requirement would be that the utilization of the computer, or whatever is going to be the cost of the equipment to be written off, must be used directly to instruct students. There is a concern that we not encourage or support any further just the administrative functions with the technology. I think that the administrative budgets will take care of that, but we are concerned about—

Mr. GORE. So your first point is you want to make sure that it gets to the students?

Dr. ROBINSON. To the students, yes.

Second, we want there to be some assurance that there will be proper geographic and economic diversity in distributing the equipment within the local district, and that the third element would be that the donation or the equipment would be treated identically as if it were a direct purchase. In other words, you would still get the attendant maintenance support from the industry, as if you were purchasing the equipment.

And the fourth element would be a responsibility on the part of the donor to provide some training support to the new users of the equipment, in much the same way that the private sector provides right now.

And, finally, that the program would also provide a very—an adequate, sufficient operational program. The equipment has to come equipped with or accompanied by adequate software. So we don't want obsolete equipment, and we don't want inadequate software accompanying the donation.

Mr. GORE. Well, those all sound like very sensible points to me.

Dr. Parent, has the National School Boards Association taken a position on this legislation?

Dr. PARENT. Yes. We supported the legislation, Congressman Gore. The only thing—one thing we wish to make sure, however, is that the gifts of computers to the schools were given through the school district, not just an individual school, and that all districts be treated alike, just going by the number of children, not the wealthy districts would get more because there would be a possibility of further purchase by the wealthy parents of those children, but we would want to make sure that it was very equal, that the poor districts and poor schools would get as many.

Mr. GORE. Very good.

In your opinion, should school districts require that students be computer literate as a condition of graduation?

Dr. PARENT. Well, I have a problem, first, with computer literacy because I'm not entirely certain what it means.

Mr. GORE. Yeah.

Dr. PARENT. But I would think that every child should know how to use a computer to be able to put information in and get it out, use it for his purposes.

Mr. GORE. Yeah.

Dr. PARENT. Because I believe that everyone will have to deal with them through their lifetime. And the same as we teach them use of other tools in our schools, I think we should teach them computer technology.

Mr. GORE. Dr. Robinson.

Dr. ROBINSON. I would agree. The term "computer literate" does not have precision in definition right now.

Mr. GORE. Yeah.

Dr. ROBINSON. And I fear that we'll use our standard technology, and some testing company will define it for us, and that definition will be far too narrow to be really useful.

Mr. GORE. A few years ago I undertook to organize a computer literacy course for Members of Congress, and we had 50 Members of the House and Senate come. We installed 20 microcomputers under the Capitol dome, and a special course was designed, about 2 hours in duration. And we called ourselves computer literate after we'd gone through that, but 2 hours didn't give us a lot of literacy. So I can certainly identify with your difficulty in defining the term "computer literate."

Well—yes, Dr. Anderson.

Dr. ANDERSON. I would just like to point out that just this week is being completed a study funded by the National Institute of Education to define operationally computer literacy utilizing a national panel of experts, and an amazing amount of consensus has been reached on that project.

The statement or the definition of computer literacy that emerges from that is very broad and comprehensive, and I think should be taken very seriously by the educational community, but it is certainly not something that you can mandate for every elementary school, because it involves a set of knowledge and skills that are ongoing and learned throughout the elementary and secondary school student period.

Mr. GORE. Well, thank you very much. I appreciate your testimony today and your responses to the questions. We really are grateful for your help in understanding this important problem.

Thank you very much.

Let me call our last panel to testify on State and local approaches. I'm particularly pleased to call, as the first member of this panel, Dr. David Moore, director of computer education with the Memphis City Schools in Memphis, Tenn.; Ms. Patricia Sturdivant, associate superintendent for technology in the Houston Independent School District in Houston, Tex.; Ms. Floretta McKenzie—well, hold on just one second here. We were informed yesterday, late yesterday, that Ms. McKenzie is unable to appear, but she has sent Dr. Kyo Jhin, the assistant superintendent for educational technology in her place. So, Dr. Jhin, if you would join us as well.

Mr. Jack Gordon, chairman of the Senate Education Committee in the Florida General Assembly; and Mr. Curman Gaines, Assistant Commissioner of Education with the State of Minnesota.

We're delighted to have all of you. We really appreciate your willingness to appear here today and assist us in wrestling with this difficult and critical issue.

And, as I said, I'm particularly pleased to have as our leadoff witness a fellow Tennessean, Dr. David Moore, who's director of computer education with the Memphis City school system.

And, without objection, we will include your prepared statement in the record, Dr. Moore. I want to compliment you on the thoroughness of your presentation and on the work that you have been doing.

Without further ado, I'd like to invite you to proceed with your testimony.

STATEMENT OF DR. DAVID MOORE, DIRECTOR, COMPUTER EDUCATION, MEMPHIS CITY SCHOOLS, MEMPHIS, TENN.

Dr. Moore. Thank you, Congressman Gore. I appreciate the opportunity to appear before the committee.

One of the factors that I would like to raise to the committee's consciousness as we begin our testimony as a panel—we as educators are dealing with an issue, that is, computer education, computer literacy for high school seniors. We have to keep in mind that our high school students enrolled in grade school before microcomputers were even developed. So we're looking at a technology that we are criticizing ourselves for not incorporating in the curriculum, when the technology itself did not exist at the time these students began their public schooling.

Mr. GORE. We Americans are impatient by nature, I think.

Dr. Moore. The "Now Generation" is here, very definitely.

And as we look to the future, I think one of the things that we need to keep in mind is the technology that we are now seeing developed and its impact in the future of education is something that 6 or 8 years from now we may be coming back and criticizing education for not incorporating something that is emerging from a laboratory, you know, this very morning. So I think that's something that we need to keep in mind to keep our perspective on the issue.

Memphis City schools began computer education, as many other school districts have, with initial efforts at a few selected locations, as staff members became competent and interested in the area of computers.

Two years ago we had a commitment by our superintendent and our elected board to provide computer education throughout the entire Memphis City school district. We addressed the issue of equity of education, as it has now become labeled, as an issue that we had a concern for.

We saw the developing trend of the more affluent communities providing the equipment for their students, and we felt that this was something that should be available to all schools, all students, all teachers.

Again, there are several chicken-and-the-egg questions that we must be mindful of as we look at implementing a program as massive as we're talking about. Some school districts don't have the size of the system that Memphis has to cope with. Other committee members this morning or panel members can identify with me in dealing with large school districts.

When you're talking in terms of teacher training and teacher in-service, Memphis City schools has in excess of 5,500 teachers. And to go back and train just 5,500 teachers, to provide stipends for all of those teachers, is a tremendous budgetary item in itself.

We have attempted to utilize the technology to teach the technology. We have developed several teleconferences, broadcasts through our local cable network, in which presentations are made live via the cable network, and provide a telephone callback for teachers, principals, and, for that matter, individuals in the community who

had access to the cable network, to raise questions of the committee of experts, the panel of witnesses, shall we say, that were trying to provide the training and the inservice preparation to the teachers.

We've also developed a library of video cassette tapes which the schools can utilize either in faculty inservice or individual inservice activities.

So I guess what we're saying is that there is more technology involved in the schoolhouse today than just computers.

I've talked to some educators whose concept of modern technology was the development of colored chalk, and I think we've gone a little bit past that at this point in time. [Laughter.]

One of the concerns that we have also looked at and has been addressed by the State of Tennessee is the place of computer education in the general curriculum. Our State department of education initiated several years ago a statewide curriculum project entitled, "Basic Skills First." What more natural sequence could you have to that than, "Computer Skills Next," which is our current statewide program for computer literacy at the junior high school level.

Of course, we find ourselves in a slightly different position in Memphis City schools. We are attempting to begin computer education or computer literacy at the elementary level, beginning with first grade and carrying a continuum of skills on up through the senior high school level.

One of the myths that we have had to try and do battle with is that computer education is intended to teach every student how to become a programmer. That is not our intent, and I think that's one of the issues that must be addressed in computer education, as we look at what is appropriate for students. The elusive definition of computer literacy is one that continues to plague us. And my response frequently has been, as soon as you can define literacy, I'll define computer literacy for you. So I think that's an ongoing issue that we will have to deal with.

We've had the question raised concerning teacher training, and I think this is a crucial issue. We are seeing colleges and universities, at least in our State, beginning to incorporate computer training or computer education, to a certain extent, in the teacher preparation programs. We are looking to State certification requirements for teachers which would include some computer science education. The primary issue at point currently is the extent of computer education a teacher must have. I don't feel that it's appropriate that a teacher in first grade be able to program in FORTRAN, COBOL, and Pascal, but some others disagree with me.

We've looked at the issues of hardware and software, and this is another one of those chicken-and-the-egg situations. Obviously, you can't have computer education, in my judgment, effectively without computers. There has been discussion about programs to provide one computer to a school, and certainly if you have one computer in a school with 500 or 1,000 students, you are definitely going to have a question of access, equitable, or inequitable. You're not going to be able to have students on that computer at all if you only have one computer in the building.

Software availability is a crucial issue. We have criticized software. Figures of 90 to 97 percent lousy, or crummy, or poor software, have rung through the room this morning. I think one of the things that we all should be mindful of is that it takes a while to develop software.

Once a computer is developed and marketed, there is a lag in the production of software. One of the things that I have been encouraged about for the past 3 or 4 years that I've been involved in computer education has been the increasing sophistication both in hardware and in software. Much of the early software, true, was nothing much more than electronic flashcards, but I think we're seeing much more sophisticated software being developed. And I think that's something that's encouraging and something that I think is a situation that is turning around. And if, again, we will be a little bit patient with that, then we will see some improvement in the quality of the software.

I have a major concern, however, about the cost of software. We talked in terms of the support to manufacturers of hardware to provide hardware to the school districts. I think you'll find it won't be long before the software will cost more than the hardware. Jokingly, we talked in terms of our elementary computer education program, which is using a very simple computer system. It would have been to the benefit of the computer manufacturer to have donated all the computers because we're going to have to turn around and buy software for those computers, and that same company is the primary supplier of that software.

A decent software package, whatever decent means, frequently costs \$100, \$200, \$300. If you have 10, 15, 25 computers in a building and you have to buy 10 of those packages, very quickly your software costs are going to go through the ceiling.

I'm mindful of the developer's time and expenses to develop good software, but at the same time a floppy disk to go in that micro-computer can be had for anywhere from \$1.50 to \$1.75 wholesale. And to pay \$150 for a \$1.50 disk, I think is slightly more than compensating the developer for the research and development cost.

Concerning the issue of evaluation of software, I think within the next year we will possibly see the development of evaluations of evaluators. Many school districts, many publishing companies, many State agencies, many organizations are beginning to evaluate software, and it's not going to be long before we're going to have to have not only a guide to software, but a guide to software evaluators.

One final concern on the software issue: I am becoming increasingly concerned that the software development question may become a roadblock to future developments in the technology. One of the big concerns that we hear frequently at education conferences is that you need to go with whatever equipment you have the most software to support.

As equipment manufacturers come out with new models, as they refine the technology, as they develop additional equipment, they're going to be mindful of that. If there is not software for the equipment, then the equipment is not going to be viable in the educational market. And it becomes a self-defeating cycle: software developers develop for the largest base of equipment. That's simply

our free enterprise system. New equipment will not have software developed for it. It will not sell. Therefore, no one will develop software for it. And you find yourself in a cycle 25 years from now using the same educational equipment because you don't have any additional educational software.

The question of curriculum development has been one that we have struggled with, not only in computer education, but in the general education area. Frequently, we find that all sorts of entrepreneurs come forward with the latest answer to the curriculum issue, and we frequently find ourselves in a posture with computer materials, as we do with general education materials, of having our curriculum defined by either the textbook or the software, depending on which technology you're utilizing. We have a concern about that.

We feel that we need to provide our curriculum for our students in the most effective method at the grade levels that we feel are effective. Frequently, however, we find ourselves tied to the textbook publishers, as they define curriculum through those media, and now we're finding ourselves beginning to be tied to software developers dictating curriculum to us because of the software that they provide.

Unfortunately, we in Memphis City schools currently do not have the resources to start developing our own software, but that is something that we're beginning to look at in some of our management applications, and, hopefully, will be forthcoming in instructional applications.

One area of concern that I have is that there are many school districts across the country that have developed teacher training models, software evaluation models, hardware evaluation models, means of providing support services to schools, to teachers, to students. I would like to see more efforts on a network of educators throughout the United States who can exchange ideas, who can exchange failures and successes. There's no sense in each school district being left out on its own to reinvent the wheel. Local initiative is fine, but I think that we can benefit from each other's mistakes and each other's successes. I think that's something that we need to look to as far as some sort of national avenue of exchanging of ideas, of exchange of materials, of exchange of programs, et cetera.

Thank you.

[The prepared statement of Dr. Moore follows:]

378

TESTIMONY SUBMITTED BY
MEMPHIS CITY SCHOOLS

U. S. HOUSE OF REPRESENTATIVES
COMMITTEE ON SCIENCE AND TECHNOLOGY

SEPTEMBER 29, 1983.

W. W. HERENTON, PH. D.
SUPERINTENDENT

DAVID M. MOORE, ED. D.
DIRECTOR, COMPUTER EDUCATION

882

COMPUTERS IN EDUCATION

The magnitude of advances in computer technology during the last decade has impacted our society with a force never before experienced by mankind. The pervasiveness of computer technology in our lives within such a short period of time has left us overwhelmed. The attraction to and fascination with computers know no societal barriers such as sex, age, race, educational background, occupation, etc.

Educators are confronted with simultaneously dealing with computer technology as a content area and as an implement of instruction. The dilemma is how to provide "computer literacy" to students when few teachers possess the prerequisite skills and knowledge to provide the instruction. Frequently students, even on the elementary and junior high school levels, are more knowledgeable than many of the teachers. A concurrent dilemma is whether to incorporate computers in the delivery of instruction before, as part of, or subsequent to computer literacy - or if at all. There is a growing concern that computers will at least alter the role of teachers.

HISTORICAL DEVELOPMENT OF COMPUTERS IN MEMPHIS CITY SCHOOLS

The Memphis City Schools System has initially placed emphasis on teaching about computers - providing computer education for our staff and students. A three-level model has emerged which generally parallels the grade level organization of the schools in the school system. Computer awareness is the goal of the computer education program in the elementary schools, grades kindergarten through grade six. Computer literacy is the goal of the seventh and eighth grade program in our junior high schools, while proficiency in computer programming is the goal of the senior high school courses.

Initially a high school course was developed in BASIC programming four years ago at one high school. The course began to be offered at other high schools as additional teachers acquired the background to teach the course and schools were able to provide the necessary equipment. Subsequent high school courses were developed in FORTRAN and Pascal and offered at a limited number of high schools during the 1982-83 school year. A vocational education program had also developed in data processing with a focus on key punch/data entry, COBOL programming, and computer operations.

A commitment was made during the 1982-83 school year by Dr. W. W. Herenton, Superintendent, to provide computer education to all students in the Memphis City Schools System beginning with the kindergarten level and extending through the twelfth grade. The Tennessee Department of Education established a state-wide microcomputer advisory committee during the summer of 1982 to develop a computer education plan beginning at the seventh grade level for all students in the State of Tennessee. Dr. David Moore, then Director, Division of Elementary and Secondary Education, represented the Memphis City Schools System on the state-wide committee. As curriculum goals and objectives were developed by the state-wide committee, Memphis City Schools System personnel decided that the local curriculum should parallel the state curriculum as closely as feasible.

Memphis City Schools
September 29, 1983
Page 2

DEVELOPMENT OF COMPUTER EDUCATION PLAN

In March, 1983, under the leadership of Mr. E. Ray Holt, Deputy Superintendent, Office of Business Services, a Computer Education Steering Committee was established utilizing a business model of involving administrators from many divisions with a variety of expertise. Dr. William Payne was appointed as the chairman of the Steering Committee. The committee consisted of Mr. Cliff Burdick, Director, Division of Plant Maintenance, Mrs. Barbara Williams Jones, Director, Division of Curriculum Development, Dr. David Moore, Mr. Stan Pruett, Director, Division of Instructional Materials, Mr. Franklin Schroot, Director, Division of Vocational Education, and Mr. Bobby Young, Director, Division of Employee Services. Mr. Holt was an ex officio member. The Steering Committee was assisted by Mrs. Norma Jones, Administrative Assistant to Mr. Holt.

The Computer Education Steering Committee developed a comprehensive Computer Education Implementation Plan which was subsequently approved by the Memphis Board of Education on April 1, 1983. The plan contained chapters dealing with computer awareness for elementary students, computer assisted instruction via a mainframe network for Chapter 1 students, computer-managed instruction as an adjunct to the basic skills instruction program for elementary students, computer literacy for junior high school students, high school computer programming courses, vocational office education programs in word processing and microcomputer based accounting applications, vocational programming classes utilizing terminals, and staff development for school system employees. Each section contained a Program Evaluation Review Techniques (PERT) chart to delineate activities, responsibilities, and completion dates. A copy of the Computer Education Implementation Plan is contained in Appendix A.

With approval by the Board of Education the Plan was set in motion and a number of subcommittees were established to implement the various components. Software and hardware committees consisting of elementary and secondary teachers, principals, subject-area supervisors, and others began a series of hearings for vendors to present their products for consideration by the committees. A number of software developers and distributors were contacted regarding types of software, cost of software, instructional design, and hardware compatibility. A number of corporations provided examination copies of materials, both computer materials and other instructional materials, for examination by the committee. Subsequently the Software Committee reported its findings to the Steering Committee and to the Hardware Committee. In the meantime the Hardware Committee was conducting similar hearings.

While the hearings were being conducted, a series of meetings were held with building principals to outline the various computer education programs and provide them with information in order that they might decide whether they and their faculty wished to participate in the computer education program.

Memphis City Schools
 September 29, 1983
 Page 3

Program proposal forms were distributed which called for each principal to apply for participation in the specific components of the program. The proposal forms called for the principal to identify faculty resource persons to assist in program operation at the local school as well as to identify plant facilities to be utilized and plant modifications necessary to implement the program. System-wide participation in the Computer Education Implementation Plan had begun in earnest.

STAFF DEVELOPMENT FOR COMPUTER EDUCATION

Not unlike other school systems, the Memphis City Schools System had a small number of personnel with expertise in computer education, but the vast majority of personnel had little, if any, background in computer technology. The Staff Development Subcommittee began to plan for employee staff development for approximately six thousand employees. Mindful of cost constraints and in an effort to establish a network of school contact persons to facilitate future components of the computer education program, a series of workshops were developed to provide training for representatives from the various schools.

A series of two-day workshops for representatives from elementary schools were conducted with a follow-up day in August after the hardware, software, and curriculum activities were completed. The elementary school resource persons are now providing additional staff development for their fellow faculty members.

Elementary principals and elementary instructional supervisors also were given the opportunity to attend four-day training sessions during the summer in order that they might better incorporate computer education into their over-all educational program as well as provide additional support to local faculties in conducting staff development for teachers.

Training for junior high school resource persons consisted of three days of training in September to introduce them to the hardware and the Tennessee Department of Education's Computer Skills Next Teachers' Guide which is being used this fall for computer literacy instruction at the eighth grade level. Some schools are also involving seventh grade students. Junior high school principals and instructional supervisors were given the opportunity to attend the same four-day training sessions mentioned above. The junior high resource persons will be conducting a minimum of twelve hours of staff development for their faculties during the fall semester.

No formal staff development workshops were provided for the senior high resource teachers. Most senior high resource persons already had some background with computers, though there have subsequently been several requests for additional formal staff development. The senior high resource persons will also be conducting additional staff development for their fellow faculty members. Senior high school principals also were included in the four-day principals' workshops.

Memphis City Schools
September 29, 1983
Page 4

A series of two-week staff development workshops were conducted for vocational office education teachers during July and August on a voluntary basis in conjunction with the College of Business Administration, Memphis State University. The workshops were designed to familiarize the teachers with the specific hardware and software which had been purchased for use this fall in the vocational office education courses. There was one hundred percent participation by the office education teachers with many teachers coming early, staying late, and coming at night and on weekends.

A number of sessions during the annual principals' and school secretaries' workshop the first week in August also focused on computer education. Hardware, software, support services, and applications such as computer-managed instruction and word processing were presented in a number of sessions.

During the system-wide staff development activities during the week preceding the opening of classes this fall there were a number of sessions at all levels and in many subject areas. While a number of the sessions focused on the computer as the topic of instruction, a number of the sessions dealt with the computer as an adjunct to the instructional process.

A number of other staff development activities have also been developed utilizing other forms of technology. Several teleconferences have been conducted utilizing the facilities of WQOX-TV, the school system's television station which is a component of the Division of Vocational Education and is broadcast on Memphis Cablevision, Channel 30. On several occasions citizens have called in and participated in the teleconferences. Several other programs have also been developed by WQOX-TV focusing on staff development and also providing some community computer literacy as citizens in the community tune in to the telecasts. The programs have also been provided to the schools on video tape and many schools have taped the programs for utilization by faculty and students at their convenience. WKNO-TV, the public broadcasting station for the Memphis area, has also broadcast several programs including the "Adventures of the Mind" series and "The Computer Programme" series. Memphis City Schools System personnel assigned to WKNO-TV for instructional television services are currently producing a computer literacy series for students in grades four through eight for broadcast this fall. Many teachers at this point can also learn from the series.

The Division of Instructional Materials which operates a film library for the school system has identified a variety of 16mm films that are available for booking by the schools for faculty meetings as well as classes. Over-head transparencies and other materials are also being produced for teacher and student training.

A new feature in the monthly "Memphis City Schools Bulletin" is a full page on computer education. The "Bulletin" is distributed to all school system personnel and will feature items of an informational nature as well as news stories. A copy of the September issue is contained in Appendix B.

Memphis City Schools
September 29, 1983
Page 5

Institutions of higher education in the area have instituted a number of courses from a variety of perspectives. Ranging from general computer literacy to indepth programming the courses have been beneficial to many and confusing and threatening to others. Many teachers are enrolling in the courses without completely knowing the objective of the course and frequently enrolling in courses that are not consistent with what they need. There has also been a slight degree of confusion as teachers take a course utilizing a computer that is different from the computer that the teacher is using in the classroom. Some teachers have quickly made the adjustment while others have really struggled.

While a number of staff development services have been provided, the familiar saying, "The more people learn the more they find out there is to learn," has certainly been given new meaning. A growing number of requests are being received for additional staff development sessions dealing with word processing, hardware trouble shooting, BASIC programming, software evaluation, LOGO applications, applications in almost every subject area, etc. The Computer Education Steering Committee is currently exploring means to provide some of the training and instruction requested.

CURRICULUM DEVELOPMENT

The initial efforts at curriculum development were simply to develop brief outlines of the high school courses in order to apply for approval by the Tennessee Department of Education to offer the courses for credit toward graduation from high school. Initially the courses were offered in conjunction with the mathematics department, but not as true mathematics courses. As the mathematics textbooks came due for adoption, a committee of teachers further outlined the courses and looked more closely at the articulation of skills and knowledge from the first programming courses to the subsequent courses in order that appropriate textbooks might be adopted for the courses. No general courses in computer literacy were developed at this time, however. As a summer curriculum workshop was conducted in 1982 to revise the mathematics curriculum from kindergarten through the twelfth grade the high school "computer mathematics" courses were further reviewed and refined by the Division of Curriculum Development.

During the 1982-83 school year the Tennessee Department of Education was requested by the Tennessee Board of Education to develop consistent guidelines for special courses in computer science for school districts across the state. Mrs. Ann Erickson represented the Memphis City Schools System on that committee. The guidelines that were developed generally followed the sequence of courses already developed by the Memphis City Schools System. One additional course in computer literacy was identified by the state committee and was implemented in Memphis this fall.

Memphis City Schools
September 29, 1983
Page 6

The following courses are currently available:

COURSE	DURATION	CREDIT
Introduction to Computers	One Semester	1/2 Unit
BASIC Programming	One Semester	1/2 Unit
Advanced BASIC Programming	One Semester	1/2 Unit
FORTRAN Programming	One Semester	1/2 Unit
Pascal Programming	One Semester	1/2 Unit
Advanced Placement Computer Science	Two Semesters	1 Unit
Computer Literacy (not a formal class)	Time Available	None

The Computer Skills Next computer literacy curriculum developed by the Tennessee Department of Education constituted the curriculum for the Memphis City Schools junior high school program. Dr. David Moore participated in the development of the Tennessee curriculum and Mrs. Elizabeth Keenan represented the Memphis City Schools System on the writing committee that developed the Teachers' Guide. The curriculum consists of strands dealing with the history of computing, computer operations, computer applications, logic and problem solving, and social impact of computers in society.

The Division of Curriculum Development and the Curriculum Subcommittee of the Computer Education Steering Committee did develop a teachers' guide for the computer awareness program for the elementary schools of the school system since the Tennessee program started at the seventh grade level. Utilizing the same strands a variety of activities were developed for elementary teachers to assist students in the development of computer awareness. A copy of the Computer Awareness Teachers' Guide is attached as Appendix C. Since this is the first year of instruction for all elementary students there is no grade level specification of skills. Grade-level specific skills and concepts are being identified this school year and the guide will be revised prior to the 1983-84 school year based on teacher feedback.

As the revisions are made this year, greater efforts will be made to incorporate computer education into the general elementary curricula. Just as computers have become an integral part of our lives, computer education is becoming an integral part of the elementary curriculum and classroom.

FINANCING OF COMPUTER EDUCATION

A variety of sources were utilized in financing the computer education program. Both Chapter I and Chapter II funds have been utilized for portions of the program. The projected funding by the State of Tennessee for the Computer Skills Next Program was not approved by the state legislature and the equipment level of the junior high school program is less than had been recommended as a result of that reduction. State and Federal vocational monies have been utilized to purchase portions of the equipment for the vocational components of the computer education program. Additional monies in the school system's

Memphis City Schools
September 29, 1983
Page 7

operating budget for fiscal year 1983 and fiscal year 1984 have been set aside for computer education.

The district-wide program was developed to make computer education available throughout the city without regard to the financial status of the different school communities. Prior to the development of the district-wide program computer education was appearing primarily in the more affluent communities. To a certain degree those communities are continuing to supplement the equipment and materials provided in the district-wide program.

SCHOOL PLANT AND MAINTENANCE SUPPORT

A significant problem which was identified in the early stages of the computer education program was the need for additional wiring for the additional equipment. While many of the schools are utilizing a computer laboratory setting, the electrical service in most of the school buildings has not been adequate. As the equipment level continues to increase, additional wiring will also be needed.

The problem of equipment theft has also already surfaced. The school system utilizes an auditory detection system to monitor break-ins and vandalism. Several procedures are being considered to make the "portable" computers less portable.

Equipment repair has been undertaken to provide support to the schools. Technicians in the district's Audio Visual Repair Shop have been trained in the repair and servicing of the equipment and may be called by any school experiencing equipment problems.

EQUIPMENT CONFIGURATIONS

Three different computers have been selected for use in the computer education program. The equipment selected for utilization in the elementary program utilizes cartridge-type software for ease and speed of operation. As students become more familiar with simple programming, cassette recorders may be utilized to enable students to save short programs that the students have written. Each participating elementary school has received three to five microcomputers with color monitors. The number of microcomputers is based on the school's enrollment.

The junior high schools and the senior high schools are utilizing the same brand of computer primarily because almost one half of the senior high schools also include a junior high school. Each participating junior high school was issued five microcomputers with monochrome monitors. Four of the microcomputers have a single disk drive while one system has two disk drives. Each junior high school also received a printer. The senior high schools

Memphis City Schools
September 29, 1983
Page 8

received ten microcomputers with monochrome monitors. Nine of the systems have a single disk drive while one system has two disk drives. The senior high schools also received one printer.

The vocational office education laboratories received two to five business-type microcomputers each of which included two disk drives. One printer was also provided to each vocational office education laboratory. Current plans provide for the equipment level to be increased to five microcomputers for all vocational office education laboratories in the near future.

The computer-managed instruction program for the elementary and junior high schools consists of the same powerful, business-type microcomputer in participating school offices equipped with a high speed printer and an optical scanner. Memphis City Schools System personnel have developed the software for the system and will be adding enhancements to the system in the future.

SOFTWARE SUPPORT

The provision of software support is as crucial to the effectiveness of the computer education program as the provision of hardware support. While businesses and homes may operate satisfactorily with a small number of software packages, a typical school will need a library of software for different grade levels and subject areas. A significant concern is the cost of commercial software, especially for schools with computer laboratories with a large number of microcomputers. If only one microcomputer were utilized in a school, then one software package might be satisfactory for a given lesson. However, when ten microcomputers are in the same room and a computer disk costing twenty-five dollars or more is needed for each computer for class instruction, it does not take long for the cost of software to exceed the cost of the computer. While software development is a costly process, commercial software will soon be cost prohibitive unless some provisions can be made for multiple copies or licensing of the school district to reproduce the software on a fee basis.

The Memphis City Schools System has initiated a software center with some commercial software for teachers to come and examine before purchasing. The software center can reproduce the software produced through the Minnesota Educational Computing Consortium which has been obtained by the Tennessee Department of Education on a license basis. The Memphis City Schools System also has a licensing agreement with two companies to reproduce their disks for individual schools on a royalty basis.

FUTURE AGENDA ITEMS

The future is always more exciting than the past, and that is certainly the case for computer education. Future agenda items include the increase in

Memphis City Schools
September 29, 1983
Page 9

equipment support for the schools. A large number of staff development activities is a certainty covering a wide variety of topics. Increasing sophistication of both students and staff will provide opportunities for curriculum revisions, probably on an annual basis for some area of the computer education curriculum. Further incorporation of computer education in the general curriculum as well as incorporation of the equipment in all areas of instruction will be emerging. Further sophistication of the hardware and software as well as a better utilization of the media by teachers will make the computer an increasingly effective tool. Further developments in computer technology will prevent educators from being content with current hardware for any considerable period of time. Computer education or computer education for adults is another great opportunity to be addressed if adults are to keep pace with our youth. Rarely has a content area emerged of such significance with which the majority of the population is in need of education.

APPENDIX A

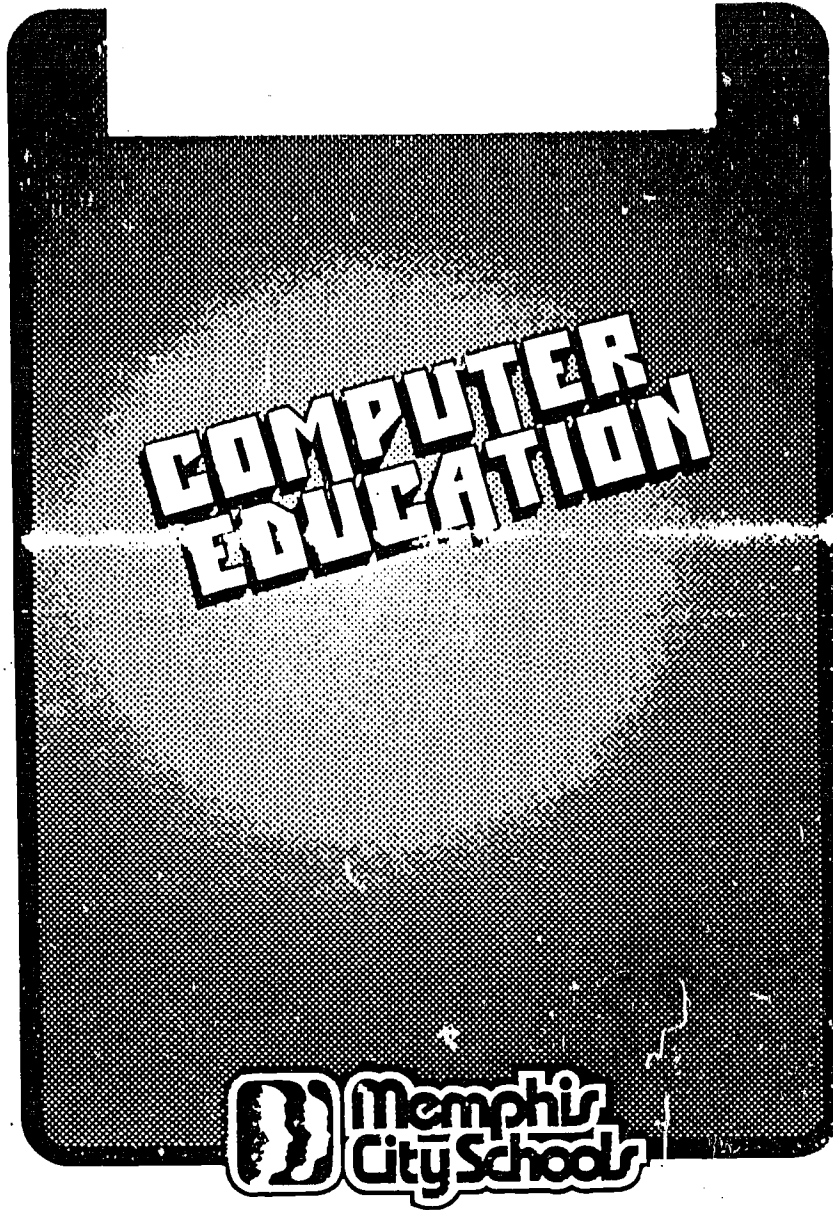

389

COMPUTER EDUCATION IMPLEMENTATION PLAN

FOR

MEMPHIS CITY SCHOOLS

GRADES K - 12

1983-84

Approved by the Memphis Board of Education
in open meeting, April 11, 1983.

393

C O N T E N T S

Introduction	ii
Chapter 1. COMPUTER AWARENESS	1
Chapter 2. COMPUTER ASSISTED INSTRUCTION	6
Chapter 3. BASIC SKILLS FIRST	9
Chapter 4. COMPUTER SKILLS NEXT	12
Chapter 5. HIGH SCHOOL SUBJECTS	16
Chapter 6. VOCATIONAL OFFICE EDUCATION	20
Chapter 7. VOCATIONAL CENTERS	24
Chapter 8. STAFF DEVELOPMENT	27
Chapter 9. SUMMARY AND RECOMMENDATIONS	29
Appendix	

INTRODUCTION

After careful research and planning, this plan providing for the immediate expansion of computer education in the Memphis City Schools is offered. The plan includes distinctive guidelines for elementary schools, junior high or middle schools, high schools, and vocational centers. The proposed program provides learning experiences which vary in terms of instructional difficulty and intensity based upon the instructional goals of each particular component.

The computer education programs presently operational in the system will be complimented, and in some cases expanded, in a coordinated fashion in concert with the new programs to be implemented. The basic mission of the plan is to provide practical implementation guidelines to give systemwide direction while allowing enough flexibility to meet the diverse needs found at the local school level. Staff Development is a vital area which is addressed in the plan; but the areas covered in previous plans, such as rationale and definition of terms, will not be repeated. The areas to be addressed will include: Computer Awareness, Computer Assisted Instruction, Basic Skills First, Computer Skills Next, High School Subjects, Vocational Office Education, Vocational Centers, and Staff Development.

To facilitate implementation and to aid in achieving systemwide participation, procedural guidelines that are not presently covered in Board Policy number 6123.1 will be utilized. A program proposal form (See Appendix A-1) has been devised as a guide for principals to indicate pertinent information such as program design, facilities, and trained staff members. The procedure of centralized planning and purchasing will be utilized for the purposes of this specific plan of implementation. This procedure will not require the principal to fill out the additional form entitled, "Use of Computer Request." The Computer Studies Articulation Committee will continue to be heavily involved in the purchase and use of computers.

CHAPTER ONE

COMPUTER AWARENESS

I. GOALS

The primary goal of the computer education plan for elementary schools is to provide elementary students, grades K-6, with computer awareness experiences. Computer Awareness includes a general knowledge of the components of a computer system, applications of computers, and terms utilized in talking about computers. Students will also develop the ability to operate, but not program, a simple computer system.

II. SCOPE

Currently, there are only a few elementary schools that are providing any computer awareness activities for their students. Under the computer education program, computer awareness activities would be made available to every elementary school wanting to participate. Each elementary school desiring to participate would be equipped with a mini-lab with three to five small microcomputer systems based on enrollment. The systems will be relatively simple with no printer and possibly no disk or tape drive. Programmed read-only memory modules for very limited applications are available for several of the very simple microcomputers.

III. PROCEDURES

Following an orientation, each principal who wishes to participate, will submit a proposal which will detail the program design and the location of the lab. One faculty member will be identified as a building resource person with the responsibility of assisting the remainder of the faculty and being the building

contact person to assist in local implementation of district-wide programs. While it is being suggested that the lab be placed in the library and the librarian serve as the building contact, there may be other arrangements that the principal may deem more appropriate.

IV. CURRICULUM

The Memphis City Schools' Staff has developed a scope and sequence of instructional objectives for Computer Awareness. Activities and resources to implement that curriculum are currently being identified. All schools will utilize the Memphis City Schools curriculum for Computer Awareness. As the software and hardware are identified for the implementation of this program, specifications will be developed for materials which have a high correlation to the curriculum and would supplement the curriculum.

V. TRAINING

The building resource person from each participating elementary school will participate in a two-day workshop to familiarize them with the computer awareness curriculum, materials and equipment. Training sessions will be scheduled for principals as needed. Arrangements are being finalized for a cable-broadcast teleconference on WQOX-TV for teachers at participating schools. The teleconference has tentatively been scheduled for Wednesday, August 24, 1983.

VI. TIMETABLE

Software and hardware identification are the primary initial tasks yet to be completed. Hardware and software should be identified prior to July 1, 1983, and delivery to participating schools will occur by August 15, with instruction commencing at the opening of school.

VII. HARDWARE COST

Participating schools will receive three to five small microcomputer systems based on enrollment. Specific software and hardware have not been identified, but there are several computer systems available for approximately \$500 including monitors and software. Software availability, cost, and simplicity of the computer system operation will be key factors in the hardware selection.

PROGRAM EVALUATION REVIEW TECHNIQUES (PERT)

PROGRAM TITLE: COMPUTER AWARENESS

PERT NO.	WHO	WHAT	WHEN
1.0	Computer Education	Principals' Orientation	April '83
1.1	Computer Education	Send Out Program Proposal Guidelines	April '83
1.2	Principal	Schools Submit Plan	May '83
1.3	Committee	Software Selection	April/May '83
1.4	Committee	Hardware Selection	April/May '83
1.5	Computer Education	Determine Programs	May '83
1.6	Purchasing	Purchase of Hardware	May '83
1.7	Staff Development	Training of School Resource Person	May/June '83
1.8	Curriculum Development	Standard Curriculum Developed	May/June '83
1.9	Purchasing	Purchase of Software	July '83
1.10	Staff Development	Training of Principals	August '83
1.11	Elem/Sec Education	Curriculum Distributed	August '83
1.12	Purchasing	Delivery of Hardware	August '83

PROGRAM EVALUATION REVIEW TECHNIQUES (PERT)

PROGRAM TITLE: COMPUTER AWARENESS

PERT NO.	WHO	WHAT	WHEN
1.13	Instructional Materials	Distribution of Software	August '83
1.14	Staff Development	Computer Teleconference	August '83
1.15	Computer Education	Follow-Up Training	As Requested

CHAPTER TWO

COMPUTER ASSISTED INSTRUCTION

I. GOALS

The goal of the Computer Assisted Instruction program is to provide subject oriented learning experiences for students while improving their computer literacy skills. This program can be effectively used for remediation and for enrichment, in addition to supplementing the regular instructional program.

II. SCOPE

The program is currently operating in twenty-six elementary schools and in sixteen secondary schools. Approximately, a total of two thousand five hundred fifty students have access to the elementary program and eleven hundred students have access to the secondary program. The hardware utilized in the program consists of four minicomputers, which drive thirty-two CRT terminals each for a terminal total of one hundred twenty-eight. There are no present plans for expansion of this program but the equipment could be used after school hours to supplement the adult education instructional program, and could be considered for summer school use.

III. PROCEDURES

This program is administered by the Division of Compensatory Education and is located in schools that qualify according to Chapter I guidelines. The terminals are located in the actual classroom which provides an opportunity for the classroom teacher to better structure the learning environment within a self-contained setting.

IV. CURRICULUM

The math curriculum utilized is furnished by Time-Share and is compatible with existing math instructional objectives.

V. HARDWARE COST

This program is financed by \$235,000 from Chapter I funds and will continue to operate at this level during 1983-84.

PROGRAM EVALUATION REVIEW TECHNIQUES (PEFT)

PROGRAM TITLE: COMPUTER ASSISTED INSTRUCTION

PERT NO.	WHO	WHAT	WHEN
2.0	Division of Compensatory Education	Review Location of Computers	April '83
2.1	Elem/Sec Education	Needs Assessment of Summer School	April '83
2.2	Vocational Education	Needs Assessment of Adult Education	April '83
2.3	Computer Education	Recommendations to Staff	May '83

CHAPTER THREE

BASIC SKILLS FIRST

I. GOALS

The goal of the Basic Skills First program is to improve student achievement in the areas of reading and mathematics. The use of microcomputers by teachers to manage each student's individual instructional program will make this goal more attainable.

II. SCOPE

The Basic Skills First program (Computer Managed Instruction) presently has the potential to be operational in forty schools. For the 1983-84 school year, fifty-five additional elementary principals have indicated an interest in adding the program. Each additional school added to the program will require an appropriate microcomputer with dual disk drives, a scanner and a printer.

III. PROCEDURES

Following an orientation, each elementary principal who wishes to participate in the program will submit a proposal listing such information as program organization, equipment location, and the identification of qualified staff participants.

IV. CURRICULUM

The curriculum is composed of thirteen hundred skills (objectives within strand) which were developed by the State Department of Education. These objectives are being correlated to

both the California Achievement Test and the school system's instructional objectives. By the fall of 1983, local modifications to this curriculum will be added to finalize the list of objectives.

V. TRAINING

All teachers involved in the computer managed basic skills first program will need training. The resource persons identified by the principals will receive five days of intensive training and will be available to work with other faculty members during in-service days at their respective schools. Training sessions will be scheduled for principals as needed.

VI. TIMETABLE

Hardware identification and procurement should be scheduled prior to July 1, 1983, and delivered to the participating schools during the months of January and February, 1984. The training of additional teachers or staff members who will be added to the program should be completed during the fall, 1983.

VII. HARDWARE COST

The hardware required for each additional school will cost approximately \$4500 and will require a total expenditure of \$247,500. Each participating elementary school would be equipped with one system consisting of a microcomputer with dual disk drives, a scanner, and a printer. Software development and compatibility will be key factors in the hardware selection.

PROGRAM EVALUATION REVIEW TECHNIQUES (PERT)

PROGRAM TITLE: BASIC SKILLS FIRST

PERT NO.	WHO	WHAT	WHEN
3.0	Computer Education	Principals' Orientation	April '83
3.1	Computer Education	Send Out Program Proposal Guidelines	April '83
3.2	Computer Division	Software Development	April-Aug. '83
3.3	Committee	Hardware Selection	April/May '83
3.4	Principal	Schools Submit Plan	May '83
3.5	Computer Education	Determine Programs	May '83
3.6	Purchasing	Purchase of Hardware	May '83
3.7	Staff Development	Training of Principals	Sept-Nov '83
3.8	Staff Development	Training of School Resource Person	Sept-Nov '83
3.9	Computer Division	Software Pilot-Tested	Sept-Nov '83
3.10	Purchasing	Delivery of Hardware	Jan/Feb '84
3.11	Computer Education	Follow-Up Training	As Requested

CHAPTER FOUR

COMPUTER SKILLS NEXT

I. GOALS

The program goal of the Computer Skills Next program is to provide computer literacy for all students in grades seven and eight. The Computer Skills Next program was initially developed by the Tennessee Department of Education. Students will learn about the applications and implications of computers in our society, how a computer operates, the components of a computer system, and the limitations of computers. Students will also learn problem-solving, flow-charting, algorithms, and a brief introduction to operating commands and programming statements.

II. SCOPE

Only a few junior high schools are currently providing computer literacy for seventh and eighth grade students. This computer education plan provides for implementation next year in the eighth grade of all schools identified for participation. Implementation in the seventh grade will occur the following year. With partial funding from the State, microcomputer labs will be placed in all participating schools, and each lab will consist of five microcomputers, monitors, and single disk drives.

III. PROCEDURES

Following an orientation, each principal who wishes to participate will submit a proposal which will detail the exact location of the computer lab including such factors as access and security. The proposal will also describe the requested approach to implement computer literacy, plus the identification of staff

members who are trained to lead computer instruction. The proposal will define the procedure for scheduling eighth grade students for fifteen hours of instruction, and will include information concerning facility needs.

IV. CURRICULUM

Software and other ancillary materials needed for the program are presently being identified. The school system has developed a scope and sequence of instructional objectives for the program incorporating the objectives of the Computer Skills Next program. Activities and resources to implement that curriculum are currently being identified, and the Memphis City Schools computer literacy curriculum will be utilized by all participating schools.

V. TRAINING

The Tennessee Department of Education will provide one week of training for one person from a portion of the participating schools. The school system will provide training for the school contact person at the remaining schools. While the State will also provide two additional days of training for the entire faculties at a portion of the participating schools, it will be the system's responsibility to provide similar training to the remaining personnel.

VI. TIMETABLE

The training of participants is scheduled for the fall of 1983 with the program implementation occurring January 1, 1984. Hardware will be delivered during the fall with set-up in the schools during December. Instruction would begin in January of all eighth grade students on a pull-out basis from other classes.

PROGRAM EVALUATION REVIEW TECHNIQUES (PERT)

PROGRAM TITLE: COMPUTER SKILLS NEXT

PERT NO.	WHO	WHAT	WHEN
4.0	Computer Education	Principals' Orientation	April '83
4.1	Computer Education	Send Out Program Proposal Guidelines	April '83
4.2	Committee	Hardware Selection	April/May '83
4.3	Principal	Schools Submit Plan	May '83
4.4	Computer Education	Determine Programs	May '83
4.5	Purchasing	Purchase of Hardware	May-July '83
4.6	State Department	Software Identification	May-July '83
4.7	Purchasing	Delivery of Hardware	Aug-Dec '83
4.8	Instructional Materials	Distribution of Software	Aug-Dec '83
4.9	Staff Development	Training of Principals	Aug-Dec '83
4.10	Staff Development	Training of School Resource Person	Aug-Dec '83
4.11	State Department	Training of Teachers	Sept-Dec '83
4.12	Computer Education	Follow-Up Training	As Requested

VII. HARDWARE COST

The cost of the five microcomputer systems for each lab will be approximately \$1836 per system. The total estimated hardware cost for the 1983-84 school year is \$367,000 and the contribution from the state is estimated at \$245,000.

CHAPTER FIVE
HIGH SCHOOL SUBJECTS

I. GOALS

Computer Education in grades 10-12 has two initial goals. There is a general goal of computer literacy for students in the upper grades who will not be able to participate in the Computer Skills Next program in grades seven and eight. The second goal is to more specifically provide computer related subjects to the segment of the student population which will need more specialized instruction.

II. SCOPE

Currently there is little being done in the area of computer literacy for high school students. Computer mathematics courses are currently being offered at approximately six high schools involving approximately five hundred students. Every participating high school will be equipped with a computer lab thus making the courses available to all students if space is available. Each lab would consist of microcomputers for nine student stations and one printer. This lab will afford the opportunity for principals to initiate credit subjects in computer math and literacy, plus computer literacy on a non-credit basis.

III. PROCEDURES

Following an orientation, each principal who wishes to participate will submit a proposal which will specify the location of the lab, the courses to be offered, and the teachers to be utilized. Teachers at the high school level should have had formal training in computer science to qualify them to teach the courses.

The proposal will also include the opportunity to express any additional training needs at the school level.

IV. CURRICULUM

The instructional program at each school will follow the Memphis City Schools curriculum for the computer literacy and the computer mathematics courses. Regular adopted textbooks are to be utilized for instruction, and as additional software and activities are developed, they will be made available to the schools.

V. TRAINING

The principal of each participating school will identify the teacher(s) who presently have or will secure formal training, thus qualifying them to instruct the courses. The proposal developed by the principal will also include the procedure for that school to provide computer literacy experiences for other staff members.

VI. TIMETABLE

Teachers wishing to teach the courses will have the summer to take formal course work in computer science if they have not already completed such training. Hardware will be purchased and delivered to the participating schools by August 15, 1983. Facility changes such as wiring will be made during the summer of 1983.

VII. HARDWARE

Microcomputers compatible with available, pertinent software materials will be selected. Each participating school would receive nine student stations and one printer at a total cost of approximately \$16,000 per lab. This hardware configuration will be necessary to meet state guidelines on the ratio of students to computers of 3:1 in the computer mathematics courses.

PROGRAM EVALUATION REVIEW TECHNIQUES (PERT)

PROGRAM TITLE: HIGH SCHOOL SUBJECTS

PERT NO.	WHO	WHAT	WHEN
5.0	Computer Education	Principals' Orientation	April '83
5.1	Computer Education	Send Out Program Proposal Guidelines	April '83
5.2	Principal	Schools Submit Plan	April '83
5.3	Committee	Hardware Selection	April/May '83
5.4	Computer Education	Determine Programs	May '83
5.5	Curriculum Development	Curriculum Developed Computer Literacy (Non-Credit)	May '83
5.6	Curriculum Development	Curriculum Developed Computer Literacy (Credit)	May '83
5.7	Committee	Software Selection	May/June '83
5.8	Purchasing	Purchase of Hardware	May '83
5.9	Purchasing	Purchase of Software	July '83
5.10	Elem/Sec Education	Curriculum for High School Subjects Distributed	August '83
5.11	Elem/Sec Education	State Approval Computer Literacy (Credit)	August '83

PROGRAM EVALUATION REVIEW TECHNIQUES (PERT)

PROGRAM TITLE: HIGH SCHOOL SUBJECTS

PERT NO.	WHO	WHAT	WHEN
5.12	Purchasing	Delivery of Hardware	August '83
5.13	Computer Education	Follow-Up Training	As Requested

CHAPTER SIX

VOCATIONAL OFFICE EDUCATION

I. GOALS

The program goal for computer education in vocational office education is to prepare students for job entry level positions in one or more office related areas. Word Processing, Data Entry, and Accounting will enable graduates to enter the job market with a higher level of skills and a better knowledge of office technology. A student should be able to secure an entry-level office position and transfer their knowledge of word processing functions to any brand of word processing equipment. The goal of computer training in accounting procedures is to supplement training in accounting basic concepts, principles, and data manipulation. The data entry component will provide skills for entering information into the computer which replaces the keypunch course.

II. SCOPE

Presently, fifty-five vocational office education programs are in thirty high schools and in six vocational-technical centers. For the 1983-84 school year eleven of the fifty-five programs will be equipped with five microcomputers and one printer while the remaining forty-four programs will be equipped with two microcomputers and one printer.

III. PROCEDURES

This plan provides for the location of microcomputers in all vocational office education labs. Computer technology, concepts and application will be integrated into the present curriculum.

IV. CURRICULUM

The present vocational office education curriculum includes training on the following equipment: electric typewriter, electronic memory typewriter, 10-key adding machine, calculating machine, machine transcription equipment (dictaphones), and keypunch machine. The keypunch instruction will be deleted to conform with proposed curriculum revisions. The State Department of Education is in the process of developing/updating the curriculum to include microcomputer training in word and data processing.

V. TRAINING

This summer, thirty vocational office education teachers will be offered training on microcomputers using accounting, data entry, and word processing software. This course will be offered for college credit, which will require the teacher to pay the normal Memphis State tuition, or for non-credit at no cost. Staff members from Memphis State will conduct a one week workshop with assistance from the school system's data processing instructors. Approximately twenty-five teachers have already completed the courses required for word and data processing endorsement. A short orientation course, using the equipment purchased, will be provided for these teachers.

VI. TIMETABLE

Forty hours of training will be scheduled for the thirty vocational office education teachers during the summer months at a vocational-technical center. The participating teachers will pre-register, and the training dates will be finalized by April 15. The selection of the hardware and software, utilizing available information, will be finalized, delivered, and installed at each school by August 15, 1983.

VII. HARDWARE COST

Fifty-five printers and one hundred forty-three microcomputers will be purchased for the fifty-five vocational office education labs. The state will provide \$269,000 of the estimated total cost of \$358,000.

PROGRAM EVALUATION REVIEW TECHNIQUES (PERT)

PROGRAM TITLE: VOCATIONAL OFFICE EDUCATION

PERT NO.	WHO	WHAT	WHEN
6.0	Computer Education	Principals' Orientation	April '83
6.1	Committee	Hardware Selection	April/May '83
6.2	Vocational Education	Training Dates Finalized	April '83
6.3	Committee	Software Selection	May/June '83
6.4	Purchasing	Purchase of Hardware	May '83
6.5	Vocational Education	Procurement of Curriculum from State Department	June '83
6.6	Purchasing	Purchase of Software	July '83
6.7	Vocational Education	Teacher Training	June-Aug '83
6.8	Purchasing	Delivery of Hardware	August '83
6.9	Vocational Education	Follow-Up Training	As Requested

CHAPTER SEVEN
VOCATIONAL CENTERS

I. GOALS

The program goal of Vocational Data Processing is to produce students with job entry level programmer trainee skills and to prepare students for entry into higher education courses leading to data processing/accounting careers.

II. SCOPE

Presently, data processing is offered in the three following schools: Craigmont High School, Trezevant Vocational-Technical Center and Southwest Vocational-Technical Center.

III. PROCEDURES

This plan adds Data Processing programs to the East Vocational-Technical Center and the Sheffield Vocational-Technical Center during the 1983-84 school year.

IV. CURRICULUM

The State and Memphis City Schools data processing curriculum will be restructured to include new programmatic changes including more emphasis on in-depth training in COBOL and business applications. The future plan is to expand data processing offerings to all vocational-technical centers, and to update equipment in the three present programs.

V. TRAINING

Prior to the 1983-84 school year, two data processing teachers will be trained for forty hours by Computer Division personnel to use the new equipment.

VI. TIMETABLE

The purchase, delivery, and installation of the required hardware will be completed by August 15, 1983. The software to be considered for selection will include BASIC, COBOL, and RPG, and it should be available in the labs by August 15th. The training of two instructors for the program will take place during the summer of 1983.

VII. HARDWARE COST

A computer lab will be equipped in each center. The lab will consist of computer equipment to provide eight work stations and one free standing microcomputer. The eight work stations will be connected to the Administration Building Computer Center by means of telephone lines. The total equipment and software cost is estimated to be \$100,000.

PROGRAM EVALUATION REVIEW TECHNIQUES (PERT)

PROGRAM TITLE: VOCATIONAL CENTERS

PERT NO.	WHO	WHAT	WHEN
7.0	Computer Education	Principals' Orientation	April '83
7.1	Committee	Hardware Selection	April '83
7.2	Computer Division	Technical Software Selection	April '83
7.3	Committee	Application Software Selection	May/June '83
7.4	Purchasing	Purchase of Hardware	May '83
7.5	Purchasing	Purchase of Technical and Application Software	June '83
7.6	Employment and Placement	Employ 2 DP Teachers	July '83
7.7	Computer Division	Training of Teachers	July/Aug '83
7.8	Purchasing	Delivery of Hardware	August '83
7.9	Vocational Division	Follow-Up Training	As Requested

CHAPTER EIGHT

STAFF DEVELOPMENT

I. GOALS

The goal of the staff development component of this plan is to adequately prepare the principals, consultants, teachers, librarians, and resource persons to assume their respective roles in providing meaningful computer education to their students.

II. SCOPE

The specific persons to be involved in the future computer education staff development workshops will be determined after the program proposals have been received and processed by the Office of Computer Education. The Division of Employee Services, the Computer Division, the Division of Elementary and Secondary Education, the Vocational Division, and the State Department of Education will all be heavily involved in a most ambitious staff development undertaking.

III. PROCEDURES

Principal orientation workshops for the elementary, junior high and senior high levels are already underway. The principals attending these sessions will be informed of the overall program philosophy, the potential course offerings, the available hardware, and the guidelines for submitting a program proposal. High priority will be given for staff development experiences to staff members who are implementing a new program in 1983-84. The staff members who will be scheduled prior to the next school year include: principals, instructional consultants, school resource persons, and teachers of specific course offerings.

PROGRAM EVALUATION REVIEW TECHNIQUES (PERT)

PROGRAM TITLE: STAFF DEVELOPMENT

PERT NO.	WHO	WHAT	WHEN
8.0	Computer Education	Principals' Orientation	April '83
8.1	Computer Education	Analyze Training Needs from School Proposal	May '83
8.2	Computer Education	Develop Training Modules for each Area	April/May '83
8.3	Staff Development	Schedule Training Sessions	May '83
8.4	Staff Development	Conduct Training Sessions	May-Dec '83
8.5	Computer Education	Follow-Up Training	As Requested

CHAPTER NINE

SUMMARY AND RECOMMENDATIONS

This implementation plan for the 1983-84 school year represents a bold beginning to a multi-year program designed to provide computer education experiences for all students of the Memphis City Schools. During the first operational year, an expansion plan will be formulated which will be based upon both the goals desired and the practical experience gained. Presently, other important factors remain to be addressed prior to the beginning of the upcoming school year.

A standard curriculum for each component of computer education offered in the school system except vocational education will be developed by the Division of Curriculum Development. For the K-6 Computer Awareness component, a first-year instructional module, featuring a sequence of objectives by grade, will be developed. A fifteen hour instructional module for the eighth grade Computer Literacy program will be designed, and the program will be expanded to include the seventh grade the following year. In the high school area, a one semester Computer Literacy curriculum will be developed in keeping with the proposed State curriculum frame-work, (credit and non-credit) and the curriculum for Computer Mathematics, Basic Programming, and Multi-Language Programming is being completed as a part of the mathematics curriculum revision.

The selection of appropriate hardware and software must be accomplished to make the plan fully operational. Technical seminars which will feature impartial experts in the field, and presentations by vendors are presently being scheduled to appear before the selection committee. Factors to consider in the selection of software include content, cost, adaptability to present hardware, and the direction to be taken in the future. Hardware needs are being studied using similar criteria, and the

committee will make recommendations to the Superintendent through the Deputy Superintendent.

The Division of Instructional Materials will continue to catalog, store and distribute software materials to the schools. The Division of Maintenance will expand the existing audio-visual repair shop to include microcomputers. The computer bid specifications will require the successful bidder to sell parts and furnish training for the appropriate maintenance employees. The cost of the hardware to be purchased the first year for all components of the plan will total approximately \$1,982,000. An equipment cost summary and a breakdown depicting the source of funding appears later in Appendix A-2 and A-3.

To help ensure the success of this program, the following recommendations are offered for consideration.

1. The Memphis Board of Education and the Superintendent and Staff will continue to support the commitment to offer computer education experiences for all students.
2. A blue ribbon steering committee composed of business leaders associated with computer science will be organized to help give the total computer education program direction and support.
3. A Director of Computer Education will be appointed to give the program systemwide direction, to work with Area Superintendents and principals in the implementation of the program and to serve as the contact person and clearinghouse for the support services in cooperating departments. The present involvement in computer education by the Division of Elementary and Secondary Education, the Division of Curriculum Development, the Division of Instructional Materials, the Division of Computer Services,

the Division of Vocational Education, and the Division of Employee Services will continue but coordination of the services will be performed by the Office of Computer Education. This position will report to the Superintendent through the Deputy Superintendent.

4. An effort will be made to solicit grants and gifts from business and industry to supplement the hardware and software purchased for the program.
5. A close association will be maintained with the State Department of Education, especially during the planning, training and implementation phases of Computer Skills Next.
6. The program proposals and the request for additional services will be forwarded from the schools through the Area Offices to the Office of Computer Education for disposition.
7. The Office of Computer Education will work with the Department of Pupil Services to plan for a computerized career information system for each secondary guidance center in the school system.

In conclusion, this plan provides for the immediate expansion of computer education in the Memphis City Schools. Conceivably, all elementary students (K-6), all eighth grade students, and the high school students who elect to sign up for a high school subject will be served. The specific instructional areas of expansion will include: Computer Awareness, Computer Assisted Instruction, Basic Skills First, Computer Skills Next, Computer Literacy, Computer Mathematics, Vocational Office Education, and Data Processing. The creation of the Office of Computer Education will facilitate the coordination and implementation of this comprehensive plan.

APPENDIX
PROGRAM PROPOSAL PLAN

- I. School Name:
- II. Principal:
- III. Program Title (limited to programs included in principals orientation):
- IV. Plan:
 - A. Program Description/Organization (number of students, mechanics of program, instructor)
 - B. Facilities(program location with special needs such as outlets)
 - C. Personnel (responsible for teaching subjects(s) and qualifications)
- V. Training:
 - A. Name and assignment of Resource Person (comprehensive training will be provided for one resource person from each school)
 - B. Additional Training Needs (Indicate your training needs for both systemwide and school level staff development)

EQUIPMENT COST SUMMARY

PROGRAM DESCRIPTION	NUMBER OF COMPUTERS	COST PER UNIT	TOTAL COST
COMPUTER AWARENESS	358	\$ 500	\$ 179,000
COMPUTER ASSISTED INSTRUCTION			235,000*
BASIC SKILLS FIRST	55	4,500	247,000
COMPUTER SKILLS NEXT	200	1,836	367,000
HIGH SCHOOL SUBJECTS	270	1,836	496,000
VOCATIONAL OFFICE	143	2,500	358,000
VOCATIONAL CENTERS	<u>2</u>	<u>2,500</u>	<u>100,000</u> **
TOTALS	<u>1,028</u>		<u>\$1,982,000</u>

*Continuation of Present program

**Remainder of this amount is for CRT's, printers, and software to be connected to the central office computer.

A-2

SOURCE OF FUNDING

CHAPTER I (CAI)	\$ 235,000
COMPUTER SKILLS NEXT	245,000
1982-83 CHAPTER II	100,000
1983-84 CHAPTER II	650,000
VOCATIONAL - STATE	269,000
VOCATIONAL - FEDERAL	89,000
BUDGET - FY 83	294,000
BUDGET - FY 84	<u>100,000</u>
TOTAL	<u><u>\$1,982,000</u></u>

Memphis City Schools Bulletin

Memphis, Tennessee

APPENDIX B

September, 1983

Positive Attitudes



Superintendent Hesteron on you

Take a good close look at your attitudes. Perhaps changes are in order. Take positive steps to pursue new activities and interests. Involve yourself more with others. Decide to make significant progress in your dealings with students. Attach a high value to your services.

Approaching a new school year with great expectations can be the key factor to success.

If we make up our minds to move into our work with positive attitudes, for a good year - chances are it WILL be a good year!

W. W. Hesteron

MIXED REACTIONS HEARD ON MERIT PAY — Public demands to upgrade teaching have lent such momentum to merit pay proposals that even the staunchest opponents - teacher organizations - are offering only muted criticism. At congressional hearings recently, the question was not whether merit pay should be offered, but how it should be implemented.

"It will be very difficult for any state to have a superior school system without changing the salary system," said Tennessee Gov. Lamar Alexander, whose merit pay plan was defeated in the state legislature after intense union lobbying. But he plans to try again this fall with greater participation from the Tennessee Education Association. "You'll find governors all over the country willing to stick their necks out over innovative pay plans," he said.

— (Education USA)



NATIVE COSTUMES — These young ladies at Oakhaven High School wore the traditional dress of their native countries during International Week. From left: Mu Heu - Hmong (Lao dress); Chan Theu Kim, Soda Ly and Kim Tou Lim, all Cambodian; and Chandy Yang - Hmong. Highlights of the event were translations of messages in four Southeast Asian languages: Laotian, Khmer, Hmong, Vietnamese, Spanish, Latin and French.

5 Principals Selected For Danforth Program

The Memphis City School System has been selected as one of five systems in the nation to participate in The Danforth School Administrators Fellowship Program during the 1983-84 school year. The purpose of The Danforth Program is to provide opportunities for continued professional growth and development of urban secondary school administrators. The Danforth Foundation pays for all expenses connected with the program.

Secondary principals selected to participate in The Danforth Program are: Mr. LaVaughn Bridges, Principal, Meirosa High School; Mr. Don Colley, Principal, White Station High School; Dr. Don Jones, Principal, Ridgeway High School; Dr. Ada Jana Walters, Principal, Craigmont High School; and Mr. Dan Ward, Principal, Fairley High School.

Make-Up Sessions Faculty/In-Service

These make-up sessions, which are equivalent to one-half (1/2) day of inservice each, will be provided for those who have been absent for an approved reason on a scheduled faculty/in-service day. The dates for make-ups for the first semester are:

Mon., Sept. 19 — 4:7 p.m. —

Arways Jr. High

Thurs., Oct. 13 — 4:7 p.m. —

Board of Education Auditorium

Thurs., Oct. 27 — 4:7 p.m. —

Board of Education Auditorium

Tues., Nov. 15 — 4:7 p.m. —

Board of Education Auditorium

It will be the teacher's responsibility to arrange to attend the sessions by contacting the Division of Employee Services (454-5441). Teachers are also expected to make up days missed for approved absences as soon as possible.

Computers! Computers! Everywhere! — Page 5

EDUCATION RANKS HIGH IN PDLL — Education ranks second to unemployment as the most important issue in the 1984 presidential campaign, according to a Gallup Poll. Less than one-third of the 780 adults surveyed said they approve of the way President Reagan is handling education. About 45 percent disapproved, while 23 percent had no opinion, the poll showed. Of the education issues Reagan is promoting, merit pay rated highest with 80 percent of those polled approving it. The same percentage said more money should go to public education and teacher training, although only slightly more than half would be willing to pay higher taxes for such improvements. A constitutional amendment to permit prayer in public schools also was highly favored, and respondents split on tuition tax credits.

— (Education, U.S.A.)

In Memoriam

MRS ERMA JOHNSON JAMES
Retired Teacher
Chicago Park
June 1, 1983

MRS ROSE D. MILLER
Retired Teacher
East High
June 6, 1983

MRS NATALEE DEAN
Teacher
South Side
June 10, 1983

MRS FLORINE BELL MILLER
Retired Teacher
Snowden Jr. High
June 22, 1983

MRS ANNETTE B. MCFIELD
Retired Teacher
Lee's Elementary
June 30, 1983

MISS MAXINE SMITH
Retired Teacher
Messick High
July 11, 1983

MRS ELIZABETH P. WHARTON
Retired Teacher
Brookmeade
July 12, 1983



FAMILIAR FIGURE — He can be seen at many Memphis City Schools functions playing the piano or in a band or practically anything to do with music. His name is Melie Gartrell. He is a great hand for this, and we appreciate him!



September Calendar

- 1—Memphis Council PTA School of Information, 9 a.m. Bd. Aud.
- 2—Time Reports Due by 4 p.m.
- 5—LABOR DAY HOLIDAY
- 8-9—Rosh Hashanah
- 9—PAY DAY, ALL EMPLOYEES
- 13—MEA Faculty Rep. Assembly
- 15—Memphis Council PTA Ex. Bd., 10 a.m.
- 16—Time Reports Due by 4 p.m.
- 17—Yom Kippur
- 19-22—Cellarone Achievement Tests, Fall Testing
- 21—Joint Meeting, Principals Ex. Bd. & Supls. Ex. Coun.
- 23—PAY DAY ALL EMPLOYEES
- MID-SOUTH FAIR STUDENT HOLIDAY
- STAFF DEVELOPMENT DAY FOR TEACHERS
- 26—Supervising Building Engineers Mtg., 1 p.m. Bd. Aud.
- 28—Adoptees of Adopt-A-School Program Sharing and Learning Session, 8-10 a.m. Bd. Aud.
- 29-30—Time Reports Due by 4 p.m.

Everywhere and at all times it is in your power to behave justly to those who are about you.

— Marcus Antonius

Reflections

The man who lives for himself is a failure. The man who lives for others has achieved true success.

— Norman Vincent Peete

BROOKS ART GALLERY TOURS — Education tours are available at the Brooks Museum of Art Tuesdays through Fridays from 10 a.m. to 5 p.m. Admission is free. To set up tours, call 726-5266. Outreach in the Classroom activities are conducted on the first and third Wednesdays of the month. Museum Muppets is for grades K-2 and Art Appreciation for grades 3-6.

MEMPHIS BOARD OF EDUCATION

Mrs. Bert Prosser, President, Carl Johnson, Vice President, James Blackburn, George Brown, Jr., Dr. Maureen, Mrs. Maureen Smith, Dr. Tom Stern, Mrs. Juanita Walkins, Dr. J. C. Williams, Commissioners

STAFF

Dr. W. W. Herenton, Superintendent; Ray Holt, Deputy Superintendent; Business Services: Area Superintendents: Callie L. Stevens, District I; Quenne McCormick, District II; Dr. B. Sweet, District III; Billy Evans, District IV; Dr. Gene Oles, Asst. Superintendent, Personnel Services; Sara L. Lewis, Asst. Superintendent, Curriculum and Instruction; Lee Thompson, Asst. Superintendent, Plant Management; Dick Walker, Asst. Superintendent, Business Affairs; and Johnnie Watson, Asst. Superintendent, Pupil Services.



Published monthly during the regular school session by the Board of Education, Memphis City Schools, 2597 Avery Avenue, Memphis, Tennessee 38112. Division of Public Information, Community Involvement, and Race Relations — Robert Simonton, Editor.

K-12 Social Studies CD Program Begins

With a reduced budget the goals of the social studies curriculum development workshop were revised to include the development of the course description, course goals, strands, units, and objectives for each grade subject area in social studies K-12.

Operating on a reduced budget this past summer, fifteen teachers, elementary and secondary, worked for five hours per day from July 18 - August 4 in the Curriculum Lab at Fairview Junior High School. The days worked varied from eight days for two teachers to fourteen days for others, depending on the assignment of subjects to the teachers. Each teacher was selected for his/her certification versatility allowing each teacher to work across subject areas in the social studies.

These teachers were outstanding in their knowledge of content, methodology, and writing ability. They worked beyond the hours, they were paid for, and worked cooperatively to reach the goals set for the workshop. The workshop goals were reached because of the dedication, hard work, and professional expertise of the teachers who are to be commended.

Area consultants worked with the lead curriculum consultant, Dr. Catherine Pickle daily. Mrs. Ann Lundgren and Mrs. Vivian Dismont worked directly with the elementary teachers with periodic support from Mrs. Ann Foreman when her schedule permitted.

At the secondary level, Mr. Tommie Conn worked with the secondary teachers each day. Curriculum development activities necessitate the involvement of content specialists. Teachers were taught how to organize content and develop objectives using the webbing technique.

Mrs. Dorothy Evans, research consultant, presented an overview of the study of the social studies curriculum which enabled the teachers to know where areas of weaknesses lay in the present curriculum and how to remedy those weaknesses.

Mrs. Barbara Jones, Curriculum Division Director, welcomed teachers to the curriculum writing arena, and Mrs. Sara Lewis, Assistant Superintendent of the Department of Curriculum and Instruction, visited the teachers and offered her support and appreciation.

There is no remainder of completion or form or behavior, like the wish to scatter joy and not pass around us.

—Ralph Waldo Emerson



THEY'RE THE GREATEST! — Administrative Clerical Personnel Employees of the year for 1982-83 being congratulated by Supl. Hixenon are, from left: Mrs. Patsy Soro, secretary - Division of Employment and Placement - Honorable Mention; Mrs. Opal Lindsay, secretary to the Board of Education - retired in June; Employee of the Year; and Mrs. Claudette White, offset printer in the Division of Compensatory Education - Honorable Mention. These outstanding employees were elected by their peers in an event which is slated to be an annual affair.

Preventive Maintenance Program is Established

The Division of Plant Operations has initiated a preventive maintenance program which is designed to provide a systematic way of helping to prevent major breakdowns within the mechanical systems in each school, as well as other component parts of the building. The preventive maintenance system is designed to provide a method whereby the Supervising Building Engineers must inspect specific items on a scheduled basis, and then indicate the time on which the item was inspected.

The Supervising Building Engineer will correct the deficiencies found provided the deficiencies are not major in nature. If the Supervising Building Engineer finds that repairs are needed, then such repairs will be requested by requisition from the Division of Plant Maintenance.

The preventive maintenance program will be monitored at the same time that some of our inspections are conducted in each of the buildings. This system should serve to improve the operations of the schools and save considerable monies which can then be used for other items.

Congress has adopted a first budget resolution that would increase funding for Educational Development programs by about \$1 billion over fiscal 1983 for a total of \$16.1 billion.

Clerical Committee Selected

The Administrative Clerical Committee has been named for 1983-1984 following an election by administrative clerical personnel.

The committee includes Ann Howard, Administrative Information System; Brenda King, Division of Research Services; One-Lyrie, Public Information, Community Involvement and Race Relations; Sandy Rice, Division of Security; and Linda Ward, Division of Employee Services.

English Teachers Set Peabody Meet Oct. 1

"Basics and Beyond - from the Delta to the Smokies" is the theme of the Tennessee Council of Teachers of English meeting scheduled for the Hotel Peabody on Oct. 1. The event is co-sponsored by the Shelby-Memphis Council of Teachers of English.

Registration is now being accepted for the meeting - contact Julia Nichols at Craigmont High School, Adrian McClaren, North Area Consultant, is program director and coordinators are Dr. June Rose Richey, Memphis State, and Frances Haynes, Shelby County.

The English teachers will convene at 8:30 a.m. and the meeting will continue throughout the day.

Eighteen writing achievement awards will be presented to students of English from around the state.

We're Proud of You!

WHITE STATION HIGH SCHOOL'S team placed first in the Tennessee Mock Trial Competition Finals at Nashville. This is the second year they have placed first in the state. Central High placed third. All expenses for the teams were paid by the Tennessee Bar Association and the Memphis Young Lawyers Association.

Memphis City Schools had three top winners in the Congressional Art Show. First Place - Lorenzo Spikes of Overton - LINDA GIBSON, teacher. Second Place - Bill Kimbrell of Trezevant - SANDRA SHORT, teacher. and Third Place - Lonnie Robinson of Overton - LINDA GIBSON, teacher. The first place winners were in the National Congressional Show in Washington, second and third place winners will be exhibited in Congressman Harold Ford's Washington office.

LORRAINE WILLIS, first grade teacher at Idlewild Elementary, has received a Recognition of Service Award for 1983 from the Association for Childhood Education International (ACEI). In bestowing this award ACEI recognizes Ms. Willis for her service to children and for actively promoting the goals of this association.

DICK WALKER, Assistant Superintendent of Business Affairs, has been elected as a Director to the Board of the National Association of Accountants. He is a Past President of the Memphis Chapter of the Association, the 1982 Past Chairman of the Tennessee Valley Council of the Association and last year received the coveted Harry Cannon Distinguished Service Award from the Memphis Chapter. He is also the immediate Past President of the Tennessee Association of School Business Officials.

ROLLIN KOCISIS, art instructor at Corry Junior High, has had several articles published recently in art journals. Four articles were published by *School Arts* and one by *Arts Activities*. He had an article in the July issue of *Art and Craft*, published in Warwickshire, England.

LORE H. HISKEY, American History and Humanities teacher at Central High, was awarded a \$3,000 fellowship by the Council for Basic Education. The award was made possible through a grant from the National Endowment for the Humanities for outstanding high school teachers. Mrs. Hiskey also received the William Coe Fellowship to study American History at Stanford University (California) during the summer.

JULIE ERVIN of Snowden School and DIANE JONES of Wooddale High, are to be commended for having students win first

places in the Tennessee History Day competition at Middle Tennessee State University. Anant Shah, twelfth grader at Wooddale, won the senior division media presentation category with a slide/tape presentation. Ethan Baer, eighth grader at Snowden, won the junior division historical paper award. These two students had previously been winners in the district competition at Memphis State and represented Tennessee at National History Day in Washington.

BETTY KRONE, resource teacher for hearing impaired students at White Station Elementary, received both the Memphis and Tennessee Councils for the Hearing Impaired Distinguished Service Awards this year.

CARL JOHNSON, a member of the Board of Education, has been re-appointed regional coordinator of the Tennessee Legislative Network (TLN) for Memphis-Delta Developmental district. The Tennessee Legislative Network is a function of the Tennessee School Boards Association, an organization of school boards throughout the state. The TLN develops legislative priorities within the scope of resolutions and positions adopted by the TSBAs Delegate Assembly and coordinates legislative activities to accomplish the priorities.

WILLIAM D. READ, Librarian at the Campus School, and MRS. VERNISTEEN SIMON, Librarian at Hamilton Elementary, were recently selected as committee members of the Tennessee Library Association Tennessee Children's Choice Book Award for the 1983-1984 year. The committee is composed of 15 members representing school librarians, public librarians and library educators from Tennessee.



VISITORS FROM AFRICA — Several educators from the Republic of South Africa were recent visitors in the Memphis City Schools. Here, they chat with Supt. Herenton about differences in education structures in Africa and the U.S. They visited several schools and administrative offices during their tour in Memphis.

(Photo by Don Huxton)

For the past six years, MRS. OLA MILLER, teacher of Cosmetology, at Northside High School, and MRS. EVA D. WESTBROOK, teacher of T.M.R. III-1, at Klondike Elementary School, have been cooperating with each other. Mrs. Miller's students shampoo and style the hair of Mrs. Westbrook's students, once every other week. Both classes of students benefit from this cooperation. Mrs. Miller's students gain experience in the field of Cosmetology, while Mrs. Westbrook's students grow in Social Relations at the same time they are learning to be well groomed.

Zoe Murray, SNOWDEN SCHOOL, Rhonda Rowland, COLONIAL JUNIOR HIGH and Pae Faudree, WHITE STATION HIGH have been chosen winners in Libertyland's "What America Means To Me" contest. The winners and their teachers were guests of Libertyland to hear the essays read on the public address system.

TOM SCRUGGS, computer teacher at East High, has received a certificate of merit from "Electronic Learning" magazine for outstanding classroom accomplishments in educational technology.

WHITNEY ELEMENTARY SCHOOL 5th and 6th graders participated in a story writing contest. It required collaboration between an author and illustrator. Louis Nelson, a Whitney parent and creator of the Uncle Louie series, initiated the project and rewarded the winners with copies of his book.

The winners were Ricky Ballard, Paul Sanders, Fonde Paschall, Marion McClure, Tamika Coleman, Daphne Hall, Matthew Hagey and Timothy Bell.

MRS. RUBY PAYNE, 6th grade teacher and MARGARET DIXON, Chapter I counselor coordinated the activity.

BYTE LINE - COMPUTERS IN THE NEWS

Computers! Computers! Everywhere!

It may just seem that way, but many Memphis City Schools' employees are being surrounded by computers. In fact over nine hundred and sixty computers have been delivered since June 15 and there are more to come! Perhaps a count by instructional program will help everyone understand just what is to be used where, by whom, for what???

The elementary computer awareness program is using the TI (Texas Instruments) 99/4A microcomputer with a Commodore color monitor. Each participating elementary school has received three, four, or five computer systems depending on the school's enrollment. Appropriate software and other instructional materials are also being provided to the schools to support the computer awareness instruction.

The junior high level program generally follows the Tennessee Department of Education's Computer Skills Next program. A part of Governor Alexander's Better Schools Program Computer Skills Next is, initially, a fifteen hour instructional program in computer literacy. A second fifteen hour program is currently being planned as a sequel to the initial program. Participating schools have received five Franklin Ace 1000 microcomputer systems with NEC monitors. Four of the Franklin systems have one disk drive while one system has dual disk drives and an Epson MX 100 dot matrix impact printer.

Each high school has also installed a microcomputer laboratory for use in teaching computer literacy and/or courses in computer programming. Each laboratory has ten Franklin Ace 1000 systems and NEC monitors. Nine systems have single disk drive while the tenth system has dual disk drives and either an Epson MX 1000 printer or an Okidata 92 printer.

Vocational office education classes will be using TI PCs (Texas Instruments Professional Computers) to teach word processing and general ledger accounting classes. Two vocational technical centers are receiving terminals to connect to the IBM mainframe at the Administration Building.

Basic Skills First computers utilized last year are being upgraded this year with the faster Okidata 92 Printers this fall and replacement of the Apple II microcomputers at the end of the fall semester with the TI PC mentioned above. The Okidata 92 has a sixty percent faster print speed and the TI PC has four times the memory and more than twice the disk capacity of the Apple currently being used.

The summer has been, indeed, busy as the four vendors have moved around the city followed by, or in front of, the electricians installing the wiring to power the equipment. The only people who possibly may have been more active have been principals and teachers who have been trying to learn how to use all the equipment.

MCS Byte's Into Computer Education

On April 11, 1983, the Memphis Board of Education approved the Computer Education Implementation Plan for Memphis City Schools thus setting in motion numerous activities. The goal of computer education for all students grades K-12 has been set a year earlier by Dr. Herenton and the Board of Education.

A Computer Education Steering Committee has been established to coordinate the various areas of the program. Dr. David Moore, Director of Computer Education, is the chairman of the committee and has responsibility for hardware coordination. Mr. Cliff Burdick, Director of Plant Maintenance, has responsibility for facilities support and equipment maintenance. Mr. Bob Hendrix, Director of Elementary Secondary Education, represents the BSF program. Mrs. Barbara Jones, Director of Curriculum Development, has responsibility for curriculum implementation. Mr. Stan Pruett, Director of Instructional Materials, has responsibility for software and related instructional materials. Mr. Franklin Schroer, Director of Vocational Education, coordinates the vocational computing operations and Mr. Bobby Young, Director of Employee Services, facilitates the computer staff development activities. Mr. Ray Hill is an ex-officio member of the committee. Mrs. Norma Jones is also assisting the committee in the coordination of the overall program.

The Computer Education Program incorporates seven smaller programs spanning all grades and potentially involving all schools. The Computer Awareness Program is the initial instructional program for students in grades kindergarten through grade six. Computer Skills Next is the junior high program which initially involves mostly eighth graders introduction to Computers and a variety of programming courses are available to high school students. Vocational office education students will be introduced to computers for word process-

Press The "H" Key For Help

As the school year begins many teachers, principals, and other personnel will be working with computer equipment which may be unfamiliar to them. There are several suggestions that might be useful for people to remember when problems are encountered.

- 1 Read the user's manual and follow directions. As simple as that may sound answers to problems and questions are not unique with you and frequently have been answered by the manufacturer.
- 2 Experiment if you encounter a software problem (the program does not operate the way it should). The Apple user's manual states that you can not hurt the computer by typing anything on the keyboard unless you are using a hammer. The Division of Instructional Materials (454-5244) may be able to assist you if they are familiar with or have a copy of the particular program you are using.
- 3 Hardware or equipment problems may be resolved by calling the Audio Visual Shop of the Maintenance Division (454-5556). A technician will discuss the problem with you by telephone and make suggestions. If all else fails, a MCS technician will be dispatched to your school to make the repair or take the equipment to the shop for repair.

REMEMBER - the best way to solve a problem is to prevent the problem by reading the manual, following instructions and taking care of your equipment and especially taking care of your software. The software is far more delicate than the hardware. If you have further questions, please call the Division of Computer Education at 454-5409.

ing and general ledger accounting programs while students at East and Sheffield Vocational Technical Centers will utilize terminals of the Memphis City Schools mainframe computer to learn programming in a vocational setting.

A variety of staff development activities have been conducted for teachers, secretaries, principals, consultants and other administrators. Many more staff development opportunities are being planned to increase the computer awareness literacy of Memphis City Schools employees.



GALLERY GRAND OPENING — The recent opening of The Lloyd C. McDougal Gallery of Art at Central High featured outstanding works by student artists and drew a large crowd of interested friends and patrons. Mr. Lloyd C. McDougal, assistant principal at Central, is pictured at left with his wife, Carolyn North, Area PE consultant. At right are Bill Hicks, Central art instructor, and Bettye Pittman, art consultant.

Employee Assistance Enters Second Year

The Memphis City Schools Employee Assistance Program (EAP) was initiated last year for principals, teachers, administrators, and clerical staff to provide professional and **CONFIDENTIAL** assistance to employees and their immediate family members. These services in the form of information or counseling are provided by Occupational and Family Counseling Services, located at 4466 Plaza Building, Bldg. in the First Memphis Plaza Building. Participation is confidential and does not affect an employee's job or become a part of the personnel file.

New descriptive brochures will be distributed this month for the 1983-84 year. In addition, counselors are available to all schools for short presentations on the program and to show a film entitled "Somewhere to Turn" based on a similar urban school system EAP.

For more information regarding the program, contact EAP counselors directly at 332-6084.

DO YOU WRITE POETRY? Maybe you have some old poems stuck back in a dresser drawer. Or hidden up in the attic. Now is your chance! To win contest money and have your poems published.

The Mid South Poetry Festival will be in Memphis, Oct. 14-16, sponsored by the Poetry Society of Tennessee.

The contest deadline is Sept. 15. There are 27 categories, with prize money of more than \$450. Winning poems will be published in the Tennessee Voices anthology.

To receive information on the contest and to take contact one of the codirectors: Lela Mae Atkins, 394-4881 or Mildred Boynton, 394-7281.

STAFF DEVELOPMENT CALENDAR 1983-84

FRIDAY	September 23	Staff Development Day (School)	8 a.m. - 3 p.m.
FRIDAY	October 7	Staff Development Day (WTEA)	8 a.m. - 3 p.m.
MONDAY	October 31	Staff Development Day (School - CAT)	8 a.m. - 3 p.m.
FRIDAY	January 20	Staff Development Day (Consultant)	8 a.m. - 3 p.m.
MONDAY	January 23	Staff Development Day (School)	8 a.m. - 3 p.m.
MONDAY	March 5	Staff Development Day (School) (Optional Day)	8 a.m. - 3 p.m.

Tuesday, January 24, and Tuesday, June 5, have been designated as Records Days. No staff development activities are required on these days and those absent on Records Days cannot make them up.

The faculty day on October 31 is scheduled primarily for the purpose of reviewing and analyzing student test scores on the CAT and for planning future instruction to meet the needs indicated. Other activities will have to be developed for secondary teachers not involved with CAT.

Monday, March 5, has been designated as an optional day. Teachers who have participated outside of regular school hours, in certain selected activities may be excused from attendance on that day. Those activities are:

- A. Completion of a 3-quarter hour or a 3-semester hour college credit course in:
 1. content areas directly related to one's area of certification or teaching assignment
 2. course which specifically relates to a system-wide or school objective (Prior approval of the course must be obtained from the principal)
- B. A minimum of seven (7) hours of participation in:
 1. Local school studies for SACS evaluation
 2. Approved area-wide system-wide committees (e.g. textbook adoption, curriculum development, etc.)
 3. Training that is required for a system area approved program (e.g. Computer Literacy, Basic Skills First, IPEL, etc.)

Several make-up sessions for approved absences on the in-service days will be provided during the school year. The dates for these sessions will be announced later and will be published monthly in the Superintendent's Bulletin.

Bus Safety Films To Air

WKNO Channel 10 will air two SCHOOL BUS SAFETY programs aimed at primary and upper level grades.

The primary level SCHOOL BUS SAFETY program is 15 minutes in length and includes a five minute video program, "Bus Not." The program deals with basic school bus rules and behavior and presents a message from Vernon Grose, Supervisor of the Division of Transportation, Memphis City Schools. This special program should be viewed and discussed with all primary students only each semester as partial fulfillment of the law requiring school bus safety instruction. September air dates are Wednesdays 21 and 28 at 12:15 p.m. Thursdays 22 and 29 at 2:45 p.m.

SCHOOL BUS SAFETY aimed at grades 4-12 is a 30 minute program which includes an 18 minute video program, "The Panic Factor."

"The Panic Factor" will deal with human reactions in emergency situations. A message from Vernon Grose, Supervisor of the Division of Transportation, Memphis City Schools, will be included in this program. This special SCHOOL BUS SAFETY program may be recorded for convenience viewing. It should be viewed and discussed with all students once each semester as partial fulfillment of the law requiring school bus safety. This semester the program will air Sept. 20 at 9:00 a.m. and Sept. 23 at 11:45 a.m.

Both SCHOOL BUS SAFETY programs will air as part of the WKNO ITV schedule.

HAVE YOU EVER WISHED that you could work toward a college degree or take a college course but were prevented by your work schedule or family responsibilities from attending classes? The college credit courses which Shelby State and Memphis State will offer this fall using television and independent study may be a way for you to meet your personal aims or career goals. Television programs are broadcast on WKNO-TV Channel 10 and repeated on Cablevision Channel 33.

Shelby State Community College will offer credit courses in American history, psychology, sociology, management, health issues, personal finance and computer literacy. For information call 528-6854.

Memphis State University will offer credit courses in social psychology, introduction to the humanities, writing and systems performance. For information call 454-2716.

Exactness in title dates is a wonderful source of cheerfulness. — F. W. Faber



COMMUNITY PROJECT — "This Medal's For You," a play about the life of Tom Lee (for whom Tom Lee Park downtown is named) was a smash hit when presented at Sherwood Elementary School. Several people made this possible and Supt. Herenton commended them for their community effort. Commending talents were from left: Carolyn Pittman, Sherwood principal; Carole Sowell, a parent and author of the play; Clifford Middleton, local poet performer who directed; Cathy Bennett of the Public Information Office who presented the certificates on behalf of Dr. Herenton; and Laila Moses, who composed music for the play. Below are scenes from the play. Sherwood students depicting Tom Lee as a boy and as an adult.

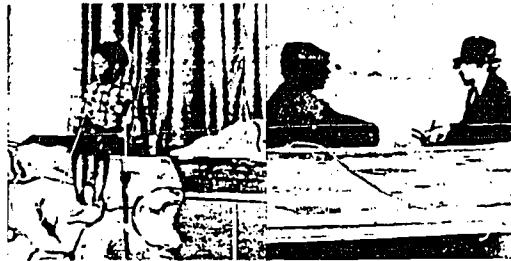

Free Resource Available

Charles Norvell, Ranger-Naturalist at Meeman Shelby State Park, will be available to visit classrooms (K-12) to present programs from Nov. 1 through April 30 on the following subjects:

- Forest Ecology
- Wildlife
- West Tennessee History
- Biology
- Science
- Environmental Ecology
- Urban Ecology
- Wildlife School or Home
- Geology
- Archaeology

All lectures, films and demonstrations are

September 5 Labor Day Holiday

a free service of the Tennessee Department of Conservation. If you are interested in using Mr. Norvell as resource for your class(es) call 876-5201 (office) or 876-5529 (home) or write Meeman Shelby State Park. PLEASE BOOK YOUR PROGRAM REQUESTS AS EARLY AS POSSIBLE.

Programs are designed to fit the current curriculum or as a special event type program activities.



CHAPTER I AWARDS — In photo at left, Miss Patricia Woods, right, student at Leam Elementary, receives the Chapter I Student Award for academic excellence from Mrs. Inez Wright, DAC Chairperson. In photo at right, Board of Education Commissioners receiving awards at the District Advisory Council Awards Banquet from left, Mrs. Bert Prosterman, president, Carl Johnson, vice president, and Mrs. Maxine Smith. The Chapter I Education is A Common Affair Awards Banquet was attended by students, parents, principals, administrators, support personnel and community leaders.

Administrative Personnel Changes Announced

Mr. Ricks W. Mason Jr.—from Division of Employment and Placement, Department of Personnel Services, Coordinator to Division of Employment and Placement, Department of Personnel Services, Director. Mr. Robert Dennis Raby—from Division of School Security, Department of School Security, Supervisor to Division of School Security, Department of Business Affairs, Director. Mr. Ronnie Beard Bynum—from Snowden Junior High, Principal to East High, Principal. Mr. William C. Koberck—from Wooddale Jr. High, Principal to Sheffield High, Principal. Mr. Reynolds Mike McDonald—from Kingsbury High, Assistant Principal to Kingsbury Jr. High, Principal.

Mrs. Debra J. Owen—from Craigmont High, Teacher to Division of Personnel Services, Employment and Placement Assistant. Dr. Glynda Ferrell Cryer—from Northside High, Guidance Counselor to Department of Pupil Services, Attendance and Guidance Services, Supervisor, Secondary Guidance. Mr. James Leck Black—from Georgian Hills Jr. High, Principal to Inglewood High, Principal. Mrs. Patricia Onocoli—from North Area Elementary, Instructional Consultant to Shady Grove Elementary, Principal. Mr. Bobby Hendrix—from Department of Pupil Services,

Attendance and Guidance Services, Supervisor, Secondary Guidance to Department of Curriculum and Instruction, Division of Elementary Secondary Education, Director. Mrs. Fay Davis Lee—from Georgia Avenue Elementary, Assistant Principal to Georgia Avenue Elementary, Principal. Mrs. Ophelia W. Flowers—from South Area, Coordinator of Instruction to South Area, District IV, District Director.

Dr. Joyce B. Weddington—from Department of Pupil Services, Division of Research Services, Coordinator to Department of Curriculum and Instruction, Division of Compensatory Education, Director. Mrs. Carole B. Hanson—from E. T. Washington High, Home Economics to Division of School Food and Nutrition Services, Department of Business Affairs, Supervisor of School Food Services. Mrs. Juna G. Pickering—from South Area, District IV, Elementary, Instructional Consultant to South Park Elementary, Principal. Dr. Kathy E. Pruett—from Division of Research Services, Department of Pupil Services, Testing and Measurement Coordinator to Division of Research Services, Department of Pupil Services, Assistant Director. Research Services. Miss Vivian A. Loma—from East Elementary, Teacher to Division of Research Services, Department

of Pupil Services, Compensatory Education, Evaluator. Dr. Joyce Ann Jensen—from Cummings Elementary, Teacher to South Area, District IV, Elementary, Instructional Consultant. Mr. Roy Lee Hopkins—from Hanley Elementary, Assistant Principal to Wells Station Elementary, Principal.

Mrs. Nettie Mae Jackson—from Atwood Elementary, Teacher to North Area, District I, Elementary, Instructional Consultant. Mr. Joy J. Ozburn—from Colonial Jr. High, Teacher to Hillcrest High, Assistant Principal. Mrs. Lora G. Sandridge—from Dryden Elementary, Assistant Principal to Lauderdale Elementary, Principal. Mr. James Wayne Finch—from Wells Station Elementary, Principal to Georgian Hills Jr. High, Principal. Mrs. Vivian C. Dillhunt—from Westwood Elementary, Teacher to South Area, District IV, Elementary, Consultant. Mrs. Emily B. Jackson—from Edgar Elementary, Assistant Principal to North Area, District II, Elementary, Consultant. James E. Huguely—from Division of Vocational and Adult Education, Assistant Director to Sheffield Vocational Technical Center, Principal. Mr. John Ricketts Ralston Jr.—from Division of Vocational and Adult Education, Fairview Office, Industrial Education Consultant to Division of Research Services, Department

(Continued on Page 10)

Welcome Back!

Personnel Changes (Continued from Page 8)

Vocational and Adult Education, Assistant Director, Mrs. Minnie F. Glover—from Gardenview Elementary, Teacher to Oakhaven Elementary, Assistant Principal

Mrs. Becky Chappell—from Central High Teacher to Division of Curriculum Development, Department of Curriculum and Instruction, Bilingual Supervisor, Mrs. Joyce Kelly—from Northside High, Teacher to Georgia Avenue Elementary, Assistant Principal, Ms. Sheila Cohen—from Ford Road Elementary, Teacher to Mental Health Center Division, Psychometrist, Dr. John Lee Malone—from Westwood High, Teacher to Whitehaven High, Assistant Principal, Mr. Michael E. Murphy—from Central High Teacher to Geeter Jr. High, Assistant Principal, Dr. Barbara U. Prescott—from Mental Health Center Division, Oakvie Center, Alcohol and Drug Worker to Division of Optional Schools, Department of Pupil Services, Ford Project, Optional School Coordinator (Interim), Mr. James Edward Robinson—from Humes Jr. High, Teacher to Humes Jr. High, Assistant Principal, Mrs. Ruby V. Payne—from Whitney Elementary, Teacher to Egypt Elementary, Assistant Principal, Mrs. Maera Koberck—from Division of Curriculum Development, Department of Curriculum and Instruction, Bilingual Supervisor to Division of Curriculum Development, Department of Curriculum and Instruction, Foreign Languages Consultant

Elections

Mr. Larry Wayne Hill, Sr.—Division of School Security, Department of Business Affairs, Security Supervisor, Mr. Calvin E. Johnson—Division of School Food and Nutrition Services, Department of Business Affairs, Food Services Supervisor, Miss Catherine C. McClure—Mental Health Center Division, Berclair Center, School Social Worker, Mrs. Caryn T. Sabatina—Mental Health Center Division, Oakvie Center, Psychometrist, Ms. Cynthia Frederick—Mental Health Center Division, Berclair Center, Psychometrist, Mr. Djord Eddar Bryant—Mental Health Center Division, Berclair Center, Psychometrist, Ms. Faye Trumbo Ray—Mental Health Center Division, Berclair Center, Psychometrist, Ms. Ornell K. Statler—Mental Health Center Division, Berclair Center, Psychometrist, Mrs. Von Woods Rayford—Mental Health Center Division, Berclair Center, School Social Worker



SEARS ROEBUCK & COMPANY-RETAIL are proud adoptors of Kingsbury High School. Principal Bill Taylor, congratulates Larry Blankenship, a senior in the Marketing and Distributive Education class, for placing in the top 15 winners of the State Competition for Decca Leadership in Nashville. Larry was presented a check for \$100 from Raleigh Store Manager, Frank Glaser, (far right) to sponsor his trip to Nashville. Mrs. Loree Tingle, teacher and coordinator for the school's adoption, participated in the presentation. (far left) to date, Sears has hired 32 students from Kingsbury as a part of their involvement in the Adopt A School program.

Adoptors Really 'Care' About Our Schools

The Adopt-A-School Program was designed to help create a more positive image of public education in Memphis, and to enrich the educational programs for students in the Memphis City Schools by tapping the wealth of business expertise, talent, creativity, and other human resources available within the adopting groups.

At the beginning of its fifth year, the program continues to meet those objectives while building community interest and support for our schools. Memphis adoptors can take pride in the large number of students and teachers who are benefiting from their groups' participation and in the impact this will have on the future of our city.

Although school has been out for the summer, Barbara Russell, Adopt A-School Specialist, and Arthur Seessel, retired businessman, have been busy contacting potential adoptors. They report that they intend to reach their goal of finding an adoptor for all our schools during the 1983-84 school year.

Adoptors and principals of some adopted schools contributed a portion of their summer to talking with people from other cities, telling about what is happening in their adoptions. Plans are being made for Memphis City Schools to host another national seminar on Adopt A-School this spring because of the nationwide interest in our program.

We proudly announce the latest additions to our Adopt-A-School "family":

First American Bank — Ridgeway Elementary
Harland Bartholomew & Associates — Denver Elementary
Service Merchandise Catalog Showrooms — Hawkins Mill Elementary
Shelby State Community College — Alton Elementary

Other companies have agreed to adopt a school(s), but have not as yet formally signed the adoption papers.

The National Council of Jewish Women is joining hands with the Junior League of Memphis and the Volunteer Center of Memphis to assist in the program by providing volunteers and a part-time paid worker to help monitor the adoptions. This is being done to help ensure that everyone is happy with their involvement in the program and that meaningful activities are taking place. We welcome this coalition! We also welcome Mrs. Rose Bauer to our staff as Adopt A-School aide.

School coordinators will participate in a Sharing and Learning Session on Wednesday, September 28, to be held in the Board Auditorium from 8:00 to 10:00 a.m. Adoptors will have their first Sharing and Learning Session on Wednesday, October 12, in the same place and at the same hour.

'Making Memphis A Better Place To Live'



COOPERATIVE EFFORT was the main topic of discussion during the Community Education Conference at Ramada Inn Convention Center. Attendees at orientation sessions are: from left, Ed Hantel, Director of Community Education Center, Tennessee State University; Mrs. Frances Coe, president of Memphis Better Schools Committee; Dr. Paul DeLafay, Director, Georgia School Based Development Enterprise; and Vida Andersen, representing Memphis Improvement Association. At right, the importance of volunteer time was a luncheon topic shared between: from left, Dr. Carol Trugent, Director, Career Community Education, Tennessee State Department of Education; Charles J. Patterson, Jr., Director, Division of Public Information, Community Improvement and Human Relations; Dr. Everett Kaine, Director, Mid West Community Education Center, University of Missouri, St. Louis; and Mrs. Bert Probstman, president of Memphis Board of Education.

Memphis Wins Top 4 Community Ed Awards

Community Education is on the move in the Memphis City Schools, and to prove it, four of the top awards presented by the Tennessee Community Education Association for 1982-83 were won by Memphis public schools.

Mrs. Frances Coe, former Board member and past president of the Memphis Better Schools Committee, won the Citizenship Leadership Award. She was cited for her unique leadership and service to local community education programs during the past four years.

Ms. Ina Ferguson, part-time coordinator of the Community Education Program, was presented the Distinguished Service Award. She has promoted and supported the philosophy of Community Education in Memphis and the State of Tennessee.

The Outstanding Community Educator Award went to Mrs. Rose Brown, Community Relations Specialist with the North Area. She has demonstrated creative and innovative work as a professional in the field of community education for more than three years. Mrs. Brown has publicly and expanded the concepts of community education on the local and state level.

Mrs. Jean Bernice Probstman, the Outstanding Educator Council Award for a teacher who has demonstrated a high level of professional achievement. Mrs. Probstman has served as a trustee of the

Retirement Planning Lecture Series Set

The Memphis Board of Education is announcing a new lecture series on the subject of RETIREMENT PLANNING. The nine session, five evening series will begin on Tuesday, evening, October 4, 1983 from 6 to 8 p.m. at the Board of Education Auditorium.

These sessions are open to employers who are 60 years of age or either have 30 years of service. Topics to be covered are: Planning Your Retirement; Fitness; Housing Choices; Middle Roles; Use of Time; Legal Readiness; Financial Security; and Estate Planning. Each topic will be discussed in detail by a prominent local professional who is an authority on the assigned subject.

Participants will receive a comprehensive Retirement Planning Handbook and a one year membership in AIM - Action for Independent Maturity, Planning starter exercises for individual use and a selection of specialized publications will also be distributed.

More information and registration forms can be obtained in the Division of Employee Services, Room 156 or call 454-5464.

STUDENTS SUPPORT STANDARDS, NOT HOMEWORK — School standards should be maintained, but not by lengthening the school day, by adding homework assignments, or by cutting budgets. In a survey of over 1,300 students of the National Association of Student Councils,

Look, But Don't Eat . . .

Jack Batten, executive chef at the Sheraton Convention Center Hotel, provided Fairley Elementary students with a lunchtime treat. This treat, however, unfortunately could not be eaten. Well, what kind of lunchtime treat is it if you can't eat it? asked one student. His question was soon to be answered as Batten sawed, sliced, cut and carved away on a 350 pound pork loin. You see, the treat was ice sculpture and the finished products were a fish and a duck.

During their lunch period, students looked on and marveled as Eatten, a 31 year old cherubic fellow wearing rubber gloves, a plastic apron, workman's heavy gloves and using an assortment of sculpturing tools, labored ardently on the block of ice. Mrs. Winhelmina Pitts, Cafeteria Manager, was delighted by the comments and responses of the students. "There's more to food than just eating it," she said as she tried to speak above the roar of the chainsaw. "We want to enrich the children and broaden their horizons," she continued. "We want to show them that there can be beauty to food and its preparation. It's important as the eating habits they develop now will carry over into the rest of their lives."

more homework was opposed almost 3 to 1. The students said many of them have jobs or take part in extracurricular activities which would have to be curtailed if they had more homework. About the same percentage objected to spending more time in school.

— Education U.S.A.

Craigmont Planetarium Star Shows For 1983-84

SCHOOL PROGRAMS FOR PRIMARY AND INTERMEDIATE GRADE LEVELS — Instructional programs based upon the science curriculum of the Memphis City Schools are available for each grade level K-6. The current night sky and special astronomical events of the month are included in each lesson. These live lecture demonstrations are custom designed by Planetarium Instructor Mrs. Ruth Lewis to correlate with the text you use and with WKSU Instructional Television programs such as The Science Corner and Vantage Point. All programs are available in introductory, concurrent, and review formats.

Some star shows for the elementary grades deal with a single concept and are presented as taped or combined live taped programs.

THE SKY TONIGHT — This 35 minute program is geared for children in preschool through second grade and serves as an introduction to both planetarium facilities and the night sky.

OUR SKY FAMILY — Our Sky Family, a 40 minute show for children under eight, introduces the planets and the concept that we are part of the solar system.

SPACEDREAM — Astrobrd visits Billy in his dreams and takes him on flights of fantasy through the night sky. Stars and constellations illustrate a story of kings and queens, a princess and a hero, and a ferocious monster in the full version of SPACEDREAM. Astrobrd returns in the Spring for another story about the stars of the current night sky. (3rd-4th)

TIME AND TIME AGAIN — A conversation between Jeff and Father Time answers many questions about the concept of time and how we measure it. (5th-6th)

MULTIMEDIA STAR SHOWS FOR INTERMEDIATE AND SECONDARY GRADE LEVELS — Multimedia Star Shows are taped and computer controlled presentations employing multiple narrators, specially selected musical backgrounds, and a variety of special visual effects. These programs are available for school groups and are shown to the public at scheduled evening and weekend showtimes at which there is an admission fee. The titles, dates of presentation, and descriptions of these star shows are as follows:

STARBUDDY (August 25 - September 29)

It seems incredible, but in the last quarter century our space program has taken us from the edge of the atmosphere to the edge of the solar system. Our hopes, dreams, national pride, and initial curiosity have taken us from grapefruit sized Earth orbiting satellites to manned walks on the Moon. Total space probe exploration of most of the planets of our solar system. Many of us are old enough to have watched the drama unfold. But now that we've gone to the Moon and trekked to the planets... Where do we go from here? This question is explored in a new multimedia planetarium production commissioned by NASA for use by planetariums around the world.

THE DAWN OF ASTRONOMY (October 13 and November 3-17)

Here are man's earliest astronomical discoveries...featuring the pyramids and temples of Egypt and Stonehenge in England. Early man is presented as intelligent and resourceful. Full scale use of building astronomical monuments of incredible size and precision and using these monuments to trace diurnal and circumpolar motion, the length of the year, the constellations, the zodiac, and probably the prediction of eclipses — observations beyond the capabilities of the human eye.

STAR DRACULA (October 17-31)

A general program from the Tennessee Bank's First Broadway Award Program made possible the Craigmont Planetarium production of a most unusual play...Dracula the Vampire. Presented in the Planetarium Theatre this play featured the creative and entertaining use of projectors and planetarium skills to help create the perfect mood for Dracula and for the Halloween season. This year's play, to be announced in October, will again be a rare blend of art and science presented in a most unusual setting.

THE STAR OF BETHLEHEM (November 27 - December 18)

Another holiday program because it is not a miracle play, or a church service. The Star of Bethlehem is a scientific re-examination of the scientific possibilities for the Christmas star and the stars of the winter holidays of other religions related to the winter solstice.

THE PIONEERS OF SPACE (January 12 - March 18)

For the first time selected for use by the Craigmont High School Planetarium has been commissioned by the National Aeronautics and Space Administration to produce a multimedia educational program for nationwide distribution to other planetariums. The Pioneers of Space is a story of the first astronaut human who ever built the Pioneer 10 spacecraft and its journey through and beyond the solar system. Pioneer 10 contains a message to any alien beings who may one day find it. The message tells who and where we are and when the message was sent. Will we ever receive a reply?



WINS TOUR — Verita Martin (center) Advanced Placement English student at Westwood High departs for tour of 7 cities approx. 10 miles for an essay on "My Black Godparents". Her mother, Mrs. Wive D. Mays, is at left and her Advanced Placement English teacher, Mrs. Cynthia A. Gentry, at right. Verita won the 1st prize in an Alpha Kappa Alpha Sorority competition. She visited New York, Boston, Philadelphia, Atlanta, Orlando, Chicago and Washington, D.C.

EASTER - THE AWAKENING (March 22 - April 12)

Easter is one of our favorite holidays, for it celebrates Nature's return to life. The origin of Easter and the reason for its occurrence on a different date from one year to the next will be explored.

SKYWATCHERS OF ANCIENT MEXICO (April 26 - May 31)

For three thousand years, stretching from 1500 B.C. to 1521 A.D., the people of Mexico and Central America built awe-inspiring cities, developed hieroglyphic writing, performed sophisticated mathematics, using the concept of zero, and made painstaking astronomical observations. When European explorers arrived in the New World, they found cultures with a calendar more accurate than theirs and with astronomical information about the cycles of Venus, the Sun, and the Moon far beyond their capabilities. Monuments carved from stone, a handful of surviving books, and the alignment of buildings are enabling archaeologists and astronomers to shed new light on these remarkable people.

Local ITV Programs Go National

When WKNO produces instructional television programs, talent and hard work of Memphis City Schools educators are at the heart of each production. School administrators, consultants and teachers share their expertise and offer counsel through advisory committees for the instructional design, scripting, program production and development of the teacher guides which accompany each series.

When the locally produced ITV series meet national broadcast standards and national educational needs, distribution agencies are in for the chance to represent the series in the national ITV market. WKNO produced ITV series now in national distribution include:

- **THE SCIENCE CORNER** a science series for grade 3, written and produced by its teacher host, Anna Catterly, Ball, then a Memphis City Schools teacher who is currently assigned to WKNO as the ITV Coordinator.
- **FOLLOW ME** a social studies series for grades 1-2, written by Edna Thomas, a sixth grade teacher at Bessie Coleman Elementary School.
- **VANTAGE POINT** an astronomy unit science series for grades 4-6, written by Duran Teague, director of the Craigmont Planetarium, and produced by Lynne Jordan, currently working with the Drift music program.
- **PASS IT ON** a primary arts social studies series for grades K-1, written and produced by its teacher host, Lynne Jordan.

An indication of WKNO's newest production, **COMPUTERBREAK**, a computer literacy series for grades 4-8, will go national. Its writer/producer is Betty Bauer, assigned by Memphis City Schools to WKNO as the ITV Instructional Designer.



DRIVER OF THE YEAR — Vernon Grose, center, Supervisor of the Division of Transportation, congratulates Lenae Allen, right, Driver of the Year for 1983, and Marie Lee Vance, left, who won the Five Year Safe Driving Award.

FREE BLOOD PRESSURE SCREENING IS NOW AVAILABLE AT THE FOLLOWING FIRE STATIONS IN MEMPHIS

- 3345 Millington Road - 38053
- 1017 Jefferson Avenue - 38104
- 387 East McLemore Avenue - 38106
- 2147 Elvis Presley Boulevard - 38106
- 686 North Breedlove Avenue - 38107
- 4715 Horn Lake Road - 38109
- 333 East Parkway North - 38112

- 4676 Airways Boulevard - 38136
- 550 South Mendham Road - 38117
- 3909 Knight Avenue - 38114
- 4472 Powell Avenue - 38122
- 625 Mississippi Boulevard - 38126
- 3423 Scenic Highway - 38126
- 2169 Ridgeway Road - 38138

Sponsored by The American Heart Association, Memphis Chapter, The Memphis Fire Department, and The Memphis High Blood Pressure Coalition.

BEST AT SIX FLAGS — Craigmont Junior High Band members recently visited Supl. Herenton with their plaque and trophy, such as Best in Class, County wide at Six Flags Over Texas. Pictured from left: Herbert Wilson, band director; Rodney Williams, Amber Houche, Perry LeBlanc, Dr. Herenton, Travis Westmore, Beth Elms, Roger Toy, Westmore and Dr. Aja Jane Waters, principal at Craigmont.

(Staff Photo by Cathy Bennett)



APPENDIX C

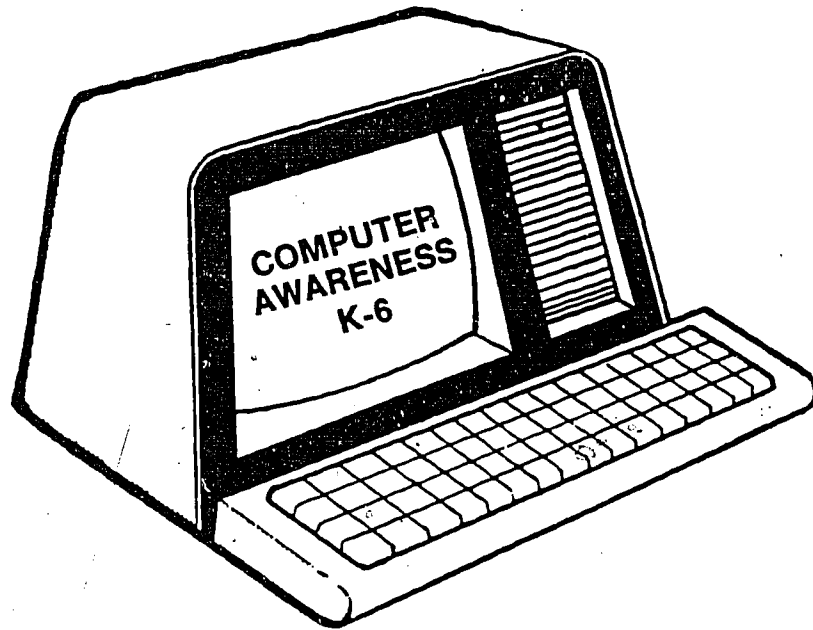

Division of Curriculum Development
Department of Curriculum and Instruction
Memphis City Schools

ACKNOWLEDGEMENTS

COMPUTER ACADEMIC CURRICULUM SUB-COMMITTEE

Dorothy Archer
Nancy Biggs
Wilma Blaylock
Larry Campbell
Don Coffey
Gloria Cox

Barbara E. Jones
Christine Johnson
David Moore
Catherine Pickle
Joyce Pinkston
Stan Pruett
Alene Williams

CONTRIBUTORS

Division of Instructional Materials

Dori Griffin, Teacher, Gardenview

Larry Campbell, Teacher, Double Tree

GRAPHICS BY: Alan Ford
Ruby Wilburn
Earl Fuller

COMPUTER AWARENESS

TABLE OF CONTENTS

	PAGE
INTRODUCTION	1
COMPUTER EDUCATION MATRIX	2
INSTRUCTIONAL MODEL	3
STRANDS AND GOALS	4
STRANDS AND OBJECTIVES	5
INSTRUCTIONAL ACTIVITIES	
STRAND I - HISTORY	7
STRAND II - COMPUTER OPERATIONS	27
STRAND III - APPLICATIONS	39
STRAND IV - SOCIAL IMPACT	47
STRAND V - LOGIC AND PROBLEM SOLVING	49
GLOSSARY OF TERMS	60
ANNOTATED RESOURCES	62
SKILLS CHECKLIST	
K - 3	65
4 - 6	66
EVALUATION IDEAS	67
COMPUTER AWARENESS RECOMMENDATION FORM	81
PROFESSIONAL GROWTH OPPORTUNITIES	82

INTRODUCTION

COMPUTER AWARENESS, K-6

Computers are tools which are becoming an increasingly important part of every day life in American society. One's ability to communicate and use the computer, a tool, of an information-based society will be a crucial element of literacy for our students, the adults of tomorrow. Our task then must be to provide learning opportunities and experiences which enable our students to become computer literate.

Computer Awareness is the first level of the Memphis City Schools Computer Education Program. The primary goal of this program is to provide beginning computer learning experiences for elementary students, grades K-6. The range of instruction includes the historical development of computers their present and future impact on society. The curriculum is designed to provide each student with instructional time in the classroom and hands-on computer experiences in the computer room, thus developing a core of computer skills. All students are expected to develop the ability to operate, but not program, a simple computer system.

Much of this computer instruction can and should be correlated into the regular academic areas such as social studies, mathematics, and science. A skills checklist has been provided to assist the teacher in monitoring students attainment of basic computer operation skills.

Each teacher is encouraged to participate in future program planning by using the Computer Awareness Recommendation form.

COMPUTER EDUCATION
MATRIX

COURSES	GRADE LEVEL	PREREQUISITE COURSE(S)	CO-REQUISITE COURSE(S)	COURSE LENGTH	INTERACTIVE TIME	UNIT OF CREDIT	GRADING
Computer Awareness	K-6				5 hours	none	-
Computer Skills Next	7-8			15 hours	6 hours	none	-
Computer Literacy	12				Variable	none	-
Introduction to Computers	12*			1 semester	30 hours	1/2	+
Basic Programming	9-12	Algebra I		1 semester	45 hours	1/2	+
Advanced Basic Programming	9-12	Basic Prog.		1 semester	45 hours	1/2	+
Fortran Programming	10-12	Advanced Basic	Algebra II or Unified Geo.	1 semester	45 hours	1/2	+
Pascal Programming	10-12	Advanced Basic	Algebra II or Unified Geo.	1 semester	45 hours	1/2	+
AP Computer Science (Advanced Pascal)	11-12	Adv. Basic Prog.	Algebra II or Unified Geo.	2 semesters	90 hours	1	+
Introduction to Data Processing INDR	10-11	none	Typewriting recommended	2 semesters	90 hours	1	+
Data Processing I DPR 1	10-12	none		2 semesters	180 hours	2/3	+
Data Processing II DPR 2	11-12	Data Processing I		2 semesters	180 hours	2/3	+

*May admit 10 through the 11 graders if space is available.

446

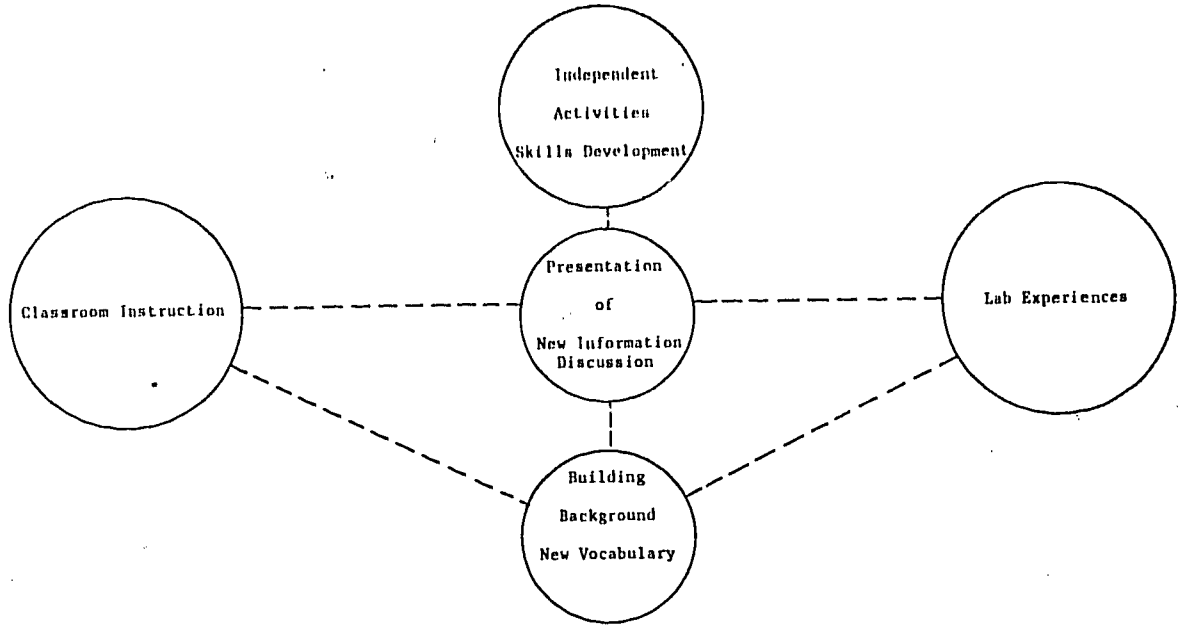

INSTRUCTIONAL MODEL

3

447

COMPUTER AWARENESS

Strands and Goals

STRANDS	GOALS
I. History	To be able to understand the historical development of the computer
II. Computer Operations	To be able to operate a microcomputer system
III. Applications	To be able to demonstrate an understanding of the applications of computers as machines, as tools, and as creative instruments
IV. Social Impact	To be able to discuss the widespread use of computers in today's society and possible future uses
V. Logic and Problem Solving	To be able to utilize systematic processes in problem solving

STRANDS AND OBJECTIVES

STRAND I: HISTORY

1. The student will be able to discuss technology before 1800 and the role of work.
2. The student will be able to discuss the industrial revolution and the role of work.
3. The student will be able to discuss the computer age and be able to identify a computer.
4. The student will be able to discuss early counting devices.
5. The student will be able to identify various calculating devices.
6. The student will be able to identify and discuss the inventors who contributed to the development of the computer.
7. The student will be able to identify and discuss the daily use of computers.

STRAND II: COMPUTER OPERATIONS

1. The student will be able to identify input devices.
2. The student will be able to identify output devices such as an audio-cassette recorder, disk drive, modem and printer.
3. The student will be able to use the keyboard to perform simple functions.
4. The student will be able to explain how to use and proper care of computer equipment.

STRAND III: APPLICATIONS

1. The student will be able to use the basic functions of the computer to run a program (how to use a computer).

Strands and Objectives
Page 2

2. The student will be able to select, load, and interact with (follow the program) a program or game designed for learning.
3. The student will be able to recognize that a computer needs instructions to operate and that those instructions come from a program written by a person using a programming language such as BASIC, Pascal, or COBOL.

STRAND IV: SOCIAL IMPACT

1. The student will be able to discuss some ways computers are used in several areas.

STRAND V: LOGIC AND PROBLEM SOLVING

1. The student will be able to order specific given steps in a solution of a problem.
2. The student will be able to choose and order the proper steps to the solution of a problem or algorithm.
3. The student will be able to develop a flowchart for a daily activity.
4. The student will be able to develop the concept of a variable as a location in the computer's memory.

STRAND I - HISTORY

SITE: CLASSROOM

OBJECTIVE 1: The student will be able to discuss technology before 1800 and the role of work.

SUPPORTIVE VOCABULARY: tools, technology, work

PRESENTING NEW INFORMATION (TEACHER-DIRECTED DISCUSSION)

Discuss with students the meaning of work. Have them name people they know who work and the type of work they do. Make a list of jobs (example: teacher, builder of houses and roads, telephone operator).

JOB	TOOLS
Teacher	Books, chalk
Builder	Hammer, saw

Discuss with students which tools are used for each job (example: teacher: blackboard, books; builder: hammer, nails; telephone operator: telephone, electrical system). Make a chart that lists the tools named by the students. Tell students that often the word technology is used to refer to the tools used to do a job.

Next, ask the students to tell what they think is the real purpose of each job listed (example: teacher - helps children

to learn; construction worker - builds structures needed to shelter people; telephone operator - helps people to send or receive messages over long distances). Now ask students how they think these jobs would have been done 200 years ago. Add the information to the chart. (Example: A telephone operator might have been a town crier or rider like Paul Revere 200 years ago, or a messenger who had to run or ride from kingdom to kingdom 2,000 years ago).

Today	WORK	
	200 years ago	2,000 year ago
Telephone Operator	Town crier or by horseback	Runner

INDEPENDENT ACTIVITY

Have each child choose a job from the first list and draw or write how he/she would do that task with technology and without the technology available today, estimating the time each might take. This could be done in small groups if the teacher prefers, instead of individually.

The following activity sheet is provided for duplication.

STRAND I: HISTORY
OBJECTIVE I

NAME _____ DATE _____

JCB

WITH TECHNOLOGY	ESTIMATED TIME	WITHOUT TECHNOLOGY	ESTIMATED TIME



Have each child/group share with the class the results of this activity. Point out the contrasts in the amount of time a task would take with and without technology, and if the students are actually "inventing" technology in their solutions (example: a branch of leaves to sweep the floor). Also point out any unrealistic answers such five minutes to wash the family's clothes by hand. Work with the group to modify and direct the presentations.

STRAND I - HISTORY

SITE: CLASSROOM

OBJECTIVE 2: The student will be able to discuss the industrial revolution and the role of work.
--

SUPPORTATIVE VOCABULARY: machines, factories, product, industry,
industrial, industrial revolution, preindustrial

PRESENTING NEW INFORMATIONTO THE TEACHER:

Review the concepts of technology and work as presented in objective 1 (History). Use this to contrast with the current lesson.

Adapt the following as appropriate for your class.

The development of new technology (or tools) has become faster and faster in the last 2,000 years. Machines were designed that did more and more of the work for all kinds of jobs: hunters and soldiers (guns), makers of clothing (looms, sewing machines), vehicles for travel (steamboats, trains, airplanes), and many more. More work was done outside the home in large buildings called factories where many workers could work with the machines at the same time. Eventually, in many of these factories, each worker would only do one small task in making a single product. Instead of one worker making all parts of a doll, for instance, one worker might make the head, another draw the eyes, nose, and mouth, and another put the head on

the body. When things are made this way, with a lot of people working on small tasks they do over and over with the help of machines, this is called an industry. Since most things are made this way today, we say we live in an industrial age.

The industrial revolution is the name for the time when things "turned around" or changed very quickly from workers making things at home to making them in factories. This has only happened in the last 200 years in Western Europe (England, France, Germany) and America, and more recently in other parts of the world. Some places are still preindustrial (pre = before) - people do most of their work at home and not in factories, and most of the things they use are not made in factories.

GUIDED ACTIVITY

What are the advantages of the industrial age?

(Possible answers)

- more products, made more quickly
- cheaper, more people have more things
- machines make work easier (physically)

Disadvantages?

- workers away from families
- less personal satisfaction in product
- less personal control of working conditions

Direct student attention to the chart first made in lesson 1 on the role of work before 1800. Point out that the term industrial would fit above the column marked today, and preindustrial would fit above the other 2 columns.

WORK

WORK		
Industrial	Preindustrial	
Today	200 years ago	2000 years ago
(Workers)	(Jobs)	
(Tools)	(Tools)	
math teacher	math teacher	math teacher
computer	chalkboard, paper and quill	sand, clay

(If the chart is not available, make another, using a 2-column format headed industrial and preindustrial).

INDEPENDENT ACTIVITY (Individual or small group activity)

Have the students find stories in their basal readers that show people living in industrial or preindustrial times. Have each student tell or write a story from each time period and tell why that story belongs there. (Example: how do they know it is industrial or preindustrial?) Allow students to respond to each other's selections. The teacher will correct and direct the discussion.

STRAND I: HISTORY

SITE: CLASSROOM

OBJECTIVE 3: The student will be able to discuss the computer age and be able to identify a computer.

SUPPORTIVE VOCABULARY: computer, mainframe, minicomputer, microcomputer

PRESENTING NEW INFORMATION

The word COMPUTER comes from a Latin word meaning to count. A computer is a machine with a memory which accepts information, works on the information to solve a problem, and puts out the answer. The computer is like a powerful calculator. To do a problem on a calculator, you put your problem in by pressing the keys on the machine. The machine then works on the information and you see the answer displayed on the calculator. Computers come in many sizes and shapes. They range from very large computer systems called mainframe computers to small minicomputers to even smaller micro-computers. (Resource pictures on page 1 in Spotlight On Computer Literacy).

Mainframe computers are very large, often taking up as much space as a classroom. They can store enormous amounts of information. They cost hundreds of thousands of dollars. Many large businesses, government agencies, and universities use mainframe computers to help them operate smoothly and efficiently (example: telephone company, U.S. Navy). These kinds of computers can do a lot of different jobs at one

time. (Resource picture on page 2, Spotlight On Computer Literacy).

Minicomputers are much smaller than mainframes. They take up very little floor space. These computers range in cost from about 10 to 100 thousand dollars. Large amounts of information can be stored in these computers, though not as much as mainframe computers. They, too, can handle more than one job at a time. They are used by medium and small-sized companies and some school systems. (Resource pictures (top) page 3, Spotlight On Computer Literacy).

Microcomputers are even smaller than minicomputers. They are small and light enough to move around. They may range in cost from \$70.00 upward to \$6,000. Microcomputers cannot store as much information as mainframes or minicomputers. They are designed to do only one job at a time. Large businesses often use microcomputers to solve smaller, more individual problems. Many small businesses use microcomputers. Many students use microcomputers daily in their classrooms. Some people have them in their homes.

GUIDED ACTIVITY

Develop a Computer Systems chart with the students. Ask students to use the computer system descriptions to identify businesses which could be listed in each category.

COMPUTER SYSTEMS		
Mainframe	Minicomputer	Microcomputer
First Tennessee Bank	Memphis Board of Education	School

RESOURCES

Text Spotlight On Computer Literacy, Chapter 1

Sound What Computers Do A 516-1 9 minutes
 Filmstrips How Computers Work A 516-2 12 minutes

 Show SVE (Sound filmstrips) to indicate ways
 computers are used in business, at school, at
 home, and for entertainment

Poster Computer Systems - Continental Press

STRAND I: HISTORY

SITE: CLASSROOM

OBJECTIVE 4: The student will be able to discuss early counting devices.

SUPPORTIVE VOCABULARY: abacus

I

PRESENTING NEW INFORMATION - Ancient Times

Explain to students that since earliest times people used their fingers to show "how many." Fingers were used to show the number of animals killed on a hunt as well as the number of people living in a dwelling. Early man also used knots in a rope and beads on a string to keep a counting record. Shepherds put rocks in their pockets or in a pile to keep track of how many sheep they had. They would put nine rocks in their pockets to remember they had nine sheep. Each stood for one animal. You can count your toys like this. You can put a rock in your pocket for each toy that is yours. Then you count the rocks. If you have 5 rocks in your pocket, you have 5 toys.

GUIDED ACTIVITY

Pass out ditto master H in the Teacher's Guide and Activity Book to accompany Computers Are Fun. Have each child cut out his or her one and bring it up to the front. Each child then marks X on the board after he has put the stone on the

teacher's desk. Count the X's. Count the stones. Are they the same number?

INDEPENDENT ACTIVITY

Pass out Ditto Master I in Teacher's Guide and Activity Book to accompany Computers Are Fun.

II

PRESENTING NEW INFORMATION - Abacus

Ask students whether or not they have seen an abacus. If one is available, show it to the class. If not, use the picture on page 21 of Computers Are Fun. Explain to students that long ago ancient man made a counting machine called an abacus. It had beads on a wire in the wooden frame. The beads were used for counting. This was one of the first tools used to express numbers. The Chinese abacus was invented in 2,600 B.C. Beads were moved on wires to add and subtract. It could be held and carried around easily. The abacus was so successful that its use spread from China to many other countries. The abacus is still in use in some countries today. People who are good at using an abacus can often do calculations as quickly as a person using a calculator.

GUIDED ACTIVITY

Bring an abacus to class and let students who know how to operate it demonstrate an addition problem to the class.

III

PRESENTING NEW INFORMATION - Adding machine

In 1642 a 19-year old French mathematician by the name of Blaise (blez) Pascal invented the first mechanical calculating machine. A mechanical machine has moving parts. This machine could add and subtract and use gears and moving parts. Later inventors improved the machine so it would multiply and divide.

GUIDED ACTIVITY

Show the picture on page 27 in My Friend - The Computer. Demonstrate an adding machine to the students. Explain that an adding machine is made up of many parts.

IV

PRESENTING NEW INFORMATION - Loom

In 1805, a Frenchman by the name of Joseph Jacquard invented a special loom for weaving cloth. Cards with holes punched through were used to design the patterns in the cloth. This machine was a real advancement in weaving. Yet workers using hand looms did not understand nor appreciate this improvement. Their lack of understanding resulted in anger and the burning of Jacquard's home and loom.

INDEPENDENT ACTIVITY

Write a story which might explain why weavers were so unhappy about the invention. Ask students if they know of present day inventions which have not been quickly accepted.

V

PRESENTING NEW INFORMATION - Calculator

In 1850, Charles Babbage, an Englishman, drew up plans for two giant calculators that would work much like a modern computer. Money was furnished by the British government. Government money ran out for the project and Babbage never finished either machine. The parts and ideas for these machines were used in the creation of modern day computers. (Resource picture on page 29 in My Friend - The Computer.)

VI

PRESENTING NEW INFORMATION - Census

Herman Hollerith was hired by the United States Government to count all the people in the country. Hollerith invented a way to record the information in punched cards. Punched cards recorded details about individual people. The holes in the cards were then read and counted electrically. His machine, using punched cards, counted people in six weeks and saved the government two years in counting people. The company Hollerith started later became the IBM Company. (Resource - Punched Cards)

INDEPENDENT ACTIVITY

Use the practice activity on page 29 in My Friend - The Computer and/or the activity on page 12-13 of Computer Tutor.

VII

PRESENTING NEW INFORMATION - ENIAC

The ENIAC (Electronic Numerical Integrator and Computer) was the first all electronic computer. It was built by John Mauchy and J. Presper Eckert at the University of Pennsylvania in 1946. The ENIAC weighed over 30 tons and filled a large room. It conducted electricity through vacuum tubes. It used over 18,000 vacuum tubes. Because vacuum tubes get hot, it was necessary to have air conditioning to keep it cool. It could do a problem in 2 hours that would have taken 100 engineers a year to do. (Resource picture on page 31 in My Friend - The Computer.)

VIII

PRESENTING NEW INFORMATION - UNIVAC

UNIVAC (Universal Automatic Computer), developed by Eckert and Mauchy in 1951, was the first machine to combine electronic calculation with internal programming. It also used vacuum tubes and needed air conditioning. UNIVAC is often called the first true computer. UNIVAC was smaller than ENIAC, but much faster and more powerful.

Computers built between 1951 and about 1960 are typically characterized as first generation computers.

IX

PRESENTING NEW INFORMATION - Four Generations of Modern Computers

1951-1960	1950's-1964	1965-1970	1970's
1st Generation	2nd Generation	3rd Generation	4th Generation
Vacuum tubes	Transistors	Integrated circuits	Integrated circuit chips
1,000 calculations per second	10,000 calculations per second	1,000,000 calculations per second	10,000,000 calculations per second

As you can see, each generation of computers used a new invention to conduct the electricity through the computer. As the new electrical devices got smaller, the computers got smaller. They became more powerful than the earlier, large computers and less expensive, which enabled small companies, schools, and individuals to buy personal computers.

INDEPENDENT ACTIVITY

Use Ditto Master 36 in the teacher's guide activity book to My Friend - The Computer.

RESOURCES

Computers Are Fun, pp. 20-21

Teacher's Guide and Activity Book to accompany Computer Are Fun, p. 23, ditto masters H, I - pp. 73, 74

My Friend - The Computer, pp. 27-31

Teaching Guide and Activity Book, pp. 19-21

Computer Tutor, pp. 11-14

Spotlight On Computer Literacy, p. 45-46, 49

STRAND I: HISTORY

SITE: CLASSROOM

OBJECTIVE 5: The student will be able to identify various calculating devices

SUPPORTIVE VOCABULARY - none

PRESENTING NEW INFORMATION

This lesson is an extension of Objective 4. The posters "Computers - Past and Present", published by Radio Shack may be used to review calculating devices.

If time permits students may work in small groups to create new ways of counting. Each group would then explain its new method to the class. Ideas generated by the groups may be used to compare and contrast the development of earlier counting systems.

RESOURCE

Poster - Computers-Past and Present - Radio Shack (Free)

STRAND I: HISTORY

STILL CLASSROOM

OBJECTIVE 6: The student will be able to identify and discuss the inventors who contributed to the development of the computer.

SUPPORT MATERIALS: none

GUIDED ACTIVITY

Guide students in making a TIME LINE of computing devices (individual or class) dating back to ancient times. Use pictures or titles and dates with a short description. Suggest that they add other computers they discover in any other reading or discussions.

RESOURCES

Radio Shack poster - Computers-Past and Present (Free)
Discussion from Objective 4
My Friend - The Computer, pp. 26-34
Spotlight On Computer Literacy, pp. 37-43

INDEPENDENT ACTIVITY

Provide students with a list of computer inventors. Suggest that students research encyclopedias or other computer books in the library for information and make written reports on them. These reports can be displayed on the bulletin board or made into booklets. Students may select from a list such as the one below.

Blaise Pascal
Charles Babbage
Herman Hollerith
Joseph Jacquard
J. P. Eckert
John Mauchly

RESOURCES

My Friend - The Computer, pp. 26-34

Spotlight On Computer Literacy, pp. 37-43

Encyclopedias

STRAND I: HISTORY

SITE: CLASSROOM

OBJECTIVE 7: The student will be able to identify and discuss the daily use of computers.

SUPPORTIVE ACTIVITY: None

GUIDED ACTIVITY

Ask students how many of them have crossed the street at a traffic light. Ask them what they think causes the light to change. Discuss the fact that in most traffic lights a computer makes the light change.

Elicit from students things that run by computers that they see every day on television or in the home: refrigerators, washing machines, microwaves, digital clocks and watches, central heat and air conditioning units, grocery checkout counters, video games, arcade and home games, automatic banking tellers (Annie, Sunny, First Banking), football and basketball scoreboards.

Organize the students to prepare a bulletin board of pictures cut from catalogs, newspapers, and magazines of items which are operated by computers. Be sure students understand the characteristics of a mechanism with a computer.

STRAND II: COMPUTER OPERATIONS

SITE: COMPUTER ROOM

OBJECTIVE 1: The student will be able to identify input devices

SUPPORTIVE VOCABULARY: computer, microcomputer, input, processing, output, keyboard, video monitor, cartridge, printout, central processing unit

PRESENTING NEW INFORMATION

Let's take a look at a small computer you can easily take with you. These are called microcomputers. The prefix micro means small. Microcomputers are often referred to as micros. Micros are run by electricity. Information goes in as input. This information is processed inside. The processed information is called OUTPUT when it is seen on the screen or printed on paper it is called a printout.

We might compare a computer to a washing machine. A computer and a washing machine have three things in common: INPUT, PROCESSING, and OUTPUT. The dirty clothing and soap into the washing machine are called input. The processing takes place inside the washing machine. The output is the clean clothing you take out of the washer.

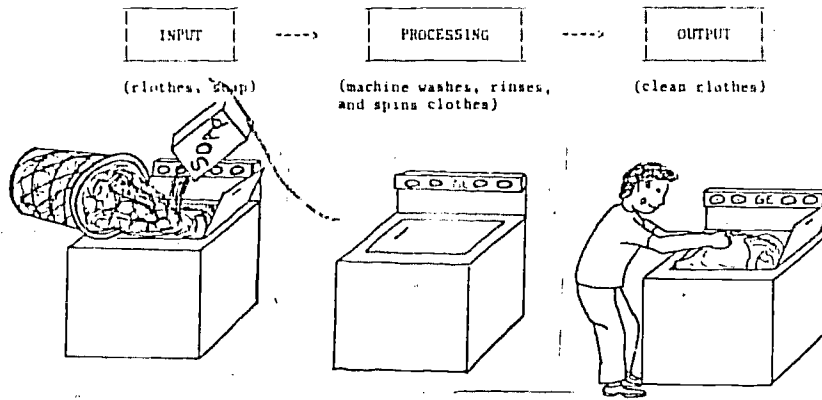
KEYBOARD

The micro usually has a keyboard like a typewriter and is about the same size as a typewriter. You input your information to the micro by typing it in on the keyboard. A small computer is inside this keyboard box called the Central Processing Unit or CPU.

Use ditto master P, Computers Are Fun, Teacher's Guide and Activity Book, page B1.

VIDEO MONITOR

A microcomputer may be connected to equipment such as a television screen or a video monitor. The information you type in at the keyboard is seen on the TV screen or video monitor.

CARTRIDGE

One way to store information outside the microcomputer is on cartridges. The cartridge slips into a slot in the microcomputer. The programs and data are permanently on the cartridge. They cannot be changed or erased.

(Resource picture on page 76 in My Friend - The Computer or actual equipment.)

NOTE: MAKE CERTAIN EACH CHILD RECOGNIZES THE KEYBOARD, VIDEO MONITOR AND CARTRIDGE. THESE WORDS SHOULD BECOME A PART OF EACH CHILD'S SPEAKING VOCABULARY.

RESOURCES

My Friend - The Computer, pp. 73-76

Computers Are Fun, Teacher's Guide and Activity Book, ditto master P, p. 81

STRAND 11: COMPUTER OPERATIONS

SITE: CLASSROOM

OBJECTIVE 2: The student will be able to identify output devices such as an audio-cassette recorder, disk drive, modem and printer.

SUPPORTIVE VOCABULARY: audio-cassette recorder, disk drive, modem, peripheral device, printer

PRESENTING NEW INFORMATION

In order for computers to serve many uses attachments are needed. These added attachments extend the services of the CPU (Central Processing Unit) and are called peripheral devices. The word "periphery" means "the outermost part or region" so these attachments are outside the computer keyboard and monitor.

The four most common peripheral devices are an audio-cassette recorder, a disk drive, a printer and a telephone modem. Special cables usually connect these components to the computer.

MODEM

For computers to phone each other, a peripheral device must be available for a telephone. This component is a coupler box or modem. The letters in the word "modem" are short for modulator/demodulator. Modems let computers "talk" to each other.

Place telephone over the circles.

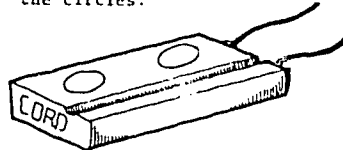

TELEPHONE COUPLER BOX
or MODEM

(Resource picture DM-34 in Teacher's Guide and Activity Book to accompany "My Friend - The Computer, and p. 85 in "My Friend Computer.")

PRINTER

Printers will type any of the information you program on the video monitor screen. The print-out on paper is called "hard copy" in computer jargon. Printers are available as a peripheral device for microcomputers. They are usually more expensive than the micro.

AUDIO-CASSETTE RECORDER

The audio-cassette recorder serves as both an input and an output device for a microcomputer such as the TI-99/4A. The tape recorder will load and store computer programs. It is the least expensive peripheral device but it is often time consuming to use.

DISK DRIVE

Data can be entered and stored on a magnetic disk about the size of a small phonograph record. The disk is inserted in a disk drive box which is electrically connected to the CPU. The disks are thinner and more flexible than "45" RPM records and are called floppy disks or diskettes. These five and one-fourth inch diameter floppy disks operate with great speed. Disk drives are also made for 8" floppy disks and for large hard disks.

NOTE: IF BSF (Basic Skills First) is implemented in your school, you may arrange for your students to see the APPLE or Texas Instruments Personal Computer which have diskettes and disk drives.

RESOURCES

My Friend - The Computer, pp. 14, 50-53, 75-77

Computers Are Fun, pp. 33-37

Teacher's Guide and Activity Book to accompany My Friend - The Computer, p. DM-34

Teacher's Guide and Activity Book to accompany Computers Are Fun, pp. 45-48, 79

STRAND 11: COMPUTER OPERATIONS

SITE: COMPUTER ROOM

OBJECTIVE 3: Students will be able to use the keyboard to perform simple functions.

SUPPORTIVE VOCABULARY: SHIFT Key, ALPHA LOCK, ENTER, FCTN (function), SPACE bar, QUIT

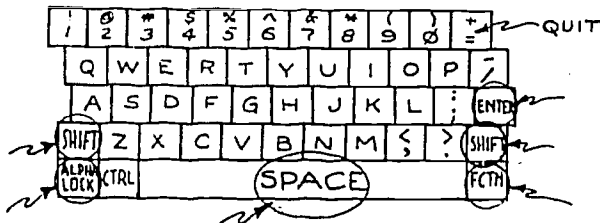
PRESENTING NEW INFORMATION

Step I

Show students the locations of the SHIFT keys (make sure the ALPHA LOCK - lower left corner - is up). Demonstrate that pressing any alphabetical key will display its "lower case" - actually a small capital - form on the screen.



Step II

Next, hold down the SHIFT key and show how the large capital letters appear on the screen. (In your demonstration, try to show use of both hands, holding down the shift key with the hand that is not typing the letter).

Step III

Next, press the ALPHA lock to show how this will cause all the alphabetical keys to display as large capitals without using the SHIFT key. Press it again (to up position) and show how the alphabetical keys come on the screen as small capitals but the numerical and punctuation keys stay the same.

Step IV

Now, show how the SHIFT key is used to display the upper symbols on the key face. For example, 8x8 would be typed by pressing the  then holding the (left) SHIFT key down and pressing  again, then releasing the SHIFT and typing the  a third time. 8x8 is typed as 8*8 in computer language.

Step V

Point out that some punctuation and other symbols are found in front of certain keys. To make these symbols press the FCTN key (right front corner) with your right hand and hold it while you press the key with the symbol on the front. For example, to display the ?; hold the FCTN key down while you press the .

Step VI

Type your full name showing how you use the space bar to separate words.

Step VII

Now type `PRINT "_____"` putting your name where the blanks are, and whatever is in the quotes will appear on the screen after you press the ENTER key.

INDEPENDENT ACTIVITY

Practice (SHIFT, ALPHA LOCK, FCTN, ENTER, SPACE). Let the students practice by using capitals (using the PRINT command) to:

1. Print their names in large capitals (using the ALPHA LOCK).
2. Print their names in small capitals.

End the session by holding down the FCTN key and pressing QUIT, or typing BYE.

NOTES TO THE TEACHER

1. To PRINT, you must have quotation marks at both ends of the statement ("___"), and press ENTER at the end of the statement.
2. These are the symbols for mathematical operations:

+ addition

+
=

 with SHIFT

- subtraction

-
/

 with SHIFT

\times multiplication $\begin{array}{|c|} \hline A \\ \hline B \\ \hline \end{array}$ with SHIFT

\div division $\begin{array}{|c|} \hline - \\ \hline / \\ \hline \end{array}$ without SHIFT

STRAND II: COMPUTER OPERATIONS

SITE: COMPUTER ROOM

OBJECTIVE 4: Students will be able to explain the use and proper care of computer equipment.

SUPPORTIVE VOCABULARY: none

PRESENTING NEW INFORMATION

A

Location: Place CPU on a hard-topped, non-metallic surface, such as a table not on top of a TV set or the video monitor. The video monitor should be placed to avoid direct sunlight or bright light on the screen surface.

Ventilation: Is necessary for continued good operation but air conditioning is not required. Air needs to flow freely through the slots on the bottom, back, and top of the keyboard and monitor.

Cleaning: DO NOT USE SOLVENTS OR OTHER CLEANSERS. Demonstrate with a damp, (not wet) lint-free cloth how to gently wipe the surfaces of the keyboard, video monitor, etc. Emphasize that the CPU must be turned OFF.

Static Electricity: Point out that care must be taken in carpeted rooms because permanent damage can be done to the computer if you touch the computer after building up a charge of static electricity. To prevent this, touch a metal object (doorknob, lamp, etc.) before working with any electronic

37

28-378 849

481

devices in a carpeted room, or use an anti-static spray on the carpet.

NEVER eat or, especially, drink near the computer. Spills could damage it permanently.

B

Demonstrate how to first turn on the monitor, then the CPU, and how to load a cartridge. The cartridge is correctly inserted when the words of the title are right-side-up and facing the student.

Emphasize that students SHOULD NOT TOUCH THE SLOT FOR THE CARTRIDGE, THE BACK OF THE CARTRIDGE (where it goes into the slot), OR ANY OTHER CONNECTIONS ON THE COMPUTER. Lack of proper care could damage the software and/or result in electrical shock to the student.

STRAND III: APPLICATIONS

SITE: COMPUTER ROOM

OBJECTIVE 1: Students will be able to use the basic functions of the computer to run a program (how to use a computer).

SUPPORTIVE VOCABULARY: prompt, cursor, space bar, shift key, keyboard, video monitor, cartridge

PRESENTING NEW INFORMATION

KEYBOARD

Look at the keyboard. The microcomputer keyboard is much like a typewriter keyboard. There are 4 rows of keys. All letters are written as capital (uppercase) letters. There are no lower case letters shown on the keyboard. The numbers are all on the top row of the keyboard. The number 1 is at the far left. The zero and the letter O are not the same. You must use zero for numbers and the letter O for words. The zero 0 has a slash through it on the keyboard. This helps you tell the difference between the number zero 0 and the letter O.

GUIDED ACTIVITY

VIDEO MONITOR - ON/OFF

Find the POWER button on the front, bottom right of the video monitor. Push the gray button in. The green POWER light should come on and the screen will light up.

POWER ON

Find the ON/OFF switch on the front right of the computer's keyboard. Use your thumb to slide the switch to the right.

The red POWER light next to the switch should come on.
(Attached diagram may be used.)

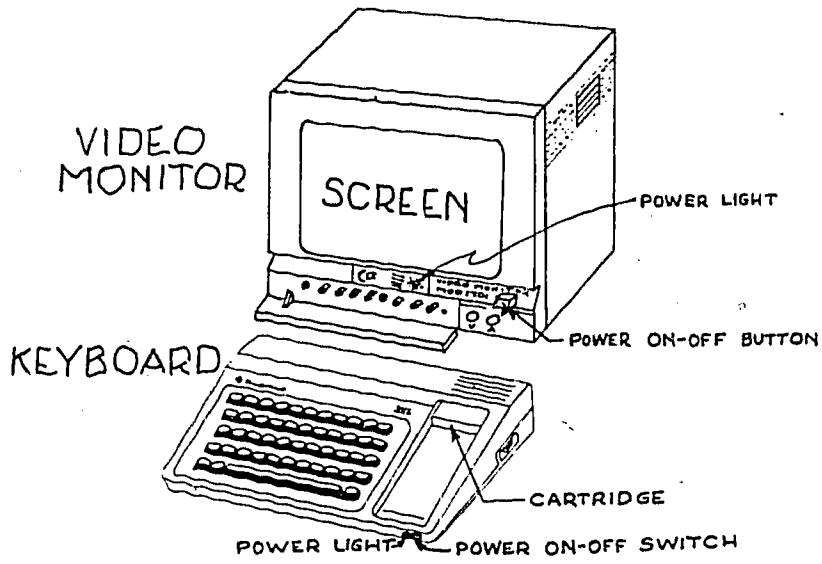

```

TEXAS INSTRUMENTS

HOME COMPUTER

READY - PRESS ANY KEY TO BEGIN

```

VIDEO MONITOR SCREEN

Do as the screen says. Press any key. The video screen will show:

```

TEXAS INSTRUMENTS

HOME COMPUTER

PRESS

1 for TI BASIC

```

Then the screen shows:

```
| TI BASIC |
```



```
| > ■ |
```

The > is called a prompt. It means the computer is waiting for you to give it directions. The flashing square is called the cursor. Cursor means "runner." The cursor "runs" across the screen. The cursor shows where the next character will appear on the screen as you type.

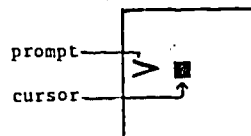

USING THE KEYBOARD

Step I

Type your name on the screen. Press the SPACE BAR to put a space between your first name and last name. The bar at the bottom is the space bar. Watch the cursor move as you type.

Step II

Now erase your name. Press and hold the FCTN (FUNCTION) key. Find the left-facing (+) arrow on the front of the S key. Press the cursor backward until it covers the first letter of your name. Release the function key. Press and hold the space bar until all letters are erased.

Step III

You will now correct a misspelled word. Type DOB. Press and hold the FCTN (FUNCTION) key. Press the left-facing arrow key (S) to move the cursor over B. Release FCTN. Now type G where the cursor is. The corrected word is DOG.

Step IV

Notice the symbols above the numbers on the top row of keys. To get a symbol above the numbers, you press the SHIFT KEY and the key itself. For example, if you want to print the \$ sign, you press the SHIFT KEY, then you press the

\$
4

 key. You get the symbols above the letters on other parts of the keyboard in the same way.

POWER OFF

Push the ON/OFF switch to the left. The red POWER light will go out.

Push the video POWER button in. The video monitor screen will become dark.

TO THE TEACHER:

From this point on, you should begin with Volume I of Creative Programming for Young Minds which is a manual for beginning programming. Lesson #1 begins on page 1.

STRAND III: APPLICATIONS

SITE: COMPUTER ROOM

OBJECTIVE 2: The student will be able to select, load, and interact with (follow the program) a program or game designed for learning.

SUPPORTIVE VOCABULARY: hardware, software

PRESENTING NEW INFORMATION

Tell students all machines used in the computer system are called hardware. Point to the keyboard and video monitor as hardware. To remember this easily, state that machines are made of hard material such as plastic, metal or glass.

The programs that go into the computer are called software. Programs are written on "softer" material. Software tells the computer what to do. Point to the programs inside the cartridges as a kind of software. (The cartridges themselves are hardware).

GUIDED ACTIVITY

Show students how to place selected cartridges into the keyboard. Turn the video monitor on and then the keyboard. Insert the cartridge and notice the students' interaction with the program.

RESOURCES

Educational programs

Educational games

STRAND III: APPLICATIONS

SITE: CLASSROOM/COMPUTER ROOM

OBJECTIVE 3: The student will be able to recognize that a computer needs instructions to operate and that those instructions come from a program written by a person using a programming language such as BASIC, Pascal, or COBOL.

SUPPORTIVE VOCABULARY: Languages - BASIC (Beginning All-Purpose Symbolic Instruction Code)
COBOL (Common Business Oriented Language)
FORTRAN (Formula Translation)
Pascal

PRESENTING NEW INFORMATION

A computer can't do anything unless it is given a set of instructions or programs. To tell a computer what to do, you must use a programming language it understands. The computer understands numbers and certain English words. Special languages have been made up to give orders to computers. BASIC is used mainly in schools and offices. COBOL is used primarily in business. FORTRAN is used mainly in math and science. Pascal is designed for use in computer science instruction. All of these programming languages are taught in the Memphis City Schools curriculum.

The simple commands we will use are from a language called BASIC because it is easier for beginners.

GUIDED ACTIVITY

TO THE TEACHER:

To explore this further, the following are suggested:

K-3 Computers are Fun, Chapter 6, pp. 49-59

4-6 My Friend - The Computer, Part 7, pp. 66-72

RESOURCES

Spotlight on Computer Literacy, "At the Computer," pp. 77-79

Computer Tutor Junior, p. 10

Sound Filmatrip: How Computers Work, A 516-2, Frames 48-65

Poster - Computer Languages - Continental Press

STRAND IV: SOCIAL IMPACT

SITE: CLASSROOM

OBJECTIVE: Students will be able to discuss some ways computers are used in several of the following areas:

Homes and recreation
 Business and industry
 Medicine
 Law and law enforcement
 Transportation
 Military
 Weather prediction
 Research
 Education
 Libraries and Information Center
 Creative Arts
 Personal uses

Supportive Vocabulary: None

Presenting New Information

Show filmstrip EVERYDAY COMPUTERS, A 516-3, SVE.

GUIDED ACTIVITY

Have students recall uses of computers in the categories listed above.

INDEPENDENT ACTIVITY

Ask students to be computer detectives. Suggest that they look for more examples of computer use in their neighborhoods, ask their parents, or watch for computers on TV.

RESOURCES

Sound Filmstrip: SVE, EVERYDAY COMPUTERS, A 516-3

Posters: Uses of Computers - Continental Press

Computers in Education

Personal Computers

Books and Teacher's Guide

Computers are Fun, pp. 9-18

My Friend - The Computer

Spotlight on Computer Literacy, pp. 51-64

Film: Computers in Our Lives, 090980, C 19 min., SND

STRAND V: LOGIC AND PROBLEM SOLVING

SITE: CLASSROOM

OBJECTIVE 1: The student will be able to order specific given steps in the solution of a problem.

SUPPORTIVE VOCABULARY: program, programmer

PRESENTING NEW INFORMATION

A computer will not work without a set of instructions. A set of instructions tells the computer what to do. The set of instructions the computer uses is called a program. The person who writes a program is called a programmer. Before a program is written, the programmer must think of all steps that will be used in the program. All steps must be put in order (first, second, third, etc.).

GUIDED ACTIVITY

When you get up in the morning, you follow certain steps. What is wrong with the order of steps in the following list?

1. Get up
2. Put on shoes
3. Put on socks
4. Go to school
5. Eat breakfast

Teaching Suggestions

Put each step on a strip of paper.
Have the students rearrange the strips vertically in the correct order.

STRAND V: LOGIC AND PROBLEM SOLVING

SITE: CLASSROOM

OBJECTIVE 2: The student will be able to choose and order the proper steps to the solution of a problem or algorithm.

SUPPORTIVE VOCABULARY: Algorithm - a step-by-step plan for solving a problem

PRESENTING NEW INFORMATION

In solving a problem think of all the steps needed to solve the problem or get the job done.

GUIDED ACTIVITY

Have the students discuss the steps to watching a favorite TV program. Write the steps on the board vertically. Discuss the proper order of the steps.

Guide the discussion with questions such as:

- What do you do first to watch TV?
- What is the next thing you do?
- What do you do when you have finished watching TV?

INDEPENDENT ACTIVITY

Ask students to think of something they like to do. List these on the board. Have each child select one and write the steps, numbering them in a column. Allow sharing with class. This may also be done in groups of three or four.

STRAND V: LOGIC AND PROBLEM SOLVING

SITE: CLASSROOM

OBJECTIVE 3: The student will be able to develop a flowchart for a daily activity.

SUPPORTIVE VOCABULARY: flowchart, decision symbol, oval, rectangle

PRESENTING NEW INFORMATION

Explain that a flowchart is a map or drawing of all the steps used by the computer to solve a problem or do some task. It shows the order of steps. It also shows how each step is connected to the other steps. Certain symbols are used when making a flowchart. Drill students on flowchart symbols. The oval  is used to begin and end a flowchart.

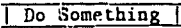
Occasionally a circle is used for the start and stop symbol in place of the oval. The rectangle  is called a "do something" or processing box. 

We connect each symbol with arrows that tell us where to go next.

SIMPLE FLOWCHARTINGTO THE TEACHER:

Go back to the activity in Objective 1 and place the following on the board.

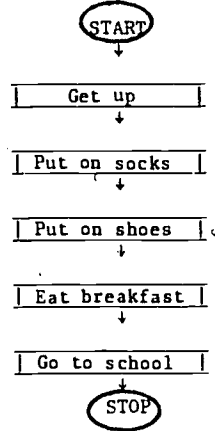
GUIDED ACTIVITY

Refer back to Objective 2 for the activity on watching TV. Have students volunteer putting steps in the flowchart form on the board using symbols.

INDEPENDENT ACTIVITY

Have students draw a flowchart for a day in school.

PRESENTING ADDITIONAL INFORMATION - Level 2DECISION SYMBOL

When solving a problem or doing a task one reaches a point where questions must be asked requiring an answer of either yes or no. A symbol used when asking a question in a flowchart is a decision symbol. It is diamond-shaped.

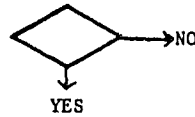

There are always at least 2 arrows coming out of a decision box. If the answer to the question is no, an arrow will lead you in one direction to another step. If the answer to the question is yes, an arrow will lead you in a different direction.

Place on the board the flowchart on page 63 in My Friend - The Computer to demonstrate the use of the decision symbol. Use the questions on p. 63 to guide discussion.

INDEPENDENT ACTIVITY

Use the flowchart made by students for a day in school with decisions of recess or library. Your chart may look something like this:

See the example on the next page 

Example:

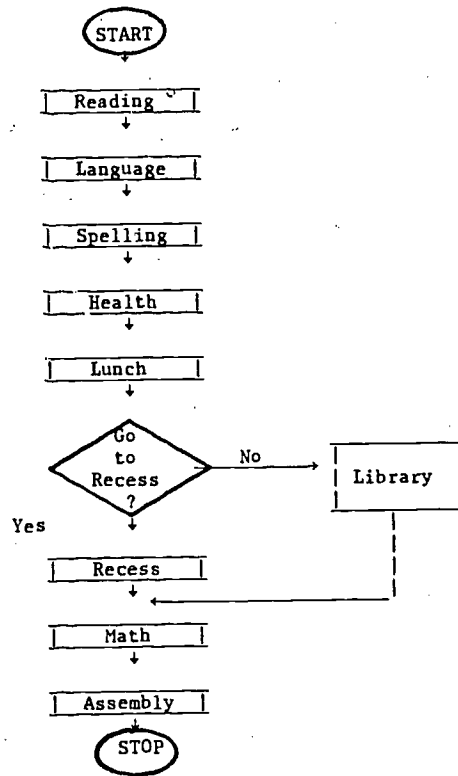

RESOURCES

Sound Filmstrip: INTRODUCTION TO PROGRAMMING, SVE A 516-4, Frames 1-13

My Friend - The Computer, pp. 59-64

Computers Are Fun, pp. 44-48, Guide, pp. 36-37, 83-87

Posters - Components of a Flowchart System, Continental Press

Introductory Flowchart, Continental Press

FLOWCHARTING

As problems become more complicated, some programmers find it useful to construct a flowchart before writing the actual program. Flowcharts are not used by all programmers. However, they are very helpful because they provide a graphical, two-dimensional representation of the many steps involved in analyzing a problem. Consistent use of flowcharts can help programmers develop a more efficient, structured style of programming. They can help a programmer become a better problem solver in general because flowcharting can be applied to all types of problems.

Flowcharting consists of using a set of standardized symbols and arrows to represent the steps necessary for problem solving. Ovals are used to indicate the starting and stopping points of a problem solution. Rectangular boxes are used to indicate the manipulation of information in the memory of the computer. A diamond is used to represent a necessary decision or question. Finally, a parallelogram is used to represent a necessary decision or question. Finally, a parallelogram is used to show what information is fed into the computer or the results of a computation. Arrows are used as connectors between the different symbols to show the direction of the information flow.

SYMBOLS



**START
or
STOP**

Indicates the beginning or end of a flowchart

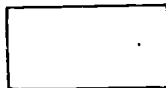

**DO
SOMETHING**

Indicates action to be performed



**INPUT
or
OUTPUT**

Shows what information is read into the computer or what is printed

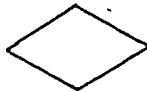

DECISION

Tells where a choice is made

STRAND V: LOGIC AND PROBLEM SOLVING

SITE: COMPUTER ROOM

OBJECTIVE 4: Students will be able to develop the concept of a variable as a location in the computer's memory.

SUPPORTIVE VOCABULARY: variable, memory

PRESENTING NEW INFORMATION

CONCEPT OF VARIABLE

Explain that a variable is something with one name that changes (varies) in make-up. Example: DOG If you are asked to take a picture of a DOG, you have to take a picture of a particular dog; it will have a certain color, size, shape, and so forth. But if 100 people are asked to take a picture of a dog, there may be 100 different-looking animals and still all be pictures of a DOG. So the word is a kind of VARIABLE.

LOCATION OF VARIABLE IN MEMORY OF THE COMPUTER

Write the letter "D" on the board and say that it will stand for DOG. Put a box around the letter and say that the box stands for a location in the computer's memory. D

Compare this to human memory: we could say that we have a certain "place" in our memory that we call DOG and fill in the details of whatever kind of dog we want to at a certain time. We are going to tell the computer to hold a place in its memory for DOG and call this place D. We haven't decided what kind of dog it is, so we will give it a value of 0.

Type `| D = 0 |`. (Don't forget to press the ENTER key at the end of each line).

CHALK BOARD Example

D (DOG)	Kinds of dogs	Number
location	D = ex. <u>Collie</u>	1
<code> 0 </code> in memory	<u>German Shepard</u>	2
	<u>Greyhound</u>	3

READING THE COMPUTER'S MEMORY

To find out what is at location D in the computer's memory, we type `| PRINT D |`. This tells the computer to go to location D and display 0 because we told the computer that D = 0.

CHANGING THE VALUE OF THE VARIABLE

We can change the information in this location (D) by changing the value of the variable. We said before that there are different kinds of dogs. (Make a list on the board: example, collie, greyhound, German shepherd). Let's give a number or value to each kind of dog. (Add these to the chart, and explain that words can be used for variables, but since numbers are simpler, we will use numbers for this example). We will now change the information in the computer's memory by giving D a new name. (Type in `| D = _____, |` filling in a number for the type of dog desired). To see if the computer received the new information, type `| PRINT D |` and the current value of D will be displayed.

INDEPENDENT ACTIVITY

Give students examples for variables. Tell them they can use any letters (doesn't have to be D).

Example: J = jobs 1 - carpenter
 PRINT J 2 - computer programmer
 3 - teacher
 4 - policeman

or numbers without names

N = 5*6
PRINT N

RESOURCES

Grades 4-6 Computer Tutor, p. 38

(p. 39, String Variables - using words instead of just numbers)

GLOSSARY OF TERMS

abacus - a counting device with beads strung on wires.

algorithm - a step-by-step procedure for solving a problem.

BASIC - Beginning All-Purpose Symbolic Instruction Code; the computer language used for most microcomputers, including the TI99/4A; (Different microcomputers use slightly different "dialects" of BASIC, however).

cartridge - a software package inserted into the computer that will extend its use and capabilities. The TI 99/4A manuals use the term Command Module.

central processing unit (CPU) - the large chip that is the "brain" of the computer where the processing of information and computation takes place.

character - a letter, number, punctuation or other symbol on the keyboard.

Command Module - a pre-programmed ROM module or cartridge which is inserted into the computer to extend its use and capabilities.

COBOL - Common Business Oriented Language; the computer language often used in business.

computer - originally, a machine that counts; now capable of many complicated problem-solving processes.

cursor - a symbol (*) which shows where the next character will appear on the screen when you press a key.

flowchart - a diagram of the steps used by a computer to solve a problem.

FORTRAN - Formula Translation; the computer language often used in science and research.

hardware - the devices which make up a computer system, such as video screen, keyboard.

input - (noun) information to be put in computer memory
(verb) the process of putting information into the memory.

keyboard - the hardware that looks like a typewriter and has the character and function keys.

mainframe - the largest computers, and the most expensive (room-sized).

microcomputers - small, desk-top computers, usually \$2,000 or less.

minicomputers - medium-sized computers of medium price.

output - (noun) information supplied by the computer.
(verb) transferring information from the computer's memory onto a device such as a screen or printer.

pascal - A programming language, developed for computer science instruction.

printout - a "hard" copy; output from the computer by means of a printer.

processing - the operations of the computer on the input.

program - a set of statements which tell the computer how to perform a complete task.

programmer - one who writes computer programs.

prompt - a symbol (>) which marks the beginning of each line or asks for input from the user.

RAM - Random Access Memory; the main memory where programs and information are stored while the user is operating the computer. Everything in RAM is erased when the power is turned off.

ROM - Read-Only Memory; permanent instructions for the computer which can be used ("read") but not changed or erased.

shift key - the key used to change between upper and lower case letters, and between upper and lower characters of the keys.

software - programs used by the computer, including those built into the ROM.

space bar - the long bar at the bottom of the keyboard used to insert spaces between words or characters.

technology - the tools used to perform a task.

variable - a name given to a value which may vary during the program; a memory location.

video monitor - the screen used to view the output of the computer.

ANNOTATED RESOURCES
K-6COMPUTER AWARENESS - SVE - (Sound Filmstrips)

This sound filmstrip kit covers what computers do, how they work, and some of the ways computers are used in business, at school, at home, and for entertainment. It also includes an introduction to computer languages and simple programming methods.

A teacher's guide and 24 reproducible skills sheet provide background and review material.

COMPUTER LITERACY AND UNDERSTANDING - ED. ACT. - (Sound Filmstrips)

Computer history and development of modern computers are both developed in this sound filmstrip kit. Today's computers are discussed including: (1) what they are; (2) how they work; and (3) different kinds of computers. Flowcharting and an introduction to programming are also covered.

A teacher's guide and duplicating masters are provided. (This set will be available September 1).

HISTORY OF COMPUTERS - (Poster Set) - Continental Press

Posters included in the set of 23" X 35" posters are:

- (1) Introductory Flowchart
- (2) Components of a Flowchart System
- (3) Uses of computers
- (4) Computer Systems
- (5) History of Computers
- (6) Computer Languages

(7) Computers in Education

(8) Personal Computers

MY FRIEND THE COMPUTER BY JEAN RICE - (Grades 4-6)

My Friend The Computer is an introduction to computers and their uses. Part one discusses what a computer is and the idea of time-sharing. In part two common uses of computers in medicine, industry, etc., are discussed. Part three presents a brief history of computers, while part four outlines the various parts of a computer. Input, output and memory devices are covered in part five, with flowcharting presented in part six. Programming in BASIC and microcomputers are discussed in parts seven and eight. A glossary of computer terms concludes the text.

The accompanying teacher's guide and activity book contains both pre-tests and post-tests with answer keys and duplicating masters.

COMPUTERS ARE FUN BY JEAN RICE - (Grades K-3)

Computers Are Fun introduces beginning computer concepts. It tells how computers help us, what early computers were like, how the computer has many parts, what microcomputers are, how flowcharts are like computer maps, and how programs tell the computer what to do.

A comprehensive Teacher's Guide and Activity Book accompanies this book.

COMPUTER TUTOR - (Paperback book) - (Grades 4-6)

Computer Tutor is an introductory book on computers. Activities include history and development, terms, uses, how computers work, how to develop programs, and computer careers.

COMPUTER TUTOR JR. - (Paperback book) - (Grades K-3)

Computer Tutor Jr. is a simple introduction to the computer written especially for primary grades. It includes information and activities on hardware, software, uses of computers, how computers work, input, output, and memory.

SPOTLIGHT ON COMPUTER LITERACY BY ELLEN RICHMAN
(Book and teacher's guide)

Spotlight On Computer Literacy is an introductory text written at a 6-7 grade reading level which may also be used as a teacher resource book. The first two units describe how computers work and relate the technology to everyday experience. The programming sections include "hands-off" and "hands-on" activities.

CREATIVE PROGRAMMING MANUALS FOR YOUNG MINDS
(manuals)

This series of eleven manuals introduces the student to programming activities for the TI-994A. The student may progress independently from beginning to more advanced programming in BASIC language.

SKILLS CHECKLIST
GRADES K-3
CLASS RECORD

Use CREATIVE PROGRAMMING
FOR YOUNG MINDS, Vol. 1:

- ENTER, p. 3
- PRINT, p. 4
- RUN, p. 5
- LIST, p. 5

TEACHER _____

NAMES	TEACHER _____								
	Turn equipment ON	Explain proper care of software and hardware	Use menu-driven program	Explain special purpose keys: FCTN	SHIFT, ALPHA Lock, ENTER	Use PRINT, RUN, and LIST to display first name (K-1)	Use PRINT, RUN, and LIST to display full name (2-3)	Calculate two problems*	Turn equipment OFF

* COMPUTERS ARE FUN, pp. 49-58



COMPUTER EDUCATION
AWARENESS EVALUATION TOOL
Grades K-3

1. Circle the abacus.

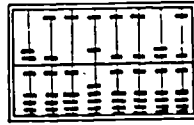
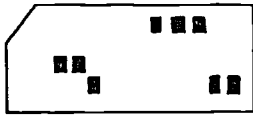
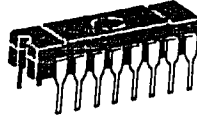
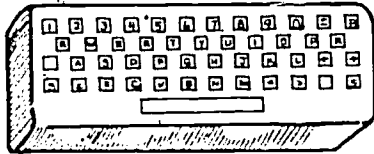

2. Circle the transistor.

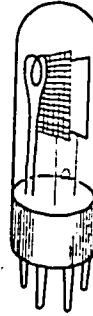
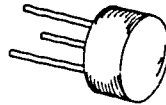
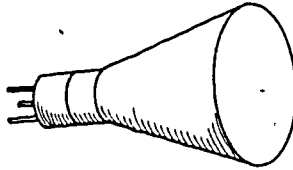
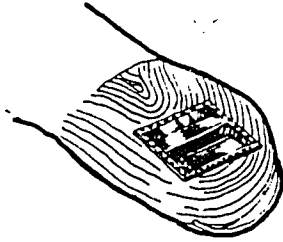

5. Circle the software item.

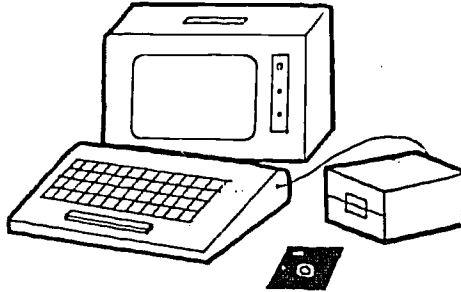

6. Circle the item used on a modem.

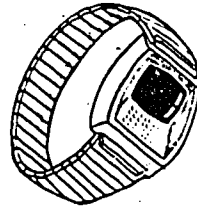
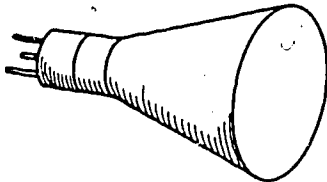
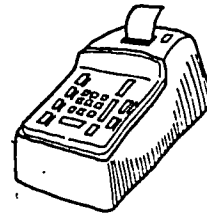
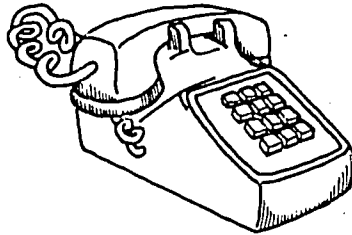

7. Draw a flow chart symbol that means "DO SOMETHING."

8. Circle the name of a computer language.

STATEMENT

BASIC

OUTPUT

BINARY

9. The amount of memory in a computer is measured in (circle the correct answer)

ANALOGS

DIGITALS

BYTES

WATTS

10. Telling a computer what to do is called (circle the correct answer)

ASSEMBLING

PROCESSING

COMMANDING

PROGRAMMING

ANSWERS

COMPUTER EDUCATION
AWARENESS EVALUATION TOOL
Grades K-3

1. Circle the abacus.

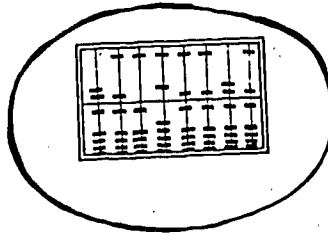
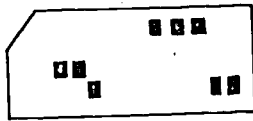
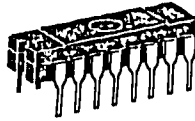
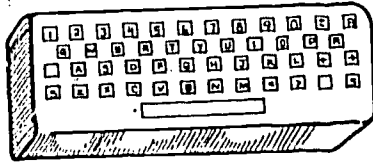

2. Circle the transistor.

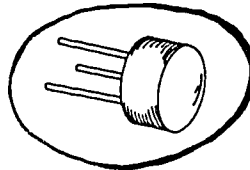
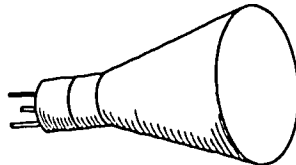
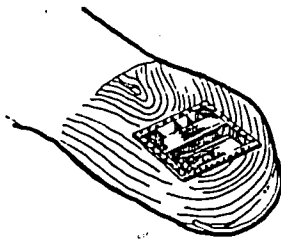

3. Circle the universal product code.

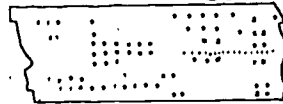
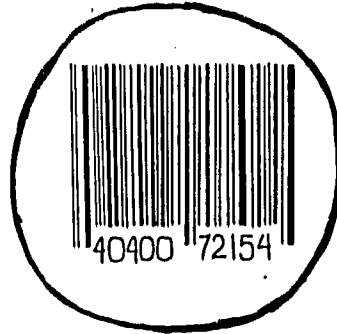
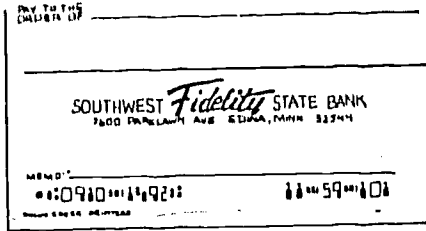

4. Circle the hardware item.

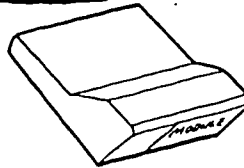
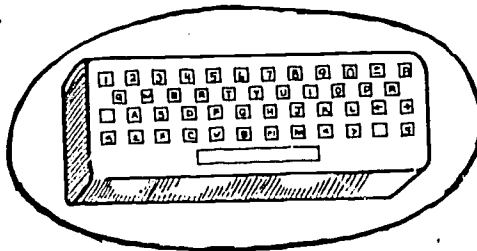
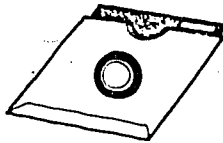

5. Circle the software item.

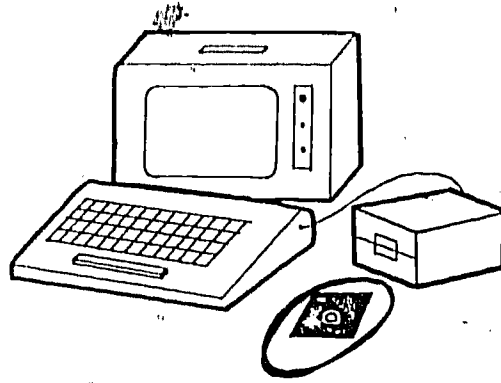

6. Circle the item used on a modem.

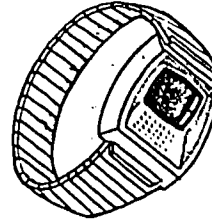
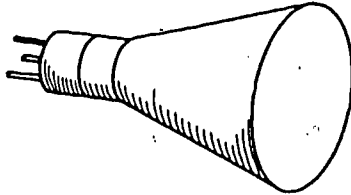
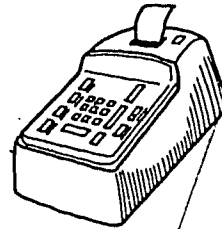
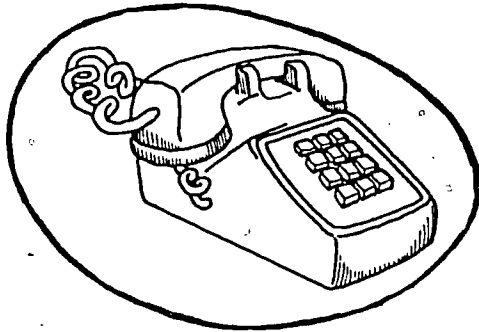

7. Draw a flow chart symbol that means "DO SOMETHING."



8. Circle the name of a computer language.

STATEMENT

BASIC

OUTPUT

BINARY

9. The amount of memory in a computer is measured in (circle the correct answer)

ANALOGS

DIGITALS

BYTES

WATTS

10. Telling a computer what to do is called (circle the correct answer)

ASSEMBLING

PROCESSING

COMMANDING

PROGRAMMING

COMPUTER EDUCATION
AWARENESS EVALUATION TOOL
Grades 4 - 6

1. Circle a future generation computer.

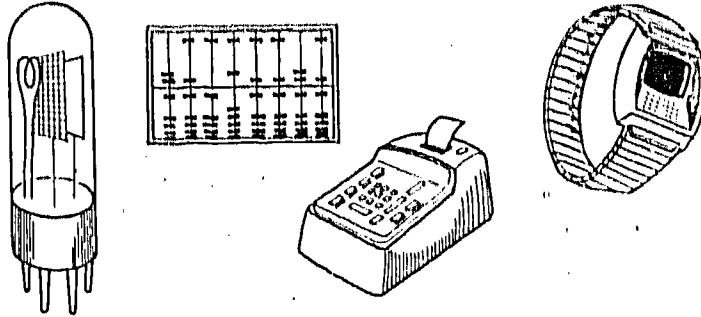

2. Circle objects computers use:

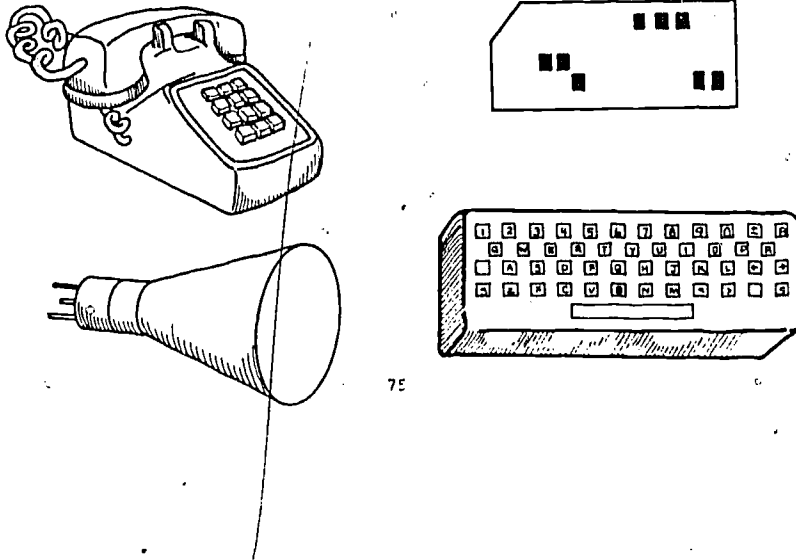

75

MULTIPLE CHOICE: Circle the letter of the best answer.

3. The term "software" refers to
 - a. a cushion on an office chair
 - b. computer programs
 - c. equipment
 - d. balloon chips
4. The blinking square that shows me where to type is called a
 - a. shift
 - b. cassette
 - c. cursor
 - d. command
5. The TV set attached to a computer is also called
 - a. a monitor
 - b. a central processing unit
 - c. an optical character recognition
 - d. a printer
6. First generation computers used large, hot vacuum tubes. These were replaced by small semi-conductors called
 - a. scanners
 - b. universal product codes
 - c. cathode ray tubes
 - d. transistors
7. The math symbol for division in BASIC is
 - a. \div
 - b. $/$
 - c. *
 - d. **

SHORT ANSWER:

8. Explain how a computer can be your teacher.
9. What brand of computer would you consider having at home? Why?
10. List three activities you would most like to do on a microcomputer.

11. List three major ways large computers help a business operation.

12. List three ways computers may help us more in the future.

MATCHING: Draw lines to connect each picture to its name.

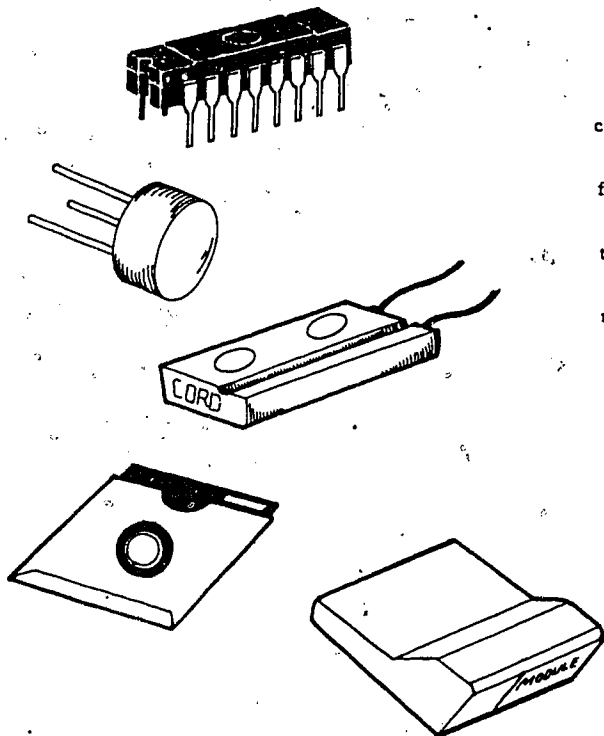

- cartridge
- floppy disc
- transistor
- microprocessor
- coupler box

ANSWERS

COMPUTER EDUCATION
AWARENESS EVALUATION TOOL
Grades 4 - 6

1. Circle a future generation computer:

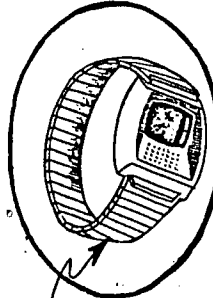
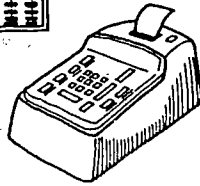
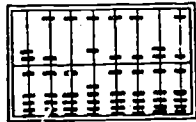

Computer
for on wrist.

2. Circle objects computers use:

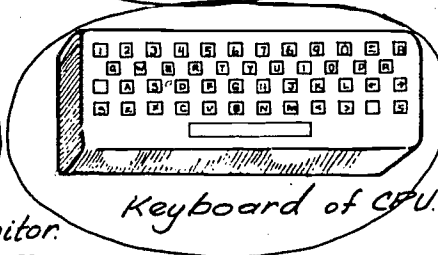
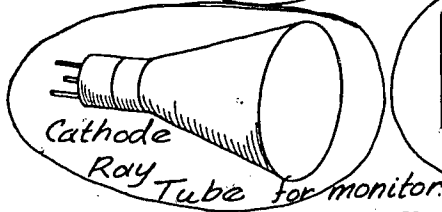
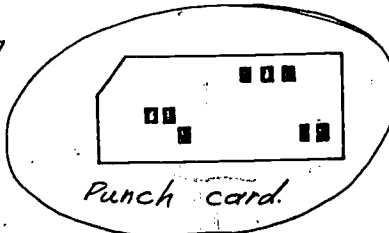
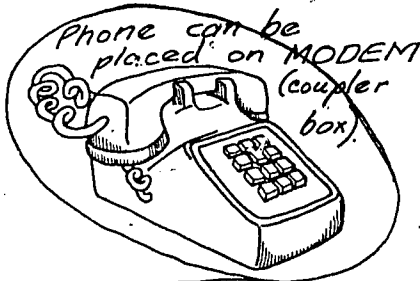

MULTIPLE CHOICE: Circle the letter of the best answer.

3. The term "software" refers to
- a cushion on an office chair
 - computer programs
 - equipment
 - silicon chips
4. The blinking square that shows me where to type is called a
- shift
 - cassette
 - cursor
 - command
5. The TV set attached to a computer is also called
- a monitor
 - a central processing unit
 - an optical character recognition
 - a printer
6. First generation computers used large, hot vacuum tubes. These were replaced by small semi-conductors called
- scanners
 - universal product codes
 - cathode ray tubes
 - transistors
7. The math symbol for division in BASIC is
- \div
 - /
 - *
 - **

SHORT ANSWER: (The following answers are suggested samples.)

8. Explain how a computer can be your teacher.
- Its lessons help me practice skills. It can test my comprehension and score my answers. It can recognize my misspelled words. It has a memory and can respond to me.
9. What brand of computer would you consider having at home? Why?
- (The purpose of the question is to encourage the use of computers at home.) Reasons may vary from - low price, will help me practice programming, will help me learn to type, will help an older person in my home to perform a job or learn career skills.
10. List three activities you would most like to do on a microcomputer.
- Learn to program
Learn to type
Practice reading and math skills
Play games
Connect to a big computer by telephone

11. List three major ways large computers help a business operation.

Compute payroll; Inventory control; Store data; Process data; Retrieve data; Calculate; Billing; Ordering; Word Processing; Financial transactions

12. List three ways computers may help us more in the future.

They may type words we speak into them. They may be so small that we can carry them easily and power them with a small battery. They may receive and transmit radio signals. They may identify anything we place on a camera inside them.

MATCHING: Draw lines to connect each picture to its name.

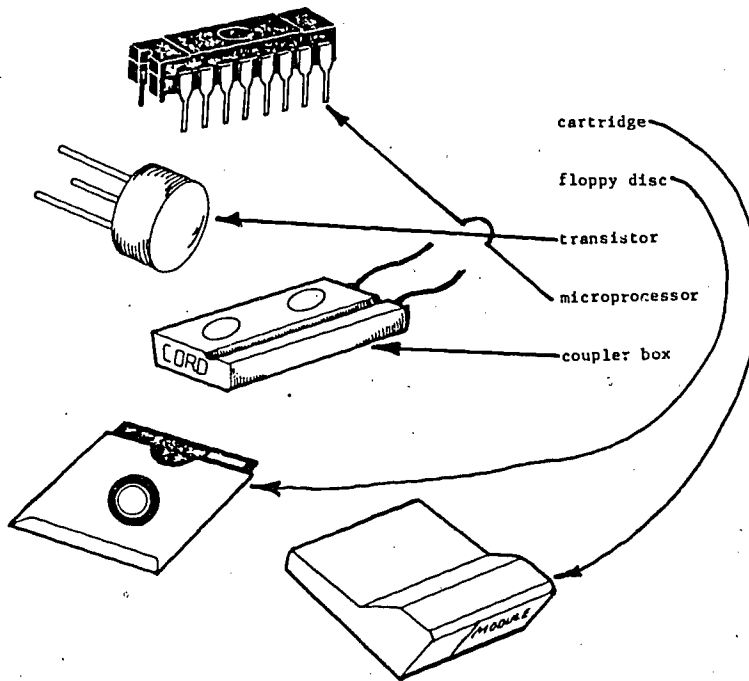

80

521

COMPUTER AWARENESS RECOMMENDATION FORM
DIVISION OF CURRICULUM DEVELOPMENT, ROOM 254

NAME: _____
(optional)

GRADE: _____

CURRICULUM RECOMMENDATIONS:

MATERIALS RECOMMENDATIONS:

STAFF DEVELOPMENT RECOMMENDATIONS:

OTHER:

81

525.

PROFESSIONAL GROWTH OPPORTUNITIES

The resource teacher at your school will be providing activities to help you become more familiar with the computer and curriculum for this program.

Additional professional growth opportunities will be made available throughout the school year in Computer Awareness and Literacy by the Division of Employee Services.

Mr. GORE. Thank you very much for an excellent statement. We appreciate it.

We'll hold off on questions until the other members of the panel have completed their statements.

Our next witness is Ms. Patricia Sturdivant, associate superintendent for technology at the Houston Independent School District in Houston.

And Houston has already acquired a national reputation for leadership in this area, and we feel it's very important to hear your testimony. We're looking forward to it.

Please proceed.

STATEMENT OF PATRICIA STURDIVANT, ASSOCIATE SUPERINTENDENT FOR TECHNOLOGY, HOUSTON INDEPENDENT SCHOOL DISTRICT, HOUSTON, TEX.

Ms. STURDIVANT. Thank you.

Many experts have testified about the problems that educators are having in using technology. My paper does address these, but I'm going to specifically focus on some of the ways that our school district has tried to address the proliferation of technology.

A year and a half ago the school board set up a Department of Technology to provide for districtwide coordination and charged that department specifically with the responsibility for staff training, going beyond just teachers, including administrators and curriculum specialists.

Also, set up a division for needs assessment and planning to take a longer look at the changing technology and what would be needed in order to plan for new technologies like video, cable, satellite communication.

A Division of Procurement was established, so that a central entity would be responsible for making purchases of computer hardware and software.

A systems design and development group was established to develop software that was needed for the growing number of microcomputers the district was purchasing.

A Maintenance Division was set up, and another group was brought on board to provide technical support to teachers and administrators who were trying to use this new technology.

Many who have spoken here today have talked about the problems we are having with software, and I'd like to begin there by making you even more aware of how difficult it is not only to get the quantity that you need, but the quality, and there are certain areas that are not being addressed at all.

For example, one of those is English as a second language. Our district will be primarily Hispanic by 1985 if the current projections hold up. We have 97 different languages that are spoken within our district, and yet no producer publishes a courseware package for teaching English as a second language.

Consequently, it became obvious to us about a year ago that if we were going to meet this need, since we do not have enough bilingual teachers to address these 97 different languages, that we were going to have to develop a program of our own.

We initially went out to bid. Several major publishers bid on the package. The lowest estimate we received for developing a K through 12 ESL package was \$1 million.

We finally began to organize such a development team ourselves, hiring the programmers, the curriculum specialists, and the ESL specialists that we needed. Had we been forced to use the vendor's own brand of computers and the software that would have been produced, we would have also sacrificed certain ownership rights and the ability to reproduce it, and we were very anxious to be able to replicate the software that was being developed.

We are now almost 1 year into this development project. We are creating software for teaching English as a second language using the voice synthesizer.

But still, even though we've undertaken a very ambitious effort, so much more needs to be done, and there are so many other areas.

I don't think the situation is going to work itself out. One industry expert estimated that only 10 percent of the software that is being produced in education by the year 1985 will really be dedicated to instructional content delivery. Since more and more parents are buying computers, the commercial publishers are focusing more on game development.

We really do need an educational software consortium. The solution to this problem on a national scale is for the public schools to form a software consortium to develop the quality programs that are needed.

The Houston district alone has about 200,000 students. Now to provide each student in our district with just one-half hour of computer time per day would require 20,000 microcomputers. And even with that number, we would have only a 10-to-1 computer-student ratio. A good microcomputer costs approximately \$1,000. A set of software costs another thousand dollars. The necessary training, another thousand dollars. That totals \$60 million for just the Houston Independent School District for a single year.

I think one of the primary points that needs to be emphasized in our discussion is the fact that the expenditure for the hardware is minuscule compared to all the other costs, many of which are recurring. One estimate has set the one-time cost of developing a K through 12 software curriculum which would cover 40 subjects at \$60 million. Well, with today's economic woes, it may seem like the height of foolishness to propose such figures. Yet, we have a \$4 trillion economy that rests on the quality of the \$200 billion educational system which desperately needs overhauling.

Judging from SAT scores, the quality of students majoring in education in college is declining. The greatest proportion of school

budget goes to teacher salaries. In fact, the national average is 87 percent.

Technology can attack both of these problems if the educational delivery system is restructured. By using computers to teach that part of the curriculum which they can do so well, a district could hire fewer more competent teachers who would be more productive. Merely adding the technology onto the existing educational system will not work. It can help if teachers and administrators use technology properly and fully and if the schools are reorganized to stay open all year to take advantage of the capital and personnel resources that have been invested.

We have established our own software resource centers. Few teachers have the time to keep up with commercial software development. Houston educators depend on our department's software resource center to help them make intelligent decisions about these matters. At the center they can preview software, hand-held learning devices, new computers, journals, and periodicals. All software is systematically reviewed using a standard evaluation instrument. Before vendors are allowed to present their programs to staff evaluators, they have to submit a proposal detailing the objectives of the program, documentation, discounts, warranties, training, and information about its validity.

I'd like to make some remarks about educating the handicapped. Technology's potential to educate the handicapped is probably the most promising element which really needs more exploration.

On September 13, 1983, CBS Evening News broadcast a story of how an Apple microcomputer expanded the horizons of a young boy that was paralyzed from the neck down in an auto accident. He can activate his computer by speaking into a microphone attached to a headset. The computer talks back using a speech synthesizer. It can control the television dials, even turning the satellite receiver in the backyard for the best reception; adjust his bed; provide reading material; play games; and dial friends on the telephone.

In Houston we have not accomplished that feat yet, but blind students are using optical character recognition devices to convert printed matter into Braille. Micros are used to teach home-bound students, and we have computers in all of the hospitals in the Medical Center, which are used to help these students keep up with their work that their classmates are doing back at school.

In fact, at one campus, Rogers Elementary, gifted students tutor deaf students in how to use microcomputers to improve their learning.

Of course, the biggest challenge of all of this is the trainers. Who will train the trainers? Everyone wants to give students a head-start learning how to use these dazzling new technologies. Reacting to parent pressures, school districts across the country are all rushing out to buy computers. The result is that teachers are being forced to use a technology they know no more about than their students.

Logically, teacher colleges and universities should be providing computer training for education majors, but, unfortunately, most are not. Very few colleges require their education students to take even a single computer course. School districts are going to have to do their own training.

In January 1982, HISD established a full-scale training effort with seven full-time teacher trainers. It set up policies requiring mandated training. And while we've talked a lot about these hearings, about the importance of teacher training, I don't think we should emphasize the leadership. It begins with the school board and the school administration and the principals.

All of our school board members, top cabinet members, and building principals have gone through a 20-hour training program, which is required before any computers can be installed in their buildings.

Depending upon the application, teachers who work with computers attend between 24 and 296 hours of training sessions. Approximately 75 percent of this training provides for hands-on experience.

Teachers who complete 296 hours of training do receive an annual salary bonus as part of our second-mile compensation package. Several hundred persons a month attend workshops at the center. In fact, in this past year we've trained approximately 10,000 people in the school district, and a sizable number of those are parents.

Although these statistics are promising, there's still so much more training that needs to be done. It's not a one-time proposition, because the technology is changing so rapidly.

There are only a few thousand people who are qualified to train teachers about computers, and there are 3 million teachers in this country. The obvious answer is to start using technology more to teach others about it.

Another big problem facing many school districts is planning. Computers are installed in the Houston school buildings only after a written implementation plan is completed. On the actual implementation plan administrators are asked to provide information about the objectives of their program, target population, the training that will be needed. They must identify the software. And only after all of these categories of information are provided do we proceed with the teacher training and the support that's necessary to assure that those computers are not installed in buildings where they will sit on shelves.

Centralized procurement is another issue of great importance, whether it is addressed at the State level or the local school district level, and certainly in a district as large as ours we are able to wield quite a lot of buying power by purchasing computers on a bid basis. But the kind of systematic planning does make campus technology users think about their programs and insure hardware compatibility, which is a very important issue, I think.

Many districts have allowed campuses to purchase various brands of equipment, a decision which virtually guarantees certain difficulties when it comes to training. For that reason, we have limited the number of options available to the schools. They cannot purchase any equipment that they would like to use. They must choose from a list.

In Houston all hardware and software is purchased centrally, not only for compatibility reasons, but to obtain lower prices. Vendors present their wares to a hardware selection committee, and in the

last year we've saved almost \$1 million on purchases of both hardware and software.

Maintenance is an issue that I have not heard addressed, but one that I think is extremely important, and it will become even more critical as school districts accumulate more and more of this hardware.

Buying large amounts of hardware, no matter what discount, guarantees one type of headache, and that's maintenance. Although modern microcomputers are relatively reliable, they do break down, especially under rough student use.

At first our school district subcontracted out for maintenance service, until a study showed that by 1985 we would be paying \$900,000 a year to keep all of our equipment running. We created our own maintenance division. Its objective is to provide faster, better service at a reduced cost.

If repairs can be made quickly onsite, then that is done. If not, a loaner unit is provided to keep students on line.

To maintain its reputation for quick service, the maintenance division warehouses parts for the district's computers and peripherals. Maintenance personnel also prepare electrical specifications for school campuses receiving five or more computers, but the costs for maintenance do keep escalating. And as certain equipment becomes obsolete, it becomes a greater and greater challenge to find parts that are in very rare supply.

Computer literacy—there's been a lot of discussion about it. What should we teach? Well, in January 1983, the Houston School Board made computer literacy a high school graduation requirement for students finishing school in 1986 and thereafter. One is computer literate who has the knowledge, skills, and attitudes necessary for functioning in a computer-oriented society.

A delineation of the computer literacy elements in our curriculum is being presented in my written testimony, so I won't address those, but I do want to emphasize that there is a lack of suitable commercial curricula on many of these computer topics, which has again forced the school district, because of the large numbers of students we are required to serve, to develop our own literacy curriculum and our own computer software.

It stresses the ability to use computing systems to solve problems in everyday life. The curriculum's objective is not to make all students computer programmers, but rather to make them aware of and capable of using a myriad of computer applications sure to pervade their lives in the 21st century.

We have talked an awful lot about delivery systems and the need for educational reform, and my paper does emphasize some of the reforms that I think are broader in context, which I won't discuss here, but they do involve upgrading high school graduation standards, provisions for making the year-round school a reality. In fact, we are piloting a year-round school now, and to make extended day program the rule, not the exception.

The coming information technologies will make vast amounts of information available to students. They will not have to waste their time searching for information in remote libraries in obscure books. Technology is going to save students time, but in doing so

makes more knowledge available to be learned in the already crowded school day.

We keep hearing a lot about the information explosion, and yet the length of the school day has really not expanded in 200 years. We have to look at that basic delivery system and look for ways that we can promote the concept of lifelong learning, and I think the ways to maximize that can be effective through the use of computer technology.

One of the most significant implications from all of this discussion is the role change that will take place on the part of many educators and, most prominently, the teachers' role. Technology will change the role of teachers, in that traditionally the teacher has been the disseminator of information. In the future the teacher will have to become the facilitator.

If computers are going to become the primary conveyors of information, then we're going to have to put more and more emphasis on higher-level thinking skills.

Children will need to compete in the world economy, and in order to do so, they're going to have to have the problem-solving skills, the abilities to analyze, synthesize, and we have to look for ways in which we can promote those higher-level thinking skills. And I think that technology offers many potentials in this area.

We've talked a lot about the kinds of reward structures that are going to be necessary in order to promote the development of these skills on the part of teachers. As a result of "A Nation at Risk" and other national critiques recently published, I think that all the State departments of education are working on plans.

I began working with computers 10 years ago. In those early days I watched a handful of teachers who immediately saw the potential benefits of technology take the initiative, teach themselves what they needed to know. They took computer classes on their own. They bought personal computers to use at home and in class. They sparked the enthusiasm of their students with their own excitement.

Are these devoted, dedicated teachers to remain forever doomed to a salary schedule based on seniority and degrees? Do they not deserve more pay?

Approximately 11,000 Texas teachers quit their jobs each year. The number of teachers graduating from Texas colleges has declined from 16,000 in 1973 to 9,000 in 1983. The entire Nation only produced 798 math teachers and 597 science teachers in 1981.

We get what we pay for. I'm convinced that people are willing to pay for excellence, but only if they are persuaded that they'll get it. This is one of the most critical issues that we must confront when we start emphasizing science and technology. We must find the reward structures to benefit the teachers.

In HISD we are paying teachers who teach science and math classes \$1,500 more than regular teachers. Those that successfully compete our technology training program receive an additional \$2,000 stipend.

We must also look at business and industry for help. The educational community must continue to build a collaboration with business and industry. Seventy-five percent of all the taxes for public

education in Houston are paid for by business and industry. The same companies are the recipients of HISD graduates.

We have initiated what we're calling "SchoolBusiness Partnerships." We now have 100 of them. Several companies, including Shell Oil and IBM, are lending full-time instructors to the district to teach computer science. The vice president of a major national oil company told us just a few weeks ago that we should scrap our entire vocational education program. He said, "We don't need welders and draftsmen anymore." Keeping vocational education up to date with the changing technologies of industry has always been a problem for the schools. Even if the district can scrape up the many thousands of dollars needed to buy an expensive computer-base machine, it becomes obsolete within a few years.

It may be necessary to allow students, with the assistance of their teachers, to leave school at an earlier age to enter business training programs.

The equity issue is one of the most important, I think, that we have to address. Unfortunately, computer hardware and software are still relatively expensive, and the wealthier schools and parents can afford to buy the equipment and the poor cannot.

I'm submitting some information in my testimony which shows how urban school districts have been hurt tremendously by the cut-backs in Federal funds.

Mr. GORE. We'll include all of your prepared text in your entire statement. If you wish to summarize the rest of your statement, we would appreciate it.

Ms. STURDIVANT. We have begun a significant effort in order to address the equity issue. We have begun training parents and teachers after school. We provide them with 12 hours of training in the use of the computer and then allow the parents to check out the equipment and take it home.

As a matter of fact, we now have 900 computers that are available in the checkout program, which involves 45 different schools. As a result, we have had a tremendous upsurge of interest and commitment to the school district, and we are now beginning a patron purchase program that will allow the middle-class parents to also benefit and participate in some of the same ways.

The education system I think is being seriously threatened at this point. Many of the national reports point to that.

Our great Nation has always responded with vigor and energy to challenges. Our national survival depends on revitalizing and redirecting our public education system, and I think that an emphasis on technology can be an important catalyst. We can turn it around with an American invention, electronic technology.

The Orwellian prophecy of an authoritarian, technological nightmare in 1984 is now only three months away. If we have the resolution and foresight to do what must be done, I believe that 1984 will find the American people using technology to rejuvenate the schools to expand our freedom, our children's horizons, our preeminence in the international community, but it is going to take a planned and concerted effort. It won't just happen.

Thank you.

[The prepared statement of Patricia Sturdivant follows:]

TESTIMONY

On Computer Technology Issues Facing the Public Schools

by Patricia Sturdivant
Associate Superintendent for Technology
Houston Independent School District
September 29, 1983

Presented to

The Committee on Science and Technology
of the U. S. House of Representatives

WE MUST RESTRUCTURE OUR EDUCATIONAL DELIVERY SYSTEM

There are now 18 national studies underway which analyze the failures of American public education. As a people, we seem to need provocative, alarmist cries for reform like those expressed in *A Nation at Risk*, for example. The sober warnings that leading educators have made for years are inadequate.

The problem with many of these studies is that they tend to lay the major blame at the feet of the most obvious target--the poor overworked schoolteacher. We know in our hearts that the problems are not that simple. The crumbling family structure and consequent explosion of single parent homes and latchkey children, the loss of religious authority and institutional trust, the astonishing rate of social and technological change, the dramatic influx of non-English speaking immigrants, the receding tax bases, the aging American population less emotionally committed to the neighborhood school, the enormous proportion of working mothers who have no time and less energy to devote to voluntary school activities--all these are powerful factors in the decline of educational performance.

There is no doubt that reform is necessary. One of five American adults is functionally illiterate. Some 850,000 teenagers drop out of high school every year. Taxpayers spend \$12.6 billion per year for welfare payments and prison inmates, the vast majority of whom are functionally illiterate. Adults used to be functionally literate if they had completed the 4th grade. Today they need an 8th grade education. With the technological imperative being what it is, they will soon need to complete the 10th grade. If the American standard of living is to be maintained in the face of increasingly brutal international competition, the country's workers must perform at a high level of excellence. I believe that technology can help us ameliorate these dismal statistics and improve our education system.

THE NEW LEARNING TECHNOLOGIES CAN HELP THE SCHOOLS

Marshall McLuhan once said, "I don't know who discovered water, but I'm sure it wasn't a fish." His point was that our immediate surroundings are invisible to us. Here we are in the middle of the greatest breakthrough ever in human intelligence, on a mass scale, but we cannot see it. We do not know what to do with all these new technologies except to use them as electronic flashboards.

We have long since passed the point of information overload. Already more than 5,000 articles are written each day, and the number doubles every two years. The technology of printing has dominated education for 500 years. That dominance is ending as America enters the information age with a host of new technologies--computers linked together by interactive databases, random-access videodisks, synthesized speech generators, and computer-generated animation.

As scientists devise better ways of positioning more and more electronic circuits onto microchips, the cost of technological hardware is dropping precipitously. Several trends are emerging for the near future:

- o High resolution, flat, color displays that consume little electricity
- o Powerful, user-friendly computers that require little programming knowledge
- o Computers with enormous memories--enough to hold entire library collections
- o Cheaper, faster transmission rates for communication among machines at distant locations using fiber optics and laser diodes
- o Two-way (interactive) cable television
- o Direct satellite-to-home hookups
- o Extensive networking of remote computer stations
- o Notebook-sized computers for students

Some of these technologies are several years away, but there is no doubt that computers have already permeated American society to an astounding degree. The business, defense, medical, banking, and energy industries have rapidly adopted the computer for two reasons: It is cheaper and it is more productive. The computer's microchips are the seeds of the second industrial revolution. American must nurture those seeds or lose the technological edge that has made it prosper.

Basically, computer technology can teach in three ways. Students can learn about computers, the most elementary sort of computer literacy. They can learn through computers' drill and practice, virtually, and they can learn with computers. The latter is the most profound and exciting for the long range.

WHO WILL FEED THE EDUCATIONAL SOFTWARE?

Assuming that 50% of the school curriculum can be taught by computer by the year 1990, where will the schools find the software to do it? Even more to the point, how will they be able to afford quality programs if they are available? Inqworld, a computing industry publication, explained the problem in its March 27, 1981 issue:

"Competition among hardware manufacturers will force prices down. Unlike hardware's technology-intensive development, software is labor-intensive, resulting in just the opposite price trend. Not only are a lot of man-hours required to write a software program, but software is also entirely dependent upon programmers, an increasingly scarce and expensive pool of talent."

If current trends continue, the schools will not have access to the programs they need. Educational publishers, the traditional suppliers of curriculum material, have been reluctant to invest their resources in wide-scale software development; as a result, "cottage industries" have sprung up to produce piecemeal video games and computer assisted instruction programs. According to Ann Elestrup, an industry expert, the funds spent on educational software are only 10% of the funds spent on game software. According to Len Komoski, director of the Educational Products Information Exchange, the quality of most educational software is largely deplorable.

Naturally, the educational publishers are targeting their educational software to the largest markets. We now have several good elementary mathematics programs, for example. We do not need more elementary mathematics programs. What we need is what the publishers are not producing. In the Houston Independent School District (HISD) alone, we have students who speak 97 different languages. By 1985, our district will have a Hispanic majority, followed by Blacks, then Whites. The commercial software being produced is designed for White, middle-class students.

HOUSTON IS WRITING ITS OWN SOFTWARE

It appears more and more obvious that the schools will have to write their own software. Houston's Department of Technology has begun to do so by developing an English-as-a-Second-Language software package. We are developing programs to teach concepts like action verbs by using animated graphics to illustrate movement. A speech synthesizer pronounces the words to be learned. A commercial software company set its price for developing such an ESL curriculum at \$1 million. HISD would have been forced to use that vendor's own brand of computers, and the company would have retained the software copyright. Houston's effort looks very promising at this point, but it is a massive, expensive

undertaking that calls for talented, dedicated educational programmers. How else are we to teach in 97 languages?

The District's programming staff is also investigating networking as a way of minimizing the costs of technology. A network links computers together; they can communicate with each other, share peripherals such as printers, and use the same software programs. Ordinarily, a separate software program must be purchased for each micro, a prohibitively expensive option for a large district.

NEEDED: AN EDUCATIONAL SOFTWARE CONSORTIUM

The solution to this problem on a national scale is for the public schools to form a software consortium to develop the quality programs needed. The Houston district alone has roughly 200,000 students. To provide each with a half hour of computer time per day would require 20,000 microcomputers for a 10:1 ratio. A good microcomputer costs approximately \$1,000. A set of software costs another \$1,000. The necessary training costs another \$1,000. That totals \$60,000,000 just for one school district.

The estimate has set the one-time cost of developing a K-12 software curriculum, covering some 40 subjects, at \$60,000,000. With today's economic woes, it may seem like the height of foolishness to propose such figures. Yet we have a four trillion dollar economy that rests on the quality of a two hundred billion dollar educational system which desperately needs overhauling.

Judging from S.A.L. scores, the quality of students majoring in education in college is declining. The greatest proportion of school budgets goes to teacher salaries. Technology can attack both of these problems if the educational delivery system is restructured. By using computers to teach that part of the curriculum which they can do so well, a district could hire fewer, more competent teachers, who would be more productive. Merely adding the technology onto the existing educational system will not work. It can help if teachers and administrators use technology properly and fully, and if the schools are reorganized to stay open all year to take advantage of their capital and personnel resources.

HOUSTON'S SOFTWARE RESOURCE CENTER

Few teachers have the time to keep up with commercial software developments. Houston educators depend on the Department of Technology's Software Resource Center to help them make intelligent decisions about these matters. At the Center they can preview software programs, hand-held learning devices, new computer text, and journals and periodicals.

All software is systematically reviewed using the ERIC Evaluation Instrument. Before vendors can present their programs to their evaluators, they must submit a proposal detailing the software's objectives, documentation, discounts, warranty, training, and validity.

TECHNOLOGY AND THE HANDICAPPED

Technology's potential to educate the handicapped is most promising. In September 13, 1983, the CBS Evening News broadcast a story on how an Apple microcomputer expanded the horizons of a young boy paralyzed from the neck down in an auto accident. He can activate his computer by speaking into a microphone attached to a headset. The computer talks back using a speech synthesizer. It can control the television dial, open turning the satellite receiver in the back yard for the best reception, adjust his bed, provide reading material, play games, and dial friends on the telephone.

In Houston, blind students use optical character recognition devices to convert printed matter into braille. Microcomputers are also used to teach the homebound and students in hospitals to enable them to keep up with their classmates. At one school, Rogers Elementary, gifted students tutor deaf students in how to use micros for learning.

WHO WILL TRAIN THE TRAINERS?

Everyone wants to give students a head start in learning how to use these dazzling new technologies. Reacting to parental pressure, school districts across the country are rushing to buy computers. The result is that teachers are being forced to use a technology they know no more about than their students. Logical-ly, teacher colleges and universities should be providing micro-computer training to education majors. Most are not. Very few colleges require their education students to take even one computer course. School districts are going to have to do their own training.

In January 1982, HISD established a Department of Technology to provide for District-wide coordination. One of its six major functions was to train teachers, administrators, and parents. Several tenets underlie HISD's approach:

1. **Mandated Training:** All principals in the District must participate in at least 24 hours of training. Depending on the application, teachers who work with computers attend between 24 and 36 hours of training.

2. **Hands-on Practice:** Approximately 70% of the training provides for hands-on experience.

3. **Stipend Compensation:** Teachers who successfully complete 24 hours of training are certified as teacher technologists. These teachers receive an annual salary bonus as part of the District's "Second Mile Plan" as long as they keep their skills updated.

Several hundred persons per month attend orientation, workshop, and hands-on classes at the Department of Technology. During the school year, approximately 8,400 educators and parents

were trained.

Although these statistics are rather impressive for one district, the national picture is not bright. There are only a few thousand trainers in the country who are qualified to teach about computers. There are three million teachers. The obvious answer is to use the technology to teach about the technology. In Houston, we plan in the coming year to begin using a new interactive television system to do just that.

PLANNING BEFORE IMPLEMENTING

Computers are installed in Houston school buildings only after a written implementation plan is completed. On the actual microcomputer implementation plan itself, the first major question asks for a description of the proposed program. For example, campus planners must choose specific applications depending on whether the goal is to teach computer programming or word processing; whether it is tutorial or for enrichment; how the subject area is addressed; which basic skills are included; whether or not it is for a special program; and the setting (laboratory or classroom).

Another question asks for the program's objectives. The objectives must be stated as educational outcomes and must be measurable.

Campus technology users must then give a breakdown of the target population expected to use the computers. They are to indicate the specific grade level to be served, the number of students at that grade level, and the subject to be addressed.

Another item addresses the personnel who will implement computer usage. At least two teachers who will ultimately use the computers must be selected for training.

The question concerns training per se. Effective use of computers in education requires extensive inservice. The staff must be trained before computers can be ordered.

Finally, planners must indicate the software they plan to use for their various applications.

CENTRALIZED PROCUREMENT SAVES MONEY

The kind of systematic planning required by Houston's microcomputer implementation plan not only makes campus technology users think through their programs, it also ensures hardware compatibility throughout the district. Many other districts have allowed campuses to purchase various brands of equipment, a decision which virtually guarantees serious difficulties when it comes to training.

In Houston, all hardware and software are purchased centrally to assure compatibility and lowest price. Vendors present their bids to a Hardware Selection Committee and a District Software Committee for evaluation. The savings of this approach are significant. Houston has saved \$70,000 to date for equipment purchases alone. The retail cost of 75 dot matrix printers, for example, is \$92,500. By buying in volume, this cost drops to

\$44,425, a savings of \$21,150.

WHO MAINTAINS THE EQUIPMENT?

Buying large amounts of hardware, no matter at what discount, guarantees one type of headache: maintenance. Although modern microcomputers are relatively reliable, they do break down, especially under rough student use. At first the District subcontracted all maintenance work, but when a study showed that by 1985 this cost would be \$900,000 annually, the Department of Technology created its own maintenance division. Its objective is to provide faster, better service at reduced cost. It repairs cannot be made quickly on site, a loaner unit is provided to keep students "on-line."

To maintain its reputation for quick service, the maintenance division warehouses parts for the District's microcomputers and peripherals. Maintenance personnel also prepare electrical specifications for school campuses receiving five or more computers since special wiring is frequently necessary for computer labs, especially at older buildings.

WHAT SHALL WE TEACH?

In January 1985, the HISD School Board made "computer literacy" a high school graduation requirement for students finishing school in 1986 and thereafter. One is computer literate who has the knowledge, skills, and attitudes necessary for functioning in a computer-oriented society. These topics are being taught by the District:

- a. Basic Skills
 - Algorithmic thinking
 - Keyboarding
 - Debugging
 - Terminology
 - Hardware functions
- b. Computers as Tools
 - Introduction to programming
 - Introduction to word processing
- c. Computers in Society
 - Computers in the workplace
 - Careers in computing
 - Ethical and legal considerations
- d. Future Trends
 - Artificial intelligence
 - Robotics
 - Telecommunications

Because of the lack of suitable commercial curricula on computer topics, Houston has developed its own literacy program for students. "Computers Demystified" covers the history, use, and impact of computers on society. It stresses the ability to use computing systems to solve problems in everyday life. The curriculum's objective is not to make all children programmers, but rather to make them aware of and capable of using the myriad computer applications sure to pervade their lives in the 21st century.

CHILDREN MUST SPEND MORE TIME STUDYING

We must relinquish our agricultural heritage of three-month summer vacations. Not many youngsters still spend the summer picking crops on their parents' farms. Our superintendent, Dr. Billy Keagan, has been driving home this "time on task" issue for years, wondering if Americans have the courage to deal with it. We have all seen the international comparisons: Japanese students attend 60 more days of school per year than their American counterparts. The Houston district just this fall opened a "year-round school" as a first step toward more time on task. The Texas Senate now has a Select Committee on Public Education analyzing our state's system. That Committee has seconded the call by recommending that more credits be required for high school graduation. Our district upgraded its high school graduation requirements last year.

In addition to a longer school day, Houston is attacking the problem of social promotions. Our "Houston Plan for Educational Excellence" sets promotional gates at grades 1-8 and grade level standards for each grade. Our school day is already 30 minutes longer than it used to be. Attendance requirements, bolstered by some attractive inducements for students, have cut no-shows to less than 5%. We require parent conferences.

The coming information technologies will make vast amounts of information available to students. They will not have to waste time searching for information in remote libraries and obscure books. There is an irony here. The technology saves students time, but in so doing makes more knowledge available to be learned in the already-crowded school day. If schools are going to make sizeable capital investments in computer technology, it makes sense to maximize student access to the equipment through a longer school day or semester.

FACILITATOR'S ROLES ARE CHANGING

Technology will change the role of teachers. Traditionally, teachers have been disseminators of information. In the future, they will become facilitators. If computers can deliver content, what we will need then is teachers who can teach students how to think about the content as it fits into the complex interrelationships of other disciplines. The Task Force on Education for Economic Growth recently decried the lack of student competence in higher level thinking skills. These are the abili-

ties American children will need to compete in the world economy of the future. One way HISD is addressing these skills is with Logo, a computer language designed to teach procedural thinking. This past year, 15 elementary schools piloted a Logo program. By giving the computer directions to move a "turtle" around on the screen, students learn the kinds of thought patterns needed for analytical problem solving. This year, 27 additional schools will introduce Logo to their students. This implies a change in the curriculum content as well. Why teach math the traditional way if Logo's problem solving approach works better? We expect to have some answers to this next year when our research is completed.

Administrators must also learn to use computers or they will not be able to effectively manage the impending changes in American education. Like their counterparts in business, educational managers need to know how to communicate with programmers; how to use, interpret the powerful statistical analyses computers can provide; how to access remote data bases; and how to send and receive data transmissions automatically after office hours.

Every HISD principal has received training in the use of simple data base programs and word processing.

MERITORIOUS TEACHERS DESERVE MERIT PAY

As a result of *A Nation at Risk* and the other national critiques recently published, all 50 state departments of education are working on ways to incorporate the recommended changes. One I would like to reinforce is the concept of merit pay for superior teachers. I began working with computers ten years ago. In those early days, I watched a handful of teachers who immediately saw the potential benefits of technology take the initiative to teach themselves what they needed to know. They took computer classes on their own, they bought personal computers to use at home and in class, they sparked the enthusiasm of their students through their own excitement.

Are these devoted, dedicated teachers to remain forever doomed to a salary schedule based on seniority and degrees? Do they not deserve more pay? Approximately 11,000 Texas teachers quit their jobs each year. The number of teachers graduating from Texas colleges has declined from 16,000 in 1973 to 8,000 in 1983. The entire nation produced only 798 math teachers, and only 547 science teachers, in 1981.

We get what we pay for. I am convinced that people are willing to pay for excellence, once they are persuaded that they will get it. Merit pay will not just attract bright young faces to the teaching profession, it will also stimulate initiative on the part of good teachers who might otherwise be considering leaving the classroom for more lucrative employment. In Houston, we are trying to keep our best teachers by providing financial compensation through "Second Mile" salary bonuses.

BUSINESS AND INDUSTRY MUST HELP

The education community must continue to build a collaboration with business and industry. Some 75% of all the taxes for public education in Houston are paid by business and industry. The same companies are the recipients of 80-90% of HISD graduates. With the economic climate being what it is, schools cannot survive without business support, much less afford large capital outlays for high technology. The Houston district already has 100 school/business programs and is seeking more. A quarter of these programs are related to computer applications. Several companies, including Shell Oil and IBM, are lending full-time instructors to teach computer science.

The vice-president of a major national oil company told us just a few weeks ago that we should scrap our entire vocational education program. "We don't need welders and draftsmen any more," he said. Keeping vocational education up-to-date with the changing technologies of industry has always been a problem for the schools. Even if a district can scrape up the many thousands of dollars need to buy an expensive computer-based machine, it becomes obsolete within a few years. It may be necessary to allow students, with the assistance of their teachers, to leave school at an earlier age to enter business training programs.

DO ALL HAVE EQUAL ACCESS TO TECHNOLOGY?

Unfortunately, computer hardware and software are still relatively expensive. The wealthier schools and parents can afford to buy the technology; the poor cannot. As the ability to use a computer becomes steadily more important in terms of access to higher education and better jobs, the danger is that the poor will be even further disenfranchised if they fail to become computer literate.

Many schools have used Chapter II of the Education Consolidation and Improvement Act to purchase computers. Federal cutbacks have slashed the program's funding to the major cities from \$110 million in 1982 to \$38 million in 1983. Further, the Act itself has undergone a policy change to give a greater proportion of funding to schools that already have computers. Market Data Retrieval, Inc., reported in October 1982 that 80% of the nation's wealthiest and largest high schools now use microcomputers, compared to 40% of poor high schools.

Another dimension to the equity issue is that federal funds, particularly Chapter I of the Elementary and Secondary Education Act, are targeted to basic skills remediation for disadvantaged students. This is laudable, but in the meantime, more advantaged students are learning how to use computers to solve problems. The poor get drill and practice while the more affluent learn programming. The computer tells the poor child what to do; the computer is told what to do by the advantaged child.

The rapid adoption of the micro is a tribute to the aggressive-ness and insight of American teachers and parents. But if the

technology is not to exacerbate the disparity between poor and rich, we must ensure that all students have equal access to the computer's power.

HOUSTON'S EQUITY PROGRAMS

One step Houston has taken toward equity is a project called "Computers Can," part of a larger parent involvement program known as "Operation Fail-Safe." "Computers Can" was begun in 1982 at eight Chapter I (disadvantaged) schools. Low-income parents and students are trained for 12 hours, side-by-side, in how to use a microcomputer. They can then check out the hardware and software to practice at home. Not only have the students in this program made learning gains, but the parental support it has engendered has been most gratifying since their involvement invariably helps their children's academic performance.

The District's teacher technologists are providing the lab instruction for "Computers Can," which usually takes place in mid-afternoons and early evenings when parents are most available. The program has been expanded to 45 campuses for the 1983-84 school year, making an additional 900 computers available for home check-out.

One way Houston uses its computer technology to gain parental cooperation in Operation Fail-Safe is by generating computer based prescriptions and individualized reading lists for every student. In this way, parents are given concrete activities they can use at home to help their children's study skills to improve academic achievement. Shortly, HISD will begin offering parents proficiency certification. They will be certified after they watch a series of television programs about helping children learn at home.

An unusual program called the "School after School Consortium" has used a foundation grant to place microcomputers at four churches in low-income neighborhoods. Students who want extra help after regular school hours are tutored by volunteers using the same type of microcomputer hardware and software used in the "Computers Can" program. The Houston district trained the program coordinators in how to use the equipment.

Another type of equity concerns extending school benefits to non-parents. In Houston, we are now planning a program to allow all HISD patrons to purchase microcomputers at discounted prices. The Patron Computer Purchase Program will allow any taxpayer to take advantage of the District's volume purchasing power and get-in free training as well. Since the birth rate is dropping in the United States, we feel it will become increasingly important to gain support for the schools from non-parents. Market predictions indicate that there will soon be far more home computer purchases than school purchases. We think that allowing all patrons to take advantage of the district's ability to educate is an excellent idea with long-range benefits for children.

A recent study found that most home microcomputer users are white, middle-class, middle-aged males. When we held our first HISD Technology Fair in April 1983, we noticed that of the 47 students who wanted to compete in a tough programming contest,

only two were female; one was black. We are addressing this aspect of the equity issue in several ways. For one, it is clear now that the skill of keyboarding--typing--is going to be the key to using a computer for many years to come. We are now teaching the skill in the elementary grades so all students will have it, not just those who take a typing course in high school. Perhaps this early familiarization with the computer keyboard will dissolve the unease many girls seem to have about computers.

HOUSTON'S TECHNOLOGY MAGNET SCHOOLS

Houston has a long history of innovative approaches to encouraging racial integration. The best known, and most successful, has been its magnet schools which offer educational programs of such high quality that students willingly volunteer to attend. To help address the equity issue relating to computer access, HISD now has five magnet schools with strong computer orientations.

One, the Lamar School of Business Professions, is designed to be a rigorous college preparatory curriculum for students who want to go into business and management. The program ties students' regular classwork to computer business applications like word processing, programming, data management, financial forecasting, project planning, and business graphics. At the same time as students are taking accounting in their business classes, for example, they study accounting software in the computer classes.

Another pair of magnet schools are called the High Schools for the Teaching Professions. The first professionally-related course that students at Austin and Furr High School will take is one about computers. This "hands-on," semester-long course will address the many ways computers can facilitate learning.

The High School for the Engineering Professions at B. T. Washington High School is a nationally-recognized program of the highest caliber. These talented students use computers daily in their work, just as they will when they enter the engineering professions.

Two other magnet programs--at Lochhart Elementary and Keenan High School--are now being planned as technology magnets which will begin in 1984-85.

TECHNOLOGY CAN ENSURE OUR FUTURE

No one seriously believes that microcomputers and related technologies will solve all the problems facing American public schools. But it is increasingly difficult to see why they cannot be used to fantastic advantage. The industrial era gave us machines that magnified our physical strength; the information age gives us computers that magnify our minds. Developing the mind is the province of education. Depletable natural resources--wood, coal, petroleum--fueled the industrial age; education will fuel the information age. The blessing is that

and it is not dependable.

The economic way to it is to get into other countries, starting with the auto of the manufacturing sector, that permit the obtaining of technology and the advantage of a cheap labor force, such as Japan, Korea, and Brazil, and constantly be coming out the U.S. industries.

We can profit from being threatened. It happened with Sputnik, for example. Our great nation has always responded with vigor and energy to the greatest challenges. Our national spiritual discipline of self-altering and restricting our public education system. We can turn it around with an American investment in education to the schools.

The deadline property of an American technological night-mare in 1984 is now only three months away. I do have the resolution and foresight to do what must be done. I believe instead that 1984 will find the American people using technology to regenerate the schools to expand our freedom, our children's horizons, our preeminence in the international community.

Mr. GORE. Thank you for an excellent statement and for the work that you've been doing.

I am sorry we're running short on time because all of these statements are really very interesting.

I'm going to hold off on questions until we've completed the panel, the next member of which is Dr. Kyo Jhin.

Have I pronounced your name correctly?

Mr. JHIN. "A+."

Mr. GORE. "A+"—OK. All right.

We look forward to hearing your statement. You are with the District of Columbia Public School System.

And, without objection, your prepared statement will be included in the record. And because we are running late today, I want to apologize to members of this last panel, but if you care to summarize any portion of your statement, please feel free to do so.

**STATEMENT OF DR. KYO R. JHIN, ASSISTANT SUPERINTENDENT,
EDUCATIONAL TECHNOLOGY, WASHINGTON, D.C., PUBLIC
SCHOOLS**

Dr. JHIN. Thank you, Mr. Chairman. It was my pleasure to receive my 5 years of undergraduate education in the great State of Tennessee, and I'm familiar with big oranges.

Mr. GORE. Well, that explains your expertise that has brought you here this morning. [Laughter.]

Dr. JHIN. Mr. Chairman, members of the committee, and my distinguished colleagues.

My name is Kyo Jhin, assistant superintendent of educational technology, representing Ms. Floretta McKenzie, Superintendent of D.C. Public Schools.

I am pleased to join you here today to discuss the integration of computer technology with the educational programs of the District of Columbia Public Schools.

It is the mission of the D.C. Public Schools to promote excellence by providing a viable and comprehensive instructional program leading to the attainment of knowledge, competencies, and skills which, upon completion, will enable each student to function as a useful citizen.

Computer literacy has become a skill every student needs in order to function in this society. An article which appeared in last Sunday's Washington Post indicated that by 1990 there will be a 50-percent growth in jobs that will require computer skills. For individuals with a combination of academic knowledge and practical experience, the door will be open to the future as hardware designers, software programmers, researchers, industrial engineers, and sales representatives. Therefore, school systems, particularly those with less affluent students, must require and provide all students with the ways and means to become computer literate citizens. With this in mind, the D.C. Public Schools is totally committed to implementing computer technology in our educational system.

On March 16, 1983, the D.C. Board of Education approved the following policies:

One, that student computer laboratories be established in all schools, with attention to security needs, by the end of school year 1983-84.

Two, that computer literacy and software selection skills be required for all instructional personnel as part of the 5-year recertification requirement.

Three, that all teachers, beginning with school year 1983-84, be required to demonstrate computer literacy before being granted permanent tenure.

Four, that every student, as a graduation requirement, demonstrate a command of the skills that constitute computer literacy beginning no later than school year 1987-88.

In order to implement the board policy and in response to the changing environment in which our students will live and work, the D.C. Public Schools has begun implementation of a systemwide computer literacy program. This program, proposed to be implemented over the next 5 years, will require major investments of staff, time, and resources.

The objectives of the computer literacy program are:

To develop computer awareness among students, teachers, supervisors, and administrators.

To develop and implement a computer literacy curriculum.

To design and implement a computer training laboratory.

To apply computer technology in the local school implementation of the competency-based curriculum through drill and practice, tutorials, problem solving, simulations, and other appropriate techniques.

To apply computer technology in classroom management, including recordkeeping and the tracking and reporting of student progress.

Computer-assisted instruction has been initiated on a systemwide basis with the establishment of student computer laboratories in 50 chapter I elementary schools with a fund from the Federal Government. What about other schools? Our board is committed. Therefore, they established 50 additional computer laboratories at junior high school levels with local funds.

In addition, as a result of the public-private partnership programs, computer laboratories will be installed in five senior high schools through the use of private funds. Currently, we have ap-

proximately 1,450 microcomputer and minicomputers installed in our schools to support our computer initiative.

A variety of computer clearinghouse activities and services are being initiated and expanded this year, including the establishment of software selection criteria, the acquisition and review of software catalogs and software, the selection of software for existing curriculum in grades K through 12, and the development of an approved software list. Subject content areas in need of software development are being identified, and we are in the process of developing some of our own software.

The work in applying technology both to school management and instruction is already underway. During the 1982-83 school year alone the D.C. Public Schools spent approximately \$3.7 million. Of this amount, approximately 35 percent came from Federal funds, 43 percent from the regular local school budget, and 22 percent came from the private sector. Everyone, whether kindergartener or school administrator, are involved in our attempt to integrate computer technology into the educational programs of the D.C. Public Schools through the following programs. I will just cite some of them.

Automated Instructional Management System [AIMS] is being developed to complement our competency-based curriculum in reading and mathematics by automating some assessment and all recordkeeping tasks which are currently performed by the classroom teachers under the student progress plan, which we call SPP.

The writing to read program is one example of kindergarten and first graders. The writing to read program is a computer-based instructional system funded by IBM which involves 1,500 kindergarten and first grade students who use computers, tape recorders, work journals, and typewriters in a special learning laboratory to compose and read their own stories.

The career development program; a senior high school computer-assisted instruction program; computeronics, which reaches 23 schools providing instruction in computer program problem solving and computers in society; the beltway microcomputer and videodisc project; the Fairbreak computer project, sponsored by Control Data. This program provides a computer laboratory for 400 students in secondary levels in reading, mathematics, science, social studies, career planning, and writing skills.

Then we use the computers for the guidance program in our senior high schools.

In order to provide all these programs, we have to have teacher training programs. So we established a computer literacy teacher training laboratory with four full-time teacher trainers. To date, approximately 1,600 teachers have been trained under this computer literacy training program.

In addition to this laboratory, the National Science Foundation, in cooperation with American University, provide approximately 50 junior high school teachers with training, equipment, and software for using computers for science activities.

Our future programs include utilization of cable television in coordination with computers; a satellite teacher training program in mathematics, special education, and gifted students, which will begin this coming Monday; an instructional television mathematics

and science program for seventh grade students; and a high technology information and demonstration center for the students as well as the community.

As is evidenced from my testimony, the D.C. Public Schools has wholeheartedly embraced new educational technology. It is my sincere belief that urban school districts, where the majority of minority students are enrolled, must as a question of equity provide opportunities for their students to become computer literate.

As noted in the Washington Post article I cited earlier, the future job market will require people who are computer literate. Currently, minorities continue to be shut out of technical and scientific fields in large numbers. Of the approximately 2.74 million scientists in this Nation in 1978, 1.5 percent were black, according to the National Science Foundation. This low participation rate of blacks can be traced, in part, to differences among the groups of graduates, collegiate and precollegiate training. At the collegiate level, only 9.3 percent of the total higher education enrollment is black.

Much of the problem begins in elementary and secondary schools. With the present 20 percent unemployment rate for adult blacks, this gap in employment opportunities for blacks will increase in the future if urban school districts do not provide all their students with opportunities to become computer literate.

Middle class families will insure that their children have access to personal computers. Those of us concerned with insuring the United States of remaining competitive in technology, and that blacks and other minorities have the opportunity to participate meaningfully in the future jobs will require computer skills. We must insure that urban school districts have the resources necessary to provide the best possible education, which will require new technology.

Mr. Chairman, I wish to leave the 5-year computer literacy plan as part of my testimony.

In conclusion, the Soviet Union, Japan, and West Germany have made tremendous gains in technology because they have a strong national commitment for technology advance through education. They have national goals and commitments, and we need similar national commitment to upgrade computer utilization in our schools.

To say that since 8 percent of education budget is coming from the Federal Government, it is a State and local responsibility, we are not serving the Nation's best interest. Our Federal Government has the responsibility to set a national goal and support the implementation of computers in education to insure equity, economic security, and, in fact, national security.

Often our national policy has been like a farmer—fixing the barn after losing horses. Our national policy should be to fix the barn before losing the horses, and get on with the maximum utilization of technology in education through a strong national support for education.

Thank you, Mr. Chairman.

[The prepared statement of Floretta Dukes McKenzie and résumé of Dr. Jhin follow:]

STATEMENT OF

FLORETTA DUKES MCKENZIE
SUPERINTENDENT OF SCHOOLS
CHIEF STATE SCHOOL OFFICER

DISTRICT OF COLUMBIA PUBLIC SCHOOLS

before

House Subcommittee on Investigations and Oversight

September 29, 1983

** ** *

Mr. Chairman, Members of the Committee, and my distinguished colleagues, I am pleased to join you here today to discuss the integration of computer technology with the educational programs of the District of Columbia Public Schools.

It is the mission of the District of Columbia Public Schools to promote excellence by providing a viable and comprehensive instructional program (pre-kindergarten through twelfth grade) leading to the attainment of knowledge, competencies, and skills which upon completion will enable each student to function as a useful citizen.

Computer literacy has become a skill every student needs in order to function in this society. An article appearing in last Sunday's Washington Post (September 25, 1983) indicated that by 1990 there will be a 50% growth in jobs that require computer skills. For individuals with a combination of academic knowledge and practical experience, the door will be open to the future as hardware designers, software programmers, researchers, industrial

engineers and sales representatives. Therefore school systems, particularly those with less affluent students, must require and provide all students with the ways and means to become computer literate citizens. With this in mind, the District of Columbia Public Schools is totally committed to implementing computer technology in our educational system.

On March 16, 1983, the District of Columbia Board of Education approved the following policies:

- That student computer laboratories be established in all schools, with attention to security needs, by the end of School Year 1983-84.
- That computer literacy and software selection skills be required for all instructional-personnel (teachers, supervisors, and administrators) as part of the five year recertification requirement.
- That all new teachers, beginning with School Year 1983-84, be required to demonstrate computer literacy before being granted permanent tenure.
- That every student, as a graduation requirement, demonstrate a command of the skills that constitute computer literacy beginning no later than School Year 1987-88.

In order to implement the board policy and in response to the changing environment in which our students will live and work, the District of Columbia Public Schools has begun implementation of a systemwide Computer Literacy Program. This program, proposed to be implemented over the next five years, will require major

investments of staff, time and resources.

The objectives of the Computer Literacy Program are:

- To develop computer awareness among students, teachers, supervisors, and administrators.
- To develop and implement a computer literacy curriculum.
- To design and implement a Computer Training Laboratory.
- To apply computer technology in the local school implementation of the Competency-Based Curriculum through drill and practice, tutorials, problem solving, simulations, and other appropriate techniques.
- To apply computer technology in classroom management, including record keeping and the tracking and reporting of student progress.
- To apply computer technology to all local schools.

Computer-assisted instruction (CAI) has been initiated on a systemwide basis with the establishment of student computer laboratories in fifty Chapter I elementary schools. Computer training laboratories are also being installed in all schools with junior high school students, five of our special education schools, and in two adult education centers. In addition, as a result of public/private partnerships computer laboratories will be installed in five senior high schools through the use of private funds. Currently, we have approximately 1450 microcomputers and minicomputers installed in our schools to support our computer initiative.

A variety of computer clearinghouse activities and services are being initiated and expanded this year, including the

establishment of software selection criteria, the acquisition and review of software catalogues and software, the selection of software for existing curriculum in grades K-12, and the development of an approved software list. Subject/content areas in need of software development are being identified. Additional hardware needs are being identified, specific equipment requirements developed and vendors selected. The work in applying technology both to school management and instruction is already well underway. During the 1982-83 school year the District of Columbia Public Schools spent approximately 3.7 million dollars for computer-related activities. Of this amount, approximately 35% came from federal funds, 43% from the regular school budget and 22% came from private sector. Everyone, whether kindergarteners or school administrators, are involved in our attempt to integrate computer technology into the educational programs of the District of Columbia Public Schools through the following programs.

AUTOMATED INSTRUCTIONAL MANAGEMENT SYSTEM

The Automated Instructional Management System (AIMS) is being developed to complement our Competency-Based Curriculum (CBC) in reading and mathematics by automating some assessment and all record keeping tasks which are currently performed by the classroom teachers under the Student Progress Plan (SPP). Each elementary school will receive core equipment consisting of a Digital Professional 350 Computer with both a Winchester Hard Disk Drive and twin diskette drives, a printer, an NCS Sentry 3000 Test Scanner, and a telephone modem to

communicate with a control computer.

The AIMS program uses the same reading and mathematics objectives found in the manual checklists and the reading and mathematics curriculum guides, and follows the current Competency-Based Curriculum procedures. By using a standardized multiple-choice AIMS test booklet, a machine scorable answer sheet, and the core equipment, the classroom teacher can take advantage of the instruction support capabilities of the AIMS program to score the test and automatically update each student's record. These reports are available to teachers on demand.

- A current checklist for each child in the class
- A class summary which can be used to organize instruction
- An in-depth diagnostic report for each child which provides information regarding the child's specific strengths and weaknesses.

In the classroom we are using educational technology with students of all ages. The response from students and teachers to our attempts to integrate computers into our curriculum has been very positive. Examples of our use of computers in instruction include the following.

WRITING TO READ PROGRAM

Writing to Read is a computer based instructional system funded by IBM which involves 1500 kindergarten and first-grade students who use computers, tape recorders, work journals and typewriters in a special learning laboratory, to compose and read their own stories.

CAREER DEVELOPMENT

Students are offered computer technology training leading to apprenticeships in electronic data processing, systems analysis and design, applications and systems programming, data collection and conversion, customer engineering, computer programming and systems engineering.

SENIOR HIGH SCHOOL COMPUTER-ASSISTED INSTRUCTION

This program enables students to acquire basic computer literacy skills, access career guidance data files, develop independent study habits and skills essential to success in higher education.

COMPUTERONICS

This program reaches 23 schools providing instruction in computer problem solving and computers in society.

THE BELTWAY MICROCOMPUTER/VIDEODISC PROJECT

This project sponsored by the U.S. Department of Education involves elementary schools and provides the Education Department and the District of Columbia School System with the opportunity to study how advanced technology can be introduced into the school setting.

FAIRBREAK COMPUTER PROJECT

Sponsored by Control Data, this program provides a computer laboratory providing four hundred students' instruction in reading, mathematics, science, social studies, career planning and writing skills.

In addition a COMPUTERIZED GUIDANCE INFORMATION PROGRAM has made guidance information available to all junior and senior

high school students.

TEACHER TRAINING

For the successful integration of computer technology in education it goes without saying that teachers must be made computer literate. To accomplish this the District of Columbia Public Schools has established a COMPUTER LITERACY TRAINING LABORATORY for teachers and administrators. The laboratory provides computer related training through courses and workshops. The laboratory operates year round, having offered this summer courses in four two-week cycles at four regional training sites.

The computer workshops are designed to meet the specific needs of specialized groups of participants and are conducted during the normal school day. Workshops may range from one to eighteen hours depending on the group request and workshop objectives. In addition to this laboratory, the National Science Foundation in cooperation with American University provides approximately fifty junior high school teachers with training, equipment and software for using computers for science activities.

As is evidenced from my testimony the District of Columbia Public Schools has wholeheartedly embraced the new educational technology. It is my sincere belief that urban school districts where the majority of minority students are enrolled must as a question of equity provide opportunities for their students to become computer literate. As was noted in the Washington Post article I cited earlier, the future job market will require people

who are computer literate. Currently, minorities continue to be shut out of technical and scientific fields in inordinate numbers. Of the approximately 2.74 million scientists in the nation in 1978, only 1.5% were Black according to the National Science Foundation.

This lower participation rate of Blacks can be traced in part to differences among the groups in graduate, collegiate and precollegiate training. At the collegiate level only 9.3% of the total higher education enrollment is Black. Much of the problem begins in elementary and secondary schools. With the present 20% unemployment rate for adult Blacks, this gap in employment opportunities for Blacks will increase in the future if urban school districts do not provide all of their students with opportunities to become computer literate. Middle class families will insure that their children have access to personal computers. Those of us concerned with insuring that United States remains competitive in the new technology and that Blacks and other minorities have the opportunities to participate meaningfully in the future jobs that will require computer skills must insure that urban school districts have the resources including additional funding, teachers and appropriate software, to teach their students to use the new technology.

INTRODUCTION OF DR. KYO R. JHIN

Dr. Kyo R. Jhin, the Assistant Superintendent for Educational Technology, District of Columbia Public Schools, received his Associate of Arts Degree from Freed-Hardeman College, Bachelor of Arts Degree in Mathematics from David Lipscomb College, Master of Arts Degree in International Relations from New York University, his second Master of Arts Degree in Mathematics from Boston College, and his Doctorate in Mathematics from Auburn University.

Dr. Jhin has a thorough knowledge of educational technology. His experiences include conceiving, directing and evaluating an experimental project for Computer-Assisted Instruction in Algebra at Auburn High School; initiating a Computer-Assisted Instruction in Mathematics Program for three high schools in Huntsville, Alabama, in cooperation with the National Aeronautics and Space Administration (NASA) computer facility where he directed the project, trained teachers, established classes and coordinated all activities related to the project; and initiating and establishing the North Alabama Applied Technology Satellite (ATS) Utilization Committee which developed a master plan for technology utilization for area schools and universities. Dr. Jhin has also served as Supervisor of the Mathematics Department for the Huntsville, Alabama school system.

Dr. Jhin has presented seminars, workshops and conferences on Computer-Assisted Instruction to educators and business leaders. He is extremely proficient in BASIC, FORTRAN and CALC computer languages.

Dr. Jhin has produced ten television lessons entitled "Mathematics for Teachers," two 30-minute television programs entitled "Your Child and Mathematics," two 30-minute television programs entitled "The Meaning of American Freedom," and four half-hour programs entitled "The Introduction to Your Future is Now." He also serves as a consulting editor for the Science Research Associate (SRA) Mathematics Series.

Dr. Jhin has traveled from coast to coast and to twenty other countries, making over 1200 addresses at youth rallies, graduation exercises, civic clubs, church groups, schools, universities and various conventions.

He is listed in the 1960 edition of Who's Who Among Students In American Colleges and Universities, and the 1969 edition of Outstanding Young Men of America.

Dr. Jhin was named "Alabama's Outstanding Young Educator of the Year, 1969" by the Alabama Jaycees; and "One of the Four Outstanding Young Educators of America, 1969" by the United States Jaycees. He was selected for this honor on the basis of his training, creativity, leadership, and contribution to the profession, community, state and nation.

He was also named "Outstanding Adult Educator of the Year, 1977" by the Alabama Adult Education Association.

In 1975, President Gerald Ford appointed Dr. Jhin to serve as a member of the National Advisory Council on Adult Education for a four-year term. During 1977-78, he was elected as the Vice Chairman of the Presidential Council.

His most recent position was senior associate of the Office of Educational Research and Improvement (OERI), United States Department of Education, where he produced an effective management system and collected and analyzed educational technology papers for the National Commission on Excellence in Education (NCEE).

Dr. Jhin has served as District Superintendent of the Alabama Regional Education Services Agency (TARESA) where he provided leadership to a staff of over fifty professional and support personnel, developed a Management by Objectives (MBO) System for the agency and supervised the development and implementation of twenty-five competitively funded projects in the amount of \$10,000,000.

As Assistant Superintendent for Educational Technology, Dr. Jhin is currently developing, planning and implementing educational technology programs for the District of Columbia Public Schools.

Mr. GORE. Thank you. I appreciate your statement, and I think it's a subject that people ought to feel strongly about, as you do. I'm glad you haven't lost your Tennessee accent.

Dr. JHIN. Sure enough. [Laughter.]

Mr. GORE. I'm pleased to welcome our next witness, and to introduce him to the committee, I'd like to recognize my colleague, Congressman Nelson.

Mr. NELSON. Thank you, Mr. Chairman.

It's my pleasure to introduce Senator Jack Gordon. Jack has been Mr. Everything in education. He started out as a member of the school board in Dade County before coming to the Florida Senate, and in that role of senator he has held most every position of importance in that body, having been Ways and Means chairman, having been Appropriations chairman, having been Finance and Tax chairman, and now the chairman of the Education Committee, while at the same time holding the role of the second ranking officer, that of president pro tempore of the Florida Senate.

Jack is an iconoclast. Jack is visionary. Jack is a good friend.

And so it's my pleasure to welcome to this committee Senator Jack Gordon of Miami.

Mr. GORE. Well, we look forward to your statement, Senator.

And, without objection, your prepared text will be included in the record. If you care to summarize any portions of it, you're welcome to do so.

We're delighted to have you here, and please proceed.

STATEMENT OF JACK GORDON, CHAIRMAN, SENATE EDUCATION COMMITTEE, FLORIDA GENERAL ASSEMBLY, TALLAHASSEE, FLA.

Mr. GORDON. I think after that introduction it's probably better not to say anything. [Laughter.]

What Bill neglected to add to that roster of responsibilities, that he had a specific interest in, is that I chaired the Congressional Reapportionment Committee in the senate. Bill's very happy with his ability to sit here, as are actually two new members of the Florida delegation who sit on this committee, Congressman Lewis and Buddy MacKay.

As a matter of fact, we have a major representation from Florida, the chairman and these other three. So that indicates a very considerable interest in technology in the State.

I'd just like to summarize a few things and make a point.

We have a big school system in Florida. We have 1½ million students in K to 12. There are about 6,000 people a week that migrate to Florida, which puts a significant growth burden on the schools throughout the State.

We've been using computers not only for administrative support, but in some classrooms over time. It wasn't until 1980 that the legislature made a policy statement concerning and requiring some emphasis on instructional use of computers.

It's interesting that that was the first—we were the first State to do that, as recently as 1980.

We have developed a statewide purchasing arrangement through the State department of education, which, while the statement

shows a savings of about \$750,000 on \$4.5 million, later figures would about double those. I mean, that program seems to have been working.

We've increased the number of microcomputers in the schools from about 350 in 1979 to over 6,300 in the fall of 1982. We now think there are probably over 12,000 in the schools, and they are in all 67 districts.

I think I should digress to say that we have one of the two States that has countywide school systems. And back in 1973 we adopted a school finance program, which Congressman Nelson is very familiar with, and that provides for interdistrict equity probably as well as any State in the Union. It was in response to the *Serrano* decision and *Rodriguez* case in Texas that we decided ahead of time to try to get an equivalent number of dollars behind each student in the State regardless of the property tax base in that county. By and large, with a lot of pushing and hauling at every session, essentially that's worked.

So we happen to be very—we respond to the equity question in a different way, and we feel that federal dollars coming through the State would provide an equitable distribution and, generally speaking, find it not an equity increase to have direct funding from the Federal Government to the individual school district. We try to pull as much of the Federal funds as we can into the State budget, because essentially, regardless of how equitable it would appear from the Federal level to make a distribution, it may not fit into our pattern, and, generally speaking, those are disequalizing.

I tell you this having served on a school board in the sixties when all the refugee aid came to Miami, the first rush of Cuban refugees, and I'm familiar with the values in that kind of a very special situation of direct assistance to school systems. By and large, I think that equity is better served in using the State as the instrument of whatever the Federal policy is. That's buttressed by some 5 years that I spent on the advisory committee to the title V program, which, you will recall, was to strengthen State departments of education, which was part of the original Elementary and Secondary Education Act. I've had some view of State departments across the country and the strengths that they acquired from the extensive Federal funding.

I know that the school boards association came in and said something different as I walked in this morning, but I just wanted to make that point.

I'd like to make another, that we enacted very—a considerable number of changes in education in Florida at this last session of the legislature. We had a commission on secondary education which came to the same conclusion, really, as the National Committee on Excellence in Education somewhat prior. It was very helpful. I came to the floor with the bill to implement our study on the day after the President's Commission report, and that made life very simple since we were saying the same thing.

One of the aspects of that is that we are not looking—one of the things you could learn from that is, as States go around and create statewide graduation requirement and you look at the argument of the school boards that "We know the needs of our community best," they may very well know the needs of their community best,

but they have some great difficulty sometimes in implementing those needs against local lack of understanding, really, of the intensity of educational experience that's necessary for students today. A broader view of that I think would make—really makes a lot more sense.

One of the things that we did along with other improvements over the last couple of years is to enact into law the standards of the National Council of Teachers of English for high school English. They said 25 years ago that students needed to write a paper a week to be able to learn anything about writing, but that teachers couldn't do it if they had more than 100 pupils. So we said to our school districts that if they would assign a paper a week, we would give them the money to reduce the teacher load to 100 pupils and a class size under 25.

That happens to be very relevant to computers, because there's no way that you can use a computer if you don't have a very coherent way of using your own language. One of the things that the computer discipline does is make you be very sequential and very precise, and one of the ways you learn that skill is not necessarily only on the computer, but that you ought to be able to do—to be able to write and summarize and understand and project from reading, and we have that as, in a sense, a parallel program.

The record shows a significant number and variety of programs that require State aid, but what I think really is more important is to tell you that our people feel very strongly that Federal restriction placed on the use of computer funds, which say you can only use the vocational in vocational and compensatory in compensatory and handicapped and migrants, and so forth, probably works against the proper utilization of—and adequate utilization of—the money.

I know the fear, and I certainly agree that protection of the migrant, for example, the minorities, for example, requires considerable vigilance. But, at the same time, it seems to me that we ought to give some credit to school people, public officials at other levels, for having at least as strong a commitment to a democratic society.

The other—the way I guess I'd like to summarize this, Mr. Chairman, is that in Florida we're operating in a context of equity. And while there are a lot of equity questions of education that have not been addressed—for example, the equity between schools in the same district or, even more, the equity involved in tracking. Do you—all this emphasis on vocational education, which is essentially directed at poor kids and minorities, on the assumption that they don't have to know more than just get a job, or the idea that education is just vocational I think works very strongly against equity.

And I would like to offer to you my operational definition of "education," which you could reflect on, and that is "Are you satisfied that an 18-year-old in your district who has a right to vote is educated enough to decide whether you or I ought to be reelected or elected?" That's essentially, in a democracy, what you're saying, and it has nothing to do much with his getting a job, but it has a lot to do with the kind of judgment that he's going to offer as a citizen. And so it seems to me that it's important to recognize that educational reform has to go far beyond the question of distribution of computers. Computers cannot do everything. They are an

assistance function. They are a way of getting some place. They are not an "it" itself, and it's important to bear that in mind.

You can't put all the emphasis on technology because technology itself has a lot of dangers. If we don't—for example, we are probably far ahead of the world in the technology of nuclear power. Yet, it is totally impossible for anybody to even hypothetically tell us how we're going to get rid of the waste any safe way. The technology really outran our concern for our own human survival in that particular case. So the humanities have a very real role.

And the notion of the kind of person that comes out of an educational system and the values are essentially much more crucial than the ability to punch a machine, which he no longer has to read because they've got some with symbols now, and you only have to know what things look like. I suppose—well, they do have them that talk, like that camera now that tells you when you're supposed to shoot. So it's not going to require any large order of intelligence to simply operate the machines.

And the other point—I'd like to reinforce the point that the—one of the best places for Federal intervention in this matter, it seems to me, would be funding the software development. The National Science Foundation was very successful in the sixties, and they spent an enormous amount of money in our last attempt to reform the sciences, in putting BSCS biology and the chemistry and the physics and all those programs.

Interestingly, textbook publishers tell us now that they're not sold very much because the school people say that the students can't do the work, which I translate to mean that we don't have teachers trained to use the books, and that's a place that the Federal Government could very well make a major investment and make sure that there is the good software there.

Just from the Florida experience, before we ever really appropriated any money, the school districts started buying the computers, and I think they will. As they get cheaper, it becomes less of a problem. So the real question is to have something that they can use well, and that seems to me to be the software.

And the other point, which I certainly—I guess I've made rather strongly—is that I think the States are natural conduits of the Federal dollars. They ought to go through the State budgets, and they will probably achieve more equity when you give somebody closer to the scene the problem of seeing that equity is carried out.

Legislators are going to be concerned about what's happening in their district. If they represent poor people, they'll see that some of this winds up in their schools, like people in other districts. It's, I think, an appropriate partnership that would work.

Thank you very much.

[The prepared statement of Mr. Gordon follows.]

560

TESTIMONY OF
SENATOR JACK D. GORDON
OF THE FLORIDA SENATE
TO THE
SUBCOMMITTEE ON INVESTIGATION OF OVERSIGHT,
COMMITTEE ON SCIENCE AND TECHNOLOGY,
U.S. HOUSE OF REPRESENTATIVES,
SEPTEMBER 29, 1983

564

For your records, I am State Senator Jack D. Gordon from Miami Beach. I serve as President Pro Tempore of the Florida Senate and am also Chairman of that body's Education Committee.

I think it's a good indication of our state's interest in the development of technology that four members of your larger Committee on Science and Technology, including Chairman Don Fuqua, are from Florida, where traditionally we've been known as a place with good climate, sandy beaches and orange groves. The recent decades have added to that image with the space program. And more recently, Florida has built an economic development program around recruitment of clean, high-tech industries.

During its last session, the Florida Legislature redirected the educational efforts of the state so that our public school graduates would have solid foundations in communications skills, mathematics, science, and some hands-on familiarity with computers. There were a number of reasons why the Legislature enacted these reforms, not the least was to prepare our students for the Informational Age into which they will graduate.

Before I go into program specifics, it may be useful to briefly describe our educational structure. At the top is the State Board of Education, which is comprised of the Governor and six, statewide elected Cabinet officers, including the Commissioner of Education.

The State Department of Education, which is headed by the Commissioner, provides administrative support to the State Board, oversees statewide programs, and provides technical support to the 67 county school districts. Up until this past legislative session, each of these districts established its own graduation requirements, a fact that will gain importance later in this presentation. In all, Florida's 2,250 public schools serve more than 1.5 million students just in the K-12 programs. And as a state that gains roughly 6,000 persons a week in population, education policymakers cannot help but plan for growth and more reliance on informational technology.

Computers have been used for a number of years for administrative support and randomly in some classrooms of our school districts. It was not until 1980 that the Florida Legislature made a policy statement concerning the instructional use of computers. Even at this seemingly late date, it is significant to note that Florida was the first state to enact a specific statute addressing the need for instructional use of computers and related technology in education.

Among other things, this legislative mandate directed the State Department of Education to assist public secondary schools in making instructional use of computers through consulting services, purchasing agreements, annual surveys of usage, project funding, and information dissemination. The tangible success of that legislation began to show itself in 1982, when a statewide microcomputer purchasing contract

collected savings of nearly \$150,000 on \$4.2 million worth of hardware and software for school districts.

The 1982 legislation also prompted establishment of a microcomputer lab within the Department of Education, which in the last two years has provided in-service training to more than 800 educators from all parts of the state. In 1981, Florida held its first Instructional Computing Conference, which was attended by 900 educators. This year, that conference drew 2,500, many of whom were from out-of-state.

During the 1982-83 school year, the Legislature funded a pilot project at an urban middle school of predominately minority students and at a university development school to assess whether the funds being spent on computers were helping students to learn basic skills.

In Florida, the number of microcomputers in our schools has risen dramatically since 1979, from about 350 to over 6,300 in the Fall of 1982; nearly 200,000 students used them for instructional purposes during that 1982-83 academic year. At the beginning of this school year, there were approximately 8,000 microcomputers in use and all 67 districts had at least one classroom computer.

As a result of a gubernatorial Commission on Secondary Schools--which reached similar and earlier conclusions than the National Commission on

Excellence in Education - the Florida Legislature in 1983 enacted sweeping changes in the state's approach to education. Among the many reforms passed by the Legislature was a required curriculum for all high school graduates that included four years of English, three of math, three of social studies, and three of science. Ninth graders who are attending school this Fall will also have to complete a semester's credit of computer literacy, which for Florida's future high school graduates will be considered a basic skill.

And if I may digress for a moment, in the Appropriations Act, we doubled to \$20 million the incentive funds available to districts to enhance writing skills, so that high school English instructors carry a daily class load of less than 100 students, each of whom is required to write a paper a week. Almost all of our districts participate in this basic skills program, which was modeled after recommendations of the National Council of Teachers of English, and which teaches students the concise and logical presentation of the written word, a value that is inherent in both the function and the use of the computer.

In the past, districts have relied on corporate donations as well as a variety of generally available federal, state and local funds to acquire computer hardware and software. During this past legislature, \$10 million was appropriated specifically to purchase additional computer equipment. Another \$1 million was appropriated for summer camps in math, science and computers, and \$200,000 was appropriated to two state universities to establish Regional Centers of Excellence for instructional

techniques in math, science and computer technology. And another \$9.2 million was set aside for summer in-service training for teachers of math and science, with future plans to include teachers of computer education.

I could go on here, Mr. Chairman, with specific appropriations that affect the administrative use of computers or those programs funded in our postsecondary institutions, but I believe the point has been made that Florida has a commitment, philosophically and financially, to a greater use of computers in our instructional programs. But that commitment, needless to say, is not without its problems.

With a student population now of over 1.5 million, only one in eight of our students has had any kind of hands-on experience with computers. And too often, it is only the bright students who have had this exposure. Although this will necessarily change because of the newly enacted graduation requirements, I can foresee funding problems with the purchase of enough equipment to give those students an adequate amount of time. We have instances now where donated equipment sits in disuse because of the prohibitive expenses of software or retrofitting of facilities.

And lastly on this subject, I would like to mention that very often federal restrictions placed on the use of computer funds for education programs run counter to the whole notion of the computer; that is,

are infinite applications. The programs that come to mind are those involving vocational education, compensatory education, those for handicapped students, and migrants. By restricting the use of equipment purchased through those programs, you are limiting access for other potential student users. The amount of flow-through federal dollars going directly to those programs--or anything for that matter--is unknown to state policymakers.

It is my understanding there are several bills now pending in Congress which would continue this same pattern. One of those measures pertains to Computer Literacy Aid (HR 3750), which would provide \$320 million over a ten-year period to local educational institutions. Two other bills pertain to the Vocational Education and High Technology funds (HR 3280 and HR 3281), which allow certain dollars to purchase certain equipment to train certain people who only work in certain areas. To one degree or another, these bills--and others like them--channel desperately needed funds into restrictive-use programs and do so directly with individual institutions.

As the Senate's Education Chairman and as its former Appropriations Chairman, I can tell you that for a state, such as Florida, that has developed a long-range policy, it is a much more prudent and manageable use of funds for them to go directly to the state's lead agency. Our separate efforts to fund these technology programs need more state and federal coordination. The speed of this ever-increasing computerized world is so dynamic that this nation can ill-afford to reach for the

brass ring and end up with a handful of spaghetti.

Our country is in the throes of a tremendous transition, one that is rapidly moving us from an industrial to an informational society. Daily, we read about the cost of this transition in terms of unemployment. We have not had the luxury of time, as when the United States slowly changed from an agricultural to an industrial society. In the broadest sense of the term, education is the key to successful competition in that society, whether that test is at the shop level or in the world marketplace.

Florida has charted its course for competition in its economic development initiatives and in its education programs. We want and expect our graduates to be able to compete in a world that is vastly different from what we knew 10 or 20 years ago. I also believe that if our competition is going to extend beyond the borders of our states and beyond our national boundaries, then the states need the support of Washington to educate our citizens for the 21st century.

Thank you, Mr. Chairman.

Mr. GORE. Thank you very much. I appreciate that.

Our final witness is Mr. Curman Gaines, assistant commissioner of education for the State of Minnesota.

Mr. Gaines, if you care to summarize any portion of your statement, we would appreciate it.

We have a vote that has just begun on the floor, and actually we have two votes in a row. And we will have to interrupt your statement 5 minutes into it, and then we'll have to adjourn and come back.

So we'll go ahead and get as much of it into the record at this point as we possibly can.

So please proceed.

**STATEMENT OF CURMAN GAINES, ASSISTANT COMMISSIONER OF
EDUCATION, STATE OF MINNESOTA**

Mr. GAINES. Thank you, Mr. Chairman and members of the committee.

First of all, I would like to thank you for inviting me to participate in this hearing on computer education. I'm representing Dr. Ruth Randall, who's commissioner of education in the State of Minnesota.

In the matter—to expedite time and try to get as much of my report in or in a summary, I am going to highlight much of what is in my written testimony.

As has been said by several members who preceded me, Minnesota is a leader in the educational use of computer education. This is evidenced by a writeup in Time magazine, Newsweek, Electronic Learning, coverage on ABC's "Nightline" television. All of these attest to the fact that we have in the past been a leader in computer education.

Also, leadership is shown on the State level. Many school districts on their own have proceeded to invest heavily in computer education programs. In addition to that, the State has appropriated funds, through the Council on Quality Education, to the school districts to experiment with computer education programs. In addition, the Minnesota Education Computer Consortium also has provided leadership through block grants in the computer education program.

As of April 1983, Minnesota has the best ratio of computers to the students of any State in the Nation. With over 10,000 microcomputers in the schools, the ratio was 1 to 73. While that ratio is insufficient to allow personal access for every student, there is at least 1 computer in each of the 435 school districts in the State of Minnesota.

Also, Minnesota excels in courseware development. A recent survey listed 3 of MECC's products in the top 10 best sellers nationwide. Another survey has stated that 60 percent of the courseware developed by MECC is being used in schools throughout the Nation.

Again, to maintain its preeminence and the commitment to computer education, the 1983 Minnesota Legislature appropriated over \$5 million for the implementation of a computer education program. That program—and, Mr. Chairman, I would like to submit

for the record a copy of the "Planning for Educational Technology for the State of Minnesota"-----

Mr. GORE. Very good.

Mr. GAINES [continuing]. Which details the points in the bill. But just to highlight that bill, it includes a comprehensive planning program for each school district, and that plan, if approved by the State Department of Minnesota, must state how the computer technology will be used in each district, specifically addressing concerns of needs of the special population, including females, minorities, and the disabled.

That plan must also state the goals for implementing that plan and instruction and management use of the computer education plan.

It must also state goals—I'm sorry. It must also state how these goals will be achieved, which includes in-service training features.

It must also include the procedures for integrating the use of technology into the district's community education program, and we believe this is important, simply because the business—we tried to stress the importance of the public-private sector. We believe this program should include a component that will address the needs of business as they look for additional training for their people. This would be a double way of using the computer program for instructional use, for the K through 12 program, as well as for adults in the community.

But we have found that one of the drawbacks—earlier we found of the computer education program—many of the parents really did not understand what the computer was all about. We embarked on a program to get what we called "computer literacy" for, hopefully, all of our citizens.

To enhance that, we say in passing this bill we want to make sure that the community is involved in the computer education program.

Third—I mean, finally—we then want to say that at the end of each year we're requiring that school districts evaluate the progress of their plans and report this to the State Department of Education.

Now much has been said about the courseware development in the use of the computer education program. We in Minnesota believe very strongly that courseware development is important, it must accompany the development of a computer education program. Evidence of that has been shown by our MECC program. We have been very, I guess you'd say, hastily and cautiously developing high quality computer software program.

The bill also stipulates that school districts cannot go out and buy any software program, what have you. You must—time to stop?

Mr. GORE. Finish the sentence, if you want.

Mr. GAINES. Oh. It must be—the software must be purchased through an approved list by the State Department of Minnesota.

Mr. GORE. OK. Let me ask your indulgence for just a few minutes. We have two votes back-to-back on the floor, and we will adjourn for approximately 10 or 12 minutes, and then we'll finish up.

Thank you.

[Recess.]

Mr. GORE. The subcommittee will come back to order.

We were hearing from Mr. Curman Gaines, assistant commissioner of education with the State of Minnesota.

Please proceed, Mr. Gaines, and, as I mentioned to you, if you can summarize the remaining portions of your statement we would appreciate it, because we've run overtime due to the votes on the House floor and the length of the proceedings this morning.

Mr. GAINES. Thank you, Mr. Chairman.

In closing, I would like to address the issues of what we in Minnesota are doing with the Minnesota Educational Computer Consortium.

Briefly, the consortium got started in 1973 with the understanding and need that school districts could best serve themselves if they combined their resources in the interest of purchasing computer time and later on as they went into the purchase of computer hardware and software. So that was the impetus for organizing MECC.

MECC provides three basic types of services to citizens of the State of Minnesota.

One, in the purchase of hardware. Initially, all school districts, via telecommunication, hooked up to the MECC computer, which had a disk which maintained a reservoir of information that school districts could tap into.

Later, with the advent of microcomputers, we're now leaving the large computer and have gone into the business of purchasing the Apple computer and the Atari. What this has done for us, it saved us a substantial number of dollars, this mass purchasing of microcomputers, and we do this via MECC.

The second major function of MECC is the development of computer software, which I've addressed earlier, which is also included in detail in my testimony.

The third area is teacher training. We believe in Minnesota that it's imperative that teacher training accompany any computer education program, and MECC has been given the responsibility of coordinating many of the teacher training programs for the State of Minnesota.

I would like to close by saying that it is evidenced from the amount of money and planning that has gone into the high technology bill which was passed by the 1983 legislature, Governor Perpich, Commissioner Randall, and the Minnesota Legislature, as well as many other leaders in the public and private sector in the State of Minnesota, are now combining their efforts in a collaborative way to really improve the computer education program in the State of Minnesota.

Thank you, Mr. Chairman.

[The prepared statement of Mr. Gaines follows:]

U.S. House of Representatives
Subcommittee on Investigations and Oversight
Honorable Albert Gore, Jr. Chairman

TESTIMONY

by

Curman L. Gaines, Assistant Commissioner
Minnesota Department of Education

Mr. Chairman, members of the committee, thank you for inviting me to participate in the subcommittee's hearing to discuss the various approaches taken by states to the use of computer technology in education. Specifically, I have been asked to discuss the efforts of the state of Minnesota to facilitate the integration of computers into its educational system and the programs now underway in the state.

Background

Minnesota is a leader in the educational use of computers. Write-ups in Time, Newsweek, and Electronic Learning; coverage on national television news programs such as ABC's "Nightline"; adoption of state-developed instructional software nationwide; all attest to the state's pre-eminence in this new, fast-changing field.

Leadership is shown on several fronts, from many individual school districts with heavy investments in computer education, to statewide encouragement of technological innovation by the Council on Quality Education (CQE), the Minnesota Educational Computing Consortium (MECC) or specially targeted block grants. Also crucial are regional efforts as provided through the Educational Cooperative Services Units (ECSUs), MECC regions, and TIES (Minnesota School Districts Data Processing Joint Board).

As of April, 1983, Minnesota had the best ratio of computers to students of any state. With 10,000 microcomputers in the schools, the ratio is 1:73. While that ratio is insufficient to allow personal access to every student, there is at least one computer in each of the 435 school districts.

Minnesota excels in courseware development. A recent survey listed three of MECC's products in the top 10 best materials nationwide; according to another survey, 60 percent of the courseware used in United States schools is MECC-developed.

Technology in Education

To maintain its pre-eminence and commitment to computer education, the 1983 Minnesota Legislature passed a high technology bill and appropriated over \$5 million for its implementation. The bill specifically addresses the issues of comprehensive planning, courseware development and evaluation, selection of demonstration sites, and teacher training.

Each school district is encouraged to develop and adopt as part of its educational policy a written technology utilization plan. The plan shall describe:

- (a) How technology will be used to provide educational opportunities for people of all ages residing in the district, affirmatively addressing the needs of special populations, including females, minorities, and the disabled;
- (b) Goals for implementing the use of technology in the district, including instruction and management uses;
- (c) Means to achieve these goals, including proposed inservice training;
- (d) Procedures for integrating the use of technology into the district's community education program;
- (e) Procedures to evaluate and report progress toward the goals.

In the area of courseware development and evaluation, the Minnesota Department of Education will compile, publish, and distribute a list of high quality courseware packages for use in elementary and secondary schools. Every six months thereafter, the Department will supplement the list with recently evaluated materials.

School districts may purchase or lease courseware packages that qualify as high quality according to the Department of Education's approved courseware package list. In addition, the Department of Education may provide for evaluation of courseware packages that have not been submitted for consideration, if districts express strong interest in using the courseware packages.

Another source for courseware packages is the Minnesota Educational Computer Consortium (MECC) in consultation with the Department of Education, who develop and design courseware packages which will meet the needs of school districts and which otherwise are unavailable or too expensive for individual districts or the state to purchase.

During the 1983-84 and 1984-85 school years, the Minnesota Board of Education is to designate from eight to ten districts as technology demonstration sites. To ensure equity of access to the technology, the selection sites shall be geographically well-distributed with representation from urban, suburban, and rural areas.

Staff training is essential to effective computer use. It is imperative that teachers receive adequate training on how to integrate the computer into instruction. The high technology bill has made provisions for each school district with an approved technology utilization plan, to receive state aid to provide inservice training for elementary and secondary public school staff on the use of technology in education. As a service to school districts, the Minnesota Department of Education documents a minimum of 200 formal training sessions offered annually to teachers.

Curriculum Development

Computers are helping to revamp Minnesota school curriculums. One beneficial side-effect of the introduction of computers into the schools has been to foster systematic curriculum planning; a return to instructional principles. Bloomington, Hopkins, and Columbia Heights are three examples.

Bloomington schools who have been using computers have used MECC's Timeshare arrangements for 12 years. In response to growing student and teacher interest, it has purchased a variety of hardware and software in recent years. The computer program expanded at a much faster rate than anticipated. In order to get a formal handle on it, instruction had to be done in an organized, structured way, with a minimum of redundancy.

The Bloomington computer education curriculum, written three years ago, has two parts. At the elementary level, students are taught to be computer literate. They receive seven and one-half hours of instruction per grade level, K-6, in the history, uses, and basic operation of the computer. At the secondary level, emphasis is students learn whatever is required to use the computer as a learning tool. Teachers in all subject areas are encouraged to use computerized instruction wherever possible.

Instructional management is another way computers are used to enhance the curriculum. This is the route taken by Hopkins, with its nationally recognized and widely used Comprehensive Achievement Monitoring (CAM) program.

CAM is a computerized record-keeping system that allows teachers to put course objectives and related test questions into the computers, which can then produce tests, keep track of student performance, and generate special reports that compare sets of data and analyze performance by objective.

Columbia Heights has an ambitious curriculum plan for computer education, but putting it into effect is a slow process, requiring moving adventurously on many fronts at once, instead of step by step. Columbia Heights' approach is to work simultaneously on curriculum planning, teacher training, and software purchase.

Three years ago, the school board adopted a statement of philosophy calling for students to be able to use computers by the second grade, to start programming in the third grade, and to shift from the simple programming language of LOGO to learning BASIC in the sixth grade, in preparation for more advanced programming in high school.

To further illustrate the advancement of computer education in Minnesota, currently the Minnesota Department of Education and Professor Franz Halberg of the University of Minnesota are collaborating to design computer education projects in chronobiology and health care. The projects involve the collection and analysis of automatic and self-measurements of variables essential to health care, with the computer as its major tool. In several projects that started in Minneapolis, St. Paul, and Mankato, Minnesota, over ten years ago, chronobiology projects wedded the computer to the use of the student's body as a cost-free, always available and very pertinent laboratory.

577

While these projects in computer science and health already constitute feasibility checks and experimental validation of the merits in education of the teaching of chronobiology with computer science, the long-term goal of such endeavors is to bring such instruction into every citizen's education.

Minnesota Educational Computing Consortium (MECC)

One of the reasons Minnesota has been cited repeatedly as a leader in the educational use of computers is MECC, the Minnesota Educational Computing Consortium. Over the past decade, MECC has assisted school districts in the acquisition and effective classroom use of computing resources.

MECC was established in 1973 in the belief that centralized leadership was the best way to promote cooperation and efficient use of public funds. It is a consortium designed to serve the state's four public education systems: University of Minnesota, state universities, community colleges, and the Department of Education (representing school districts) which historically have provided the funding for the organization.

MECC provides three main types of instructional computing service:

1. **Hardware:** For the past nine years, the MECC Timeshare System has offered statewide service via a telecommunications network to users of large computer applications. Due to the rising popularity of microcomputers, this system will be phased out in the near future.

MECC has established purchase contracts for the APPLE II and ATARI microcomputers, allowing Minnesota school districts to purchase these products at a reduced cost. To date, about 7,000 computers have been purchased, generating a savings over list price of about \$2 million.

2. **Software:** MECC produces and distributes a collection of over 700 programs for the Apple and Atari computers. The Minnesota districts receive these programs for the simple cost of materials. This translates into a cost of less than \$10 per product compared to commercial courseware priced at several times that amount.

MECC courseware is also sold to other states and countries at full price, generating revenue used to produce more products for Minnesota. At present, over 100 educational institutions around the world, representing 3,000 school districts, have courseware acquisition agreements with MECC.

3. **Training:** With an inservice training staff of seven, MECC helps school districts train educators to use computers effectively. It offers call-in consulting, site visits, workshops, classes, conferences, local informational meetings, and newsletter publication. Except for special classes and conferences, these services are offered at no charge to educators as a result of legislative appropriations to the Minnesota Department of Education.

In any given year, MECC staff will make 600 visitations, produce over 100 workshops, and hold 50 classes and conferences. MECC also publishes its training materials to assist other educators in carrying out training of local staff.

In summary, Governor Perpich, the Minnesota Legislature, and Commissioner Randall, Department of Education, have made high technology a top priority in the state. The public and private sectors are beginning to develop partnerships to continue improvement of computer education programs in schools.

Biographic Sketch

Curman L. Gaines, Assistant Commissioner
Minnesota Department of Education
550 Cedar Street
St. Paul, Minnesota 55101

B.S. (1963), M.S. (1972) -- Southern University, Baton Rouge, Louisiana

Currently, Ph.D. Candidate in Educational Administration --
University of Minnesota, Minneapolis, Minnesota

Teaching Experience -- 10 years Junior High School math and science

Educational Administration - 7 years Assistant Principal,
Junior/Senior High Schools

- 1 year Principal,
Junior High School

Public Administration -- 2 years Deputy Commissioner
Minnesota Department of Human Rights

CLG:pccc1
09/27/83

Mr. GORE. Thank you very much. I appreciate it. I think this has been an excellent panel.

Let me ask a couple of questions, and then, with your cooperation, we would like to submit a few more questions in writing for you all to respond later on. There won't be many of them.

First of all, Dr. Moore, what kind of participation did you get among the Memphis teachers when you used the cable system for training purposes?

Dr. MOORE. We conducted the teleconference during the teacher in-service period before schools opened. Of our 160 school sites, probably three-fourths of those are currently connected to the cable. The remaining schools do not have cable drops installed at this point.

As best as our survey of schools indicates, approximately half of the schools that did have cable connections did view the program on a live basis and did participate in the teleconference portion. Approximately another one-fourth of the elementary schools had members of their staff that taped off the cable network the telecast for a delayed broadcast to that faculty, using videotape equipment in the school.

Mr. GORE. Well, that's—that's excellent.

Now you and others have identified support for software as a key part of this problem.

Senator Gordon, you pinpointed the software development as the place where the Federal Government could most usefully put its emphasis.

And, Dr. Jhin, you have made similar statements.

And, Ms. Sturdivant, you mentioned the possibility of a software consortium to pool the efforts of school districts around the country for the development of software.

And, Mr. Gaines, you pinpointed the same sort of problem as one of the keys to realizing this enormous potential.

One of our witnesses yesterday proposed that we consider at the Federal level formation of a COMSAT-type public-private corporation to stimulate the development of excellent educational software, and that's one recommendation that we're going to consider.

I wonder, Senator Gordon, if you have any thoughts on that idea.

Mr. GORDON. Well, I think the better model—the problem is to get the best people in the academic discipline into the building of the software.

Mr. GORE. Yeah.

Mr. GORDON. I don't think it's an economic question. That's why I don't think the COMSAT model makes much sense.

If the Federal Government puts the money there, the software will appear. Then the question is, who's going to make it appear? And if one were to use, certainly in the science areas, the National Science Foundation as a conduit for the development, so that we'd have—that's why I would have some problem with the consortium of school people. While they're certainly aware of how a classroom operates and what you might do in a school, I'm much more concerned to get the academic content into the—into the work.

And the Federal Government might very well have to, in addition to providing the software development dollars, go back to some of the better features of the old NDEA and get some school dis-

tricts to cooperate in teacher training, which is the other side of the coin.

I think if you—you know, one of the things that happens—this is one of the few educational situations where a significant amount of it, that time is on our side. As the computer gets cheaper and more pervasive, a lot of the training becomes unnecessary because people are going to do it themselves, and so on. That's not generally true of innovation, but it happens to be—happens to be here.

Mr. GORE. Well, I appreciate your response.

The Carnegie Foundation for the Advancement of Teaching called for the creation of a National Commission on Computer Instruction appointed by the Secretary of Education to evaluate the software. We've had so many national commissions lately that maybe the proposal for a new one has a heavy burden to bear, but perhaps if we called it a national clearinghouse on educational software to evaluate software for schools, that might be a good—a good proposal.

Anybody disagree?

Mr. GORDON. Well, I—I really think the emphasis ought to be on getting people involved, instead of just evaluating what happens to happen out there.

Mr. GORE. Yeah.

Mr. GORDON. You really need to put the money so that the right people will take time off—

Mr. GORE. Stimulate the development of it.

Mr. GORDON. From doing what they're doing to getting involved in this, because we see this as a priority. I think that's where the incentives fall.

Mr. GORE. Yes.

Ms. Sturdivant, I want to look particularly closely at the details you provided in your testimony on the checkout program that you've put in place in Houston. That sounds very intriguing, and other school systems around the country might benefit from the experience that you've had on that.

As I said, we'd like to submit some additional questions for the record, if you all have no objection to that procedure.

I'm sorry we've run short on time for this hearing, but over the last 2 days we have learned a great deal. We're going to deliberate on the recommendations that the witnesses have made and explore this area further, and then publish some recommendations of our own and coordinate our work with Secretary Bell's; so that perhaps we can begin to move in a more sensible direction to realize this enormous potential.

I'd like to thank the witnesses on this last panel. You've been enormously helpful. I'd like to thank all the witnesses during the 2 days of hearings, and the staff who've worked so hard to make this hearing successful, particularly Steve Owens.

And, with that, let me declare the hearing adjourned.

[Whereupon, at 12:43 p.m., the subcommittee recessed, to reconvene at the call of the Chair.]

APPENDIX

QUESTIONS AND ANSWERS SUBMITTED FOR THE RECORD

FOR THE RECORD
OFFICE OF THE CLERK
U.S. HOUSE OF REPRESENTATIVES
WASHINGTON, D.C. 20541
TELEPHONE (202) 541-2100
FACSIMILE (202) 541-3100
MAIL ROOM (202) 541-3100
RECEPTION (202) 541-3100
LIBRARY (202) 541-3100
COMPUTER CENTER (202) 541-3100
CONFERENCE ROOMS (202) 541-3100
OFFICE OF THE CLERK
U.S. HOUSE OF REPRESENTATIVES
WASHINGTON, D.C. 20541
TELEPHONE (202) 541-2100
FACSIMILE (202) 541-3100
MAIL ROOM (202) 541-3100
RECEPTION (202) 541-3100
LIBRARY (202) 541-3100
COMPUTER CENTER (202) 541-3100
CONFERENCE ROOMS (202) 541-3100

U.S. HOUSE OF REPRESENTATIVES
COMMITTEE ON SCIENCE AND TECHNOLOGY

SUITE 2321 HAYBURN HOUSE OFFICE BUILDING
WASHINGTON, DC 20515
(202) 225-6371

October 18, 1983

FOR THE RECORD
OFFICE OF THE CLERK
U.S. HOUSE OF REPRESENTATIVES
WASHINGTON, D.C. 20541
TELEPHONE (202) 541-2100
FACSIMILE (202) 541-3100
MAIL ROOM (202) 541-3100
RECEPTION (202) 541-3100
LIBRARY (202) 541-3100
COMPUTER CENTER (202) 541-3100
CONFERENCE ROOMS (202) 541-3100

Ms. Patricia Sturdivant
Associate Superintendent for Technology
Houston Independent School District
5300 San Felipe
Houston, TX 77056

Dear Ms. Sturdivant:

I want to thank you for your participation last month in our hearing on Computers and Education. Your testimony was extremely interesting, and your thoughts will be useful to the Subcommittee as we consider ways to address the problems identified at the hearing.

As I mentioned at the hearing, the Subcommittee has several questions that time did not permit us to ask you orally. Consequently, I have attached written questions to this letter to which we ask you to respond. We would be appreciative if you could answer these questions in writing within 30 days. Your written responses will be printed as part of the hearing record.

Additionally, the staff of the Subcommittee has sent to you under separate cover a copy of your testimony at the hearing. Please review your testimony and correct any errors or inaccuracies in grammar in it. Please do not make any substantive changes in your testimony, however; the Rules of the Committee on Science and Technology require the printing of essentially verbatim transcripts of hearings.

Thank you again for your participation.

Sincerely,

Albert Gore, Jr.
Albert Gore, Jr.
Chairman
Subcommittee on Investigations
and Oversight

AG:Otk

(579)

582

1. One problem that has been cited is school curricula that are not designed to take advantage of the benefits of computers. How significant is this problem?
 - a. What should be done to help develop appropriate computer-based courses?
2. Concern has been expressed that many teachers are not trained to utilize computers.
 - a. What types of teacher training programs are in place in your system?
 - b. What role should the federal government play in this area?
3. Should teachers be required to be "computer literate" for certification?
4. Should students be required to be "computer literate" to graduate?
5. The National Science Foundation recently released a study which found that a gap in access to computers in schools is beginning to appear between economically advantaged and disadvantaged students. Do you believe that this is a serious problem?
 - a. What should be done to combat this problem?
 - b. What is your system doing to address this question?
6. How do you react to the criticism made by the Carnegie Foundation for the Advancement of Teaching that current efforts to place computers in schools typify a "by now, plan later" approach?
7. What is your opinion of the adequacy of available educational software?
 - a. What should be done to encourage the development of good software?
 - b. The Carnegie Foundation report proposed the creation of a National Commission on Computer Instruction to evaluate software, and one of our other witnesses suggested a public-private joint effort, modeled on the COMSAT legislation, to generate quality software and serve as a clearinghouse. What do you think of these proposals?
8. What problems, if any, do you foresee for schools in financing computer technology, as well as the training and support programs it requires?
 - a. Should the federal government assist states and local school districts in financing equipment and programs?
9. What role have computer manufacturing companies played in training teachers, designing curricula, or donating equipment in your system?
10. What is your opinion of the so-called "Apple III" approach -- i.e., legislation to give tax breaks to companies that donate computer equipment to schools?
11. What is an optimum student/computer ratio?
12. What lessons should other school systems learn from the experiences of your system?

Houston Independent School District

1100 HOUSTON AVENUE • HOUSTON, TEXAS 77002
 AREA CODE (713) 821-5000



Department of Technology - 5100 San Felipe - Houston, TX 77056-(713) 960-8888

November 13, 1983

The Honorable Albert Gore, Jr.
 Chairman, Subcommittee on Investigations
 and Oversight
 U. S. House of Representatives
 Suite 232 Rayburn House Office Building
 Washington, DC 20515

Dear Representative Gore:

Enclosed are my responses to your questions about the use of computers in public schools. You have asked some provocative questions. I hope I have provided sufficient detail for your report.

The hearings you conducted were handled with skill and sensitivity. I appreciate the background that you brought to this assignment.

Please contact me (713 960-8888) if you need more information. I am glad that you are seeking the opinions of school administrators. I am sure you will reach some interesting conclusions. Good luck with your study.

Sincerely yours,

Patricia Sturdivant
 Associate Superintendent for Technology

PS:aa
 Enclosures

110329.A03.1891

1. One problem that has been cited is school curricula that are not designed to take advantage of the benefits of computers. How significant is this problem? What should be done to help develop appropriate computer-based courses?

Nearly all educational software developed so far has been designed to supplement or replace small, discrete units in the existing curriculum. However, the structure of the curriculum has remained essentially unchanged. This means that the real educational capabilities of the computer are mostly being ignored.

It takes a great deal of time and money to develop good software. School systems and educational publishers, acting separately, probably cannot afford the time and risk involved in developing fully integrated computer-based curricula. A larger cooperative effort will be required.

One such effort is outlined in the enclosed paper, "An Educational Consortium Programming America for the Information Age."

2. Concern has been expressed that many teachers are not trained to utilize computers. What types of teacher training programs are in place in your system? What role should the federal government play in this area?

There are several types of teacher training being used within Houston Independent School District. The major teacher training program in operation now is the Teacher Technologist training program. In this program, a teacher from each school completes 296 hours of training at the Department of Technology. Thirty hours of renewal training are also required each year upon completion of the 296 hours. The Teacher Technologists are responsible for coordinating all computer-related courses and activities at the campus level. They will also provide the liaison between the campus and the Department of Technology.

In addition to the Technologist training program, the Department of Technology offers training sessions to meet basic teacher training requirements. A school is not eligible for hardware or software without first meeting Department guidelines. This includes required administrative and teacher hands-on training as well as four to eight hour training modules on all software packages requested. The training must be completed before the school can receive the hardware or software.

Elective training sessions are also offered to other personnel in the District. These sessions are four to eight hours in length, and topics range from micro-computer awareness to high resolution graphics in the secondary school.

The federal government should provide financial support for regional training centers for districts undertaking comprehensive training programs for teachers.

4. Should teachers be required to be "computer literate" for certification?

Teachers should definitely be required to be "computer literate" for certification. The Texas Education Agency has published a bulletin describing the "Essential Computer Competencies for Educators." Due to the profound impact of the computer in education, it has become increasingly important for all teachers to have computer skills. In order for the computer to become an integral part of the curriculum, it is essential that all teachers have some knowledge of the function of computers and their ability to impart education.

4. Should students be required to be "computer literate" to graduate?

Computer literacy should certainly be required for all students. Computer literacy programs must be offered to students in order to prepare them for an increasingly technological society. A chilling report recently issued by the Congressional Office of Technology Assessment says "lifelong ratification is expected to become the norm for many people. There is considerable evidence that children now being educated in the use of computers are generally the children of the white middle class." If only the most able students are provided with computer access, the gap will surely widen between the have and have-nots. Any computer literacy mandate must address this fundamental equity issue and the implications it has for the allocation of computer resources.

The obstacles need to be fully recognized in implementing a computer literacy requirement. Provisions must be made for systematic teacher training and funds must be identified for hardware and software. Obviously, choices have to be made about the levels at which schools will expose students to computers. These decisions must be made in view of available resources. Targeting certain grade levels is suggested but is problematic, for after students use computers, they are not satisfied with a curriculum that does not provide this experience.

5. The National Science Foundation recently released a study which found that a gap in access to computers in schools is beginning to appear between economically advantaged and disadvantaged students. Do you believe that this is a serious problem? What should be done to combat this problem? What is your system doing to address this question?

The Houston Independent School District views the "equity of access" issue in computers as serious, requiring immediate attention and specific actions. Recent studies show schools in middle and upper class neighborhoods are purchasing computer equipment at a much faster rate than those in low-income areas. Just as important is the fact that when children in low income areas do receive computer instruction, it is usually based on commercial drill and practice software, where the computer controls the student. Middle and upper class students typically receive instruction in programming; they learn to control the computer.

The Houston Independent School District is implementing the following projects to address these issues:

COMPUTERS CAN - Low income parents in any one of 45 Chapter 1 funded elementary schools may come to school for a free computer workshop with their children. When they finish the training

sequence, the computers are checked out to the parents for use in their home. Eligibility for the program is established with income and student achievement data.

CHURCH PROJECT - Fifty computers were purchased for four Church Learning Center sites with a grant from the Gullen Foundation. Volunteers staff the labs, conducting computer and non-computer based tutoring sessions after regular school hours.

PUBLIC HOUSING PROJECT - Thirty computers have been placed in two public housing locations to provide computer assisted instruction.

The "equity gap" is a problem with serious implications for the future of our whole country, so serious that a major national effort to close the gap is warranted. Federal efforts should support the development and dissemination of projects like COMPUTERS CAN and the Public Housing Project on a national basis. In addition, federal support is needed to insure that high-quality, high-level software is made available at low or no cost to low-income schools.

6. How do you react to the criticism made by the Carnegie Foundation for the Advancement of Teaching that current efforts to place computers in schools typify a "buy now, plan later" approach?

The criticism is too often valid, however it is not necessary. Each school district could identify an Educational Computing Coordinator whose function would be to assist the individual schools' administrators in designing a school implementation plan. The plan would outline the objectives of the school computer program, identify the students to be served and the teachers to be trained. It would identify the software appropriate to meet the objectives and then select the hardware that best meets the needs identified. This method has worked very well in the Houston Independent School District. Each school has purchased computers or has been funded by the District for computer hardware and software. This has only been allowed after the Department of Technology has approved the school's implementation plan. Thus, the school must "plan first" and "buy later," or they are not permitted to buy at all.

7. What is your opinion of the adequacy of available educational software? What should be done to encourage the development of good software? The Carnegie Foundation report proposed the creation of a National Commission on Computer Instruction to evaluate software, and one of our other witnesses suggested a public-private joint effort, modeled on the COMSAT legislation, to generate quality software and serve as a clearinghouse. What do you think of these proposals?

Some excellent software is available, but most of the educational programs now being marketed to schools and parents do not measure up to any reasonable standard of educational quality. The good software which is available consists mostly of isolated units. This makes it difficult or impossible, in almost all subjects, to assemble software for a full curriculum which makes effective use of the computer.

387

587

The best way to encourage the creation of high-quality, integrated software would be to support a number of regional software development consortia. Even large districts such as the Houston Independent School District cannot develop more than a fraction of the programs which they themselves will need, but an alliance of school districts could do so at considerable savings to all of its members.

The disadvantages of a single national venture are:

- " Too many eggs in one basket - If it is not managed well, the whole national effort is undermined.
- " Lack of diversity - one school of thought is almost certain to dominate.
- " Lack of competition to spur innovation and cost reduction.
- " Excessive size and bureaucratic programmers and program designers work best in lean, internal environments.
- " Distance from the users and the needs of the schools.

It is particularly important that the software development institutions remain small, diverse and under the control of the schools. At the moment, our universities employ many people with theories about how education ought to be done but very few people with practical experience in the use of micro-computers and software by ordinary teachers in ordinary classrooms. Any systematic attempt by inexperienced theoreticians to impose their own software concepts on the schools will fail. Schools will not use software which does not fit their own perceived needs and large amounts of the taxpayers' money will be wasted as a result.

8. What problems, if any, do you foresee for schools in financing computer technology, as well as the training and support programs it requires? Should the federal government assist states and local school districts in financing equipment and programs?

It is already clear that computers will amplify our ability to process information in much the same way that steam engines and electric motors amplified our ability to do physical labor. The impact of this new technology on society will be tremendous, at least comparable to the first industrial revolution. This is greatly increasing the demands on education, while at the same time providing education with powerful new tools.

As a result, education, which has always been an especially labor-intensive industry, is now facing very heavy pressure to invest capital in technology in order to achieve greater productivity. The question is whether and how this round of capital investment can be financed on a national scale.

Surprisingly, the greatest long-term problem is not hardware but software. Hardware costs continue to decline as capabilities increase. By the end of the decade, we expect to be paying approximately four hundred dollars for a notebook-size computer with rechargeable batteries, a megabyte or more of low-power RAM, and a full-sized screen and keyboard, hinged to fold together. The color version will be more powerful and less portable, and will cost about \$200 more. Both will be designed to tie into a building-wide network and its associated printers, data bases and other peripherals. This hardware will be sufficient for almost all projected educational uses, and most schools will be able to afford at least the essential core of such a system, especially as most families will choose to buy students their own portable units.

Currently, a software developer (whether public or private) spends time and money developing an educational program and then must spend even more time and money marketing and distributing the product in an effort to recover the initial investment. A substantial markup must be added as a risk premium for the producer. In the process, the buyers are forced to pay the additional costs or do without. In addition, producers feel they must use elaborate copy-protection schemes to protect their investment, which results in balky, unreliable diskettes and prevents schools from putting the programs on hard disk systems and/or networks, thus raising costs still further.

In short, a lot of money is wasted on both sides of the transaction, and the schools end up with an inferior product. Yet, in many cases, a software developer would have been happy to have sold all rights to the product early in the marketing cycle for a fraction of the sum which would eventually be expended by the schools in buying individual copies of it. Even this does not fully represent the net public benefit, however, since a program which has been carefully selected, purchased for a flat sum, and placed into the public domain, will be a better product (networkable, more reliable, more convenient) and will be used far more widely in far more schools than it otherwise would have been. Furthermore, the greatest benefit would go to precisely those very small and/or very poor institutions which are in greatest danger of falling behind.

Educational software is an almost perfect example of a "public good." The cost to produce the first copy of a program may be as much as a hundred thousand dollars or more. But the cost to produce each additional copy is effectively zero, since users can copy and distribute the product themselves, through users groups, electronic bulletin boards, and educational clearing-houses.

This is essentially identical to the "lighthouse" example so often used in economics textbooks: the cost is unitary and the benefit nearly indivisible. Right now, of necessity, publishers are attempting to limit the "light" to only the paying customers. It would be much better and more efficient to find some other way to finance the lighthouse and let all benefit who happen to be passing by.

There are several ways to implement such a solution:

- ° Encourage foundations to purchase outstanding programs and place them in the public domain.
- ° Provide 50% matching funds to educational consortia which purchase unlimited distribution rights to programs.
- ° Establish a national policy that, beginning in 1985, no federal monies can be spent on software which cannot be networked.
- ° Provide tax credits for companies which purchase distribution rights to software and then make it freely available to all schools.
- ° Support a national educational software evaluation program, such as EPIE, and provide funds for buying outstanding educational programs and making them available to schools.
- ° As an incentive to students and independent programmers, establish a series of substantial cash awards for the best educational programs placed in the public domain each year.

All of these approaches would make major contributions to the serious capital-investment problem facing our schools nationwide.

9. What role have computer manufacturing companies played in training teachers, designing curricula, or donating equipment in your system?

Computer manufacturers have played a very small role in training teachers in the Houston Independent School District because most of the computer manufacturers teach programming. Few companies have qualified staff who can teach teachers how to integrate the computer into the classroom.

Few computer companies design quality software. Such developments require the interaction of programmers, instructional designers and content experts.

Equipment has not been donated to the Houston Independent School District. Equipment is worthless unless accompanied by quality software. This software would have to be compatible with the objectives, goals and philosophy of the District.

10. What is your opinion of the so-called "Apple bill" approach -- i.e., legislation to give tax breaks to companies that donate computer equipment to schools?

On the one hand, the Apple bill provides for an indirect transfer of funds from the federal treasury to the schools for hardware purchases, and the schools can certainly use the help. On the other hand, the mechanism for

the transfer is not particularly efficient and schools may end up with equipment which is not much use to them.

The bill would look a lot better if it were modified to encourage companies to "adopt" individual schools, instead of spreading their efforts among so many schools. One possibility is to set minimums. The bill might require that a donation to a school include at least ten computers, a local area network, some network-compatible software, and twelve hours of training. This is just about the minimum which will enable a school to get real value out of the donation.

In a small district, this might mean that one school would receive all of the donated computers but based on our experience, there is no doubt at all that the total value to the students is higher if it is done this way instead of giving each school a solitary computer.

There are other ways to improve the bill. One of the simplest has already been suggested: require that a comparable donation be made to a low-income school for every donation made to a medium or high-income school.

11. What is an optimum student/computer ratio?

In the long run, the optimum will be one "notebook" computer for every student, one desktop computer for each teacher and administrator, and some specialized equipment for music, art, science and other laboratory subjects. (The 1:1 ratio will become essential as computers become integrated into the curriculum to the point where there is no practical way to do homework without them.)

In the nearer future, our target ratio is 1:6, which would provide each student with one hour of computer time each day.

12. What lessons should other school systems learn from the experiences of your system?

The most important lesson is that money cannot be spent on hardware alone. The school district which spends \$300,000 on computers and nothing on software or training will not get anything like \$300,000 worth of educational value for its money. The district which spends \$100,000 each on hardware, software and training is far more likely to get results which would cost several times \$300,000 to achieve in other ways.

Prepared by

Patricia Sturdivant
 Patricia Sturdivant
 Associate Superintendent for
 Technology
 Houston Independent School District
 November 1983

118323.AM3.DK.1891

591

ERIC

Department of Technology

AN
EDUCATIONAL
COURSEWARE
CONSORTIUM:
PROGRAMMING
AMERICA
FOR
THE
INFORMATION
AGE

HOUSTON INDEPENDENT SCHOOL DISTRICT

590

AN EDUCATIONAL COURSEWARE CONSORTIUM:
PROGRAMMING AMERICA FOR THE INFORMATION AGE

A Position Paper

by

PATRICIA STURDIVANT
Associate Superintendent for Technology

Houston Independent School District

April 1983

593

PRELUDE

The public schools face some remarkable opportunities and challenges in developing a high technology environment. According to Chris Argyris, author of Leadership in the 80's, people feel that institutions are not performing as they should. School administrators are not going beyond "single loop learning," which he defined as the detection and correction of routines of operation. In other words, administrators tend to make incremental decisions — paring a budget item here, reorganizing a little there. Argyris contends that incrementation inhibits the invention of solutions needed to fully exploit the new information technology. New policies, routines and values are needed — not just "patch jobs."

Leaders with vision will form new constructs and take the risks necessary to carry them out. Bold action will be required and the propensity for risk taking will separate the new wave thinkers from the old-line bureaucrats.

The economic and military security of the United States depends upon the vitality of the country's educational system. Educational leaders have never had a more compelling calling. This paper examines the emerging role of technology and the need for an educational software consortium, the vital link that will support tomorrow's public schools.

THE TECHNOLOGICAL IMPERATIVE

As the U. S. moves from an industrial to an information society, brain-power will become more important than physical power. Technology has the potential to extend and enhance mental ability. The challenge facing America will be to train people to work in an information society. Jobs will be available for those with the high tech skills to fill them.

The Third World countries are taking over many industrial tasks. The U. S., in order to avoid massive unemployment, will need to venture forward as a provider of information, knowledge and expertise. Current weaknesses in science and technology education will contribute to the country's economic and military weakness. It will take energy, resources, effort and money to provide the right information at the right time. Education is the key.

Last year, the U. S. House Committee on Science and Technology (May 7, 1982) heard testimony on the economic implications of our technology lag.

- Without technological leadership, the U. S. economic position will decline along with the standard of living.
- Major and minor technology decisions will be poorly made.
- People will be pushed to their technological level of incompetence because talent is in such short supply.
- Leaders and managers will not be able to plan adequately because they do not understand technical opportunities and limitations and because they cannot depend upon knowledgeable employees.
- The quality of life for those who are not part of the technological elite will decline as people struggle to get their share of a shrinking economic pie.

COMPUTERS AND PUBLIC SCHOOLS

There's a computer revolution in progress and the public schools are at the heart of it. According to Dataquest, a California based research company, the number of microcomputers in the public schools will continue to triple each year. Despite declining revenues, administrators

are buying computers in record numbers. By 1990, experts predict there will be two million computers in the public schools. According to a recent estimate in Time Magazine (January 1983), the average student/computer ratio is now 1:400. Despite a recent emphasis on the importance of computers in education, there are too few computers in most schools to make computer literacy for all students an achievable goal.

USA Today (April 21, 1983) reported that 91% of the U. S. population now thinks that students should learn to use computers in school in order to better prepare them for the future. Many states are moving swiftly toward computer literacy mandates (e.g., Florida, Tennessee, Minnesota) and some are initiating new computer training requirements for teachers (e.g., Texas, Pennsylvania, Massachusetts). Obviously schools must make substantial changes in order to prepare students for a computer oriented society. It's clear that the computer is becoming an increasingly important delivery system for education. But, even more significantly, the software that runs on the computer will have a major impact upon the development of both academic competence and computer literacy. This paper establishes the need and rationale for a major software development effort by the public schools.

With such universal agreement about the importance of computer literacy, it's surprising that computers have not made more of an impact. The pressures to integrate computer skills are coming from outside (rather than within) the educational establishment as evidenced by these trends:

- PTA's are buying computers for the schools through fund raising drives (Benson, Laura. "Erwin Open School Computer Program," Educational Computing, May 1982).
- Computer stores and colleges are offering courses for interested community members.
- The success of coin-operated versions of Pac Man prompted \$1 billion in sales of home cartridges.

There is no doubt that students are fascinated by computers. Educators are intrigued by arcade games and wonder why they are so compelling to children. Students who are bored in school can spend hours riveted to video games. As computers proliferate in the schools, the challenge is to make software that is as exciting as the most compelling video game and as educational as the best crafted school lesson. Kids are interested in computers but changes come slowly. Electronic Learning, a computing journal for educators, recently reported on some of the deterrents that are slowing down the computers in education movement. Specifically the journal said that teachers and educators need computer training in order to adequately prepare their students.

ECONOMIC INDICATORS

Five years ago most administrators and teachers were apprehensive about computers. According to an Instructor Magazine survey, that situation has turned around. By May 1982, 85% of the nation's teachers were eager to upgrade their skills but lacked an opportunity to learn about computers. It appears that the current educational system has some of the right ingredients for change — technology oriented students, supportive parents and receptive staff — but the dollars for teacher training, hardware and software are not available.

Professor J. Licklider of MIT reported that one billion dollars a year would need to be spent by schools in order to capitalize on new information technologies (EDUCOM Bulletin, Winter 1981). With today's economic woes, it seems foolish to propose such a figure. Yet, we have a four trillion dollar economy that rests on the quality of our educational system. Education is a \$200 billion a year industry that desperately needs overhauling. Curriculum development is like a critical bearing that supports a massive machine. The bearing is crumbling. If it crumbles, our entire society is in danger. The commitment to educational technology and software development is not an excessive investment — the entire future of our country depends upon it.

Realistic budgetary planning must take current technology into account. Obviously, staff salaries will continue to rise. The public schools have no alternative but to use computer technology to improve productivity and contain costs. With the computer's increasing capabilities, more and more of the curriculum can be conveyed through the use of technology. The teacher's role will change from disseminator to manager. Classroom organization models will become more work-station oriented. The traditional groupings of students by grade level will become increasingly less relevant since the computer will be able to accommodate a wide range of student interests and abilities. Learning will become a lifelong enterprise, not an exercise that takes place during the traditional six hour day.

One of the most critical factors facing public schools in this organizational and role transition is software — its availability, quality and cost. The software market is lagging far behind the current state of hardware development, therefore there are a limited number of programs now available. Much of the educational software currently on the market is inferior in quality. The good programs are expensive. While the cost of hardware is plummeting, the cost of the programs that run on it is increasing at staggering rates. One computing industry publication explains the trend: "Competition among hardware manufacturers will force prices down. Unlike hardware's technology-intensive development, software is labor-intensive, resulting in just the opposite price trend. Not only are a lot of man-hours required to write a software program, but software is also entirely dependent upon programmers, an increasingly scarce and expensive pool of talent." (Infoworld, March 29, 1982.)

The escalating costs of educational software have already become obvious. Milliken, one of the nation's leading publishers of computer programs, has increased the cost of its math and reading programs 38% over the last two years. The consumer market has been impacted as well. David Wagman, chairman of the world's largest personal computer software distributor, reports that the retail price of software has been increasing by about 20% each year.

HARDWARE AND SOFTWARE REDIRECTION

The National Science Foundation published a report four years ago (Technology in Science Education: The Next Ten Years, July 1979) which pointed out a fundamental problem with technology adoption in the schools. Since education is so labor-intensive (districts spend an average of 87% of their annual budgets on salaries), there is little revenue left for hardware and software. The only possibility for rectifying this situation is a redirection of resources. If funding is made available, the future of educational technology will open up many new horizons for teaching children. According to Joseph Lipson's report to the Pre-College Commission on Math, Science and Technology (April 1983) there will be some significant hardware and software developments:

- Computer memory will continue to grow, providing for the development of more user-friendly programs.
- Large, flat, high resolution screens will be available for group instruction as well as powerful hand-held computing devices.
- Optical character readers will allow computer input of text documents.
- By 1995, speech recognition devices will be able to understand unfamiliar voices.
- Videodisc access will provide the teacher with additional means of organizing and presenting information.
- Networks will allow students to communicate with each other and share computer programs.

LOCUS OF CONTROL

Most status reports on public education emphasize the same problem. These concerns include eroding taxpayer support, diminished teacher competence, and declining SAT scores. But the basic problem is more important than any of these -- a disturbing shift in the locus of control.

The schools, and ultimately the teachers, are losing control of the curriculum. Parents, with their access to the computer as a pedagogical tool, are assuming an important role in the academic instruction of their children. The potential for using the computer as a tutor is hardly tapped with computer games like Adventure, Pac-Man and Lemonade.

PUBLISHING: TEXTBOOKS VS. SOFTWARE

For the last 200 years, publishers have controlled the curriculum. Committees of teachers and board members have selected books that reflect community values and skill requirements. Publishers have used "content experts" to write textbooks that have been adopted in cycles which usually last 5-10 years. Most publishers, fearing rejection of their textbooks in statewide adoptions, have made only superficial efforts to add a computer management system to their textbook series. None of the publishers have revamped their products to the extent that they are concentrating on electronic publishing. They are unwilling to surrender their current \$2.2 billion a year textbook business.

As Dr. Robert Baker, President of Ginn and Company, a Xerox subsidiary explained, the school market would need to be \$60 million to be viable. In 1982 school systems spent only \$28 million for educational software. Continuing uncertainty about the availability of funds for instructional materials will probably continue to work against the publishers' willingness to develop computer software. In other words, publishers will continue to produce more of the same.

While the computer will not eliminate the need for textbooks, it will certainly diminish their importance. States will have to reexamine their textbook adoption procedures in view of these facts:

- In today's era of information explosion, textbooks become outdated quickly, particularly in science and social studies.
- Textbooks are organized for sequential presentation. The computer provides for random access, thereby increasing the opportunities for individualized instruction.
- The textbook publishers do not have the expertise within their companies that is required to develop computer software. Creative educational software has the potential to teach in an entertaining manner.
- Computer software has greater potential than textbooks for introducing challenges, providing learner feedback, offering flexibility, stimulating aesthetic consciousness, and motivating students.

Probably not. Software publishers are being advised to develop their wares for the home market rather than for the schools. TALMIS, an information and marketing company that keeps publishers up to date on technology, noted that the number of home computers will grow much more rapidly than the number of computers in the schools. TALMIS advised its subscribers to market materials that could be sold to parents. In view of this recommendation, it is not surprising that the supply of systematic courseware for school use is limited. Publishers find it easier to sell \$39 games through retail computer stores. If the games are challenging, provide instant feedback and require problem solving skills, they will benefit students. However, there is a great need for computer programs that teach earth science, organic chemistry and advanced physics.

SOFTWARE PRODUCTION DILEMMA

Assuming that 80% of the school curriculum can be taught by computer by the year 1990, where will the schools find the software to do it? Even more importantly, how will they be able to afford quality programs if they are available?

If current trends continue, the schools will not have access to the programs they need. Educational publishers, the traditional suppliers of curriculum material, have been reluctant to invest their dollars in wide-scale software development. Hundreds of "cottage industries" have sprung up over the past five years. Many are producing video games and CAI programs that are piecemeal. According to Ann Piestrup, an industry expert, the funds spent on computer software for school use is only 10% of what is spent on development of home computer games (Theory Into Practice, Fall 1982). The quality of most educational software is largely "deplorable" according to Ken Komoski, Director of Educational Products Information Exchange, a national software clearinghouse for the Consumers Union. According to him, the key is quality, not quantity.

SOFTWARE CONSORTIUM NEEDED

Educational software development requires a big investment. To create quality programs, a developer must assemble a team of courseware design specialists, content advisors and expert programmers. Computer assisted design and development is an expensive undertaking. According to Dr. Dustin Heuston, Director of WICAT (a major software development firm), the average cost of a K-8 CAI package is \$1 million. On the surface, this seems high, yet most large districts will probably spend that much on software by 1985. For example, the Houston Independent School District spent \$55,000 on computer software in 1980. By 1983, the cost was \$225,000. In another two years, the number of micros is expected to triple from 1,500 to 4,500 units. The District's \$1 million software expense in 1985 will increase proportionately as the number of computers increases.

0600

Districts all across the country are facing these problems with little resolution in sight. Specific problems include:

- Stiff pricing structures that require schools to purchase one copy of a program for each user with no free "back up" copies.
- Reluctance on the part of software vendors to lease their programs on a quantity-sale basis.
- Few computer programs available in areas other than reading/language arts and advanced mathematics.
- Refusal of publishers to make programs available on a computer network which would allow schools to reduce their software costs.
- Refusal of publishers to provide sample copies to schools for purposes of review and evaluation. Publishers fear having commercial software electronically copied.

The obvious solution to this software dilemma is to form a consortium to develop quality software programs. Few districts have attempted this development project because they do not have computer scientists, system analysts, courseware design specialists and microcomputer programmers on staff. This kind of talent is expensive but this necessary investment in human resources would pay off in terms of product development.

There is no doubt that the formation of an educational software consortium would be expensive. But in light of the competitive world economy our children will face, the question becomes not, "Can the nation afford to do this?" but rather, "Can it afford not to?"

DON JUDDA (R) Chairman

ROBERT A. ROY (R)
 GEORGE E. BROWN (R) CALIF
 JAMES H. SCHLUSER (D)
 RICHARD I. OTTINGER (R)
 TOM HARRIS (D) ILL
 MARVIN LLOYD (D) IOWA
 DOUG WALLEN (R) PA
 DAN CLARK (D) MISSOURI
 ALBERT GORE, JR. (D) TENN
 ROBERT A. YOUNG (D) MO
 HAROLD D. VOYLES (D) MO
 DON WILSON (D) ILL
 STAR LUNDQVIST (R) WASH
 SAUL W. WELLS (D) TEX
 DAVE MCCURDY (D) GA
 MERVYN D. D'EMALL (D) CALIF
 PAUL SIMON (D) ILL
 NORMAN D. MARTE (D) CALIF
 RICHARD J. DURBIN (D) ILL
 MICHAEL A. ANDREWS (D) TEX
 BURD G. MACKAY (D) ILL
 TIM VALENTINI (R) CT
 HARRY W. MOY (D) ILL
 ROBERT G. TORRACELLI (D) N.J.
 FREDERICK C. BOUCHER (D) VA

U.S. HOUSE OF REPRESENTATIVES
 COMMITTEE ON SCIENCE AND TECHNOLOGY

SUITE 2321 RAYBURN HOUSE OFFICE BUILDING
 WASHINGTON, D.C. 20515
 (202) 225-8371

October 18, 1983

LEAH WILSON (D) ILL
 MARSHALL TUCKER (D) N. CAR
 ROBERT E. WATKINS (D) PA
 WILLIAM LAMPTON (D) N.Y.
 J. JAMES BENTLEY (D) IOWA
 JUDG. LIPSON (D) N.Y.
 ARTHUR D. HICKS (D) N.Y.
 JOE BROWN (D) MISSOURI
 CLAUDE SCHNEIDER (D) ILL
 BILL LOWERY (D) CALIF
 ADD. CHAIRMAN: WASH
 MURPHY (D) CALIF
 SHERWOOD J. DOMINICK (D) ILL
 ALBERT R. MCCANDLISH (D) CALIF
 TOM STEWART (D) PA

J. H. POORE
 Executive Director
 Legislative Staff
 General Counsel
 DAVID S. MILLER
 Member Staff Director

Dr. Kyo R. Jhin
 Assistant Superintendent
 for Education Technology
 District of Columbia Public Schools
 415 12th Street, NW
 Washington, D.C. 20004

Dear Dr. Jhin:

I want to thank you for your participation last month in our hearing on Computers and Education. Your testimony was extremely interesting, and your thoughts will be useful to the Subcommittee as we consider ways to address the problems identified at the hearing.

As I mentioned at the hearing, the Subcommittee has several questions that time did not permit us to ask you orally. Consequently, I have attached written questions to this letter to which we ask you to respond. We would be appreciative if you could answer these questions in writing within 30 days. Your written responses will be printed as part of the hearing record.

Additionally, the staff of the Subcommittee has sent to you under separate cover a copy of your testimony at the hearing. Please review your testimony and correct any errors or inaccuracies in grammar in it. Please do not make any substantive changes in your testimony, however; the Rules of the Committee on Science and Technology require the printing of essentially verbatim transcripts of hearings.

Thank you again for your participation.

Sincerely,

Albert Gore, Jr.
 Albert Gore, Jr.
 Chairman
 Subcommittee on Investigations
 and Oversight

AG:Otk

1. One problem that has been cited is school curricula that are not designed to take advantage of the benefits of computers. How significant is this problem?
 - o What should be done to help develop appropriate computer-based courses?
2. Concern has been expressed that many teachers are not trained to utilize computers.
 - o What types of teacher training programs are in place in your system?
 - o What role should the federal government play in this area?
3. Should teachers be required to be "computer literate" for certification?
4. Should students be required to be "computer literate" to graduate?
5. The National Science Foundation recently released a study which found that a gap in access to computers in schools is beginning to appear between economically advantaged and disadvantaged students. Do you believe that this is a serious problem?
 - o What should be done to combat this problem?
 - o What is your system doing to address this question?
6. How do you react to the criticism made by the Carnegie Foundation for the Advancement of Teaching that current efforts to place computers in schools typify a "by now, plan later" approach?
7. What is your opinion of the adequacy of available educational software?
 - o What should be done to encourage the development of good software?
 - o The Carnegie Foundation report proposed the creation of a National Commission on Computer Instruction to evaluate software, and one of our other witnesses suggested a public-private joint effort, modeled on the COMSAT legislation, to generate quality software and serve as a clearinghouse. What do you think of these proposals?
8. ~~What problems, if any, do you foresee for schools in financing computer technology, as well as the training and support programs it requires?~~
 - o Should the federal government assist states and local school districts in financing equipment and programs?
9. What role have computer manufacturing companies played in training teachers, designing curricula, or donating equipment in your system?
10. What is your opinion of the so-called "Apple bill" approach -- i.e., legislation to give tax breaks to companies that donate computer equipment to schools?
11. What is an optimum student/computer ratio?
12. What lessons should other school systems learn from the experiences of your system?

601



Office of Educational Services

415 12th Street, N.W. Washington, D.C. 20004

Program Development

November 10, 1983

Mr. Albert Gore, Jr.
Chairman
Subcommittee on Investigations
and Oversight
U.S. House of Representatives
Suite 2321 Rayburn House
Office Building
Washington, D.C. 20515

Dear Mr. Gore:

Please accept my sincere appreciation for your letter dated October 18, 1983 regarding the Committee on Science and Technology's hearing on Computers in Education.

As requested, enclosed is a corrected copy of my testimony as well as responses to the additional questions that time did not permit you to ask me orally.

If you need further information, please contact me at 724-4148.

Sincerely,

A handwritten signature in cursive that reads "K. R. Johnson".

K. R. Johnson
Assistant Superintendent
Educational Technology

KRJ:gmw

Enclosures

604

98

Additional Questions

Question 1.a. One problem that has been cited is school curricula that are not designed to take advantage of the benefits of computers. How significant is this problem?

Response Teachers are not familiar enough with computers to know their full potential. In addition, the computer community is not as sensitive to the educational needs as they should be.

1.b. What should be done to help develop appropriate computer-based courses?

response In order to develop computer-based courses, teachers must become familiar with existing computer software. This software should be matched with the school curriculum. However, in the long run, teachers should be trained to develop computer-based courseware for their respective areas.

Question 2.a. Concern has been expressed that many teachers are not trained to utilize computers. What types of teacher training programs are in place in your system?

Response In order to prepare our teachers to become computer literate, the District of Columbia Public Schools (DCPS) established a Computer Literacy Teacher Training Laboratory. We have employed three full-time instructors to train our teachers and administrators. As of October 1983, approximately 1600 DCPS teachers and administrators have been trained through the laboratory. In addition, our teachers and administrators are encouraged to take computer courses at area colleges and universities.

2.b. What role should the federal government play in this area?

Response The federal government should provide adequate funds to states for the purpose of employing teacher trainers and purchasing microcomputers and software. In addition, the federal government should provide funds to the universities and colleges to provide computer training for teachers in local school districts.

Question 3.a. Should teachers be required to be "computer literate" for certification?

Response Yes, teachers should be required to be "computer literate" for certification. The District of Columbia Public Schools approved computer literacy policy including the following two items:

- That computer literacy and software selection skills be required for all instructional personnel (teachers, supervisors and administrators) as part of the five year recertification requirement;
- That beginning with SY 1983-84, all new teachers would have to demonstrate computer literacy before being granted permanent tenure.

Question 4. Should students be required to be "computer literate" to graduate?

Response Yes, students should be required to be "computer literate" to graduate. The District of Columbia Public Schools has the following board policy which states:

- That every student be required to demonstrate a command of the skills that constitute computer literacy before the completion of grade nine, beginning no later than SY 1987-88.

Question 5.a. The National Science Foundation recently released a study which found that a gap in access to computers in schools is beginning to appear between economically advantaged and disadvantaged students. Do you believe that this is a serious problem?

5.b. What should be done to combat this problem?

Response Yes, this is a serious problem. In order to eliminate the gap in access to computers in schools which is beginning to appear between economically advantaged and disadvantaged students, the federal government should provide Chapter 1 type funds to purchase computers, software and provide teacher training to serve this segment of the population.

5.c. What is your system doing to address this question?

Response The District of Columbia Public School Board of Education adopted the following policy statement to address this need:

- That by the end of SY 1983-84, student computer laboratories be established in all schools, with attention to security needs.

In order to implement this policy, federal funds have been utilized to establish student computer laboratories in fifty Chapter 1 elementary schools; regular local funds have been utilized for establishing computer laboratories in all schools with junior high school students, five special education schools, and two adult education centers; as a result of public/private partnership programs, computer laboratories will be installed in five senior high schools through the use of private funds. In addition, Writing To Read, a computer-based instructional laboratory funded by IBM has been established in fifteen elementary schools.

Question 6.a. How do you react to the criticism made by the Carnegie Foundation for the Advancement of Teaching that current efforts to place computers in schools typify a "buy now, plan later" approach?

Response The "buy now, plan later" approach is not necessarily true for all school systems. For example, the District of Columbia Public Schools developed a Computer Literacy Five Year Plan before the purchase of computers for our schools. This Five Year Plan has been submitted as part of the testimony. (Please see attachment A, District of Columbia Public Schools Computer Literacy Five Year Plan)

Question 7.a. What is your opinion of the adequacy of available educational software?

Response Educational software that meets the needs of a Competency-Based Curriculum is not adequate.

7.b. What should be done to encourage the development of good software?

Response Experienced master teachers in various subject areas should be given grants to develop software for classroom use.

7.c. The Carnegie Foundation report proposed the creation of a National Commission on Computer Instruction to evaluate software, and one of our other witnesses suggested a public-private joint effort, modeled on the COMSAT legislation, to generate quality software and serve as a clearinghouse. What do you think of these proposals?

We need all three services mentioned through these proposals:

- evaluation of quality software,
- generation of quality software and
- clearinghouse services.

Question 8.a. What problems, if any, do you foresee for schools in financing computer technology, as well as the training and support programs it requires?

Response The lack of trained professionals who are willing to work for the school system because of the low pay salary scales for teachers as compared to the private sector has become a very serious problem. The private sector attracts beginning teachers that have a technical background as well as teachers school systems train in the technical field because the private sector has greater incentives for promotion as well as a \$5,000 to \$10,000 increase in the salary school systems can pay.

8.b. Should the federal government assist states and local school districts in financing equipment and programs?

Response In order to insure that economically advantaged and disadvantaged students have equal access to computer technology, the federal government should assist states and local school districts earmarked for this target economically disadvantaged student population in financing equipment and programs.

Question 9. What role have computer manufacturing companies played in training teachers, designing curricula, or donating equipment in your system?

Response A number of computer manufacturers are an integral part of assisting us in designing our curriculum and our computer literacy program including training teachers and donating equipment to our school system.

Question 10. What is your opinion of the so-called "Apple bill" approach --i.e., legislation to give tax breaks to companies that donate computer equipment to schools?

Response We are in favor of such tax breaks to the computer companies provided that they meet the following criteria:

- equipment is up-to-date
- availability of quality software
- availability of teacher training materials.

Question 11. What is an optimum student/computer ratio?

Response In the classroom situation it should be two students to one computer and in the school setting it should be twelve students to one computer.

Question 12. What lessons should other school systems learn from the experiences of your system?

Response The Board of Education must be committed to support computer-related activities.

School administrators must become familiar with the capabilities of computers in education and support computer-related activities.

A formal computer literacy planning committee should be established.

Software selection and development committee should be established.

Don Edwards (D-Calif.) Chairman
Jesse Helms (R-N.C.)
John Dingell (D-Mich.)
Casper H. W. Wilder (D-Miss.)
James H. Rogoff (D-N.Y.)
Joseph P. Kamp (R-Calif.)
Frank Lautenberg (D-N.J.)
Carl Albert (D-Mont.)
Mack Matlock (D-Iowa)
Clyde W. Ray (R-Miss.)
James E. Eastland (D-Miss.)
Barth J. Burton (D-Calif.)
Walter D. Dill (D-Ore.)
Bill Brock (R-Mich.)
William V. Roth (D-Del.)
Clyde R. Haynes (D-Ore.)
Richard M. Nixon (R-Calif.)
Murray Constantine (D-N.Y.)
William H. E. Bull (D-Tenn.)
Richard L. Shelby (R-Tenn.)
Ralph S. Abner (D-Texas)
Richard H. Dorough (D-Texas)
Jesse Helms (R-N.C.)
James E. Eastland (D-Miss.)
Casper H. W. Wilder (D-Miss.)
James H. Rogoff (D-N.Y.)
Joseph P. Kamp (R-Calif.)
Frank Lautenberg (D-N.J.)
Carl Albert (D-Mont.)
Mack Matlock (D-Iowa)
Clyde W. Ray (R-Miss.)
James E. Eastland (D-Miss.)
Barth J. Burton (D-Calif.)
Walter D. Dill (D-Ore.)
Bill Brock (R-Mich.)
William V. Roth (D-Del.)
Clyde R. Haynes (D-Ore.)
Richard M. Nixon (R-Calif.)
Murray Constantine (D-N.Y.)
William H. E. Bull (D-Tenn.)
Richard L. Shelby (R-Tenn.)
Ralph S. Abner (D-Texas)
Richard H. Dorough (D-Texas)

U.S. HOUSE OF REPRESENTATIVES
COMMITTEE ON SCIENCE AND TECHNOLOGY
SUITE 2321 HAYBURN HOUSE OFFICE BUILDING
WASHINGTON, D.C. 20515
(202) 225-6371

October 18, 1983

1983-10-18
MEMPHIS, TENN. (R-015)
DR. DAVID MOORE
2597 AVERY AVENUE
MEMPHIS, TN 38112
JAMES H. ROGOFF
1000 N. BROADWAY
NEW YORK, NY 10017
JOSEPH P. KAMP
1000 N. BROADWAY
NEW YORK, NY 10017
FRANK LAUTENBERG
300 RIVERSIDE DRIVE
NEWTON, MA 02459
CARL ALBERT
1000 N. BROADWAY
NEW YORK, NY 10017
MACK MATLOCK
1000 N. BROADWAY
NEW YORK, NY 10017
CLYDE W. RAY
1000 N. BROADWAY
NEW YORK, NY 10017
JAMES E. EASTLAND
1000 N. BROADWAY
NEW YORK, NY 10017
BARTH J. BURTON
1000 N. BROADWAY
NEW YORK, NY 10017
WALTER D. DILL
1000 N. BROADWAY
NEW YORK, NY 10017
BILL BROCK
1000 N. BROADWAY
NEW YORK, NY 10017
WILLIAM V. ROTH
1000 N. BROADWAY
NEW YORK, NY 10017
CLYDE R. HAYNES
1000 N. BROADWAY
NEW YORK, NY 10017
RICHARD M. NIXON
1000 N. BROADWAY
NEW YORK, NY 10017
MURRAY CONSTANTINE
1000 N. BROADWAY
NEW YORK, NY 10017
WILLIAM H. E. BULL
1000 N. BROADWAY
NEW YORK, NY 10017
RICHARD L. SHELBY
1000 N. BROADWAY
NEW YORK, NY 10017
RALPH S. ABNER
1000 N. BROADWAY
NEW YORK, NY 10017
RICHARD H. DOROUGH

Dr. David Moore
Director, Computer Education
Memphis City Schools
2597 Avery Avenue
Memphis, TN 38112

Dear Dr. Moore:

I want to thank you for your participation last month in our hearing on Computers and Education. Your testimony was extremely interesting, and your thoughts will be useful to the Subcommittee as we consider ways to address the problems identified at the hearing.

I was especially impressed by the efforts of the Memphis City Schools to integrate computers into your educational programs. I would be interested in talking with you and Dr. Herrenton in more detail about your efforts.

As I mentioned at the hearing, the Subcommittee has several questions that time did not permit us to ask you orally. Consequently, I have attached written questions to this letter to which we ask you to respond. We would be appreciative if you could answer these questions in writing within 30 days. Your written responses will be printed as part of the hearing record.

Additionally, the staff of the Subcommittee has sent to you under separate cover a copy of your testimony at the hearing. Please review your testimony and correct any errors or inaccuracies in grammar in it. Please do not make any substantive changes in your testimony, however; the Rules of the Committee on Science and Technology require the printing of essentially verbatim transcripts of hearings.

Thank you again for your participation. I hope to see you sometime in Memphis.

Sincerely,
Albert Gore, Jr.
Albert Gore, Jr.
Chairman
Subcommittee on Investigations
and Oversight

1. One problem that has been cited is school curricula that are not designed to take advantage of the benefits of computers. How significant is this problem?
 - o What should be done to help develop appropriate computer-based courses?
2. Concern has been expressed that many teachers are not trained to utilize computers.
 - o What types of teacher training programs are in place in your system?
 - o What role should the federal government play in this area?
3. Should teachers be required to be "computer literate" for certification?
4. Should students be required to be "computer literate" to graduate?
5. The National Science Foundation recently released a study which found that a gap in access to computers in schools is beginning to appear between economically advantaged and disadvantaged students. Do you believe that this is a serious problem?
 - o What should be done to combat this problem?
 - o What is your system doing to address this question?
6. How do you react to the criticism made by the Carnegie Foundation for the Advancement of Teaching that current efforts to place computers in schools typify a "by now, plan later" approach?
7. What is your opinion of the adequacy of available educational software?
 - o What should be done to encourage the development of good software?
 - o The Carnegie Foundation report proposed the creation of a National Commission on Computer Instruction to evaluate software, and one of our other witnesses suggested a public-private joint effort, modeled on the COMSAT legislation, to generate quality software and serve as a clearinghouse. What do you think of these proposals?
8. What problems, if any, do you foresee for schools in financing computer technology, as well as the training and support programs it requires?
 - o Should the federal government assist states and local school districts in financing equipment and programs?
9. What role have computer manufacturing companies played in training teachers, designing curricula, or donating equipment in your system?
10. What is your opinion of the so-called "Apple bill" approach -- i.e., legislation to give tax breaks to companies that donate computer equipment to schools?
11. What is an optimum student/computer ratio?
12. What lessons should other school systems learn from the experiences of your system?

NOV 17 1983



Memphis City Schools • 2597 Avery Avenue • Memphis, Tennessee 38112 • Phone (901) 454-5200

Reply To The Office Of:
David M. Moore, Director
Division of Computer Education

November 14, 1983

The Honorable Albert Gore, Jr.
U. S. House of Representatives
Committee on Science and Technology
Suite 2321 Rayburn House Office Building
Washington, D. C. 20515

Dear Mr. Gore:

The opportunity to testify before the Subcommittee was a most interesting experience. Hopefully the testimony was as beneficial to those receiving it as the opportunity to render it was to those testifying.

Enclosed are responses to the additional questions which were received from your office. While the responses are not lengthy, we have endeavored to make them adequately succinct.

If you or your committee have further questions or need any clarification of the materials submitted, we welcome the opportunity to be of further assistance. The next time you are in Memphis, please give me a call in order that I may take you to some of our classrooms to see first-hand our computer education program in action.

Sincerely,

A handwritten signature in dark ink, appearing to read "David M. Moore".

David M. Moore, Ed. D.
Director
Computer Education

DMH/ol

Enclosure

612

RESPONSES TO SUPPLEMENTAL QUESTIONS
MEMPHIS CITY SCHOOLS

1. The recent acceptance of the concept of mastery learning has reshaped curriculum formats significantly. The concept that there are discrete, identifiable learning objectives which each child can and should master facilitates the development of computer delivery of instruction. The primary problem has to this point been the inflexibility of the scope and sequence of learning objectives in instructional systems developed by commercial concerns. The addition, deletion, or adjustment of grade level of objectives is not currently provided in the current commercial systems. Local autonomy in controlling the curriculum is negated. Local school systems either must accept the scope and sequence of objectives set by the commercial developers or attempt to develop their own system. The situation is similar to the control publishers have previously exerted through publication of textbooks. The mastery learning approach and the power of computer instructional delivery systems presents the possibility of local option and control.
2. Limited activities in the area of teacher training have been initiated by Memphis City Schools. Three days of in-service training have been provided to a representative from each elementary or junior high school. Building principals have also been provided four days of training. Each local school faculty is expected to utilize the representative and the principal in providing further training to the remainder of the faculty. Films and video cassette materials have also been made available to local schools. While providing minimal training, the limited efforts have been far from adequate. A brief after school training program is also being made available this fall, but more extensive training is needed, in order to give teachers depth of knowledge and confidence in their skills and knowledge.

Federal stipends or other financial incentives to return to institutions of higher education for further training would be one approach. Federally sponsored summer training institutes might be another beneficial program.

- 3-4. Both teachers and students need to be "computer literate" if a definition of that term can be established. A caution needs to be kept in mind in defining computer literacy relative to the amount of programming ability expected. An expectation of extensive programming ability would be analogous to expecting driver education students to be able to rebuild a transmission and over-haul an engine. While limiting a definition of "computer literacy" might be prudent on the one hand, expansion of the concept to "technology literacy" should be thoroughly explored. A number of technological advances in communications and related fields hold significant implications for education and society at large.

There has been mention in some quarters of a grandfather clause to exempt teachers from being computer literate. Such an exemption would be a dis-service to our students. A more practical approach would be to

set a deadline of three to five years for teachers to complete their training in computer literacy.

5. The equity of access issue is one of which educators need to be mindful. While there will always be some inequality of access, school districts can minimize the access gap by providing equipment, materials, and trained teachers in adequate numbers throughout the school district. Memphis City Schools has taken significant steps in that direction by not requiring local school committees to finance the computer education program. It is doubtful that an effective method exists for preventing local school committees from supplementing educational programs if they have the means and the desire.
6. It has been said that, "A good plan today is better than a perfect plan tomorrow." Planning should be a key ingredient in any large-scale undertaking. The development and infusion of computer technology in our society and in our educational system is not a single static event. Computer education is not an activity that can be planned upon the completion of a given event. While there certainly has been some "huy now" activity, it would be foolish to forgo implementing a computer education program while awaiting the conclusion of technological development.
7. While a portion of current software is marginal at best, there has been a general improvement in the quality of educational software. Software development has generally been slower than hardware development and the continuing rapid pace of hardware development has tended to make hardware obsolete before the software has totally been developed. The standardization of disk formats, operating systems and other facets of the computer system to make software independent of hardware would greatly encourage software development because of the universality of usage.

As mentioned in earlier testimony a vicious circle is developing. Software developers prepare their software for the computer with the greatest number of units. The greater base of software helps further sales of that computer which prompt even more software development for that computer and even more subsequent sales. There is a distinct possibility that twenty years from now education will be using the current technology because newer computers will not have the sales/software support to be a viable option for schools. An illustration would be the development a superior 20mm motion picture projector. Few, if any, film companies would produce films for the 20mm projector because of the small market compared to the significant current market for 16mm films. Without a significant number of films becoming available for the new projector, sales would be minimal and eventually the projector would be removed from the market.

Joint public-private effort at software development may well help, but not to the extent of encouraging private development. While the role and functions of the clearinghouse were not specified, software evaluations are proliferating faster than they can be utilized.

8. School districts would obviously benefit from Federal financial assistance. Financial assistance, however, for equipment and training would be inadequate. Such an approach would likely result in schools with equipment without software and trained teachers who suddenly become attractive to business and industry - neither of whom have difficulty in offering teachers very attractive pay. Federal support should be provided for software as well as hardware and salary incentives for teachers to stay in teaching after having received computer training.
9. To this point computer manufacturers have played a relatively minor role in the Memphis City Schools computer education program. While manufacturers have provided some training through the school district, most training has been provided by our own personnel. A number of teachers have taken advantage of one company's offer of free programming training for teachers and thus contributed indirectly to the computer education program.

The Tennessee Department of Education has played a more significant role in the development of curricula than the private sector. The seventh and eight grade Computer Skills Next program developed by the Tennessee Department of Education has set the direction for the curriculum and identified the curriculum strands or topics of the curriculum.

10. The approach of granting tax breaks to companies for the donation of equipment has several areas for concern. The amount of equipment may not significantly contribute to a school district's needs and could well be more beneficial to the corporation than to the school district. There also is a concern relative to the appropriateness of the type or brand of equipment being donated.

If a school district has elected to utilize one computer and has software and repair parts and service for that computer, the donation of a different computer which would require different software which may be more costly to the school district than the value of the equipment donated.

The donation of a very limited computer system which would have to be upgraded by the district in order to be appropriately utilized would create another burden.

The stipulation that equipment will be donated only if teachers receive training from the manufacturer may be a way of introducing teachers to the equipment and influencing them to buy that computer for themselves.

11. For computer literacy classes one computer for every three or four children is sufficient. Beginning programming classes should have one computer for every three students, while advanced classes need one computer for each two students.
12. As has been the experience in many other districts there can never be enough planning. The planning must include curriculum people, instructional materials people, staff development people, maintenance people, and other related professionals.

~~Staff development training must be a top priority. In-depth, comprehensive training is essential and not something that can be done quickly.~~

Software and repair support are also essential factors to be given top consideration.

UNITED STATES GOVERNMENT
OFFICE OF THE CLERK
U.S. HOUSE OF REPRESENTATIVES
WASHINGTON, D.C. 20541

U.S. HOUSE OF REPRESENTATIVES
COMMITTEE ON SCIENCE AND TECHNOLOGY

5015 RAYBURN HOUSE OFFICE BUILDING
WASHINGTON, D.C. 20541
(202) 225-6171

October 18, 1983

U.S. HOUSE OF REPRESENTATIVES
OFFICE OF THE CLERK
U.S. HOUSE OF REPRESENTATIVES
WASHINGTON, D.C. 20541
(202) 225-6171

Honorable Jack Gordon
Chairman, Senate Education Committee
Florida General Assembly
Room 40, Senate Office Building
Tallahassee, FL 32301

Dear Senator Gordon:

I want to thank you for your participation last month in our hearing on Computers and Education. Your testimony was extremely interesting, and your thoughts will be useful to the Subcommittee as we consider ways to address the problems identified at the hearing.

As I mentioned at the hearing, the Subcommittee has several questions that time did not permit us to ask you orally. Consequently, I have attached written questions to this letter to which we ask you to respond. We would be appreciative if you could answer those questions in writing within 30 days. Your written responses will be printed as part of the hearing record.

Additionally, the staff of the Subcommittee has sent to you under separate cover a copy of your testimony at the hearing. Please review your testimony and correct any errors or inaccuracies in grammar in it. Please do not make any substantive changes in your testimony, however; the Rules of the Committee on Science and Technology require the printing of essentially verbatim transcripts of hearings.

Thank you again for your participation.

Sincerely,

Albert Gore, Jr.

Albert Gore, Jr.
Chairman
Subcommittee on Investigations
and Oversight

AG:0tk

1. One problem that has been cited is school curricula that are not designed to take advantage of the benefits of computers. How significant is this problem?
 - o What should be done to help develop appropriate computer-based courses?
2. Concern has been expressed that many teachers are not trained to utilize computers.
 - o What types of teacher training programs are in place in your system?
 - o What role should the federal government play in this area?
3. Should teachers be required to be "computer literate" for certification?
4. Should students be required to be "computer literate" to graduate?
5. The National Science Foundation recently released a study which found that a gap in access to computers in schools is beginning to appear between economically advantaged and disadvantaged students. Do you believe that this is a serious problem?
 - o What should be done to combat this problem?
 - o What is your system doing to address this question?
6. How do you react to the criticism made by the Carnegie Foundation for the Advancement of Teaching that current efforts to place computers in schools typify a "by now, plan later" approach?
7. What is your opinion of the adequacy of available educational software?
 - o What should be done to encourage the development of good software?
 - o The Carnegie Foundation report proposed the creation of a National Commission on Computer Instruction to evaluate software, and one of our other witnesses suggested a public-private joint effort, modeled on the COMSAT legislation, to generate quality software and serve as a clearinghouse. What do you think of these proposals?
8. What problems, if any, do you foresee for schools in financing computer technology, as well as the training and support programs it requires?
 - o Should the federal government assist states and local school districts in financing equipment and programs?
9. What role have computer manufacturing companies played in training teachers, designing curricula, or donating equipment in your system?
10. What is your opinion of the so-called "Apple bill" approach -- i.e., legislation to give tax breaks to companies that donate computer equipment to schools?
11. What is an optimum student/computer ratio?
12. What lessons should other school systems learn from the experiences of your system?



OFFICE OF THE PRESIDENT PRO TEMPORE

November 30, 1983

Mr. Steve Owens
Subcommittee on Investigations
and Oversight
Committee on Science and Technology
Suite 2321 Rayburn Office Bldg.
Washington, D. C., 20515

Dear Mr. Owens:

Please find the attached answers to the additional questions from the September hearing on Computers and Education.

I regret the belated response to the questionnaire; however, travel and committee meetings have precluded a more prompt response.

Sincerely,

A handwritten signature in cursive script, appearing to read "Jack D. Gordon".

Jack D. Gordon
President Pro Tempore

Enclosure

JDG/ja

Answers to Additional Questions

1. This is a significant problem where computer use in a given discipline is a major goal. Development of appropriate computer-based could be accomplished by providing grant money for that purpose to scholars in the respective disciplines. I suspect a conduit for those funds might exist through the national secondary school organizations, such as the National Council of Teachers of English or the Mathematics Association.

2. As mentioned in my written testimony, Florida has a modest training program at the state level and several local in-service institutes. The federal role in this area should be limited to fiscal support, which, as I also mentioned in my testimony, should go to the state education agency.

3. & 4. Looking toward the 21st century, my answer would be that "yes," both our teachers and graduates should be computer literate. The problem I foresee with that is whether we can arrive at a common definition of "computer literacy."

5. The computer access gap reported by the NSF has not, in my opinion, reached a level of "serious," as yet, but it is a problem. The commonality of home computers will put economically advantaged students further ahead because they will have had more hands-on time with terminals. We are essentially in a Genesis stage with computer education and educators tend to treat programs involving computers as "advanced" work. This, in turn, usually limits access to computers to economically advantaged students, who are invariably perceived as the most advanced students.

This situation could possibly be remedied by funding through Title I or a similar program. Florida is currently doing nothing to address this problem.

6. I believe the Carnegie Foundation's criticism is a correct observation, the result of which will be a surplus of obsolete hardware.

7. Other than the facts that current educational software is limited and expensive, I have no opinion about its adequacy. As I suggested in my answer to Question 1, we should encourage development of software through recognized academic organizations.

8. For the average citizen, I think the word "computer" conjures up an image of a technology so complex that few can understand or use. Convincing the public, who is the financier vis-a-vis taxes, that computer technology is a vital and universal of daily life will be a major problem.

The federal government should assist in financing equipment and programs through the respective states' educational agencies.

9. Private enterprise's participation in computer programs has been limited to a local basis, and because of that, I have no real way of determining a level of assistance. I am aware of some cases where donated computer equipment is sitting idle because of the expenses involved in retrofitting facilities or the cost of software.

10. I am very cautious about legislation such as the "Apple Bill," because I am leery about the potential in creating an advertent or inadvertent monopoly. I would not want our schools to receive computer equipment from one specific manufacturer whose product dictated exclusive use of its software. This can be avoided through legislation that stipulates that equipment donated for tax purposes must have the capability for interchangeable software.

11. The emphasis on learning computer technology is going to determine an optimum student/computer ratio. In most Florida high schools in their programs for writing, the teacher/pupil ratio is 1:20. This has only come about because of incentive funding from state sources. Current state resources would preclude us from doing anything near that ratio without substantial federal funding.

12. The single most important lesson to be learned from Florida's experience is that centralization of your purchasing power at the state level can save local districts significant amounts of money.

Submitted

11/30/83

Jack D. Gordon