

DOCUMENT RESUME

ED 242 563

SE 044 373

AUTHOR Palmer, Virginia C., Ed.
 TITLE Reforestation in Arid Lands. Appropriate Technologies for Development. Manual M-5.
 INSTITUTION Peace Corps, Washington, DC. Information Collection and Exchange Div.
 PUB DATE Sep 83
 NOTE 248p.
 AVAILABLE FROM Peace Corps, Information Collection & Exchange, Office of Training and Program Support, 806 Connecticut Ave., NW, Washington, DC 20526.
 PUB TYPE Guides - Classroom Use - Guides (For Teachers) (052)
 EDRS PRICE MF01/PC10 Plus Postage.
 DESCRIPTORS Botany; Classification; Community Involvement; Developing Nations; *Forestry; *Land Use; Long Range Planning; *Nurseries (Horticulture); Postsecondary Education; *Program Implementation; Site Selection; *Trees
 IDENTIFIERS *Africa (West); *Reforestation

ABSTRACT

This manual presents some current, state-of-the-art examples of forestry programs in West Africa. It is based on the collective experiences of foresters and of local farmers and herders. Since many of the problems of reforestation of dry areas are the same worldwide, the text (which focuses on the broad subject of project implementation) includes methods and planning guides useful in more than a West Africa context. Following an introduction, text material is presented in sections discussing: (1) long-range planning (present land uses, community involvement, selecting sites); (2) soil and water (erodability, shallowness, texture, compaction); (3) selecting appropriate species; (4) project planning (natural regeneration, direct seeding, cuttings, nursery planning, design considerations, seed preparation); (5) nursery management; (6) the planting site (preparation, lifting out, transporting, and planting, spacing, survival); and (7) uses and prevention of fires, windbreaks, and sand stabilization. Appendices include: a directory of 165 West Africa trees; an expanded look at 30 of these trees; maps and charts explaining climate, rainfall, soil, vegetation, and characteristics of sub-Saharan West Africa; guide to writing funding proposals for reforestation projects; and a list of information sources and bibliographic materials. The manual assumes basic familiarity with reforestation terms and methods. (JN)

 * Reproductions supplied by EDRS are the best that can be made *
 * from the original document. *

INFORMATION COLLECTION & EXCHANGE

Peace Corps' Information Collection & Exchange (ICE) was established so that the strategies and technologies developed by Peace Corps Volunteers, their co-workers, and their counterparts could be made available to the wide range of development organizations and individual workers who might find them useful. Training guides, curricula, lesson plans, project reports, manuals and other Peace Corps-generated materials developed in the field are collected and reviewed. Some are reprinted "as is"; others provide a source of field based information for the production of manuals or for research in particular program areas. Materials that you submit to the Information Collection & Exchange thus become part of the Peace Corps' larger contribution to development.

Information about ICE publications and services is available through:

Peace Corps
Information Collection & Exchange
Office of Training and Program Support
806 Connecticut Avenue, N.W.
Washington, D.C. 20526

Add your experience to the ICE Resource Center. Send materials that you've prepared so that we can share them with others working in the development field. Your technical insights serve as the basis for the generation of ICE manuals, reprints and resource packets, and also ensure that ICE is providing the most updated, innovative problem-solving techniques and information available to you and your fellow development workers.

Peace Corps

Reforestation In Arid Lands

FRED R. WEBER
TECHNICAL CONSULTANT

Illustrated by **FREDERICK J. HOLMAN**

Edited by **VIRGINIA C. PALMER**

VITA

Prepared for Peace Corps by
Volunteers in Technical Assistance

Peace Corps
Information Collection and Exchange
Manual M-5
September 1982
September 1983

REFORESTATION IN ARID LANDS

© VITA, 1977

May be reproduced without payment of royalty
for official U.S. Government purposes.

About this manual...

Reforestation in Arid Lands is the third manual in a series of publications being prepared by the United States Peace Corps and VITA, Volunteers in Technical Assistance. These publications combine Peace Corps' practical field experiences with VITA's technical expertise on subjects about which development workers have special difficulties finding useful resource materials.

PEACE CORPS

Since 1961 Peace Corps Volunteers have worked at the grassroots level in countries around the world in program areas such as agriculture, public health, and education. Before beginning their two-year assignments, Volunteers are given training in cross-cultural, technical, and language skills. This training helps them to live and work closely with the people of their host countries. It helps them, too, to approach development problems with new ideas that make use of locally available resources and that are appropriate to the local cultures.

Recently Peace Corps established an Information Collection & Exchange so that these ideas developed during service in the field could be made available to the wide range of development workers who might find them useful. Materials from the field are now being collected, reviewed, and classified in the Information Collection & Exchange system. These most useful materials are being shared as widely as possible. The Information Collection & Exchange provides an important source of field-based research materials for the production of manuals such as *Reforestation in Arid Lands*.

VITA

VITA people are also Volunteers who respond to requests for technical assistance. In providing solutions, their aim is to find the most appropriate answers for specific problems. Therefore, VITA specialists often must produce new designs or adapt technologies so that they are of value in developing areas.

Many VITA Volunteers have lived and worked abroad. Most VITA people now live in the United States and other developed countries where they are engineers, doctors, scientists, farmers, architects, writers, artists, and so on. But they continue to work with people in other countries through VITA. Thanks to their contributions of time and expertise, VITA has been providing technical assistance to the Third World for more than 15 years.

(iii)

Requests for technical assistance come to VITA from many nations. Each request is sent to a Volunteer with the right skills. For example, a question about fish pond operation might be sent to a VITA Volunteer who has had years of experience working to develop ponds in Asia, and who is now a university professor.

THE PEOPLE WHO PREPARED THIS MANUAL

Fred R. Weber is actively involved with both Peace Corps and VITA. Mr. Weber has participated in 12 Peace Corps training programs; he has been a VITA technical consultant for 10 years.

Mr. Weber is a civil engineer with an advanced degree in Forest Engineering. He operates his own consulting business and specializes in providing assistance in the fields of agriculture, community development, range management, forestry and soil conservation, and irrigation engineering.

In 1971, Mr. Weber authored the *Conservation and Forestry Manual*, a handbook for Peace Corps Volunteers in Niger. The present manual is an outgrowth of this earlier publication.

Virginia C. Palmer, the editor, has been a VITA Volunteer for almost eight years. She holds a degree in English Literature from Stanford University and a Master's in Interdisciplinary Studies in Education. She has done advanced work at Harvard, San Francisco State College, and the University of Chicago. Ms. Palmer specializes in curriculum development and in teaching methods for both adults and children.

Frederick J. Holman, who provided the illustrations for the manual, is a landscape architect specializing in residential, commercial, and institutional site design. He holds degrees from Paul Smiths College and the State University of New York, College of Forestry. He has been a VITA Volunteer for five years.

OTHER CONTRIBUTORS

Many thanks are due to John Camp, Consulting Forester, Rockefeller Brothers Fund, New York, N.Y., and to William R. Chapline, Consulting Forester, Washington, D.C., for technical review of materials in this publication.

Other people and organizations that provided information or assistance are:

J. W. Duffield, North Carolina State University, Raleigh, North Carolina; Jeffrey L. Wartluft, United States Department of Agriculture, Forest Service, Princeton, W. Virginia; Lawrence R. Deede, Hopewell Junction, New York; National Agricultural Library of the United States Department of Agriculture, Beltsville, Md.; and the Botany Library, Smithsonian Institution, Washington, D.C.

A special note of thanks to Laurel Druben, PC/VITA Series Editor and VITA Publications Director, and to Brenda Gates, Director, Peace Corps Information Collection & Exchange, for their continued support during preparation of this manual and others in the PC/VITA series; to John Goodell, VITA, for research and layout of Appendix A; and to Carolyn Marcus, VITA, for overall layout and staff assistance.

REPLY FORM

For your convenience, a reply form has been provided here. Please send it in and let us know how the manual has helped or can be made more helpful. If the reply form is missing from the manual, just put your comments, suggestions, descriptions of problems, etc., on a piece of paper and send them to: REFORESTATION, 3706 RHODE ISLAND AVENUE, MT. RAINIER, MD, 20822, U.S.A.

PLEASE RETURN THIS FORM

NOTE TO THE USER: This manual was published because Peace Corps and VITA Volunteers and staff wish to help in an area of growing, worldwide interest. In order to provide the most effective help, the preparers of the manual need to know how it is being used, or how you feel it could better serve your needs. Please fill in the following form and return it to:

REFORESTATION
3706 RHODE ISLAND AVENUE
MT. RAINIER, MD 20822
U.S.A.

WHEN WE RECEIVE THIS FORM, WE WILL AUTOMATICALLY PLACE YOUR NAME ON A MAILING LIST SO THAT YOU WILL RECEIVE:

- . Updates and/or additions and corrections to the manual as they become available.
- . Notice of other publications which may be of interest to you.

If you have questions on the material presented in the manual, or if you run into problems implementing the suggestions offered here, please note them in the space provided. Use additional paper if you have to in order to be as specific as you can about the problem. Wherever possible, we will try to provide or direct you to an answer.

* * *

Date _____

Your Name _____ Your Company or Agency, if any _____

Your Address _____

1. How did you find out about the PC/VITA *Reforestation in Acid Lands* manual? How did you get your copy?
2. Which parts of the manual have you found most useful? Least useful? Why?

3. Did you find the manual easy to read, too simple or complex, complete or incomplete?
 4. How has this manual helped your work? What have you done to apply the information?
 5. Can you recommend additional information which you feel should be included in a new edition of the manual?
 6. What were your successes using the manual or implementing any of the suggestions? Problems? Please describe completely.
-
7. Do you have other recommendations?

(viii)

Table of Contents

SECTION	PAGE
	iii
"About This Manual"	
Reply Form	vii
1 INTRODUCTION	1
2 LONG-RANGE PLANNING	5
Present Land Uses; Community Involvement; Selecting Sites; Other Land Uses	
3 SOIL AND WATER	15
Erodability; Shallowness; Texture; Compaction	
4 CHOOSING SPECIES	23
Environmental Constraints; Purpose; Human Factors; Other Guidelines	
5 PROJECT PLANNING	29
Natural Regeneration; Direct Seeding; Cuttings; Nursery Planning; First Decisions; Overall Design and Layout; Other Design Considerations; Water; Protection; Seed Preparation	
6 NURSERY MANAGEMENT	61
Administering the Nursery; Ground and Soil Preparation; Seeding; Watering and Cultivation; Transporting	
7 THE PLANTING SITE	75
Preparation; Lifting Out, Transporting, and Planting; Spacing; Survival	

8	SPECIAL SUBJECTS	87
	Fires; Uses and Prevention; Windbreaks; Sand Stabilization	
	APPENDIX A	97
	Species Identifications	
	APPENDIX B	153
	A Field Guide to 30 Tree Species Commonly Found in West Africa	
	APPENDIX C	225
	Climate, Vegetation, and Soils of Sub-Saharan West Africa	
	APPENDIX D	237
	A Guide to Writing Funding Proposals for Reforestation Projects	
	APPENDIX E	243
	Information Sources; Bibliography	

(x)

1

Introduction

Wherever people live, they make demands upon the earth. People need land on which to grow food; they use wood to build houses and to cook food; etc. More and more the demands of human populations on forests, lakes, fields, and so forth are increasing, while supplies of such natural resources are decreasing. This scarcity brings attention to the fact that natural resources often are used unwisely; for example, trees, which protect soil from erosion (and help land retain moisture) sometimes are excessively cut down for firewood. The demand for this resource must be met in other ways, perhaps through planting trees to be grown especially for firewood.

More and more countries around the world are now trying to solve such problems and are taking steps to stop the incorrect use of their national resources.

The subject of this manual is reforestation in arid lands. Reforestation programs are part of larger conservation efforts. Increasingly they are being conducted with the realization that it is very difficult to separate reforestation from overall revegetation efforts -- range management, sand stabilization, and similar activities. So while reforestation deals mainly with planting trees in locations able to support at least some species, it is important to think broadly of revegetation -- planting trees, shrubs, bushes, grasses, and other ground cover in areas which do not now have sufficient vegetation.

Reforestation efforts are begun for two important reasons: (1) to conserve and protect and (2) to increase production of forestry resources. For example, programs have been undertaken to provide:

- erosion control, e.g., trees keep water and wind from carrying away rich topsoils that help make and keep the land fertile for growing crops;
- general protection from extremes of climate, e.g., trees are planted to provide shade for animals and people.

- production of adequate supplies of special products -- wood for construction purposes; fruit and nuts for food, and so on.

One area of the world where reforestation projects have been of great importance over the past few years is Africa, south of the Sahara. The desert, already one of the world's largest, has been growing. Fires and poor use of already limited vegetation resources have added to the hardships caused by drought. People are beginning to respond to these problems in a number of ways. Reforestation and revegetation projects are among the most effective ways to reclaim the land.

This manual is an attempt to present some current, state-of-the-art examples of forestry programs in West Africa. It is based on the collective experiences of foresters and of local farmers and herders.

However, many of the problems of reforestation of dry areas are the same worldwide. Therefore, the text, which focuses on the broad subject on project implementation, presents methods and planning guides useful in a more than West Africa context. The appendices contain most of the very specific information on climate, soils, plants, and trees in sub-Saharan West Africa. Eventually, it is hoped, similar appendices can be developed for other areas of the world.

The appendices to this manual are worthy of special note:

- Appendix A -- a directory of 165 tree species found in West Africa. Synonyms and common names (from West Africa) are given as available. Brief pictorial views of each tree -- a leaf, flower, branch, etc. -- are provided for most of the species. Where possible, information is given on the uses of the tree (not a comprehensive listing, but an indicator of the value of that tree for certain purposes).
- Appendix B -- an expanded look at 30 of the trees highlighted in Appendix A. Each of the trees is treated individually in an attempt to show the value of having comprehensive data sheets which can be used to guide field activities. For example, the sheet has spaces for listing relevant nursery data (such as time needed in the nursery bed or pot) and for noting planting criteria (such as the soil and water requirements of each tree). Hopefully, as reforestation efforts continue, and more project data are recorded, these information sheets will become a more complete and important data bank.
- Appendix C -- maps and charts explaining climate and rainfall, soil, vegetation, and characteristics of sub-Saharan West Africa.

- Appendix D -- a guide to writing funding proposals for reforestation projects.
- Appendix E -- a listing of other information sources and of bibliographic material which those who require further information and assistance will find extremely valuable.

This manual assumes basic familiarity with reforestation terms and methods. For example, it takes for granted that the reader will be familiar with laterite soils and with the use of such forestry tools as climate maps and vegetation charts.

The text uses only one Latin name for each tree. However, some trees are known by two or several Latin names: these synonyms are given in Appendix A. More than one name per tree can result from any of several causes: a tree may have been "discovered" and named by several different people; disagreement may exist among the experts as to whether a certain tree is a species or a variety of a species; the difference may simply be in spelling because of phonetic dissimilarities among the languages of forestry people.

2

Long-Range Planning

In most nations concerned with land protection (among them the sub-Saharan countries of Senegal, Mali, Upper Volta, Niger, and Chad), land has been set aside for special purposes. These areas, called forest reserves, wildlife reserves, parks or special reserves, can be identified on good, large-scale government-issued maps.

The uses of these and other lands are regulated in a number of ways; for example:

- . The "northern limit of cultivation" in Niger makes farming north of that limit illegal. This cultivation law was passed to protect grazing resources and to conserve the natural ground cover (See Appendix E.)
- . Throughout West Africa, governments have legislated land use in order to prevent and control the frequent bush fires.
- . In some nations, such as Niger and Ghana, land has been identified and set aside for production of certain species of trees.
- . Many governments control the use of particular trees and plants.

Most countries have an agency or department which is responsible for developing, managing, and protecting natural resources. Some of these agencies provide suggestions for proper land use like:

- . taking into account social and cultural factors;
- . using resources only on a sustained-yield basis (in other words, not using resources faster than they can be replaced);
- . producing the highest possible net income for any given area through the best use of the land;
- . improving, developing, and further building up natural resources for the future; and

recognizing that conservation and production are interdependent (in the long run, neither is possible without the other).

All programs to conserve or develop natural resources -- land, water, soil, trees, and other vegetation -- must keep these suggestions in mind. A forester, for example, cannot begin a tree-planting program without carefully looking at the given location in terms of all its natural resources and the ways in which they are being used.

As noted in the Introduction, reforestation programs have two important goals: conservation and production. The primary conservation concern is to prevent and control erosion; the first priority of production activities, in West Africa, at least, is to increase the amount of wood available as firewood. While these are the major objectives, there are, of course, other goals of both conservation and production programs. Therefore, forestry programs are planned with these objectives in mind and implemented within the resource management suggestions mentioned earlier. A reforestation program should not produce a lot of firewood on land which could have been used more profitably for some other purpose.

Foresters prevent poor programming by looking into the land use situation very carefully before beginning a project. The first things taken into consideration are the ways in which land is now being used or not used.

Present Land Uses

What is the land suited for now? What could the land produce if changes were made? Would the new use be a better use than the old? Local customs, soils, topography, vegetation, and water supply all must be looked at before these questions can be answered fully.

The most important thing to consider when looking at a location is whether or not land can be used for growing food or crops which allow people to support themselves. Because, above all else, people living in that area must get enough out of the land to live. Therefore, even if a staple crop they grow is not as valuable by itself as a cash crop might be in market terms, the land may already be serving its most important function.

In any area, there is a value placed on certain products. First place always is and must be given to agricultural products which are needed for food or for market. Certainly forests should not be planted in areas where bananas or rice will grow, and where there is a good market for such crops. What might be called secondary subsistence needs also must be kept in mind. These are uses of the land and trees which fill other demands made by local people -- wood for fuel; grass for thatching; plants for medicine; bush fruits; base materials for cordage, detergents, tanning, and dyes. If the land area is now filling one or several important purposes, the question to be asked is, "Would land use be improved by a forestry project?"

Which conservation efforts would improve land use? Where should they be located? What special efforts -- such as fire barriers, planting Acacia albida, terracing, or planting an orchard (perhaps of Anacardium occidentale)-- would increase the value and usefulness of the land?

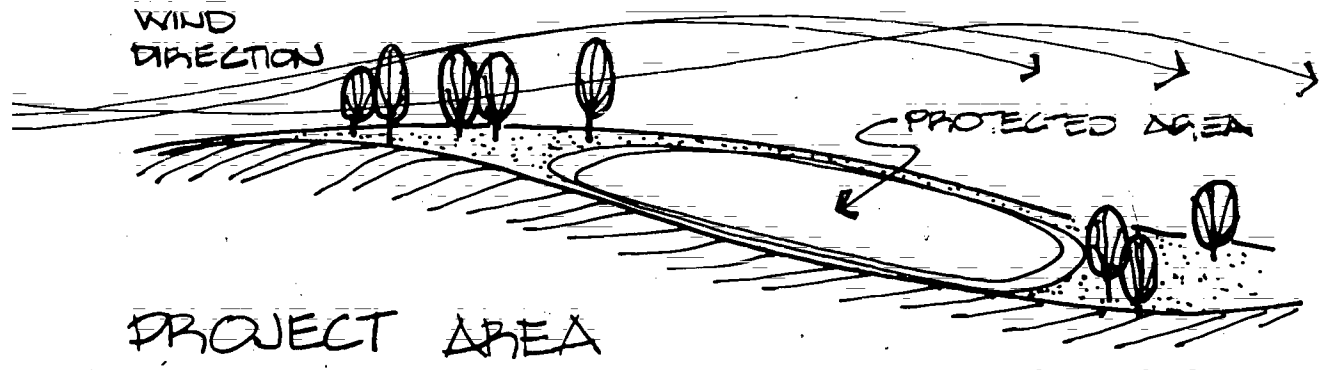

Are wind erosion controls, such as windbreaks, or water erosion controls needed around farm lands? Are there low spots which are not now being farmed which could be used for crops if they were protected? For example, gentle side slopes may be a good place to grow some farm crops if the crop can be protected by vegetation from erosion. Careful observation and detailed study of the project area provide answers to such questions.

Community Involvement

Foresters, and other conservation personnel, should keep local concerns in mind. This is not always easy because there are always local, national, and international concerns, and these may conflict. But a conservation project must be supported by the people living in an area, or it will not work. Local people are the ones who may be asked to give land for a project, or to work on it. And often a reforestation effort will have to be supported by people for years before results can be seen. Therefore, a project should not be started before communities are ready to sustain the effort. And to make this commitment, residents must believe that (1) the project will affect their environment and their lives positively, and (2) the results will be worth the effort.

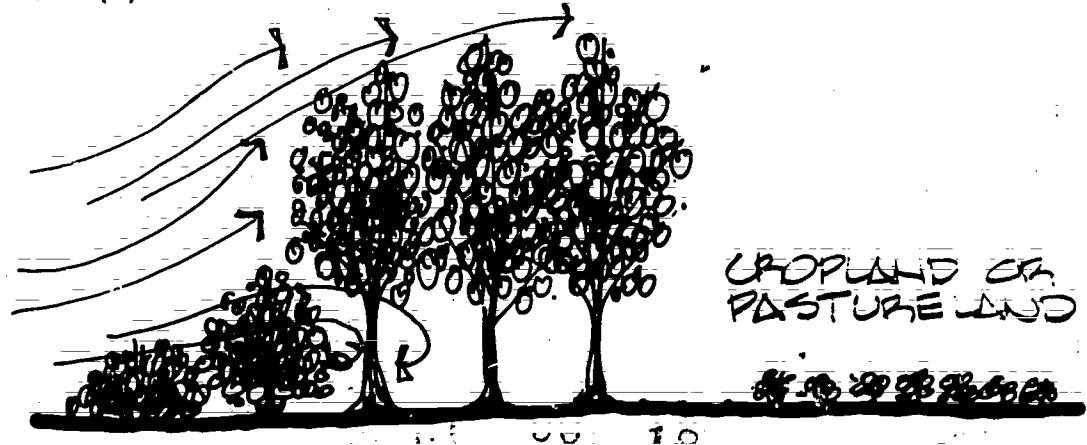

Reforestation projects which provide wind and water erosion controls can result in better farm lands and increased supplies of fodder and firewood. However, if the results of such projects are likely to take years to show, local residents may look for more immediate benefits, such as individual potted trees which they can plant in their fields for shade. For example, on one project the technical consultant undertook, he found it difficult to keep up with the demand for potted *Parkia biglobosa*. If at all possible, it is a good idea for a project manager to plan so that the project can provide the requested trees and respond to this level of need. Community support for the project will increase, and it will become easier to convince the community of the necessity for the project at other, longer-range levels.

The Conservation Community

The conservation community includes everyone. Foresters, and particularly those who are managing projects being carried out locally, contact farmers individually; work through traditional authorities, such as village chiefs and elders; involve and consult officials of local, district, and national governments, as well as representatives of the various government bureaus and agencies. Preparing for a project calls for maximum cooperation between technical representatives and those concerned with social programs. Of course, coordinating the groups and interests involved in a forestry project is all part of the forester's job; it requires patience, diplomacy and skill to promote a reforestation project. Often it is necessary to explain, bring together, and reconcile a number of interest groups, some of which have very differing ideas about the same project.

Foresters work cooperatively with representatives of all sectors of the local economy. Such cooperation sometimes means filling an advisory role to a certain agency or undertaking responsibility for a special project. There is a lot of informal instruction to be done in order to sell a forestry or resource management project and get plans made for smooth program operation. This "teaching," when done well, lays a good foundation for the entire effort, and the project has a much better chance of success.

The previous paragraphs present some general guidelines or characteristics of a forestry project. Of course, each specific project requires planning in a much more detailed way. Selecting the right location, determining the best trees to plant for a given purpose, and making sure money and materials are available are areas which require a great deal of long-range planning. This manual will not discuss seeking money and materials in detail, though Appendix D does offer guidelines for writing reforestation project proposals. Site selection, however, is discussed further in the following paragraphs.

Selecting Sites

For the type of reforestation effort with which this manual is mainly concerned, it is usually necessary for the planner to think in terms of

two locations; a site for the nursery (the place where young trees will be seeded and grown until they are large enough to have a good chance for continued growth in another place), and the location where the trees

will finally be planted. This planting site may be known from the beginning because, as a site in need of reforestation, it suggested the scope of the project. Or the planting site may be chosen later in the planning stage to provide the best location for a productive effort.

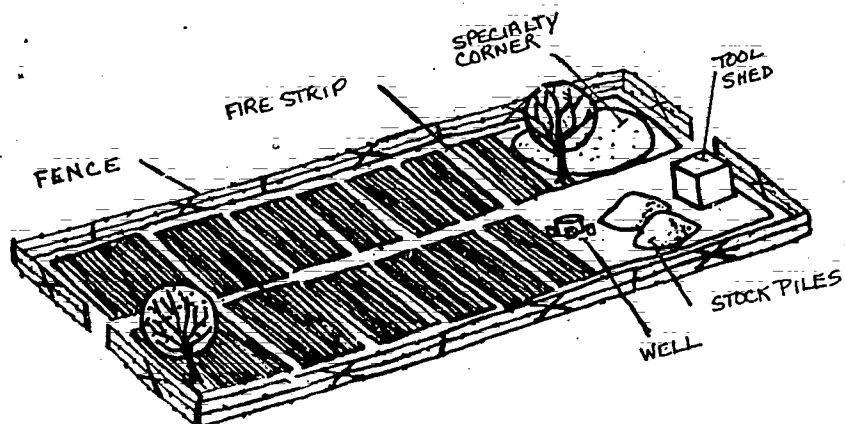

Nursery Site

Nurseries may be constructed at a central location to produce trees on an ongoing basis for forest plantings,

shade for village squares, roads, individual houses, etc. Such central nurseries often are permanent and are maintained by government funds.

When trees are needed for only one project, a temporary nursery can be built. Nurseries are located near water, roadways for transport, and a settled area so that nursery activities can be supervised easily.

If the nursery will be using plastic pots or other containers (plant leaves, cardboard boxes, clay jars), finding a good site is not as difficult. Pots can be filled with soil that comes from somewhere else, stacked, and tended in areas where nothing else will grow.

If seeds are to be planted directly into the ground at the nursery site, the soil must be rich, deep, and well-drained. Sandy clay with a loose crumbly texture is the best kind of soil for a nursery. Also, locating a nursery on a slight slope is helpful. This slope helps water to drain across the surface.

Other factors to be considered when deciding upon a nursery site are:

- availability of water
- protection from prevailing winds
- nearness to the planting site

Of course a nursery does not really require a great deal of land, particularly if plastic pots are used. But a planting site is usually a larger area -- usually the smallest is 100 X 100m, and most are larger.

Planting Site

Choosing a planting site is very complex. The forester or funding agency must consider the following points before choosing a site:

- . What is the best land use?
- . What are the goals -- protection or production?

If protection of the land is the main goal, the sites are selected to give the best possible conservation results.

If wood production is the main goal, such issues as transportation and marketing are more important.

- . What will the social effects be?

Who uses the land? Who will use it in the future? What are the benefits of the project to the local people?

The site in turn determines both which trees and vegetation and what planting methods will be most successful.

Great care must be taken from the beginning of the planning process to make sure that the lines of authority for land use regulation are clear. The forest service must work together with other interested agencies to draw up forest management plans that define which resource development and management techniques are planned and acceptable. Such agreements should contain details concerning maintenance and protection of the land, types of land use possible, kinds of fees which must be paid for using the land, and who gets the money paid for the rights to use the land.

Once it has been decided that a site is available for use as part of a reforestation effort, it is time to plan for the fullest use of the site. In other words, the land should be used as completely and wisely as possible during the reforestation efforts. The following paragraphs present some of the uses of the land which can be incorporated as part of a reforestation program.

Other Land Uses

Other land uses, like traditional or improved grazing, roads, improved and intensified agricultural land use (e.g., rotation from peanuts to cotton to fallow) must be taken into account during the planning process, particularly when the programs are located near relatively high density population centers.

Whenever possible, foresters choose or develop sites so that local residents receive more immediate benefits while the trees (also shrubs, grass, and other vegetation) are growing, and so that the land is being used as completely as possible. Some of the land uses which increase benefits during revegetation efforts are intercropping, controlled grazing, grass cutting by hand, and collecting and gathering for special forestry projects. These subjects are discussed briefly below. (More is being done in each of these areas every day, but it is not possible to go into detail in this manual: grazing alone could be the subject of an entire book.)

Intercropping

Intercropping, or *taungya* as it is also called, is the practice of planting and growing agricultural crops between rows of planted trees. If left uncultivated, the area between the trees would soon be covered with grass and other vegetation. This growth of vegetation would cause the grass roots and the roots of the trees to compete for water and, to a lesser degree, for nutrients from the soil. However, it has been found that root competition for water is not as severe when crops such as peanuts or beans are grown and the area is kept free from weeds.

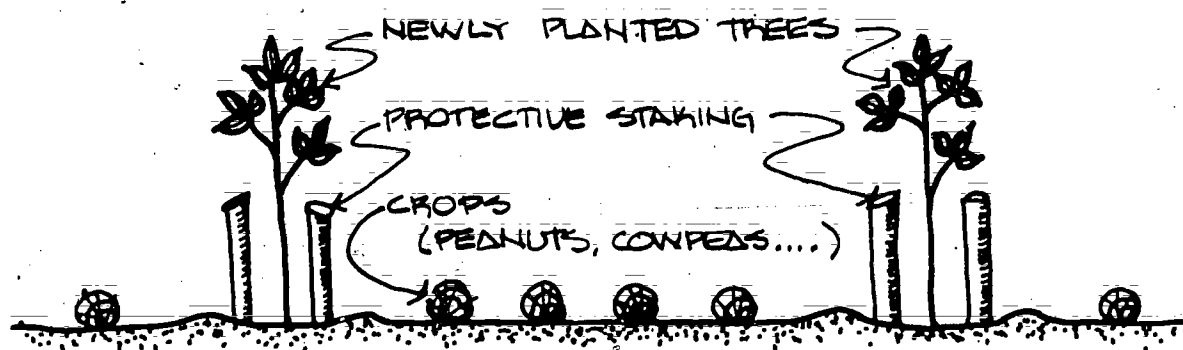

At the few places where intercropping has been tried in the drier zones (500-700mm mean annual rainfall), excellent results have been obtained for the trees and for the farmers. Even where poorer results have been obtained, intercropping may still be cheaper than handweeding grasses, especially during the rains when labor is short because everyone is working in his own field. (Machine weeding and cultivation usually are even more expensive, especially when maintenance and depreciation of machines are included in the cost figure.)

For an intercropping effort to be successful -- that is, beneficial to trees, crops, and farmers alike -- farmers must know the special restrictions and conditions necessary for good intercropping. For example, the spacing of individual crops in relation to the young trees must be specified, since both crops and trees need enough room to grow successfully.

When the young trees are hard to see, such as Acacia albida or Gmelina arborea, it is also helpful to mark each tree with colored stakes or other markers easily seen by persons using three- to four-meter push-hoes. As a rule, it is generally best for foresters to work with and teach intercropping methods in cooperation with agents from the agricultural services.

Of course, the choice of crop makes a big difference to the success or failure of intercropping. Peanuts, cowpeas, and other legumes have worked well, but millet and sorghum have affected some young trees badly. The decision about which crops to raise as part of an intercropping effort must be based on information about the crops, the nature of the site, and the type of tree which will be planted there.

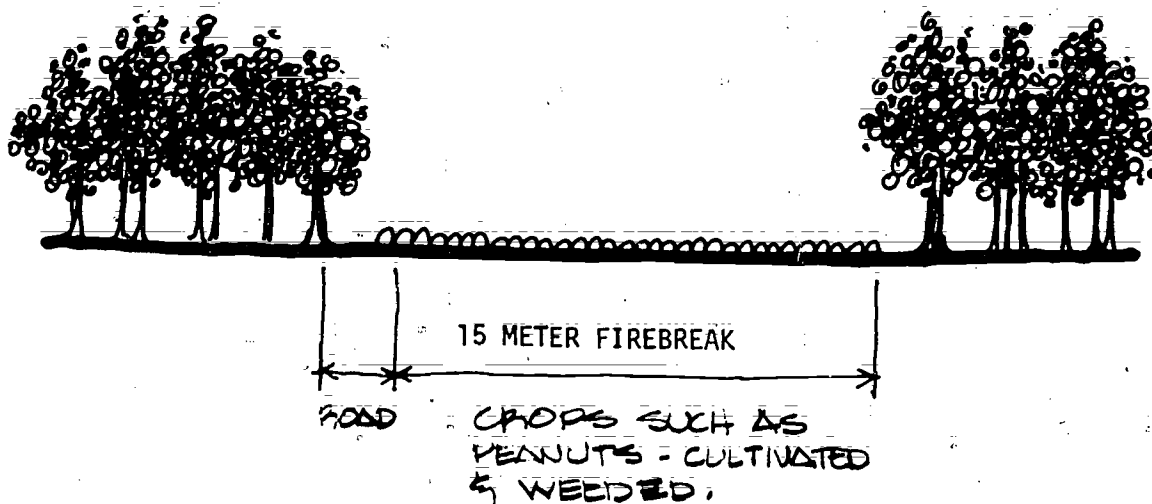

It is particularly useful to grow crops in firebreaks. These are spaces left between blocks of trees or other vegetation so that fires which may break out can be stopped before they burn down an entire plantation or nursery. Firebreaks in tree plantations are often quite wide, thus giving a lot of space for growing crops. For them to be effective, it is very important that the firebreak area be kept free of weeds: planting and cultivating crops such as peanuts serves this purpose. When the area is completely cleaned after harvest, a good, and relatively trouble-free firebreak is created that lasts until the next growing season. Of course, the need for a complete cleaning of the area after each harvest must be stressed and enforced.

Grazing

Good land use projects include introduction (planting, seeding, or natural) of vegetation which can be used for grazing in or near the same area where trees are planted. This kind of overall revegetation effort illustrates the fact that the divisions between forestry and range management programs are becoming less important than they once were.

Grazing is possible within the tree planting site, as long as certain conditions are kept in mind:

- . The number and kind of animals, as well as length of grazing time, must be controlled.
- . Grazing is not possible until the trees are tall and strong enough to escape damage done to their foliage and bark by animals. A goat, for example, can stand on its hind legs and reach up to 2m. Donkeys also stand on their hind legs to reach leaves.
- . Grazing cannot be allowed to continue in one spot for too long.

If grazing does go on in one spot, there is a danger the soil will become so hard that air and water can penetrate the soil only with great difficulty.

However, if grazing can be controlled, the combination of forestry and range management programs can lead to good land use projects.

Handcutting and Gathering

Strictly controlled handcutting of grass for fodder, thatch, or mats may be feasible. Forest products, such as nuts, fruits, gums or resins may be collected.

As the area becomes more and more attractive to individuals, it becomes increasingly important to be sure that any use of the land, even cutting grass for animal feed, is controlled by an authority which everyone recognizes. And it is a good idea to charge a fee for such uses of the land. Land use fees will probably not bring in a lot of money, but they are important for laying a good and fair framework for the future of the area. Usually the national conservation agency is responsible for resource use and establishes limits for all cutting, grazing, or farming allowed on the land.

So far, this manual has mentioned the need for:

- . looking at an area in terms of all its conservation possibilities and problems;
- . making sure there is full support for the project;
- . taking into account what local residents want and expect;
- . planning project sites carefully so that they take advantage of all land use possibilities.

This is a good point at which to consider soil and water in reforestation efforts. Planning reforestation activities, either on a short- or a long-range basis, cannot be completed without a careful site study of these natural resources.

3

Soil and Water

As soon as careful study shows that a reforestation effort is needed, whether to protect a given resource or to produce more of a certain product, soil and water questions come to mind. Trees (and other vegetation), of course, depend upon soil and water to provide all that they need for growth and survival. (It is interesting to note that while a certain species of tree may grow almost anywhere, it does not look the same from one area to the next because of different soil and water factors. A tree growing in poor soil with little water supply may be short, sparse, and produce no fruit. On the other hand, the same tree grown in soil with more nutrients, better texture, and a good water supply, may be much taller, densely covered with foliage, and a good producer of fruit.)

Soil and water resources have been studied by many scientists. Soil maps show the kinds of soil which appear in different areas. Rainfall maps indicate the amount and distribution of rain. Another kind of map shows lakes, rivers, and other large bodies of water. (Appendix C contains soil and rainfall distribution maps of West Africa.) But these maps provide only very general information and a starting point. The key to soil and water for reforestation purposes is the way in which soil and water do or do not, can or cannot, be made to work together at particular nursery or planting sites.

Soil and water interact in various ways. For example, in some areas there is plenty of water, but the soil is too rocky to hold the water well. Instead, the water may run down a slope and carry away what little good soil there is.

In another area, surface runoff is more gentle and collects in depressions in the land. These basins may be an additional water resource depending upon the soil and how well it holds water. Therefore, the result of the interaction of soil and water resources determines the quality of the site for planting trees.

Foresters often can get their best information concerning soil and water at a given site by careful observation and by asking questions of local farmers. There are certain characteristics of soil which are of particular interest to foresters; these are the conditions which (1) cause soil to interact with water and wind in specific ways and (2) make the soil more or less useful for forestry purposes. These characteristics are:

- . erodability
- . shallowness
- . texture and water retention capacity
- . compaction

Erodability

A primary concern of the forester is preventing soil erosion (the washing away of rich topsoils). Vegetation helps prevent erosion because:

- . the roots of trees and other plants hold down the topsoil;
- . the vegetation provides decaying organic matter which forms a water-holding layer;
- . it places a physical barrier in the path of running water.

Any soil which has lost its vegetative cover is more likely to erode, and some soils are more easily eroded than others. Soils which erode easily are:



WATER EROSION

Water has carried topsoil away and left deep ditches or channels in the earth.

- light soils such as silt, sand, or sand-loam mixes
- soils having little or no organic matter or having a fine granular consistency

WIND EROSION

WIND
DIRECTION →

Fine, light dry sand, with no organic matter, being blown by the wind.



Shallowness

Shallow soil is a frequent result of soil erosion. Shallow soil is a condition where there is very little good topsoil in which trees can grow. This lack of good soil limits the choice of trees that can be planted to a few local species.

DEEP TOPSOIL
GOOD GROWTH

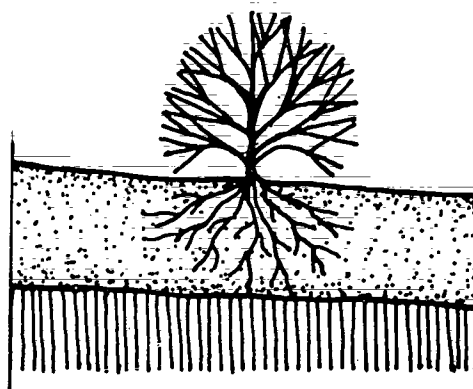

SHALLOW TOPSOIL
STUNTED GROWTH

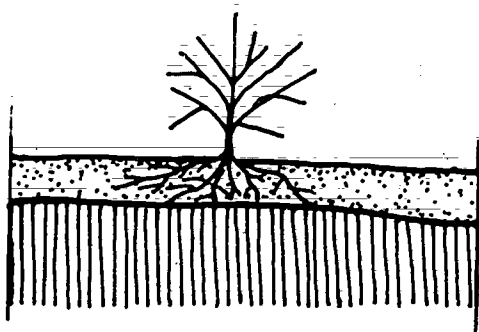

Even when the local species are planted, the root systems cannot develop well, and tree growth is likely to be very poor.

Texture

There is a direct relationship between soil texture and tree growth. Where the texture is loose, such as in sandy soil, roots have no difficulty pushing down through the soil. In fact, root growth rates of almost a meter per week have been observed (in *Acacia albida*). Unfortunately, this kind of loose soil does not hold water well, and once the rains are over, this soil becomes very dry. It is almost impossible to grow trees under these conditions unless special techniques are used.

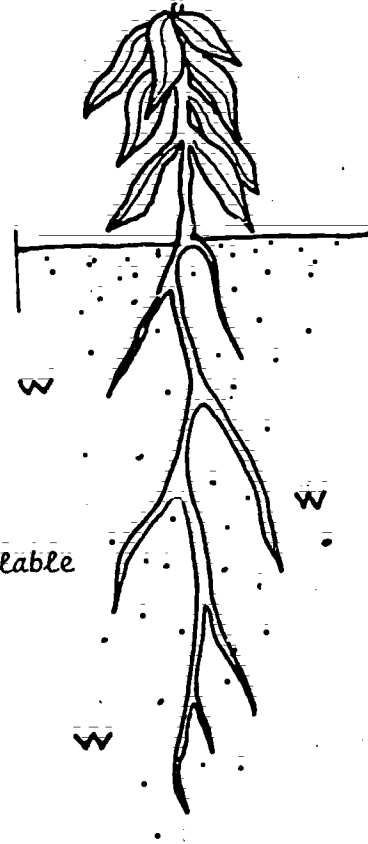

Loose, Sandy Soil

- *little water available*
- *rapid root growth*

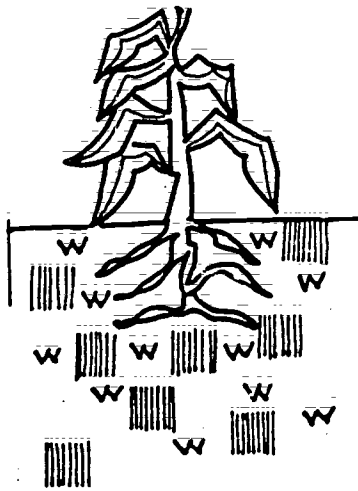

Heavy, Clay Soil

- *water available*
- *slow, stunted root growth*

Heavy clay soils, on the other hand, present different problems. They are formed by an accumulation of fine clay particles and are found in depressions and in low areas around ponds. These clay soils can be recognized most easily during the dry season when large cracks form in the surface.

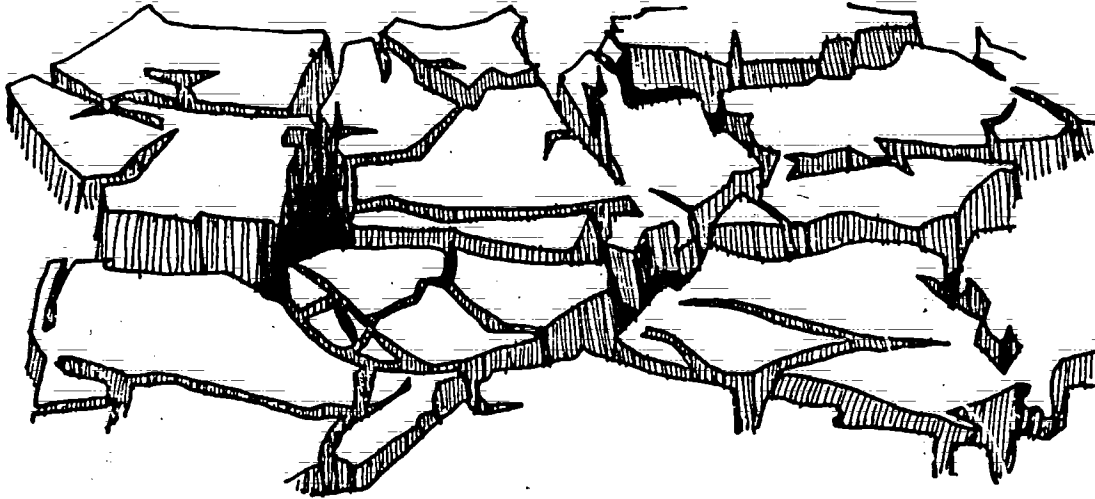

CLAY CRACKING PATTERNS

Unlike the loose, sandy soils, these clay soils hold water well and are quite fertile. However, tree roots have trouble pushing through the tightly packed earth. Special and expensive site preparations are required to improve this soil's condition enough so that trees can grow in it.

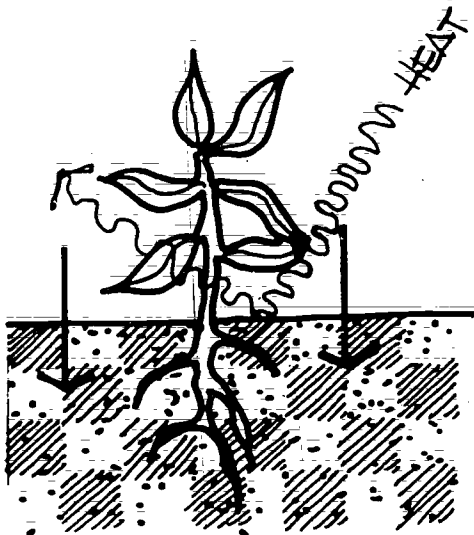

The best soil textures for tree planting efforts are those textures between the loose sand and baked clays described here. In the best situation, there is a good amount of topsoil covered by decaying organic material which protects the roots from too much heat, acts like a fresh, clean sponge, and holds relatively large quantities of water. The plants then use this water after the rains stop.

Good topsoil, covered by decaying organic matter, retains water and nutrients.

Unfortunately, hot dry climates are unfavorable to proper formation and retention of organic matter, and the soil tends to leach (wash out) during the rains, leaving it once again a prime candidate for erosion.

Poor, sandy soils have little ability to retain water. The water simply filters directly down through the soil without remaining in the earth long enough to provide nourishment for trees.

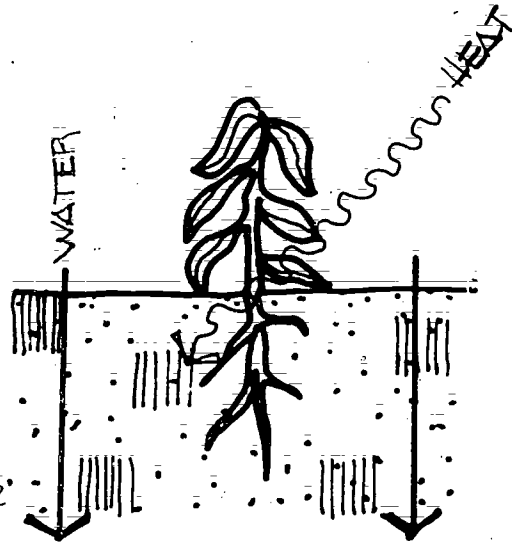

Compaction

Compacted soil is soil which is packed down so hard that air and water can penetrate the soil only with difficulty. Sometimes the soil is so compacted that a crust forms on the surface. It is very difficult to grow bush and tree species under these conditions.

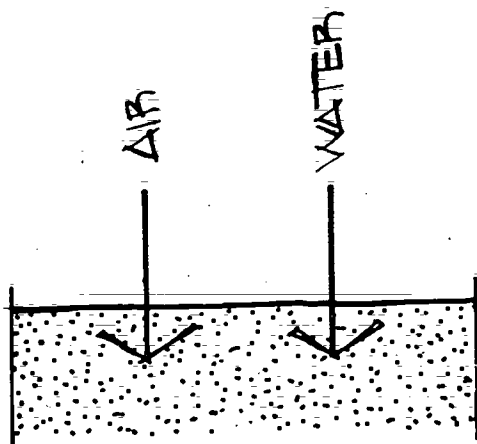

Air and water can penetrate the surface of this soil.

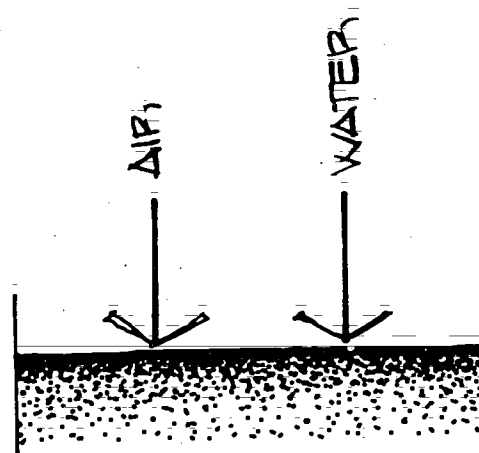

This soil is packed or compacted. Air and water cannot penetrate the surface.

There are a number of ways to counteract poor soil conditions such as compaction. One of these techniques, subsoiling, involves digging deep holes and breaking up the soil so that it can receive and hold water better than the nearby tight, or compacted, ground. Subsoiling can greatly improve the growth and survival rate of trees. When subsoiling is done by hand methods -- using shovels and local tools -- it can take a lot of time, especially when the project is large. There is heavy machinery available which can do the subsoiling quickly and efficiently. However, the machines are costly to operate and may not be available. The decision as to whether to use hand or machine methods for subsoiling will depend upon such factors as the size of the project and the amount of money available.

Another soil improvement method is composting (mixing already decaying leaves and/or dung into the soil). Often, however, materials for composting are either unavailable, or they are too expensive to use.

Soil and water are discussed later as they relate directly to nursery and planting sites. The purpose of the above discussion has been to present some basic ideas about the importance and interaction of these two factors. Foresters, of course, will also need access to additional technical data concerning soil and water. Appendix C presents some of the data which have been prepared for use in West Africa. Similar information should be provided to foresters and project managers working in all arid areas.

4

Choosing Species

As mentioned earlier, many countries protect and regulate the use of natural resources and of certain tree species. In some cases, traditional laws give a specific tree special status. In West Africa, *Acacia albida*, for instance, was protected by local customs even before the national government protected it for ecological reasons.

It is impossible to give detailed information in this manual on such restrictions. But it is readily available, and foresters familiar with an area know the restrictions. (Appendix B, which provides details for some of the common trees of sub-Saharan West Africa, does note when a species has certain legal status.) However, having a list, such as the one on the following page that names tree species of sub-Saharan West Africa that have been regulated by law, can be very useful. This list can be referred to for help with the final choice of species, after a number of other factors have been calculated.

Some Guidelines

Foresters who are managing projects analyze tree species and sites before matching particular species to given sites. To do this successfully, it is necessary to consider (1) environmental constraints, (2) purposes of the project, and (3) human factors.

Environmental Constraints

The most important question here is which species can survive and grow well given the water, soil, and climatic characteristics of the site. Among the specific points to be considered are: What kind of texture does the soil have? Does it retain water well? How deep is the soil?

Tree Species Regulated by Law in West Africa

USE, CUTTING, AND REMOVAL LIMITED BY LAW
IN AT LEAST ONE COUNTRY

<i>Acacia albida</i>	<i>Hyphaene thebaica</i>
<i>Acacia scorpioides</i>	<i>Khaya senegalensis</i>
<i>Acacia senegal</i>	<i>Parinari macrophylla</i>
<i>Adansonia digitata</i>	<i>Parkia biglobosa</i> (Benth.)
<i>Balanites aegyptica</i>	<i>Pterocarpus erinaceus</i>
<i>Bombax costatum</i>	<i>Sclerocarya birrea</i>
<i>Borassus aethiopum</i>	<i>Tamarindus indica</i>
<i>Butyrospermum parkii</i> (Kotschy)	

CLASSIFIED AS "SPECIALLY USEFUL" IN AT LEAST ONE COUNTRY

<i>Acacia macrostachya</i>	<i>Landolphia heudelotii</i>
<i>Acacia scorpioides</i>	<i>Lannea microcarpa</i>
<i>Adansonia digitata</i>	<i>Prosopis africana</i>
<i>Anogeissus leiocarpus</i>	<i>Pseudocedrela kotschyi</i>
<i>Balanites aegyptica</i>	<i>Pterocarpus erinaceus</i>
<i>Boswellia dalzielii</i>	<i>Pterocarpus lucens</i>
<i>Ceiba pentandra</i>	<i>Saba senegalensis</i>
<i>Dalbergia melanoxylon</i>	<i>Sterculia setigera</i>
<i>Detarium senegalense</i>	<i>Teclea sudanica</i>
<i>Elaeis guineensis</i>	<i>Vitex cuneata</i>
<i>Guiera senegalensis</i>	<i>Ziziphus mauritiaca</i>

Rugh, David. Guide des Onze Arbres Protégés du Niger. Maradi, (Niger),
Atelier Inter-Service. 1972.

To determine environmental constraints, foresters study climatic records for given areas. In dry areas, among them sub-Saharan West Africa, the single most important climatic factor is rainfall. Before the project can be started, therefore, managers must find answers to a number of questions. How much rain falls during the rainy season (the period when the young trees are planted)? How is the rainfall distributed over time during the rainy season? (If the timing of the rains is wrong, for example if the total rainfall occurs within two days instead of a number of weeks, the project can be ruined.)

In addition to the above information, there are other things about rainfall to consider. For example:

- How hard does the rain fall? Gentle, spread-out rains are more likely to soak into the soil than are heavy, torrential rains.
- What is the temperature? If temperatures are very high, the moisture evaporates much more quickly.
- When do the rainy seasons occur? Some areas have two rainy seasons; others have only one in the hot summer months; still others have one rainy season in the cooler winter months. A tree species which grows well in a region where the rain falls during the winter usually does not adapt well to an area where it rains during the warmer weather -- even though the amount of rainfall is the same.

The single most useful rainfall measurement is the mean annual precipitation measured in millimeters (mm) per year. In the tropics, however, annual rainfall tends to vary greatly, so it is necessary to consider the variation from year to year in determining the figures upon which to base a choice of species. Foresters plan after determining the average annual rainfall.

The drier the area, the less reliable is the average rainfall figure and the greater the range of averages. If two species look good, but one requires less water and the project area is one where supply is often uncertain, choose the one requiring less water.

Unfortunately, there are many areas where accurate rainfall records do not exist, and it is necessary for project managers to use very general information such as that presented on the maps in Appendix C and upon the basis of information from local residents.

It is a good idea to make a list of tree species and the water needs of each for any area in which forestry projects are being conducted. The list on the following page was prepared for West Africa.

Common African Tree Species by Water Requirement

DRY SITES -- 200 - 500mm Mean Annual Precipitation

*Acacia albida**Acacia radiana**Acacia senegal**Annona senegalensis**Balanites**Commiphora**Parkinsonia**Prosopis juliflora**Ziziphus*

MEDIUM SITES -- 500 - 900mm

*Anacardium occidentale**Azadirachta**Cassia siamea**Eucalyptus**Parkia**Sclerocarya*

POTENTIALLY USEFUL IN SHRUB SAVANNA*

*Ficus sycomorus**Haloxylon persicum**Salvadora persica**Tamarix articulata*

MOIST SITES -- 900 - 1200mm

*Borassus**Butyrospermum**Casuarina**Tamarindus*

POTENTIALLY USEFUL IN WOODED SAVANNA*

*Albizia lebeck**Anogeissus**Dalbergia*

*As defined in Appendix C.

In addition to climate, soil, and water, there are other factors in the environment which affect the choice of species:

- Fire history of the area. Are there frequent or few fires? Some tree species are more fire-resistant than others. Of course, if the area has a lot of fires, it is better to plant a fire-resistant species.
- Insects. Some trees are more affected by certain insects than other trees.
- Animals. Do goats, camels, cows, and other animals common in the area like the leaves and bark of certain trees more than other trees being considered?

While considering the species in terms of environmental constraints, it is necessary to keep the purpose or objective of the project in mind.

Purpose

What is the objective of the reforestation (or revegetation) effort? Is the project objective to conserve resources, for example, a sand stabilization program for an eroded area? Or does the project seek to increase production of a given forestry product, for example, firewood? Obviously, certain species can be used for one purpose and not the other. However, some species can be used to fill both requirements.

Human Factors

The key here is finding out what the residents of the area would like the project to do, and what is attractive to them. For example, if *Acacia albida* is highly thought of locally and can be grown on the site (i.e., it meets the environmental constraints), and it serves the project's purposes well, then it is a good choice of species: everyone takes better care of something that is highly valued.

Other Guidelines

A planting site which has several kinds of trees is less likely to be destroyed by insects or disease: an insect or disease which attacks one species of tree will not always affect another tree.

Project results also indicate that in a dry climate, local species will grow more slowly, but will survive better than species brought in from other areas or countries. Therefore, in parts of West Africa where the mean annual rainfall is less than 1,000mm, it is recommended that such rapidly growing species as *Eucalyptus*, which originally came from Australia, be planted where the ground water table is near the surface, so that the trees will have access to more water.

The process of matching trees to available sites will give the names of trees which can be used in a particular situation. Sometimes only one species will fit; often several species are suitable. Once the list is prepared, it is possible to make decisions concerning which type of tree (or mixture of species) will lead to the best use of the land.

5

Project Planning

Much of the background which is part of planning a reforestation (or revegetation) effort, in terms of general considerations, has been presented. Foresters call upon all this information as they plan the nature of individual projects.

As planning is done for a specific project, there are additional considerations. Reforestation areas usually are lands unusable for intensive agriculture because the soil is poor and does not contain enough nutrients for horticulture or subsistence and commodity crops. However, some trees will grow almost anywhere. If the forester studies the site and finds that it is possible for a certain species to grow there, and if that particular species is native to the area, he then has to investigate why that tree is not growing at the site.

Very often the major reason is a lack of seeds in that particular area. If there are no adult trees nearby producing seeds which can be carried by natural methods (for example, eaten by animals and deposited on the ground in their manure) vegetation will be sparse, and the seeds will be scarce. Even if seeds are available, the species may not be growing because of overgrazing, fires, or blowing sand in the area. And if these things are allowed to continue, seeds continue to become harder and harder to find.

Before any revegetation project can be undertaken, therefore, it is necessary to make sure the factors which kept the species from growing on the site are not still present, or that they can be overcome in the course of the project. These thoughts bring into focus the question of the type of reforestation or revegetation effort needed.

The key decision at this point is whether a nursery effort is necessary for a given species or whether revegetation can be accomplished in some other way: direct seeding of the area, planting cuttings directly on the site, or by simply protecting the area and leaving it alone so that it can regenerate naturally.

Natural Regeneration

Nature, as shown by several pilot projects, can heal a barren area if given enough time. But, in most cases, natural regeneration cannot occur unless special efforts are made to help it along. Such efforts might include fencing the area, protecting it from being used for grazing, and setting up good neighborhood cooperation so that the residents realize the importance of leaving the area alone. Sometimes, a forester will decide that a certain area can be helped best simply by making arrangements to insure the area is left alone for a number of years.

Direct Seeding

If the species chosen for planting in a given area responds well to direct seeding, this method is certainly worth trying. Obviously, it is cheaper to scatter seeds on the planting site than it is to establish a nursery, maintain it for a time, and transfer young trees to the planting site. It is even possible to direct seed by feeding pods of certain trees to cattle and allowing the cattle to graze on the land. The cattle deposit their manure, containing the seeds, on the ground, and a sometimes very effective direct seeding operation takes place.

Some direct seeding results have been good in areas with rainfall as low as 700mm, but there is still much to be learned about direct seeding techniques.

One of the reasons for this method not being used more often in the past has undoubtedly been the scarcity of seeds. Direct seeding requires relatively large quantities of seed.

Good results of direct seeding have been obtained in sub-Saharan West Africa with *Borassus* and *Anacardium occidentale*. *Acacia albida* seeds have been sown in clumps in fenced-in areas and have started to grow. Other good results have been obtained with seeds scattered in busy areas where the young trees were at least partially protected by thorn branches and twigs.

Some trees simply will not grow if direct seeding techniques are used.

Cuttings

It is sometimes possible to take cuttings of trees and transfer them directly to a planting site. *Commiphora* and several *Euphorbia* species are possible choices for this method of revegetation. However, use of cuttings still is very much on a research basis.

In many cases, after all the alternatives are investigated, it is necessary to undertake a project which includes nursery seeding and transplanting of the young trees to the planting site. The following pages detail the planning of the nursery phase of the project.

Nursery Planning

Planning includes the forester's preparation to direct activities, keep good records, and work with crew members. Crew members who understand conservation and reforestation and are trained to work independently are much more effective. A well-trained crew can mean a much more successful project.

There are a number of decisions and plans to make before beginning a nursery. Is the nursery to be permanent or temporary? In other words, is there a need for one which can continue to supply trees even after the end of a project? Should the seeds be planted in plastic pots or other containers (clay jars, leaves, cardboard, etc.), or placed directly into the ground (open-rooted)? These decisions depend, in part, on the species which will be grown.

What is the time-frame for the project? How long will it take to set up the nursery? When should seeds be planted? When is the best time to transplant?

It is necessary to make a detailed layout and design of the nursery. Is there an adequate water supply? Is the land cleared? Does a fence have to be built?

At the same time, the seeds must be readied for planting. If the seeds are collected locally, they must be prepared.

Above all else, a successful project demands good record keeping.

Each of the important decision areas is discussed in further detail in the following pages.

First Decisions

Permanent or Temporary

As mentioned, nurseries can be set up permanently or on a temporary basis. The nature of the project determines which type of nursery is necessary.

Open-Rooted or Potted

Some species cannot be moved easily or safely from a nursery to a planting site unless they are grown and transported in pots; other species

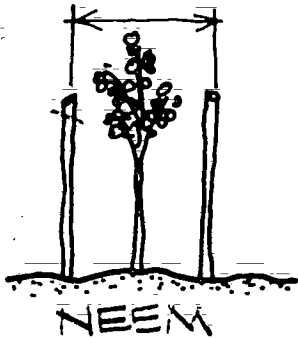

In West Africa, most of the area's Azadirachta indica (neem) trees are raised by the open-rooted method, and it is still used for Cassia siamea, Khaya senegalensis, Sclerocaria, and Prosopis (See Appendix A).

cannot grow well in pots. It is always cheaper to use the open-rooted stock method. But sometimes a certain species requires the use of pots and, in these cases, the money must be spent. If, however, a species will grow either in pots or as open-rooted stock, each method has advantages and disadvantages which should be considered:

OPEN-ROOTED STOCK The advantages of open-rooted stock are:

- . there is less weight to transport from the nursery to the permanent site -- pots are heavy;
- . it takes less time to transplant open-rooted stock;
- . less care of open-rooted seedlings is required in the nursery.

The disadvantages of this method are:

- . open-rooted seedlings need more space;
- . they need more time in the nursery;
- . the nursery location must have good soil conditions;
- . the roots are exposed to air when they are lifted out of the nursery soil and again when they are planted at the permanent site. (This can cause damage to the plants.)

PLASTIC POT STOCK The advantages of using plastic pots are:

- . good soil is not required at the nursery site;
- . seedlings can be placed closer together than in the open-rooted method;
- . the time in the nursery is shorter (although pots require expense at the beginning, the shorter nursery time cuts down on the other expenses);

- the pots can be moved easily to the permanent site just as long as watering continues;
- the root growth is contained in a package which is easy to transport, and there is little or no exposure of hair roots to the air during transporting and transplanting.

The disadvantages of using plastic pots are:

- the seedlings require root pruning while in nursery pots;
- pots cannot be piled up for transport;
- they are heavy to transport and more difficult to transplant;
- the pots must be purchased (which, as indicated above, may or may not be a problem depending upon time saved in the nursery or on the expense of making certain soils ready for open-rooted planting).

Determining Dates

Survival chances of the young trees depend directly upon the size of the trees when they are transplanted, and upon replanting at exactly the right time of year. Therefore, the timing of the project must be carefully planned. Ideally, a tree should have as large a root system as possible before transplanting: this increases its survival chances. But, trees also must be reasonably light and small so that transportation and transplanting are more easily done.

Location, soil, the amount of sunlight, and other factors can change the time needed in nursery beds. These differences make it hard to time projects exactly, but much good information often is available from local experience and carefully kept records of other projects. For some species, it is important that trees be past the yearly germination stage to survive dry heat and winds such as those occurring in sub-Saharan West Africa during the months of April and May. This kind of information must be considered when deciding the seeding dates.

The planting schedule is set up so that trees will be strong and well-developed for transplanting to their permanent sites immediately after the first rains. To time the planting correctly, foresters determine

how long each species to be grown has to remain in the nursery. Then they calculate the dates for seeding by subtracting the estimated time in the nursery from the number of weeks left before the predicted start of the rains. Thus, if *Acacia albida* is to be seeded in plastic pots (see chart below), and the rains are due to start in 24 weeks, it can be figured that pots must be seeded in 9 or 10 weeks, thus:

$$\begin{array}{r} 24 \text{ weeks left before rains} \\ - 14 \text{ weeks necessary in nursery} \\ \hline 10 \text{ weeks} = \text{time for planting} \end{array}$$

The following chart lists some species commonly found in Africa and classifies them according to the time needed in nursery beds under controlled conditions (irrigation and shade). If conditions in an area are not well controlled, more time may have to be allowed for in the nursery.

PLASTIC POTS

6-10 weeks	10-14 weeks	14-18 weeks	18-24 weeks
<i>Parkinsonia</i>	<i>Acacia albida</i> <i>Acacia radiana</i>	<i>Acacia nilotica</i> <i>Acacia senegal</i> <i>Ancardium occidentale</i> <i>Azadirachta indica</i> * <i>Eucalyptus</i> ¹ <i>Prosopis</i>	<i>Balanites</i> <i>Butyrospermum</i> <i>Casuarina</i> * <i>Eucalyptus</i> ² <i>Parkia</i> <i>Tamarincus</i> <i>Tamarix (cuttings)</i> <i>Ziziphus</i>

OPEN-ROOTED STOCK

30-35 weeks	35-40 weeks
<i>Cassia siamea</i> <i>Sclerocarya</i>	<i>Azadirachta indica</i>

- * Not native to Africa
1 Transplanted into pots.
2 Seeding

ORDERING POTS Pots should be ordered well ahead of time, if they are to be used. Only one size plastic pot is used; this makes ordering easier. Usually the pot is a standard 8cm (3in.) diameter by 30cm (9in.) depth. Only very special conditions, such as those which would be encountered when dealing with the *Mangifera indica* (mango), would require using larger pots.

Overall Design and Layout

The best sites are those which are close to (1) a dependable source of water, (2) a road that is passable for heavy trucks during the rains, and (3) the supervisor's living quarters.

If the stock is to be open-rooted, the nursery soil must be rich, deep, and well drained. The best soil is sandy clay, which has a loose, crumbly structure. If plastic pots are used, the pots can be filled with a mix brought from somewhere else.

A slight slope will facilitate surface runoff, and protection from prevailing winds is desirable. Often a large shade tree in one of the corners of the nursery is very useful to protect very young seedlings from extreme sunlight. (Find out whether the land next to the nursery site would be suitable and available if the nursery had to expand.)

A detailed sketch of the nursery layout is a good idea. Show the size and location of the beds and water storage facilities. Plan for irrigation during dry times and drainage during the rains. Allow room for walkways, driveways, and turnaround space. Plan for enough storage and tool space. The storage area or construction shed should be large enough to provide shelter for the crew in times of intense heat and driving rain. Space is also needed for research or germinating beds, compost piles, and safety or fire prevention strips (especially along the fences).

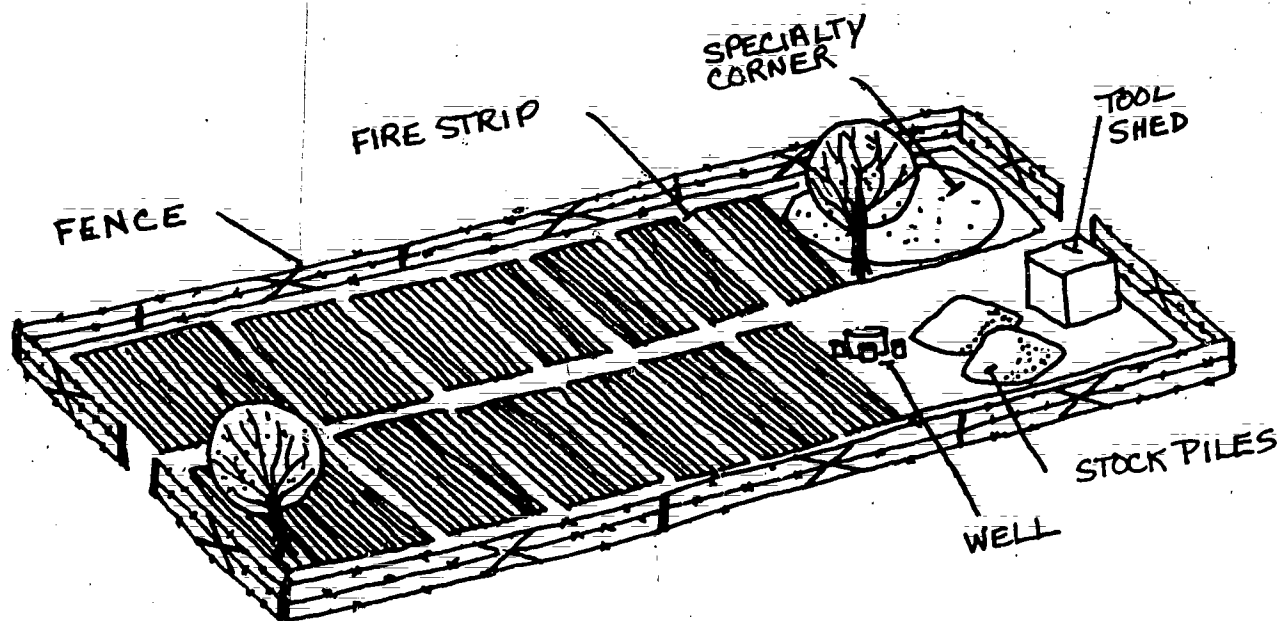

NURSERY LAYOUT

More detailed information which will help when preparing the layout of the nursery and when putting together a well-planned nursery is given in the following pages.

Planning Nursery Beds

Estimate the amount of land needed for beds (the land within the nursery where the seeds will be placed -- either in the ground or in pots). If the open-rooted stock method is being used, figure that each group of 1,000 trees needs 10 square meters (10m^2) of land. If plastic pots are used, 1,000 trees need only 7m^2 . Add 20% to the figure calculated as land needed for the nursery beds. The 20% will be for additional space for roads, work areas, construction shed, etc.

If at all possible, plan the beds so that their longer dimension is placed in an east-west direction and their narrower side faces north-south. Placing the beds this way gives the trees on the inside the same exposure to the sun as those in the outside rows. The planting areas should not be wider than 1.2m so that weeding in the center can be done more easily.

For open-rooted stock, standard-sized beds contain five rows of trees and are approximately one meter wide. The length of the beds varies from 5 to 20 meters, depending partly upon handling needs and the amount of labor and transportation available. Always allow room for extra beds.

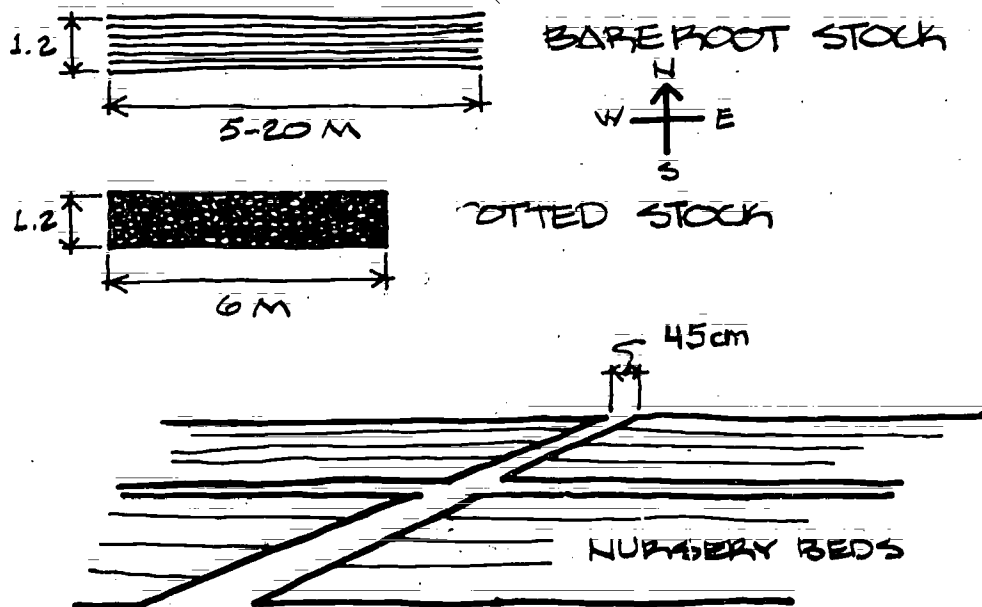

A bed which is 1.2m wide and approximately 6m long can hold approximately 1,000 plastic pots in 15 rows of 70 pots.

Walkways between the beds must be wide enough to permit foot and wheelbarrow traffic -- a minimum of 45cm (18in.).

Other Design Considerations

Long distances for hand carrying can be avoided by planning driveways in the layout. A small truck should be able to drive into the center of any nursery which holds 10,000 trees or more. It is even more useful if the nursery has a central access road which runs the full length of the nursery with a turnaround or drive-through facility at the far end.

Small research plots can be placed in a corner of the nursery. The location of these special beds should be planned not to interfere with the regular nursery efforts.

Young trees should be placed in the shade during their first weeks, especially during the worst weeks of the hot dry weather. If a large shade tree is available in the nursery, plastic pot seedlings can be started underneath it and later moved into the full sunlight.

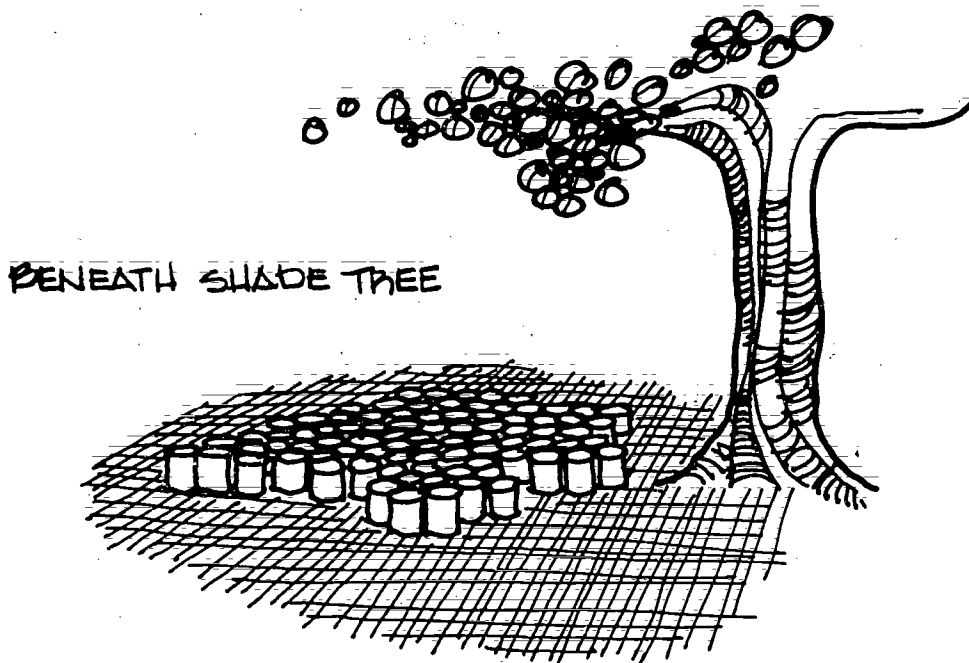

Another shade possibility is to rig straw or reed mats over some of the beds. These can be used to regulate the amount of shade. However, shading

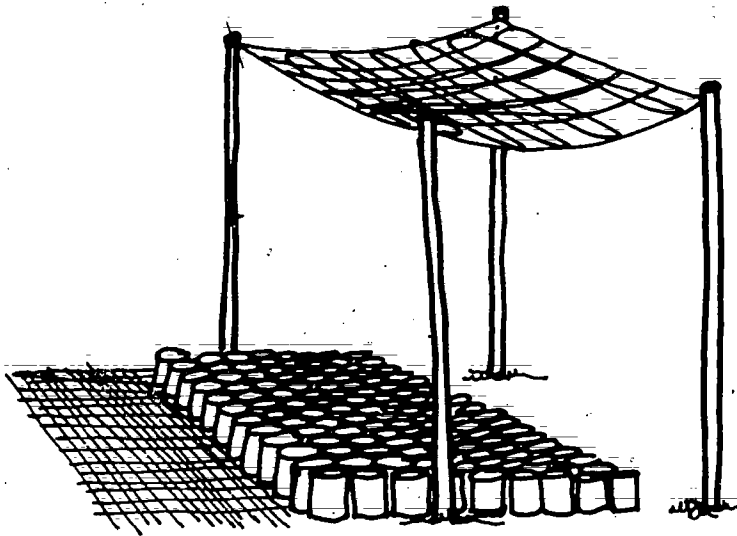

is only necessary for a short time. It is a good idea to have trees under partial or complete shade during their entire stay in the nursery. Gradually, put the seedlings into the full sunlight: this will help prepare them to survive full exposure to the sun at the planting site. Most species adapt themselves early and quite well to full sunlight.

Water

This manual has mentioned the importance of the water supply. When planning nursery activities, it is necessary to consider water supply and costs carefully. Much money and time could have been saved

(for example, at several sites in the Sudan area) if the first year had been used only to observe and test the water supply and perhaps raise a few thousand trees on a trial basis. This kind of testing is usually not possible. However, a project manager or developer cannot be too careful when it comes to the subject of water supply. All too often what looks like a good water source turns into a dry, or nearly dry, hole just at the time the water is needed most -- when the trees in the nursery are requiring the most water for growth (January to June) or when temperatures are highest (March through April), and the plants are using more water through transpiration and evaporation.

Foresters learn that it is advisable to be very realistic about water supply, the project's need for water, and the costs involved. It is important not to underestimate any of these factors. In sub-Saharan West Africa, for example, it is usually not possible to get a steady water supply without (1) lifting the water from deep under the ground (as in a deep well), or (2) carrying it considerable distances from the source to the nursery. Both of these methods are expensive. And, even if the project has access to a deep well with a steady supply of water, the cost of a pump has to be included in the project budget. While it is possible to handlift a few hundred liters of water a day from a deep, open well, pumps are necessary when quantities such as 400 liters, twice a day, are called for. Failure to plan adequately in terms of any of these factors can lead to trouble for the project.

Water Quality

FOR THE CREW. It is likely that the water used at the site will contain a variety of disease-causing organisms. Water can be treated so it is safe to drink, but this is not always possible. Moreover, it is not

necessary to treat water which will only be used to water the trees. However, a project manager has to make sure that the crew realizes the water probably is not good to drink, and, when possible, provide good drinking water at the site; when this is done, there are likely to be fewer absences because of sickness.

FOR THE TREES. Many water sources, whether they are wells or surface depressions, contain considerable amounts of salt. In fact, in some areas along coastlines, a well may contain mostly salt water with only a thin layer of fresh water floating on the surface. Even water which may not contain much salt originally can collect salt as it flows over the ground. Often salt remains in ponds or holding basins after the water evaporates. Sometimes salt concentrations are so heavy that trees cannot be grown in the area.

Some trees and crops can stand more salt than others. Salt tolerance (the amount of salt a plant can take and still survive) of farm crops is being studied, and good information is becoming available for selecting crops which can live in water containing some salt. Unfortunately, however, relatively little is known about how much salt trees can take and still grow well. It does seem, however, that *Casuarina equisetifolia* (Australian pine), *Phoenix dactylifera* (date palm), and *Tamarix* (Tamarisk), all are rather salt tolerant. As a general rule, however, water containing more than about 550 parts per million of dissolved salt seems unfit for nursery work.

Sometimes, there is no way to keep from using water which contains some salt. In a borderline situation -- where it seems the trees might be able to live even if the water has some salt in it -- the usual practice is to "over"-irrigate. Over-irrigation is accomplished by putting on too much water so that any damaging substances in the water are more likely to be washed down and are less likely to build up and remain on the surface of the nursery beds.

How Much Water

The nursery will need a certain amount of water each day. This daily figure will control all water supply plans and activities. Once the daily amount is known, it is possible to estimate how much water will be needed for the project. This figure can then help determine the pumping rates needed (as well as the kind and size of pumps and pipes) and water storage capacity required. It is even possible to figure the number of watering cans which will be needed for the project.

To calculate the amount of water needed each day, multiply the length of the area to be watered by the width. Then multiply this number by 0.02m. The resulting quantity is what is needed in order to apply a 2cm sheet or layer of water over the area where the trees are being grown.

WATER NEED CALCULATION

DAILY REQUIREMENT:

$$1.0 \times 5.0 \times 0.02 = 0.1 \text{ M}^3$$

$$= 100 \text{ L OR}$$

$$\text{APPROX. 25 GAL.}$$

AT 5 ROWS & 5 CM
INTERVALS, THIS BED
CONTAINS 500 TREES.

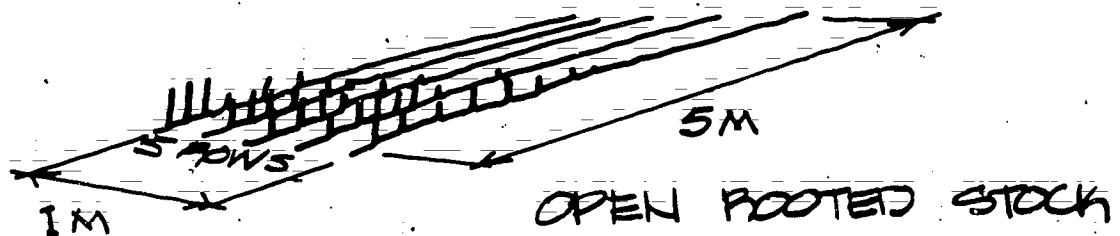

If this calculation is used and followed, there will be enough water even under the most demanding circumstances. If all the conditions in the nursery remain good during the project -- there is enough shade, protection from the wind, effective watering during the coolest part of the day, and good water retention by the soil or nursery mix -- the amount of water needed will be less than this. In fact, if all of these conditions remain good, only half the amount of water calculated may be needed. However, experienced project managers plan for maximum need. It is far better to have the problem of not using all the water than it is to plan poorly and risk losing the entire stock.

PLASTIC POTS

THIS BED CONTAINS
500 TREES.

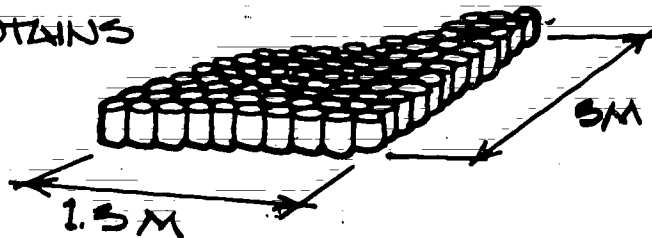

DAILY REQUIREMENT:

$$1.5 \times 3.0 \times 0.02 = 78 \text{ L OR}$$

$$\text{APPROX 20 GAL.}$$

24

Ground Water and Wells

Water in the ground can be reached by constructing various types of wells using methods which have been studied extensively in West Africa, for example, by local governments, international organizations, consultants, and engineering firms.

Traditionally, in West Africa, wells are dug by hand. This is especially sensible where the water under the earth's surface is only a few meters below ground level. In such cases, well construction is relatively simple and little more than a simple hole is needed. When water is reached within the first 50m, well-digging becomes somewhat more complex but can still be accomplished by hand methods at reasonable costs.

In other areas, deeper wells are necessary, and these wells require even more complicated construction procedures. In some places, it is necessary to dig 100m before reaching aquifers (water-bearing layers of the earth). And even when water is reached, the well may not give enough water to make the effort worthwhile. The subsoil may be so loose that it is hard to dig without taking expensive precautions. Still worse, water may be found only in a fine sand aquifer. It is almost impossible to separate water from this type of sand: the screening must be so fine that only a little water can pass through. On the other hand, if pumping is increased without adequate screening, the walls begin to fall in.

One point cannot be stressed enough: when wells are dug, they must penetrate the water-bearing layers as much as possible so that the well will continue giving water even during the dry season when the water table in the aquifer drops.

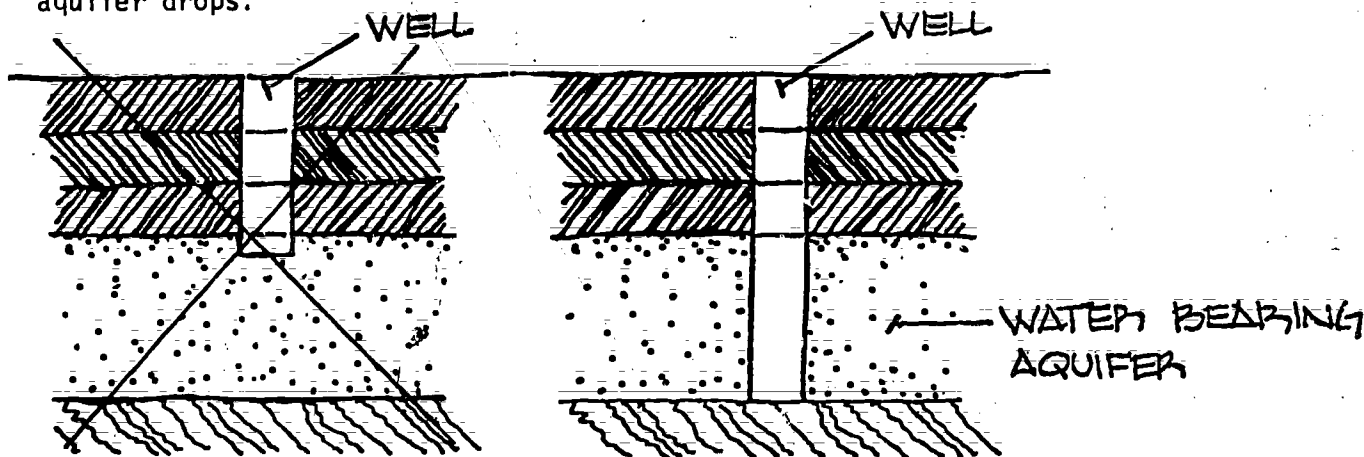

This well does not penetrate the aquifer completely. Therefore, not enough water will be available during the dry season.

This well penetrates the aquifer and will give sufficient water during the dry season.

Large projects which use a well for a water source cannot rely on that well if it does not have an adequate water lifting or pumping system. These systems insure that sufficient water is available at all times with the least possible effort.

It is worth taking extra time and effort to plan a well and water-lifting system carefully. It could make the difference between a project which is successful and one which is not.

Surface Water Development

Surface water development is still relatively unknown in many areas of Africa and elsewhere. Catching the rainwater and storing it is possible and is being tried. Using the water resources which are available, such as rivers, lakes, streams, is often difficult for a number of reasons:

USE OF AVAILABLE WATER RESOURCES. In the dry areas of Africa, for example, the land is flat and the soils are sandy. Often the soil is so sandy that even when water is available, it cannot hold the water sufficiently well for vegetation to thrive. The water just disappears down through the sand.

In other places, for example, along many running streams, the slopes are so flat that it is very difficult to make an effective diversion channel to carry water from the source to the site. Gravity just cannot be used. Sometimes, the valleys near water are too narrow -- laterite and rocky outcrops begin so soon that any effort to channel water effectively is just too expensive to be feasible.

The general flatness of the topography in many dry areas causes water to pool in large, shallow, depressions (basins). But it is difficult to use this water as a resource because it:

- . usually evaporates before it is needed most;
- . frequently contains large amount of salt;
- . has to be lifted and transported to be used.

Even when the banks of the water sources are flat and accessible, there can be problems. A water intake which channels water for irrigation purposes must be built so that it reaches the water at its different levels. That is expensive, but it can be done by:

- . constructing a platform, pipe, catwalk, etc, so that the intake is at the center of the pond;
- . digging a canal from the center of the pond to the intake site;

- using a portable pump system that can be moved as the edge of the water recedes or advances.

Silt is another problem. When there are rains, the heavier flow of water carries gravel, sand, and silt. Creeks and streams often look chocolate brown and carry as much sediment (solids) as they do water. In fact, there is so much sediment in the water, that any lake, pond, reservoir, or other open area that it flows into can be silted up within one or two rains. It is possible to build special areas to catch this sediment, but sediment basins are often expensive and must be maintained carefully. And, of course, they add expenses to the project budget.

There is, however, quite a potential for surface water development of smaller watersheds and local supply sources.

The following is an Australian method for harvesting rainwater:

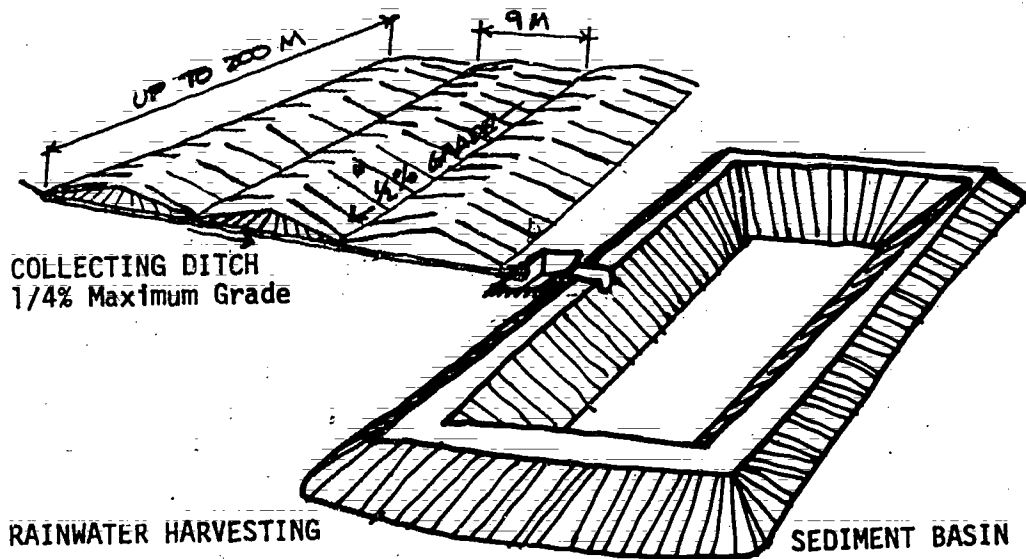

COLLECTING DITCH
1/4% Maximum Grade

RAINWATER HARVESTING

SEDIMENT BASIN

A flat piece of land is graded and shaped as shown; ditches, drains & storage unit(s) are added.

Cost: \$30-40 per acre

Source: Department of Agriculture
Western Australia, 1960

Included in *More Water for Arid Lands*, National
Academy of Science, 1974.

Microcatchments are being used in various parts of the world with success. This water catching method involves forming a small basin around each tree which is planted.

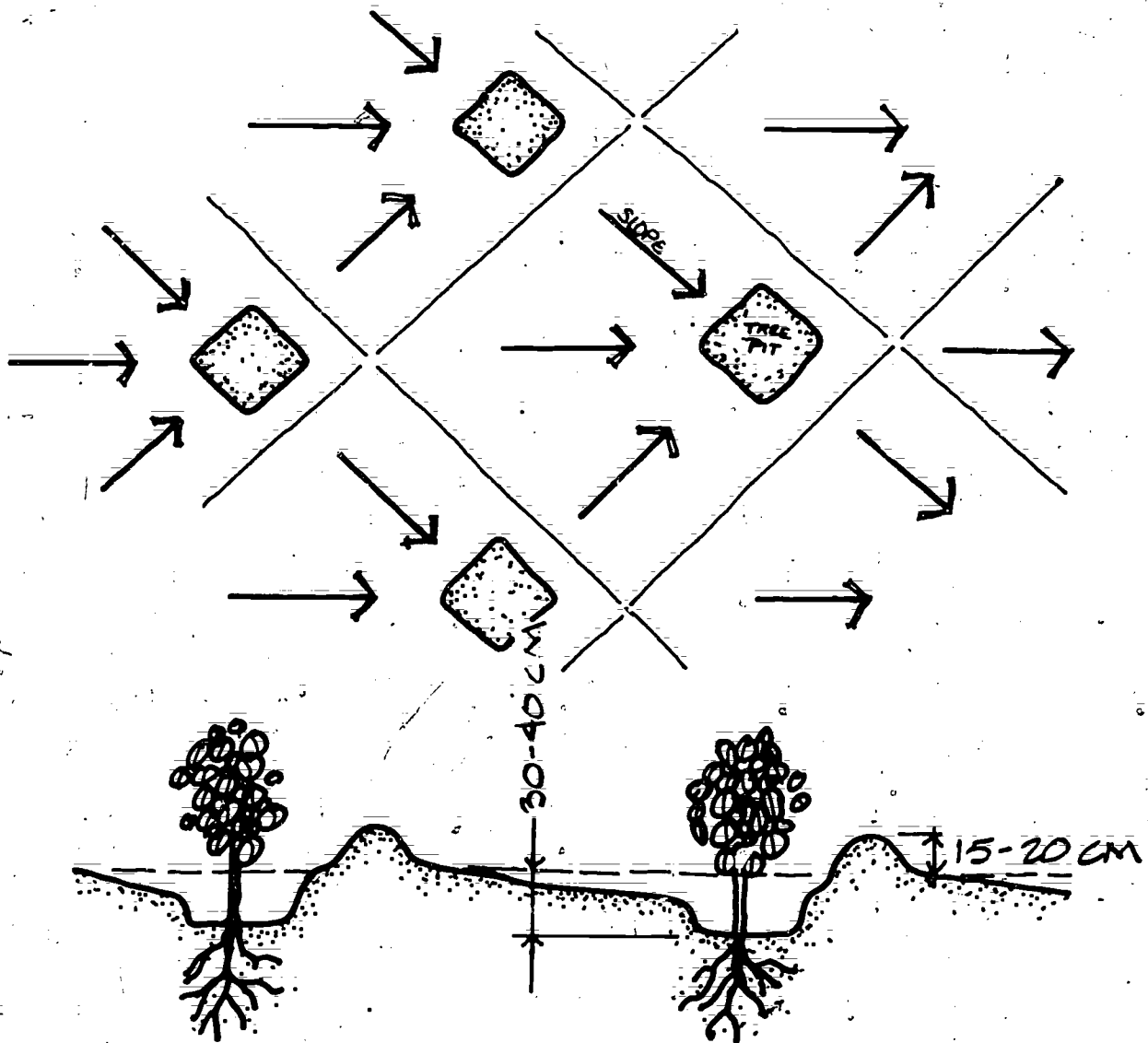

MICROCATCHMENT

LENGTH CAN BE FROM 2 METERS TO 50 METERS DEPENDING ON TERRAIN, SOIL, RAINFALL, TREE SPECIES, ETC.

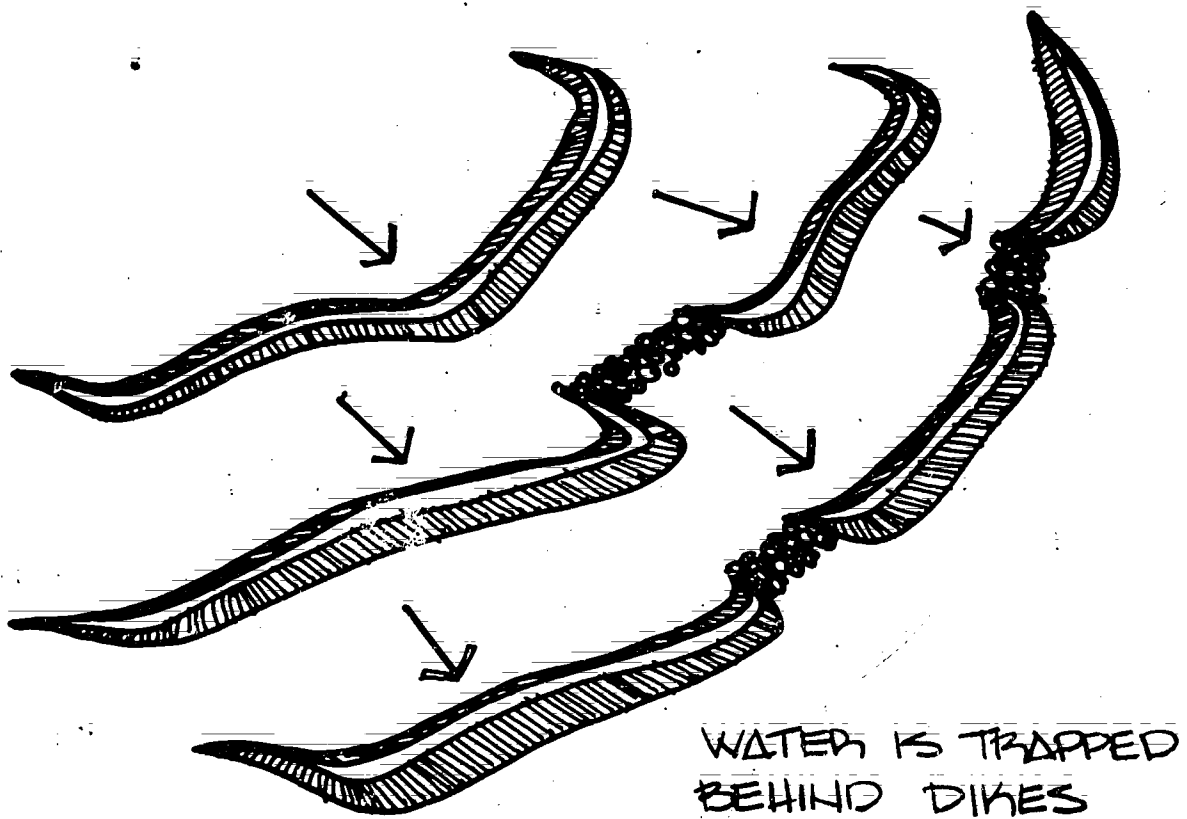

DIGUETTES

THESE DIGUETTES, IN USE IN UPPER VOLTA, ALLOW THE GROWTH OF RICE WHERE RICE WAS NOT ABLE TO GROW PREVIOUSLY.

In Niger, rock walls 1m high have been constructed across river runs to hold back runoff water. These efforts have been very successful.

There are other successful techniques. However, most methods require substantial investment in terms of money, labor, tools, equipment, and

maintenance. Some techniques involve reducing evaporation from water surfaces, reusing water, and reducing infiltration losses. These all are described in various articles which are mentioned in the bibliography at this end of this handbook.

WATER CATCHMENT AND STORAGE. In many parts of the world, tin, galvanized metal, asbestos cement, and ferrocement are being used to build structures for catching and collecting rainwater. One method which works well is to catch rain runoff from buildings in containers and store the water for later use. This works especially well where there is a large building, such as a school or hospital.

Calculating the storage capacity needed to hold a given amount of water gives a good indicator of the value of the effort. Assume that a building is 10m wide and 30m long and that 300mm of rain fall:

$$10\text{m} \times 30\text{m} \times 0.3\text{m} = 90 \text{ cubic meters or } 90,000 \text{ liters}$$

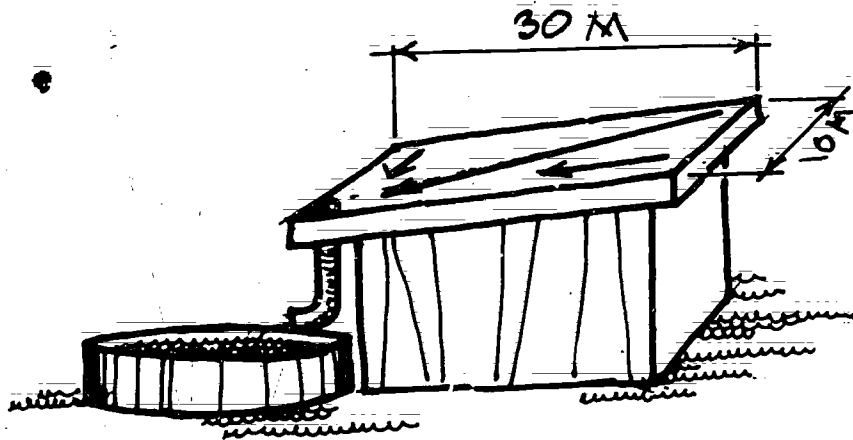

RAINWATER CATCHMENT
FROM BUILDING RUNOFF

Thus, a storage capacity of 90 cubic meters is needed. A concrete box, 9m X 5m X 2m will contain this amount of water. An open cistern of 4m X 3m X 1.5m would catch 18,000 liters (enough to last 15 people approximately 100 days). Empty oil drums can be relied on to catch and store water for a project or for extra supplies in case of dry weather. Whenever possible, water storage facilities should be covered to prevent losses of valuable water through evaporation.

Protection

Whether in a nursery or planting site, trees have practically no chance to survive without protection from animals.

The project manager arranges for protection of the trees by finding people to keep animals out of the area, by building fences, or by some combination of both methods.

Surveillance

This approach calls for protecting the trees by having people watch over the area to keep animals and other unwanted visitors from disturbing the trees. Surveillance may be possible and practical at one site, but not at another. Two of the factors which must be considered with respect to this method are (1) whether people are available who can and want to do the job, and (2) how much it would cost to have them do it. Experience shows that it is too much to ask villages or individuals to bear the burden of watching a planting site for years without some form of payment -- either in food, money, or some other locally accepted form. If the people protecting the site receive a return for their services, they are more likely to do the job well.

Fencing

The project manager has two important things to keep in mind when considering the use of fences in a project: custom and habit; and cost.

CUSTOM. A fence should be arranged so it requires the fewest possible changes in land use patterns. Fences can be social, as well as physical, barriers. If residents of the area are used to letting nomads graze their herds inside harvested fields, this practice must be considered before those same fields are fenced. Such grazing serves economic and social needs, as well as helping fertilize the land through the manure which is deposited. In order to take such customs into account, it may be necessary to plan a different kind of fence, place it differently, or even change the shape of the site before the land use problem can be solved satisfactorily.

COST. No matter what type of fence is built, there are going to be materials, construction, and maintenance costs involved.

- stalks of millet or sorghum;
- sticks and branches from brush and bushes;
- banco (earth) bricks.

Fence posts are built from those local woods which are most resistant to rot and insect damage. Borassus, for example, is relatively resistant to termite damage. Hyphaene thebaica can be substituted, although it does not last as long and is much harder to split for posts.

Most posts should be treated with insecticide before they are used. Azadirachta indica branches, available from pruning (it is good practice never to cut down a tree in order to get post material), can be used once they have been given the barrel treatment with dieldrin (as shown on this page) to increase their resistance to termites. Limbs and branches should be about 10cm in diameter. The largest ones are used for corner gate-posts and line braces.

BARREL - TREATMENT

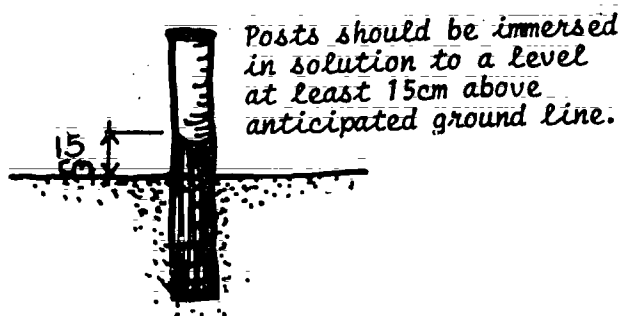
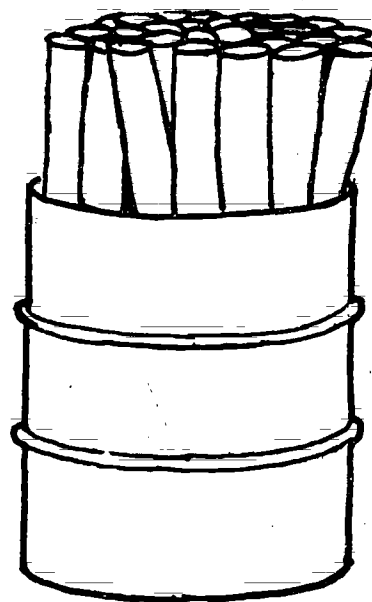
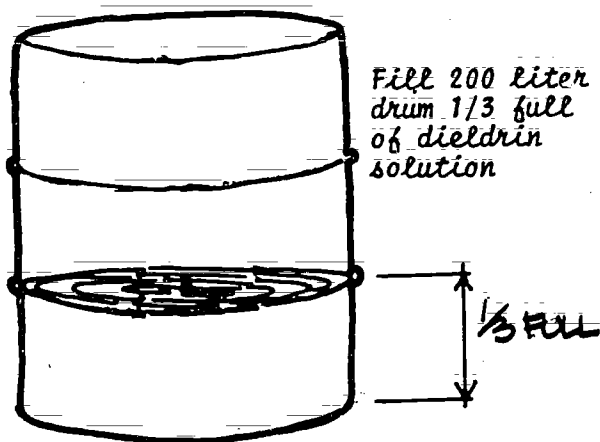

Set posts into drum and soak for 4 hours minimum

DIELDRIN

- OTHER NAMES:** HEOD
- TYPE:** Contact Insecticide.
- FORMULATIONS:** Emulsion Concentrate (EC), Wettable Powder (WP), Dust, and Granules.
- WARNING:** DO NOT TOUCH. IT CAN BE ABSORBED THROUGH THE SKIN. IT IS EXTREMELY DANGEROUS TO MAN IF NOT USED CORRECTLY.
- DO NOT APPLY DIRECTLY TO ANIMALS OR LET ANIMALS EAT TREATED CROPS.
 - DO NOT DUMP EXTRA SOLUTION INTO LAKES, STREAMS, OR PONDS. IT WILL KILL FISH, AND IT CAN KILL PEOPLE WHO EAT THE FISH.
 - IT IS POISONOUS TO BEES.
 - DO NOT USE TO TREAT GRAIN OR ANY PRODUCT TO BE USED FOR FOOD, ANIMAL FEED, OR OIL PURPOSES.
- USE TO:** Protect fence posts against insect attack.

HELPING SOMEONE WHO HAS BEEN POISONED BY INSECTICIDE*

1. These are signs of poisoning:

HEADACHE	WEAKNESS
NAUSEA	SWEATING
DIZZINESS	VOMITING
2. IF: The person feels sick while using an insecticide or soon afterward:

Get the poisoned person to the doctor, dispensary or health officer as soon as possible.

Find the insecticide container or label so the doctor will know which insecticide poisoned the person.
3. IF: The person swallowed a poison, and if he is awake, and he cannot see a doctor right away:

Mix a tablespoonful of salt in a glass of warm water and make the victim vomit. Or stick your finger down the person's throat. Make him vomit!

Make the victim lie down. Keep him warm, and do not let him move until help comes.
4. IF: The person spilled an insecticide concentrate or oil solution on his skin or clothing, get the clothing off and wash the skin with soap and plenty of water.

Get help as soon as possible.

* *Small Farm Grain Storage*, Lindblad and Druben, PC/VITA, 1976.

Any sort of thorny or sharp branch is useful and can be woven into the fence wires. For example, although stems from palm trees cannot be used for fence posts, they make ideal staywires or pickets because they are strong and durable, and some of them have sharp barbs.

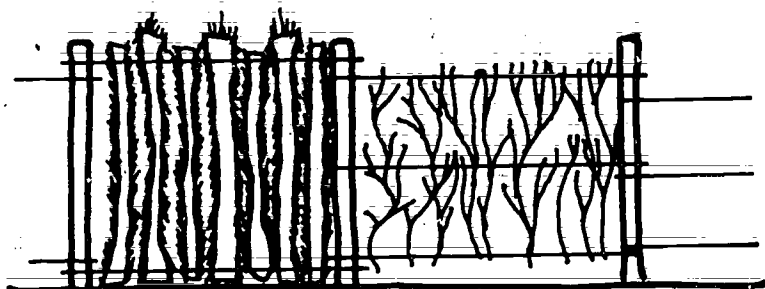

LOCAL MATERIAL FENCE TYPES

Posts: *borassus* or *Doum*,
Comiphora, treated neem.
 Railing: Branches, sticks,
Doum "Lath".
 Filler: Thorny limbs, millet
 stalk (temporary), palm-
 leaf stems.

Some African woods, such as *Commiphora africana*, are likely to take root and sprout if freshly cut branches are planted at the beginning of the rains. (This species is also useful for establishing live fences; that is fences established entirely by growth of certain species rather than by constructions of wood and wire.) Normally, one would not wait until the beginning of the rainy season to build fences, but this might be done when using post materials that may take root. Care is taken not to damage the wood when attaching wire for the fence.

Live Fencing. A number of species have shown that they adapt well to being live fences. Members of the *Euphorbia* family are especially good because animals cannot eat them. (People, too, must be careful -- when *Euphorbia* are cut, the milky sap causes severe irritation if it touches skin.) African species useful in live fencing include: *Acacia ataxacantha*, *Acacia macrostachya*, *Acacia senegal*, *Comiphora africana* (mainly for posts), *Euphorbia balsamifera*, *Parkinsonia acculeata*, *Prosopis juliflora*, and *Zyziphus* spp.

Live fencing possibilities are interesting to foresters and conservation people, but there are practical problems which have not yet been solved. In spite of extensive efforts to raise and transplant live fencing in a short time period, no practical and rapid ways have been found. The fences, of course, are necessary from the beginning of the reforestation project, and one cannot wait years for the fences to grow. One practical solution may be to construct temporary fencing in front of the live fence while the latter is growing to an effective size. Then when the live fence is large enough, the other materials (posts, wires, etc.) can be moved to another site and reused.

The fence around the nursery or permanent site should demonstrate several kinds of fences and fencing materials. It should be tight and sturdy, and the gates easy to open and close.

Gates. Any strong gate which closes tightly is fine. A self-closing gate is even better. People passing through do not have to stop, put down their loads, close the gate, and pick up the load again before going on. And the gate cannot be left open to let animals through by accident.

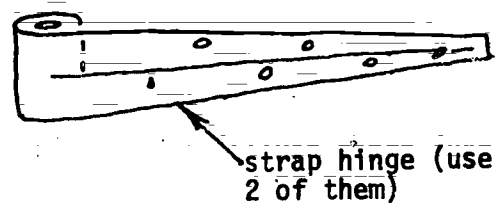
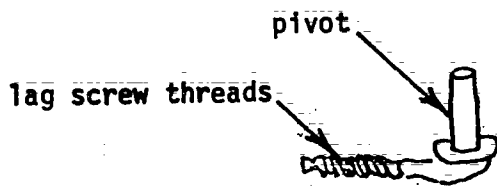
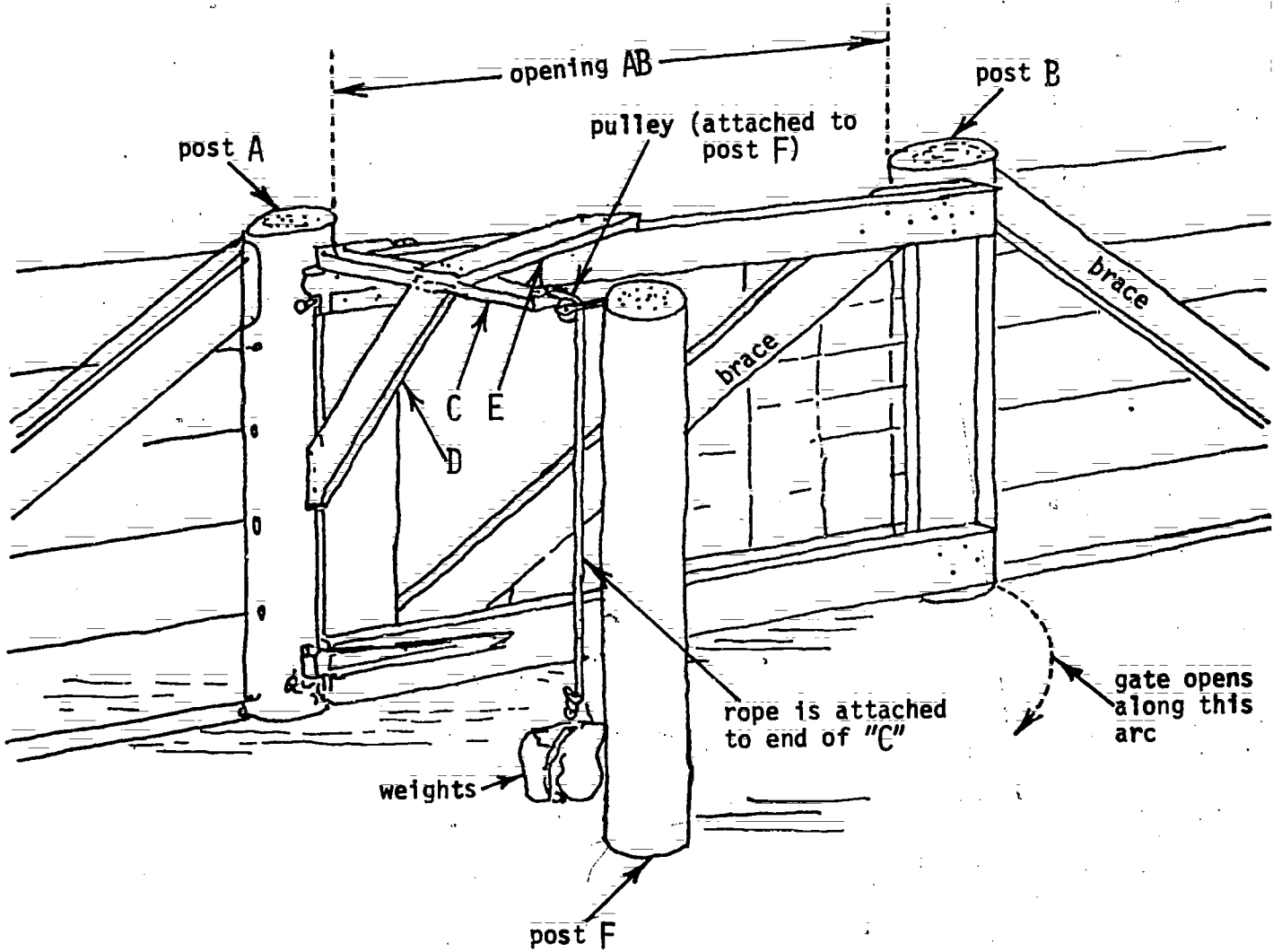

Description -- Self-Closing Gate

This gate consists of a strong frame with a diagonal brace. Wire fencing material is stretched between the pieces of the frame. The gate is supported by a pair of heavy, well-greased strap hinges. The gate operates very simply: when the gate opens, wood piece "C" swings away from post "F" and pulls the rope through the pulley. The gate closes when the weight on the end of the rope pulls wood piece "C" back into position.

Construction Points

- Wood piece "C" attaches to the gate at the hinge side. "C" should be about one third of the length between posts "A" and "B" (length "AB").*
- "C" is braced by pieces "D" and "E."*
- Strong cord or rope is attached to the end of "C" and passed through a pulley. The end of the cord is attached to a large rock or other weight.*
- Post "F" prevents the gate from opening too far. Allow room for the pulley and knot for attaching rope to "C."*
- Hinges, pulley, and weight must work easily for the gate to close properly.*
- Gate opens outward from the protected area so animals cannot push it open. No latch is necessary.*
- Gate posts are braced to prevent the pull of the wire fencing from tilting them.*
- Although pieces "C", "D", and "E" can be made of wood, it is better to use iron if at all possible.*

Tension. When using wire for fences, tension is very important: the wire must be stretched tightly between the fence posts if the fence is to remain strong. Tension can be maintained along the fence by making sure the wire is stretched tightly between posts, and that it cannot slip out of place. When the wire is placed correctly, each post exerts an equal pull against the next post, and this equal pressure creates a tension which keeps the fence posts strong and in place. However, if the tension on one section of fence is lessened, the posts in this section will begin to bend toward that part of the fence having the stronger pull, and the fence will become weaker and weaker.

Tension becomes harder to maintain as fences get longer or when there are large spaces between fence posts. Generally when building a fence, it is a good idea to use a line brace every 120-150M. A line brace is pictured below. Sticks are inserted into loops in the wire as shown. These sticks can be twisted to tighten the wire and thereby increase tension.

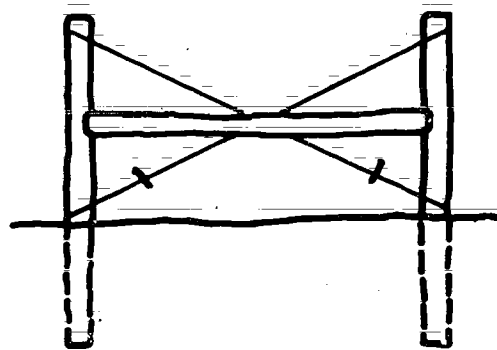

LINE BRACE EVERY 120-150M

Corners and openings (for roads, gates) require additional bracing for strength. One such way of providing extra support is by using a deadman. A deadman is simply a heavy stone or block of cement or piece of metal which is used as an anchor. One end of the fence wire is wrapped securely around the deadman which is then placed in the ground where it can serve as a permanent anchor. The following illustrations give clearer ideas of the use of deadmen.

POSTS ARE NOTCHED FOR
WOODEN BRACE & DIAGONAL
WIRE.

Deadman anchoring a gate post

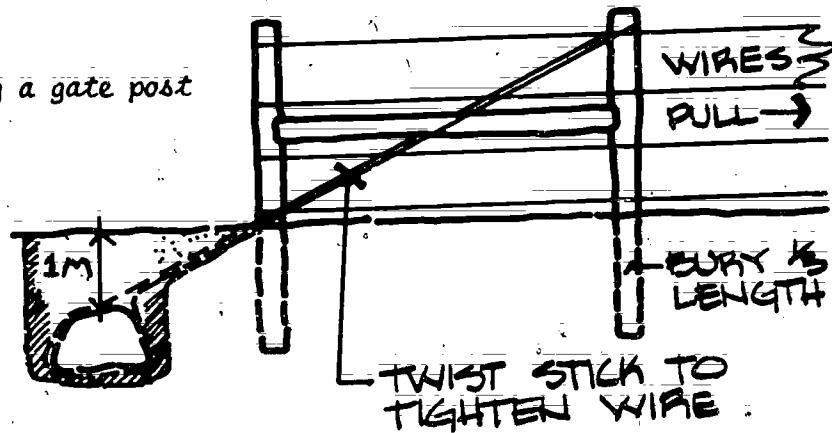

A sloping trench is dug as shown. The fence wire is placed around a rock or piece of metal. About midway along the wire, between the top of the post and the deadman, a stick is inserted into a loop of the wire. This stick can then be twisted as necessary to tighten the wire and maintain tension. The deadman is placed in the hole so that the wire is tight, and there is a strong diagonal pull. The dirt is piled back into the hole and packed down tightly around the deadman.

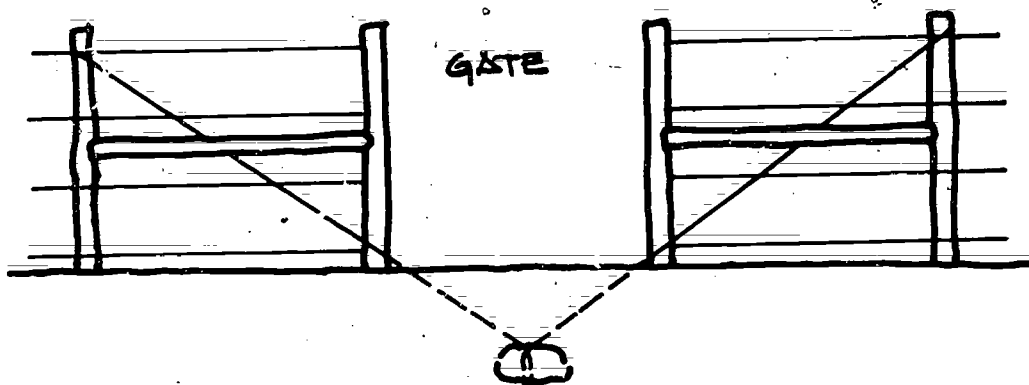

One deadman being used to support two posts. The deadman is creating a pull on the posts equal to that being created by the tension of the wire being stretched in the opposite direction.

DOUBLE DEADMAN

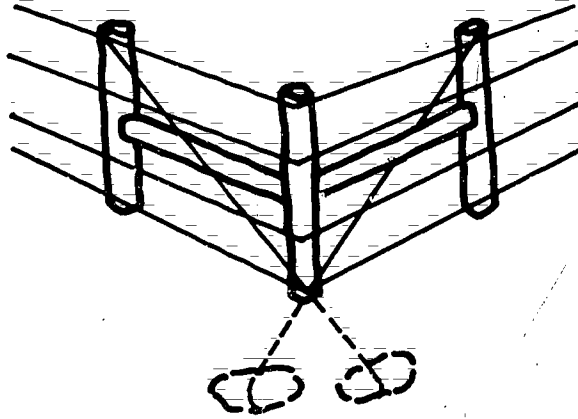

AT CORNERS

A deadman is not the only way to support a corner. The illustration presented here shows how rocks can be used to strengthen corner posts and help maintain tension on the wires.

4 POSTS WRAPPED WITH WIRE MESH / BARBED WIRE, AND THEN FILLED WITH ROCK.

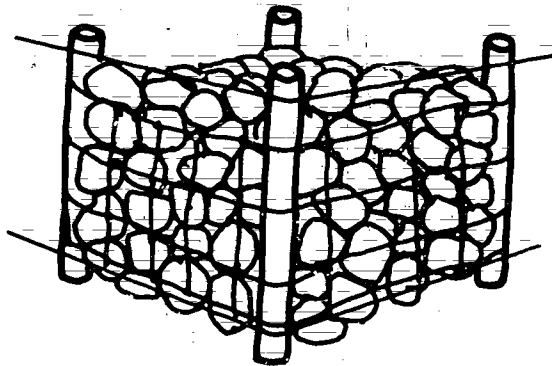

Animal Control. The following illustrations show ways of constructing fences to keep out the widest possible number of animals.

SIDE VIEW
OF FENCE

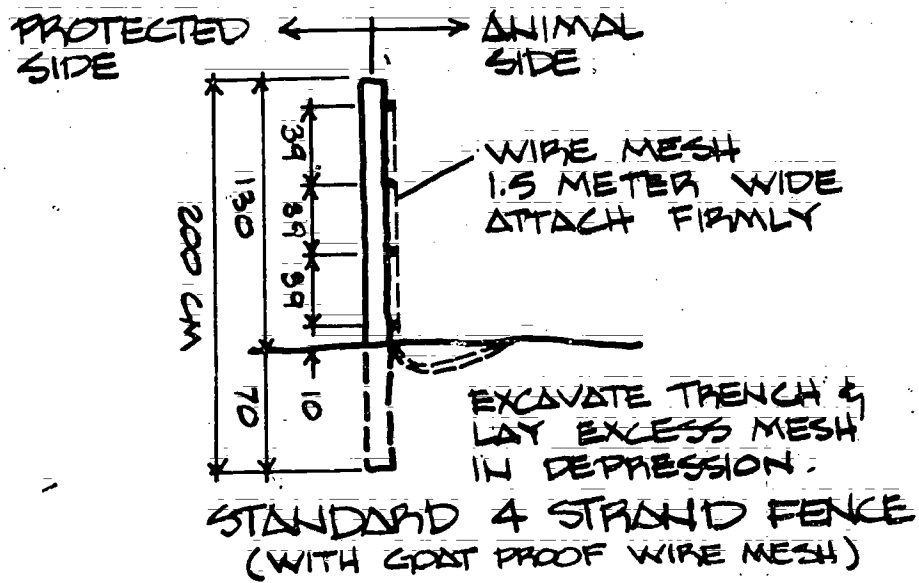

THORN LIMBS INTERWOVEN IN WIRE MESH
WOOD OR METAL POSTS
2 STAY WIRES BETWEEN POSTS

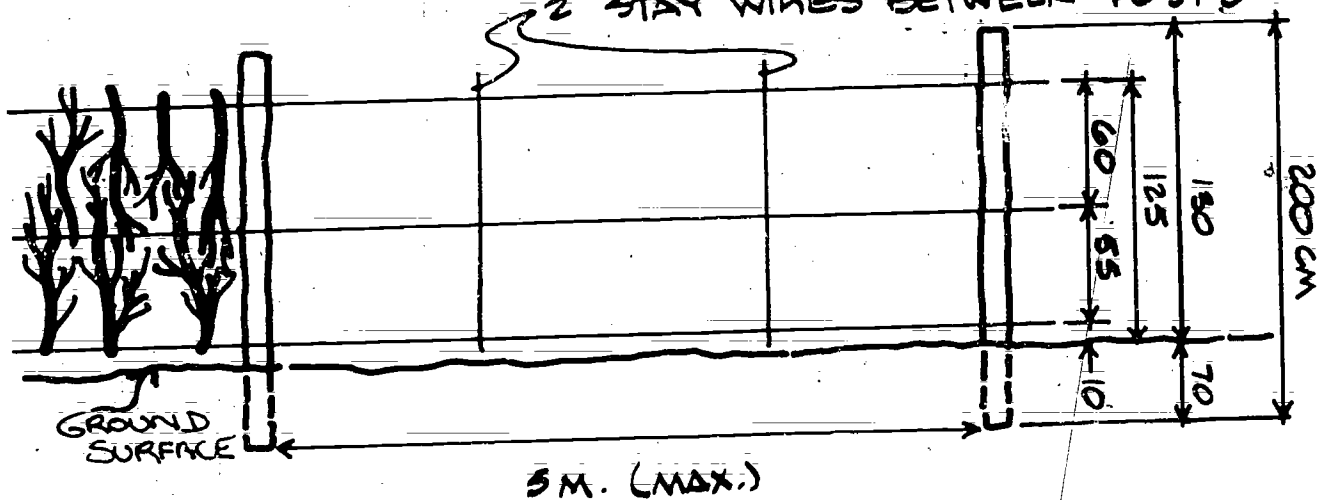

STANDARD 3 STRAND FENCE

(NOTE: MINIMUM IMPORTED MATERIALS)

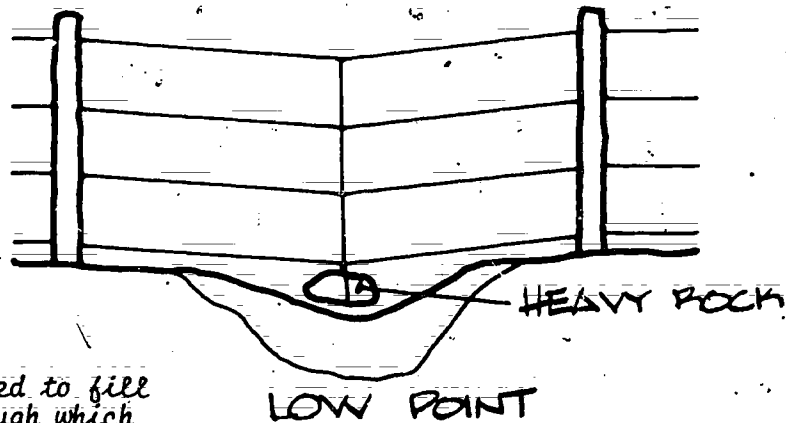

A heavy rock used to fill in a space through which animals might crawl and to maintain tension.

COMBINED PROTECTION. In most areas, it is a good idea to use a combination of fencing and surveillance. Often fencing materials are attractive for a number of other uses and may disappear unless the area is regularly patrolled.

There does not seem to be any one method of protection which is clearly the best since the decision must be based on such factors as local customs, willingness and ability of community residents to contribute to the protection of the trees, cost per tree and effectiveness of the methods.

When possible, foresters often try several protection methods in one project. Then it becomes easy to see when one is working better than another. And it sometimes is the case that a method which did not work at one site is successful at another because of differences in the factors mentioned above.

Seed Preparation

Some seeds may have to be ordered, and this should be done early. Other seeds come from trees in the area and are collected and prepared for use.

Collection

The best seeds come from strong, healthy parent trees. Fully ripened seeds are picked directly from the trees, or collected at least daily as they fall. (Collection can be made more efficient by spreading large pieces of cloth, mats, or tarpaulins under the trees to catch the seeds as they fall.) Whenever possible, seeds are collected as soon as they fall;

otherwise, many of them are attacked by insects and destroyed for seeding purposes.

Seeds purchased in the market must be fresh, undamaged by insects, and reasonably dry (but not dried out). Damaged seeds are less likely to germinate.



Fruit containing seed

Extraction

Seeds must be removed from the fruits and pods which contain them, and there are various ways to do this.

- Most fruits can be pounded carefully in mortars, bowls, or on clean, hard ground to separate the fruit from the seed. Then the seeds are cleaned out by hand or by dropping them through the air (mortar and wind separation). Most of the Acacias and Cassia siamea seeds can be extracted using this method.
- With other species, like Balanites aegyptica, the fruit must be soaked before the pulp can be removed and the seeds extracted and dried.
- Some seeds, like Ziziphus spinachristi, must be soaked to soften the pulp, and then only can the remaining hard shell be cracked with a hammer to remove the seeds.
- Others, like Parkinsonia acculeata, can be shelled easily by hand.



Extracted seed

Drying and Storing

The two most important factors in good seed storage are keeping the seeds dry and keeping them cool.

Wet seeds spoil and rot if they are stored, so seeds must be dried in the air first. Then they can be stored in dry containers,



BAGS

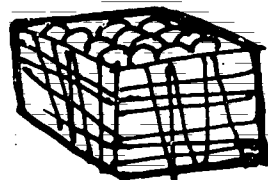

BOXES

such as jars, boxes and bags. Care must be taken to keep the containers off floors and away from walls. This practice helps keep insects and dampness away from the seed containers.

Store the containers so that air can circulate around them. This helps keep the seeds drier and cooler. Extreme heat can destroy the seed's ability to germinate. Seeds should not be left to dry under a hot sun for the same reason. For example, the viability of seeds like Eucalyptus is destroyed by temperatures above 40° C.

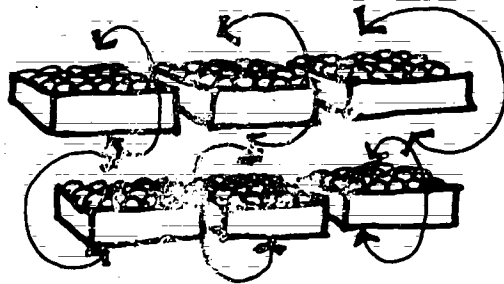

If at all possible, the seeds should be treated with some general insecticide to keep weevils and worms away. The containers should be checked frequently for damage to the seeds; the seeds should be turned over in their containers at that time.

Each container of seeds should be labelled with the following information:

Species:	Name
Collection:	Date Location Name of Collector
Storage:	Beginning date Treatment
Quantity:	Number of seeds in the container.

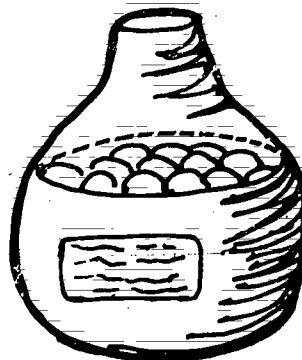

JARS

Once the water supply is fixed, the area fenced or protected in some way, the seeds ready, nursery activities can begin. Also, the preparations for the planting site should be underway. The site must be ready to receive the young trees from the nursery before the first rains. And fencing a large planting site is a big job.

6

Nursery Management

Administering the Nursery

Project managers must keep good records of all activities. Their accurate, detailed accounts make the project a valuable resource to others -- whether the result was success or failure.

Project Diary

Some foresters find that keeping a diary is a good way to record important facts. Information which relates to the amount of labor and time spent on nursery activities goes into the diary. The project manager records what he did; who else worked and what they did; how many hours were spent by each person on which activity. This information can then be used to (1) fill out time sheets for payroll records; (2) calculate how many work-hours it took to build 100m of fence or to stack 1,000 pots; (3) make cost and time estimates for future projects.

Other important data relate the technical details of the project. For example: How were the seeds collected and pre-treated? When were the seeds planted? How many were planted in each bed or pot? When did the seeds germinate? How much water did the seedlings receive? (Appendix B is a start at gathering in one place relevant nursery and planting data for certain West African species. This kind of information greatly facilitates planning of future projects.)

Field personnel should be prepared to keep the following records, in addition to the diary mentioned above:

Monthly Report. This report should include:

- . A summary of the activities of the previous month, based on the more detailed accounts in the diary;
- . A basic plan of activities for the coming month;
- . A brief explanation whenever actual activities differ from those which had been planned for the month.

Such comparisons and explanations enable both the project manager and the sponsoring agency to better understand and support the project, and, thereby, lead to fewer problems arising from lack of communication.

Project Reports. If necessary, separate reports of special project activities can be prepared using material from the diary and monthly report.

Technical Notes. These are notes made of conclusions and specific observations. This kind of information can be sent to the funding agency, evaluated, and, where appropriate, incorporated into new projects and training programs.

Ground and Soil Preparation

Tree Removal

The first step in preparing the nursery is to remove all but one or two trees which may be there already. These trees are kept for shading young trees until they can stand full sunlight. Aside from these shade trees, old trees and quantities of young trees simply do not mix: the competition for light and water damages young trees. If it seems wrong to cut trees down, it is sometimes possible to move them elsewhere. All remaining roots, stumps, and other vegetative matter should be removed from the area.

Nutrients

Ideally, if open-rooted stock is being raised, the soil should be fertilized to add nutrients. Open-rooted trees draw large amounts of nutrients out of the soil and special fertilizing efforts should be made, particularly when spading the beds for a new crop. Nitrogen and phosphorus are fertilizers of particular importance. Compost, animal manure, and green manure up to 90kg per hectare can help build or keep good soil structure. In many areas, however, fertilizers are not available or are too expensive to purchase.

Filling Pots

Good results have been achieved by mixing plain sand with sieved cattle manure at a ratio of 1:1. This is usually done by:

- heaping the mixture in sizable piles in the nursery near the location of the block beds.

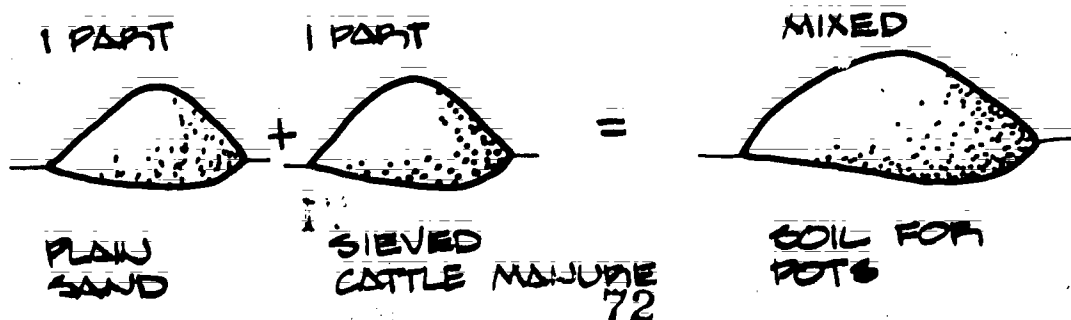

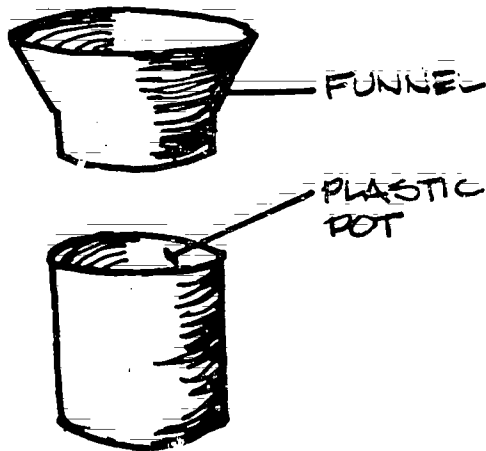

- filling the plastic pots using a metal funnel just large enough to fit into the top of the pot.
- scooping the mix into the funnel. The soil is lightly packed as the pot is being filled by tapping the pot on the ground with the funnel kept in place.

filling the pots full. Watering will cause the mixture to settle so that there is a 1/4 inch collar between the mixture and the top of the pot.

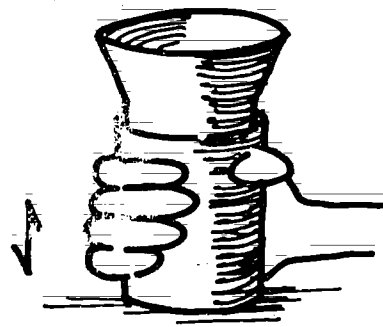

TAP POT ON GROUND WITH FUNNEL STILL IN TO LIGHTLY COMPACT SOIL

As some workers fill the pots, others set them in neat lines and rows. Although lining the pots up perfectly is extra work, it greatly reduces work during the rest of the nursery operations.

FILL POTS UP TO BRIM UTILIZING FUNNEL



Sinking Pots

Seeds planted in the outside row of pots should be protected against sunburn and excessive heat by slightly countersinking or burying the rows of pots. Use the earth dug out from this operation to build a ridge against the outside pots, thus creating shade for them.

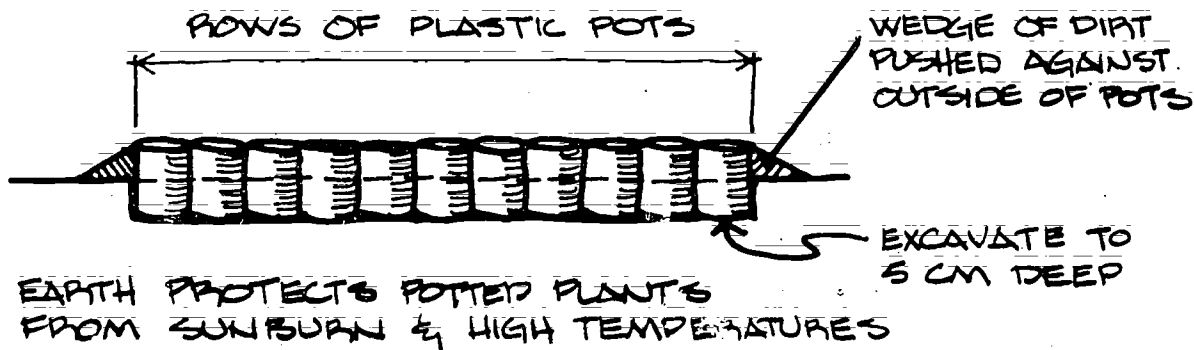

Seeding

Seeding involves prewatering, weeding, pre-treating and planting. Each of these steps is discussed separately.

Prewatering

The earth should be watered daily beginning two weeks before planting the seeds. Regular and gradual prewatering in small amounts (rather than adding a lot of water at the last moment) allows the water to mix evenly and thoroughly with the soil. The top 20cm of the soil should be moist. Water penetration of the soil can be checked by opening some of the pots to check the moisture levels inside.

Weeding

Prewatering causes weed seeds in the soil to germinate and become visible before the tree seeds are planted. Then all the germinated weeds can be removed. Weeding at this point saves time later and increases the young trees' chances for survival.

Pretreating

Many seeds must be treated in some way to give reliable germination results. Some seed coats are impermeable to water and will not germinate without help. Pretreating the plants causes them to germinate faster.

This is an important fact. Earlier germination makes it possible to plant without great losses: if some seeds do not germinate, the beds or pots can be reseeded without too much loss of valuable time.

As a rule, any seed that has a glossy, hard cover, as, for example, most of the Acacias, must be treated before it can be planted. Usually, treatment involves soaking the seed and/or scratching the hull. For example, here is one pre-treatment:

Warm stratification method.

- . Bring water to a boil in a suitable container.
- . Remove from the fire and let stand for five minutes.
- . Add the seeds and let them soak overnight.
- . Plant the seeds next day.

Eucalyptus seeds are germinated by the Nobila method shown here, or seeded by using the method illustrated on Page 66. Later, the seedlings are moved to pots or beds. In the Nobila method, capillary pressure in a special sand germinating mix is used to provide constant moisture around the seeds without having to use elaborate spraying or watering arrangements.

NOBILA METHOD FOR GERMINATING SEEDS

STEP 1

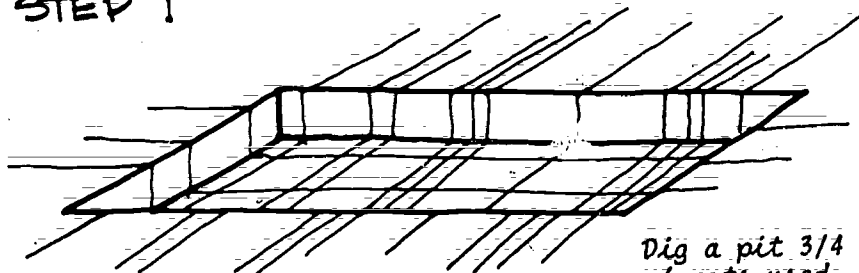

*Dig a pit 3/4 height
of pots used.*

STEP 2

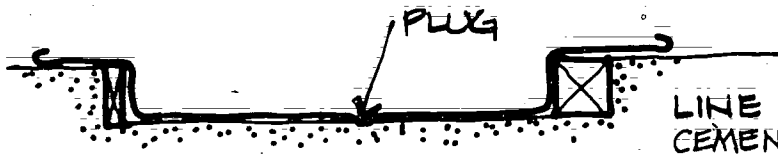

LINE SIDES WITH WOOD OR CEMENT BLOCKS OR SOMETHING SOLID TO FORM A FRAME. MAKE WATER PROOF "BASIN" WITH PLASTIC SHEET.

STEP 3

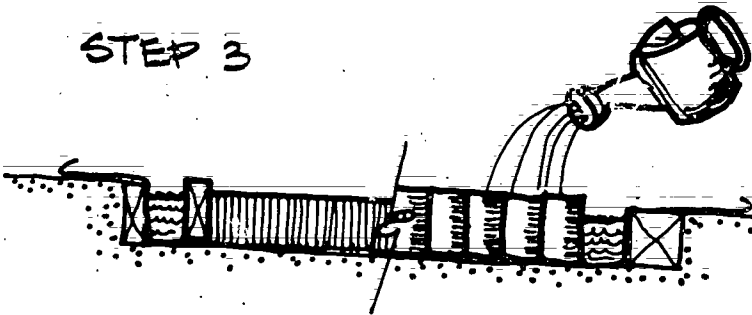

FILL BASIN WITH EITHER PLASTIC POTS OR BUILD A WOODEN FRAME INSIDE DEPRESSION; FILL FRAME WITH SOIL.

WATER SOIL & FILL BASIN WITH WATER, TO WITHIN 5-10 CM OF TOP OF SOIL. LEAVE TO DRAIN OVER NIGHT.

STEP 4

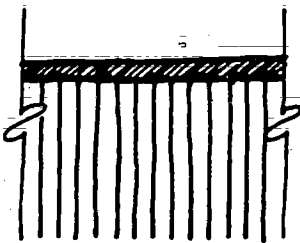

MIX SEEDS WITH FINE SAND & SPRINKLE OVER TOP. PUT 1MM LAYER OF FINE SAND/MANURE MIX OVER SEEDS.

NOTE:

KEEP SEEDLINGS MOIST BY FILLING BASIN WITH WATER

STEP 5

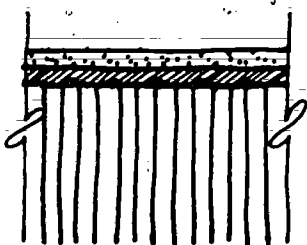

COVER SEEDS WITH ANOTHER 2-4 MM SAND

SEEDING

THIS SEEDING METHOD IS USED FOR MOST SPECIES:

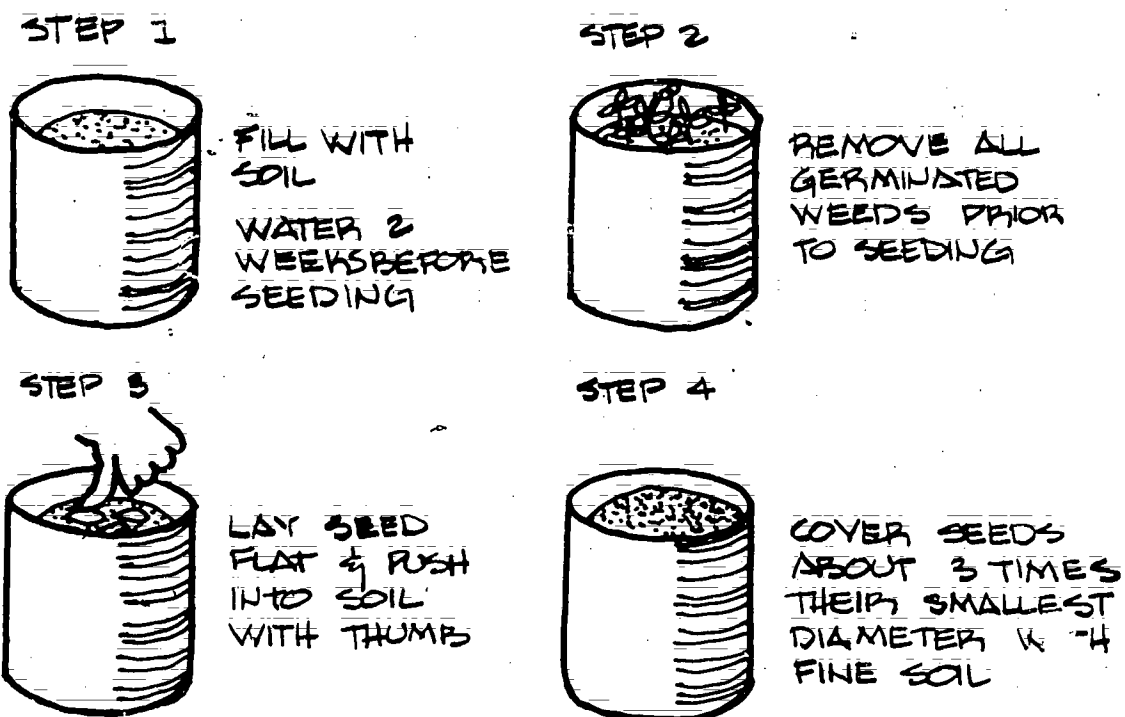

One notable exception is Anacardium occidentale which is planted upright rather than flat; another exception are Eucalyptus seeds because they are very small and must be planted using special methods (See Pages 65 and 66).

Seeds are spaced according to their predicted germination results. In other words, if germination results are expected to be high, fewer seeds are planted. Generally, one or two seeds are placed in a pot, depending upon the germination rate. In open-rooted seeding, extra seeds are planted. The seedlings are thinned to the desired spacing later. String can be used to lay out straight lines in the open beds. Weeding and cultivating are much easier when the trees are planted in straight lines.

SEEDING EUCALYPTUS

STEP 1



PUT 3-5 MM OF WATER INTO A CUP

STEP 2



MOISTEN NEEDLE OR THIN SLIVER OF WOOD TO A HEIGHT NOT MORE THAN 3 MM

STEP 3



PLUNGE THE NEEDLE INTO EUCALYPTUS SEEDS.

YOU WILL FIND SEEDS STICKING TO THE POINT

STEP 4

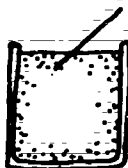

PUT THE PIN INTO THE SOIL AT A 45° ANGLE TO A DEPTH NO GREATER THAN 10 MM

NOTE: ANY WATERING METHOD MAY BE USED.

STEP 5



TRANSPLANT SEEDLING INTO EMPTY POT WHEN THE PLANTS ARE BETWEEN 25 & 50 MM HIGH.

Protecting Seedlings

If it is possible, seed beds should be mulched. Mulch is a special mixture of materials (for example, decayed leaves) which when piled on the seed beds keeps down soil temperature, lessens erosion damage, and helps the topsoil remain loose and crumbly. Rodent damage to young plants can be reduced by further covering the mulch with small branches.

One problem which might be worse when mulch is used is termites. If there are termites in the area, the mulch should be checked often and insecticide applied as necessary.

Watering and Cultivation

WATERING. Watering is relatively easy if plans have been made carefully. Even such improvements as water storage tanks beside the nursery beds are useful. The general rule for watering is simple: adequate amounts

of water are added at regular intervals. The water must be added gradually so that it does not form puddles or run off before it has a chance to soak in. The plants should be watered daily, including holidays. Such a watering schedule leads to improved germination and survival of young seedlings.

Seeds should be watered as soon as they have been planted and covered with soil. And watering should be done twice a day (of course, it is often necessary to make allowances for soil types and locations which may make more or less water necessary) for at least the first month. Plants should receive about 5mm of water at each watering. The top 20cm of soil in the pot or bed must be kept moist. Regular soil or pot samples will show whether the soil is sufficiently moist.

CULTIVATION. Young nursery plants should be weeded about once every 10 days. No fancier techniques are needed than those used in a small vegetable garden. The object is to get rid of weeds and to keep the surface of the soil loose and crumbly. Sticks or hand weeding tools are all that is necessary.

Thinning and Root Pruning

THINNING OPEN-ROOTED STOCK. Young trees must be thinned out: the single most frequently made mistake in raising open-rooted stock is failure to thin the young plants. When there are too many young plants in crowded conditions, the resulting trees are of uneven size and have poor root development. Many trees will die if thinning is not done at the proper time.

Trees should be thinned before root competition becomes severe. The best time is usually when the trees are between 10 and 15cm tall. Thinning is done by:

- . placing a 5cm-long stick lengthwise beside the first stem;
- . removing all the stems that may be growing between the first stem and the end of the stick;
- . allowing the first stem not touching the stick to remain; and
- . lifting the stick, placing it next to the stem allowed to remain, and repeating the entire process.

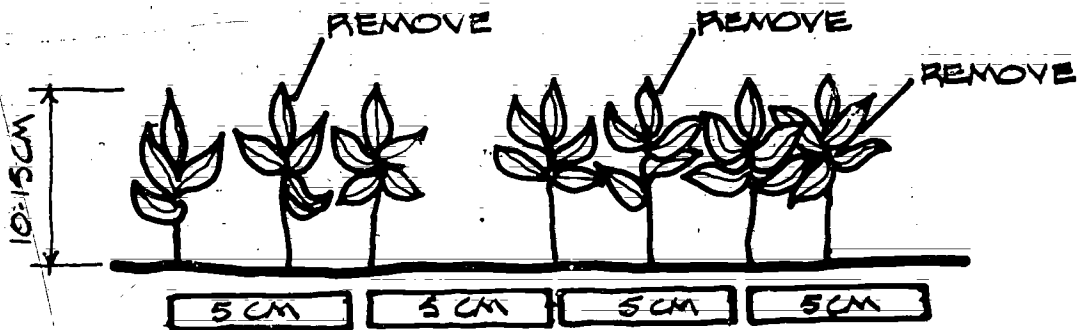

THINNING OPENROOTED STOCK

Sometimes empty spaces in beds can be filled with plants that become available as a result of a thinning operation in nearby beds. This has been done successfully with Mirachta indica, Prosopis, Parkinsonia, and even with some Acacia. Such an operation will succeed if the following precautions are taken:

- Roots of trees being transplanted do not exceed 5cm.
- Dirt is left around the roots when lifting out is done.
- Plants are handled carefully and not injured.
- Roots are exposed to air as little as possible.
- Experienced workers with proper tools do the work.
- Airpockets around roots are eliminated by gentle pressure -- earth must not be packed too hard.
- Trees are planted at the proper collar height.
- Freshly transplanted roots are kept moist.
- Plants are kept shaded until they are growing well in their new location.

If there is enough seed available and time is not a problem, it is probably better, in the long run, to reseed empty spaces or pots than it is to transplant young plants from the thinning operation.

ROOT PRUNING. Plastic pots must have some drainage, and thus are perforated in the bottom. Small roots will grow out the hole(s) into the soil below. If nothing is done to prevent it, the tree will develop a second root system below and outside the pot. Consequently, those roots which grow below the pot and which are the major part of the root system will be destroyed when the pots are moved. This kind of situation defeats the main objective of using pots which is to allow trees to be moved and planted with the least disturbance of the root structure.

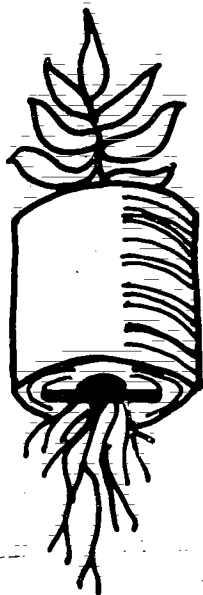

**CUT ALL ROOTS
WHICH ARE GROWING
OUT OF THE BOTTOM
OF THE POT**

Root pruning prevents the development of a root system outside the pots. Generally, after the first 6 to 8 weeks (for Acacias, it is earlier), all trees in plastic pots have to be moved once a month, the outside roots cut off, and the pots set back in place.

To reduce work, each block of pots can be shifted, pot by pot, a convenient, arm's length distance. To do this a worker picks up a pot with one hand, prunes the roots with pruning shears,

transfers the pot to the other hand and puts the pot down on the other side. When pruning is finished, the entire block of pots will have been moved.

Insects

It is best to be prepared for insect attack by having insecticides on hand, or by knowing where they can be found quickly. In West Africa, a product similar to American methoxychlor, or HCH, and dieldrin, similar to American chlordane, are available in the bigger towns.

Insecticides kept at the nursery site must be stored and handled with extreme care. Improper use of dieldrin, for example, has caused a number of deaths. Dieldrin is very effective against termites, maggots, and other soil insects when it is used according to directions. It is important to follow the cautions given on the label. Dieldrin must be used so that none of the insecticide gets on the foliage of the trees -- even small quantities will burn holes in the leaves.

Most above-ground insect problems can be controlled

The manager and other project personnel must watch constantly for signs of insect attack and be prepared to respond immediately when insects are first noticed. Insect attacks can be quite rapid, and delay in treating the trees has been known to result in loss of much of the planting.

Transporting

The general rule of thumb for judging whether a tree is the right size for transplanting is that the above-ground portion of plastic pot stock should not be less than .2m and no more than 1.0m tall. Open-rooted stock should have between 1.5m and 2m of growth above ground.

However, great variations exist among species in the ratio of above-ground growth to root systems. For example, Acacias have very long root systems compared with their portion above ground; Azadirachta indica develop rather tall, single shoots over a limited root growth. The only way to check whether a tree is growing as expected and to find out the relationship of above-ground growth to root system is to expose the root systems of a few sample trees of each species.



When lifting-out open-rooted stock, it is usually the case that no more than about 20cm of the root depth can be excavated without damage. Obviously a tree that has a major portion of its roots below this level cannot be transplanted safely; therefore, the trees must be checked so that they can be transplanted on time.

HARDENING OFF. Hardening off is the gradual reduction in watering rates during the last few weeks in the nursery. This lessening of water helps prepare trees for the less steady water supplies they are likely to receive at the planting site. About 4 to 6 weeks before moving time, water is reduced to once a day. After about a week at that rate, the young trees should be watered only every other day. If the trees do not begin to wilt, the amount of water can be reduced even further. If, however, the trees do wilt, additional water must be applied immediately to prevent permanent damage.

PREPARATION FOR MOVING. Normal, relatively heavy watering should be resumed at least three days before lifting out and/or transport. The objective of this last period of watering is to have the soil evenly moist; this cannot be accomplished by heavy watering at the last minute.

The soil in open-rooted beds, and in certain pots should be checked to make sure the soil is moist enough -- before transplanting. It is physically impossible to transplant potted stock when the bottom half of the soil in the pot is dry.

If open-rooted stock is lifted out of soil which is dry, the roots tear. Also, tiny hair roots are immediately exposed to air because the dry soil around them falls off.

During moving and transplanting, the tree roots must be kept moist; the trees must be kept in the shade as much as possible.

7

The Planting Site

Preparation

Site Factors

The planting site should be completely ready well before the first rains are due because the trees must be transported in time to catch the very first rains.



Planting area staked out.

Well before the trees arrive, the fence or other protection should have been planned. The control of land use at the site and the lines of authority involved should be clear to everyone in the area.

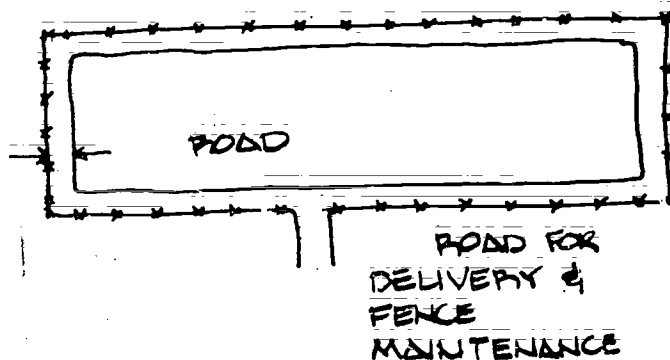

Access routes to large sites should have been established, and road work completed, if necessary. In large sites, a 6m strip should have been left just inside the fence so that a truck can pass through, and the fence can be repaired easily. If the site is large enough to have firebreaks in addition to space left for the roadway, the firebreak areas also should be planned and completely cleared.

Access routes to large sites should have been established, and road work completed, if necessary. In large sites, a 6m strip should have been left just inside the fence so that a truck can pass through, and the fence can be repaired easily. If the site is large enough to have firebreaks in addition to space left for the roadway, the firebreak areas also should be planned and completely cleared.

Plan to provide water for the trees as soon as they are placed in the planting site. The soil at the site must be moist: the tree roots cannot be placed into dry ground if they are to survive.

As noted before, the only time to plant trees is at the beginning of the rains. When planting is delayed, survival rates decrease greatly. Transplanted trees need the entire rainy season to get a good start. Therefore, nothing can be gained by planting in the second half of the rainy season, even if there is more cloudy, wet weather than usual.

The limited time span during which successful planting takes place requires proper planning and adequate preparation. Preparation should include alternative plans for action and substitute resources in case difficulties occur.

Personnel Management

Dependable work crews should be developed. Start training relatively early with a small group so that activities can be well explained and shown in detail. Leaders will start showing up in people who have more experience, and who are willing and able to accept responsibility. As these people are found, they can be given extra training and prepared to become supervisors or crew chiefs.

Having good crew chiefs means that during times of maximum effort, the routine work will be carried out competently and well and automatically. Project managers will have more time for dealing with urgent, special problems as they arise.

Project managers should teach by demonstration, as well as through discussion. During this teaching process, there will be an opportunity to watch different people and see how they master techniques. The manager will get a good idea of those who are most capable. Activities and jobs may have to be explained again and again, but explanations must be done positively in order to provide encouragement and to build enthusiasm and support for the project.

High quality work and proper tool use and maintenance are far more important to the effort than is speed. The most effective means of teaching this is to provide the crew with a good model. If the project manager makes a point of maintaining his own equipment by cleaning it and putting it away properly, the lesson will have been effectively taught. Everything a project manager does, whether the crew members are watching or not, should be consistent with the techniques and values he wants to encourage in the other personnel.

Project managers who are on time, plan well and do what they say they are going to do will have more support and better projects. People enjoy working with someone who is in control of a situation and knows what he is doing. The ability to self-analyze and willingness to accept suggestions from crew members are indicators of a good project manager.

All of these personnel development activities should be started well before planting. The goal is to establish a team of people used to working together, so that when the actual work arrives, each knows what to do without being told. The crew bosses will work without being supervised all the time. Staff sessions held to brief them and encourage crew bosses can help to prevent problems and misunderstandings from occurring.

Other Factors

It is difficult to give specific guidelines for organizing planting work because each project is distinctly different. However, foresters often find the following pointers helpful:

- Make contingency plans, especially for transportation and labor. It is very important that no delays occur. Planting is the time when careful planning and good relationships with the workers and the community pay off.
- Plan realistically and attempt only what can be accomplished. A small, solid job, well done, is worth more than a marginal performance on a bigger scale. Goals should not be set so high that they cannot be achieved.
- Each planting effort is worthwhile and is worth of the same degree of personal commitment.
- Weather factors can, perhaps, be planned for, but not controlled. There is a limit to the project manager's ability to guide the project, and it is important that he realize he cannot do the impossible.

Lifting Out, Transporting, and Planting

Throughout the operations of uprooting, transporting, and planting, the workers must have plenty of room. It is a good idea to set up a number of small deposit points for unloading trees so that hand carrying can be kept to a minimum. Each team should know in advance the exact area in which it will be working. As soon as the work plan is ready, it should be discussed at staff meetings. Each crew chief, therefore, will know what he and his assistants must do. If everyone is sure of his job, the work should go much more smoothly.

REMOVE & TRANSPORT
MATERIAL FROM
NURSERY

START AT EXIT GATE FIRST

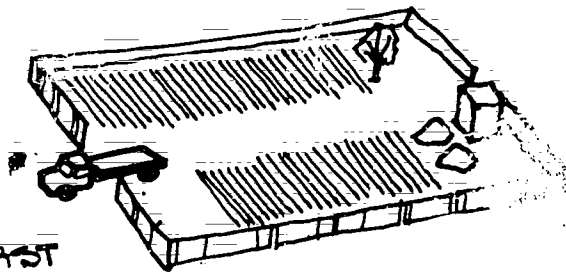

Moving Nursery Stock

PLASTIC POTS. Transporting plants in plastic pots is relatively easy on the plants, but is more difficult in other ways (the pots are heavy, for example). However, since well-watered pots can be loaded and transported to the site at any time, it is possible to start moving potted stock beforehand in smaller batches.

OPEN-ROOTED STOCK. The young stock must be dug up slowly and carefully using shovels and strong, local tools to dig carefully around the roots.

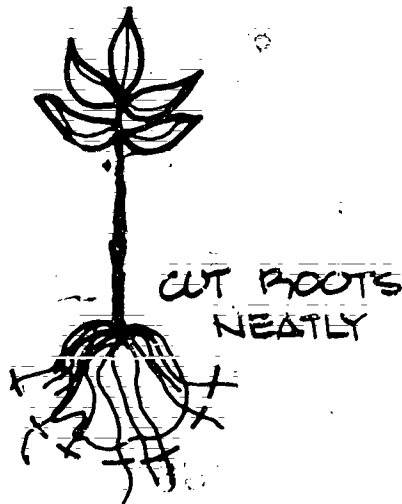

Even during careful digging, the majority of roots break. These breaks sometimes leave long, tearing wounds through which the tree loses liquid, and disease can enter. Therefore, as soon as open-rooted trees are lifted out of the ground, the roots, especially the big ones, must be cut off neatly.

Lifting-out and root pruning must be done as quickly as possible.

After the roots are pruned, the trees are bunched in groups of 20-50. Wet mud gets packed around the bunched roots. A layer of wet grass or leaves is then placed over the mud. Then the entire bundle is tied together well. Water should be poured over the bundle before it is loaded and taken to the site.

SPECIAL PREPARATIONS. Some special preparations are used to reduce transpiration (loss of moisture through the leaves) when lifting out open-rooted stock. These preparations help maintain the balance between root and leaf systems until the roots have a chance to re-establish their supply functions. Otherwise the fluids in the plant are used up faster than the newly transplanted roots can take in a new supply.

Some trees such as *Azadirachta indica* and *Kahya senegalensis*, should be stripped of all leaves, except for the terminal bud and the last two or three near it. The plant must not be ripped and torn, so stripping has to be done carefully. Also, the terminal bud must not be damaged. The leaves are stripped as soon as the tree is lifted out and before the bundles are made. The stripped leaves can be used for packing and wrapping material to protect the roots during transport.

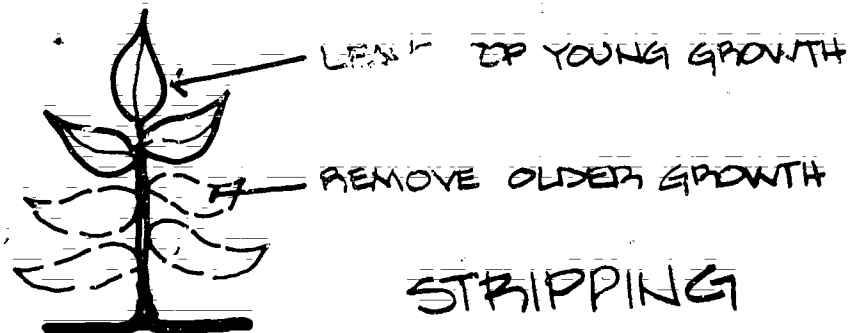

Some trees, *Cassia* and *Gmelina*, for example, can stand even more extensive cutting. In fact, they seem to recover best if the entire top portion of the tree is cut back 5-15cm above the ground line. The result is a rather odd-looking short stem attached to the first 15cm of its roots. In both these methods, roots must be kept moist. Many stumps can be transported in very little space.

Remove entire top from *Cassia* and *Gmelina*.

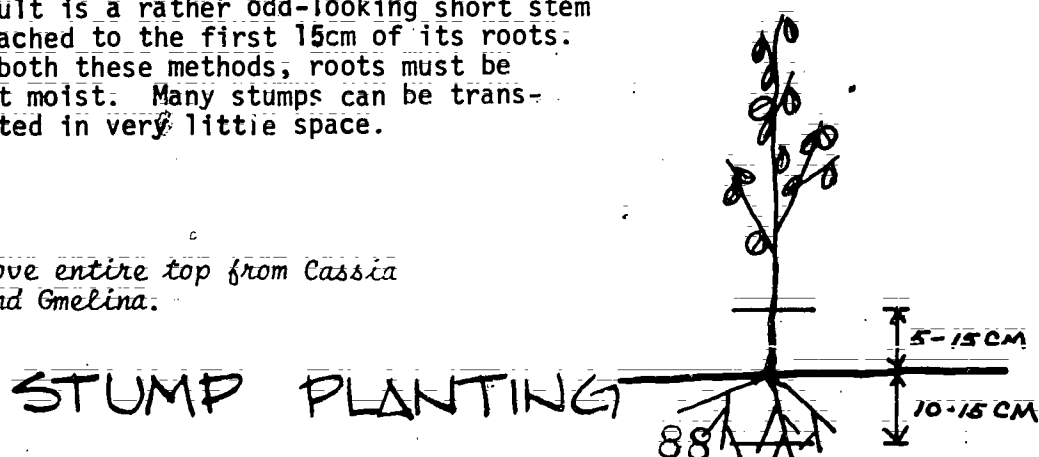

Planting

Planting includes clearing the ground, digging the hole for the tree, planting the tree, and refilling.

Clearing

The area around each tree's location should be cleared of all vegetation, including all the roots of the vegetation. Each tree should have a cleared area of at least 1m^2 in which to grow. This spacing eliminates all competition for food and water and gives the tree a better chance for a good start in the new location.

Digging

In areas with less than 1,200mm mean annual precipitation, holes should not be dug before they are to be used. The purpose of pre-digging is to allow rain to fall directly in the hole, thus supplying moisture. However, this technique does not work in dry areas for the following reasons:

- Rains are usually driven by the wind so that the drops hit the sides of the hole, rather than reaching the bottom and;

- as soon as the showers stop, the sun and wind dry out the holes and piles of excavated dirt. This drying process leaves the soil drier than before it was before digging.

Each hole should be approximately 40cm X 40cm. This size should hold the tree or plastic pot easily. When digging, the soil is placed in two equal piles, one on each side of the hole. This technique greatly speeds backfilling. The soil from the bottom of the hole should be put on top of the piles; the soil will then be placed against the bottom roots when backfilling starts. This is done because the soil from the bottom of the hole is the best soil and holds more moisture.

Planting

Plant the tree so that its collar is even with the ground. The collar is the point where the tree's stem came through the surface of the soil in the pot or the nursery bed. This is an important step. If the collar is misplaced by as little as 1cm, the tree's chances of surviving can be much poorer. The first small roots often start right under the collar, and these roots must be carefully covered if the tree is to grow well.

Finding the collar of open-rooted stock is more difficult because the collar of the potted stock is right at the top of the soil in the pot, and the soil remains around the plant. It is worth taking time to be sure that everyone handling the plants knows where to look for the collar.

Backfilling

Backfilling is done carefully by hand. The soil from the top of the piles is put around the bottom root structure of the open-rooted stock or the bottom soil of the potted stock. The person doing the planting should tamp the soil with his heel to get rid of air pockets. Tamping is done diagonally against the bottom of the roots.

After the hole is filled, a layer of loose soil is left around the tree. This loose soil is shaped into a shallow depression that acts as a basin to catch additional water.

Decayed organic matter (mulch) can be put around the newly planted trees if such material can be found. Again, it is necessary to watch for termites when mulch is used. Pages 81 and 82 illustrate the steps involved in planting open-rooted and potted stock.

Delays

The trees must be watered abundantly the moment they arrive at the site. Delays in planting, whether overnight or longer, (at either the nursery or the planting site) call for special techniques to be used.

Plastic pots, placed close together, are sunk into the soil.

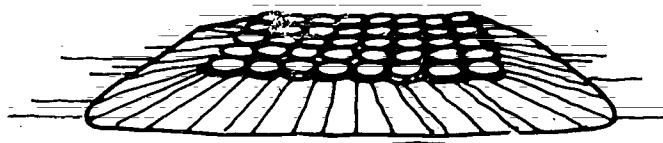

NOTE: PLANTS
NOT SHOWN IN
SKETCH

POTS COUNTERSUNK IN SOIL

Open-rooted stock must be "heeled-in", as shown on the following page.

HEELING IN OPEN ROOTED STOCK

STEP 1

DIG TRENCH
EAST TO WEST

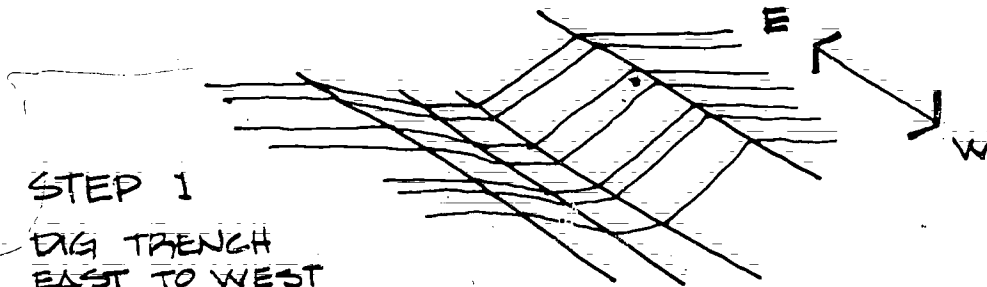

STEP 2

LAY PLANTS
IN ROWS ALONG
THE SIDE OF THE
DITCH

REMOVE ANY WRAPPINGS

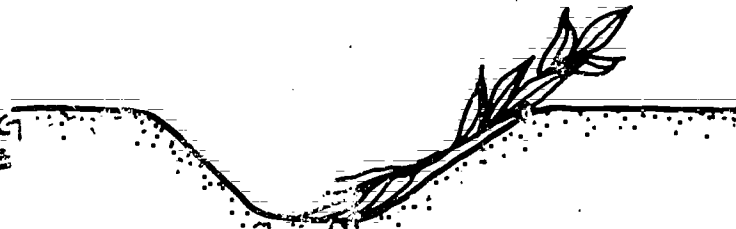

STEP 3

COVER WITH
SOIL ALMOST
TO THE TOP OF
THE BRANCHES

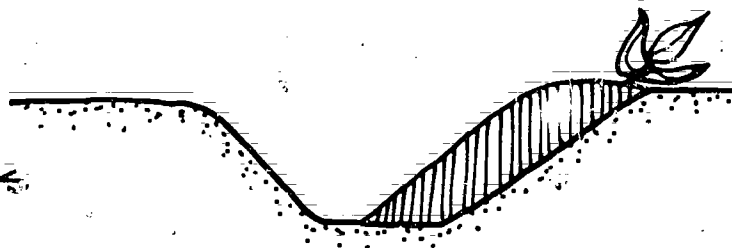

STEP 4

LAY IN NEXT
ROW OF PLANTS
& COVER THEM AS
BEFORE

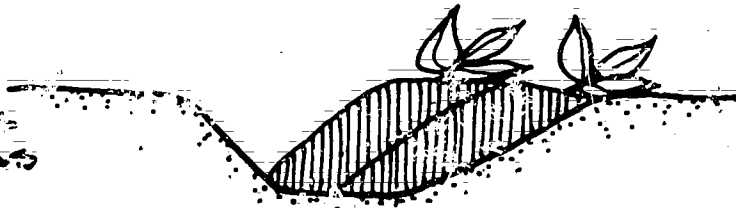

REPEAT PROCEDURE UNTIL ALL PLANTS ARE HEeled IN.

PLANTING POTTED STOCK

STEP 1
DIG HOLE PLACING SUBSOIL
ON TOP (AS FOR OPEN ROOT)

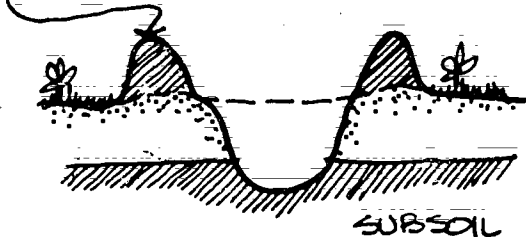

STEP 2
CUT BOTTOM
FROM POT

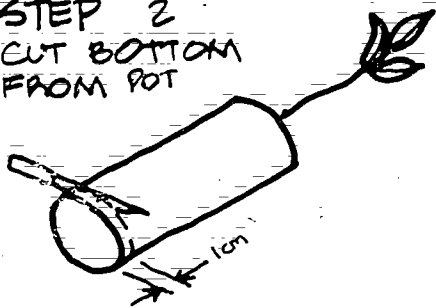

STEP 3
CUT POT LENGTHWISE

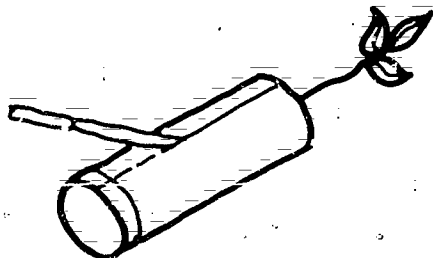

STEP 4
PLACE POT IN HOLE (HOLD
POT TOGETHER WITH HANDS)



STEP 5

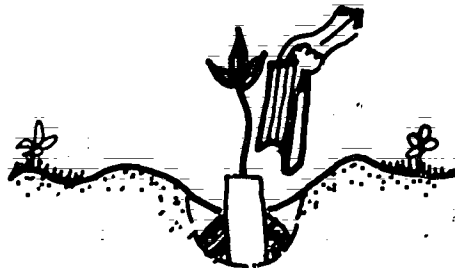

BACKFILL, THEN REMOVE POT

STEP 6

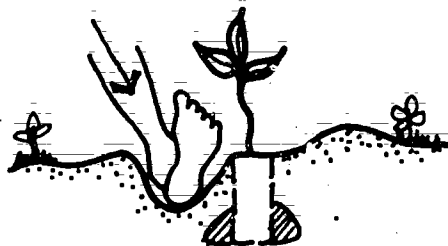

REMOVE AIR POCKETS.
PACK SOIL FROM 2 OR 3
DIRECTIONS
AS SHOWN.

STEP 7



MAKE SLIGHT DEPRESSION
AND MULCH WHERE
POSSIBLE

PLANTING OPEN FLOATED STOCK

STEP 1

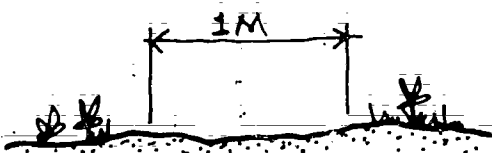

CLEAR THE GROUND OF ALL VEGETATION AT THE TREE LOCATION

STEP 2

DIG HOLE PLACING SUBSOIL ON TOP

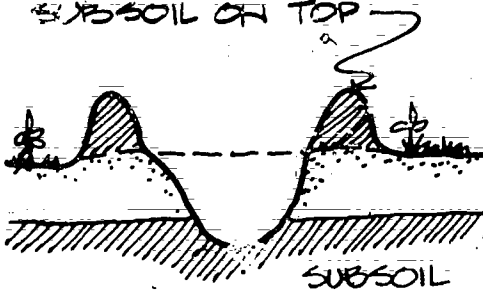

STEP 3

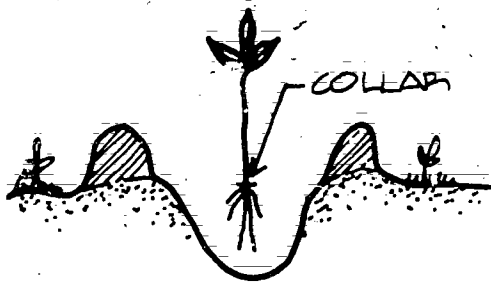

HOLD TREE ABOUT 3CM BELOW ITS FINAL POSITION

STEP 4

RAISE TREE TO FINAL POSITION AFTER SOME SOIL HAS BEEN PLACED AROUND ROOTS

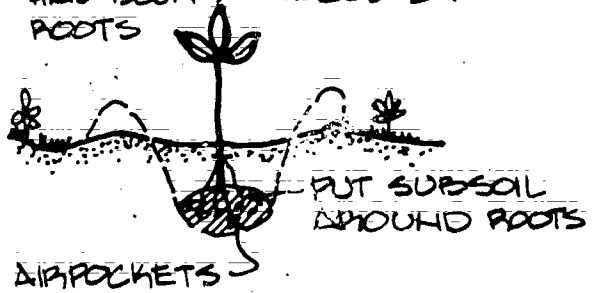

STEP 5

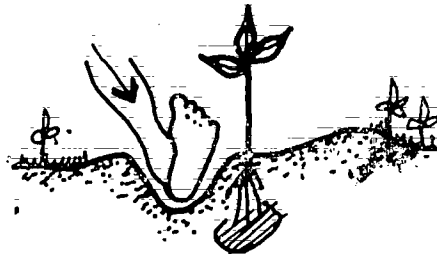

REMOVE AIR POCKETS

STEP 6

SLIGHT DEPRESSION

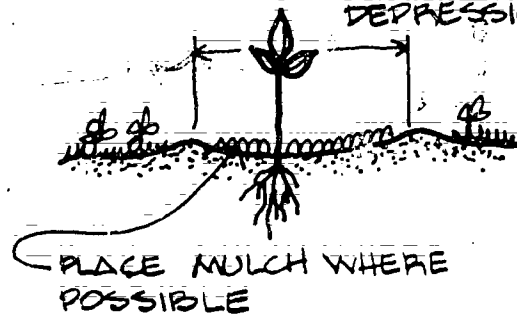

NOTE:

PACK SOIL WITH HEEL (AS SHOWN, STEP 5) FROM 2 OF 3 DIFFERENT DIRECTIONS

Special Procedure

There is a special planting technique which, only used at present for planting shade trees around villages, might be considered. The clay jar reservoir method has a number of advantages and disadvantages. The advantages are:

- The soil does not become hard and crusty around the base of the tree.
- The roots are kept evenly moist, not being subjected to alternate wetting and drying.
- The roots will grow down around the base of the clay jar in search of moisture.
- The amount of water needed is reduced (by 1/3 to 2/3) because evaporation from the soil does not take place.
- The growth rate of the tree can be doubled in the first year or two and its heartiness is greatly increased.
- The survival rate is increased.

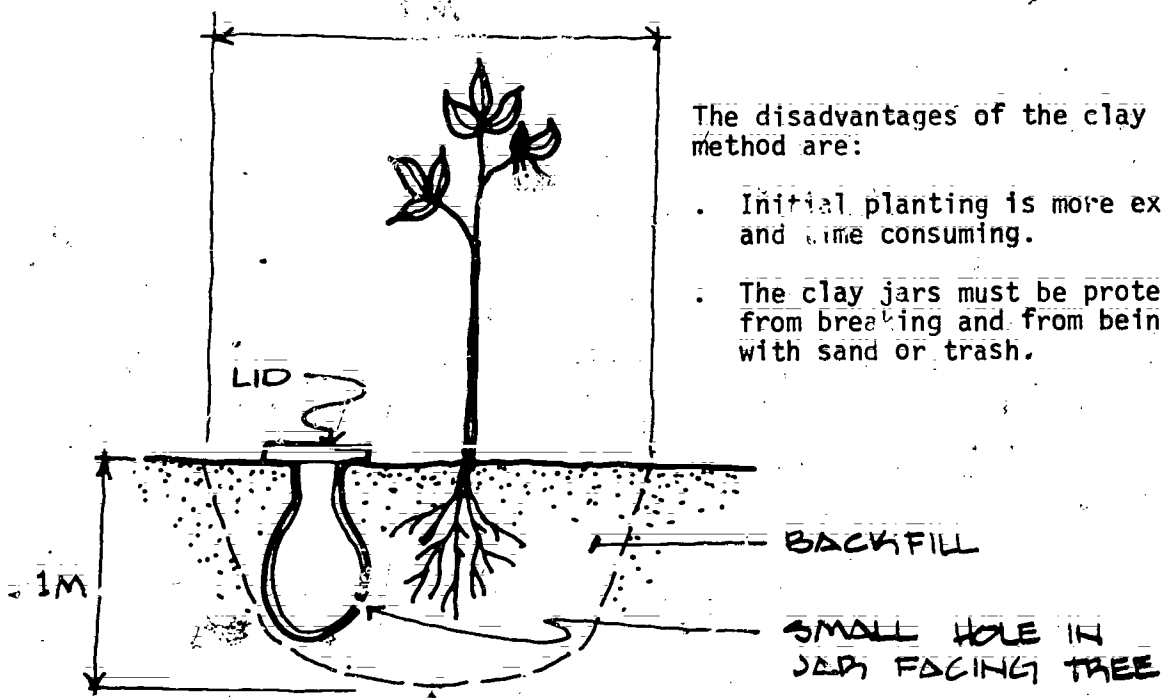

In most West African markets, clay jars, 40-50cm deep and 25-30cm in diameter are available. Make a hole in the jar about 4cm up from the bottom. The size and number of holes depend on the soil at the planting site: in sandy locations a small hole (half the diameter of a pencil) should be sufficient; in a site with very heavy soils, two or more (pencil sized) holes located side by side may be needed.

To plant the jar:

- Dig a large hole about one meter square and one meter deep.
- Partly refill the hole with a mixture of organic fertilizer (if available) and wet soil.
- Place the clay jar to one side of the dug-out space with the holes in its bottom facing the center of the area where the tree will be planted. The mouth of the jar should show above ground level only a few centimeters.
- Plant the tree in the center of the hole about 20cm from the clay jar.
- Continue refilling the hole in the ground with the mixture of wet soil and fertilizer.
- Fill the jar with water and cover the top to keep the water clean and prevent evaporation.

For the first 3 or 4 weeks after planting, the tree roots grow toward the moist soil at the bottom of the jar. During this time keep the jar full but water the tree by pouring water around its base.

After this time, the tree is watered only by filling the jar with water. If the hole in the jar has been correctly matched to the soil consistency, a jar of water should take about 1 week to flow through the hole into the ground. Keep the level of the water in the jar high water every 2 or 3 days. The holes in the jar can be made if necessary:

- Dig out entire jar, enlarge holes, and replace. This must be done very carefully, or the tree may be injured.
- If the mouth of the jar is large, reach in with a sharp nail or drill bit and carefully enlarge the existing holes or add another.

Remember: Keep the level of water high by adding water every 2 or 3 days. However, just a trickle of water is necessary to keep the tree watered. Do not make the holes too large.

Spacing

Based on experience relating spacing to groundwater tables, most trees in West Africa are now planted with an average of 3-4m between trees. This, of course, differs depending upon the kind of tree and its needs. The following figures can be used as a guide in determining the number of trees which can be planted in a site depending upon area needed by the tree.

<u>AREA PER TREE</u>	<u>TREES PER HECTARE</u>
2 X 2 meters	2500 trees per hectare
3 X 3 meters	1100 trees per hectare
4 X 4 meters	600 trees per hectare
10 X 10 meters	100 trees per hectare

Some, if not most, of the large trees of West Africa seem to be loners, for example, Acacia albida and Tamarindus indica. Plant these and similar species in small groups to ensure that one plant will survive.

Sometimes a lot of time is spent spacing trees very exactly. This is often done in areas where cultivation will be practiced using tractors and other vehicles. However, this use of vehicles is not as likely in a village situation or where the ground is very rough. In these cases, exact spacing is not called for, and it is better not to waste time trying to space the trees exactly. Spacing can be done very simply and easily by determining how many shovel lengths or steps must be left between each of the trees which is being planted. Then work crews space the distance using shovels or footsteps as measures. The first line of trees is planted along a boundary line such as a firebreak or road. The second line is then placed in line with the first.

Survival

If the trees have been properly cared for, if no animals get into the planting area, and if there are no attacks by insects and rodents, survival of the trees depends directly upon the weather immediately after planting. Cloudy weather with frequent showers for the first 3 or 4 days after planting can mean that up to 90% of the trees survive. A dry spell lasting several days after planting, on the other hand, can reduce the percentage of survival to 30%. Abundant rains during the rainy season help plants to build up reserves and roots which are long enough to reach down to lower water tables during the dry season.

Generally, only those trees that are weak, diseased, or slow starting are affected by insects, rodents, and disease. Also, trees that look dead above the surface may resprout from the ground up the following year if conditions are good. While they may always be stunted, they can add to the ground cover.

8

Special Subjects

Fires: Uses and Prevention

Mention has already been made of the need for firebreaks around both the nursery and the permanent site. These serve as protection from fire. Fire does, however, have some important positive uses.

In arid zones, fires are used to burn off old grass. Once that growth is gone, fresh tender grass is more likely to sprout. This happens quite quickly and can help bring relief to starving herd animals. It also breaks the tendency of scrub trees and bushes to take over the grass range.

Where vegetation is plentiful, methodical burning is a traditional method of clearing land before planting, keeping snakes and insects in check, and driving wildlife into traps or within range so that they can be killed for food.

Fire requires oxygen and fuel; if either is eliminated, the fire will not burn. Fire prevention and control consist of removing one of these elements. Normally, the easiest to remove is fuel.

Firebreaks

In sub-Saharan West Africa, prevailing winds tend to be high and constant. Thus the spread of a fire can be reasonably well predicted, and the necessary width and direction of firebreaks fairly accurately calculated. Firebreaks should be constructed at right angles to the direction of prevailing winds with secondary lanes dividing the resulting strips of land or trees.

The high winds dictate wide firelanes in order to keep the danger of the fire jumping the lane to a minimum. Inside planting areas, maintenance and access roads can be combined with strips of cultivated land adding additional width to the firelanes. As previously mentioned, good protection has been achieved by clearing strips of land 15m wide of all vegetative matter and allowing the land to be used for cultivating beans or as roadways -- either use guaranteeing elimination of dry grass and weeds.

Plowing the natural vegetation under provides only temporary relief; in the long run, the area becomes a larger fire hazard. Disking and plowing eliminate perrenial plants, but make more room for annuals, which tend to become dense and dry creating a high burning index. When this happens, the fire spreads more rapidly in the firebreak than on the adjacent land.

Firefighting

Most firefighting efforts are limited to what materials can be found on the spot. Provided the fire is not yet large or too hot, the front of the fire can be attacked directly with branches, brooms, and mats. This is an effort to beat out the flames and kill the fire by shutting off its supply of oxygen.

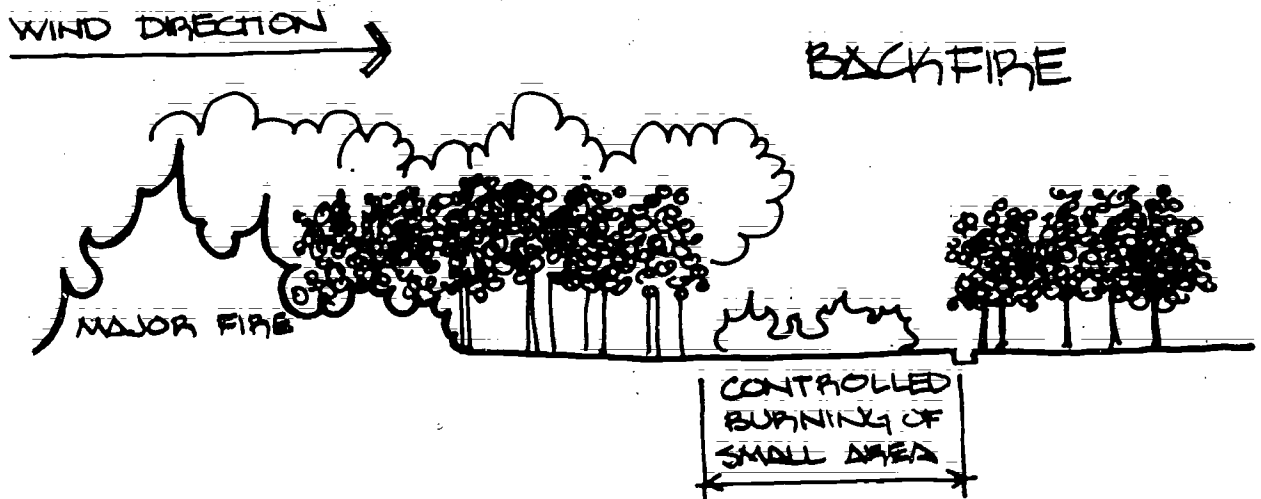

Backfires can be quite effective, particularly in areas where the normal vegetative cover is sparse, the prevailing winds are constant, and necessary control lines can be constructed quickly and easily. A backfire is simply a small, controlled fire started in the path of a larger fire. The backfire destroys fuel, and thus halts the larger fire which has no new fuel to burn.

Windbreaks

Windbreaks--strips of trees and other vegetation which block the flow of the wind--are very important in the battle against wind and sand. The most successful windbreaks are those found on enclosed farm lands or demonstration and pilot projects under government or private control. The biggest problems in other areas have been the difficulty and high cost of protecting windbreak trees against animal grazing. It is worthwhile, however, to continue the effort to plant and maintain windbreaks.

The effectiveness of the windbreak depends on how impenetrable the wall of vegetation is. A dense row of trees not only blocks the wind, but also confines the effects of the wind close to the windbreak. A row of

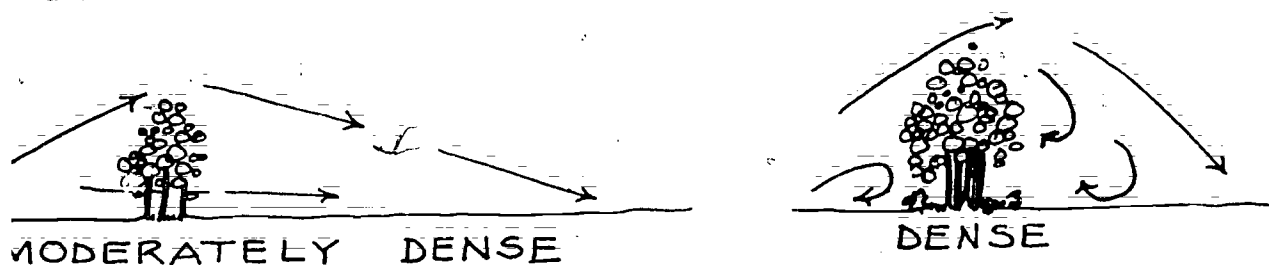

trees which provides less complete wind reduction also means that the effects of the wind are felt further away. A vegetation density of 60% to 80% seems to work best in arid zones.

Gaps or openings in windbreaks should be avoided as much as possible. Wind rushes through gaps, concentrating its strength, so that its final effect can be very damaging.

Shelterbelts

A shelterbelt is generally wider and more dense than a windbreak. It can provide protection for downwind areas up to 20 times its height provided it consists of several rows of plants of different heights. Large trees should be chosen for the center row (A). Fast growing species can be mixed with slower growing trees, the choices depending on local preference. The next two rows (B) are of smaller species. If possible, these trees should be chosen for their by-products. Rows C and D are auxiliary rows. These rows are planted with lower, bushier trees, shrubs and grasses. A well-chosen "mix" of vegetation in the shelterbelt will not only provide protection from the wind, but will also yield fruit, nuts, firewood, bark, resins, and possibly grass for grazing.

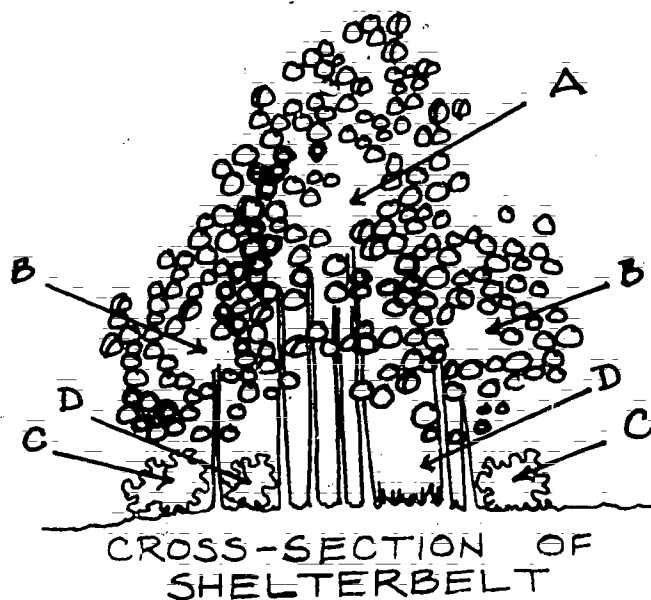

Windbreaks and shelterbelts can include carefully planned pathways and driveways for stock. In this way, people and animals can benefit from a shaded passageway that otherwise would be very hot. Any opening through the windbreak should be at an oblique angle. This will allow the orderly movement of people or livestock without opening a gap for the wind to roar through.

This windbreak is protecting the cropland from high winds which would carry away topsoil and make the land useless for farming.

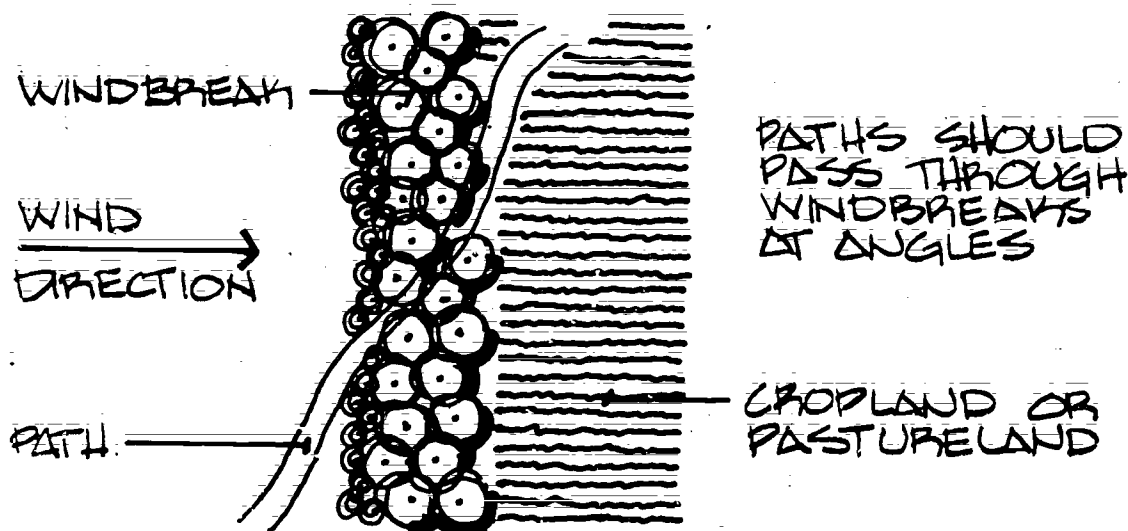

Some other points to consider about windbreaks:

- 1) The selection of species for the windbreak should follow the general guidelines for the different rainfall zones. Good selections can be made from species protected by law. Whenever possible, use species which local residents themselves have chosen and value.
- 2) Although double lines of Azadirachta indica have been used with satisfactory results, a strip 4 or 5 lines wide is better. Low growing bushes like Bauhinia, Combretaceae, and Salvadora should also be considered. The most efficient windbreaks are those with 1 or 2 rows of low growing shrubs or trees on the outside and 2 or 3 rows of taller trees on the inside.
- 3) Frequently a combination of planting methods is highly practical when establishing windbreaks. In other words, a combination of nursery transplants, live fencing, cuttings and stumps can be planted (according to the time of year best for planting in the area).
- 4) An additional merit in a slightly wider belt is that it can be designed for multiple usage by selective choice of species for the middle portion, such as Tamarindus, Acacia senegal, or native fruit and medicinal species.

5) Preparation and protection of the site involved are possibly more important for windbreaks than for regular plantations. Keeping animals away from a long narrow strip of land is very difficult and much more costly than fencing a field of similar area but more rectangular in shape.

6) In complex situations, or where more extensive protection is desirable--for example, around towns or larger villages--it is most effective to stagger windbreaks in a pattern of overlapping blocks as shown below.

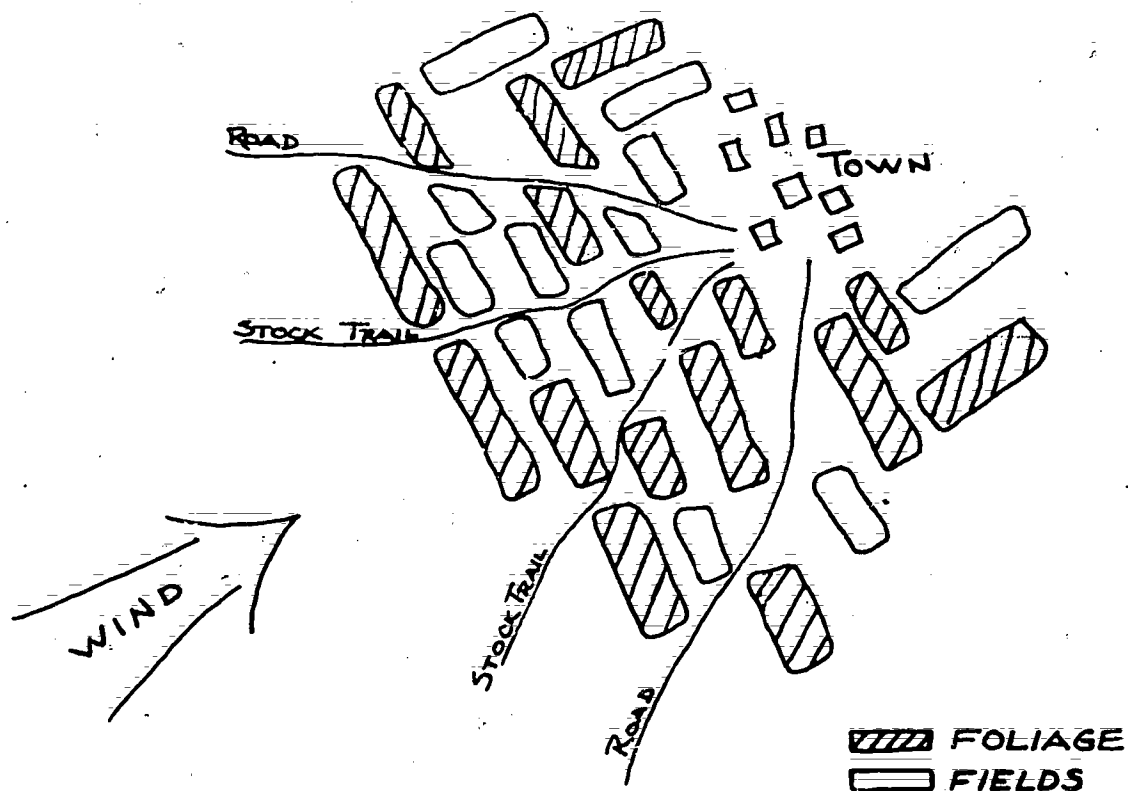

7) Another planting pattern is to line farm fields with wide windbreaks and plant trees such as Acacia albida in grids at 10m intervals inside the field.

Sand Stabilization

Shifting and blowing sand causes great damage to farmland, buildings, installations, roads. Entire settlements can be threatened by sand and shifting dunes. Sand stabilization is an important phase of revegetation and conservation efforts in many arid places.

The best protection against any drifting or blowing sand is to prevent the sand from being picked up by the wind in the first place. But once airborne, drifting sand can be made to settle and be kept from further shifting. The best ultimate results are obtained when the open area where the sand is picked up can be permanently covered by vegetation. Nothing can grow, however, until the movement of sand is stopped. This can be done by erecting some type of windbreak in the form of fence, barrier or hedge.

Windbreaking fences can take many forms and be made of many different types of materials. Basically, the flow of the wind must be reduced or blocked so that sand particles will be dropped. Some possibilities for windbreaks in barren sand:

1) Hedge rows of a species such as *Euphorbia balasamifera* can be planted successfully even in areas where annual rainfall does not exceed 300-400mm. Branches of Euphorbias partially buried in rows of shallow trenches will sprout and form new plants. Sand will become entrapped in such rows, and ridges will slowly form. Plant growth then becomes possible in the protected areas behind these ridges.

2) Arm-sized branches of tamarisk can be used to construct a diamond pattern of criss-cross rows across areas of open sand. Many of these branches will also sprout, forming live hedges that reduce the movement of wind. Less wind will pick up less sand. What sand is carried by the wind will quickly be deposited in or behind these rows of branches. Again, less sand movement creates a more favorable environment for plants.

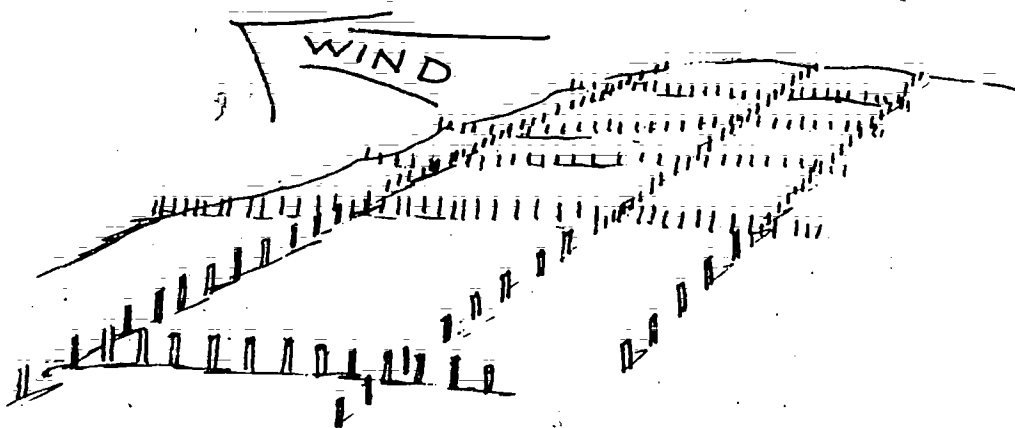

TYPICAL WIND BARRIER PATTERN

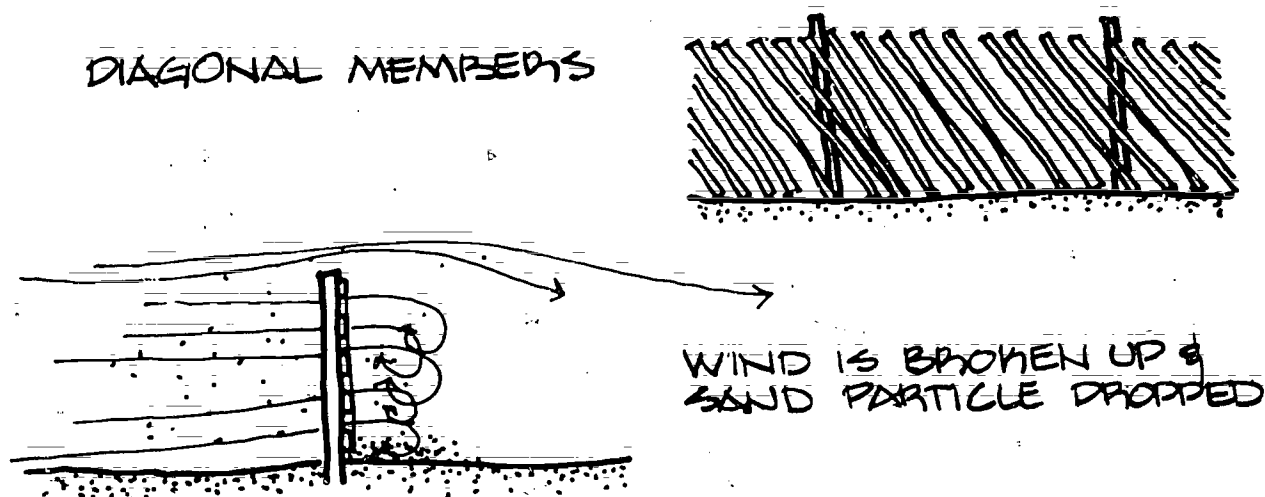

WINDBREAK FENCES USED FOR SAND STABILIZATION

3) Fenced-in squares and sand traps can also be constructed of materials as basic as bundles of millet stalks (UNDP research project northeast of Dakar, Senegal). Other possibilities are palm fronds, sticks, branches, cardboard boxes--anything reasonably sturdy, easily available, and free. Some problems may be encountered. Termites eating introduced wooden material and goats and sheep nibbling on bark and twigs of some of the vegetation are the greatest hazards.

Once these squares or hedges have been established and the movement of sand has been effectively reduced, vegetation can be introduced in the now-protected areas. Several vine-like plants are very well adapted to grow in almost pure sand, covering the ground with runners and shoots. With the sand thus tied down, site conditions are improved enough to permit introduction of grasses and other small plants. Finally, nursery grown trees can be planted. This gradual revegetation sequence builds the soil and improves growing conditions, helping nature to re-establish the area.

Appendix A

SPECIES IDENTIFICATIONS

This appendix identifies 165 of the species found in West African lands by pictures, Latin names, and common names. Synonyms (other Latin names) for a species, common names in up to 12 languages, and some very brief notations on uses of a species are given where this information is available; it is not intended to be definitive. All the species which appear in Appendix B, where further information is given, are included here, with the notation "Also see APPENDIX B."

Pictures include leaves, branch configurations, fruits, flowers, and inflorescences (arrangement of flowering branches and the flowers on them). They are not labelled individually, but the different items should be recognizable. There is no consistent scale relative to life-size. Illustrations are drawn from Flore Forestiere Soudano-Guineenne by A. Aubreville, Flore Illustree du Senegal and Flore du Senegal by Jean Berhaut, West African Trees by Dr. D. Giedhill, and Trees for Vana Mahotsava by S. K. Seth, M. B. Raizada, and M. A. Waheed Khan. The artists are J. Adams, M. J. Vesque, Jean Berhaut, Douglas E. Woodall, and P. Sharma.

A NOTE ON LATIN NAMES

- The genus and species of each tree appear in boldface type (genus first, species second).
- An abbreviation of the name of the author of the tree name follows the boldface type in lighter faced type.
- "var." means variety. The name of the variety appears in boldface immediately following the abbreviation "var."
- An abbreviation of the name of the author of the variety name follows the name of the variety in lighter faced type.
- "L." is an abbreviation for "Linnaeus," a Swedish botanist who initiated the development of this present, widely used system of nomenclature.

Drawings in this appendix are reprinted, with permission, from the following sources:

Aubreville, A., *Flore Forestiere Soudano-Guinéene*, Paris, Société d'Editions Géographiques, Maritimes et Coloniales, 1950.

Artists: J. Adams, M. J. Vesque

Berhaut, J., *Flore Illustrée du Sénégal*, Direction des Eaux et Forêts, Government du Sénégal, 1975.

Artist: J. Berhaut

Gledhill, D., *West African Trees*, London, Longman Group Ltd., 1972.

Artist: Douglas E. Woodall

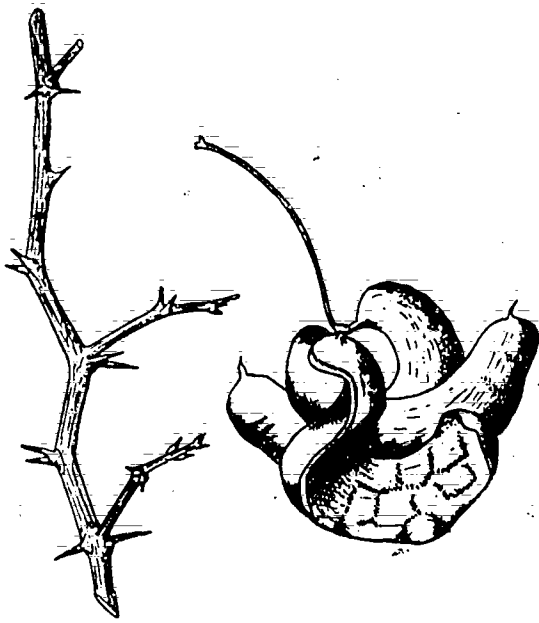

1. *Acacia albida* Del.

Also see APPENDIX B

SYNONYMS:

Faidherbia albida (Del.) Chev.
Acacia gyrocarpa Hochst.
Acacia saccharata Benth.

ENGLISH	gao	FULANI	ɸaiki
FRENCH	gao	HAUSA	gao
ARABIC	harraz	KANOURI	haragu
CHAD ARABIC	araza	MORE	zanga
BAMBARA	balanzan	SONGHAI	gao
DJERMA	gao	WOLOF	cadde

2. *Acacia ataxacantha* D.C.

BAMBARA	bonsoni	DJERMA	koŋgou
	sofekauenl	HAUSA	goumbi
	korr		

Use for live fences, posts, firewood, fodder (valuable), branch fencing



3. *Acacia caffra* Willd. var. *campylacantha* Aubr.

Also see APPENDIX B

SYNONYMS:

Acacia campylacantha Hochst., ex A. Rich.
Acacia catechu W.
Acacia polycantha Willd. subsp. *campylacantha* (Hochst.) Preneh

CHAD ARABIC	ai guetter	HAUSA	karo
BAMBARA	kuroko		tserkakla
FULANI	ɸatarlahi	KANOURI	golawai
		MORE	guara

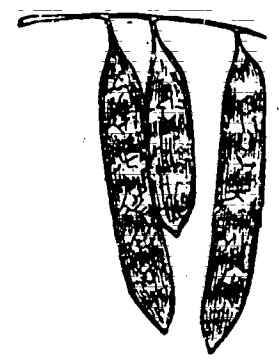

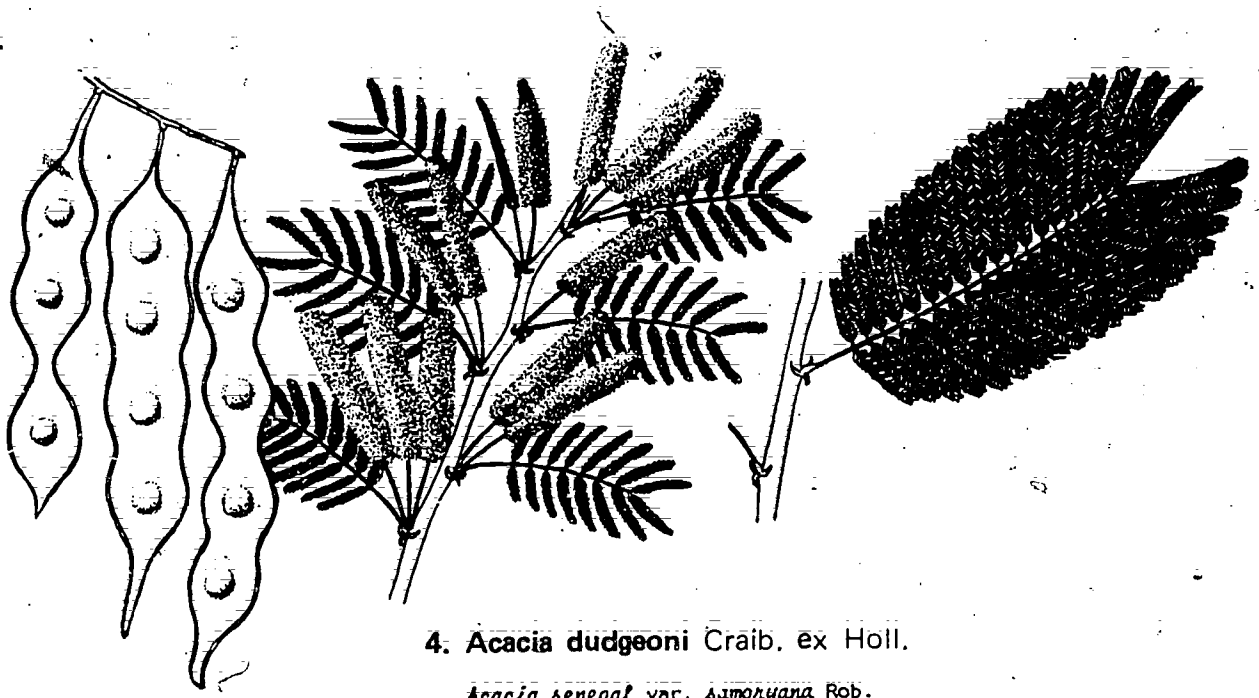

4. *Acacia dudgeoni* Craib, ex Holl.

Acacia senegal var. *samoyana* Rob.
Acacia samdry

5. *Acacia farnesiana* Willd.

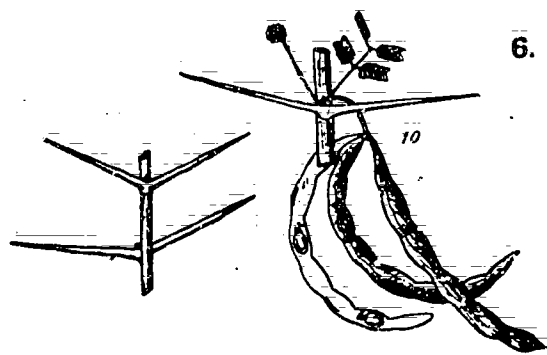
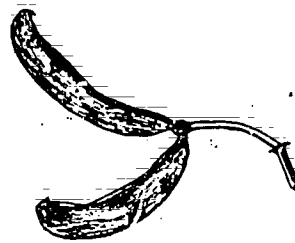

6. *Acacia flava* (Forsk.) Schwfth.

SYNONYMS:

Acacia flava var. *atacorensis*
Acacia atacorensis

DJERMA	tamat	HAUSA	tamat
	menne		

7. *Acacia gourmaensis* A. Chev.

not illustrated

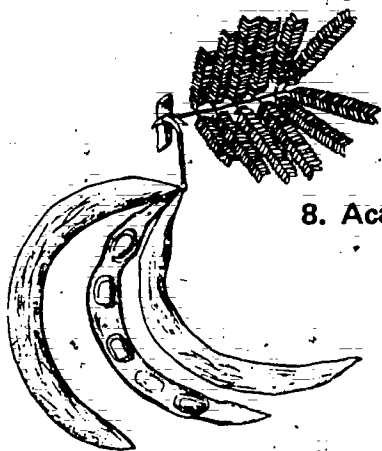
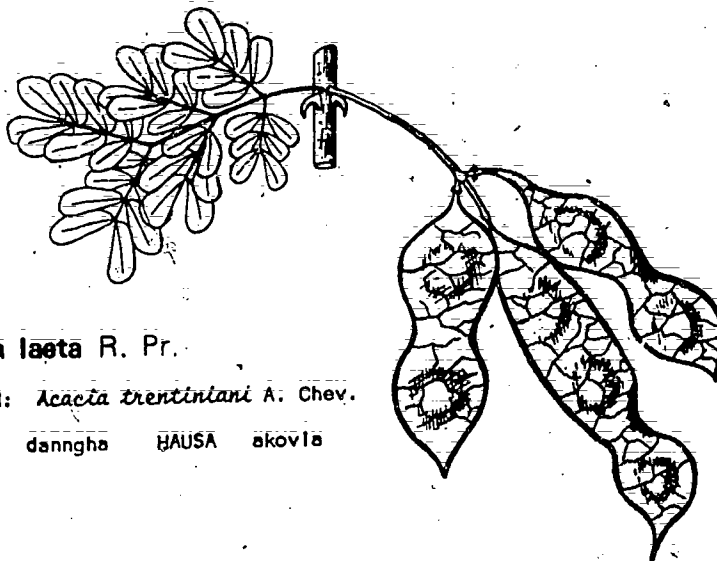
MORE gonponiäll
gonsablegaLike *Acacia mellifera* in East Africa8. *Acacia hebecyladoides* Harms.9. *Acacia laeta* R. Pr.SYNONYM: *Acacia trentiniana* A. Chev.

DJERMA dangha HAUSA akovla

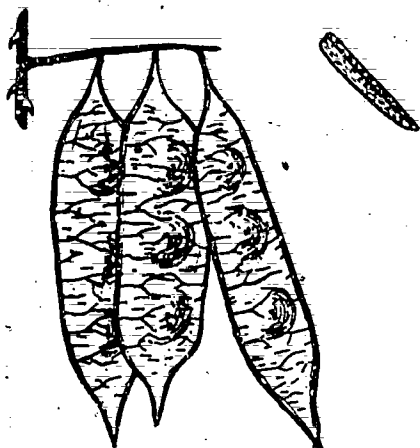
10. *Acacia macrostachya* Reichenb.

BAMBARA	ouenidie	FULANI	chidi
	kordonfinfo		patahemi
	mbourour	MORE	karadega
DJERMA	goumbi		guembaogo

Use for edible seeds; leaves to graze, live fences, posts, firewood, fodder (valuable), branch fencing

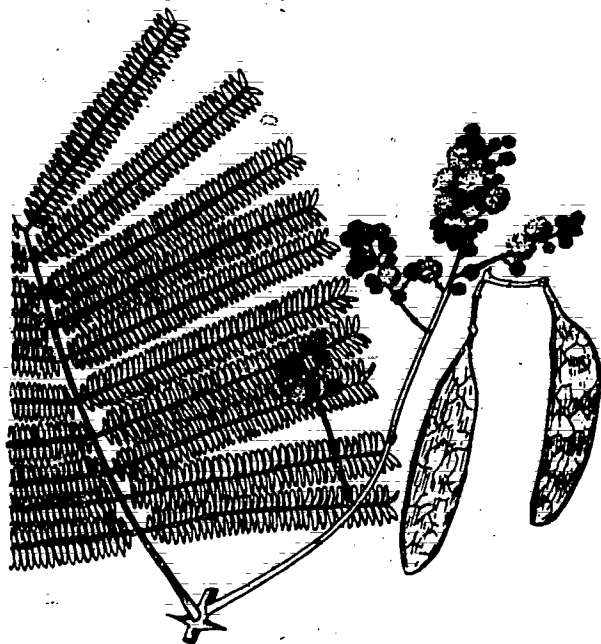

11. *Acacia macrothrysa* Harms.

SYNONYMS:
Acacia dalzielii Craib.
Acacia prorsispinnata Stapf.
Acacia buchananii Harms

KANOURI gardaye

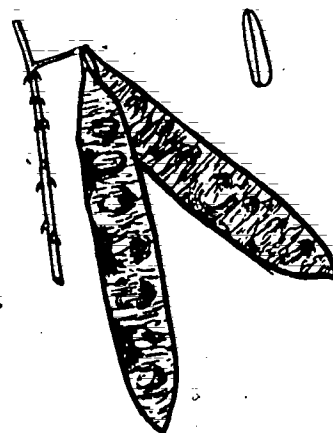

12. *Acacia pennata* Willd.

13. *Acacia raddiana* Savi.

SYNONYMS:
Acacia tortilis Hayne
Acacia fasciculata Guill. & Perr.

CHAD ARABIC	salele	FULANI	chilluki
BAMBARA	sayele	HAUSA	kandiii
DJERWA	bissau	KANOURI	kandii

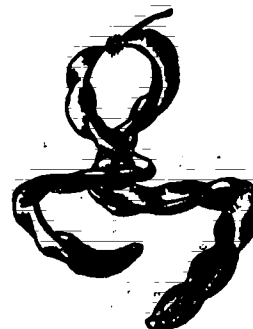
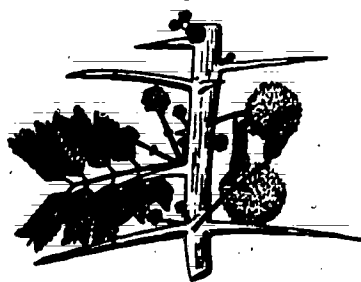

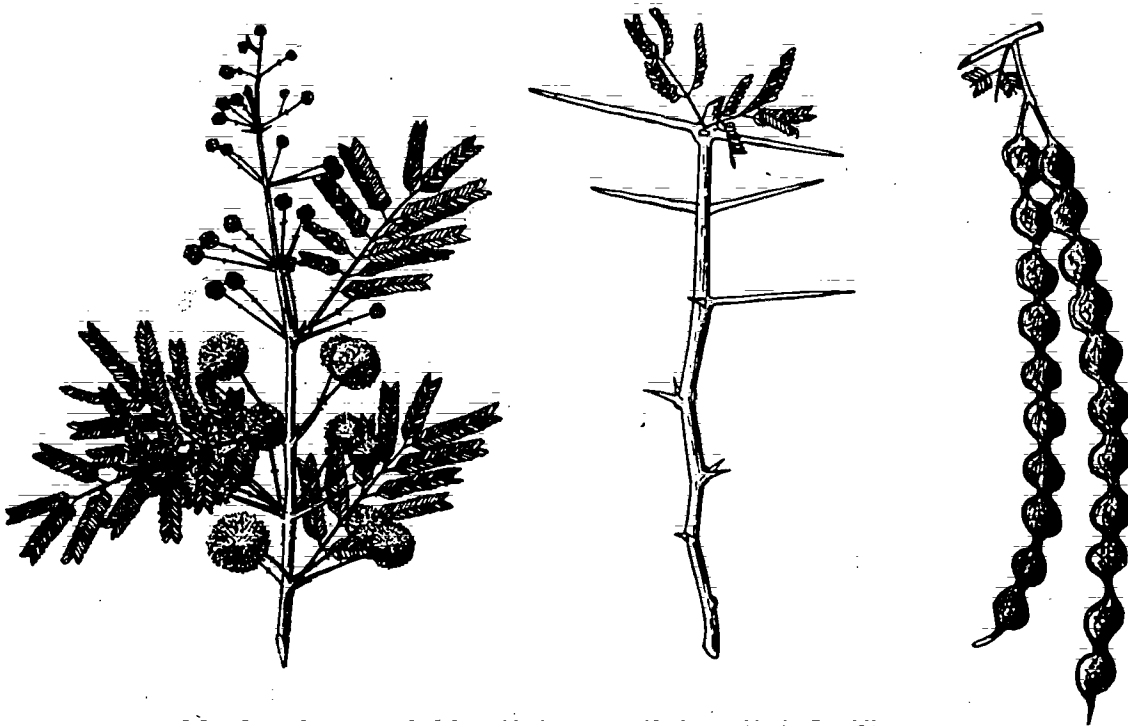

14. *Acacia scorpioides* (L.) var. *nilotica* (L.) A. Chev.

Also see APPENDIX B

SYNONYMS: *Acacia nilotica* (L.) Willd.
Mimosa nilotica L.
Acacia arabica (Lam.) var. *nilotica* (L.) Benth.

FRENCH	gonakler	DJERMA	bani
CHAD ARABIC	sunta, charat, senet, sunt	FULANI	gaudi
BAMBARA	barana diabe boina	HAUSA	bagarua
		MORE	peguenega

Found in lowlands; near water or in moist soils

15. *Acacia scorpioides* (L.) var. *adstringens* Bak.

SYNONYM: *Acacia adansonii* Guill. & Perr.



FRENCH	gonakler	DJERMA	bani
CHAD ARABIC	sunta, charat, senet, sunt	FULANI	gaudi
BAMBARA	barana diabe boina	HAUSA	bagarua
		KANOURI	kangar kissau
		MORE	perananga

Found in highlands; in drier environments

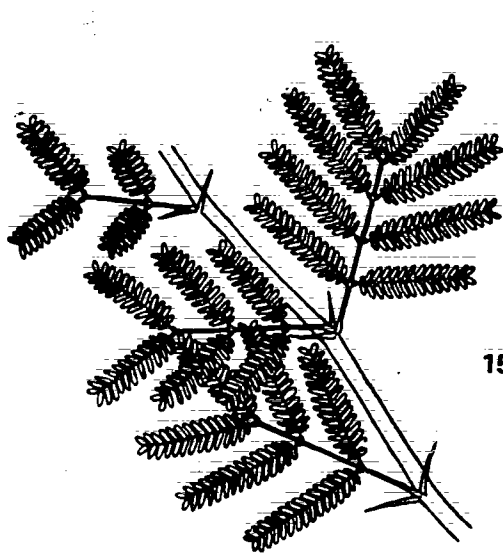

15.

Acacia scorpioides
var.
adstringens



16. *Acacia senegal* (L.) Willd.

Also see APPENDIX B

SYNONYM: *Acacia verec* Guill. & Perr.

ENGLISH	gum arabic	FULANI	dibehi
FRENCH	gommler	HAUSA	patuki
CHAD ARABIC	asharet	KANOURI	dakworo
	kltr al ablod	MORE	kolo!
BAMBARA	donkori		goniminiga
DJERMA	danya		

Source of gum arabic

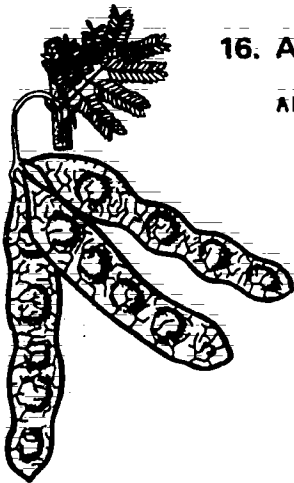

17. *Acacia seyal* Del.

SYNONYMS: *Acacia stenocarpa* Hochst.
Acacia boboensis Aubr.

CHAD ARABIC	talhaye	HAUSA	farin kaya
BAMBARA	segnie	KANOURI	karamga
DJERMA	saykire	MORE	gompelaga
FULANI	buiki		

Use for firewood, fodder

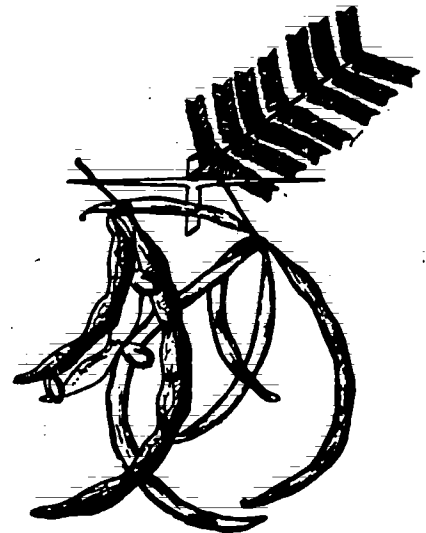



18. *Acacia sieberiana* D.C.

Also see APPENDIX B

SYNONYMS:

- Acacia verugera* Schweinf.
- Acacia sanguinea* Guill. & Perr.
- Acacia rehmanniana*
- Acacia villosa*
- Acacia fischerii*
- Acacia monga*
- Acacia verhmoensis*
- Acacia nefasia* Schweinf.

CHAD ARABIC	kuk
BAMBARA	baki
FULANI	gle daneji
HAUSA	boudji
	dushe
KANOURI	katalogu
MORE	golponsgo



19. *Acacia stenocarpa* Hochst.
var. *chariensis* A. Chev.



112

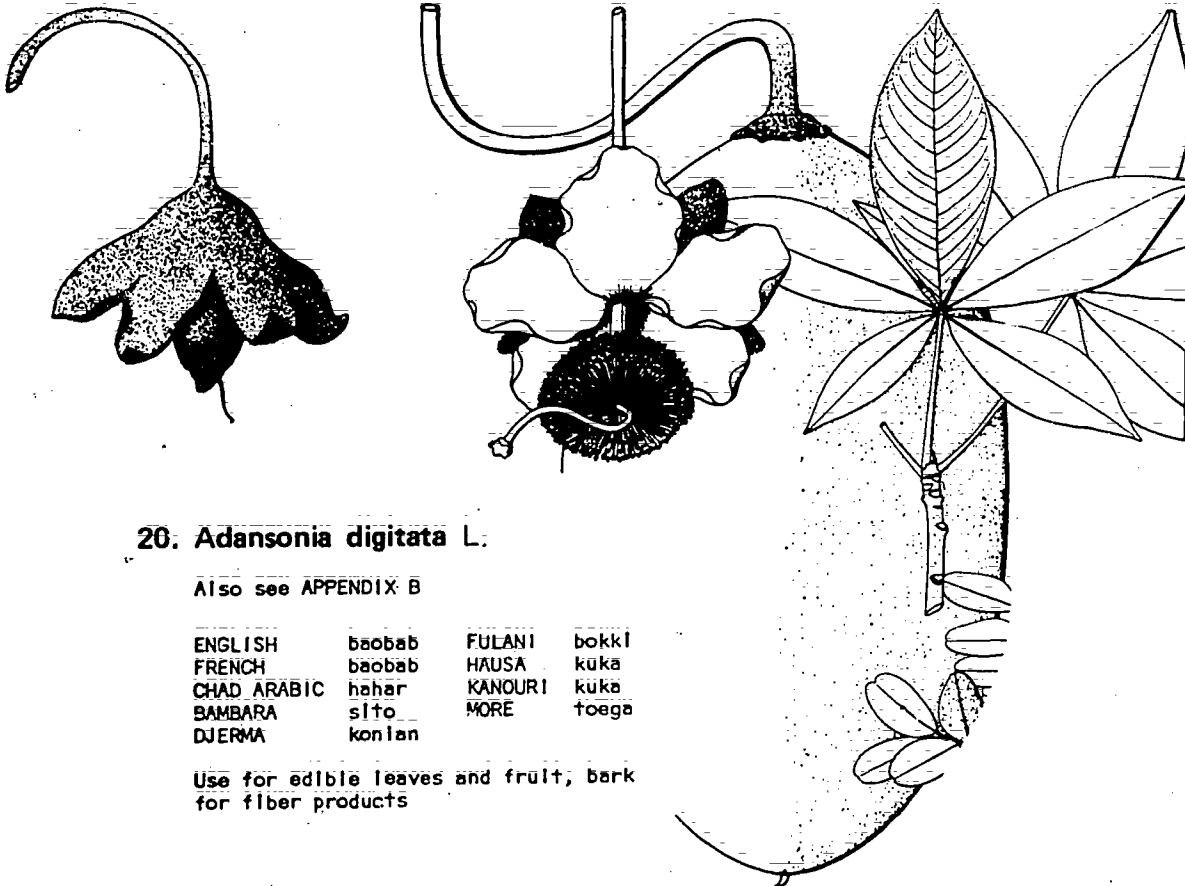

20. *Adansonia digitata* L.

Also see APPENDIX B

ENGLISH	baobab	FULANI	bokki
FRENCH	baobab	HAUSA	kuka
CHAD ARABIC	hahar	KANOURI	kuka
BAMBARA	sito	MORE	toega
DJERMA	konlan		

Use for edible leaves and fruit, bark for fiber products

21. *Adenium obesum* (Forsk.)
Roem. et Schult.

SYNONYMS: *Adenium arabicum* Palf. f.
Adenium coetaneum Stapf.
Adenium hongkel A. x.

CHAD ARABIC	kuka meru
BAMBARA & MORE	foukala sitandi kongosita
FULANI	leki peouri
HAUSA	karya

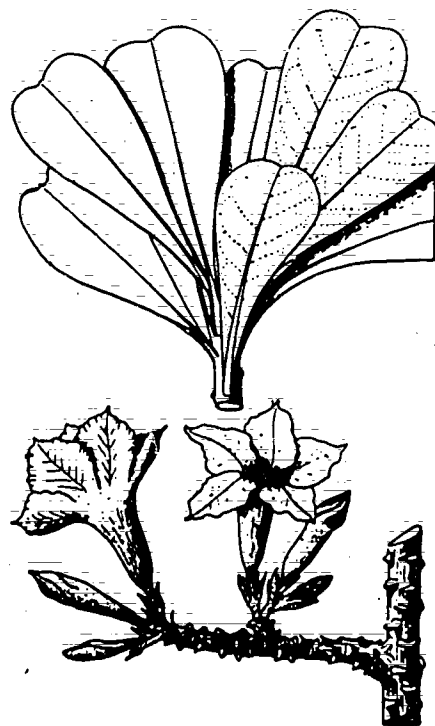
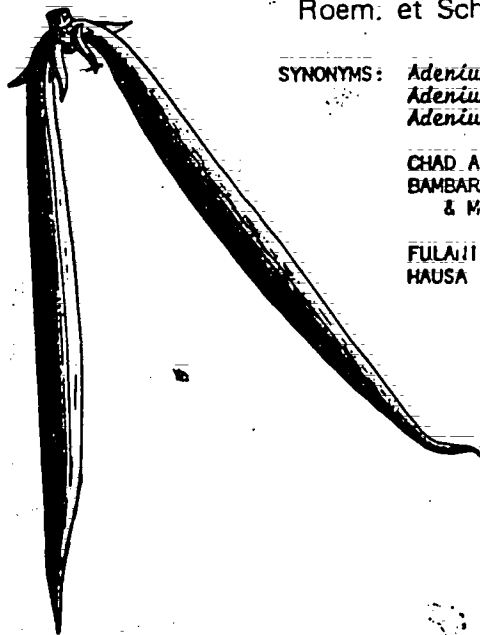

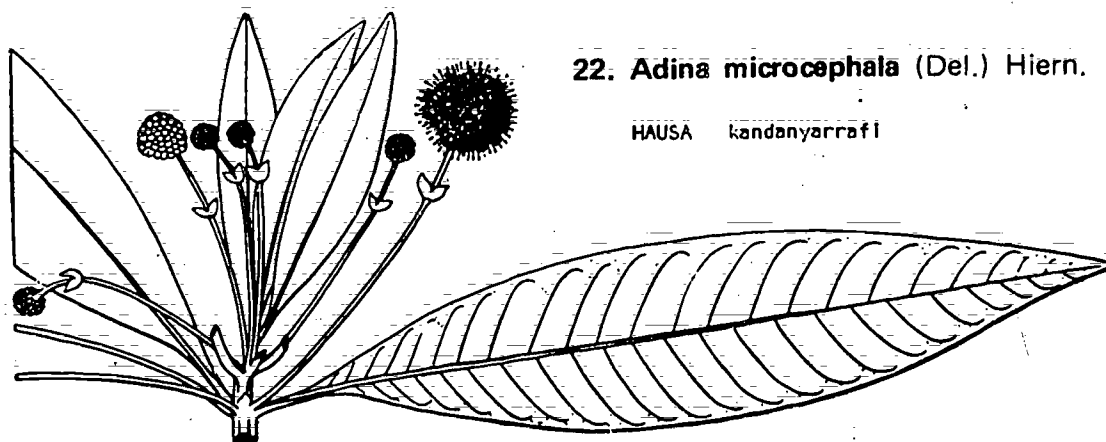

22. *Adina microcephala* (Del.) Hiern.

HAUSA kandanyarraf i

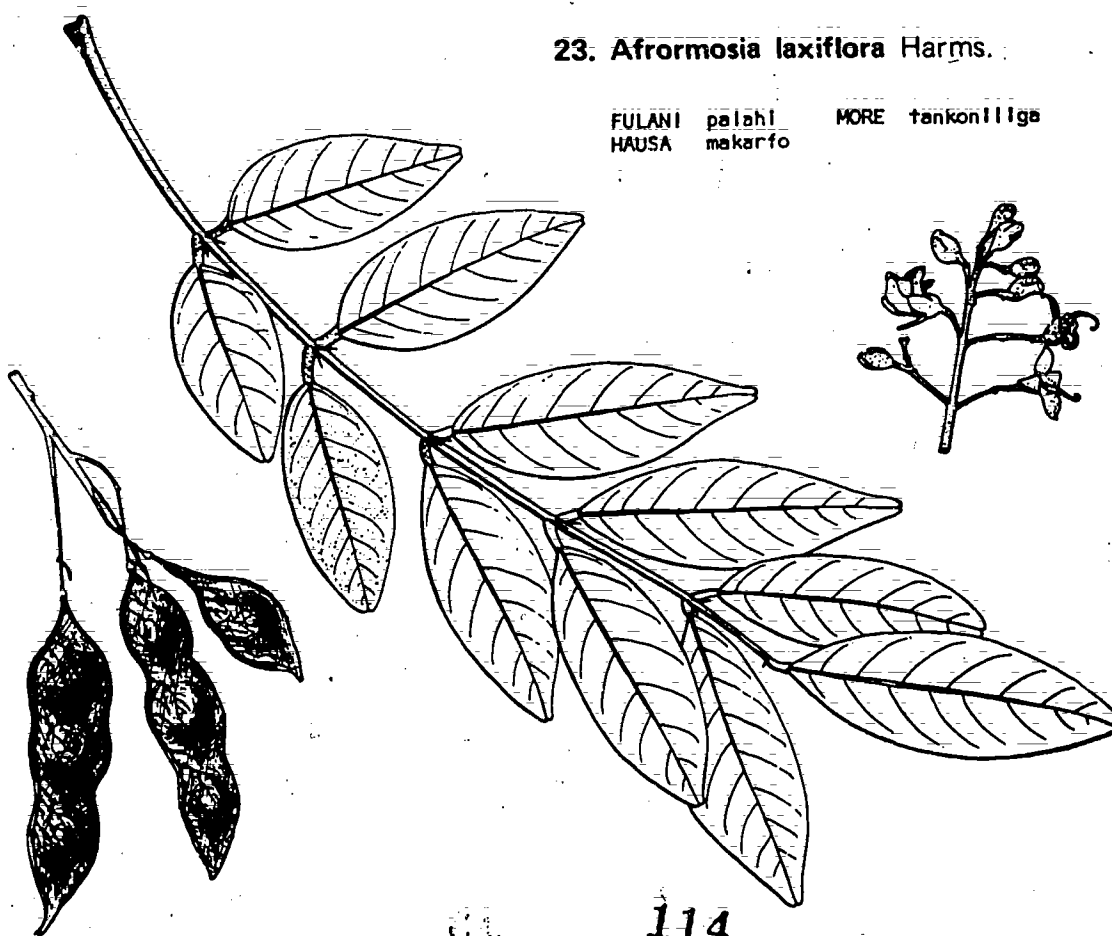

23. *Afrosmosia laxiflora* Harms.

FULANI palahi MORE tankonlliga
HAUSA makarfo

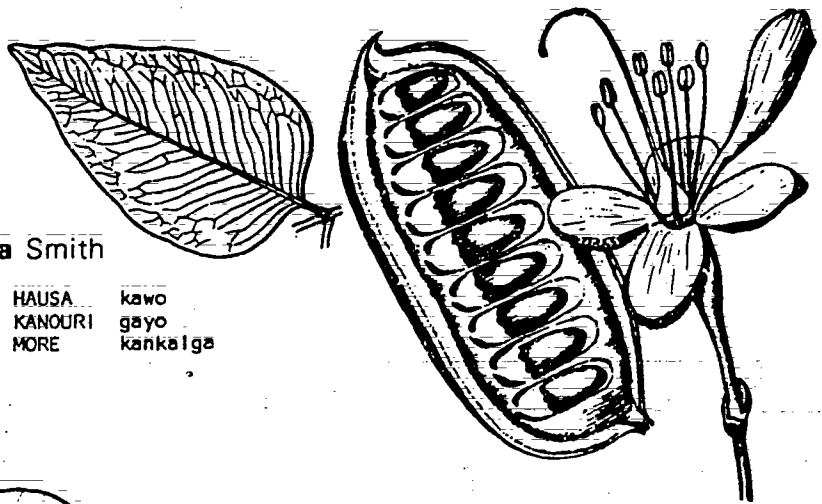

24. Afzelia africana Smith

FRENCH	Ilinguo	HAUSA	kawo
DJERMA	kao	KANOURI	gayo
FULANI	gayoh!	MORE	kankaiga

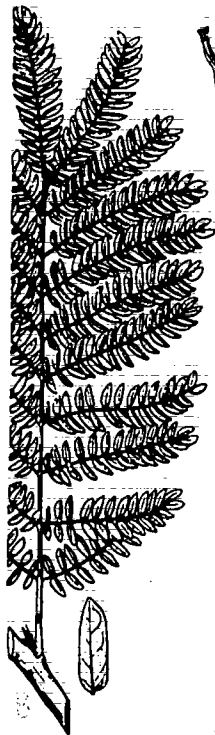

25. Albizzia chevalieri Harms.

Also see APPENDIX B

CHAD ARABIC	ared	HAUSA	katsari
BAMBARA	golo iri	KANOURI	tsagle
FULANI	jarichi	MORE	ronsedonga
	nyebal		

Use for fodder, construction, roots to repair gourds

26. Ampelocissus grantii (Bak.) Planch.

HAUSA	rogon daji
FULANI	gufugafal

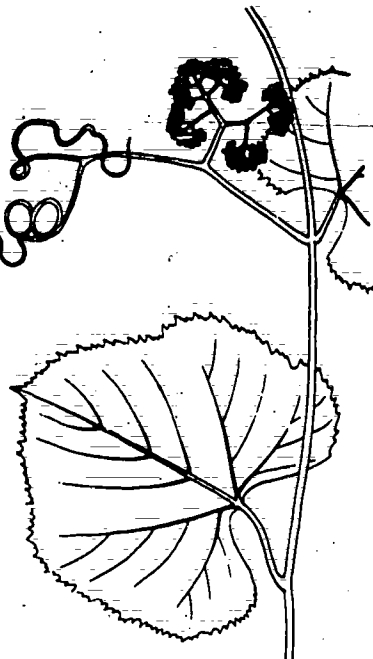
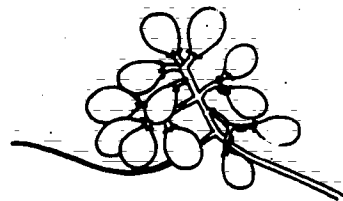
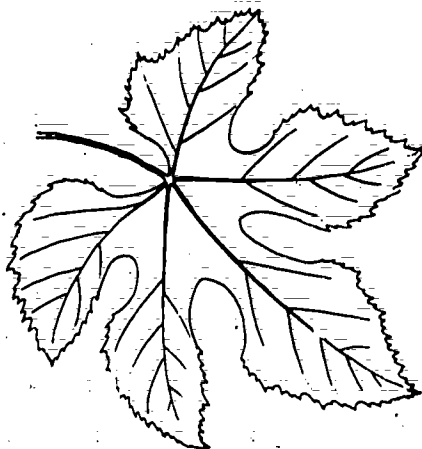



27. *Anacardium occidentale* L.

Also see APPENDIX B

Use for edible nut (valuable),
firewood, construction, soil
regeneration

28. *Anclomanes difformis* not illustrated

HAUSA cakara KANOURI gazamagal

29. *Andira inermis* H.P. & K.

FULANI	daluhl
HAUSA	madobla
	gwaska
MORE	ouenlebende

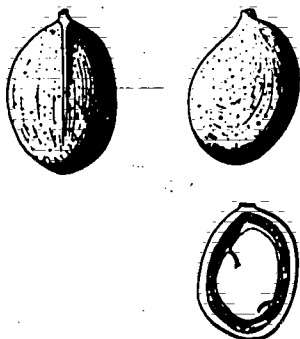

116

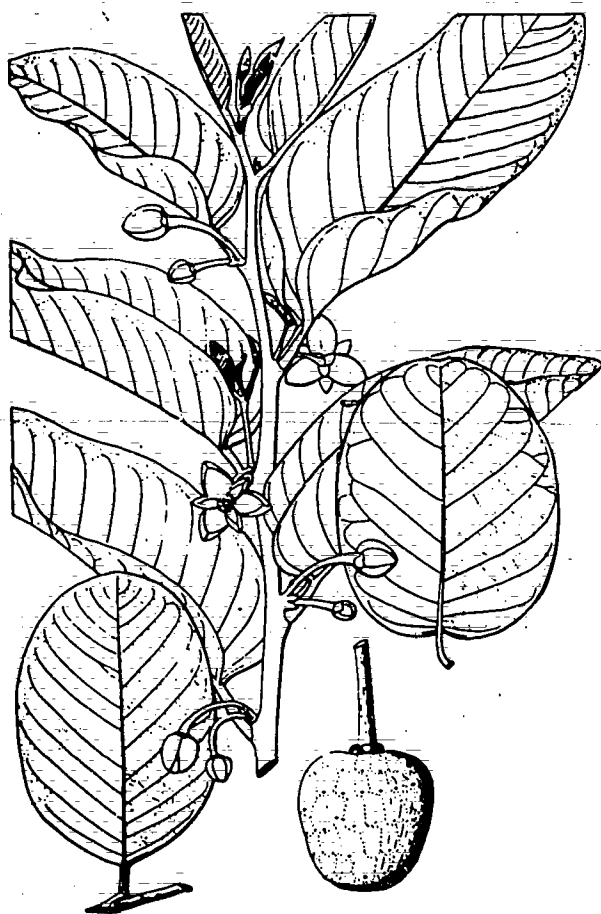

30. *Annona senegalensis* Pers.

CHAD ARABIC	um boro
BAMBARA	sunsun
DJERMA	moupa
FULANI	dukuhi
HAUSA	gouanda
KANOURI	fissa
	ngonowo
MORE	baki kudige

31. *Anogeissus leiocarpus*
Guill. & Perr.

Also see APPENDIX B

SYNONYM:

Anogeissus schimperii Hochst. ex
Hutch & Dalz.

CHAD ARABIC	sehab
BAMBARA	krekeke
DJERMA	gonga
FULANI	kojoli
HAUSA	mariko
KANOURI	annum
MORE	sigha plega



117

32. Azadirachta indica A. Juss.

Also see APPENDIX B

ENGLISH Neem FRENCH Neem

Use for firewood, poles, construction; brush your teeth with the bark

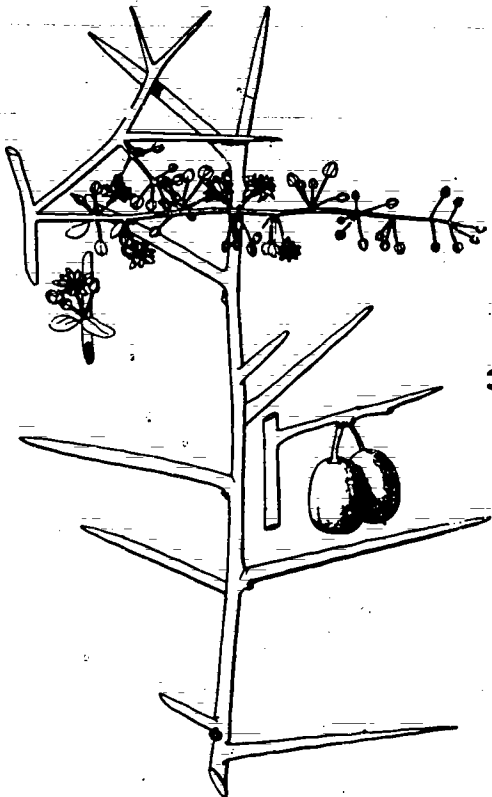

33. Balanites aegyptiaca (L.) Del.

Also see APPENDIX B

CHAD ARABIC	hajlij	KANOURI	chingo
BAMBARA	seguene		bifo
DJERMA	garbey	MORE	flegallga
FULANI	fanni		
HAUSA	adous		

Use for edible fruits, firewood, tool handles, soap, poison

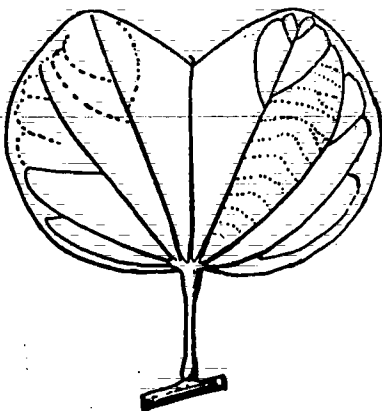
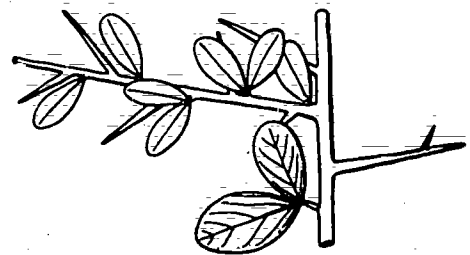

34. Bauhinia reticulata D.C.

Also see APPENDIX B

SYNONYMS: *Bauhinia glabra* A. Chev.
Bauhinia glauca A. Chev.
Ptilostigma reticulatum (D.C.) Hochst.

CHAD ARABIC	harum	HAUSA	calgo
BAMBARA	niemaba	KANOURI	kaldul
DJERMA	kosseye	MORE	barani
FULANI	barkevl		

Use for smoking wood

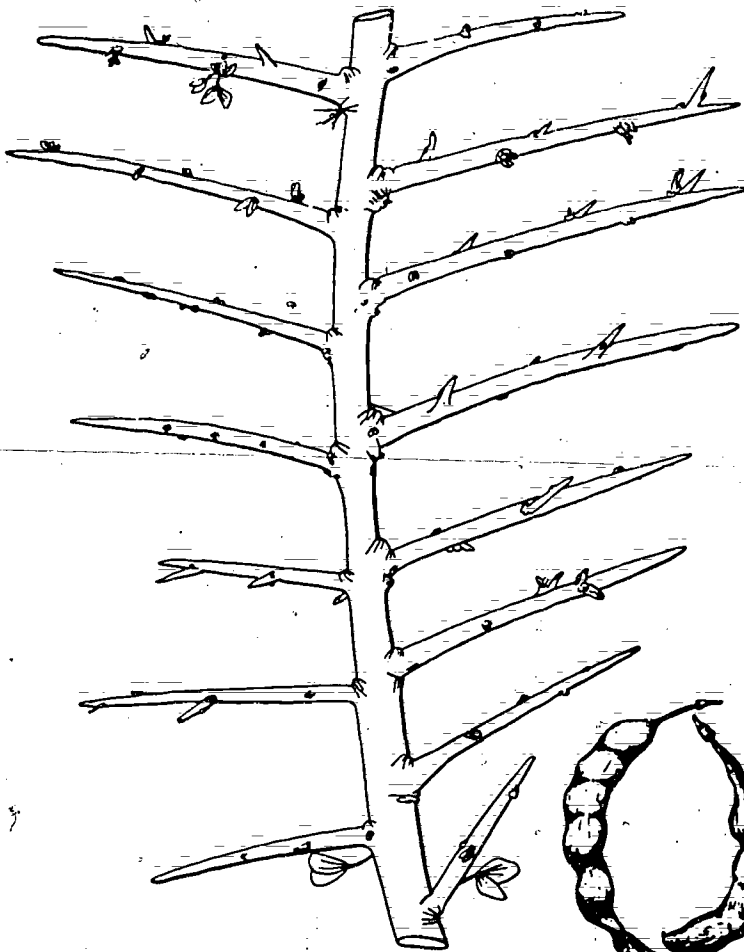

35. Bauhinia rufescens Lam.

SYNONYMS:

Bauhinia adansoniana Guill. & Perr.
Bauhinia parvifolia Hochst.

CHAD ARABIC	kula kula
BAMBARA	guesembr
DJERMA	namari
FULANI	namal
HAUSA	dirga
KANOURI	sisl
MORE	tipoege

Use for firewood,
 medicine

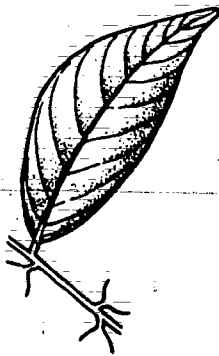
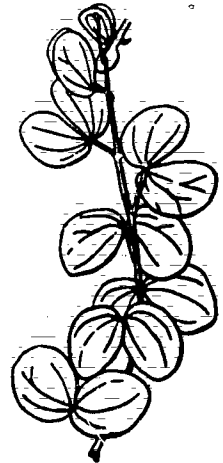

**36. Berlinia grandiflora (Vahl)
 Hutch. & Dalz.**

SYNONYM:

Berlinia auriculata

HAUSA rafi





37. *Bombax buonopozense* Beauv.

ENGLISH kapok tree
FRENCH kapokier

Use for kapok fiber - not as fine as *Ceiba petiolaris* (see #54, this appendix, and appendix B)

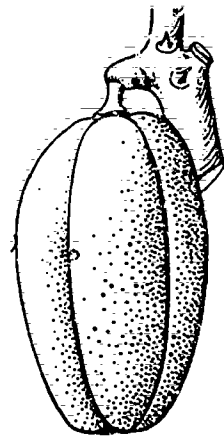

39

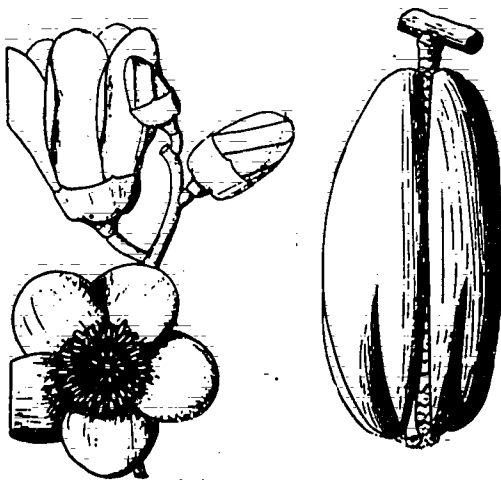

38. *Bombax costatum* Pellegr. & Vuillet.

SYNONYM: *Bombax flammeum* Uibr.

ENGLISH	kapok tree	DJERMA	forogo
FRENCH	kapokier	FULANI	kuruhl
CHAD ARABIC	johé	HAUSA	kurle
BAMBARA	zoumbou	KANOURI	yeita
		MORE	ouaka

Use for kapok, edible leaves

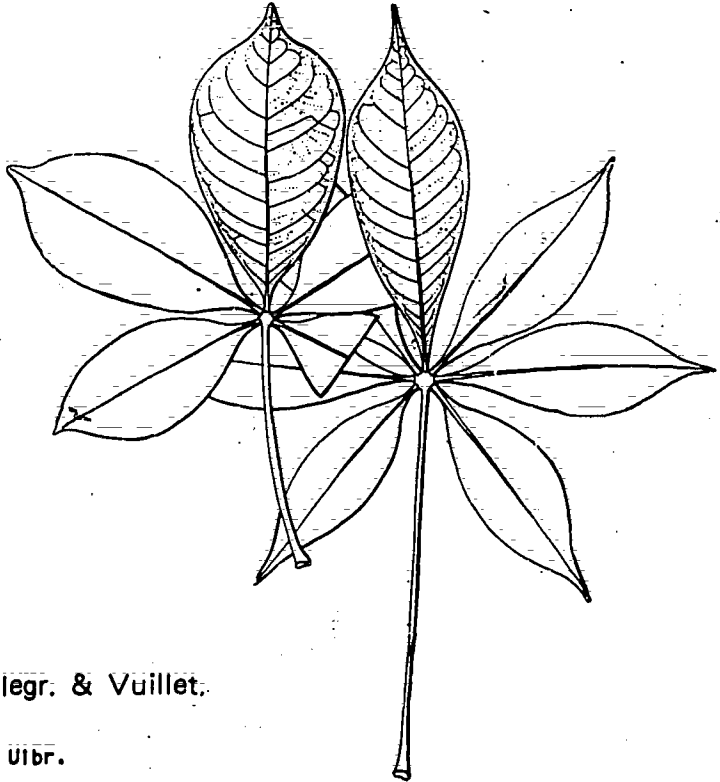



40. Boscia ang

BANE

**FULA
HAUS
KANC
MORE**



39. *Borassus aethiopum* Mart.

Also see APPENDIX B

SYNONYM:

Borassus flabellifer L. var.
aethiopum (Mart.) Warb.

FRENCH	ronler
CHAD ARABIC	deleb
DJERMA	sabouze
FULANI	dubbi
HAUSA	gigunfa
KANOURI	ganga kemelutu

Use for termite-proof posts for construction, fences, etc.; leaves and "stems" for fencing reinforcement. Slow growing.

40. *Boscia angustifolia* A. Rich.

BAMBARA	diaba guinadlou toutigul
FULANI	anzagi
HAUSA	agaJini
KANOURI	marga
MORE	kisinkinde



41. *Boscia salicifolia* Oliv.

CHAD ARABIC mahkei
HAUSA zoure

Use for edible leaves

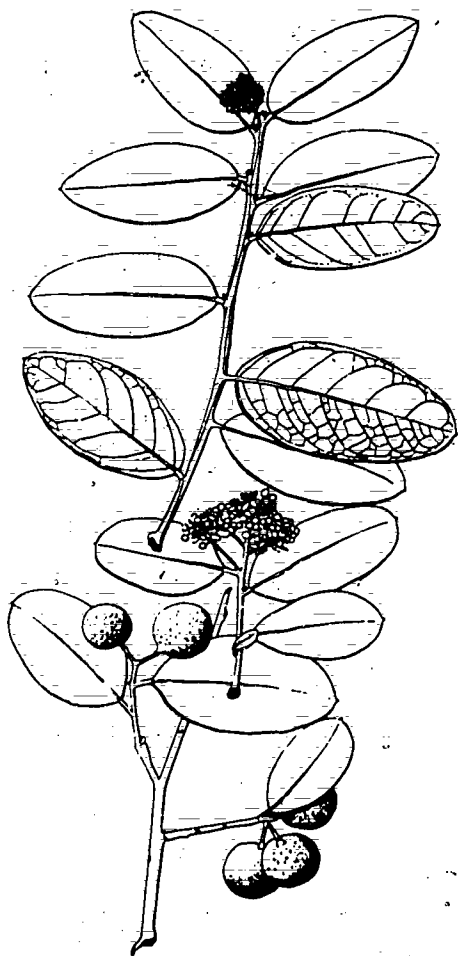
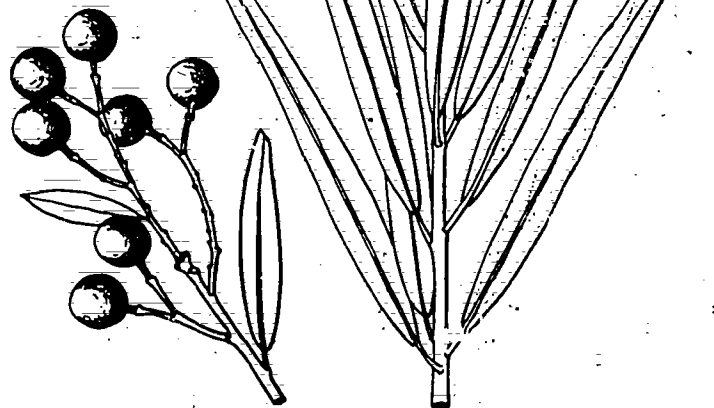
42. *Boscia senegalensis* Lam.

CHAD ARABIC hemmet-mohob
BAMBARA bere
DJERMA orba
 dilo
FULANI gulguile
HAUSA anza
 dielew
KANOURI bultus
MORE nabadega
 lamboiga

Use for construction, edible fruits
and seeds

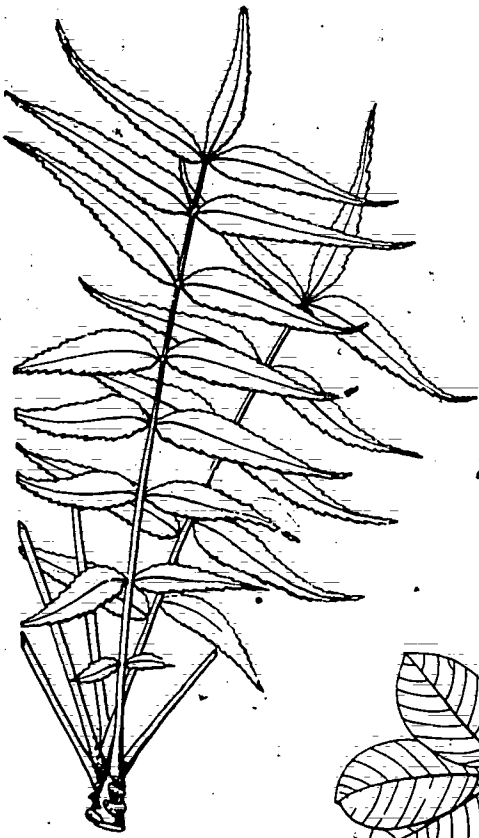

43. *Boswellia dalzielli* Hutch.

FULANI	andakehi	KANOURI	kafi dukan
HAUSA	hano		

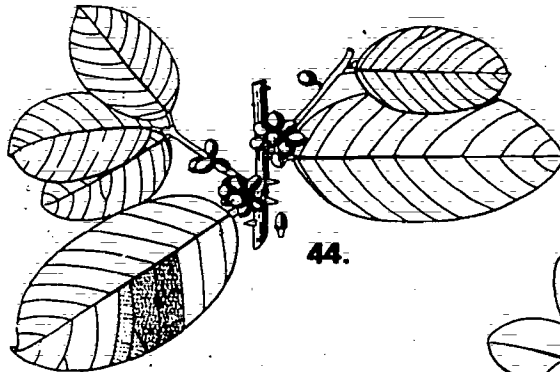

44.

44. *Bridelia ferruginea* Benth.

BAMBARA	baboni	HAUSA	kirni
	sagua	KANOURI	zindi
FULANI	marenl	MORE	tansaloga
	dafi		

Use for firewood, fodder

45. *Burkea africana* Hook.

CHAD ARABIC	azrak ana
FULANI	kokobi
HAUSA	bakin-makarfo
MORE	sienra

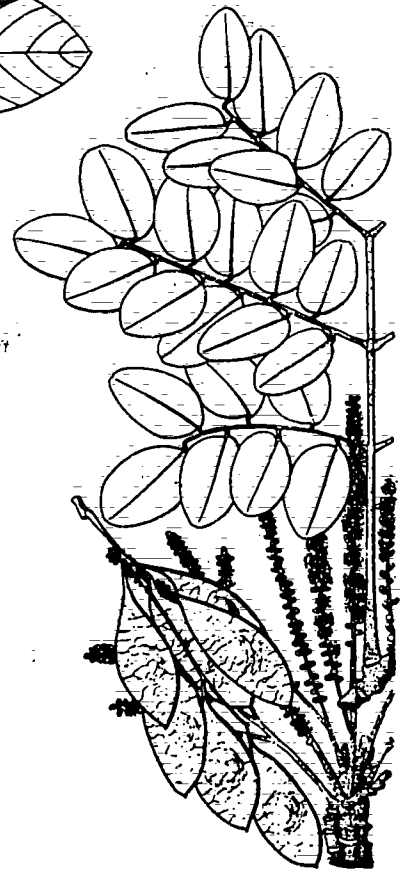

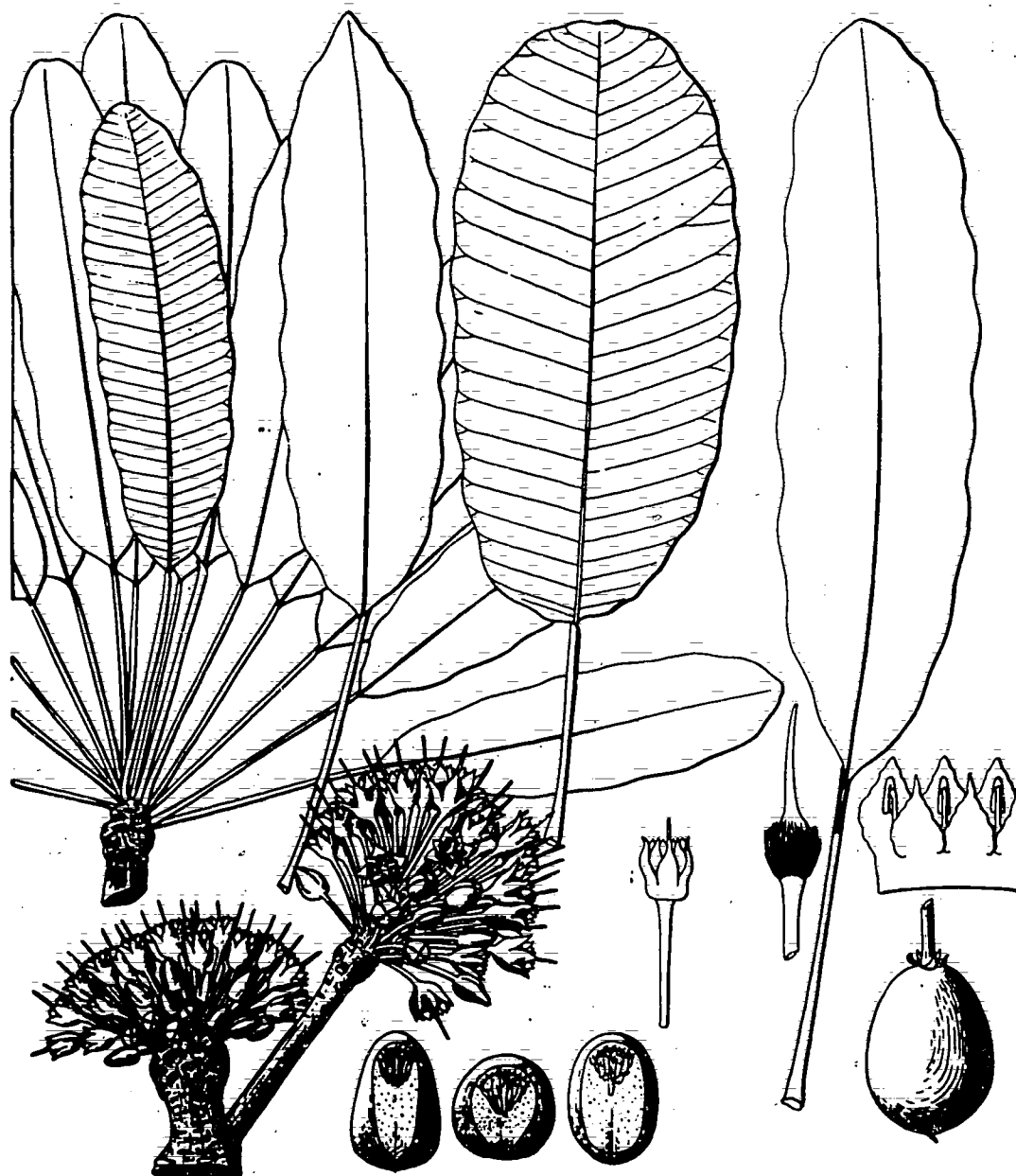

46. *Butyrospermum parkii* Kotschy

Also see APPENDIX B

SYNONYM: *Butyrospermum paradoxum* (Gaertn. f.) Hepper

ENGLISH	shea nut tree	FULANI	karehi
FRENCH	karite	HAUSA	kandanya
CHAD ARABIC	um kurum	KANOURI	toso
DJERMA	boulanga	MORE	tanga

Use for shea butter, hard wood for mortar



47. *Cadaba farinosa* Forsk.

CHAD ARABIC	sirreh
BAMBARA	berekunan
	tamba
HAUSA	bagay
KANOURI	marga

48. *Calotropis procera* (Ait.) Dryand

CHAD ARABIC	rhalga
BAMBARA	fugolri
	ngounyo
FULANI	bambani
HAUSA	tumfalya
KANOURI	kayo

Use for construction

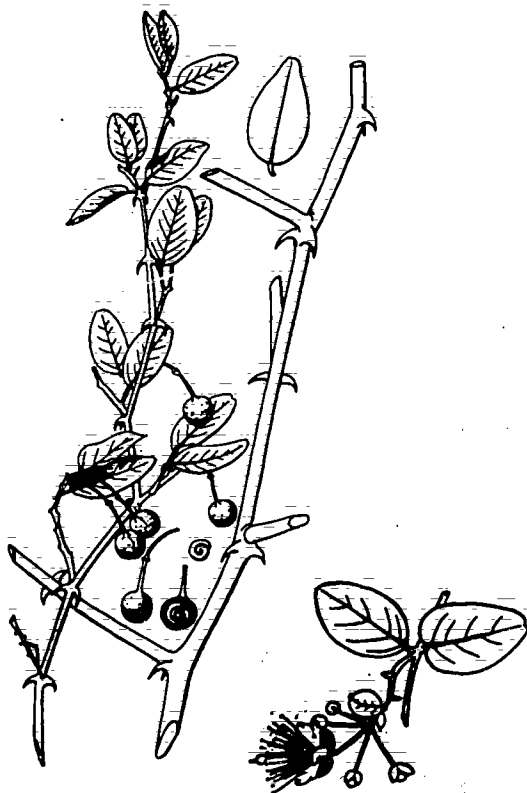
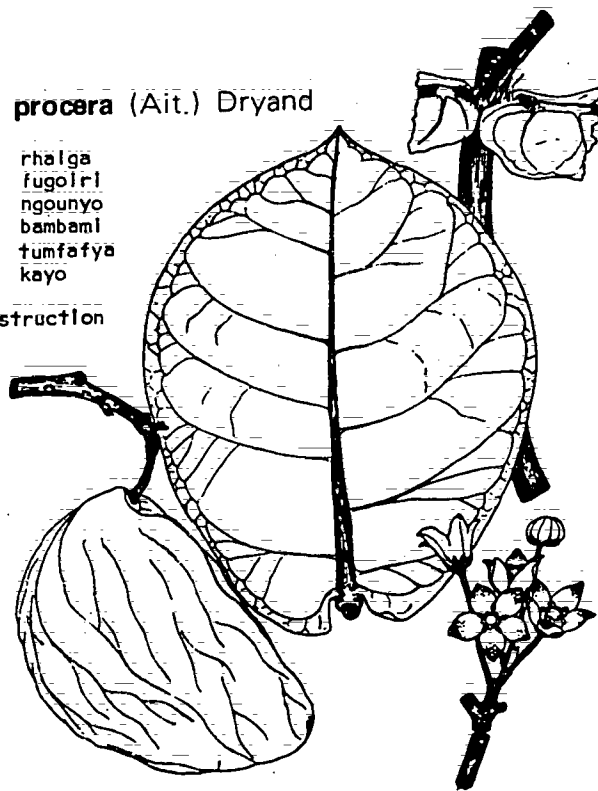

49. *Capparis corymbosa* Lam.

CHAD ARABIC	mardo
HAUSA	haujari-mutane
KANOURI	pido
	damsa

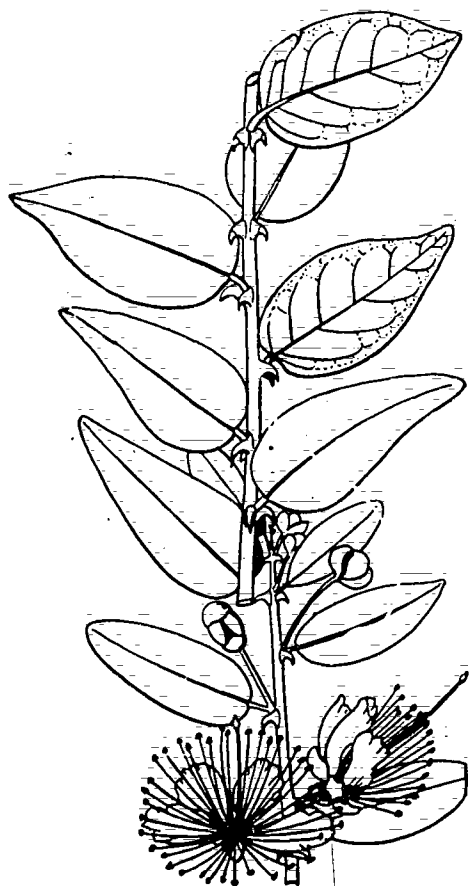

50. *Capparis tomentosa* Lam.

SYNONYM:

Capparis polymorpha A. Rich.

CHAD ARABIC	gulum
HAUSA	haujari
KANOURI	zaji

Use for fodder

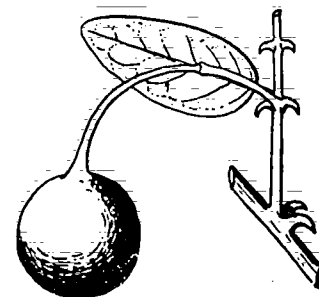

51. *Cassia siamea* Lam.

Also see APPENDIX B

FRENCH cassia

Use for construction,
firewood, windbreaks

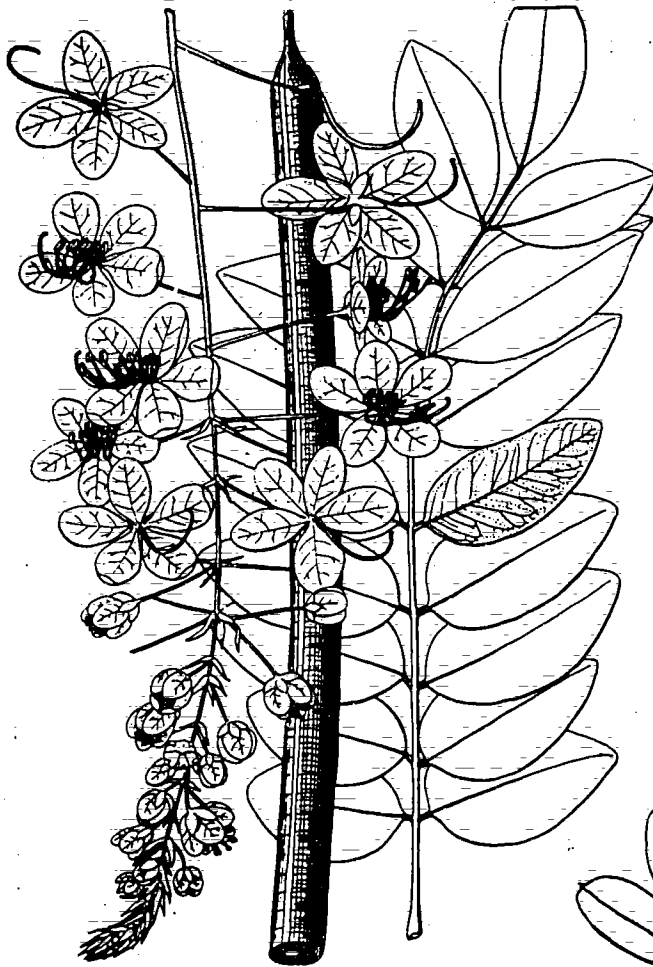

126

52. *Cassia sieberiana* D.C.

CHAD ARABIC	siraih
BAMBARA	sinie
	sinedlan
DJERMA	samturi
FULANI	malagahi
HAUSA	malga
KANOURI	badin zikki
	marga
MORE	kombissaka

Use for hard firewood

53. *Cassia singueana* Del.

SYNONYM:
Cassia goratensis Fres.

CHAD ARABIC	shaderat- al bashima
FULANI	rumfuhl wabilihl
HAUSA	rumfu
KANOURI	tugulele
MORE	gueleponsgo

Use for fodder, firewood

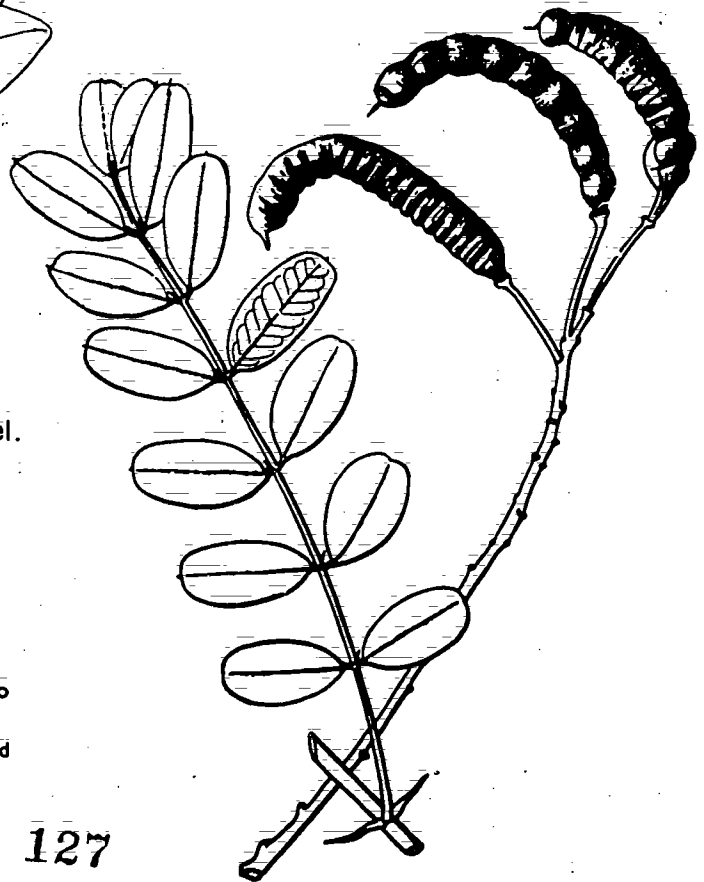

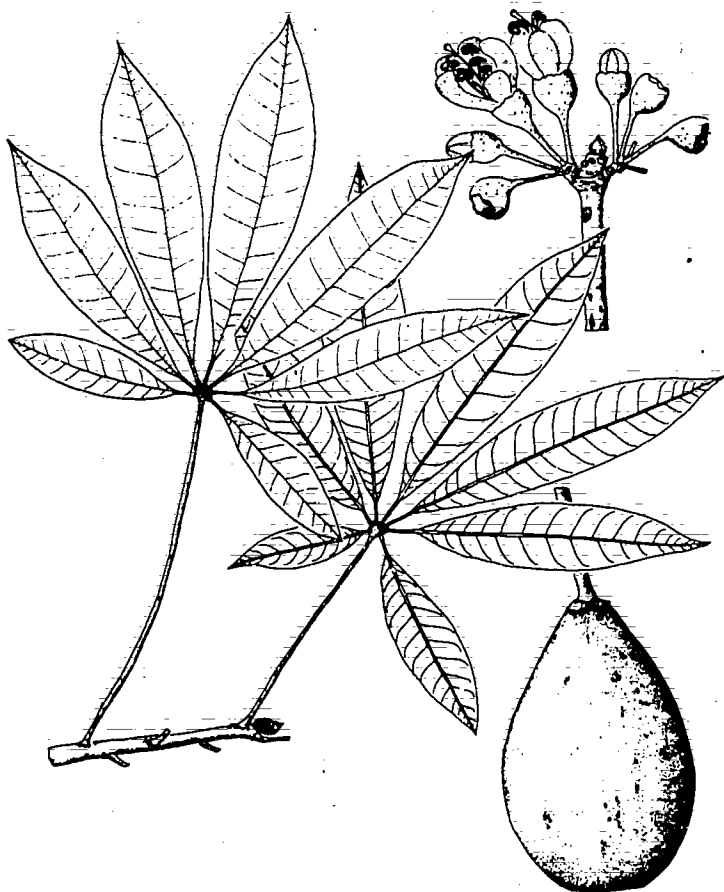

54. *Ceiba petandra* (L.) Gaertn.

Also see APPENDIX B

SYNONYM:
Eriodendron orientale

ENGLISH	silk cotton tree
FRENCH	fromager
CHAD ARABIC	rum
FULANI	bantahl
HAUSA	rimi
KANOURI	tom
MORE	gunga

Best source of kapok fiber

55. *Celtis integrifolia* Lam.



CHAD ARABIC	abun gatu
BAMBARA	gaua
	kamaguan
FULANI	ganli
HAUSA	dikki
	zuwo
	kouka
KANOURI	nguso
MORE	tintigella

Use for fodder, firewood

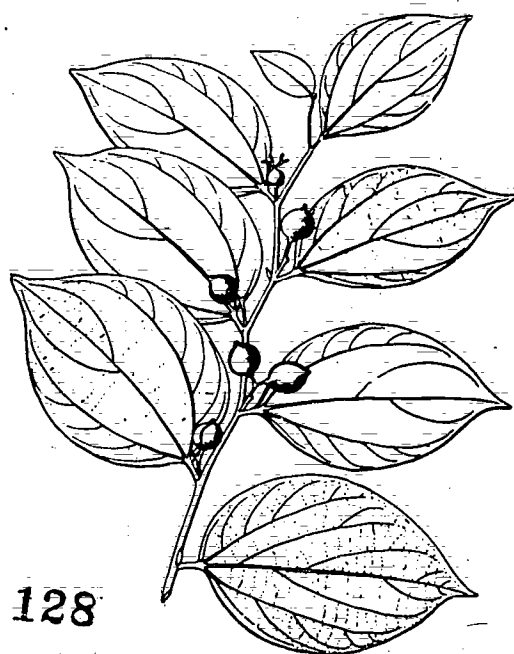

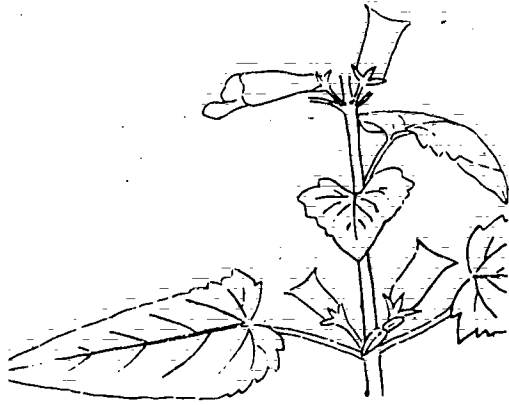

56. *Ceratotheca sesamoides* Endl.

FULANI	wanko
HAUSA	karkashi
KANURI	kembulubul

57. *Cochlospermum tinctorium* Perr.

CHAD ARABIC	meghr
FULANI	jarundal
HAUSA	rawaya
KANURI	masauwe



58. *Combretum aculeatum* Vent.

BAMBARA	ouolo	FULANI	buteral
	konti		oualo
DJERMA	bouboure	HAUSA	bubukya
		MORE	koditambiga

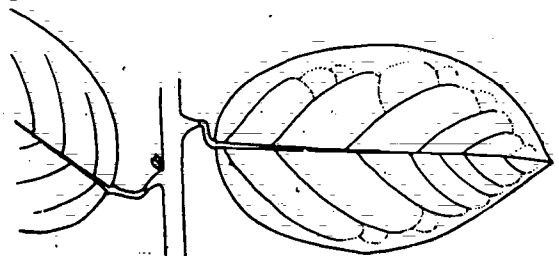

59. *Combretum binderianum* Kotschy

HAUSA fara geza

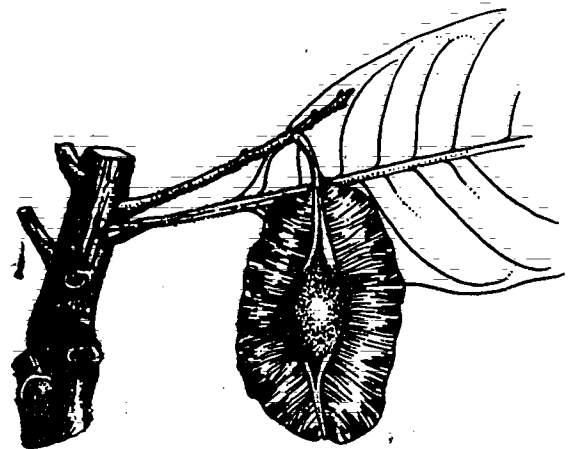
60. *Combretum ghasalense* Engl. & DielsSYNONYM:
*Combretum dalzielii*HAUSA bakin
taramnya
KANOURI zindi61. *Combretum glutinosum* Perr.

CHAD ARABIC	hebil	HAUSA	taramnya
BAMBARA	damba	KANOURI	katagar
DJERMA	kokorbe	MORE	kwenga
FULANI	buski		

Use for gum, firewood, charcoal

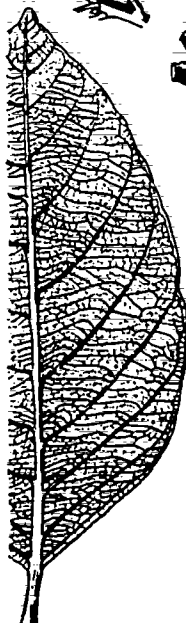

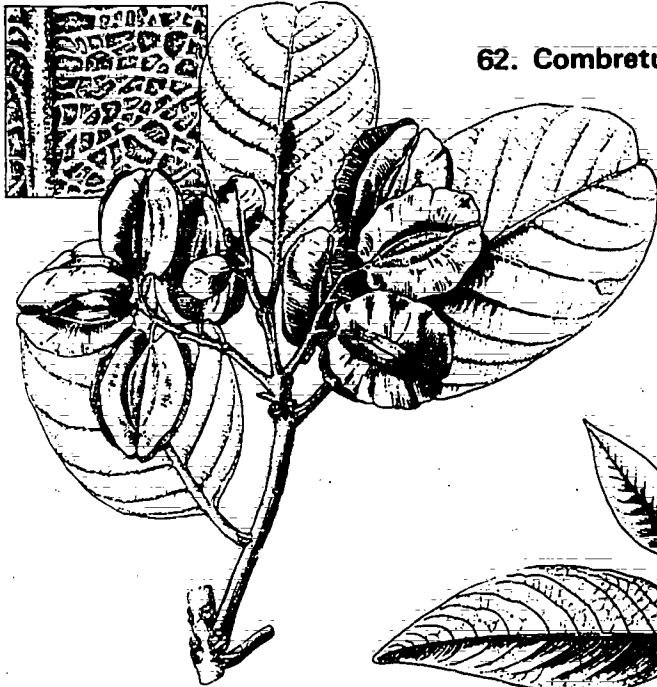

62. *Combretum glutinosum* var. *passargei* Aubr.

HAUSA taramnya

Use for firewood

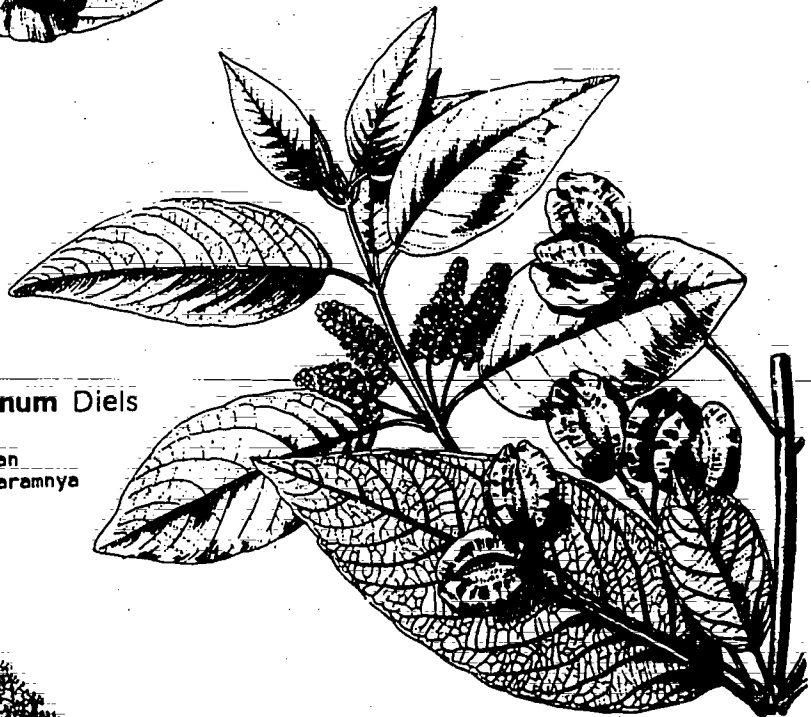

63. *Combretum hypopilinum* Diels

HAUSA jan
taramnya



64. *Combretum lamprocarpum* Diels

SYNONYM: *Combretum verticillatum*

HAUSA taramnya



65. *Combretum micranthum* G. Don.

BAMBARA	kolobe	HAUSA	gleza
DJERMA	koubou	MORE	landaga
FULANI	talli		
	gugumi		

Use for hut sticks, medicine,
gum, firewood

66. *Combretum molle* R. Br.
ex G. Don

SYNONYMS:
Combretum velutinum D.C.
Combretum sokodense
Combretum Leonense

FULANI damoruhl
HAUSA wuyan daho



66.



67. *Combretum nigricans* Leprieur var. *elliottii* Aubr.

SYNONYM:
Combretum lecananthum Engl. & Diels.

BAMBARA	diangara
DJERMA	delligna
FULANI	dokigorl
HAUSA	dagera
MORE	kuarehtuaga

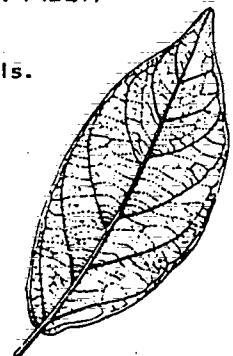

68. *Commiphora africana* (Rich.) Engl.

SYNONYMS: *Palsamodendron africanum* Arn.
Heudelotia africana Rich.

CHAD ARABIC	hbarkat	HAUSA	dashi
	gafal	KANOURI	kabl
FULANI	badadi	MORE	kodemtaboga

Use for live fences

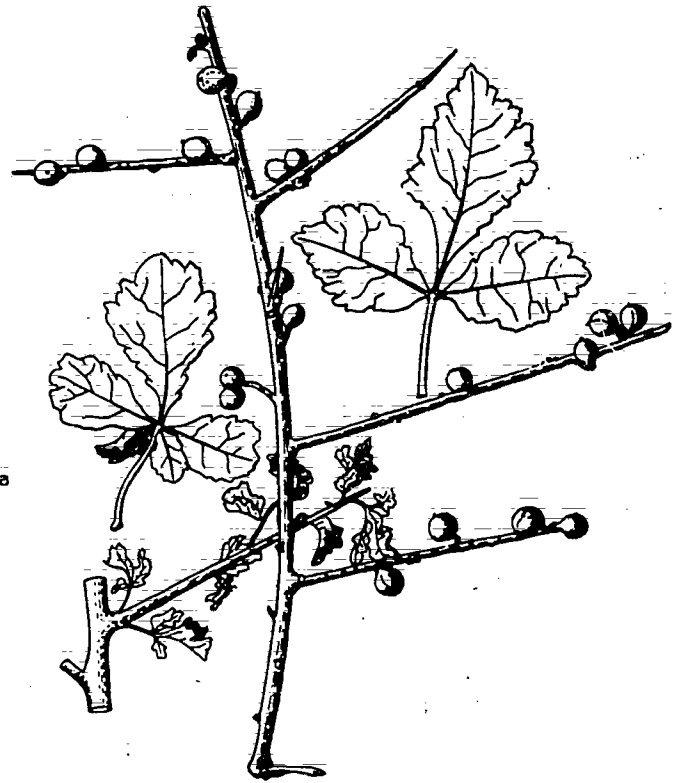

69. *Cordia abyssinica* R. Br.

SYNONYMS: *Cordia africana* Lam.
Cordia ubanghensis Chev.

CHAD ARABIC	birjjuk	HAUSA	aliliba
	ngirli	KANOURI	aluba
FULANI	illibani		

Use for edible fruit

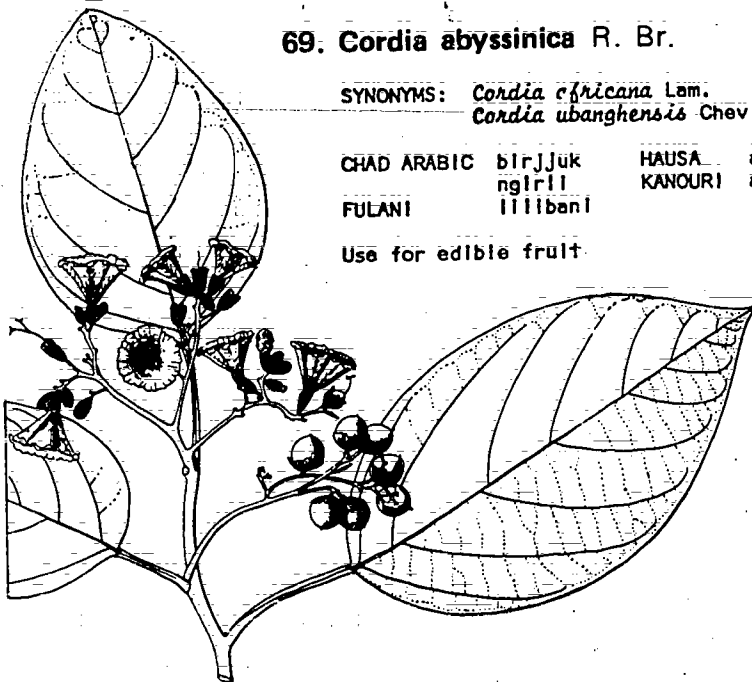

70. *Corchorus olitorius* L.

CHAD ARABIC	mulckhiye
HAUSA	malafya
KANOURI	ganzaino

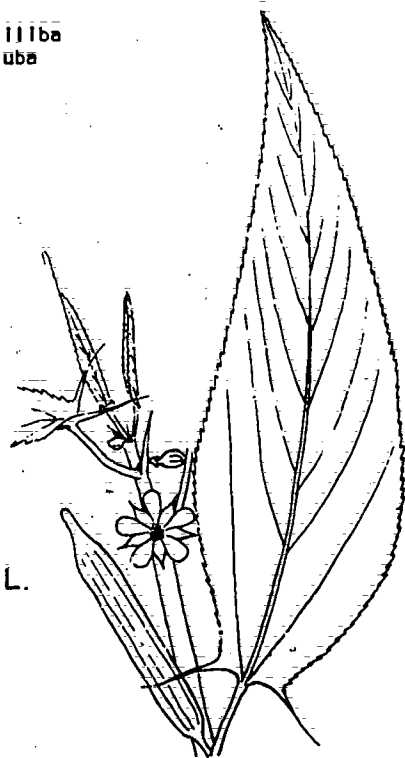



71. Courbonia virgata Brongn.

SYNONYMS:
Courbonia pseudopetalosa Gilg. & Ben.
Kaeria pseudopetalosa (Gilg.) de Wolf

HAUSA Ialo
 KANOURI kumkom

72. Crataeva religiosa Forsk.

SYNONYM: *Crataeva adansonii* D.C.

CHAD ARABIC dabkar
 FULANI landam bani
 HAUSA ungodudu
 goude
 KANOURI ngulido
 MORE kaelegaln-tohiga

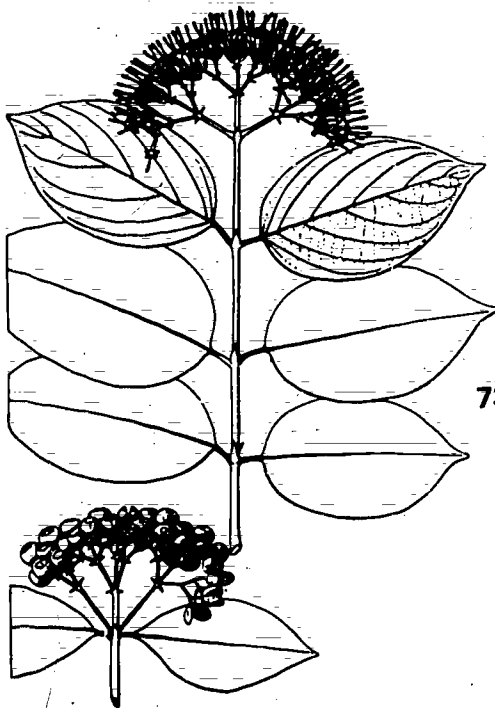
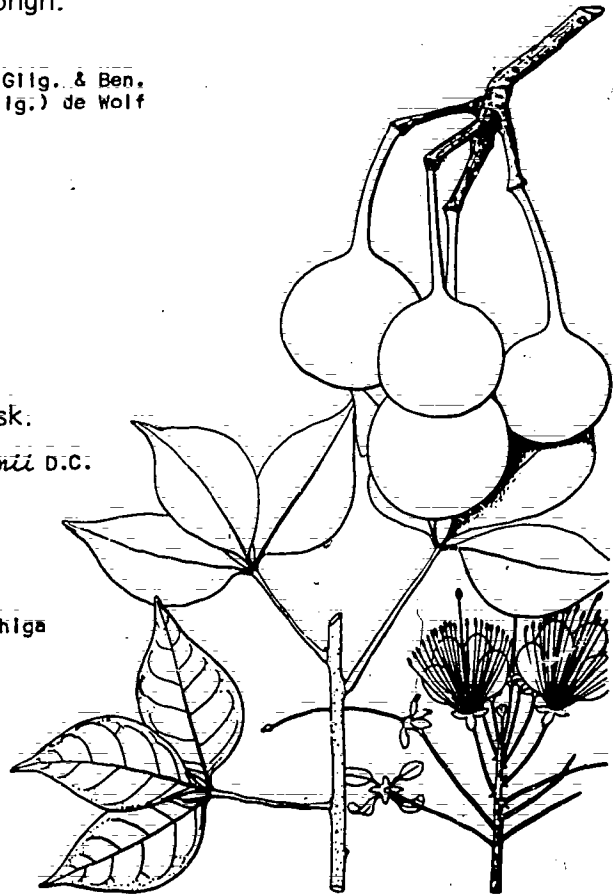

73. Crossopteryx febrifuga Benth.

SYNONYMS:
Crossopteryx africana Balli.
Crossopteryx kotschyana Fenzl.

BAMBARA balimba HAUSA kasfiya
 klenke MORE kumronanga
 FULANI brakoli

74. *Croton macrostachys* Hochst. ex A. Rich.

SYNONYM: *Croton amabilis* Muell.

CHAD ARABIC	deepa
HAUSA	korlbe
KANOURI	moromoro

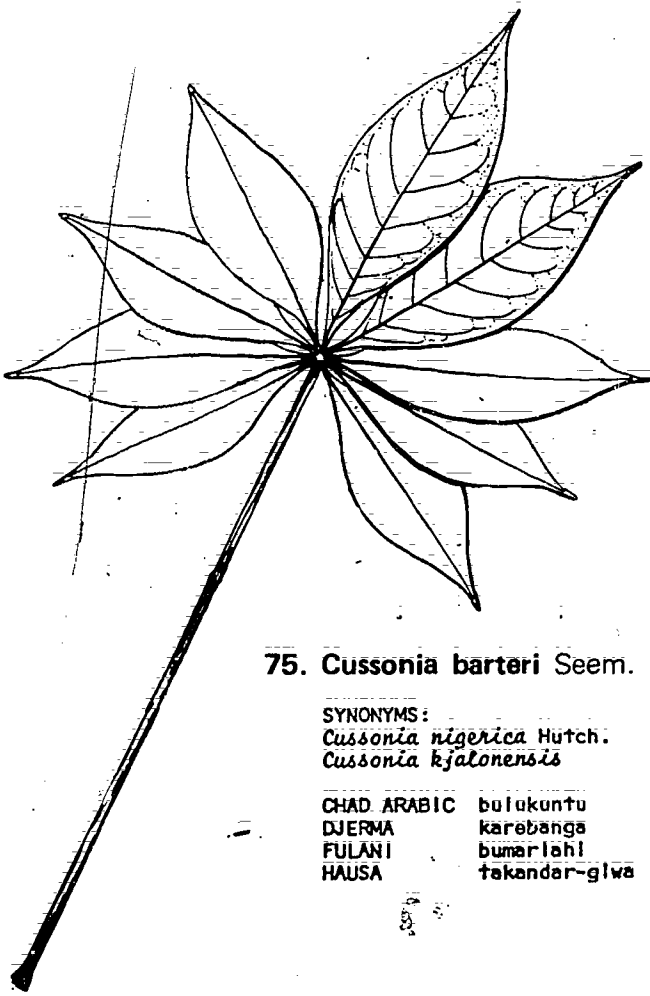
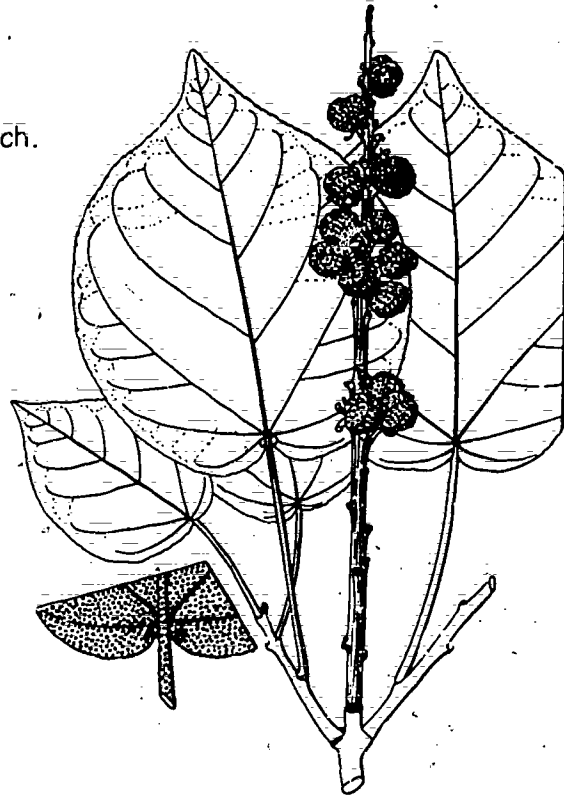

75. *Cussonia barteri* Seem.

SYNONYMS:
Cussonia nigerica Hutch.
Cussonia kjalonensis

CHAD ARABIC	bulukuntu
DJERMA	karebanga
FULANI	bumarlahi
HAUSA	takander-giwa

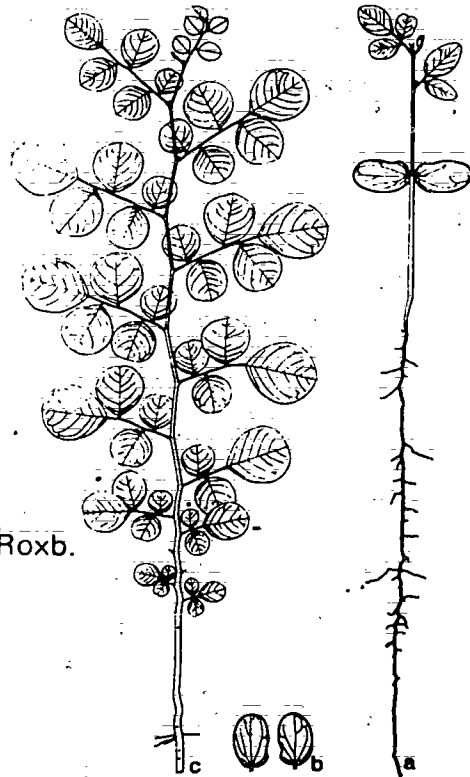

76. *Dalbergia sissoo* Roxb.

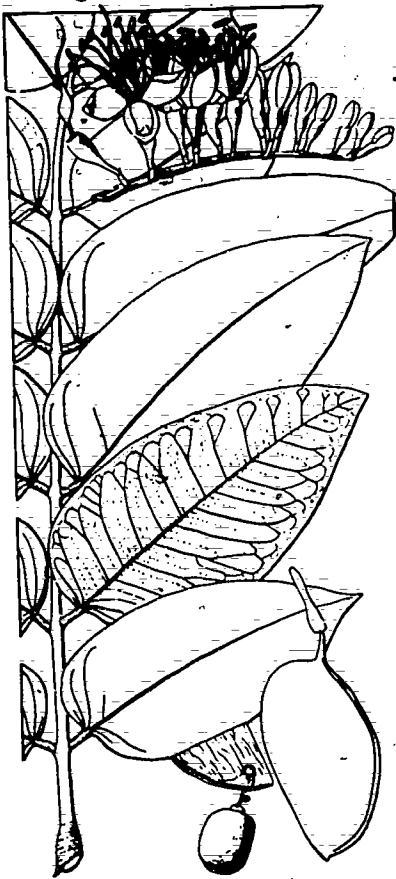

77. *Daniella oliverii* (Rolfe) Hutch. & Dalz.

SYNONYM: *Paradaniellia oliveri* Rolfe.

FRENCH	santan
CHAD ARABIC	samelm
DJERMA	farmey
FULANI	kaharlahl
HAUSA	maje
KANOURI	maje
MORE	honga

78. *Detarium microcarpum*
Guill. & Perr.

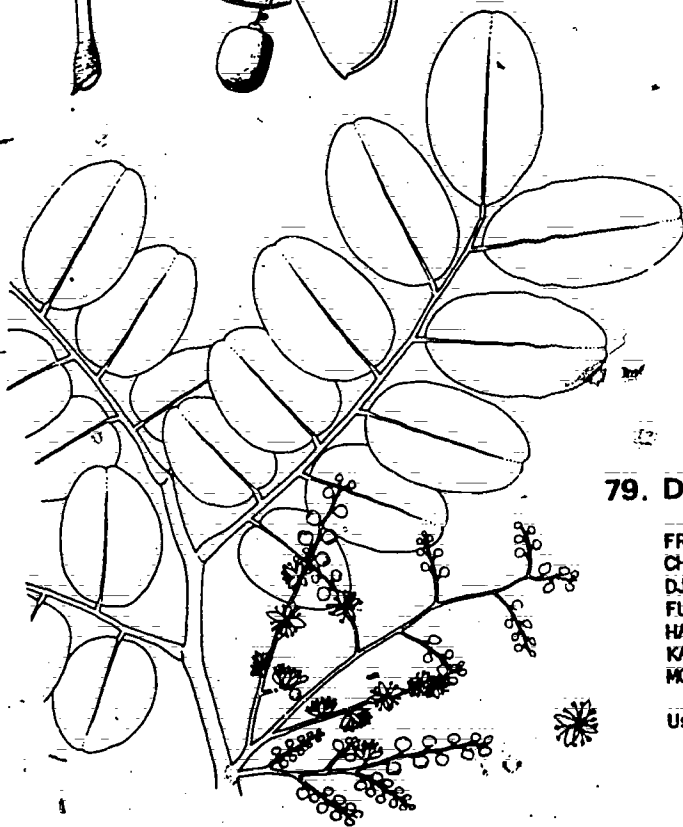
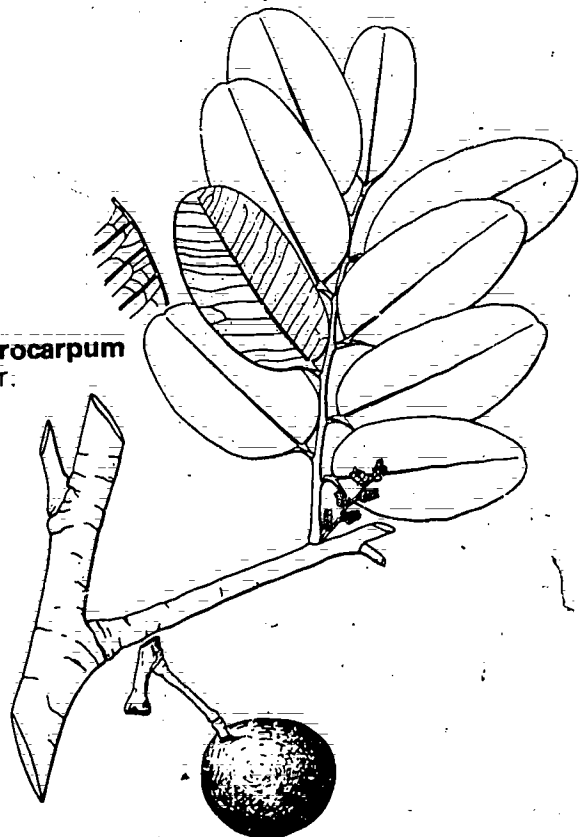

79. *Detarium senegalense* Gmel.

FRENCH	moroda
CHAD ARABIC	abulelie
DJERMA	fantou
FULANI	konkehl
HAUSA	taura
KANOURI	gatapo
MORE	kagtega

Use for drum-wood

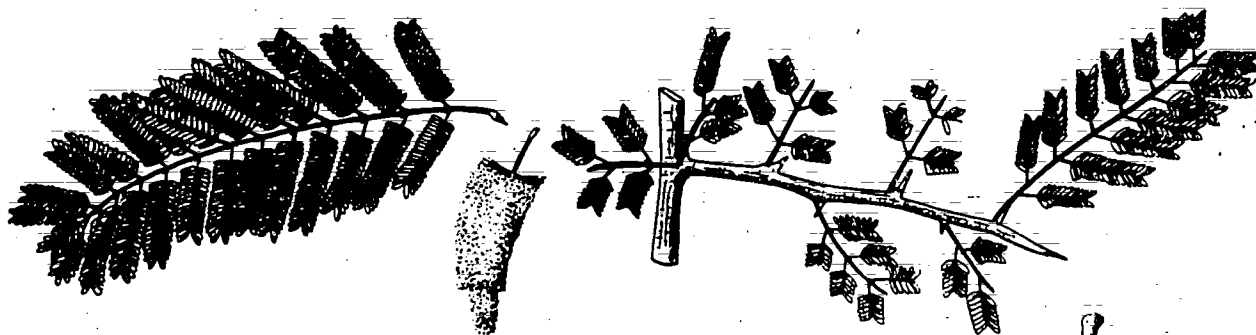

80. *Dichrostachys glomerata* (Forsk.) Hutch. & Dalz.

SYNONYMS: *Dichrostachys arborea* N.E. Br.
Dichrostachys cinerea (L.) Micht & Arn.
Dichrostachys nutans Benth.
Dichrostachys platycarpa Welw.
Gailliea dichrostachys Guill. & Perr.

CHAD ARABIC	dhigingap	HAUSA	dundu
BAMBARA	glikl-goro	KANOURI	garbinna
	ntlligul	MORE	sunsutiga
FULANI	burll		
	patrulaki		

Use for thorn fencing, medicine, root fibers

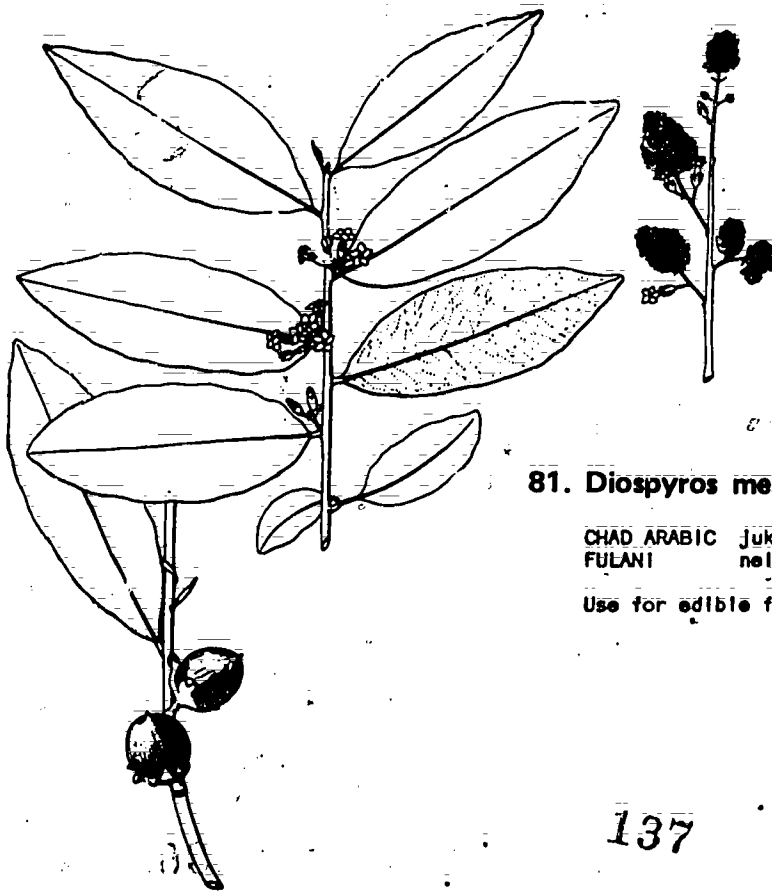

81. *Diospyros mespiliformis* Hochst.

CHAD ARABIC	jukhan	HAUSA	kanyan
FULANI	nei'bi	KANOURI	burgum

Use for edible fruit, firewood

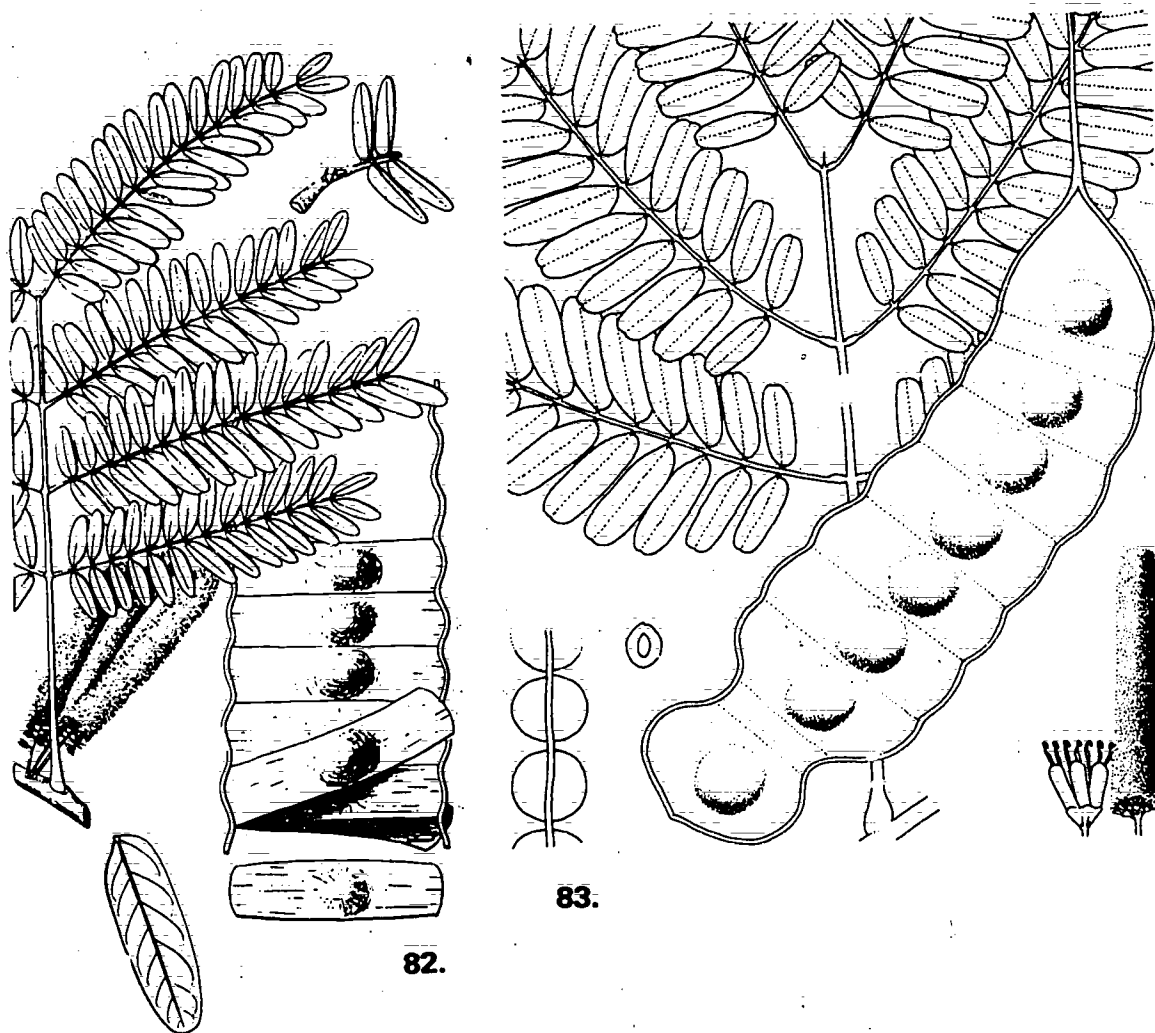
82. *Entada africana* Guill. & Perr.83. *Entada sudanica* Schweinf.

Also see APPENDIX B

CHAD ARABIC	dorot	HAUSA	tawatsa
BAMBARA	dianba	KANOURI	falofala
	samanere	MORE	slanlogo
FULANI	fado-wanduhl		

Use for firewood, medicine

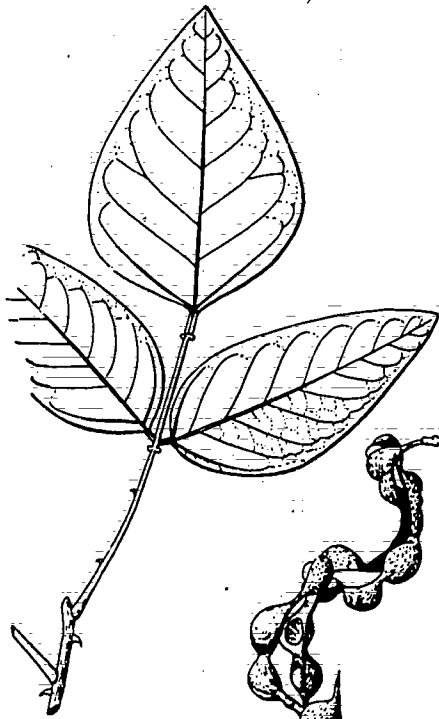

84. Erythrina senegalensis D.C.

BAMBARA	timeba
	lerung
HAUSA	madjirya

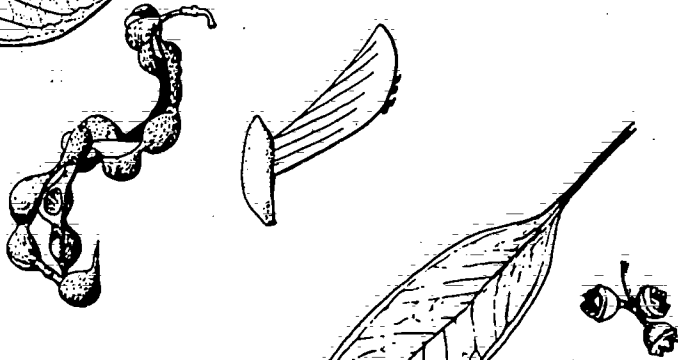

85. Eucalyptus camaldulensis Dehnh.

Also see APPENDIX B

SYNONYM:
Eucalyptus rostrata Schlecht.

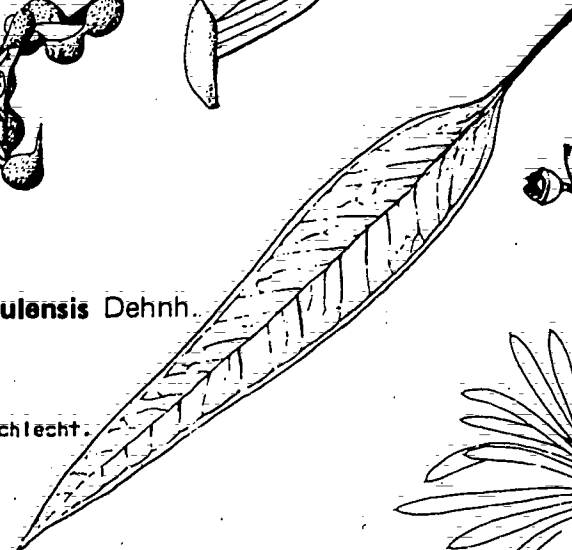

86. Euphorbia balsamifera Ait.

SYNONYMS: *Euphorbia rogeri* N.E. Br.
Euphorbia septium N.E. Br.

DJERMA	berre
FULANI	yero
	magara
HAUSA	agoua
KANOURI	yero
	magara

Use for live hedges

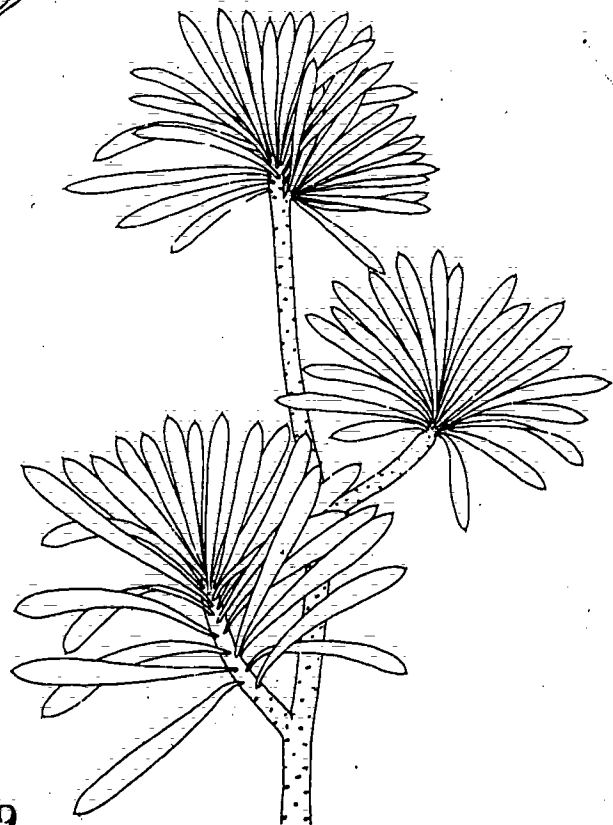
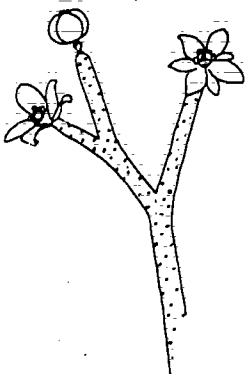

87. *Ficus gnaphalocarpa* A. Rich.

SYNONYMS:

Ficus sycomoroides L.
Ficus trachyphylla Fenzl.
Grosse crenata Warb.

CHAD ARABIC	Jameiz al abiad	HAUSA	baoure
BAMBARA	nituro toro n'toro	KANOURI	tarmu obbo
FULANI	yibe obbi	MORE	Jivi kankanga

Use for edible fruit, medicine, bark

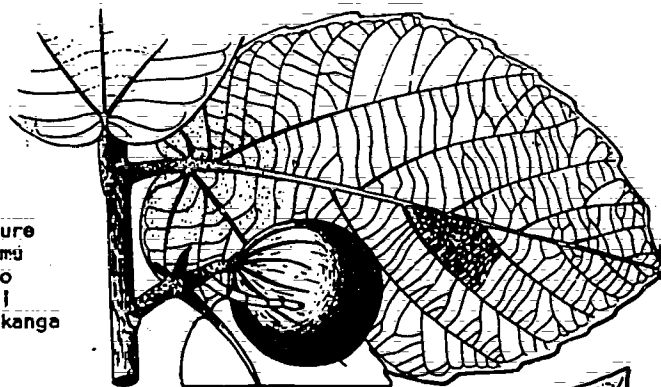
88. *Ficus ingens* Miq.

SYNONYMS:

Ficus kawuri Hutch.
Ficus lutea Vah.

BAMBARA	туру
HAUSA	kawuri
KANOURI	busugu
MORE	kampsera-manga

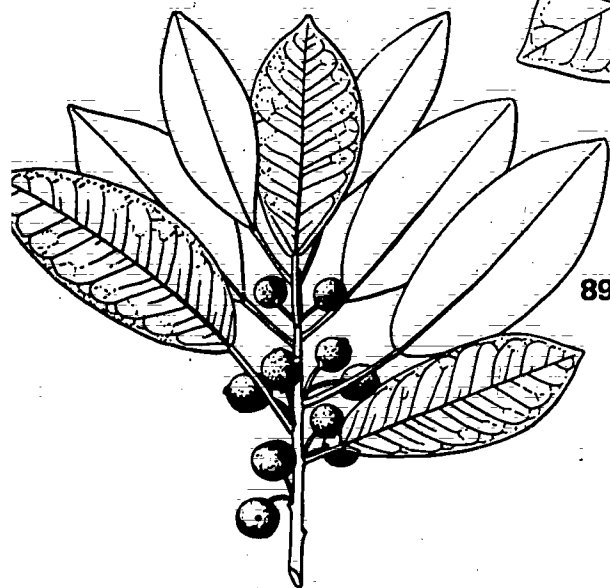
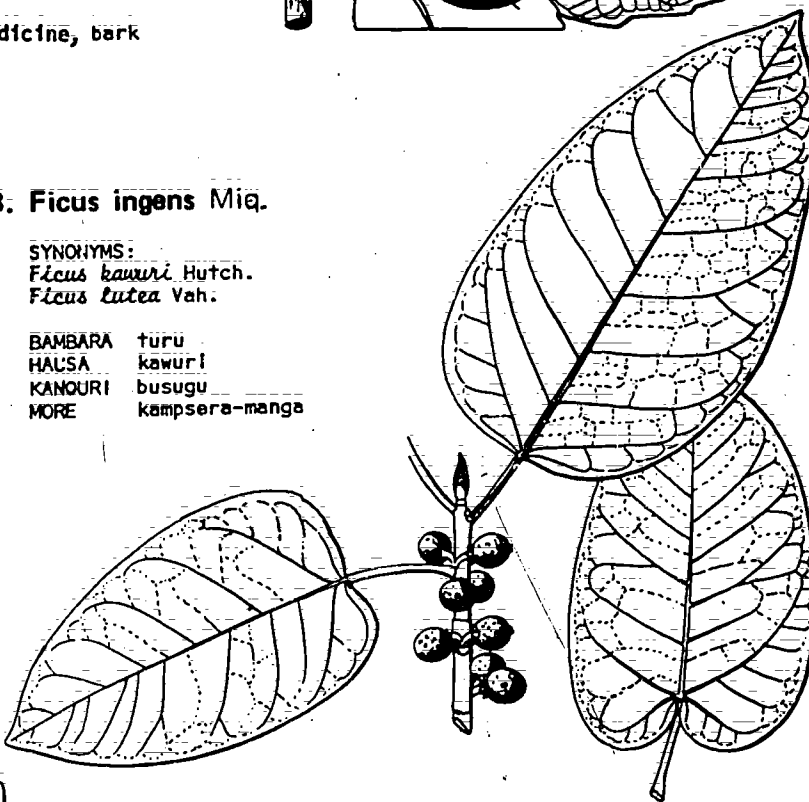
89. *Ficus iteophylla* Miq.

SYNONYMS:

Ficus bongoensis Warb.
Ficus spragueana

FULANI	sekehi
HAUSA	shirya
KANOURI	nja-nja

Use for firewood

90. *Ficus platyphylla* Del.

SYNONYMS:

Ficus bibracteata Warb.
Ficus umbrosa Warb.

CHAD ARABIC	jameiz		
	ei ahmahar		
BAMBARA	n' kobo		
FULANI	dundehi		
HAUSA	gamji		
KANOURI	ngabara		
MORE	kempsaogo		

Use for shade, medicine

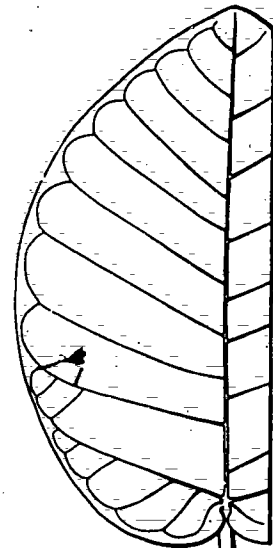

91. *Ficus polita* Vahl

SYNONYMS: *Ficus niarniamensis* Warb.
Ficus stenosiphon Warb.
Ficus syringifolia Warb.
Ficus syringoides Warb.

CHAD ARABIC	djimeimb	HAUSA	duruml
	azrak	KANOURI	rita
FULANI	litahi	MORE	pampanga

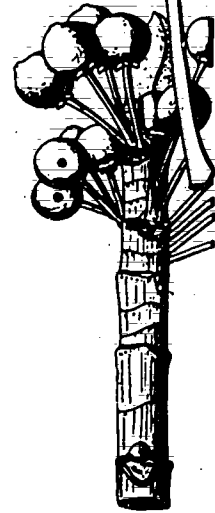
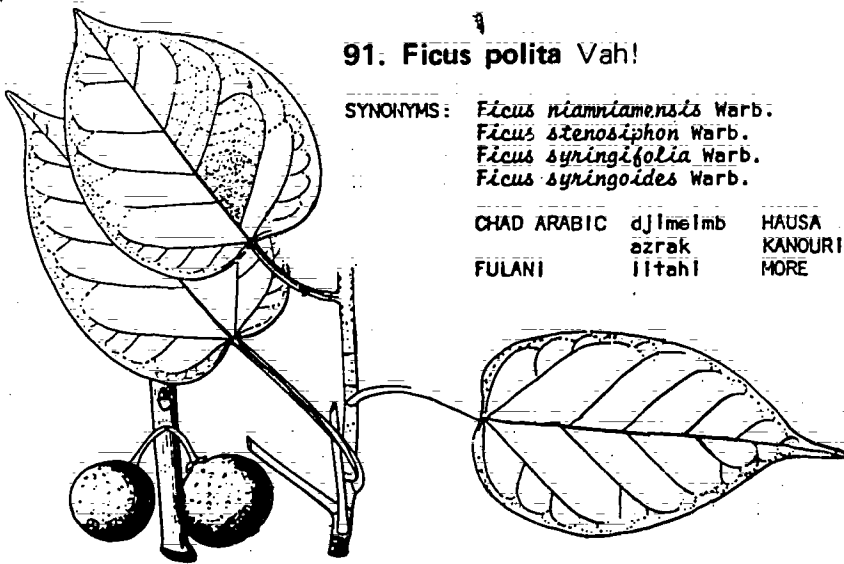

92. *Ficus thonningii* Blume

CHAD ARABIC	jameiz	HAUSA	tchedla
	ei abled	KANOURI	jeja
BAMBARA	dubale	MORE	kusga
FULANI	biskehi		

Use for medicine

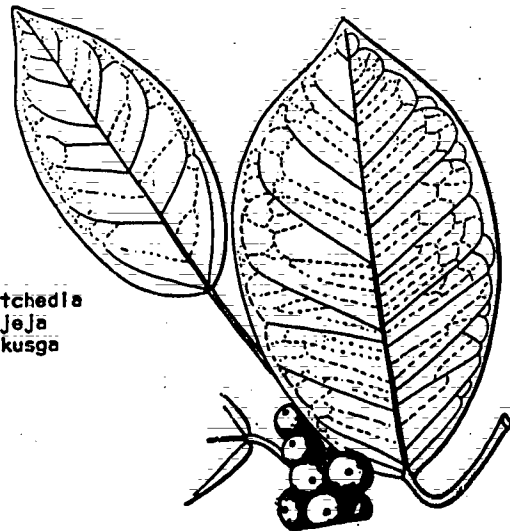

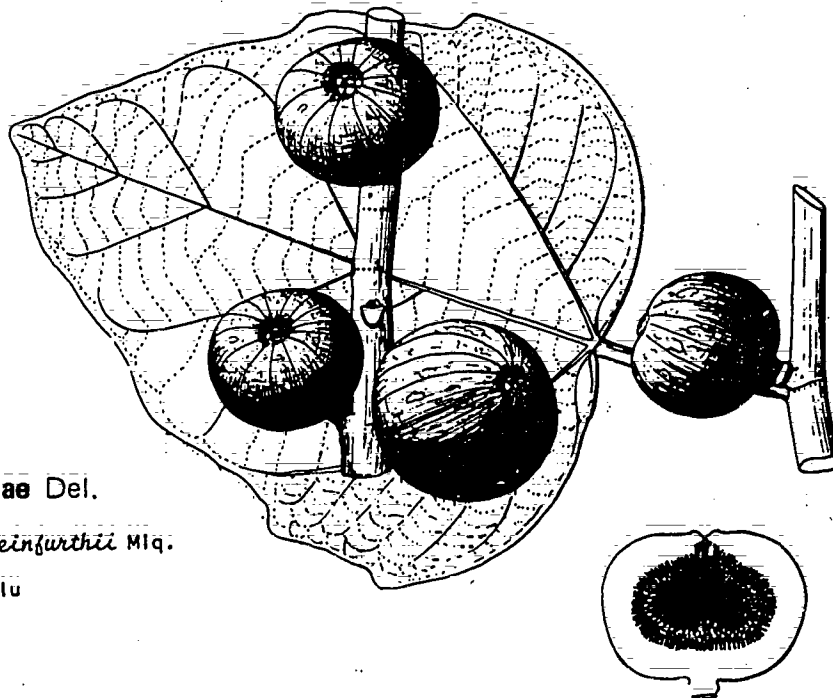

93. *Ficus vallis choudae* Del.

SYNONYM: *Ficus schweinfurthii* Miq.

HAUSA datu

94. *Fluggea virosa* (Roxb. ex Willd.) Baill.

SYNONYMS:

Fluggea microcarpa Blume
Fluggea virosa Buch.-Ham. ex Wall.
Securinea microcarpa (Blume)
 Pax & Hoffm.
Phyllanthus virosus Roxb.

HAUSA daghirto
 tsa
 KANOURI shim shim

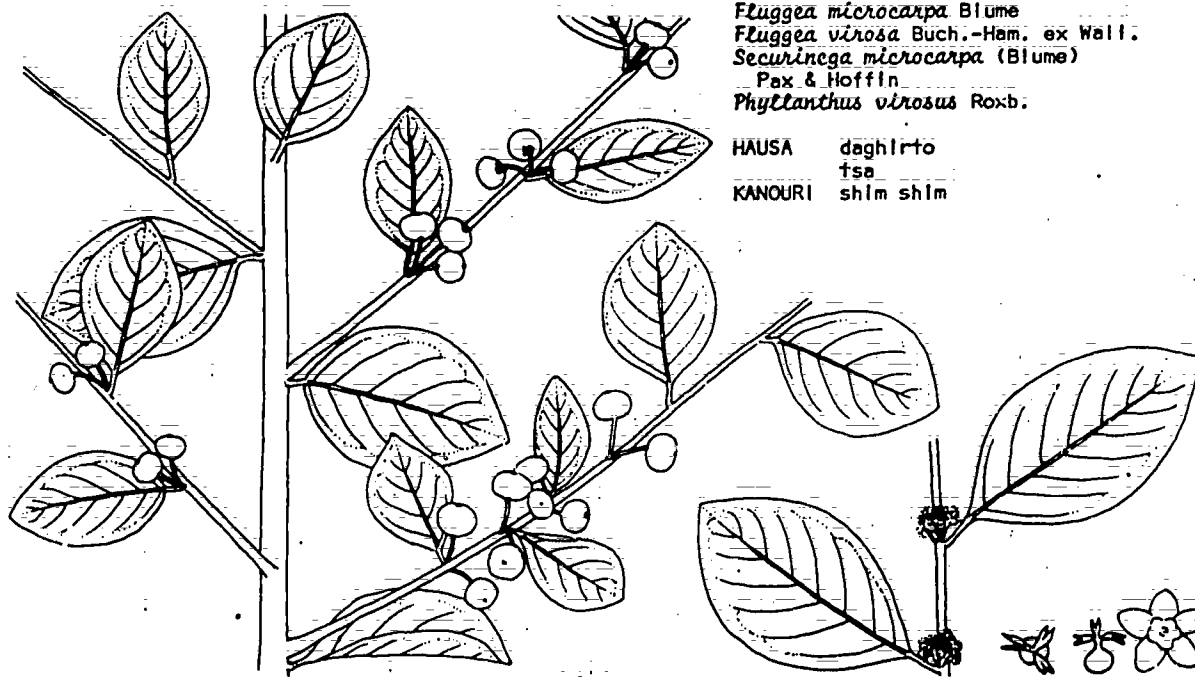

142

95. *Gardenia erubescens* Stapf. & Hutch.

CHAD ARABIC	am mififene
BAMBARA	m'bure
	mussama
DJERMA	sinesan
FULANI	dingail
HAUSA	gaoude
KANOURI	gursime
	gogut
MORE	tankorah-gonga

Use for dye

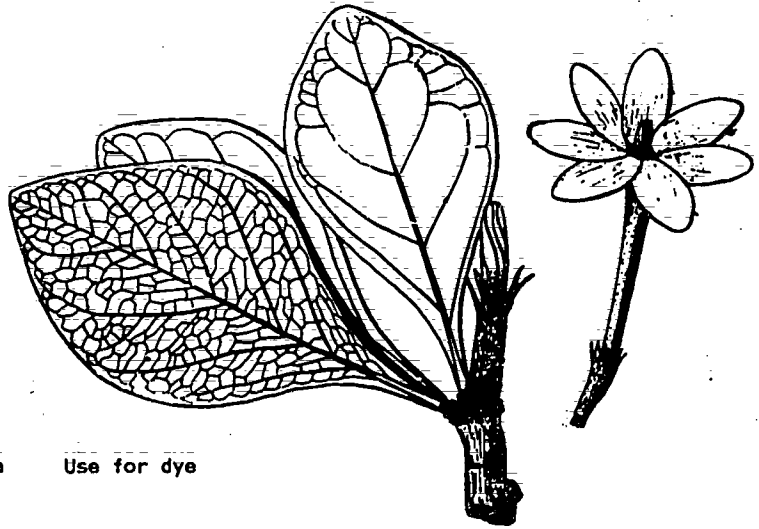

96. *Gmelina arborea* Roxb. not illustrated

Also see APPENDIX B

ENGLISH melina

Use for soft wood (for matches, boxes, etc.)

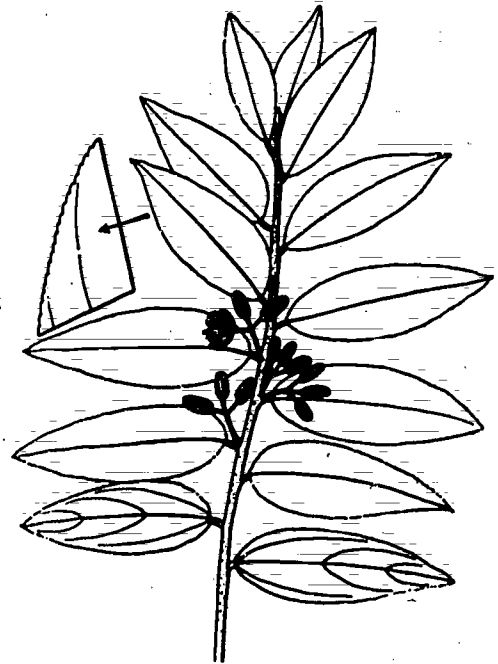

97. *Grewia bicolor* Juss.

CHAD ARABIC	abesh
FULANI	leloko
KANOURI	djimdjime
MORE	tonlaga

Use for edible fruit

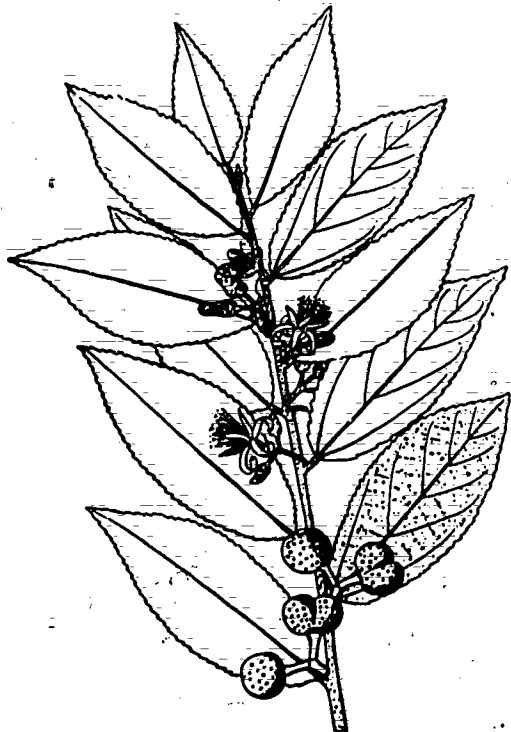

98. *Grewia flavescens* Juss.

CHAD ARABIC	gueddeb
HAUSA	kamanmoa
KANOURI	karnal
MORE	somkondo

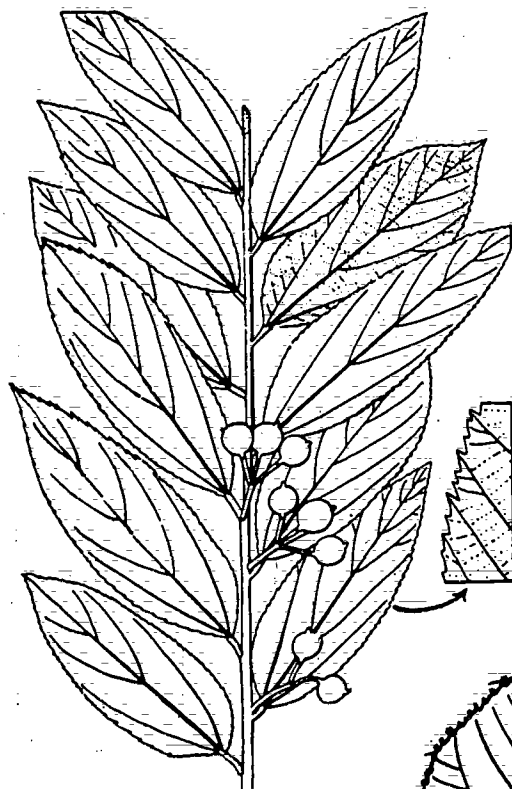

99. *Grewia mollis* Juss.

CHAD ARABIC	ghebbesh	HAUSA	dargaza
BAMBARA	nogo nogo	KANOURI	karno
FULANI	keili	MORE	munimuka

Use for salt from ashes

100. *Grewia villosa* Willd.

SYNONYM:
Grewia corylifolia
Gill. & Perr.

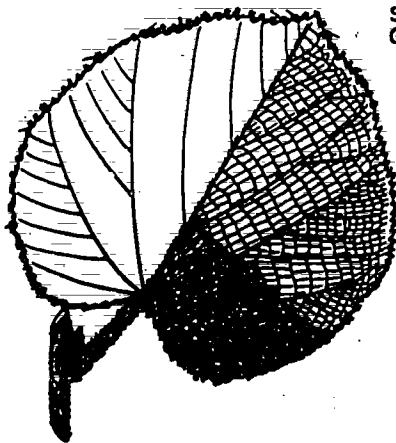

101. *Guiera senegalensis* Lam.

Also see APPENDIX B

CHAD ARABIC	kabeah
BAMBARA	kudlengbe
DJERMA	sabara
FULANI	geiloki
HAUSA	sabara
KANOURI	kasasai
MORE	unulga

Use for firewood, seeds for
dysentery medicine



144

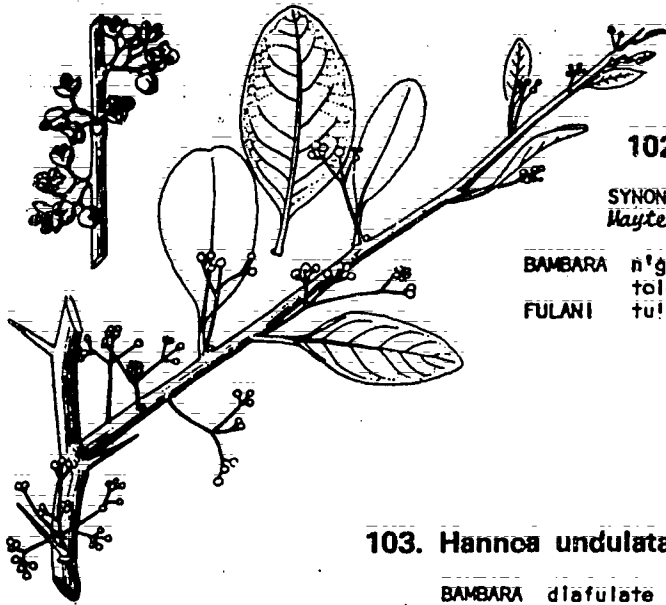

102. *Gymnosporia senegalensis* Loes.

SYNONYM:
Maytenus senegalensis (Lam.) Excell

BAMBARA	n'gulgue	HAUSA	namljin-tsada
	tele	MORE	tokuvuguri
FULANI	tu!tuide		

103. *Hannoa undulata* Planch.

BAMBARA	diapulata
FULANI	bummere
	badl
HAUSA	takandar
	giwa

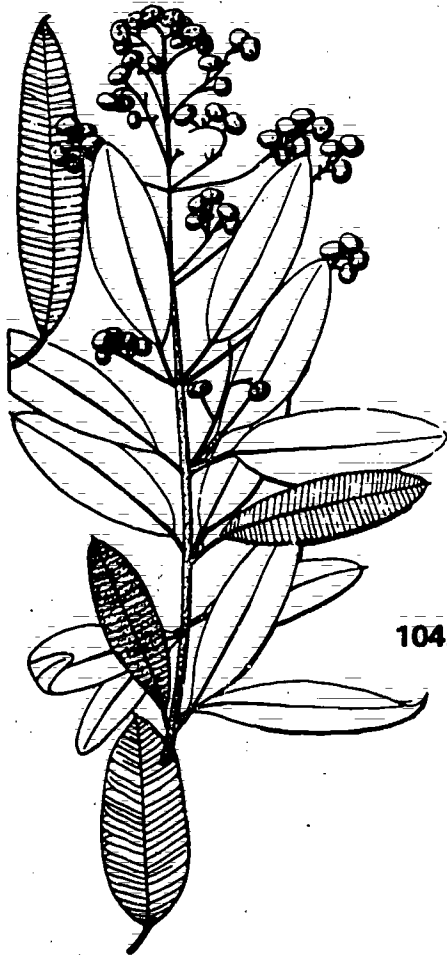
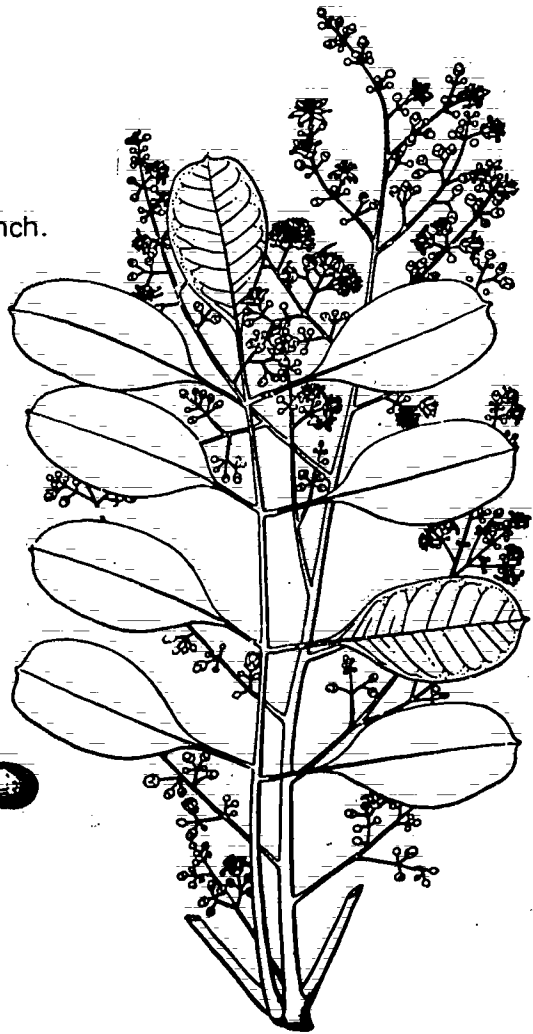

104. *Heeria insignis* (Del.) O. Ktze.

SYNONYMS:
Anaphrenum abyssinicum Hochst.
Rhus insignis Del.

BAMBARA	kalakari	HAUSA	kasheshe
FULANI	badl	MORE	niinore

105. *Hibiscus asper* Hook.

not illustrated

FULANI	follere
HAUSA	yakuwar daji
KANOURI	karasu

106. *Hibiscus cannabinus* L.

CHAD ARABIC	tii libe
FULANI	gabai
HAUSA	rama
KANOURI	ngabai

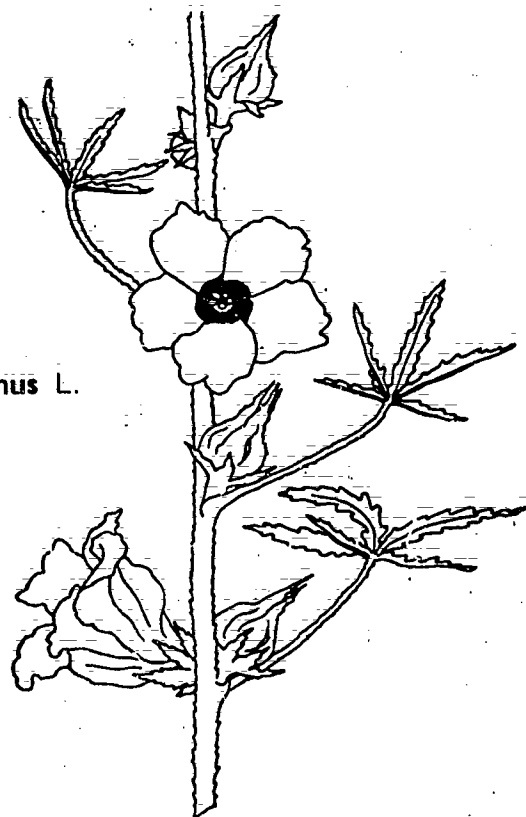
107. *Hibiscus esculentus* L.

not illustrated

CHAD ARABIC	bamiya
FULANI	takeyi
HAUSA	kubawa
KANOURI	nubaito

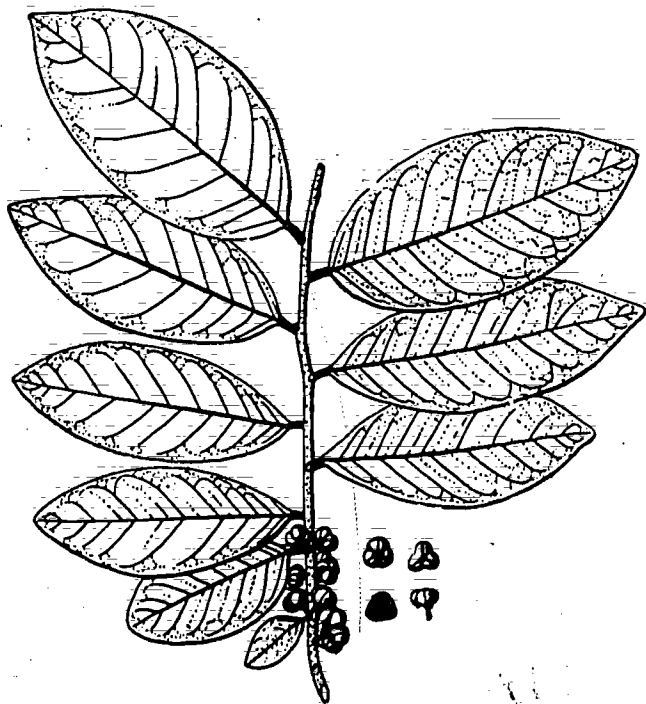
108. *Hymenocardia acida* Tul.

BAMBARA	tanloro
FULANI	yawa sotoje bodehi
HAUSA	Jan-yaro djan-ltche

Use for red-colored wood



109. *Hyphaene thebaica* (L.) Mart.

FRENCH	doum	FULANI	gellohi
CHAD ARABIC	dom	HAUSA	goriba
DJERMA	kangau	KANOURI	kerzun

Use for construction, edible fruit

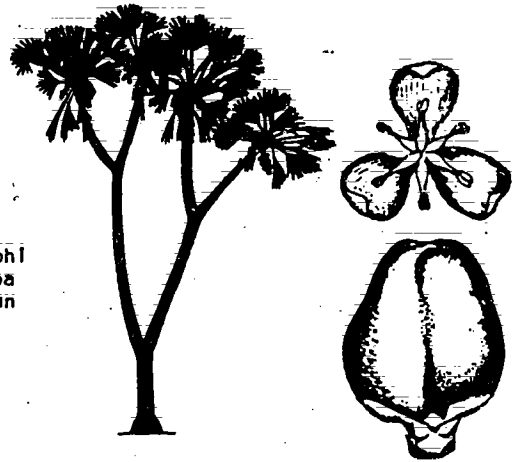

110. *Isoberlinia dalzielii* Craib & Stapf. not illustrated

SYNONYM: *Isoberlinia tomentosa* (Harms.) Craib. & Stapf.

BAMBARA	sau	HAUSA	fara doka
	slo	MORE	kalsaka
FULANI	kubahi		

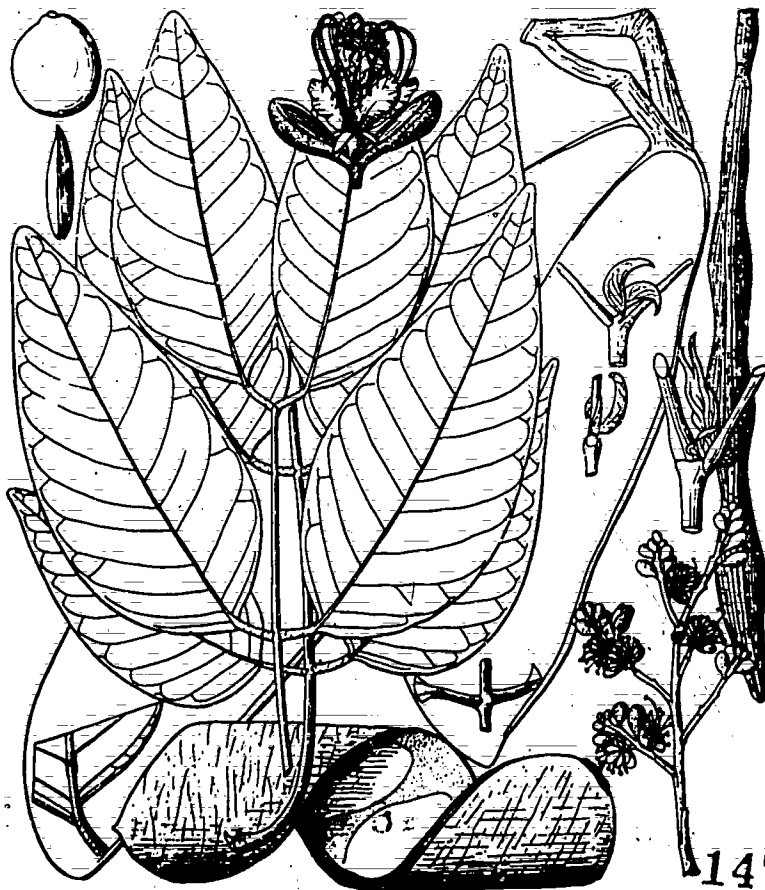

**111. *Isoberlinia doka*
Craib & Stapf**

HAUSA	doka
-------	------

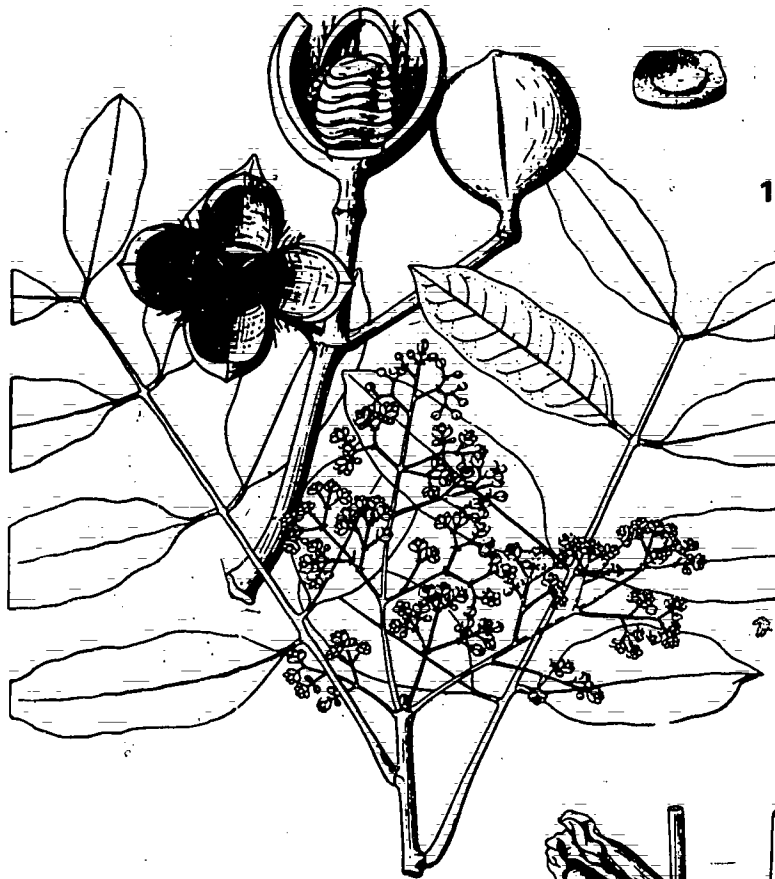

112. *Khaya senegalensis* Juss.

ENGLISH	African "mahogany"
FRENCH	calicedrat
CHAD ARABIC	muray
BAMBARA	diala
DJERMA	farel
FULANI	dalehi
	call
HAUSA	madadji
KANOURI	kagam
MORE	küga

Use for fodder

113. *Kigelia africana* Benth.

SYNONYMS:
Kigelia aethiopica Decne.
Kigelia africana var.
aethiopica Aubr.

CHAD ARABIC	kouk
FULANI	gir lahi
HAUSA	rahma
	baounia
KANOURI	bulungu
MORE	dindon
	limbi

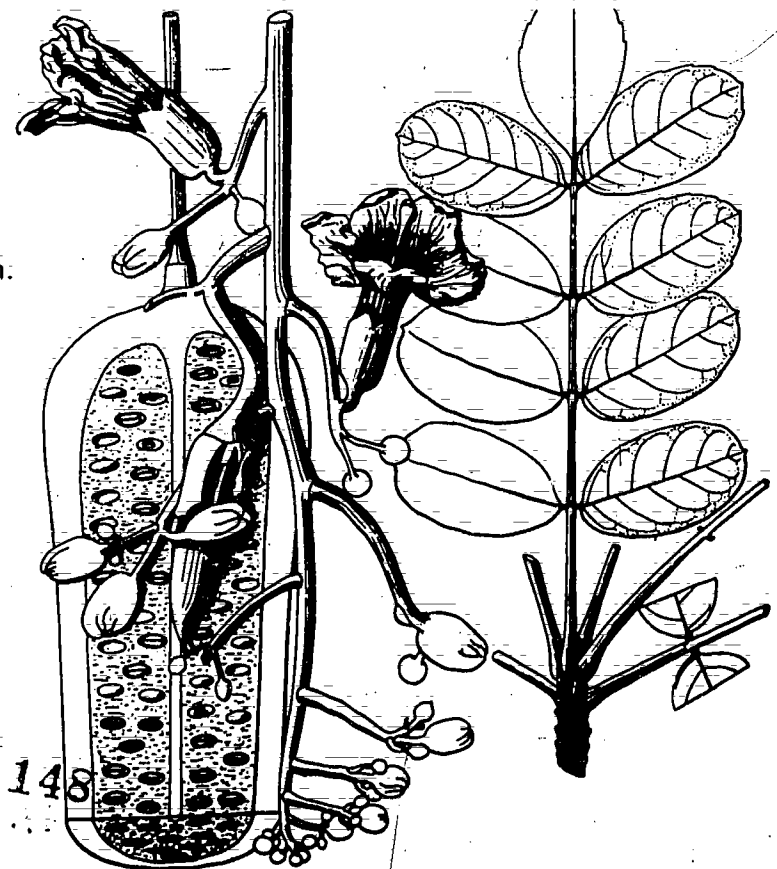

114. *Lannea acida* A. Rich.

Also see APPENDIX B

FULANI	faruhl
HAUSA	farou
KANOURI	adarazaga
MORE	pekunl
	sabga

Use for edible fruit



115. *Lannea afzели* Engl.

SYNONYMS:

Lannea glaberrima Engl. & Krause
Lannea grossularia A. Chev.
Lannea nigritana (Sc. Ell.) Keay

HAUSA daoya

Use for medicine



116. *Lannea humilis* (Oliv.) Engl.

SYNONYMS: *Lannea baginensis* Engl.
Odina humilis Oliv.

KANOURI kurubulul

117. *Lannea oleosa* not illustrated

SYNONYM: *Odina acida*

118. *Leptadenia lancifolia* Decne.

SYNONYMS:
Leptadenia hastata (Pers.) Decne.
Cynanchum hastatum Pers.

CHAD ARABIC	sha'alob
FULANI	yahj
HAUSA	yadiya
KANOURI	njara

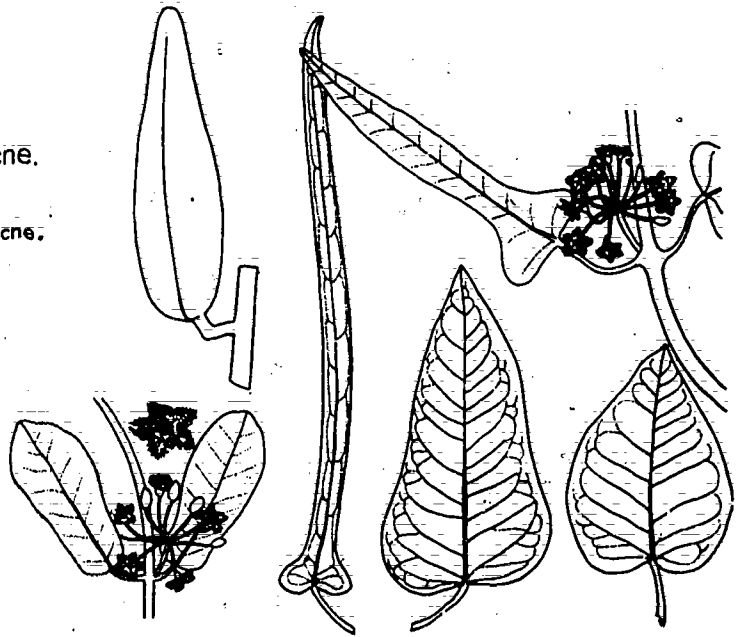

119. *Leptadenia spartium* Wright

SYNONYM:
Leptadenia pyrotechnica (Forsk.) Dec.

CHAD ARABIC	merakh
FULANI	sabale
HAUSA	kalumbo
KANOURI	karimebo

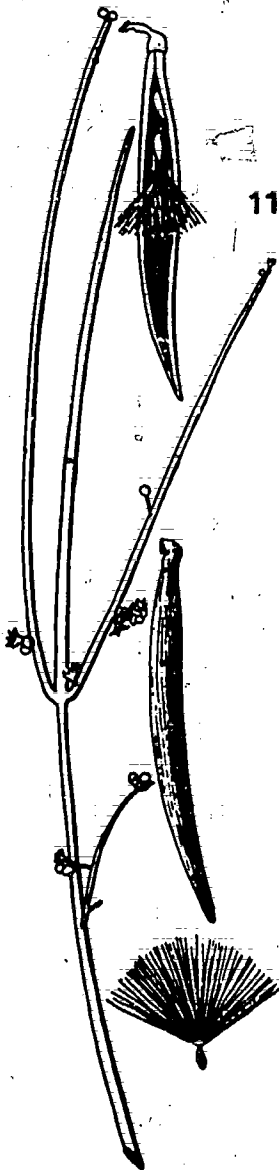

120. *Lophira alata* Banks

SYNONYM:
Lophira lanceolata
 Van Tiegh. ex Keay

BAMBARA	mana
FULANI	karehi gori
HAUSA	nanjin
	kadal

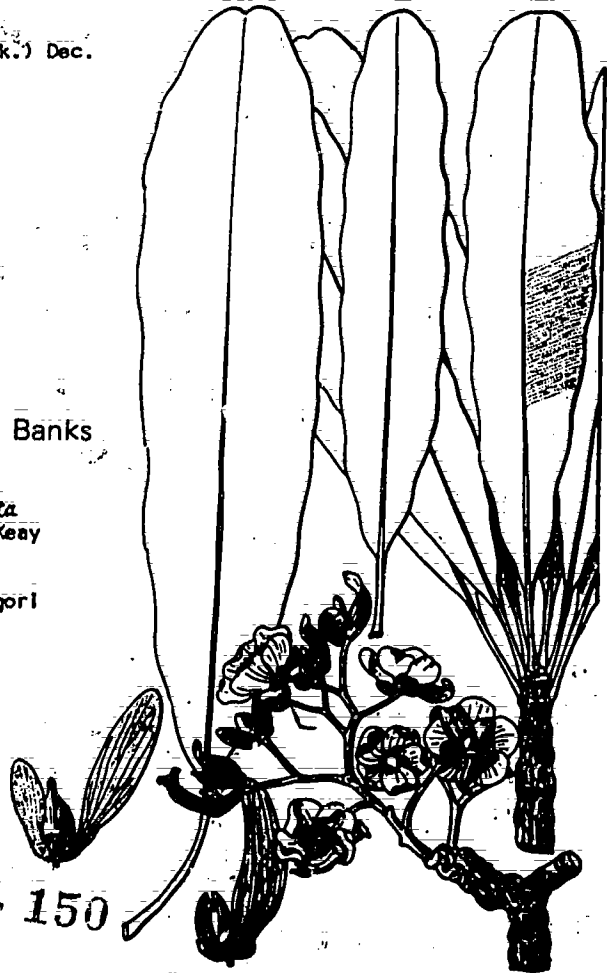

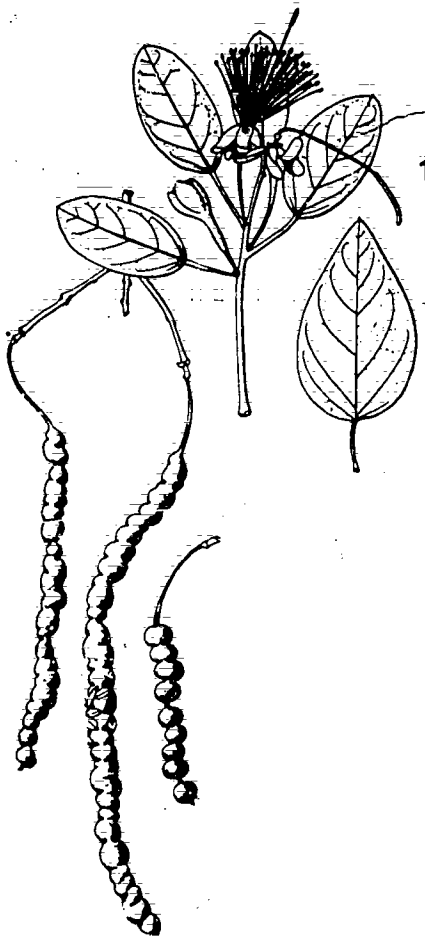

121. *Maerua angolensis* D.C.

CHAD ARABIC	shagara el zeraf
BAMBARA	bre-bre kokali
FULANI	leggal ball
HAUSA	ci-ciwa
KANOURI	abchi
MORE	kessiga

Use for fodder



122. *Maerua crassifolia* Forsk.

CHAD ARABIC	zorhale sarah
BAMBARA	beredlou
FULANI	sogui
HAUSA	jiga
KANOURI	jiga
MORE	kessiga

Use for tool handles,
firewood, fodder

123. *Menotes keratingii*

FULANI	Jangi
HAUSA	ferin rua

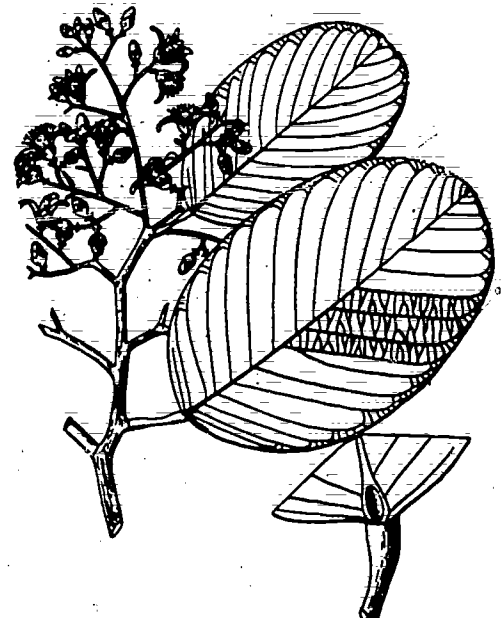
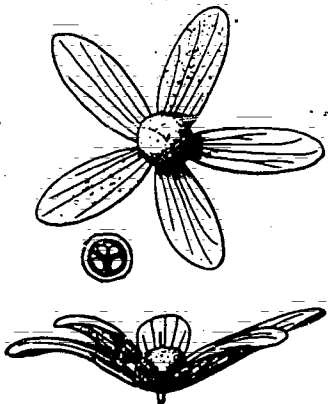

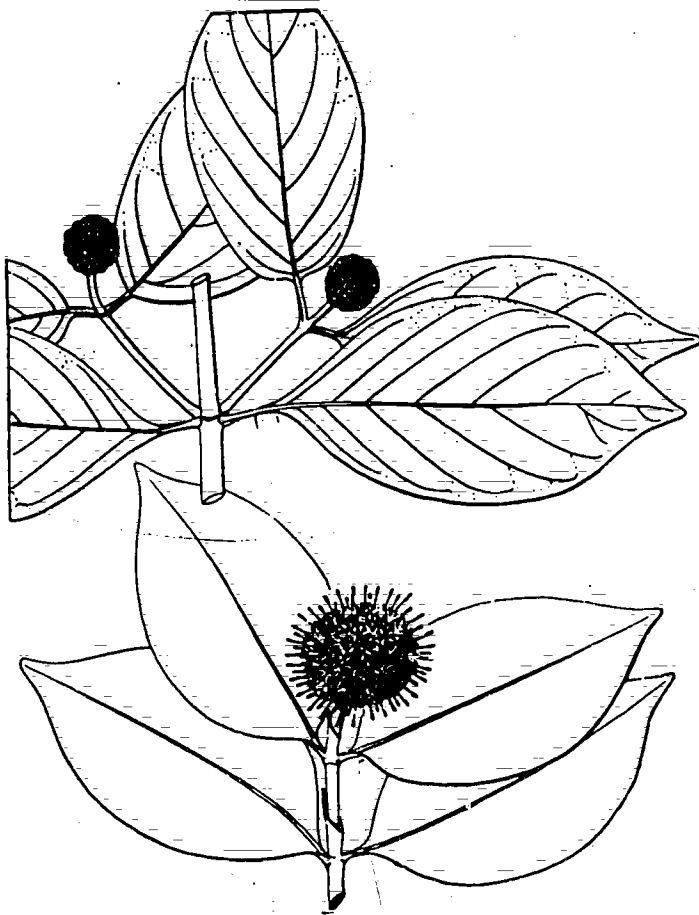

124. *Mitragyna inermis* O. Kuntze

SYNONYM:
Mitragyna africana Korth.

CHAD ARABIC	ngato
BAMBARA	dloun
FULANI	koli
HAUSA	guljeja
KANOURI	kawul
MORE	lloga

Use for firewood, medicine,
fish baskets

125. *Momordica balsamina* L.

HAUSA	garafuni
KANOURI	dugdoge

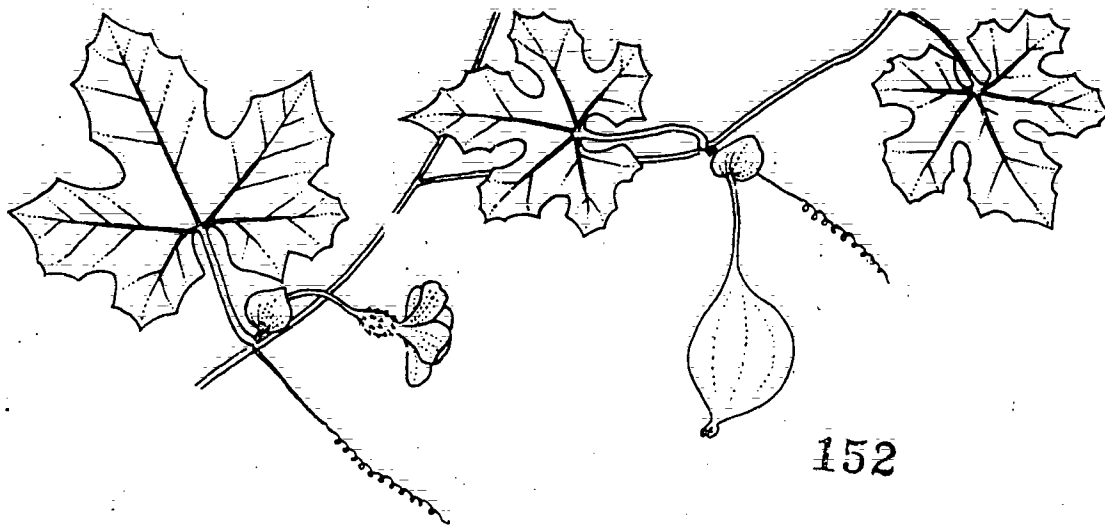

126. *Moringa pterygosperma* Gaertn.

SYNONYM: *Moringa oleifera* Lam.

CHAD ARABIC	allm
FULANI	gulligandani
HAUSA	zogolangandi
KANCURI	allum
MORE	argentiga

Use for edible leaves



127. *Nauclea esculenta*

not illustrated

FULANI	bakurehi
HAUSA	tefashiya

128. *Nauclea latifolia* Smith





129. *Nymphaea lotus* L.

CHAD ARABIC	sittelb
FULANI	tabbera
HAUSA	bado
KANOURI	dambi

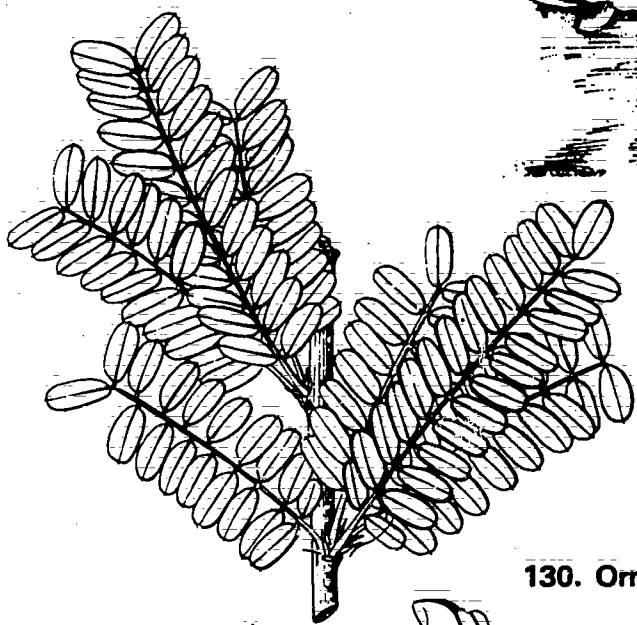

130. *Ormocarpum bibracteatum* Bak.

HAUSA	fashkara
	glwa
KANOURI	sabram

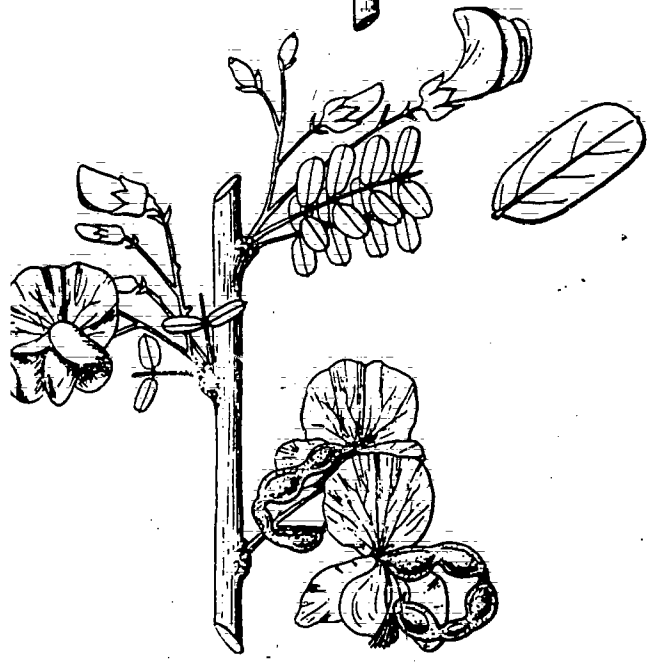

131. *Oryza barthii*

not illustrated
HAUSA shimkafa

132. *Ostryoderris chevalieri* Dunn

SYNONYM: *Ostryoderris stuhlmannii*
(Taub.) Dunn ex Harms.

BAMBARA	musse sana
HAUSA	fugu
MORE	burdl baombanko

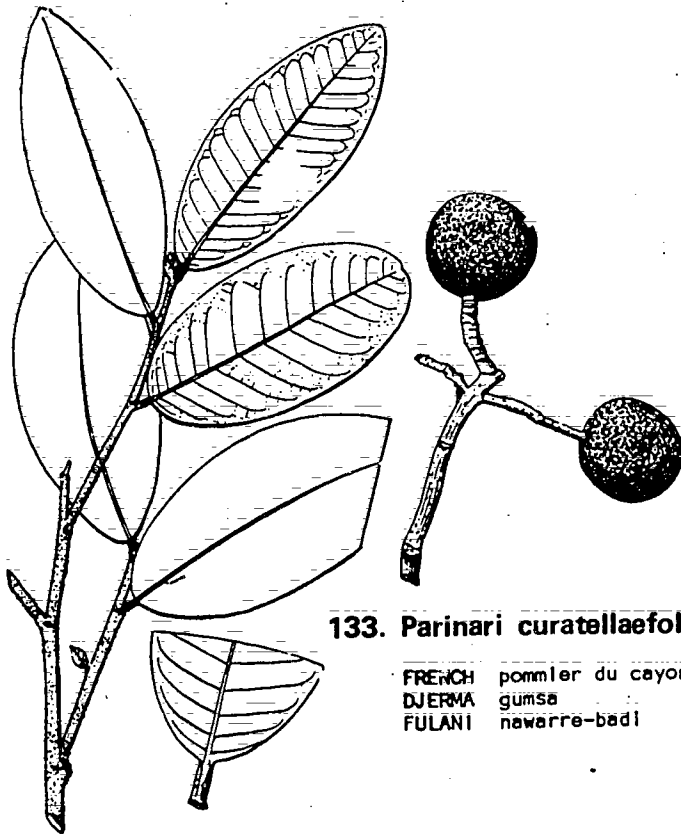
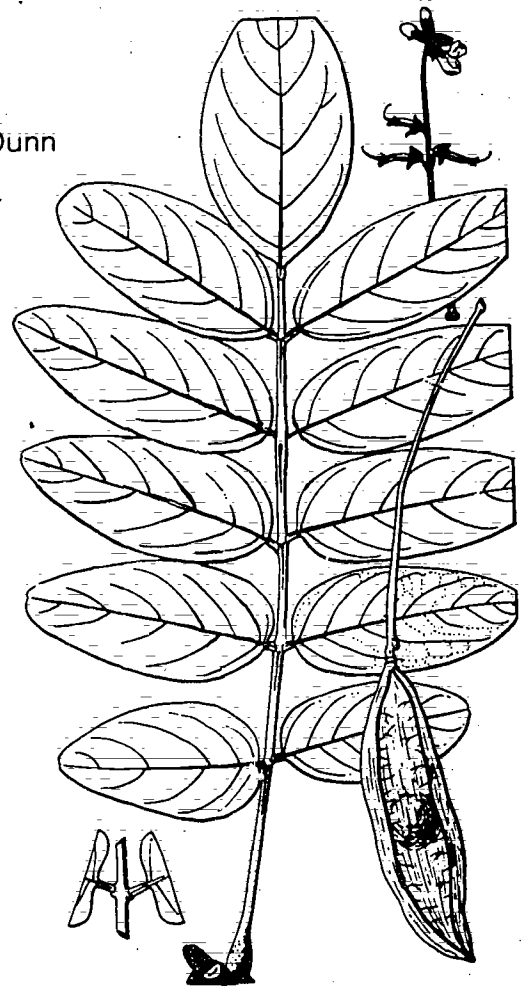

133. *Parinari curatellaefolia* Planck.

FRENCH	pommier du cayor	HAUSA	rura
DJERMA	gumsa	KANOURI	gawassa
FULANI	nawarre-badi		mande

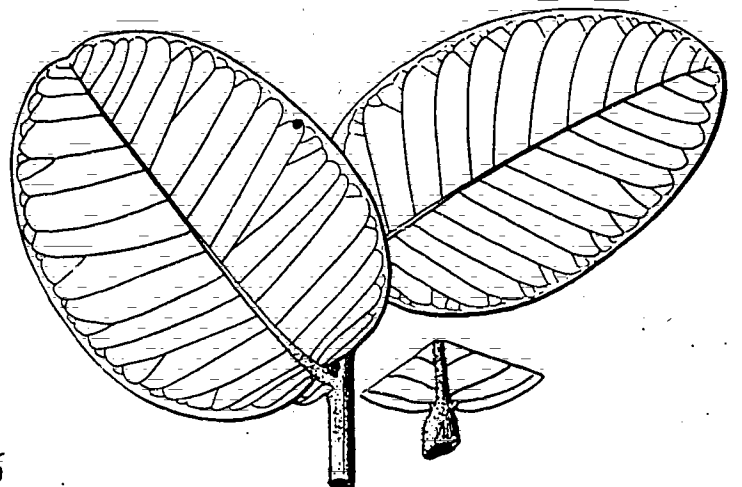

134. *Parinari macrophylla* Sabine

FULANI	nawarre
HAUSA	gawasa
MORE	ouamtanga

Use for edible fruit

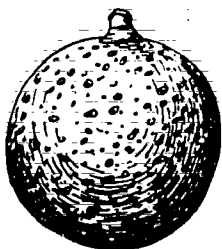

135. *Parkia biglobosa* Benth.

Also see APPENDIX B

SYNONYMS:
Parkia clappertonia Keay
Mimosa biglobosa Jacq.

FRENCH	nere
CHAD ARABIC	malto
BAMBARA	nere
DJERMA	dosso
FULANI	narghi
HAUSA	dorowa
KANOURI	runo
MORE	rouaga

Use for edible fruit

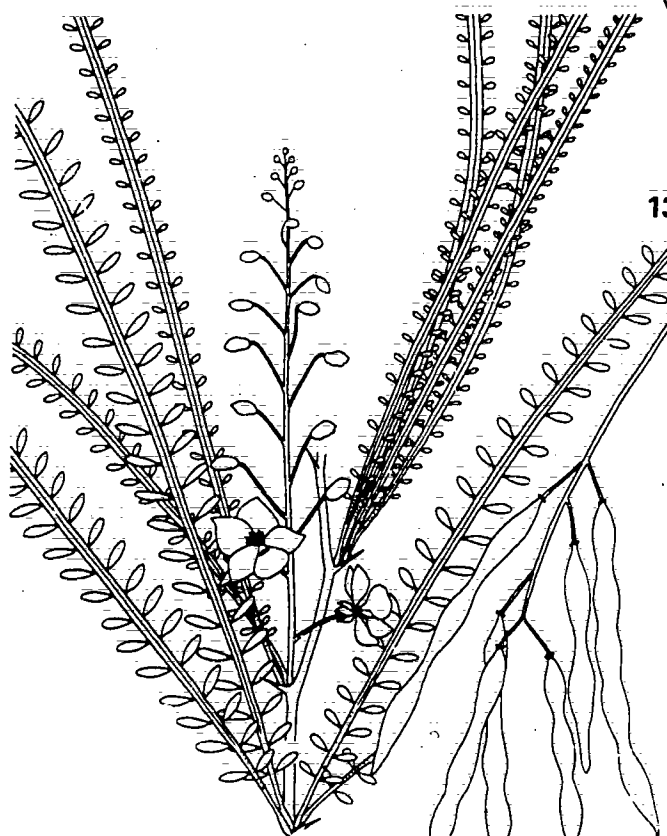
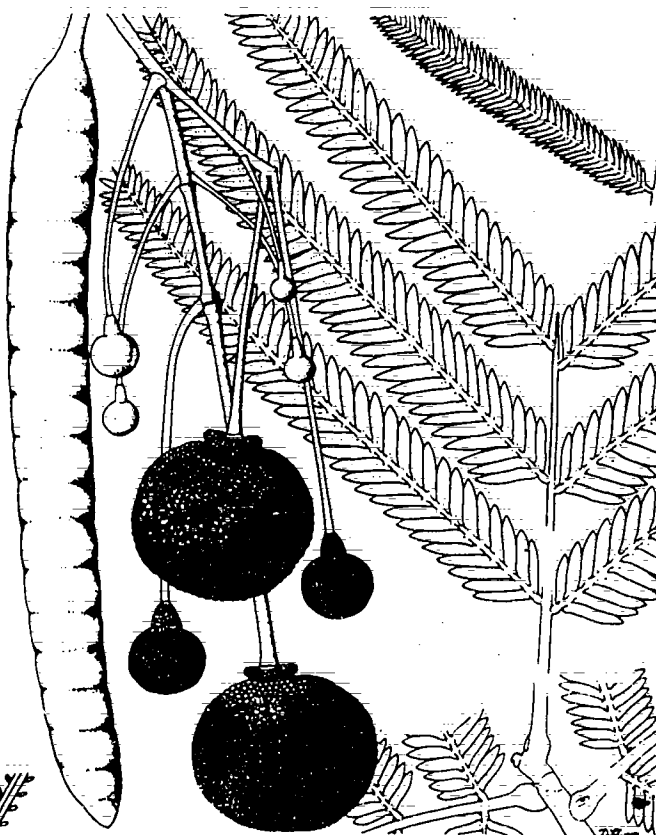

136. *Parkinsonia acculeata* L.

Also see APPENDIX B

DJERMA	sassa bani
HAUSA	sharan abi
KANOURI	sharan labi

Use for firewood, live
fencing, windbreaks,
soil cover

137. *Phoenix dactylifera* L.

not illustrated

ENGLISH	date palm
FRENCH	palmier dattier
CHAD ARABIC	famrel
FULANI	bukki
	d'binobi
HAUSA	dabino
KANOURI	difono

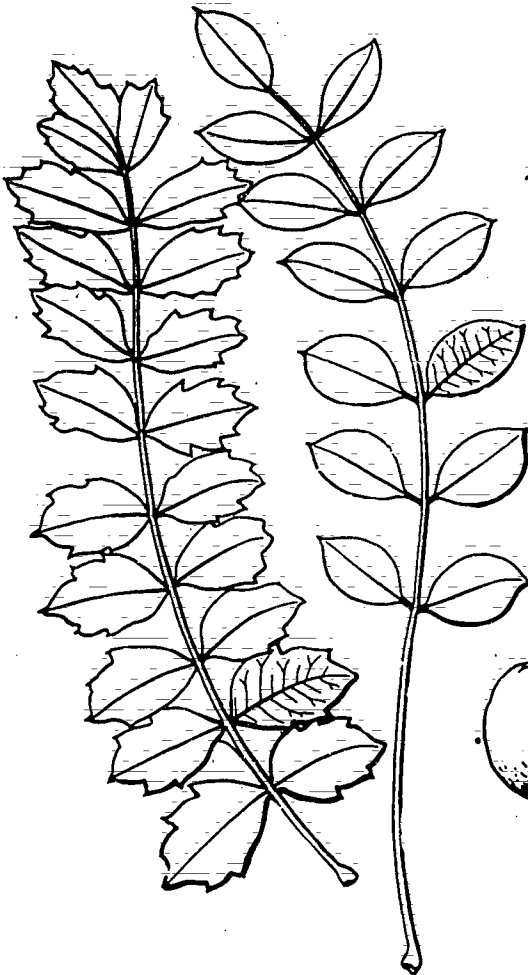

138. Poupartia birrea (Hochst.) Aubr.

Also see APPENDIX B

SYNONYM: *Sclerocarya birrea* Hochst.

FRENCH	dine	HAUSA	danya
CHAD ARABIC	homeid	KANOURI	kunagu
BAMBARA	kuntan	MORE	nobega
FULANI	heri		

Use for edible fruit,
light woodworking

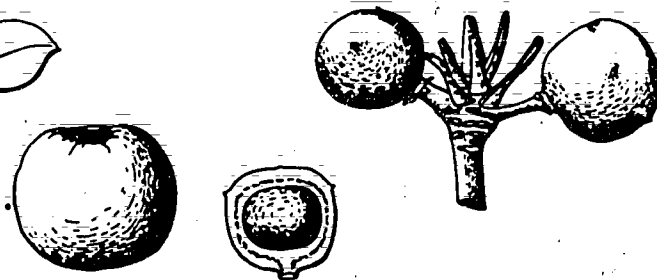

139. Prosopis africana Taub.

Also see APPENDIX B

SYNONYM:
Prosopis oblonga Benth.

BAMBARA	guela
FULANI	kohl
HAUSA	kiriya
KANOURI	simaim
MORE	niuri-segue

Use for construction,
woodworking, charcoal,
tanning

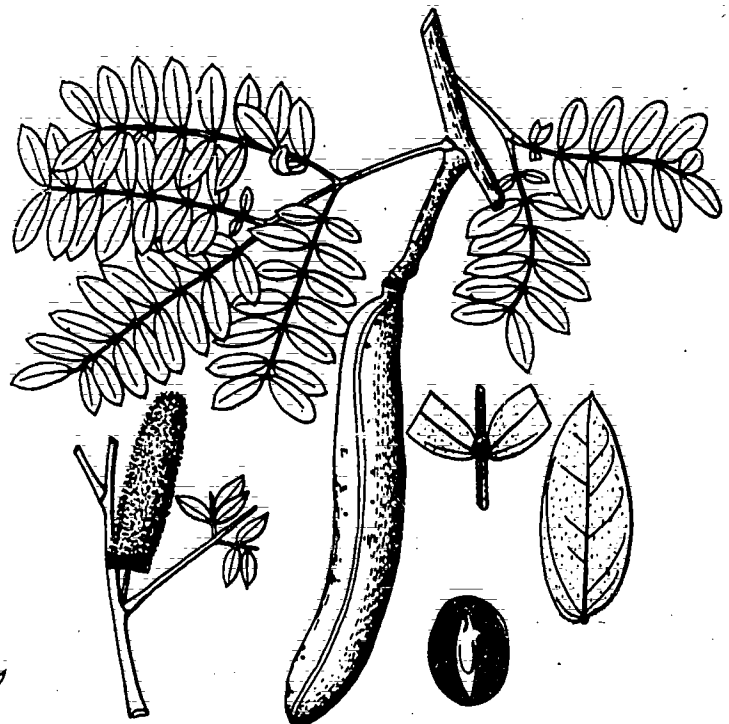

140. *Prosopis juliflora* (Sw.) D.C.

Also see APPENDIX B

SYNONYMS:
Prosopis chilensis (Mol.) Stuntz
Ceratonia chilensis Mol.

ENGLISH (USA) mesquite

Use for fence posts, firewood,
 live fencing, windbreaks,
 fodder

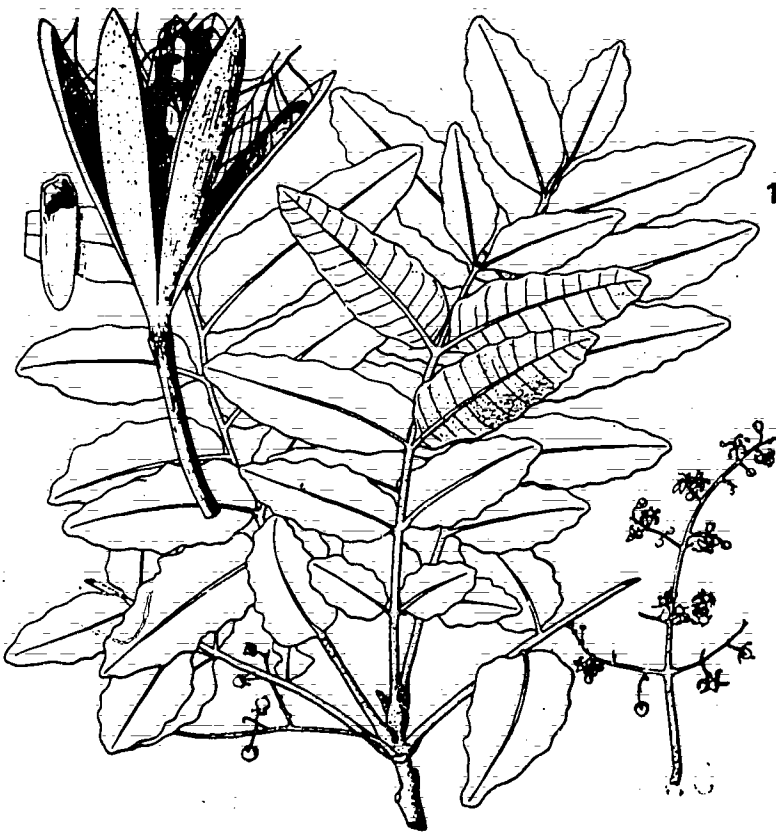
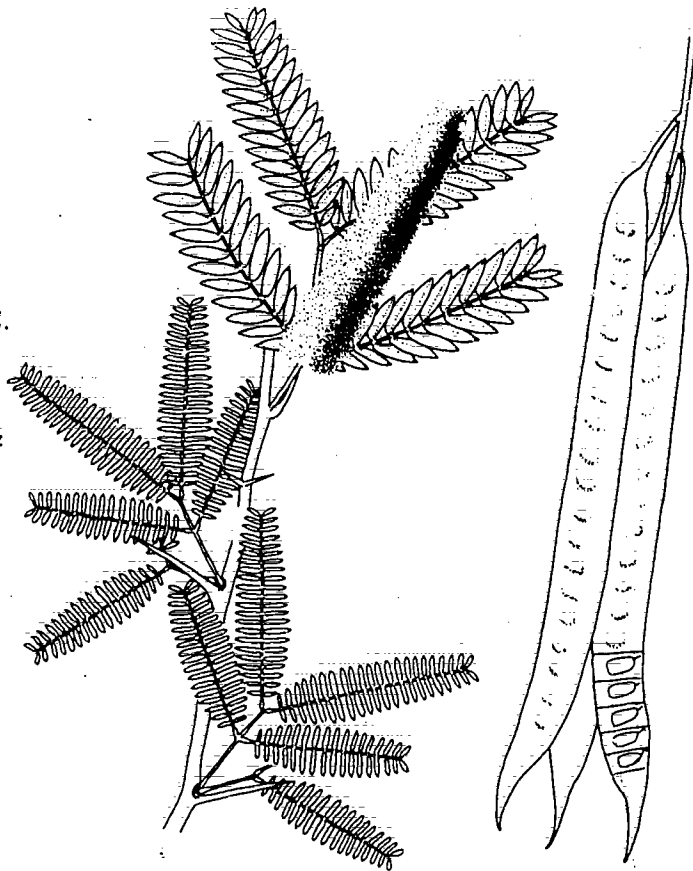

141. *Pseudocedrales kotschyi* Harms.

SYNONYM:
Cedrales kotschyi Schweinf.

FULANI	bodo
HAUSA	tuna
KANOURI	kagarakagum
MORE	seguedere

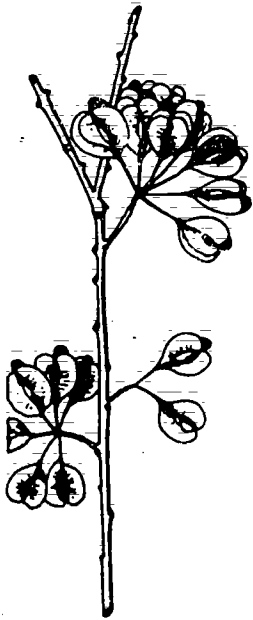

142. *Pteleopsis suberosa*
Engl. & Diels.

SYNONYM:
Pteleopsis keratingii Gilg.

HAUSA wyan damo

Use for fodder

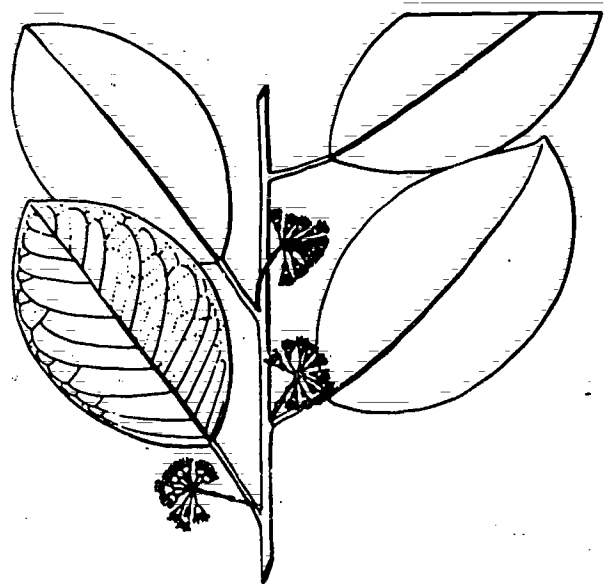

143. *Pterocarpus erinaceus* Poir.

FRENCH	vene
BAMBARA	diabe
DJERMA	tolo
FULANI	banuhl
	gaodl
HAUSA	madobla
KANOURI	buwa
NDRE	pempelaga

Use for firewood, flowers
for sauce, & construction

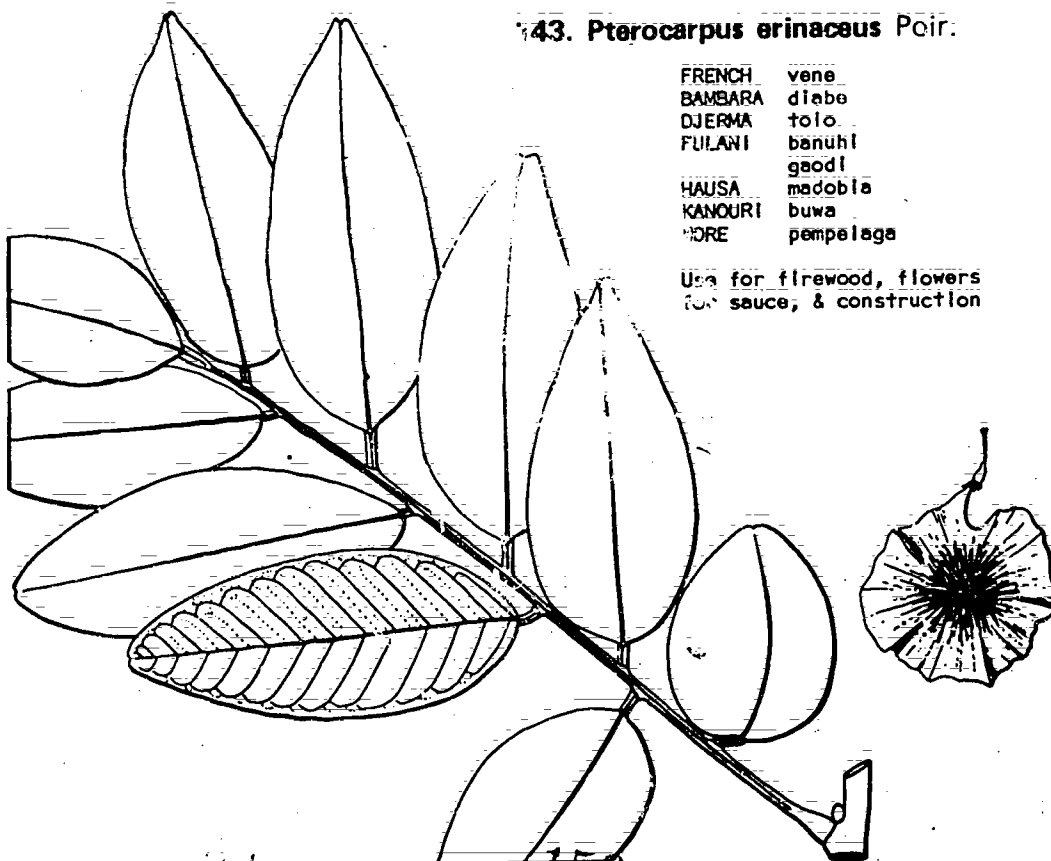

144. *Raphionacme brownii* Sc. Elliot

FULANI fugore
HAUSA rujiya
KANOURI gadagar

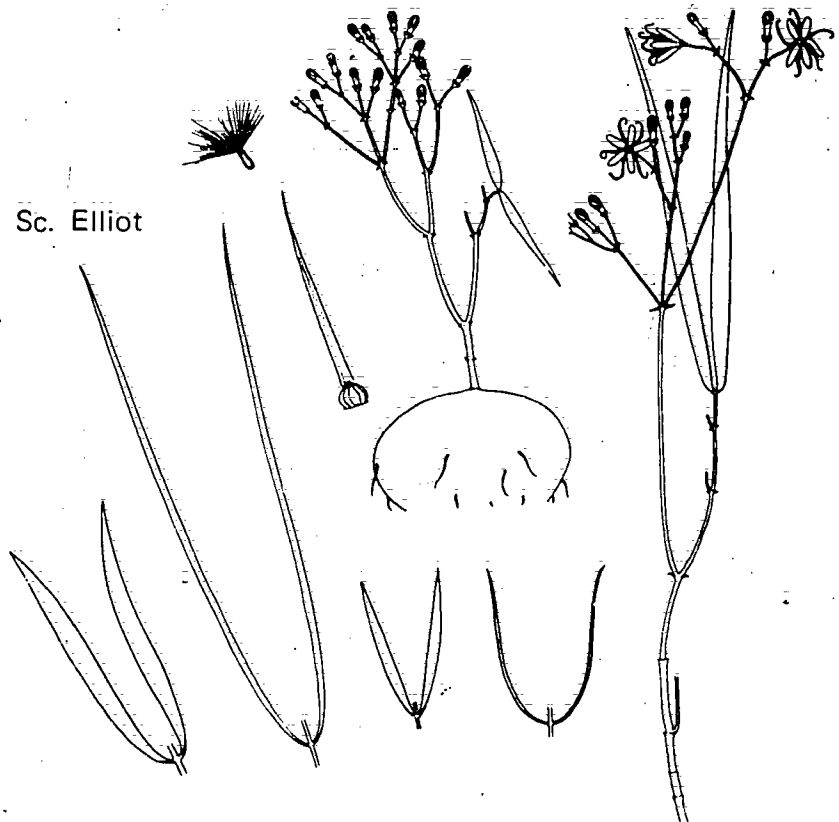
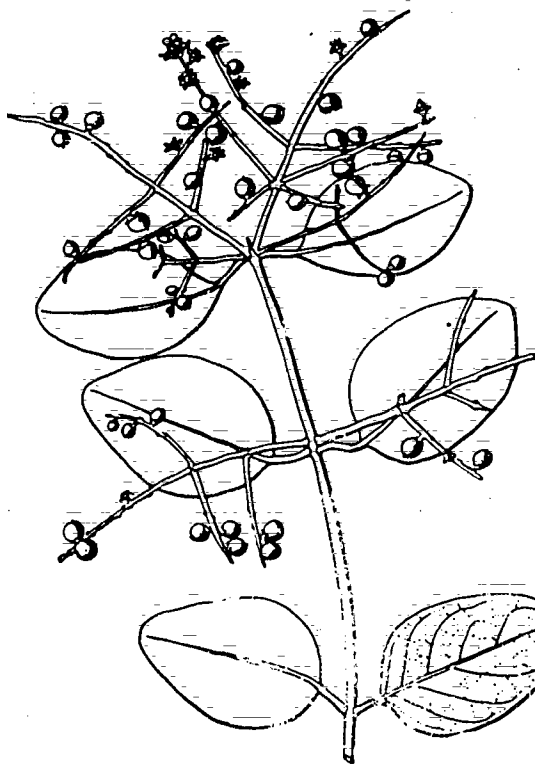

145. *Salvadora persica* L.

CHAD ARABIC	arak	FULANI	hirohi
	siwak	HAUSA	talakia
BAMBARA	hiriguesse	KANOURI	babul
DJERMA	hiro	MORE	irak

Use leaves for stocksalt



146. *Acacia longispodunculata* Fres.

CHAD ARABIC	siati
DJERMA	diota
FULANI	siati
HAUSA	magunguna
KANOURI	gazaboro
MORE	pelaga

Use for fibroind



147. *Sterculia setigera* Del.

SYNONYM:
Sterculia tomentosa Gull. & Perr.

CHAD ARABIC	shadarot al damn
BAMBARA	koko kongurani
FULANI	bo' boll
HAUSA	kukuki
KANOURI	sugubo
MORE	pupunga

Use for gum

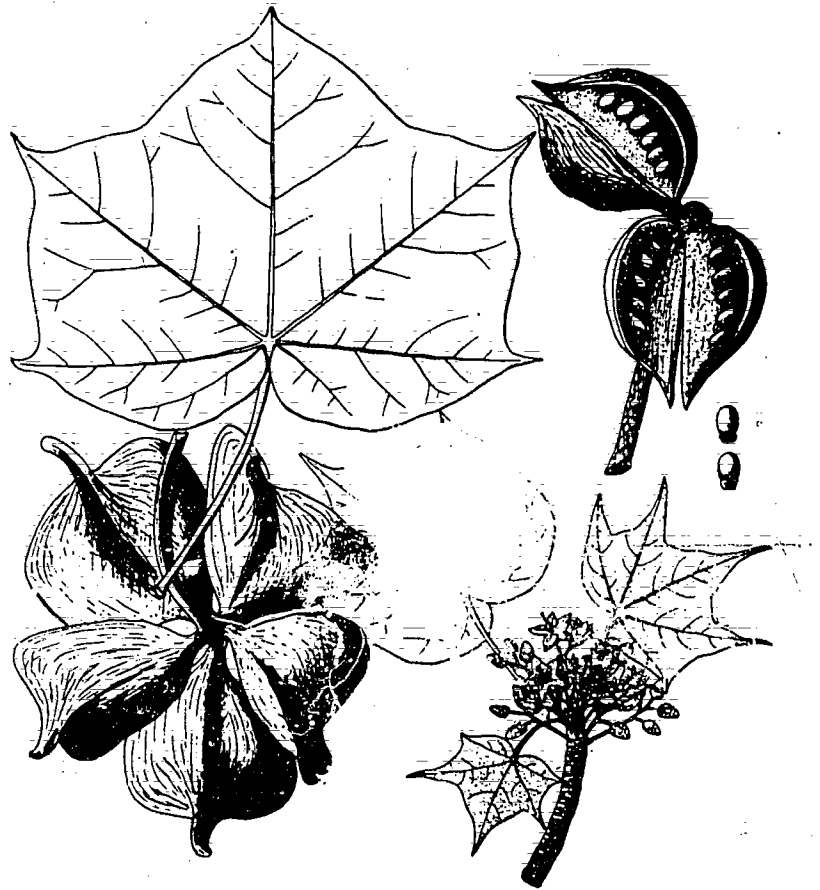
148. *Stereospermum kunthianum* Cham.

CHAD ARABIC	ess ared
BAMBARA	mogo kolo
FULANI	golombi
HAUSA	sansami
KANOURI	golombi
MORE	vuige nihlenga

Use for firewood

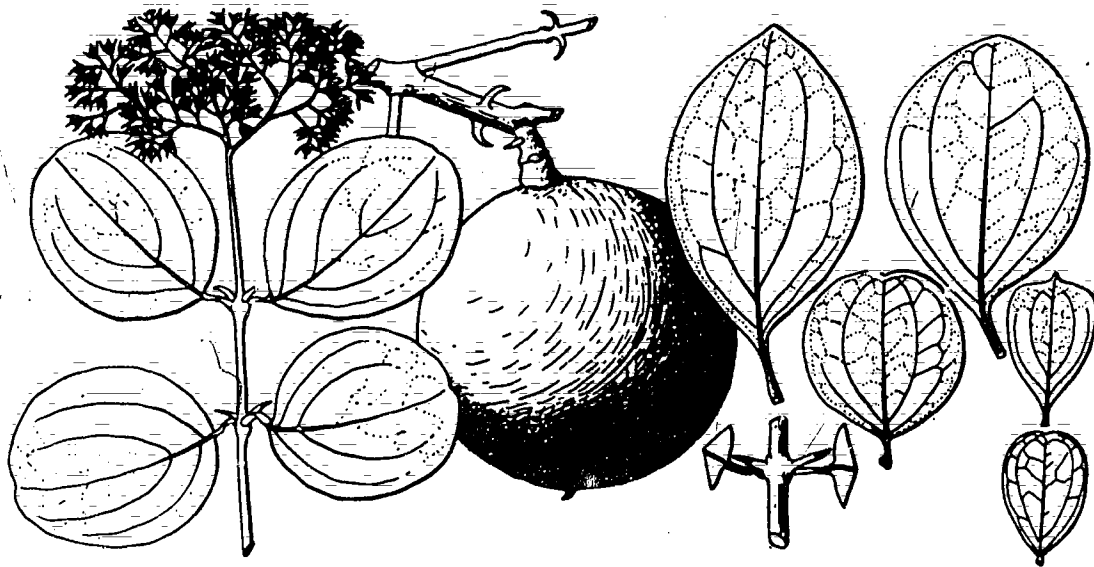

149. Strychnos spinosa Lam.

SYNONYMS:

Strychnos courteti Chev.
Strychnos dulcis Chev.
Strychnos emarginata Bak.

Strychnos gracillima Glig.
Strychnos lokua A. Rich.
Strychnos volkensii Glig.

BAMBARA	kankoro	HAUSA	kokiya
FULANI	kumbija	KANOURI	torla

Use for edible fruit

150. Stylochiton warneckii Engl.

not illustrated

HAUSA	gwandai
KANOURI	ngura

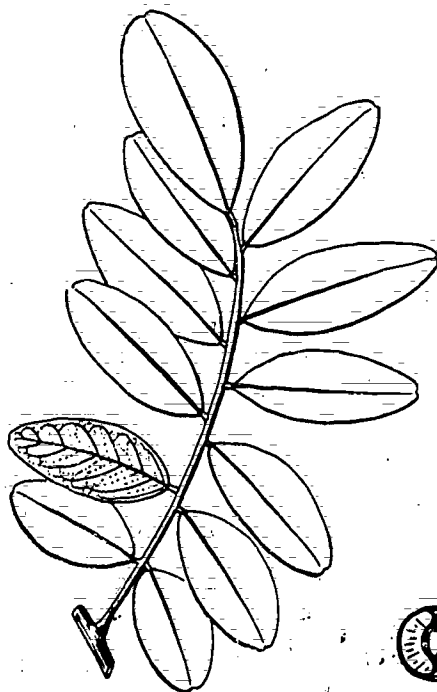

151. Swartzia madagascaraensis Desv.

HAUSA	gwaskia
	gema fada

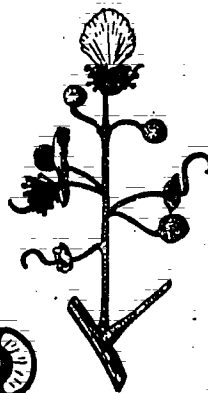

152. *Syzygium guineense* D.C.

BAMBARA	kissa
FULANI	asurahi
HAUSA	maimo
KANOURI	kunar

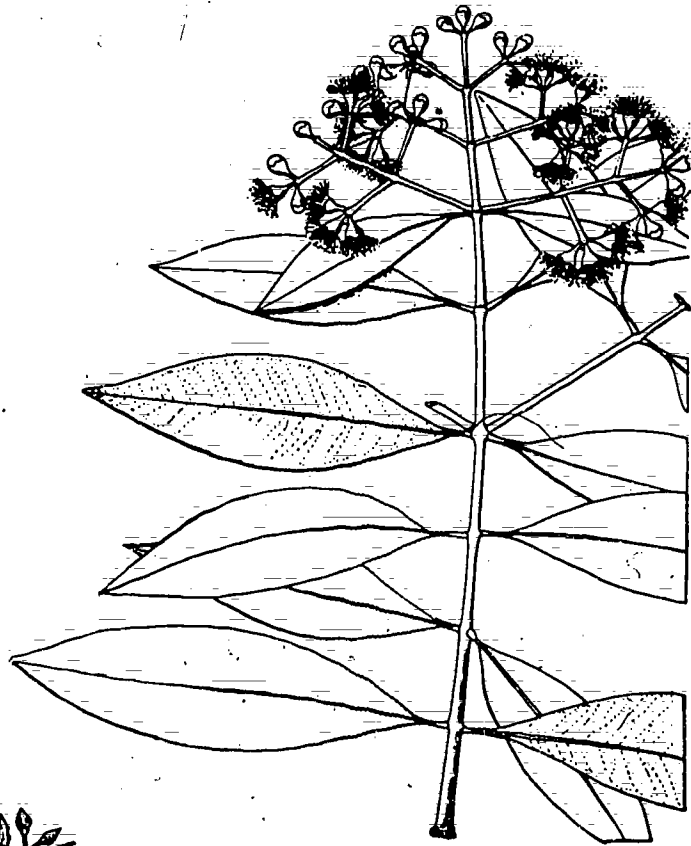
153. *Tamarindus indica* L.

Also see APPENDIX B

ENGLISH	tamarind tree
FRENCH	tamarinier
CHAD ARABIC	tamr hindi
BAMBARA	tombi
DJERMA	bosseye
FULANI	jtatami
HAUSA	tsamiya
KANOURI	tamsugu
MORE	pousiga

Use for juice from fruit;
woodworking, charcoal

154. *Terminalia avicennioides* Guill. & Perr.

SYNONYMS:
Terminalia dictyonera Diels.
Terminalia lecardii Engl. & Diels.

BAMBARA	oudlotieni	HAUSA	bauchi
DJERMA	farkahanga	KANOURI	kumanda
FULANI	bodeyi	MORE	barbar
			kufruagala

Use for fodder, firewood, roots
 for dye

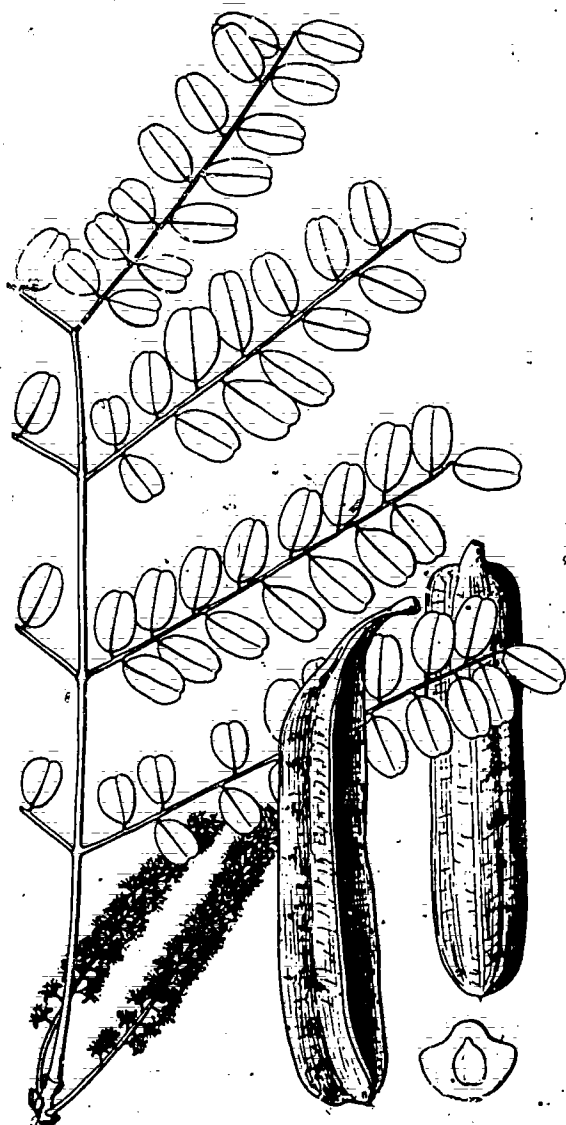

155. *Tetrapleura andongensis* Weiw.
 var. *schweinfurthii* Aubr.

SYNONYMS:
Tetrapleura obtusangala Weiw.
Tetrapleura nilotica Taub.
Tetrapleura schweinfurthii Taub.
Amblygonocarpus andongensis Weiw. ex Oliv.
Amblygonocarpus schweinfurthii

FULANI	jigarehi	HAUSA	kirya ta mata
			tsago

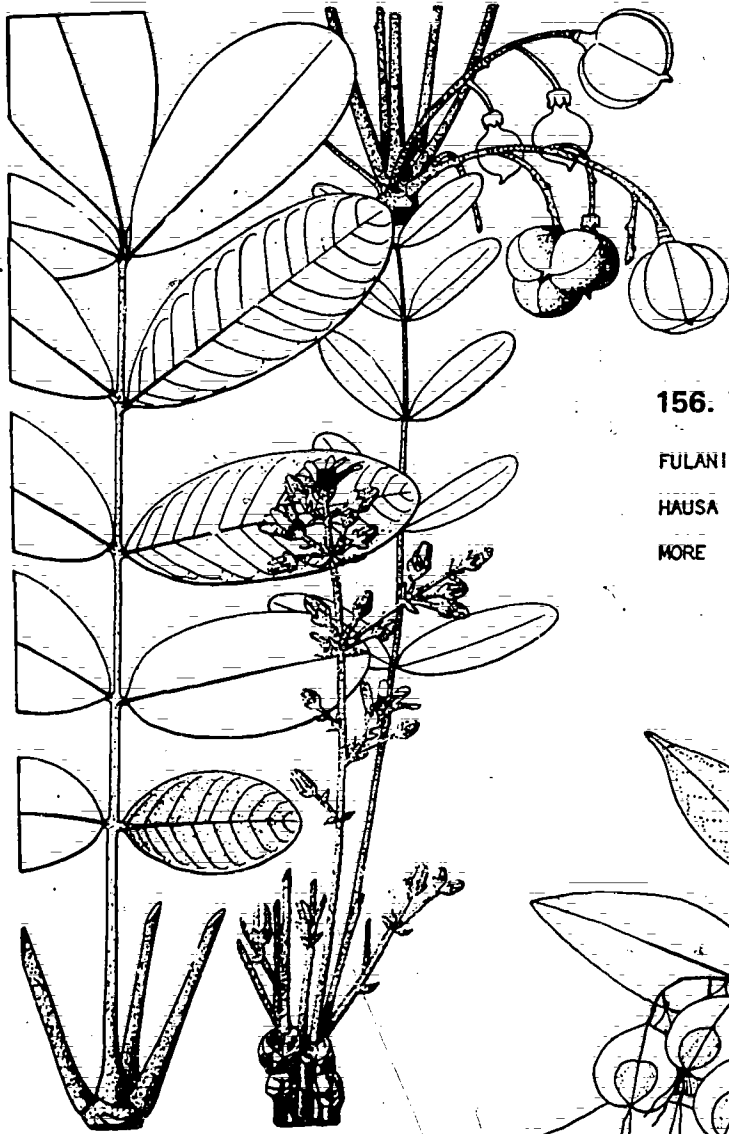

156. *Trichilia emetica* Valh.

FULANI	baszi
	bakurchi
HAUSA	kusa
	jansaye
MORE	kikiramtanga

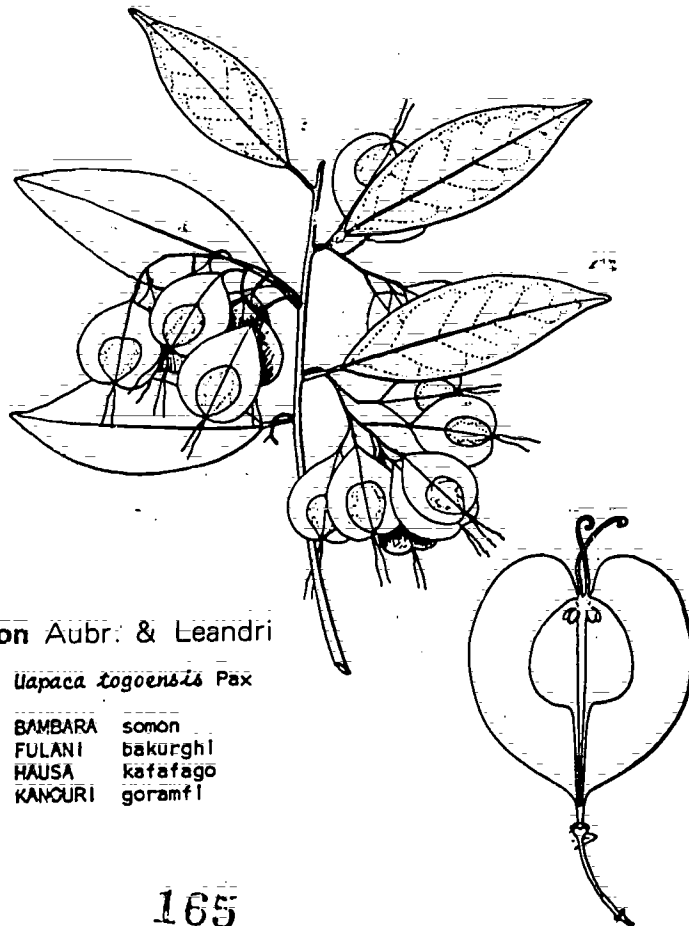

157. *Uapaca somon* Aubr. & Leandri

SYNONYM: *Uapaca togoensis* Pax

BAMBARA	somon
FULANI	bakurghi
HAUSA	kafafago
KANOURI	goramfi

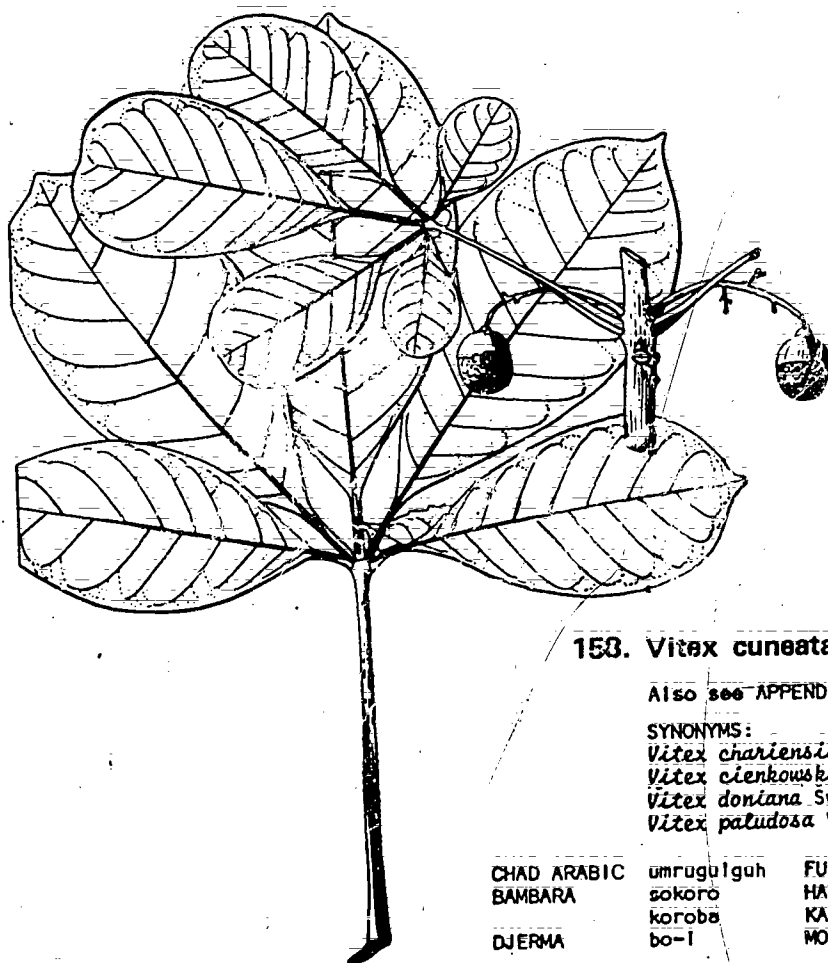

153. *Vitex cuneata* Schum. & Thonn.

Also see APPENDIX B

SYNONYMS:

Vitex chariensis Chev.
Vitex cienkowski Kotschy & Perr.
Vitex doniana Sweet
Vitex paludosa Vatke

CHAD ARABIC	umrugulguh	FULANI	galbihi
BAMBARA	sokoro	HAUSA	dumjja
	koroba	KANOURI	ngaribi
DJERMA	bo-l	MORE	andega

Use for edible fruit, light
 woodworking, leaves for
 dysentery medicine

159. *Vitex diversifolia* Bak.

SYNONYM:

Vitex simplicifolia Oliv.

BAMBARA	kotoni
FULANI	bummehi
HAUSA	dInyar

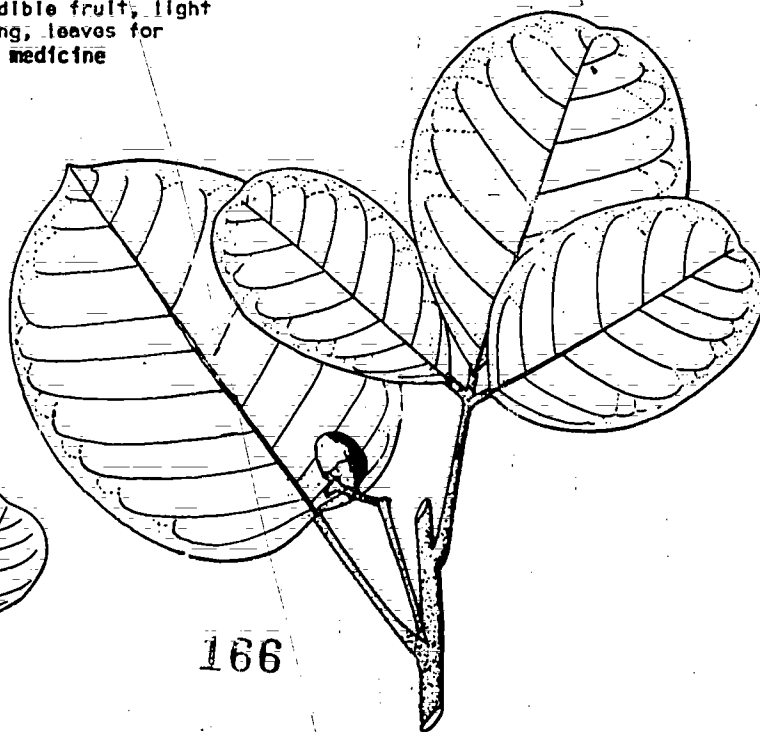
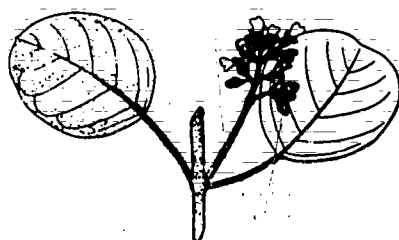

160. Xeromphis nilotica (Stapf.) Keay

not illustrated

SYNONYMS:

Randia nilotica Stapf.
Lachnosiphonium nil-ticum (Stapf.) Dandy

FULANI glogotl
 HAUSA kwanarile
 KANOURI bentatal

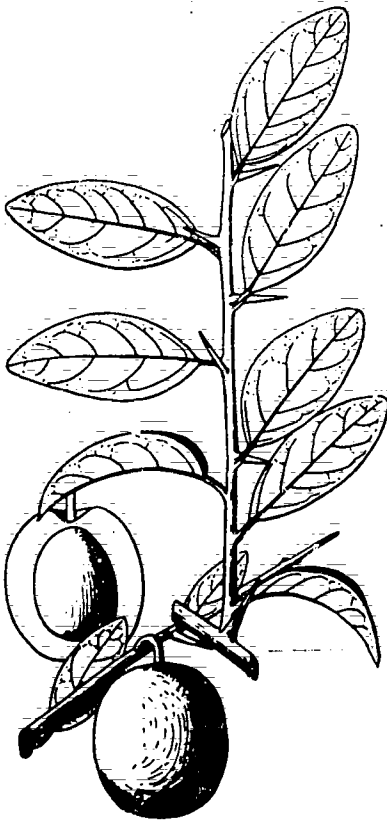
**161. Ximena americana** L.

SYNONYM:

Ximena nilotica

CHAD ARABIC kalto
 BAMBARA tonkalin
 guani
 FULANI chobull
 sene
 HAUSA tsoda
 KANOURI dadin
 MORE leanga

Use for edible fruit

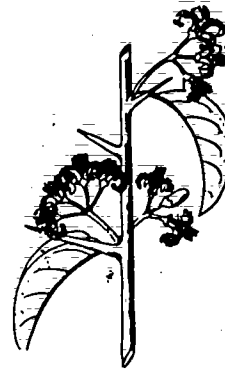
**162. Ziziphus abyssinicus** Hochst. ex A. Rich.

not illustrated

SYNONYMS:

Ziziphus atacorensis Chev.
Ziziphus baguirmiae Chev.

CHAD ARABIC nabaqa
 DJERMA dare
 FULANI gulum jabl
 HAUSA magaria-kura
 KANOURI kalulu bina

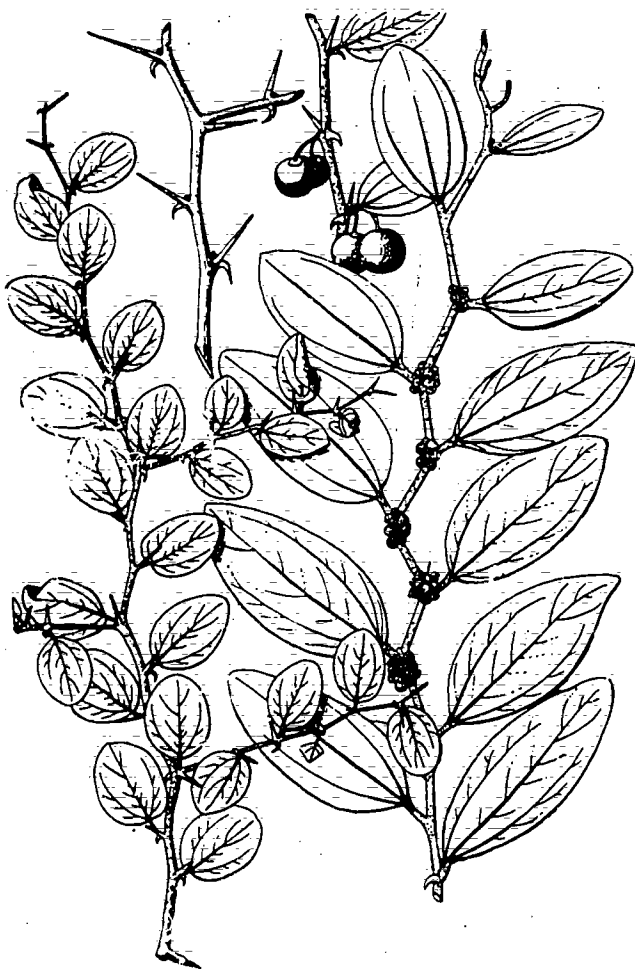

163. *Ziziphus mauritiana* Lam.

SYNONYMS:

Ziziphus mauritiana Lam.
Ziziphus orthacantha D.C.
Ziziphus jujuba (L.) Lam.

CHAD ARABIC	nebagele
BAMBARA	tomboron
	niama ba
FULANI	Jali
	barkevi
HAUSA	magaria
KANOURI	kusulu
MORE	mugunuga
	bagandre

Use for sweet edible fruit,
 & leaves

164. *Ziziphus sieberiana*

not illustrated

HAUSA magari-kura

165. *Ziziphus spina christi* (L.) Willd.

Also see APPENDIX B

CHAD ARABIC	karno
FULANI	kurnahi
HAUSA	kurna
KANOURI	korna

Use for edible fruit (bitter)

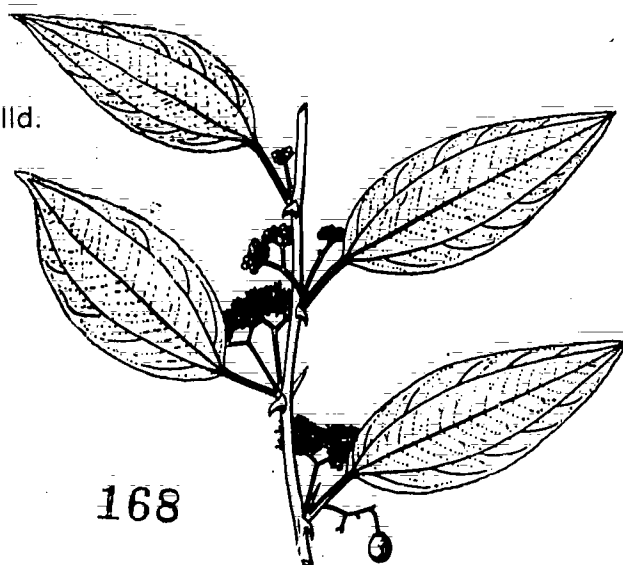

Appendix B

A FIELD GUIDE TO 30 TREE SPECIES COMMONLY FOUND IN WEST AFRICA

This appendix attempts to combine tree data relevant to reforestation activities in a form which will be particularly useful to field personnel as they make decisions and undertake projects. A standard format has been used; where there are empty spaces on a tree data sheet, the pertinent information was not available for inclusion.

Acacia albida Del.

Synonyms: *Faidherbia albida* (Del.) Chev.
Acacia gyrocarpa Hochst.
Acacia saccharata Benth.

Common Names:	ENGLISH	gao	FULANI	tiaiki
	FRENCH	gao	HAUSA	gao
	ARABIC	harraz	KANQURI	haragu
	CHAD ARABIC	araza	MORE	zanga
	BAMBARA	balanzan	SONGHAI	gao
	DJERMA	gao	WOLOF	cadde

Legal Restrictions: Cutting and Removal

GENERAL DESCRIPTION

Large tree, growing as tall as 10m with a large spread-out crown. The bark is dull grey, fissured and scaly. Branchlets are white; spines are thick, white, straight and point downward. Leaves are grey-green; 3-10 pairs pinnules and 6-23 pairs leaflets. *A. albida* flowers with creamy white blossoms. Seeds are dark brown inside yellow pods which are 8-15cm long. *A. albida* is highly valued in conservation efforts. It is the only species which loses its leaves during the rainy season; therefore, farming under these trees is not only possible but profitable.

SEEDS

Source: Strong, healthy parent trees.
Collection: Collect pods from ground; seeds ripen January - February (Upper Volta).
Watch for small-size worm holes -- worms destroy the seeds.
Extraction: Mortar/wind separation.
Storage: Stores well.
Pre-Treatment: Necessary; soak in hot water or scarify hull.

NURSERY

Pots/Open-rooted: Only grow in pots because of long tap root.
Time: 10-14 weeks for good size plants. Earlier seeding may be required so plants get somewhat larger before hot weather.
Other Notes: Attempts to collect young plants in the wild not successful because of long tap root. Frequent root pruning required because of tap root. Watch for caterpillar and locust attacks which destroy young leaves. Spray with ordinary insecticide.

PLANTING/SITE REQUIREMENTS

- Soil: Sandy soil; grows well in same type of ground where millet grows (ask farmers). Also can be grown in heavier soils and will stand occasional flooding.
- Water: 350-500mm mean annual precipitation; may be necessary to water newly planted trees in areas where precipitation is at the low end of the scale.
- Direct Seeding: Can be tried under good conditions. Seeds can be fed to livestock. Livestock then graze over the desired area and eliminate seeds with their manure. Leads to natural regeneration.
- Other Notes: Do not disturb potted mix more than necessary when transplanting. Wide spacing of plants (10m X 10m) is required.

USES

- . Good soil conservation tree (can lead to higher yields of crops planted underneath).
- . Pods good food for cattle.
- . Branches useful for fences.
- . Leaves used for animal feed.
- . Wood -- for carving.
- . Bark contains tannin.

SPECIAL NOTES

- Introduction of Acacia albida is considered important and worthwhile by many farmers, a fact which helps gain acceptance of a project using this tree.
- A. albida trees have reached heights of 2 to 4m after only three and four years of growth (Niger and Upper Volta).
- It is not clear yet just how much Acacia albida does enrich the ground around the tree.
- Young trees are hard to protect. The young branches and leaves are enjoyed by animals; young trees are small and hard to see and may be lost during hoeing if not marked. It is usually necessary to protect these trees for 5 - 8 years depending upon area and site conditions.
- The benefits of planting Acacia albida, in terms of initial investment, are not clear. Thus, it may be hard to justify a project when seeking funds from certain agencies. However, to eliminate

grazing so that the tree can regenerate naturally is harder to do than to raise the young plants in protected areas.

- A. albida until recently was able to regenerate naturally because the seeds were eaten by and passed from the bodies of animals. Now land and grazing pressures have increased so much that the young trees are being destroyed by browsing animals and cleaning operations.

Acacia caffra Willd. var. **campylacantha** Aubr.

Synonyms: *Acacia campylacantha* Hochst., ex A. Rich.
Acacia catechu W.
Acacia polycantha Willd. subsp. *campylacantha*
 (Hochst.) Prenah

Common Names: CHAD ARABIC al guetter HAUSA karo
 BAMBARA kuroko tserkafia
 FULANI fatarlahi KANOURI golawai
 MORE guara

Legal Restrictions:

GENERAL DESCRIPTION

Tall, slender tree. Short, curved spines. Seed pods are flat and thin and hang in clusters. Brown seeds are small, flat, and thin.

SEEDS

Source: Strong, healthy trees.
 Collection: Pods mature January and February.
 Extraction:
 Storage:
 Pre-Treatment: Put in hot water and soak overnight.

NURSERY

Pots/Open-rooted: One project planted 50 pots with 3 seeds each.
 41% of seeds germinated.
 Time:
 Other Notes: Good germination; grows rapidly.

PLANTING/SITE REQUIREMENTS

Soil: Heavy soil, has adapted to variety of conditions.
 Water: Along water courses.
 Direct Seeding:

Other Notes:

USES

- . Localized use for construction purposes. Heartwood very hard and resistant to insects.
- . Leaves used for fodder.
- . Bark yields tannin.

SPECIAL NOTES

Acacia scorpioides (L.) var. nilotica (L.) A. Chev.**Synonyms:**

Acacia nilotica (L.) Willd.
Mimosa nilotica L.
Acacia arabica (Lam.) var. *nilotica* (L.) Benth.

Common Names:

FRENCH	gonakier	DJERMA	bani
CHAD ARABIC	sunta, charat,	FULANI	gaudi
	senet, sunt	HAUSA	bagarua
BAMBARA	barana	MORE	peguerfega
	diabe		
	boina		

Legal Restrictions: Classified as "Specially Useful"; Cutting and Removal.

GENERAL DESCRIPTION

Small or medium tree 3-8m with long white or grey spines and very dark, almost black, fissured bark. It grows rapidly. Balls of yellow flowers, narrow whitish grey flattened pods.

SEEDS

Source: Strong, healthy trees.
Collection: Seeds ripen in November-December, Upper Volta, and December-January, Niger.
Extraction:
Storage:
Pre-Treatment: Soak overnight.

NURSERY

Pot/Open-rooted: Pots
Time: 14-18 weeks
Other Notes:

PLANTING/SITE REQUIREMENTS

Soil: Heavy soil
Water: Likes a lot of water. Plant where water table is close to surface. Will do well even in areas where periodic flooding occurs.
Direct Seeding:

172

USES

Live fences and windbreaks. Pods and bark provide natural tanning material.

SPECIAL NOTES

176

Acacia senegal (L.) Willd.

Synonyms: *Acacia vereh* Guill. & Perr.

Common Names:

ENGLISH	gum arabic	FULANI	dibehi
FRENCH	gommier		patuki
CHAD ARABIC	asharat	HAUSA	dakworo
	kitr al abiod	KANOURI	kolol
BAMBARA	donkori	MORE	goniminiga
DJERMA	danya		

Source of gum arabic.

Legal Restrictions: Cutting and removal. The nature, site, and propagation requirements of this species place its development, protection, and production under control of forest services.

GENERAL DESCRIPTION

Bush or small tree usually less than 5m high, but sometimes is as tall as 9m. Bushes are low branched with flat crowns and form thickets. Pale brown or grey bark. Branches have short, curved thorns or spines in groups of 3. Grey-green leaves, 3-6 pairs of pinnules and 8-18 pairs of leaflets. *A. senegal* has creamy white flowers; brown seed pods which are flat and papery. Each pod contains 1-5 greenish brown seeds. *A. senegal* produces gum arabic between ages of 4 and 18.

SEEDS

Source: Strong, healthy parent trees.
Collection: Seeds ripen in November-December, South-central Niger, and January, Upper Volta.
Extraction:
Storage:
Pre-Treatment: Put seeds in hot water and soak overnight.

NURSERY

Pot/Open-rooted: Pots or open-root. One project planted 50 pots with 3 seeds per pot. 27% germination.
Time: 14-18 weeks in pots.
Other Notes: Only fair germination.

PLANTING/SITE REQUIREMENTS

- Soil:** Sandy soils, dry savanna, abandoned fields or dunes stabilized by grasses.
- Water:** Driest sites; 350mm mean annual rainfall.
- Direct Seeding:** Can be directly seeded easily. Watch for insect and rodent damage.
- Other Notes:**

USES

- . Produces gum arabic, a money crop on world market.
- . Live fencing.
- . Source of tannin.
- . Browse for animals.
- . Firewood and charcoal.

SPECIAL NOTES

- It is not known how this tree will grow in regions of heavier rainfall.
- Because this tree produces a special product (gum arabic), it is being studied in many ways. Extension activities are underway to advise people on how to get higher yields from tapping procedures and how to market the product. Countries are seeking ways to increase output of gum arabic for world markets.
- It may be more feasible to protect and encourage natural regeneration than to start extensive planting efforts.

Acacia sieberiana D.C.

Synonyms: *Acacia verugera* Schweinf.
Acacia sanguinea Guill. & Perr.
Acacia rehmanniana
Acacia villosa
Acacia fischerii
Acacia monga
Acacia verhoensis
Acacia nefasia Schweinf.

Common Names:

CHAD ARABIC	kuk
BAMBARA	baki
FULANI	gie daneji
HAUSA	boudji dushe
KANOURI	katalogu
MORE	golponsgo

Legal Restrictions:

GENERAL DESCRIPTION

Acacia sieberiana is a large acacia, up to 15m tall. It has long white, straight spines and fairly smooth, light olive or yellowish-colored bark. Crown is flat-topped, umbrella-shaped or irregular. 10-25 pinnules; 20-40 folioles. Seed pods are brown and thick-skinned. The wood is semi-hard and termite resistant.

SEEDS

Source:
Collection:
Extraction:
Storage:
Pre-Treatment: Put in hot water and soak seeds overnight.

NURSERY

Pots/Open-rooted: Pots; one project planted 50 pots, 3 seeds per pot. 8.7% germination.
Time:
Other Notes: Varying germination results.

PLANTING/SITE REQUIREMENTS

Soil: Prefers low-lying, heavy soil, but grows in a variety of soils.

Water: Grows well in areas with higher rainfall.

Direct Seeding:

Other Notes:

USES

- . Wood is easy to work with and is used to make tool handles and other light objects.
- . Good firewood and charcoal.
- . Bark is a source of tannin.
- . Some value in live fencing and windbreaks.
- . Produces a type of gum arabic.

SPECIAL NOTES

Adansonia digitata L.**Synonyms:**

Common Names:	ENGLISH	baobab	FULANI	bokki
	FRENCH	baobab	HAUSA	kuka
	CHAD ARABIC	hahar	KANOURI	kuka
	BAMBARA	sito	MORE	toega
	DJERMA	konian		

Legal Restrictions: "Specially Useful": Cutting and Removal;

GENERAL DESCRIPTION

Large tree up to 18m tall with an enormous trunk. Roots which extend far from base of tree. Seeds do not germinate well; therefore, young trees in wild are hard to find. Adult tree flowers with white blossoms; fruit hangs from long stem and is good to eat. Seeds are acid and may be cooked or eaten fresh. Leaves are palmately divided into 5-7 segments.

SEEDS

Source:

Collection: Seeds ripen December-February, Upper Volta.

Extraction:

Storage:

Pre-Treatment:

NURSERY

Pots/Open-rooted: Good results with open-rooted stock.

Time:

Other Notes: In pot culture, some seeds can take up to a year to germinate.

PLANTING/SITE REQUIREMENTS

Soil:

Water:

Direct Seeding:

Other Notes:

USES

- . A major food tree of Hausa -- leaves dried and used for flavoring sauces.
- . Bark used to make mats, paper

SPECIAL NOTES

Albizzia chevalieri Harms.Synonyms:

Common Names:	CHAD ARABIC	ared	HAUSA	katsari
	BAMBARA	golo iri	KANOURI	tsagle
	FULANI	jarichi	MORE	ronsedonga
		nyebal		

Legal Restrictions:GENERAL DESCRIPTION

Small to medium tree with a branching crown. Leaves contain 8-12 pinnules and 20-40 folioles. Pods are thin and oblong and contain flat round seeds. It is found throughout the region.

SEEDS

Source:
 Collection:
 Extraction:
 Storage:
 Pre-Treatment: Put in hot water and soak overnight.

NURSERY

Pots/Open-rooted: Pots planted in one test -- 40 pots with 3 seeds each -- showed 61% germination.

Time:
 Other Notes:

PLANTING/SITE REQUIREMENTS

Soil: Sahel and Sudan zones.

Water:

Direct Seeding:

Other Notes:

USES

- . Primarily firewood.
- . Some uses for root fiber.

183

SPECIAL NOTES

Anacardium occidentale L.

Synonyms:

Common Names:

Legal Restrictions: The nature of the tree places its development and production under protection of forestry service programs.

GENERAL DESCRIPTION

Small spreading evergreen tree which grows to about 9m. Bark is rough; flowers are small. Fruit is a kidney-shaped nut with a hard covering which contains bitter black juice. Stalk of the flower swells into a juicy pear-shaped body. A hardy tree for planting in poor soil and dry areas.

SEEDS

Source: Ripe fruit.
 Collection: Pick fruit from trees in late February, Southwest Niger.
 Extraction: Separate hull from fruit.
 Storage: Leave in hull and dry; stores well.
 Pre-Treatment: None necessary.

NURSERY

Pots/Open-rooted: Plant only in pots; open-rooted stock almost impossible to transplant without root damage.
 Time: 14-18 weeks in pots.
 Other Notes: Plant seed with convex side up. Cover with 3cm of dirt. Watch for termite problems during germination and again when transplanting. Spray with Dieldrin or Chlordane.

PLANTING/SITE REQUIREMENTS

Soil: Will grow in many types of soil; grows well in sandy soil, low country up to 150m; grows well eroded and other poor sites.

Water: At least 500-700mm annual precipitation.

Direct Seeding: Possible; some projects have had good results; many seeds are needed.

Other Notes:

184

USES

- . Tree produces the cashew nut -- a valuable product in foreign markets.
- . Construction - packing cases; boat-building; firewood.

SPECIAL NOTES

- Ideal tree for soil cover and conservation purposes.
- Seems to grow in all soils, except for rock, down to about 500mm mean annual precipitation. However, in areas of lower rainfall, the tree produces less fruit.
- Bark contains up to 10% tannin.

Anogeissus leiocarpus Guill. & Perr.

Synonyms: *Anogeissus schimperi* Hochst. ex
Hutch & Dalz.

Common Names:

CHAD ARABIC	sahab
BAMBARA	kreketé
DJERMA	gonga
FULANI	kojoli
HAUSA	marike
KAMOURI	annum
MORE	sigha piega

Legal Restrictions: Classified as "Specially Useful."

GENERAL DESCRIPTION

Anogeissus leiocarpus is a medium to large tree which often gets very tall. Leaves are small and lanced; fruits are small, yellowish-brown colored cones containing many seeds. The wood is heavy and hard.

SEEDS

Source:
Collection:
Extraction:
Storage:
Pre-Treatment: None necessary.

NURSERY

Pots/Open-rooted: Experiments with growth in pots proved non-successful.
Time:
Other Notes: Slow growth discourages artificial propagation. There has been little success in germinating.

PLANTING/SITE REQUIREMENTS

Soil: Moist, low-lying soil along water courses.
Water: 900-1,200mm mean annual precipitation.
Direct Seeding:
Other Notes:

USES

- . Hard wood useful for fence posts. Construction and woodworking.
- . Ashes of the wood used for potash in soap-making and dyeing.

SPECIAL NOTES

- This is an impressive tree because of its large size. But growth is very slow, and discouraging nursery results make its potential doubtful at the moment. More research is needed.

4-37

Azadirachta indica A. DC.Synonyms:

Common Names: ENGLISH Neem FRENCH Neem

Legal Restrictions:GENERAL DESCRIPTION

Moderate-sized to large evergreen tree (11m tall) with dense, rounded crown. Grows fairly rapidly. Bark is thick and dark grey. Flowers with bunches of small white blossoms, from March to May; fruit ripens from mid-May.

SEEDS

Source: Local trees; use fresh seeds only.
 Collection: For best harvest, clean area under tree and collect freshly fallen seeds only.
 Extraction: Soak seeds and pulp in water. Separate by hand while under water; spread seeds out to dry.
 Storage: Seeds do not store well; viability drops near zero within a few weeks unless special storage is possible.
 Pre-Treatment: None required, but pre-germinating in moist sand helps reduce empty space in nursery. Bury seeds in sand and keep wet for one week. Plant only seeds which are swollen.

NURSERY

Pots/Open-rooted: Can be planted in pots -- good-sized trees in 3 months. Usually planted as open-rooted stock.
 Time: Leave open-rooted stock 8-11 months (trees average 1m high).
 Other Notes: Plant seeds in horizontal position, in beds or pots.
 When transporting open-rooted stock, strip to terminal bud and wrap roots. Keep roots moist.

PLANTING/SITE REQUIREMENTS

Soil: Grows on most kinds of soil, even clay; will grow on rocky ground with good drainage; not suitable for laterite outcrops.

- Water:** Plant in areas having 500-700mm mean annual precipitation. Grows well where groundwater is available within 9-12m of the surface.
- Direct Seeding:** Works well in good locations; best to plant as individual trees or in lines
- Other Notes:** Needs rain within 4-6 days after planting or survival is doubtful.

USES

- Firewood
- Construction wood
- Fence posts, when treated with pesticide
- Reforestation purposes
- Seeds yield oil for soap and burning

SPECIAL NOTES

Balanites aegyptiaca (L.) Del.**Synonyms:**

Common Names:	CHAD ARABIC	hajlij	KANOURI	chingo
	BAMBARA	seguene		bito
	DJERMA	garbey	MORE	tlegaliga
	FULANI	tanni		
	HAUSA	adoua		

Legal Restrictions: Classified as "Specially Useful"; cutting and removal.

GENERAL DESCRIPTION

Small or medium tree, up to 10m high, with small, oval, grey-green leaves and long, straight, green spines. Bark is grayish green to brown and is fissured. Fruits resemble dates and are yellow when ripe. The wood is hard and heavy and has a fine texture. This tree is fairly resistant to termites.

SEEDS

Source:
Collection: Seeds ripen in September-October, Upper Volta; October-December, Niger;
Extraction: Soak fruit in water and separate seeds from pulp.
Storage:
Pre-Treatment: Soak in lukewarm water overnight.

NURSERY

Pots/Open-rooted: Seeds planted in pots -- 50 pots, 2 seeds per pot -- showed 61% germination.
Time: 18-24 weeks in pots.
Other Notes:

PLANTING/SITE REQUIREMENTS

Soil: Dry sites, prefers sandy soil which occasionally floods.
Water: 350-500mm mean annual precipitation.
Direct Seeding: Possible and worth doing.
Other Notes:

USES

- . Construction from light woodworking to heavy carpentry
- . Fruit is sweet and is a favorite food
- . Animals, particularly camels, use for browse
- . Strong emulsions of fruits may be used to poison fish

SPECIAL NOTES

- An excellent, all-around species well worth propagating, either in plastic pots or by direct seeding.
- The wood is fine-grained, easy to work, durable, and resistant to insects.

Bauhinia reticulata D.C.

Synonyms: *Bauhinia glabra* A. Chev.
Bauhinia glauca A. Chev.
Piliostig: reticulatum (D.C.) Hochst.

Common Names: CHAD ARABIC harum HAUSA calgo
 BAMBARA niamaba KANOURI kaldul
 DJERMA kosseye MORE barani
 FULANT barkevi

Legal Restrictions:

GENERAL DESCRIPTION

Bush or small tree up to 6m with spherical crown. Leaves are large grey-green color and consist of two distinct symmetrical lobes. Bark is dark brown to grey or nearly black. Seed pods hang and are large, thick and reddish-brown in color.

SEEDS

Source: Local trees.
 Collection: Seeds ripen December-January; as early as October, November in some areas (parts of Upper Volta, for example).
 Extraction:
 Storage:
 Pre-Treatment: Hot water overnight.

NURSERY

Pots/Open-rooted: Pots; 3 seeds per pot.
 Time:
 Other Notes: Poor germination results in nursery.

PLANTING/SITE REQUIREMENTS

Soil: Wide variety of soil, including sand, laterite and heavy clay.
 Water:
 Direct Seeding: Possible.
 Other Notes:

USES

- . Firewood.
- . Local medical purposes.
- . Shade tree because of large crown.
- . Bark contains tannin.

SPECIAL NOTES

- This is an abundant tree, and this fact makes it of questionable value for a nursery project. Nevertheless, it should be encouraged in fallow areas by direct seeding or cuttings.

Borassus aethiopum Mart.

- Synonyms: *Borassus flabellifer* L. var. *aethiopum* (Mart.) Warb.
- Common Names: FRENCH ronier FULANI dubbi
 CHAD ARABIC deleb HAUSA gigunia
 DJERMA sabouze KANOURI ganga, kemelutu
- Legal Restrictions: Cutting and Removal; the nature, site, and propagation requirements of this species place its development, protection, and production under control of forest services.

GENERAL DESCRIPTION

Tall palm up to 25m. Stem is straight and smooth in old trees. Bark is dark grey; fan-shaped leaves up to 4m long. Orange fruit about 15cm long and 12cm wide. Each fruit contains 3 hard-coated edible seeds surrounded by edible flesh. Hard, heavy wood very resistant to termites.

SEEDS

Source: Local trees.
 Collection: Pick from ground.
 Extraction: Not applicable.
 Storage:
 Pre-Treatment: None required.

NURSERY

Pots/Open-rooted:
 Time:
 Other Notes: Not raised in nursery.

PLANTING/SITE REQUIREMENTS

Soil: Moist, low spots.

Water: Over 800mm annual precipitation; lowland areas with high watertable; swamp grass sites.

Direct Seeding: Any method possible. Good results in likely sites.

Other Notes:

USES

- Construction -- housing, fencing, etc. It is especially useful as rafters in mudwall housing. It is rarely attacked by termites and natural oils make it one of the most durable natural post materials known.

SPECIAL NOTES

- Tree grows slowly. May take 10 years for good crown to develop.
- Borassus brings prices on the construction market almost equal to imported structural steel.
- Regeneration attempts have shown good results.

Butyrospermum parkii Kotschy

Synonyms:

Common Names: CHAD ARABIC sirreh HAUSA bagay
BAMBARA berekunan KANOURI marga
tamba

Legal Restrictions: Cutting and Removal.

GENERAL DESCRIPTION

Small tree with thick, dark-grey, deeply fissured bark and long strap-like leaves. Flowers with white blossoms between May and August. Mature fruit is green and about 5cm long. Each fruit contains one seed (shea nut); collected in July.

SEEDS

Source: Strong, healthy trees.
Collection: Find newly fallen seeds.
Extraction: Shells easily.
Storage:
Pre-Treatment: None required.

NURSERY

Pots/Open-rooted: Pots.
Time: 14-24 weeks in pots.
Other Notes: Plant with the point of the white part of the seed down.

PLANTING/SITE REQUIREMENTS

Soil: Moist, medium-to-heavy soil;
Water: Above 700mm mean annual precipitation or along mares and low spots.
Direct Seeding: Possibilities unknown.
Other Notes:

USES

- . Hard wood used for mortar.
- . Hard to work but accepts a polish.
- . Nut produces butter -- useful for cooking, lamp burning and cosmetic purposes -- both for local and export use.

SPECIAL NOTES

-- Tree is tolerant of annual burning.

Cassia siamea Lam.

Synonyms:

Common Names: FRENCH - cassia

Legal Restrictions:

GENERAL DESCRIPTION

Moderate-sized evergreen with dense crown and smooth grey bark. Yellow flowers in large bunches. Pods 10-25cm long hanging in clusters. Foliage is especially attractive to pigs. However, the leaves are poisonous and animals must not be allowed to browse on these trees. Tree grows fairly rapidly.

SEEDS

Source: Strong, healthy trees.
 Collection: December and January collect unopened pods.
 Extraction: Dry in sun and beat with stick. Mortar and wind separation.
 Storage:
 Pre-Treatment: Cut; soak in warm water.

NURSERY

Pots/Open-rooted: Pots only in special situations. Most seeds are open-rooted.
 Time: 4-5 months in pots; 30 weeks to one year open-rooted.
 Other Notes: Potted plants require pruning; plant as a "stump."

PLANTING/SITE REQUIREMENTS

Soil: Moist soil with good drainage.
 Water: 500-700mm minimum annual precipitation; trees do better with more rainfall.
 Direct Seeding: Possible, but not done extensively.
 Other Notes: Plant a stump 10cm above ground; cut roots to 20cm.

USES

- . Firewood, but is smokey.
- . Construction.
- . Good, dense windbreaks with no undergrowth.
- . Reforestation purposes.

SPECIAL NOTES

Ceiba petandra (L.) Gaertn.

Synonyms:	<i>Eriodendron orientale</i>	
Common Names:	ENGLISH	silk cotton tree
	FRENCH	fromager
	CHAD ARABIC	rum
	FULANI	bantahi
	HAUSA	rimi
	KANOURI	tom
MORE	gunga	

Legal Restrictions: Classified as "Specially Useful."

GENERAL DESCRIPTION

Ceiba petandra is an impressive tree up to 60m with a wide trunk and large base roots. The trunk gradually tapers to a narrow tip. Bark is smooth and grey; it is valued for beauty, shade and cotton-like material yielded from seed pods. This is an important plantation crop tree.

SEEDS

Source: Healthy trees.
 Collection:
 Extraction:
 Storage:
 Pre-Treatment:

NURSERY

Pots/Open-rooted: Open-rooted.
 Time:
 Other Notes:

PLANTING/SITE REQUIREMENTS

Soil: Forest conditions, low elevations.
 Water: Prefers sites where water is near or on the surface or areas having heavy rainfall.
 Direct Seeding:
 Other Notes:

USES

- . Shade tree.
- . Cotton-like fiber (kapok) used for stuffing.
- . Canoes from wood.
- . Cuttings used as living fence posts.
- . Seeds edible fresh, germinated or after extracting oil for cattle feed.
- . Leaves yield hair lotion and medicine.

SPECIAL NOTES

Entada sudanica Schweinf.**Synonyms:**

Common Names:	CHAD ARABIC	dorot	HAUSA	tawatsa
	BAMBARA	diamba	KANOURI	falofala
		samanere	MORE	sianlogo
	FULANI	fado-wanduhi		

Legal Restrictions:**GENERAL DESCRIPTION**

Small tree with leaves containing 5-7 pairs of pinnules and 14-24 pairs of folioles. Pods are shaped like large, flat plates.

SEEDS

Source:
Collection:
Extraction:
Storage:
Pre-Treatment: Hot water overnight.

NURSERY

Pots/Open-rooted: Pots.
Time:
Other Notes: 10 pots planted with 3 seeds per pot showed 67% germination.

PLANTING/SITE REQUIREMENTS

Soil: Sudan savanna.
Water:
Direct Seeding:
Other Notes:

USES

- : Firewood (fair).
- : Bark used for rope.
- : Medical purposes.

SPECIAL NOTES

202

Eucalyptus camaldulensis Dehnh.

Synonyms: *Eucalyptus rostrata* Schlecht.

Common Names:

Legal Restrictions:

GENERAL DESCRIPTION

A fast-growing, tall (18-45m) tree. Bark of older tree rose-pink; flowers profusely; seed germinates well. Moderately heavy, hard wood.

SEEDS

Source: Nearest seeds available in Northern Nigeria (*Eucalyptus camaldulensis*, Australian origin). There are, however, reports of the first fruit-bearing by some of the oldest trees planted in Niger. Seeds can be ordered direct from Australia. Israel also has seeds available and so does the French Tropical Forestry Research Agency (C.T.F.T.). Considerable lead time is needed. Varieties selected must be drought resistant and termite proof in both green and dead stage.

Collection:

Extraction:

Storage:

Pre-Treatment:

NURSERY

Pots/Open-rooted: Pots.
 Time: 18-24 weeks in plastic pots.
 Other Notes: Seeds are very, very small and can be germinated by Nobila Method (See SPECIAL NOTES) or planted directly into plastic pots.

PLANTING/SITE REQUIREMENTS

Soil: Heavy or rocky soils at altitudes under 610m.

Water: At least 800mm of rain or access to plentiful groundwater. Where mean annual rainfall is 1,000mm or less, plant only along water courses.

Direct Seeding:

Other Notes: May require additional care and watering during first year.

USES

- Reforestation -- root system useful in protecting banks of water courses from erosion.
- Bark yields tannin.

SPECIAL NOTES

Nobila Method: (see Section 6, "Nursery Management", page 63)

- Prepare germination beds.
- Screen materials (sand and manure) for top 4 inches.
- Treat with Dieldrin solution, 0.5% to 1% concentration.
- Mix seeds with fine sand and spread over bed.
- Cover lightly with screened sand.
- Keep top layer moist at all times.
- Apply water as fine spray.
- Transplant into plastic pots after trees have developed 3 or 4 primary leaves.
- Water frequently with fine spray.
- Keep in complete shade for first week.

Direct seeding into pots:

- Prepare soil mixture for the pots by adding RCH or Dieldrin -- 1 kilogram/2500 pots.
- Fill pots as usual.
- Put seeds into soil.
- Put 3-5mm of water into a cup.
- Moisten needle with the water to a height not exceeding 3mm.
- Plunge the needle into the eucalyptus seeds (you will find several seeds clinging to the point of the needle).
- Pierce the surface of the soil in the pots with the needle at an angle of 45° and to a depth of not over 10mm.
- Any sort of watering method may now be used.
- When transplanting seedlings into empty pots, one should only use seedlings which are between 25mm and 50mm high.

Gmelina arborea Roxb.Synonyms:

Common Names: ENGLISH melina

Legal Restrictions:

GENERAL DESCRIPTION

Rapidly growing species, up to 15-80m. Many wonderfully scented yellow and brown flowers and yellow fruits. Wood lasts well under water. Introduced as a firewood tree from tropical Asia; suffers from infection in certain areas.

SEEDS

Source: Old trees (scarce); import from other countries.
 Collection: Seeds ripen in March-April, Upper Volta.
 Extraction:
 Storage:
 Pre-Treatment: Soak overnight.

NURSERY

Pots/Open-rooted: Not planted in pots. Open-rooted.
 Time:
 Other Notes:

PLANTING/SITE REQUIREMENTS

Soil: Good, well-drained soils.
 Water: Where mean annual rainfall is 1,000mm or less, plant only along water courses or in irrigated areas.
 Direct Seeding: Possible in tropical forests.
 Other Notes: Plant as a stump.

USES

: Wood for match sticks.
 : Boxes.

SPECIAL NOTES

Guiera senegalensis Lam.Synonyms:

Common Names:	CHAD ARABIC	kabeah
	BAMBARA	kudiengbe
	DJERMA	sabara
	FULANI	gelloki
	HAUSA	sabara
	KANOURI	kasasai
	MORE	unuiga

Legal Restrictions: Classified as "Specially Useful."

GENERAL DESCRIPTION

Bush or small tree. Small grey-green leaves opposite one another on the branches. Fruits are long, narrow capsules covered with large hairs.

SEEDS

Source:
 Collection:
 Extraction:
 Storage:
 Pre-Treatment: None necessary.

NURSERY

Pots/Open-rooted: Pots.
 Time:
 Other Notes: Project which planted 10 pots, 3 seeds per pot, showed 10% germination. Poor germinator.

PLANTING/SITE REQUIREMENTS

Soil: Sandy areas, particularly fields in fallow.
 Water:
 Direct Seeding: Probably best method; reproduces rapidly.
 Other Notes: Worthwhile to plant cuttings.

USES

- . Firewood -- a principal firewood species.
- . Browse for camels.
- . Local medicine against dysentery.

SPECIAL NOTES

Lannea acida A. Rich.**Synonyms:**

Common Names:	FULANI	faruhi
	HAUSA	farou
	KANOURI	adarazagai
	MORE	pekuni
		sabga

Legal Restrictions:**GENERAL DESCRIPTION**

Small-to-medium tree with scaly, fissured, dark-colored bark on a red trunk. Leaves consist of 3-6 pairs elliptical folioles. Fruits look like cherries.

SEEDS

Source:
Collection:
Extraction: Soak fruit to separate seed and pulp. Dry seeds.
Storage:
Pre-Treatment: Soak in lukewarm water overnight.

NURSERY

Pots/Open-rooted: Good germination in pots.
Time:
Other Notes: 10 pots planted with 2 seeds per pot showed 80% germination.

PLANTING/SITE REQUIREMENTS

Soil: Sudan zone.

Water:

Direct Seeding:

Other Notes:

USES

- . Firewood -- high quality.
- . Rope from bark.
- . Food -- fruits widely eaten.

SPECIAL NOTES

-- A valuable tree for firewood and food whose propagation should be encouraged.

Parkia biglobosa Benth.

Synonyms:	<i>Parkia clappertoniana</i> Keay <i>Mimosa biglobosa</i> Jacq.			
Common Names:	FRENCH	nere	FULANI	narghi
	CHAD ARABIC	maito	HAUSA	dorowa
	BAMBARA	nere	KANOURI	runo
	DJERMA	dosso	MORE	rouaga

Legal Restrictions: Cutting and Removal.

GENERAL DESCRIPTION

Medium-to-large tree, up to 15m, with dense, spreading crown. Leaves consist of 14-30 pairs of pinnules and 50-70 pairs of small leaflets. Tree has hanging red flowers; seeds develop in long, narrow pods. Bark is thick and deeply fissured. The wood is hard and heavy but is easily attacked by termites.

SEEDS

Source: Strong, healthy trees; local market.
Collection: Pick the largest, freshly fallen seeds.
Extraction: Remove from pod.
Storage: Viability better when used right away.
Pre-Treatment: Soak overnight in hot water.

NURSERY

Pots/Open-rooted: Pots only.
Time: 10-14 weeks.
Other Notes: Special care; germination results variable depending upon age of seeds.

PLANTING/SITE REQUIREMENTS

Soil: Deep, heavy sand (type where sorghum grows well); known to survive on poor, rocky sites as well.
Water: 500-700mm mean annual precipitation.
Direct Seeding: Worth trying.
Other Notes:

USES

- : Light woodworking.
- : Pulp of seed dried and used as flour.
- : Seeds produce flavoring for sauces.
- : Bark yields tannin for tanning and dyeing.

SPECIAL NOTES

- Parkia is often left standing in millet fields for its shade and fruits. It is one of the few species farmers will actually plant themselves.
- There is great demand for this tree. Given the demand and the ease of raising the tree, it may be good to consider as a cash crop. In some areas, there is enough market for the seeds to warrant establishing special plantations.

Parkinsonia acculeata L.**Synonyms:**

Common Names: DJERMA sassa bani
 HAUSA sharan abi
 KANOURI sharan labi

Legal Restrictions:**GENERAL DESCRIPTION**

Tree grows to about 10m. Long branches which are covered with 3cm-long spines and which droop. Many bright-yellow flowers.

SEEDS

Source: Local trees.
Collection: Seeds ripen in December-January, Upper Volta. Pods containing viable seeds often remain on tree for several months. Pick dry pods only.
Extraction: Shell by hand; shells come off easily.
Storage:
Pre-Treatment: Soak overnight in hot water, or clip end for faster germination (few days only).

NURSERY

Pots/Open-rooted: Pots.
Time: 6-10 weeks in pots.
Other Notes: Easy to raise, but roots need pruning.

PLANTING/SITE REQUIREMENTS

Soil: Dry sites.
Water: 350-400mm mean annual precipitation.
Direct Seeding: Worth trying.
Other Notes:

USES

- : Firewood.
- : Live fences.
- : Windbreaks and soil cover for conservation.

SPECIAL NOTES

Poupartia birrea (Hochst.) Aubr.

Synonyms: *Sclerocarya birrea* Hochst.

Common Names:

Legal Restrictions:

GENERAL DESCRIPTION

Small tree with well-developed crown. Leaves contain 7-8 pairs of folioles. Fruits are large, round, and yellow when ripe.

SEEDS

Source:

Collection: Seeds ripen in April-May, Niger.

Extraction:

Storage:

Pre-Treatment: Lukewarm water overnight.

NURSERY

Pots/Open-rooted: Pots.

Time:

Other Notes: 10 pots, 2 seeds per pot, had germination rate of 90%.

PLANTING/SITE REQUIREMENTS

Soil: Throughout Sahel and Sudan zones.

Water:

Direct Seeding:

Other Notes:

USES

- . Light woodworking, particularly in manufacture of mortars.
- . Pulp of fruit is a popular food and is used to produce a kind of beer.
- . Local value for medical purposes.

SPECIAL NOTES

The tree's high germination rate and the value of its wood and fruit seem to justify propagation in the nursery.

Prosopis africana Taub.

Synonyms: *Prosopis oblonga* Benth.

Common Names:

BAMBARA	guele
FULANI	kohi
HAUSA	kiriya
KANOURI	simain
MORE	niuri-segue

Legal Restrictions: Classified as "Specially Useful."

GENERAL DESCRIPTION

Medium tree with light-colored foliage. It grows rapidly. Leaves have 2-4 pinnules and 6-12 folioles. There is a gland between each pair of pinnules and folioles. Pods are dark-brown cylinders which are thick and hard. Wood is hard and semi-heavy and has fine texture.

SEEDS

Source:
Collection: Seeds ripen in February-March, Niger.
Extraction:
Storage:
Pre-Treatment: Warm stratification. Hot water overnight.

NURSERY

Pots/Open-rooted: Pots.
Time: 14-18 weeks.
Other Notes:

PLANTING/SITE REQUIREMENTS

Soil: Usually grows in abandoned fields or where forest has been replaced by savanna.

Water:

Direct Seeding:

Other Notes: Grows singly, not in clusters.

USES

- . Heavy carpentry and light woodworking uses.
- . Charcoal for blacksmithing.
- . Bark of the roots used for tanning hides.

SPECIAL NOTES

- Should be encouraged in the nursery because of rapid growth and high-quality of wood.

Prosopis juliflora (Sw.) D.C.

Synonyms: *Prosopis chilensis* (Mol.) Stuntz
Ceratonia chilensis Mol.

Common Names: ENGLISH (USA) mesquite

Legal Restrictions:

GENERAL DESCRIPTIONSEEDS

Source: Order trees.
Collection: Pick when yellowish and partly dry.
Extraction: Messy. Mortar and wind, or hand separation; powder is sticky.
Storage:
Pre-Treatment: Hot water; clipping is possible but difficult.

NURSERY

Pots/Open-rooted: Pots. Open-root possible, but needs special lifting-out care.
Time: 12-14 weeks.
Other Notes:

PLANTING/SITE REQUIREMENTS

Soil: Rich, heavy soil; prefers some clay.
Water: Areas under 600mm mean precipitation.
Direct Seeding: Should be encouraged on a trial basis.
Other Notes:

USES

- Wood useful for fence posts.
- Firewood.
- Live fencing and windbreaks.
- Food for animals.

217

SPECIAL NOTES

Tamarindus indica L.**Synonyms:**

Common Names:	ENGLISH	tamarind tree
	FRENCH	tamarinier
	CHAD ARABIC	tamr hindi
	BAMBARA	tombi
	DJERMA	bossaye
	FULANI	jtatami
	HAUSA	tsamiya
	KANOURI	tamsugu
	MORE	pousiga

Legal Restrictions: Cutting and Removal:

GENERAL DESCRIPTION

Tree of medium-to-large size up to 15m recognized by its dense, well-rounded crown. Bark is reddish-grey and is fissured. Leaves consist of 10-15 pairs of folioles. Seed pods are reddish-brown and cylindrical. Pale yellow wood bends well and is strong.

SEEDS

Source:
 Collection: January-March, depending upon location.
 Extraction: Soak fruit to remove pulp; dry the seeds.
 Storage:
 Pre-Treatment: None required.

NURSERY

Pots/Open-rooted: Pots.
 Time: 18-24 weeks.
 Other Notes: Project planted 50 pots, 3 seeds per pot; 63% germination. Germinates well and grows rapidly in pots.

PLANTING/SITE REQUIREMENTS

Soil: Grows best in sandy soil along coasts.
 Water: More than 800mm annual precipitation or along mares and low spots.
 Direct Seeding:

Other Notes:USES

- . Wood for furniture and boatbuilding.
- . Excellent charcoal.
- . Produces tamarind fruit, which is used to make drinks and soups.
- . Shade.
- . An herb/spice to add flavor to main dishes.

SPECIAL NOTES

- In some areas, there is sufficient demand for the fruit to justify special plantations.
- Some countries export the fruit.

Vitex cuneata Schum. & Thonn.

Synonyms: *Vitex chariensis* Chev.
Vitex cienkowski Kotschy & Perr.
Vitex doniana Sweet
Vitex paludosa Vatke

Common Names: CHAD ARABIC unrugulguh FULANI galbihi
 BAMBARA sokoro HAUSA dumnjaa
 koroba KANOURI ngaribi
 DJERMA bo-i MORE andega

Legal Restrictions: Classified as "Specially Useful."

GENERAL DESCRIPTION

Small or medium savanna tree, 10-12m high. Dark green, rounded crown. Bark is pale brown to greyish white with fissures. Leaves are large with oblong folioles. Fruits are large, black, and good to eat. Wood is semi-hard and susceptible to insect attack.

SEEDS

Source:
 Collection: October in Niger.
 Extraction: Soak fruit to remove pulp; dry seeds.
 Storage:
 Pre-Treatment: Soak seeds in lukewarm water overnight.

NURSERY

Pots/Open-rooted: Pots.
 Time:
 Other Notes: Project planted 50 pots, 3 seeds per pot; germination of 2%.

PLANTING/SITE REQUIREMENTS

Soil: Dense forest, wooded savanna, river borders, and cultivated fields.
 Water: Needs access to water for good growth.
 Direct Seeding:
 Other Notes: Widely distributed throughout Africa.

USES

- : Wood used for light woodworking and building small boats.
- : Fruits are popular food.
- : Leaves used in sauces and as medicine against dysentery.

SPECIAL NOTES

- This is a popular tree mainly because of its fruits. Unfortunately, it is a slow and poor germinator and propagation is difficult.

Ziziphus spina christi (L.) Willd.

Synonyms:

Common Names: CHAD ARABIC karno
 FULANI kurnahi
 HAUSA kurna
 KANOURI korna

Legal Restrictions:

GENERAL DESCRIPTION

Medium-sized tree which lives a long time. Small, elliptical leaves on slender branches with short, curved spines.

SEEDS

Source: Strong, healthy trees.
 Collection: October-January, depending on location.
 Extraction: Soak fruit to remove pulp; crack shell with hammer to extract seeds.
 Storage:
 Pre-Treatment: Soak in lukewarm water overnight.

NURSERY

Pots/Open-rooted: Pots.
 Time:
 Other Notes: Project planted 50 pots, 2 seeds per pot; 35% germination. Grows fairly rapidly in pots.

PLANTING/SITE REQUIREMENTS

Soil: Extends into dry, desert areas but prefers alluvial plains with deep soils.
 Water: Likes sites where some ground water is available; has long tap root.
 Direct Seeding:
 Other Notes: Strong regenerative powers and is resistant to heat and drought.

USES

- . Conservation uses for erosion control: windbreaks, shelterbelts and dune fixation.
- . Wood used for fuel, tools and charcoal.
- . Branches and leaves weed for animal browse.

SPECIAL NOTES

Appendix C

CLIMATE, VEGETATION, AND SOILS
OF SUB-SAHARAN WEST AFRICA

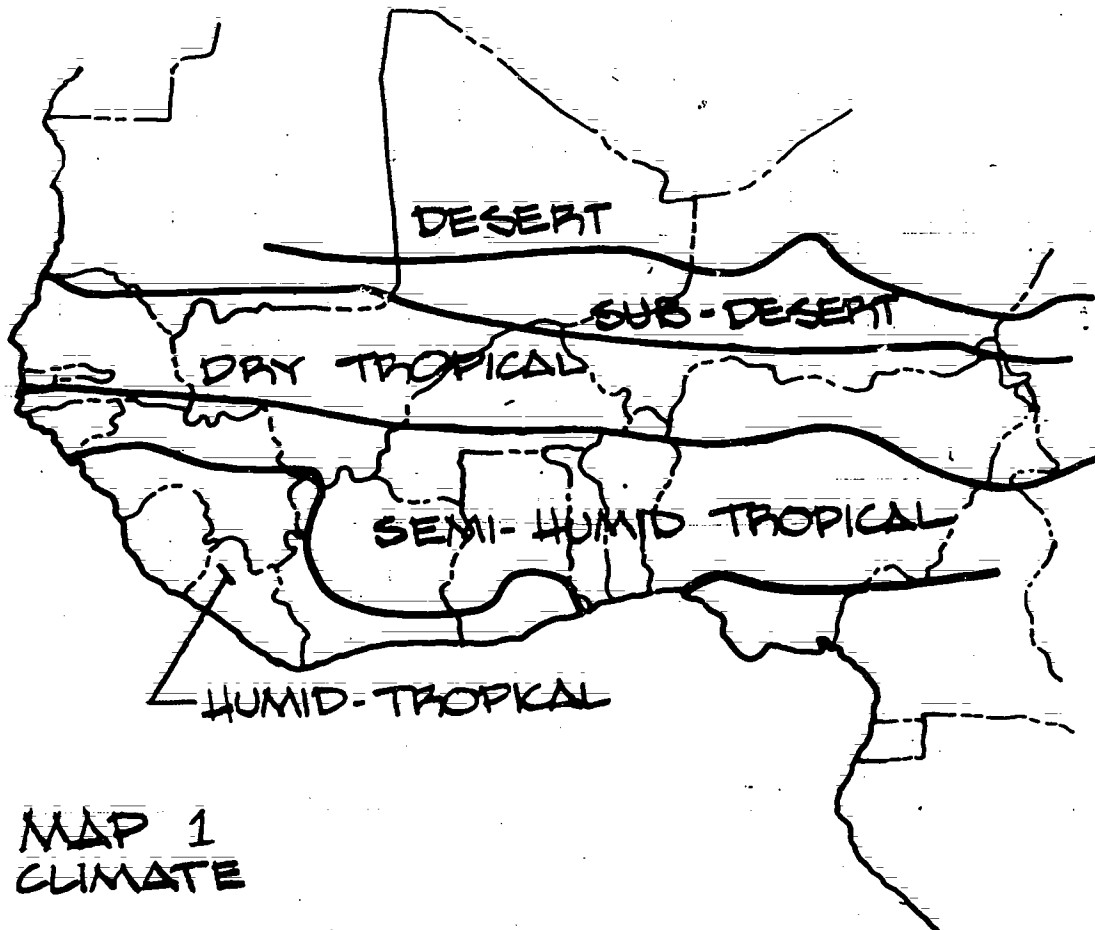

GENERAL DESCRIPTION	MILLIMETERS MEAN ANNUAL RAINFALL	WEST-AFRICAN ZONATION
Desert	0 to 200mm	Saharien (SA)
Sub-Desert	200 to 400mm	Northern Sahel (SSa)
Dry-Tropical	400 to 1,200mm	Southern Sahel (So)
Semi-Humid Tropical	1,200 to 1,750mm	Sudano-Guinéen (SG)
Humid Tropical	1,750mm and up	Forest Zone (GF)

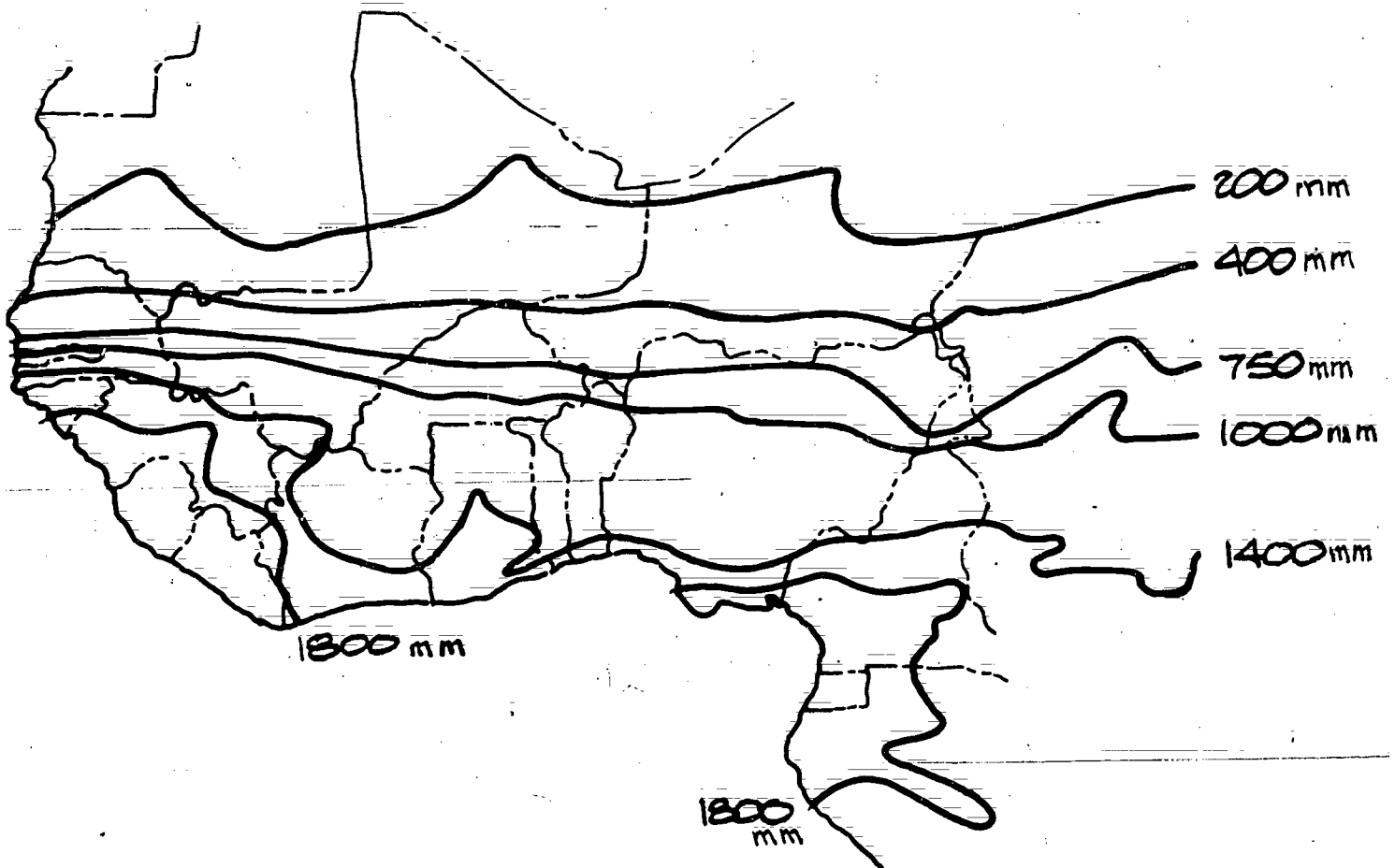

MAP 2 MEAN ANNUAL PRECIPITATION

NOTE: Lines on this map do not exactly coincide with those drawn on Map 1: "Climate." These lines are based on more recent and extensive information.

COMPARISON OF TERMINOLOGY

Mean Annual Precipitation in millimeters	2500	2000	1500	1000	500	100	0
	+	+	+	+	+	+	+
Aubreville Climatic- francophone			Sudano- Guinéen	Soudaneen	Sahelo- Soudanais	No. Sahel	Saharien
Anglophone terms Nigeria			Derived Savanna	Guinea Savanna	Sudan Savanna	Sahel Savanna	
Vegetation Map Map 4			Mosaic	Woodland	Wooded Savanna	Shrub Savanna	Tree Steppe
						Grass Steppe	

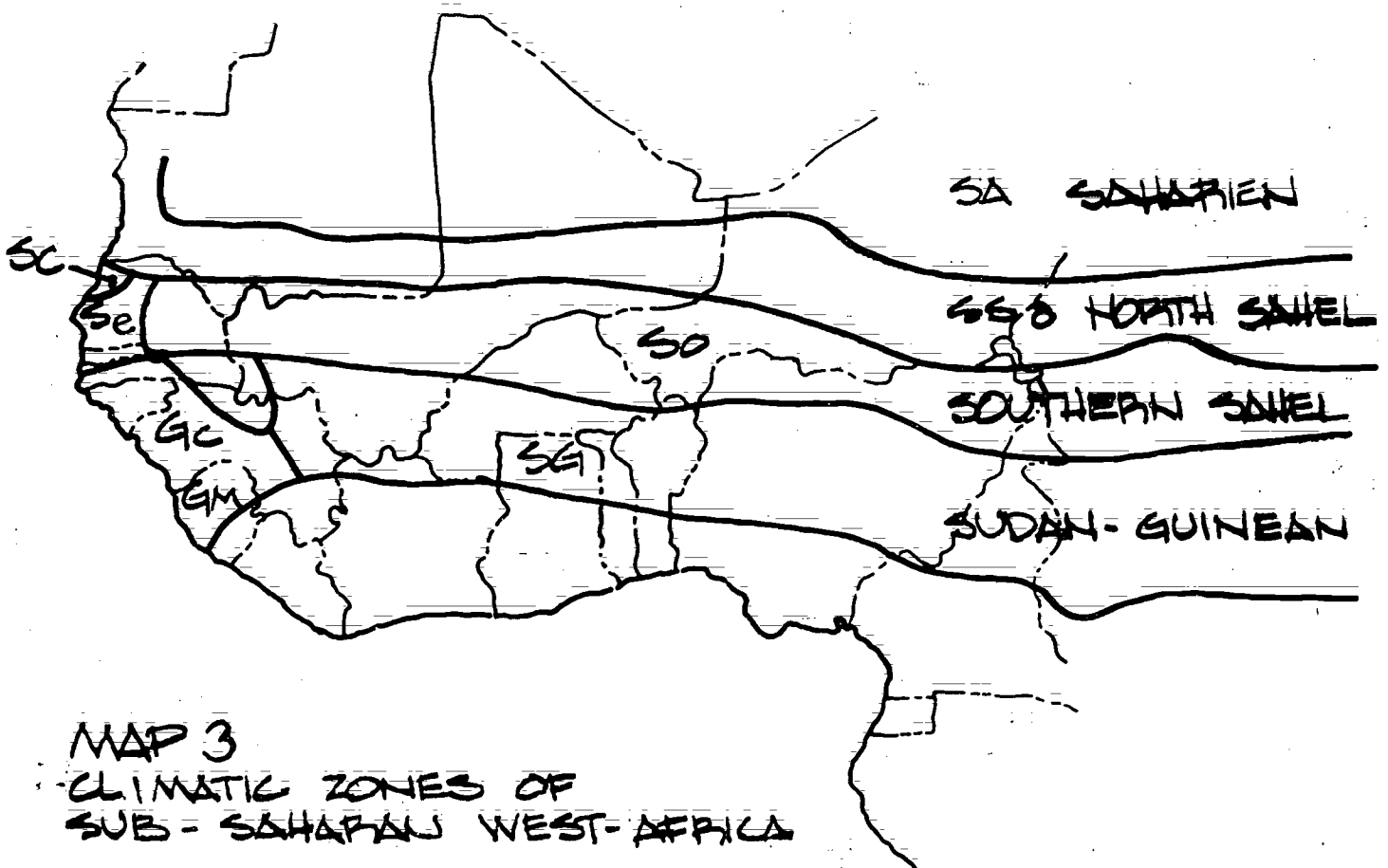

MAP 3
CLIMATIC ZONES OF
SUB-SAHARAN WEST-AFRICA

SYMBOL	DESCRIPTION FRENCH	DESCRIPTION ENGLISH	MEAN ANNUAL PRECIPITATION	MEAN ANNUAL SATURATION DEFICIT
SA	Saharien	Saharan	less than 200	20mm
SSa	Sahélo-saharien	Northern Sahel	200 to 400	15mm
Sc	Sahélo-Côte sénégalais	Senegal Coastal Sahel	400 to 500	5.3-7mm
Se	Sahélo-sénégalais	Senegal Sahel	500 to 900	9-12mm
So	Sahélo-soudanais	Southern Sahel	400 to 1200	11.5-22mm
SG	Soudano-Guinéen	Sudan-Guinean	950 to 1750	7-12mm
Gc	Guinéen basse Casamance	Casamance Guinean	1200 to 1750	6.5-7mm
Gm	Guinéen-maritime	Costal Guinean	1950 to 4500	4.4-5.5mm
Gf	Guinéen - foutanien	Fouta Guinean	1800 to 2050	6-7mm

Source "Flore forestière Soudano-Guinéene"

This terminology used here is commonly used in sub-Saharan West Africa and is based on the work of Aubreville. (As such it came into use prior to the creation of the Yangambi classification of African vegetation types.)

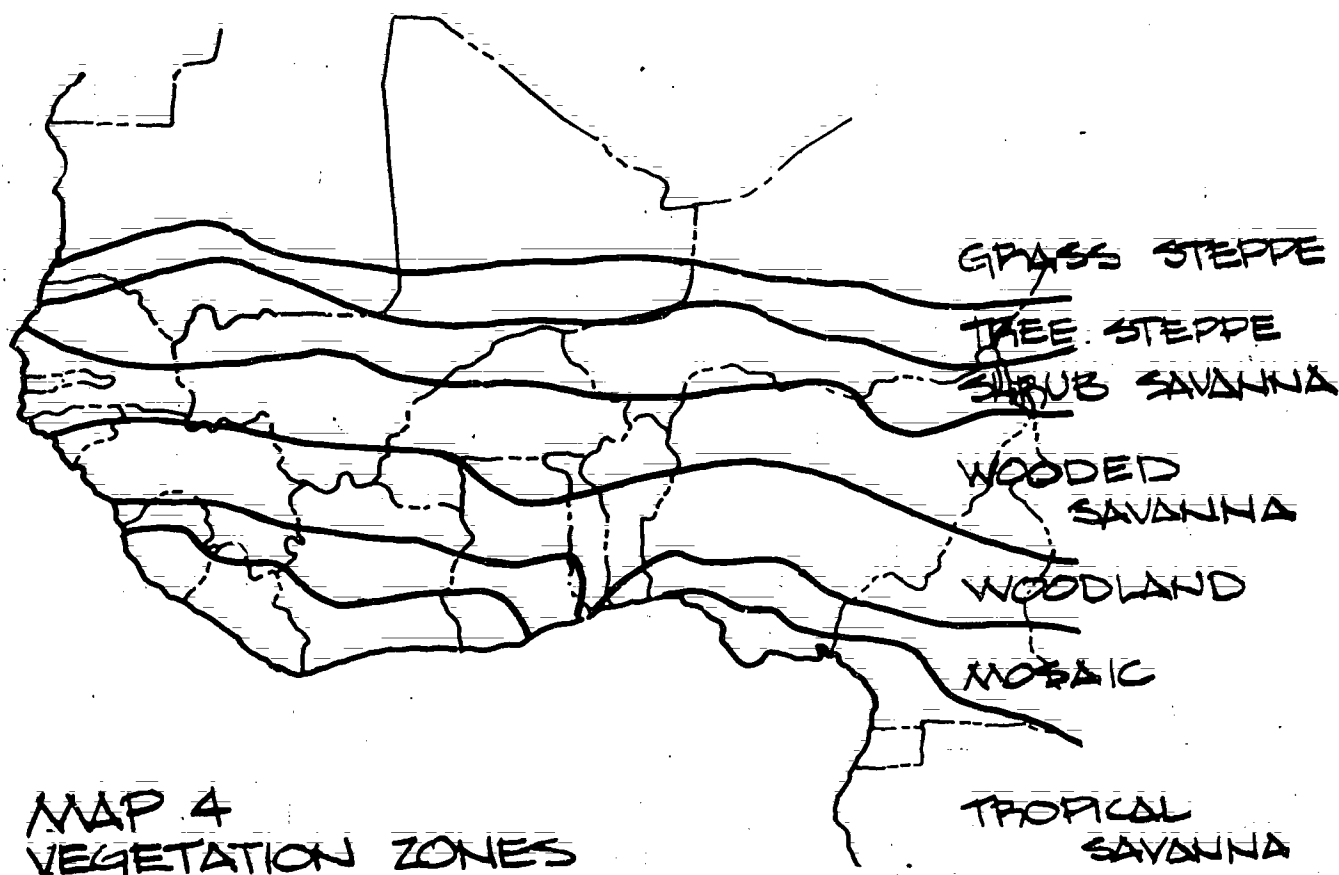

In 1950, the Commission for Technical Cooperation in Africa South of the Sahara/Scientific Council sponsored an international meeting of specialists in phytogeography at Yangambi. They created a classification of African vegetation types and recommended its adoption. In general, FAO and other agencies related to the United Nations, now follow this Yangambi classification.

The method of classification used here is based on the "Vegetation Map of Africa," by Keay and Aubreville, and is consistent with the terms used in the FAO publication, *Tree Planting Practices in African Savannas*.

SOUTH

NORTH

750 mm

1600 mm

200 mm

900 mm

500 mm

200 mm

TROPICAL
RAIN
FOREST

MOSAIC

WOODLAND

WOODED
SAVANNA

SHRUB
SAVANNA

TREE
STEPPE

GRASS
STEPPE



FERRALITE SOILS

FERRUGINOUS SOILS

BROWN SOILS



FERRISOLS

VEGETATION PROFILE

NORTH - SOUTH

* SEE CHART BEGINNING
NEXT PAGE FOR MORE
INFORMATION

VEGETATION AND SOILS

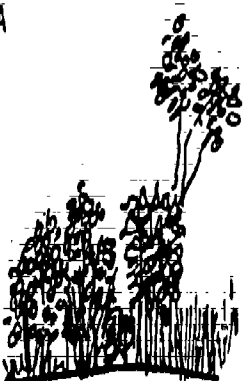
ZONE	SUB-AREA	MEAN ANNUAL RAINFALL (in millimeters)	GRASSES	BUSHES & TREES	SOILS
SAHEL	 GRASS STEPE	0-200mm	<u>Salvadora</u> <u>Leptadenia</u> <u>Aristida</u> <u>Panicum</u>	<u>Acacia radiana</u> Some <u>Balanites</u>	<u>Undifferentiated soils</u> : less than 30cm deep; sub-desert sands in hot dry climate -- often rich in carbonates and soluble salts.
SAHEL	 TREE STEEPE	200-500mm	<u>Aristida stipoides</u> <u>Cenchrus ciliaris</u> <u>Schoenefeldia gracilis</u>	<u>Acacia</u> <u>Comiphora</u> Some thickets	<u>Brown Soils</u> : Highly saturated non-kaolinitic clays; fairly fertile but dry.
SAVANNA	 SHRUB SAVANNA	500-900mm		<u>Acacia nilotica</u> <u>Terminalia</u> <u>Anogeissus</u> (lower locations) <u>Acacia albida</u> <u>Hyphaene thebaica</u> <u>Guiera senegalensis</u> <u>Annona senegalensis</u> <u>Ziziphus</u> <u>Bauhinia</u>	<u>Ferruginous Soils</u> : Begin here often contain impermeable layers of iron oxides. Outcrops form "cutrace". SiO ₂ /Al ₂ O ₃ ratio around 2. Cation exchange capacities rather poor. Free carbonates are lacking, but free iron oxide is common. Range: 500-1200mm rainfall (See also Wooded Savanna) Fair Fertility

ZONE	SUB-AREA	MEAN ANNUAL RAINFALL (in millimeters)	GRASSES	BUSHES & TREES	SOILS
------	----------	---------------------------------------	---------	----------------	-------

SAVANNA

900-1200mm

Thick, tall grasses

Terminalia
Butyrospermum
Parkia
Borassus

Ferruginous Soils: See
"Shrub Savanna".

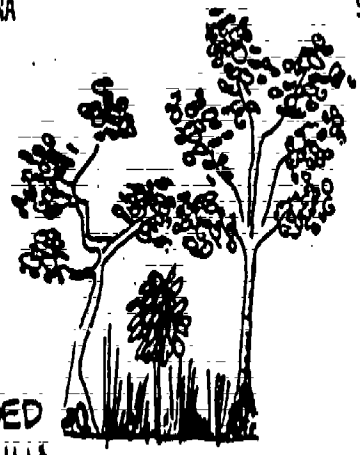

WOODED SAVANNA

SAVANNA

1200-1600mm

soberlinia doka
Khaya
Hyparrhenia
Andropogon
gayanus

Ferralitic Soils: Begin over 1200mm rainfall. Cation exchange capacity very poor. SiO₂/Al₂O₃ ratio less than 2. Often, these soils are very deep. (Oxisols USDA). Similar to laterized* red earth soils of East Africa. Sometimes layers of iron oxides but not as common as in ferruginous soils.



WOODLAND

Low Fertility

* The term "laterite" is frequently used especially in connection with tropical soils. In spite of voluminous writings it is not possible to define this term to everyone's satisfaction. In its purest sense the following description is given: "zone(s) rich in sesquioxides (Al₂O₃ and Fe₂O₃) that, when cut into bricks, become hard as they dry."

Geologists, on the other hand, frequently use the term to describe ferruginous layers, already hard and cellular or clin-ker-like, including concretionary coatings of iron oxides.

ERIC Even parent material is slowly transformed into laterite under the influence of its exposure to a certain climate, chemical changes take place to considerable depths. Much of the original silica is removed. Aluminum oxide (Al₂O₃) leading -- in its purest form -- to commercially exploitable accumulations of bauxite.

MEAN ANNUAL
RAINFALL
(in millimeters)

SUB-AREA

GRASSES

BUSHES & TREES

SOILS



MOSAIC

1600-1750mm

Patches of moist forest surround areas of dense, coarse savanna grass.

Hymenocardia acida
Lophira lanceolata

Ferralitic Soils: Ferrisols, Kaolinite and oxides in clay complex. See also "Woodland".

over 1750mm.



236

237

235

Appendix D

A GUIDE TO WRITING FUNDING PROPOSALS
FOR REFORESTATION PROJECTS

A GUIDE TO WRITING FUNDING PROPOSALS
FOR REFORESTATION PROJECTS

Forestry and conservation projects are so diverse and requirements of funding agencies so different, it is not practical to give a step-by-step formula for writing a proposal. Any proposal must, however:

1. describe the problem briefly, but well;
2. give specific details of how the project will be accomplished; and
3. in the long run, convince the funding agency that the project is worthy of receiving its money.

Usually, a good project proposal consists of four parts:

- I. Statement of the Problem
- II. Statement of Project Goal(s)
- III. Steps Which Will be Taken to Achieve Goal(s)
- IV. Detailed Cost Estimate

I. Statement of the Problem

Describe the problem fully, but as briefly as possible.

What is unsatisfactory and/or getting worse? How does the problem keep people from a better life, make water inaccessible, restrict the growth of crops and herds? What specific circumstances keep the situation from improving?

Once the problem has been identified, give examples of what it means to individuals and to localities trying to cope with the situation on a day-to-day basis. How much money has to be spent or is lost? How many wasted efforts occur? How much suffering is caused? Be as specific as possible: outsiders may or may not be familiar with the local situation and must be given a complete picture of the character and extent of the problem as it affects individuals and the economic, cultural, and social sectors. In particular, how does this problem affect the ability of the area to change from a traditional to a more modern way of life.

II. Statement of Project Goal(s)

Goal The goal of the project should be to create a situation which is a permanent improvement. Describe the goal in a sentence or two. (This is not the place to describe the means of achieving the goal.)

Objectives Outline the new situation and why it is better. Give examples of the ways in which individuals will be affected, and discuss quite specifically the social, cultural, and economic impacts. Explain why the goal can be met. In other words, what situation exists or can exist which suggests the project will work?

In general terms, outline what activities or operations will be undertaken to achieve the goals of the project. Establish objectives for various stages of the project and show how they will be met. Describe any available resources in the existing situation, limited as they may be.

III. Steps Taken to Achieve Objectives

This section is the place to be specific in terms of what needs to be done, who is going to do it, and when it will be done:

For example, if the first step is to clear land, list that as the first objective. Show where the labor to clear the land will come from. Indicate where animals or machines for traction will come from. Show when and how local resources will be used and when available government resources, such as heavy equipment, will be available. Indicate when materials will have to be purchased and labor hired. State the date at which this step of the project will be completed.

It is very useful to make an overall schedule or flow chart of activities. This chart should show the dates when each step of the project should be begun and when each step of the project will be completed.

This is an important part of the proposal. And if the planning has been good, this section will be easy to prepare. Moreover, people reading the proposal will get a sense of good management. This feeling on their part is a must if they are going to release funds for the project.

IV. Detailed Cost Estimate

Based on the plan set forth in the previous section, prepare a detailed cost estimate. Try to make these estimates as exact as possible. To do this, first decide how much of something will be needed:

- . What must be paid for and what might be gotten free?
- . How much is it realistic to expect one worker to do in a day?
- . How many workers do you need?
- . How much time will it take to do teaching and extension work?

- . How much transportation will be needed?
- . How much nursery equipment is needed? This should include a detailed list of all equipment -- from pruning shears to plastic pots.
- . How much material is needed for fence building?

Again, if the project is planned well, these questions will not be difficult to answer.

After realistic estimates of all possible cost areas are made, attach a price tag to each. For example, once the price of each plastic pot is known, it is easy to figure the total costs of plastic pots for a nursery project.

Do not spend too much time on costing the small items. In other words, small costs which can easily be dropped or for which substitution can be found do not require detailed attention. Instead, give full details on major costs and expensive items. For example, a \$10 expenditure for pruning shears does not need the same amount of supporting detail as expenditures for 2,000km of five-strand barbed wire fence or for 2,000 plastic pots.

It is wisest to separate out large expenses such as plastic pots; small expenditures for scissors, watering cans, pliers, etc. can be lumped together under a category such as "Other Nursery Equipment."

Some logical cost headings for proposals are:

- . Salaries and Wages
- . Transportation (including vehicles, vehicle rent, operating costs, and maintenance costs).
- . Major equipment (pumps, portable cistern, animal-drawn equipment).
- . Major materials (including reinforcing steel, structural steel, roofing).
- . Minor Materials and Hand Tools (including nursery tools, fencing tools, and shovels).
- . Special items: Any item that does not fit into the above categories and whose cost exceeds 10% of the total predicted cost of the project.

Keep track of price information in an orderly way. Keep records of current prices for pods, seeds, and other products of various tree species.

This is the kind of information which can be used to justify a project in terms of its costs versus its benefits. All pricing information can be updated as necessary and used as a basis for preparing other proposals for funding.

Appendix E

INFORMATION SOURCES AND BIBLIOGRAPHY

INFORMATION SOURCES

RESEARCH STATIONS

The following stations work in arid forestry and/or range development and can be contacted for information on specific problems:

Centre Technique Forestier Tropical
45 Bis Avenue de La Belle Gabrielle
94 Nogent Sur Marne
FRANCE
(Regional offices in Dakar; Stations in Fort Lamy, Niamey and
Ouagadougou)

Conservator of Forests
Ministry of Animal and Forest Resources
Private Mail Bag #3022
Kano, Nigeria

Institute for Agricultural Research
Ahmadu Bello University
Samuaru, Zaria
Northern Nigeria

Intermountain Forest and Range Experiment Station
25th Street, Forest Service Building
Ogden, Utah 84401

Reforestation Service
Dr. Karschon, Director
Keren Kayemet
BP 45 Kiryat Haim
Haifa, Israel

Rocky Mountain Forest and Range Experiment Station
240 West Prospect
Fort Collins, Colorado 80521

Tropical Products Institute
Culham, Abingdon
Berkshire, ENGLAND

U.S. AGENCIES

USAID (Agency for International Development)
 Department of State
 Washington, D. C.

AID field offices can be contacted through the respective U.S. Embassies.

INTERNATIONAL ORGANIZATIONS

CBLT (Arid Basin Commission)
 Forestry Division
 B.P. 727
 N'Djamena, Tchad

CIEH (Interafrican Committee for Hydraulic Studies)
 B.P. 369
 Ouagadougou, Upper Volta

CILSS, Projects & Programs Division
 B.P. 7049
 Ouagadougou, Upper Volta

FAO/Forest Resources Division
 FAO, 00100
 Rome, Italy

Forestry and Environmental Information Ctr. - Sahel Zone
 B.P. 537
 Niamey, Niger

ILCA (International Live Stock Center)
 P.O.Box 5689
 Addis Ababa, Ethiopia

UNEP, Ecosystems Natural Resource Division
 P.O.Box 30552
 Nairobi, Kenya

BIBLIOGRAPHY

- 1976 *Mémento du Forestier.* Ministère de la Coopération, Paris.
- Aubreville, A. 1950 *Climats, Forêts et Désertification De L'Afrique Tropicale.* Paris, Société d'éditions géographiques, maritimes et coloniales.
- Berhaut, J. 1975 *Flore Illustrée du Senegal.* Direction des Eaux et Forêts, Gouvernement du Senegal.
- Bernstein, C. et al. 1974 *More Water for Arid Lands.* Washington, National Academy of Sciences, Résumé Français.
- Boudet, G. 1975 *Manuel sur les Paturages Tropicaux et les Cultures Fourragères.* Paris, I.E.M.V.T.
- Catinot, R. 1974 *Contribution Du Forestier à la Lutte Contre la Désertification En Zones Sèches.* Paris, Revue Bois et Forêts des Tropiques, No. 155, May-June, 1974.
- Cocheme, J. & Franquin, P. 1967 *An Agroclimatic Survey of a Semiarid Area in West Africa.* Geneva, WMO No. 210 T.P. 110.
- Delwaulle, J.C. 1976 *Le Rôle De La Forestière Dans La Lutte Contre La Désertification.* Ouagadougou. CILSS Consultation April 1976.
- FAO 1963 *Tree Planting Practices for Arid Zones.* Rome.
- FAO 1965 *Crop Ecologic Survey in West Africa.* Rome.
- FAO 1974 *Heathland and Sand Dune Afforestation.* Rome, Inter-Regional Training Centre.
- FAO 1976 *Conservation in Arid and Semi-Arid Zones.* Rome.
- Gledhill, D. 1972 *West African Trees.* London, Longman Group Ltd.
- Goor, A.Y. & Barney, C.W. 1968 *Forest Tree Planting in Arid Zones.* New York, The Ronald Press Company.
- Griffiths, J.F. 1972 *World Survey of Climatology.* Amsterdam, H. E. Landsberg Elsevier Publ. Co.
- Grove, A.T. 1971 *Africa South of the Sahara.* Oxford, University Press.

- Keay, R.W.J.
1959 *Vegetation Map of Africa South of the Tropic of Cancer.* Oxford, University Press. Translated by A. Aubreville.
- Keay, R.W.J., Onochie, C.F.A. & Stanfield, D.P. *Nigerian Trees.* Lagos: Federal Government Printer.
- Pagot, J.
1975 *Manuel Sur Les Paturages Tropicaux..* Paris, I.E.M.V.T.
- Phillips, J.
1959 *Agriculture and Ecology in Africa.* London, Faber and Faber.
- Rattray, J.M.
1960 *The Grass Cover of Africa.* Rome FAO.
- Riou, G.
1971 *Quelques Arbres Utiles De Haute-Volta.* C.V.R.S., Ouagadougou, Upper Volta.
- Rugh, D.
1972 *Guide Des Onze Arbres Protégés Du Niger.* Maradi: (Niger), Atelier Inter-Service. (Washington, Peace Corps Information Collection & Exchange)
- Swami, K.
1973 *Moisture Conditions in the Savanna Region of West Africa,* Ottawa, McGill University Series No. 18.
- USDA
1974 *Seeds of Woody Plants in the United States.* Washington, D. C. Agricultural Handbook No. 450.
- Weber, F.R.
1975 "Optimum Programming", Washington, D.C., ACTION/Peace Corps Program and Training Journal Vol. III, No. 5.

Since 1961 when the Peace Corps was created, more than 80,000 U.S. citizens have served as Volunteers in developing countries, living and working among the people of the Third World as colleagues and co-workers. Today 6000 PCVs are involved in programs designed to help strengthen local capacity to address such fundamental concerns as food production, water supply, energy development, nutrition and health education and reforestation.

Peace Corps overseas offices:

BELIZE
P.O. Box 487
Belize City

BENIN
BP 971
Cotonou

BOTSWANA
P.O. Box 93
Gaborone

BURUNDI
c/o American
Embassy
Bujumbura

CAMEROON
BP 817
Yaounde

CENTRAL AFRICAN
REPUBLIC
BP 1080
Bangui

COSTA RICA
Apartado Postal
1266
San Jose

DOMINICAN REPUBLIC
Apartado Postal
1414
Santo Domingo

EASERN CARRIBBEA
Including: Antigua,
Barbados, Grenada,
Montserrat, St.
Kitts-Nevis, St.
Lucia, St. Vincent,
Dominica "Erin
Court" Bishops
Court Hill
P.O. Box 696-C
Bridgetown, Barbados

ECUADOR
Casilla 635-A
Quito

FIJI
P.O. Box 1094
Suva

GABON
BP 2098
Libreville

GAMBIA, The
P.O. Box 582
Banjul

GHANA
P.O. Box 5796
Accra (North)

GUATEMALA
6a Avenida 1-46
Zona 2
Guatemala

HONDURAS
Apartado Postal
C-51
Tegucigalpa

JAMAICA
Musgrove Avenue
Kingston 10

KENYA
P.O. Box 30518
Nairobi

LESOTHO
P.O. Box 554
Maseru

LIBERIA
Box 707
Monrovia

MALAWI
Box 208
Lilongwe

MALAYSIA
177 Jalan
Raja Muda
Kuala Lumpur

MALI
BP 85
Box 564

MAURITANIA
BP 222
Nouakchott

MICRONESIA
P.O. Box 336
Saipan, Mariana
Islands

MOROCCO
I. Zanquat Benzerte
Rabat

NEPAL
P.O. Box 613
Kathmandu

NIGER
BP 10537
Niamey

OMAN
P.O. Box 966
Muscat

PAPUA NEW GUINEA
P.O. Box 1790
Boroko
Port Moresby

PARAGUAY
c/o American Embassy
Asuncion

PHILIPPINES
P.O. Box 7013
Manila

RWANDA
c/o American Embassy
Kigali

SENEGAL
BP 254
Dakar

SEYCHELLES
BP 697
Victoria

SIERRA LEONE
Private Mail Bag
Freetown

SOLOMON ISLANDS
P.O. Box 547
Honiara

SWAZI LAND
P.O. Box 362
Mbabane

TANZANIA
Box 9123
Dar es Salaam

THAILAND
42 Soi
Somprasong 2
Petchburi Road
Bangkok 4

TOGO
BP 3194
Lome

TONGA
BP 147
Nuku'Alofa

TUNISIA
BP 96
1002 Tunis-
Belvedere
Tunis

UPPER VOLTA
BP 537-Samandin
Ouagadougou

WESTERN SAMOA
P.O. Box 880
Apia

YEMEN
P.O. Box 1151
Sana'a

ZAIRE
BP 697
Kinshasa