

DOCUMENT RESUME

ED 226 250

CE 035 247

AUTHOR Greer, David R.; And Others
TITLE Provide Buildings and Equipment for Vocational Education. Module LT-G-1 of Category G--Facilities and Equipment Management. Competency-Based Vocational Education Administrator Module Series.

INSTITUTION Ohio State Univ., Columbus. National Center for Research in Vocational Education.

SPONS AGENCY Consortium for the Development of Professional Materials for Vocational Education.

REPORT NO ISBN-0-89606-112-4

PUB DATE 83

NOTE 96p.; For related documents see CE 035 239-251 and note on ED 212 839.

AVAILABLE FROM American Association for Vocational Instructional Materials, 120 Driftmier Engineering Center, Athens, GA 30602 (\$6.00; complete set--\$151.80).

PUB TYPE Guides - Classroom Use - Materials (For Learner) (051)

EDRS PRICE MF01/PC04 Plus Postage.

DESCRIPTORS *Administrator Education; Case Studies; Competency Based Education; Educational Equipment; Educational Facilities; *Educational Facilities Design; *Educational Facilities Improvement; Educational Facilities Planning; Higher Education; Individualized Instruction; Job Skills; Learning Activities; *Management Development; Needs Assessment; Postsecondary Education; School Administration; Secondary Education; Site Analysis; *Vocational Directors; *Vocational Education

ABSTRACT

This module, one in a series of competency-based administrator instructional packages, focuses on a specific competency that vocational education administrators need to be successful in the area of facilities and equipment management. The purpose of the module is to teach administrators the process of providing facilities, including assessing the need for new or altered facilities, conducting a site analysis, dealing with an architect, supervising construction activities, and purchasing associated major pieces of equipment. An introduction provides terminal and enabling objectives, a list of resources needed, and glossary of selected terms. The main portion of the module includes five sequential learning experiences. Overviews, which precede each learning experience, contain the objective for each experience and a brief description of what the learning experience involves. Each learning experience consists of a number of activities that may include information sheets, case studies, samples, checklists, and self-checks. Optional activities are provided. The final learning experience also provides an assessment form for administrator performance evaluation by a resource person. (YLB)

ED226250

Provide Buildings and Equipment for Vocational Education

MODULE
LT-G-1

Module LT-G-1 of Category G —
Facilities and Equipment Management

COMPETENCY-BASED VOCATIONAL EDUCATION ADMINISTRATOR MODULE SERIES

Consortium for the Development of
Professional Materials for Vocational Education

- Robert E. Norton, Consortium Program Director
- David R. Greer, Graduate Research Associate
- Lois G. Harrington, Program Associate
- Nancy F. Puleo, Program Assistant

The National Center for Research in Vocational Education
The Ohio State University

1983
ISBN 0-89606-112-4

Copyright © 1983 by The National Center for Research in Vocational Education, The Ohio State University, 1960 Kenny Road, Columbus, Ohio 43210.

Published and distributed by the American Association for Vocational Instructional Materials (AAVIM) in partnership with the Engineering Center, University of Georgia, Athens, Georgia 30602. (404) 542-2586

U.S. DEPARTMENT OF EDUCATION
NATIONAL INSTITUTE OF EDUCATION
EDUCATIONAL RESOURCES INFORMATION CENTER (ERIC)

✓ The document has been reproduced as received from the person or organization originating it.
Minor changes have been made to improve reproduction quality.

• Points of view or opinions stated in this document do not necessarily represent official NIE position or policy.

PERMISSION TO REPRODUCE THIS MATERIAL HAS BEEN GRANTED BY

L. P. Puster

TO THE EDUCATIONAL RESOURCES INFORMATION CENTER (ERIC)."

035247



Development Sponsorship

The initial development of this module was supported by a contract with the Office of Vocational and Adult Education, U.S. Department of Education (Contract No. 300780032, Project No. 498MH00014). Field testing and revision of the module was supported by the Consortium for the Development of Professional Materials for Vocational Education. The following states have been members for one or more years:

- Arizona
- Florida
- Illinois
- Michigan
- New York
- North Carolina
- Ohio
- Pennsylvania
- Texas

Developed by



The National Center for Research in Vocational Education's mission is to increase the ability of diverse agencies, institutions, and organizations to solve educational problems relating to individual career planning, preparation, and progression. The National Center fulfills its mission by:

- Generating knowledge through research.
- Developing educational programs and products.
- Evaluating individual program needs and outcomes.
- Providing information for national planning and policy.
- Installing educational programs and products.
- Operating information systems and services.
- Conducting leadership development and training programs.

Published and distributed by

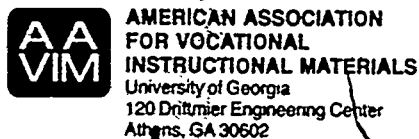

The American Association for Vocational Instructional Materials (AAVIM) is a nonprofit national institute.

The institute is a cooperative effort of universities, colleges and divisions of vocational and technical education in the United States and Canada to provide for excellence in instructional materials.

Direction is given by a representative from each of the states, provinces and territories. AAVIM also works closely with teacher organizations, government agencies and industry.

The work presented herein was performed by the National Center for Research in Vocational Education on behalf of the Consortium for the Development of Professional Materials for Vocational Education. Sponsors and members of the Consortium for 1980-1981 included the following states and/or cooperating agencies: the Florida Department of Education, Division of Vocational Education, and Florida International University, Division of Vocational Education; the Illinois State Board of Education, Department of Adult, Vocational, and Technical Education, and Southern Illinois University at Carbondale; the New York State Education Department, Office of Occupational and Continuing Education; the North Carolina Department of Public Instruction, Division of Vocational Education; the Ohio State Department of Education, Division of Vocational Education; and the Pennsylvania Department of Education, Bureau of Vocational Education, and Temple University, Department of Vocational Education. The opinions expressed herein do not, however, necessarily reflect the position or policy of any of the sponsors, and no official endorsement by them should be inferred.

FOREWORD

The need for competent administrators of vocational education has long been recognized. The rapid expansion of vocational education programs and increased student enrollments have resulted in a need for increasing numbers of vocational administrators at both the secondary and postsecondary levels. Preservice and inservice administrators need to be well prepared for the complex and unique skills required to successfully direct vocational programs.

The effective training of local administrators has been hampered by the limited knowledge of the competencies needed by local administrators and by the limited availability of competency-based materials specifically designed for the preparation of vocational administrators. In response to this pressing need, the Occupational and Adult Education Branch of the U.S. Office of Education, under provisions of part C--Research of the Vocational Education Amendments of 1968, funded the National Center for the Vocational Education "Development of Competency-Based Instructional Materials for Local Administrators of Vocational Education" during the period 1975-77. That project had two major objectives:

1. To conduct research to identify and nationally verify the competencies considered important to local administrators of vocational education.
2. To develop and field test a series of prototypic competency-based instructional packages and a user's guide. One hundred sixty-six (166) high priority competencies were identified and six prototypic modules and a user's guide were developed, field tested, and revised.

Although six modules had been developed, many more were needed to have competency-based materials that would address all the important competencies that had been identified and verified. In September 1978 several states joined with the National Center for Research in Vocational Education to form the Consortium for the Development of Professional Materials for Vocational Education. Those states were Illinois, Ohio, North Carolina, New York, and Pennsylvania. The first five states were joined by Florida and Texas later in the first year. The first objective of the Consortium was to develop and field test additional competency-based administrator modules of which this is one.

Several persons contributed to the successful development and field testing of this module on providing buildings and equipment for vocational education. David R. Greer, Graduate Research Associate, assumed the major responsibility for reviewing the literature and for preparing the actual manuscript. Recognition also goes to the two consultants who helped conceptualize the module and prepared draft materials for the manuscript: Al Barrs, Coordinator, Occupational Program Development, Seminole Community College, Sanford, Florida; and Clifford Migal, Administrative Specialist, Curriculum and Instruction, Great Oaks Joint Vocational School District, Cincinnati, Ohio.

Acknowledgement is given to the official reviewers who provided critiques of the module and suggestions for its improvement: Robert Birge, Vocational Director, East Richland Community Unit District #1, Olney, Illinois; A. Perkins Marquess, Provost, Cocoa Campus, Brevard Community College, Cocoa, Florida; and Frank Oliverio, Assistant Director, Ohio Department of Education, Columbus, Ohio.

Credit goes to Lois G. Harrington, Program Associate, who helped to refine the module for publication after field testing; and to Robert E. Norton, Consortium Program Director, for providing program leadership and content reviews. Thanks go to Ferman B. Moody, Associate Director for Personnel Development, for his administrative assistance.

Appreciation is also extended to Calvin Cotrell, Carroll Curtis, James Haire, George Kosbab, Helen Lipscomb, Aaron J. Miller, Dominic Mohamed, Robert Mullen, James Parker, Dale Post, and Wayne Ramp for their service as state representatives, state department contacts, and field-test coordinators; and to the other teacher educators and local administrators of vocational education who used the modules and provided valuable feedback and suggestions for their improvement. Last, but certainly not least, thanks and credit are due Deborah Linehan, Consortium Program Secretary, for her patience and expert skill in processing the many words necessary to make this module a quality document.

Robert E. Taylor
Executive Director
The National Center for Research
in Vocational Education

INTRODUCTION

Many elements make up a successful vocational education program. They include a sound curriculum, dedicated and qualified faculty and staff, adequate financial resources, and interested and motivated students. However, the contributions of all of these elements will be impaired if up-to-date, comfortable, and useful facilities are not available also. These facilities usually include buildings (with their constituent classrooms, laboratories, shops, clinics, offices, and so on) and equipment, especially those larger items that are often built-in or installed when a building is constructed or renovated.

In this module, we will use the term facilities to mean both buildings and equipment in a general way. The term buildings might refer to a complete freestanding structure or to a significant part thereof (wing, floor, or annex). The term equipment will usually refer to a fixed, built-in, or relatively expensive item--often provided in the construction contract or subcontract--as opposed to a loose, portable, or noncontract device. Some equipment might not be absolutely rigid, but it requires special provisions that need to be coordinated during the construction/remodeling. For example, welders need 220 v, high-amperage wiring. Dental chairs need compressed air and vacuum lines and high-intensity lighting. Kitchen ranges need exhaust hoods. Photographic developing tanks need chemical resistant plumbing. Because of their special needs, these are items of fixed equipment. Movie projectors, wooden executive desks, and electric typewriters are loose equipment, even though they might cost just as much as the fixed items.

The process of providing facilities is not an overnight task. An administrator, or administrative team, might well spend weeks, months, or even years (on at least a part-time basis) from the stage of developing specifications until the final project is inspected and accepted. This module will deal in considerable detail with the many steps of this process. Items covered include assessing the need for new/alterd facilities, conducting a site analysis, dealing with an architect, supervising construction activities, and purchasing associated major pieces of equipment.

As enrollments taper off and public funds become less plentiful, many vocational institutions find that they are no longer involved with the construction of new buildings. Rather, they will be forced to rent or remodel other types of facilities. In addition, they may seek to alter their current buildings just to keep abreast of technological changes in the areas that are being taught. Therefore, this module will attempt to deal with both new construction and renovation/remodeling in balanced ways. Many of the planning and analysis factors are interchangeable, fortunately, and administrators who have been smitten with a bit of the "edifice complex" should not be dismayed if they no longer have the opportunity to rear a dazzling new structure--the challenges and rewards can be just as great when one is involved with the face-lifting or modification of older buildings to suit modern needs.

Throughout this module, you will be reminded that the provision of facilities cannot be performed in a vacuum. The process will need to be coordinated with the planning of instructional programs, the development of budgets, the acquisition of needed resources, and several business functions. Therefore, you might want to consult several other modules in this series, notably Develop Local Plans for Vocational Education (Parts I and II), Prepare Vocational Education Budgets, Identify Financial Resources for Vocational Education, and Manage the Purchase of Equipment, Supplies, and Insurance. Once the new/remodeled facilities have become available, it would naturally be useful to study the module Manage Vocational Buildings and Equipment, dealing with the timely subjects of maintenance, inventory control, safety, and assignment/scheduling.

Module Structure and Use

This module contains an introduction and five sequential learning experiences. Overviews, which precede each learning experience, contain the objective for each experience and a brief description of what the learning experience involves.

Objectives

Terminal Objective: While working in an actual administrative situation, provide buildings and equipment for vocational education. Your performance will be assessed by your resource person, using the "Administrator Performance Assessment Form," pp. 85-87. (Learning Experience V)

Enabling Objectives:

1. After completing the required reading, critique the performance of an administrator in a given case study in assessing the need for additional/remodeled facilities. (Learning Experience I)
2. After completing the required reading, complete a site analysis of an actual educational facility. (Learning Experience II)
3. After completing the required reading, critique a given set of educational specifications for a new building, providing corrected or additional elements as needed. (Learning Experience III)
4. After completing the required reading, critique the performance of an administrator in a given case study in supervising the remodeling of facilities. (Learning Experience IV)

Resources

A list of the outside resources that supplement those contained within the module follows. Check with your resource person (1) to determine the availability and the location of these resources, (2) to locate additional references specific to your situation, and (3) to get assistance in setting up activities with peers or observations of skilled administrators.

Learning Experience I.

Optional

- AN ADMINISTRATOR WITH EXPERIENCE IN FACILITY CONSTRUCTION/RENOVATION whom you can interview.

- A RECENTLY CONSTRUCTED OR RENOVATED, FUNCTIONING VOCATIONAL EDUCATION FACILITY that you can visit.
- A COPY OF THE SPACE AND EQUIPMENT PLANNING STANDARDS from your state education agency that you can study.

Learning Experience II

Required

- AN EDUCATIONAL FACILITY that you can use to complete a site analysis--visiting and touring the building and interviewing its administrators.

Optional

- A VOCATIONAL EDUCATION FACILITY CURRENTLY UNDER CONSTRUCTION OR UNDERGOING RENOVATION that you can visit and whose administrators you can interview.

Learning Experience III

Optional

- AN ARCHITECT EXPERIENCED IN DESIGNING VOCATIONAL EDUCATION FACILITIES whom you can interview.
- A STATE OFFICIAL INVOLVED IN THE DEVELOPMENT/ ENFORCEMENT OF STATE/FEDERAL STANDARDS OR THE APPROVAL OF DESIGNS whom you can interview.

Learning Experience IV

Optional

- A VOCATIONAL EDUCATION FACILITY UNDER CONSTRUCTION OR UNDERGOING RENOVATION that you can visit and whose administrators you can interview.

Learning Experience V

Required

- AN ACTUAL ADMINISTRATIVE SITUATION in which, as part of your duties, you can provide buildings and equipment for vocational education.
- A RESOURCE PERSON to assess your competency in providing buildings and equipment for vocational education.

Selected Terms Administrator--refers to a member of the secondary or post-secondary administrative team. This generic term, except where otherwise specified, refers to the community college president, vice-president, dean, or director; or to the secondary school principal, director, or superintendent.

Board--refers to the secondary or postsecondary educational governing body. Except where otherwise specified, the term "board" is used to refer to a board of education and/or a board of trustees.

Institution--refers to a secondary or postsecondary educational agency. Except where otherwise specified, this generic term is used to refer synonymously to secondary schools, secondary vocational schools, area vocational schools, community colleges, postsecondary vocational and technical schools, and trade schools.

Resource Person--refers to the professional educator who is directly responsible for guiding and helping you plan and carry out your professional development program.

Teacher/Instructor--these terms are used interchangeably to refer to the person who is teaching or instructing students in a secondary or postsecondary educational institution.

User's Guide

For information that is common to all modules, such as procedures for module use, organization of modules, and definitions of terms, you should refer to the following supporting document:

Guide to Using Competency-Based Vocational Education Administrator Materials. Columbus, OH: The Center for Vocational Education, The Ohio State University, 1977.

This module addresses task statement numbers 132-141, 150, and 151 from Robert E. Norton et al., The Identification and National Verification of Competencies Important to Secondary and Post-Secondary Administrators of Vocational Education (Columbus, OH: The Center for Vocational Education, The Ohio State University, 1977). The 166 task statements in this document, which were verified as important, form the research base for the National Center's competency-based administrator module development.

Learning Experience I

OVERVIEW



Enabling Objective

After completing the required reading, critique the performance of an administrator in a given case study in assessing the need for additional/remodeled facilities.



Activity

You will be reading the information sheet, "Determining the Extent of Need for New or Remodeled Facilities," pp. 9-23.



Optional Activity

You may wish to interview an administrator who has had recent experience in conducting a facilities needs survey.



Optional Activity

You may wish to tour a vocational education facility to determine its adequacy for current and projected educational activities.



Optional Activity

You may wish to study the space and equipment planning standards used by your state education agency.

continued



You will be reading the "Case Study," pp. 25-26, and critiquing the performance of the administrator described in assessing the need for additional/remodeled facilities.



You will be evaluating your competency in critiquing the administrator's performance in assessing the need for additional/remodeled facilities by comparing your completed critique with the "Model Critique," p. 27.

For information about how to assess whether your institution needs new or remodeled facilities and how extensive they should be, read the following information sheet.

DETERMINING THE EXTENT OF NEED FOR NEW OR REMODELED FACILITIES

So you've just been given \$5 million and told to build a new vocational building? Or was it only \$10 thousand, and now you get to replace three office typewriters and move a partition or two? Perhaps the students are coming out through the bursting seams of the auto shop, and you've finally decided it's time to ask the powers that be (legislature, county commission, or general voting public) for X amount of money to add facilities.

In every situation (including the unlikely one in which you already have a considerable amount of money on hand), the decision to add new facilities, or to alter the ones you already have, should be preceded by an orderly assessment of the need that exists. However, the question isn't always as simple as "Do we need more facilities, and if so, how much more?" In addition, you might need to determine whether you need better facilities, rearranged space, or just more suitable equipment within the current buildings or rooms.

Let us consider a common household situation that is analagous--bathrooms. If you acquire a spouse one year and a set of twins in each of the next three years, it's obvious that the old house with one bathroom will soon be inadequate. In this case, you need more--lots more. On the other hand, suppose there is just you and a spouse; one of you prefers a shower to a tub bath, but all you have is a bathtub. In this case, the solution is merely one of altering the equipment--adding a shower head, rod, and curtain. Or if yours is a two-story home and you entertain frequently, a downstairs "half bath" can be added to meet the need for convenience, better suiting the particular traffic plan and heavy use that accompanies parties.

The comparable situations within a vocational education setting are perhaps already apparent. The addition of several thousand square feet of new space is an appropriate response when the institution's student enrollments rise. On the other hand, equipping a shop with newer versions of machine tools or adding word processing machines to a secretarial lab requires no new space, but it constitutes a sensible response to the technological changes occurring within the career field that students are being prepared for. Likewise, an exhaust gas containment system could be added to an auto shop to facilitate doing tune-ups without having to open the garage doors, thereby preventing the loss of expensive heat in winter. And finally, the arrangement of rooms could be altered--to avoid traffic or tool noise, for example, or to place the cosmetology lab closer to the door used by customers. In similar fashion, the furnishings within a child-care lab might be rearranged, moving the noisy play area away from the corridor door or taking the nap corner away from the route to the bathroom.

In summary, the question of "What do we need?" can be answered in at least three principal ways:

- Do we need more space and/or equipment?
- Do we need better facilities within the same walls or campus/school-ground boundaries?
- Do we need to better arrange the rooms and equipment we already have?

Keep these three questions in mind. The answers to these questions depend on the types of information you are going to read about next, but that information will be emphasized differently in answering each question. And above all, you will have to consider how much it will cost to achieve each type of improvement.

Summarizing Current Use of Facilities

An important first step in assessing your need for facilities' improvement is to secure, accumulate, and compile data about how buildings and equipment are currently being used. This process will of course require coordination with those who manage the class schedule, those who record student enrollments, and those who rent rooms to outside organizations for events.

The most obvious bit of data that you look for here is number of students accommodated in a unit (room, lab, or shop) during each class hour or period. Also, you will want to find how many hours each day or week a room is vacant. Do not confine your census to filled seats. A more general, useful term is student stations: laboratory sinks, dental patient chairs, drill presses, typewriter desks, drawing boards, computer terminals, store window mock-ups, and so on.

Census data is quantitative; you should give equal emphasis to qualitative data, being vigilant in obtaining comments or complaints about the suitability of rooms or equipment. For example, periodic review of repair orders or safety reports might reveal problems as they occur. In addition, you could solicit comments about facilities at fixed intervals through questionnaires, or you could arrange for occasional mutual inspection of facilities in cooperation with the teachers that use them. Sample 1 shows an evaluation checklist you could use to guide your review of your facilities.

Finally, ad hoc investigation of suspected problem areas could yield useful information. The traffic-counter wire laid across a street near a hazardous intersection is a common example, helping the engineer decide if a new signal light is necessary. Along these lines, you might wish to station an observer near exit doors or to ask someone to count the number of people waiting in line at the cafeteria, at the tool crib, or at the computer console. Likewise, a technician with an audiometer might measure just how loud the scream of a saw is at the other end of the corridor, or a custodian could be asked to count the number of spills that had to be mopped up in a certain

SAMPLE 1

EVALUATION OF EDUCATIONAL FACILITY

Thirteen categories for evaluation are covered in this form. Each item listed may be marked excellent (E), good (G), satisfactory (S), or poor (P). The space for comment that follows each category is to be used to explain those items rated as being poor.

It should be recognized that certain categories included in this form may not fall within the area of concern of each evaluator; these may be left blank.

Additional space is provided at the end of this form for noting observations related to specific areas of the institution, whether they be instructional or supporting.

Name of Institution/Building _____

1. Esthetics and general appearance of the facility

- a. ___ Overall appearance of building within its setting
- b. ___ Outside appearance of building
- c. ___ Utilization of materials to enhance appearance
- d. ___ Utilization of color to enhance appearance

Comments _____

2. Site and grounds

- a. ___ General development and beautification of site
- b. ___ Location of recreation areas in relation to building
- c. ___ Suitability of handling crowds on the grounds
- d. ___ Adequacy of facilities for recreation

Comments _____

3. Traffic on site--auto and pedestrian

- a. ___ Accommodations for auto traffic on site
- b. ___ Accommodations for service vehicle traffic on site
- c. ___ Parking facilities for faculty, staff, and visitors
- d. ___ Accommodations for buses
- e. ___ Efficient layout for pedestrian walkways
- f. ___ Accessibility to handicapped

Comments _____

4. Classrooms and other educational spaces in general

- a. ___ Size (area)
- b. ___ Shape
- c. ___ Chalkboard
- d. ___ Corkboard
- e. ___ Storage for students
- f. ___ Storage for teacher
- g. ___ Equipment
- h. ___ Furniture

Comments _____

5. Adequacy of spaces related to and supporting instruction

- a. ___ Library reading room
- b. ___ Library workroom
- c. ___ Individual study spaces
- d. ___ Seminar rooms
- e. ___ Resource and special rooms
- f. ___ Large-group rooms
- g. ___ Faculty rooms
- h. ___ Cafeteria
- i. ___ Student activity rooms
- j. ___ Materials preparation areas
- k. ___ Instructional materials storage
- l. ___ Conference rooms
- m. ___ Book storage
- n. ___ General school storage (secured and unsecured)
- o. ___ Display space
- p. ___ General office
- q. ___ Administrative offices
- r. ___ Duplicating offices
- s. ___ Counseling offices
- t. ___ Health service facility

Comments _____

6. Arrangement and location of facilities in relation to total institution

- a. Accessibility to administrative offices
- b. Classroom arrangement and location
- c. All-purpose room or cafeteria location
- d. Relation of kitchen to dining area
- e. Relation of kitchen to service drives
- f. Location and arrangement of library
- g. Facilities for physical education
- h. Location and arrangement of special facilities--shops, labs
- i. Lockers and student storage areas
- j. Instructional supply and storage facilities
- k. Student traffic flow within the buildings

Comments _____

7. Other considerations relating to efficiency of the institution

- a. Number and location of faculty toilets
- b. Number and location of student toilets
- c. Number and location of custodial rooms
- d. Relationship of classrooms to other spaces
- e. Location of administrative offices
- f. Location of library
- g. Location of cafeteria
- h. Location of physical education rooms
- i. Adequacy of drinking fountains
- j. Location of telephones
- k. Adequacy of projection screens
- l. Adequacy of projection equipment
- m. Adequacy of darkening shades
- n. Provision of electronic equipment
- o. Appropriate acoustical treatment where necessary

Comments _____

8. Lighting and color

- a. Classroom lighting
- b. Classroom colors
- c. Lighting in instructional spaces
- d. Color in instructional spaces
- e. Lighting in corridors and stairways
- f. Color in corridors and stairways
- g. Color considered in selection of furnishings and equipment
- h. Design and provision for control of glare
- i. Window design for natural lighting

Comments _____

9. Heating and ventilation

- a. Adequacy of ventilation system
- b. Control of sound generated by ventilation equipment
- c. Adequacy of heating system
- d. Control of heating equipment
- e. Window design for natural ventilation
- f. Window design for control of heat transmission

Comments _____

10. Safety and security provisions

- a. Design of stairs, composition of treads, and presence of railings
- b. Absence of dangerous projections inside and outside building
- c. Adequacy of safety closers on outside doors
- d. Freedom from slick floors
- e. Absence of windows that protrude open at eye level
- f. Adequacy of emergency lighting
- g. Security afforded by outdoor lighting
- h. Location of walks, drives, and recreational areas relative to safety
- i. Identification and safeguards of danger areas
- j. Adequacy of fire protection features and equipment
- k. Adequacy of storage of chemicals and flammables

Comments _____

11. Maintenance and operation considerations

- a. Functionality of interior materials
- b. Functionality of exterior materials
- c. Adequacy of mechanical equipment
- d. Adequacy of window and door mechanisms
- e. Provision for good drainage of site
- f. Durability of instructional equipment
- g. Ease of cleaning floors
- h. Ease of cleaning stairs
- i. Ease of cleaning heating units
- j. Ease of cleaning windows and window sills
- k. Adequacy and location of custodial storage

Comments _____

12. Workmanship

- | | |
|---------------------------------------|---|
| a. <input type="checkbox"/> Masonry | e. <input type="checkbox"/> Floors |
| b. <input type="checkbox"/> Carpentry | f. <input type="checkbox"/> Roof |
| c. <input type="checkbox"/> Cabinetry | g. <input type="checkbox"/> Heating equipment |
| d. <input type="checkbox"/> Painting | h. <input type="checkbox"/> Windows and doors |

Comments _____

13. Adequacy of accessibility for physically impaired

- a. Accessibility to all areas by ramp or elevator
- b. Adequacy of restroom facilities, telephones, and water fountains
- c. Adequacy of door widths to accommodate wheelchair and walkers
- d. Ease of adapting lab facilities to meet the needs of the handicapped

Comments _____

Additional pertinent comments. The space below may be used to comment on items not noted above and may also be used to record observations relating to special educational facilities such as shops, labs, clinics, lecture hall/auditorium, gymnasiums, or the learning resources center/library. The evaluator should feel free to record any other observations accruing from his/her examination of the institution.

corner of the assembly hall because of a badly located vending machine or water fountain.

Once those data are available, you should examine them critically to see if patterns of overuse, underuse, or abuse are apparent. In some cases, this may require the computation of occupancy rates, which can then be compared with standards published by a professional organization or a state agency.

For example, one state has established a goal that each room should be occupied by a class during at least three-fourths of the customary class day and that two-thirds of the student stations be occupied at those times. Against these criteria, consider the following situation:

Nursing Lab--12 student stations (beds)

<u>Time</u>	<u>Occupancy</u>	<u>Student Hours</u>
8-10 a.m.	x 6	= 12
10-12 a.m.	x 0	= 0
1- 3 p.m.	x 8	= 16
3- 5 p.m.	x 4	= 8
6- 8 p.m.	x 10	= 20
		<u>56</u> (actual rate of occupation)

$$\begin{array}{r}
 12 \text{ hours} \\
 \times \frac{3}{4} \\
 \hline
 \end{array}
 \times
 \begin{array}{r}
 12 \text{ stations} \\
 \times \frac{2}{3} \\
 \hline
 \end{array}
 = 72 \text{ (ideal rate of occupation)}$$

$$56 \div 72 = .777 \text{ or } 77.7\%$$

Sample 2 shows more complete sets of standards for two other states.

Overcrowding of a classroom can be detected in a similar fashion by calculating the number of square feet per student station (SS). A total of 15 square feet per SS is a typical architectural standard for a lecture situation using tablet-arm chairs. Thus, a room that is 600 square feet (30 ft. x 20 ft.) with 50 chairs is packed too tightly (12 square feet per SS), whereas a room that is 450 square feet with only 20 chairs is quite spacious (22.5 square feet per SS) and probably underused.

Granted, these standards will not always be available or so easily compared with available data. But they will help you detect some of the wider departures from the acceptable use of space. This is true of the qualitative comments as well. Twelve complaints about the noisy keypunch machines indicate a more severe problem than do only three gripes about an inconveniently placed printing press, but neither compares with a leaky hydraulic hoist that drops a car onto a student, nearly killing her.

As in any analysis process, you have a choice in selecting the criteria against which to compare your current situation: last year's situation, your neighbor's situation, a standard set by an authority, a theoretical maximum, the public's level of acceptance, a minimum survival level--or whatever you can afford.

SAMPLE 2

SPACE REQUIREMENT STANDARDS

Laboratories for Selected Occupational Specialties

<u>Program</u>	<u>Square Feet Per Student Station (Florida)</u>	<u>OR</u>	<u>Square Feet Per Laboratory (Ohio)</u>
AGRICULTURE EDUCATION			
Agribusiness	50- 55		1,200
Ag Mechanics/Equipment	120-150		6,000
Forestry	65- 72		3,200
Horticulture	45- 50		2,000
Production	122-134		2,400
Resource Conservation and Recreation	70- 77		3,000
BUSINESS AND OFFICE EDUCATION			
Accounting	53- 58		2,200
Correspondence/Information Processing	55- 61		1,600
Data Processing	60- 66		2,500
DISTRIBUTIVE EDUCATION			
Distributive Education	38- 42		1,850
General Merchandising	54- 59		1,850
Management and Supervision	25- 29		1,850
HEALTH OCCUPATIONS			
Co-op Health Occupations	32- 36		800
Dental Assistant	47- 52		2,500
Dental Lab Worker	47- 52		2,500
Medical Lab Assistant	108-120		2,500
Practical Nursing	75- 83		2,500
HOME ECONOMICS EDUCATION			
Child Care	49- 54		3,500
Clothing and Textiles	52- 57		3,500
Food Production and Management	90- 99		6,300
Upholstery	88- 98		4,800

<u>Program</u>	<u>Square Feet Per Student Station (Florida)</u>	<u>Square Feet Per Laboratory (Ohio)</u>
TRADE AND INDUSTRIAL EDUCATION		
Air Conditioning and Heating	135-150	3,500
Cosmetology	144-158	3,000
Drafting	72- 79	2,400
Law Enforcement	68- 75	4,000
Machine Shop	140-154	5,000
Painting and Decorating	81- 89	3,000
Sheet Metal	108-119	3,500
Welding	135-149	5,000

General and Administrative Areas

<u>Purpose</u>	<u>Square Feet Per Occupant</u>
Chief Administrator	200-300
Vice-President/Dean/Director	175-225
Counselor	150-200
Registration	175-275
Faculty	100-110

	<u>Square Feet Per Student Enrolled</u>
Conference Rooms	0.2-0.3
Food Service (including kitchen)	4.0-5.0
Auditorium	2.7-3.3
Learning Resources Center-- Reading Room	2.6-3.0

	<u>Square Feet Per Volumes Held</u>
Learning Resources Center-- Stacks	.07-.09

	<u>Square Feet Per Worker</u>
Learning Resources Center-- Workroom	25-30

Projecting Future Use

Up until now we have been dealing with current situations. In your planning and assessment, however, you will obviously need to deal with the future as well. Formerly, the standard projection for the coming years was one of growth; the only question was, "What percentage of growth can be expected per year?" Now that has changed. Some areas of the country have experienced outward migration as energy prices rose or dominant local industries closed. In other cases, the population of a community has risen, but the demand for workers in a particular vocation has declined.

Thus, your projections for enrollment in a given class are affected by a whole hierarchy of factors: the attractiveness of that course of study, the overall enrollment of the institution, the population of the community, the economic climate of the state, and the nationwide changes in a technology. As an additional complication, the methods of teaching or learning in a career area may change. Consider the open-classroom concept that became popular in elementary education in the 1960s and '70s, requiring substantial architectural modification. Likewise, adoption of competency-based education might alter the patterns of equipment use or allow you to try a different kind of schedule.

If there's any one thing you can count on, it is change. Therefore, you should emphasize flexibility and plan to provide facilities that can accommodate numerous changes in student numbers, teaching/learning methods, or types of equipment and materials required. A format for planning future space needs is shown in sample 3.

Securing Information from Many Sources

Considering such complexity, you may now be ready to throw up your hands in perplexity. But who said you have to do all this alone? Many of the most successful construction or remodeling projects did not rely on one administrator to "brainchild" the whole operation. Instead, a team was used--including, especially, those who would be affected by the new facilities and drawing from those who had had relevant experience or special training. Let's look at some of these resources--these potential teammates--more closely.¹

Teachers/instructors. These should be your first rank of experts. Unless they all have spent their entire careers in your institution, they will have some ideas about alternative ways to provide effective learning environments for students. Given an opportunity, they can give you advice worth considering, ranging from a better way to lay out a home economics

1. For more information about using local experts and the planning process, you may wish to refer to Develop Local Plans for Vocational Education: Part I, part of the Competency-Based Vocational Education Administrator Module Series (Columbus, OH: The National Center for Research in Vocational Education, The Ohio State University, 1977.)

SAMPLE 3

PLANNING FUTURE SPACE NEEDS

Population Projections of Sponsoring Area:

1. High School Graduates:

<u>Actual Past 4 Years</u>				<u>Actual Current Year</u>	<u>Projected</u>		
19__	19__	19__	19__	19__	<u>Next 3 Years</u>	<u>5 Years</u>	<u>10 Years</u>
19__	19__	19__	19__	19__	19__ 19__ 19__	19__	19__
_____	_____	_____	_____	_____	_____	_____	_____

2. All Other Adults Through Age 30:

<u>Actual Past 4 Years</u>				<u>Actual Current Year</u>	<u>Projected</u>		
19__	19__	19__	19__	19__	<u>Next 3 Years</u>	<u>5 Years</u>	<u>10 Years</u>
19__	19__	19__	19__	19__	19__ 19__ 19__	19__	19__
_____	_____	_____	_____	_____	_____	_____	_____

3. All Other Adults Age 31 and Over:

<u>Actual Past 4 Years</u>				<u>Actual Current Year</u>	<u>Projected</u>		
19__	19__	19__	19__	19__	<u>Next 3 Years</u>	<u>5 Years</u>	<u>10 Years</u>
19__	19__	19__	19__	19__	19__ 19__ 19__	19__	19__
_____	_____	_____	_____	_____	_____	_____	_____

4. Total of 1, 2, and 3:

_____	_____	_____	_____	_____	_____	_____	_____
-------	-------	-------	-------	-------	-------	-------	-------

5. Actual Enrollment and Enrollment Projections as of the fall term:

<u>Actual FTE/Past 4 Years</u>				<u>Actual FTE Current Year</u>	<u>Projected FTE</u>		
19__	19__	19__	19__	19__	<u>Next 3 Years</u>	<u>5 Years</u>	<u>10 Years</u>
19__	19__	19__	19__	19__	19__ 19__ 19__	19__	19__
_____	_____	_____	_____	_____	_____	_____	_____

<u>Actual Head Count Past 4 Years</u>				<u>Actual Head Count Current Year</u>	<u>Projected Head Count</u>		
19__	19__	19__	19__	19__	<u>Next 3 Years</u>	<u>5 Years</u>	<u>10 Years</u>
19__	19__	19__	19__	19__	19__ 19__ 19__	19__	19__
_____	_____	_____	_____	_____	_____	_____	_____

SOURCE: "Community College Guidelines for Space Approval" (Harrisburg, PA: Commonwealth of Pennsylvania, Department of Education, n.d.).

- | | | |
|---|----------------------------------|-------|
| 6. Projected number enrolling in community colleges:* | High school graduates | _____ |
| 7. Projected number enrolling in community colleges:* | All other adults through Age 30 | _____ |
| 8. Projected number enrolling in community colleges:* | All other adults age 31 and over | _____ |
| 9. Total projected number enrolling in community colleges:* | (Sum of Items 6, 7, and 8) | _____ |

In order to develop student FTE, the following steps are necessary:

- | | |
|--|-------|
| 10. Projected percentage of Item 9 enrolling as first-year full-time students: | _____ |
| 11. Projected percentage of Item 9 enrolling as first-year part-time students: | _____ |
| 12. Projected number enrolling as first-year full-time students (product of Item 9 x Item 10): | _____ |
| 13. Projected number enrolling as first-year part-time students (product of $\frac{\text{Item 9} \times \text{Item 11}}{2}$): | _____ |
| 14. Projected percentage of full-time (Item 12) enrolling as second-year full-time students: | _____ |
| 15. Projected percentage of part-time day (Item 13) enrolling as second-year part-time students: | _____ |
| 16. Projected number enrolling as second-year full-time students (product of Item 12 x Item 14): | _____ |
| 17. Projected number enrolling as second-year part-time students (product of Item 13 x Item 15): | _____ |
| 18. Total projected number enrolling as full-time equivalent students (total of Items 12, 13, 16, and 17): | _____ |

*The projected number is to be calculated on the basis of the projected 10-year population figures and should include only students entering the institution for the first time.

kitchen to a suggestion about where to buy a prefabricated greenhouse. Their advice is not infallible, but it can give the foundation for further study of quickly focus efforts into a practical area.

Program advisory committees. Like the faculty members, these people have experience in diverse settings and often know a lot about equipment, efficient physical arrangements, and good sources of labor and materials. They are particularly useful in helping project the community's future economic activity, with resultant changes in the need for more trained workers, and at forecasting technological changes.

Consultants. These individuals can aid your efforts through their detailed knowledge of current building standards, equipment applications, methods of ensuring accessibility to the handicapped, or the experiences of other institutions that have implemented various construction ideas. Moreover, some of them are well acquainted with the process of needs assessment and can devote the time and attention that is not always available to a local administrator. They are especially helpful at the early stages--conceptualizing and launching a needs assessment--and at the final stages--data analysis and report writing.

Agency officials. Many state departments of education--or their fellow state offices of public services, administration, or economic development--contain officials who have much of the same information and expertise as do private consultants. They don't always have as much time to devote to any one institution's research, but they might have prepared a handbook or guidelines that the administrator can follow. In addition, they might make a few on-site visits to help you through the difficult stages. They, of course, are the experts on (and often the drafters of) current state requirements and can thus assure your compliance with applicable regulations from the outset.

Institutional building committee. This is an "all-of-the-above" category. By forming a building committee of selected fellow administrators, affected instructors and support staff members, advisory committee members, and a consultant or two, you can develop continuity that will extend throughout the complete construction, remodeling, and equipment-purchasing activity. The membership of the committee might change as new facility needs are discovered, as priorities change for solving those needs, or as different phases are undertaken. Nevertheless, it is important for you to retain the committee, both as a source of information and as a channel for comments from colleagues. The committee can be a sounding board for your ideas and can help you explain to other staff why certain decisions or courses of action are being taken.

Using the Outcomes of the Needs Analysis

Let's assume that you've accumulated great amounts of data, both quantitative and qualitative. Furthermore, you've considered the future populations of your community, your school/college, and the various vocational programs

within it. Moreover, you've enlisted the expert assistance of teachers/instructors and fellow administrative staff members, as well as advisory committee and board members, appropriate officials, and a consultant or two. In order for their careful analysis of this voluminous data to be significant and useful, you need to develop recommendations about the same three questions posed much earlier in this information sheet:

- Do we need more space and/or equipment? (If so, how much?)
- Do we need better facilities? (If so, how should they be improved?)
- Do we need to better arrange our current facilities through remodeling?

At the minimum, especially if your study has concluded that additional facilities are needed or existing facilities should be reallocated, you should prepare a tabular summary showing each type of institutional and instructional space (e.g., classroom, shop, lab, clinic, office, assembly area) and the number of square feet that should be allocated to each. Sample 4 shows one such set of calculations, using projected census data and room-area standards similar to those shown in samples 2 and 3.

This summary will be more effective if it is supported by a complete written report, including a narrative that describes who was involved in the study, what data they considered, what factors and criteria they considered to be most important, and how they reached their decisions. Also, your report should discuss factors besides the mere amount of space, especially if you concluded that the answers to Questions 2 and 3 were also yes. The amount and type of equipment should be mentioned, including the degree to which the equipment supports instruction at the current state of the art in each vocational area and whether it is harmonious with the rooms in which it is located.

You should also consider alternative ways of providing more space. If the need is temporary, then leasing or renting rooms or buildings is an appropriate response, as is sharing with other public agencies in the use of specialized facilities. In some cases, the space on hand can be better used through more creative scheduling or by extending the "school day" into the evening hours or weekends.

Finally, your recommendations should assign some degree of priority to each need. You can accomplish this by citing the probable effect if each deficiency is not remedied, thus estimating the urgency of each requested improvement. Also, you should estimate the relative cost of adding or altering each substandard facility and indicate whether fixing just one area would be so expensive that it would preclude any progress on the others.

SAMPLE 4

CALCULATION OF SPECIFIC FUTURE FACILITIES NEEDS

The following sample calculation will show the various space category needs of an institution with a projected 10-year full-time equivalent (FTE) enrollment of 1,970 students.

Assume that the total population in the service area for ten years hence is projected to be 250,000. Further, it is projected that 2,500 will enroll in the community college. This is broken down as 40% high school graduates, or 1,000; 40% all other adults through age 30, or 1,000; and 20% all other adults age 31 and over, or 500. In order to determine space needs, it becomes necessary to convert to FTE students by counting those taking 12 or more credit hours at full credit, counting part-time students at "half-value," and adding them together.

Example: 600 full-time plus 400 part-time ($400 \times 50\% = 200$) equals 800 FTE students.

Experience has shown that 60% of the students are enrolled full time. On this basis, we can calculate the projected FTE students as follows:

FTE enrolling as full-time students	$2,500 \times 60\% = 1,500$
FTE enrolling as part-time students	$\frac{2,500 \times 40\%}{2} = 500$
Total projected FTE students:	<u>2,000</u>

Classroom needs: (15 SF/FTE)*

$2,000 \times 15 = 30,000$

Laboratory space: (6 SF/FTE)

Assume the following:

Total full-time enrollment = 2,000

50% are college transfer = 1,000
50% are occupational = 1,000

Occupational

70% are general career = 700 (additional 10 SF/FTE)
30% are career lab emphasis = 300 (additional 40 SF/FTE)

Total enrollment	$2,000 \times 6 = 12,000$
Additional	$700 \times 10 = 7,000$
Additional	$300 \times 40 = 12,000$
	31,000

Remedial space: (12 SF/FTE)

10% FTE (200) are in remedial work $200 \times 12 = 2,400$

Administrative space: (5 SF/FTE)

$2,000 \times 5 = 10,000$

Faculty space: (10 SF/FTE)

$2,000 \times 10 = 20,000$

*SF/FTE = Square feet per full-time equivalent student

SOURCE: "Community College Guidelines for Space Approval" (Harrisburg, PA: Commonwealth of Pennsylvania, Department of Education, n.d.).

Physical education: (10 SF/FTE)

Assume that the college program requires only transfer and general career students to take two years of credit in physical education.

$$1,000 + 700 = 1,700 \text{ students}$$

$$1,700 \times 10 = 17,000$$

Food services: (4 SF/FTE)

$$2,000 \times 4 = 8,000$$

Student services: (8 SF/FTE)

Lounge, recreation and merchandising, student government and publications

$$2,000 \times 8 = 16,000$$

Learning resources: (10-15 SF/FTE)

Transfer
Occupational & remedial

$$1,000 \times 15 = 15,000$$

$$1,000 \times 10 = 10,000$$

$$25,000$$

Supporting facilities: (5 SF/FTE)

$$2,000 \times 5 = 10,000$$

Total projected approval net assignable space this campus: 169,400 square feet

Total approval gross space this campus: $\frac{169,400}{.68} = 249,117$ square feet

Gross square feet per FTE: $\frac{249,117}{2,000} = 124.6$ square feet

Net square feet per FTE: $\frac{169,400}{2,000} = 84.7$ square feet

*Net assignable area to gross area ratio: This is calculated by dividing the net assignable area by the gross area. Normally this should be approximately 68 percent. Each individual building may vary in net-to-gross ratio depending on its primary function. The figure of 68 percent is used as an appropriate overall ratio for an entire campus. ("Gross area" includes corridors, stairwells, mechanical and custodial areas, and toilets, as well as "net assignable"--useful--space.)

You may wish to visit a vocational education institution to see whether you are able to detect examples of both adequate and deficient facilities. You could arrange (perhaps through your resource person) to be escorted on a tour by an administrator of that institution. As you walk through the buildings, you could note the answers to questions such as the following:



Optional
Activity

- Do some rooms seem to be more crowded than others of similar function or activity?
- Are there areas of visible congestion?
- Do high levels of noise, strong odors, or periodic student movement seem to intrude on the concentration of students in neighboring rooms/labs?
- Do some rooms or items of equipment appear to have been unused for long periods of time?
- Have any of these facilities experienced rapid or drastic changes in their extent of use? Why?
- Are all areas conveniently accessible to handicapped students?

You may wish to visit with a person who has served recently as the coordinator of a facilities needs assessment. This may be an administrator, a consultant, or a citizen serving on an advisory committee. You could select someone you know or arrange through your resource person for this visit. During your visit, you might want to ask these or similar questions:



Optional
Activity

- Who was involved in the needs assessment?
- Did the investigation cover the entire institution, one building, just one room, a set of rooms, or only the equipment in them?
- Has the institution or its community experienced any notable changes in population, economic development, or land use? How were the future trends of these factors predicted?
- What data were available within the institution to help those involved reach conclusions about facilities needs? If possible, should other kinds of data be available? Which kinds?
- What was the hardest part of the needs assessment process?



You may wish to secure (using your resource person, if necessary) a copy of the space and equipment planning standards used by your state department of education or higher education coordinating agency. Perhaps you can practice calculating space requirements using hypothetical data or actual statistics from an institution with which you are familiar.



The following "Case Study" describes the process used by a vocational education administrator in assessing the needs for additional/remodeled facilities in an institution. Read the situation, and critique in writing the performance of the administrator described.

CASE STUDY

Lone Pine City School District has recently decided to withdraw from an area vocational school district (effective at the end of the next school year) because of the distances involved and the increased financial costs of participation. As a result, district officials have decided to make Central High a comprehensive high school by adding the necessary vocational programs. Sally Zanzibar has been appointed as director of vocational programs, reporting directly to the superintendent of the district.

It appears obvious to all concerned that some vocational facilities will need to be developed quickly in order to meet state requirements and to attract students to these new curricular offerings. Considerable studies have already been completed by the director of guidance concerning the enrollments by current Lone Pine students in vocational programs at the nearby area vocational school.

Using these data as an indication of student demand, Ms. Zanzibar has used formulae and space standards supplied by the state department of education to calculate the amount of space needed--about 90,000 assignable square feet. She has also been working with the principal of Central High and the assistant superintendent for business and facilities to measure the amount of the existing high school building that will be required for the college preparatory and general-subjects students who have been the sole users of the Central High School building until now.

Because of declining enrollments within the city district, it appears that about 20,000 square feet of conventional classroom space will be surplus, thus available for vocational instruction. Based on the guidance director's data and her computations, Ms. Zanzibar has recommended to the superintendent that those rooms be converted, through slight remodeling, to classrooms and

labs for business and office education and for marketing and distributive education. She accordingly has requested that a wing of 70,000 square feet be added to the Central High building to accommodate various trade and industrial, health services, and home economics programs.

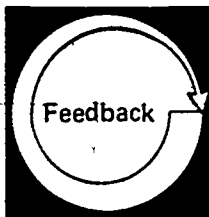

Compare your completed written critique of the "Case Study" with the "Model Critique" given below. Your response need not exactly duplicate the model response; however, you should have covered the same major points.

MODEL CRITIQUE

Let's look first at the things Ms. Zanzibar did well. Obviously she coordinated her efforts with fellow administrators by checking with them about student enrollments and available rooms. She also used the standards developed by the state in determining how much space these students would require. Furthermore, she did not seem bent on erecting a new building but rather recognized that some currently unused facilities could be readily adapted, at low cost, for satisfactory use. She probably recognized that the current structure could accommodate an addition that would utilize present heating, plumbing, and electrical systems. It would also be conveniently near to the food service, student activity, and recreational spaces that the old building presumably already provides.

However, there is a good probability that the data considered by Ms. Zanzibar are incomplete. In particular, the participation by current students in the area vocational school is not necessarily a valid prediction of future student choices; a survey of younger high school and junior high students could have ascertained this." She should also have considered the needs and interests of prospective adult learners. Moreover, the needs of just the Lone Pine City area might differ from those broader ones served by the area vocational school. In this case, consultation with some newly formed advisory committees would help determine particular local needs for vocationally trained workers.





Also, there is no evidence that Ms. Zanzibar talked with vocational teachers to determine what their needs and preferences were. Perhaps they might have been more aware than she of instructional and technological changes that might impose special requirements on new equipment or classroom/lab space.

Finally, a consultant might have been able to share some ideas about creative ways to remodel old academic classrooms or could have helped evaluate the facilities at the area vocational school, recommending which ideas should be retained and which ones improved upon.

Level of Performance: Your completed written critique should have covered the same major points as the "Model Critique." If you missed some points or have questions about any additional points you made, review the material in the information sheet, "Determining the Need for New or Remodeled Facilities," pp. 9-23, or check with your resource person if necessary.

Learning Experience II

OVERVIEW

 <p>Enabling Objective</p>	<p>After completing the required reading, complete a site analysis of an actual educational facility.</p>
 <p>Activity</p>	<p>You will be reading the information sheet, "Selecting a Site for New or Remodeled Facilities," pp. 31-36.</p>
 <p>Optional Activity</p>	<p>You may wish to visit a vocational facility undergoing construction or remodeling and learn how administrators decided which site to use.</p>
 <p>Activity</p>	<p>You will be conducting a site analysis of an actual vocational educational facility, recording your findings on an appropriate rating sheet, summarizing your findings, and recommending another site if applicable.</p>
 <p>Feedback</p>	<p>Your resource person will be evaluating your competency in completing a site analysis, using the "Site-Analysis Checklist," pp. 39-40.</p>

For information about the factors involved in selecting a site for facility construction and/or remodeling and how to evaluate sites, read the following information sheet.

SELECTING A SITE FOR NEW OR REMODELED FACILITIES

Once the need for additional or improved vocational education facilities has been documented and demonstrated, the administrator must turn his/her attention to the selection of an appropriate site.

To some extent, the latitude of this choice will be constrained by the scope of the project. For example, if an area vocational school has just been formed or a community college has decided to establish a branch campus, then the administrator might be faced with the selection of the county or city where the new building(s) should be located. At the other extreme, an administrator seeking to add a greenhouse to a one-building school located in a congested downtown area might have only one choice--add it onto the roof.

Between these extremes, the choices might relate to whether to add new facilities onto an existing campus or school grounds or to place them elsewhere. Likewise, the decision might involve comparing the advantages of a separate building with those of an addition (e.g., upper level, annex, wing) to an existing structure.

Even in the face of what may seem to be obvious constraints, it might be useful for the administrator to challenge some of these limitations. For example, the disadvantages of having a building located a mile or so away (difficulty of control, inefficiency of support services, transportation problems) might be outweighed by the advantages (relief of congestion, proximity to industries served, separation from a noisy highway).

Site selection, however, cannot proceed in a vacuum. It must be closely related to the development of educational specifications in particular. That is, a certain plot of land does not have values that are intrinsic. Rather, its suitability depends on the extent to which it matches the total needs of an institution. If the educational objectives are compelling enough, then an otherwise undesirable site might have to be used anyway, adding considerable costs for site improvement. On the other hand, the availability of an attractive site might cause the administrator to consider ways in which educational programs could be rearranged to take advantage of it.

In nearly every case of site selection, the same general factors must be considered--function, environment, physical characteristics, and cost. They will be presented in greater detail on the following pages. Some of them might seem trivial and obvious--but others are so technical that you might shy away from them. Never fear. As in so many other problems that you face, what is most important is your ability to secure qualified advice and assistance,

then to manage the information given you, and finally to exert your leadership to reach a productive decision.

What are some of these sources of advice? Those persons who are uniquely suited for site analysis are planners (city, county, or regional), surveyors, real estate appraisers, attorneys, and engineers (especially civil engineers). You should also consult those who assisted with the needs determination and who will also be participating in the development of educational specifications--advisory committee members, faculty, fellow administrators, board members, and students. Nobody says you have to play it by ear or go it alone--so don't.

Factors Relating to Function

Unlike the other elements of site analysis, the factors relating to function are somewhat under your control. In fact, the functions to be served by your desired new/alterred vocational education facilities should be the criteria against which all other factors are measured. If you are seeking to develop an outdoor sports playing area, you need level, cleared ground with adjacent parking. (Conversely an environmental science study area could be hilly, covered with vegetation, and relatively isolated. Likewise, the machine tools shop and fire science practice area could well be located on the back side of the grounds with their own service drive, but the cosmetology lab or dental hygiene clinic should be close to the main entrance.

The functions to be served include not only those of each program whose facilities are being provided but also the overall functions of the institution. Thus, the school or college mission must be considered. A master plan (if one has been developed) should be consulted; it might already decree where the contemplated facilities should be located. Review this plan to see if its assumptions and recommendations still are valid and amend it or abide by it as appropriate. If no master plan exists, consider preparing one now to assure harmony between current facilities, those about to be provided, and those yet to be conceived.

Matched against the requirement of suitability is the need for flexibility. Vocational programs, based on community needs, are necessarily subject to change. Thus you should not select a site that is only large enough for current student populations and existing programs. Likewise, you should pause before accepting (just because it's free or inexpensive) an abandoned factory building with extensive, load-bearing interior partitions, which is seemingly suitable only for industrial processes involving heavy machinery, or a phased-out air base that is many miles away from the feeder schools, where future students are expected to be drawn from.

These same concerns for flexibility might also suggest that you will want to select a site that is either firm enough to allow for the addition of upper floors to the new building or spacious enough to allow annexes/wings to be added.

Factors Relating to Surroundings (Environment)

The location, in the broadest possible sense, of a vocational education building is very important, often profoundly affecting the extent to which the educational programs will be attended and supported. In particular, the site should be close both to the students who attend and to the businesses and industries supported. And this proximity should be assessed not only in terms of the current distribution of population and economic activity but projected patterns as well. (That's where your regional planners, chamber of commerce, and state development officers can help you.)

Just like an industrial site, a school or college requires the ready availability of such important services as water, sewage, and energy (electricity, gas, petroleum products). Since an educational facility involves so many people, it is an important consumer of civic services as well, so their availability also must be investigated. For example, police, fire, and emergency medical personnel or stations must be located within just a few minutes' driving distance.

Speaking of driving, you obviously want to be located on or near thoroughfares with sufficient capacity to absorb the additional traffic generated by the students who are attending educational programs. Your main entrance needn't be on the main highway itself, but the building(s) should be visible from there, and directions to reach the access road should be simple and prominent.

As you explore various sites, it might occur to you that many persons and firms--shopping center developers, real estate speculators, expanding industries, religious congregations, farmers, home owners, hospital planners, and many others--want land having the same basic characteristics. Obviously, not all of them can occupy the same real estate. Indeed, the use of a plot of land by one of them can make its environs more, or less, attractive to the others. (Everybody likes to live near a school or hospital but not next to a stockyard or an oil refinery.)

It is for just such cases that land-use planning has arisen, manifested by zoning ordinances or other restrictions. You need to be aware of these, (both in their current form, or as others may wish to change them), noting not only how they exclude or permit your institution's own plans, but how they affect your prospective neighbors. Will zoning allow houses and condominiums to be built right up to your doorstep, with their attendant traffic but demand for quiet? Will land-use plans induce new industries to locate on the other side of town, making cooperative programs less convenient to coordinate? Who "gets" to build under the approach patterns of the jet airliners?

A useful overall principle to apply in assessing a site environment is that of "neighborliness." Will you and your intended facility be a good neighbor, or will you attract unwelcome traffic, noise, nighttime activity, and higher tax rates? On the other hand, how will your prospective neighbors affect you? Will they help you obtain larger water mains and four-lane

highways, or will they attract crime, congest your access route, and fill your air with noxious sounds, sights, and smells?

Factors Relating to Physical Characteristics

Physical characteristics include those of vegetation, slope and contour, drainage, soil and bedrock, accessibility, and size and shape. Let us look at each in turn.

Vegetation can be an esthetic asset (a poet's dream) or a construction and maintenance liability (the contractor's and groundskeeper's nightmares). Note closely whether the proposed site has an extensive growth of trees that must be cleared or "built around." Will their shade save energy or require more for illumination and heating? Are there large grass areas that either will require continual mowing or will grow into weed patches? Examine vegetation critically but creatively--some wooded areas can become arboretums for study and recreation, and open fields can be used for laboratory cropland or as buffer areas against intrusion by residential or commercial development.

Slope and contour likewise have both positive and negative aspects. An utterly flat site may be unappealing, vulnerable to wind damage or drifting snow, but it requires virtually no preparation for construction of a building. On the other hand, hills complicate access to a building (especially in snowy climates), but add scenic interest and can provide visual separation from neighboring industries or highways.

Drainage is affected by the factor just mentioned and also interacts with the next one (soil composition). While a small marsh can be attractive, standing water can breed mosquitos and is likely to eventually damage the foundations of nearby structures. The alternative--steep slopes--might erode or slide unless properly (expensively) treated, and gullies would have to be controlled. Water eventually reaches its lowest level; the trick is for that point to lie somewhere outside your property lines, preferably at the connection with the public storm sewer lines.

Soil and bedrock composition is important not only in determining the type of foundation for a building but also for driveways and parking lots. Likewise, it can prevent--or make more costly--the construction of a building with a basement or several upper floors. For the expert assessment of both soil/bedrock suitability and drainage effects, you should secure the services of a civil engineer, who will extensively survey the proposed sites and bore many test holes. Local soil and water conservation organizations (publicly funded) have technicians on their staff who can offer good preliminary advice and can also suggest exemplary ways to integrate existing conditions with your plans. For example, you might construct a pond that can be studied by vocational agriculture or recreation management students or sow grasses that develop a water-retaining sod and resist pedestrian wear.

Accessibility goes beyond the broader notions of location presented earlier. It is one thing to be one-fourth of a mile ("as the crow flies")

and highly visible from the interstate highway, it is quite another thing if the nearest interchange is six miles down the road. Likewise, railroad tracks and industrial sidings frequented by slow-moving trains impose frustrating barriers. We have already hinted how snow can turn an otherwise attractive, curved, sloping access drive into a deathtrap. The capacity and traffic flow on nearby highways should be examined closely, concerning both present and future conditions and including the effect of your own student/staff traffic. You also need to be particularly attentive to the special needs of physically impaired individuals; ramps, elevators, and wider parking spaces and doors need to be provided.

Size and shape can restrict your building site options to a considerable extent. Being limited to a single city block needn't ruin your whole program, but it will tax your creative ability to make multistory buildings interesting, functional, and accessible. Lots with curved or angled sides are attractive but can complicate the relative positioning of buildings. As far as overall size goes, you should use a general planning factor of 10 acres per 25,000 population in the institution's service area. Then you can modify this depending on the land available, programs now or likely to be offered, and your capability to expand up rather than out.

Factors Relating to Cost

Unfortunately, the finest of site-analysis studies are sometimes ignored because of financial limitations or the irresistibility of a site that is made available through public or private donation. How can these problems be minimized?

First, be certain that cost comparisons are made on an equal basis. The high purchase price of extremely suitable land might, in the long run, amount to less than the cost of site improvement for inferior property. Likewise, the acceptance of a standing structure might necessitate renovation and remodeling, whereas new construction could assure the provision of a facility that is both well suited to immediate needs and flexible enough to be adapted to likely future uses.

Second, assess the trend of real estate values in the areas considered and weigh that against the cost of waiting until the additional funds can be secured. Here is where the real estate appraiser's advice is useful.

Third, determine whether the prices asked for desirable real estate are excessive and to what extent "condemnation" processes can be used. This procedure enables certain public agencies to ask courts to determine the fair value of property that is needed for "public purposes" under the doctrine of Eminent Domain. However, it is a two-edged sword that can lead to unfavorable public relations for the agency seeking recourse that way. Investigate these ramifications closely, relying not only on an attorney's advice but also that of prominent citizens and other landowners.

Finally, assess the nonmonetary elements of cost: the frustration of students and faculty in a new facility that cannot serve its intended function; the chagrin of citizens who find the new facility to be so far away as to be useless; the displeasure of elected officials whose advice you ignored, opposed, or never sought; the unfavorable publicity that arises when it appears you bought property from a board member's relative or close friend.

The selection of a site, including the choice of whether to build or remodel, will never be an easy one. In fact, it is highly political, and you need to be aware of the partisan, social, and interpersonal aspects of the choices available. However, by analyzing the factors listed in a systematic way, you will at least be able to proceed rationally. Then it will be essential that you involve as many other persons as possible--both as sources of expert advice and as arbiters of differing values--to help you arrive at a satisfactory weighting of these factors.

You may wish to visit a vocational facility that is currently being or recently was built or remodeled to learn how institutional administrators decided which site to use. You could arrange through your resource person to set up this visit, and you should have an administrator of that institution--preferably one who was involved in the site selection--serve as your host.

During your visit, you might want to seek the answers to questions such as the following:



- Why did the administration/staff/others decide to [build instead of remodel/remodel instead of build]?
- What one factor or several factors figured most prominently in the decision to build/remodel in this particular location?
- What other factors were also analyzed but were of secondary importance?
- Who provided information or expert advice in analyzing all the aspects of the proposed sites?
- Who was involved in weighing the various factors and reaching a decision?

You might also ask your host to point out to you various examples of particularly favorable or problematic features of the selected site in the areas that you have just read about: functionality, surroundings, physical characteristics (including all subclassifications), and cost. Or you could see if you can identify them yourself.

Arrange through your resource person to conduct a site analysis of an actual educational facility. (It need not have been recently built or remodeled.) In order for your resource person to evaluate your competency in this skill, the facility must be one with which your resource person is familiar, or he/she must be available to accompany you on the visit. The facility could be (1) a secondary or postsecondary institution in which either you or your resource person are employed, (2) one with which either of you is familiar, or (3) one entirely new to both of you.



Activity

To structure your appraisal, select, adapt, or develop a rating form that includes all factors you think are relevant.

In conducting the site analysis, you need to keep in mind that your inspection is unofficial. You are a guest of the institution involved (unless it is one where you are already employed), and as such, you are not in a position to criticize what might appear to have been a wrong choice. If the institution wishes to receive a copy of your findings, arrange for this through-your resource person.

In addition to conducting the site inspection tour, you should prepare a report of your analysis, including both the completed rating sheet and a summary of your findings.



Feedback

After you have conducted your site analysis, arrange to have your resource person review and evaluate your completed report. Give him/her the "Site-Analysis Checklist," pp. 39-40, to use in evaluating your work.

Name _____

Date _____

SITE-ANALYSIS CHECKLIST

Directions: Place an X in the NO, PARTIAL, or FULL box to indicate that each of the following performance components was not accomplished, partially accomplished, or fully accomplished. If, because of special circumstances, a performance component was not applicable, place an X in the N/A box.

LEVEL OF PERFORMANCE

N/A No Partial Full

In preparing to conduct the analysis, the administrator:

- | | | | | |
|--|--------------------------|--------------------------|--------------------------|--------------------------|
| 1. selected, adapted, or developed a checklist that was appropriate for the site being analyzed..... | <input type="checkbox"/> | <input type="checkbox"/> | <input type="checkbox"/> | <input type="checkbox"/> |
| 2. consulted with an administrator of the institution to determine the primary function for which it was designed..... | <input type="checkbox"/> | <input type="checkbox"/> | <input type="checkbox"/> | <input type="checkbox"/> |

While conducting the site analysis, the administrator:

- | | | | | |
|--|--------------------------|--------------------------|--------------------------|--------------------------|
| 3. sought, with the cooperation of the institutional host, relevant information about the desired functions to be served by the facilities..... | <input type="checkbox"/> | <input type="checkbox"/> | <input type="checkbox"/> | <input type="checkbox"/> |
| 4. determined what other sources of information--such as city or regional planners, surveyors, chamber of commerce and state economic development officials, and soil specialists--had been consulted..... | <input type="checkbox"/> | <input type="checkbox"/> | <input type="checkbox"/> | <input type="checkbox"/> |

In the summary report, the administrator:

- | | | | | |
|--|--------------------------|--------------------------|--------------------------|--------------------------|
| 5. showed that he/she had considered the factor of <u>function</u> , including flexibility for future uses..... | <input type="checkbox"/> | <input type="checkbox"/> | <input type="checkbox"/> | <input type="checkbox"/> |
| 6. showed that he/she had considered the factor of <u>environment</u> , including land-use plans of adjacent property..... | <input type="checkbox"/> | <input type="checkbox"/> | <input type="checkbox"/> | <input type="checkbox"/> |

LEVEL OF PERFORMANCE

N/A No Partial Full

- | | | | | |
|---|---|---|---|---|
| <p>7. showed that he/she had considered the factor of <u>physical characteristics</u>, including vegetation, slope and contour, drainage, soil and bedrock, accessibility, and size and shape.....</p> <p>8. showed that he/she had considered the factor of <u>cost</u>...</p> <p>9. wrote a clear and concise explanation of:</p> <p> a. how each factor had been evaluated.....</p> <p> b. what sources of information were used.....</p> <p> c. which factors seemed most important.....</p> <p>10. stated an overall rating on the suitability of the site.....</p> | <p><input type="checkbox"/></p> <p><input type="checkbox"/></p> <p><input type="checkbox"/></p> <p><input type="checkbox"/></p> <p><input type="checkbox"/></p> <p><input type="checkbox"/></p> <p><input type="checkbox"/></p> <p><input type="checkbox"/></p> <p><input type="checkbox"/></p> | <p><input type="checkbox"/></p> <p><input type="checkbox"/></p> <p><input type="checkbox"/></p> <p><input type="checkbox"/></p> <p><input type="checkbox"/></p> <p><input type="checkbox"/></p> <p><input type="checkbox"/></p> <p><input type="checkbox"/></p> | <p><input type="checkbox"/></p> <p><input type="checkbox"/></p> <p><input type="checkbox"/></p> <p><input type="checkbox"/></p> <p><input type="checkbox"/></p> <p><input type="checkbox"/></p> <p><input type="checkbox"/></p> <p><input type="checkbox"/></p> | <p><input type="checkbox"/></p> <p><input type="checkbox"/></p> <p><input type="checkbox"/></p> <p><input type="checkbox"/></p> <p><input type="checkbox"/></p> <p><input type="checkbox"/></p> <p><input type="checkbox"/></p> <p><input type="checkbox"/></p> |
|---|---|---|---|---|

Level of Performance: All items must receive FULL or N/A responses. If any item receives a NO or PARTIAL response, the administrator and resource person should meet to determine what additional activities the administrator needs to complete in order to reach competency in the weak area(s).



Learning Experience III

OVERVIEW



After completing the required reading, critique a given set of educational specifications for a new building, providing corrected or additional elements as needed.



You will be reading the information sheet, "Describing the Desired Facilities to Prospective Users, Builders, and Suppliers," pp. 43-56.



You may wish to visit a school architect to discuss how to communicate the intent and functions of proposed facilities through the use of educational specifications.



You may wish to interview an official of the state government about the role and impact of state/federal regulations and standards affecting new construction and remodeling.

continued



You will be reading the "Case Situation," pp. 59-62, which includes a set of educational specifications covering a portion of a planned new building, and critiquing those specifications, providing additional or corrected elements where needed.

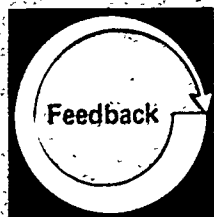

You will evaluating your competency in critiquing a given set of educational specifications for a new building by comparing your completed critique with the "Model Critique," pp. 63-64.



Activity

For information about how to convert the needs and intended functions of proposed facilities from the thoughts of prospective users to detailed written and graphic plans through the use of verbal "educational specifications," read the following information sheet.

DESCRIBING THE DESIRED FACILITIES TO PROSPECTIVE USERS, BUILDERS, AND SUPPLIERS

Fundamental rule: Educational administrators are not architects. Period! Just as the administrator played a role different from that of a member of the faculty or staff in verifying and documenting the need for new facilities, so too does the architect perform a different role from that of the administrator in "designing" a new or remodeled facility.

Perhaps this role distinction can best be understood by thinking of the administrator as one who poses a problem (question, puzzle) and the architect as one who develops the solution. In fact, architects often apply that very word--solution--to what appears to be just a thick stack of papers and several rolls of blueprints. However, the tinkering, dreaming, and detailed work that lie behind the preparation of all those papers represent a high level of creative thinking. Architects don't go to school for five years--staying up all night hatching strange ideas and drawing hundreds of little trees and carefully lettered dimensions--for nothing. Through it all they develop a knack for problem solving that the administrator should use to the fullest extent.

Now, let's translate that professional admiration into a specific concept. The entire process of "providing buildings and equipment for vocational education" amounts to a massive task of translation, beginning with the pipe-dreams of teachers and administrators who think, "I'd really like to have a room--or a tool--that can do XYZ better," and then continuing through the following steps:

1. After a process of needs assessment, this wish becomes a documented statement that program A needs N number of rooms, totalling S square feet, to accommodate P number of students through the year 19--.
2. You, as an administrator involved in this process, must then rewrite these pipe-dreams to specific types of affordable reality--educational specifications.
3. It is then the architect's role to merge the specifications from a whole set of users (faculty and staff) and convert them to plans (drawings) and construction (or purchasing) specifications.
4. Ultimately, a building contractor will assemble materials from suppliers in rather standardized ways, using persons with formalized skills to transform those plans into physical reality.

Dreams to reality, in four steps.

Each of those steps, of course, involves its own type of challenge. You can learn elsewhere, if you need to, about how to dream, assess needs, draw blueprints and follow building codes, or lay bricks and thread pipes. This information sheet is intended to help you develop skill in writing educational specifications in such a way that the architect understands the problem but has full freedom to design the best feasible solution. Your statement of the problem must not restrict his/her problem-solving process; otherwise, you don't get your money's worth.

Educational specifications become the vehicle for communicating your justifiable "wish list" not only to the architect but also to those who first originated the dreams, those who pay for the new facilities, and those who approve their construction. With such a wide and diverse audience, it is therefore appropriate that they be written in a consistent format, in a clear manner, and in plain English. Jargon is useful only among peers within the same profession, who share common experiences and can instantly recognize what a bollard, plenum, or pilaster is without further elaboration. Such is not the case among teachers, legislators, auditors, and John/Jane Q. Public. The ultimate test--and purpose--of educational specifications is that they communicate clearly. Then any reader can respond, "Yes, that's what I want in my shop or classroom," or "Now why do those folks at Anytown Vocational School want one of those," or even "Millions for defense, but not one cent for education if they're going to ask for twelve widgets per shop!"

Resources for Information and Advice

Clearly, you cannot learn everything there is to know about both the construction design business and the wide array of vocational programs within your institution. Therefore, you need to rely upon various sources of information, namely the intended users, prospective suppliers, facility planning consultants, designers, and engineers.

Intended users are the most important persons in the process of describing needs and wishes, but their concepts may not always be specific or realistic. Nevertheless, they should be encouraged to elaborate their "druthers" as extensively as possible. Then they should be given repeated opportunities to review your attempts at translation to assure that you have reflected their wishes accurately. Their comments are especially important if they will be affected by remodeling or space reassignment.

Eventually you will delete something they wanted, and it may get unpleasant before everything is settled. However, it's a good negotiating strategy to start at the "pie-in-the-sky" level, then add doses of reality as the budget requires. Not everybody--in fact, probably nobody--will get everything he/she wanted; however, if you don't even let them ask, the level of satisfaction will be far lower. Just make it clear from the outset that there are limits on what can be done.

Prospective suppliers can be helpful too, but be certain they understand that you assume no obligation (to buy exclusively from them) by accepting

their advice. In many cases, most major items of equipment will be bought at the same time as the building is constructed. If this is true, you should go ahead and also develop their specifications at this time to assure harmony between the equipment and its surroundings.²

Even if you were not acquiring any equipment as part of the construction/remodeling project, you would want to be sure that the building and rooms had the necessary space, electrical service, plumbing, ventilation, and so on, to accommodate the equipment you purchase separately. At the very least, you and the likely users should check catalogs from vendors to see what items are available and what space and services they need. For example, if all vertical milling machines seem to be at least 48" wide and weigh at least 3,000 lbs., this should be noted so the architect will provide wide doors and strong floors. Likewise, an X-ray device might require 220-volt wiring and 18" thick (or lead-lined) walls.

Facility planning consultants are available from a variety of sources. Perhaps your state education department/community college board provides such a service or can secure it from another state department. Many university research bureaus or departments of educational administration can provide assistance on a contract basis. Of course, self-employed consultants can be found too, or you might wish to contact the Council of Educational Facility Planners (325 Ramseyer Hall, 29 W. Woodruff Ave, Columbus, OH 43210, phone 614-422-1521) for prepared materials or on-site assistance.

Designers, architects, and engineers can be retained for a fee at this early stage, but the problem of "translation" still remains. One advantage of using professionals for preliminary studies or for the development of educational specifications is that you can get a low-cost preview of the capabilities of an individual or firm, perhaps helping you decide later whom to hire as the overall project architect and manager.

Fellow administrators who have experienced one or more building programs similar to yours may be contacted for advice. They might even loan you the educational specifications book they used, along with annotations about how they would improve it if they had to do it again. Go ahead and copy from it--judiciously. Imitation is a sincere, and often appreciated, form of flattery--especially if you acknowledge their assistance in a footnote.

2. For information about how to develop specifications for the bidding and purchase of equipment, you may wish to refer to Manage the Purchase of Equipment, Supplies, and Insurance, part of the Competency-Based Vocational Education Administrator Module Series (Columbus, OH: The National Center for Research in Vocational Education, The Ohio State University, 1981).

Format of the Educational Specifications

Let's look now at some specific educational specifications. Sample 5 is a model outline for a complete educational specifications document. (In some states it might be called a program of requirements or a requirements listing.) Note that it has both general and detailed sections.

The General Section is designed to give the architects (also legislators, voters, state education agency officials, and so on) a brief introduction to the entire educational institution. Thus they can better understand the physical, philosophical, economic, and social context within which the new facilities are to be placed. It may be tempting to use "college-catalog" verbiage here; resist the temptation if you can. If you want students to feel sociable in the cafeteria, say so. Do not say ". . . design concepts should be optimally supportive of the development of gregarious traits in postadolescent psyches." If lots of windows are desirable and the energy costs are not prohibitive (maybe your district has its own gas well), say just that. Do not say ". . . insulation efficiency and fuel conservation are factors secondary to the innate human affection for maximum illumination through fenestration."

The Detailed Section begins with a listing of all the rooms and areas being requested. It is helpful if the square footage estimates are cited here also, along with a notation of the priority assigned to each item. However, realize that these are estimates for initial planning only. Don't necessarily expect the architect to arrive at exactly the same quantities in the design solution. Keep in mind who the expert is.

The remainder of the Detailed Section consists of a series of pages, each of which describes what goes on within a particular room or area and what capabilities the room must have. Sample 6 shows one such description, following the format given in sample 5.

Note the ninth item of each description--proximity (some call it affinity). This item tells the designer which rooms or areas need to be adjacent to each other. For example, the office of the chief administrator's secretary needs to be adjacent to the administrator's office and also to a reception or waiting area. A lab preparation area usually is next to a lab--or better yet, sandwiched between two or more labs.

If you just have to play designer, it's all right to tinker a little with circle diagrams to figure out proximity/affinity (see sample 7). You might discover that what you want is not feasible, at least not in two dimensions. (The use of a dumbwaiter in Victorian mansions was a good way to add a third dimension, so everybody's room could be near the kitchen.)

SAMPLE 5

MODEL FORMAT FOR EDUCATIONAL SPECIFICATIONS

General Section

1. Description of the community
2. Overview of the institution--philosophy, goals, objectives
3. Description of entire curriculum
4. Features of instructional media, materials, and methods
5. Demographic analysis and trends of enrollment
6. Type and extent of use of facilities by outside organizations
7. General desired characteristics of proposed facilities
8. Listing of all rooms to be included in construction/remodeling project

Detailed Section (room-by-room description of proposed facilities)

(Name of room/laboratory/shop/clinic)

- A. Number of such rooms needed
- B. Priority
- C. Estimated area required (minimum-maximum number of square feet)
- D. Number of personnel to be accommodated in room
- E. Activity they will be engaged in
- F. Method of instruction to be used
- G. Occupant seating/working arrangement (fixed chairs, movable chairs, conference table, standing at benches)
- H. Equipment to be included
 1. Fixed (specified by architect, provided by contractor)
 2. Movable (specified and purchased by institution)
- I. Proximity (location in relation to other rooms)
- J. Utilities and services required
- K. Special requirements

SAMPLE 6

SAMPLE EDUCATIONAL SPECIFICATIONS IN MODEL FORMAT

The following is an example of the type of information that would be included within the Detailed Section (room-by-room description of proposed facilities) of the educational specifications.

I. Upholstery Laboratory (within HOME FURNISHINGS COMPLEX)

- A. Number of such rooms needed: One (1)
- B. Priority: One (1)
- C. Estimated area required: 1600-2000 square feet
- D. Number of personnel to be accommodated in room:
One (1) teacher, one (1) aide, twenty-five (25) students
- E. Activity they will be engaged in:
Selection, arrangement, and maintenance of furniture and accessories; studying and experiencing characteristics and performance of textiles; practicing methods of installing fabrics on household furniture, motor vehicles, aircraft, and boats
- F. Method of instruction to be used:
Demonstration and supervised practice, independent student projects
- G. Occupant seating/working arrangement:
Standing at tables or seated at sewing machines (all movable)
- H. Equipment to be included:
 - 1. Fixed:
 - a. One (1) air compressor, 220 V, 15-20 cubic feet per minute capacity
 - b. Seventy-five (75) student lockers, 60"H x 12"W x 18"D, with shelf, rack, and louvered door with master key-lock system
 - 2. Movable:
 - a. Six (6) sewing machines, industrial quality free-arm design with complete attachments
 - b. Four (4) fabric cutting tables, 96"L x 54"W x 36"H
 - c. Wheeled upholstery rack, suitable for storing and dispensing thirty (30) rolls of upholstery fabric.

I. Proximity:

1. Immediately adjacent to all other rooms of home furnishings complex (upholstery classroom, materials storage room, paint spray laboratory, furniture drying and storage area, and faculty office)
2. Accessible to loading dock and vehicle driveway via overhead door

J. Utilities and services required:

1. 220 volt AC for air compressor
2. 110 volt AC in duplex outlets 18" above floor level at 12' intervals along wall
3. Six (6) 110 volt AC overhead recoiling wire cords (for sewing machines)
4. Standard pressure hot and cold water in mixing faucet at stainless steel double sink, 36" L x 12" W x 8" D
5. Compressed air manifold and distribution system with six (6) quick-disconnect couplers on self-recoiling hoses, 15' long
6. Dust collection system
7. Waste water and solvent disposal system
8. High turnover ventilation system
9. Floor drain system

K. Special requirements:

1. Twelve foot (12') overhead ceiling clearance
2. Overhead garage-type door to loading dock
3. Non-slip floor suitable for truck and automobile traffic (suggest terrazo or equivalent)
4. All drains must be solvent resistant

SAMPLE 7

CIRCLE DIAGRAM

Space Relations (Home Furnishings)

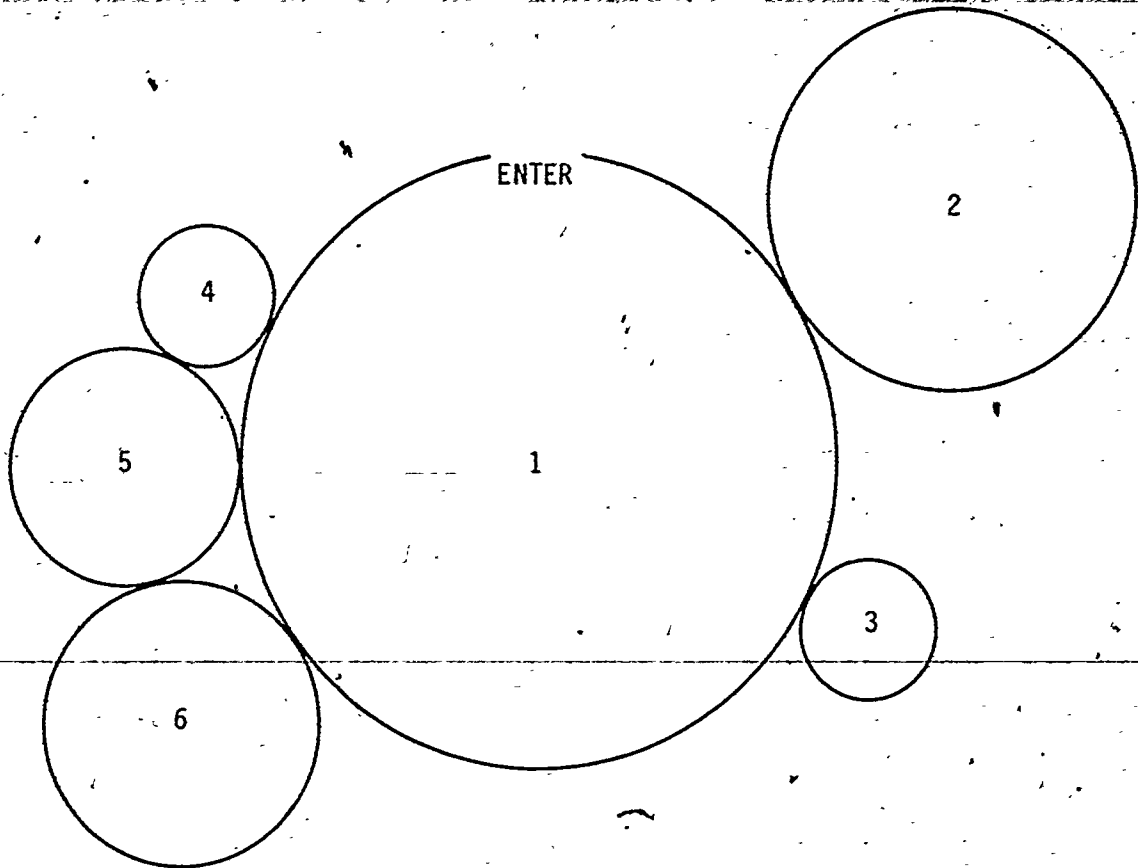

1. Upholstery Laboratory.....	1,800 square feet
2. Classroom.....	600 square feet
3. Office.....	100 square feet
4. Materials Storage.....	100 square feet
5. Paint Spray Laboratory.....	324 square feet
6. Furniture Drying and Storage.....	450 square feet
Total Area	3,374 square feet

(Not Necessarily to Scale)

Dissemination and Review of the Educational Specifications

The document containing your initial educational specifications should be reviewed and revised at least once. Before anybody outside of your institution sees it, excerpts should be disseminated to the prospective users. Double-spaced copy will make it easy for them to add their comments. In fact, you may want to enclose a sharp red pencil, which they may keep. Then call these persons in a day or two to set up a time to get together and improve the document.

The point is that dialogue with users is important and should be encouraged by you, lest it later be demanded by them. Most efforts at translation require validation with the source, so keep at it. Don't regard any detection of error as a personal affront. A bathroom-type sink--to be used for patient education in dental hygiene in a new building that we know of--ended up practically big enough to bathe in--not just brush one's teeth--because the administrator had just guessed by holding his hands fisherman-style and estimating size from them. The user had taken his word for it, failing to sit down and see just how large a 16" x 22" x 6" sink would be! Check things out personally. Twice. And encourage others to be equally thorough and critical.

After the second or third or fourth draft, you will be ready to reassemble the complete document and publish a sufficient number of copies for review by the state education agency and appropriate other state and federal offices (for example, the Occupational Safety and Health Administration [OSHA] or the office that assures compliance with Section 504 of the Rehabilitation Act of 1974, which refers to access for physically impaired persons).

Next, the document may make its way to the state budget management office, either for incorporation into a future capital appropriations bill or to qualify you for funding from an appropriation already in force. Alternatively, you might present it to a budget commission in order to qualify for current local funds or to go before the voters to seek approval of a tax levy or bond issue.

Ultimately, the educational specifications will be ready for transmittal to the several architects who wish to compete for selection as the project architect. If you've done your part well, they will be able to understand, in large part, what you and your colleagues want in the new facilities and will be able to determine if the project fits their abilities and interest.

Selection of an Architect

The process of selecting an architect is not as straightforward as that of purchasing supplies and equipment or awarding a construction contract. This difference arises primarily because the "product"--the architect's service--is not a stable commodity, but rather a dynamic interaction between him/her (or his/her firm) and the institution. Thus, it is more important for you to be concerned with the prospective architect's experience, interest,

staff, credentials, and references. Likewise, the architect should not be selected solely on the basis of a lowest bid. Rather, the fee should be negotiable based upon (1) the complexity of the design and construction/remodeling project and (2) the amount of consultation and construction supervision expected. (For planning purposes, calculate that the architect's fees will comprise from 5 to 10 percent of the total project cost.)

In order to solicit the interest of qualified architects, your institution should announce its intention to undertake a construction/remodeling project and invite contact from architectural firms. This announcement should describe the general nature of the project--including its size, expected cost, activities and facilities to be included, target completion date, and approximate location. In addition, the name, title, address, and phone number of the contact person at the institution should be given.

Applicants should be instructed to include at least the following information in their response: name of firm (including principal partners); size and qualifications of staff; related or similar projects they have completed; honors and awards won; statement of their philosophy or approach to design and supervision; engineering, interior decorating, or other services provided or available by consultation; and names of individuals or institutions that could provide references.

Once you have identified a few best candidates, you should arrange for interviews in which several individuals from both the institution and each architectural firm could further explore the institution's needs and expectations vis-a-vis the architect's qualifications, experience, and services. These interviews would then lead to a recommendation concerning which firm should be formally engaged by the board.

Preparation of Plans, Drawings, and Construction Specifications

Although your task of preparing educational specifications is complete at this point, you should know what happens next in the design process.

The architect selected by your institution will prepare, in several stages, many documents that describe your new facilities in language understandable by construction contractors and suppliers. These documents should be returned to you after each stage for your review, verification, or possible modification, in the same manner that you consulted others as you refined the educational specifications. In fact, in several cases you will want to share these plans further with prospective users and the various agencies that had reviewed the educational specifications.

The first product of the architect's work will probably be a refinement of your circle diagram, showing little more than the rough rectangular outline of each room, its approximate dimensions and relationships to the rest of the building, the general exterior appearance of the building, and its location on the site.

Once this first product is approved or modified, the architect will proceed to the development of a preliminary set of drawings. These will include considerably more detail, showing the interior arrangement of furnishings and equipment in each room; exact dimensions of rooms; locations of doors and windows; lighting, electrical and plumbing schematics; and perhaps landscaping.

These preliminary drawings may come in several forms as follows, each having a different perspective (see sample 8):

- Plan is an overhead view, similar to a road map, showing the relative positions of rooms and equipment.
- Elevation is a side view, used to show how an exterior wall might look or to reveal the details of doors and windows.
- Schematics are used for wiring diagrams and for showing the routing of heating, plumbing, gas, and so on, in abstract rather than exact form.
- Perspective or 3/4 view simulates a three-dimensional effect, as if the structure were viewed from a distance above a corner.
- An architect's rendering resembles a painting or a photograph, usually including rather artificial-looking pedestrians, automobiles, and trees around the building for a nearly realistic appearance.

These drawings should be regarded as manifestations of the architect's tentative solution for the "problem" you posed in the educational specifications. As before, they should be shared with you and, through you, be referred to the prospective users and state approval agencies, as required, for critique, review, refinement, and modification. You should examine these drawings to determine whether the size and shape of the rooms are adequate and the proximity of rooms remains as requested.

Once the necessary changes have been suggested, discussed, and decided upon, the architect will prepare the final documents. These will consist of a thick roll of drawings (including plan, elevation, schematic, and other versions), plus verbal descriptions of general construction standards and particular specifications relating to mechanical systems, major items of equipment, certain techniques to be used, and so forth.

The drawings will proceed from the general to the specific, ranging from a site plan of the entire campus/school grounds in relation to the community, the proposed building in relation to the campus/grounds, and contour/drainage patterns of the immediate environs of the construction site. The plans for the building itself will be extremely detailed, including not only large-scale drawings of each floor of the building, but perhaps smaller-scale plans for certain complex laboratories and shops. All dimensions will be carefully penned in, and there will be enlarged sketches showing the details of light fixtures, shelf and cabinet mountings, layering of roofing materials, door hinges, decorative and safety door hardware, and so forth.

SAMPLE 8

TYPES OF PERSPECTIVE USED IN ARCHITECTURAL DRAWING

PLAN

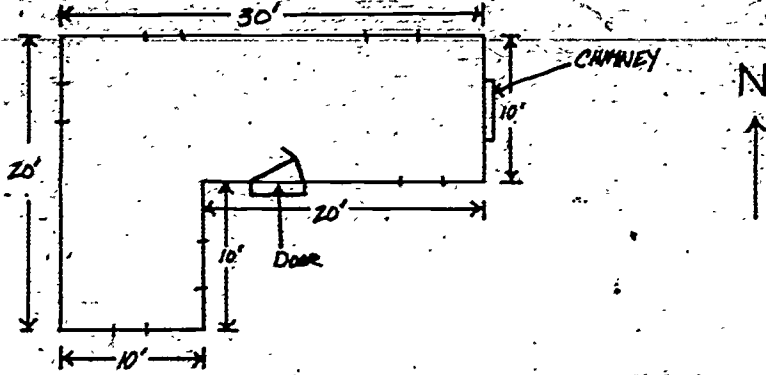

ELEVATIONS

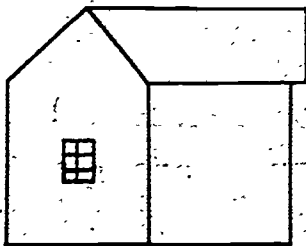

WEST

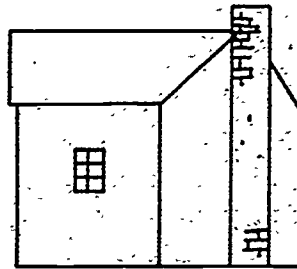

EAST

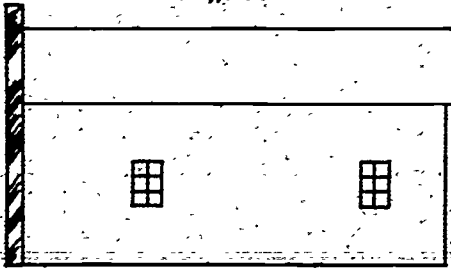

NORTH

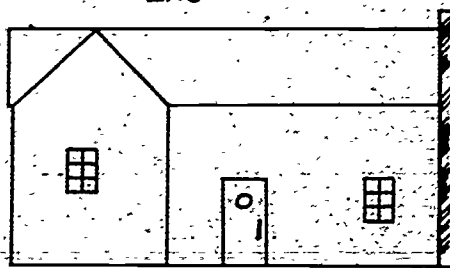

SOUTH

3/4 OR PERSPECTIVE

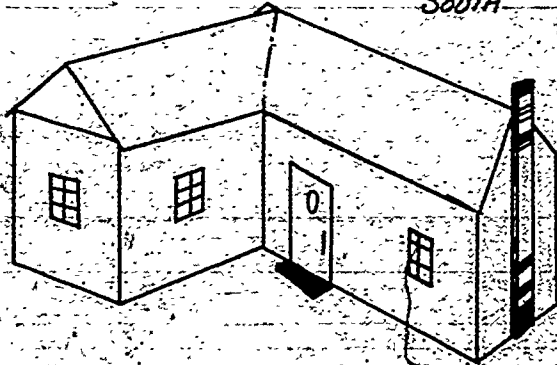

The drawings will probably be further organized into sections corresponding to the major construction subdivisions: (1) general (the construction of the building shell, including masonry, carpentry, structural steel, painting, insulating, and related work); (2) electrical and power distribution; (3) HVAC (heating, ventilation, and air conditioning); (4) plumbing (these latter three are often called mechanical areas); plus (5) any special work that needs to be done (e.g., landscaping, signs, extensive cabinet work, radiologic protection).

At this point, you will be asked to sign off on the drawings, thereby committing them to stone. After this sign-off, any change orders will be charged as extras by the architect or the contractor. Remember, the architect is not an educator. You and your professional colleagues are the ones who must examine the plans in meticulous detail, room by room, comparing drawings with the educational specifications to determine whether you are getting what you ask for. Some questions you should ask include the following:

- Will the room size and shape accommodate the equipment?
- Will it work for that particular program?
- Are there any blind spots?
- Are the doors large enough to accept the largest piece of equipment?
- Do the doors swing the right way?
- Are receptacles for electricity, gas, air, and water located where needed and in sufficient numbers?
- Are windows located to prevent outside distractions?
- Is the floor surface suitable for the program?
- Are floor drains indicated if needed?
- Has wall color and material been selected to control light and sound?

Remember the problems you don't catch at this time will mean costly change orders and a delay in construction later.

The verbal specifications will supplement--and in some cases repeat--those intentions shown on the drawings. Again, the information will flow from general to specific. The first several pages usually describe important requirements such as the following: the construction schedule; coordination between the architect, primary and subcontractors, and institution; inspection standards and procedures; payment procedures; responsibilities for site security and cleanliness; employment rules (including equal opportunity/affirmative action expectations, whether union-scale wages will be paid, resolution of labor disputes, and so on); and procedures for seeking changes to plans.

Specific performance standards of the building materials--such as flammability, weather resistance, insulation properties, or colorfastness--will also be described here, including the manner in which they are to be tested. Likewise, the physical characteristics of building materials (e.g., color,

thickness, composition, manner of manufacture) will be stipulated. An important part of this section of the specifications will be descriptions of all those items of fixed equipment that are to be provided by any of the contractors. When you consider that anything from carpeting to chalkboards, welders to dental chairs, or auto hoists to microwave ovens are included in this section, you might suspect that this section will be large. Voluminous might be an even more accurate word. Not many people will want to carry around more than one set of specifications and drawings at a time.

So there you have it. What might have begun several months or years before as some fond wishes have now been transferred--through the close coordination you have established between yourself, the future users (students and instructors), and the architect--into a set of graphic and verbal instructions. Now you are prepared to turn them over to one or several contractors to make these dreams and plans come true.

You may wish to arrange through your resource person to meet with and interview an architect who has had experience in designing facilities for vocational education institutions. Before the interview takes place, you should prepare a list of questions, such as the following, that you wish to have answered:



- Do you have any examples of useful sets of educational specifications that you have worked with recently? What are their particular strong points?
- What mistakes do educational administrators most often make in communicating their wishes and intentions to you? How can I avoid making them?
- Who are some individuals within this state who would be available to assist me if I were assigned the task of developing educational specifications for a building/remodeling project?

You may wish to arrange through your resource person to meet with and interview a government official who has had experience in enforcing compliance with various federal or state regulations affecting facilities for vocational education institutions. Before the interview takes place, you should prepare a list of questions, such as the following, that you wish to have answered:



- What regulations have the most significant impact on proposed facilities?
- What is the prognosis for additional or reduced regulation in these areas?
- At what stage should educational specifications and/or architectural plans be submitted for review to assure compliance with applicable standards? How long does that review take?
- To whom should those plans be submitted for review in this state?



Activity

The following "Case Situation" contains (1) a brief description of the recent history of an institution that is about to add a new building to its facilities and (2) the table of contents and excerpted educational specifications for three rooms in that building. Read the situation and then identify in writing any deficiencies that you believe exist in the excerpted contents and specifications. Rectify these errors either by providing the correct information or by adding items that should have been included. (You can make these changes in the margins or on a separate sheet of paper.) Also provide in writing a general critique--strengths and weaknesses--of the specifications provided.

CASE SITUATION

Mohican Community College has had an occupational education program during the entire 18 years of its existence, including a few programs in all of the traditional vocational service areas. Acting on the advice of its Health Services Advisory Committee--and in response to the growth of many hospitals, clinics, and private physicians' office complexes in its service area--the college has decided to institute a program to train medical records transcribers. The inauguration of this program has been timed to coincide with the planned opening of the college's sixth building two years hence.

This building, tentatively named Fenimore Hall, will also contain facilities for emergency medical technician training, the college's expanded data processing/computer center, and a day-care center.

James Cooper, the dean of occupational education, has been working for six months with a building committee (consisting of the vice-president for administration, the chairman of the health services department, three instructors, a student senate representative, and two advisory committee members) on the educational specifications for Fenimore Hall. Now in its second draft version, this is what the specifications look like, as shown by the table of contents and three typical pages--those referring to the medical records transcriber program.

MOHICAN COMMUNITY COLLEGE (MCC)

EDUCATIONAL SPECIFICATIONS

Fenimore Hall (tentative name, subject to board approval)

TABLE OF CONTENTS

General Section

1. Project Description
2. Site--Environs, Access Roads, Utility Services
3. Proposed Expansion of Proposed Building
4. Summary of Institutional Purchasing and Personnel Policies
5. Innovational Education Practices at MCC
6. Description of Buildings Already on MCC Campus

Detailed Section

1. Summary of Proposed Rooms, with Estimates of Needed Area
2. Medical Records Transcriber Complex
3. Emergency Medical Technician Complex
4. Data Processing/Computer Center
5. Child-Care Center

EXCERPTS

Room 2.1 Medical Records Classroom (1 required, priority 2)

- A. Occupants: 1 instructor, 25 students
- B. Activity: Lecture and study of medical terminology, anatomy, pharmaceutical and surgical procedures, medical instruments, etc.

Room 2.1 (continued)

- C. Equipment: 14 tables, 30" x 60"
25 chairs, stacking, vinyl covered
Lectern, table model, with light
- D. Services: 110 volt, AC current, in duplex outlets at 12' intervals
along wall
Clock >
Light system that can be dimmed for projecting movies,
slides, and overhead transparencies
- E. Special Requirements: None
- F. Proximity: Adjacent to Room 2.2 (Medical Records Transcriber
Laboratory) and Room 2.3 (Faculty Office)

Room 2.2 Medical Records Transcriber Laboratory (1 required, priority 1)

- A. Occupants: 1 instructor, 25 students
- B. Activity: Demonstration and supervised practice of transcription
techniques
- C. Equipment: (Built-in) 6' tackboard, 6' chalkboard
10' of bookshelves, 60" high
(Movable) 25 secretarial desks, 30" x 60", with
L-annex, 30" x 42"
25 electric typewriters, 14"
25 posture chairs, swiveling
25 electronic transcribers, assorted media
(belt, disc, tape), with foot controls
- D. Special Requirements: Acoustical treatment of ceiling and floor
- E. Proximity: No particular requirement

Room 2.3 Faculty Office (Medical Records Transcription Instructor)
(1 required, priority 1)

- A. Occupants: 1 instructor, 1-3 students or other visitors
- B. Activity: Preparation for classes, helping students with project
assignments

Room 2.3 (continued)

- C. Equipment: 1 double pedestal desk, 30" x 60"
1 swivel chair with arms, fabric covered
1 file cabinet, 4 drawer
2 side chairs without arms, vinyl covered
1 bookshelf unit, open front, 36" x 78" x 12"
- D. Services: Telephone
110 volt AC in 3 duplex outlets, 18" above floor, on wall surfaces
- E. Proximity: Adjacent to Rooms 2.1 (Medical Records Transcriber Classroom) and 2.2 (Medical Records Transcriber Laboratory) and corridor



Compare your written critique of and corrections and additions to the educational specifications described in the "Case Situation" with the "Model Critique" listed below. Your response need not exactly duplicate the model response; however, you should have identified and corrected errors of the same general type.

MODEL CRITIQUE

With only a few exceptions, the educational specifications were clearly written, logical, and complete, even though their format did not correspond exactly to that shown in sample 5. Most important, they were written as problems so as not to limit the architect's discretion. (For example, they asked for acoustical treatment, but did not specify the type of ceiling material, carpet for the floor, and so on. The solution is up to the professional designer, once he/she knows the institution's needs.)

In the General Section (as shown in the table of contents), a great deal of background information was covered that should help the architect design a building that will fit in with those already on campus, facilitating harmony of appearance and style. Instructional innovations were described also, but the absence of a statement of the college's mission, approach, total curriculum, and target populations may make it harder for the architect to develop a feel for the institutional climate.

On the other hand, there is no particular need to cite the college's personnel and purchasing policies here, even in summary form.

Within the detailed descriptions of the three rooms comprising the medical records transcription complex, there are a few inconsistencies. Not all of the proximity statements are mutually supportive. According to the section on Room 2.1, it is supposed to be adjacent to Room 2.2; however, the section on Room 2.2 states that there is "no particular requirement." It would be difficult to prepare a circle diagram from the information available. (It's probably just an oversight, but it will require that the architect either guess at the meaning or make a special call back to the college to clarify the matter, and such errors can impair the credibility of the entire document.)

The sections for Rooms 2.2 and 2.3 do not have all the elements that are present in 2.1: the paragraph on Services is missing from 2.2, and Special Requirements is absent in 2.3.

Furthermore, the Equipment paragraph of 2.1 is not segregated according to fixed vs. movable. That's probably an omission, since the classroom should require at least some chalkboards and tackboards and probably a ceiling-mounted projection screen. Even if no pieces of equipment or requirements are called for in a category, that category should still be

listed, with a None or Not Applicable entry to reveal that the specifications drafter at least had not forgotten that item.

To return to some positive comments, note that most of the equipment descriptions are fairly complete, giving dimensions, types of upholstery, structural details, and special features. And although the format of each entry is not identical to that shown in sample 6, it still affords a clear picture of what is planned for each room and what activities it should be designed to accommodate.

Level of Performance: Your overall critique should have covered the same major points as the model response. Your corrections should have dealt with most of the same errors and corrected them in approximately the same way as was done in the model response. If you missed some of the errors or have questions about any additional points you made, review the material in the information sheet, "Describing the Desired Facilities to Prospective Users, Builders, and Suppliers," pp. 43-56, or check with your resource person if necessary.

Learning Experience IV

OVERVIEW



Enabling
Objective

After completing the required reading, critique the performance of an administrator in a given case study in supervising the remodeling of facilities.



Activity

You will be reading the information sheet, "Managing the Progress and Results of Construction and Remodeling Activities," pp. 67-76.



Optional
Activity

You may wish to visit a recently built or remodeled vocational education facility to learn the procedures followed by institutional administrators in supervising the construction/remodeling.



Activity

You will be reading the "Case Study," pp. 77-79, and critiquing the performance of the administrator described in supervising the remodeling of some educational facilities.

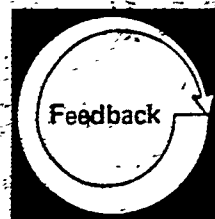

Feedback

You will be assessing your competency in critiquing the administrator's performance in supervising the remodeling of facilities by comparing your completed critique with the "Model Critique," pp. 81-82.

NOTES

Lined writing area with horizontal lines and some faint handwritten marks.

For information about how to oversee the construction of new facilities and/or the remodeling of current ones in order to assure on-time completion according to specifications, read the following information sheet.

MANAGING THE PROGRESS AND RESULTS OF CONSTRUCTION AND REMODELING ACTIVITIES

"The best-laid schemes o' mice an' men gang aft a-gley [often go amiss]."

These quaint words, written by Robert Burns in the eighteenth century, seem to ring just as true now as they did two hundred years ago. But today, the thought might sound more familiar expressed in the words of Murphy's Law, "If anything can go wrong, it will."

Such is surely the case with the provision of facilities for vocational education. Schemes might very well have been laid, calling on the finest contributions of men and women in many roles: teachers/instructors, administrators, board members, advisory committee members, consultants, and architects. However, unless some careful supervisory measures are taken, you and your institution will probably experience many snafus, delays, and hassles, and you might never enjoy the facilities you were seeking--at least not in the form and at the time and price you had expected.

Basically, the major tasks involved with the supervision of the construction and renovation of buildings and the installation of equipment can be remembered as three Cs: control, coordination, and change orders.

Control

In order to assure that needs, designs, and specifications are fulfilled as ordered, you need to employ several control devices, including at least the following.

On-site inspection. The direct, day-to-day supervision of construction or remodeling is usually performed by the architect. The actual supervisor might be a regular member of the architect's firm, or it might be a local individual hired just for that purpose (especially practical if the architect is located in a faraway city).

However, the institution, acting through a member of its administrative staff, has the ultimate responsibility for making certain that all work meets the needs for which it is being done. If the institution is quite large or is involved in intensive, continual construction activity, the institutional representative could be a member of the staff for whom this is a regular full-time responsibility. More likely, it will be an administrator having other

primary duties, to which this one is added as a part-time assignment. His/her authority must be clearly defined.

Channels of communication. Since inspection/supervision seems to be thus divided between two parties and since the institutional representative often faces the competition of other duties, it is more important than ever that the two parties decide at the outset exactly how and when they will communicate, what information and reports they will exchange, when they will conduct joint inspections of the construction site, and so forth.

This information should be shared with the contractors so that they will know whom they are to consult or report to and who has the authority to make on-the-spot decisions.

Internally, it is equally important that members of the faculty and staff be informed that any questions and comments about ongoing construction/remodeling work be directed only to the institutional representative. Simply stated, teachers/instructors do not call the architect; counselors, directors, and chairpersons do not go onto the worksite for unescorted inspection tours. However, it would be quite appropriate for the institutional representative to invite a member of the faculty/staff to accompany him/her and the architect's supervisor when they check out a particular aspect of the work.

Contracts. Growing quite naturally from the specifications and bidding process are the necessary contracts for construction work and the acquisition of equipment. The terms of the contract are substantially spelled out in the specifications developed by the architect, and these terms should have been incorporated into both the bid solicitation (written by the institution) and the bid response (written by the prospective contractor/vendor).³

A fairly complete list of the subjects to be covered by an adequate construction contract is given in sample 9. The complete text concerning these 57 items might well require over 20 pages of single-spaced copy. Many of these items deal with the same control and coordination measures that we will be talking about in the next several pages.

It is important for you to recognize the difference between the primary (or prime) contractor and a subcontractor. In most instances, the institution executes a primary contract directly with a general contractor for the largest share of the construction work. The task of the general contractor is to provide the basic structure of the building--foundation, floors, walls, and roof--plus many of its basic furnishings. To do this, he/she will probably need to contract in turn with other construction firms or miscellaneous service providers, such as excavators, carpet installers, painting companies,

3. For further information concerning bid advertising and contract awarding procedures, you may wish to refer to Manage the Purchase of Equipment, Supplies, and Insurance, part of the Competency-Based Vocational Education Administrator Module Series (Columbus, OH: The National Center for Research in Vocational Education, The Ohio State University, 1981).

SAMPLE 9

LIST OF TOPICS TO BE COVERED BY CONSTRUCTION/
EQUIPMENT INSTALLATION CONTRACT

1. Definition of "Work"
2. Definition of "Owner"
3. Definition of "Supplier"
4. Site and Scope
5. Delivery and Installation
6. Examination of the Premises
7. Specifications
8. Copies Furnished
9. Detail Instructions
10. Color Selections
11. Shop Drawings
12. OSHA Requirements
13. Submittal of Brochures and Production Drawings
14. Equipment, Furniture, and Apparatus
15. Substitutions
16. Guarantee
17. Royalties and Patents
18. Laws and Ordinances
19. Inspection of Work
20. Changes in the Work
21. Claims for Extra Cost
22. Deduction for Uncorrected Work
23. Delays
24. Correction of Work Before Final Payment
25. Correction of Work After Final Payment
26. Certificates of Payments
27. Payments Withheld
28. Assignment
29. Coordination with Other Contractors
30. Arbitration
31. Protection of Work and Property
32. Damages
33. Mutual Responsibility of Suppliers
34. Supervision, Supplier's Responsibility
35. Owner's Right to Do Work
36. Owner's Right to Terminate Contract
37. Supplier's Right to Terminate Contract
38. Use of Premises
39. Cutting and Patching
40. Cleaning Up
41. Safety Precautions
42. Employees
43. Workmanship
44. Damages to Buildings and Public Property
45. Security
46. Parking
47. Worker's Compensation, Indemnification, and Hold Harmless
48. Liability Insurance
49. Personal Property, Fire, Broad Form and Special Extended Coverage, Vandalism, and Malicious Mischief Insurance
50. Bid Bond and Performance Bond
51. Other Contracts
52. Owner's Use or Occupancy
53. Taxes
54. Permits and Certificates
55. Liens
56. Progress and Completion
57. Standard Specifications and Manufacturer's Data

glaziers (glass workers), cabinet makers, and so on. These parties are then known as subcontractors.

Subcontractors are selected and paid by the primary contractor; the costs of the materials and services provided by the subcontractor are negotiated between him/her and the primary contractor. Because the primary contractor now becomes a supervisor of the subcontractors' work, the institution is partially relieved of the task of directly overseeing the details of work performed by them. Nevertheless, it will remain in your institution's interest for you and the architect to spot check. These unannounced examinations will make certain that the primary contractor is exerting the controls needed to assure that the final product meets the standards imposed by the design and your needs.

Plumbing, electrical, and heating/ventilation/air conditioning (HVAC) work are usually also done by primary contractors, since the amount of work done by each of them often amounts to hundreds of thousands of dollars, and the institution is in a better position to secure a favorable price through either the bidding process or negotiation. However, for a fairly small building or remodeling project (that is, one of less than half a million dollars), it might be simpler to issue only one primary contract, presumably to a general contractor, and then to let that firm subcontract with the other types of construction companies.

In summary, the decision concerning whether to secure services by direct (primary) or indirect (subcontract) means should be based on the cost of the project, the complexity of the work required, and the institution's capability to supervise construction and purchasing on a day-to-day basis.

Meetings. By now you have no doubt noticed that many parties are involved in this task of providing buildings and equipment for vocational education: the institution, the architect, primary contractors, subcontractors, suppliers, and labor unions or individual workers. Since most of these supervise or depend on at least one of the others, you should provide an opportunity for them to meet from time to time to exchange information, express concerns, and reach necessary decisions. At the minimum, you should establish a schedule of regular meetings, then specify who has the authority to request or call a special meeting.

One individual should be designated as the regular chairperson of the sessions (probably either the architect or the general contractor). Another should be appointed to record, publish, and distribute the minutes of these meetings (either the architect or your institution's representative--someone with immediate access to clerical support and duplicating facilities).

In most cases, these meetings will be most effective if they are held on or near the work site.

Work schedules. A fundamental means for assuring timely completion of work in a coordinated fashion is a schedule. Acting within those requirements posed by the institution, the architect should develop this schedule,

identifying important milestones such as groundbreaking (or demolition of existing structure, in the case of remodeling); erection of structural steel; completion of the roof; connection of electricity, gas, water, or other utilities; initiation of heat/ventilation; and final acceptance and occupancy,

The architect is probably experienced in developing these schedules. In examining the result, look for evidence that he/she has considered important factors such as weather and the seasons, a likelihood of a strike against a contractor or supplier (learn when important labor contracts expire), the general level of activity in the construction industry, the novelty and complexity of the design, and the local availability of skilled workers.

Nearly every party involved will want to complete the work as soon as possible in order to minimize labor costs or to save the expense of making the work site comfortable (the new building's own roof and heating system are far more efficient and effective than are temporary covers, plastic wind barriers, and gasoline-fired space heaters). However, guard against overly optimistic timetables or plans that depend on split-second performance by third or fourth parties. Consider the reliability record of crucial contractors and suppliers.

In general, the schedule should be developed "backwards," beginning with the latest possible date by which the institution can accept and occupy the new facilities, and ending with a groundbreaking or contract award date. The key milestones should be expressed as a range of dates, with the degree of acceptable flexibility or "slack" specified for each critical point.

Partial payments. Few incentives motivate as effectively as does money. Closely tied to schedules are partial payments. Consider for a moment the plight of the contractors. They must pay their workers and the suppliers of the materials they use--cement, steel, lumber, wire, pipe, and so on. Clearly, they should not have to wait for all of their money until the 100 percent completion of the project; that would force them to borrow money for their payroll and other bills. (This problem is often referred to as cash flow.)

In most cases, your institution should already have secured the necessary funds, either from tax revenue, the sale of bonds, accumulation of a cash reserve, or a grant. Therefore, one option is to pay the architect and the primary contractors periodically, in approximate proportions to the amount of work completed. On the other hand, retaining these funds is a legal and logical means to enforce timely performance. Thus, a payment schedule could be announced in advance but implemented only contingent upon the architect's recommendation, based upon his/her inspection of the work accomplished to date.

The most important "partial" payment is the final one. Once you have completely paid a contractor, you have forfeited most of your leverage. Therefore, all parties should be particularly attentive to the final inspection, and a list of deficiencies (often called a punch list) should be developed as a result. This punch list must clearly state each defect noted, the

remedial action required, the party who must rectify it, a deadline, and whether payment will be withheld pending the correction.

Penalties/premiums. Closely related to partial payments are those additional amounts of money that are either added (for exceptionally speedy performance) or deducted (for tardiness). Be careful in the latter instance, however. Courts have usually declared that penalties for late completion of contracted work cannot be excessive and must be based upon a demonstrable cost that was incurred by the institution due to the contractor's or supplier's lateness (e.g., the cost of renting portable or temporary classrooms elsewhere or the cost of storing equipment until the room where it was to be installed became available). Also, the cause of delay must have been within the negligent party's normal area of control or influence

Guarantees and warranties. Finally, your institution should insist on certain customary safeguards that will allow you to be paid for defects in workmanship or materials that become apparent after the project is completed. To be fair, you should have cited these expectations as part of the bid solicitation and should have included them as terms in the construction or purchase contracts.

As buildings are completed and equipment is delivered, you need only to follow through by securing the necessary warranty documents, noting carefully the description and serial numbers of the items to which they refer. File these documents in a safe but accessible location.

Coordination

In any situation in which two or more parties are involved, certain coordination measures are necessary. This is particularly true when one contractor is constructing or remodeling a room and another contractor (or the institution) is providing the equipment that goes into it. (You may recall that equipment has been classified as either fixed or movable, with the principal distinction being not size, immobility, or cost, but rather whether its characteristics significantly affect the design and construction of the room or building.)

Consider this example. If you decide to buy an executive office chair from Jones Furniture Co. but don't like any of their upholstery choices, you may buy it on "C.O.M." terms (customer's own material): Consequently, you must purchase the fabric somewhere else, say from the Smith Leather Tannery. In order to receive the chair as soon as possible, you must (1) find out (from Jones) how much leather is needed to cover the new chair, then (2) order the leather (from Smith), then (3) have it delivered (from Smith) to Jones's factory, and finally (4) have the completed chair sent (from Jones) to you. Lots of bother. You'd really need to have a strong preference for that fabric to go through all those complicated dealings.

Let's look at another case that does not rely so much on individual whim. Automatic film processing machines are useful. Students and faculty can use

them when developing X-ray pictures for many health occupations classes. Administrators can use them when preparing slides and prints for promotional shows.

These wondrous but complicated devices usually are recessed in a counter or cabinet. They require thermostatically controlled water. They use electricity for light, timing, and the drive mechanisms. They might emit noxious fumes. They must be protected from stray light. Thus you have a need for coordination among all four of the principal construction trades: general (cabinet work and light-tight doors), electrical (power, tamperproof light switches), plumbing (water and drains), and HVAC (fresh air, evacuation of fumes).

Or the problem can be relatively simple--but frustrating if it goes awry. For example, assume that your institution purchases office equipment separately. Where are you going to store it if it arrives before the roof is on or even before the carpet is installed? Nobody wants to handle it twice. And you shouldn't unpack it if the ceiling tiles have not yet been set in place--a job that will generate some dust and falling debris.

How can you, working primarily through the architect, ensure that this coordination takes place? Using the following coordination techniques should help.

Specifications. First of all, see to it that complete sets of specifications are available to all primary contractors. (It is their responsibility to coordinate internally among their subcontractors, if any, using mostly these same techniques.)

Shop drawings, brochures, and production instructions. Next, supplement the specifications by requiring that contractors and suppliers provide several copies of shop drawings, brochures, production instructions, or other directions and descriptions of the particular item that they will build or buy in fulfillment of the specifications. The architect should distribute copies to those other contractors affected and retain at least one copy for eventual filing in your institutional records--probably in the maintenance department, with the purchasing files, or with the warranty documents.

Critical path analysis. Review the tasks to be accomplished, identify which ones must come before others, and devise a network diagram that depicts the sequence of these events (see sample 10). Assign deadlines to each. You don't have to develop the network sketch yourself; the architect can do it, or one of the contractors can be assigned as the responsible party for each coordinated project.

Plan delivery times and sites carefully. Once the critical path has been derived, establish realistic delivery dates for items of loose equipment--and designate a standby storage area in case they arrive too soon.

Complete some areas early. Arrange for one or a few rooms to be completed, inspected, and accepted early. Use them as dry, warm, dustfree holding areas for unpacking, assembling, and storing movable furniture. This

SAMPLE 10

GRAPHIC PORTRAYAL OF EVALUATION ACTIVITY SEQUENCING

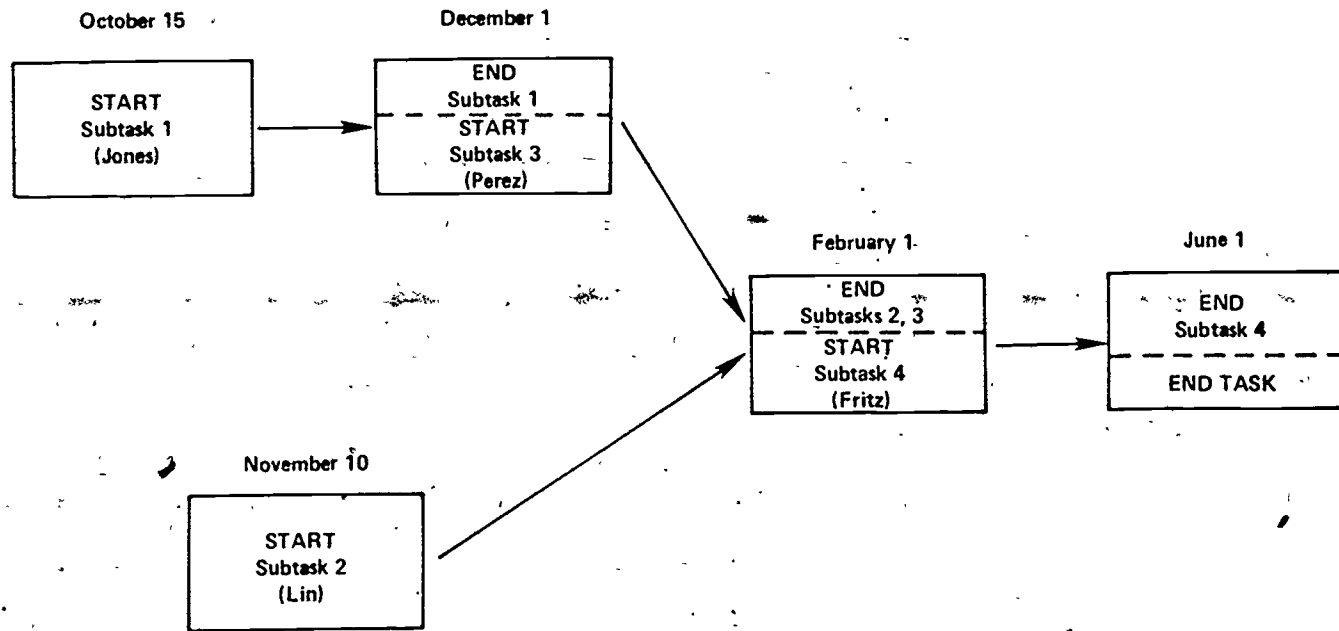

process is sometimes termed beneficial occupancy, and the institution accepts some risk that its use of these areas can delay scheduled work in adjacent areas or increase the contractors' costs. To minimize these expenses or disputes, arrange for such early-occupancy provisions from the very outset and include this information in design descriptions, bid advertisements, and contracts.

Assess your own resources accurately. In other words, don't assume that you can always call on the institution's custodial and maintenance staff to unload equipment, move it around, and set it up. The size of that staff has already been planned very carefully to just barely cover the primary duties required. If you use this staff for other tasks, suddenly floors and windows will stay dirty, machines won't get oiled, cracked windows will break completely out, and the grass will grow ever longer.

Change Orders

In spite of your farsighted planning and built-in flexibility, you will undoubtedly discover--sometime before construction, remodeling, or equipment purchase is complete--that a design needs to be changed. Such changes have a way of costing both time and money, so they must be pursued with care and prudence. If you have already been thorough in establishing control and coordinating measures, then change orders can be processed rather easily. As you have already read, there must be clear channels of communication, and meetings must take place fairly regularly among the important participants of the construction/remodeling project.

In some ways, the handling of change orders also resembles a budgeting process, and it demonstrates the wisdom of the ancient admonition to count the cost before starting on a journey. That is, a desired change should first be proposed. Next the expense should be projected. Then a decision concerning whether to proceed should be made. And only then should the decision be carried out--as illustrated in the following example:

The librarian recently has learned of a book theft detection system that has just come onto the market. He/she wants to install it in the new learning resource center, which is being provided through the remodeling of five old classrooms. A separate cost-benefit analysis has determined that theft prevention is a good idea--the \$4,000 system requires little annual upkeep and will deter an estimated \$2,000 worth of pilferage per year.

The institutional representative describes the equipment, drafts an accompanying set of educational specifications, and sends it to the architect.

The architect considers all ramifications of the added project and determines a location for the device (basically a gateway with an attached console the size of a breadbox). After identifying the changes in traffic pattern needed, the new signs required, and the electrical service

involved, he/she prepares a rough sketch and writes construction specifications. These documents are sent to the general contractor, the electrical contractor, and the supplier of the security system for estimates of (1) the cost of the additional needed materials and labor and (2) the effect on the construction/delivery schedule.

After all three replies reach the architect, he/she reviews them for accuracy and completeness and notifies the institutional representative of the resulting net effect on both cost and time. If they are affordable, the institutional representative instructs the architect to proceed with final design documents.

After producing accurate, detailed drawings and specifications, the architect publishes a written change order that authorizes the contractors and suppliers to modify their work in accordance with the new instructions. Upon completion of the work, he/she inspects it per the altered specifications. The change order constitutes a legal amendment of the construction and purchasing contracts with regard to both cost and deadlines.

Note in particular that the desired change was routed to all concerned parties twice--once as a proposal to determine its feasibility and the second time as an authorization. If the idea had been too expensive or delaying, it would have stopped after the first trip to architect, contractor, and supplier.

You may wish to arrange through your resource person to visit a vocational education facility that was recently or is currently being constructed or remodeled. You may also be able to arrange to meet with the administrator who is/was serving as the institutional representative for the project. As you view the work in progress (or the completed facility) and talk with the administrator, you should seek answers to questions such as the following:



- Who are/were the key persons within the chain of communication dealing with this project?
- How often were coordinating meetings held among those persons?
- Were there any areas of activity that were not adequately addressed by the various contracts? How were they resolved?
- Were any changes proposed after construction/remodeling had begun? Did they take place, and how was the change effected?

The following "Case Study" describes how a vocational education administrator supervised the remodeling of some facilities. Read the situation, and critique in writing the performance of the administrator described: what did he do correctly, what did he do incorrectly, and what should he have done instead?

CASE STUDY

Mr. Terry Lister is the supervisor of vocational agriculture education at High Plains County Vocational School. Because of growing enrollments in vo-ag, the addition of some new programs (ag mechanics and landscape/turf management), and the hiring of two new instructors, Mr. Lister had been requesting for several years that their facilities be expanded. Finally in October, the board decided to go ahead with such a project.

The decision was made easier when an elderly local farmer, now deceased, named the district as the inheritor of a parcel of property adjacent to the land where the school is located. These 20 acres included a large poultry building that had been vacant for several years. Mr. Lister and Jeanne Lash, the assistant superintendent for business, examined the building and were pleased to find that both the 20,000-square-foot area where the birds were kept, as well as the adjoining 5,000-square-foot egg crating rooms and offices, were in excellent structural condition. Consequently, the board approved the remodeling of this building for all vocational agriculture classes, including offices for the instructors and a chapter meeting room for the Future Farmers of America (FFA).

The only "string" on this good news was that Mr. Lister had to agree to serve as the school's representative to supervise all aspects of the remodeling, both design and contractor work. His part-time teaching responsibilities were assumed by one of the new teachers.

In spite of his lack of administrative experience in this area, Mr. Lister successfully completed the design aspects by January, working with Eli Schwann and Associates, an architectural firm from a large city ninety miles away. (They had completed two similar school projects in the previous five years.) Then it was time to submit the state-approved drawings and specifications to contractors for the actual remodeling work. A budget of \$800,000 was available for this work, with about \$200,000 of that earmarked for special equipment such as engine hoists, valve grinders, welders, electronic engine analyzers, sod cutters, and seeding machines.

Mr. Lister again worked with Ms. Lash. Bids were solicited, opened, and ultimately awarded in March to the Acme Construction Company. Acme agreed to erect the needed partitions, construct the ceiling, and widen some of the doors to facilitate access for large tractors. For the remainder of the work,

Acme planned to subcontract with the following companies: Climate Masters, Inc. (to air condition the entire structure), Spence Electric Corporation (for rewiring), and Aqua Dux Company (to install rest rooms and rehabilitate the plumbing).

In April, work began in earnest. Although no completion date was firmly stated in the contract, Mr. Lister was hoping that everything would be done by mid-August in time to get ready for the coming school year. Accordingly, he asked Ms. Lash to write the purchase orders (for the several equipment items) with a delivery date of August 10.

Because their firm was relatively far away, Eli Schwann sent his son Barney, just out of engineering school, to rent an apartment near the school and to represent the architects in supervising the construction. Reassured by Barney's apparent good sense and knowledge and realizing that most of the work was being done by subcontract through Acme, Mr. Lister visited the site about once every two to three weeks. The bulk of his time was devoted to getting FFA projects ready for the county fair and orienting the new instructors.

At the June 10 board meeting, he was asked to justify the payment of a bill for \$300,000 to Acme. This represented 50 percent of the construction phase of the remodeling program, and the board was skeptical that even 30 percent of the work had been completed. Mr. Lister hurriedly called Barney Schwann, who was unaware of the bill, and they agreed that \$200,000 was a fair figure (Acme had indeed bought most of the materials and was working with nearly full crews.)

In July, Mr. Lister decided that he should visit the site every other day, usually in the company of Barney Schwann. He also asked Barney to call a coordination meeting every ten days and orally report the results to him.

On July 20, the board approved payment of another \$200,000 to Acme.

Right on schedule, on August 10, a large truck arrived with a load of ag mechanics' tools, testers, and a large hoist. However, an Acme foreman refused to allow the equipment to be unloaded in the building, claiming that it would be in the way of the workers who were in the process of insulating pipes and installing ventilating grills in the new ceiling.

Also, it was discovered that the new welders required three special receptacles (a fuse-protected, 3-wire, twist-lock type). Mr. Lister talked with one of the electricians, who said he could install such devices, but would have to quit working on the air conditioner circuit breaker box to do so and would have to find a way to save \$200 (the cost of the special receptacles) somewhere else in the building.

In late August, some of the Aqua Dux workers were transferred to another work site, and it became evident that the remaining plumbers would not be able to finish installing the floor drains before Labor Day.

On September 12, Mr. Lister, Mr. Schwann, and a vice-president of Acme conducted a joint inspection of the premises. A few minor defects were recorded, and Acme agreed to correct them within seven days. Mr. Lister wished that there were a way to add more outside faucets to the building for a sprinkling system. However, he realized that time and money were all gone--teachers had already had to meet with their classes elsewhere for three weeks, and the board was scheduled to approve Acme's final payment that evening.

NOTES

Lined writing area with horizontal lines and scattered handwritten marks.

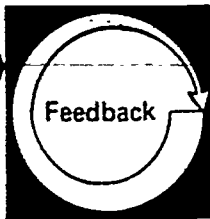

Compare your completed written critique with the "Model Critique" given below. Your response need not exactly duplicate the model response, however, you should have covered the same major points.

MODEL CRITIQUE

Perhaps Terry Lister carries around a four-leaf clover, because it is only through good fortune, not good administrative practice, that he and the High Plains school were able to occupy the remodeled building only three weeks behind schedule.

The elements for a well-controlled project certainly were there: Mr. Lister had been granted sufficient freedom from other duties and was given the necessary authority to supervise the remodeling work. He was familiar with the entire concept, having been involved from the earliest phases of design, and showed that he could cooperate with fellow administrators, notably Ms. Lash.

However, he placed undue faith in the supervisory skills of others. For example, the Schwann firm had worked with only two such projects before, was far away, and was relying on an inexperienced, new employee in the key role of overseeing the work.

Furthermore, only one firm--Acme--was directly responsible (as a primary contractor) to the school district for the work. Considering the size of the project (\$600,000), it might have been better for the school to have contracted directly also with the HVAC, plumbing, and electrical contractors. Perhaps a lower bid could have been secured, and the school would have been able to wield some influence in preventing that transfer of Aqua Dux workers.

Speaking of contracts, the primary construction contracts certainly should have specified when the work was to be completed and included a schedule of partial payments and penalties for late work.

If, indeed, partial payments were to be processed, they should have gone through the established channel of contractor-architect-institutional representative-board, not directly from Acme to the board. This routing would have given the architect, as the "first line of defense," an opportunity to detect behind-schedule work and to take remedial action. The board's refusal to pay a partial bill would certainly have been an effective recourse if work had continued not to progress satisfactorily.

Obviously, visits every ten days or so are too infrequent. The every-other-day schedule adopted later was definitely better. The frequency of coordination meetings (once they finally were begun) was about right, but Mr. Lister ought to have attended also. Written, not oral, minutes of the meeting should have been prepared and distributed.

In coordinating between work (by a contractor) and equipment purchases (by the institution), Mr. Lister again started somewhat systematically but failed to follow through. There is no way of knowing if he had shared the schedule of equipment deliveries with the architect. If he had, the ability of the building to receive the equipment on August 10 could have been discussed, especially in on-site meetings as that day approached. Also, the supplier of the welding equipment should have been directed to provide special installation instructions in advance. That measure would have enabled the architect, primary contractor, and, appropriate subcontractor (Spence Electric) to have already secured those special receptacles.

The alterations needed for the welders, as well as the outside faucets that Mr. Lister wished he had asked for, should have been handled by the change order process. This way, the cost--in terms of both time and money--could have been assessed in advance, and a decision to authorize the necessary work could have been made more deliberately, not while the institution was "over a barrel."

Finally, Mr. Lister should have recommended that the board delay making that final payment for at least one more week, after which time he and Mr. Schwann could have verified that all the items on the final "punch list" had indeed been corrected.

Level of Performance: Your completed written critique should have covered the same major points as the "Model Critique." If you missed some points or have questions about any additional points you made, review the material in the information sheet, "Managing the Progress and Results of Construction and Remodeling Activities," pp. 67-76, or check with your resource person if necessary.

Learning Experience V

FINAL EXPERIENCE



Terminal Objective

While working in an actual administrative situation, provide buildings and equipment for vocational education.*



Activity

As part of your administrative responsibility, provide buildings and equipment for a vocational education institution or program. This will include--

- assessing the need for additional or renovated facilities
- evaluating prospective land and/or internal building sites
- developing educational specifications
- supervising construction, equipment selection, purchase and installation, and facility acceptance

NOTE: Due to the nature of this experience, you will need to have access to an actual administrative situation over an extended period of time.

As you complete each of the above activities, document your actions (in writing, on tape, through a log) for assessment purposes.

continued

*If you are not currently working in an actual administrative situation, this learning experience may be deferred, with the approval of your resource person, until you have access to an actual administrative situation.

FINAL EXPERIENCE continued

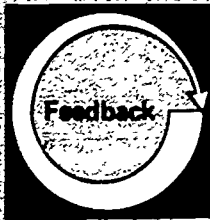

Arrange to have your resource person review the documentation of your activities and any products developed under your leadership. If possible, arrange to have your resource person observe at least one instance in which you are working with others in the process of providing buildings and equipment (e.g., a meeting with prospective users to review an architect's preliminary drawings).

Your total competency will be assessed by your resource person, using the "Administrator Performance Assessment Form," pp. 85-87.

Based upon the criteria specified in this assessment instrument, your resource person will determine whether you are competent in providing buildings and equipment for vocational education.

Name _____

Date _____

ADMINISTRATOR PERFORMANCE ASSESSMENT FORM

Provide Buildings and Equipment for Vocational Education

Directions: Indicate the level of the administrator's accomplishment by placing an X in the appropriate box under the LEVEL OF PERFORMANCE heading. If, because of special circumstances, a performance component was not applicable, or impossible to execute, place an X in the N/A box.

LEVEL OF PERFORMANCE

N/A None Poor Fair Good Excellent

While calculating the extent or nature of need for additional space, the administrator:

1. consulted statistics on the projected population of the community, enrollment of the entire institution, and specific programs and activities.....
2. considered the degree to which current rooms and buildings are being (appropriately) used or occupied.....
3. used faculty, staff, students, advisory committee members, and community experts as sources of information about changing needs of specific programs.....
4. applied, where appropriate, standard formulas for basing space needs on the nature of activity or number of occupants involved....

	N/A	None	Poor	Fair	Good	Excellent
1. consulted statistics on the projected population of the community, enrollment of the entire institution, and specific programs and activities.....	<input type="checkbox"/>	<input type="checkbox"/>	<input type="checkbox"/>	<input type="checkbox"/>	<input checked="" type="checkbox"/>	<input checked="" type="checkbox"/>
2. considered the degree to which current rooms and buildings are being (appropriately) used or occupied.....	<input type="checkbox"/>	<input type="checkbox"/>	<input type="checkbox"/>	<input type="checkbox"/>	<input checked="" type="checkbox"/>	<input checked="" type="checkbox"/>
3. used faculty, staff, students, <u>advisory</u> committee members, and community experts as sources of information about changing needs of specific programs.....	<input type="checkbox"/>	<input type="checkbox"/>	<input type="checkbox"/>	<input type="checkbox"/>	<input checked="" type="checkbox"/>	<input checked="" type="checkbox"/>
4. applied, where appropriate, standard formulas for basing space needs on the nature of activity or number of occupants involved....	<input type="checkbox"/>	<input type="checkbox"/>	<input type="checkbox"/>	<input type="checkbox"/>	<input checked="" type="checkbox"/>	<input checked="" type="checkbox"/>
5. examined current land-use patterns and their trends.....	<input type="checkbox"/>	<input type="checkbox"/>	<input type="checkbox"/>	<input type="checkbox"/>	<input checked="" type="checkbox"/>	<input checked="" type="checkbox"/>

During the process of evaluating prospective sites for new construction, the administrator:

5. examined current land-use patterns and their trends.....

LEVEL OF PERFORMANCE

N/A None Poor Fair Good Excellent

- 6. consulted with local government officials about zoning laws and applicable transportation and utility service extension plans.....
- 7. considered current and likely future real estate prices.....
- 8. studied relevant physical characteristics (e.g., drainage, slope, accessibility, vegetation) of the property under consideration.....

While determining suitable locations for alteration or remodeling of facilities, the administrator:

- 9. secured expert opinions on the likely cost of work at each alternative location.....
- 10. considered effects of the relocation on the programs, offices, or personnel to be housed, or displaced, by the altered facilities.....

While preparing specifications for new or remodeled/ altered facilities, including associated major equipment, the administrator:

- 11. prepared educational specifications in the form of a problem, such that the architect could exercise professional discretion in achieving a suitable design solution.....
- 12. fully described the intended use of the desired facility in such terms as number of occupants, activity, utility and services required, equipment included, proximity, and priority.....
- 13. involved users of proposed new/altered facilities (faculty, students, staff), as well as advisory committees/councils and consultants, in the development of specifications.....

LEVEL OF PERFORMANCE

N/A None Poor Fair Good Excellent

While overseeing activities leading to remodeling or new construction, the administrator:

	N/A	None	Poor	Fair	Good	Excellent
14. ensured that, at all stages of planning, proposed designs and construction/purchasing specifications were reviewed by institutional officials and prospective users, as appropriate.....	<input type="checkbox"/>	<input type="checkbox"/>	<input type="checkbox"/>	<input type="checkbox"/>	<input checked="" type="checkbox"/>	<input checked="" type="checkbox"/>
15. developed time lines to coordinate planning, construction, completion, and occupancy.....	<input type="checkbox"/>	<input type="checkbox"/>	<input type="checkbox"/>	<input type="checkbox"/>	<input checked="" type="checkbox"/>	<input checked="" type="checkbox"/>
16. awarded construction contracts on the basis of institutional purchasing policies and procedures.....	<input type="checkbox"/>	<input type="checkbox"/>	<input type="checkbox"/>	<input type="checkbox"/>	<input checked="" type="checkbox"/>	<input checked="" type="checkbox"/>
17. held meetings between contractors, architects, and institutional officials as needed to assess progress and to discuss the cost of needed changes to the plans.....	<input type="checkbox"/>	<input type="checkbox"/>	<input type="checkbox"/>	<input type="checkbox"/>	<input checked="" type="checkbox"/>	<input checked="" type="checkbox"/>
18. chose between institutional or contractor provision of major equipment items based on relative cost, supervision/coordination required, and design or inspection services available.....	<input type="checkbox"/>	<input type="checkbox"/>	<input type="checkbox"/>	<input type="checkbox"/>	<input checked="" type="checkbox"/>	<input checked="" type="checkbox"/>
19. coordinated purchase of major equipment items, when done by the institution, so as not to delay construction operations.....	<input type="checkbox"/>	<input type="checkbox"/>	<input type="checkbox"/>	<input type="checkbox"/>	<input checked="" type="checkbox"/>	<input checked="" type="checkbox"/>
20. conducted or coordinated inspections of constructed/renovated facilities to ensure that specifications and applicable regulations were met before partial or final payments were authorized.....	<input type="checkbox"/>	<input type="checkbox"/>	<input type="checkbox"/>	<input type="checkbox"/>	<input checked="" type="checkbox"/>	<input checked="" type="checkbox"/>

Level of Performance: All items must receive N/A, GOOD, or EXCELLENT responses. If any item receives a NONE, POOR, or FAIR response, the administrator and resource person should meet to determine what additional activities the administrator needs to complete in order to reach competency in the weak area(s).

Additional Recommended References

Council of Educational Facility Planners. *Guide for Planning Educational Facilities*. Columbus, OH: CEFP, The Ohio State University, 1979.

Culver, Harold W., and Belyea, Richard. "Construction Management—An Application," *CEFP Journal*. 4 (July-August 1979): 6-10.

Dee, Richard K., ed. *Barrier Free Site Design*. McLean, VA: American Society of Landscape Architects Foundation, 1977. ED 173 984

Erekson, Thomas L. *Accessibility to Laboratories and Equipment for the Physically Handicapped: A Handbook for Vocational Education Personnel*. Springfield, IL: Illinois State Board of Education, 1981.

Field-Proven Programs to Conserve Energy in Schools. Park Ridge, IL: Association of School Business Officials, 1980. ED 188 349

Jones, Michael A. *Accessibility Standards Illustrated*. Springfield, IL: Illinois State Capital Development Board, 1978. ED 163 738

Leu, Donald J. *Planning Educational Facilities*. New York, NY: Center for Applied Research in Education, 1965. ED 030 272

Merrell, Russell G. *A Report on Alternatives to School Building Construction*. Salt Lake City, UT: Utah State Board of Education, 1980. ED 197 484

Physical Accessibility of Public Supported Vocational Schools for Handicapped Students. Pittsburgh, PA: Associated Educational Consultants, 1978. ED 177 287

Schoolhouse Planning. Park Ridge, IL: Association of School Business Officials, 1980. ED 188 348

Schwartz, Stuart E. *Architectural Considerations for a Barrier Free Environment*. Gainesville, FL: University of Florida, College of Education, 1977. ED 153 048

Williams, William A. *Accident Prevention Program for School Shops and Laboratories: A Suggested Guide for School Administrators*. Chicago, IL: National Safety Council, 1966. ED 035 733

Competency-Based Administrator Education Materials

LEADERSHIP & TRAINING (LT) SERIES

Category A: Program Planning, Development, and Evaluation

- LT-A-1 Develop Local Plans for Vocational Education; Part I
- LT-A-2 Develop Local Plans for Vocational Education; Part II
- LT-A-3 Direct Program Evaluation

Category B: Instructional Management

- LT-B-1 Direct Curriculum Development
- LT-B-2 Guide the Development and Improvement of Instruction
- LT-B-3 Manage the Development of Master Schedules

Category C: Student Services

- LT-C-1 Manage Student Recruitment and Admissions
- LT-C-2 Provide Systematic Guidance Services
- LT-C-3 Maintain School Discipline
- LT-C-4 Establish a Student Placement Service and Coordinate Follow-up Studies

Category D: Personnel Management

- LT-D-1 Select School Personnel
- LT-D-2 Supervise Vocational Education Personnel
- LT-D-3 Evaluate Staff Performance
- LT-D-4 Manage School Personnel Affairs

Category E: Professional and Staff Development

- LT-E-1 Appraise the Personnel Development Needs of Vocational Teachers
- LT-E-2 Provide a Staff Development Program
- LT-E-3 Plan for Your Professional Development

Category F: School-Community Relations

- LT-F-1 Organize and Work with a Local Vocational Education Advisory Council
- LT-F-2 Promote the Vocational Education Program
- LT-F-3 Involve the Community in Vocational Education
- LT-F-4 Cooperate with Governmental and Community Agencies

Category G: Facilities and Equipment Management

- LT-G-1 Provide Buildings and Equipment for Vocational Education
- LT-G-2 Manage Vocational Buildings and Equipment
- LT-G-3 Manage the Purchase of Equipment, Supplies, Insurance

Category H: Business and Financial Management

- LT-H-1 Prepare Vocational Education Budgets
- LT-H-2 Identify Financial Resources for Vocational Education
- LT-H-3 Develop Applications and Proposals for Funding Vocational Education

Category I: Program Improvement

- LT-I-1 Use Information Resources to Help Improve Vocational Education Programs
- LT-I-2 Use Inquiry Skills to Help Improve Vocational Education Programs

Supportive Materials

- Guide to Vocational-Technical Education Program Alternatives: Secondary and Postsecondary—An Introduction
- Guide to Using Competency-Based Vocational Education Administrator Materials
- Resource Person's Guide to Implementing Competency-Based Administrator Education Concepts and Materials
- An Introduction to Competency-Based Administrator Education (slide/audiotape)

For information regarding availability and prices of these materials contact—AAVIM, American Association for Vocational Instructional Materials, 120 Driftmier Engineering Center, University of Georgia, Athens, Georgia 30602, (404) 542-2586.

"END OF DOCUMENT"

ISBN 0-89606-112-4