

DOCUMENT RESUME

ED 225 011

CE 034 964

TITLE Fire Protection Specialist, Blocks IV and V, 17-3. Military Curriculum Materials for Vocational and Technical Education.

INSTITUTION Chanute AFB Technical Training Center, Ill.; Ohio State Univ., Columbus. National Center for Research in Vocational Education.

SPONS AGENCY Office of Education (DHEW), Washington, D.C.

PUB DATE 78

NOTE 508p.; For a related document see CE 034 963.

PUB TYPE Guides - Classroom Use - Materials (For Learner) (051) -- Guides - Classroom Use - Guides (For Teachers) (052)

EDRS PRICE MF02/PC21 Plus Postage.

DESCRIPTORS Equipment Maintenance; *Equipment Utilization; *Fire Fighters; *Fire Protection; *Fire Science Education; Guidelines; Lesson Plans; Military Personnel; Military Training; Postsecondary Education; Rescue; Safety Education; *Technical Education; Workbooks

IDENTIFIERS *Aircraft; *Fires; Military Curriculum Project

ABSTRACT

This military-developed text contains the fourth and fifth blocks of a five-block course for use in training fire protection specialists. Covered in the individual volumes are the following topics: structural firefighting (operation and maintenance of hydrants, emergency response activities, structural pumpers, vehicle positioning and relay, hose operations, hose loads and finishes, hose lays, structural firefighting procedures and operations, preservation of evidence, and fire station maintenance) and aerospace vehicle firefighting (rescue operations, ramp vehicles, procedures for on-scene operations, emergency response exercises, aircraft approach exercises, small-frame aircraft fires, medium-frame aircraft fires, large-frame aircraft fires, and aircraft arresting systems). This half of the course includes both teacher and student materials. Among the printed instructor materials provided are lesson plans with an outline of the teaching steps and a plan of instruction detailing the units of instruction, objectives, duration of the lessons, and supportive materials needed. Student materials include two study guides with objectives, text readings, and review questions as well as two workbooks with exercises. (MN)

 * Reproductions supplied by EDRS are the best that can be made *
 * from the original document. *

MILITARY CURRICULUM MATERIALS

The military-developed curriculum materials in this course package were selected by the National Center for Research in Vocational Education Military Curriculum Project for dissemination to the six regional Curriculum Coordination Centers and other instructional materials agencies. The purpose of disseminating these courses was to make curriculum materials developed by the military more accessible to vocational educators in the civilian setting.

The course materials were acquired, evaluated by project staff and practitioners in the field, and prepared for dissemination. Materials which were specific to the military were deleted, copyrighted materials were either omitted or approval for their use was obtained. These course packages contain curriculum resource materials which can be adapted to support vocational instruction and curriculum development.

The National Center Mission Statement

The National Center for Research in Vocational Education's mission is to increase the ability of diverse agencies, institutions, and organizations to solve educational problems relating to individual career planning, preparation, and progression. The National Center fulfills its mission by:

- Generating knowledge through research
- Developing educational programs and products
- Evaluating individual program needs and outcomes
- Installing educational programs and products
- Operating information systems and services
- Conducting leadership development and training programs

FOR FURTHER INFORMATION ABOUT Military Curriculum Materials

WRITE OR CALL

Program Information Office
The National Center for Research in Vocational
Education

The Ohio State University
1960 Kenny Road, Columbus, Ohio 43210
Telephone: 614/486-3655 or Toll Free 800/
848-4815 within the continental U.S.
(except Ohio)



THE NATIONAL CENTER
FOR RESEARCH IN VOCATIONAL EDUCATION
The Ohio State University, 1960 Kenny Road, Columbus, Ohio 43210
Tel: 614/486-3655
Cable: CVT008883/UC/EDUCATION

Military Curriculum Materials for Vocational and Technical Education

Information and Field
Services Division

The National Center for Research
in Vocational Education



Military Curriculum Materials Dissemination Is . . .

an activity to increase the accessibility of military-developed curriculum materials to vocational and technical educators.

This project, funded by the U.S. Office of Education, includes the identification and acquisition of curriculum materials in print form from the Coast Guard, Air Force, Army, Marine Corps and Navy.

Access to military curriculum materials is provided through a "Joint Memorandum of Understanding" between the U.S. Office of Education and the Department of Defense.

The acquired materials are reviewed by staff and subject matter specialists, and courses deemed applicable to vocational and technical education are selected for dissemination.

The National Center for Research in Vocational Education is the U.S. Office of Education's designated representative to acquire the materials and conduct the project activities.

Project Staff:

Wesley E. Budke, Ph.D., Director
National Center Clearinghouse

Shirley A. Chase, Ph.D.,
Project Director

What Materials Are Available?

One hundred twenty courses on microfiche (thirteen in paper form) and descriptions of each have been provided to the vocational Curriculum Coordination Centers and other instructional materials agencies for dissemination.

Course materials include programmed instruction, curriculum outlines, instructor guides, student workbooks and technical manuals.

The 120 courses represent the following sixteen vocational subject areas:

Agriculture	Food Service
Aviation	Health
Building & Construction	Heating & Air Conditioning
Trades	Machine Shop Management & Supervision
Clerical Occupations	Meteorology & Navigation
Communications	Photography
Drafting	Public Service
Electronics	
Engine Mechanics	

The number of courses and the subject areas represented will expand as additional materials with application to vocational and technical education are identified and selected for dissemination.

How Can These Materials Be Obtained?

Contact the Curriculum Coordination Center in your region for information on obtaining materials (e.g., availability and cost). They will respond to your request directly or refer you to an instructional materials agency closer to you.

CURRICULUM COORDINATION CENTERS

EAST CENTRAL
Rebecca S. Douglass
Director
100 North First Street
Springfield, IL 62777
217/782-0759

MIDWEST
Robert Patton
Director
1515 West Sixth Ave.
Stillwater, OK 74704
405/377-2000

NORTHEAST
Joseph F. Kelly, Ph.D.
Director
225 West State Street
Trenton, NJ 08625
609/292-6562

NORTHWEST
William Daniels
Director
Building 17
Airdustrial Park
Olympia, WA 98504
206/753-0879

SOUTHEAST
James F. Shill, Ph.D.
Director
Mississippi State University
Drawer DX
Mississippi State, MS 39762
601/325-2510

WESTERN
Lawrence F. H. Zane, Ph.D.
Director
1776 University Ave.
Honolulu, HI 96822
808/948-7834

FIRE PROTECTION SPECIALIST, BLOCKS IV AND V

Table of Contents

Course Description	Page 1
Plan of Instruction	Page 3
Block IV - Structural Firefighting Tactics	
Lesson Outlines	Page 37
<u>Structural Firefighting Tactics</u> - Study Guide	Page 107
<u>Structural Firefighting Tactics</u> - Workbook	Page 181
Block V - Aerospace Vehicle Firefighting (Crash Firefighter)	
Lesson Outlines	Page 215
<u>Aerospace Vehicle Firefighting</u> - Study Guide	Page 308
<u>Aerospace Vehicle Firefighting</u> - Workbook	Page 395

Course Description:

This is the second half of the course to train the fire protection specialist. The entire course provides training in firefighting and fire protection techniques for use with aircraft, structural and materials fires, and other emergencies. Topics covered in this half of the course include emergency response procedures; inspection, maintenance and use of firefighting vehicles and other equipment; and control and extinguishment of aircraft fires. Two blocks of instruction covering 188 hours are included. Students should complete Fire Protection Specialist, Blocks I, II, and III, (17-2), before beginning this second half of the course.

Block IV — *Structural Firefighting Tactics* contains fourteen lessons with 78 hours of instruction. Many pieces of equipment are identified with military numbers but the lessons can be adapted for use with similar equipment used in the civilian sector. The lesson topics and respective hours follow:

Operations and Maintenance of Hydrants (1 hour)
Emergency Response Activities (1 hour)
Inspection, Maintenance, Mounted Equipment and Operations on the 530B/P-8 Structural Pumps (6 hours)
Pumping Operations on the 530B/P-8 Structural Pumps (8 hours)
Inspection, Maintenance, Mounted Equipment and Operations on the 750A/P-12 Structural Pumps (8 hours)
Pumping Operations on the 750A/P-12 Structural Pumps (4 hours)
Vehicle Positioning, Relay and Hose Operations (4 hours)
Hose Loads and Finishes (8 hours)
Hose Lays (8 hours)
Structural Firefighting Procedures (8 hours)
Structural Firefighting Operations (8 hours)
Structural Firefighting Tactics (8 hours)
Preservation of Evidence (3 hours)
Fire Station Maintenance (3 hours)

Block V — *Aerospace Vehicle Firefighting (Crash Firefighter)* has seventeen lessons covering 110 hours of instruction.

Block V, Orientation (.5 hours)
Principles and Procedures of Aerospace Vehicle Firefighting (7.5 hours)
Principles and Procedures of Rescue (8 hours)
Rescue Operations (4 hours)
Ramp Vehicle Inspection, Maintenance and Operations (4 hours)
O-11A Inspection, Maintenance and Operations (8 hours)
O-118 Inspection, Maintenance and Operations (8 hours)
P-2 Inspection, Maintenance and Operations (8 hours)
P-4 Inspection, Maintenance and Operations (8 hours)
Procedures for Ori-Scene Operations (8 hours)
Emergency Response Exercises (8 hours)
Emergency Response and Aircraft Approach Exercises (8 hours)
Control and Extinguishment on Small Frame Aircraft Fires (8 hours)
Control and Extinguishment; Overhaul and Rescue on Small Frame Aircraft Fires (7 hours)
Control, Extinguishment, Overhaul and Rescue on Medium Frame Aircraft Fires (6 hours)
Control, Extinguishment, Overhaul and Rescue on Large Frame Aircraft Fires (6 hours)
Aircraft Arresting Systems (3 hours)

This half of the course contains both teacher and student materials. Printed instructor materials include lesson plans with an outline of the teaching steps and a plan of instruction detailing the units of instruction, objectives, duration of the lessons, and support materials needed. Student materials include two study guides with objectives, text readings, and review questions and two workbooks with exercises.

Additional military manuals and commercially produced texts are recommended as references and texts, but these are not provided. Audiovisual aids suggested for use with the entire course consist of 29 films and 14 slide sets. This material can be presented in a group instructional setting or adapted for individualized study.

PLAN OF INSTRUCTION		COURSE TITLE	
		Fire Protection Specialist	
BLOCK TITLE			
Structural Firefighting Tactics			
UNITS OF INSTRUCTION AND CRITERION OBJECTIVES		DURATION HOURS	SUPPORT MATERIALS AND GUIDANCE
<p>1. Operations and Maintenance of Hydrants</p> <p>a. Using fire hydrants, inspect and perform operator maintenance on fire hydrants. The procedures listed in the WB must be followed with minimum instructor assistance.</p>		<p>1 Day 21</p>	<p><u>Column 1 Reference</u> <u>STS Reference</u> 1a 13a(4)</p> <p><u>Instructional Materials</u> 3ABR57130-1-SG-401, Operations and Maintenance of Hydrants 3ABR57130-1-WB-401, Operations and Maintenance of Hydrants</p> <p><u>Training Equipment</u> Trainers: Portable Fire Hydrants, 3279 (10) Fire Hydrant Cutaway, 3150 (10) Hydrant Wrench (10)</p> <p><u>Training Methods</u> Discussion/Demonstration (.5 hr) Performance (.5 hr)</p> <p><u>Instructional Environment/Design</u> Classroom (.5 hr) Laboratory (.5 hr)</p> <p><u>Instructional Guidance</u> Check the outside assignment given the previous day in Block III. Emphasize the importance of not overtightening the "hydrant operating nut" of the fire hydrant in order to prevent damage to the stem. Have students check the gaskets in the hydrant caps to insure a tight fit and to further prevent leakage. Stress that the hydrant wrench is not used to tighten the discharge caps on fire hydrants. Stress energy and materials conservation.</p>
PLAN OF INSTRUCTION NO. 3ABR57130-1		DATE 7 Jul 75	BLOCK NO. IV PAGE NO. 33

17-3

PLAN OF INSTRUCTION (Continued)

UNITS OF INSTRUCTION AND CRITERION OBJECTIVES	DURATION (HOURS)	SUPPORT MATERIALS AND GUIDANCE	
<p>2. Emergency Response Activities</p> <p>a. Without reference, identify safe and unsafe procedures concerning emergency response activities. Eighty percent of the procedures must be identified correctly.</p>	<p>1 Day 21</p>	<p><u>Column 1 Reference</u> 2a</p>	<p><u>STS Reference</u> 3b(4)</p> <p><u>Instructional Materials</u> 3ABR57130-1-SG-402, Emergency Response Activities</p> <p><u>Audio Visual Aids</u> Film: CFL 033, "FireCode 3"</p> <p><u>Training Methods</u> Discussion/Demonstration (1 hr)</p> <p><u>Instructional Environment/Design</u> Classroom (1 hr)</p> <p><u>Instructional Guidance</u> Stress the need for arriving at the fire scene safely in order to perform our primary job of saving lives and protecting property from fire. Stress that when responding to emergencies the red light and siren merely asks for the right of way, it does not give it! Also be prepared to yield. Relate these items as students will shortly be trained for driving at their next base. Stress energy and materials conservation.</p>
<p>3. Inspection, Maintenance, Mounted Equipment and Operations on the 530B/P-8 Structural Pumps</p> <p>a. Given AFIO Form 434 and technical data, inspect and perform operator maintenance on the 530B/P-8 structural firefighting vehicle and mounted equipment. All applicable items on the AFIO Form 434 must be inspected. Operator maintenance must be accomplished according to technical orders.</p>	<p>6 (4/2) Day 21</p>	<p><u>Column 1 Reference</u> 3a 3b 3c</p>	<p><u>STS Reference</u> 3b(3), 4c, 13a(1) 3b(3), 4c, 10j 3b(2), 13b, 13c</p> <p><u>Instructional Materials</u> 3ABR57130-1-SG-403, Inspection, Maintenance, Mounted Equipment and Operations on the 530B/P-8 Structural Pumps 3ABR57130-1-WB-403, Inspection, Maintenance, Mounted Equipment and Operations on the 530B/P-8 Structural Pumps TO 36A12-12-9-61, Truck, Firefighting 530B TO 36A12-12-12-1, 500 GPM Brush and Structural Firefighting Truck</p>
<p>PLAN OF INSTRUCTION NO. 3ABR57130-1</p>	<p>DATE 7 Jul 75</p>	<p>BLOCK NO. IV</p>	<p>PAGE NO. 34</p>

PLAN OF INSTRUCTION (Continued)

1 UNIT OF INSTRUCTION AND CRITERION OBJECTIVES	2 DURATION (HOURS)	3 SUPPORT MATERIALS AND GUIDANCE
<p>b. Given a 530B/P-8 structural fire-fighting vehicle and mounted equipment, perform a booster operation in accordance with technical order procedures. Booster operation must be completed in less than five minutes, while observing all applicable safety practices.</p> <p>c. Given necessary equipment, perform preventive maintenance on the 530B/P-8 structural firefighting vehicle and mounted equipment IAW AFIO Form 434. Maintain station facilities as required.</p>	<p>2</p>	<p><u>Audio Visual Aids</u> Charts</p> <p><u>Training Equipment</u> Vehicles: A/S32P-8, Structural Firefighting Vehicle and Mounted Equipment (5) 530B, Structural Firefighting Vehicle and Mounted Equipment (5) Trainer: 530B Operators Panel, 3223 (10) Helmet (1) Gloves (1) Preventive Maintenance Materials (10)</p> <p><u>Training Methods</u> Discussion/Demonstration (2.5 hrs) Performance (1.5 hrs) Outside Assignments (2 hrs)</p> <p><u>Instructional Environment/Design</u> Classroom (2 hrs) Laboratory (2 hrs)</p> <p><u>Instructional Guidance</u> Stress safety during pump operations to include watching for loose or nozzleless lines, excessive pressure, proper vehicle and pump operation and insure chocks are in place. When pumping on the hangar floor, insure that the hangar exhaust pipes are connected to the pumps. Remind students of the dangers involved while performing on a vehicle with the engine running. Do not allow students to handle the exhaust piping system with bare hands especially after the system has been used, because the piping system is extremely hot. Also assure that the aisle hallway hangar doors are kept closed to reduce the noise level. Report any damaged exhaust system problems to the instructor-supervisor immediately. Stress the importance of properly operating Air Force equipment in order to prevent damage resulting in costly repairs. Stress energy and materials conservation. Give the outside assignment for the next subject.</p>
PLAN OF INSTRUCTION NO. 3ABR57130-1	DATE 7 Jul 75	BLOCK NO. IV PAGE NO. 35

6

PLAN OF INSTRUCTION (Continued)

UNITS OF INSTRUCTION AND CRITERION OBJECTIVES	DURATION (HOURS)	SUPPORT MATERIALS AND GUIDANCE
<p>4. Pumping Operations on the 530B/P-8 Structural Pumpers.</p> <p>a. Given a 530B/P-8 structural fire-fighting vehicle and mounted equipment, perform hydrant operations in accordance with technical order procedures. Hydrant operation must be completed in less than five minutes while observing all applicable safety practices.</p> <p>b. Given a 530B/P-8 structural fire-fighting vehicle and mounted equipment, perform a drafting operation in accordance with technical order procedures. Drafting operation must be completed in less than five minutes, while observing all applicable safety practices.</p> <p>c. Given a 530B/P-8 structural fire-fighting vehicle and mounted equipment, perform a foam pumping operation in accordance with technical order procedures. Foam pumping operation must be completed in less than five minutes, while observing all applicable safety practices.</p> <p>d. Given necessary equipment, perform preventive maintenance on the 530B/P-8 structural pumper and mounted equipment IAW AFIO Form 434. Maintain station facilities as required.</p>	<p>8 (6/2) Day 22</p>	<p><u>Column 1 Reference</u> 4a, 4b, 4c 4d</p> <p><u>STS Reference</u> 3b(3), 4c, 10j 3b(2), 13b, 13c</p> <p><u>Instructional Materials</u> 3ABR57130-1-SG-404, Pumping Operations on the 530B/P-8 Structural Pumpers 3ABR57130-1-WB-404, Pumping Operations on the 530B/P-8 Structural Pumpers TO 36A12-12-9-61 TO 36A12-12-12-1</p> <p><u>Training Equipment</u> Vehicles: 530B, Structural Firefighting Vehicle and Mounted Equipment (5) A/S32P-8, Structural Firefighting Vehicle and Mounted Equipment (5) Drafting Pit (10) Helmets (2) Gloves (1) Preventive Maintenance Materials (10)</p> <p><u>Training Methods</u> Discussion/Demonstration (1 hr) Performance (5 hrs) Outside Assignments (2 hrs)</p> <p><u>Instructional Environment/Design</u> Classroom (.5 hr) Laboratory (5.5 hrs)</p> <p><u>Instructional Guidance</u> Check the outside assignment given the previous day. Stress safety during pump operations to include watching for loose or nozzleless lines, excessive pressure, proper vehicle and pump operation and insure chocks are in place. When pumping on the hangar floor, insure that the hangar exhaust pipes are connected to the pumper. Remind students of the dangers involved while performing on a vehicle with the engine running.</p>
<p>PLAN OF INSTRUCTION NO. 3ABR57130-1</p>	<p>DATE 7 Jul 75</p>	<p>BLOCK NO. IV PAGE NO. 36</p>

PLAN OF INSTRUCTION (Continued)

1 UNITS OF INSTRUCTION AND CRITERION OBJECTIVES	2 DURATION (HOURS)	3 SUPPORT MATERIALS AND GUIDANCE
<p>5. Inspection, Maintenance, Mounted Equipment and Operations on the 750A/P-12 Structural Pumpers</p> <p>a. Given AFTO Form 434 and technical data, inspect and perform operator maintenance on the 750A/P-12 structural firefighting vehicle and mounted equipment. All applicable items on the AFTO Form 434 must be inspected. Operator maintenance must be accomplished according to the technical order.</p> <p>b. Given a 750A/P-12 structural fire-fighting vehicle and mounted equipment, perform a hydrant operation in accordance with technical order procedures. Hydrant operation must be completed in less than five minutes, while observing all applicable safety practices.</p> <p>c. Given a 750A/P-12 structural fire-fighting vehicle and mounted equipment, perform a drafting operation in accordance with technical order procedures. Drafting operation must be completed in less than five minutes, while observing all applicable safety practices.</p>	<p>8 (6/2). Day 23</p>	<p>Do not allow students to handle the exhaust piping system with bare hands especially after the system has been used because the piping system is extremely hot. Also assure that the side hallway hangar doors are kept closed to reduce the noise level. Report any damaged exhaust system problems to the instructor-supervisor immediately. Stress the importance of properly operating Air Force equipment in order to prevent damage resulting in costly repairs. Stress energy and materials conservation. Give the outside assignment for the next subject.</p> <p><u>Column 1 Reference</u> <u>STS Reference</u> 5a 3b(3), 4c, 13a(1) 5b, 5c, 5d 3b(3), 4c, 10j 5e 3b(2), 13b, 13c</p> <p><u>Instructional Materials</u> 3ABR57130-1-SG-405, Inspection, Maintenance, Mounted Equipment and Operations on the 750A/P-12 Structural Pumpers 3ABR57130-1-WB-405, Inspection, Maintenance, Mounted Equipment and Operations on the 750A/P-12 Structural Pumpers TO 36A12-12-8-51, Powered Pumper Fire Truck, Class 750A TO 36A12-12-15-1, Firefighting Truck - 750 GPM, Structural Type A/S32P-12</p> <p><u>Audio Visual Aids</u> Charts</p> <p><u>Training Equipment</u> Vehicles: 750A, Structural Firefighting Vehicle and Mounted Equipment (5) A/S32P-12, Structural Firefighting Vehicle and Mounted Equipment (5) Drafting Pit (10) Trainer: 750A Pump Panel, 1470 (10) Helmets (1) Gloves (1) Preventive Maintenance Materials (10)</p>
<p>PLAN OF INSTRUCTION NO. 3ABR57130-1</p>	<p>DATE 7 Jul 75</p>	<p>BLOCK NO. IV PAGE NO. 37</p>



8

PLAN OF INSTRUCTION (Continued)

UNITS OF INSTRUCTION AND CRITERION OBJECTIVES	DURATION (HOURS)	SUPPORT MATERIALS AND GUIDANCE						
<p>d. Given a 750A/P-12 structural fire-fighting vehicle and mounted equipment, perform a foam operation in accordance with technical order procedures. Foam operation must be completed in less than five minutes, while observing all applicable safety practices.</p> <p>e. Given necessary equipment, perform preventive maintenance on the 750A/P-12 structural firefighting vehicle and mounted equipment IAW APTO Form 434. Maintain station facilities as required.</p> <p>6. Pumping Operations on the 750A/P-12 Structural Pumps</p> <p>a. Given a 750A/P-12 structural fire-fighting vehicle and mounted equipment, perform a booster operation in accordance with technical order procedures. Booster operation must be completed in less than five minutes, while observing all applicable safety practices.</p> <p>b. Given necessary equipment, perform preventive maintenance on the 750A/P-12 structural firefighting vehicle and mounted equipment IAW APTO Form 434. Maintain station facilities as required.</p>	<p>4 (2/2) Day 24.</p>	<p><u>Training Methods</u> Discussion/Demonstration (2 hrs) Performance (4 hrs) Outside Assignments (2 hrs)</p> <p><u>Instructional Environment/Design</u> Classroom (1.5 hrs) Laboratory (4.5 hrs)</p> <p><u>Instructional Guidance</u> Check the outside assignment given the previous day. Stress safety during pump operations to include watching for loose or nozzleless lines, excessive pressure, proper vehicle and pump operation, and insure chocks are in place. Stress the importance of properly operating Air Force equipment in order to prevent damage resulting in costly repairs. Stress energy and materials conservation. Give the outside assignment for the next subject.</p> <table border="0"> <tr> <td><u>Column 1 Reference</u></td> <td><u>STS Reference</u></td> </tr> <tr> <td>6a</td> <td>3b(3), 4c, 10j</td> </tr> <tr> <td>6b</td> <td>3b(2), 13b, 13c</td> </tr> </table> <p><u>Instructional Materials</u> 3ABR57130-1-SG-406, Pumping Operations on the 750A/P-12 Structural Pumps 3ABR57130-1-WB-406, Pumping Operations on the 750A/P-12 Structural Pumps TO 36A12-12-8-51 TO 36A12-12-15-1</p> <p><u>Training Equipment</u> <u>Vehicles:</u> 750A, Structural Firefighting Vehicle and Mounted Equipment (5) A/S32P-12, Structural Firefighting Vehicle and Mounted Equipment (5) Helmets (1) Gloves (1) Preventive Maintenance Materials (10)</p>	<u>Column 1 Reference</u>	<u>STS Reference</u>	6a	3b(3), 4c, 10j	6b	3b(2), 13b, 13c
<u>Column 1 Reference</u>	<u>STS Reference</u>							
6a	3b(3), 4c, 10j							
6b	3b(2), 13b, 13c							
PLAN OF INSTRUCTION NO. 3ABR57130-1	DATE 7 Jul 75	BLOCK NO. IV PAGE NO. 38						



PLAN OF INSTRUCTION (Continued)

1 UNITS OF INSTRUCTION AND CRITERION OBJECTIVES	2 DURATION (HOURS)	3 SUPPORT MATERIALS AND GUIDANCE
<p>7. Vehicle Positioning, Relay and Hose Operations</p> <p>a. Without the aid of references, select the correct procedures for positioning firefighting vehicles. Eighty percent of the procedures must be selected correctly.</p> <p>b. Without reference, select the proper procedures for vehicle relay operations. Eighty percent of the procedures must be selected correctly.</p> <p>c. Without the aid of references, select the correct procedures for hose operations. Procedures must be selected with 80 percent accuracy.</p>	<p>4 Day 24</p>	<p><u>Training Methods</u> Discussion/Demonstration (1 hr) Performance (1 hr) Outside Assignments (2 hrs)</p> <p><u>Instructional Environment/Design</u> Classroom (.5 hr) Laboratory (1.5 hrs)</p> <p><u>Instructional Guidance</u> Check the outside assignment given the previous day. Stress safety during pump operations to include watching for loose or nozzleless lines, excessive pressure, proper vehicle and pump operation and insure chocks are in place. Stress the importance of properly operating Air Force equipment in order to prevent damage resulting in costly repairs. Stress energy and materials conservation.</p> <p><u>Column 1 Reference</u> <u>STS Reference</u> 7a 10f 7b 10h 7c 10g</p> <p><u>Instructional Materials</u> 3ABR57130-1-SG-407, Vehicle Positioning, Relay and Hose Operations</p> <p><u>Audio Visual Aids</u> Film: TFI 5049, "Care and Maintenance of Hose" Charts</p> <p><u>Training Methods</u> Discussion/Demonstration (4 hrs)</p> <p><u>Instructional Environment/Design</u> Classroom (4 hrs)</p>
<p>PLAN OF INSTRUCTION NO. 3ABR57130-1</p>	<p>DATE 7 Jul 75</p>	<p>BLOCK NO. IV PAGE NO. 39</p>



PLAN OF INSTRUCTION (Continued)

UNITS OF INSTRUCTION AND CRITERION OBJECTIVES	DURATION 2 (HOURS)	3 SUPPORT MATERIALS AND GUIDANCE
<p>8. Hose Loads and Finishes</p> <p>a. Given a structural pumper, fire hose, necessary equipment, TO and WB, load hose on pumpers and make hose load finishes IAW the WB procedures with minimum instructor assistance.</p> <p>b. Given necessary equipment, perform preventive maintenance on structural fire-fighting vehicles and mounted equipment IAW AFTO Form 434. Maintain station facilities as required.</p>	<p>8 (6/2) Day 25</p>	<p><u>Instructional Guidance</u> Stress the importance of positioning the vehicle so that it can be used most advantageously. Explain why a relay operation may be necessary and why efficient hose operations are essential to combat fires. Stress energy and materials conservation. Give the outside assignment for the next subject.</p> <p><u>Column 1 Reference</u> <u>STS Reference</u> 8a 3b(3), 10r 8b 3b(2), 13b, 13c</p> <p><u>Instructional Materials</u> 3ABR57130-1-SG-408, Hose Loads and Finishes 3ABR57130-1-WB-408, Hose Loads and Finishes TO 36A12-12-8-51 TO 36A12-12-9-61 TO 36A12-12-12-1 TO 36A12-12-15-1</p> <p><u>Audio Visual Aide</u> Film: FTA 258D, "Hose Loads" Charts</p> <p><u>Training Equipment</u> Trainer: 750A Hose Bed Loader, 3019 (5) Hose Washer (10) Dryer, Fire Hose (10) Vehicles: 530B, Structural Firefighting Vehicle and Mounted Equipment (5) 750A, Structural Firefighting Vehicle and Mounted Equipment (5) A/S32P-8, Structural Firefighting Vehicle and Mounted Equipment (5) A/S32P-12, Structural Firefighting Vehicle and Mounted Equipment (5) Helmets (1) Gloves (1) Preventive Maintenance Materials (10)</p>
PLAN OF INSTRUCTION NO. 3ABR57130-1	DATE 7 Jul 75	BLOCK NO. IV PAGE NO. 40



11

PLAN OF INSTRUCTION (Continued)

1 UNITS OF INSTRUCTION AND CRITERION OBJECTIVES	2 DURATION (HOURS)	3 SUPPORT MATERIALS AND GUIDANCE
<p>9. Hose Lays</p> <p>a. Given a structural firefighting vehicle and necessary tools, perform straight hose lays. All procedures outlined in the WB must be strictly adhered to, while observing applicable safety procedures. Position and operate tools and equipment as required.</p> <p>b. Given a structural firefighting vehicle and necessary tools, perform reverse hose lays. All procedures outlined in the WB must be strictly adhered to, while observing applicable safety procedures. Position and operate tools and equipment as required.</p>	<p>8 (6/2) Day 26</p>	<p><u>Training Methods</u> Discussion/Demonstration (2.5 hrs) Performance (3.5 hrs) Outside Assignments (2 hrs)</p> <p><u>Instructional Environment/Design</u> Classroom (2 hrs) Laboratory (4 hrs)</p> <p><u>Instructional Guidance</u> Check the outside assignment given the previous day. Stress the importance of loading the hose so that it will "pay out" without jamming. Stress the use of the different load finishes. Stress safety during all phases of the operation. Stress the importance of properly operating Air Force equipment in order to prevent damage resulting in costly repairs. Stress energy and materials conservation. Give the outside assignment for the next subject.</p> <p><u>Column 1 Reference</u> <u>STS Reference</u> 9a, 9b 3b(3), 3b(5), 10g, 10j, 10n 9c 10h, 10j 9d 3b(2), 13a(3), 13b, 13c</p> <p><u>Instructional Materials</u> 3ABR57130-1-SG-409, Hose Lays 3ABR57130-1-WB-409, Hose Lays TO 36A12-12-8-51 TO 36A12-12-9-61 TO 36A12-12-12-1 TO 36A12-12-15-1</p> <p><u>Training Equipment</u> <u>Vehicles:</u> 530B, Structural Firefighting Vehicle and Mounted Equipment (5) 750A, Structural Firefighting Vehicle and Mounted Equipment (5) - A/S32P-8, Structural Firefighting Vehicle and Mounted Equipment (5) A/S32P-12, Structural Firefighting Vehicle and Mounted Equipment (5)</p>
PLAN OF INSTRUCTION NO. 3ABR57130-1	DATE 7 Jul 75	BLOCK NO. IV
		PAGE NO. 41

PLAN OF INSTRUCTION (Continued)

UNITS OF INSTRUCTION AND CRITERION OBJECTIVES	DURATION (HOURS)	SUPPORT MATERIALS AND GUIDANCE								
<p>c. Given two structural firefighting vehicles, perform vehicle relay operation in accordance with the WB procedures, while observing all applicable safety procedures.</p> <p>d. Given necessary equipment, perform preventive maintenance on structural firefighting vehicles and mounted equipment IAW AFTO Form 434. Maintain station facilities and protective clothing as required.</p>		<p>Protective Clothing (1) Preventive Maintenance Materials (10)</p> <p><u>Training Methods</u> Discussion/Demonstration (.5 hr) Performance (5.5 hrs) Outside Assignments (2 hrs)</p> <p><u>Instructional Environment/Design</u> Classroom (.5 hr) Laboratory (5.5 hrs)</p>								
<p>10. Structural Firefighting Procedures</p> <p>a. Without reference, identify principles of structural firefighting. Eighty percent of the principles must be identified correctly.</p> <p>b. Without reference, identify the principles of building heat and smoke ventilation. Eight of 10 principles must be identified correctly.</p>	<p>8 (6/2) Day 27</p>	<p><u>Instructional Guidance</u> Check the outside assignment given the previous day. Observe operations to detect excessive nozzle pressure that could cause injury to personnel or equipment, students straddling hose, or personal inattention that could result in injury. Observe proper coupling and handling to prevent damage and insure personnel stay clear of "flying" couplings during hose laying operations. During excessively cold weather, the hose lays will be performed on the hangar floor. Hose lays should be 100 to 200 feet long. Stress the importance of properly operating Air Force equipment in order to prevent damage resulting in costly repairs. Stress energy and materials conservation. Give the outside assignment for the next subject.</p> <table border="0"> <tr> <td><u>Column 1 Reference</u></td> <td><u>STS Reference</u></td> </tr> <tr> <td>10a</td> <td>10a</td> </tr> <tr> <td>10b</td> <td>10c</td> </tr> <tr> <td>10c</td> <td>10q(2)</td> </tr> </table> <p><u>Instructional Materials</u> 3ABR57130-1-SG-410, Structural Firefighting Procedures</p> <p><u>Audio Visual Aids</u> 35mm Slides, Carousel Set #410, Structural Firefighting Procedures Charts</p>	<u>Column 1 Reference</u>	<u>STS Reference</u>	10a	10a	10b	10c	10c	10q(2)
<u>Column 1 Reference</u>	<u>STS Reference</u>									
10a	10a									
10b	10c									
10c	10q(2)									
<p>PLAN OF INSTRUCTION NO. 3ABR57130-1</p>	<p>DATE 7 Jul 75</p>	<p>BLOCK NO. IV PAGE NO. 42</p>								

PLAN OF INSTRUCTION (Continued)																		
UNITS OF INSTRUCTION AND CRITERION OBJECTIVES	DURATION HOURS	SUPPORT MATERIALS AND GUIDANCE																
<p>c. Without reference, identify visual inspection procedures for determining structural stability of a building. Eighty percent of the procedures must be identified correctly.</p>		<p>Films: TFI 5283, "Getting the Most Out of Water" TFI 5337; "Tale of Two Towns" TFI 5971, "The Moxsleman" TFI 5972, "Coordinated Fire Attack" TVL 5713, "Moss Stream Application"</p> <p>Training Equipment Trainers: Door and Door Frame, 4097 (10) Check Rail Window, 4098 (10)</p> <p>Training Methods Discussion/Demonstration (6 hrs) Outside Assignments (2 hrs)</p> <p>Instructional Environment/Design Classroom (6 hrs)</p> <p>Instructional Guidance Check the outside assignment given the previous day. Emphasize how all aspects of structural firefighting procedures are interrelated. Stress the importance of the visual inspection for structural stability to prevent firefighting crews from being hurt. Stress energy and materials conservation. Give the outside assignment for the next subject.</p>																
<p>11. Structural Firefighting Operations</p> <p>a. Given a structural pumper and mounted equipment, AFTO Form 434 and technical data, inspect and perform operator maintenance on structural firefighting vehicles and mounted equipment. Operator maintenance must be accomplished according to the technical order. All applicable items on the AFTO Form 434 must be inspected.</p>	<p>8 (6/2) Day 28</p>	<p>Column 1 Reference</p> <table border="0"> <tr><td>11a</td><td>3b(2), 3b(3), 4c, 13a(1)</td></tr> <tr><td>11b</td><td>3b(3), 3b(4), 3b(5), 10j, 12e, 14b(5)</td></tr> <tr><td>11c</td><td>3b(1), 3b(5), 12e, 12f(1)</td></tr> <tr><td>11d</td><td>3b(1), 3b(5), 10j, 10o, 12e</td></tr> <tr><td>11e</td><td>3b(1), 3b(5), 10j, 12e</td></tr> <tr><td>11f</td><td>3b(1), 3b(5), 10j, 10m</td></tr> <tr><td>11g</td><td>3b(5), 10j, 10q(3)</td></tr> <tr><td>11h</td><td>3b(2), 13a(3), 13b, 13c</td></tr> </table> <p>STS Reference</p>	11a	3b(2), 3b(3), 4c, 13a(1)	11b	3b(3), 3b(4), 3b(5), 10j, 12e, 14b(5)	11c	3b(1), 3b(5), 12e, 12f(1)	11d	3b(1), 3b(5), 10j, 10o, 12e	11e	3b(1), 3b(5), 10j, 12e	11f	3b(1), 3b(5), 10j, 10m	11g	3b(5), 10j, 10q(3)	11h	3b(2), 13a(3), 13b, 13c
11a	3b(2), 3b(3), 4c, 13a(1)																	
11b	3b(3), 3b(4), 3b(5), 10j, 12e, 14b(5)																	
11c	3b(1), 3b(5), 12e, 12f(1)																	
11d	3b(1), 3b(5), 10j, 10o, 12e																	
11e	3b(1), 3b(5), 10j, 12e																	
11f	3b(1), 3b(5), 10j, 10m																	
11g	3b(5), 10j, 10q(3)																	
11h	3b(2), 13a(3), 13b, 13c																	
PLAN OF INSTRUCTION NO. 3ABR57130-1	DATE 7 Jul 75	BLOCK NO. IV PAGE NO. 43																



PLAN OF INSTRUCTION (Continued)

1 UNITS OF INSTRUCTION AND CRITERION OBJECTIVES	2 DURATION (HOURS)	3 SUPPORT MATERIALS AND GUIDANCE
<p>b. Given firefighting vehicles, tools, equipment, breathing apparatus, protective clothing and technical data, perform crew duties in firefighting drills and emergency response exercises. Workbook procedures must be strictly adhered to while observing all applicable safety practices.</p> <p>c. Given a building, demonstrate normal and emergency entry procedures. All entry procedures must be in accordance with the WB procedures. All applicable safety procedures must be strictly adhered to.</p> <p>d. Given a burning building, firefighting vehicles, tools, equipment, breathing apparatus, protective clothing and technical data, perform as a member of a firefighting crew to control and extinguish structural fires. Each fire must be completely extinguished while observing all applicable safety procedures.</p> <p>e. Given an occupied building, locate and evacuate personnel from building in less than three minutes.</p> <p>f. Given structural firefighting vehicle and a building on fire, protect adjacent/nearby building exposures and equipment from fire hazards in accordance with the WB procedures, while observing all applicable safety procedures.</p> <p>g. Given a building and appropriate cleanup equipment, perform firefighting overhaul cleanup operations. All debris and water must be removed.</p>		<p><u>Instructional Materials</u> 3ABR57130-1-SG-411, Structural Firefighting Operations 3ABR57130-1-WB-411, Structural Firefighting Operations TO 36A12-12-8-51 TO 36A12-12-9-61 TO 36A12-12-12-1 TO 36A12-12-15-1</p> <p><u>Training Equipment</u> Three-Story Training Tower and Building (10) Vehicles: 750A, Structural Firefighting Vehicles and Mounted Equipment (5) 530B, Structural Firefighting Vehicles and Mounted Equipment (5) A/S32P-8, Structural Firefighting Vehicles and Mounted Equipment (5) A/S32P-12, Structural Firefighting Vehicles and Mounted Equipment (5) Breathing Apparatus (1) Air Compressor (10) Drafting Pit (10) Protective Clothing (1) Deluge Gun (5) Preventive Maintenance Materials (10)</p> <p><u>Training Methods</u> Discussion/Demonstration (.5 hr) Performance (5.5 hrs) Outside Assignments (2 hrs)</p> <p><u>Instructional Environment/Design</u> Classroom (.5 hr) Laboratory (5.5 hrs)</p> <p><u>Instructional Guidance</u> Check the outside assignment given the previous day. Insure students are fitted with provided clothing and have necessary equipment. Check vehicle chocks, watch for safe practices in vehicle operation, mounting</p>
PLAN OF INSTRUCTION NO. 3ABR57130-1	DATE 7 Jul 75	BLOCK NO. IV PAGE NO. 44

PLAN OF INSTRUCTION (Continued)

1 UNITS OF INSTRUCTION AND CRITERION OBJECTIVES	2 DURATION (HOURS)	3 SUPPORT MATERIALS AND GUIDANCE																										
<p>h. Given necessary equipment, perform preventive maintenance on structural firefighting vehicles and mounted equipment IAW AFTO Form 434. Maintain station facilities and protective clothing as required.</p> <p>12. Structural Firefighting Tactics</p> <p>a. Given a structural pumper and mounted equipment, AFTO Form 434 and technical data, inspect and perform operator maintenance on structural firefighting vehicles. Operator maintenance must be accomplished according to the technical order. All applicable items on the AFTO Form 434 must be inspected.</p> <p>b. Given firefighting vehicles, tools, equipment, breathing apparatus, protective clothing and technical data, perform crew duties in firefighting drills and emergency response exercises. Workbook procedures must be strictly adhered to while observing all applicable safety practices.</p> <p>c. Given a building, demonstrate normal and emergency entry procedures. All entry procedures must be in accordance with the WB. All applicable safety procedures must be strictly adhered to.</p> <p>d. Given a building, locate master switch and shutoff building utilities in less than one minute.</p>	<p>8 (6/2) Day 29</p>	<p>of vehicles, forcible entry, and during rescue and lifting operations. Caution all on horseplay and/or inattention and the dangers involved. Stress the importance of properly operating Air Force equipment in order to prevent damage resulting in costly repairs. Stress energy and materials conservation. Give the outside assignment for the next subject.</p> <table border="0"> <tr> <td><u>Column 1 Reference</u></td> <td><u>STS Reference</u></td> </tr> <tr> <td>12a</td> <td>3b(2), 3b(3), 4c, 13a(1)</td> </tr> <tr> <td>12b</td> <td>3b(3), 3b(4), 3b(5); 10j, 12e, 14b(5)</td> </tr> <tr> <td>12c</td> <td>3b(1), 3b(5), 12e, 12f(1)</td> </tr> <tr> <td>12d</td> <td>3b(1), 3b(5), 10k, 12a</td> </tr> <tr> <td>12e</td> <td>3b(1), 3b(5), 10j, 10o, 12a</td> </tr> <tr> <td>12f</td> <td>3b(1), 3b(5), 12e, 12i(1)</td> </tr> <tr> <td>12g</td> <td>3b(1); 3b(5), 10j, 10m</td> </tr> <tr> <td>12h</td> <td>3b(1), 3b(5), 10p(1)</td> </tr> <tr> <td>12i</td> <td>3b(1), 3b(5), 10p(2)</td> </tr> <tr> <td>12j</td> <td>3b(1), 3b(5), 10p(3), 12e</td> </tr> <tr> <td>12k</td> <td>3b(5), 10j, 10q(3)</td> </tr> <tr> <td>12l</td> <td>3b(2), 13a(3), 13b, 13c</td> </tr> </table> <p><u>Instructional Materials</u></p> <p>3ABR57130-1-SC-412, Structural Firefighting Tactics 3ABR57130-1-WB-412, Structural Firefighting Tactics TO 36A12-12-8-51 TO 36A12-12-9-61 TO 36A12-12-12-1 TO 36A12-12-15-1</p> <p><u>Training Equipment</u></p> <p>Three-Story Training Tower and Building (10) Vehicles: 750A, Structural Firefighting Vehicle and Mounted Equipment (5) 530B, Structural Firefighting Vehicle and Mounted Equipment (5) A/S32P-8, Structural Firefighting Vehicle and Mounted Equipment (5) A/S32P-12, Structural Firefighting Vehicle and Mounted Equipment (5)</p>	<u>Column 1 Reference</u>	<u>STS Reference</u>	12a	3b(2), 3b(3), 4c, 13a(1)	12b	3b(3), 3b(4), 3b(5); 10j, 12e, 14b(5)	12c	3b(1), 3b(5), 12e, 12f(1)	12d	3b(1), 3b(5), 10k, 12a	12e	3b(1), 3b(5), 10j, 10o, 12a	12f	3b(1), 3b(5), 12e, 12i(1)	12g	3b(1); 3b(5), 10j, 10m	12h	3b(1), 3b(5), 10p(1)	12i	3b(1), 3b(5), 10p(2)	12j	3b(1), 3b(5), 10p(3), 12e	12k	3b(5), 10j, 10q(3)	12l	3b(2), 13a(3), 13b, 13c
<u>Column 1 Reference</u>	<u>STS Reference</u>																											
12a	3b(2), 3b(3), 4c, 13a(1)																											
12b	3b(3), 3b(4), 3b(5); 10j, 12e, 14b(5)																											
12c	3b(1), 3b(5), 12e, 12f(1)																											
12d	3b(1), 3b(5), 10k, 12a																											
12e	3b(1), 3b(5), 10j, 10o, 12a																											
12f	3b(1), 3b(5), 12e, 12i(1)																											
12g	3b(1); 3b(5), 10j, 10m																											
12h	3b(1), 3b(5), 10p(1)																											
12i	3b(1), 3b(5), 10p(2)																											
12j	3b(1), 3b(5), 10p(3), 12e																											
12k	3b(5), 10j, 10q(3)																											
12l	3b(2), 13a(3), 13b, 13c																											
PLAN OF INSTRUCTION NO. 3ABR57130-1	DATE 7 Jul 75	BLOCK NO. IV PAGE NO. 45																										



PLAN OF INSTRUCTION (Continued)

UNITS OF INSTRUCTION AND CRITERION OBJECTIVES	DURATION (HOURS)	SUPPORT MATERIALS AND GUIDANCE
<p>e. Given a burning building, firefighting vehicles, tools, equipment, breathing apparatus, protective clothing and technical data, perform as a member of a firefighting crew to control and extinguish structural fires. Each fire must be completely extinguished while observing all applicable safety procedures.</p> <p>f. Given a building, protective clothing, rescue equipment and a rescue dummy, locate dummy victim and perform rescue from building using the appropriate type of carry. The rescue must be accomplished in less than three minutes while observing all applicable safety procedures.</p> <p>g. Given structural firefighting vehicle and a building on fire, protect adjacent/near-by building exposures and equipment from fire hazards in accordance with the WB procedures, while observing all applicable safety procedures.</p> <p>h. Given salvage covers and a furnished room, perform as a member of a crew to protect building contents. Contents must be sufficiently protected with salvage covers to prevent further damage.</p> <p>i. Given salvage covers and a building, perform as a member of a crew and construct catch basins and drain chutes. Basins and chutes must be designed/constructed in such a manner as to prevent further water damage to the building and contents.</p> <p>j. Given a furnished room, perform as a member of a crew and remove equipment and furnishings in less than 30 minutes in accordance with the WB procedures.</p>	<p>2</p>	<p>Breathing Apparatus (1) Air Compressor (10) Drafting Pit (10) Protective Clothing (1) Deluge Gun (5) Rescue Dummies (5) Preventive Maintenance Materials (10)</p> <p><u>Training Methods</u> Discussion/Demonstration (.5 hr) Performance (5.5 hrs) Outside Assignments (2 hrs)</p> <p><u>Instructional Environment/Design</u> Classroom (.5 hr) Laboratory (5.5 hrs)</p> <p><u>Instructional Guidance</u> Check the outside assignment given the previous day. Ensure students are fitted with provided clothing and have necessary equipment. Check vehicle chocks, watch for safe practices in vehicle operation, mounting of vehicles, forcible entry and during rescue and lifting operations. Caution all students on horseplay and/or inattention and the dangers involved. Stress the importance of properly operating Air Force equipment in order to prevent damage resulting in costly repairs. Stress energy and materials conservation. Give the outside assignment for the next subjects.</p>
PLAN OF INSTRUCTION NO. 3ABR57130-1	DATE 7 Jul 75	BLOCK NO. IV PAGE NO. 46

PLAN OF INSTRUCTION (Continued)

UNITS OF INSTRUCTION AND CRITERION OBJECTIVES	DURATION (HOURS)	SUPPORT MATERIALS AND GUIDANCE	
<p>k. Given a building and appropriate cleanup equipment, perform firefighting overhaul cleanup operations. All debris and water must be removed.</p> <p>l. Given necessary equipment, perform preventive maintenance on structural firefighting vehicles and mounted equipment IAW AFTO Form 434. Maintain station facilities and protective clothing as required.</p> <p>13. Preservation of Evidence</p> <p>e. Without reference, identify procedures for preserving evidence to determine cause of a fire. Eighty percent of the procedures must be identified correctly.</p> <p>14. Fire Station Maintenance</p> <p>e. Given firefighting protective clothing, inspect and perform maintenance on clothing as required. Procedures listed in WB must be followed without error.</p>	<p>3 (2/1) Day 30</p> <p>3 (2/1) Day 30</p>	<p><u>Column 1 Reference</u> <u>STS Reference</u> 13a 10q(1)</p> <p><u>Instructional Materials</u> 3ABR57130-1-SG-413, Preservation of Evidence</p> <p><u>Training Methods</u> Discussion/Demonstration (2 hrs) Outside Assignments (1 hr)</p> <p><u>Instructional Environment/Design</u> Classroom (2 hrs)</p> <p><u>Instructional Guidance</u> Check the outside assignments given the previous day. Stress the importance of preserving evidence at a fire scene to help in determining the cause of the fire and how to protect the evidence from being tampered with. Stress energy and materials conservation.</p> <p><u>Column 1 Reference</u> <u>STS Reference</u> 14a 3b(2), 13a(3) 14b 3b(2), 3b(3), 13b, 13c</p> <p><u>Instructional Materials</u> 3ABR57130-1-SG-414, Fire Station Maintenance 3ABR57130-1-WB-414, Fire Station Maintenance</p>	
PLAN OF INSTRUCTION NO. 3ABR57130-1	DATE 7 Jul 75	BLOCK NO. IV	PAGE NO. 47



PLAN OF INSTRUCTION (Continued)

UNITS OF INSTRUCTION AND CRITERION OBJECTIVES	DURATION (HOURS)	SUPPORT MATERIALS AND GUIDANCE
<p>b. Given necessary tools and equipment, maintain station facilities in accordance with the WB procedures. Perform preventive maintenance on structural firefighting vehicles and mounted equipment as required.</p>	<p>2</p>	<p><u>Training Equipment</u> Preventive Maintenance Materials (10) Structural Pumps and Mounted Equipment (5) Protective Clothing (1)</p> <p><u>Training Methods</u> Discussion/Demonstration (.5 hr) Performance (1.5 hrs) Outside Assignments (1 hr)</p> <p><u>Instructional Environment/Design</u> Classroom (.5 hr) Laboratory (1.5 hrs)</p> <p><u>Instructional Guidance</u> Stress safety on mounting vehicles, opening hoods, doors, etc. Stress safety while performing station maintenance. Stress energy and materials conservation. Give the outside assignment for the next subject in Block V.</p>
<p>15. Measurement Test and Test Critique</p> <p>a. Measurement Test</p> <p>b. Test Critique</p>	<p>2 Day 30 (1.5) (.5)</p>	

PLAN OF INSTRUCTION NO. 3ABR57130-1: DATE 7 Jul 75 BLOCK NO. IV PAGE NO. 48



PLAN OF INSTRUCTION		COURSE TITLE	
		Fire Protection Specialist	
BLOCK TITLE			
Aerospace Vehicle Firefighting (Crash Firefighter)			
UNITS OF INSTRUCTION AND CRITERION OBJECTIVES		DURATION (HOURS)	SUPPORT MATERIALS AND GUIDANCE
1. Block V, Orientation		.5	
a. Block Content		Day 31	<u>Column 1 Reference</u> <u>STS Reference</u> 1a, 1b, 1c None <u>Instructional Materials</u> 3ABR57130-1-SG-501, Block V, Orientation <u>Training Methods</u> Discussion/Demonstration (.5 hr) <u>Instructional Environment/Design</u> Classroom (.5 hr) <u>Instructional Guidance</u> Check the outside assignment given the previous day in Block IV. Insure that all students are aware of the safety procedures for Block V. They are posted on the display board in front of Building 902. Stress conservation of training literature, better care of protective clothing, minimum rpm when operating vehicles, overflowing trucks with water, better conservation of cleaning materials, tires and tire pressures, leaking trucks, expanding gasoline tanks, reduced booster heater operation, better inspection/operator maintenance. Read letter that restricts students from driving and parking in the Block V training area.
2. Principles and Procedures of Aerospace Vehicle Firefighting		7.5 (5.5/2) Day 31	<u>Column 1 Reference</u> <u>STS Reference</u> 2a 11b 2b 11a 2c 11m 2d 11l 2e 11n 2f 11c
a. Without reference, identify principles and procedures of aircraft firefighting. Eighty percent of the principles and procedures must be identified correctly.			
PLAN OF INSTRUCTION NO.	3ABR57130-1(2ASR57150)	DATE	7 Jul 75
BLOCK NO.	V (I)	PAGE NO.	49



PLAN OF INSTRUCTION (Continued)

UNITS OF INSTRUCTION AND CRITERION OBJECTIVES	DURATION (HOURS)	SUPPORT MATERIALS AND GUIDANCE								
<p>b. Without reference, identify principles of missile firefighting. Eighty percent of the principles must be identified correctly.</p> <p>c. Without reference, identify runway foaming operation procedures. Eighty percent of the procedures must be identified correctly.</p> <p>d. Without reference, identify standby operation procedures. Eighty percent of the procedures must be identified correctly.</p> <p>e. Without reference, identify airfield patrol and surveillance operation procedures. Eighty percent of the procedures must be identified correctly.</p> <p>f. Without reference, identify principles of large frame aircraft heat and smoke ventilation. Eighty percent of the principles must be identified correctly.</p> <p>3. Principles and Procedures of Rescue</p> <p>a. Without reference, identify principles and procedures relating to rescue of personnel from aircraft. Eighty percent of the principles and procedures must be correctly identified.</p> <p>b. Without reference, identify procedures for safetying egress systems. Eighty percent of the procedures must be identified correctly.</p>	<p>8 (6/2) Day 32</p>	<p><u>Instructional Materials</u> 3ABR57130-1-SG-502, Principles and Procedures of Aerospace Vehicle Firefighting</p> <p><u>Audio Visual Aids</u> Film: TFI 5605, "Foaming the Runway"</p> <p><u>Training Methods</u> Discussion/Demonstration (5.5 hrs) Outside Assignments (2 hrs)</p> <p><u>Instructional Environment/Design</u> Classroom (5.5 hrs)</p> <p><u>Instructional Guidance</u> Stress safety while dealing with fires involving aerospace vehicles and their associated fuel. Stress the importance of runway foaming, standby operations and ramp patrol. Stress energy and materials conservation. Give the outside assignment for the next subject.</p> <table border="0"> <tr> <td><u>Column 1 Reference</u></td> <td><u>STS Reference</u></td> </tr> <tr> <td>3a</td> <td>12a, 1-1(2)</td> </tr> <tr> <td>3b</td> <td>12h</td> </tr> <tr> <td>3c</td> <td>12g</td> </tr> </table> <p><u>Instructional Materials</u> 3ABR57130-1-SG-503, Principles and Procedures of Rescue TO 00-105E-9, Aircraft Rescue Emergency Information</p> <p><u>Audio Visual Aids</u> Films: -TF 5489, "Man on a Hot Seat" TVL 5728, "Operation Size-Up, Crash Rescue from Tactical Aircraft"</p> <p>Charts</p>	<u>Column 1 Reference</u>	<u>STS Reference</u>	3a	12a, 1-1(2)	3b	12h	3c	12g
<u>Column 1 Reference</u>	<u>STS Reference</u>									
3a	12a, 1-1(2)									
3b	12h									
3c	12g									
PLAN OF INSTRUCTION NO. 3ABR57130-1	DATE 7 Jul 75	BLOCK NO. V	PAGE NO. 50							

PLAN OF INSTRUCTION (Continued)													
1 UNITS OF INSTRUCTION AND CRITERION OBJECTIVES	2 DURATION (HOURS)	3 SUPPORT MATERIALS AND GUIDANCE											
<p>c. Without reference, identify procedures for shutting down aircraft engines and systems. Eighty percent of the procedures must be identified correctly.</p> <p>4. Rescue Operations</p> <p>a. Given a simulated crashed aircraft and P-10 rescue vehicle and mounted equipment, operate tools and equipment. All applicable technical order procedures and safety practices must be strictly adhered to with minimum instructor assistance.</p> <p>b. Given a simulated crashed aircraft and P-10 rescue vehicle and mounted equipment, demonstrate normal and emergency entry procedures. All entry procedures must be followed in accordance with TO 00-105E-9. All applicable safety procedures must be strictly adhered to with minimum instructor assistance.</p>	<p>4 (3/1) Day 33</p>	<p><u>Training Methods</u> Discussion/Demonstration (6 hrs) Outside Assignments (2 hrs)</p> <p><u>Instructional Environment/Design</u> Classroom (6 hrs)</p> <p><u>Instructional Guidance</u> Check the outside assignment given the previous day. Stress the importance of proper rescue procedures, safetying egress systems, and shutting down aircraft engines and systems. Have students report to the hangar for tomorrow's training on rescue operations and the ramp vehicle inspection, maintenance and operations. Have students hand carry their individual TO 00-105E-9 to the hangar. Stress energy and materials conservation. Give the outside assignment for the next subjects.</p> <table border="0"> <tr> <td><u>Column 1 Reference</u></td> <td><u>STS Reference</u></td> </tr> <tr> <td>4a</td> <td>3b(3), 4c, 11e, 11h</td> </tr> <tr> <td>4b</td> <td>3b(3), 4c, 12f(2)</td> </tr> <tr> <td>4c</td> <td>3b(3), 4c, 12i(2)</td> </tr> <tr> <td>4d</td> <td>3b(2), 3b(3), 13b, 13c</td> </tr> </table> <p><u>Instructional Materials</u> 3ABR57130-1-SG-504, Rescue Operations 3ABR57130-1-WB-504, Rescue Operations TO 00-105E-9 TO 36A12-12-13-1, Firefighting Truck Forcible Entry, USAF Type A/S32P-10</p> <p><u>Training Equipment</u> Trainer: Seat and Canopy T-33, 3188 (5) Vehicle: A/S32P-10 Rescue Vehicle and Mounted Equipment (5) Preventive Maintenance Materials (10) C-133 Aircraft (10) F-102 Aircraft (5) C-97 Aircraft (10) T-37 Aircraft (5)</p>		<u>Column 1 Reference</u>	<u>STS Reference</u>	4a	3b(3), 4c, 11e, 11h	4b	3b(3), 4c, 12f(2)	4c	3b(3), 4c, 12i(2)	4d	3b(2), 3b(3), 13b, 13c
<u>Column 1 Reference</u>	<u>STS Reference</u>												
4a	3b(3), 4c, 11e, 11h												
4b	3b(3), 4c, 12f(2)												
4c	3b(3), 4c, 12i(2)												
4d	3b(2), 3b(3), 13b, 13c												
PLAN OF INSTRUCTION NO. 3ABR57130-1	DATE 7 Jul 75	BLOCK NO. V	PAGE NO. 51										

PLAN OF INSTRUCTION (Continued)

1 UNITS OF INSTRUCTION AND CRITERION OBJECTIVES	2 DURATION (HOURS)	3 SUPPORT MATERIALS AND GUIDANCE								
<p>c. Given a simulated crashed aircraft, rescue aircrew members in accordance with procedures listed in TO 00-105E-9. All procedures must be followed using all applicable safety practices with minimum instructor assistance.</p> <p>d. Given necessary equipment, perform preventive maintenance on the P-10 rescue vehicle and mounted equipment IAW AFTO Form 433. Maintain station facilities as required.</p> <p>5. Ramp Vehicle Inspection, Maintenance and Operations</p> <p>a. Given the appropriate inspection checklist and technical data, inspect and perform operator maintenance on the ramp vehicle. All appropriate items on the checklist must be inspected. Operator maintenance must be accomplished according to the appropriate technical order.</p> <p>b. Given an aerospace airfield ramp firefighting vehicle and available technical data, operate the firefighting system(s). All applicable</p>	<p>4 (3/1) Day 33</p>	<p><u>Training Methods</u> Discussion/Demonstration (1 hr) Performance (2 hrs) Outside Assignments (1 hr)</p> <p><u>Instructional Environment/Design</u> Classroom (.5 hr) Laboratory (2.5 hrs)</p> <p><u>Instructional Guidance</u> Check the outside assignments given the previous day. Stress safety required when rescuing from aircraft because of canopy and seat removal systems. Use T-33 seat and canopy trainer for rescue training. No smoking in or around the aircraft. Cover the instructions on procedures to be used when opening cargo doors. Also include checks of landing gear controls, down lock pins and steering bypass relief valves as applicable. Coordinate with the rescue course instructor-supervisor as required in cross-utilization of the C-133, C-97, F-102 and T-37 aircraft. Stress energy and materials conservation.</p> <table border="0"> <tr> <td><u>Column 1 Reference</u></td> <td><u>STS Reference</u></td> </tr> <tr> <td>5a</td> <td>3b(3), 4c, 13a(1)</td> </tr> <tr> <td>5b</td> <td>3b(3), 4c, 11e</td> </tr> <tr> <td>5c</td> <td>3b(2), 3b(3), 13b, 13c</td> </tr> </table> <p><u>Instructional Materials</u> 3ABR57130-1-SG-505, Ramp Vehicle Inspection, Maintenance and Operations 3ABR57130-1-WB-505, Ramp Vehicle Inspection, Maintenance and Operations TO 36A12-8-15-1, Truck, Firefighting Airfield Ramp, A/S32P-13</p> <p><u>Training Equipment</u> Vehicle: A/S32P-13 Ramp Vehicle (5) Preventive Maintenance Materials (10)</p>	<u>Column 1 Reference</u>	<u>STS Reference</u>	5a	3b(3), 4c, 13a(1)	5b	3b(3), 4c, 11e	5c	3b(2), 3b(3), 13b, 13c
<u>Column 1 Reference</u>	<u>STS Reference</u>									
5a	3b(3), 4c, 13a(1)									
5b	3b(3), 4c, 11e									
5c	3b(2), 3b(3), 13b, 13c									
PLAN OF INSTRUCTION NO. 3ABR57130-1	DATE 7 Jul 75	BLOCK NO. V	PAGE NO. 52							

PLAN OF INSTRUCTION (Continued)			
1	2	3	
US TS OF INSTRUCTION AND CRITERION OBJECTIVES	DURATION (HOURS)	SUPPORT MATERIALS AND GUIDANCE	
<p>technical order procedures and safety practices must be strictly adhered to with minimum instructor assistance.</p> <p>c. Given necessary equipment, perform preventive maintenance on the ramp vehicle IAW AFTO Form 434. Maintain station facilities as required.</p>		<p><u>Training Methods</u> Discussion/Demonstration (1.5 hrs) Performance (1.5 hrs) Outside Assignments (1 hr)</p> <p><u>Instructional Environment/Design</u> Classroom (1 hr) Laboratory (2 hrs)</p> <p><u>Instructional Guidance</u> Stress the importance of proper care and maintenance of equipment and safety during operation of motorized equipment. Have students to return to the Block V training area for tomorrow's training on the O-11A inspection, maintenance and operations. Stress energy and materials conservation. Give the outside assignment for the next subject.</p>	
<p>6. O-11A Inspection, Maintenance and Operations</p> <p>a. Without reference, identify operational procedures on the O-11A aerospace crash fire and rescue vehicle. Eighty percent of the procedures must be identified correctly.</p> <p>b. Given AFTO Form 433 and technical data, inspect and perform operator maintenance on the O-11A aerospace crash fire and rescue vehicle. All applicable items on the AFTO Form 433 must be inspected. Operator maintenance must be accomplished according to the appropriate technical order.</p>	<p>8 (6/2) Day 34</p>	<p><u>Column 1 Reference</u></p> <p>6a 6b</p>	<p><u>STS Reference</u></p> <p>11e 3b(3), 4c, 13a(1)</p> <p><u>Instructional Materials</u> 3ABR57130-1-SG-506, O-11A Inspection, Maintenance and Operations 3ABR57130-1-WB-506, O-11A Inspection, Maintenance and Operations TO 36A12-8-9-1, Operation and Service Instructions, Truck-Crash, Fire and Rescue Foam High Pressure, Type O-11A</p> <p><u>Audio Visual Aids</u> Charts</p> <p><u>Training Equipment</u> Vehicle: O-11A (5)</p> <p><u>Training Methods</u> Discussion/Demonstration (3.5 hrs) Performance (2.5 hrs) Outside Assignments (2 hrs)</p>
PLAN OF INSTRUCTION NO.	3ABR57130-1	DATE	7 Jul 75
		BLOCK NO.	V
		PAGE NO.	53

PLAN OF INSTRUCTION (Continued)

1 UNITS OF INSTRUCTION AND CRITERION OBJECTIVES	2 DURATION (HOURS)	3 SUPPORT MATERIALS AND GUIDANCE						
<p>7. O-11B Inspection, Maintenance and Operations</p> <p>a. Without reference, identify operational procedures on the O-11B aerospace crash fire and rescue vehicle. Eighty percent of the procedures must be identified correctly.</p> <p>b. Given AFTO Form 433 and technical data, inspect and perform operator maintenance on the O-11B aerospace crash fire and rescue vehicle. All applicable items on the AFTO Form 433 must be inspected. Operator maintenance must be accomplished according to the appropriate technical order.</p>	<p>8 (6/2) Day 35</p>	<p><u>Instructional Environment/Design</u> Classroom (3 hrs) Laboratory (3 hrs)</p> <p><u>Instructional Guidance</u> Check the outside assignment given the previous day. During inspection, do not allow more than five students on the top of the O-11A at a time. Request assistance from the instructor-supervisor if required during the short period of time that this situation will occur. Stress energy and materials conservation. Give the outside assignment for the next subject.</p> <table border="0"> <tr> <td><u>Column 1 Reference</u></td> <td><u>STS Reference</u></td> </tr> <tr> <td>7a</td> <td>11a</td> </tr> <tr> <td>7b</td> <td>3b(3), 4c, 13a(1)</td> </tr> </table> <p><u>Instructional Materials</u> - 3ABR57130-1-SG-507, O-11B Inspection, Maintenance and Operations - 3ABR57130-1-WB-507, O-11B Inspection, Maintenance and Operations TO 36A12-8-12-1, Operation and Service Instructions, Crash, Fire and Rescue Truck</p> <p><u>Audio Visual Aids</u> Charts</p> <p><u>Training Equipment</u> Vehicle: O-11B (5)</p> <p><u>Training Methods</u> Discussion/Demonstration (3.5 hrs) Performance (2.5 hrs) Outside Assignments (2 hrs)</p> <p><u>Instructional Environment/Design</u> Classroom (3 hrs) Laboratory (3 hrs)</p>	<u>Column 1 Reference</u>	<u>STS Reference</u>	7a	11a	7b	3b(3), 4c, 13a(1)
<u>Column 1 Reference</u>	<u>STS Reference</u>							
7a	11a							
7b	3b(3), 4c, 13a(1)							
<p>PLAN OF INSTRUCTION NO. 3ABR57130-1</p>	<p>DATE 7 Jul 75</p>	<p>BLOCK NO. V PAGE NO. 54</p>						

PLAN OF INSTRUCTION (Continued)									
1 UNITS OF INSTRUCTION AND CRITERION OBJECTIVES	2 DURATION (HOURS)	3 SUPPORT MATERIALS AND GUIDANCE							
<p>8. P-2 Inspection, Maintenance and Operations</p> <p>a. Without reference, identify operational procedures on the P-2 aerospace crash fire and rescue vehicle. Eighty percent of the procedures must be identified correctly.</p> <p>b. Given AFTO Form 433 and technical data, inspect and perform operator maintenance on the P-2 aerospace crash fire and rescue vehicle. All applicable items on the AFTO Form 433 must be inspected. Operator maintenance must be accomplished according to the appropriate technical order.</p>	<p>8 (6/2) Day 36</p>	<p><u>Instructional Guidance</u> Check the outside assignment given the previous day. During inspection, do not allow more than five students on the top of the O-11B at a time. Request assistance from the instructor-supervisor if required during the short period of time that this situation will occur. Stress energy and materials conservation. Give the outside assignment for the next subject.</p> <table border="0"> <tr> <td><u>Column 1 Reference</u></td> <td><u>STS Reference</u></td> </tr> <tr> <td>8a</td> <td>11e</td> </tr> <tr> <td>8b</td> <td>3b(3), 4c, 13s(1)</td> </tr> </table> <p><u>Instructional Materials</u> 3ABR57130-1-SG-508, P-2 Inspection, Maintenance and Operations 3ABR57130-1-WB-508, P-2 Inspection, Maintenance and Operations TO 36A12-8-13-1, Truck, Firefighting Type, A/S32P-2</p> <p><u>Audio Visual Aids</u> Film: TVL 5724, "Operational Maintenance Check of the A/S32P-2 Truck" Charts</p> <p><u>Training Equipment</u> Vehicle: A/S32P-2 (5)</p> <p><u>Training Methods</u> Discussion/Demonstration (3.5 hrs) Performance (2.5 hrs) Outside Assignments (2. hrs)</p> <p><u>Instructional Environment/Design</u> Classroom (3 hrs) Laboratory (3 hrs)</p>		<u>Column 1 Reference</u>	<u>STS Reference</u>	8a	11e	8b	3b(3), 4c, 13s(1)
<u>Column 1 Reference</u>	<u>STS Reference</u>								
8a	11e								
8b	3b(3), 4c, 13s(1)								
PLAN OF INSTRUCTION NO. 3ABR57130-1	DATE 7 Jul 75	BLOCK NO. V	PAGE NO. 55						



PLAN OF INSTRUCTION (Continued)

1 UNITS OF INSTRUCTION AND CRITERION OBJECTIVES	2 DURATION (HOURS)	3 SUPPORT MATERIALS AND GUIDANCE	
<p>9. P-4 Inspection, Maintenance and Operations</p> <p>a. Without reference, identify operational procedures on the P-4 aerospace crash fire and rescue vehicle. Eighty percent of the procedures must be identified correctly.</p> <p>b. Given AFTO Form 433 and technical data, inspect and perform operator maintenance on the P-4 aerospace crash fire and rescue vehicle. All applicable items on the AFTO Form 433 must be inspected. Operator maintenance must be accomplished according to the appropriate technical order.</p>	<p>8 (6/2) Day 37</p>	<p><u>Instructional Guidance</u> Check the outside assignment given the previous day. During inspection do not allow more than five students on the top of the P-2 at a time. Request assistance from the instructor-supervisor if required during the short period of time that this situation will occur. Emphasize strongly that high pressure water streams can injure personnel. Stress energy and materials conservation. Give the outside assignment for the next subject.</p> <p><u>Column 1 Reference</u> <u>STS Reference</u> 9a 11e 9b 3b(3), 4c, 13a(1)</p> <p><u>Instructional Materials</u> 3ABR57130-1-SG-509, P-4 Inspection, Maintenance and Operations 3ABR57130-1-WB-509, P-4 Inspection, Maintenance and Operations TO 36A12-12-14-1, Operation and Maintenance Instructions - Truck, Fire-fighting, Multipurpose Air Transportable Type A/S32P-4</p> <p><u>Audio Visual Aids</u> Charts</p> <p><u>Training Equipment</u> Vehicle: A/S32P-4 (5)</p> <p><u>Training Methods</u> Discussion/Demonstration (3.5 hrs) Performance (2.5 hrs) Outside Assignments (2 hrs)</p> <p><u>Instructional Environment/Design</u> Classroom (3 hrs) Laboratory (3 hrs)</p>	
PLAN OF INSTRUCTION NO. 3ABR57130-1	DATE 7 Jul 75	BLOCK NO. V	PAGE NO. 56



PLAN OF INSTRUCTION (Continued)													
1 UNITS OF INSTRUCTION AND CRITERION OBJECTIVES	2 DURATION (HOURS)	3 SUPPORT MATERIALS AND GUIDANCE											
<p>10. Procedures for On Scene Operations</p> <p>e. Without reference, identify the procedures for determining proper vehicle approach at the scene of an aircraft emergency. Eighty percent of the procedures must be identified correctly.</p> <p>b. Without reference, determine the procedures for positioning aerospace crash, fire and rescue vehicles. Eighty percent of the procedures must be identified correctly.</p> <p>c. Without reference, identify aerospace vehicle crash fire salvage operation procedures. Eighty percent of the procedures must be identified correctly.</p> <p>d. Without reference, identify procedures for preserving evidence used to determine the cause of an aerospace vehicle crash/fire. Eighty percent of the procedures must be identified correctly.</p>	<p>8 (6/2) Day 38</p>	<p><u>Instructional Guidance</u> Check the outside assignment given the previous day. During inspection do not allow more than five students on the top of the P-4 at a time. Request assistance from the instructor-supervisor if required during the short period of time that this situation will occur. Stress energy and materials conservation. Give the outside assignment for the next subject.</p> <table border="0"> <tr> <td><u>Column 1 Reference</u></td> <td><u>STS Reference</u></td> </tr> <tr> <td>10a</td> <td><u>11f</u></td> </tr> <tr> <td>10b</td> <td><u>11g</u></td> </tr> <tr> <td>10c</td> <td><u>11k</u></td> </tr> <tr> <td>10d</td> <td><u>11(1)</u></td> </tr> </table> <p><u>Instructional Materials</u> 3ABR57130-1-SG-510, Procedures for On Scene Operations</p> <p><u>Audio Visual Aids</u> Film: TF 6176, "Aircraft Fire and Rescue Procedures"</p> <p><u>Training Methods</u> Discussion/Demonstration (6 hrs) Outside Assignments (2 hrs)</p> <p><u>Instructional Environment/Design</u> Classroom (6 hrs)</p> <p><u>Instructional Guidance</u> Check the outside assignment given the previous day. Emphasize the importance of proper approach and positioning of fire and rescue vehicles, salvage operations and preserving evidence. Issue protective clothing to the students. Allow time so that students can adjust necessary items of the clothing for proper fit. Stress energy and materials conservation. Give the outside assignment for the next subject.</p>		<u>Column 1 Reference</u>	<u>STS Reference</u>	10a	<u>11f</u>	10b	<u>11g</u>	10c	<u>11k</u>	10d	<u>11(1)</u>
<u>Column 1 Reference</u>	<u>STS Reference</u>												
10a	<u>11f</u>												
10b	<u>11g</u>												
10c	<u>11k</u>												
10d	<u>11(1)</u>												
PLAN OF INSTRUCTION NO. 3ABR57130-1	DATE 7 Jul 75	BLOCK NO. V	PAGE NO. 57										



PLAN OF INSTRUCTION (Continued)

1 UNITS OF INSTRUCTION AND CRITERION OBJECTIVES	2 DURATION (HOURS)	3 SUPPORT MATERIALS AND GUIDANCE	
<p>11. Emergency Response Exercises</p> <p>a. Using TO, operate the O-11A/B or P-4 aerospace crash fire and rescue vehicle with minimum instructor assistance.</p> <p>b. Using protective clothing, TO, and a workbook, perform crew duties in aerospace crash firefighting drills and emergency response exercises using an O-11A/B or P-4 aerospace crash fire and rescue vehicle with minimum instructor assistance.</p> <p>c. Given a firefighting vehicle and protective clothing, and following all pertinent safety procedures, flood or wash down simulated hazardous spills. Spills must be diluted until the simulated hazardous conditions are eliminated.</p> <p>d. Given necessary equipment, perform preventive maintenance on aerospace crash fire and rescue vehicles IAW AFTO Form 433. Maintain station facilities and protective clothing as required.</p>	<p>8 (6/2) Day 39</p>	<p><u>Column 1 Reference</u></p> <p>11a 11b 11c 11d</p> <p><u>Instructional Materials</u></p> <p>3ABRS7130-1-SG-511, Emergency Response Exercises 3ABRS7130-1-WB-511, Emergency Response Exercises TO 36A12-8-9-1 TO 36A12-8-12-1 TO 36A12-12-14-1</p> <p><u>Audio Visual Aids</u></p> <p>Charts</p> <p><u>Training Equipment</u></p> <p><u>Vehicles:</u> O-11A/B (5) A/S32P-4 (5)</p> <p><u>Trainers:</u> Simulated F-102 Aircraft, 3089 (10) Simulated F-105 Aircraft, 3091 (10) Simulated F-106 Aircraft, 3092 (10) Firefighting (B-47), 3122 (10) Firefighting (C-135), 3090 (10) Roof Turret O-11B, 3225 (5) Mounted Crash Firefighting Vehicle, 3226 (5) Preventive Maintenance Materials (10) Complete set of protective clothing (1)</p> <p><u>Training Methods</u> Discussion/Demonstration (1 hr) Performance (5 hrs) Outside Assignments (2 hrs)</p> <p><u>Instructional Environment/Design</u> Classroom (1 hr) Laboratory (5 hrs)</p>	<p><u>STS Reference</u></p> <p>3b(3), 11e. 3b(3), 3b(4), 3b(5), 11e, 14b(5) 3b(3), 3b(4), 3b(5), 7d, 11e 3b(2), 3b(5), 13a(3), 13b, 13c</p>
PLAN OF INSTRUCTION NO. 3ABRS7130-1	DATE 7 Jul 75	BLOCK NO. V	PAGE NO. 58



PLAN OF INSTRUCTION (Continued)

1 UNITS OF INSTRUCTION AND CRITERION OBJECTIVES	2 DURATION (HOURS)	3 SUPPORT MATERIALS AND GUIDANCE
<p>12. Emergency Response and Aircraft Approach Exercises</p> <p>a. Using TO, operate the O-11A/B or F-4 aerospace crash fire and rescue vehicle with minimum instructor assistance. Participate in firefighting drills and emergency response exercises as required.</p> <p>b. Using TO, operate the P-2 aerospace crash fire and rescue vehicle with minimum instructor assistance. Participate in firefighting drills and emergency response exercises as required.</p> <p>c. Given necessary equipment, perform preventive maintenance on aerospace crash fire and rescue vehicles IAW AFTO Form 433. Maintain station facilities and protective clothing as required.</p>	<p>8 (6/2) Day 40</p>	<p><u>Instructional Guidance</u> Check the outside assignment given the previous day. Give students a briefing on burn training area operations and procedures stressing safety while working around vehicles. Ascertain each student is under constant supervision of an instructor while in training area. Preplan for emergencies. Stress the importance of properly operating Air Force equipment in order to prevent damage resulting in costly repairs. Stress energy and materials conservation. Give the outside assignment for the next subject.</p> <p><u>Column 1 Reference</u> <u>STS Reference</u> 12a, 12b 3b(3), 3b(4), 3b(5), 11e, 14b(5) 12c 3b(2), 3b(5), 13a(3), 13b, 13c</p> <p><u>Instructional Materials</u> 3ABR57130-1-SG-512, Emergency Response and Aircraft Approach Exercises 3ABR57130-1-WB-512, Emergency Response and Aircraft Approach Exercises TO 36A12-8-13-1 TO 36A12-12-14-1 TO 36A12-8-9-1 TO 36A12-8-12-1</p> <p><u>Audio Visual Aids</u> Charts</p> <p><u>Training Equipment</u> <u>Vehicles:</u> O-11A/B (5) A/S32P-2 (5) A/S32P-4 (5)</p> <p><u>Trainers:</u> Simulated F-102 Aircraft, 3089 (10) Simulated F-105 Aircraft, 3091 (10) Simulated F-106 Aircraft, 3092 (10) Roof Turret O-11B, 3225 (5) Mounted Crash Firefighting Vehicle, 3226 (5) Complete set of protective clothing (1) Preventive Maintenance Materials (10)</p>
PLAN OF INSTRUCTION NO. 3ABR57130-1	DATE 7 Jul 75	BLOCK NO. V PAGE NO. 59



PLAN OF INSTRUCTION (Continued)

1 UNITS OF INSTRUCTION AND CRITERION OBJECTIVES	2 DURATION (HOURS)	3 SUPPORT MATERIALS AND GUIDANCE
<p>13. Control and Extinguishment on Small Frame Aircraft Fires</p> <p>a. Given a burning aircraft mock-up, protective clothing and technical data, perform as a member of a firefighting crew to control and extinguish aerospace crash fires using an O-11A/B or P-4 aerospace crash fire and rescue vehicle. Each fire must be completely extinguished while observing all applicable safety practices.</p>	<p>8. (6/2) Day 41</p>	<p><u>Training Methods</u> Discussion/Demonstration (1 hr) Performance (5 hrs) Outside Assignments (2 hrs)</p> <p><u>Instructional Environment/Design</u> Classroom (1 hr) Laboratory (5 hrs)</p> <p><u>Instructional Guidance</u> Check the outside assignment given the previous day. A briefing will be given prior to going to the fire training area. Stress safety prior to and during the burning operation. Ascertain that each student is under constant supervision while in the fire training area. Be sure to check students for full set of serviceable protective clothing before each burn. Stress the importance of properly operating Air Force equipment in order to prevent damage resulting in costly repairs. Stress energy and materials conservation. Give the outside assignment for the next subject.</p> <p><u>Column 1 Reference</u> 13a 13b</p> <p><u>STS Reference</u> 3b(1), 3b(3), 3b(4), 3b(5), 11e, 11i, 14b(5) 3b(2), 3b(5), 13a(3), 13b, 13c</p> <p><u>Instructional Materials</u> 3ABR57130-1-SG-513, Control and Extinguishment of Small Frame Aircraft Fires 3ABR57130-1-WB-513, Control and Extinguishment of Small Frame Aircraft Fires TO 36A12-8-9-1 TO 36A12-8-12-1 TO 36A12-12-14-1</p> <p><u>Audio Visual Aids</u> Charts</p>
<p>b. Given necessary equipment, perform preventive maintenance on aerospace crash fire and rescue vehicles IAW AFTO Form 433. Maintain station facilities and protective clothing as required.</p>		
<p>PLAN OF INSTRUCTION (ICD. 3ABR57130-1</p>	<p>DATE 7 Jul 75</p>	<p>BLOCK NO. V PAGE NO. 60</p>

PLAN OF INSTRUCTION (Continued)

1 UNITS OF INSTRUCTION AND CRITERION OBJECTIVES	2 DURATION (HOURS)	3 SUPPORT MATERIALS AND GUIDANCE
		<p><u>Training Equipment</u> <u>Vehicles:</u> O-11A/B (5) A/S32P-4 (5) <u>Trainers:</u> Simulated F-102 Aircraft, 3089 (10) Simulated F-105 Aircraft, 3091 (10) Simulated F-106 Aircraft, 3092 (10) Complete set of protective clothing (1) Preventive Maintenance Materials (10)</p> <p><u>Training Methods</u> Discussion/Demonstration (1 hr) Performance (5 hrs) Outside Assignments (2 hrs)</p> <p><u>Instructional Environment/Design</u> Classroom (1 hr) Laboratory (5 hrs)</p> <p><u>Instructional Guidance</u> Check the outside assignment given the previous day. A briefing will be given prior to going to the fire training area. Stress safety prior to and during the burning operation. Ascertain that each student is under constant supervision while in the fire training area. Be sure to check students for full set of serviceable protective clothing before each burn. Stress the importance of properly operating Air Force equipment in order to prevent damage resulting in costly repairs. Stress energy and materials conservation. Give the outside assignment for the next subject.</p>
<p>14. Control, Extinguishment, Overhaul and Rescue on Small Frame Aircraft Fires</p> <p>z. Given a burning aircraft mock-up, protective clothing and technical data, perform as a member of a firefighting crew to control</p>	<p>7 (6/1) Day 42</p>	<p><u>Column 1 Reference</u> 14a 14b 14c</p> <p><u>STS Reference</u> 3b(1), 3b(3), 3b(4), 3b(5), 11e, 11i, 12i(2), 14b(5) 3b(3), 3b(5), 11e, 11j(2), 12i(2), 14b(5) 3b(2), 3b(5), 13a(3), 13b, 13c</p>
<p>PLAN OF INSTRUCTION NO. 3ABR57130-1</p>	<p>DATE 7 Jul 75</p>	<p>BLOCK NO. V PAGE NO. 61</p>



PLAN OF INSTRUCTION (Continued)

UNITS OF INSTRUCTION AND CRITERION OBJECTIVES	DURATION 2 (HOURS)	3 SUPPORT MATERIALS AND GUIDANCE
<p>and extinguish aerospace crash fires using an O-11A/B or P-4 aerospace crash fire and rescue vehicle. Each fire must be completely extinguished while observing all applicable safety practices. Simulate rescue from aircraft as required.</p> <p>b. Given a simulated aircraft and appropriate cleanup equipment, perform fire-fighting overhaul cleanup operations while observing all applicable safety practices with minimum instructor assistance.</p> <p>c. Given necessary equipment, perform preventive maintenance on aerospace crash fire and rescue vehicles IAW AFTO Form 433. Maintain station facilities and protective clothing as required.</p>		<p><u>Instructional Materials</u> 3AERS7130-1-SG-514, Control, Extinguishment, Overhaul and Rescue on Small Frame Aircraft Fires 3ABRS7130-1-WB-514, Control, Extinguishment, Overhaul and Rescue on Small Frame Aircraft Fires TO 36A12-8-9-1 TO 36A12-8-12-1 TO 36A12-12-14-1</p> <p><u>Training Equipment</u> Vehicles: O-11A/B (5) A/S32P-4 (5) Trainers: Simulated F-102 Aircraft, 3089 (10) Simulated F-105 Aircraft, 3091 (10) Simulated F-106 Aircraft, 3092 (10) Firefighting (B-47), 3122 (10) Firefighting (C-135), 3090 (10) Complete set of protective clothing (1) Preventive Maintenance Materials (10) Rescue Dummies (5)</p> <p><u>Training Methods</u> Discussion/Demonstration (1 hr) Performance (5 hrs) Outside Assignments (1 hr)</p> <p><u>Instructional Environment/Design</u> Classroom (1 hr) Laboratory (5 hrs)</p> <p><u>Instructional Guidance</u> Check the outside assignment given the previous day. Stress safety while working around the vehicles in the fire training area. Be sure that each student in the fire training area is under constant surveillance of an instructor, preplan for emergencies. Give students a briefing on</p>
PLAN OF INSTRUCTION NO. 3ABRS7130-1	DATE 7 Jul 75	BLOCK NO. V PAGE NO. 62



PLAN OF INSTRUCTION (Continued)			
1 UNITS OF INSTRUCTION AND CRITERION OBJECTIVES	2 DURATION (HOURS)	3 SUPPORT MATERIALS AND GUIDANCE	
<p>15. Control, Extinguishment, Overhaul and Rescue on Medium Frame Aircraft Fires</p> <p>a. Given a burning aircraft mock-up, protective clothing and technical data, perform as a member of a firefighting crew to control and extinguish aerospace crash fires using aerospace crash fire and rescue vehicles. Each fire must be completely extinguished while observing all applicable safety practices. Simulate rescue from aircraft as required.</p> <p>b. Given a simulated aircraft and appropriate cleanup equipment, perform firefighting overhaul cleanup operations while observing all applicable safety practices with minimum instructor assistance.</p> <p>c. Given necessary equipment perform preventive maintenance on aerospace crash fire and rescue vehicles IAW AFTO Form 433. Maintain station facilities and protective clothing as required.</p>	<p>6 Day 43</p>	<p>safety procedures to use in the fire training area. Stress the importance of properly operating Air Force equipment in order to prevent damage resulting in costly repairs. Stress energy and materials conservation.</p> <p><u>Column 1 Reference</u> <u>STS Reference</u> 15a 3b(1), 3b(3), 3b(4), 3b(5), 11e, 11i, 12i(2), 14b(5) 15b 3b(3), 3b(5), 11e, 11j(2), 12i(2), 14b(5) 15c 3b(2), 3b(5), 13a(3), 13b, 13c</p> <p><u>Instructional Materials</u> 3ABR57130-1-SG-515, Control, Extinguishment, Overhaul and Rescue on Medium Frame Aircraft Fires 3ABR57130-1-WB-515, Control, Extinguishment, Overhaul and Rescue on Medium Frame Aircraft Fires TO 36A12-8-9-1 TO 36A12-8-12-1 TO 36A12-12-14-1 TO 36A12-8-13-1</p> <p><u>Audio Visual Aids</u> Charts</p> <p><u>Training Equipment</u> <u>Vehicles:</u> O-11A/B (5) A/S32P-2 (5) A/S32P-4 (5) <u>Trainers:</u> Simulated (B-47) Aircraft, 3122 (10) Simulated (C-135) Aircraft, 3090 (10) Complete set of protective clothing (1) Rescue Dummies (5) Preventive Maintenance Materials (10)</p>	
PLAN OF INSTRUCTION NO. 3ABR57130-1	DATE 7 Jul 75	BLOCK NO. V	PAGE NO. 63



PLAN OF INSTRUCTION (Continued)

1. UNITS OF INSTRUCTION AND CRITERION OBJECTIVES	2. DURATION (HOURS)	3. SUPPORT MATERIALS AND GUIDANCE								
<p>16. Control, Extinguishment, Overhaul and Rescue on Large Frame Aircraft Fires</p> <p>a. Given a burning aircraft mock-up, protective clothing and technical data, perform as a member of a firefighting crew to control and extinguish aerospace crash fires using aerospace crash fire and rescue vehicles. Each fire must be completely extinguished, while observing all applicable safety practices. Simulate rescue from aircraft as required.</p> <p>b. Given a simulated aircraft and appropriate cleanup equipment, perform firefighting overhaul cleanup operations, while observing all applicable safety practices with minimum instructor assistance.</p>	<p>6 Day 44</p>	<p><u>Training Methods</u> Discussion/Demonstration (1 hr) Performance (5 hrs)</p> <p><u>Instructional Environment/Design</u> Classroom (1 hr) Laboratory (5 hrs)</p> <p><u>Instructional Guidance</u> A briefing will be given prior to going to the fire training area. Stress safety prior to and during the burning operation. Ascertain that each student is under constant supervision while in the fire training area. Be sure to check students for full set of serviceable protective clothing before each burn. Stress the importance of properly operating Air Force equipment in order to prevent damage resulting in costly repairs. Stress energy and materials conservation.</p> <table border="0"> <tr> <td><u>Column 1 Reference</u></td> <td><u>STS Reference</u></td> </tr> <tr> <td>16a</td> <td>3b(1), 3b(3), 3b(4), 3b(5), 11e, 11i, 12i(2), 14b(5)</td> </tr> <tr> <td>16b</td> <td>3b(3), 3b(5), 11e, 11j(2), 12i(2), 14b(5)</td> </tr> <tr> <td>16c</td> <td>3b(2), 3b(5), 13a(3), 13b, 13c</td> </tr> </table> <p><u>Instructional Materials</u> 3ABR57130-1-SG-516, Control, Extinguishment, Overhaul and Rescue on Large Frame Aircraft Fires 3ABR57130-1-WB-516, Control, Extinguishment, Overhaul and Rescue on Large Frame Aircraft Fires TO 36A12-8-9-1 TO 36A12-8-12-1 TO 36A12-12-14-1 TO 36A12-8-13-1</p> <p><u>Audio Visual Aids</u> Charts</p>	<u>Column 1 Reference</u>	<u>STS Reference</u>	16a	3b(1), 3b(3), 3b(4), 3b(5), 11e, 11i, 12i(2), 14b(5)	16b	3b(3), 3b(5), 11e, 11j(2), 12i(2), 14b(5)	16c	3b(2), 3b(5), 13a(3), 13b, 13c
<u>Column 1 Reference</u>	<u>STS Reference</u>									
16a	3b(1), 3b(3), 3b(4), 3b(5), 11e, 11i, 12i(2), 14b(5)									
16b	3b(3), 3b(5), 11e, 11j(2), 12i(2), 14b(5)									
16c	3b(2), 3b(5), 13a(3), 13b, 13c									
<p>PLAN OF INSTRUCTION NO. 3ABR57130-1</p>	<p>DATE 7 Jul 75</p>	<p>BLOCK NO. V PAGE NO. 64</p>								

PLAN OF INSTRUCTION (Continued)			
1	2	3	
UNITS OF INSTRUCTION AND CRITERION OBJECTIVES	DURATION (HOURS)	SUPPORT MATERIALS AND GUIDANCE	
<p>c. Given necessary equipment, perform preventive maintenance on aerospace crash fire and rescue vehicles IAW AFIO Form 433. Maintain station facilities and protective clothing as required.</p>		<p><u>Training Equipment</u> <u>Vehicles:</u> O-11A/B (5) A/S32P-2 (5) A/S32P-4 (5) <u>Trainers:</u> Simulated (B-47) Aircraft, 3122 (10) Simulated (C-135) Aircraft, 3090 (10) Complete set of protective clothing (1) Preventive Maintenance Materials (10) Rescue Dummies (5)</p> <p><u>Training Methods</u> Discussion/Demonstration (1 hr) Performance (5 hrs)</p> <p><u>Instructional Environment/Design</u> Classroom (1 hr) Laboratory (5 hrs)</p> <p><u>Instructional Guidance</u> A briefing will be given prior to going to the fire training area. Stress safety prior to and during the burning operation. Ascertain that each student is under constant supervision while in the fire training area. Be sure to check students for full set of serviceable protective clothing before each burn. Stress the importance of properly operating Air Force equipment in order to prevent damage resulting in costly repairs. Stress energy and materials conservation.</p>	
<p>17. Aircraft Arresting Systems</p> <p>s. Without reference, identify simple facts relating to assisting the inspection and operation of aircraft arresting systems. Eighty percent of facts must be identified correctly.</p>	<p>3 Day 45</p>	<p><u>Column 1 Reference</u> <u>STS Reference</u> 17e 11o</p> <p><u>Instructional Materials</u> ✓ 3ABR57130-1-SC-517, Aircraft Arresting Systems</p> <p><u>Audio Visual Aids</u> ✓ Film: FR 192, Aircraft Barrier Systems</p> <p><u>Training Methods</u> Discussion/Demonstration (3 hrs)</p>	
PLAN OF INSTRUCTION NO. 3ABR57130-1	DATE 7 Jul 75	BLOCK NO. V	PAGE NO. 65

PLAN OF INSTRUCTION (Continued)		
1 UNITS OF INSTRUCTION AND CRITERION OBJECTIVES	2 DURATION (HOURS)	3 SUPPORT MATERIALS AND GUIDANCE
		<u>Instructional Environment/Design</u> Classroom (3 hrs)
		<u>Instructional Guidance</u> Stress the importance of proper inspection of aircraft arresting systems. Stress that fire protection personnel only assist C.E. power production in aircraft arresting systems operational inspection. Assure students know that TOs must be used when actually performing the inspection on aircraft arresting systems in field operations. Stress energy and materials conservation.
18. Measurement Test and Test Critique	1.5	
a. Measurement Test	Day 45 (1)	
b. Test Critique	(.5)	
19. Course Critique and Graduation	1.5	
a. Course Critique	Day 45 (.5)	
b. Graduation	(1)	
PLAN OF INSTRUCTION NO. 3ABR57130-1	DATE 7 Jul 75	BLOCK NO. V
		PAGE NO. 66



INTRODUCTION

TIME: 5 min

Attention: You respond to a fire with your crew; you are assigned as plugman and as you attempt to attach the fire hose to the hydrant, you find that you can not get the cap off. What has happened? Why is the hydrant in this condition? What do you do now?

Review: We have just completed a basic study of hydraulics; in these classes we covered rule of thumb, terms, and the principles of drafting.

Overview: We will discuss the maintenance and operation of hydrants to include checking for leaks, cracks, and ease of operation.

Motivation: Fire hydrants are an important part of the installation fire protection system and must be kept in good working order at all times.

Transition: Today's lesson begins with procedures for checking fire hydrants.

BODY

TIME: 50 min

Presentation:

TIME: 15 min.

1. Using fire hydrants, inspect and perform operator maintenance on fire hydrants. The procedures listed in the WB must be followed with minimum instructor assistance.

Check outside assignment given in Block III
Stress energy and materials conservation

Use WB 401

- a. Start inspection at hydrant nearest source of supply. Locate nearest valves on hydrant stub so they can be shut off if the hydrant is found defective during inspection.

Use Fire Hydrant Cutaway 3150
Hydrant Wrench

- (1) Most fire hydrant valves are turned counterclockwise to open and clockwise to close. Hydrants usually have an arrow cast into the top bonnet to indicate the direction of operation.
- (2) The first few turns close the drain valve before the main valve is opened. This accounts for the ease of operation when the first few turns are made.

Use Portable Fire Hydrant 3279
Hydrant Wrench

- (3) The number of turns necessary to open a fire hydrant vary with the make, and usually it takes 15 to 20 turns.
- (4) To get the best flow, the hydrant must be completely open.
- (5) If a hydrant can not be opened with reasonable force, the direction of the operation should be checked before additional leverage is used.
- (6) Fire hydrants should be closed slowly.
- (7) Check tightness of nozzles. Inspect at point where nozzles enter hydrant barrel.
- (8) Check for leakage at top of hydrant.
- (9) Check for leaks past gaskets under other caps. (replace defective gaskets)
- (10) Check for cracks in the barrel.
- (11) Look for leakage through drain valve.
 - (a) Valve should be closed when hydrant is wide open.
 - (b) Replace drain-valve facing or gasket if water comes out or up around hydrant, when hydrant valve is opened.

Do not use hydrant wrench to tighten caps.

INTERIM SUMMARY

b. Check tightness of valve and seat.

- (1) Watch lowering of water level in hydrant after valve is closed.
- (2) If level of water does not drop listen with ear against hydrant.
- (3) If noise is heard, main hydrant valve is leaking and must be replaced.
- (4) If water is quiet, drain valve is fouled and must be opened.

Do not overtighten.

c. Inspect nozzle threads.

- (1) Replace if threads are damaged.

d. Check chains.

- (1) If paint has frozen chains tight to cap, chip out paint to free chain.
- (2) Replace lost chains.

f. Lubricate operating nut.

- (1) Remove screw in top of operating nut and apply oil, grease, or graphite grease recommended by manufacturer.
- (2) If hydrant does not operate freely after lubrication, lubricate packing and thrust collar by oiling joint between nut and collar.

Application:

Interspersed throughout the presentation.

TIME: 30 min

Evaluation:

Interspersed throughout the presentation.

TIME: 5 min

CONCLUSION

TIME: 5 min

Summary: We have just completed a discussion on the operation and maintenance of fire hydrants. During this discussion we covered inspection, operation, and lubrication of hydrants.

Remotivation: It is vitally important that hydrants, just as vehicles, be in good operating condition. Without an operational hydrant, you may not have a water source and could lose an entire building.

Assignment: N/A. Continue with Emergency Response Activities

Closure: Properly operating fire hydrants are a must for fast and efficient operation during any emergency.

EMERGENCY RESPONSE ACTIVITIES

INTRODUCTION

TIME: 5 min

Attention: Each base has a mission and the Fire Department helps support that mission. If there were no fire departments or the fire department was undermanned this would jeopardize the mission. Accidents can put men in the hospital and with enough accidents you would underman a fire department.

Review: We have just studied the operation and maintenance of fire hydrants.

Overview: Safety in the Air Force means the same as it does in Civilian life. In this lesson we shall discuss safe and unsafe procedures concerning safety in fire protection.

Motivation: Hundreds of people are injured or lose their lives each year due to accidents and one of these could be you unless you are aware of how accidents occur by unsafe acts in day to day living.

Transition: Today's lesson will cover basic safety procedures and safe vehicle response activities.

BODY

TIME: 50 min

Presentation:

TIME: 45 min

- 1. Without reference, identify safe and unsafe procedures concerning emergency response activities. Eighty percent of the procedures must be identified correctly.

Stress energy and materials conservation.

Show Film: CFL 033, "Fire... Code"

a. Safe procedures

- (1) Use siren and red light. They ask for right of way, they do not give it.
- (2) Observe all traffic.
- (3) Be prepared to yield the right of way.
- (4) Don't form tunnel vision when responding.

You will be trained to drive at your next base.

- 41
- (5) Always wear protective clothing.
 - (6) Stay seated or use available hand holds at all times.
 - (7) Keep doors securely closed while vehicle is in motion.
 - (8) Do not jump off of a moving vehicle.

INTERIM SUMMARY

b. Unsafe procedures

- (1) Any action that tends to result in bodily harm to yourself or someone else due to carelessness or complete disregard of all established safety procedures.
- (2) Think before you act.

Stress the need of arriving at the fire scene safely in order to perform our primary job of saving lives and protecting property from fire.

Application:

TIME: N/A

Evaluation:

TIME: 5 min

Interspersed throughout the presentation.

CONCLUSION

TIME: 5 min

Summary: We have just discussed safe and unsafe procedures concerning responding to emergencies. We know that we must arrive safely before we can perform our primary job.

Remotivation: In responding to emergencies, we sometimes have a tendency to disregard our safety, but, in order for us to perform our job, we must first arrive. Caution should always be exercised.

Assignment: N/A. Continue with Inspections, Maintenance, Mounted Equipment and Operations of the 530B/P-8 Structural Pumps.

Closure: Think safety, you are an important part of the Air Force team, you must be available to support the mission.

INSPECTIONS, MAINTENANCE, MOUNTED EQUIPMENT
AND OPERATIONS OF THE 530B/P-8
STRUCTURAL PUMPERS

INTRODUCTION

TIME: 5 min

Attention: Have you ever wondered how the fireman holding a nozzle received the water he is applying to a fire?

Review: We have just learned about safe and unsafe emergency response procedures.

Overview: Today we will inspect, perform operator maintenance, check mounted equipment and do a pumping operation with the 530B/P-8 structural pumper.

Motivation: In order to progress up to driver/operator on a structural pumper, we must know the equipment and how to operate it.

Transition: Today's lesson will begin with a general description of the 530B/P-8 structural pumper.

BODY

TIME: 3 hrs 50 min

Presentation:

TIME: 2 hrs 10 min

1. Given AFTO Form 434, and technical data, inspect and perform operator maintenance on the 530B/P-8 structural firefighting vehicle and mounted equipment. All applicable items on the AFTO Form 434 must be inspected. Operator maintenance must be accomplished according to Technical Order.

Stress energy and materials conservation.

Use WB 403.

a. 530B Pumper

- (1) Specific Use: Provides a self-contained mobile firefighting unit for combatting structural, crash and natural cover fires.

Charts, CAFB 65-611, 530B Pumper Truck, left side." CAFB 65-610 "530B Pumper truck, right side."

- (2) Water and foam tank capacity:



(a) Water - 400 gallons, it may be filled from a pressure source or through the tank filler located at the rear of the truck.

Properly operate Air Force equipment. Prevent damage resulting in costly repair.

(b) Foam - 40 gallons, it is filled from the top of the truck only.

(3) Fire Pump

(a) Type - single stage centrifugal

(b) Discharge capacity: Rated from a draft.

1. 500 GPM @ 120 PSI

2. 250 GPM @ 200 PSI

3. 167 GPM @ 250 PSI

(c) Primer

Chart CC 75-03
"Fire Pump Primer, Rotary Vane, Electric Driven."

1. Electric rotary vane

2. Oil for sealing and lubrication

3. 6 quart oil reservoir

4. Engage electric primer 10-20 sec.

(d) Relief valve

Chart CAFB 61-4999
"Fire Pump Relief Valve"

1. Controls discharge pressure

2. Protects personnel and equipment

3. May be set to control pressure up to 300 PSI

(e) Intakes and discharges

- 1. 1 2½ inch intake, Trainer 3223
has a control valve 530B Operator's panel
- 2. 2 4½ inch intakes
- 3. 2 2½ inch discharges
- 4. Hose (amount and sizes) These are minimum amounts.
 - a. 1200 feet - 2½ inch
 - b. 300 feet - 1½ inch
 - c. 300 feet - 1 inch Booster Line
 - d. 16 feet x 4½ inch soft suction
 - e. 2 - 10 foot x 4½" sections hard suction

INTERIM SUMMARY

b. P-8 Pumper

- (1) **Specific Use:** Provides a self-contained mobile firefighting unit for combatting structural, crash and natural cover fires.
- (2) **Truck**
 - (a) **Make** Ward La France
 - (b) **Type** AS32P-8 500 GPM Pumper. 4 X 4 Chassis
- (3) **Water and foam. Tank Capacity:**
 - (a) **Water tank** 600 gallons. It may be filled from pressure or through the tank filler located on

Stress danger when working around vehicle with engine running.

top at the front of the hose bed. Fill valve on pump panel and water tank Gauge on pump panel.

- (b) Foam tank 55 gallon, is filled from the top of the truck only.

(4) Fire Pump

Chart CAFB 64-570

- (a) Type-Two Stage Centrifugal

Two Stage Pump.
Chart CAFB 61-5000,
"Parallel Operation"
Chart CAFB 61-5001,
"Series Operation."

- (b) Discharge Capacity:

- 1. 500 GPM @ 150 PSI
- 2. 350 GPM @ 200 PSI
- 3. 250 GPM @ 250 PSI
- 4. 30 GPM @ 400 PSI

- (c) Priming Pump

Chart CC 75-03,
"Fire Pump Primer
Rotary Vane
Electric Driven"

- 1. Rotary vane electric driven
- 2. Oil for sealing and lubrication
- 3. 6 Qts. Oil Reservoir
- 4. Engage electric primer 10 to 30 seconds
- 5. Engine RPMs to be between 1300-1500.

- (d) Relief Valve

Chart CAFB 61-4999,
"Fire Pump Relief Valve"

- 1. Controls discharge pressure
- 2. Protects personnel and equipment.
- 3. Pilot light illuminates when relief valve opens.



(e) Transfer Valve

- 1. Controlled by a switch on the pump panel Activated by water pressure.
- 2. Two positions, Volume/Parallel Pressure/Series
- 3. Normally stored for Volume/Parallel operation
- 4. Pressure/Series operation used for pump pressure above 150 PSI

(f) Intakes and discharges

- 1. 1 2½ inch intake has a control valve
- 2. 2 4½ inch intakes
- 3. 3 2½ inch discharges

(g) Hose (amount and sizes)

- 1. 1000 feet - 2½ inch These are minimum amounts
- 2. 400 feet - 1½ inch
- 3. 300 feet - 1 inch booster line
- 4. 3 - 10 ft x 4½ inch hard suction
- 5. 16 foot x 4½ inch soft suction hose

(5) Safety procedures

- (a) When backing truck, have a back-up man on each side at the rear.

47

- (b) Set handbrake and chock wheels
- (c) Do not saddle hose
- (d) Open and close all discharge valves slowly.
- (e) Always throttle up and down slowly.
- (f) Watch for loose or nozzleless lines. Excessive pressure proper vehicle and pump operation
- (g) Insure that hangar exhaust pipes are connected to pumps
- (h) Do not handle exhaust piping with bare hands; pipes get extremely hot.

Report any damaged exhaust system to the instructor-supervisor.

Conduct a demonstration for .5 hr on the vehicles.

Application:

1. Given AFTO Form 434, and technical data, inspect and perform operator maintenance on the 530B/P-8 structural firefighting vehicle and mounted equipment. All applicable items on the AFTO Form 434 must be inspected. Operator maintenance must be accomplished according to Technical Order.
2. Given a 530B/P-8 Structural fire-fighting vehicle and mounted equipment, perform a booster operation in accordance with Technical Order procedures. Booster operation must be completed in less than 5 minutes, while observing all applicable safety practices.
 - a. Refer to TO 36A12-12-9-61, Truck Firefighting 530B, Pages 2-3, 2-4, and 2-19, 2-20 for booster operation procedures.
 - b. Refer to T036A12-12-12-1, 500 GPM brush and structural fire-fighting truck, Pages 4-13 thru 4-14 for Booster Operation Procedures.

TIME: 1 hr 30 min
2 INSTRUCTORS ARE REQUIRED

TO 36A12-12-9-61
TO 36A12-12-12-1
Use: Vehicles
A/S32 P-8 Structural Firefighting Vehicle and Mounted Equipment
530B Structural Firefighting Vehicle and Mounted Equipment

Helmet
Gloves

Keep side hallway hanger doors closed to reduce noise level.



3. Given necessary equipment, perform preventive maintenance on the 530B/P-8 structural firefighting vehicle and mounted equipment IAW AFTO Form 434. Maintain station facilities as required.

Use preventive maintenance materials.

Evaluation:

TIME: 10 min

Interspersed throughout the presentation.

CONCLUSION

TIME: 5 min

Summary: We have discussed the specific use, capacity, fire pump and performed inspection and operator maintenance and a booster operation on the 530B/P-8 structural pumpers.

Remotivation: All fires are not large ones, it is important that you know the booster operation for your ability; it may prevent a small fire from developing into a large one.

Assignment: Read and study TO 36A12-12-12-1, 500 GPM Brush and Structural Firefighting Truck, Section IV, Pages 4-1 to 4-15.

Outside Assignment: (2 hrs) Read and study SG-404, Pumping Operations on the 530B/P-8 Structural Pumpers and answer the questions at the end of the unit.

Closure: One day you may be the driver/operator of one of these vehicles; the more you know will greatly increase your confidence in your operation.

PUMPING OPERATIONS ON THE 530B/P-8 STRUCTURAL PUMPERS

INTRODUCTION

TIME: 5 min

Attention: Did you know a firefighting vehicle is capable of delivering water from different sources, and also capable of producing a foam mixture?

Review: We have just had a lesson on performing a booster operation with the 530B/P-8 structural pumper.

Overview: Today we will perform a hydrant, drafting, and foam operation with the 530B/P-8 structural pumpers.

Motivation: The 530B/P-8 are very versatile vehicles; they are capable of delivering water and foam under various operating conditions, you must know how to operate these vehicles in order to perform your job as a fire protection specialist.

Transition: Today's lesson will begin with a review of our safety procedures.

BODY

TIME: 5 hrs 50 min

Presentation:

TIME: 40 min

1. Given a 530B/P-8 structural fire-fighting vehicle and mounted equipment, perform hydrant operations in accordance with technical order procedures. Hydrant operation must be completed in less than 5 minutes, while observing all applicable safety practices.

Stress energy and materials conservation

Check outside assignment

Use WB 404

a. Safety procedures

- (1) When backing truck, have a backup man on each side at the rear
- (2) Set handbrake and chock wheels
- (3) Do not straddle hose
- (4) Open and close all discharge valves slowly
- (5) Always throttle up and down slowly
- (6) Watch for loose or nozzleless lines, excessive pressure, proper vehicle and pump operation

Stress dangers when working around vehicle with engine running

Keep side hallway hangar doors closed to reduce noise level

50

- (7) Insure that hangar exhaust pipes are connected to pumps
- (8) Do not handle exhaust piping with bare hands; pipes get extremely hot

Report any damaged exhaust system to the instructor-supervisor

Conduct a Demonstration for .5 hr on the vehicles

2 INSTRUCTORS ARE REQUIRED

Application

TIME: 5 hrs

2 INSTRUCTORS ARE REQUIRED

1. Given a 530B/P-8 structural firefighting vehicle and mounted equipment, perform hydrant operations in accordance with technical order procedures. Hydrant operation must be completed in less than 5 minutes, while observing all applicable safety practices.

- TO 36A12-12-9-61
- TO 36 A12-12-12-1

- a. Refer to TO 36A12-12-9-61, Truck, Firefighting 530B, page 2-18 for hydrant operation procedures
- b. Refer to TO 36A12-12-12-1, 500 GPM Brush and Structural Firefighting Truck, page 4-1, para 4-6, page 4-12, para 4-62 for hydrant operation procedures.

Use: Vehicles
 530B Structural Firefighting Vehicle and Mounted Equipment
 A/S32 P-8 Structural Firefighting Vehicle and Mounted Equipment
 Drafting Pit
 Helmet, Gloves

- (1) To change transfer valve to pressure setting, reduce pump pressure down to hydrant pressure

Properly operate Air Force Equipment
 Prevent damage resulting in costly repair

2. Given 530B/P-8 structural firefighting vehicle and mounted equipment, perform a drafting operation in accordance with technical order procedures. Drafting operation must be completed in less than 5 minutes, while observing all applicable safety practices.

- a. Refer to TO 36A12-12-9-61, Truck, Firefighting 530B, page 2-17 for drafting operation procedures
- b. Refer to TO 36A12-12-12-1, 500 GPM Brush and Structural Firefighting Truck, page 4-12A, 4-12B and 4-13 for drafting operation procedures

3. Given a 530B/P-8 structural firefighting vehicle and mounted equipment, perform a foam pumping operation in accordance with technical order procedures. Foam pumping operation must be completed in less than 5 minutes, while observing all applicable safety practices.

92



- a. Refer to TO 36A12-12-9-61, Truck, Firefighting 530B, page 2-21 for foam pumping operation procedures
- b. Refer to TO 36A12-12-12-1, 500 GPM Brush and Structural Firefighting Truck, page 4-14 and page 4-15 for foam pumping operation procedures

NOTE: Intake pressure must be regulated to 10 PSI from hydrant

3. Given necessary equipment, perform preventive maintenance on the 530B/P-8 structural pumper and mounted equipment IAW APTO Form 434. Maintain station facilities as required.

Use preventive maintenance materials

Evaluation:

TIME: 10 min

Intersperse throughout the presentation.

CONCLUSION

TIME: 5 min

Summary: We have just performed various pumping operations with the 530B/P-8 structural pumpers and know the versatility of each vehicle.

Remotivation: The need for proficient driver/operators of structural vehicles is great. You should continually strive to update your knowledge of this and be ready in the case of any emergency.

Assignment: Read and study TO 36A12-12-15-1, Fire Fighting Truck - 750 GPM Structural Type A/S32P-12, pages 1-1 thru 1-5.

Outside Assignment: (2 hrs) Read and study SG 405, Inspection, Maintenance, Mounted Equipment and Operations of the 750A/P-12 structural pumpers, and answer the questions at the end of the unit.

Closure: While we have been here in this classroom, many Air Force fire departments have been operating to save lives and property. Soon you will have the opportunity to do the same and maybe even use the 530B/P-8 structural pumper.

INSPECTION, MAINTENANCE, MOUNTED EQUIPMENT AND OPERATIONS

OF THE 750A/P-12 STRUCTURAL PUMPERS

INTRODUCTION

TIME: 5 min

Attention: The alarm sounds, and as you respond to your assigned vehicle, the assistant chief tells you to stand by with the second run 750A and be prepared to respond with it as driver/operator to assist the first run pumper.

Review: We have discussed the P-8 and 530B structural pumpers, their use and capacity, and performed various pumping operations.

Overview: During this lesson we will have a discussion on specific use capacity, fire pump operation, and safety. You will be required to perform all pumping operations.

Motivation: Even as a newly assigned member of a structural vehicle, you could be called upon to act as driver/operator, and it is a must that you be able to operate this vehicle in a proficient manner.

Transition: Today's lesson will begin with a general description of the 750A/P-12 structural pumper.

BODY

TIME: 5 hrs 50 min

Presentation:

TIME: 1 hr 40 min

1. Given AFIO Form 434, and technical data, inspect and perform operator maintenance on the 750A/P-12 structural firefighting vehicle and mounted equipment. All applicable items on the AFIO Form 434 must be inspected. Operator maintenance must be accomplished according to the Technical Order.

Stress energy and materials conservation

Check outside assignment

Use WB 405

a. 750A Pumper

- (1) Specific Use: Provides a self-contained mobile firefighting unit for combating on-base fires, including supplying water to sprinkler systems and relay operations

Properly operate Air Force equipment. Prevent damage resulting in costly repairs.

- (a) Water - 175 gallons, it may be filled from a pressure source or through the tank filler located on top of the truck.



(b) Foam - 40 gallons, it is filled from the top of the truck only.

(3) Fire Pump

(a) Type - two stage centrifugal

Chart CAFB 64-570, "Two Stage Pump"

(b) Discharge capacity

1. 750 GPM @ 150 PSI

2. 525 GPM @ 200 PSI

3. 375 GPM @ 250 PSI

(c) Primer

Chart CAFB 65-79, "Rotary Gear Primer"

1. Electric or manual

2. Rotary gear

3. Oil for sealing and lubrication

4. One gallon (4 qt) reservoir

5. Engage manual primer - 20 to 30 seconds

6. Engage electric primer - 10 to 20 seconds

(d) Relief valve

Chart CAFB 61-4999, "Fire Pump Relief Valve"

1. Controls discharge pressure

Chart CC 74-23, "Relief and Stop Valve Operation"

2. Protects personnel and equipment

(e) Stop valve - Overrides relief valve for temporary increase of pump pressure

Trainer: 64-31470, 750A Pump Panel

1. Stored in open position (counterclockwise) to allow relief valve to function

(f) Stage valve

Chart CAFB 61-5000, "Parallel Operation"

- 1. Controlled by a wheel on the left pump panel
- 2. Two Positions: volume/parallel, clockwise; pressure/series, counter-clockwise

Chart CAFB 61-5001, "Series Operation"

(g) Intake and Discharge

- 1. One 2½ inch intake has a control valve
- 2. Three 1½ inch intakes front 1½ has a control lever located on left pump panel
- 3. Four 2½ inch discharge

(h) Hose (Amount and Sizes)

These are minimum amounts

- 1. 1500 feet - 2½ inch
- 2. 300 feet - 1½ inch
- 3. 150 feet - 1 inch booster line
- 4. 16 feet x 1½ inch soft suction
- 5. 2 - 10 foot x 1½ inch hard suction

INTERIM SUMMARY

b. P-12 Pumper

- (1) Specific use: Provides a self-contained mobile firefighting unit for combating on-base fires, including supplying water to sprinkler systems and relay operations. This vehicle is able to perform both on paved roads and unimproved roads.



(2) Truck

- (a) Make, Ward La France
- (b) 4 x 2 commercial chassis

(3) Water and foam tank capacity

- (a) Water tank 300 gallons.
It may be filled from pressure or through the tank filler located on top at the front of the hose bed. Fill valve on pump panel and water tank guage on pump panel.
- (b) Foam tank, 55 gallons, filled from top of the truck only.

(4) Fire Pump

- (a) Type - two stage centrifugal

Chart CAFB 64-570, "Two Stage Pump"

- (b) Discharge Capacity

- 1. 750 GPM @ 150 PSI
- 2. 525 GPM @ 200 PSI
- 3. 375 GPM @ 250 PSI
- 4. 50 GPM @ 400 PSI

- (c) Primer

Chart CC 75-03, "Fire Pump Primer, Rotary Vane, Electric Driven"

- 1. Electric Rotary Vane
- 2. Oil for sealing and lubrication
- 3. 6 qt oil reservoir
- 4. Engage primer for 10 - 30 seconds with RPMs at 1300 to 1500

- (d) Relief valve

- 1. Controls discharge pressure
- 2. Protects personnel and equipment

- 3. Pilot light illuminates when relief valve is open

(e) Transfer valve

Chart CAFB 61-5000, "Parallel Operation"

- 1. Manually operated
- 2. Two positions; volume/parallel, counterclockwise; pressure/series, clockwise
- 3. Volume/Parallel position should be used at any pump pressure under 150 PSI

Chart CAFB 61-5001, "Series Operation"

(f) Intaker and discharger

- 1. One 2½ inch intake has a control valve
- 2. Two 4½ inch intakes
- 3. Four 2½ inch discharges
- 4. Two 1½ inch pre-connect discharges

(g) Hose amounts and sizes

These are minimum amounts

- 1. 1200 feet - 2½ inch
- 2. 400 feet - 1½ inch
- 3. 400 feet - 1 inch booster line
- 4. 16 feet by 4½ inch soft suction
- 5. Two 10 foot x 4½ inch hard suction

(5) Safety procedures

- (a) When backing truck, have a backup man on each side at the rear
- (b) Set handbrake and chock wheels



- 57
- (c) Do not straddle hose
 - (d) Open and close all discharge valves slowly
 - (e) Always throttle up and down slowly
 - (f) Watch for loose or nozzleless lines, excessive pressure, proper vehicle and pump operation

Conduct a Demonstration
for .5 hr on the vehicles
2 INSTRUCTORS ARE REQUIRED

INTERIM SUMMARY

Application:

1. Given AFTO Form 434, and technical data, inspect and perform operator maintenance on the 750A/P-12 structural firefighting vehicle and mounted equipment. All applicable items on the AFTO Form 434 must be inspected. Operator maintenance must be accomplished according to the technical order.
2. Given a 750A/P-12 structural fire-fighting vehicle and mounted equipment, perform a hydrant operation in accordance with technical order procedures. Hydrant operation must be completed in less than 5 minutes, while observing all applicable safety practices.
 - a. Refer to TO 36A12-12-8-51, Powered Pumper Fire Truck, Class 750A, Page 23, Para 4-36 for hydrant operation procedures.
 - b. Refer to TO 36A12-12-15-1, Fire-fighting Truck, 750 GPM, Structural Type A/S32P-12, page 5-15, 5-16, para 5-24 for hydrant operation procedures.
3. Given a 750A/P-12 structural fire-fighting vehicle and mounted equipment, perform a drafting operation in accordance with technical order procedures. Drafting operation must be completed in less than 5 minutes, while observing all applicable safety practices.

TIME: 4 hrs
2 INSTRUCTORS ARE REQUIRED

Use:
TO 36A12-12-8-51
TO 36A12-12-15-1

Use: Vehicles
750A Structural Firefighting Vehicle
and Mounted Equipment
A/S32 P-12 Structural Firefighting
Vehicle and Mounted Equipment

Use Drafting Pit

Helmet, Gloves

- a. Refer to TO 36A12-12-8-51, Powered Pumper Fire Truck, Class 750A, pages 20, 21 and 22, para 4-30 through 4-34 for drafting operation procedures.
- b. Refer to TO 36A12-12-15-1, Fire-fighting Truck, 750 GPM, Structural Type A/S32P-12, page 5-16, para 5-25 for drafting operation procedures.

4. Given a 750A/P-12 structural firefighting vehicle and mounted equipment, perform a foam operation in accordance with technical order procedures. Foam operation must be completed in less than 5 minutes, while observing all applicable safety practices.

- a. Refer to TO 36A12-12-8-51, Powered Pumper Fire Truck, Class 750A, pages 22, 23, para 4-35 through 4-37 for foam operation procedures.
- b. Refer to TO 36A12-12-15-1, Fire-fighting Truck, 750 GPM, Structural Type A/S32P-12, pages 5-17, 5-18, para 5-27 through 5-29 for foam operation procedures.

5. Given necessary equipment, perform preventive maintenance on the 750A/P-12 structural firefighting vehicle and mounted equipment IAW AFIO Form 434. Maintain station facilities as required.

Use Preventive Maintenance Materials

Evaluation:

TIME: 10 min

Intersperse throughout the presentation.

CONCLUSION

TIME: 5 min

Summary: We have just inspected and performed the hydrant, drafting and foam operation on the 750A/P-12 structural pumper.

Remotivation: As a member of a structural firefighting crew, your ability to operate depends upon the training you have received and the desire you have to become a proficient firefighter.

Assignment: Read and study SG 407, Vehicle Positioning, Relay and Hose Operations and answer the questions at the end of the unit. 59

Outside Assignment: (2 hrs) Read and study SG 406, Pumping Operations on the 750A/P-12 Structural Pumpers and answer the questions at the end of the unit.

Closure: Although not actually involved in the extinguishment of a fire, the driver/operator is relied upon by all members of his crew, and he should be proud of a job well done.

PUMPING OPERATIONS ON THE 750A/P-12 STRUCTURAL PUMPERS

INTRODUCTION

TIME: 5 min

Attention: The alarm sounds, we have a trash fire behind the dining hall, it is not too large, so we will probably use the booster tank water supply. Can you operate the pump from the booster tank?

Review: We have operated the 750A/P-12 structural pumper from a hydrant and draft water source and performed a foam operation.

Overview: During this lesson we will review our safety procedures and perform a booster operation on the 750A/P-12 structural pumper.

Motivation: The fastest method to extinguish a fire after arrival is to apply our extinguishing agent, if this is water, the speed and efficiency of the driver/operator is the keystone to success.

Transition: Today's lesson will begin with a review of our safety procedures.

BODY

TIME: 1 hr 50 min

Presentation:

TIME: 10 min

1. Given a 750A/P-12 structural firefighting vehicle and mounted equipment, perform a booster operation in accordance with technical order procedures. Booster operation must be completed in less than 5 minutes, while observing all applicable safety practices.

Stress energy and materials conservation

Check outside assignment

a. Safety procedures

Use WB 406

- (1) When backing truck, have a backup man on each side at the rear
- (2) Set handbrake and chock wheels
- (3) Do not straddle hose
- (4) Always throttle up and down slowly
- (5) Watch for loose or nozzleless lines, excessive pressure, proper vehicle and pump operation

Properly operate Air Force equipment. Prevent damage resulting in costly repair

Conduct a Demonstration for .5 hr on the vehicles

2 INSTRUCTORS ARE REQUIRED

Application:

TIME: 1 hr

2 INSTRUCTORS ARE REQUIRED

1. Given a 750A/P-12 structural fire-fighting vehicle and mounted equipment, perform a booster operation in accordance with technical order procedures. Booster operation must be completed in less than 5 minutes, while observing all applicable safety practices.

Use:
TO 36A12-12-8-51
TO 36A12-12-15-1

- a. Refer to TO 36A12-12-8-51, Powered Pumper Fire Truck, Class 750A, page 23, para 4-37 for booster operation procedures.
- b. Refer to TO 36A12-12-15-1, Fire fighting Truck, 750 GPM Structural Type A/S32P-12, pages 5-16 and 5-17, para 5-26 for booster operation procedures.

Use Vehicles:
750A Structural Firefighting Vehicle and Mounted Equipment
A/S32 P-12 Structural Firefighting Vehicle and Mounted Equipment

Helmet

Gloves

2. Given necessary equipment, perform preventive maintenance on the 750A/P-12 structural firefighting vehicle and mounted equipment IAW AFTO Form 434. Maintain station facilities as required.

Use Preventive maintenance materials

Evaluation:

TIME: 10 min

Intersperse throughout the presentation.

CONCLUSION

TIME: 5 min

Summary: We have just performed a booster operation with the 750A/P-12 structural firefighting vehicles and know the versatility of each vehicle.

Remotivation: We have demonstrated the versatility of our structural firefighting vehicles, and you have seen the importance of a proficient driver/operator. This should be your goal to work for.

Assignment: N/A. Continue with Vehicle Positioning, Relay and Hose Operations.

Closure: Remember, all the vehicles we have studied and the pumping operations we have performed. One day you will be performing this important job of driver/operator.

VEHICLE POSITIONING, RELAY AND HOSE OPERATIONS

INTRODUCTION

TIME: 5 min

Attention: You arrive at the scene of an emergency, and you are required to supply water to a crash vehicle. It has been determined that the closest water supply is 2,500 feet away. How do you position your vehicle to provide the needed water?

Review: We have covered the operations and maintenance of structural vehicles and used applicable safety procedures at all times.

Motivation: When the alarm sounds, your vehicle must start and arrive at the scene of the emergency, but where do you position your pumper at the fire? We will cover these procedures to assure that you are familiar with laying hose and positioning vehicles for relay operations.

Overview: Today we will have a discussion on the procedures for positioning fire-fighting vehicles, relay operations, and hose operations.

Transition: Today's lesson will begin with procedures for spotting structural fire-fighting vehicles.

BODY

TIME: 3 hrs 50 min

Presentation:

TIME: 3 hrs 40 min

1. Without the aid of references, select the correct procedures for positioning fire-fighting vehicles. Eighty percent of the procedures must be selected correctly.

Stress energy and materials conservation

a. Positioning vehicles

(1) Spotting fire apparatus is the act of maneuvering the vehicle into the best position for its most effective use

(2) Three important factors in determining vehicle positioning are

(a) Volume of water needed

(b) Immediate need for an effective fire stream

(c) Availability of water, hose and pumper capacity

Position vehicle so that it can be used most advantageously

b. Positioning for the use of hoseline from the booster tank

- (1) Spot the pumper as close to the fire as safety and convenience permits
- (2) Booster tank operation permits preconnected lines to be used which usually provides a fast attack on the fire

c. Positioning for hydrant operation

Avoid sharp kinks in hose

- (1) Pumpers are positioned at a hydrant for use of the 1 1/2" x 16 ft soft suction hose
- (2) Stop the pumper close enough to the 1 1/2" intake to utilize the soft suction hose

d. Position for drafting operation

- (1) Spot the pumper as close to the water source as safety will permit
- (2) A lift of not more than 10 to 12 feet is the maximum lift

2. Without reference, select the proper procedures for vehicle relay operations. Eighty percent of the procedures must be selected correctly.

a. Relay operations

- (1) Used on long lays when one truck cannot support a good fire stream
- (2) Truck at hydrant supplies water in volume to second truck
- (3) Second truck in relay supplies pressure needed at nozzle for a good working stream

b. Controlling factors

- (1) Length of hose lay
- (2) Size of hose

- (3) Number of lines between pumpers
- (4) Number of pumpers being used.

c. Basic guide lines

- (1) Pumpers within relay usually should not operate above 200 psi discharge pressure (in emergencies may pump up to 250 psi but do not exceed discharge capacity of pumper)
- (2) Each pump operator must know the amount of water flowing
 - (a) Determine friction loss.
 - (b) 10 psi intake pressure for next pumper in relay
- (3) When possible, all pumpers operate at about the same pressure
 - (a) Standardizes operations of all pumpers
 - (b) Equalizes loads for all pumpers
- (4) Open and close nozzles and valves slowly
- (5) When starting operation bleed air from lines
- (6) Place largest pumper at source
- (7) Relay operations are limited to the capacity of the smallest pumper
- (8) Each pumper should reserve a minimum of 100 feet of hose
 - (a) For emergency use
 - (b) For a burst line
- (9) If possible, use radio communications

d. Spacing pumpers (rule of thumb for spacing second pumper)

- (1) Select nozzle to be used, nozzle pressure and GPM must be known
- (2) Using GPM flow determine friction loss per 100 ft of hose.
- (3) Divide nozzle pressure by friction loss per 100 ft. Answer is in hundreds of feet of 2 1/2" hose of an imaginary line
- (4) Add imaginary line to actual hose lay
- (5) Divide total distance by 2. The answer is the distance the second pumper is spaced from the first pumper.
- (6) Pumper #1 computes for FL + 10 PSI intake pressure
- (7) Pumper #2 computes for FL + NP

e. Relay operation example using 2300 feet total hose lay with a one inch tip

- (1) Divide friction loss into standard nozzle pressure (10 into 50)
 - (a) This answer is in hundreds for an imaginary line (500)
- (2) Add to total hose lay (2300 + 500)
 - (a) Divide this (2800) by 2
 - (b) Answer 1400. This is the distance between the pumpers
- (3) Subtract 1400 from 2300 and this is the distance from the second pumper to the fire (900)
- (4) First pumper pumps for friction loss in 1400 feet of hose with a 1 inch tip plus 10 PSI intake pressure for second pumper - PP=150 PSI



- 66
- (5) Second pumper pumps for 900 feet of hose with a 1 inch tip plus SNP 50 PSI.
FP equals 140 PSI.

INTERIM SUMMARY

3. Without the aid of references, select the correct procedures for hose operations. Procedures must be selected with 80 percent accuracy.

a. Safety practices

- (1) When using the master stream (deluge gun) always make certain it is anchored.
- (2) Assure that only serviceable hose is used when making up hose line
- (3) Ascertain all personnel wear protective clothing
- (4) Open and close all nozzles and hose clamps slowly
- (5) The nozzle should be kept closed while
 - (a) Making up hose lines
 - (b) Hoisting or advancing hose
 - (c) Moving charged lines from one position to another
- (6) Keep hose straight for at least 10 feet behind nozzle while discharging water
- (7) If nozzleman receives too much pressure, nozzle should be partially shut down until pressure can be adjusted.
- (8) If nozzle should get away from nozzleman, it is normally safer to quickly jump in front of the nozzle and get wet, rather than get injured by nozzle backlash.

b. Hose advancement

(1) Over-shoulder carry

- (a) Used when entering a building
- (b) Climbing stairs
- (c) Cross chest with nozzle resting on your back

(2) Underarm carry

- (a) Used at street level
- (b) Fast and easy carry
- (c) Hose is folded in 6' to 8' folds and carried underneath one arm with the two couplings in the other hand

(3) Moving charged hose lines

- (a) Close nozzle
- (b) Place one man at each coupling

Hose is heavy when filled with water

c. Care and maintenance of hose

(1) Marking hose

- (a) Use stencil
- (b) Indelible ink

Show Film TFI 5049, "Care and Maintenance of Hose"

(2) Storing hose

- (a) Clean, dry and well ventilated place
- (b) Do not store damp or dirty hose

(3) Washing hose

- (a) Plain water and brush
- (b) Hose exposed to oil - wash with soap and rinse with clear water

(c) Hose exposed to acid - wash with a solution of baking soda and water

(4) Drying of hose

(a) Hose tower

(b) Hose rack

(c) Hose dryer

Never in direct sunlight

(5) Repairing hose

(a) Length - explain: At least 2/3 of section (33-2/3"). Shorter sections may be used for special purpose; filling tanks on crash trucks, etc.

(b) Expander set

(c) Barway coupling

(d) Protect hose from extreme heat and cold

d. Inspection periods

(1) Daily

(2) Monthly

(3) Quarterly/90 days

(4) Annually

(5) After each use

e. Inspect hose

(1) Couplings - use mild soap and water to loosen a female coupling

(2) Gaskets

(3) Lining

(4) Jacket

Stress importance of not dropping couplings



69

f. Testing periods

- (1) When first received
- (2) Annually

g. Hydrostatic testing pressure for different hose types

- (1) Polyester jacket hose (400 PSI new) 250 PSI
- (2) Double jacket cotton hose (400 PSI new) 250 PSI
- (3) Single jacket cotton hose - 150 PSI

h. It is recommended that no more than 300 feet be tested in one line

i. Hydrostatic pressure should be maintained for a period of five (5) mins

INTERIM SUMMARY

j. Straight lay

This is a true straight lay, not used as a feeder line

- (1) Hydrant to fire
- (2) Fastest method of getting water to fire
- (3) Tools available at the fire
- (4) Truck available for another lay
- (5) Must have adequate hydrant pressure

k. Crew duties

Chart CAFB 67-200, "Hand Signals for Structural Operations"

- (1) Straight lay out
 - (a) IR - stops truck at hydrant
 - (b) PM - Catches the hydrant as directed
 - (c) BM & NM -- Rides at the side of tail board while hose is paying off
 - (d) DR - stops truck at fire

These procedures should be considered as a guide and adjustments made to fit a local situation

Chart CAFB 72-37, "Removable Firefighting Equipment"

- (e) CC - Goes to size up fire
- (f) IR - Applies hose clamp approximately 20 ft behind truck and at least 6 ft from any coupling
- (g) NM - Takes nozzle from compartment.
- (h) HM - Removes working line from hose bed, breaks coupling and returns loose coupling to hose bed
- (i) HM & NM - attaches nozzle to hose and advance hose and nozzle to fire
- (j) IR - Removes hose clamp and assists with advancing working line or as directed by crew chief
- (k) FM - Turns on hydrant as soon as hose clamp has been applied, follows hose line removing kinks, tightening leaking couplings, and reports to crew chief

Enough to reach any part of building on fire

1. Reverse lay

- (1) Fire to hydrant
- (2) Must always be used when hydrant pressure is inadequate
- (3) Longer time required to get water to the fire
- (4) Truck not available for another lay

m. Crew Duties

- (1) Reverse Lay Out
 - (a) IR - stops at fire
 - (b) CC - Goes to size up fire
 - (c) IR & FM - Remove ladder from truck

These procedures should be considered as a guide and adjustments made to fit a local situation



- (d) EM & NM - Remove force-able entry tools and extinguishers
- (e) NM - Removes load finish
- (f) EM - Removed adaptor, nozzle and anchors pay out line
- (g) DR - Drives truck to hydrant
- (h) PM - Goes with truck
- (i) NM & EM - Advance nozzle or nozzles and hose to the fire
- (j) DR - Spots truck at hydrant
- (k) PM - Removes enough hose from bed to reach discharge outlet breaks hose, returns hose to hosebed and connects discharge hose to pump outlet
- (l) DR - Set up cab controls, removes suction hose and connects to truck and hydrant
- (m) PM - Opens hydrant
- (n) DR - Operates pump
- (o) PM - Follows hose line straightening kinks in hose - tightening leaking couplings and reports to crew chief

Application:

TIME: N/A

Evaluation:

TIME: 10 min

Intersperse throughout the presentation.



CONCLUSION

TIME: 5 min

Summary: We have just discussed the importance of proper vehicle positioning, used the rule of thumb for spacing vehicles for a relay operation and covered hose operations to include care and maintenance of hose and crew duties during hose lays.

Remotivation: No one can tell for sure, but at some time you may be called upon to perform a relay operation, or perform a hose lay, and the manner in which you perform may be the difference between life and death.

Assignment: Read and study TO 36A12-12-15-1, Firefighting Truck, 750 GPM Structural Type A/S32P-12, pages 5-12 through 5-14, para 5-15 through 5-21.

Outside Assignment: (2 hrs) Read and study SG 408, Hose Loads and Finishes, and answer the questions at the end of the unit.

Closure: Soon we will be performing hose operations, be prepared to work as a team.



INTRODUCTION

TIME: 5 min

Attention: How is it that when a structural pumper lays hose, it pays off nice and smooth? Is there a trick to loading it? No, just knowing what type of lay you desire and the proper loading procedure is all that is required.

Review: We have just covered vehicle positioning, relay operations and hose operations.

Overview: We will cover the various types of hose loads and finishes and actually perform hose loading today.

Motivation: To quickly get our hose lines into operation for fast extinguishment, we must know how to correctly load the hose on the vehicle.

Transition: Today's lesson will begin with the different types of hose lays.

BODY

TIME: 5 hrs 50 min

Presentation:

TIME: 2 hrs 10 min

1. Given a structural pumper, fire hose, necessary equipment, T.O. and WB, load hose on pumpers and make hose load finishes IAW the WB procedures with minimum instructor assistance.

Stress energy and materials conservation

Check outside assignment

a. Hose loads

(1) Horse shoe load

Use WB 408

(a) Less bends

Chart CAFB 72-44, "Horseshoe Load"

(b) Less jamming of hose on lays

(c) Place coupling in right front corner of open hose bed to start load

All hose must be loaded correctly, so it will pay out without jamming

(d) First coupling is determined by the type finish to be used

(e) Second layer is began by gradually raising hose from rear to front of hose bed

(2) Accordion Hose Load

- (a) Easier to load
- (b) More hose in bed
- (c) Longer lays
- (d) Place coupling in right front corner of open hose bed to start load
- (e) First coupling is determined by the type of finish to be used
- (f) Second layer is began by gradually raising hose from front to rear of hose bed

Chart CAFB 72-43, "Accordion Load"

(3) Divided Load

- (a) Make two lays at once
- (b) One long lay by connecting sides
- (c) One straight and one reverse lay
- (d) Hose bed is divided by a baffle board
- (e) Place coupling at rear center next to baffle board
- (f) First coupling is determined by the type finish to be used

Chart CAFB 72-41, "Divided Load"

(4) Dutchman - use in loads to prevent jamming of coupling in the hose load (used on all hose loads)

(5) Combination Load

- (a) 1½ inch hose used in conjunction with 2½" hose
- (b) May be loaded on top of hose in hose bed or loaded alongside in a small compartment

Chart CAFB 72-42, "Combination Load"

- (c) One method is the Cisco Load for reverse lay

Chart CAFB 72-40, Cisco Load Finish"

75

INTERIM SUMMARY

b. Load finishes

(1) Doughnut roll

Chart CAFB 72-38, "Doughnut Roll Finish"

- (a) Normally used on loads for straight lays
- (b) One section of hose
- (c) Male coupling should be placed 4 - 6 feet from female
- (d) Can be used with any lay

(2) Skid Finish

Chart CAFB 72-39, "Skid Load Finish"

- (a) Normally used on loads for reverse lay
- (b) Consists of 150-200 feet of 2½" hose
- (c) Finish is removed fast and efficiently by pulling the skids
- (d) Skid gives adequate working line at the fire

(3) One and one-half inch finish

- (a) Can be used with any type lay
- (b) Hose can be loaded in small compartment alongside 2½" hose
- (c) One method is on top of 2½" hose for reverse lay called Cisco Finish

Chart CAFB 72-40, "Cisco Load Finish"

INTERIM SUMMARY

Show Film: FTA 258D "Hose Loads"

Conduct a Demonstration for
.5 hr on hose loading/finishes
2 INSTRUCTORS ARE REQUIRED

Application:

TIME: 3 hrs 30 min

2 INSTRUCTORS ARE REQUIRED

1. Given a structural pumper, fire hose, necessary equipment, T.O. and WB, load hose on pumpers and make hose load finishes IAW the WB procedures with minimum instructor assistance.

- Use T.O. 36A12-12-8-51
- 36A12-12-9-61
- 36A12-12-12-1
- 36A12-12-15-1

Trainer: 750A Hose Bed Loader, 63-3019

Vehicles: 530B Structural Fire-fighting Vehicle and Mounted Equipment

750A Structural Fire-fighting Vehicle and Mounted Equipment

A/S32P-8 Structural Fire-fighting Vehicle and Mounted Equipment

A/S32P-12 Structural Firefighting Vehicle and Mounted Equipment

Helmet, Gloves

Watch for couplings when loading hose to avoid injury to hands

Do not drop couplings

Properly operate Air Force equipment. Prevent damage resulting in costly repair.

Watch for personnel on vehicle.

Use Hose Washer; Dryer, Fire Hose

Wash and-dry fire hose

Preventive maintenance

Materials to clean vehicles and station.

2. Given necessary equipment, perform preventive maintenance on structural firefighting vehicles and mounted equipment IAW AFTO Form 434. Maintain station facilities as required.

Evaluation:

TIME: 10 min

Intersperse throughout the presentation.

77

Summary: We have just discussed the various types of hose loads and finishes and actually performed them on the hangar floor.

Remotivation: Knowing how to correctly load hose and construct the finishes is very important in that it tends to produce a smooth hose lay for fast and efficient operation.

Assignment: Review and study the following SG units:

1. SG-401, Operations and Maintenance of Hydrants
2. SG-407, Vehicle Positioning, Relay and Hose Operation

Outside Assignment: (2 hrs) Read and study SG-409, Hose Lays, and answer the questions at the end of the unit.

Closure: Today we have prepared ourselves for our operations at the hose pad tomorrow.

HOSE LAYS

INTRODUCTION

TIME: 5 min

Attention: In the early days of fire departments, the bucket brigade was used to transport water from its source to the fire, and buildings were generally lost with this method. With the advent of fire hose, fire departments can now pump water from hydrants or other sources to the fire, at correct pressure to make extinguishment easier.

Review: We have discussed the different types of hose loads and finishes and performed them on the hangar floor.

Overview: During this lesson you will perform straight and reverse hose lays and rotate crew positions.

Motivation: During a fire situation the speed of extinguishment is directly dependent on the knowledge and ability of crew members to operate nozzles and handle hoses correctly. After the emergency has passed it is necessary that all members work together to replace hose on pumpers quickly, so that you and your crew are prepared to make the next emergency response.

Transition: Today's lesson begins with a review of our safety practices.

BODY

TIME: 5 hrs 50 min

Presentation:

TIME: 10 min

1. Given a structural firefighting vehicle and necessary tools, perform straight hose lays. All procedures outlined in the WB must be strictly adhered to, while observing applicable safety procedures. Position and operate tools and equipment as required.

Stress energy and materials conservation

Check outside assignment

Use WB 409

a. Safety practices

Students will not open hangar doors. A minimum of two instructors will be used at all times to open and close hangar doors

(1) When using the master stream (deluge gun) always make certain it is anchored

Do not drop couplings

(2) Assure that only serviceable hose is used when making up hose loads

Properly operate Air Force equipment. Prevent damage resulting in costly repair

(3) Ascertain all personnel wear protective clothing

(4) Open and close all nozzles and hose clamps slowly

- 79 }
- (5) The nozzle should be kept closed while:
 - (a) Making up hose lines
 - (b) Hoisting or advancing hose lines
 - (c) Moving charged line from one position to another
 - (6) Keep hose line straight for at least ten feet behind nozzle while discharging water
 - (7) If nozzleman receives too much pressure, nozzle should be partially shut off until pressure can be adjusted.
 - (8) If the nozzle should get away from the nozzleman it is normally safer to quickly jump in front of nozzle and get wet rather than get injured by nozzle backlash
 - (9) Do not straddle hose
 - (10) Watch for "flying" couplings when hose is paying out
 - (11) Always stay alert and pay attention to your job

Application:

1. Given a structural firefighting vehicle and necessary tools, perform straight hose lays. All procedures outlined in the WB must be strictly adhered to, while observing applicable safety procedures. Position and operate tools and equipment as required.

TIME: 5 hrs 30 min

4 INSTRUCTORS ARE REQUIRED

NOTE: During excessively cold weather, the hose lays will be performed on the hangar floor.

Hose pad lays should not exceed 200 feet in length

Use TO 36A12-12-8-51
TO 36A12-12-9-61
TO 36A12-12-12-1
TO 36A12-12-15-1

Vehicles: 530B Structural Fire-fighting vehicle and mounted equipment

750A structural fire-fighting vehicle and mounted equipment

Vehicles: A/S32P-8 Structural Firefighting Vehicle and Mounted Equipment

Protective Clothing

NOTE: During excessively cold weather, the hose lays will be performed on the hangar floor

Hose pad lays should not exceed 200 feet in length

Vehicle: A/S32 P-12 Structural Firefighting Vehicle and Mounted Equipment

Use preventive maintenance materials

- 2. Given a structural firefighting vehicle and necessary tools, perform reverse hose lays. All procedures outlined in the WB must be strictly adhered to, while observing applicable safety procedures. Position and operate tools and equipment as required.
- 3. Given two structural firefighting vehicles, perform vehicle relay operation in accordance with the WB procedures, while observing all applicable safety procedures.
- 4. Given necessary equipment, perform preventive maintenance on structural firefighting vehicles and mounted equipment IAW AFPO Form 434. Maintain station facilities and protective clothing as required.

Evaluation:

TIME: 10 min

Intersperse throughout the presentation.

CONCLUSION

TIME: 5 min

Summary: We have completed discussions on hose loads and finishes, hose lays, safety during hose operations, and care and maintenance of hose, also we have actually operated as crew members during hose lays performing all duties as would be performed during fire emergencies.

Remotivation: It is important that you handle hose and operate nozzles, efficiently, yet safely, for this allows you to attack a fire in its early stages before it can increase in intensity and make extinguishment difficult.

Assignment: Review and study SG 409, Hose Lays.

Outside Assignment: (2 hrs) Read and study SG-410, Structural Firefighting Procedures, and answer the questions at the end of the unit.

Closure: Soon your knowledge of the subjects you have learned will be used at the smoke house. After that it will be continually used at your new duty station. Keep prepared!



STRUCTURAL FIREFIGHTING PROCEDURES

INTRODUCTION

TIME: 5 min

Attention: "There goes the axe squad." "They're washing the building from its foundation!" These are some of the comments made by onlookers as they watch a fire department in action. Are they necessary?

Review: We have now completed discussions on hose loads and finishes; hose lays, safety during hose operations, and care and maintenance of hose. You have also acted as crew members during hose lays.

Overview: We will now begin a discussion on principles of structural firefighting, of building heat and smoke ventilation and visual inspection procedures for determining structural stability of a building.

Motivation: A small fire can be extinguished quickly, and yet with incorrect procedures, more damage can be done than you may realize. Place yourself in the position of the fire victim. You must prevent as much damage as possible.

Transition: Today's lesson will begin with the various types of windows and doors we may encounter.

BODY

TIME: 5 hrs 50 min

Presentation:

TIME: 5 hrs 40 min

1. Without reference, identify principles of structural firefighting. Eighty percent of the principles must be identified correctly.

Stress energy and materials conservation

Check outside assignment

a. Types of Roofs

(1) Shingle

(a) Wood, metal, asphalt and asbestos

Use natural openings if possible

(b) These are opened by stripping off the shingle and cutting away the sheathing

(2) Composition

(a) Sheet roofing (generally asphalt or impregnated felt)

- (b) The covering is cut away and rolled back before the sheathing is cut away to make the opening

b. Types of Windows

- (1) Wood or metal frame
 - (a) Wood-Pry with a wedge is the principle operation
 - (b) Metal-Break glass, reach inside and open

Use care working around broken glass

- (2) Factory Type
 - (a) Consists of steel sashes which are often set solidly in the frame
 - (b) Open same as metal frame type

- (3) Check rail type
 - (a) Made of wood with two frames or sashes which are in contact at the top and bottom horizontals
 - (b) Prying should be done at the center of the sash to prevent breaking the glass
 - (c) Tools recommended for opening windows

Use Check Rail Window, 4098

- 1. Fire axe
- 2. Pike pole
- 3. Claw tool/crowbar
- 4. Spanner wrench or any wedge shaped tool

- c. Type of Doors - Two factors which determine the methods of opening doors forcibly, the way it is hung and the way it is locked

NOTE: Try doorknob first

(1) Panel door

- (a) May have horizontal or vertical panels, or a combination of both with material
- (b) If the door opens outward, it can be opened by inserting a door opener or the blade of an axe in the crack between door and jamb and prying them apart until the bolt clears.

(2) Slab door

Use door and door frame, 4097

- (a) Generally made of veneered hardwood with a white pine core or frame
- (b) Generally this door is opened the same as a panel door

(3) Industrial door

- (a) Metal, wood or combination
- (b) The method for opening this type of door is determined by the manner in which it is hung, locked or opens
- (c) These doors are used in garage, warehouses, and are single or double wing, single or double sliding, overhead lift or overhead rolling
- (d) Tools recommended for opening doors
 - 1. Fire axe
 - 2. Door opener
 - 3. Crowbar/Claw tool

INTERIM SUMMARY

d. Structural Firefighting Steps

(1) Control



- (a) Halting the spread of fire
- (b) You must determine the location of the fire. Ventilation is the main means of accomplishing this
- (c) Protect exposures to keep the fire from spreading
- (d) External exposures
 - 1. Use of hose streams
 - 2. Use of water curtains
- (e) Internal exposures
 - 1. Close doors and windows
 - 2. Use fog streams for initial control

All aspects of structural firefighting procedures are interrelated

35mm slides Set #410, "Structural Firefighting Procedures"

(2) Ventilation

- (a) Helps in locating and confining the fire and is accomplished during the control phase of firefighting

(3) Extinguishment

- (a) Actually putting the fire out. It begins when the control of the fire has been established.
 - 1. Direct method - fog or straight stream aimed directly at the base of the fire
 - 2. Indirect method - a water fog applied at a point away from the actual point of the fire (i.e., ceiling) which is carried to the fire by convection currents
 - a. This method is limited to closed buildings, and is not effective on "open fires"

- 85
3. Combination method is using the direct and indirect method simultaneously

- a. Nozzle is rotated in a circular motion covering the entire area

- (b) To accomplish extinguishment we use various hose streams

1. Straight streams - used for long reach
 2. Fog streams - effective for initial control of an interior fire
 3. Master streams, straight or fog

Show Film TFI 52-83, "Getting the Most Out of Water"

- (c) Hose Stream Usage

1. Extinguish fire
 2. Protect exposures
 3. Ventilating
 4. Protection of firemen from heat
 5. Water curtains

Show Film TFI 57-13, "Hose Stream Application"

Show Film TFI 59-71, "The Nozzlemans"

- (d) Broken Streams

1. Dented nozzle tips
 2. Damaged or worn discharge gates
 3. Obstructions in nozzle assembly

Explain how they affect your fire stream

INTERIM SUMMARY

(4) Salvage

- (a) The prevention of excessive damage by smoke, heat or water

(b) Amount of salvage governed by

Show Film TFI 5337, "Tale of Two Towns

- 1. Type of building and contents
- 2. Nature of fire
- 3. Availability of tools and equipment
- 4. Number of personnel

(c) Method of salvage

- 1. Removal
 - a. More time involved
 - b. More personnel required
- 2. Protecting material by using salvage covers
 - a. Catch basins
 - b. Drain chute
 - c. Salvage cover over material
- 3. Catch basin
 - a. Used to catch water from upper stories
 - b. Place furniture or boxes in a circle
 - c. Place salvage cover over furniture or boxes forming a basin
 - d. Secure salvage cover to furniture
 - e. Shallow basins may be made by rolling all four edges to the side of the basin
- 4. Drain chutes
 - a. Used to get leaking water out of the building

- b. Suspend two corners of salvage cover on pike poles
- c. Have other end of salvage cover outside the building

- d. Secure outside corners with S hooks or ropes

5. Equipment used for salvage

- a. Salvage covers
Small - 12x18'
Large - 14x18'
- b. S hooks
- c. Pike poles
- d. Brooms, buckets, mops, and squeegees
- e. Shovels

Charts CAFB 67-204, "Accordion Fold for Small Salvage Covers"

CAFB 67-205, "Fold For Large Salvage cover"

(5) Overhaul

- (a) A complete and thorough check of the structure to insure the fire is completely out (no glowing embers, hot spots, etc.)
- (b) Thoroughly inspect building for concealed fires or hot spots
 - 1. Between floor joists
 - 2. Ceiling beams or false ceilings
 - 3. Walls and partitions
 - 4. Window and door casing
 - 5. Stairways and elevator shafts
 - 6. Upholstery and over-stuffed chairs

Show Film TFI 5972, "Coordinated Fire Attack"



(c) Use back of hand to check for hot spots

(d) Cut inspection holes

- 1. Cut as close to hot spots as possible
- 2. Cut square holes and close to studs
- 3. Do not cut through studs

2. Without reference, identify the principles of building heat and smoke ventilation. Eight of ten principles must be identified correctly.

a. Prior to ventilation, building utilities will be shut off

(1) Electric

- (a) Main shut off switch usually cuts power for entire building
- (b) DO NOT attempt to disconnect electric lines from building

(2) Gas

- (a) Main shut off valve cuts off gas in entire building

(3) Electric shut off switch will be shown on pre-fire plan

(4) Gas shut off valve will be shown on pre-fire plan

- (a) Turn valve off using spanner wrench

b. Safety procedures for ventilation

(1) Open windows on leeward side before the windward side

(2) Have a charged hoseline standing by for immediate use

(3) Stand to one side when breaking glass windows



- (4) Check condition of roof supports
- (5) Have a means of escape from roof
- (6) Utilize lifeline when working on roof
- (7) Always work with the wind to your back

c. Purpose of ventilation

- (1) Aids in life saving and rescue
- (2) Speeds attack and extinguishment
- (3) Reduces the danger of backdrafts
- (4) Lessens the chances of mushrooming
- (5) Makes firefighting easier
- (6) Reduces fire and water damage
- (7) Reduces smoke and heat damage
- (8) Permits prompt salvage operations

d. Vertical ventilation

- (1) Define - Removing smoke, heat and gases from a closed building. Generally, the opening is made in the roof
- (2) The seven most important steps to follow
 - (a) Check condition of roof supports to insure that they have not been burned away or weakened.
 - (b) Plan a means of escape for firefighters from the roof if in trouble
 - (c) Use available natural openings, scuttle holes, skylights, and penthouses



- 90
- (d) Keep a charged line available to protect firefighters and cool down the area around the opening
 - (e) Be sure roof openings are extended down through room ceiling
 - (f) Make opening large enough to provide quick exit for smoke, heat and gases
 - (g) Work on the windward side of the opening, keep in mind the heat, possible explosive characteristics and toxic effects of escaping gases

e. Horizontal ventilation

- (1) Define - Removing smoke and gases from a closed building if they have not reached the uppermost level. Natural outside openings are used at each floor level
- (2) This method required more care than vertical ventilation because large vertical shafts, such as open stairwells, may allow downward drafts of fresh air
- (3) The five most important steps to follow are:
 - (a) Open windows on leeward side first then open windows on windward side
 - (b) If windows are the check rail type, open the upper half on the leeward side and the lower half on the windward side
 - (c) After on floor is clear, ventilate the next in the same way, or into one already cleared.
 - (d) Do Not make an opening below the level of the fire

(e) If opening is made at same level as the fire, have a hoseline standing by for immediate use

f. Natural outside openings must be available on each floor level. We must have the proper openings so that hot gases and smoke can escape before fireman can enter the building

g. The fire can be expected to spread as soon as the opening is made, so adequate protection must be provided at points of entry to the building. A fog spray should be used on entry as the water will absorb and carry away the gases ahead of firemen

h. Walls and Ceilings

(1) Tools

- (a) Pike Poles
- (b) Fire axe

(2) Methods and precautions to use when opening ceilings

- (a) Do not stand under area to be opened
- (b) Pull down and away to avoid being hit by falling material
- (c) Keep the upper hand on the top side of the pole to assist you in above
- (d) Always wear your helmet when pulling down a ceiling or upper part of a wall, because you don't know how much material may fall with each thrust

i. Floors

(1) Tools

- (a) Fire axe
- (b) K-12 saw



- (2) Angle of cut: The cut follows the side of the joist toward the required opening
- (3) Sub flooring: The sub floor is laid at a 45 degree angle to the joist
- (4) Locating joists: They are located by sound
- (5) Standing position: Hold the axe half way down the handle, with feet spread

INTERIM SUMMARY

3. Without reference, identify visual inspection procedures for determining structural stability of a building. Eighty percent of the procedures must be identified correctly.

NOTE: Brief students on smoke house operations for tomorrow, using Building Pre-Fire Plan Charts:

- 71-91
- 71-92
- 71-93
- 71-94
- 71-95

- a. Prior to overhaul check
 - structure for unsafe condition
 - (1) Damaged or weakened floor, wall or ceiling supports
 - (2) Cracks in masonry walls
 - (3) Overloading of floors by saturated stock piles
 - (4) Check to make sure all utilities have been turned off.
- b. Visual inspections for structural stability prevent injury to structural firefighting crews

Application:

TIME: N/A

Evaluation:

TIME: 10 min

Interspersed throughout the presentation.



93
Summary: We have just completed our lesson on the principles of structural firefighting: building heat and smoke ventilation, and procedures for determining structural stability of a building.

Remotivation: When you attack and extinguish a fire using the correct principles of structural firefighting, you know you have done a job to be proud of

Assignment: Review and study SG 407, "Vehicle Positioning, Relay and Hose Operations."

Outside Assignment: (2 hrs) Read and study SG-411, Structural Firefighting Operations and answer the questions at the end of the unit.

Closure: Soon what we have studied and practiced on the hose pad and in the classroom will be put into operation at the smoke house.

STRUCTURAL FIREFIGHTING OPERATIONS

INTRODUCTION

TIME: 5 min

Attention: Look at that confusion; fire trucks coming from different directions; men getting tools and equipment off one, while one is laying hose. It may look like a circus sideshow, but it is actually a planned structural firefighting operation.

Review: We have just completed our lesson on structural firefighting procedures, including building heat and smoke ventilation.

Overview: Today will be our first day at the smoke house. We will put into operation everything we have learned about hose lays, hose loads, crew position, structural firefighting principles, and ventilation procedures.

Motivation: Each crew member is a vital part of any structural operation. You must know your job in order to perform as a trained crew.

Transition: Today's lesson will begin with a review of our safety procedures prior to going to the smoke house.

BODY

TIME: 5 hrs 50 min

Presentation:

TIME: 10 min

1. Given a structural pumper and mounted equipment, AFTO Form 434 and technical data, inspect and perform operator maintenance on structural firefighting vehicles and mounted equipment. Operator maintenance must be accomplished according to the technical order. All applicable items on the AFTO Form 434 must be inspected.

Stress energy and materials conservation

Check outside assignment

Use WB 411

Students will not open hangar doors. A minimum of two instructors will be used at all times to open/close hangar doors

a. Safety procedures

NOTE: Check breathing apparatus

Ensure students have proper bunker clothing and necessary equipment

- (1) Always be fully bunkered out in protective clothing before mounting vehicles
- (2) Protective headgear, with strap in place, will be worn during every emergency response, and at all other times
- (3) Gloves will be worn at all times during an emergency response.

136

- (4) Use handholds when riding vehicle tailboard
- (5) When operating on ladders, always "lock in" and secure hose with a strap
- (6) Never throw equipment - pass by hand. Be observant when tools are hoisted or lowered
- (7) Always step up onto tailboard NEVER jump on
- (8) Do not dismount vehicle while in motion
- (9) Do not straddle hose, especially charged lines
- (10) Be especially careful on ice, wet and oily surfaces
- (11) Set handbrake and chock wheels

Caution: NO emergency will be tolerated, you could get injured

95

Stress safety in forcible entry and rescue operation

Application:

1. Given a structural pumper and mounted equipment, AFTO Form 434 and technical data, inspect and perform operator maintenance on structural firefighting vehicles and mounted equipment. Operator maintenance must be accomplished according to the technical order. All applicable items on the AFTO Form 434 must be inspected.

2. Given firefighting vehicles, tools, equipment, breathing apparatus, protective clothing and technical data, perform crew duties in firefighting drills and emergency response exercises. Workbook procedures must be strictly adhered to while observing all applicable safety practices.

3. Given a building, demonstrate normal and emergency entry procedures. All entry procedures must be in accordance with the WB procedures. All applicable safety procedures must be strictly adhered to.

TIME: 5 hrs 30 min
6 INSTRUCTORS ARE REQUIRED

- Use TO 36A12-12-8-51-
- TO 36A12-12-9-61
- TO 36A12-12-12-1
- TO 36A12-12-15-1

Protective Clothing

Properly operate Air Force equipment. Prevent damage resulting in costly repair.

- Use: Breathing apparatus
 Drafting pit
 Deluge gun
 Three story training tower and building

- Vehicles: 750A Structural Firefighting Vehicles & Mounted Equipment
 530B Structural Firefighting Vehicles & Mounted Equipment
 A/S32P-8 Structural Firefighting Vehicles & Mounted Equipment
 A/S32P-12 Structural Firefighting Vehicles & Mounted Equipment

4. Given a burning building, firefighting vehicles, tools, equipment, breathing apparatus, protective clothing and technical data, perform as a member of a firefighting crew to control and extinguish structural fires. Each fire must be completely extinguished while observing all applicable safety procedures.

5. Given an occupied building, locate and evacuate personnel from building in less than three minutes.

6. Given structural firefighting vehicle and a building on fire, protect adjacent/nearby building exposures and equipment from fire hazards in accordance with the WB procedures, while observing all safety procedures.

7. Given a building and appropriate cleanup equipment, perform firefighting overhaul clean-up operations. All debris and water must be removed.

8. Given necessary equipment, perform preventive maintenance on structural firefighting vehicles and mounted equipment IAW AFTO Form 434. Maintain station facilities and protective clothing as required.

Use Preventive maintenance materials

Air compressor

Evaluation:

TIME: 10 min

Interspersed throughout the presentation.

CONCLUSION

TIME: 5 min

Summary: We have just completed part of our lesson on structural firefighting operations and have performed crew duties in smoke house operations.

Remotivation: The need for well trained and efficient crew members cannot be overemphasized. It is up to you to become proficient in your job.

Assignment: Review and study SG 408, "Hose Loads and Finishes."

Outside Assignment: (2 hrs) Read and study SG 412, Structural Firefighting Tactics and answer the questions at the end of the unit.

Closure: Today was just a small sampling of what it is like fighting a fire.

STRUCTURAL FIREFIGHTING TACTICS

INTRODUCTION

TIME: 5 min

Attention: How do you know exactly how to combat a structural fire? Do you play it as it goes along or is there a procedure to follow.

Review: We have just completed one day of structural firefighting operations at the smoke house.

Overview: Today we will continue our smoke house operations to include rescue of personnel, and the shutting off of utilities.

Motivation: You have had one day of operations, now is your chance to improve yourself and correct any mistakes you made before.

Transition: Today's lesson will begin with a review of our safety procedures.

BODY

TIME: 5 hrs 50 min

Presentation:

TIME: 10 min

1. Given a structural pumper and mounted equipment, AFIO Form 434 and technical data, inspect and perform operator maintenance on structural firefighting vehicles. Operator maintenance must be accomplished according to the technical order. All applicable items on the AFIO Form 434 must be inspected.

Stress energy and materials conservation

Check outside assignment

Use WB 412

Students will not open hangar doors. A minimum of two instructors will be used at all times to open/close hangar doors.

NOTE: Check breathing apparatus

Ensure students have proper bunker clothing and necessary equipment

Caution: No horseplay or inattention will be tolerated. You could get injured

a. Safety procedures

- (1) Always be fully bunkered out in protective clothing before mounting vehicles
- (2) Protective headgear, with strap in place, will be worn during every emergency response, and at all other times
- (3) Gloves will be worn at all times during an emergency response
- (4) Use handholds when riding vehicle tailboard

- (5) When operating on ladders always "lock in and secure hose with a strap
- (6) Never throw equipment - pass by hand. Be observant when tools are hoisted or lowered
- (7) Always step up onto tailboard. Never jump on.
- (8) Do not dismount vehicle while in motion
- (9) Do not straddle hose, especially charged lines
- (10) Be especially careful on ice, wet and oily surfaces
- (11) Set handbrake and chock wheels

Stress safety in forcible entry and rescue operations

Application:

1. Given a structural pumper and mounted equipment, AFTO Form 434 and technical data, inspect and perform operator maintenance on structural firefighting vehicles. Operator maintenance must be accomplished according to the technical order. All applicable items on the AFTO Form 434 must be inspected.
2. Given firefighting vehicles, tools, equipment, breathing apparatus, protective clothing and technical data, perform crew duties in firefighting drills and emergency response exercises. Workbook procedures must be strictly adhered to while observing all applicable safety practices.
3. Given a building, demonstrate normal and emergency entry procedures. All entry procedures must be in accordance with the WB. All applicable safety procedures must be strictly adhered to.
4. Given a building, locate master switch and shut off building utilities in less than one minute.

TIME: 5 hrs 30 min

6 INSTRUCTORS ARE REQUIRED

- Use: TO 36A12-12-8-51
 TO 36A12-12-9-61
 TO 36A12-12-12-1
 TO 36A12-12-15-1

Protective Clothing

Properly operate Air Force equipment. Prevent damage resulting in costly repair

Use Breathing apparatus, drafting pit, deluge gun, three story training tower and building

Vehicles: 750A Structural Fire-fighting vehicle and mounted equipment; 530B structural firefighting vehicle and mounted equipment; A/S32P-8 structural firefighting vehicle and mounted equipment; A/S32P-12 structural firefighting vehicle and mounted equipment

99

5. Given a burning building, firefighting vehicles, tools, equipment, breathing apparatus, protective clothing and technical data, perform as a member of a firefighting crew to control and extinguish structural fires. Each fire must be completely extinguished while observing all applicable safety procedures.

6. Given a building, protective clothing, rescue equipment and a rescue dummy, locate dummy victim and perform rescue from building using the appropriate type of carry. The rescue must be accomplished in less than three minutes while observing all applicable safety procedures.

Use Rescue dummies

7. Given structural firefighting vehicle and a building on fire, protect adjacent/nearby building exposures and equipment from fire hazards in accordance with the WB procedures, while observing all applicable safety procedures.

8. Given salvage covers and a furnished room, perform as a member of a crew to protect building contents. Contents must be sufficiently protected with salvage covers to prevent further damage.

9. Given salvage covers and a building, perform as a member of a crew and construct catch basins and drain chutes. Basins and chutes must be designed/constructed in such a manner as to prevent further water damage to the building and contents.

10. Given a furnished room, perform as a member of a crew and remove equipment and furnishings in less than 30 minutes in accordance with the WB procedures.

11. Given a building and appropriate cleanup equipment, perform firefighting overhaul clean up operations. All debris and water must be removed.

12. Given necessary equipment, perform preventive maintenance on structural firefighting vehicles and mounted equipment IAW AFTO Form 434. Maintain station facilities and protective clothing as required.

Use Preventive maintenance material
air compressor.

Evaluation:

100
TIME: 10 min

Intersperse throughout the presentation.

CONCLUSION

TIME: 5 min

Summary: Today, you have performed all the tasks and procedures necessary in efficient and effective structural firefighting operations. You have acted as crew members of structural firefighting vehicles, and have gained insight into these positions.

Remotivation: You should now be much more proficient in structural firefighting operations, and this proficiency will be of utmost importance to you today and as you prepare for the field.

Assignment: Review and study SG 410, "Structural Firefighting Procedures." Have students to review all materials and notes in preparation for the Block IV final measurement test.

Outside Assignment: (2 hrs) Read and study the following SG units and answer the questions at the end of each unit.

1. SG 413, Preservation of Evidence (1 hr)
2. SG 414, Fire Station Maintenance (1 hr)

Closure: You should now have a good insight into what it takes to become an efficient structural firefighter.

101
PRESERVATION OF EVIDENCE

INTRODUCTION

TIME: 5 min

Attention: Fire can destroy in minutes what it takes man years to build. If there is some way to prevent fire from occurring then man's efforts are not in vain.

Review: We have just completed our days at the smoke house and know what an enemy fire can be.

Overview: Today we will cover preserving evidence at the scene of a fire.

Motivation: To discover the cause of a fire and to take action to prevent the same cause from occurring in other areas.

Transition: We will begin today's lesson with methods to preserve evidence.

BODY

TIME: 1 hr 50 min

Presentation:

TIME: 1 hr 40 min

1. Without reference, identify procedures for preserving evidence to determine the cause of a fire. Eighty percent of the procedures must be identified correctly.

a. Preserve evidence

Stress energy and materials conservation

(1) There are two things a firefighter should keep in mind regarding the preservation of evidence

Check outside assignment

(a) Keep evidence where it is found, untouched and undisturbed.

(b) Evidence which cannot be left at the scene, properly identify, remove, and safeguard it.

(2) Photographs are excellent supporting evidence, if immediately taken (color photographs if possible)

b. Types of evidence

- (1) All fires are not deliberately set, some are caused by carelessness, some by ignorance, and some by a complete disregard of fire safety
- (2) Fire in kitchen could be due to frying pan left unattended on stove
 - (a) Cabinets above stove and ceiling would be burnt area
- (3) Fire in clothes dryer, caused by lint filter not being cleaned and causing motor to overheat and ignite lint and clothes
- (4) Fire in electrical wiring could be caused by
 - (a) Taping circuit breaker
 - (b) Overloading of outlets
 - (c) Wrong size fuses
 - (d) Bridging fuses
 - (e) Improper wiring

Use personal experience on types of fires you have seen

c. Protect and guard evidence

- (1) Evidence can be protected at the scene in various ways
 - (a) Rope off the area
 - (b) Material can be piled around the evidence to keep people away until arrival of investigators
 - (c) Guards can be posted to prevent tampering with evidence
 - (d) Leave plenty of room around evidence to protect it exactly as it was found
 - (e) Protect tire and footprints so casts can be made

Especially important if sabotage is suspected



d. Identify, preserve, remove, and safeguard evidence

- (1) All evidence collected by firefighters should be properly tagged and preserved in a clean container.
- (2) Notation of date, time, and the place where the evidence was found should be made. Container should have the initials of the person who collected the evidence. Persons handling evidence should be kept to a minimum, a record should be kept of all persons who handle evidence.

Application

TIME: N/A

Evaluation:

TIME: 10 min

Intersperse throughout the presentation.

CONCLUSION

TIME: 5 min

Summary: We have just discussed the methods to preserve evidence at the scene of a fire and briefly covered some types of evidence.

Remotivation: If we are to become proficient firefighters, we need to know what causes fires so we can take steps to prevent them.

Assignment: N/A. Continue with Fire Station Maintenance.

Closure: Remember, fires don't happen, they are caused.

FIRE STATION MAINTENANCE

INTRODUCTION

TIME: 5 min

Attention: Training and combating fires are not all that firemen do. They also have to maintain the fire station and equipment they have.

Review: We have just discussed how to preserve evidence at the scene of a fire.

Overview: Today we will discuss the other side of the firemen's life, including care of his protective clothing and his station facilities and equipment.

Motivation: Protective clothing protects you while combating a fire. Your tools and equipment must function properly when needed, and the fire station, like any building, needs to be clean.

Transition: Today's lesson will begin with the care of our protective clothing.

BODY

TIME: 1 hr 50 min

Presentation:

TIME: 10 min

1. Given firefighting protective clothing, inspect and perform maintenance on clothing as required. Procedures listed in the WB must be followed without error.

Stress energy and materials conservation

Check outside assignment

a. Perform inspection and maintenance on protective clothing

Use WB 414

(1) After each operation, protective clothing should be inspected thoroughly. Check for burns, rips, holes, etc.

Use protective clothing, preventive maintenance materials

(2) Protective clothing should be cleaned with the use of mild soap and water

Use Structural Pumper and mounted equipment
Preventive maintenance materials

(3) Protective clothing, after cleaning, should be allowed to air dry

Stress Safety on mounting vehicles, opening hoods, doors, etc.

2. Given necessary tools and equipment, maintain station facilities in accordance with the WB procedures. Perform preventive maintenance on structural firefighting vehicles and mounted equipment as required.

a. Maintaining Station Facilities

- (1) Facilities maintenance may be divided into station, equipment and apparatus. Although equipment and apparatus are usually considered jointly
- (2) Station maintenance may be divided into routine house-keeping and repair
- (3) Station maintenance requires the cooperation of all personnel
- (4) Certain parts of the station require daily upkeep, other sections weekly, while other areas may require only periodic attention

b. Daily maintenance includes, but is not limited to the following

Stress safety while performing station maintenance

- (1) Sweep all floors
- (2) Disinfect toilets, lavatories and bath facilities
- (3) Make all beds
- (4) Maintain a clean and clear driveway
- (5) Dust all furniture

c. Weekly maintenance

- (1) Mop all floors
- (2) Police grounds and trim grass
- (3) Wash all windows

d. Periodic maintenance

- (1) Clean and service all electric motors
- (2) Wash woodwork
- (3) Check and service doors
- (4) Clean all light fixtures

Application:

TIME: 1 hr 30 min

Intersperse throughout the presentation.

Evaluation:

TIME: 10 min

Intersperse throughout the presentation.

CONCLUSION

TIME: 5 min

Summary: We have had a discussion on care of protective clothing, station and equipment and actually performed some preventive maintenance.

Remotivation: Care of your protective clothing and equipment is of the utmost importance; the time you need them is the time they must be in condition to do their job.

Assignment: Read and study SG 501, "Block V Orientation."

Outside Assignment: (2 hrs) Read and study SG 502, "Principles and Procedures of Aerospace Vehicle Firefighting," and answer the questions at the end of the unit.

Closure: You have completed your introduction to structural firefighting, but you must stay proficient in all areas as this had been just the beginning of your career in Air Force firefighting.

Technical Training

17-3

Fire Protection Specialist

BLOCK IV
STRUCTURAL FIREFIGHTING TACTICS

8 August 1975



CHANUTE TECHNICAL TRAINING CENTER (ATC)

This supersedes 3ABR57130-1-SG-400, 13 April 1973; 3ABR57130-SG-401A, 15 November 1973.

OPR: TWS

DISTRIBUTION: X

TWS - 2,000; TTVGC - 2

Designed For ATC Course Use

DO NOT USE ON THE JOB

108

OPERATIONS AND MAINTENANCE OF HYDRANTS

OBJECTIVES

After completing this study guide and your classroom instructions, you will be able to inspect and perform operator maintenance on hydrants.

INTRODUCTION

Fire hydrants are an important part of the installation fire protection system and must be kept in good working order at all times.

INFORMATION

INSPECTION

Start inspection at hydrant nearest source of supply. Locate nearest valves on hydrant stub or grid system so they can be shut off if hydrant is found defective during inspection. If during inspection, any caps are found missing, replace them.

Remove one hydrant cap and replace with cap fitted with pressure gage. Open hydrant SLOWLY until wide open.

Check hydrant for leaks around gaskets, top of hydrant, and around caps. Note location of all leaks.

Close hydrant SLOWLY to prevent water hammer from causing damage to water distribution system.

MAINTENANCE

Hydrants can be maintained by replacing all worn or malfunctioning parts and seats through the top of the hydrant.

If operating nut has rounded corners from using improper wrench, replace with a new one.

To lubricate operating nut remove screw in top of nut and apply oil, grease, or graphite grease recommended by manufacturer. If hydrant does not operate freely after lubrication, lubricate packing and thrust collar by oiling joint between nut and collar.

QUESTIONS

Please answer questions on a separate sheet of paper. Please do not write in this training literature. Other students will use it after you.

1. _____ are an important part of the installation fire protection system.
2. Start _____ at hydrant nearest source of supply.
3. Open hydrant _____ until wide open.
4. Close hydrant slowly to prevent _____.
5. If operating _____ has rounded corners, replace with a new one.

REFERENCE

1. AFM 85-13, Maintenance and Operation of Water Plants and System.

EMERGENCY RESPONSE ACTIVITIES

OBJECTIVES

After completing this study guide and your classroom instructions, you will be able to identify safe and unsafe procedures concerning emergency response activities.

INTRODUCTION

There is a major difference between driving an emergency vehicle and a private auto. When you are in the emergency vehicle, you are a public servant and have an added responsibility of driving in a manner to set an example for other drivers to follow.

INFORMATION

EMERGENCY RESPONSE

It is recommended that you always use the beacons, emergency flashers, and headlights when responding. During the daylight hours, drivers may not see the approaching vehicles when they are going in the same direction even with emergency lights operating. The use of headlights (flashing from bright to dim) is usually much more effective attention-getters than the red lights. During the night hours, getting the other driver's attention isn't such a problem.

For the safety of yourself and the crew, use the siren at all times when responding except in housing areas and residential areas where there is the danger of kids running in front of you. Children are always fascinated by the sound of sirens and the red lights. Always keep in mind that kids don't act responsibly and may walk or run directly into your path. In some instances, such as after school hours in the housing areas on base or in residential districts, it may be wise to merely drive through without the use of sirens. Usually, the first truck will get through without too much problem but the following vehicles may have to slow to a crawl to avoid hitting the children.

The siren warns other drivers of an approaching emergency vehicle before the drivers are within sight of each

other. You should leave the siren operating during the response whether you feel that you need them or not. No harm is done by using them and they may save your life or the life of an innocent person. Try to provide an alternating sound such as "wail," "yelp," or "hi-lo."

Just because you are using emergency lights and audiowarning devices doesn't mean you are always in the right or that other drivers and persons will automatically yield. Many people will panic when they see an emergency vehicle and maybe they don't realize the urgency of your mission. There isn't very much that you can do about it right at the time, but you can get their license number and turn it over to the policing agency. You will probably be required to formally charge the driver with failing to yield to an emergency vehicle. If necessary, this should be done because it will probably benefit other emergency agencies in the future.

Always use your headlights when driving any emergency vehicle whether on a response or normal driving. (This is merely a precaution against a poor-sighted, drunk, etc., person.)

Always use the safety belts whether in a fire vehicle or in your private automobile. Use them when on an emergency response or normal driving. They are there for your protection and should be used 100% of the operational time of that vehicle. Use of seat belts is required by Air Force regulations and it also makes good common sense.

Remember that you are responsible to the people you serve when you are in an emergency vehicle. You have the proper warning equipment to use in cases of emergency, so use them. Don't be afraid of drawing attention to yourself

110

because that's exactly what you wish to accomplish.

It has been stated that during the night hours no vehicle is safe at excess of 60 mph. By the time something gets into view, which requires you to stop, it will be impossible to avoid it. You will probably respond during the night and may exceed the recommended speed, but always keep in mind what would happen if you ever hit and killed anyone on an emergency response.

During night driving, headlights will get the attention of drivers but also will blind the other driver unless properly used. It will probably be unnecessary to alternate from bright to dim in the dark hours because the emergency lights will do all that is necessary to warn the drivers of your approach. Once the scene of the emergency is reached, the headlights should be turned completely off. Many times when a driver is facing an emergency vehicle, the headlights will blind the driver to the point where he will not even see the emergency lights; therefore, he may not reduce his speed.

When backing an emergency vehicle, whether on an emergency or not, always turn on the beacon light and honk the horn to warn other people and vehicles that you are backing.

UNSAFE PROCEDURES

Many times, when responding to an emergency, we tend to get excited and disregard our own safety. As firemen, we should always keep our safety in mind for we are responding to render aid and assistance to others.

Some common mistakes that firemen make are jumping on the tailboard instead of stepping up on it, continuing to bunker out while vehicle is in motion, using improper hand holds and not holding on with both hands, not watching for other vehicles or aircraft when on a flight line and dismounting the vehicle before a full stop is made.

QUESTIONS

Please write your answers to the following questions on a separate sheet of paper.

1. There is a major difference between driving an _____ vehicle and a private _____.
2. For the safety of yourself and your crew, use the _____ at all times when responding.
3. Just because you are using emergency lights and audiowarning devices doesn't mean you have the _____.
4. As firemen, we should always keep our own _____ in mind.
5. One of the common mistakes that firemen make is continuing to _____ out while vehicle is in motion.

REFERENCES

1. CDC 57150, Fire Protection Specialist.
2. IFSTA #106, Fire Apparatus Practices.

111

INSPECTIONS, MAINTENANCE, MOUNTED EQUIPMENT AND OPERATIONS OF THE 530B/P-8 STRUCTURAL PUMPERS

OBJECTIVES

After completing this study guide and your classroom instructions, you will be able to:

1. Inspect and perform operator maintenance on the 530B/P-8 structural firefighting vehicle and mounted equipment.
2. Perform a booster operation.
3. Perform preventive maintenance on the 530B/P-8 structural firefighting vehicle and mounted equipment.

INTRODUCTION

Preventive maintenance consists of systematic inspection and correction of the causes of equipment failures before they occur or develop into major defects. If your firefighting apparatus is in excellent condition, you will have both a fast and a safe operation. When you use a firefighting vehicle, your life and the lives of many others depend on the reliability of your vehicle and associated equipment. In order to carry out fire control and rescue operations successfully, proper inspection and maintenance must be carefully performed. Inspection and maintenance routines should take place daily and corrective measures should be performed before it is necessary to use your vehicle. You must remember that when firefighting equipment is needed, there is an emergency. When your vehicle is needed, it is too late to perform preventive maintenance.

INFORMATION

INSPECTION

The importance that fire trucks play in the control of fire emergencies cannot be stressed too much. If a fire truck is unable to produce its full capability at these emergencies, a routine fire could turn into a major one. The fire chief is responsible for the proper operation of fire trucks, but through the chain of command, the responsibility will rest with the pump operator. There are several items of primary importance

on a fire truck that must be checked to insure proper operation. Among these are the battery, fuel, oil, water, foam, and tire pressure. A full gasoline tank is particularly important since a truck often has to operate several hours after it reaches a fire. There have been instances where fire trucks ran out of gasoline at crucial times during major fires. Oil levels of the engine(s) should be checked. The water level in the radiator also should be checked for proper level. All lights should be checked by turning them on and making a visual examination. This includes headlights, tail lights, spot lights, instrument lights, marker lights, compartment lights, etc. All warning signals, such as siren, horn, and low air pressure buzzer should be checked. Windshield-wipers and washers should be checked for proper operation, and washer bottle filled, if necessary. The fluid in the battery should be at the proper level. The level should not be permitted to fall below the top of the plates. Distilled water is highly desirable, but not mandatory for use in lead-acid batteries.

Tires should be checked for unusual signs of wear and the presence of nails or glass that may have been picked up during travel. Use a tire gage to determine whether the pressure is within the recommended limits. Check for missing valve caps and tightness of wheel lug nuts.

Valves and levers on the pump should work easily and be positioned for quick

operation. Caps on the suction and discharge outlets should be in place and should not stick or bind. The threads should be cleaned with a brush, as necessary. Suction strainers should be checked to assure that they are not clogged.

Careful visual examination should be made of the whole truck, including close inspection of the underside of the chassis. Any unusual condition should be examined and corrected. Note any signs of water, oil, foam, gasoline, or hydraulic fluid leakage and trace these leaks to their source. Correct any leaks discovered, if possible, and, if not, report them to your supervisor. Tighten all loose body bolts and sheet metal screws.

All tools and equipment should be checked for serviceability and securely fastened in their normal places. Attention should be given to nozzles and nozzle tips to assure that each size is in its proper place. No cleaning rags, gloves, or other foreign material should be allowed to be stored in nozzles, suction hose, or in any other equipment where they may block the flow of water.

The primer should be checked for proper operation. If oil is used in the priming pump, the oil reservoir should be checked and filled, if required.

Examine the engine for any signs of leaks, looseness, chaffing, or other defects. The engine should be wiped clean with a rag, for a clean engine is usually a sign of good maintenance. Frequently, points of possible failure can be found during the simple task of cleaning.

In general, the same inspections are required after emergency runs as those made daily. The preparation for the next emergency is started by picking up all tools, hose, and equipment used and returning to the station. Upon returning to the station, thoroughly check and clean all equipment used during the emergency and return it to its proper place on the vehicle. All accessories that have been used, such as protective breathing equipment and extinguishers, should be checked and refilled. The vehicle should be washed and the hose bed reloaded with clean, dry hose, as necessary. All soiled sections of hose

should be washed and dried. Gas, oil, water, and foam levels are checked and refilled as necessary.

If the pump has been operated from draft, it should be connected to a hydrant or other source of clean water and thoroughly flushed. This is especially important if salt or dirty water was pumped. A centrifugal pump may be "back flushed" by connecting a hydrant line to the pump discharge and allowing the water to emerge through the suction connection. This will often release foreign matter that may be imbedded in the pump propellers. Hose gate valves should be cleared of sand or grit that may have been picked up during the pumping operations. Gaskets in caps and connections should be replaced as needed.

READING ASSIGNMENT

INSPECTION AND MAINTENANCE

To help you understand the inspection and perform operator maintenance on the 530B/P-8 structural firefighting vehicle, study the following reading assignments from:

TO 36A12-12-9-61

Page	Paragraph
1-1 through 1-4	1-1 through 1-2
2-1 through 2-11	2-1 through 2-9

TO 36A12-12-12-1

Page	Paragraph
1-1 through 1-3	1-1 through 1-19

BOOSTER TANK OPERATIONS

To help you understand and perform the booster operations on the 530B/P-8 structural firefighting vehicle, study the following reading assignments from:

TO 36A12-12-9-61

Page	Figure
2-3 through 2-4	1-1 through 1-19
2-19 through 2-20	2-10



Page	Paragraph
4-13 through 4-14	4-66

PREVENTIVE MAINTENANCE

To maintain the vehicles and mounted equipment in a constant state of readiness required a preventive maintenance program. This will include but is not limited to washing the vehicle and cleaning the compartments. All windows should be cleaned with water or window cleaner.

QUESTIONS

Please write your answers to the following questions on a separate sheet of paper.

1. When your _____ is needed, it is to late to perform _____.
2. A _____ gasoline tank is particularly important since a truck often has to operate several hours after it reaches a fire.
3. Any unusual condition should be _____ and _____.
4. All tools and equipment should be checked for _____ and security fastened in there normal places.

113

5. The primer oil tank is located under the _____ in the truck cab.

6. In setting up the cab of the 530B depress clutch pedal and place _____ shift lever in neutral position.

7. In performing a booster operation on the 530B, move the pump clutch control lever from _____ to _____ position.

8. In performing a booster operation on the P-8, open _____ tank suction line valve.

9. When priming the pump on the P-8, water should enter the fire pump in _____ to _____ seconds of primer operation.

10. The _____ and _____ should be cleaned and put in the correct compartment.

11. Clean all windows with _____ or _____.

REFERENCES

1. TO 36A12-12-9-61, Truck Firefighting 530B.
2. TO 36A12-12-12-1, 500 GPM Brush and Structural Firefighting Truck.

114

PUMPING OPERATIONS ON THE 530B/P-8 STRUCTURAL PUMPERS

OBJECTIVES

After completing this study guide and your classroom instructions, you will be able to:

1. Perform a hydrant operation.
2. Perform a drafting operation.
3. Perform a foam pumping operation.
4. Perform preventive maintenance on the 530B/P-8 structural pumper and mounted equipment.

INTRODUCTION

The 530B pumper is normally considered as a combat type vehicle. This vehicle has the ability to maneuver over rough terrain and is quite often used for off-base emergencies. It is also used for brush and forestry fire service. This truck is one of the most versatile vehicles the Air Force uses. You will learn how to perform pumping operations on the 530B and the P-8.

The P-8 is designed to replace all 530B pumpers on a one for one basis. It is designed as a tactical firefighting vehicle for transporting in predesignated type aircraft. It is primarily a structural, brush vehicle but it can also be used in aircraft emergencies because it carries 600 gallons of water and 55 gallons of foam.

INFORMATION

READING ASSIGNMENT

HYDRANT OPERATION

To help you understand and perform the hydrant operation on the 530B/P-8 structural firefighting vehicle, study the following reading assignments from:

TO 36A12-12-9-61	
Page	Figure
2-3 through 2-4	2-1
2-18	2-9

TO 36A12-12-12-1

Page	Paragraph
4-12 through 4-12A	4-64

DRAFTING OPERATION

To help you understand and perform the drafting operation on the 530B/P-8 structural firefighting vehicle, study the following reading assignments from:

TO 36A12-12-9-61	
Page	Figure
2-17	2-8

TO 36A12-12-12-1

Page	Paragraph
4-12A through 4-13	4-65

FOAM PUMPING OPERATION

To help you understand and perform the foam pumping operation on the 530B/P-8 structural firefighting vehicle, study the following reading assignments from:

TO 36A12-12-9-61	
Page	Figure
2-21	2-11

TO 36A12-12-12-1

Page	Paragraph
4-14 through 4-15	4-67 through 4-69

PREVENTIVE MAINTENANCE

After using the vehicles in pumping operation, they should be cleaned and reserviced. When washing the trucks, never use a 2-1/2 inch or 1-1/2 inch under high pressure as this may peel the paint from the vehicle. The station should be maintained in a clean and healthful condition.

QUESTIONS

Please write your answers to the following questions on a separate sheet of paper.

1. The 530B pumper is normally considered as a _____ type vehicle.
2. The 530B is also used for _____ and _____ fire service.
3. The P-8 is designed to replace all _____ on a one for one basis.
4. In performing a hydrant operation with a 530B, move _____ clutch control lever from road to pump position.

5. In performing a hydrant operation with a P-8, place transmission range selector in _____.

6. In performing a drafting operation with a 530B, after priming the pump move pump clutch control lever from _____ to _____ position.

7. In performing a drafting operation with a P-8, place transfer valve in the _____ position.

8. In performing a foam pumping operation with a 530B, after putting the pump in operation, open the foam _____ lever.

9. In performing a foam pumping operation with a P-8 from a hydrant, the vacuum gage should show a maximum of _____ psi.

10. Never use a 2-1/2" or 1-1/2" hose under high pressure as this may peel the paint from the _____.

REFERENCES

1. TO 36A12-12-9-61, Truck Firefighting 530B.
2. TO 36A12-12-12-1, 500 GPM Brush and Structural Firefighting Truck.

INSPECTION, MAINTENANCE, MOUNTED EQUIPMENT AND OPERATIONS OF THE 750A/P-12 STRUCTURAL PUMPERS

OBJECTIVES

After completing this study guide and your classroom instructions, you will be able to:

1. Inspect and perform operator maintenance on the 750A/P-12 structural firefighting vehicle and mounted equipment.
2. Perform a hydrant operation.
3. Perform a drafting operation.
4. Perform a foam operation.
5. Perform preventive maintenance on the 750A/P-12 structural firefighting vehicle and mounted equipment.

INTRODUCTION

(The first few paragraphs are a repeat of SG-403 to try to impress upon the importance of preventative maintenance.)

Preventive maintenance consists of systematic inspection and correction of the causes of equipment failures before they occur or develop into major defects. If your firefighting apparatus is in excellent condition, you will have both a fast and a safe operation. When you use a firefighting vehicle, your life and the lives of many others depend on the reliability of your vehicle and associated equipment. In order to carry out fire control and rescue operations successfully, proper inspection and maintenance must be carefully performed. Inspection and maintenance routines should take place daily and corrective measures should be performed before it is necessary to use your vehicle. You must remember that when firefighting equipment is needed, there is an emergency. When your vehicle is needed, it is too late to perform preventive maintenance.

INFORMATION

INSPECTION

The importance that fire trucks play in the control of fire emergencies cannot be stressed too much. If a fire

truck is unable to produce its full capability at these emergencies, a routine fire could turn into a major one. The fire chief is responsible for the proper operation of fire trucks, but through the chain of command, the responsibility will rest with the pump operator. There are several items of primary importance on a fire truck that must be checked to insure proper operation. Among these are the battery, fuel, oil, water, foam, and tire pressure. A full gasoline tank is particularly important since a truck often has to operate several hours after it reaches a fire. There have been instances where fire trucks ran out of gasoline at crucial times during major fires. Oil levels of the engine(s) should be checked. The water level in the radiator also should be checked for proper level. All lights should be checked by turning them on and making a visual examination. This includes headlights, tail lights, spot lights, instrument lights, marker lights, compartment lights, etc. All warning signals, such as siren, horn, and low air pressure buzzer should be checked. Windshield wipers and washers should be checked for proper operation, and washer bottle filled, if necessary. The fluid in the battery should be at the proper level. The level should not be permitted to fall below the top of the plates. Distilled water is highly

desirable, but not mandatory for use in lead-acid batteries.

Tires should be checked for unusual signs of wear and the presence of nails or glass that may have been picked up during travel. Use a tire gage to determine whether the pressure is within the recommended limits. Check for missing valve caps and tightness of wheel lug nuts.

Valves and levers on the pump should work easily and be in position for quick operation. Caps on the suction and discharge outlets should be in place and should not stick or bind. The threads should be cleaned with a brush, as necessary. Suction strainers should be checked to assure that they are not clogged.

Careful visual examination should be made of the whole truck, including close inspection of the underside of the chassis. Any unusual condition should be examined and corrected. Note any signs of water, oil, foam, gasoline, or hydraulic fluid leakage and trace these leaks to their source. Correct any leaks discovered, if possible, and, if not, report them to your supervisor. Tighten all loose body bolts and sheet metal screws.

All tools and equipment should be checked for serviceability and securely fastened in their normal places. Attention should be given to nozzles and nozzle tips to assure that each size is in its proper place. No cleaning rags, gloves, or other foreign material should be allowed to be stored in nozzles, suction hose, or in any other equipment where they may block the flow of water.

The primer should be checked for proper operation. If oil is used in the priming pump, the oil reservoir should be checked and filled, if required.

Examine the engine for any signs of leaks, looseness, chaffing, or other defects. The engine should be wiped clean with a rag, for a clean engine is usually a sign of good maintenance. Frequently, points of possible failure can be found during the simple task of cleaning.

In general, the same inspections are required after emergency runs as those made daily. The preparation for the next

emergency is started by picking up all tools, hose, and equipment used and returning to the station. Upon returning to the station, thoroughly check and clean all equipment used during the emergency and return it to its proper place on the vehicle. All accessories that have been used, such as protective breathing equipment and extinguishers, should be checked and refilled. The vehicle should be washed and the hose bed reloaded with clean, dry hose, as necessary. All soiled sections of hose should be washed and dried. Gas, oil, water, and foam levels are checked and refilled as necessary.

If the pump has been operated from draft, it should be connected to a hydrant or other source of clean water and thoroughly flushed. This is especially important if salt or dirty water was pumped. A centrifugal pump may be "back flushed" by connecting a hydrant line to the pump discharge and allowing the water to emerge through the suction connection. This will often release foreign matter that may be imbedded in the pump propellers. Hose gate valves should be cleared of sand or grit that may have been picked up during the pumping operations. Gaskets in caps and connections should be replaced as needed.

READING ASSIGNMENT

INSPECTION AND MAINTENANCE

To help you understand the inspection and perform operator maintenance on the 750A/P-12 structural firefighting vehicle and mounted equipment, study the following reading assignments from:

TO 36A12-12-8-51

Page	Paragraph
1 through 3	1-1 through 1-22
14 through 16	3-1 through 3-53

TO 36A12-12-15-1

Page	Paragraph
1-1 through 1-4	1-1 through 1-42
6-15 through 6-19	

HYDRANT OPERATION

To help you understand and perform the hydrant operation on the 750A/P-12 structural firefighting vehicle, study the following reading assignments from:

TO 36A12-12-8-51

Page	Paragraph
23	4-36

TO 36A12-12-15-1

Page	Paragraph
5-15 through 5-16	5-24

DRAFTING OPERATION

To help you understand and perform the drafting operation on the 750A/P-12 structural firefighting vehicle, study the following reading assignments from:

TO 36A12-12-8-51

Page	Paragraph
20 through 22	4-30 through 4-34

TO 36A12-12-15-1

Page	Paragraph
5-16	5-25

FOAM OPERATION

To help you understand and perform the foam operation on the 750A/P-12 structural firefighting vehicle, study the following readings assignments from:

TO 36A12-12-8-51

Page	Paragraph
22 through 23	4-35 through 4-37

TO 36A12-12-15-1

Page	Paragraph
5-17 through 5-18	5-27 through 5-29

PREVENTIVE MAINTENANCE

118

Proper preventive maintenance will extend the life of the vehicle and reduce maintenance cost. This is accomplished by a thorough inspection and cleaning of the vehicle. To insure the health and well-being of firefighting personnel, the station should be maintained in a proper state of cleanliness.

QUESTIONS

Please write your answers to the following questions on a separate sheet of paper.

1. All lights should be _____ by turning them on and making a visual examination.
2. _____ should be checked for unusual signs of wear and the presence of nails and glass.
3. Use the _____ to determine whether the pressure is within the recommended limits.
4. Always refer to the sides of the vehicle as if you were seated in the _____ seat.
5. In performing a hydrant operation with a 750A, connect the _____ to suction barrel and hydrant.
6. In performing a hydrant operation with a P-12 when pumping, the transmission range selector level will be in _____.
7. In performing a drafting operation with a 750A when priming the pump, speed up the engine from _____ to _____ rpm.
8. In performing a drafting operation with a P-12, attach _____ hose to a pump suction inlet.
9. In performing a foam operation with a 750A with water being discharged, open _____ valve _____ valve and _____ valve to the desired percentage.

10. In performing a foam operation with a P-12, slightly close auxiliary suction valve until a maximum 10 psi pressure is indicated on _____ gage.

REFERENCES

1. TO 36A12-12-8-51, Powered Pumper Fire Truck, Class 750A.
2. TO 36A12-12-15-1, Firefighting Truck, 750 GPM Structural Type A/S32P-12.

PUMPING OPERATIONS ON THE 750A/P-12 STRUCTURAL PUMPERS

OBJECTIVES

After completing this study guide and your classroom instructions, you will be able to:

1. Perform a booster operation.
2. Perform preventive maintenance on the 750A/P-12 structural firefighting vehicle and mounted equipment.

INTRODUCTION

One of the four pumping operations that the 750A/P-12 is capable of is the booster operation. A booster operation consists of pumping water from the internal water tank through the pump discharges.

INFORMATION

READING ASSIGNMENT

BOOSTER OPERATION

To help you understand and perform the booster operation on the 750A/P-12 structural firefighting vehicle, study the following reading assignments from:

TO 36A12-12-8-51

Page	Paragraph
23	4-37

TO 36A12-12-15-1

Page	Paragraph
5-16 through 5-17	5-26

PREVENTIVE MAINTENANCE

Preventive maintenance after performing a booster tank and primer oil reservoir to insure that they are full. Excess oil from around the primer oil tanks should be removed. The vehicle should be washed if needed. If oil from the primer has leaked onto the floor, area should be cleaned with soap and water.

QUESTIONS

Please write your answers to the following questions on a separate sheet of paper.

1. A _____ operation consists of pumping water from the internal water tank through the pump discharges.
2. In performing a booster operation on the 750A, open _____ valve to admit water to the pump.
3. In performing a booster operation on the P-12, turn transfer valve control wheel to _____ position.

REFERENCES

1. TO 36A12-12-8-51, Powered Pumper Fire Truck Class 750A.
2. TO 36A12-12-15-1, Firefighting Truck, 750 GPM Structural Type A/S32P-12.

VEHICLE POSITIONING, RELAY AND HOSE OPERATIONS

OBJECTIVES

After completing this study guide and your classroom instructions, you will be able to:

1. Select the correct procedures for positioning firefighting vehicles.
2. Select the proper procedures for vehicle relay operations.
3. Select the correct procedures for hose operations.

INTRODUCTION

In previous years, hose wagons (nonpumpers) were used predominately in fire protection to provide a means of transferring water from its source to the fire. This procedure soon proved to be inadequate due to lack of pressure available to reach the base of the fire for complete extinguishment. Pumper trucks corrected the water pressure problem by laying hose from the water source and pumping the water at the desired pressure. As conditions require, various sizes of hose are used, and in connection with the hose, nozzles with various sized tips are employed.

In order for fire apparatus to properly perform at a fire, the driver must be able to place the vehicle into a position where it can function. Spotting fire apparatus is the act of maneuvering the vehicle into position for the most effective performance. Sometimes to get the most effective performance, it will require the use of one or more pumpers pumping in series. This is called a relay operation. To get the water from the source of supply to the fire will require the use of hose operations. The hose will be laid out in either a straight or reverse lay, depending upon the source of water.

INFORMATION

POSITIONING FIREFIGHTING VEHICLES

The volume of water that is needed at a given fire, the immediate need for effective fire streams, the availability of water, and hose and pumper capacity are some of the factors which determine

where and how drivers should spot fire department pumpers. Spotting a fire department pumper to supply hose lines from the tank on the apparatus differs greatly from the process of spotting a pumper to get its supply from a fire hydrant or from a static source by drafting.

When supplying hose lines from the water tank on the apparatus, it is desirable to spot the pumper as close to the fire as safety and convenience will permit. Spotting pumpers for water tank operation permits preconnected hose lines to be used, which usually provides a fast attack on the fire. The main factors which handicap the use of pumpers from such a location are that the water tank supply is necessarily limited and that full capacity of the pump is not generally utilized. Provisions or plans should always be made to supplement the tank supply before it is exhausted and to reinforce tank operation with other pumpers which supply large capacity hose lines.

In most cases, when a fire department pumper is used at fires, water, under pressure, is brought to the pump. The pumper must be connected to the water source with hose large enough to provide adequate flow to the pump. Most fire departments use a large soft or flexible hose exclusively to supply pumpers from hydrants. The ease and speed of connecting a pumper to a fire hydrant with flexible hose makes it preferred for intake supply hose under pressure.

If a pumper is not equipped with large flexible supply hose, the noncollapsible "hard suction" hose must be used. Drivers of pumpers should be

able to spot the pumpers at a fire hydrant for either soft or hard suction hose.

Positioning For Draft

When spotting a pumper to draft water, place the pumper as close to the water supply as safety will permit. A lift of not in excess of 10 to 12 feet is preferable. The intake hose may be connected to the pumper before it is maneuvered into place. A rope should be attached to the intake strainer to hold it off the bottom.

Positioning For Hydrant

When spotting a pumper at a hydrant, the driver must stop the pumper with the pump intake a few feet short of being in line with the hydrant outlet. Stopping short of the hydrant outlet permits the flexible hose to be curved and this prevents kinks from impeding the flow of water.

RELAY OPERATIONS

The word relay means to receive and pass on. When two or more pumpers are used in a series so that the entire volume of water from each pumper within the relay is passed on to the next pumper in the series, it is called "relay pumping." The last pumper in the relay feeds the hose lines for use at the scene of the fire.

Relay pumping should be used when the distance between the water source and the point where the water is used is so great that it requires excessive pump pressure for a single pumper. The excessive pressure required may be beyond the capacity of the pumper or it may be greater than the hose is capable of handling. Relays can be difficult and time consuming and any means should be used which will simplify the process and obtain satisfactory results. Radio communication between pumpers is very desirable.

Even though your base fire department may have only one pumper, the personnel should study this, since they may be called upon to participate in a relay operation. A study of relay pumping may be made a mutual aid project between base and local community departments.

These departments should hold joint practice sessions and relay water in varied amounts. Drills of this nature not only produce proficient pumper and relay operations but it also builds good relationship between departments.

Factors Controlling Pumper Relay

Obviously, one controlling but variable factor is the overall distance to deliver water. The length of the hose line, then, becomes one controlling factor. The size of the hose is also a controlling factor, although most relays are conducted with 2-1/2 inch hose because it is most common. Another controlling factor is the number of hose lines between each pumper. A study of siamesed hose lines and how they reduce friction loss in fire hose will reveal the importance of this factor. The number of pumpers that is used in the relay is a controlling factor because, when the distance between pumpers can be kept at a minimum, the relay problem is made easier and a greater volume and pressure can be maintained. Very closely related to the number of pumpers available is the capacity of the pumpers. The larger pumpers should be used near the water source. It is necessary for the discharge pressure and volume to be known so that all pump operators can coordinate their efforts and operate at approximately the same pressure. From these controlling factors, basic guide rules are developed. These guide rules or guide lines must be known by all pump operators if the most efficient water relay is successfully carried out.

Pumpers within a relay should usually not operate above 200 psi discharge pressure. This pressure does not exceed the recommended test pressure for fire hose and leaves a margin of safety. If maximum capacity is needed, do not exceed the rated discharge pressure of the pump. Each pump operator must know the amount of water flowing. The volume of water determines the amount of friction loss in the hose. The pump discharge pressure is equal to the amount of friction loss, the correction for elevation, and at least 10 psi intake pressure for the next pumper in the series.



When possible, operate all pumpers at approximately the same pressure. This standardizes the operations of all the pumpers. Standardization of pressures is exceedingly difficult if the length of hose between each pumper differs greatly. Open and shut nozzles slowly. Slow operation of nozzle valves prevents water hammer. The effect of water hammer can burst fire hose and cause a shutdown of the entire relay.

When starting the operation, open the pump drain cocks or an unused discharge opening. This procedure is necessary to bleed the air from the lines between pumpers. It is also a good policy to continually discharge a small amount of water from each pumper to prevent heating of the pump. This discharge should be at a point where it will not hinder the pump operator or bog down the apparatus.

Place the largest pumper at the water source and smallest pumper at the fire. The relay will be limited to the capacity of the smallest pumper. Extra "work" from the pumper at the source is required if it is a location where drafting is required. Extra work may also be required of the pumper at the fire if long lines are used or high nozzle pressure is required. Each pumper should reserve 100 feet of hose for emergency use, should a hose burst or need replacement,

Spacing Pumpers

Formulas are available to permit calculation of relay setups so the work being done by each pump is equalized. Most fire ground operations result in each pumper laying out its entire load of hose and hooking up at the end of the lay. The distance between pumpers is often governed by the quantity of hose carried on the pumpers. Usually the placement of pumpers is not a critical factor, especially if judgment is used in selecting the number and size of nozzles to be supplied at the fire. With proper training and planning, the most desirable layouts can be anticipated.

The most simple and most often used type of relay is one in which a single line of hose connects the various pumpers. The success of the relay is dependent on the amount of water that can be moved

123
through this single hose line. The volume of water to be used for fire streams from a relay setup must be within the limits of the hose lines.

The following rule of thumb method was developed for locating a second pumper in a single relay when more than one pumper is being used. The method is described by the following steps.

1. Select the nozzle to be used. The required nozzle pressure and discharge of the nozzle must be known.

2. Using the GPM flow, find the friction loss per 100 feet of 2-1/2 inch hose.

3. Divide the nozzle pressure required by the friction loss per 100 feet of 2-1/2 inch hose. The answer is in hundreds of feet or 2-1/2 inch hose of an additional imaginary line.

4. Add the length of the imaginary line to the actual total distance required.

5. Divide the sum total length of the actual distance and the imaginary line by 2. The answer is a distance between the first and second pumper which will tend to equalize the work load of each pumper.

HOSE OPERATIONS

Safety Precautions

In order to safely and successfully handle fire hose and fire stream nozzles, there are several safety precautions which must be observed. Some of these precautions should be observed before the actual application of water takes place. These precautions are:

Care should be exercised to assure that only serviceable hose is used when making up hose loads.

Protective clothing should be worn at all times during hose operations.

The nozzles should be checked for proper gasket, for operation of control valves, and for dents and obstructions that might interfere with proper flow of the fire stream.

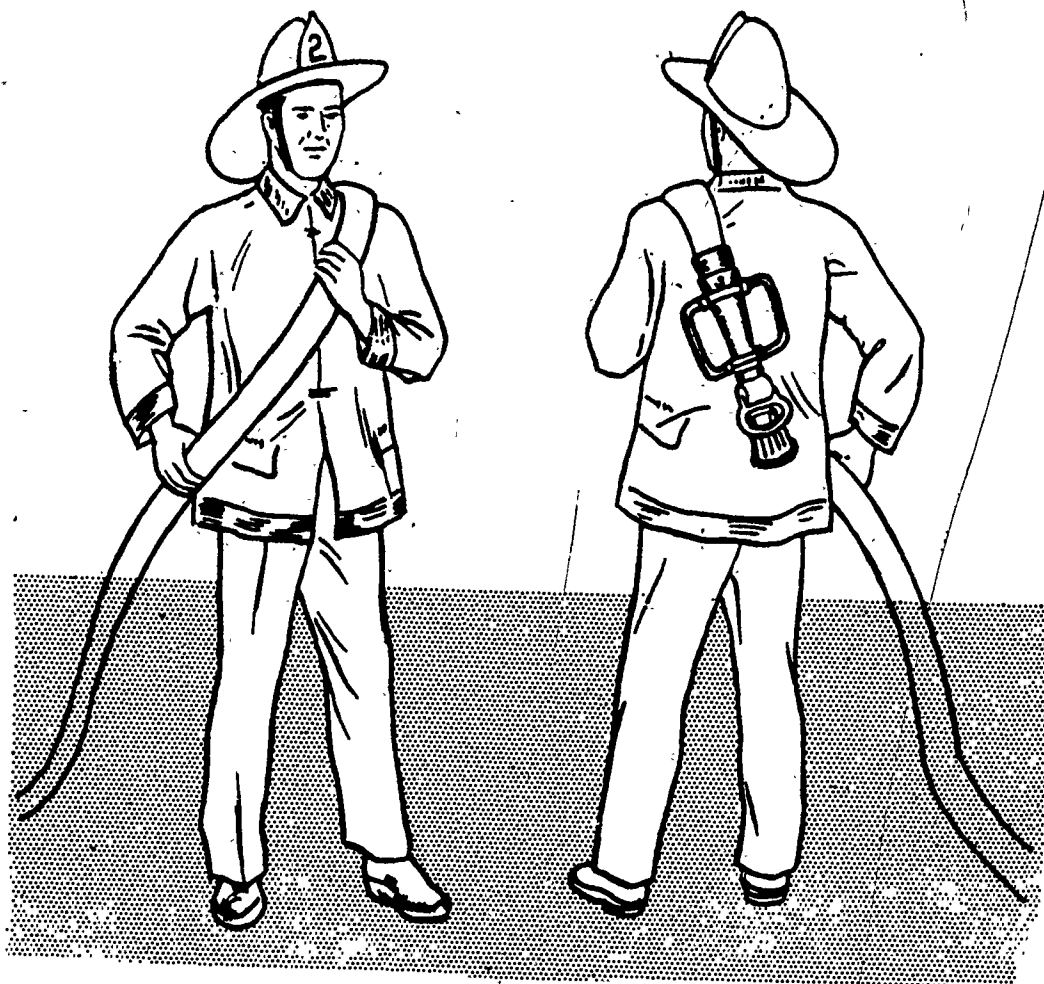

Figure 1. Carrying Nozzle in Cross-Chest Position.

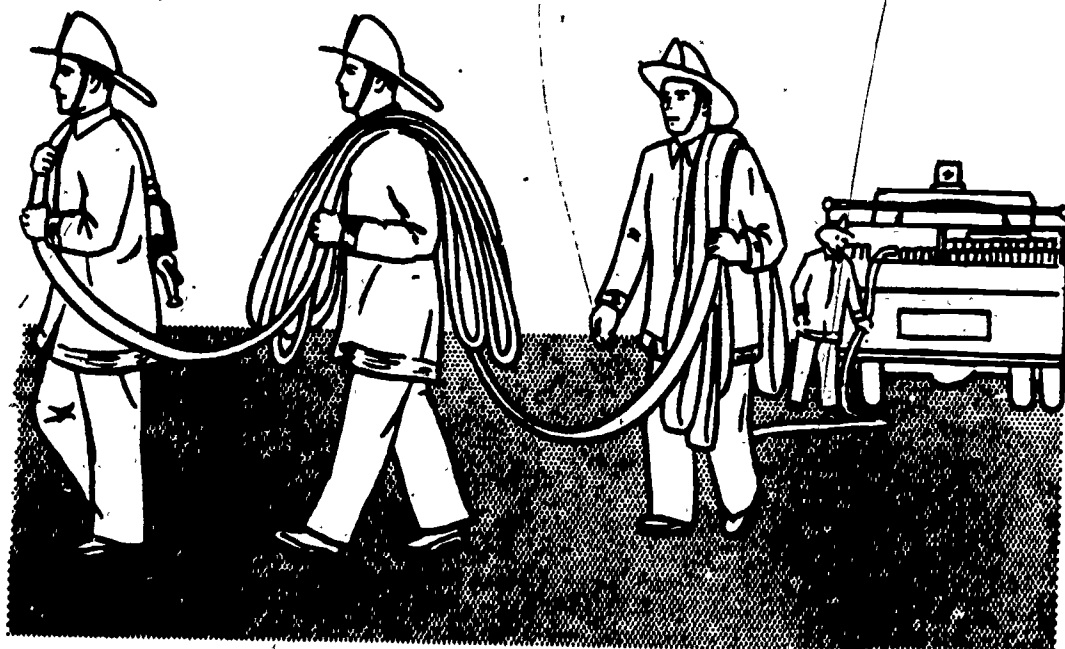

Figure 2. Shoulder Carry.
20



Figure 3. Underarm Carry.

The flow of water should be controlled by opening and closing all nozzles, valves, and hose clamps slowly. Slow operation prevents sudden surges of pressure upon the hose and equipment and is a precaution against injury of firemen.

The nozzle should be kept closed while the firefighters are making up hose lines, hosting or advancing lines, and changing operating position. When operating hose streams, the hose line and the nozzle must be kept under control at all times.

The following safety precautions must be observed when the stream is in operation:

Keep the hose straight for at least 10 feet behind the nozzle, thereby avoiding a kink in the line which may upset the nozzle crew.

If the stream is to be moved or directed at an excessive angle from the center line, the nozzle should be closed, the hose straightened, and the operating position resumed.

If the nozzle becomes difficult to handle, the stream should be partially shut off until the hose line can be straightened or additional help can be summoned.

If a nozzle should jerk away from a nozzleman, it may be safer to jump

ahead of the nozzle and get wet rather than to get hit by the nozzle backlash.

Don't straddle charged hose lines.

Stand clear of couplings and hose lines during hose laying operations.

Advancing Hose Line

To "advance the line," or move the hose toward the fire efficiently, the method of carrying hose must be uniform throughout the department, so the personnel from different stations will encounter no conflict in procedure. (This standardization throughout the base is, of course, necessary on all operations which require teamwork or cooperative effort.) Once the specific operations in the maneuvering of hose are mastered, they must be applied in cooperation with other workers. Mistakes of one fireman often throw the crew off balance and wastes valuable time. For advancing an uncharged line, a recommended method of carrying the nozzle end of the hose is the cross-chest carry, figure 1. This method of carrying the nozzle end of the hose leaves both hands free for opening doors, climbing ladders, and adds to the general safety of the man as well as protection to the nozzle.

Personnel to the rear of the nozzleman carry the hose by means of the shoulder carry, figure 2. When the shoulder carry is employed, care should be taken



that the men following the nozzleman place the hose on the same shoulder that the nozzleman is using.

The underarm carry is particularly good for advancing lines at street level, figure 3. Underarm loads may be picked up easily and quickly.

Replacing Damaged Hose

When a section of charged line ruptures, it must be replaced. Generally, it will take more than one section of hose to replace the damaged section of hose because of the "stretch" of the line after it is charged with water. The new section or sections will be laid along the damaged section. Then, the hose clamp, will be used on the section toward the water source to shut off the water. The damaged section will be replaced. If no hose clamp is available, the water must be shut off at the water source or pumper.

FIRE HOSE

Fire hose must be flexible, watertight, and durable to convey water under pressure from a source to a fire area. Dependability and life of fire hose depend on the quality and the care with which it is handled, the pressures to which it is subjected in service, and the maintenance and care of the hose when it is not in use. The following types of fire hose are currently in use in the Air Force. Polyester-fiber-jacketed, rubber-lined; cotton-jacketed rubber-lined; unlined linen hose; rubber-covered, rubber-lined booster hose; and rubber-covered, rubber-lined suction hose. All fire hoses are issued in sections fitted with a male-threaded coupling at one end and a female-threaded coupling at the other. All fire hose coupling threads must conform to the Table of National Standard Fire Hose Thread, unless otherwise authorized. Fire hose is supplied in 50 foot lengths, except suction hose, which is normally provided in 10 foot lengths, for hard suction hose, and 16 foot lengths for soft suction hose.

Types

POLYESTER-FIBER-JACKETED, RUBBER-LINED HOSE. Polyester-fiber-jacketed, rubber-lined hose consists of a single seamless, circular wove, polyester-fiber-jacket

with a three or more ply, lap-jointed low temperature flexing synthetic rubber liner. This type of hose is made entirely from synthetic materials. The hose is subject to mechanical injury, as is rubber or cotton-jacketed fire hose. Its advantages are: resistance to oil, grease, many chemicals, and some acids; after use, it can be replaced, if clean, on the truck and is ready for reuse; it is not affected by mildew and does not need special care in drying. It is made in 1-1/2 and 2-1/2 inch sizes, with larger sizes for soft suction use. Polyester-fiber-jacketed, rubber-lined hose is the approved standard type fire hose for military fire department service.

COTTON-JACKETED, RUBBER-LINED HOSE.

Cotton-jacketed, rubber-lined hose consists of a single, double, or triple-woven cotton jacket with a three, or more ply, lap-jointed inner rubber liner. The inner surface of the rubber liner is smooth to reduce friction losses and thereby increase the pressure and volume delivered at the nozzle. The rubber liner and the cotton jacket are bonded by a vulcanizing process which produces a firm bond and added strength. This type of hose is in 1-1/2 and 2-1/2 inch sizes, with large diameter (4-1/2 inches) utilized for soft suction hoses to connect fire pumpers to hydrants.

UNLINED LINEN HOSE.

Unlined linen hose consists of one or two jackets of woven linen without a rubber inner liner or cover. It is issued only in the 1-1/2 inch size for use where excessive pressures are not encountered, such as on standpipe systems. Linen hose is light and pliable, but not immediately watertight. It depends on the tightness of the weave to hold water, and there is usually seepage until the fabric is saturated with water.

RUBBER-COVERED, RUBBER-LINED HOSE.

Rubber-covered, rubber-lined booster hose consists of at least three plies of cotton braid covered internally and externally with rubber layers. This hose is less flexible than cotton-jacketed hose but is able to withstand higher pressures. It is issued in sizes varying from 3/4 to 1-1/2 inch for booster lines.

RUBBER-COVERED, RUBBER-LINED SUCTION HOSE. Rubber-covered, rubber-lined suction hose consists of at least three plies of cotton braid covered internally and externally with rubber layers reinforced with spirally wound wire molded into the rubber and fabric. Wire-reinforced suction hose is issued in sizes varying from 2-1/2 inches to 4-1/2 inches, and in 10 foot lengths for hard suction lines.

Care of Fire Hose

The principal source of damage to fire hose are mechanical injury, heat, mildew, mold, acid, gasoline, and oils. The hose may be damaged in many different ways -- for example, damage may result during emergencies, caused by negligence and a lack of understanding of the required handling procedures.

CARRYING FIRE HOSE. Carry fire hose carefully to avoid dropping it and damaging the couplings. Dragging the hose along the ground frequently results in cuts, abrasions, punctures, and damaged couplings, threads, and lugs. When the hose is carelessly handled, the exposed threads of the male couplings may be so damaged it cannot be connected properly to the female coupling. The female coupling is easily knocked out-of-round, thus making the entire 50 foot length of hose useless in a layout.

FROZEN FIRE HOSE. Fire hose is frequently damaged by rough handling during the winter in areas where freezing temperatures prevail. When the hose freezes, the cotton fibers are weakened and the lengthwise threads in the hose are warped. Handle frozen hose as little as possible. A break in the hose will be caused if it is not carefully handled. After a frozen hose is thawed, it should be stretched out, washed, and dried.

BURNED FIRE HOSE. Fire hose may be unavoidably burned at fires. Carefully inspect all hose that has been exposed to fire. Replace the hose if extensive damage is found a considerable distance from either of the couplings. When damage is close to the couplings, the damaged portions may be cut off and the coupling replaced.

MARKING FIRE HOSE. Paint and paint thinner are harmful to fire hose; therefore, do not use paint to mark the hose. Instead, use a stencil and a thin application of indelible ink.

STORING FIRE HOSE. Proper storage is a vital part of fire hose care. To prevent rapid deterioration, store hose in a clean, dry, well-ventilated location out of direct sunlight and away from heating pipes and radiators. Heat and sunlight cause rubber covers and linings to become hard and brittle. Do not store hose that is damp or dirty until it has been cleaned and dried. Reload hose on racks, reels, or on fire trucks periodically, preferably once a month, to change the folds, and to prevent kinks that may damage the hose.

Maintenance of Fire Hose

Improper and incomplete maintenance shortens the life of fire hose and may result in hose failures at critical times. Hose maintenance presents unusual problems because hose components are dissimilar. The cotton jacket and rubber lining deteriorate with age regardless of whether the hose is used. The deterioration of the rubber may be delayed if the lining is kept moist. If the jacket is kept wet, however, it is subject to mildew and fungus growth that destroys the cotton fiber. Also, to keep the rubber moist and the cotton clean and dry necessitates frequent handling of the hose which makes the couplings more liable to damage.

Fire hose inspections are made daily, monthly, quarterly, and after each use. Inspect the hose for serviceability.

DAILY INSPECTION. Check the hose loads on trucks daily to see that it is dry and correctly loaded in hose body. Folds are not tightly jammed together but arranged in alternate short and long folds, moderately loose. Inspect the hose on the drying rack daily to see that it is correctly laid out. Make sure drippings from the end of the hose on upper racks are not falling on the hose below. Drippings may contain a mild acid formed by combination of water

127

and sulfur in the rubber lining, which could damage the outer jacket of the hose.

AFTER USE INSPECTION. On returning to the station after a fire, inspect and clean all hoses and couplings as follows:

1. Remove from the truck all 1-1/2 and 2-1/2 inch hose that was used or wet; wash the hose carefully, using clean water and a scrub brush or a mechanical hose washer; mild soap may be used on greasy spots, but must be thoroughly rinsed off. Examine the hose couplings, and place the hose on drying racks. If necessary, take the remaining hose from the truck, clean and dry. Inspect all couplings and gaskets as connections are made as you reload the hose bed compartment.

2. Remove the rubber-covered booster and hard suction hose from the rack, basket, or ree; wipe the hose clean with a damp rag and replace it on the truck.

3. Wash all cotton-jacketed, rubber-lined, soft suction hose. Lay out the hose to dry near the truck so it can be replaced on the truck immediately if needed.

4. Examine coupling threads; if they are damaged for defective, replace the coupling. Clean dirty or jammed couplings, using soapy water to loosen any hardened lubricants. Lubricate the female coupling by immersing it in a mixture of mild soap and water and allow it to dry. Do not use strong soap, chemicals, gasoline, oil, or grease to clean or lubricate couplings because they may damage the hose jacket or lining.

5. Inspect the coupling gaskets and replace them if they are worn or damaged. Make sure gaskets do not project into the waterway, particularly at the nozzle coupling, because this will cause a ragged stream.

MONTHLY INSPECTION. Remove all 1-1/2 inch and 2-1/2 inch cotton-jacketed, rubber-lined hose that has been on a truck continuously for 30 days. Examine it visually, if satisfactory, repack it in the hose body, repeating the procedures in the previous paragraphs. When rolling hose, lay it out on a clean floor and start the roll with the male coupling.

When folding hose in a bed, take care not to have too sharp a fold at the coupling, and make sure folds are not always made at the same point as before, which will cause cracking.

QUARTERLY INSPECTION. Take all hose that has not been used for 90 days or more from the apparatus or storage rack, and run water through it. Excess water should be drained and the jacket allowed to dry before the hose is returned to storage. This procedure will prolong the service life of the hose lining by keeping it moist.

Hydrostatic Testing of Fire Hose

Inspect all discharge and suction hose annually, making hydrostatic tests as follows for all 1-1/2 and 2-1/2 inch polyester-fiber and cotton-jacketed, rubber-lined hose, and rubber-covered, rubber-lined chemical, or high pressure hose.

1. Before hydrostatic testing fire hose inspect the couplings for:
 - a. Damage to threads.
 - b. Bent or misshapen couplings.
 - c. Binding swivels.
 - d. Injury to expansion ring.
 - e. Loose couplings.
 - f. Broken or damaged lugs.
 - g. Cracked, broken, or poorly fitting washers.
 - h. Dirt or obstruction in washer grooves.

2. After the couplings have been inspected, inspect the lining for:
 - a. Presence of oil or grease.
 - b. Cracks or leaks.
 - c. Hardness due to age.
 - d. Signs of separation from the inner jacket or fabric.



3. Inspect the jacket for:
- Scorches, burns, or heat damage.
 - Abrasions.
 - Cuts.
 - Lumps or blisters.
 - Grease, oil, paint, or chemicals.

4. Attach suction hose between hydrant and pumper.

5. Attach the hose to be tested to a discharge gate of a pumper or special testing pump.

6. Partially close the discharge nozzle at the end of the hose and open the discharge gate at the pump.

7. When the water flows freely, close the discharge nozzle at the end of the hose.

8. Place the pump in operation and increase to the required pressure of 400 pounds when running the service test on new hose, and 250 pounds on all old hose. Close the discharge gate partially and hold the required pressure for five minutes. (Adjust the throttle as necessary to maintain the desired test pressure.)

a. Inspect cotton jacket or the rubber covering of each hose length for moisture on the outer jacket that may indicate leakage.

b. Examine the hose couplings for leaks.

c. Check for signs of separation from the inner jacket or outside fabric.

QUESTIONS

Please write your answers to the following questions on a separate sheet of paper.

1. The driver must be able to place the _____ into a position where it can function.

2. A _____ operation requires the use of two or more pumpers.

3. The hose will be laid out, in either a _____ or _____ lay.

4. When supplying hose lines from the booster tank, it is desirable to spot the pumper as close to the fire as _____ and _____ will permit.

5. Drivers of pumpers should be able to spot the pumpers at a fire hydrant for either _____ or _____ suction hose.

6. A lift of not in excess of _____ to _____ feet is preferable.

7. A _____ should be attached to the intake strainer to hold it off the bottom.

8. Stopping short of the hydrant prevents _____ from impeding the flow of water.

9. The last pumper in the _____ feeds the hose lines for the use at the scene of the fire.

10. Relay pumping should be used when the _____ between the water source and the point where the water is used is too great for one pumper.

11. Pumpers in a relay should usually not operate above _____ psi discharge pressure.

12. Each pump operator must know the _____ of water flowing.

13. The distance between pumpers is often governed by the _____ of hose carried on the pumpers.

14. _____ should be worn at all times during hose operations.

15. When operating hose streams, the hose line and the _____ must be kept under control at all times.

- 16. Keep the _____ straight for at least 10 feet behind the _____.
- 17. Don't _____ charged hose lines.
- 18. Stand clear of _____ and _____ during hose laying operations.
- 19. Generally it will require more than one section of hose to replace a damaged section of hose because of the _____ of the line after it is charged with water.
- 20. Fire hose must be _____, _____ and _____ to convey water under pressure.
- 21. Fire hose is normally supplied in sections of _____ feet.
- 22. Carry fire hose carefully to avoid dropping it and damaging the _____.
- 23. Use a _____ and this application of _____ to mark fire hose.

- 24. _____ is a vital part of fire hose care.
- 25. Improper or incomplete _____ shortens the life of fire hose.
- 26. Inspect the hose for _____.
- 27. Examine coupling threads if they are _____ or _____ replace the coupling.
- 28. Inspect the coupling _____ and replace them if they are worn or damaged.
- 29. Remove and reload all hose that has been on the vehicle for _____ days.
- 30. When hydrostatically testing hose, examine the _____ for leaks.

REFERENCES

- 1. IFSTA #103, Fire Hose Practices.
- 2. IFSTA #105, Fire Stream Practices.
- 3. IFSTA #106, Fire Apparatus Practices.



HOSE LOADS AND FINISHES

OBJECTIVES

After completing this study guide and your classroom instructions, you will be able to:

1. Load hose on pumpers and make hose load finishes.
2. Perform preventive maintenance on structural firefighting vehicles and mounted equipment.

INTRODUCTION

Training in hose practices is not complete without a study of layouts, loading, and advancing fire hose. In fact, all hose practices are preparation for firefighting. It is not necessary to develop speed for loading fire hose, nor is loading hose an emergency, but time is an important factor when making hose layouts and advancing hose.

INFORMATION

FACTORS IN LOADING HOSE

In order to clarify hose bed positions, the front of the hose bed is toward the front of the apparatus. The rear of the hose bed is toward rear of the apparatus. When loading hose you should observe certain basic rules to enable the hose to lie evenly and to prevent difficulty in disconnecting the couplings. Some of the factors are:

Before connecting any coupling, check gaskets and swivel.

When two sections of hose are connected, keep the flat sides of the hose lined up. The alignment of the lugs on the coupling is not important.

When two sections of hose are connected, the couplings should be made hand-tight. Do not use wrenches or undue force.

HOSE LOADS

Now that you are aware of some of the factors that must be observed during hose loading, we will discuss hose loads

and finishes that are commonly used on Air Force structural fire protection vehicles. These loads are the "horseshoe," accordion," and "divided," and are described as follows:

Horseshoe Load (2-1/2 Inch)

The horseshoe load is started with the coupling in the right front corner of the bed, as indicated in figure 4. The hose is laid from the right front corner, back to the right edge of the bed where it is folded and laid back to the front of the bed, then around the inside of the bed to the left edge. Another fold is made and the hose is laid around the bed, back to the right edge and folded. However, this time, the fold should be about three inches short of the edge so that the folds are staggered. This procedure is repeated, except that the long folds in the left half of the load should be about one inch longer than those in the right half. When that layer is completed, the hose is laid from the center around the right half of the load and tucked in between the side of the bed and the hose already laid, then to the front of the bed, gradually working upward until reaching the right corner. Bend the hose to the left and start the second layer. On this layer, the folds of the right half should be longer than the left and when the layer is completed, the hose is laid around the left half of the load. Repeat until bed is loaded.

Accordion Load (2-1/2 Inch)

The accordion load is much simpler to load. It is started with the coupling

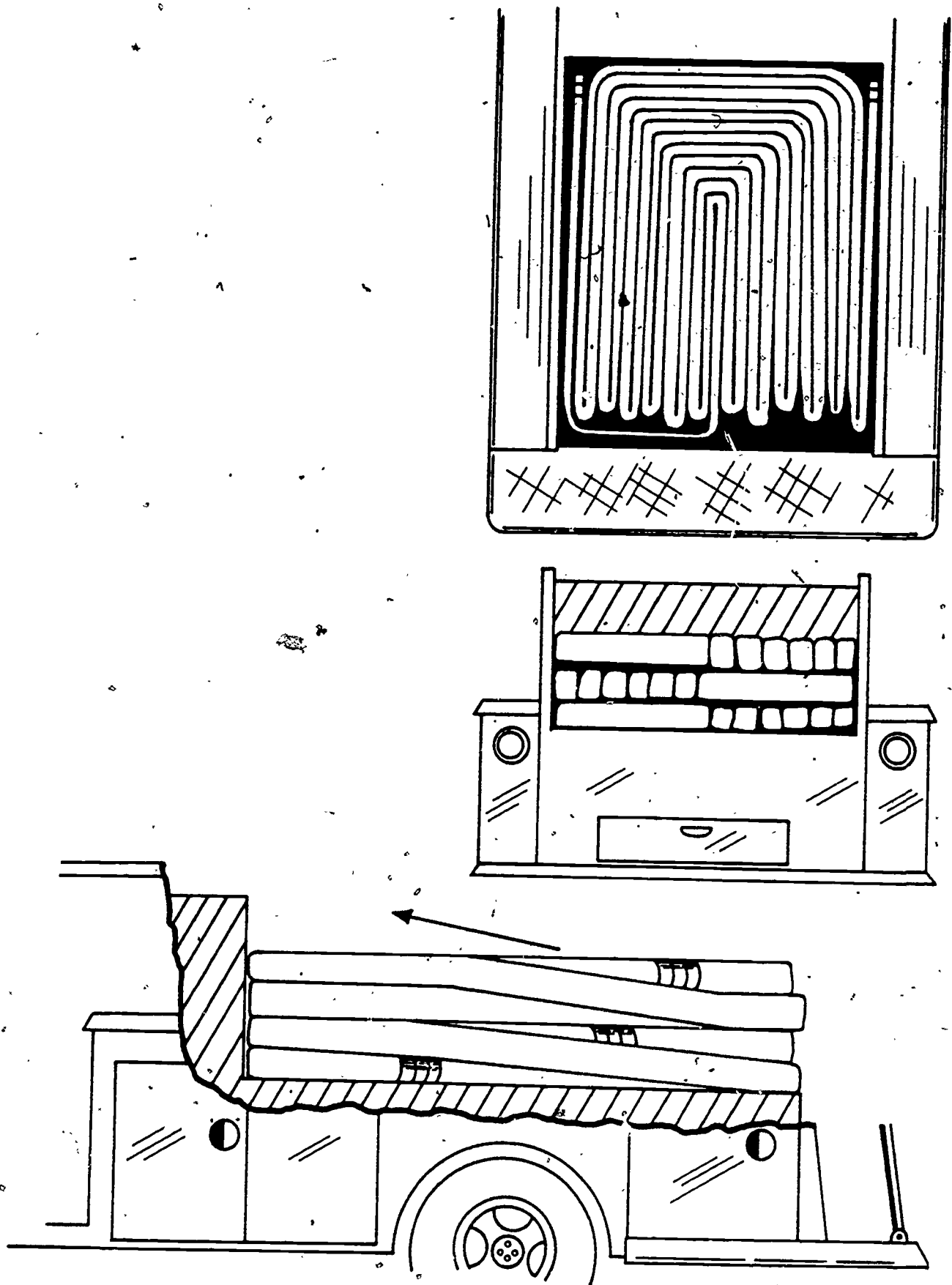

Figure 4. Horseshoe Load.

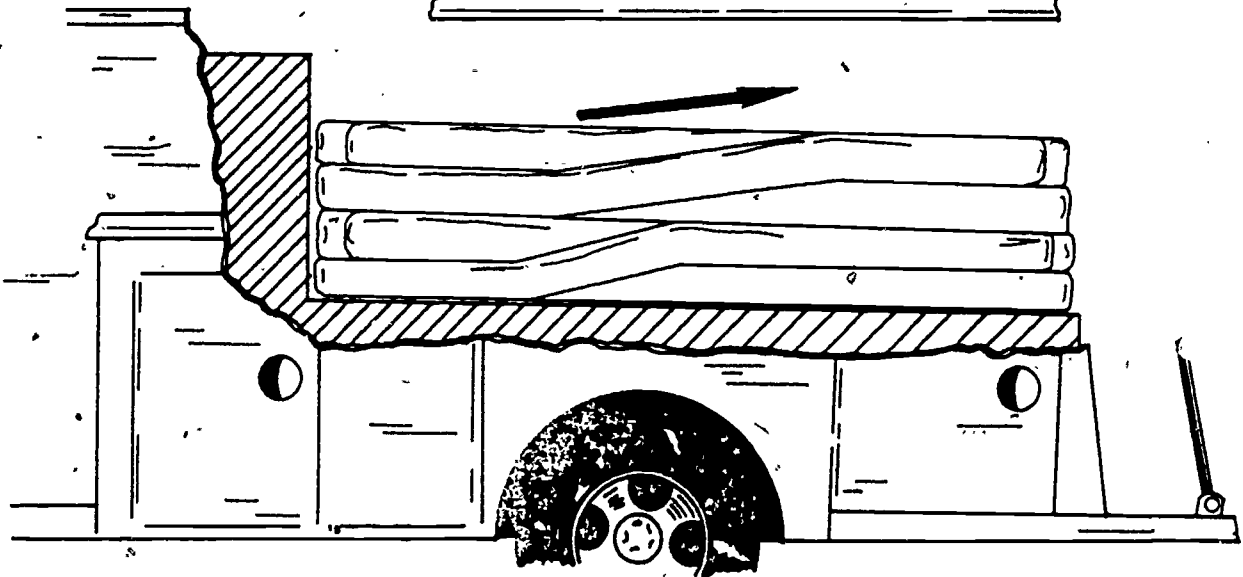
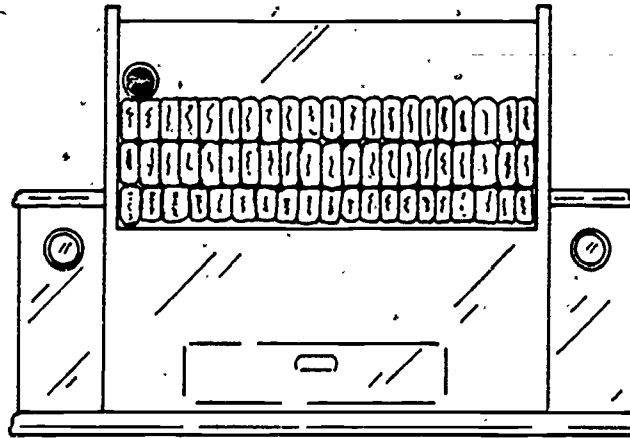
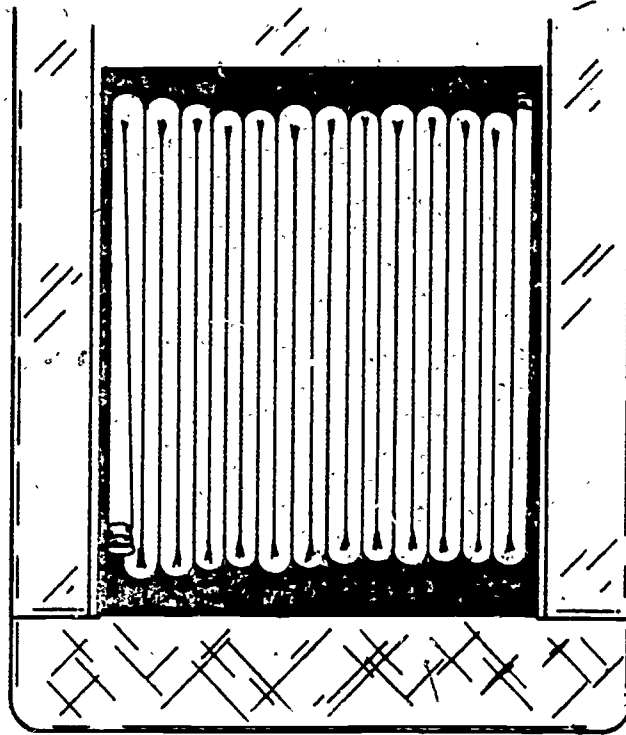

Figure 5. Accordion Load.
29

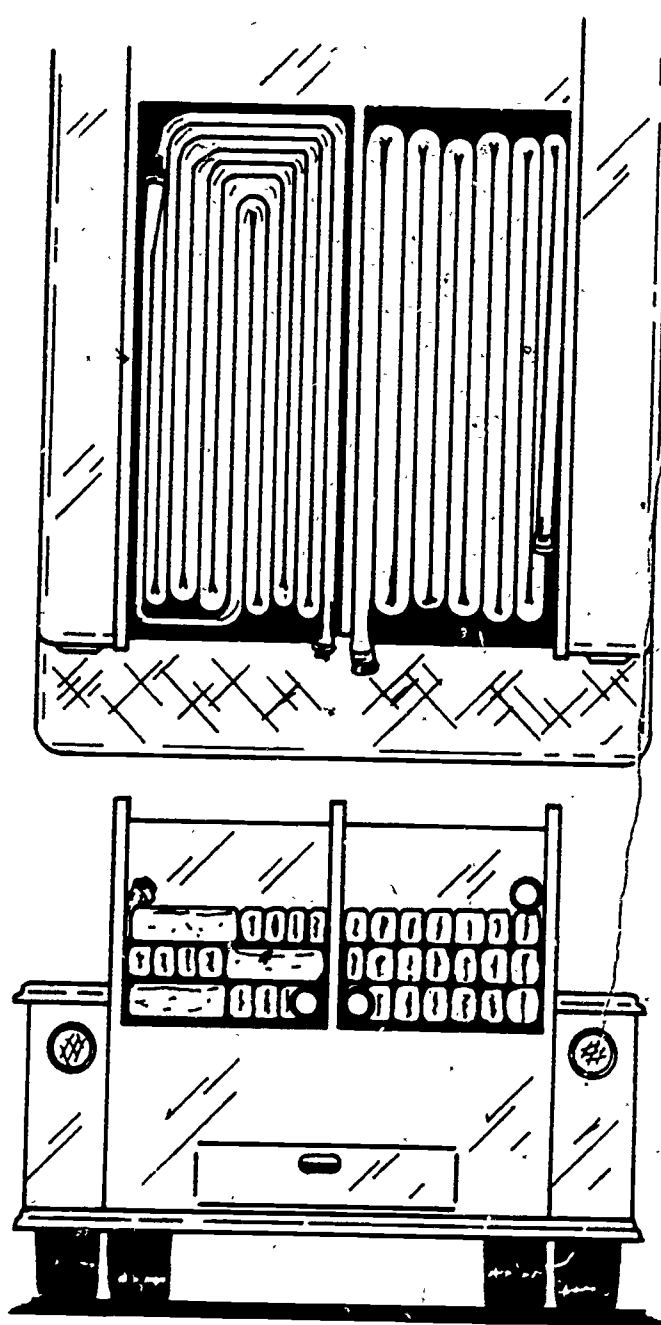

Figure 6. Divided Load.

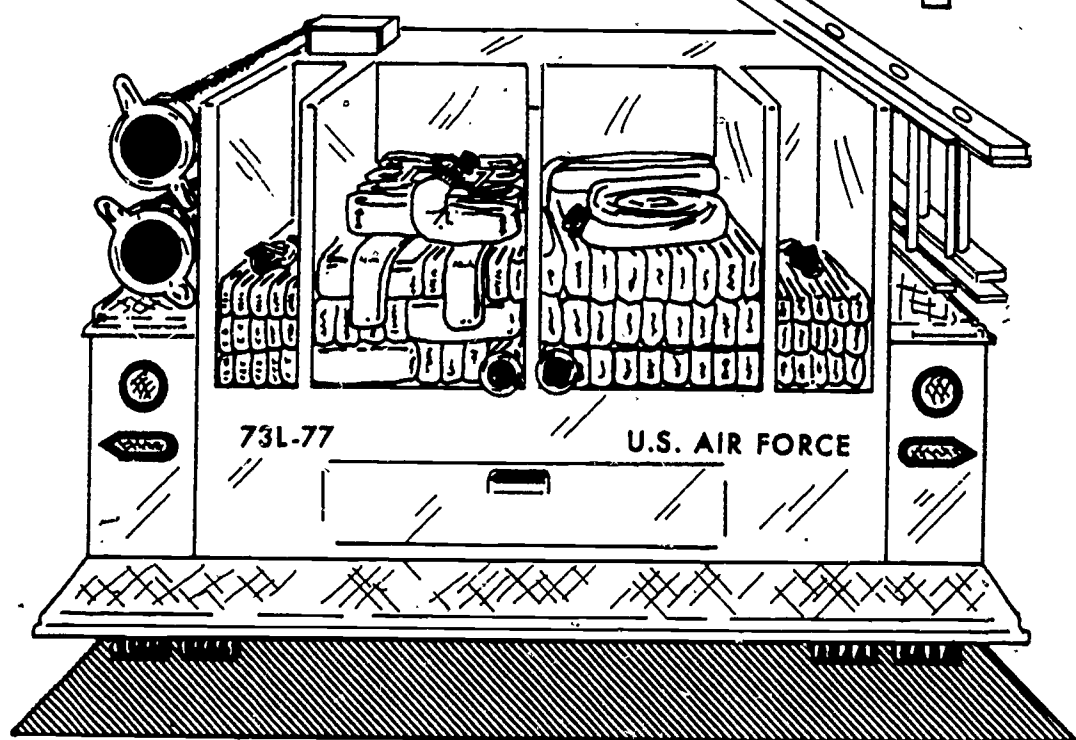
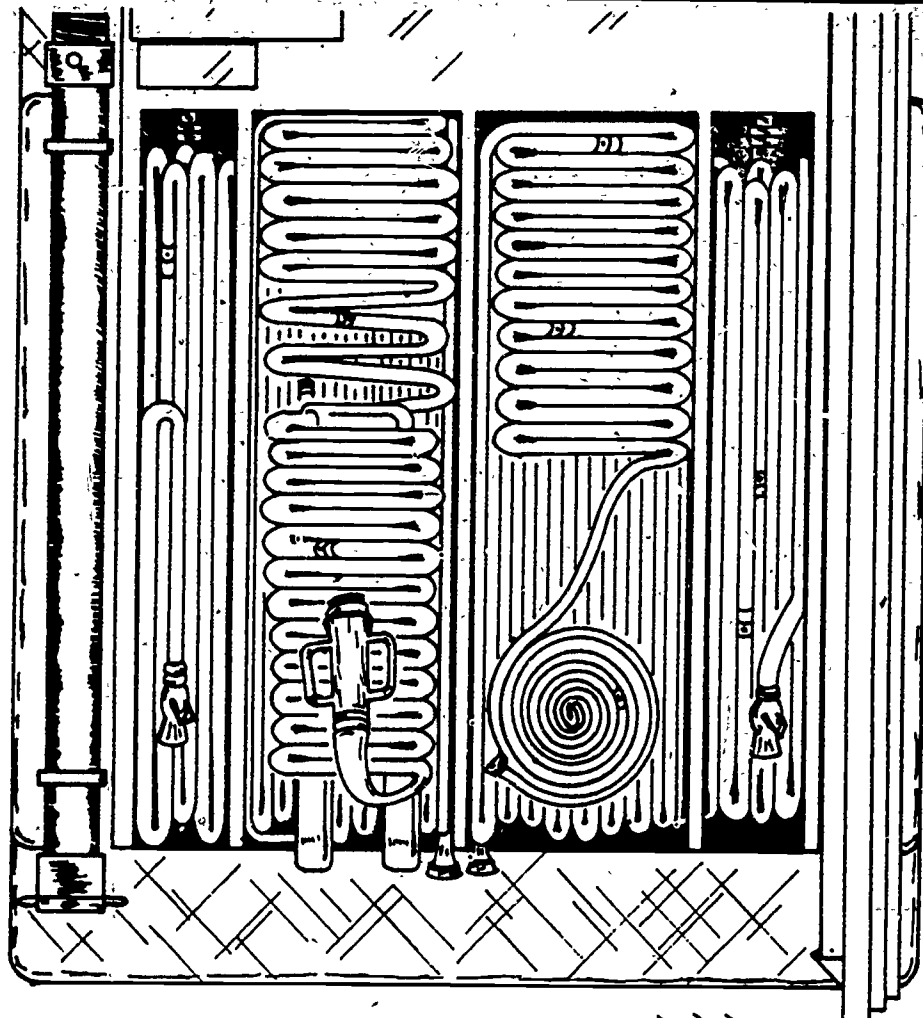
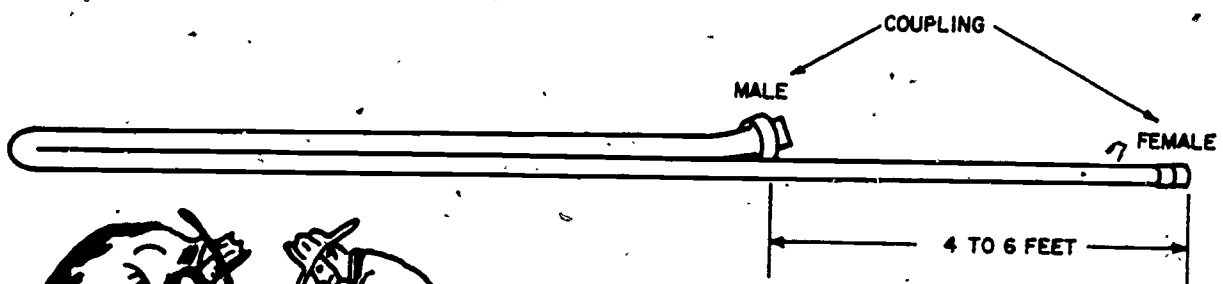
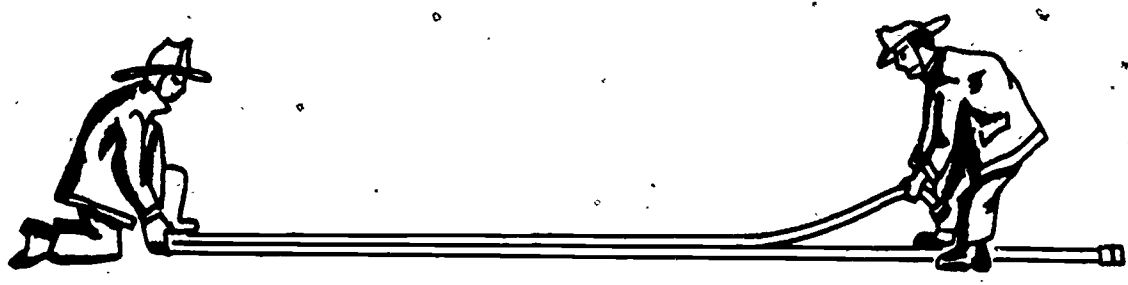

Figure 7. Dutchman.
31



Four feet for polyester hose.
Six feet for double jacket cotton
hose.



It's best to use two men when making a
doughnut-roll.

DOUGHNUT ROLL

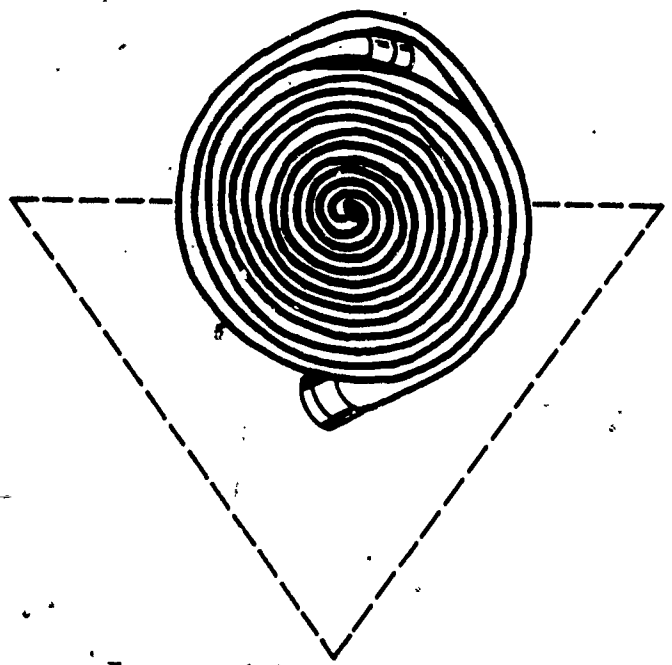

For a good doughnut-roll, the
female coupling must end in this
area.

CROSS FOLDS

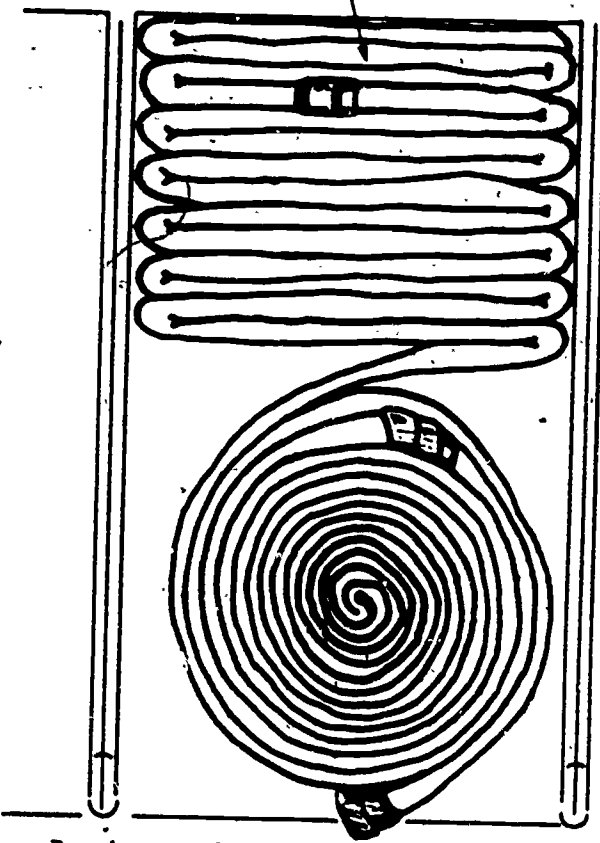

Doughnut-roll, connect to the hose on
the hose bed.

Figure 8. Doughnut-Roll.

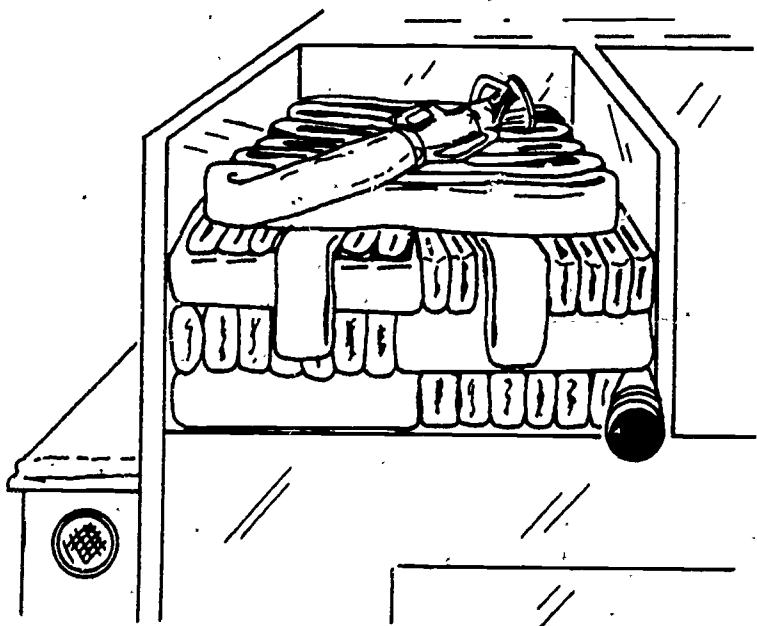
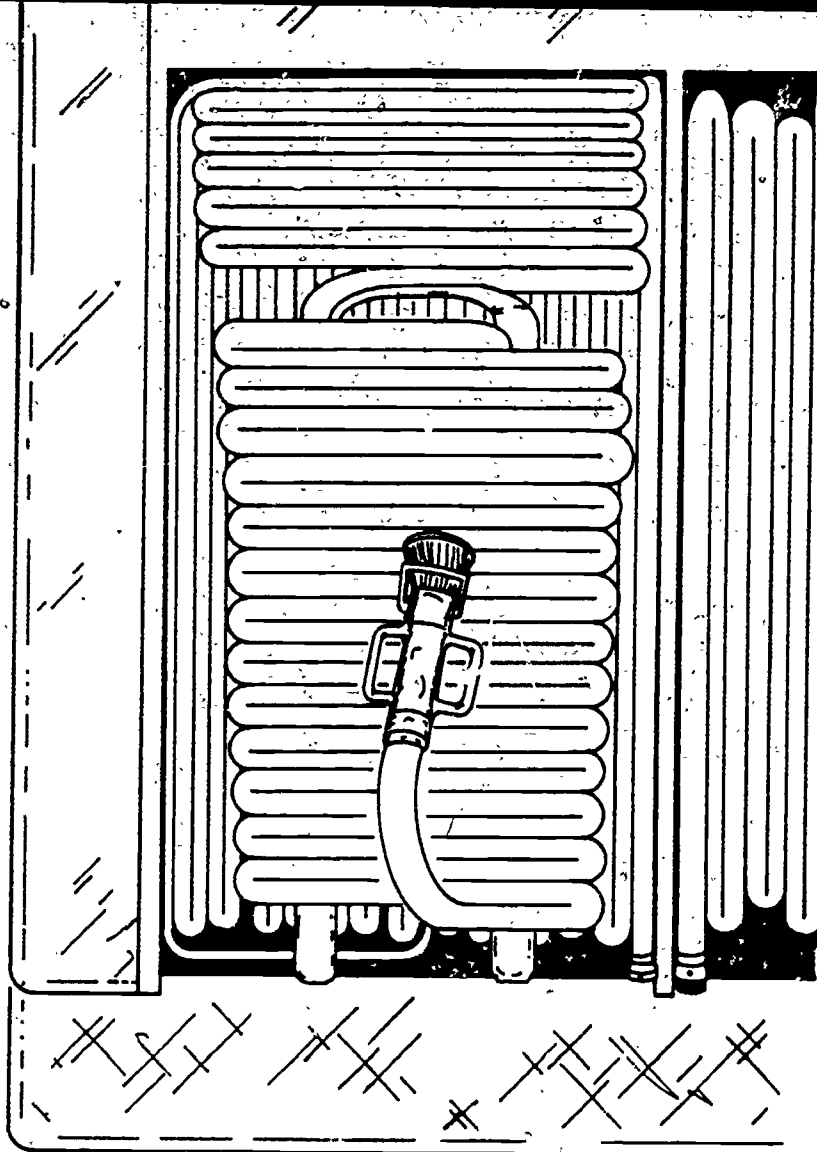

Figure 9. Skid Finish.
33

in the right front corner of the bed, and the hose laid back and forth, as shown in figure 5. Every other fold in both ends of the load should be about three inches longer than the preceding one, so that the folds will be less sharp. Also, staggering the folds permits more hose to be laid in each layer. When completing a layer at the side of the bed, the hose is gradually raised from front to rear to start the next layer.

Divided Load (2-1/2 Inch)

The divided load is very useful in localities where fire hydrants are spaced at a distance where only short lays are necessary. This load has the added advantage of making it possible to lay two lines of hose simultaneously. The bed is divided and hose is loaded in each side separately, using either the horseshoe or accordion load. One single long lay can be made by connecting the male coupling from the top of the left section to the female coupling at the bottom of the right section and starting the hose lay from the right section, figure 6.

Dutchman

In all three of the foregoing methods of loading hose, care should be taken to avoid jamming, which will occur if a coupling must turn around in a narrow space while paying out. To avoid this situation, make a short fold or reverse bend. This practice is commonly referred to as a "dutchman." The dutchman, figure 7, serves two purposes: one, to change the direction of the hose and; the other, to change the location of a coupling so that when loaded, a hose bed does not have all the couplings across from each other.

HOSE LOAD FINISHES

There are several methods of finishing off 2-1/2 inch hose loads. We will cover only those that are commonly used by Air Force Fire Departments. These are the doughnut-roll finish, the skid finish and the 1-1/2 inch hose finish used in conjunction with 2-1/2 inch hose loads.

Doughnut-Roll Finish (2-1/2 Inch)

The doughnut-roll finish is made up of one section of 2-1/2 inch hose. This finish is used chiefly on straight lays but can be used with any hose load. When this finish is being loaded, start at the front of the hose bed with a number of cross folds (approximately 25 feet) to allow the doughnut-roll to be removed with minimum resistance. Then connect the doughnut-roll to these cross folds. See figure 8.

Skid Finish (2-1/2 Inch)

The skid finish is used chiefly for reverse lays, and is very popular due to the speed in removing sufficient working line from the truck at the fire. The last three to four sections of hose are used for this finish. See figure 9. Start at the front end of the body and rip rap about 25 feet crosswise; then make a pair of skids with an eight or 10 inch overhang at the rear of the bed for handhold loops. Rip rap the remaining hose crosswise on the skid with two or three inches clearance at both sides and all couplings riding on the skids. The nozzle should be connected to the hose and placed on top. When the truck stops at the fire, the load is removed by pulling on the skids. This gives 150 feet of working line immediately available.

One and One-Half Inch Finish

There are several methods of loading 1-1/2 inch hose in conjunction with 2-1/2 inch hose. One very popular method is the cisco finish. Any of the three conventional hose loads described in this study guide may be arranged with the cisco load finish. The cisco finish is a prearranged load finish for a reverse layout. The hose is usually loaded with the male coupling coming out of the load first before the finish is applied. The male coupling must be placed so that it is in the center rear of the hose bed. This position is natural from the horseshoe load but may need to be arranged for other loads.

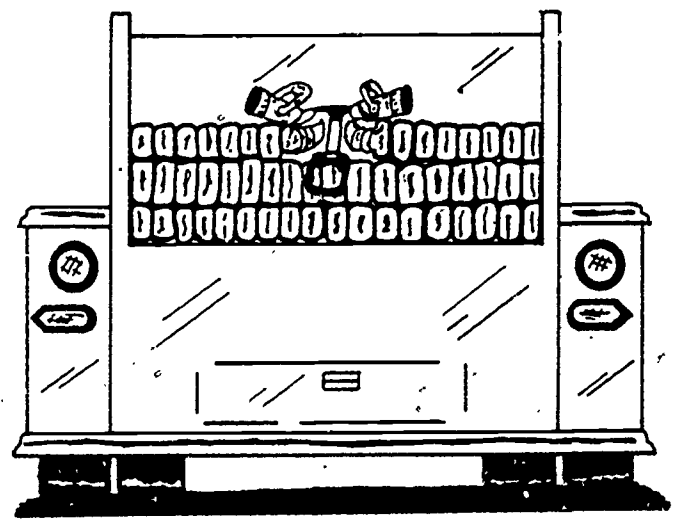
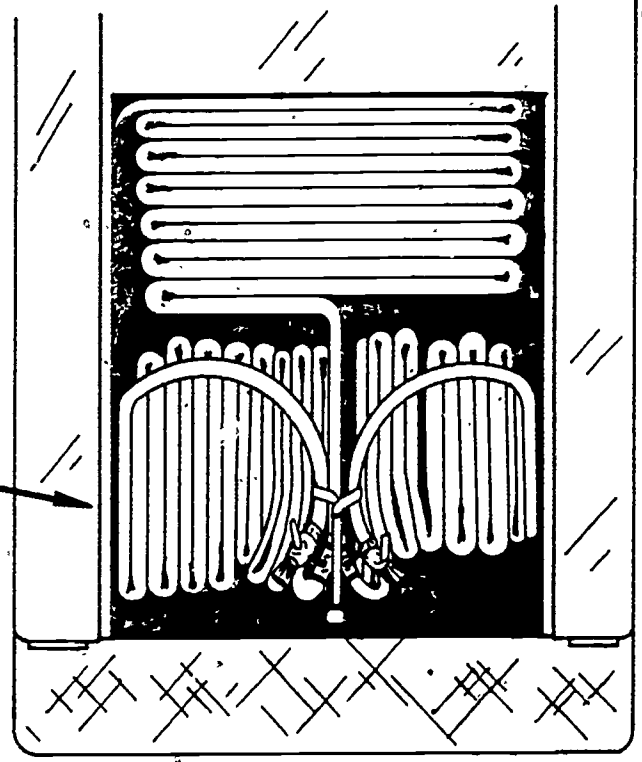
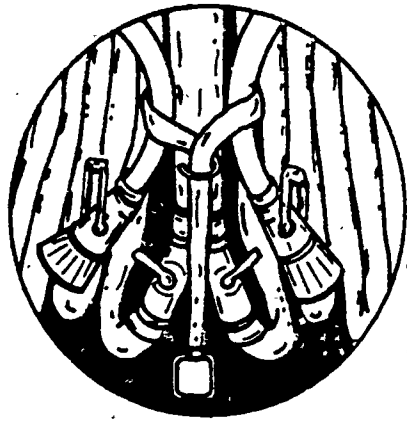

Figure 10. Cisco Load Finish.

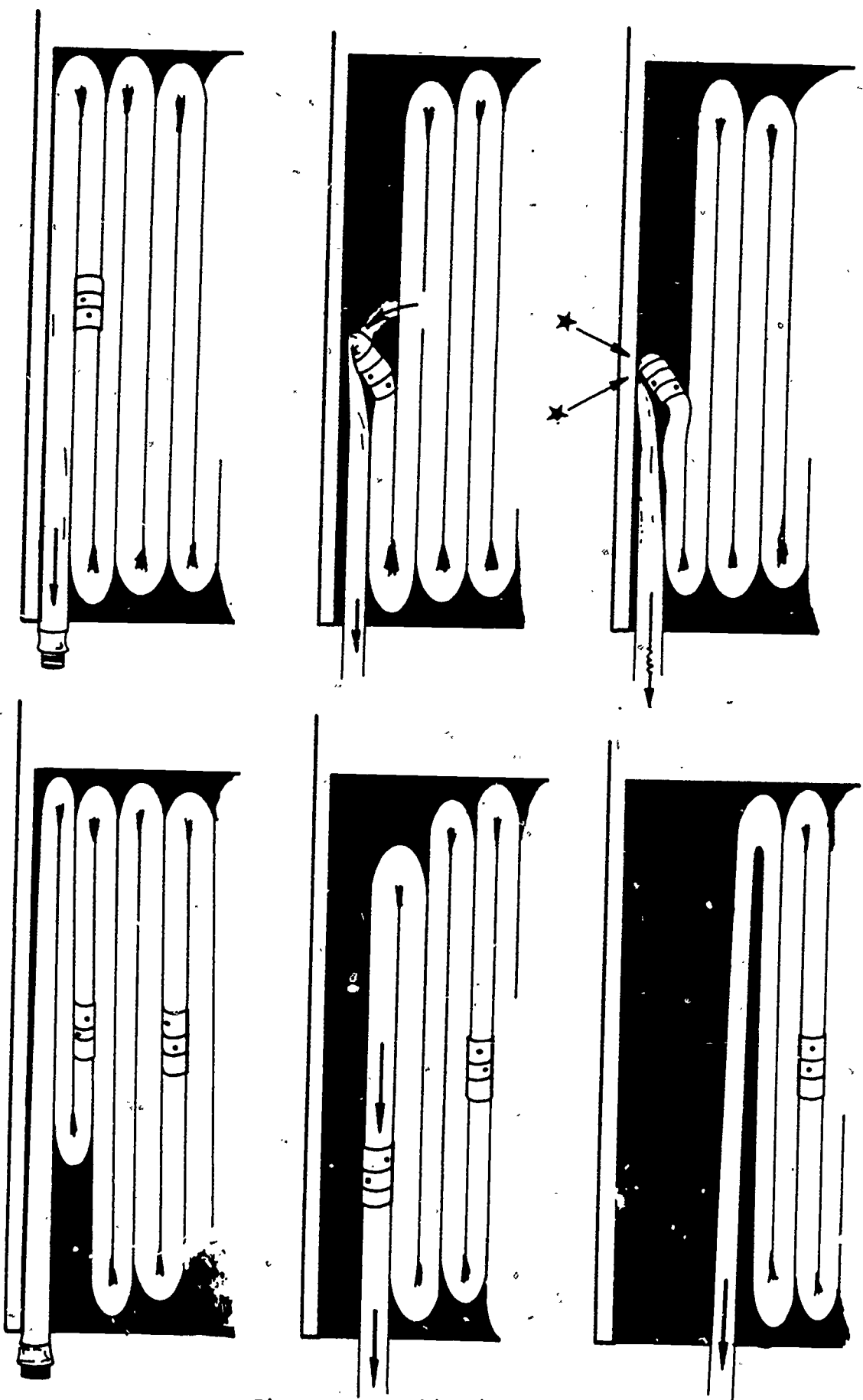

Figure 11. Combination Load. 182

Cisco Load Finish

1. Connect two 1-1/2 inch hose lines to a 2-1/2 by 1-1/2 inch gated wye adapter and connect the wye to the 2-1/2 inch body load. Arrange the wye at the rear of the load so that the two 1-1/2 inch lines extend directly over the rear center as shown in figure 10.

2. Fold each 1-1/2 inch line short at the wye and carry them down the center toward the front of the bed. Load each line of 1-1/2 inch hose by the accordion method toward the outside of the hose body until the nozzle ends are reached.

3. Bring the nozzle ends over the load and secure them to the wye with a small rope or hose strap.

UNLOADING PROCEDURES. The cisco load finish can only be used in connection with the reverse lay since the wye connection is fastened to the 2-1/2 inch hose and is described by the following steps:

1. Wait for the apparatus to stop and other firefighters to step clear of the tailboard. Grasp the strap and/or wye adapter and pull straight backward from the hose bed. Lower the wye adapter and nozzles directly to the ground and hold the assembly while the apparatus starts to advance toward the source of water supply.

2. Continue to hold the assembly until the load finish has completely unloaded from the hose bed. This action places both 1-1/2 inch hose lines straight and without kinks.

Combination One and One-Half Inch Hose Load

The combination load consists of a special arrangement of 1-1/2 inch hose lines that are connected to a wye and can be used two ways. These two ways refer to its use with the straight or reverse lay, hence its name, "combination load." Some fire departments have a baffle board installed eight or 10 inches from one side of the hose bed. See figure 11. This forms a narrow compartment from rear to front. As shown in figure, put one fold on top of the preceding fold,

with the gated wye at the bottom and the nozzles on top. H1

PREVENTIVE MAINTENANCE

Proper cleaning methods will insure that the exterior paint on the vehicle will not become faded and scratched. When washing the exterior, always use cold or lukewarm water, along with a mild soap. Never use a 2-1/2 inch or 1-1/2 inch hose under high pressure as this may peel the paint from the exterior. The tools and equipment should be cleaned and put in the correct compartment. The compartments should be wiped clean. After washing the vehicle with soap and water, a good grade of autowax should be applied. When removing the wax, a clean, dry soft rag should be used.

When cleaning the interior, you should first dust the dash, seats, and other equipment with a soft brush and then use a damp rag to clean the floor. The seats should be wiped regularly with a clean, damp cloth. Clean all windows with water or window cleaner, also using a soft, clean rag.

To maintain the station facilities in a clean and healthful condition, a regularly scheduled clean-up program is established. This includes, but is not limited to, sweeping, mopping and refuse removal.

QUESTIONS

Please write your answers to the following questions on a separate sheet of paper.

1. The front of the hose bed is toward the _____ of the apparatus.
2. The rear of the hose bed is toward the _____ of the apparatus.
3. Before connecting any coupling, check _____ and _____.
4. When two sections of hose are connected, keep the _____ sides of the hose lined up.

5. When two sections of hose are connected, the couplings should be made _____.

6. Loads commonly used in the Air Force are the _____, _____ and _____.

7. The horseshoe load is started with the coupling in the _____ front corner of the bed.

8. The _____ load is much simpler to load.

9. _____ the folds permits more hose to be laid in each layer of an accordion load.

10. _____ load makes it possible to lay two lines of hose simultaneously.

11. A _____ is used to avoid jamming of the coupling in a hose load.

12. A _____ is used to _____ the location of the couplings in a hose load.

13. The _____ finish is used chiefly for straight lays.

14. The last _____ to _____ sections of hose are used for the skid finish.

15. The cisco finish is a prearranged load finish for a _____ layout.

16. The _____ consists of a special arrangement of 1-1/2 inch hose lines that are connected to a wye and can be used two ways.

REFERENCE

- 1. IFSTA #103, Fire Hose Practices.



HOSE LAYS

OBJECTIVES

After completing this study guide and your classroom instructions, you will be able to:

1. Perform straight hose lays.
2. Perform reverse hose lays.
3. Perform vehicle relay operation.
4. Perform preventive maintenance on structural firefighting vehicles and mounted equipment.

INTRODUCTION

The application of water to a fire, in the form of fog or straight stream, is accomplished by various hose laying procedures. It should be kept in mind that a few gallons of water quickly applied early in the developing stages of a fire are more effective than thousands of gallons later on. For this reason, speed and proficiency in laying and handling hose must be attained by all firefighters through constant drill and practice. In some instances, these lays may be of such distance that they require two or more pumps in relay to supply the fire stream. The following basic hose lays are commonly used by Air Force firefighters.

INFORMATION

HOSE LAYS

Straight Lay (Hydrant To Fire), Table 1

The straight lay is a very fast method of getting water on the fire, and is sometimes used entirely where hydrant water pressure is adequate to supply good fire streams. In some cases, this lay is used as a feeder line to a pumper which is supplying one or more 1-1/2 inch lines. The use of the straight lay also makes equipment carried on the vehicle available, such as hose fittings, ladders, axes, etc. In the event that more water and pressure are needed after the straight lay is made, the vehicle can be used to make a reverse lay to another hydrant or back to the first hydrant. The straight

lay is accomplished as follows: on the approach to a fire, the truck stops at a hydrant chosen by the crew chief. (The chosen hydrant should be as near to the fire as possible without endangering the truck or driver should the fire spread.) The plugman steps off with sufficient line and takes a turn around the hydrant with the hose, the truck then proceeds to the fire. The plugman removes the 2-1/2 inch cap nearest the fire, places the hydrant wrench on the operating nut, and removes the loop that is around the hydrant, connects the hose to the outlet, opens the hydrant with his hydrant wrench, and proceeds to the fire, straightening out kinks or bends in the hose and checking for loose hose connections on the way. When the truck arrives at the fire, a hose clamp is applied to the hose and sufficient working line is removed from the truck by grasping one or more folds and walking backward until the loop or loops are clear of the truck, then going back to the truck and repeating the procedure. When sufficient hose has been removed, the nearest coupling is disconnected, the loose end put back in the truck bed, and the nozzle connected to the hose. The nozzle will now be advanced to the fire and the hose clamp disconnected.

Reverse Lay (Fire To Hydrant), Table 1

When using the "reverse" lay, the hose is laid from the fire to the hydrant. This lay is used when the hydrant pressure is inadequate to support a good fire

- CC - Crew Chief
- DR - Driver
- NM - Nozzleman
- HM - Hoseman
- PM - Plugman

Straight Lay

- DR - Stops the truck at the hydrant
- PM - "Catches" the hydrant as directed
- HM & NM - Rides at the side of tailboard while the hose is paying out
- DR - Stops the truck at the fire
- CC - Goes to size up the fire
- DR - Applies the hose clamp approximately 20 feet behind the truck and at least 6 feet from any coupling
- HM - Removes working line from the hose bed, breaks the coupling and returns the loose coupling to the hose bed
- HM & NM - Attaches the nozzle to the hose, advances the hose and the nozzle to the fire
- DR - Removes the hose clamp and assists with advancing the working line or as directed by the crew chief
- PM - Turns on the hydrant as soon as the hose clamp has been applied; follows the hose line removing kinks, tightens leaking couplings, and reports to the crew chief

Reverse Lay

- DR - Stops the truck at fire
- CC - Goes to size up the fire
- DR & PM - Removes the ladders from the truck
- HM & NM - Removes the forcible entry tools and extinguishers
- NM - Removes the load finish
- HM - Removes the adapter, nozzles, and anchors pay out line
- DR - Drives the truck to hydrant
- PM - Goes with the truck
- NM & HM - Advances nozzles and hose to the fire
- DR - Stops the truck at hydrant
- PM - Breaks and connects hose to the pumper
- DR - Sets up the cab controls, removes suction hose and connects to the truck and hydrant.
- PM - Opens the hydrant.
- PM - Follows line, straightening kinks in the hose, tightens leaking couplings, and reports to the crew chief

Table 1. Legend for Five Man Crew.





CHARGE LINE



SHUT OFF WATER IN LINE



CEASE OPERATIONS



INCREASE PRESSURE



DECREASE PRESSURE

Figure 12. Hand Signals For Structural Operations.

stream. Although the time required to make a reverse lay may be a little greater than for the straight lay, the assurance of consistent pressure from the pumper frequently compensates for the small loss of time. As stated previously, this lay is often used in conjunction with the straight lay.

To accomplish the reverse lay, the following procedures may be used. The driver will stop the truck at the fire. The nozzleman, hoseman, driver, and plugman remove such other equipment as may be needed, such as ladders, forcible entry tools, lanterns, pike pole, etc. The nozzleman will remove the working line, which will be accomplished by pulling the skid or other chosen hose load finish.

This equipment should be placed off the road and on the fire side of the truck. The hoseman will anchor the hose line as it pays out and then he will assist the nozzleman in advancing the hose. The nozzleman will use the cross-chest carry when advancing the nozzle, making sure that a man is anchoring the hose. The driver and plugman remount the truck, the plugman riding on the side of the tailboard to avoid injury from hose and couplings as the load is paying out. The driver drives the truck to the hydrant.

The driver performs the "in-cab" procedures, dismounts, and connects the suction hose first to the truck and then to the hydrant. The plugman dismounts, disconnects the hose at a coupling, making sure there is sufficient hose to reach the discharge outlet at the pump, returns the loose end of the hose to the hose bed, carries the end of the hose that leads to the fire around to the pump on the side opposite the hydrant, and connects the hose to the discharge outlet of the pump. He may, if necessary, assist the driver in connecting the suction hose to the hydrant. The plugman will then open the hydrant valve and then proceed down the hose toward the fire, removing all kinks in the hose and tightening any leaking couplings and report to the crew chief. The driver will put the pump into operation and remain at the pump controls at all times while the pump is being used.

PLANNED JOB ASSIGNMENT FOR COORDINATED HOSE OPERATIONS

In order that a crew may work smoothly and efficiently, each man on the crew must know his part of a coordinated hose operation. By changing places on the team, each man may be trained for any part in a crew operation.



Planned job assignments for hose operations means that a prearranged plan must first be established for the operation. In the plan, various positions must be designated and these positions may vary with different departments. Consequently, the procedures should be considered as a guide and adjustments should be made to fit a local situation. The purpose of this guide is to show how prearranged plans may be used to an advantage when cross-training members of the same crew.

A minimum number of hand signals have been worked out for use in structural operations in the school. Some of them are widely used throughout the Air Force. These signals are needed since it is very difficult to give verbal instructions that can be understood above operational noises. These hand signals are shown in figure 12 and should only be used when necessary.

RELAY OPERATION

We have previously covered the procedures used in performing relay operations. Tomorrow, after completing your straight and reverse lays, you will perform a relay operation. The procedures will be explained by your instructor.

PREVENTIVE MAINTENANCE

After a hose laying operation, it is necessary to perform preventive maintenance on the structural firefighting vehicle and mounted equipment. This is done to insure that it is ready for emergency use if the need arises. If wet lays have been performed it will require you to reload the vehicle with dry hose.

QUESTIONS

Please write your answers to the following questions on a separate sheet of paper.

1. The application of water to a fire, in the form of _____ or _____ stream, is accomplished by various hose laying procedures.
2. The _____ is a very fast method of getting water on a fire.
3. The use of the _____ also makes _____ carried on the vehicle available.
4. On a straight lay, the _____ applies the hose clamp.
5. On a straight, lay the _____ removes working line from the hose bed.
6. When using the "reverse lay", the hose is laid from the _____ to the _____.
7. This lay is used when the hydrant pressure is _____ to support a good fire stream.
8. To accomplish the reverse lay, the driver will stop the truck first at the _____.
9. On a reverse lay, the _____ and _____ removes the ladders from the truck.
10. On a reverse lay, the _____ removes the load finish.
11. On a reverse lay, the _____ connects the suction hose to the truck and hydrant.
12. On a reverse lay, the _____ breaks and connects hose to the pumper.

REFERENCE

1. IFSTA #103. Fire Hose Practices.

147

STRUCTURAL FIREFIGHTING PROCEDURES

OBJECTIVES

After completing this study guide and your classroom instructions, you will be able to:

1. Identify principles of structural firefighting.
2. Identify the principles of building heat and smoke ventilation.
3. Identify visual inspection procedures for determining structural stability of a building.

INTRODUCTION

During this part of your training, you will be studying the control and extinguishment of structural fires and the overhaul and salvage phases of firefighting. After these phases are discussed, you will have completed your introduction to structural firefighting. All that is left to be done now is to practice what you have learned. In addition to being proficient in each crew position, it is important that you understand and apply basic firefighting procedures. This will be accomplished in the remaining hours during simulated structural firefighting operations.

INFORMATION

FORCIBLE ENTRY

Forcible entry means gaining access to closed spaces by opening locked doors and windows, roofs, floors, skylights, partitions, and walls by mechanical means. Even the breaching of masonry walls with a battering ram and other extreme operations may be necessary. However, indiscriminate destruction of buildings must be discouraged. Responsibility for careful methodical forcible entry rests directly with the fire department. Forcible entry may be required for rescue, ventilation, control, or extinguishment and must be effected with fast, methodical judgment and tactics.

CUTTING WITH THE AX

In cutting with a fire ax, short, quick, forceful strokes are used for better aim. This prevents the ax from

striking personnel or from catching in overhead obstructions. This method of cutting is particularly important in dark or smoke-filled areas. Cuts are made across the grain rather than with the grain of the board and as close to a joist or stud as possible. A proficient firefighter should be able to use the ax either right- or left-handed. Cutting in difficult corners and under obstructions with the ax can be efficiently done only by men who have been properly trained. Cuts in flooring, roofing, or sheathing should be made at an angle of about 60 degrees, as illustrated in figure 13, instead of straight across. Diagonal sheathing is cut slantwise to the grain of the sheathing, so that chips will tend to split out. If cuts are made with the grain of the sheathing, the ax may bind and require extra effort and time. Cuts through a lath-and-plaster wall are made in a direction diagonal to the run of the lath rather than perpendicular to it. After the boards are cut, the pick end of the ax may be used for prying and removing them.

DOORS

The various types of doors must be understood by fireman before successful forcible entry can be accomplished with the proper tools. The doors normally found on air bases are panel doors, slab doors, and industrial doors. The method for opening a door is first determined by the manner in which the door is locked and hung.

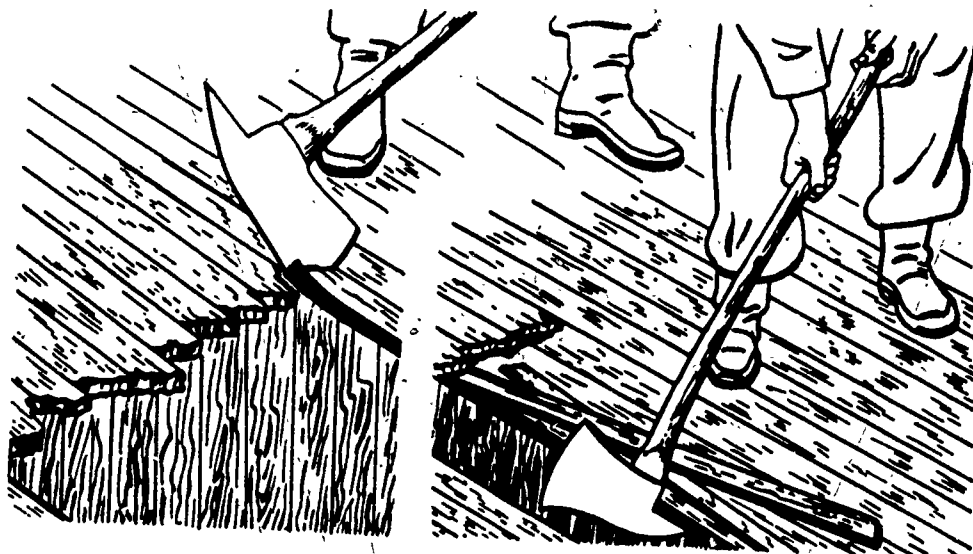

Figure 13. Cutting and Prying With Ax.

Slab Doors

Slab doors are generally made of veneered hardwood with a white pine core or frame. They usually employ the same general hardware as panel doors and, because they are solid, are not usually sprung.



Figure 14. Removing Hinge Pins.

Panel Doors

Panel doors may have horizontal or vertical panels, or a combination of both with the panels made of thin material. The locks can be either surface or recessed and the hinges mounted on the surface of the door or installed on the butt of the door to hide them. The common door hinge has removable hinge pins which are easily removed by a spanner wrench or ax without causing damage to the door or door casing, as shown in figure 14.

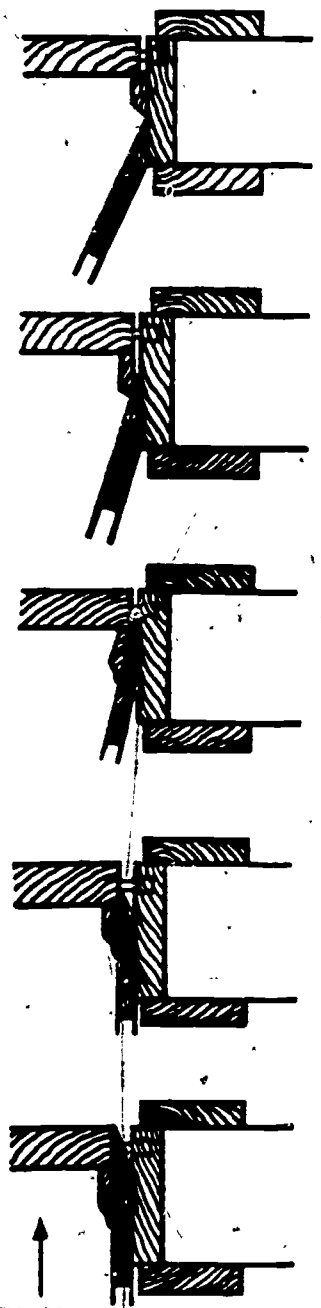

Figure 15. Using the Door Opener.

Industrial Doors

Industrial doors used in garages, warehouses, and storehouses, are single- or double-wing, single- or double-sliding, overhead-lift or overhead-rolling. Outside double doors in barracks, office buildings

and recreation halls and smaller doors of other buildings may be against stops, or against a rabbeted shoulder in the door jamb. Doors on Air Force buildings usually open outward. In using a door opener, the wedge should be inserted just above or below the lock, figure 15. A spanner wrench with a wedge end may also be used where there is no requirement for a large amount of leverage.



PUSH
 Figure 16. Springing a Door
 In a Spanned Frame.

149
 Overhead-rolling doors are made of steel and offer the greatest resistance to forcible entry tools. Normally, these doors cannot be raised except by operating a gear and chain. The best method is to find some other means of entrance and open this type of door from the inside.

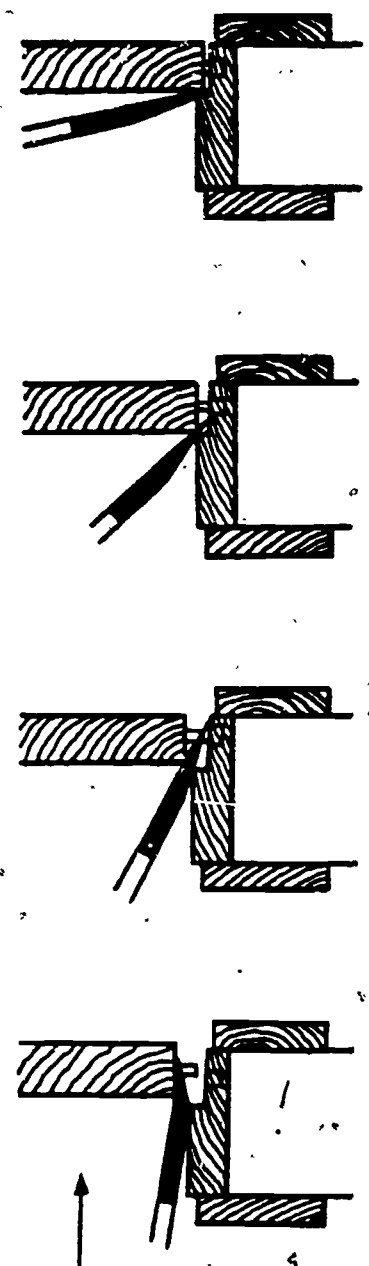

PUSH
 Figure 17. Opening a Door
 In a Rabbeted Frame.

If doors are stopped only by frame stops, the stop is loosened or removed with a sharp wedge (ax or door opener) and the door is sprung open by prying the door clear of its lock or latch, as in figure 16.

Rabbeted frames pose a different problem. By forcing the door opener between the door and the frame and pushing and prying, as in figure 17, you can get enough of a "bit" on the door to spring it past the lock or latch.

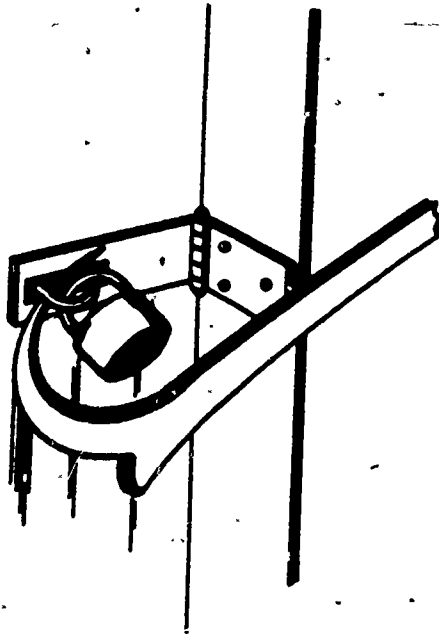

Figure 18. Using Door Opener on Hasp.

In all instances, you must take as much care as possible to keep the damage to a minimum. Double doors may be opened by prying between the doors until the lock or latch clears its keeper. If a wooden strip covers the opening between the doors, it must be removed or cut away before the wedge can be inserted. Doors with other securing devices, such as night latches, will require more drastic or direct action. If no battering ram is available, a sharp blow with the shoulder or foot will in most cases spring the door. Overhead lift doors can sometimes be forced by prying upward at the bottom of the door with a crowbar or claw tool. After the lock bar is broken, the door lifts up readily. When doors are secured by padlock and hasp, you can force the

staple off with the door opener, as shown in figure 18, without damage to the lock and in many cases the door. We have been discussing various ways of opening doors. You should always remember to cause as little damage as possible; however, there will be instances when time will mean more than the damage inflicted. Do not hesitate; do what must be done.

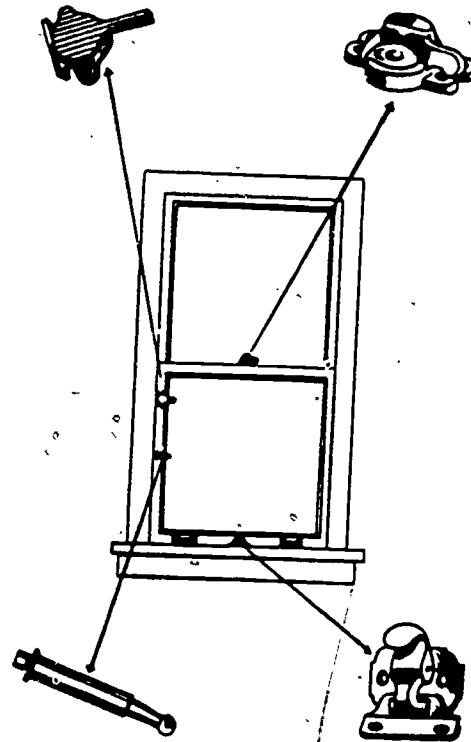

Figure 19. Locking Devices for Checkrail Windows.

WINDOWS

Prying with a wedge is the principal operation in forcing wooden framed windows; however, with the advent of crank adjusting windows, metal framed windows, new locking devices, and other innovations, it has become necessary to change our way of thinking. A wooden frame can be forced with a minimum amount of damage, but metal framing, once it is forced, usually is beyond repair, especially aluminum. The least amount of damage is caused by breaking the window, removing the glass pieces that could cause injury, reaching in, and opening the window. The fire ax, claw tool, spanner wrench, or any other wedge-shaped instrument

can be used for forcible entry on windows. Factory type windows consist of steel sashes, which are often set so solidly in the frame that only a portion of the window may be opened. The moveable portion is generally either pivoted at the center or hinged at the top and latched on the inside. Since factory type windows have small panes, breaking a glass near the latch becomes a fast, simple operation which causes negligible damage. Jagged pieces of glass left on the sash are cleared out before reaching in with the hand. Wired glass must be completely removed from the sash.

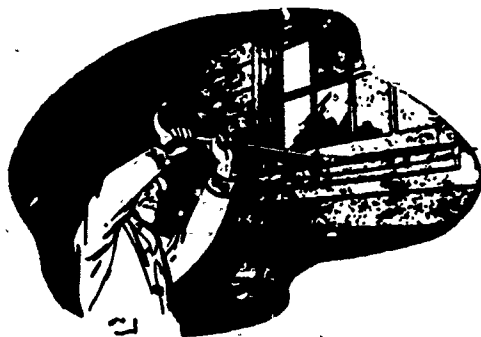

Figure 20. Opening a Checkrail Window.

The checkrail windows has two frames, or sashes, which are in contact at the top and bottom horizontals. If the window has no weights, the sash is locked with pins in the window stiles (the channel the sash rides in) or by a friction lock pressing against the window jamb. Several types of locks are shown in figure 19. Checkrail windows may be opened by prying upward on the lower sash rail as shown in figure 20. If the window is locked on the checkrail, the screws of the lock give way as the sashes separate. When the window is locked with spring-activate bolts, they must be broken or bent before the sash can be raised. Prying should be done at the center of the sash to prevent breaking the glass. However, if the checkrail latch is on the side, the pry should be made directly beneath it. Basement windows may be opened in the same manner as a door in a rabbeted frame. If the prying is done at the center of the lower rail, the lock may be pulled off or sprung.

To open windows on upper floors, primarily to provide ventilation, the firefighter lies face down on the roof

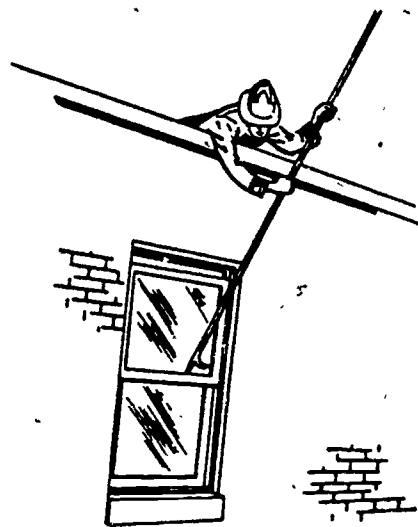

Figure 21. Using a Pike Pole to Open a Window From Above.

or leans from a window on the floor above and applies the point or hook of a pike pole to window below. See figure 21. The pike pole also can be used to break the glass if the window cannot be raised or lowered and ventilation is essential.

ROOFS

Roofs may be classified, according to the construction of the covering, as shingle roofs, composition roofs, or metal roofs.

Shingle roofs include all those made of small sections of material -- such as wood, metal, or asbestos -- fastened to the sheathing. Shingles are nailed to sheathing and can be removed easily. Shingle roofs are opened by stripping off the shingles and cutting away the sheathing.

Composition roofs contain from one to six sheets of roofing material generally consisting of tarred felt nailed to the sheathing and cemented together with asphalt. Hot asphalt that hardens when it cools is spread over the entire covering. Gravel may be spread into and over the hot asphalt to become a part of the covering when the asphalt cools. The sheathing consists of one inch boards nailed tightly to



Figure 22. Removing Plastered Ceiling.

wood joists or laid on solid concrete. Composition roofs require more care to open because they are more difficult to repair. The covering is cut and rolled back before you cut the sheathing to make an opening. To locate joists, the roof should be "sounded" before it is cut. You should make your cuts as close to the joists as possible to make both cutting and repairing easier.

Metal roofs — generally corrugated metal sheeting, aluminum, or galvanized iron — are nailed so that they overlap, making a weatherproof covering. The support for the metal is usually wood sheathing into which the nails are driven. To make a forcible entry on this type of roof, at least two sections of the sheeting must be removed. An ax, wrecking bar, or forcible entry tool is inserted under the edge of the metal sheeting on one side of a nail and pried up. This action is continued until the full sheet is free to be removed. The metal sheets should

never be allowed to fall to the ground uncontrolled, but should be lowered by rope to eliminate the possibility of injuries to the personnel below. When the wood sheathing is bared, cut it with your ax in the same manner as you were told earlier.

FLOORS AND CEILINGS

Permanent-construction wood floors are laid double on joists generally set on 16 inch centers. The subfloor is usually laid on a 45 degree angle to the joists, and the top or finish floor at right angles to the joists. In mobilization type buildings, a single floor is laid directly on the joists, the joists set on 16 inch centers. In theater-of-operation type construction, a single floor is laid on joists on 24 inch centers. Floors may be opened in much the same ways as flat roofs, except that two distinct floor run in different directions. You locate joists

by sounding, and both cuts follow the side of the joists toward the inside of the required opening. For efficient cutting, the hand which applies the force is held halfway up the ax handle. The feet are spread for proper balance and to avoid cutting the foot in the event of a misplaced or glancing stroke. If you are the one doing the cutting, you must be careful to stand outside the area to be opened. You can open a plastered ceiling by breaking the plaster and pulling off the material. A pike pole of proper length is the most effective tool for this job, figure 22. Metal and composition ceilings can be pulled from joists in the same manner. Board ceilings are somewhat difficult to remove because the lumber offers considerable resistance when an attempt is made to jam the pole through or between the boards to get a solid grip for the hood.

The following precautions must be observed when opening ceiling and walls:

1. Do not stand under the areas to be opened even though you are waiting to apply water or perform other duties that require you to be there.

2. Pull downward so that the tip of the pike pole is forced in the direction away from you to avoid being struck by falling material.

3. Keep the upper hand on the top side of the pole, to assist you in (2) above.

4. Always wear your helmet when pulling down a ceiling or upper part of a wall, because you don't know how much material may fall with each thrust.

As shown in figure 23, glass in doors and windows is broken easily with the flat side of an ax. When breaking the glass, you should stand to one side (in case the internal pressure blows the glass out) and strike the upper portion of the pane first, being careful that broken glass does not slide down the ax handle. After the glass is broken out, remove all jagged pieces from the sash to safeguard personnel, hose, and ropes from injury and damage when they pass through the opening. The removal of the jagged glass may be done with the head of an ax.

STRUCTURAL FIREFIGHTING STEPS

In earlier discussions we stated that there are phases in firefighting. We do not want you to think that only one phase can go on at a time. As you read through the unit, you should remember that rescue and extinguishment may be performed at the same time. In fact, the order presented in this unit may vary a great deal from fire to fire. However, firefighting is normally considered a step-by-step operation and these steps are usually carried out in the order given below.

1. Approach.
2. Size up.
3. Attack.
4. Control.
5. Extinguishment.

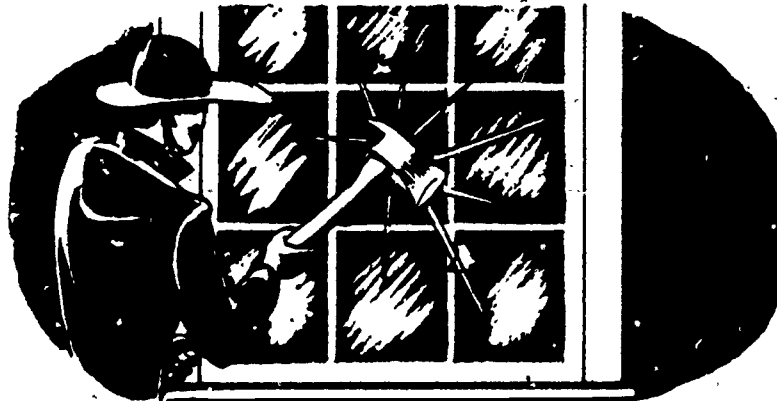

Figure 23. Breaking Glass Window With an Ax.

6. Overhaul.

7. Salvage.

Rescue is the most important part of any firefighting operation; however, it is not a part of one of the seven steps listed above.

Approach

The approach is the response to a structural fire by the quickest and safest routes. Certain factors must be considered when deciding which route to take to the fire scene. Some of the factors are:

Amount of traffic involved

Exposures involved

Road hazards

Hydrant locations

If possible, you should select routes that will not interfere with the other trucks responding to the same alarm. When picking out hydrants and laying hose, keep the hose layout close to the curb so backup crews can approach. Every crew member must know the base and be alert for road repairs, changing traffic regulations, and other temporary problems.

Size Up

When you size up a fire, you are forming a picture in your mind of what must be done to quickly extinguish the fire and perform rescue if necessary. The primary duty of the fire chief or his assistant while approaching a fire is to quickly size up the situation to determine what must be done. The most valuable tool that he has while sizing up a fire is the prefire plan. Prefire plans, as we recall, tell us known facts about every building and facility on the base. Some of the known facts that prefire plans give us are:

Type of building construction (wood, metal)

Contents of the building

Other buildings close to the burning building

Life hazard

Hydrant locations in relation to that building

These facts and many more you can get from a prefire plan before you arrive at the fire. With this information already known to you, you should form a mental picture of all your actions. Also you will have an idea of what to do if anything unusually comes up. At this point, if you have any doubt, take a few minutes to review the items on a prefire plan.

Factors to Consider During Size Up

As we stated, many facts can be learned by looking at the prefire plan for the building or facility that is on fire. There will also be some things you will not know until you arrive at the scene. Let's cover the items that must not be overlooked while making your size up.

LIFE HAZARD. People that may be in the building are your first problem. Some buildings normally hold a large number of people. We call these buildings, "places of public assembly." Buildings falling into this category include theatres, clubs, gymnasiums, and chapels. Other buildings that would hold large numbers of people would include offices and barracks.

TIME OF FIRE. The time of the fire is a very important factor to consider during size up. You would not expect many people to be in a barracks during a working day. On the other hand, you would not expect an office to be filled with people in the evening. But, many people would be expected in clubs and movie theatres in the evening. From this we can see that the time of the fire and the building involved is a very important factor to consider.

EXPOSURE HAZARD. During the planning stage you will also need to consider other buildings near the fire. These buildings present a hazard because they could also catch fire if they are left unprotected. One thing you cannot know during size up is how bad the fire is. It could be just a small electrical

fire or the whole building may be involved. But you do know from looking at the prefire plan that there are several nearby buildings that must be protected. You should have a plan in mind to protect these buildings before you ever arrive at the fire.

TYPE OF BUILDING CONSTRUCTION. Any building can burn. In the Air Force fire service we do not use the term "fireproof." On the other hand, a steel or brick building presents less hazard than a wooden building. Even the type of roof makes a big difference. You should know which buildings are likely to burn quickly. Then when the alarm sounds you have an idea how to fight the fire before you get there.

BUILDING CONTENTS. You should know what is inside the building before you get to the fire. Several years ago an Air Force fire department was called to help put out a fire in a service station near the base. When the firemen arrived at the scene they found a large fire in the grease rack area. They knocked down most of this fire in a short time with foam. By this time, fire had spread to the front section of the building. They did not think any special hazard would be found in this area, so they entered with 2-1/2 inch hoselines. The instant they entered, several explosions occurred. For Air Force firemen were injured by exploding shotgun shells. They had no reason to think this kind of material was stored in the station. As a fireman, you must know what hazards you will find in the building. This knowledge will help you during the firefighting operation, and may save your life as well.

TYPES AND AMOUNT OF EQUIPMENT NEEDED. You have only so much equipment to start with. Let's say one or two of your trucks are out of service for repair. Then let's say you have a fire in a large warehouse. At once you know that you may not have enough equipment to do the job. You should always plan ahead to make sure enough firefighting equipment is on hand.

ATTACK

The seven steps of firefighting are not always done separately. In fact, two or even three steps may be carried out at the same time. For example, we

155
can size up a fire while we are making our approach, or we can attack and control the fire at the same time. Actually there IS a fine line between attack and control. In many cases they may seem to be one operation, but for our purposes they will be treated as two separate operations.

When we speak about attacking the fire we are thinking of two things. The first thing we think about is making the proper hose lays. If the hose is not layed out correctly, the attack will not be effective and control of the fire may be impossible. We already know from the size up what type of hose lay we are going to make. However, size up is only forming a mental picture of what we must do. Now we must actually do it. We may make a straight lay or a reverse lay or even a combination of both. When we make our hose lay and bring our hose into position, we have just completed the first part of the attack. The next thing we must do is position our hose streams. In attack we use a general rule. This rule is to attack the fire from as many sides as possible. If our hoselines are in the correct position, water can be put on the fire from any direction. The first two or three hoselines may be used to cool and protect other buildings close to the fire. The next two or three lines can be used to attack the fire from the directions that would do the most good. It would not make too much sense to have five or six hoselines on one side of the building and one hoseline on the other side. Good judgment when placing these hose streams will determine whether you can go into the control step of firefighting.

CONTROL

When you have the fire controlled you are the master. This does not mean that the fire is out. There is a big difference between control and final extinguishment. We cannot say what a fire will look like when it is controlled, but you will know. Sometimes you will have the fire controlled, then a change in the wind will cause you to lose control. For years firemen have been debating what items make up control. This is true because

many different operations make up the steps of firefighting. However, we shall put the following operations under the control step of firefighting.

Protecting exposures

Ventilation

Forcible entry

In the process of covering these three operations, you will learn many facts about firefighting.

Protecting Exposures

What is an exposure? It is any building or its contents that is not involved in fire but is in danger of catching fire. When we protect exposures, we are stopping buildings and materials from catching fire. The two types of exposures are internal (inside) and external (outside).

INTERNAL EXPOSURES. We think of internal exposures as any material inside a building that is in danger of catching fire. There are two ways to protect internal exposures. If the exposures are moveable, such as items of furniture, they can be moved away from the fire area. If they cannot be moved, they can be kept cooled below their ignition point with water streams. Some examples of internal exposures are walls, ceilings, floors, and items of furniture. In short, anything that will burn can be an exposure. By protecting these exposures, you are keeping the fire from spreading. By keeping the fire from spreading you are, in fact, "controlling" the fire.

EXTERNAL EXPOSURES. Often, the best way to control a fire is to limit the damage to one building. When we protect external exposures, we are talking about keeping the fire from spreading to other buildings. In block I of this course you learned three methods of heat transmission. You also learned that fire spreads by one or more of these three methods. You must now learn how to fight the effects of conduction, convection, and radiation as they apply to external exposures. Factors such as temperature, humidity, and wind are important to consider when protecting other buildings. Also,

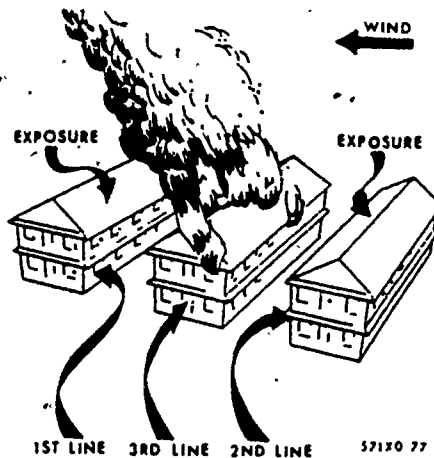

Figure 24. Protecting External Exposures.

you should consider the distance between the buildings and the height of the burning building and nearby buildings. An exposure hazard is shown in figure 24. A second fire could be started by radiation. Fires from radiation can start up as far as 1,000 feet from the first fire. Flying embers have caused fires as far away as six miles. The best protection against exposure fires is the open space between buildings. It is hard to say what is enough space to prevent the spread of fire. You must protect nearby buildings with water when you are not sure of the space needed. Figure 24 shows how this is done. We will discuss the use of such hose line in the next three paragraphs.

As a rule, the first hose lay is always laid to the exposure that is in most danger of fire. When using hose streams on exposed buildings, you must cool the building below its ignition temperature. From time to time you may be able to direct the stream of water to the burning building to help put out the fire. Normally water fog is used on exposed buildings. In an earlier part of this course, we told you that water fog is up to 10 times better for cooling than a straight stream. We call this a water curtain. A water curtain is also used to stop radiated heat and knock down flying embers from the burning building.

The second hoseline is used to protect the other exposed buildings. As shown in figure 24 the second line is used to cover the building on the right. The wind is blowing away from this building; however, this building will still receive a lot of radiated heat. If the wind should change direction this building will still be protected. The second hoseline then is used to stop some of this heat. It is also used to help fight the fire.

The third hoseline is used to fight the fire. You can see from this that the exposed buildings are more important to use than the one completely involved in fire. Why? Because the burning building has already suffered much damage. We want to limit the fire to one building if at all possible.

EXTINGUISHMENT

The next step of firefighting is extinguishment. Extinguishment begins when a fire is under control. There are some basic facts that must be considered before extinguishment is made. They are the type and amount of material that is burning and where it is located in the building. The best way is opening the door of the building and extinguishing the fire from outside where the air is cool and plentiful. Usually it is not this easy. Often you have to move inside the building and contend with high temperatures, dense smoke, and poor oxygen supply. We can say that there are two methods of extinguishing a fire. They are the direct method and the indirect method.

The direct method is to move right in on the fire, using fog streams or straight streams to put the fire out. Care must be taken to prevent the fire from starting up again because of areas that were not put out. Firefighters have had to fight their way out of a building because of fires starting up behind them that they thought they had already put out. This is called overrunning a fire and can be very dangerous. Make sure you have the fire in front of you completely extinguished before advancing the hoselines.

The second method of extinguishment is the indirect method. With this method,

157
water fog is used. High velocity fog is used at an area away from the actual point of fire. The water in fine particles is carried to the fire by convection currents. This method can only be used in closed buildings. The water fog creates steam inside the building and this steam extinguishes the fire by removing the oxygen. This method is desired because the fire is extinguished with a minimum amount of water damage. But as we said before, this method of extinguishment cannot be used for open fires.

SALVAGE

Salvage can be done two ways:

Move the material to the outside.

Protect the material where it stands.

Moving Material Outside

This method is used when there is plenty of time and enough personnel to move the material. Normally, this method is used when there is only a small amount of material. Normally, this method is used when there is only a small amount of material to be protected. The order in which the material is moved depends on the cost and importance of the material. Safes or filing cabinets that are used to store classified material are always given a high priority.

Protecting Material Where it Stands

Normally, this method is used because of the size or amount of material in the building. It is impossible to clear a large warehouse in a short time, yet a small office can be emptied in minutes with little trouble. In order to protect the material where it is, salvage covers must be used. Salvage covers will be covered later in this study guide.

If you use large amounts of water on building fires, you can cause a large amount of water damage. This is especially true if you are fighting fires in buildings such as warehouses, office buildings, or supply rooms. Some of this damage is caused by the improper use of water streams, such as using a straight stream instead of water fog, applying water

where there is no fire, or applying the water longer than is necessary.

OVERHAUL

The overhaul step of firefighting is a careful check to make sure the fire is out. During overhaul you make a detailed check of the building and the material inside. This is to prevent the fire from starting up again. One of the worst things that can happen to a fire department is to return to a fire that they thought they had extinguished. A second fire is much harder to control than the original fire.

The building should be checked for hidden areas where the fire may still be burning. Some of these hidden areas include false or hanging ceilings, between floor joists, walls, and partitions. In addition, check areas around windows, door casings, light and air shafts, and places where pipe or wire go into the wall. When checking for "hot spots," place the back of your hand on the area suspected. For example, if a wall feels warm or looks blackened, you should open the wall and check it. When cutting inspection openings, make a square cut near the wall studs. This will make repair easier. Finish your inspection by checking other areas such as attics, basements, and nearby buildings.

BUILDING HEAT AND SMOKE VENTILATION

Advantages of Ventilation as Applied to Firefighting

AIDS LIFESAVING AND RESCUE. Proper ventilation simplifies and speeds up the rescue of victims that may be trapped in a burning or smoke-filled area, and it usually makes conditions safer for firefighters.

SPEEDS ATTACK AND EXTINGUISHMENT. Once created by fire, the removal of the smoke, gases, and heat from a building permits firefighters to locate the fire and proceed with its extinguishment. Proper ventilation of a building further enables firefighters to determine the path or travel of the fire and to take proper steps for its control.

REDUCES THE DANGER OF BACKDRAFT. During a fire, flammable gases are vaporized from the combustible materials of a building. When these fuel gases are heated to their ignition temperature, they will burn if sufficient oxygen is present. If there is insufficient oxygen, the unburned gases may collect in pockets throughout the area or occupy the entire building. Such a condition needs only the admission of sufficient fresh air to cause a very rapid burning of these gases, the expansion of which may be sufficient to cause an explosion. Such an explosion is commonly referred to as a backdraft. The degree and intensity of the backdraft depends upon the amount of heated gases and the volume of fresh air admitted. Proper ventilation by opening the building at the highest point involved permits the heated gases and smoke to be expelled and makes your entrance at the lower levels safer.

LESSENS THE CHANCE OF MUSHROOMING. Proper ventilation of a building during a fire reduces the possibility of heat and gases spreading out laterally at the top of the structure. It tends to draw the fire to a point by restricting the convection of heat currents.

MAKES FIREFIGHTING EASIER. Proper ventilation not only reduces the need for protective breathing equipment, but it also reduces the obstacles in rescue, and overhaul procedures.

REDUCES FIRE AND WATER DAMAGE. Quick extinguishment of a fire reduces not only the actual fire damage, but also water damage. Proper ventilation assists in making this damage reduction possible. Another method of ventilation that may prove advantageous is applying water into the heated area in the form of rapid expansion of the water when it is converted to steam. In addition to removing gases, smoke, and heat, this method also reduces the amount of water used to extinguish the fire.

REDUCES SMOKE AND HEAT DAMAGE. Smoke may be removed from a burning building by controlling heat currents, by collecting carbon in the condensing steam, and by dissipating smoke through



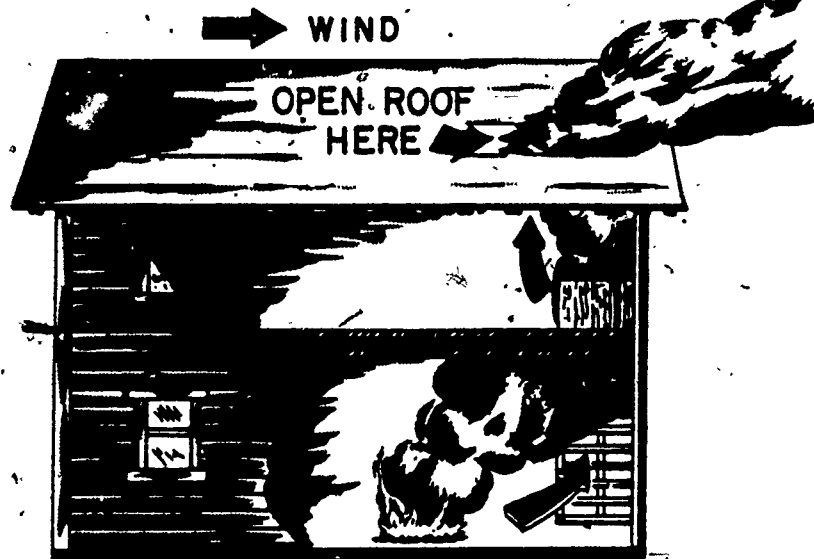

Figure 25. Vertical Ventilation.

the expansion of water as it is turned into steam. Regardless of the method used, fire ventilation reduces smoke damage because fuel vapors and carbon particles are removed.

Situations Requiring Ventilation

In a closed structure, sufficient oxygen is present to support free burning when the fire starts. The hot gases formed rise to the ceiling due to convection. This forces the cooler air downward to feed the fire. If fresh air is unable to enter the building from the outside, the amount of oxygen is gradually reduced until the fuel smolders or smokes. Theoretically the fire should finally smother and extinguish itself. Actually, the smoldering is sustained because in most cases the oxygen supply is never completely exhausted.

Vertical Ventilation

To accomplish vertical ventilation, you must work from the top down. Heated gases and smoke rise to the highest point available, and the roof is the highest point whether it is flat or peaked. Figure 25 shows how the gases and smoke will escape when vertical ventilation is done properly.

There are certain important rules in the procedure for ventilating a roof

which you should take into account for your own safety and the accomplishment of a thorough job of ventilation. The following six rules should be kept in mind when ventilating a building vertically:

1. Check the condition of the roof supports to insure they have not been burned away or weakened to a point where they may collapse under your weight. Feeling the roof for hotspots, as you were told before, will help you determine if the fire has reached a point to cause weakening.
2. Plan a means of escape from the roof in case of emergency, such as roof collapse. You should have a lifeline, especially when working on a peaked roof, to prevent falling.
3. Use any available openings that are part of the roof construction, such as skylights or roof trapdoors.
4. Make certain the passage way for the smoke and heat extends down through the ceiling of the room. A hole in the roof is of no use if there is no relief for gases, heat, and smoke in the room below.
5. The openings should be large enough to provide a rapid exit for the smoke and gases.



Figure 26. Horizontal Ventilation.

6. Work with the wind to your back, keeping in mind the heat, explosive characteristics, and toxic effects of escaping gas.

Horizontal Ventilation

If the smoke and gases have not reached the higher levels, horizontal ventilation may be used to clear the buildings one floor at a time. Windows are the easiest and generally most available for the common types of buildings, but the indiscriminate opening of windows and doors can defeat the purpose of ventilation. See figure 26.

The general procedures for cross ventilation are as follows:

1. Open windows on the leeward side first; then open windows on the windward side.
 - a. Checkrail windows -- open the upper half on the leeward side and the lower half on the windward side.
 - b. Windows that cannot be opened -- break the upper half of the windows on the leeward side and the lower half on the windward side. Remember to stand to one side when you break a window.

2. After one floor is clear, ventilate the next floor in the same manner.
3. Do not make openings below the level of the fire if at all possible.
4. If the opening is made at the same floor level as the fire, hoselines should be available for immediate use.
5. Avoid ventilating a building in such a way as to allow the fire to be drawn through any part of the building that is not ventilated.
6. When making an opening, exercise great care to prevent the spread of the fire to exposures and have hoselines available to protect the exposure.

Forced Ventilation

Ventilation has thus far been considered from the standpoint of the natural flow of air currents, the currents created by fire, and the effect of fog streams. Forced ventilation is accomplished by mechanical blowers or fans. The fact that forced ventilation is effective and can be depended upon for smoke removal when other methods are not adequate proves its value and importance.



Advantages of Forced Ventilation

The value of mechanical ventilation may be further realized when, in order to protect human life, it becomes necessary to rid premises or areas of an undesirable atmosphere. Even though fire may not be a factor, contaminated atmospheres must be rapidly and thoroughly ejected. Forced ventilation, if not the only means of clearing a contaminated atmosphere, is always a welcome addition to normal ventilation. Some of the reasons for employing mechanical or forced ventilation are indicated in the following list:

1. Ensures more positive control.
2. Supplements natural ventilation.
3. Speeds the removal of contaminants, facilitating more rapid rescue under safer conditions.
4. May be used where other methods fail.
5. Reduces smoke damage.
6. Promotes good public relations.

Disadvantages of Forced Ventilation

If mechanical or forced ventilation is misapplied or uncontrolled, it can cause a great deal of harm. Forced ventilation requires considerable supervision because of the mechanical force that is behind it. Some of the disadvantages of forced ventilation are indicated in the following list:

1. Can move fire along with the smoke and extend it to lateral areas.
2. Can introduce air in such great volumes that it can be the cause of a fire spreading.
3. Dependent upon power, the interruption of which renders it ineffective.
4. Employs additional manpower for its operation.
5. Requires special equipment.

Forced Ventilation Equipment

161
It is difficult to classify forced ventilation equipment by any particular type. The principle applied is that of moving large quantities of air and smoke. These portable blowers are all powered by electric motors or gasoline-driven engines. Various types of electric forced air blowers are identified by different names, such as ejectors, extractors, exhausters, and blowers. Forced air blowers should always be equipped with explosion-proof motors and power cable connections when used in a flammable atmosphere. Forced air blowers should be shut down when they are moved. Before they are started, be sure that there are no persons near the blades and that clothing, curtains, or draperies are not in a position to be drawn into the fan. Blowers should always be moved by the handles which are provided for this purpose.

STRUCTURAL STABILITY

Since it is conceivably difficult to outline all of the operations that may be performed in searching for hidden fires, only the more fundamental conditions will be discussed. One prerequisite, before starting a search for hidden fires, is to determine the condition of the building in the area to be searched. The degree of intensity which the fire attained during burning and the amount of water used during its control are two important factors that influence the condition of the building. The first determines the additional weight on floors and walls because of the absorbent qualities of the stock. Consideration given to these two factors may prevent unnecessary loss of life during overhaul because of building collapse. A sagging roof means that the supports are weak. Sagging ceilings and floors tell you that there is damage to structural beams and supports. Large cracks in masonry walls show they are weak. Firemen have been injured or killed from falling walls and ceilings that were weakened by the fire. Weakened walls and building supports must be made "safe" before any attempt at overhaul.

is made. Walls or chimneys which have been weakened and are in a position that would endanger personnel should be pulled down. Holes which have been burned or cut in the floors should be covered or blocked off. Approaches to damaged stairways, stair wells, or elevator shafts should be blocked off. Weakened building supports should be braced if possible to assure safety to firemen during overhaul. If the gas and electricity have not been turned off, they should be turned off.

QUESTIONS

Please write your answers to the following questions on a separate sheet of paper.

1. Forcible entry means gaining access to closed spaces by _____ means.
2. In cutting with a fire ax, _____ strokes are used for better aim.
3. The method for opening a door is first determined by the manner in which the door is _____ and _____.
4. _____ doors are generally made of veneered hardwood with a white pine core or frame.
5. Overhead-rolling doors are made of steel and offer the _____ to forcible entry tools.
6. _____ with a wedge is the principle operation in forcing wood framed windows.
7. The _____ windows have two frames, or two sashes, which are in contact at the top and bottom horizontals.
8. Roofs may be classified, according to the _____ of the covering, as shingle roofs, composition roofs, or metal roofs.
9. The _____ is the response to a structural fire by the quickest, and safest routes.

10. The most valuable tool for sizing up a fire is the _____.

11. When we make our hose lay and bring our hose into position, we have just completed the first part of the _____.

12. _____ does not mean that the fire is out.

13. When we _____, we are stopping buildings and materials from catching fire.

14. _____ begins when the fire is under control.

15. There are two methods to extinguish a fire, the _____ and _____ method.

16. The _____ method cannot be used to extinguish an open fire.

17. The _____ step of firefighting is a careful check to make sure that the fire is out.

18. The building should be checked for _____ areas where the fire may still be burning.

19. Ventilation aids _____ and rescue.

20. Proper ventilation reduces _____ and _____ damage.

21. To accomplish _____ ventilation, you must work from the top down.

22. For horizontal ventilation, open windows on the _____ side first.

23. _____ ventilation is accomplished by mechanical blowers or fans.

24. A sagging roof means that the _____ are weak.

25. Holes which have been burned
or cut into floors should be
_____ or _____
off.

REFERENCES

1. IFSTA #104, Salvage and Overhaul Practices.
2. CDG 57100, Fire Protection Specialist,
Volume 2.

169

STRUCTURAL FIREFIGHTING OPERATIONS

OBJECTIVES

After completing this study guide and your classroom instructions, you will be able to:

1. Inspect and perform operator maintenance on structural firefighting vehicles and mounted equipment.
2. Perform crew duties in firefighting drills and emergency response exercises.
3. Demonstrate normal and emergency entry procedures into a building.
4. Perform as a member of a firefighting crew to control and extinguish structural fires.
5. Locate and evacuate personnel from an occupied building.
6. Protect adjacent/nearby building exposures and equipment from fire hazards.
7. Perform firefighting overhaul clean-up operations.
8. Perform preventive maintenance on structural firefighting vehicles and mounted equipment.

INTRODUCTION

Let's take a look into your future. You are a crewmember on a structural fire truck. You're busy cleaning the truck as part of your regular duties. The alarm rings! FIRE!! You don your protective clothing and take your position on the truck. Now, your crew chief has the word, the truck is rolling, and you're on your way - to where? - to what? Until the crew chief gives you the information he received, all you know is - you are answering an alarm. "Building 434 - warehouse - west end - smoke."

The first facts are known. To where? Building 434, west end. To what? Smoke in a warehouse. Is this all you know? No! You think back. You think of prefire plans you've studied.

INFORMATION

INITIAL PREPLANNING

You actually started your firefighting a long time ago. The fighting of this fire began when the prefire plans were

drawn up. Such plans are made by members of the fire department for all buildings and areas of the air base. They show the location of the building, construction, floor plan, exits, use, life hazards, safety hazards, exposure hazards, main electric switch, gas cutoff, hydrant locations, response routes, required hose lays, how many pieces of equipment are to respond, and other information that may be peculiar to that building or area. You should receive training on these plans, both "skull practice" and "dry runs" at your next base. This training is designed to acquaint all fire protection specialists, not only with the individual buildings, areas, their features, and hazards but also the base as a whole.

Now, let's return to Chanute. You are at the point in training when the team idea takes shape. As was mentioned earlier, you will now practice to be proficient in the different structural crew positions and apply basic firefighting procedures while functioning as a structural crew, working in conjunction with other structural crews. The simulated structural firefighting operations will

be covered under the prefire plan drawn up for building #903 (smokehouse), and the narrative description accompanying it. Each plan gives a brief description of one crew in operation. You may be working with as many as four crews in coordinated structural firefighting operations. You must study and know the plan assigned to your crew.

All through this course you have learned points of safety as it is applied to the subject being learned at the time. To avoid injury and equipment damage, you must practice all you've learned plus any new ones listed below or pointed out to you by an instructor.

1. No water fights (directing streams on each other).
2. Wear proper protective clothing during operations.
3. Don't throw equipment - pass it by hand.
4. Be alert when tools or equipment are being raised or lowered.
5. Hold handrails when ascending or descending stairs and when riding on vehicle tailboards.
6. When operating on ladders, always lock in and secure hose with strap.
7. Don't climb a ladder until it is secured by the instructor or is "butted."
8. Don't shut nozzles down suddenly.
9. Don't run and no horseplay.
10. Be especially careful on ice, wet concrete, and wet tile.
11. In case of injury or illness, regardless of how slight, report to an instructor at once.
12. Don't wear rings, bracelets, watches, or necklaces, during practical training or during clean-up.

The remainder of your training in the structural firefighting phase will be to improve your proficiency in tasks you have already learned. These drills are designed to closely parallel the real situations you will encounter in the field.

It is necessary that you recognize your mistakes in the operations in which you will be participating. Also, look for the mistakes made by others. As a crewmember, you will critique after each operation while the facts are still fresh in your mind. Difficulties that are cleared up early will make for a better training situation.

OPERATOR MAINTENANCE

Today, we will be using all the structural pumpers we have previously presented to you. Operator maintenance is a vital part of any structural operation. The crew has to be sure that the vehicle has been thoroughly inspected and is in operating condition. A necessary part of inspection and operator maintenance is to assure that all mounted equipment is on the vehicle and in its proper place so that a crewmember does not lose vital time when a tool is needed.

STRUCTURAL FIREFIGHTING DRILLS

A majority of your firefighting career in the Air Force will be spent in training to prepare you for the eventuality of an actual fire.

When the station alarm sounds, we automatically assume there is a fire. Overexcitement should not be generated because it is our job to put out fires. We must react calmly and efficiently because lives and property are at stake when the alarm sounds.

During emergency responses and structural drills, we must do our best to prepare for the real thing. All crewmembers, from the plugman to the crew chief, are a vital part of a crew. Speed and efficiency are attained through constant training.

When there is a structural fire it will quite often require one to enter the building to accomplish extinguishment. When the need arises to enter a building the first thing for the firemen to do is try the normal entry points. When trying to gain entry, before doing unnecessary damage, simply try the door knob to see if the door is unlocked. If the door is locked, try the windows before resorting to some type of forcible entry.

CONTROL AND EXTINGUISHMENT OF STRUCTURAL FIRES

When combatting a structural fire, it is necessary for a fireman to protect himself from heat, flames, and noxious gases. To do this he must wear full protective clothing and self-contained breathing apparatus while combatting the fire. To establish control of a fire will require proper size-up and ventilation. Size-up to determine what part of the building is involved. Once this is determined, ventilation may be necessary. Ventilation helps in fighting the fire by removing heated gases and smoke so that the actual fire can be located without causing extensive water damage. Once this has been accomplished, we will try and gain control of the fire. Once control has been established it is possible to begin actual extinguishment. If the fire is small and in a confined area a direct method of attack using the appropriate stream will be implemented to effect extinguishment.

LOCATE AND EVACUATE PERSONNEL

In all firefighting operations, the rescue of personnel is the primary concern of the firefighter. The prefire plan is used to give the lay out of the building and the interior design. If the building is not completely engulfed, a systematic search of each room may be necessary to insure that all personnel are evacuated. Quite often, personnel will just need the assurance of a trained rescuer to lead them to safety.

Protecting exposures is the act of preventing fire from spreading to another building, vehicle or other material that is subject to damage from a burning exposure. To protect external exposures may be as simple as moving the exposure, if possible, to a safe location. If the exposure is of a permanent nature, then other means will be required for protection.

If the fire is small, all that may be necessary to provide protection for a permanent external exposure is to wet the material down. This could be done so that flying sparks and embers will not ignite the material. With a large fire a water curtain produced by the master stream should be used.

The main factors determining the type of protection to use for the exposure is the size of the building (area and height) and the magnitude of the fire.

BUILDING CLEAN-UP

In the process of extinguishing a fire, there will be water and other types of debris remaining. It is the responsibility of the fire protection personnel to remove the water and debris. Nonsalvageable materials, such as plaster, rags, paper, and the like, may be scooped into a carrier, carried out of a building, and piled in a conspicuous place for future examination. After the bulk of all debris has been removed, excess water on floors should be mopped or squeezed dry. If the floor is wood, it is a good policy to take up excess moisture by covering the floor with sawdust for a period and then clean. Damp sawdust should not be left on the floor longer than absolutely necessary, for it may damage the floor.

PREVENTIVE MAINTENANCE

After completing a structural firefighting operation, it is necessary to do a thorough preventive maintenance job on the vehicles and mounted equipment. After a fire all contaminants should

167

be removed. The fire hose will need washing and drying to protect it from rot and mildew.

QUESTIONS

Please write your answers to the following questions on a separate sheet of paper.

1. Wear proper _____ during structural firefighting operations.
2. Don't _____ equipment, pass it by hand.
3. When operating on ladders, always _____ and secure hoses with hose strap.
4. Don't run and no _____.
5. A necessary part of inspection and operator maintenance is to assure that all _____ is on the vehicle.
6. A majority of your career will be spent in _____.
7. We must react _____ and _____ when the alarm sounds.
8. All crewmembers from the _____ to the _____ are a vital part of a crew.
9. _____ and _____ are attained through constant training.
10. When the need arises to enter a building the first thing for a fireman to do is to try the _____.
11. Once _____ has been established it is possible to begin actual extinguishment.
12. In all firefighting operations, the _____ of personnel is the primary concern of the firefighter.

13. The _____ is used to give the lay out of the building.

14. A _____ search of each room may be necessary to insure that all personnel are evacuated.

15. _____ is the act of preventing fire from spreading to another building.

16. In the process of extinguishing a fire there will be _____ and other types of _____ remaining.

17. After a fire, the fire hose will need washing and drying to protect it from _____ and _____.

REFERENCES

1. TO 36A12-12-9-61, Truck Firefighting 530B.
2. TO 36A12-12-12-1, 500 GPM Brush and Structural Firefighting Truck.
3. TO 36A12-12-8-51, Powered Pumper Fire Truck, Class 750A.
4. TO 36A12-12-15-1, Firefighting Truck, 750 GPM Structural Type A/S32P-12.
5. IFSTA #102, Fire Service Ladder Practices.
6. IFSTA #104, Salvage and Overhaul Practices.
7. IFSTA #105, Fire Stream Practices.
8. IFSTA #107, Fire Ventilation Practices.
9. IFSTA #108, Fire Rescue Practices.

STRUCTURAL FIREFIGHTING TACTICS

OBJECTIVES

After completing this study guide and your classroom instructions, you will be able to:

1. Inspect and perform operator maintenance on structural firefighting vehicles.
2. Perform crew duties in firefighting drills and emergency response exercises.
3. Demonstrate normal and emergency entry procedures.
4. Locate master switch and shut off building utilities.
5. Perform as a member of a firefighting crew and control and extinguish structural fires.
6. Locate dummy victim and perform rescue from building.
7. Protect adjacent/nearby building exposures and equipment from fire hazards.
8. Perform as a member of a crew and protect building contents.
9. Perform as a member of a crew and construct catch basins and drain chutes.
10. Perform as a member of a crew and remove equipment and furnishings.
11. Perform firefighting overhaul clean-up operations.
12. Perform preventive maintenance on structural firefighting vehicles and mounted equipment.

INTRODUCTION

Today is our second day of combined structural drills using the smoke house. You will again put into practice all of your past training. Let's review the safety procedures and have another safe day.

1. No water fights (directing stream on each other).
2. Wear proper protective clothing during operations.
3. Don't throw equipment - pass it by hand.
4. Be alert when tools or equipment are being raised or lowered.

5. Hold handrails when ascending or descending stairs and when riding on vehicle tailboards.

6. When operating on ladders, always lock in and secure hose with strap.

7. Don't climb a ladder until it is secured by the instructor or is "butted."

8. Don't shut nozzles down suddenly.

9. Don't run and no horseplay.

10. Be especially careful on ice, wet concrete, and wet tile.

11. In case of injury or illness, regardless of how slight, report to an instructor at once.

12. Don't wear rings, bracelets, watches, or necklaces, during practical training or during clean-up.

make all the necessary hose connections. And finally, the crew chief must make the decisions as to the type of attack to make, whether rescue is needed, and take complete charge of the operation until the arrival of the assistant fire chief.

INFORMATION

ENTRY PROCEDURES

OPERATOR MAINTENANCE

Again, we will be using our structural firefighting vehicles. Operator maintenance cannot be overemphasized. Using our inspection checklist, we must check and insure that all vehicles are fully serviced and capable of performing as they were designed. Place particular emphasis on the tools and mounted equipment. A visual check is not sufficient to insure that equipment will operate, try the hydrant wrench, see if the handle turns freely, check the ladder, make sure the halyard is not frayed, check the nozzles, so they open and close smoothly. These are just a few of the items to be checked all tools and equipment should be checked thoroughly and, if defective, should be repaired or replaced. The time it is needed is not the time to find out that it won't operate.

Applying forcible entry to normal openings that are locked means to force open doors and windows with mechanical tools. The breaking of a lock, prying a jamb apart, or forcing a window, may cause some damage to a door, window, or other part of a building. Damage in this respect is for less than it would be if firefighters smashed down doors and door frames or broke through window glass and frame. A skillful use of forcible entry methods will aid in the saving of lives, cause less damage to property, and result in better public relations.

There are many types of doors and windows and we will not try to cover all the various types at this time. We will, however, cover one method of forcible entry on doors.

CREW DUTIES IN FIREFIGHTING DRILLS AND EMERGENCY RESPONSES

FORCING SWINGING DOORS

To attain proficiency in your job, you must participate in firefighting drills. The speed and efficiency of each crewmember is increased by constant training. We will cover some of the crew duties each member will have. The plugman is responsible for getting water to the nozzle in either a straight or reverse lay. The hoseman must be able to quickly remove hose from the hose bed for working line on a straight lay and quickly remove tools and equipment on a reverse lay. The nozzleman must be able to select the correct nozzle and attach it to the working line on a straight lay and on a reverse lay, remove tools and equipment and pull the skid finish. The driver must safely operate the vehicle and, on a straight lay, apply the hose clamp rapidly. On a reverse lay, the driver must be able to properly spot the vehicle and

The method to use to force a swinging door is determined, first, by how the door is hung, and secondly, by how it is locked.

Before any door is opened or forced, the condition of the building should be observed and hose lines should be made available for use. The firefighter should then feel the door for heat by using the back of the hand, because the back of the hand is more sensitive to heat. The temperature of the door will indicate whether a back draft is likely when the door is forced or opened.

SHUT OFF BUILDING UTILITIES

In most structural fires, there will be utilities that must be shut off. Ideally, this would be the responsibility of the civil engineering heating and electrical shops. However, it is usually required before they



can arrive at the fire scene. Thus, this responsibility will fall to the fire department.

While responding to a structural emergency, the crew chief will be checking the prefire plan to familiarize himself with the location of the building utilities shut off. To minimize the hazard of electrical shock and the possible spark that could cause an explosion if gas lines were ruptured, the utilities to the building must be shut off.

Prior to shutting off utilities at the fire scene, the senior fire official should be advised so he can make the decision. He usually has more information about the situation than an individual crew chief.

CONTROL AND EXTINGUISH STRUCTURAL FIRES

Before a fire can be controlled or extinguished, it must be located within the structure with some degree of certainty. The practice of standing in the middle of the street and directing hose streams through window, regardless of where the fire may be inside the building, is now largely related to the movie version of fire suppression. Frequently, because of winds, smoke from the building may entirely envelop an adjacent building. A fire in the basement may appear to be in the attic or top floor; where smoke is escaping. Remember, in many cases, more damage is attributed to the misuse of hose streams than actually caused by the fire.

Extinguishment begins when defensive action against the fire is no longer necessary because control has been established. The most suitable extinguishing agent (depending on the class of fire) should be employed in an amount consistent with the speed of suppression and minimum damage from its use. Standpipe systems within a building may be used to save time and damage when the fire is too large for extinguishers and not grown to an extent requiring the volume of water supplied by larger lines. The indirect control method employs finely divided water fog, usually in large quantities, applied at a point away from the actual point of the fire, and carried

170
to the fire by convection currents. The use of this method is limited to closed buildings where the only entrance made is to introduce the water fog. This method is not effective on "open" fires. That is, fires in the open or open-sided structures in which convection cannot be secured from point of introduction to the fire escape.

RESCUE

Rescue is an operation that is completely different from firefighting, although both jobs are usually done together. Each firefighter in the Air Force is also a rescuer. He must perform a dual role and do them both well. Saving lives and property is the goal and purpose of the firefighter. Human life is much more important than a burning building, so of course rescue effort comes before anything else. In this section we will cover some of the things a rescuer must know before he can be considered "qualified." One of the first things a rescuer has to know is how to get into a burning building. You have already learned this part of the job when we discussed forcible entry. You already know about the tools that are used for forcible entry. In addition to these, tools, ladders, ropes, portable lights, and breathing apparatus must also be used. The senior officer is in charge at the fire scene. He will direct you and your fellow firefighters during rescue and firefighting operations. In this respect, you are also a tool of rescue. While rescue is made, other firefighters will be directed to position hoselines and equipment for the purpose of helping in rescue and controlling the fire.

Many times the normal escape routes such as doorways and stairways will be cut off by fire, and windows offer the only path to safety. In this event, you would find yourself placing ladders at windows where trapped victims may be. Your breathing apparatus will allow you to enter a smoke-filled building to search for victims. With breathing apparatus, a rescuer can rescue a victim quickly with no danger to himself from the harmful smoke and gases. Inside stairways offer the safest and quickest

71

route of rescue if they are not cut off by fire. Before a rescuer enters a building, he should have a lifeline tied around his waist in case he becomes lost in the dense smoke. The lifeline will lead other firefighters to him and it will also lead him and the victim back to safety. Most victims in a smoke-filled building can be expected to be lying face down on the floor. The reasons for this is that the oxygen that is remaining in the building will usually be found at floor level. Victims may also be found near openings such as windows or doorways. Sometimes they are found hiding in closets or enclosed areas. This is a human reaction to escape the intense heat of a fire. Although these areas mentioned are suspected victim locations, you may find them anywhere in the building.

But what do you do with a victim once you have found him? You don't know what condition the victim is in because you are not a doctor. However, you must remove him from the danger area. He might have a broken neck or back. He might be conscious or in shock. It may require two or even three men to move him. You as the rescuer must select the appropriate carry to prevent further injury.

Drag.

Backstrap carry.

Fireman's carry.

Arms carry.

Seat carry.

Chair litter carry.

PROTECTION OF EXPOSURES

The spread of fire is controlled by covering internal and external exposures. Exposures may be classified as internal or external. An example of an internal exposure is adjoining rooms or floors located within the burning structure. An external hazard would be adjacent houses or buildings in the immediate area. Control is the action necessary to prevent the fire from spreading to uninvolved areas. External exposures

can be protected by hose streams, water curtain methods, or physical separation. The greatest possibility of fire spread to an external exposure is usually to the leeward side of the fire. Although this may be the most difficult approach to make because the wind carries the heat and smoke in the direction of the firefighters, it does offer the greatest protection to exposures. The control of internal exposure fires is accomplished by shutting communicating doors and windows, and using hose streams properly.

PROTECTING BUILDING CONTENTS

There are two general methods used in protecting contents. One method is to remove the material to the outside or to an area that is not involved in the fire. This method is used when there is sufficient time and personnel to carry out this duty, or there is only a small amount of material that needs protecting. Precedence of the material being moved may be established by the fire priority that is assigned by the building occupants, or by the monetary value of the material involved. Classified safes or filing cabinets would fall under the priority factor. The other method of protecting contents is to protect the material where it stands. Generally, this method is used because of the size or the quantity of the contents of the building. It would be a near impossibility to clear a large warehouse, yet a small office can be emptied in minutes with little confusion and with maximum security.

For stacks or piles of material such as on base exchange display counters, warehouse stored items, upholstered furniture, or unwieldy shop equipment, some fire departments use salvage covers. These covers are also known as tarpaulins, or "tarps." They are made of cotton canvas material treated with a waterproofing compound. You will find that there are usually only two standard size covers used in Air Force fire departments -- small, 12 by 18 foot; and large, 14 by 18 foot. When the 12 x 18 foot cover is folded correctly, one man can handle and manipulate it easily. It is kept folded in an accordion fold on the truck, ready for immediate use.

CONSTRUCT CATCH BASINS AND DRAIN CHUTES

Basins

The contents and interiors of buildings may be severely damaged by water dripping through a floor or ceiling in which a drain cannot be made. To prevent this, improvised basins, such as shown in figure 28, are frequently needed to catch water which can be removed later by bailing, dumping, or pumping. A catch basin is constructed by placing furniture, boxes, or other equipment in a circle or square beneath the leak. Form a basin with the salvage cover by placing it over the furniture and boxes. Fasten the cover to the boxes and furniture or to the floor, with the bottom of the basin resting on the floor. Where the quantity of water is not great, shallow catch basins may be made by rolling all four edges toward the center. The rolls then form the sides of the basin.

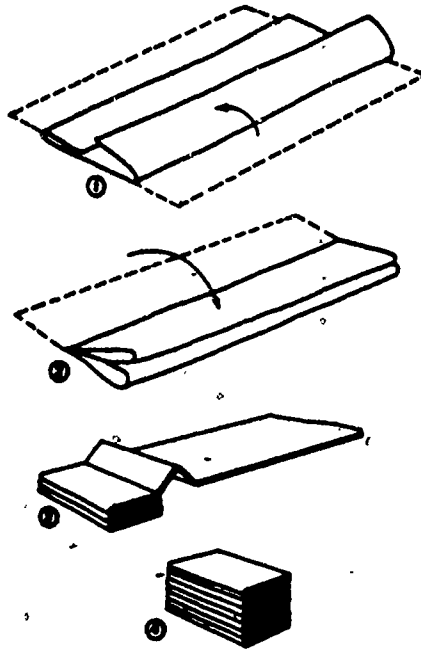

Figure 27. Accordion Fold For Small Salvage Covers.

As part of your training, you will learn to work with this cover. With practice, you will become proficient in "throwing it." Before you can "throw" the cover well, however, you must understand the way it is folded. The steps are shown in figure 27. To fold, bring the two long sides to the center (step 1); fold again (step 2); then, starting at one end of the folded cover, make 10 inch folds (step 3) and complete (step 4).

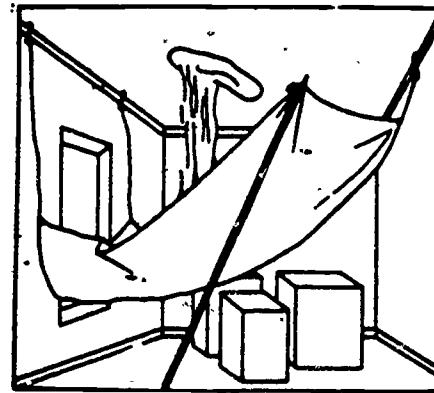

Figure 29. Window Drain Cover.

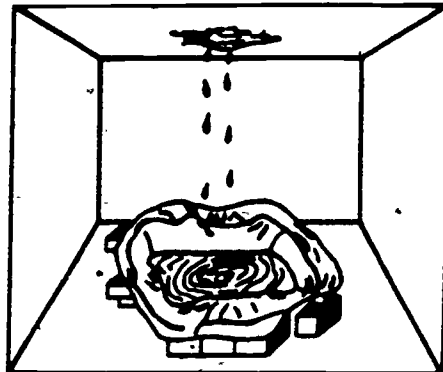

Figure 28. Salvage-Cover Basin.

Chutes

S-hooks, cord, salvage covers, and pike poles can be used to build a chute which directs water through windows, thus protecting contents and interiors of buildings from water damage, figure 29. Light rope or heavy cord can be tied through the grommets to support the covers.

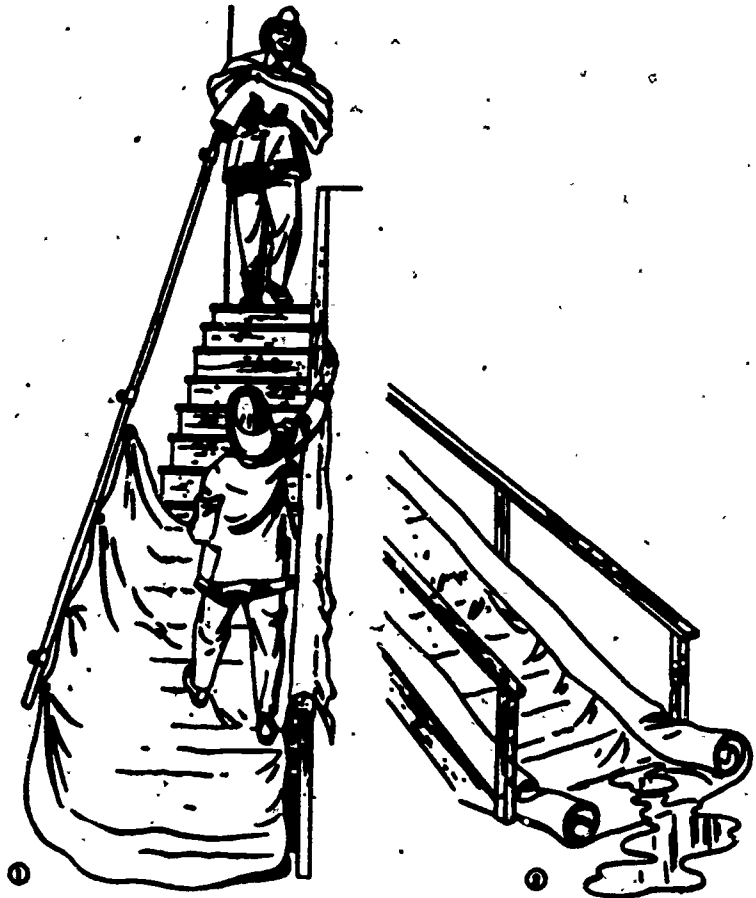

Figure 30. Stairway Drains.

Drains

To protect the interior of structures and contents from water damage, stairway drains of canvas covers are frequently needed to direct water from upper floors to the outside, figure 30. Two methods of forming stairway drains are commonly used. Two men and two canvas covers are required to perform the operation efficiently. The first cover is spread by the one-man throw at the bottom of the stairs and fitted to the steps. The second cover is placed at the top of the steps in the same manner, overlapping the lower cover about one foot.

REMOVAL OF EQUIPMENT AND FURNISHINGS

In structural firefighting operations, you will be required to assist in the removal of equipment and furnishings. When removing articles from a building,

you should use extreme care and not cause further damage. In placing material outside of the building, an area away from the fire scene is preferred so as not to get contaminated with the clean-up procedures and not impede the movement of firefighting vehicles. Removal of equipment and furnishings is limited because of the size and weight of the objects and the number of personnel available. It is usually preferred to protect the materials where they stand.

CLEAN-UP OPERATIONS

Salvage work in firefighting is designed to lower the fire, smoke, and water damage. This does not mean that salvage starts after the fire is out. Salvage may start right after the approach or size-up.



We must use water to control and extinguish fire, but in doing so, we cause water damage. We cannot wait until all the movables are taken to a safe area because this would permit the fire to gain too much headway. Instead of waiting, there are alternate methods. Many fire departments carry common, inexpensive sawdust to help them control the excess water. Sawdust can be used to absorb small quantities of water before damage has occurred. When there is too much water to absorb, the sawdust is piled in dike form to keep the water localized or to channel it to the outside through doorways or other openings. There may be occasions when it will be necessary to drill or chop drainage holes in the floor to help remove the accumulated water. If these drainage holes are made with poor judgment as to location, more damage can result than if no holes had been made.

In addition to the tarpaulin or salvage cover, the tools most commonly used in salvage work are squeegees, brooms, buckets, mops, rags, and sawdust. Shovels and buckets are used to remove debris. Rags are used to wipe down equipment and furnishings. Water is removed from floors with squeegees, mops, buckets, and brooms. When properly executed, salvage work is frequently capable of preventing more property loss than is the act of fire extinguishment itself.

One objective of salvage practices is to leave a building and its contents in as nearly the same condition when the fire department leaves as it was before the fire occurred. The building should be left in a condition that is as livable as possible. Salvage work would not be complete if debris and water were left in a building, for this practice would add to the damage already done by the fire. Partially burned articles should not be discarded, for considerable salvage may be involved, and sometimes parts of burned articles serve a useful purpose in making inventories of losses. The overhaul crew should not destroy articles or remove them from the scene until the origin of the fire has been determined.

PREVENTIVE MAINTENANCE

To maintain vehicles in a constant state of readiness, you must perform preventive maintenance. This is especially true after a firefighting operation. The mounted equipment should be checked for damage or missing items. The fire hose should be replaced if needed. The fuel, oil, water and agent tanks should be checked and refilled if necessary to return the vehicle to service.

QUESTIONS

Please write your answers to the following questions on a separate sheet of paper.

1. Don't shut nozzles down _____
2. In case of injury or illness, report to an _____ at once..
3. _____ cannot be overemphasized.
4. A _____ check is not sufficient to insure that equipment will operate.
5. To attain proficiency in your job, you must participate in _____
6. The _____ is responsible for getting water to the nozzle in either a straight or reverse lay.
7. The _____ must make the decision as to the type of attack to make.
8. A skillful use of _____ methods will aid in saving lives and property.
9. Before any door is opened or forced, a _____ should be available.
10. In most structural fires, there will be _____ that must be shut off.



11. The responsibility of shutting off utilities falls to the _____

12. Each firefighter in the Air Force is also a _____

13. Inside stairways offer the _____ and _____ route of rescue if they are not cut off by fire.

14. The spread of fire is controlled by covering _____ and _____ exposures.

15. One method of protecting contents is to protect the material _____

16. Form a basin with the _____ by placing it over furniture and boxes.

17. Salvage work in firefighting is designed to lower the _____, _____ and _____ damage.

18. To maintain vehicles in a constant state of readiness you must perform _____

REFERENCES

1. TO 36A12-12-9-61, Truck Firefighting 530B.
2. TO 36A12-12-12-1, 500 GPM Brush and Structural Firefighting Truck.
3. TO 36A12-12-8-51, Powered Pumper Fire Truck, Class 750A.
4. TO 36A12-12-15-1, Firefighting Truck, 750 GPM Structural Type A/S32P-12.
5. IFSTA #102, Fire Service Ladder Practices.
6. IFSTA #104, Salvage and Overhaul Practices.
7. IFSTA #105, Fire Stream Practices.
8. IFSTA #107, Fire Ventilation Practices.
9. IFSTA #108, Fire Rescue Practices.



PRESERVATION OF EVIDENCE

OBJECTIVES

After completing this study guide and your classroom instructions, you will be able to identify procedures for preserving evidence to determine cause of a fire.

INTRODUCTION

Fires of intentional origin may be caused, responded to, and extinguished without being noticed, reported, or investigated if fire department personnel do not recognize the evidence that is sometimes quite pronounced during and immediately after fires. Arson is a peculiar crime in that there are usually no complaining witnesses to the crime. Arson is sometimes a result of planning and considerable preparation although arson committed on a spur of the moment decision is common. Since firefighters are normally not enforcement officers, trained arson investigators are summoned to investigate suspected individuals and conditions. Recognizing and preserving evidence of arson is the responsibility of firefighters. Without this evidence a trained investigator will always be seriously handicapped. Firefighters can become proficient in recognizing and preserving evidence of arson by organizing evidence or information in a sequence that will benefit the investigator when he arrives. The purpose here is to outline such activities for this use.

INFORMATION

PROTECTING AND PRESERVING MATERIAL EVIDENCE

There are two things that should be kept clearly in mind by firefighters regarding the protection and preservation of material evidence. These are: (1) keeping the evidence where it is found, untouched, and undisturbed, if at all possible; and (2) when evidence, which cannot be left at the scene of the fire, is discovered, properly identify, remove, and safeguard it. No changes of any kind should be permitted in the evidence other than what is absolutely necessary in the extinguishment of the

fire. Photographs are excellent supporting evidence if they are immediately taken.

One precaution which must be exercised by all firefighters during the fighting of a fire is avoid trampling over possible arson evidence and obliterating it so much that it becomes useless. The same precaution applied to the excessive use of water may avoid similar unsatisfactory results.

PROTECT AND GUARD EVIDENCE

Evidence remaining at the scene of the fire can be protected in various ways, if and when discovered. Areas containing the evidence can be roped off, or goods and materials of various kinds can be piled around the evidence to keep people away until the arrival of the investigator. Guards can be posted to prevent tampering with or needless handling of evidence. Leave plenty of room around the evidence to protect it exactly as it was found. Protect several feet of discovered tire tracks, and if the car turned around, protect the print of all four wheels where the car turned. Detection work of this kind by firefighters makes it possible for trained investigators to later take measurements and photographs and to make plaster casts.

The protection of several human footprints permits measurements of the prints, comparison of prints, estimate of length of stride, position of feet, and any peculiarities in the gait (walk or run) of a suspect. It may also be possible to secure identifying marks on soles and heels of the shoes. Take similar precautions with animal footprints. Boxes placed over prints will prevent dust from blowing over otherwise clear prints and keep them in good condition for

either photographs or plaster casts at a later time.

Burned and partially burned papers found in a furnace, stove, or fireplace should be protected by immediately closing dampers and other openings upon discovery. This operation will eliminate or reduce the draft. Wet rags may be used to smother the fire or to stuff stovepipes, but streams of water directed on such evidence should be avoided.

Call to the attention of the investigator any grease that is suspected to have had a part in the fire. Bottles which have been used to carry flammable liquids can sometimes be used to develop latent fingerprints, although this possibility is not general because of the smudging of prints by the oil. It is, however, considered of sufficient importance to protect all such bottles from indiscriminate handling, so that if such prints do exist, they can be identified. Sometimes bottles filled with flammable liquids and tightly sealed are hung over the set so that, when they reach a sufficient temperature, the bottle will break and allow the liquid to increase the intensity of the fire.

IDENTIFY, PRESERVE, REMOVE, AND SAFEGUARD EVIDENCE

All evidence collected by firefighters should be properly marked, tagged, identified, and preserved in clean containers. Careful notation should be made of the date, the time, and the place they are found. Additional identifying marks on cans, bottles, and other articles such as the initials of the person who collected the evidence may also be noted. This procedure may establish unquestionable identity. There must be a record of witnesses and of each person who has had or will have responsibility for care and preservation of the evidence.

When facilities for good paper and ash protection are not available, partly burned paper and ash may be protected between layers of plastic or between pieces of window glass for the investigator and for later transportation to a laboratory. When the fire is

in a heating device where suspected paper evidence is located, remove the ashes and partially burned bits of paper by fanning them gently upon a clean glass plate. Keep this plate as near the paper and ash as possible. Flatten the ash and paper carefully with another plate of similar size and fasten together. By this means photographs can be taken without removing the burned material from the container.

Letters, documents, or bills demanding payment of money should be preserved to assist in establishing a person's financial condition which might indicate a motive for arson.

Place wood suspected of containing paraffin or oil in a clear container and seal until a chemical analysis can be made. All bottles should be labeled with gummed stickers and identified. Objects such as charred candlewick and burned matches should be packed in a bottle containing cotton to prevent breaking the evidence by jarring and handling. Samples of materials, such as cotton, wood, rayon, felt, and other fabrics can be stored in clean, large-mouthed bottles and then tightly sealed and properly marked. Volatile liquid, oil samples, oil-soaked rags, waste, and the like should be put in tin cans and sealed. This procedure will preserve odors as well as the materials themselves and can then be presented in court in its original condition. Any evidence of this sort should be sealed with wax, so that, when necessary, a laboratory technician may testify in court that the wax seal was unbroken until the proper time.

The firefighter who detects and finds evidence of arson should be able to identify it later. When such material has been tagged, labeled, and properly marked, it is ready to be turned over to the proper authorities. Evidence should be kept under lock and key and as few persons as possible should be permitted to handle it. A record of each person who has handled this evidence should always be kept.



QUESTIONS

Please write your answers to the following questions on a separate sheet of paper.

1. _____ is a peculiar crime in that there are usually no complaining witnesses to the crime.

2. Recognizing and preserving evidence is the responsibility of _____.

3. No change of any kind should be permitted in the _____ other than what is absolutely necessary in the _____ of the fire.

4. _____ are excellent supporting evidence if they are immediately taken.

5. _____ can be posted to prevent tampering with or needless handling of evidence.

6. All evidence collected by firefighters should be properly _____, _____, and preserved in clean containers.

7. Evidence should be kept under _____ and _____.

8. A _____ of each person who has handled this evidence should always be kept.

REFERENCE

1. IFSTA #104, Salvage and Overhaul Practices.

FIRE STATION MAINTENANCE

OBJECTIVES

After completing this study guide and your classroom instructions, you will be able to:

1. Inspect and perform maintenance of clothing as required.
2. Maintain station facilities.

INTRODUCTION

In the fire protection career field, you will spend many hours in the fire station. Many of these hours will be spent in classes increasing your knowledge of the fire service which is continually changing with new firefighting tactics, new building materials, and new firefighting equipment. Other hours will be spent in the care and maintenance of your protective clothing and the station facilities.

INFORMATION

CARE OF PROTECTIVE CLOTHING

To each and every firefighter, protective clothing is of great importance. Wear it correctly and handle it carefully. After use, check all types of protective clothing for damage from cuts, abrasions, burns, or wear. Reflective fabrics of the coat and trousers are somewhat more susceptible to cuts and tears, especially when working in close proximity to jagged metal such as damaged buildings or aircraft. Report any defect in protective clothing to your instructor immediately. All items of clothing should be "flushed off" after use to remove any residues of fuel, extinguishing agents, oils, chemicals, dirt, etc. Dirt or other contamination should be removed by washing with soap or mild detergents, water, and a brush. In some cases, cleaning by the mild application of safety solvents may be warranted. Clothing should be thoroughly dried after cleaning to prevent molding or rotting.

MAINTAIN STATION FACILITIES

You will be required to maintain the station facilities in a clean and healthful condition. This may seem like housekeeping to you but it is necessary and a part of your job. Station maintenance will consist of maintaining the floors. This is accomplished by daily sweeping, mopping and buffing and usually once a week, removal of all wax and the application of a new coat to prevent excessive wax build-up.

All windows and doors will require cleaning to remove film and hand prints.

The apparatus floor will require a thorough cleaning with soap and water to remove any accumulation of oil dropping from the vehicles.

The vehicles and mounted equipment will also require a periodic time for a thorough cleaning. This will prevent the deterioration of the firefighting vehicle fleet and will assure that they are maintained in a constant state of readiness.

QUESTIONS

Please write your answers to the following questions on a separate sheet of paper.

1. To each and every firefighter, _____ is of great importance.

180

2. After use check all types of _____ for damage for cuts, abrasions, burns, or wear.

3. Clothing should be thoroughly _____ after cleaning to prevent molding or rotting.

4. You will be required to maintain the station facilities in a _____ and _____ condition.

5. The apparatus floor will require a thorough cleaning with _____ and _____.

6. The vehicles and mounted equipment will require a periodic _____.

REFERENCE

1. AFR 92-1, Fire Protection Program.



Technical Training

Fire Protection Specialist

17-3

BLOCK IV
STRUCTURAL FIREFIGHTING TACTICS

9 September 1975



CHANUTE TECHNICAL TRAINING CENTER (ATC)

This supersedes 3ABR57130-1-400, 16 July 1973.

OPR: TWS

DISTRIBUTION: X,

TWS - 2000; TTVGC - 2

Designed For ATC Course Use

DO NOT USE ON THE JOB

Study Guides and Workbooks are training publications authorized by Air Training Command (ATC) for student use in ATC courses.

The STUDY GUIDE (SG) presents the information you need to complete the unit of instruction or makes assignments for you to read in other publications which contain the required information.

The WORKBOOK (WB) contains work procedures designed to help you achieve the learning objectives of the unit of instruction. Knowledge acquired from using the study guide will help you perform the missions or exercises, solve the problems, or answer questions presented in the workbook.

The STUDY GUIDE AND WORKBOOK (SW) contains both SG and WB material under one cover. The two training publications may be combined when the WB is not designed for you to write in, or when both SG and WB are issued for you to keep.

Training publications are designed for ATC use only. They are updated as necessary for training purposes, but are NOT to be used on the job as authoritative references in preference to Technical Orders or other official publications.

CONTENTS

<u>UNIT</u>	<u>TITLE</u>	<u>PAGE</u>
401	Operations and Maintenance of Hydrants	1
403	Inspections, Maintenance, Mounted Equipment and Operation of the 530B/P-8 Structural Pumpers	3 through 7
404	Pumping Operations on the 530B-P-8 Structural Pumpers	9 through 10
405	Inspection, Maintenance, Mounted Equipment and Operations of the 750A/P-12 Structural Pumpers	11 through 15
406	Pumping Operations on the 750A/P-12 Structural Pumpers	17
408	Hose Loads and Finishes	19 through 26
409	Hose Lays	27 through 29
411	Structural Firefighting Operations	31 through 37
412	Structural Firefighting Tactics	39 through 45
414	Fire Station Maintenance	47 through 48



OPERATIONS AND MAINTENANCE OF HYDRANTS

OBJECTIVES

After completing the study guide, classroom instruction, and this workbook, you will be able to inspect and perform operator maintenance on hydrants with minimum instructor assistance.

EQUIPMENT

Pencil or Pen	Basis of Issue
Portable Fire Hydrants	1/student
Fire Hydrant Cutaway	1/10 students.
Hydrant Wrench	1/10 students
	1/10 students

PROCEDURE

As the instructor covers the information on operations and maintenance of hydrants, answer questions 1 through 3 in the classroom. The class will then go to the hangar floor, inspect and perform operator maintenance on the fire hydrant trainer.

QUESTIONS

1. Most fire hydrants are turned _____ to open.
2. The first few turns close the _____
before the main valve is opened.
3. Caps on hydrants should be _____ tightened.

Inspection Procedures:

1. Check caps for ease of removal.
2. Check gasket under cap.
3. Check for roundness of operating nut.
4. Check for cracks and visible damage.
5. Check for ease of opening and closing.

Maintenance Procedures:

1. Tighten nozzles.
2. Replace gaskets.
3. Replace last chains from caps.
4. Lubricate operating nut.

INSPECTIONS, MAINTENANCE, MOUNTED EQUIPMENT AND OPERATIONS
OF THE 530B/P-8 STRUCTURAL PUMPERS

OBJECTIVES

After completing the study guide, classroom instruction, and this workbook, you will be able to:

1. Inspect and perform operator maintenance on the 530B/P-8 structural firefighting vehicle and mounted equipment.
2. Perform a booster operation in accordance with technical order procedures.
3. Perform preventive maintenance on the 530B/P-8 structural firefighting vehicle and mounted equipment IAW AFTO Form 434.

EQUIPMENT

	Basis of Issue
Pencil or Pen	1/student
TO 36A12-12-9-61	1/student
TO 36A12-12-12-1	1/student
Helmet	1/student
Gloves	1/student
A/S32P-8	1/5 students
530B	1/5 students
530B Operators Panel	1/10 students
Preventive Maintenance Materials	1/10 students

PROCEDURE

As the instructor covers the information on the subject of inspections, maintenance, mounted equipment and operations of the 530B/P-8 structural pumpers, answer questions 1 through 5 in the classroom. After completing the questions, the class will go out to the vehicles and you will use the AFTO Form 434, figures 1, 2, and 3 in this workbook and inspect the 530B/P-8 structural vehicles. After inspection, you will perform a booster operation and perform preventive maintenance.

QUESTIONS

1. What is the water tank capacity of the 530B? _____
2. What is the purpose of the relief valve? _____

3. How many 2-1/2" intakes are on the 530B? _____
4. What is the water tank capacity of the P-8? _____
5. How many 2-1/2" intakes on the P-8? _____

Preventive Maintenance Procedures:

1. Clean vehicle.
2. Insure all tools and equipment are stored in proper location.

186

OPERATOR'S INSPECTION GUIDE AND TROUBLE REPORT (530A/B, 750A, P-6, P-8, P-12, 1000/1900 GALLON WATER DISTRIBUTORS, P-6/F-7 FOAM DISTRIBUTORS)		DATE (MO/YR)
VEHICLE TYPE		REGISTRATION NO.
USING ORGANIZATION	LOCATION	PHONE NO.
VEHICLE CONTROL OFFICER NAME		GRADE
		PHONE NO.
ITEMS TO BE CHECKED	OPERATOR SIGNATURE	DAY
1. LUBRICATING OIL LEVELS (engine/trans./priming pump)		1
2. COOLANT, FUEL, AND HYDRAULIC LEVELS		2
3. FOR LEAKS (oil, fuel, coolant, hydraulic, air, exhaust, etc.)		3
4. CONDITION OF ALL DRIVE BELTS (visual only)		4
5. TIRES, WHEELS AND LUG BOLTS FOR TIGHTNESS, PRESSURE AND DAMAGE		5
6. BATTERIES (front and rear) FOR FLUID LEVEL, DAMAGE, CLEANLINESS AND SECURITY.		6
7. CLEANLINESS, DAMAGE, MISSING ITEMS (all interior and exterior items)		7
8. LUBE/OIL CHANGE		8
9. BRAKES, CLUTCHES (Operation), AIR TANKS (Drain), OPERATE PARKING BRAKE		9
10. STEERING, SPRINGS & SHACKLES FOR OPERATION & DAMAGE		10
11. SAFETY DEVICES (warning lights, buzzers, fire extinguishers, seat belts)		11
12. OPERATION OF ALL LIGHTS, SIRENS, RADIO, HORNS, MIRRORS		12
13. WIRING/CIRCUIT BREAKERS (visual only)		13
14. SPECIAL EQUIPMENT (axe, first aid kit, breathing apparatus, ladders, p.a. speakers, hydrant wrench, portable electric lanterns, etc.)		14
15. FIREFIGHTING SYSTEM FOR CORROSION/DAMAGE AND FOAM/WATER LEVELS (include booster tank)		15
16. ON/OFF BASE GRID MAPS/STATE MAPS		16
17. HEATER/DEPROSTER		17
18. WINDSHIELD/WIPER/WASHERS (condition and operation)		18
19. INSTRUMENTS AND GAUGES (during operation)		19
		20
		21
		22

Figure 1. AFTO Form 434 (Front).

188

ITEMS TO BE CHECKED (CONT'D)			OPERATOR SIGNATURE	DAY
20. UNUSUAL NOISES (during operation)				23
21. GREASE SPECIAL LUBE FITTINGS				24
22. 50 FOOT 1 1/2" x 2 1/2" HOSE (couplings) ALL FIRE HOSES FOR DRYNESS AND CORRECT LOADING				25
23. REELS FOR OPERATION				26
24. PUMPS/PIPING/VALVES/COUPLINGS FOR LEAKS AND CORROSION (during operation)				27
25. HANDLINES AND NOZZLES (on/off)				28
26. FOAM SPREADER AND CHAINS				29
27. SUCTION HOSE (gaskets, etc.) AND STRAINER FOR CLEANLINESS				30
28. INSURE AIR VENT HOLE IS OPEN IN PRIMING TANK				31
29. NITROGEN TANK PRESSURE				
30. PRESSURE REGULATOR OR RELIEF VALVE FOR OPERATION				
31. BUST DISC.				
32. OPERATIONS OF CHARGE, VENT AND PURGE FUNCTIONS				
33. DISCHARGE GATES FOR LOCKS AND EASE OF OPERATION (open and close daily)				
34.				
35.				
36.				
37. SPARK CHECK (Weekly and Scheduled Inspection Intervals)				
TYPE INSPECTION (Weekly or Sched)	DATE DUE	DATE ACCOMP	OPERATOR OR MECHANIC SIGNATURE AND GRADE	

Figure 3. AFTO Form 434 (Back).



PUMPING OPERATIONS ON THE 530B/P-8 STRUCTURAL PUMPERS

189

OBJECTIVES

After completing the study guide, classroom instruction, and this workbook, you will be able to:

1. Perform hydrant operations in accordance with technical order procedures. Hydrant operation must be completed in less than 5 minutes, while observing all applicable safety practices.
2. Perform a drafting operation in accordance with technical order procedures. Drafting operation must be completed in less than 5 minutes, while observing all applicable safety practices.
3. Perform a foam pumping operation in accordance with technical order procedures. Foam pumping operation must be completed in less than 5 minutes, while observing all applicable safety practices.
4. Perform preventive maintenance on the 530B/P-8 structural pumper and mounted equipment IAW AFTO Form 434.

EQUIPMENT

	Basis of Issue
Pencil or Pen	1/student
TO 36A12-12-9-61	1/student
TO 36A12-12-12-1	1/student
Helmet	1/student
Gloves	1/student
A/S32P-8	1/5 students
530B	1/5 students
Drafting Pit	1/10 students
Preventive Maintenance Materials	1/10 student

PROCEDURE

After completing the pumping operation on the 530B/P-8 structural pumper, you will perform preventive maintenance on the vehicles. After returning to the classroom answer questions 1 through 4 at the end of this workbook.

Preventive Maintenance Procedures:

1. Clean vehicle.
2. Insure all tools and equipment are stored in proper location.

QUESTIONS

1. In performing a hydrant operation with a P-8, when will the transfer valve be changed from volume to pressure? _____

2. When pumping with the 530B/P-8, what action is taken to control discharge pressure? _____

3. When priming the pump on the 530B, the pump clutch control lever is in what position? _____

4. In performing a foam operation from a hydrant, what intake is used? _____

INSPECTION, MAINTENANCE, MOUNTED EQUIPMENT AND OPERATIONS OF THE 750A/P-12 STRUCTURAL PUMPERS

OBJECTIVES

After completing the study guide, classroom instruction, and this workbook, you will be able to:

1. Inspect and perform operator maintenance on the 750A/P-12 structural firefighting vehicle and mounted equipment.
2. Perform a hydrant operation in accordance with technical order procedures. Hydrant operation must be completed in less than 5 minutes, while observing all applicable safety practices.
3. Perform a drafting operation in accordance with technical order procedures. Drafting operation must be completed in less than 5 minutes, while observing all applicable safety practices.
4. Perform a foam operation in accordance with technical order procedure. Foam operation must be completed in less than 5 minutes, while observing all applicable safety practices.
5. Perform preventive maintenance on the 750A/P-12 structural firefighting vehicle and mounted equipment IAW AFTO 434.

EQUIPMENT

	Basis of Issue
Pencil or Pen	1/student
TO 36A12-12-8-51	1/student
TO 36A12-12-15-1	1/student
Helmet	1/student
Gloves	1/student
750A	1/5 students
A/S32P-12	1/5 students
750A Pump Panel	1/10 students
Drafting Pit	1/10 students
Preventive Maintenance Materials	1/10 students

PROCEDURE

As the instructor covers the information on the subject of inspection, maintenance, mounted equipment and operations of the 750A/P-12 structural pumpers, answer questions 1 through 6 in the classroom. After completing the questions, the class will go out to the vehicles and you will use the AFTO Form 434, figures 4, 5, and 6 in this workbook and inspect the 750A/P-12 structural vehicles. After inspection, you will perform a hydrant drafting and foam pumping operation then perform preventive maintenance.

QUESTIONS

- 1. What is the water tank capacity of the 750A? _____
- 2. How many cooling systems does the 750A have? _____
- 3. How many 2-1/2" intakes on the 750A/P-12? _____
- 4. What is the purpose of the stop valve on the 750A? _____

5. Where is the primer oil reservoir located on the P-12?

6. What type fire pump is mounted on the P-12? _____

Preventive Maintenance Procedures:

- 1. Clean vehicle.
- 2. Insure all tools and equipment are stored in proper location.

MODIFICATIONS

Pages 13-15 of this publication has (have) been deleted in adapting this material for inclusion in the "Trial Implementation of a Model System to Provide Military Curriculum Materials for Use in Vocational and Technical Education." Deleted material involves extensive use of military forms, procedures, systems, etc. and was not considered appropriate for use in vocational and technical education.

PUMPING OPERATIONS ON THE 750A/P-12 STRUCTURAL PUMPERS

OBJECTIVES

After completing the study guide, classroom instruction, and this workbook, you will be able to:

1. Perform a booster operation in accordance with technical order procedures. Booster operation must be completed in less than 5 minutes while observing all applicable safety practices.
2. Perform preventive maintenance on the 750A/P-12 structural firefighting vehicle and mounted equipment IAW AFTO Form 434.

EQUIPMENT

	Basis of Issue
Pencil/or Pen	1/student
TO 36A12-12-8-51	1/student
TO 36A12-12-15-1	1/student
Helmet	1/student
Gloves	1/student
750A	1/5 students
A/S32P-12	1/5 students
Preventive Maintenance Materials	1/10 students

PROCEDURE

After completing the booster operation on the 750A/P-12 structural pumpers, you will perform preventive maintenance on the vehicles. After returning to the classroom, answer questions 1 through 3 at the end of this workbook.

Preventive Maintenance Procedures:

1. Clean vehicle.
2. Insure all tools and equipment are stored in proper location.

QUESTIONS

1. The booster line is used on what type of fires? _____
2. When performing a booster operation with the P-12, the transmission shift lever is in what position? _____
3. When performing a booster operation with the P-12, is the vehicle moveable? _____

HOSE LOADS AND FINISHES

OBJECTIVES

After completing the study guide, classroom instruction, and this workbook, you will be able to:

1. Load hose on pumpers and make hose load finishes IAW the WB procedures with minimum instructor assistance.
2. Perform preventive maintenance on structural firefighting vehicles and mounted equipment IAW AFTO Form 434.

EQUIPMENT

	Basis of Issue
Pencil or Pen	1/student
TO 36A12-12-8-51	1/student
TO 36A12-12-9-61	1/student
TO 36A12-12-12-1	1/student
TO 36A12-12-15-1	1/student
AFTO Form 434	1/student
Helmet	1/student
Gloves	1/student
750A Hose Bed Loader	1/5 students
530B	1/5 students
750A	1/5 students
A/S32P-8	1/5 students
A/S32P-12	1/5 students
Hose Washer	1/10 students
Dryer, Fire Hose	1/10 students
Preventive Maintenance Materials	1/10 students

PROCEDURE

As the instructor covers the information on hose loads and finishes answer questions 1 through 5 in the classroom. Then using the examples given in figures 7 through 12, the class will go to the hangar floor and construct the various hose loads and finishes. Upon completion, you will perform preventive maintenance.

QUESTIONS

1. List two advantages of the horseshoe hose load.
 - a. _____
 - b. _____
2. The accordian hose load has less hose in the hose bed.
 - a. True.
 - b. False.

3. On a divided hose lead, what divides the hose bed?

4. In the doughnut roll finish, how far should the male coupling be placed from the female coupling? _____

5. The skid finish consists of 150 to 200 feet of 1-1/2 inch hose.

- a. True.
- b. False.

Preventive Maintenance Procedures:

- 1. Clean vehicle.
- 2. Wash hose.
- 3. Dry hose.
- 4. Insure all tools and equipment are stored in proper location.

196

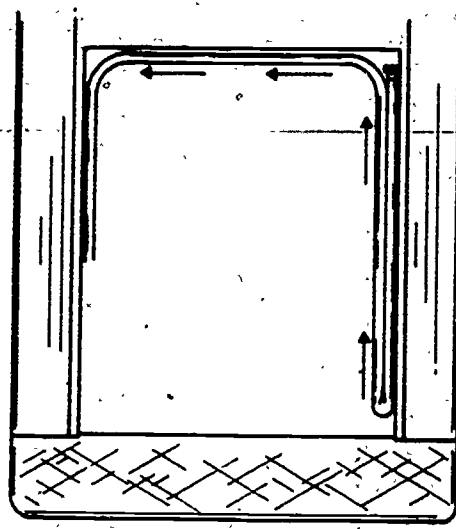

Step 1

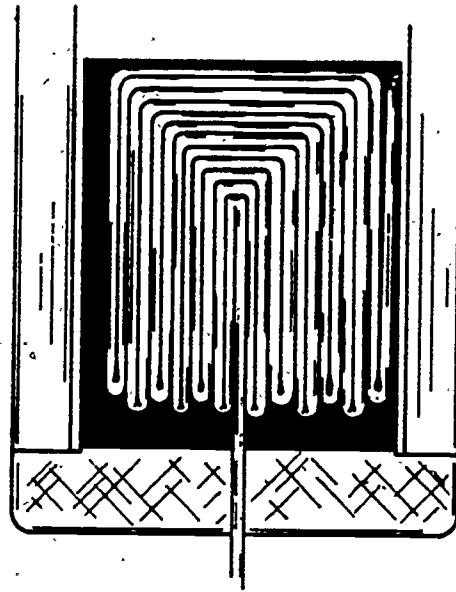

Step 2

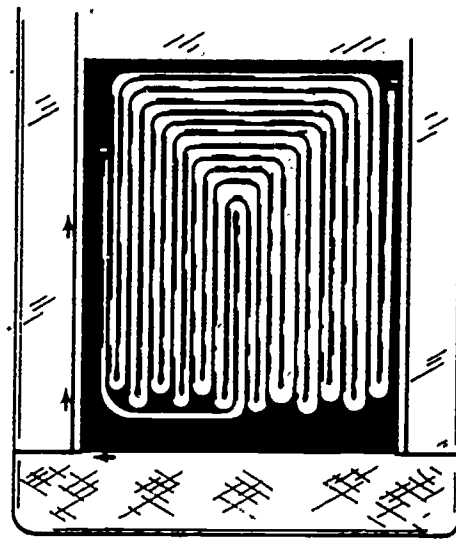

Step 3

Figure 7. Horse Shoe Load Construction.
21

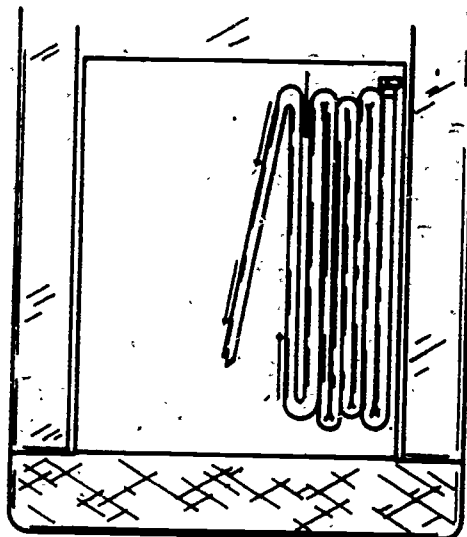

Step 1

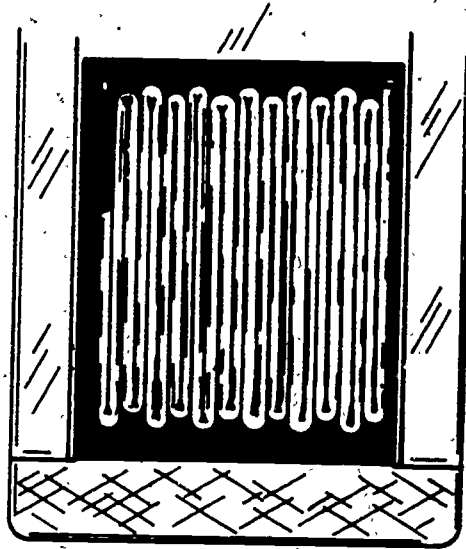

Step 2

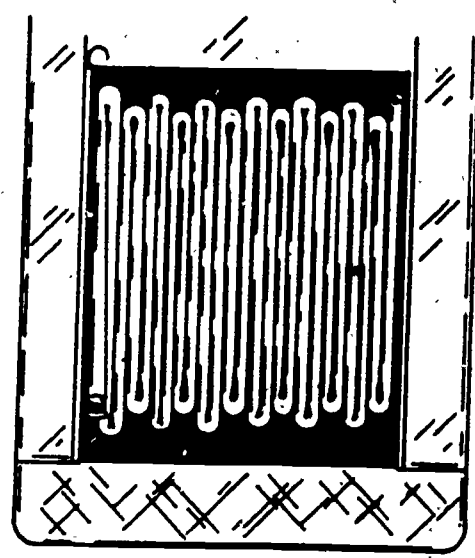

Step 3

240

Figure 8. Accordion Load Construction.

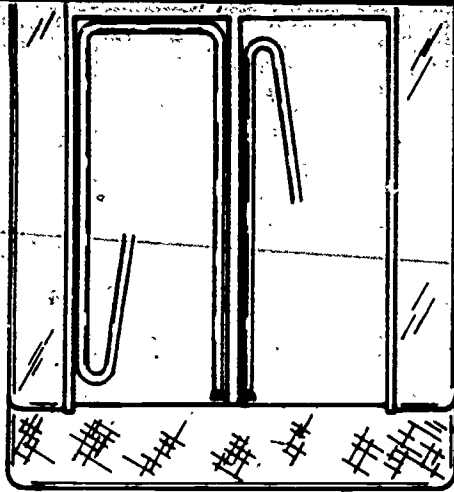

Step 1

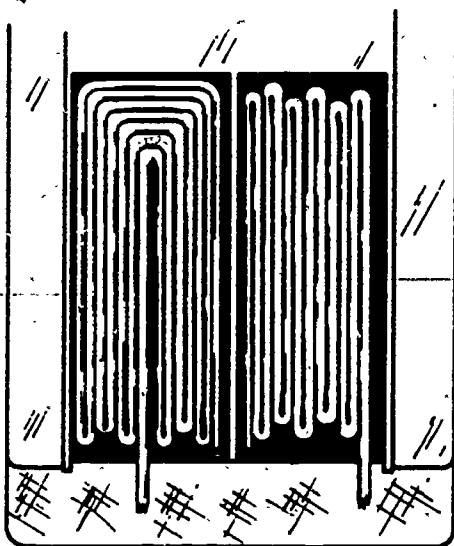

Step 2

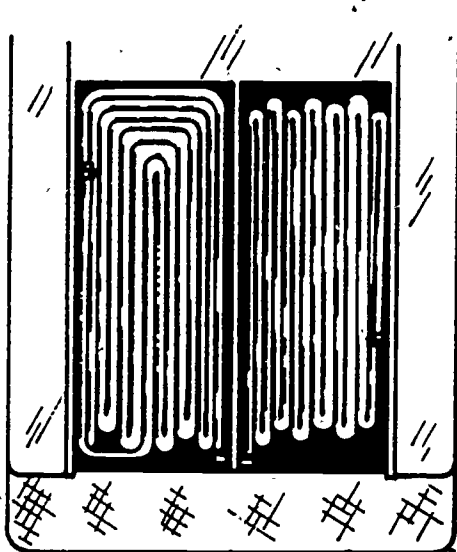

Step 3

Figure 9. Divided Load Construction.

199



Step 1

4 TO 6 FT.

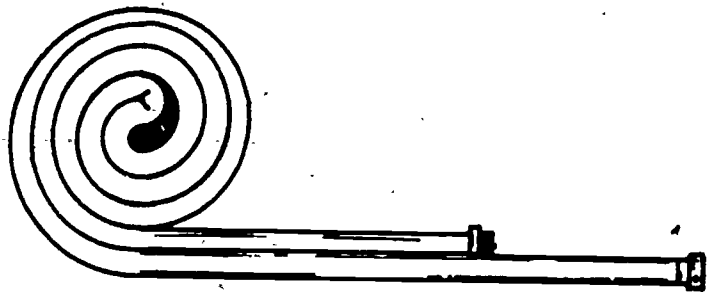

Step 2

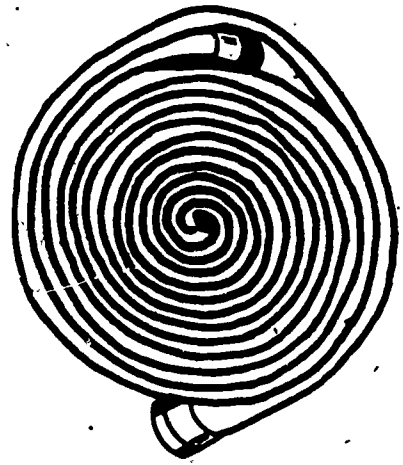

Step 3

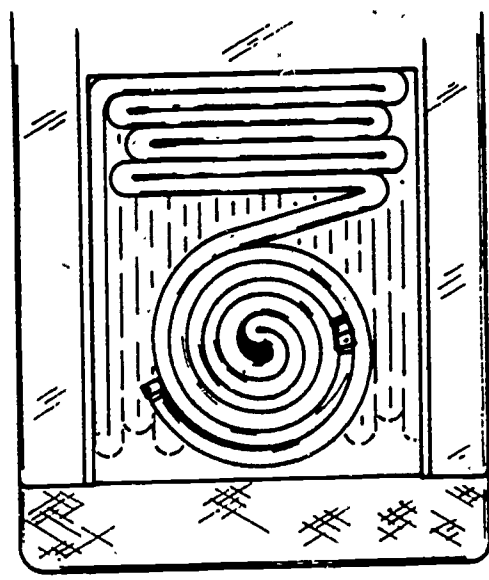

Step 4

242

Figure 10. Doughnut Roll Construction.

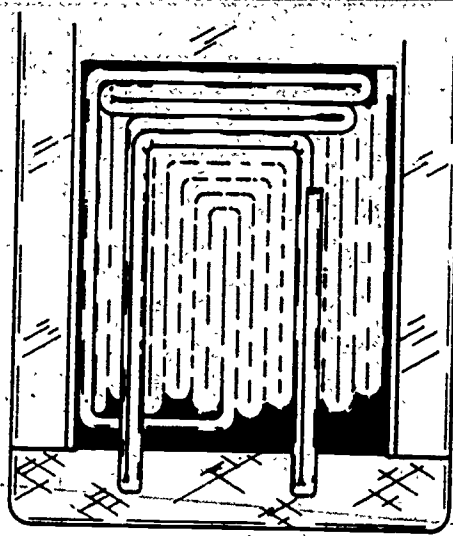

Step 1

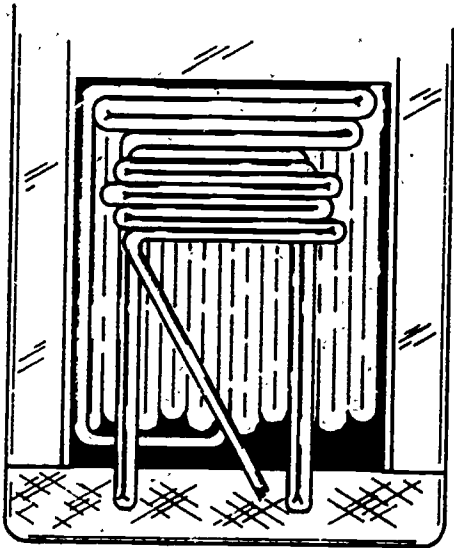

Step 2

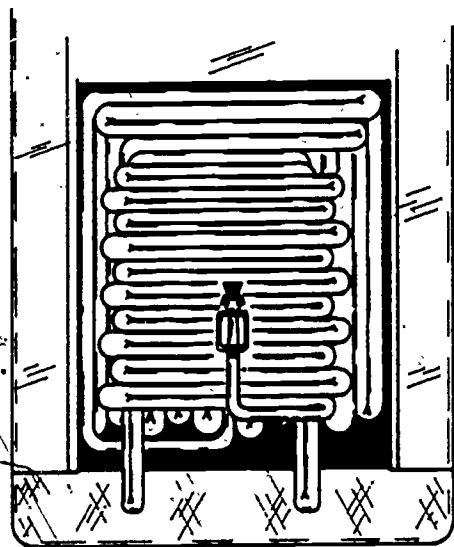

Step 3

Figure 11. Skid Finish Construction.
25

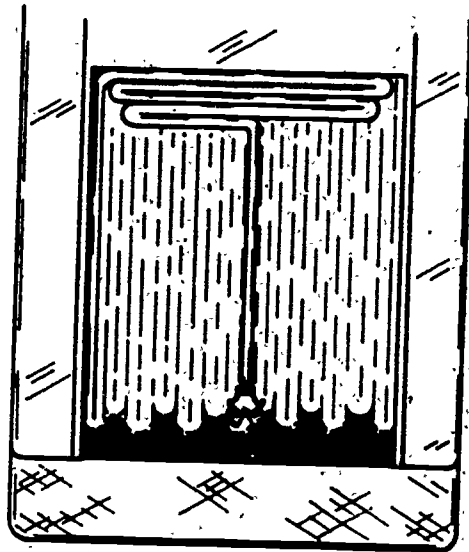

Step 1

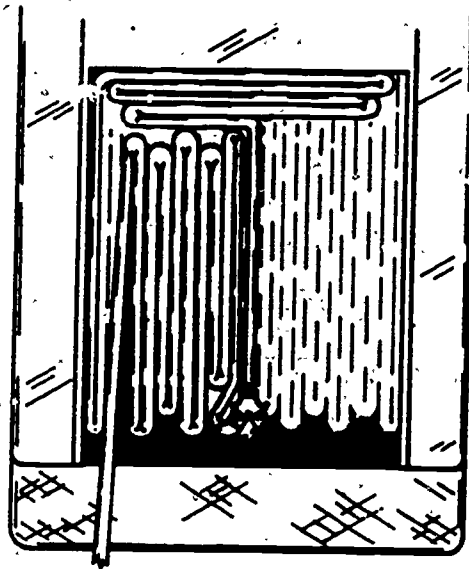

Step 2

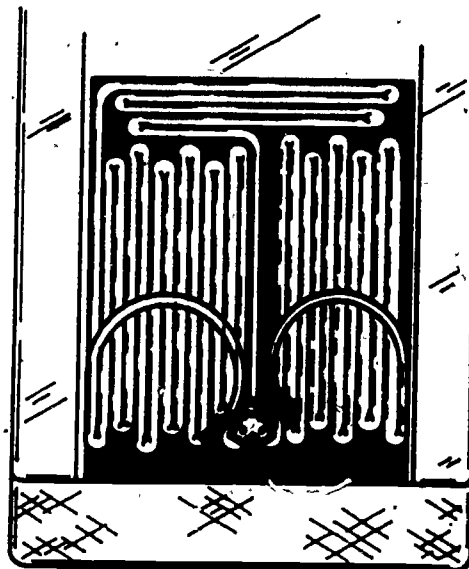

Step 3

244

HOSE LAYS

OBJECTIVES

After completing the study guide, classroom instruction, and this workbook, you will be able to:

1. Perform straight hose lays. All procedures outlined in the WB must be strictly adhered to, while observing applicable safety procedures.
2. Perform reverse hose lays. All procedures outlined in the WB must be strictly adhered to while observing applicable safety procedures.
3. Perform vehicle relay operation in accordance with the WB procedures while observing all applicable safety procedures.
4. Perform preventive maintenance on structural firefighting vehicles and mounted equipment IAW AFTO Form 434.

EQUIPMENT

	Basis of Issue
Pencil or Pen	1/student
TO 36A12-12-8-51	1/student
TO 36A12-12-9-61	1/student
TO 36A12-12-12-1	1/student
TO 36A12-12-15-1	1/student
Protective Clothing	1/student
530B	1/5 students
750A	1/5 students
A/S32P-8	1/5 students
A/S32P-12	1/5 students
Preventive Maintenance Materials	1/10 students

PROCEDURE

After completing the hose lays, relay operation and performing preventive maintenance, answer questions 1 through 5 upon returning to the classroom.

Straight Lay Procedures:

1. DR - Stops the truck at the hydrant.
2. PM - "Catches" the hydrant as directed.
3. HM & NM - Rides at the side of tailboard while the hose is paying out.
4. DR - Stops the truck at the fire.
5. CC - Goes to size up the fire.
6. DR - Applies the hose clamp approximately 20 feet behind the truck and at least 6 feet from any coupling.
7. HM - Removes working line from the hose bed, breaks the coupling and returns the loose coupling to the hose bed.

8. HN & NM - Attaches the nozzle to the hose, advances the hose and the nozzle to the fire.

9. DR - Removes the hose clamp and assists with advancing the working line or as directed by the crew chief.

10. PM - Turns on the hydrant as soon as the hose clamp has been applied; follows the hose line removing kinks, tightens leaking couplings, and reports to the crew chief.

Reverse Lay Procedures:

1. DR - Stops the truck at fire.

2. CC - Goes to size up the fire.

3. DR & PM - Removes the ladders from the truck.

4. HM & NM - Removes the forcible entry tools and extinguishers.

5. NM - Removes the load finish.

6. HM - Removes the adapter, nozzles, and anchors pay out line.

7. DR - Drives the truck to hydrant.

8. PM - Goes with the truck.

9. NM & HM - Advances nozzles and hose to the fire.

10. DR - Stops the truck at hydrant.

11. PM - Breaks and connects hose to the pumper.

12. DR - Sets up the cab controls, removes suction hose and connects to the truck and hydrant.

13. PM - Opens the hydrant.

14. PM - Follows line, straightening kinks in the hose, tightens leaking couplings, and reports to the crew chief.

Relay Procedures:

1. Place largest capacity pumper at water source.

2. Divide friction loss into standard nozzle pressure.

3. This answer is in hundreds for an imaginary line.

4. Add this imaginary line to total hose lay.

5. Divide this total by two.

6. This answer is the distance between the two pumps.

7. Subtract this answer from total hose lay and this is the distance from the second pumper to the fire.

Preventive Maintenance Procedures:

1. Wash vehicle.

2. Insure all tools and equipment are stored in proper location.

QUESTIONS

209

1. In performing a straight lay, who applies the hose clamp to the hose? _____
2. In performing a straight lay, who moves the working line from the hose bed? _____
3. During a reverse lay, who pulls the skid finish? _____
4. The correct procedure in a relay operation has the largest capacity pumper at the fire.
 - a. True.
 - b. False.
5. Identify the following hand signals:

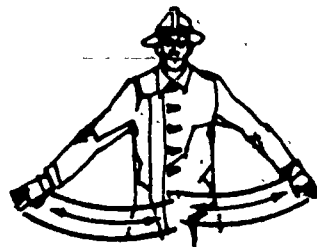

Figure 13. Hand Signals.

STRUCTURAL FIREFIGHTING OPERATIONS

OBJECTIVES

After completing the study guide, classroom instruction, and this workbook, you will be able to:

1. Inspect and perform operator maintenance on structural firefighting vehicles and mounted equipment.
2. Perform crew duties in firefighting drills and emergency response exercises. Workbook procedures must be strictly adhered to while Observing all applicable safety practices.
3. Demonstrate normal and emergency entry procedures. All entry procedures must be in accordance with the WB procedures.
4. Perform as a member of a firefighting crew to control and extinguish structural fires. Each fire must be completely extinguished while observing all applicable safety procedures.
5. Locate and evacuate personnel from building in less than three minutes.
6. Protect adjacent/nearby building exposures and equipment from fire hazards in accordance with the WB procedures, while observing all applicable safety procedures.
7. Perform firefighting overhaul clean-up operations. All debris and water must be removed.
8. Perform preventive maintenance on structural firefighting vehicles and mounted equipment IAW AFTO Form 434.

EQUIPMENT

Pencil or Pen	Basis of Issue
TO 36A12-12-8-51	1/student
TO 36A12-12-9-61	1/student
TO 36A12-12-12-1	1/student
TO 36A12-12-15-1	1/student
Protective Clothing	1/student
Breathing Apparatus	1/student
750A	1/5 students
530B	1/5 students
A/S32P-8	1/5 students
A/S32P-12	1/5 students
Deluge Guns	1/5 students
Drafting Pit	1/10 students
Air Compressor	1/10 students
Three-story Training Tower	
and Building	1/10 students
Preventive Maintenance Materials	1/10 students

PROCEDURE

After inspecting and performing operator maintenance on structural firefighting vehicles using AFTO Form 434, figures 14, 15, and 16 in this workbook, you will participate in structural firefighting operations and perform preventive maintenance. Answer questions 1 through 3 upon returning to the classroom.

The following procedures will be adhered to while performing firefighting drills and emergency responses:

Legend for Fireman Crew:

- CC - Crew Chief
- DR - Driver
- NM - Nozzleman
- HM - Hoseman
- PM - Plugman

Straight Lay Crew Duties:

1. DR - Stops the truck at the hydrant.
2. PM - "Catches" the hydrant as directed.
3. HM & NM - Rides at the side of tailboard while the hose is paying out.
4. DR - Stops the truck at the fire.
5. CC - Goes to size up the fire.
6. DR - Applies the hose clamp approximately 20 feet behind the truck and at least 6 feet from any coupling.
7. PM - Removes working line from the hose bed, breaks the coupling and returns the loose coupling to the hose bed.
8. HM & NM - Attaches the nozzle to the hose, advances the hose and the nozzle to the fire.
9. DR - Removes the hose clamp and assists with advancing the working line or as directed by the crew chief.
10. PM - Turns on the hydrant as soon as the hose clamp has been applied; follows the hose line removing kinks, tightens leaking couplings, and reports to the crew chief.

Reverse Lay Crew Duties:

1. DR - Stops the truck at fire.
2. CC - Goes to size up the fire. 219
3. DR & PM - Removes the ladders from the truck.

4. HM & NM - Removes the forcible entry tools and extinguishers. 201
5. NM - Removes the load finish.
 6. HM - Removes the adapter, nozzles, and anchors pay out line.
 7. DR - Drives the truck to hydrant.
 8. PM - Goes with the truck.
 9. NM & HM - Advances nozzles and hose to the fire.
 10. DR - Stops the truck at hydrant
 11. PM - Breaks and connects hose to the pumper.
 12. DR - Sets up the cab controls, removes suction hose and connects to the truck and hydrant.
 13. PM - Opens the hydrant.
 14. PM - Follows line, straightening kinks in the hose, tightens leaking couplings, and reports to the crew chief.

Normal Entry Procedures:

1. Use door, if unlocked.

Emergency Entry Procedures:

1. Through door
 - a. Remove hinge pins.
 - b. Use door opener to force open.
2. Through windows
 - a. Pry up from bottom.
 - b. Break glass with fire ax.

Protect Exposures:

1. Use water curtains
 - a. Produced by 1-1/2" or 2-1/2" hose lines.
 - b. Produced by deluge gun.

Preventive Maintenance Procedures:

1. Wash vehicles.
2. Wash hose.
3. Insure all tools and equipment are clean and stored in proper location.

QUESTIONS

1. On a straight lay, all personnel dismount vehicle at the hydrant.

- a. True.
- b. False.

2. What are the Crew Chief's duties on a straight lay? _____

3. Normal entry into a building is usually the _____.

MODIFICATIONS

Pages 35-37 of this publication has (have) been deleted in adapting this material for inclusion in the "Trial Implementation of a Model System to Provide Military Curriculum Materials for Use in Vocational and Technical Education." Deleted material involves extensive use of military forms, procedures, systems, etc. and was not considered appropriate for use in vocational and technical education.

STRUCTURAL FIREFIGHTING TACTICS

OBJECTIVES

After completing the study guide, classroom instruction, and this workbook, you will be able to:

1. Inspect and perform operator maintenance on structural firefighting vehicles and mounted equipment.
2. Perform crew duties in firefighting drills and emergency response exercises. Workbook procedures must be strictly adhered to while observing all applicable safety practices.
3. Demonstrate normal and emergency entry procedures. All entry procedures must be in accordance with the WB.
4. Locate master switch and shut off building utilities in less than one minute.
5. Perform as a member of a firefighting crew to control and extinguish structural fires. Each fire must be completely extinguished while observing all applicable safety procedures.
6. Locate dummy victim and perform rescue from building using the appropriate type of carry. The rescue must be accomplished in less than three minutes while observing all applicable safety procedures.
7. Protect adjacent/nearby building exposures and equipment from fire hazards in accordance with the WB procedures, while observing all applicable safety procedures.
8. Perform as a member of a crew to protect building contents. Contents must be sufficiently protected with salvage covers to prevent further damage.
9. Perform as a member of a crew and construct catch basins and drain chutes. Basins and chutes must be designed/constructed in such a manner as to prevent further water damage to the building and contents.
10. Perform as a member of a crew and remove equipment and furnishings in less than 30 minutes in accordance with the WB procedures.
11. Perform firefighting overhaul clean-up operations. All debris and water must be removed.
12. Perform preventive maintenance on structural firefighting vehicles and mounted equipment IAW AFTO Form 434.

PROCEDURES

After inspecting and performing operator maintenance on structural firefighting vehicles complete AFTO Form 434, figures 17, 18, and 19 in this workbook. Then, you will perform structural firefighting tactics and preventive maintenance. Answer questions 1 through 3 upon returning to the classroom.

The following procedures will be adhered to while performing firefighting drills and emergency responses:

Legend for Fireman Crew:

- CC - Crew Chief.
- DR - Driver
- NM - Nozzleman
- HM - Hoseman
- PM - Plugman

Straight Lay Crew Duties:

1. DR - Stops the truck at the hydrant.
2. PM - "Catches" the hydrant as directed.
3. HM & NM - Rides at the side of tailboard while the hose is paying out.
4. DR - Stops the truck at the fire.
5. CC - Goes to size up the fire.
6. DR - Applies the hose clamp approximately 20 feet behind the truck and at least 6 feet from any coupling.
7. HM - Removes working line from the hose bed, breaks the coupling and returns the loose coupling to the hose bed.
8. HN & NM - Attaches the nozzle to the hose, advances the hose and the nozzle to the fire.
9. DR - Removes the hose clamp and assists with advancing the working line or as directed by the crew chief.
10. PM - Turns on the hydrant as soon as the hose clamp has been applied; follows the hose line removing kinks, tightens leaking couplings, and reports to the crew chief.

Reverse Lay Crew Duties:

1. DR - Stops the truck at fire.
2. CC - Goes to size up the fire.
3. DR & PM - Removes the ladders from the truck.



5. NM - Removes the load finish.
6. HM - Removes the adapter, nozzles, and anchors pay out line.
7. DR - Drives the truck to hydrant.
8. PM - Goes with the truck.
9. NM & HM - Advances nozzles and hose to the fire.
10. DR - Stops the truck at hydrant.
11. PM - Breaks and connects hose to the pumper.
12. DR - Sets up the cab controls, removes suction hose and connects to the truck and hydrant.
13. PM - Opens the hydrant.
14. PM - Follows line, straightening kinks in the hose, tightens leaking couplings, and reports to the crew chief.

Normal Entry Procedures:

1. Use door if unlocked.

Emergency Entry Procedures:

1. Through door
 - a. Remove hinge pins.
 - b. Use door opener to force open.
2. Through windows
 - a. Pry up from bottom.
 - b. Break glass with fire ax.

Protect Exposures:

1. Use water curtains
 - a. Produced by 1-1/2" or 2-1/2" hose lines.
 - b. Produced by deluge guns.

Remove Equipment and Furnishings:

1. Prevent further damage.
2. Carry to safe location.
3. Do not drag equipment or furnishings.



Preventive Maintenance Procedures:

- 1. Wash vehicles.
- 2. Wash hose.
- 3. Insure all tools and equipment are clean and stored in proper location.

QUESTIONS

- 1. In performing a reverse lay, who connects the hose to the discharge outlets? _____
- 2. In performing a drafting operation, what type of hose is connected to the 4-1/2" intake? _____
- 3. On a reverse lay, the vehicle is available for another lay.
 - a. True.
 - b. False.

MODIFICATIONS

Pages 43-46 of this publication has (have) been deleted in adapting this material for inclusion in the "Trial Implementation of a Model System to Provide Military Curriculum Materials for Use in Vocational and Technical Education." Deleted material involves extensive use of military forms, procedures, systems, etc. and was not considered appropriate for use in vocational and technical education.

FIRE STATION MAINTENANCE

OBJECTIVES

After completing the study guide, classroom instruction, and this workbook, you will be able to:

1. Inspect and perform maintenance on clothing as required. Procedures listed in WB must be followed without error.
2. Maintain station facilities in accordance with the WB procedures.

EQUIPMENT

	Basis of Issue
Pencil or Pen	1/student
Protective Clothing	1/student
Structural Pumpers and Mounted Equipment	1/5 students
Preventive Maintenance Materials	1/10 students

PROCEDURE

As the instructor covers the information on fire station maintenance, answer questions 1 through 3 in the classroom. After completing the questions, the class will go to the hangar floor and perform maintenance on structural clothing and station facilities.

QUESTIONS

1. Protective clothing should be cleaned with mild soap and water.
 - a. True.
 - b. False.
2. How should protective clothing be allowed to dry? _____
3. Station maintenance requires the cooperation of _____ personnel.

214

Use the following checklist to inspect protective clothing:

PROTECTIVE CLOTHING INSPECTION CHECKLIST	
Check for: Burns	
Rips	
Broken Snaps	
Liners	
Chin Straps	
Suspenders	
Torn Boots	
Helmets for Cracks	

Figure 20. Protective Clothing Checklist.

Clean Protective Clothing:

1. Use mild soap.
2. Use plain water.
3. Air dry.

Station facilities will be maintained in accordance with the following:

1. Sweep all floors.
2. Mop all floors.
3. Remove wax if necessary.
4. Clean all doors and walls.
5. Clean all light fixtures.
6. Wash all windows.
7. G I hangar floor.
8. Clean outside area.

257

BLOCK V ORIENTATION

17-3 215

INTRODUCTION

TIME: 5 min

Attention: With the coming of newer, more sophisticated and larger aircraft, our job as firefighters is becoming ever increasingly more difficult.

Review: For the last three weeks you have been studying structural firefighting tactics and vehicles.

Overview: During the next 30 minutes, we will discuss what is going to be accomplished in the next three weeks, to include block content, safety and energy conservation.

Motivation: This will enable you to know exactly what is expected of you for the next three weeks.

Transition: We are going to start today with block content.

BODY

TIME: 20 min

Presentation:

TIME: 15 min

1. Block Content

Check outside assignment given in Block IV

a. Block V policies

- (1) Conduct and appearance
- (2) School hours
- (3) Class leader
- (4) Clean-up responsibilities
- (5) Visitors in Burn Area

b. Student responsibilities

Read letter on driving to school

2. Safety

- a. Jewelry
- b. Walk, don't run
- c. No horseplay
- d. Eye glass retainer
- e. Report all injuries
- f. Report defective clothing and equipment

Stress safety about hangar doors (students will not open or close hangar doors), warn students about getting hands or fingers caught in vehicle doors or compartments

- g. Fatigues worn under bunkers
- h. Gloves
- i. No smoking in vehicles
- j. Vehicle windows up when approaching fires
- k. Dismount from vehicle when it has stopped

3. Energy Conservation

- a. Use of gasoline power tools
- b. Care of protective clothing
- c. RPMs when operating vehicle
- d. Overflowing trucks with water
- e. Conservation of cleaning materials
- f. Tires and tire pressures
- g. Leaking trucks
- h. Expanding gasoline tanks
- i. Reduce booster heater operation
- j. Inspection and operation maintenance

Application:

TIME: N/A

Evaluation:

TIME: 5 min

Interspersed throughout the presentation.

CONCLUSION

TIME: 5 min

Summary: We have covered block content, safety and energy conservation.

Remotivation: The facts that were covered will help you in the successful completion of Block V.

Assignment: N/A. Continue with Principles and Procedures of Aerospace Vehicle Fire-fighting.

Closure: You should now have an idea of what your schedule for the next three weeks will be. Hopefully all of you will enjoy Block V.



PRINCIPLES AND PROCEDURES OF AEROSPACE VEHICLE FIREFIGHTING

INTRODUCTION

TIME: 5 min

Attention: Crash firefighting in Block V and in the field consists of time, accuracy and mental alertness, thereby making your job in Block V paramount to none.

Review: For the last thirty minutes we discussed what is going to be covered in Block V to include, Block content, safety and energy conservation.

Overview: During the next five and a half hours, we will discuss Principles and Procedures of Aerospace Aircraft Firefighting, to include Principles and Procedures, Missile Firefighting, Runway Foaming, Standby Operation, Airfield Patrol and Surveillance, and Ventilation of Large Frame Aircraft.

Motivation: There is almost unlimited opportunity in the field of crash firefighting for interested, well-informed personnel.

Transition: We are going to start today's lesson with principles and procedures.

BODY

TIME: 5 hrs 20 min

Presentation:

TIME: 5 hrs 10 min

1. Without reference, identify principles and procedures of aircraft firefighting. Eighty percent of the principles and procedures must be identified correctly.

Stress energy and materials conservation

a. Pre-fire planning

- (1) Each type mission-assigned aircraft
- (2) Touch-and-go landings if they average seven times a week for three consecutive months
- (3) AF Form 1028
 - (a) Optimum vehicle positioning
 - (b) Aircraft characteristics and information
 - (c) Predesignated rescueman's duties



(d) Copy on each chief's truck
and copy in alarm center

b. Mission

(1) Rescue of personnel

Safety

(2) Protect property

(3) Fight fires

(4) Hazards

(a) Fire

(b) Smoke

(c) Explosion

c. Emergency First Aid

(1) Given emergency treatment to
rescuee as required

d. Control Fuel Spills

(1) Classifications

(a) three types

1. Class 1

a. Area less than 2
feet in dimension

b. Normally only
monitor until
aircraft has
departed

2. Class 2

a. Area not over 10
feet in dimension

b. Dispatch sufficient
equipment to
neutralize spill

3. Class 3

a. Area over 10 feet
in dimension

b. Dispatch fire suppression and rescue equipment and take action to control the condition

(2) Oil and hydraulic spills

(a) Removed by agency responsible

(b) Fire protection equipment must not be used

INTERIM SUMMARY

2. Without reference, identify principles of missile firefighting. Eighty percent of the principles must be identified correctly.

a. Functions

(1) Aircraft firefighting and rescue responsibilities

(a) Standby fire protection for recognized exceptional hazard operations preceding test or launch

(b) Control and extinguishment of fires involving facilities, missiles, or vehicles.

(c) Personnel rescue as may be required

(d) Fire prevention inspection and maintenance of fire protection equipment as required

b. Pre-planning, same as pre-fire planning

(1) Elements

(a) Basic procedures for emergency response

(b) The number, type, configuration and general operation of missile or space vehicles assigned

(c) The layout of the launch site area

1. Roads
2. Terrain
3. Water Supply
4. Support facilities

(d) Propellant Storage area

1. Location
2. Layout
3. Type

(2) Exact nature of the relationship between the fire department and support services

- (a) Safety
- (b) Utility
- (c) Fueling and defueling
- (d) Medical
- (e) Heavy equipment

c. Standby operations

(1) Hazardous operations requiring standby can be predetermined within reason and personnel and equipment assigned accordingly

(2) Deployment can be expedited through the use of sketches or charts

- (a) Location of vehicles
- (b) Location of charged handlines
- (c) Location of fire extinguishers
- (d) Number of personnel at each point

(3) Plan should establish the most effective use of personnel and equipment

- (4) Wherever possible or practicable, rely on charged handlines for standby purposes
 - (5) Communication channels should be checked immediately upon reporting to the standby
- d. Test or launch operation
- (1) With one exception, everything covered under standby operations is the same.
 - (2) Launch operations the stand is cleared and operating personnel have withdrawn to the block house and emergency personnel and equipment withdrawn to fall back areas.
- d. Post launch operations
- (1) Extinguish incidental fires
 - (2) Wash away any propellant spills
- f. Critiques and post accident analysis
- (1) Obtain results of fire protection operations
 - (2) Eliminate deficiencies if possible
 - (3) Improve operations if possible

INTERIM SUMMARY

3. Without reference, identify runway foaming operation procedures. Eighty percent of the procedures must be identified correctly.

Show Film TFI 5605, "Foaming the Runway"

- a. Foam applied over portion of runway
- (1) Pilot request the foaming operation
 - (2) The length, width and depth of the foam pattern will depend upon certain factors
 - (3) Fire Chief supervises operation
 - (4) Use a 6% ratio



b. Minimizes fire hazard

- (1) Extinguishes spark from friction
- (2) Covers fuel to stop ignition

c. Vehicles used

- (1) 1,000 or 1,500 gal water tanker
- (2) F-6 or F-7 semi-trailer modified for foaming operations

INTERIM SUMMARY

4. Without reference, identify standby operation procedures. Eighty percent of the procedures must be identified correctly.

a. Non Emergency Standby

(1) Mild fire risk

Safety

(a) Type operation

- 1. Engine runup
- 2. Powered ground equipment
- 3. Refueling or defueling (normal)
- 4. Oxygen and deicing operations (normal)
- 5. Up or down loading weapons (normal)

(b) Fire protection needed

- 1. Portable or mobile fire extinguishers

(2) Moderate fire risk

(a) Type operation

- 1. Abnormal fueling operation
- 2. Mass engine starts or movements of aerospace vehicles

3. Welding or cutting operations in a hazardous location

(b) Fire protection needed

1. P-6/P-13 vehicle

(3) Severe fire risk

(a) Type operation

1. Hospital evacuation

2. Class 3 fuel spills

3. Nuclear weapons, missiles/propellents, or high hazard items are involved in accidents/incidents

(b) Fire protection needed

1. At least one major fire vehicle

b. Emergency Standby

(1) Vehicle standby during inflight aircraft emergencies

(2) Positioned along runway

(3) Fully dressed and alert

c. Standby

(1) Major piece of equipment and full crew

(2) Location - determined by fire chief, along runway, in station/other area.

INTERIM SUMMARY

5. Without reference, identify airfield patrol and surveillance operation procedures. Eighty percent of the procedures must be identified correctly.

a. Airfield patrol and surveillance

- (1) Purpose
 - (a) Watch for unsafe conditions
 - (b) Moderate fire risk operation
- (2) Vehicle
 - (a) P-6
 - (b) P-13
 - (c) Major piece of equipment may be used if P-6 or P-13 is not available

INTERIM SUMMARY

6. Without reference, identify principles of large frame aircraft heat and smoke ventilation. Eighty percent of the principles must be identified correctly.

a. Principles

- (1) Purpose planned release and removal of heated air, smoke, and gases from an aircraft.
- (2) Aids life saving
- (3) Makes firefighting easier
- (4) Speeds attack and extinguishment

b. Procedures

- (1) Ventilate by opening all doors, hatches, and windows on leeward side first, repeat then on windward side if conditions allow
- (2) Additional ventilation is accomplished by using all cut in areas following leeward to windward if conditions allow
- (3) Exhaust fans must be used to draw smoke and gases from the aircraft interior
- (4) Vertical ventilation may be used by opening hatches or cut in areas on top of the aircraft

Safety

(5) Any combination of ventilation procedures may be used together as the need is there.

Application: TIME: N/A

Evaluation: TIME: 10 min

Intersperse throughout the presentation.

CONCLUSION TIME: 5 min

Summary: Cover the main points of the lesson to include, principles and procedures of missile firefighting, runway foaming, standby operations, airfield patrol and surveillance and ventilation of large frame aircraft.

Remotivation: It is important that you remember today's lesson. This is the basis for your training in aerospace vehicle firefighting.

Assignment: Read and study TO 00-105E-9, Section II, pages 2-1 thru 2-15.

Outside Assignment: (2 hrs) Read and study SG #503, Principles and Procedures of Rescue, and answer the questions at the end of the unit.

Closure: This completes the unit on Principles and Procedures of Aerospace Vehicle Firefighting.



226

PRINCIPLES AND PROCEDURES OF RESCUE

INTRODUCTION

TIME: 5 min

Attention: Structural rescue and crash rescue go together because in both, your job will be to save lives.

Review: In yesterday's lesson we covered Principles and Procedures of Aerospace Vehicle Firefighting.

Overview: During the next six hours we will cover Principles and Procedures of Rescue to include principles and procedures, procedures for safetying egress systems, and procedures for shutting down aircraft engines and systems.

Motivation: Stress the reasons why the students need to accomplish the objectives of this lesson. When you leave this school and get to your next base you will be performing the duties of a fireman and at some time or another you will probably rescue a crew member from a crashed aircraft. Crashes do not always occur in the daylight; they happen at all hours of the day and night. Should this happen to you in the dark of night, and you are not familiar with the aircraft, you not only further endanger the life of a crew member, but you are also endangering your life as well as the lives of your fellow workers. To keep yourself from doing this, it is important that you become familiar with aircraft structure, jettison and egress systems so that you will be able to make a rescue under any condition without making a fatal mistake.

Transition: We are going to start today's lesson with principles and procedures of rescue.

BODY

TIME: 5 hrs 50 min

Presentation:

TIME: 5 hrs 40 min

1. Without reference, identify principles and procedures relating to rescue of personnel from aircraft. Eighty percent of the principles and procedures must be correctly identified.

Check outside assignment
Use TO 00-105E-9

Stress energy and materials conservation

a. Different types of aircraft

(1) Fighter

(2) Bomber

(3) Cargo

b. Parts of an aircraft

(1) Wings

(2) Fuselage

(3) Tail

Use Chart 73-232, "C-135 Construction Group Break-Down"

Use Chart 72-82, "C-54 Fuel and Oxygen Tanks and Battery Location"
Use Chart 72-88, "C-5A Fuel and Oxygen Tanks and Battery Location"

c. Aircrew locations

- (1) Cockpit
- (2) Fuselage
- (3) Tail - section

d. Danger areas from exhaust and intake path

Use Chart 72-89, "KC-135 A Danger Area Engines Running"

e. Exits

Use Chart 65-602, "Exterior Marking Cut In Area"

- (1) Normal
- (2) Emergency
 - (a) Cut in areas
 - (b) Escape hatches
 - (c) Windows and blisters

Use Chart 65-603, "Exterior Marking Astrodome and Exterior Marking Window"

f. Aircraft tubing

- (1) Red - fuel
- (2) Green - breathing oxygen
- (3) Brown - fire protection
- (4) Yellow - lube oil
- (5) Blue Yellow - hydraulic oil
- (6) Orange - compressed gas

Use Chart 73-127, "Piping System Identification"

INTERIM SUMMARY

2. Without reference, identify procedures for safetying egress systems. Eighty percent of the procedures must be identified correctly.

a. Safety egress systems

Stress safety

- (1) Egress is defined as a way out (exit)
- (2) Explain terms
 - (a) Ejection
 - (b) Jettison
- (3) Egress systems are found on aircraft. Fighters and bombers.

Use TO 00-105E-9

Show Films TF 5489, "Man on a Hot Seat"

TVL 57-28, "Operation Size Up, Rescue from Tactical Aircraft"

Use Chart 67-604, "Exterior Marking Rescue Firefighting Information"

- (4) Used by aircrew personnel, by means of an ejection seat, for means of escape from aircraft
- (5) Ejection seat presents a hazard to the rescue of personnel due to the explosive charge used to initiate the system.
- (6) Warning ejection seat marking
- (7) Ejection seats must be safetied to eliminate this hazard
- (8) There are three methods used to safety ejection seats
 - (a) Pins
 - (b) Quick disconnects
 - (c) Cut initiator hoses or lines
- (9) Once seat is safetied, continue with rescue operation

Use Chart 65-605, "Exterior Marking Rescue Firefighting Information"

Use Chart 72-85, "F-102A Exit Details Emergency Entrance"

INTERIM SUMMARY:

3. Without reference, identify procedures for shutting down aircraft engines and systems. Eighty percent of the procedures must be identified correctly.

a. Electrical system

- (1) Turn off master switch to cut off power
- (2). Batteries
 - (a) 28 volt wet cell contains liquid acid
 - (b) Battery locations
 - 1. Wings
 - 2. Wheel wells
 - 3. Fuselage
 - 4. Engine nacelles
 - (c) Marking of battery location - in black letters
 - (d) Quick disconnects

Use Chart 72-90, "KC-135A Fuel and Oxygen Tanks and Battery Locations"

b. Fuel system

(1) Fuel tanks

- (a) Metal
- (b) Synthetic rubber
- (c) Hazards

- 1. Fire
- 2. Explosion
- 3. Jettison

(d) Locations

- 1. Wings
- 2. Fuselage
- 3. Auxiliary tanks

(2) Turn off fuel control switch

- (a) Toggle switch located in cockpit
- (b) Stop flow of fuel in lines

(3) Oxygen tanks

- (a) Cylinders
- (b) Color
- (c) Location
- (d) Hazards

- 1. Explosion of container (fragmentation)
- 2. Supports combustion
- 3. Freeze burns from liquid oxygen

c. Shutting down engines

(1) Stop cock engines

- (a) Pull throttle back, then to left, and all the way back
- (b) Turn off master switch

Application:

230
TIME: N/A

Evaluation:

TIME: 10 min

Interspersed throughout lesson

CONCLUSION

TIME: 5 min

Summary: Reemphasize the main points of the lesson to include rescue procedures, safety egress systems, and shutting down aircraft engines and systems.

Remotivation: You, as an Air Force fireman, have a prime purpose and mission of saving lives. Mainly, you will be involved with aircraft incidents, involving from one to any number of personnel depending on the type aircraft involved. Each man assigned to an Air Force fire department has to know the procedures for entering and performing a rescue, regardless of the circumstances, which will vary as no two aircraft incidents are the same. Be prepared to do your best, and a little more, it is your responsibility and a human life may need saving.

Assignment: Read and study TO's:

1. TO 00-105E-9, Section X, pages 10-1, 10-6 and 10-7.
2. TO 36A12-8-15-1, Section II, page 2-1

Outside Assignment: (2 hrs) Read and study the following SG units and answer the questions at the end of each unit:

1. SG-504, Rescue Operations (1 hr)
2. SG-505, Ramp Vehicle Inspection, Maintenance and Operations (1 hr)

Closure: That completes our lesson for today. Remember to report to the hangar for tomorrow's class and bring your TO 00-105E-9.

RESCUE OPERATIONS

INTRODUCTION

TIME: 5 min

Attention: Have you ever rescued a pilot from a burning aircraft?

Review: In yesterday's lesson we covered Principles and Procedures of Rescue.

Overview: During the next three hours we will perform rescue operations to include: operate tools and equipment off P-10 rescue vehicle, demonstrate normal and emergency entry procedures and rescue aircrew member.

Motivation: It is important that you learn this lesson in order for you to be able to perform a rescue operation. Remember, our most important mission is saving lives.

Transition: We are going to start today's lesson with operating tools and equipment off P-10 rescue vehicle.

BODY

TIME: 2 hrs 50 min

Presentation:

TIME: 40 min

1. Given a simulated crashed aircraft and P-10 rescue vehicle and mounted equipment, operate tools and equipment. All applicable technical order procedures and safety practices must be strictly adhered to with minimum instructor assistance.

Check outside assignment

Safety

a. Operation Procedures

Stress Safety

(1) K-12

(2) Exhaust fans

(3) Auxiliary generator

(4) Portable lights

Application:

TIME: 2 hrs

1. Given a simulated crashed aircraft and P-10 rescue vehicle and mounted equipment, operate tools and equipment. All applicable technical order procedures and safety practices must be strictly adhered to with minimum instructor assistance.

2 INSTRUCTORS ARE REQUIRED

Stress safety

Energy and materials conservation

Use TO 00-105E-9

Use Trainer: Seat and Canopy T-33, 3188

C-133 aircraft

F-102 aircraft

C-97 aircraft

T-37 aircraft

Use WB 504

2. Given a simulated crashed aircraft and P-10 rescue vehicle and mounted equipment, demonstrate normal and emergency entry procedures. All entry procedures must be followed in accordance with TO 00-105E-9. All applicable safety procedures must be strictly adhered to with minimum instructor assistance.

Use: TO 36A12-12-13-1
Vehicle: A/S32 P-10
Rescue Vehicle and
Mounted Equipment

3. Given a simulated crashed aircraft, rescue aircrew members in accordance with procedures listed in TO 00-105E-9. All procedures must be followed using all applicable safety practices with minimum instructor assistance.

4. Given necessary equipment, perform preventive maintenance on the P-10 rescue vehicle and mounted equipment IAW with AFTO Form 433. Maintain station facilities as required.

Use: Preventive Maintenance
Materials

Evaluation:

TIME: 10 min

Intersperse throughout the presentation.

CONCLUSION

TIME: 5 min

Summary: Cover main points of lesson to include operating tools and equipment on P-10, normal and emergency entry points, and rescue of aircrew members.

Remotivation: Remember you may have the chance to save someone's life.

Assignment: N/A. Continue with Ramp Vehicle Inspection, Maintenance and Operations

Closure: Next hour we will cover the ramp vehicle.



253

RAMP VEHICLE INSPECTION, MAINTENANCE AND OPERATIONS

INTRODUCTION

TIME: 5 min

Attention: Probably some of you have driven a 3/4 ton pick up truck well, the ramp vehicle is just a 3/4 ton pick up truck with fire extinguishing systems.

Review: During the last three hours we covered rescue operations.

Overview: During the next three hours we will cover the ramp vehicle inspection, maintenance and operation.

Motivation: Stress the reasons why the students need to accomplish the objectives of this lesson. It is vitally important that you learn the operation of the ramp fire truck, in-as-much as you may be required to perform a fast, safe and efficient operation. How well you can do this may determine the life or death of individuals who may be trapped within an aircraft.

Transition: We are going to start this lesson with inspection and maintenance of ramp vehicles.

BODY

TIME: 2 hrs 50 min

Presentation:

TIME: 1 hr 10 min

1. Given the appropriate inspection checklist and technical data, inspect and perform operator maintenance on the ramp vehicle. All appropriate items on the checklist must be inspected. Operator maintenance must be accomplished according to the appropriate technical order.

Stress to properly operate Air Force Equipment in order to prevent damage resulting in costly repair

a. Inspect

- (1) Underhood
- (2) Right side
- (3) Left side
- (4) Cab
- (5) Bed of truck

b. Operator Maintenance

- (1) Adding oil, brake fluid, coolant, etc.
- (2) Cleaning and servicing
- (3) Energy conservation

Application:

1. Given the appropriate inspection checklist and technical data, inspect and perform operator maintenance on the ramp vehicle. All appropriate items on the checklist must be inspected. Operator maintenance must be accomplished according to the appropriate technical order.

2. Given an aerospace airfield ramp firefighting vehicle and available technical data, operate the firefighting system(s). All applicable technical order procedures and safety practices must be strictly adhered to with minimum instructor assistance.

3. Given necessary equipment, perform preventive maintenance on the ramp vehicle. LAW AFTO Form 434. Maintain station facilities as required.

Evaluation:

Interspersed throughout the presentation.

TIME: 1.5 hrs

2 INSTRUCTORS ARE REQUIRED
~~Stress safety, energy and materials~~
conservation

Use WB 505

Use TO 36A12-8-15-1

Use A/S32P-13, Ramp Vehicle

Use preventive maintenance materials

TIME: 10 min

CONCLUSION

TIME: 5 min

Summary: Cover the main points of the lesson to include inspection and operation of the truck.

Remotivation: Remember, if you can properly operate this vehicle, you may someday be able to prevent the loss of an aircraft or life by putting out the small fires.

Assignment: Read and study TO 36A12-8-9-1, Section II, pages 43 thru 50.

Outside Assignment: (2 hrs) Read and study SG-506, O-11A Inspection, Maintenance, and Operations, and answer the questions at the end of the unit.

Closure: Remember to return to the block V training area for class tomorrow.

O-11A INSPECTION, MAINTENANCE AND OPERATIONS

INTRODUCTION

TIME: 5 min

Attention: The truck we are going to discuss today is probably older than you are.

Review: In yesterday's lesson we covered rescue operations and the ramp vehicle.

Overview: During the next six hours we will cover the O-11A inspection, maintenance and operation.

Motivation: It is important that you learn today's lesson because the O-11A is over 20 years old and is subject to break down from many years of use. Your life may depend on how well your vehicle operates.

Transition: We are going to start today's lesson with operational procedures on the O-11A.

BODY

TIME: 5 hrs 50 min

Presentation:

TIME: 3 hrs 10 min

1. Without reference, identify operational procedures on the O-11A aerospace crash fire and rescue vehicle. Eighty percent of the procedures must be identified correctly.

Check outside assignment

a. General description of vehicle supporting components essential to the operation of the firefighting system

Stress to properly operate Air Force Equipment in order to prevent damage resulting in costly repair

(1) Main engine

(a) 6 cylinder - 310 hp

(b) Water cooled

(2) Crew - 5

Use TO 36A12-8-9-1

(a) Crew Chief

(b) Driver

(c) Turret Operator

(d) Handlineman (2)

(3) Hydraulic System (3)

(a) Brake system

- 1. Hydraulic air assist
- 2. All wheels
- 3. Reservoir - main engine fire wall (right side) - one pint

(b) Turret system

- 1. Hydraulic pump geared on accessory drive
- 2. Pressure 450-550 PSI
- 3. Gauge - cab dash
- 4. Reservoir
 - a. Location - Fire Pump Compt
 - b. Capacity - 12 gal

(c) Steering

- 1. Part time
- 2. Relief valve
- 3. Reservoir
- 4. Gauge
 - a.

INTERIM SUMMARY

(4) Air System

(a) Air reservoir - two

- 1. Quick build up (0-65 PSI)
- 2. Maximum - 115 PSI

(b) Serves

- 1. Brakes
- 2. CB system

- 3. Windshield wipers and washers
- 4. Air hose
- 5. Transfer case
- 6. Handline blowout

(c) Governor

- 1. 80-85 PSI minimum
- 2. 100-105 PSI normal
- 3. 115 PSI maximum

INTERIM SUMMARY

(5) Electrical system

- (a) 24 DCV - two 12 volt batteries connected in series

Use Chart 65-187, "Electrical System O-11A/B"

(b) Generator/Alternator

- 1. Main engine
- 2. Purpose

(c) External receptacles

- 1. Types
- 2. Location

(d) Auxiliary generator

- 1. Purpose
- 2. Location
- 3. Controls - 4 settings
- 4. Rheostat - set 25 amps

(6) Fuel system

- (a) Tank fill location - CB compartment
- (b) Capacity - 65 gal
- (c) Purpose - main engine, pump engine, booster heater and auxiliary generator



- (d) Two electric fuel pumps (pump compartment)

INTERIM SUMMARY

Use Charts 65-185, "Foam Truck Heating and Cooling System O-11A/B"

(7) Heating and cooling system

(a) Three interconnecting systems

- 1. System #1 - regular cooling like your car
- 2. System #2
- 3. System #3 -heat exchanger for main water tank

(b) Booster heater

- 1. 90,000 BTU (rated)
- 2. Controls - dash/caution activate the circulation pump.
- 3. Automatic controls.
 - a. Outlet side - 190° to 200°
 - b. Inlet side - 150° to 165°
 - c. Exhaust stack- temperature switch

(c) Diversion valve

- 1. Purpose
- 2. Location

(d) Fuel system

- 1. Electric fuel pump
- 2. Pressure - 30 PSI (plus or minus 3 PSI)

(e) Warning system light on dash (red-horn blows)

- 1. Lack of fuel
- 2. No ignition

INTERIM SUMMARY

239

b. General description of firefighting components

(1) Water system

(a) Water tank

1. Capacity 1000 gals.
2. Location - rear
3. Filling
 - a. Gravity - top.
 - b. Pressure - rear
4. Tank temp and level gauge

(b) Tank suction valve

1. Purpose
2. Location - pressure fill compartment

(c) Fire pump

1. Two stage centrifugal (locked in series)
2. Rated - 500 gpm at 350 psi
3. Located - opposite pump engine (right rear compartment)
4. Connect to pump engine by a step up transmission
5. Pressure and vacuum gauge

(d) Relief valve (fire pump)

1. Purpose
2. By pass back to inlet side of pump

(e) Primer

- 1. Purpose
- 2. Location

(f) Churn valve

- 1. Location of control handle
(between driver-turret operator seats)
- 2. Purpose
 - a. Open - down
 - b. Close - up

(2) Foam system

(a) Foam tank

- 1. Capacity - 100 gal
- 2. Location - inside water tank
- 3. Filling
 - a. Gravity - top
 - b. Pressure - rear
- 4. Level gauge - dash right side

(b) Foam valve

- 1. Location of control handle
(by churn valve)
- 2. Purpose

(c) Metering valve

- 1. Purpose
- 2. Location pressure fill compartment

(3) Pump engine

- (a) 8 cylinder air cooled
- (b) Idle rpm - 1000 to 1500
- (c) Governed at 2400 rpm

- 241
- (d) Tachometer - dash
 - (e) Location - left rear compartment
 - (f) Oil gauge - dash
 - (g) Cylinder temp gauge - color code
 - (h) Pump primer (fuel)
 - (i) Pump engine hour meter
 - (j) Starter detent
- 1. Purpose
 - 2. 0 and below

INTERIM SUMMARY

c. General description of agent discharging devices

- (1) Turrets - two (identify and describe turret nozzle assembly)
 - (a) Manual or hydraulic
 - (b) Streams - three
 - 1. Straight
 - 2. Intermediate
 - 3. Full fog
 - (c) Discharge rate - 200 gpm @ 350 psi ea
 - (d) Range - 50-75 feet
- (2) Groundsweeps
 - (a) Three (one if modified)
 - (b) Discharge rate - 35 gpm ea @ 350 psi or 105 gpm at 350 psi on the modified
 - (c) Control handle - (between the driver and turret operator seats)

- (3) Undertruck nozzles (2)
 - (a) Discharge rate 15 gpm at 350 psi each
 - (b) Purpose
 - (c) Control handle - (same location as the groundsweep)
- (4) Handlines (2)
 - (a) Location - right and left side of the truck
 - (b) Size 150' x 1"
 - (c) Discharge rate - 50-60 gpm @ 100 psi
 - (d) Bayonet nozzle - 15 gpm @ 100 psi. Stored - handline compartment

INTERIM SUMMARY

d. General description and location of secondary firefighting system

- (1) Location - middle compartment right side
- (2) Capacity of tank - 80 gals CB
- (3) Volume - 40 gal of CB when air pressure is used
- (4) Expelling force - 200 psi of dry air (if modified use nitrogen)
- (5) Dehumidifier (Drys the air)
- (6) Hose
 - (a) Size 150' x 1"
 - (b) Discharge rate 32 gpm @ 100 psi
 - (c) Reel location - left side

Conduct a Demonstration for .5 hr on the vehicle
2 INSTRUCTORS ARE REQUIRED

Application

1. Given AFTO Form 433 and technical data, inspect and perform operator maintenance on the O-11A aerospace crash fire and rescue vehicle. All applicable items on the AFTO Form 433 must be inspected. Operator maintenance must be accomplished according to the appropriate technical order.

TIME: 2 hrs 30 min
2 INSTRUCTORS ARE REQUIRED
 Use TO 36A12-8-9-1
 Stress Safety
 Energy and materials conservation
 Use O-11A
 Use WB-506



Evaluation:

293
TIME: 10 min

Interspersed throughout the presentation .

CONCLUSION

TIME: 5 min

Summary: Cover main points to cover operations and inspection of the O-11A.

Remotivation: Once you have become familiar with this vehicle you will have a better idea of what you will be doing in the field.

Assignment: Read and study TO 36A12-8-12-1, Section II, pages 29 thru 41.

Outside Assignment: (2 hrs) Read and study SG-507, O-11B Inspection, Maintenance and Operation and answer the questions at the end of the unit.

Closure: That concludes the O-11A, one of the oldest trucks in the Air Force inventory.

O-11B INSPECTION, MAINTENANCE AND OPERATIONS

INTRODUCTION

TIME: 5 min

Attention: The truck we are going to discuss today is the O-11A . . . with modifications.

Review: In yesterday's lesson we covered inspection, maintenance and operations of the O-11A.

Overview: During the next six hours, we will cover the O-11B inspection, maintenance and operations.

Motivation: Since this is one of the most common trucks used in crash firefighting, it is very important to learn its operation. We will cover all parts of the vehicle necessary for firefighting and aircraft rescue.

Transition: We are going to start today's lesson with operational procedures on the O-11B.

BODY

TIME: 5 hrs 50 min

Presentation:

TIME: 3 hrs 10 min

1. Without reference, identify operational procedures on the O-11B aerospace crash fire and rescue vehicle. Eighty percent of the procedures must be identified correctly.

Check outside assignment

Stress to properly operate Air Force Equipment in order to prevent damage resulting in costly repair

a. General description of vehicle supporting components essential to the operation of the fire-fighting system

Use TO 36A12-8-12-1 throughout presentation

(1) Main engine

- (a) 6 cylinder
- (b) Water cooled
- (c) 325 HP @ 2800 RPM

(2) Crew 5 men

- (a) Crew chief
- (b) Driver
- (c) Turret operator
- (d) Handlineman (2)

- (3) Hydraulic system (3)
 - (a) Brake system
 - 1. Hydraulic air assist
 - 2. All wheels
 - 3. Reservoir main engine firewall (right side) one pint

- (b) Turret system
 - 1. Positive displacement pump, driven by pump engine
 - 2. Pressure 450-550 psi
 - 3. Gauge pump engine compartment
 - 4. Reservoir
 - a. Location (fire pump compartment)
 - b. Capacity - 12 gal

- (c) Steering
 - 1. Part time
 - 2. Relief valve set at 1000 psi
 - 3. Reservoir - same as turret reservoir
 - 4. Gauge - located in pump engine compartment

INTERIM SUMMARY

- (4) Air system
 - (a) Air reservoir (2)
 - 1. Quick build up (0 - 65 psi)
 - 2. Maximum (115 psi)

(b) Serves

- 1. Brakes
- 2. Air primer
- 3. Windshield wipers and washers
- 4. Air hose
- 5. Transfer case
- 6. Handline blow out

(c) Governor

- 1. 80 - 85 psi minimum
- 2. 100 - 105 psi normal
- 3. 115 psi maximum

(5) Electrical system

Use Chart 65-187, "Electrical System O-11A/B"

(a) 24 VDC two 12 volt batteries connected in series

(b) Generator/alternator

- 1. Belt driven from main engine
- 2. Purpose

(c) External receptacles

- 1. Type
- 2. Location

(d) Auxiliary generator

- 1. Purpose
- 2. Location
- 3. Controls - 4 settings
- 4. Rheostat - at present at 25 amps

INTERIM SUMMARY



(6) Fuel system.

(a) Tank location - right side

(b) Capacity - 65 gal

(c) Purpose (serves)

1. Main engine

2. Pump engine

3. Booster heater

4. Auxiliary generator

(d) Electrical fuel pumps

1. Location pump compartment

(7) Heating and cooling system

Use Chart 65-185, "Foam Truck Heating and Cooling System O-11A/B"

(a) Three interconnecting systems

1. System #1 regular cooling like an auto

2. System #2 booster heater

3. System #3 heat exchanger for main water tank

(b) Booster heater

1. 90,000 BTU

2. Controls dash cab

a. Booster heater

b. Circulation pump

3. Automatic controls on booster heater

a. Inlet side 150°F to 165°F

b. Outlet side 190°F to 200°F

c. Exhaust stack temperature switch

(c) Diversion valve

- 1. Location cab
- 2. Purpose

(d) Fuel system (booster heater)

- 1. Electric fuel pump
- 2. Fuel pressure 30 psi (plus or minus 3 psi)

(e) Warning system

- 1. Red light on dash
- 2. Horn blows
- 3. Causes
 - a. Lack of fuel
 - b. No ignition
 - c. Insufficient combustion air

b. General description of firefighting components

(1) Water system

(a) Water tank

- 1. Capacity 1000 gal
- 2. Location
- 3. Description
- 4. Filling location
 - a. Gravity
 - b. Pressure
 - c. Level gages

(b) Tank suction valve

- (1) Purpose
- (2) Location fire pump compartment



(c) Fire pump

- 1. Location left side
- 2. Two stage centrifugal (locked in series)
- 3. Rated 500 GPM @ 350 PSI
- 4. Connected to pump engine by a step up transmission
- 5. Fire pump pressure and vacuum gage

INTERIM SUMMARY

(d) Relief valve

- 1. Purpose
- 2. Setting 350 psi
- 3. By pass back to inlet side of pump

(e) Primer

- 1. Purpose
- 2. Type air
- 3. Location fire pump compartment

(f) Churn valve

- 1. Location cab
- 2. Function
- 3. Purpose

(2) Foam system

(a) Foam tank

- 1. Capacity
- 2. Location
- 3. Description
- 4. Filling location

- a. Pressure
- b. Gravity
- 5. Level gage
- (b) Foam valve
 - 1. Location cab
 - 2. Purpose
- (c) Foam metering valve
 - 1. Location
 - 2. Settings

INTERIM SUMMARY

- (3) Pump engine
 - (a) Location left
 - (b) Air cooled 8 cylinder
 - (c) 200 HP @ 2400 RPM
 - (d) Idle RPM 1000 to 15000
 - (e) Tachometer dash
 - (f) Oil gage dash
 - (g) Cylinder head and oil temperature gage explain color code
 - (h) Fuel primer
 - (i) Choke
 - (j) Starter detent control
 - (k) Starter switch

c. General description of agent discharging devices

- (1) Turret (one)
 - (a) Hydraulic or manual operation



- (b) Streams
 - 1. Straight
 - 2. Dispersed
- (c) Discharge
 - 1. 200/400 GPM @ 350 PSI
- (d) Range
- (e) State location and function of turret controls
 - 1. Rate control
 - 2. Discharge control
 - 3. Stream control
 - 4. Micro switch
 - 5. Decontrol valves

INTERIM SUMMARY

- (2) Ground sweeps
 - (a) Controls (location)
 - (b) Discharge rate @ 350 PSI
 - 1. 3 outlets 35 GPM each
 - 2. 1 outlet 105 GPM
- (3) Undertruck nozzles (2)
 - (a) Location
 - (b) Purpose
 - (c) Rate of discharge 15 GPM
- (4) Handlines
 - (a) Location
 - (b) 150 ft x 1 1/4 inch
 - (c) Discharge rate



- 1. Foam 100 GPM @ 100 PSI
- 2. Water 50 GPM @ 100 PSI
- 3. Bayonet 15 GPM @ 100 PSI

(d) Rewind

- 1. Electric
- 2. Manual

(e) Blowout

INTERIM SUMMARY

d. General description and location of secondary firefighting system

- (1) 40 gallon CB
- (2) Expelling force 200 PSI nitrogen
- (3) 3 tanks of CB for one tank nitrogen
- (4) Relief valve 275 psi
- (5) Recharge
 - (a) Pressure
 - (b) Gravity
- (6) 150 x 1 inch handline
 - (a) Location
 - (b) Discharge 32 GPM @ 100 PSI
 - (c) Stream patterns

Conduct a demonstration for .5 hr on the vehicle.
2 INSTRUCTORS ARE REQUIRED

Application:

1. Given AFIO Form 433 and technical data, inspect and perform operator maintenance on the O-11B aerospace crash fire and rescue vehicle. All applicable items on the AFIO Form 433 must be inspected. Operator maintenance must be accomplished according to the appropriate technical order.

TIME: 2 hrs 30 min
2 INSTRUCTORS ARE REQUIRED
Use TO 36A12-8-12-1
Stress Safety
Energy and Materials Conservation

Use WB-507

Use O-11B

Evaluation:

TIME: 10 min

Intersperse throughout the presentation.

CONCLUSION

TIME: 5 min

Summary: Cover main points to cover operations and inspection of the O-11B.

Remotivation: It is important that you retain this lesson because the O-11B is one of the most common trucks used in crash firefighting.

Assignment: Read and study TO 36A12-8-13-1, Section II, pages 2-1 thru 2-9.

Outside Assignment: (2 hrs) Read and study SG-508, P-2 Inspection, Maintenance and Operations, and answer the questions at the end of the unit.

Closure: This concludes the O-11B inspection, maintenance, and operation.



P-2 INSPECTION, MAINTENANCE AND OPERATIONS

INTRODUCTION

TIME: 5 min

Attention: If you were extinguishing a fire of a crashed aircraft, and ran out of agent before rescue was accomplished, and had to watch a trapped crew member die, how would you feel?

Review: In yesterday's lesson we covered inspection, maintenance and operation of the O-11B.

Overview: During the next six hours, we will cover the P-2 inspection, maintenance and operations.

Motivation: Stress the reasons why the students need to accomplish the objectives of this lesson. The reason for this vehicle was seen with the development of aircraft refueling in flight, and the coming of bigger aircraft. As this is a fairly new vehicle in the field, not many people know how to operate it properly. You will now have the opportunity to be ahead of many of them by learning everything that you can in class today.

Transition: We are going to start today's lesson with operational procedures on the P-2.

BODY

TIME: 5 hrs 50 min

Presentation:

TIME: 3 hrs 10 min

1. Without reference, identify operational procedures on the P-2 aerospace crash fire and rescue vehicle. Eighty percent of the procedures must be identified correctly.

Check outside assignment

a. General description of vehicle supporting components essential to operation of the vehicle, in order to operate fire-fighting system.

Stress to properly operate Air Force Equipment in order to prevent damage resulting in costly repair

(1) Fuel system

(a) Operation

- 1. Location of tank
- 2. Supplies - drive engines - auxiliary generator, booster heater

3. Inspect to insure that tank is 3/4 full at all times

(2) Explain the operation of the following electrical components

(a) Alternator

- 1. Location - mounted on traction engine
- 2. Purpose - Supplies A/C current

(b) Rectifier

- 1. Location - mounted on traction engine
- 2. Purpose - change A/C current to D/C current

(c) Voltage regulator

- 1. Location - mounted on traction engine
- 2. Purpose - to supply batteries

(d) Batteries

- 1. Location - right side of vehicle
- 2. Check batteries and wiring daily
- 3. Two locked in series (explain)
- 4. Purpose

INTERIM SUMMARY

(3) Explain the operation and inspection of the air system to include:

- (a) Air compressor
 - 1. Location - driven by traction engine
 - 2. Purpose - supply three (3) tanks
- (b) Alcohol injector - capacity 1 quart
 - 1. Location - connected to compressor outlet line
 - 2. Purpose - remove moisture from air
- (c) Air tanks
 - 1. Location
 - 2. Purpose
 - 3. Bleed daily and check lines
- (d) Engines (throttle cylinders)
 - 1. Locations
 - 2. Purpose
- (e) Transmission (shift cylinders)
 - 1. Location
 - 2. Purpose
- (f) Service brake system (brake air packs)
 - 1. Location
 - 2. Purpose
- (g) Check system for leaks
 - 1. Check for loose connections

INTERIM SUMMARY

- (h) Power clusters (differential locks)
 - 1. Location
 - 2. Purpose
- (i) Windshield wiper motors
 - 1. Location
 - 2. Purpose
- (j) Windshield washers
 - 1. Location of controls
 - 2. Purpose
- (k) Hand line blow out valve
 - 1. Location
 - 2. Purpose
- (l) Horn
 - 1. Location

INTERIM SUMMARY

(4) Explain the operation, inspection of vehicle hydraulic systems to include

- (a) Power steering system
 - 1. Full time (front 4 wheels)
 - 2. Hydraulic pump mounted on main engine
 - 3. Location and filling of hydraulic tank
- (b) Turret system
 - 1. Hydraulic pump located on pump engine
 - 2. Location and filling of hydraulic tank

258
(c) Collector gear box hydraulic system

1. Location
2. Purpose
3. Lights on dash controlled by hydraulic pressure from this unit
4. Inspection of collector gear box

INTERIM SUMMARY

(5) Explain types and purpose of vehicle winterization kits to include:

(a) Class I = 0° or above

1. Foam tank
2. Hose reel compartment
3. Metering valve compartment
4. Pump compartment
5. Cab heater
6. W/S defroster heater
7. Water tank heat exchanger

(b) Class II = 0 to -65°

1. Booster heater - 90,000 BTU
2. 28 VDC Aux Gen
3. Engine pan, gear case lub
4. Inner windshield

(6) Explain the operation, inspection of the engines and drive train assembly

(a) Traction engine 340 HP-2800 RPM

Show film TVL 57-24, "Operational Maintenance check of the A/S32P-2 Truck"

- 1. Alternator
- 2. Steering hydraulic pump
- 3. Air compressor
- (b) Pump engine
 - 1. Collector gear box hydraulic pump
 - 2. Explain throttle controls
- (c) Drive train assembly
 - 1. Transmissions - automatic
 - 2. Collector gear box - purpose
 - 3. Transfer case - purpose
 - 4. Drive through units - purpose
 - 5. Bogie unit - purpose

Use Chart 70-357, "P-2 Drive Train Components"

INTERIM SUMMARY

b. General description of pump controls, agent discharging devices and component parts

(1) Explain the operation, inspection of the water system

Use Chart 65-402, "Water and Foam Discharge System P-2"

(a) Capacity 2300 gallons

- 1. Aluminum
- 2. Part of truck body

(b) Filler points

- 1. Gravity - top of truck
- 2. Pressure - rear of truck
- 3. Level gauge

a. Cab

b. Pump for reading

(c) Fire pump

Stress Safety
Water Pressure

- 1. Discharge - 1400 GP,
at 250 PSI
- 2. Type - single stage,
dual impeller, centri-
fugal with dual inlet
- 3. Engagement
 - a. Barksdale valve
 - b. Location - cab
 - c. 1250 RPM on pump
engine tachometer
 - d. Pressure gauge -
2600 RPM

(2) Explain the operation, inspection
of the foam system

(a) Foam tank

- 1. Capacity - 200 gals
- 2. Location - behind
water tank
- 3. Fiberglass - styrofoam top

(b) Filling

- 1. Gravity
- 2. Pressure
- 3. Level gauge
 - a. Location - cab
 - b. Pump for
reading

(c) Foam pump

- 1. Rated discharge - 125 GPM
at 250 PSI
- 2. Engagement
 - a. Barksdale valve -
opens foam tank
suction valve

b. Light (engaged on dash in cab)

(d) Foam metering valves

- 1. Location- cab, crew chiefs seat
- 2. Purpose - calibrated (0 to 10)
- 3. How to adjust them

(e) Explain foam induction into bumper, roof turret and handline discharge outlets

(3) Explain discharge outlets

(a) Roof Turret

- 1. Discharge capability - 1000 GPM at 200 PSI
- 2. Operation
 - a. Hydraulic
 - b. Manual
- 3. Barrels
 - a. Two Foam
 - b. Two water
- 4. Streams
 - a. Straight
 - b. Dispersed
- 5. Manual discharge lever
- 6. Decontrol levers
 - a. One hydraulic operation
 - b. Emergency water shut off
- 7. Dispersion control lever

Handwritten scribble or mark on the right side of the page.

8. Agent selector lever

a. Large barrels - foam

b. Small barrels - water

9. Rate control lever

a. 1000 GPM

b. 500 GPM

10. Discharge valve switch - electric - located on cab ceiling

(b) Bumper turret

1. Discharge valve control

2. Dispersion control - straight or dispersed

3. Agent selection control - foam or water

4. Discharge capacity - 300 GPM at 200 PSI

5. Operation - manual

6. Movement

a. Horizontal - 180°

b. Vertical - 45°

7. Barrels - two

a. Water

b. Foam

8. Streams

a. Straight

b. Dispersed

INTERIM SUMMARY

c. Description and location of handline

- (1) Discharge capacity - 100 GPM at 100 PSI
- (2) Size of line - 1 1/2 x 150 feet
- (3) Nozzle - located right front side of truck
- (4) Hose reel
 - (a) Front of vehicle
 - (b) Manual rewind only
 - (c) Crank (hand) front of vehicle
- (5) Bayonet nozzle
 - (a) Location - nozzle compartment
 - (b) Purpose - same as O-11B
- (6) Discharge valve - nozzle compartment
- (7) Air blow-out valve
 - (a) Purpose - prevent freezing
 - (b) Uses air from brake system

Conduct a demonstration for .5 hr on the vehicle
2 INSTRUCTORS ARE REQUIRED

Application

TIME: 2 hrs 30 min
2 INSTRUCTORS ARE REQUIRED

1. Given AFTO Form 433 and technical data, inspect and perform operator maintenance on the P-2 aerospace crash fire and rescue vehicle. All applicable items on the AFTO Form 433 must be inspected. Operator maintenance must be accomplished according to the appropriate technical order.

Use TO 36A12-8-13-1
Stress Safety
Energy and Material Conservation
Use WB 508
Use P-2

Evaluation:

TIME: 10 min

Intersperse throughout the presentation.



Summary: Cover main points to cover operations and inspection of the P-2.

Remotivation: It is important that you learn this vehicle. It has the largest fire-fighting capability and must be operated by competent personnel.

Assignment: Read and study TO 36A12-12-14-1, Section II, pages 2-1 thru 2-7.

Outside Assignment: (2 hrs) Read and study SG-509, P-4; Inspection, Maintenance and Operations and answer the questions at the end of the unit.

Closure: This concludes the lesson on the largest fire truck in the Air Force.

P-4 INSPECTION, MAINTENANCE AND OPERATIONS

205

INTRODUCTION

TIME: 5 min

Attention: To this date we have put men on the moon and soon we will be going even farther. Can you imagine all the systems and components that are needed to get men off the earth to the moon and back safely. In some cases, if just one little valve, switch, or safety device malfunctions, the mission or lives may be lost. The P-4 is not as an elaborate piece of equipment as a space capsule, but it must have some systems to effectively operate the truck during emergencies.

Review: In yesterday's lesson we covered inspection, operation and maintenance of the P-2 crash truck.

Overview: Basically the operational systems on the P-4 are the same as on the P-2 crash truck. The major differences are the sizes and additional usages of the systems. In this lesson we will cover for the next six hours, the P-4 inspection maintenance and operations.

Motivation: Just like the astronauts, we must have a working knowledge of the operation and preventive maintenance of our vehicles, as they did theirs. How well you learn may well mean how efficient your vehicle will operate at your base.

Transition: We are going to start today's lesson by covering AFTO Form 433.

BODY

TIME: 5 hrs 50 min

Presentation:

TIME: 3 hrs 10 min

Check outside assignment

1. Without reference, identify operational procedures on the P-4 aerospace crash fire and rescue vehicle. Eighty percent of the procedures must be identified correctly.

a. General description of vehicle supporting components essential to operation of vehicle in order to operate firefighting system

Stress to properly operate Air Force Equipment in order to prevent damage resulting in costly repair

(1) Fuel system

(a) Fuel tank

1. Capacity

2. Type of fuel

3. Level

4. Filter

(b) Components requiring fuel for the operation of the vehicle

- 1. Engine
- 2. Booster heater

(2) Electrical system

(a) Alternator

- 1. Purpose
- 2. Location
- 3. Operation
- 4. Type and amount of current produced
- 5. Rectifier built into alternator

(b) Voltage regulator

- 1. Purpose
- 2. Location

(c) Batteries

- 1. Purpose
- 2. Location

INTERIM SUMMARY

(3) Air system

(a) Air compressor

- 1. Purpose
- 2. Location
- 3. Operation
- 4. Lubricated
- 5. Cooled
- 6. Air filter

(b) Alcohol Injector

- 1. Purpose
- 2. Location
- 3. Operation
- 4. Type of Alcohol
- 5. Capacity

(c) Air tanks

- 1. Purpose
- 2. Location
- 3. Types
 - a. Quick build up
(2 each small)
 - b. System tanks
(2 each large)

(d) Throttle cylinder (linkage)

- 1. Purpose
- 2. Location
- 3. Operation
 - a. Normal idle (controlled air pressure)
 - b. Acceleration
- 4. Minimum pressure required

(e) Service brake system (power clusters)

- 1. Purpose
- 2. Location
- 3. Type of brakes
- 4. Operation
- 5. Parking Brake

- a. Power clusters
- b. Brake assembly

INTERIM SUMMARY

(f) Differential locks

- 1. Purpose
- 2. Location
- 3. Operation
 - a. Controlled air pressure
 - b. Air pressure to locks
- 4. Engagement
- 5. Disengagement

(e) Transmission

- 1. Controlled by shift selector
- 2. Pump drive normal shift (crash mode)

INTERIM SUMMARY

(4) Hydraulic systems

- (a) P-4 power steering system
 - 1. Purpose
 - 2. Type
 - 3. Operation

INTERIM SUMMARY

(b) P-4 turret system

- 1. Purpose
 - a. Turret movement
 - b. Discharge of agent
- 2. Turret hydraulic system
 - a. Purpose
 - b. Operation



- 3. Pump
 - a. Reservoir
 - b. Type fluid
- 4. Decontrol valves and hydraulic manifold
 - a. Purpose
 - b. Location
- 5. Turret movement
 - a. Manual
 - b. Hydraulic
- 6. Turret discharge
 - a. Controls
 - b. Operation

INTERIM SUMMARY

(5) Engine and drive train assembly

Use Chart _____, "P-4 Drive Train Assembly"

(a) Engine

- 1. Alternator
- 2. Voltage regulator
- 3. Air compressor
- 4. Power steering pump
- 5. Alcohol injector
- 6. Turbocharger

(b) Power divider

- 1. Purpose
- 2. Location
- 3. Operation
 - a. Fire pump



b. Foam pump

c. Modulating clutch

(c) Transmission

1. Location

2. Type and Operation

3. Purpose

INTERIM SUMMARY

(d) Transfer case

1. Location

2. Type

3. Purpose

(e) Differentials

1. Location

2. Purpose

INTERIM SUMMARY

(6) Heating and cooling system

(a) Temperature range of operation

(b) Components

1. Engine (source of heat)

2. Water pumps (circulation)

3. Fin heaters

4. Heat exchanger

a. Operation

b. Circulation

5. Agent recirculating system

a. Circulatory pump

b. Tank suction valve

- 6. Cab heater
- 7. Coolant shut-off valve
- 8. Defrosters and bleeders
- 9. Booster heater
- 10. Double windshields
- 11. Electric circulating coolant pump
- 12. Radiator
- 13. Shutter
- 14. Air conditioner
 - a. Output 24,500 BTU
 - b. Temp range

INTERIM SUMMARY

b. General description of pump controls, agent discharging devices and components parts

Use Chart _____, "P-4 Firefighting System"

- (1) Water tank
 - (a) Capacity
 - (b) Construction
 - (c) Methods of filling
 - 1. Gravity
 - 2. Pressure
- (2) Fire pump
 - (a) Type
 - (b) Discharge capacity
 - (c) Lubrication
- (3) Fire pump relief valve
 - (a) 4 way valve
 - 1. On position
 - 2. Off position



- (b) Pilot valve
 - 1. Setting
 - 2. Operation
- (c) Dual purpose of relief valve
 - 1. Maintains constant pressure
 - 2. Cools fire pump
- (4) Fire pump primer
 - (a) Type
 - (b) Operation

INTERIM SUMMARY

- (5) Foam tank
 - (a) Capacity
 - (b) Const lion
 - (c) Methods of filling
 - 1. Gravity
 - 2. Pressure
- (6) Foam pump
 - (a) Type
 - (b) Capacity
 - (c) Lubrication
 - (d) Churn lines
- (7) Foam sensing device
 - (a) Purpose
 - (b) Operation
- (8) Air actuated foam valves
 - (a) Locations
 - (b) Purpose
 - (c) Operation

(9) Foam metering valves

- (a) Location
- (b) Purpose
- (c) Operation

(10) Foam pressure relief valve

INTERIM SUMMARY

(11) Roof turret

(a) Capacity

- 1. Two barrels
- 2. One barrel
- 3. Foam barrels
- 4. Water barrels

(b) Controls

- 1. Decontrol valves
- 2. Solenoid-toggle switch
- 3. Rate selector and tube selector lever
- 4. Stream selector lever
- 5. Interrupter switches

(c) Travel

- 1. Horizontal
- 2. Vertical

(d) Range

(e) Windshield cooling spray

(12) Bumper turret

(a) Capacity

- 1. Two barrels
- 2. One foam barrel



3. One water barrel

(b) Control

- 1. Manual
- 2. Barrel selection
- 3. Stream selector

(c) Travel

- 1. Horizontal
- 2. Vertical
- 3. Range

(13) Handline

- (a) Capacity
- (b) Length and size of hose
- (c) Charging valve
- (d) Blowout valve
- (e) Air motor rewind
 - 1. Location
 - 2. Lubricator

Conduct a Demonstration for
 .5 hr on the vehicle
2 INSTRUCTORS ARE REQUIRED

TIME: 2 hrs 30 min
2 INSTRUCTORS ARE REQUIRED
 Stress safety, energy and materials
 conservation

Use TO 36A12-12-11-1
 Use WB #509
 Use P-4

Application

1. Given AFTO Form 433 and technical data, inspect and perform operator maintenance on the P-4 aerospace crash fire and rescue vehicle. All applicable items on the AFTO Form 433 must be inspected. Operator maintenance must be accomplished according to the appropriate technical order.

Evaluation:

TIME: 10 min

Interspersed throughout the presentation.

Summary: Cover main points of lesson to cover operation and inspection of the P-4.

Remotivation: It is important that you learn this vehicle. It is the newest vehicle and must be operated by competent personnel.

Assignment: Review and study SG 502, Principles and Procedures of Aerospace Vehicle Firefighting. In future lessons we will be applying what you learned to actual operations.

Outside Assignment: (2 hrs) Read and study SG-510, Procedures for on Scene Operations, and answer the questions at the end of the unit.

Closure: This concludes the lesson on the newest crash truck in the Air Force.

276
PROCEDURES FOR ON SCENE OPERATIONS

INTRODUCTION

TIME: 5 min

Attention: Have you ever seen an aircraft crash site?

Review: Yesterday we covered the P-4 crash truck inspection and operation.

Overview: Now that you have learned about the equipment and its operation, we will apply what we have learned to actual operations. As we used prefire plans in structural operations, we will also pre-incident plan crash operations. In this lesson, we will cover approach, position, salvage and procedures for preserving evidence.

Motivation: Stress why approach and position are important to the student. How it may mean the difference between life and death.

Transition: We are going to start today's lesson by covering approach to an aerospace vehicle crash.

BODY

TIME: 5 hrs 50 min

Presentation:

TIME: 5 hrs 40 min

1. Without reference, identify the procedures for determining proper vehicle approach at the scene of an aircraft emergency. Eighty percent of the procedures must be identified correctly.

Check outside assignment

a. Factors

- (1) Air traffic
- (2) Moving aerospace vehicles
- (3) Terrain
- (4) Type aircraft
- (5) Weather
- (6) Wind

Show Film TF 6176, "Aircraft Fire and Rescue Procedures"

b. Crew responsibilities

- (1) Watch for impending danger
- (2) Scan for aircrew members
- (3) Watch for munitions

2. Without reference, determine the procedures for positioning aerospace crash, fire and rescue vehicles. Eighty percent of the procedures must be identified correctly.

a. Factors

- (1) Type aircraft
- (2) Type weapons
- (3) Terrain

b. Position

(1) Field

- (a) Vehicles to respond will be determined by type of emergency at the discretion of the senior fire officer in charge
- (b) First vehicle will set up on rescue side

(2) School

- (a) Light fires
 - 1. Two trucks
 - 2. One on each side of fuselage
- (b) Medium and heavy
 - 1. Four trucks
 - 2. Two trucks on rescue side
 - 3. Two trucks on off rescue side

3. Without reference, identify aerospace vehicle crash/fire salvage operation procedures. Eighty percent of the procedures must be identified correctly.



a. Salvage

(1) Protect cargo

(a) Remove or where stands

1. Prevent smoke damage

2. Prevents water damage

(2) Clothing required

Issue Bunkers to Students

(a) Hood

(b) Coat and pants (protective)

(c) Boots and gloves

4. Without reference, identify procedures for preserving evidence used to determine the cause of an aerospace vehicle crash/fire. Eighty percent of the procedures must be identified correctly.

a. Procedures

(1) Look for evidence

(2) Recognize evidence

(3) Do not move parts unless necessary for the performance of your duty

(4) Classified documents should be shielded from public view

(5) Relay information to senior fire officials for evaluation

Application:

TIME: N/A

Evaluation:

TIME: 10 min

Interspersed throughout the presentation.

CONCLUSION

TIME: 5 min

Summary: Cover main points of lesson to include approach, position, salvage and procedures for preserving evidence.

Remotivation: Remember how you set up may determine your survival.

Assignment: Review SG 506, O-11A Inspection, Maintenance and Operations, and SG-509, P-4 Inspection, Maintenance and Operation to cover turret and handline operation for use in the drill area.

Outside Assignment: (2 hrs) Read and study SG 511, Emergency Response Exercises, and answer the questions at the end of the unit.

Closure: This completes today's lesson on procedures for on the scene operations.

EMERGENCY RESPONSE EXERCISES

INTRODUCTION

TIME: 5 min

Attention: During emergency response, the second you save may mean someone's life.

Review: In yesterday's lesson, we covered procedures for on scene operations.

Overview: During the next six hours we will perform Emergency Response Exercises to include: Operator O-11A/B or P-4 aerospace crash fire and rescue vehicle; perform crew duties in aerospace crash/firefighting drills and flood or wash down simulated hazardous spills.

Motivation: It is important that you learn today's lesson so that you can perform your duties in the fires.

Transition: We are going to start today's lesson with operating the O-11A/B or P-4 aerospace crash fire and rescue vehicle.

BODY

TIME: 5 hrs 50 min.

Presentation:

TIME: 40 min

1. Using TO, operate the O-11A/B or P-4 aerospace crash fire and rescue vehicle with minimum instructor assistance.

Check outside assignment.

a. Crew Duties

Stress energy and materials conservation

(1) Turret Operators

(a) O-11A/B

- 1. Hood and gloves on engine compartment
- 2. Start pump engine
- 3. Idle between 10-1500 RPMs
- 4. Wait for signal to throttle up

Stress safety seat belts.

Use Charts CC73-03 thru CC73-14. "Burn Procedure Charts"



5. Practice moving turrets and changing patterns

Stress to properly operate Air Force Equipment in order to prevent damage resulting in costly repair

(b) - P-4

- 1. Hood and gloves to right side seat
- 2. Take turret off roof manually
- 3. Wait for throttle up signal - ask driver when to engage pump
- 4. Practice moving turrets and changing patterns

(2) Crew Chiefs

- (a) Meet between trucks, never go in front of vehicles
- (b) Wait for back-up man's signal to get in cockpit
- (c) Perform rescue and use first aid as required

(3) Handlineman

(a) O-11A/B

- 1. Change handline
- 2. Get out of truck
- 3. Open handline compartment and remove reel.
- 4. Advance on fire
- 5. Handlineman closest to the fuselage is the lead lineman.

6. Each additional
lineman are back-
up linemen

(b) P-4

1. Open doors and
pull off 3 or 4
feet of line off
reel

2. Remove nozzle
and pull charge
valve

3. Advance on fire

4. Handlineman closest
to the fuselage
is the lead
lineman

5. Each additional
lineman are back-
up linemen

b. Signals

(1) Turret Operators

- (a) Throttle up
- (b) Throttle down
- (c) Straight stream
- (d) Dispersed stream
- (e) Full fog
- (f) Under truck nozzles
- (g) Groundsweeper

(2) Crew Chiefs

- (a) Way out
- (b) Cool down
- (c) Thumbs up rescue
complete



(3) Handlineman

- (a) Open or close hand-line nozzle
- (b) Change barrel
- (c) Change stream
- (d) Advance
- (e) Retreat
- (f) Thumbs up or down
- (g) Turn around and pick up lines

c. Safety

- (1) Seat belts
- (2) No jewelry
- (3) Glasses -- retainer straps, no contact lenses
- (4) Keep away from burn barrels
- (5) Keep nozzle in your chest
- (6) Proper side of nozzle

Application:

1. Using TO, operate the O-11A/B or P-4 aerospace crash fire and rescue vehicle with minimum instructor assistance.

2. Using protective clothing, TO, and a workbook, perform crew duties in aerospace crash/ firefighting drills and emergency response exercises using an O-11A/B or P-4 aerospace crash fire and rescue vehicle with minimum instructor assistance.

3. Given a firefighting vehicle and protective clothing, and following all pertinent safety procedures, flood or wash down simulated hazardous spills.

TIME: 5 hrs

4 INSTRUCTORS ARE REQUIRED

Stress Safety

- Use TO 36A12-8-9-1
- Use TO 36A12-8-12-1
- Use TO 36A12-12-14-1
- Use WB-511
- Use Vehicles O-11A/B, A/S 32P-4
- Use complete set of protective clothing
- Use training simulated F-102 Aircraft
- Simulated F-105 Aircraft
- Simulated F-106 Aircraft

Spills must be diluted until the simulated hazardous conditions are eliminated.

Firefighting B-47
Firefighting C-135
Roof turret O-11B
Mounted crash firefighting vehicle

4. Given necessary equipment, perform preventive maintenance on aerospace crash fire and rescue vehicles IAW AFTO Form 433. Maintain station facilities and protective clothing as required.

Use preventive maintenance materials

Evaluation:

TIME: 10 min

Intersperse throughout the presentation.

CONCLUSION

TIME: 5 min

Summary: Cover main points of lesson to include: Operate the O-11A/B or P-4 aerospace crash fire and rescue vehicle, perform crew duties in aerospace crash/firefighting drills and flood or wash down simulated hazardous spills.

Remotivation: Remember what you learned today; you will use for the next five days.

Assignment: Review SG-510 for use in tomorrow's lesson.

Outside Assignment: (2 hrs) Read and study SG-512, Emergency Response and Aircraft Approach Exercises, and answer the questions at the end of the unit.

Closure: This completes today's lesson.

EMERGENCY RESPONSE AND AIRCRAFT APPROACH EXERCISES

INTRODUCTION

TIME: 5 min

Attention: Picking the right approach route may mean saving your life as well as someone else's.

Review: In yesterday's lesson we covered Emergency Response Exercise.

Overview: During the next 6 hours we will perform Emergency Response and Approach Exercises, to include operating O-11A/B or P-4 and P-2.

Motivation: It is important that you learn today's lesson, so that you can perform your duties in the live fires.

BODY

TIME: 5 hrs, 50 min

PRESENTATION:

TIME: 40 min

- 1. Using TO, operate the O-11A/B or P-4 aerospace crash fire and rescue vehicle with minimum instructor assistance. Participate in firefighting drills and emergency response exercises as required.

Check Outside Assignment

a. Crew Duties

Stress Safety Seat Belts

(1) Turret Operator

(a) O-11A/B

- 1 Hood and gloves on engine compartment
- 2 Start Pump engine
- 3 Idle between 10-1500 RPMs
- 4 Wait for signal to throttle up
- 5 Practice moving turret and changing patterns

Use Charts CC 73-03 thru CC 73-14, "Burn Procedure Charts"

Stress to properly operate Air Force Equipment in order to prevent damage resulting in costly repair

(b) P-4

- 1 Hood and gloves to right side seat
- 2 Take turret off roof manually

3 Wait for throttle up signal - ask driver when to engage pump

4 Practice moving turret and changing patterns

(2) Crew Chief

(a) Meet between trucks, never go in front of vehicle

(b) Wait for back-up man's signal to get in cockpit

(c) Perform rescue and use first aid as required

(3) Handlineman

(a) O-11A/B

1 Charge handline

2 Get out of truck

3 Open handline compartment and remove reel

4 Advance on fire

5 Handlineman closest to the fuselage is the lead lineman

6 Each additional linemen are back-up linemen

(b) P-4

1 Open doors and pull off 3 or 4 feet of line off reel

2 Remove nozzle and pull charge valve

3 Advance on fire

4 Handlineman closest to the fuselage is the lead lineman

5 Each additional linemen are back-up linemen



b. Signals

- (1) Turret Operators
 - (a) Throttle up
 - (b) Throttle down
 - (c) Straight stream
 - (d) Dispersed stream
 - (f) Full fog
 - (g) Groundsweep
- (2) Crew Chiefs
 - (a) Way out
 - (b) Cool down
 - (c) Thumbs up - rescue complete
- (3) Handlinemen
 - (a) Open or close handline nozzle
 - (b) Change barrel
 - (c) Change stream
 - (d) Advance
 - (e) Retreat
 - (f) Thumbs up or down
 - (g) Turn around and pick up lines

c. Safety

- (1) Seat belts
- (2) No jewelry
- (3) Glasses - retainer strap, no contact lenses
- (4) Keep away from burn barrels
- (5) Keep nozzle in your chest
- (6) Proper side of nozzle

Application:

TIME: 5 hrs

4 INSTRUCTORS ARE REQUIRED

1. Using TO, operate the O-11A/B or P-4 aerospace crash fire and rescue vehicle with minimum instructor assistance. Participate in firefighting drills and emergency response exercises as required.
2. Using TO, operate the P-2 aerospace crash fire and rescue vehicle with minimum instructor assistance. Participate in firefighting drills and emergency response exercises as required.
3. Given necessary equipment, perform preventative maintenance on aerospace crash fire and rescue vehicles IAW AFTO Form 433. Maintain station facilities and protective clothing as required.

Stress safety, energy and materials conservation.

Use TO 36A12-8-13-1
 Use TO 36A12-12-14-1
 Use TO 36A12-8-9-1
 Use TO 36A12-8-12-1
 Use Vehicles: O-11 A/B, A/S 32P-2, and A/S 32P-4

Use WB - 512
 Use complete set of protective clothing

Use Trainers:
 Simulated F-102 Aircraft
 Simulated F-105 Aircraft
 Simulated F-106 Aircraft
 Roof Turret O-11 B
 Mounted crash firefighting vehicle
 Use preventive maintenance materials

Evaluation:

TIME: 10 min

Interspersed throughout the presentation.

CONCLUSION

TIME: 5 min

Summary: Cover main points of lesson to include operation of the O-11A/B or P-4 and P-2.

Remotivation: Remember what you learned today because tomorrow is the first day of live fires.

Assignment: Study SG-510 for use in tomorrow's lesson.

Outside Assignment: (2 hrs) Read and study SG-513, Control and Extinguishment on Small Frame Aircraft Fires and answer the questions at the end of the unit.

Closure: Be ready to burn in the morning.

289

CONTROL AND EXTINGUISHMENT ON SMALL FRAME AIRCRAFT FIRES

INTRODUCTION

TIME: 5 min

Attention: Simulation is over, nothing but the real thing from now on.

Review: In yesterday's lesson we covered emergency response and aircraft approach exercises.

Overview: During the next six hours we will perform control and extinguishment on small frame aircraft fires to include, performing as a member of a firefighting crew to control and extinguish aerospace crash fires using an O-11A/B or P-4.

Motivation: It is important that you pay attention today because simulation is over, we will be using real fire.

Transition: We are going to start today's lesson performing as a member of a firefighting crew.

BODY

TIME: 5 hrs 50 min

Presentation:

TIME: 40 min

1. Given a burning aircraft mock-up, protective clothing and technical data, perform as a member of a firefighting crew to control and extinguish aerospace crash fires using an O-11A/B or P-4 aerospace crash fire and rescue vehicle. Each fire must be completely extinguished while observing all applicable safety practices.

Check outside assignment

Stress to properly operate
Air Force Equipment in order
to prevent damage resulting
in costly repair

a. Crew duties

(1) Turret operator

Stress Safety - Seat Belts

(a) O-11A/B

(b) P-4

(2) Crew chiefs

(a) O-11A/B

Use Charts CC-73-03 thru CC73-14
"Burn Procedure Charts"

(b) P-4

b. Signals

- (1) Turret operators
- (2) Crew chiefs
- (3) Handlineman

c. Safety

- (1) Seat belts
- (2) No jewelry
- (3) Glasses - retainer straps, no contact lenses
- (4) Keep away from burn barrel
- (5) Keep nozzle in your chest
- (6) Proper side of nozzle

Application:

1. Given a burning aircraft mock-up, protective clothing and technical data, perform as a member of a firefighting crew to control and extinguish aerospace crash fires using an O-11A/B or P-4 aerospace crash fire and rescue vehicle. Each fire must be completely extinguished while observing all applicable safety practices.

2. Given necessary equipment, perform preventive maintenance on aerospace crash fire and rescue vehicles IAW AFTO Form 433. Maintain station facilities and protective clothing as required.

Evaluation:

Intersperse throughout the presentation.

TIME: 5 hrs

7 INSTRUCTORS ARE REQUIRED
Stress safety

Energy and materials conservation

Use TO 36A12-8-9-1

Use TO 36A12-8-12-1

Use TO 36A12-12-14-1

Use Vehicles O-11A/B; A/S 3ZF-2

Use Trainers:

Simulated F-102 aircraft

Simulated F-105 aircraft

Simulated F-106 Aircraft

Use WB 513

Use Complete Set of Protective Clothing

Use preventive maintenance materials

TIME: 10 min

CONCLUSION

291
TIME: 5 min

Summary: Cover main points of lesson to include, control and extinguishment of aerospace crash fires using an O-11A/B or F-4 aerospace crash fire and rescue vehicle.

Remotivation: Remember what you learned today because we will be doing live fires again tomorrow.

Assignment: Review SG-511 for use in tomorrow's lesson.

Outside Assignment: (1 hr) Read and study SG-514, Control, Extinguishment, Overhaul and Rescue on Small Frame Aircraft Fires and answer the questions at the end of the unit.

Closure: This completes today's lesson.

CONTROL, EXTINGUISHMENT, OVERHAUL AND RESCUE ON SMALL FRAME AIRCRAFT FIRES

INTRODUCTION

TIME: 5 min

Attention: Proper firefighting procedures in aerospace crash fires is important to you.

Review: In yesterday's lesson we covered control and extinguishment on small frame aircraft fires.

Overview: During the next six hours, we will perform control, extinguishment, overhaul and rescue on small frame aircraft fires to include performing as a member of a firefighting crew to control and extinguish aerospace crash fires, rescue from aircraft as required and perform firefighting overhaul cleanup operations.

Motivation: It is important that you learn the proper firefighting procedures in aerospace crash fires for your own safety and well being.

Transition: We are going to start today's lesson performing as a member of a firefighting crew.

BODY

TIME: 5 hrs 50 min

Presentation:

TIME: 40 min

1. Given a burning aircraft mock-up, protective clothing and technical data, perform as a member of a firefighting crew to control and extinguish aerospace crash fires using an O-11A/B or P-4 aerospace crash fire and rescue vehicle. Each fire must be completely extinguished while observing all applicable safety practices. Simulate rescue from aircraft as required.

Check outside assignment

Stress to properly operate Air Force Equipment in order to prevent damage resulting in costly repair

a. Crew duties

(1) Turret operators

(a) O-11A/B

Stress safety

(b) P-4

Seat Belts

(2) Crew chiefs

(a) O-11A/B

Use charts CC73-03 thru CC73-14

(b) P-4

"Burn Procedure Charts"

- (3) Handlineman
 - (a) O-11A/B
 - (b) P-4

b. Signals

- (1) Turret operators
- (2) Crew chiefs
- (3) Handlineman

c. Safety

- (1) Seat belts
- (2) No jewelry
- (3) Glasses - retainer straps; no contact lenses
- (4) Keep away from burn barrels
- (5) Keep nozzle in your chest
- (6) Proper side of nozzle

Application

1. Given a burning aircraft mock-up, protective clothing and technical data, perform as a member of a firefighting crew to control and extinguish aerospace crash fires using an O-11A/B or P-4 aerospace crash fire and rescue vehicle. Each fire must be completely extinguished while observing all applicable safety practices. Simulate rescue from aircraft as required.
2. Given a simulated aircraft and appropriate cleanup equipment, perform firefighting overhaul cleanup operations while observing all applicable safety practices with minimum instructor assistance.
3. Given necessary equipment, perform preventive maintenance on aerospace crash fire and rescue vehicles IAW AFIO Form 433. Maintain station facilities and protective clothing as required.

TIME: 5 hrs

7 INSTRUCTORS ARE REQUIRED

Stress Safety
Energy and materials conservation

- Use TO 36A12-8-9-1
- TO 36A12-8-12-1
- TO 36A12-12-14-1

Use vehicles O-11A/B; A/S32P-4

Use WB-514

Use complete set of protective clothing

Use Rescue Dummies

- Use Trainers: Simulated F-102 acft
- Simulated F-105 acft
- Simulated F-106 acft
- Firefighting (B-47)
- Firefighting (C-135)

Use Preventive maintenance materials



Evaluation:

TIME: 10 min

Intersperse throughout the presentation.

CONCLUSION

TIME: 5 min

Summary: Cover main points of lesson to include performing as a member of a firefighting crew to control and extinguish aerospace crash fires, rescue from aircraft as required and performing firefighting overhaul cleanup operations.

Remotivation: Your safety and well being depends on how well you learned today's lesson.

Assignment: Read and study SG-515, Control, Extinguishment, Overhaul and Rescue on Medium Frame Aircraft Fires and answer the questions at the end of the unit.

Closure: Remember, tomorrow's fires start betting bigger.

INTRODUCTION

TIME: 5 min

Attention: Today is the day the fires get a little bigger.

Review: In yesterday's lesson we covered control, extinguishment, overhaul and rescue from small frame aircraft.

Overview: During the next six hours, we will perform, control, extinguishment, overhaul and rescue on medium frame aircraft fires while performing as a crew member of a aerospace crash firefighting vehicle.

Motivation: Not only to protect others lives, but your own, it is important that you learn proper firefighting procedures.

Transition: We are going to start today's lesson by covering crew duties.

BODY

TIME: 5 hrs 50 min

Presentation:

TIME: 40 min

1. Given a burning aircraft mock-up, protective clothing and technical data, perform as a member of a firefighting crew to control and extinguish aerospace crash fires using aerospace crash fire and rescue vehicles. Each fire must be completely extinguished while observing all applicable safety practices. Simulate rescue from aircraft as required.

Stress to properly operate Air Force Equipment in order to prevent damage resulting in costly repair

a. Crew duties

(1) Turret operators

Stress safety

(a) C-11A/B

(b) P-2/4

Use charts CC73-03 thru CC73-14
"Burn Procedure Charts"

(2) Crew chief

(a) C-11A/B

(b) P-2/4

(3) Handlines

(a) C-11A/B

(b) P-2/4

b. Signals

- (1) Turret operators
- (2) Crew chiefs
- (3) Handlines

c. Safety

- (1) Seat belts
- (2) Jewelry
- (3) Glasses
- (4) Burn barrels
- (5) Nozzle

Application

1. Given a burning aircraft mock-up, protective clothing and technical data, perform as a member of a firefighting crew to control and extinguish aerospace crash fires using aerospace crash fire and rescue vehicles. Each fire must be completely extinguished while observing all applicable safety practices. Simulate rescue from aircraft as required.

2. Given a simulated aircraft and appropriate cleanup equipment, perform firefighting overhaul cleanup operations, while observing all applicable safety practices with minimum instructor assistance.

3. Given necessary equipment perform preventive maintenance on aerospace crash fire and rescue vehicles IAW APTO Form 433. Maintain station facilities and protective clothing as required.

Evaluation:

Intersperse throughout the presentation.

TIME: 5 hrs

7 INSTRUCTORS ARE REQUIRED

Stress Safety
 Energy and Materials Conservation

- Use TO 36A12-8-9-1
- TO 36A12-8-12-1
- TO 36A12-12-14-1
- TO 36A12-8-13-1

Use Vehicles O-11A/B
 A/S32 P-2
 A/S32 P-4

Use WB-515

Use complete set of protective clothing

Use rescue dummies

Use Trainers: Firefighting B-47
 Firefighting (C-135)

Preventive Maintenance Materials

TIME: 10 min



Summary: Cover main points of lesson to include control, extinguishment, rescue and overhaul of medium frame aircraft.

Remotivation: Your safety depends on how well you learned today's lesson.

Assignment: Read and study SG-516, Control, Extinguishment, Overhaul and Rescue on Large Frame Aircraft Fires and answer the questions at the end of the unit.

Closure: Well, you only have one more day of live fire.

**CONTROL, EXTINGUISHMENT, OVERHAUL
AND RESCUE ON LARGE FRAME
AIRCRAFT FIRES**

INTRODUCTION

TIME: 5 min

Attention: Today is the day of the big one.

Review: In yesterday's lesson we covered control, extinguishment, overhaul and rescue from medium frame aircraft.

Overview: During the next 6 hours, we will perform, control, extinguishment, overhaul and rescue on large frame aircraft fires.

Motivation: This is it.....the big fire! Today you will be participating in the fire that you have been waiting for during the past nine weeks. We have confidence in you.....show your confidence to us.

Transition: We are going to start today's lesson by covering crew duties.

BODY

TIME: 5:50

Presentation:

TIME: 40 min

1. Given a burning aircraft mock-up, protective clothing and technical data, perform as a member of a firefighting crew to control and extinguish aerospace crash fires using aerospace crash fire and rescue vehicles. Each fire must be completely extinguished, while observing all applicable safety practices. Simulate rescue from aircraft as required.

Stress to properly operate Air Force Equipment in order to prevent damage resulting in costly repair

a. Crew duties

Stress Safety.

(1) Turret operators

(a) 011A/B

(b) P-2/4

(2) Crew Chief

(a) 011A/B

(b) P-2/4

Use Charts CC73-03 thru CC73-14.

"Burn Procedure Charts"

(3) Handlines

(a) 011A/B

(b) P-2/4

b. Signals

(1) Turrets

(2) Crew Chief

(3) Handlines

c. Safety

(1) Seat belts

(2) Jewelery

(3) Glasses

(4) Burn barrels

(5) Nozzel

Stress

Application:

1. Given a burning aircraft mock-up, protective clothing and technical data, perform as a member of a firefighting crew to control and extinguish aerospace crash fires using aerospace crash fire and rescue vehicles. Each fire must be completely extinguished, while observing all applicable safety practices. Simulate rescue from aircraft as required.

2. Given a simulated aircraft and appropriate cleanup equipment, perform firefighting overhaul cleanup operations, while observing all applicable safety practices with minimum instructor assistance.

3. Given necessary equipment, perform preventive maintenance on aerospace crash fire and rescue vehicles IAW AFTO Form 433. Maintain station facilities and protective clothing as required.

TIME: 5 hrs

7 INSTRUCTORS ARE REQUIRED

Stress safety energy and materials conservation.

Use TO 36A12-8-9-1

Use TO 36A12-8-12-1

Use TO 36A12-12-14-1

Use TO 36A12-8-13-1

Rescue Dummies

Use Vehicles 011A/B

A/S 32 P-2

A/S 32 P-4

Use Trainers:

Firefighting (B-47)

Firefighting (C-135)

Preventive Maintenance Materials

Use: WB 516



Evaluation:

TIME: 10 min

Interspersed throughout the presentation.

CONCLUSION

TIME: 5 min

Summary: Cover main points of lesson to include control, extinguishment, rescue and overhaul of large frame aircraft.

Remotivation; Your life and someone elses depends on how well you learned today's lesson.

Assignment: Read and study SG 517 Aircraft Arresting Systems and answer the questions at the end of the unit. Review all areas for the block test tomorrow.

Closure: Be ready for the test tomorrow.

AIRCRAFT ARRESTING SYSTEMS

INTRODUCTION

TIME: 5 min

Attention: Did you ever wonder how an aircraft stops when it has a brake failure?

Review: For the last four days we have been having live fires and actual firefighting operations.

Overview: During the next three hours we will be covering aircraft arresting systems to include inspection, responsibilities, purpose and use of arresting systems.

Motivation: It is going to be up to you to see that aircraft have a chance to engage a barrier to prevent the loss of life and property.

Transition: The first area we are going to cover is responsibilities.

BODY

TIME: 2 hrs 50 min

Presentation:

TIME: 2 hrs 40 min

1. Without reference, identify simple facts related to assisting the inspection and operation of aircraft arresting systems. Eighty percent of facts must be identified correctly.

a. Responsibilities

(1) Fire protection

(a) Normal duty hours

1. Assist power production

(b) Other than normal duty hours

1. Perform visual inspections

2. Perform activation or deactivation of barrier

3. Accomplish routine inspection after all engagements

(2) Power production

(a) Normal duty hours

- 1. Responsible for barriers installation and removal
- 2. Performs maintenance
- 3. Provide OJT to firemen

(b) Other than normal duty hour

- 1. Responds to calls for emergency maintenance

(c) Combat situations

- 1. Totally responsible for all aircraft arresting systems

b. Arresting Barriers

Show Film FR-192, "Arresting Barrier System"

(1) Purpose and uses

(a) Save lives (primary purpose)

(b) Save aircraft (Secondary purpose)

(c) May be called emergency barriers

- 1. Usually placed in the overrun area of runway
- 2. Used for aircraft taking off or landing
- 3. May be placed 1500 ft from the runway end

(d) Some barriers are operational types used for normal landings and emergency landings

- 1. Emergency barriers

- a. A barrier that will save lives and prevent damage to the aircraft during an aborted takeoff or on emergency landing
- b. MA-1A, BAK-9, 12 and 13 may be used as emergency barriers
- c. Usually installed at the end of the active runway
- d. Bi-directional emergency barriers are installed 950 to 1500 feet from end of runway. (This barrier may also have operational capability)
- e. Emergency barriers may be used for aircraft taking off or landing

2. Operational barriers

- a. A barrier with rapid recycling capabilities
- b. Needed to avert a possible emergency which may be caused by weather conditions, or a short runway, or a known or suspected aircraft malfunction
- c. Bi-directional operational barriers may be installed 1500 ft to halfway point of runway

(2) Operating characteristics

(a) MA-1A

- 1. Arrests hook and non-hook equipped aircraft
- 2. Webbing engages nose gear and throws cable into main gear

- 3. Anchor chain is the energy absorbing device
- 4. 1000 foot runout
- 5. Engaged from one direction only

(b) BAK-12 and BAK-9

- 1. Can be engaged from either direction
- 2. Engages hook equipped aircraft only
- 3. The BAK-9 may be interconnected with the MA-1A webbing for non-hook equipped aircraft.
- 4. Aircraft hook snares the runway pendant which in turn pulls the purchase tape from the reels
- 5. The reel assembly is the power source for the hydraulic pump

- 6. Hydraulic pump supplies the pressure for the brakes
- 7. Aircraft type brakes (B-52) are the energy absorbers
- 8. 950 feet runout
- 9. Rewind is by electric motor or gasoline engine

(c) BAK-13

- 1. Can be engaged from either direction
- 2. Engages hook equipped aircraft only
- 3. Aircraft engages the runway pendant which pulls the tape from the reel assembly.

- 4. Shaft spins the turbine in the tank
- 5. Force of the fluid against the turbine is the energy absorber
- 6. 950 feet runout
- 7. Rewinding tape is accomplished by a gasoline engine

(3) Barrier configurations

(a) MA-1A

- 1. Used as an emergency barrier only

(b) BAK-12

- 1. Used as an emergency or operational barrier
- 2. Installed 1500 feet from the end of the overrun area
- 3. Installed in pits, expeditionary method, semi-permanent or permanent installation

(c) BAK-9

- 1. Used as an emergency barrier
- 2. Normally installed in pits for a permanent installation
- 3. Placed in the overrun area

(d) BAK-13

- 1. Used as an operational barrier
- 2. Installed where needed on runway



- 3. Semi-permanent or expeditionary method of installation can be used

(4) Principle assemblies

- (a) All barriers consist of an energy absorber, an engaging device, and a rewind system

- (b) Types of energy absorbers

- 1. MA-1A - anchor chain
- 2. BAK-9 and BAK-12 - have rotary friction brakes
- 3. BAK-13 - rotary turbine (velocity sensitive turbine)

- (c) Types of engaging devices

- 1. MA-1A uses nylon webbing assembly
- 2. BAK-9, BAK-12 and BAK-13 use a runway pendant

- (d) Types of rewind system

- 1. Coleman M-4 (MA-1A)
- 2. Electric motor (BAK-9)
- 3. Packette engine (BAK-12)
- 4. Wisconsin engine (BAK-12 and BAK-13)

(5) Importance and use of technical orders in barrier maintenance and safety

- (a) When maintenance is done on barriers, the TO will be followed
- (b) Must be used to maintain the flight safety factor

Application:

TIME: N/A

Evaluation: Interspersed throughout the lesson

TIME: 10 min

CONCLUSION

TIME: 5 min

Summary: Cover main points of lesson to include fire protection responsibilities, power production responsibilities and aircraft arresting barriers.

Remotivation: Just think you will be the one to see that the barrier is always ready to save lives and aircraft.

Assignment: N/A. Prepare to give the written measurement

Closure: Well, it is now time to take the block test and pass it.

INITIATE MEASUREMENT TEST AND TEST CRITIQUE

INITIATE COURSE CRITIQUE

PREPARE FOR GRADUATION



Technical Training

Fire Protection Specialist
Crash Firefighter

17-3

AEROSPACE VEHICLE FIREFIGHTING

29 July 1975

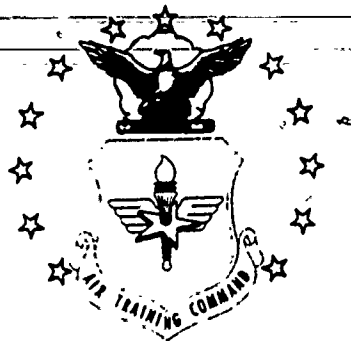

CHANUTE TECHNICAL TRAINING CENTER (ATC)

This supersedes 3ABR57130-1-SG-500, 11 June 1973 and 3ABR57130-1-HO-100,
7 December 1972.

OPR: TWS

DISTRIBUTION: X

TWSTC - 2000; TTVGC-3

Designed For ATC Course Use

DO NOT USE ON THE JOB

Study Guides and Workbooks are training publications authorized by Air Training Command (ATC) for student use in ATC courses.

The STUDY GUIDE (SG) presents the information you need to complete the unit of instruction or makes assignments for you to read in other publications which contain the required information.

The WORKBOOK (WB) contains work procedures designed to help you achieve the learning objectives of the unit of instruction. Knowledge acquired from using the study guide will help you perform the missions or exercises, solve the problems, or answer questions presented in the workbook.

The STUDY GUIDE AND WORKBOOK (SW) contains both SG and WB material under one cover. The two training publications may be combined when the WB is not designed for you to write in, or when both SG and WB are issued for you to keep.

Training publications are designed for ATC use only. They are updated as necessary for training purposes, but are NOT to be used on the job as authoritative references in preference to Technical Orders or other official publications.

CONTENTS

<u>UNIT</u>	<u>TITLE</u>	<u>PAGE</u>
501	Block V Orientation	1 through 3
502	Principles and Procedures of Aerospace Vehicle Firefighting	5 through 16
503	Principles and Procedures of Rescue	17 through 34
504	Rescue Operations	35 through 42
505	Ramp Vehicle Inspection, Maintenance and Operations	43 through 44
506	O-11A Inspection, Maintenance and Operations	45 through 47
507	O-11B Inspection, Maintenance and Operations	49 through 50
508	P-2 Inspection, Maintenance and Operations	51 through 53
509	P-4 Inspection, Maintenance and Operations	55 through 57
510	Procedures for On Scene Operations	59 through 64
511	Emergency Response Exercises	65 through 70
512	Emergency Response and Aircraft Approach Exercises	71 through 72
513	Control and Extinguishment on Small Frame Aircraft Fires	73 through 75
514	Control Extinguishment, Overhaul and Rescue on Small Frame Aircraft Fires	77 through 78
515	Control, Extinguishment, Overhaul and Rescue on Medium Frame Aircraft Fires	79 through 81
516	Control, Extinguishment, Overhaul and Rescue on Large Frame Aircraft Fires	83 through 86
517	Aircraft Arresting Systems	87 through 90
	Bibliography	91

BLOCK V ORIENTATION

OBJECTIVES

After completing this study guide and your classroom instruction, you will participate in a discussion consisting of questions and answers on block contents, safety, and energy conservation.

INTRODUCTION

Welcome to Block 5. Most people have a desire to know what will be required of them in any given situation. At this point we feel it is important for you to have a clear picture of your three weeks in Block 5. This study guide contains specific information which will aid you in successfully completing this course. The extent of your success or failure depends on you. If you apply yourself, use your abilities, participate in classroom work and take advantage of your practical exercises, you will be successful in this block and will be on your way to a better education. We will acquaint you with the principles and procedures of extinguishing fires resulting from aerospace vehicle crashes. In addition, you will be informed of the procedures which are required to safely remove or assist personnel from aerospace vehicles.

INFORMATION

BLOCK CONTENT

Duty Hours

Because training is better accomplished during daylight hours, the duty hours of training for Block 5 have been adjusted to better benefit all of our needs. Block 5 personnel have been divided into two equal shifts. "A" shift conducts training from 0600 hours to 1200 hours and "B" shift from 1200 hours to 1800 hours. Regardless of which shift you may be assigned you can be assured that the efficiency of training that you will receive is equal.

Your duty hour may be slightly extended in Block 5 for the purpose of remedial instruction (R&I). This type of instruction is assigned to further assist you in ~~difficult areas.~~ Remedial instruction is often conducted and should never be considered as a form of punishment. With you in mind, your instructor may schedule you for R&I. You may also request it at any time you feel the need of additional assistance. Remedial instruction for "A" shift is conducted from 1330 to 1500 hours and for "B" shift 0930 to 1100 hours.

Chain of Command

You have a definite channel to follow for any assistance you may need in Block 5. Your chain of command is as follows:

1. Instructor.
2. Block Supervisor.
3. Course Supervisor.
4. Branch Chief.

Instructional Periods

The length of this block is three weeks, classes are conducted five days a week, six hours per day.

Proper Care and Handling of Equipment

The equipment that you will use in this course is provided for training purposes only. Many students have used it before you and many more will use it after you graduate. Use proper care in handling the equipment. Remember, a unit of equipment is only as good as the person who uses it. It is often said, "Care for a piece of equipment as if it were your own." Unfortunately, many people do not care for their own tools and equipment. In fire protection, we continually stress the importance of proper handling and care of equipment. Handle it properly now, and later, when it may mean the difference between life or death, you will use it properly. In keeping with school policy, you will be required to clean up what you "mess up." This usually includes the classrooms, latrines, vehicles, break areas, and the fire training area. The area you will be required to clean up will be assigned by your instructor. Your personal equipment will be taken care of and properly hung when not in use.

Military Courtesy and the Uniform

Military courtesy and the uniform are the most important emblems of the Air Force. They readily identify us from other large organizations. Remember that your conduct reflects you and on you as well as on the Air Force. Policies on saluting, calling attention in classrooms, and other matters pertaining to military courtesy and the uniform will be explained by your instructor.

SAFETY

We have never lost a fireman in this school. There have been some minor injuries which were caused mostly by not following instructions. There should be no need to fear fire, but there is a need to respect it. With your instructor's knowledge and guidance, plus training prior to the burning phase, you will be adequately prepared to perform rescue, and control and extinguish fire. Your instructors will be with you at all times. Remember, he does not have a nozzle, you have it. Do what he tells you and you will have a safe and enjoyable experience in live fire training. The following safety rules must be observed:

1. Wear no jewelry.
2. Walk, do not run.
3. Mount, dismount or unlatch doors only when the vehicle is stopped.
4. Ride a vehicle only in an authorized position, never on top.
5. Do not smoke in the vehicles.
6. Leave vehicle windows up during training fires.
7. Keep trash and unnecessary equipment out of vehicles.
8. Wear full protective gear in the fire area at all times.
9. Report all broken or defective clothing and equipment at once.
10. Use equipment only when supervised.

- 11. Never use or move other people's protective clothing.
- 12. Stay alert - comply with instructor's directives.
- 13. Never horseplay.
- 14. Use all vehicle hand holds and steps.

Training fires safely is our mission, but it requires your cooperation. This school has an excellent record of taking care of its students, and your safety is your instructor's primary concern. All instructors are carefully screened and selected, and have proven their ability in the field before being assigned here. You can depend upon their giving you top quality instructions. Give your best to Block 5 nothing less will be acceptable, and you will find it an enjoyable experience. Your instructor will be observing you during all your training in Block 5. He will verify that you are cooperative, can perform as a team member, can display courage, and good judgment, and that you have the necessary ability to perform as a fireman. You will be counseled for any lack of effort or ability in these areas.

ENERGY CONSERVATION

While you attend this course, energy conservation will be practiced to the fullest extent to include the use of classroom cleaning materials, room temperature and lighting when not in the classroom. While working on the vehicle, energy conservation will be practiced in regard to leaking vehicles (water, foam, gas, and oil), overflowing tanks (water, foam and gasoline), cleaning materials (water, soap, wax and rags). Conservation of fuel can be practiced by operating the vehicle at low RPMs.

QUESTIONS

Please answer questions on a separate sheet of paper.

- 1. What are the duty hours for A shift? _____ to _____; B shift? _____ to _____.
- 2. In keeping with the School _____, you will be required to _____ up what you _____ up.
- 3. Name five safety precautions we observe when we are utilizing Crash Aerospace Vehicles.
 - a. _____.
 - b. _____.
 - c. _____.
 - d. _____.
 - e. _____.
- 4. What is the length of Block V? _____.
- 5. Remedial instruction should never be considered as a form of _____.

REFERENCES

None



PRINCIPLES AND PROCEDURES OF AEROSPACE VEHICLE FIREFIGHTING

OBJECTIVES

After completing this study guide and classroom instructions, you will be able to:

1. Identify principles and procedures of aircraft firefighting.
2. Identify principles of missile firefighting.
3. Identify runway foaming operation procedures.
4. Identify standby operation procedures.
5. Identify airfield patrol and surveillance operation procedures.
6. Identify principles of large frame aircraft heat and smoke ventilation.

INTRODUCTION

There are many duties performed by crash crews in addition to firefighting and rescue. Firefighters must constantly be on the alert for aircraft and flightline fire hazards. This is why aircraft firefighting crews spend most of their duty hours patrolling the aircraft parking ramp and flightline. They are also called upon to provide fire protection for aircraft refueling, defueling, and maintenance operations. Firemen also stand by during loading or unloading of special weapons on aircraft. Protecting the aircraft parked on their base is the fire department's responsibility.

INFORMATION

AEROSPACE VEHICLE FIREFIGHTING

Crew Responsibilities

In this block of training, you will find yourself simulating crash firefighting, as in figure 1. This means you have a definite responsibility to perform as a team. WHY? This is the first time you will be involved in actual firefighting under simulated conditions. With this in mind, it becomes apparent that you must know your duties as a crew member and as an individual. As part of a crew you will find that protection of your fellow crew members is a must during firefighting operations. As an individual you must know what nozzle stream is to be used and how and when to apply it. You must know hand signals and how to protect yourself in the event of overexposure to heat. You must remember you are an important part of a very important team. For the individual, team work extends to the single crash crew, to other crash crews, then to all activities involved. Not as individual units, but as component parts of a general overall plan, each with full knowledge of the objectives of other participants.

Rescue

Lives may depend upon how well you perform rescue. It is rarely possible to complete a rescue operation without first being exposed to some type of hazard. It may be fire, smoke, explosion, or the accidental actuation of an aerospace vehicle ejection seat. Normally, there will be fire, and if rescue operations are necessary, the proper use of special tools and equipment will greatly assist you in your work.



Figure 1. Hot Simulated Crash Fire.

Teamwork is also very important in rescue activities where time is a limiting factor. The degree of success depends on a well trained team. Many Air Force personnel have jobs that call for an average amount of accuracy. These jobs do offer an opportunity to do it again if someone makes a mistake. The crash rescuer does not have this second chance. Rescue has to be accomplished during the first try. Rescue procedures will be introduced in detail to help you accomplish the successful first-try rescue.

Firefighting

Every year, many lives and millions of dollars are lost because of aerospace vehicle accidents. We have the direct responsibility to perform rescue, control, and extinguishment of fires involving aerospace vehicles. In such operations a firefighter must know how to apply extinguishing agents effectively in order to control the fire

in minimum time. It must be remembered, regardless of your initial crew assignment, that you must remain "flexible" to perform any job during an emergency.

315

Training

In order to become professional in the fire protection career field, your training must include many subjects. Your training begins now and will continue throughout your Air Force Career. Through on-the-job training programs and technical schools, you will progress to higher levels of proficiency and job knowledge. This training is provided for you at Air Force expense. Your only expense will be to give your attention and time to the programs. It is up to you how far you want to progress in the fire protection career field.

Pre-Fire Planning

Each fire organization develops a prefire plan on each type of mission assigned aircraft, also, mission support and transient aircraft that land and takeoff. Also, aircraft that make touch and go landings from the same installation on an average of seven times a week during any three consecutive month period will have prefire plans. Prepare AF Form 1028 to help aerospace vehicle firefighting crews to arrive on the scene of an emergency in minimum time. Where will we concentrate most of the aerospace vehicle firefighting equipment while awaiting the arrival of an aerospace vehicle in trouble? Which route will be taken if an aerospace vehicle crashes off base? These questions and many more can be answered through prefire planning. AF Form 1028 should be reviewed at least annually and updated when required.

Fuel Spills

Fuel spills are caused by human carelessness and faulty fuel systems on the aircraft or refueling vehicles. These spills may occur any place where fuel is used, transferred, or handled. Your job is to dispose of or neutralize these spills. Suppose there is a 150 gallon fuel spill under an aircraft. What should you do? The following information should answer this question.

Of all the operations the fire department has, some are very simple and safe to do. Others may be very dangerous. Are fuel spills very dangerous? You bet they are! A 10 gallon gasoline or JP-4 fuel spill in an open flat surface is not hard to wash down and get rid of, but this same spill in an enclosed area is dangerous and presents many problems.

Most fuel spills occur on the flightline. Firefighters must figure out how big the spill is and how close it is to aircraft, hangars, shops, vehicles, and sewers. You must also decide whether aircraft parked near the spill should be moved away. You must also decide how close you can position your fire trucks to the area. Will you clear people out of nearby buildings as a precaution? Will you notify the security police to rope off the area around the spill? You must also check sources of ignition that could ignite the fumes from the spill. These ignition sources could be heaters, open flames from welding shops, draft doors on furnaces, and arcing electrical devices. A large fuel spill should never be washed down a sewer drain. Fuel and fumes may run unnoticed through the sewer system on the base. If someone tossed a lighted cigarette down the sewer, an explosion or fire could destroy the entire base.

How do you guard against these danger? Small spills, if they are in open areas away from danger, may be flushed with water and spread over a large area. The force of the water stream not only moves the fuel, but also creates air currents so that vapors cannot gather.

Fuel spills under aircraft are flushed in the same way, except that the water streams should move the fuel away from the aircraft--never under it. Large fuel spills

beneath aircraft should be foamed first. Then the aircraft should be towed away. Other aircraft nearby should also be towed away. All electrical power sources should be turned off before the aircraft is moved. After the aircraft has been moved, large amounts of water can be used to wash the foam and fuel away to a safe area. Sewers that have had fuel spilled, washed, or poured into them should be flushed with large amounts of water. Dry, warm, and windy weather will help dry and evaporate the fuel and keep the fuel vapors below the explosive limits.

First Aid

What is first aid? First aid is the immediate but temporary care given to a victim until medical help arrives. First aid is often needed during aircraft crashes. Rescuemen normally are the first to reach trapped aircrew members and passengers. For this reason, all fire protection personnel must have a working knowledge of first aid. But what if rescuemen could cause greater injury or even death to the victim by improper or hasty removal. So it is important that rescuemen have a far better knowledge of first aid than other individuals. It is most important that rescuemen remove a victim from a crash scene without making the victim's injury worse. Although medical help will almost always be at the scene, there may be times when rescuemen may need to give first aid.

MISSILE FIREFIGHTING

The functions of a fire organization at a missile or space vehicle test or launch site must be well established. In addition to responsibilities for structural firefighting, it will be necessary at some sites to define aerospace vehicles firefighting and rescue responsibilities. These include:

Certain standby fire protection for recognized exceptional hazard operations preceding test or launch.

Control and extinguishment of fires involving facilities, missiles or space vehicles.

Personnel rescue as may be required.

Fire prevention inspection. Proper use of AF Form 1487 and maintenance of fire protection equipment as required.

The range of functions to be performed at a particular site will depend upon the nature of the operation. Where the site is surrounded by heavily wooded terrain, peat-burning and forest or brush fire control will be required to minimize exposure hazards.

The importance of careful preplanning of fire protection operations cannot be overstressed. No feature of the fire protection program can do more to assure effective use of men and equipment under normal and emergency conditions than a review of simulated drills in anticipated problems before an emergency develops. Through preplanning it is possible to anticipate the nature of the problem at a given site, to develop a program of coordination with related services, to establish optimum plans for assignment of men and equipment for various types of operations, to determine areas where more intensive training may be required, and to resolve new problems. Elements of preplanning should cover:

Basic procedures for emergency response.

The number, type, configuration, and general operation of missiles or space vehicles and the stands related thereto.

317

The layout of the launch site area, including access roads, terrain features, water supplies (both installed systems and hydrant installations) and the number, type, and location of support facilities.

The location and layout of bulk, and ready propellant storage areas and the hazards of materials stored therein.

The exact nature of the relationship between the fire department and other support services will be established in preplanning sessions. It is important that the fire department should know that other support services are available and the extent of their availability. A close working relationship with missile safety personnel is of primary importance. Likewise, it is important to know where responsibility lies for the operation of utility services including water and electricity, the stopping of fueling or defueling operations, the availability of medical services and of heavy equipment that may be essential to rescue operations.

PREPLANNING FOR LAUNCH FACILITIES

The hazardous operations requiring standby can be predetermined with reason and personnel and equipment assigned accordingly. Periodic review of these standby operations on the basis of actual experience will allow for the correction of deficiencies in such programming, with a view toward the evaluation of the continued need for such standbys.

The development of men and equipment for required standby operations can be expedited through the use of sketches or charts showing the respective position of vehicles, charged hand lines, fire extinguishers, and the number of personnel at each point. Such visual aids in the assignment of duties should be supplemented by a typed list of the requirements for each operation, showing not only procedures and instruction for fire organization personnel that are expected to be present. These instructions will assist in minimizing confusion that might develop during standby emergency operation and will establish a basis for coordinated action on the part of all emergency personnel.

The plan for each type of operation should establish the most effective use of personnel and equipment for standby procedures. Enough flexibility must be maintained, however, to permit the officer in charge of the fire organization to adapt preconceived planning to the fullest extent of a particular situation. Ability to form such judgments will, to a large extent, determine the effectiveness of the fire organization.

In responding to a call for standby service, the officer in charge of the fire organization should immediately size up the situation and put into effect the procedures required. In most instances the fire organization will be called by the missile safety officer and will of necessity be required to work closely with that person.

On any standby operation the officer in charge of the fire organization must consider the particular operation in relation to other possible hazardous operations and the presence of combustible materials in the area. He must also check the number of persons working on the stand with a view to most effective withdrawal or rescue in the case of accident. Where fueling or defueling is involved, attention must be given to temporary construction or operational procedures and equipment that may affect normal drainage or washdown of spills that might occur. The selection of hydrants and laying of lines should be done with due consideration to the location and drainage of possible spills. Men and equipment should be positioned so that they would not be cut off from escape or otherwise immobilized in the event of an accident.

Wherever possible or practicable it is desirable to rely upon the use of charged hand lines for standby purposes rather than to commit vehicles.

Communication channels should be checked immediately upon reporting for standby so that in the event of emergency, additional assistance may be called without delay.

Assuming proper sizeup of the particular operation and the availability of men and equipment to meet the specific procedures, the action to be taken in the event of emergency should be routine. Care should be taken, however, that the fire organization officer in charge is in a position where he can follow the entire emergency operation and exercise judgment as to when withdrawal or change in tactics may be required.

LAUNCH FACILITY OPERATIONS

With one exception, the procedure outlined under standby operations above is generally applicable to test and launch operations. For instance, in launch operations the stand is cleared, and operating personnel have withdrawn to the blockhouse, and emergency personnel and equipment are withdrawn to fallback areas.

Standard fire protection operating procedures should be developed prior to any actual test or launch and for each type of operation, specifying the number and classification of personnel, the number and type of firefighting equipment, the number and size of hose lines to be preconnected on the pad, and the nature of other emergency services to be present.

Prearranged signals from the missile safety officer will indicate the time at which all emergency vehicles will withdraw to the fallback area. Similarly the missile safety officer will indicate when and which of the emergency services will be called into the area after test or launch. Under most circumstances, static tests on launch stands will be conducted on "wet" stands, and emergency services will not be required.

On "dry" stands used for launch, the missile safety officer, when required, will call the fire department to extinguish fires occurring in air conditioning ducting, insulation, and minor fuel spills. The cooling of hot metal parts of the launch stand may be required and should be done with care to avoid excessive stresses caused by too sudden cooling of the metal parts involved.

The most severe fires on stands have developed when fuel and oxidizer tanks on liquid-propelled vehicles have become involved because of failure of high-pressure lines or valves, or toppling of the missile itself. In such an event the fire department will not be called nor will respond until the danger of explosion or detonation is lessened so that firefighters are not unnecessarily exposed to these hazards. Also the capability of fixed water systems on and about the pad are greater than the capability of the fire department for controlling this type of fire. Should failure in fixed water systems occur, the fire department may be called to protect elements of ground support equipment and to wash down excess fuel. The proper use of water fog can reduce heat exposure to personnel and equipment. Turret or deluge nozzles are more effective under such conditions.

Under these circumstances, care should be taken to prevent unnecessary hazardous exposure of personnel and equipment. Propellant tank ruptures have occurred with explosive force, throwing burning propellant and shrapnel-like fragments for some distance.

The missile safety officer is responsible for calling in the fire organization, but once on the site the officer in charge of the fire organization is responsible for the actions of his crews and equipment.

After a successful launching, the fire organization normally is called in by the missile safety officer. Their function at this time is to extinguish incidental fires and to wash away any propellant spills.



After every major operation on the pad, a critique is usually held. A fire organization representative should attend to obtain results of fire protection operations; eliminate deficiencies if possible; and improve operations, if possible. Such critiques are particularly important after major accidents, when full capabilities of the department have been utilized.

RUNWAY FOAMING

If the pilot of an aircraft declares an emergency, the nature of this emergency may also cause him to ask that the base fire department blanket the runway with foam. Foam is applied to the runway to reduce the danger of fire caused by the sparks from the aircraft sliding on the runway surface.

Pilots may request that the runway be foamed when they cannot get their landing gear lowered and need to make a wheels up (belly) landing. A pilot may request runway foaming if he has an unsafe landing gear indication. Each pilot who requests a foamed runway states the nature of his emergency. He also states the flying time he has left, amount of fuel aboard, weapons on board, and the number passengers he is carrying. All this information is sent to the control tower by radio. The control tower then passes this information on to the fire department to allow them the maximum possible time to complete the runway foaming operation.

The water in the foam is what actually prevents the sparks that cause a fire. As the water slowly drains out of the foam, it settles on the surface of the runway. This water cools the sparks and pieces of hot metal from the aircraft as it slides through the foam. With the proper equipment, a foam blanket can be spread to do this important job. The foam blanket should be about 1-1/2 inches thick; however, the correct amount of water mixed with the foam is more important than the depth of the foam.

The foam should stand about 4 minutes to allow enough water to drain to the runway surface. After the blanket has been laid, it should be effective up to 1 hour under normal weather conditions. High temperatures, low humidity, and high winds may cause the foam to dry and ruin the blanket in less time.

The foam blanket should be spread without breaks or bare spots. One bare spot in the blanket could cause the aircraft to catch fire and destroy the purpose of the entire operation. The firefighting crew that is foaming the runway should keep in constant radio contact with the pilot. He may have to land sooner than he planned.

The length, width, and depth of the foam blanket will change with the type of aircraft, type of emergency, and the amount of foam that is available. The chart at the end of this paragraph shows you the correct amounts of water and foam liquid to use when foaming a runway. The foam blanket should never be more than 30 feet wide and may be less for smaller aircraft. Study the following information before going on.

FOAM WIDTH IN FEET	FOAM LENGTH IN FEET	GALLONS OF WATER NEEDED	GALLONS OF LIQUID FOAM NEEDED
20	1,000	2,000	120
30	1,000	3,000	180
20	2,000	4,000	240
30	2,000	6,000	360
20	3,000	6,000	360
30	3,000	9,000	540



Figure 2. 5,000 Gallon Runway Foaming Unit.

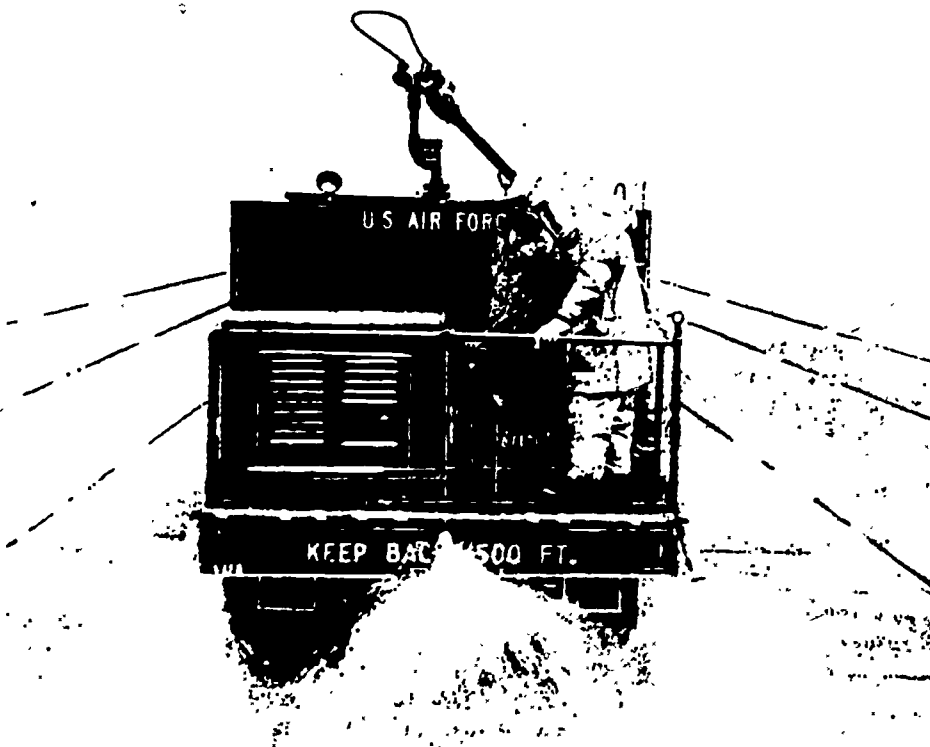

57130/50-43

Figure 3. Laying A Foam Blanket on A Runway.

321

Special equipment is authorized for foaming runways. USAF Fire Departments have locally developed foam spray bars that are mounted on the rear of the 1000 and 1500 gallon water distributors. These water distributors have been modified with a foam tank and piping system for runway foaming. Many departments are also converting refueling trucks to runway foaming vehicles. These refueling trucks are larger and hold more foam. At one Air Force Base, the base fire department changed a 5,000 gallon tractor trailer into a runway foaming unit. They did this by attaching a 500 gallon pump with engine and a sprayer bar on the rear of the trailer. They also added the necessary piping and fittings. This unit is capable of laying a foam blanket 32 feet wide and 6,000 feet long. The pump, engine, spray nozzles, and controls can be operated by one firefighter on the rear of the trailer. The 5,000 gallon runway foaming unit is shown in figure 2.

When the unit is put into operation, the vehicle travels at a speed between 3 and 5 miles per hour. A constant speed is needed to insure that the blanket is free of breaks or bare spots. The foam blanket, as shown in figure 3, is laid on the runway by foam sprayer bars. NOTE: constant speed of the unit is very important when laying a foam blanket. Installing a tachometer on the truck will help the driver hold a constant speed.

STANDBYS

Non-Emergency Standby

Non-emergency standby will be commensurate with the fire organization's capability. Based on an analysis of fire-incident experience, the essentiality of each vehicle standby service is considered in terms of the degree of fire risk involved.

MILD FIRE RISK. The majority of flight line maintenance and operational functions (for example, engine runup, powered ground equipment operation, refueling or defueling, oxygen and deicing operations, and up or down loading weapons under normal conditions) present a mild fire risk. Appropriate portable or mobile fire extinguishers provide adequate fire protection for these operations.

MODERATE FIRE RISK. Provide standby P-13 service when:

Abnormal fueling operations exist.

Mass engine starts/movements of aerospace vehicles occur.

Welding or cutting operations are in a hazardous location.

SEVERE FIRE/LIFE RISK. Provide standby services by at least one major fire vehicle when:

A hospital evacuation aircraft transporting litter patients lands, taxis, defuels/refuels, loads, unloads patients, or takes off.

Class III fuel spills.

Nuclear weapons, missile/propellants, or high hazard items are involved in accidents/incidents.

Emergency Standby

Many emergencies happen when aerospace vehicles are in flight. Because an emergency happens does not mean that a crash will result. However, precautionary measures are taken so that maximum fire protection is provided along the runway. When an emergency is declared, firefighting, rescue, and other support equipment will respond to await

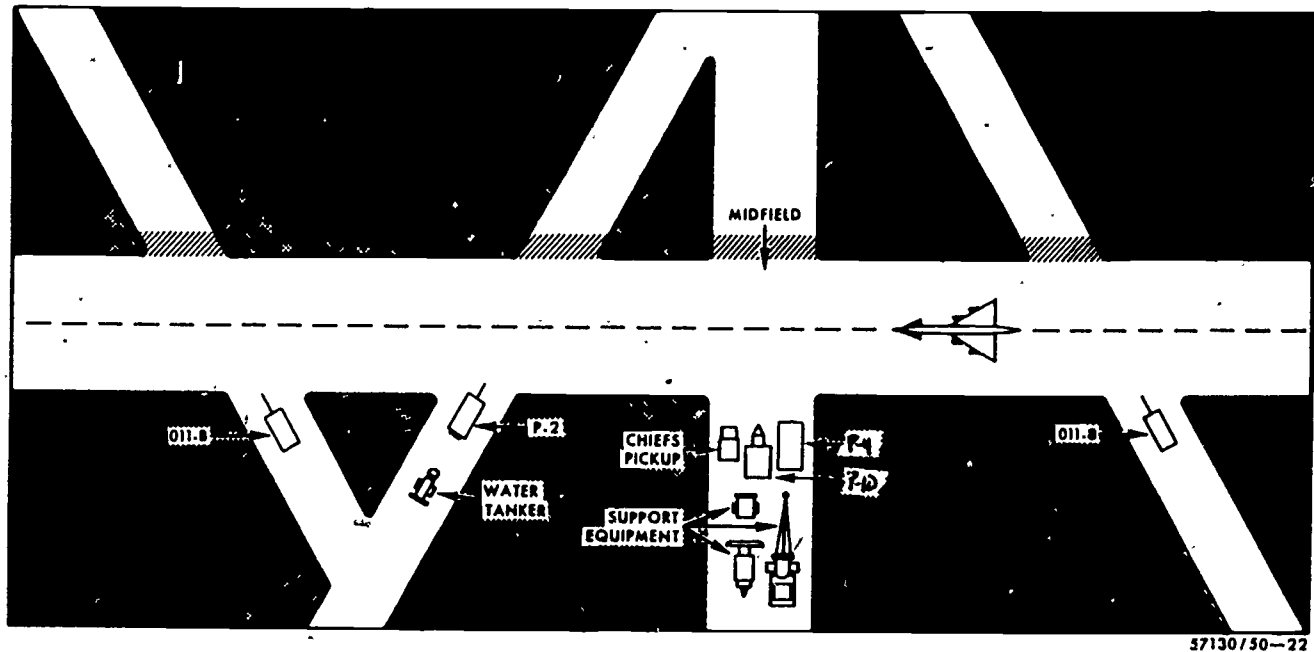

57130/50-22

Figure 4. Runway positions for aircraft firefighting vehicles.

365

the arrival of the aerospace vehicle. Aerospace vehicles - fire trucks will locate strategically along the runway. The firefighting crews will be mentally alert, fully dressed in protective clothing, and ready for anything until the emergency has been terminated. See figure 4.

Standby

It is essential that a crash crew be constantly and instantly available on alert status during flying operations. The fire Chief determines the location of this vehicle.

RAMP SURVEILLANCE

The purpose of ramp surveillance is to detect unsafe conditions on the flightline. Ramp surveillance is accomplished by fire protection personnel patrolling the flightline in a vehicle. Your objective is to locate, identify, and correct any unsafe condition or hazard before it develops into an accident or incident. Many unsafe conditions are noted during the ramp patrol. When such situations do occur, responsible authorities are notified to eliminate the condition.

VENTILATION

The act of ventilating an aircraft does not consist of destroying property for destruction sake itself. Ventilation, if properly accomplished, should clear the aircraft of the smoke and gases, localize the fire, reduce smoke and forcible entry damage, and enable you to extinguish the fire with the least amount of agent and in the shortest time. There are only two types of ventilation, vertical and horizontal.

To accomplish vertical ventilation, you must work from the top down. To horizontal ventilate, you cross ventilate by making openings on the leeward side first and then on the windward side.

QUESTIONS

Please answer questions on a separate sheet of paper.

- 1. What types of hazards are you normally exposed to when performing rescue?

- 2. We, as firefighters, have the direct responsibilities to perform _____, and extinguishment of aerospace vehicle fires.
- 3. _____ is normally used to eliminate the hazards of fuel spills.
- 4. Fuel spills normally occur when fuel is _____, _____, or _____.
- 5. Give a brief explanation of preplanning.

- 6. Through training programs and schools you can progress to higher levels of _____ and _____.
- 7. The purpose of ramp surveillance is to _____



324

8. During standby, all personnel should be _____
and _____ at all times.

9. When is emergency standby required? _____

10. What aerospace vehicle problem usually requires foaming of the runway?

11. Fire situations at Missile and Space sites are going to be
unlike those at _____

12. All severe fire/life risk standby's require _____

13. Runway foaming is done by what vehicle? _____ or

14. To vertically ventilate an aircraft an opening is made on
the _____

15. At a missile site, it is your function to standby for
_____ preceding test or launch.

REFERENCES

AFR 92-1, Fire Protection Program.

367



PRINCIPLES AND PROCEDURES OF RESCUE

OBJECTIVES

After completing this study guide and your classroom instructions, you will be able to:

1. Identify principles and procedures relating to rescue of personnel from aircraft.
2. Identify procedures for safetying egress systems.
3. Identify procedures for shutting down aircraft engines and systems.

INTRODUCTION

Aircraft fires and accidents do not happen very often; however, when they do, they cost the Government a lot of money. In addition to the damage done to the aircraft and equipment, in many cases, human life is lost. Lives can never be replaced. The Air Force must have well trained, qualified firefighters to keep aircraft damage to a minimum. But more important, a good firefighter can often prevent the loss of human life.

When an aircraft crashes, fire is almost always present and there is the danger of explosion. Air Force firefighters are trained to work under these conditions and are capable of handling the many hazards that make up aerospace vehicle (aircraft) firefighting.

Think for a minute what an aircrew member's chances would be of escaping a crashed and burning aircraft if there were no firemen to extinguish the fire and lead him to safety. He would have very little chance of making it to safety without the help of trained firefighters. You become the most important person in the world to him at that moment. He is depending on you to extinguish the fire and lead him to safety. That is quite a job when you think of it. But if you do the right things, the pilot or crew member will live to fly again.

The key to successful firefighting and rescue operations is to be completely familiar with the aircraft. In other words, know the aircraft inside and out. We do not attempt to cover every aircraft in the Air Force, but we can teach you the parts of an aircraft and their systems that would be important to you as a firefighter and rescuer. In this unit, then, we will cover the different types of aircraft, their components, markings, and systems.

INFORMATION

PRINCIPLES RELATING TO RESCUE

Types of Aircraft

For our purposes we can say that there are three general groups of aircraft. They are:

- Fighter Aircraft
- Bomber Aircraft
- Cargo/Passenger Aircraft

Fighter Aircraft

Fighter aircraft are generally, the smallest of these aircraft. All fighter aircraft in use today have jet engines. Because they are jet aircraft, they are capable of very high speeds and may fly faster than the speed of sound. These aircraft have small fuel capacities because they are designed for short range (distance).

Depending on the model, fighter aircraft may carry armament such as 50 mm guns, rockets, missiles, or bombs. Some of these aircraft are manned by one pilot and others have two crew members. But none of the fighter aircraft have more than two crew members.

Because these aircraft travel at such high speeds, they are equipped with special escape systems for the pilot and copilot. The escape system is an ejection seat which a pilot triggers to shoot the seat and himself safely away from the speeding aircraft. This seat, while it is necessary to a pilot during an in-flight emergency, presents a serious problem to firefighters. This system will be explained later in the unit.

Bomber Aircraft

Bomber aircraft have jet engines. They are much larger than the fighter type aircraft and are built for longer range flights. Their larger size and longer range create more problems to firefighters because of their larger capacity for fuel, armament, and crew. Most bombers are also equipped with ejection seats which present still another problem to firefighters. The main hazard to firefighters is the amount of fuel these larger aircraft carry. The fuel is stored in the wings or along the fuselage of the aircraft. The crew on bomber aircraft is at least two men and can be more.

Cargo Aircraft

The last group of aircraft is the cargo type aircraft. These aircraft are basically large aircraft and are used for carrying large amounts of cargo, fuel, or passengers. If the aircraft is designed to carry cargo, it might be carrying hazardous material such as missiles, rockets, or bombs. If the aircraft is designed to carry fuel, it may be carrying over 100,000 gallons; and if the aircraft is designed to carry passengers, they can number in the hundreds. The C5A aircraft, can carry as many as 700 passengers. In short, no matter what these aircraft may be carrying, there will always be hazards and problems for firefighters and rescuers.

AIRCRAFT COMPONENTS

All aircraft, whether they are fighter, bomber, or cargo aircraft, are built basically the same way. For example, they all have wings, engines, a tail, and carry fuel in tanks. It is these components that we shall cover in the following paragraphs. In order to do good forcible entry and rescue work, you must know the name and purpose of all major aircraft components.

Fuselage

The fuselage is the main structure of central section of an aircraft. The fuselage houses or contains the crew, passengers, or cargo. See item A of figure 5.

Empennage

Item B of figure 5 shows the empennage. It is the assembly at the rear of an aircraft which includes the horizontal and vertical stabilizers. The common name of the empennage is the "tail assembly."

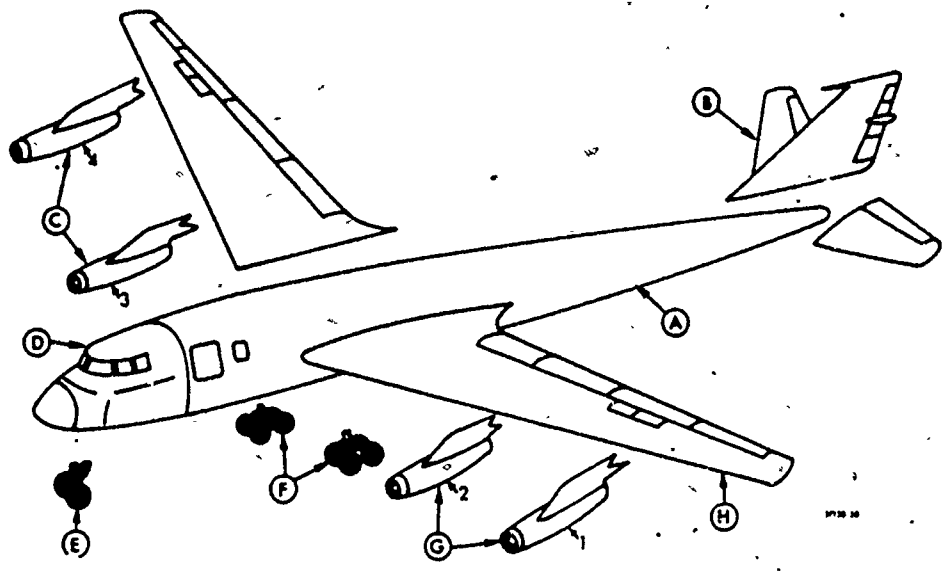

- A. FUSELAGE
- B. EMPENNAGE
- C. ENGINE PODS
- D. FLIGHT DECK
- E. NOSE GEAR
- F. MAIN LANDING GEAR
- G. ENGINE PODS
- H. WING

Figure 5. Major Aircraft Components.

Engines

Aircraft may have jet or propeller type engines. They may number from one engine on fighter aircraft to as many as eight on large bomber aircraft. Items C and G of figure 5, show the location of the jet engines on one type of aircraft.

As shown in figure 5, the number of aircraft engines always begins with the engine nearest the wing tip on the pilot's left. Then the other engines are numbered from left to right.

Inboard is a term used for items closest to the fuselage of the aircraft. For example, number 2 engine and number 3 engine in figure 5 are called the inboard engines because they are nearest the fuselage. On the other hand, number 1 engine and number 4 engine are called outboard engines because they are nearest the wing tips.

Flight Deck

Large aircraft, such as bombers and cargo type aircraft, have a flight deck. This is the area where the pilot and most of the crew are located. In small jet aircraft, we call the area the cockpit. See item D of figure 5.

Landing Gear

The landing gear is the name used for the aircraft wheel struts, wheels, and tires. The landing gear consists of the main landing gear and the nose gear. See items E and F of figure 5.



Wings

The wing is shown as item H in figure 5. There are basically three wing shapes. These shapes are called rectangular, swept back, and triangular (delta wing). These basic shapes may vary slightly. The leading edge (front) of the swept back wing may have different degrees of sweep, but it is always straight; however, the trailing edge (back) of the swept back wing, may be broken by the positions of the flaps, dive brakes, and ailerons.

The thickness of the wings, especially the area near the fuselage, depends upon the size of the aircraft and the mission the aircraft was made for. Cargo and passenger aircraft are used for carrying heavy loads for long distances. They have to have large wings to support heavy loads; therefore, the structural members are large. The space between these members is used for fuel tanks. Fuel is also stored in the thick wings of the bomber aircraft. Some aircraft store added fuel in parts of the fuselage to increase their flying range. Fighter type aircraft, because their mission requires speed, have thin wings to reduce wind drag. Part of their fuel may be carried in the wings, but most of the fuel is carried in the fuselage. Longer range missions require some of the fighter aircraft to carry external (outside) fuel tanks. These tanks are carried beneath the wings, on the wing tips, or in the belly of the fuselage.

On some aircraft the inside of the wing opens directly into the fuselage. In the event of a crash, the fuel stored in the wing could enter the area where the pilot or crew members are located.

You may wonder at this point why wings are so important. To a firefighter, the wing area is the most dangerous area on almost all aircraft. The wings normally carry the fuel. As a firefighter, fuel is your biggest hazard.

Bomb Racks

The bomb racks are devices attached to the aircraft for holding and dropping bombs. These racks can be located under the wings, under the fuselage, or in the bomb bay.

Bulkhead

The bulkhead is the partition or frame that divides, supports, and gives shape to the fuselage. Because it is the frame of the fuselage, it is also the thickest part of an aircraft. Forcible entry should not be tried through any part of a bulkhead.

Belly and Bomb Bay

The belly is the underside of the fuselage. The bomb bay is in the belly of the aircraft. Bomb bay doors are found on some fighter aircraft and all bomber aircraft.

Glass

Glass is found on all aircraft. As a firefighter, you should have a fairly complete knowledge of the types of glass used. This knowledge will be needed when performing rescue duties.

Bulletproof glass is heavy, thick glass which will hold up against the impact of small caliber bullets. This glass is usually found in the forward part of the canopy that covers the cockpit on jet fighter aircraft. Because of its thickness and strength, forcible entry through this glass should be tried only as a last resort.

Flexiglass is the trade name for a transparent, glass-like plastic used to cover crew positions such as canopies on jet fighters or windows on other aircraft. This



329

glass is not as thick as bulletproof glass, but is still difficult to try forcible entry through.

A knowledge of all of the components mentioned to this point will aid you greatly in becoming familiar with basic aircraft structures. We cannot overstate the importance of these aircraft components. The best way to learn aircraft structures for rescue is to spend time looking at and identifying the aircraft and their components. You will find that this will be a regular training function when you get on the job. You will study each aircraft first hand; then return to the station and study aircraft charts such as TO 00-105E.

AIRCRAFT MARKINGS

Tubing Markings

All aircraft, whether large or small, have certain markings that rescuemen have to recognize in order to perform forcible entry and rescue personnel. In the following paragraphs, we will cover these markings.

If an aircraft were to crash at your base today, chances are there would be twisted and broken parts of this aircraft scattered over the ground. There would be fuel lines, tubing, and electrical cables scattered about and all of them would look about the same to you. What if you had to cut or chop through some of these lines to get a pilot that was pinned underneath? Without knowing what was in these lines, it would be a dangerous task. You had better know what is in these lines before you cut them!

To make installation, repair, and maintenance easier, a standard marking system is used on all aircraft to show mechanics, crew members—and yes even firemen—what is inside the tubing and lines of aircraft. There are three ways to identify the contents of these lines. They are identified by:

- Colors
- Words
- Designs

There is a reason for each of these methods of identification. Take color for example. Color can be recognized from a distance and is therefore the easiest. Color blindness is overcome by reading the words. And foreign mechanics can remember designs more easily than words. The color code shown in figure 6 is a requirement for all Air Force firefighting personnel to remember. Study this chart before you continue reading.

If a line is red, it contains fuel. If a line is blue and yellow, you know that there is hydraulic fluid inside. If a line is brown, the line contains a fire extinguishing agent such as CO₂ or CB. You can see now that knowing this coding system may save not only a crew member's life, but yours as well.

Access Markings

As stated before, all aircraft have standard Air Force marking whether they are small jet trainers or large troop transports. These markings are very valuable in helping firefighters in firefighting, forcible entry, and rescue. For example, the emergency cut-in panels on aircraft are all painted with yellow corners and the words "CUT HERE FOR EMERGENCY RESCUE" in red letters in the middle of these yellow painted corners. If an aircraft did not have these markings, a rescueman might cut through a fuel line, hydraulic line, or try to cut through part of the bulkhead which is often 6 to 8 inches thick. The following aircraft markings, shown in figure 7 are the markings

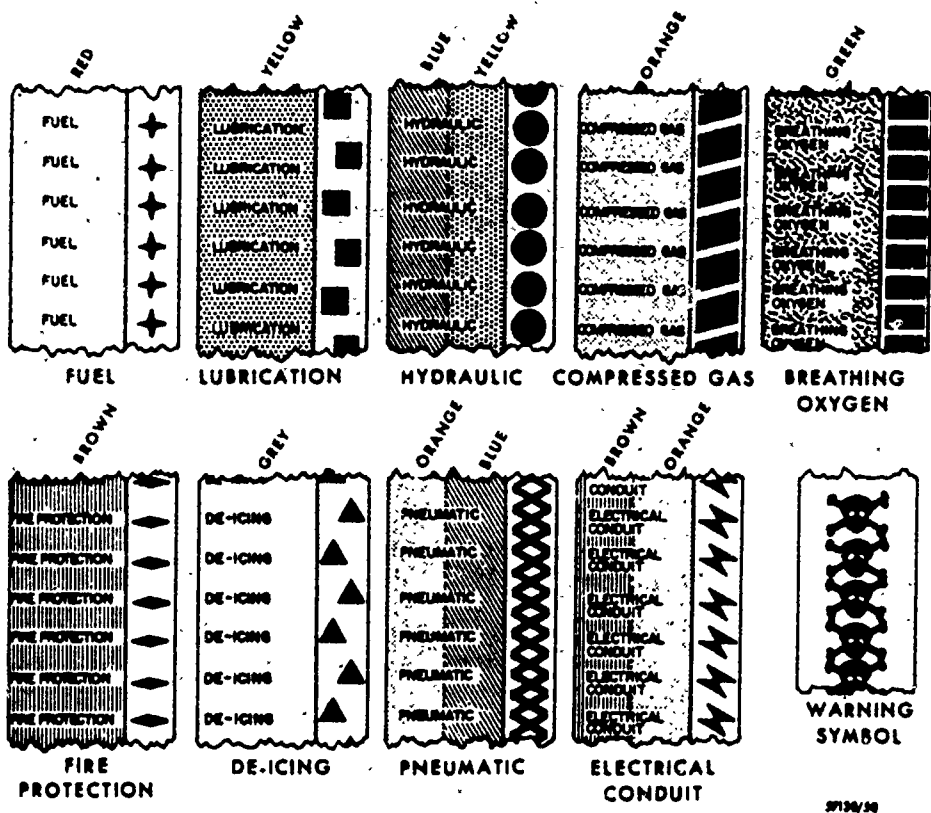

Figure 6. Color Code for Aircraft Tubing and Hose.

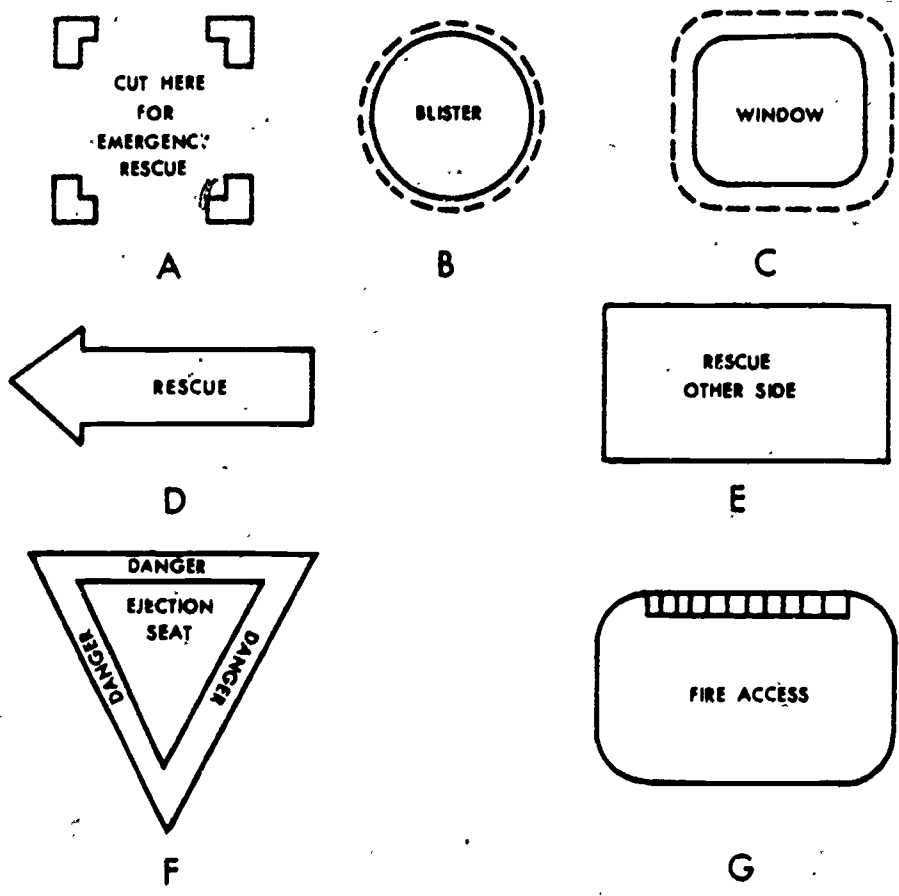

Figure 7. Aircraft Markings.

that firefighters should be able to identify. Study and remember them before you continue reading.

EMERGENCY CUT-IN PANELS. As we stated before, these areas are shown by an outlined square with yellow corners or yellow dashes. Within the square are the words "CUT HERE FOR EMERGENCY RESCUE." These areas were picked because they are free of tubing, wiring, structural members, and obstructions. Use these cut-in areas only if all other means of entrance to the aircraft are impossible.

BLISTERS. Blisters are made of see-through Plexiglass and are often bubble or dome shaped. Blisters are found on some older model cargo and bomber type aircraft and are used by the aircrew for such purposes as observation, navigation, or gunnery. These see-through blisters are bordered with a yellow painted strip for identification. They are sometimes used by rescue crews for forcible entry and rescue.

WINDOWS. Windows are also outlined in yellow and can be made of sections of "Plexiglass" or safety glass laminated (layers) with plastic. Plexiglass and laminated glass can be broken into, but care must be taken to prevent injury to crew members and passengers when using this method of entrance.

RESCUE ARROW. The rescue arrows are painted yellow and are found on aircraft that have egress (a way to exit) systems. This makes it much simpler and quicker for rescue crews to get into the cockpit or flight deck, because these arrows point to the area where an entry to the inside can be made. The rescue arrow may point to any of the following locations:

- Canopy jettison lanyard.
- Manual handcrank.
- Electrical switches or buttons.
- Hatches and crew position coverings.

RESCUE OTHER SIDE. As shown in figure 7, this marking is rectangular and is painted yellow with the words "RESCUE OTHER SIDE" painted in black letters. It tells rescuemen that the controls for gaining entrance to the cockpit or flight deck are located on the other side of the aircraft.

DANGER EJECTION SEAT. This marking shows that the aircraft is equipped with one or more ejection seats. It is triangular shaped marking and is usually painted red in the center with a white or black border and the words "DANGER EJECTION SEAT" painted in black letters.

FIRE ACCESS DOORS. The purpose of the fire access door is to give firefighters a way of extinguishing aircraft interior fires (usually engine fires). They are rectangular doors and may be painted yellow, red, or black with the letters "FIRE ACCESS DOOR" printed on them. These doors are located in the engine sections of large and small aircraft. They are spring-hinged doors which allow handlinemen to insert a nozzle to extinguish any fire inside the engine housing.

EGRESS SYSTEMS

An egress system is a combination of two systems. (1) The canopy jettison system and (2) the seat ejection system. As we said before, high speeds of modern aircraft made it necessary to have some means of escape for crew members during in-flight emergencies. The canopy jettison and seat ejections systems are the means of escape in high speed aircraft. To a fireman, however, these systems create some serious problems. Firefighters must gain access to the cockpit or flight deck of an aircraft and remove a pilot or crew member without accidentally firing the seat or seats.

No attempt will be made to cover all the Air Force aircraft and their particular egress systems. This would take a separate course on the subject. Your best source of information on the egress systems of different aircraft will be found in TO 00-105E-9. All fire protection organizations should have TO 00-105E-9. We will, however, give you the basic facts about canopy jettison systems and seat ejection systems.

Canopy System

Canopies, as you have already learned, are coverings for the pilots. These canopies are most often found on fighter type aircraft. On most jet bomber aircraft, crew positions are covered with hatches.

When in flight, canopies or hatches are held firmly in place, but in an emergency they must be jettisoned before the seat is ejected.

There are various ways of removing canopies or hatches to gain access to injured or unconscious crew members. Most canopies or hatches can be opened from the outside of the aircraft by one of the following methods:

- Manual canopy or hatch opening
- Normal (electric or air)
- Jettison of the canopy or hatch

emergency entrance

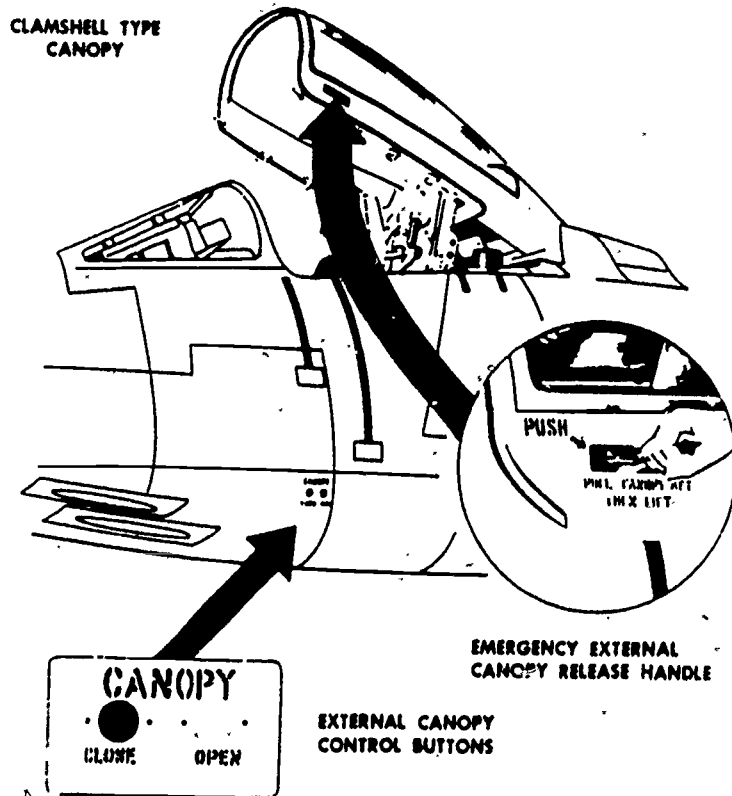

Figure 8. Manual and Electrical Canopy Controls.

As shown in figure 8, some canopies can be opened by disengaging the locks. You then lift or slide the canopy back by using a handle attached to the frame of the canopy.

Some aircraft canopies have a hand crank or wrench, as shown in figure 9, which is inserted below the canopy and is used to manually crank the canopy open. On some aircraft, the crank is used to unlock the canopy locks so the canopy can be lifted up. Manual opening of the canopy or hatch should always be tried first!

As shown in figure 8, some aircraft have an electric switch or button that is used to open the canopy. Remember, this method cannot be used if the batteries have been disconnected. Keep in mind the fact that hatches are not like canopies; hatches cannot be opened electrically.

When you cannot raise the canopy manually or electrically, you must use the canopy jettison system. Jettison of canopies and crew hatches can be dangerous so be very careful when "blowing" these coverings.

All canopies and hatch coverings are jettisoned in about the same manner. Located below or near each covering or canopy is a small compartment containing a 6 to 9 foot lanyard. See figure 10. The directions for use are stenciled close to the cover. The lanyard should be removed and pulled out to its full length before use. Before pulling the lanyard, you should warn personnel around the aircraft to stay clear. Some canopies and hatches only pop up to 3 to 6 inches; others blow higher than 10 feet. Normally these jettisoned coverings will move up and to the rear. However, you cannot be sure which direction they will go; so be cautious when using a jettison system.

It is very important that you be completely familiar with all the aircraft and their egress systems before you ever try to jettison an aircraft canopy or hatch. Suppose you were assigned as rescuer on the rescue vehicle and one day the alarm bell went off and a voice came over the loudspeaker saying, "Attention all personnel we have an F-106-A that has just crashed on runway 1-8." You arrive at the scene and look through the canopy and see that the pilot is unconscious and the handgrips on the ejection seat are raised. You decide that there is no time to waste and you grab the canopy jettison lanyard and you give it a sharp tug to jettison the canopy.

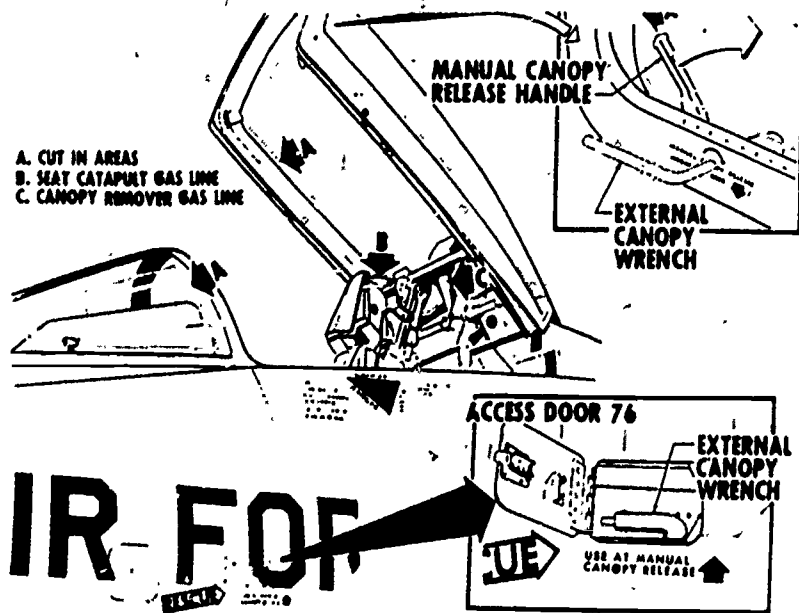

Figure 9. Manual Canopy Release.

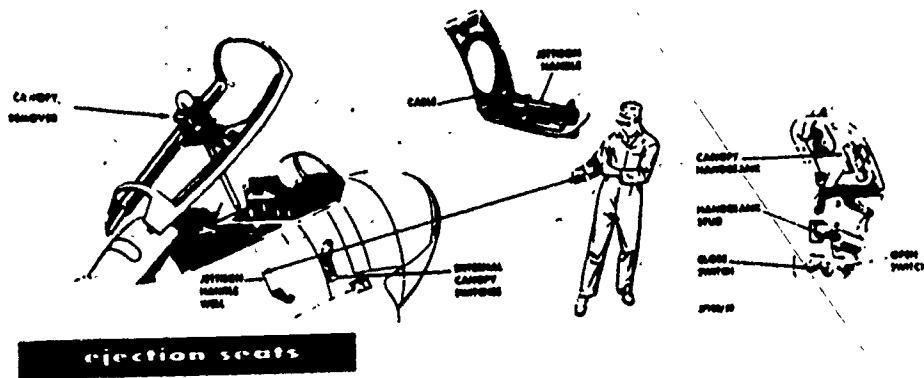

Figure 19. Emergency Canopy Jettison

You have just killed the pilot by your ignorance! You were not familiar with the egress system on this aircraft! If you were, you would have known that the canopy jettison and the seat ejection system on the F-106 are locked together; when you jettisoned that canopy with the handgrips raised, you also ejected the seat and the pilot about 150 feet into the air!

You can see that you must be completely familiar with egress systems that are found on certain aircraft. There is no room for error when dealing with these systems.

We know now that a canopy can be opened manually and electrically from the outside of the aircraft. We also know that a canopy or hatch covering an ejection seat can be jettisoned from the outside. The pilot or crew member can also open a canopy and hatch from the inside by these methods. This means that once you have gained entrance to an aircraft cockpit you can also accidentally jettison the canopy by tripping the system from inside the aircraft. One thing to remember is that once you have gained entrance to the cockpit, you do not want to jettison the canopy or eject the seat accidentally or someone will get hurt! To keep from accidentally tripping a canopy jettison system, you must be familiar with the system itself. All aircraft egress systems will be somewhat different, depending upon the type of aircraft. But these systems work basically the same in all aircraft. You must also be familiar with the different parts of this system before any attempt is made to safety it. A canopy jettison system consists of the following parts:

- Canopy
- Seat handgrips
- Canopy initiator
- Canopy initiator hose
- Canopy remover

The canopy, as you know, is the see-through covering that is built over the cockpit to protect the pilot or crew.

One or both of the seat handgrips (depending upon the aircraft) when raised will jettison the canopy. These handgrips are attached to the arms of the ejection seat.

When the handgrips are raised, the canopy initiator sends a gas through the initiator hose to the canopy remover. When this gas reaches the canopy remover, it causes an explosive charge in the canopy remover to explode, thereby jettisoning the canopy.

The initiator hose comes out of the initiator and connects the initiator to the canopy remover. It is this hose that carries the gas from the initiator to the canopy remover. A canopy remover houses the explosive charge that jettisons the canopy from the aircraft.

Ejection System

The second and most important part of an egress system is the seat ejection system. A seat ejection system consists of the following parts:

- Ejection seat
- Seat firing trigger
- Ejection seat initiator
- Ejection seat initiator hose
- Catapult

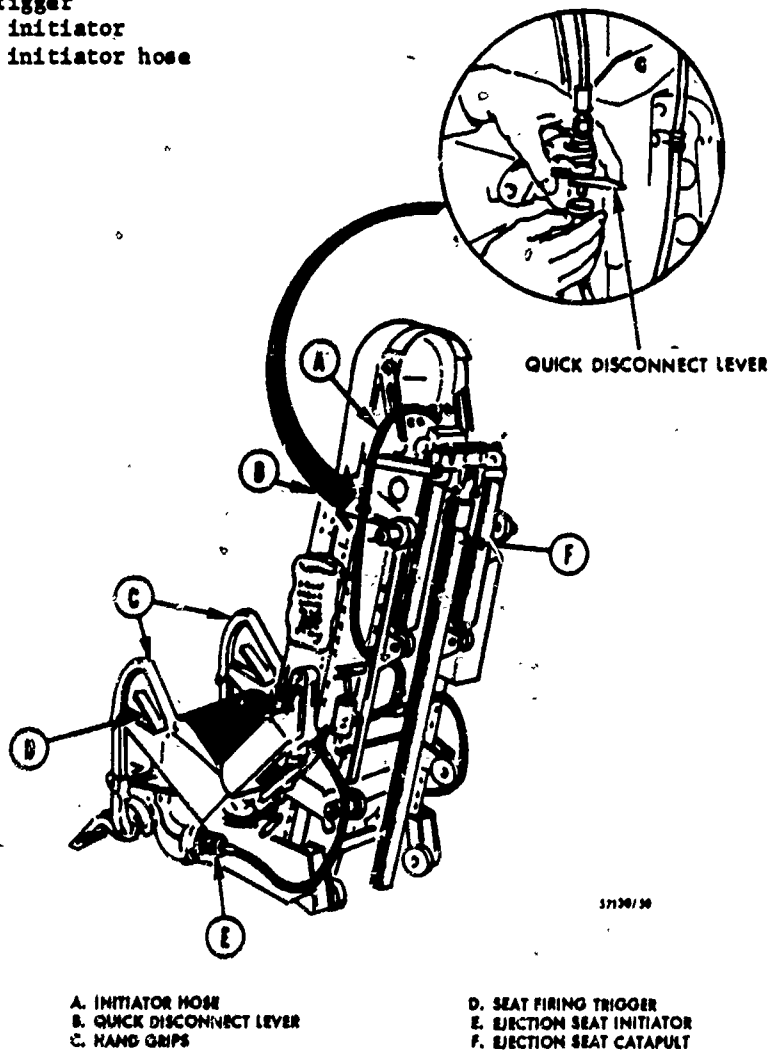

Figure 11. Seat Ejection System.

You should be completely familiar with a seat ejection system before any attempt is made to safety the system. The ejection seat is where the pilot or crew member sits. It is mounted on guide rails that guide the seat out of the aircraft when it is ejected.

One of both of the seat firing triggers (depending upon the aircraft), when raised, fires the ejection seat. The firing triggers on most ejection seats are located under the seat handgrips, extending from the arms of the seat. See item D of figure 11.

The ejection seat initiator works on the same principle as the canopy initiator. When the seat firing trigger is raised, the seat initiator sends a gas to a thruster inside the catapult. An explosive charge within the catapult "blows" the seat out of the aircraft. The ejection seat initiator is shown as item E of figure 11.

The ejection seat initiator looks much like the canopy initiator. You can get the two items confused if you are not careful. If in doubt as to which one is which, simply follow the hose from the initiator to see where it goes. If the hose leads to the canopy remover, then it's the canopy initiator. If the hose leads to the seat catapult then it's the ejection seat initiator.

The ejection seat initiator hose comes out of the initiator and connects the initiator to the seat catapult. It is this hose that carries the gas from the initiator to the seat catapult. See item A of figure 11. The quick disconnect, item B in figure 11, is a feature which is used to keep the gas from reaching the catapult.

The catapult operates the same way as the canopy remover. The catapult houses a thruster and the explosive charge that ejects the seat from the aircraft. Item F of figure 11, shows an ejection seat catapult.

Canopy and hatch jettison systems present some danger to the firefighter. But these dangers are small compared to the dangers of the ejection system. The force of a seat ejecting will blow the seat and a fully equipped crew member as high as 150 feet into the air. When rescuing a crew member, a firefighter (in most cases) must work directly over the seat. Picture what would happen to you and the crew member if you were in the middle of a rescue and the ejection seat fired! So you can see that the first job you must perform is to safety the canopy jettison and seat ejection system. The following paragraphs explain the methods used to make the seat safe.

By far the quickest and safest method to safety the canopy jettison and seat ejection system is to cut the initiator hose. When you cut this hose, the entire system is made safe because the gas from the initiators can not reach the catapult or canopy remover. In most aircraft crashes, you will find that the canopy has already been jettisoned by the pilot so you will only be concerned with safetying the seat ejection system. If the canopy has been jettisoned, the handgrips on the ejection seat will be in the up (raised) position exposing the seat firing trigger. This is dangerous because the ejection seat has been armed and ready to fire. One accidental movement of that trigger will eject the seat. Figure 12 shows a rescueman cutting an initiator hose. The tool being used allows the rescueman to cut the hose without coming in the path of the ejection seat in case it is accidentally fired. As we said before, you can become confused as to which hose to cut. You simply have to follow the hose to the system it leads to. If it leads into the seat catapult and you cut it, you have safetied the ejection seat. If the hose leads into the canopy remover and you cut it, you have safetied the canopy jettison system. The initiator hose is very difficult to cut by anything other than the de-arming tool because it is made of woven steel and is wire reinforced so as to stand high pressure between the catapult and the initiator. Every vehicle in a well organized fire department should carry a de-arming tool.



B-52F

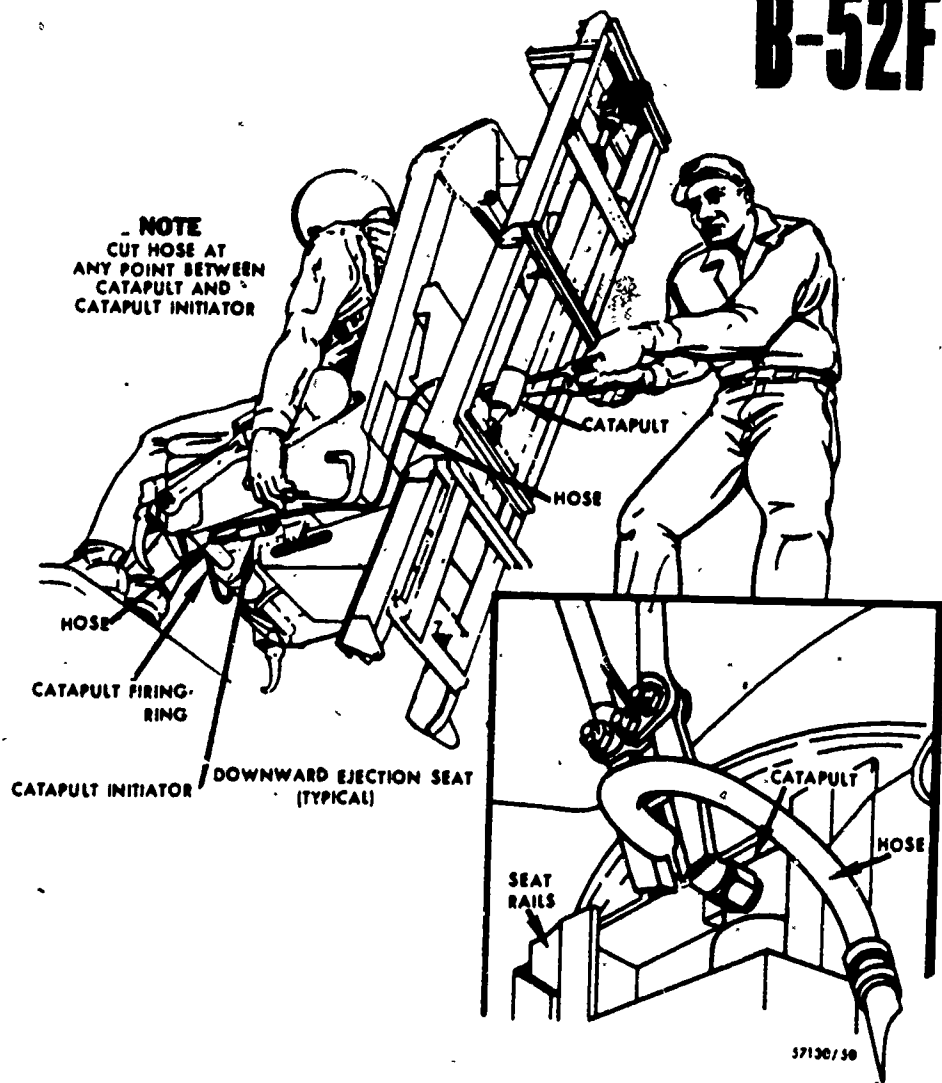

Figure 12. Cutting the Initiator Hose.

A second method of safetying egress systems is to install ground safety pins. All aircraft equipped with egress systems have ground safety pins which, when installed, safety the egress system. These pins are carried in the cockpit or crew area. When the aircraft is on the ground, the pins are installed in the seat and canopy initiators to prevent accidental firing of the systems. These pins have red streamers with the letters "ground safety pins" and/or "remove before flight" printed on them. Before flight, these pins are removed and placed in a storage pouch or map case, depending on the type aircraft. If a crash occurs, you may have to safety the egress system by installing these pins in their initiators. You should know where the pins are stowed on each aircraft and, more important, how to install them. As a rule, these pins are inserted into a hole on the end of each initiator.

When these pins are installed properly, they prevent any movement of the seat handgrips or firing trigger. This keeps the gas in the initiator from traveling up to either the catapult or the canopy remover. You must be very careful when installing these pins. If you were to notice the handgrips on a seat were raised and the canopy

had not jettisoned, you may think that you can push these handgrips down and insert the safety pin into the initiator thereby safetying the canopy jettison system. You are wrong! This system would not be safetyed because the gas has already left the initiator and is probably trapped somewhere in the initiator hose. You should then cut the initiator hose to make the system safe.

When using ground safety pins, you must also make sure that the pin is properly inserted in the initiator. You may insert a ground safety pin and think you have made the system safe, but you would be dead wrong if this pin is not put in properly.

The third method of safetying egress systems on aircraft is by using quick disconnects. Most of the newer model aircraft are using quick disconnects on their egress systems. These disconnects connect the initiator hose on both systems. They may be located anywhere between the initiator and the catapult or canopy remover. Item B of figure 11, shows how to use the quick disconnect. They may be the clip-on type or the coupling type; when operated, they separate the initiator hose and safety the system. The advantage of having these quick disconnects is that the initiator hose does not have to be cut; therefore, the same hose can be used many times over.

These three methods of safetying egress systems must be learned by all firefighters. These systems vary slightly from aircraft to aircraft. It is your duty to learn the procedures for each aircraft. As we stated earlier, this requires many hours of training.

EXTERNAL EQUIPMENT JETTISON SYSTEM

Not only are there jettison systems that blow the canopies, but some also have jettison systems that are used to drop equipment during inflight emergencies. These systems are operated and controlled by the pilot. Some of these systems are manually operated and other systems use explosive squibs or explosive bolts. Some of the equipment designed to be jettisoned includes: external fuel tanks, weapons such as bombs and rockets, and jet assist take-off bottles.

All the components mentioned up to this point will aid you greatly in becoming familiar with basic aircraft structures. It is the ground work to becoming a knowledgeable rescuer, and should be understood completely by every firefighter.

AIRCRAFT SYSTEMS

An aircraft is a highly complex piece of equipment. It needs many systems to make it operate. The systems we shall cover in the following paragraphs are most important because of their hazards to firefighters and rescue crews.

Fuel System

As we mentioned before, fuel is the main hazard in any type of aircraft because it causes fire. There are two types of fuels used for Air Force aircraft today: aviation gasoline, and jet propulsion (JP) fuel. JP fuel is used much more than gasoline. Even greater use of this fuel has been made with the changeover to jet cargo and passenger aircraft. As aircraft get bigger, the fuel systems become more complex and this, in turn, causes more chances for accidents and fires. Fuel tanks, fuel lines, control valves, and fuel pumps are spread throughout the aircraft. When an aircraft crashes, the force of the crash may rupture a fuel line or a tank. When a tank or line is ruptured, fire danger is always present.

The main parts of a fuel system are the fuel tanks. Fuel tanks may be made of metal or synthetic rubber. Fuel tanks may be separate units installed between the structural framework of the wing, or they may be built in as part of the wing framework. For all practical purposes, we can say that wings contain fuel tanks. Drop tanks may

be installed in the bomb bay areas or hung below the fuselage or wings. This is so that the tanks can be dropped from the aircraft in flight. Tanks that cannot be dropped from the aircraft may be installed in the same areas. Fuel loads can vary from 50 gallons on small planes to many thousands of gallons on large aircraft. This is why fuel is the main hazard in any crash. Figure 13 shows some typical fuel tank locations. We can see from this, that tanks may be located almost any place in the aircraft. This is another reason that we must keep up to date on the different types of aircraft in service. To do this, you will need to study TO 00-105E-9 and the actual aircraft on your base.

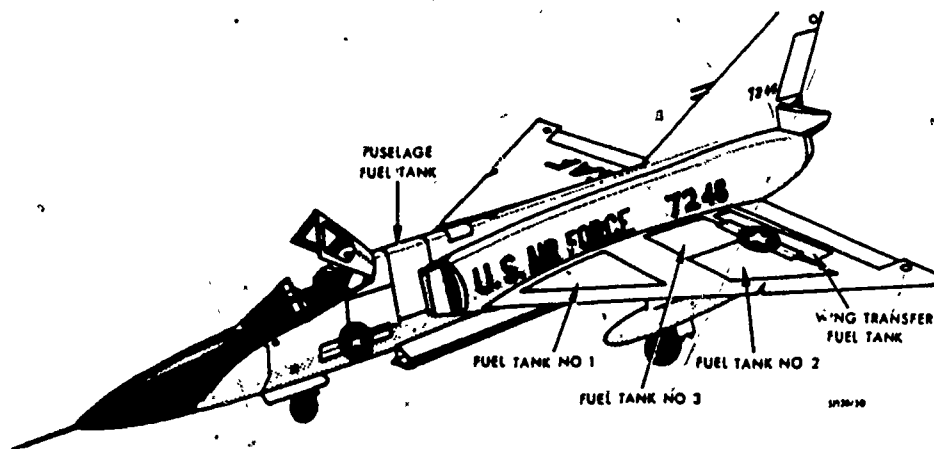

Figure 13. Fuel Tank Locations.

Electrical Systems

The electrical system of an aircraft supplies the current for the operation of the engines, lights, electronic equipment, fuel pumps, hydraulic pumps, armament systems, warning systems, and many other electrical devices. On a large aircraft, there could be as much as 25 miles of wiring. Some aircraft produce enough electrical power to light up a city of 5,000 people. All modern aircraft have either AC or DC or both AC and DC electrical systems. The electrical system on an aircraft presents a fire hazard because one spark coming in contact with fuel can cause a fire or explosion. To cut off the electricity in an aircraft, you must disconnect the aircraft batteries. Aircraft batteries may be located in any of the following places depending on the aircraft:

- Wings
- Wheel wells
- Fuselage
- Engine

Some larger aircraft have two batteries that must be disconnected. In studying the aircraft electrical systems, there are two important tasks you must learn to do quickly.

Disconnect the battery.

Switch off the master power switch located on the pilot's console panel on most aircraft. (The master switch cuts off the power in the aircraft except from the battery to the master switch.)

Armament Systems

The armament systems on aircraft also create a hazard to firefighters. Armament means any weapons or munitions that an aircraft may be carrying. Armament is usually thought of as being guns and rockets, but sometimes armament includes all offensive or defensive weapons.

Whenever an aircraft crashes, there is always a chance that ammunition is aboard. Heat from a fire can cause guns, rockets, and bombs to "cook off" and seriously injure someone. A word of extreme caution, when you respond to any fire, do not walk in front of the guns or to the rear of the rockets if at all possible. Treat them with respect. If the guns on an aircraft are loaded, and "cook off" from the fire's heat, the bullet, the casing, and the primer may all be shot through the air. It may be one round or many. Heat also can cause rockets to explode or shoot off. This can cause injury or death to personnel behind the rockets as well as in front of them. It is important to keep these weapons cooled below their ignition point with streams of foam or water from handlines or turrets. By cooling these weapons, you prevent their exploding or "cooking off."

Oxygen System

All high altitude aircraft are equipped with oxygen systems that are used by crew members for breathing. This oxygen is stored either as a gas or as liquid oxygen (LOX). Most modern aircraft use the LOX system as an oxygen supply. The amount of oxygen in an aircraft depends on the size of the aircraft, the type of aircraft, and its mission. Gaseous oxygen systems may contain over 600 cubic feet of oxygen confined in bottles under as much as 1800 psi of pressure. Some aircraft carry up to 25 gallons of LOX. Fighter aircraft normally carry about 5 quarts.

Fire hazards from oxygen are twofold: (1) the hazard from explosion, and (2) the hazard of fire, because oxygen intensifies burning. The danger of explosion is extreme when liquid oxygen comes in contact with flammable materials such as JP fuel and oil. When these liquids come together, one small spark can cause a violent explosion. LOX can also cause serious injury by freezing if the liquid is spilled on a person.

The oxygen supply systems are found in the fuselage of all aircraft, but in different places. On fighter aircraft, the oxygen supply is normally carried in the nose section. Larger aircraft can carry the supply anywhere in the fuselage. Some have several containers located throughout the fuselage. You should make it a point to know the oxygen locations on each aircraft on your base.

A word of caution! Be able to recognize LOX containers. They are painted yellow. These containers have been known to be ripped from the aircraft and thrown free. If you see a LOX container at the scene of a crash, leave it alone. Notify your crew chief. He will know what to do about it.

Hydraulic System

The hydraulic system of an aircraft is used for many purposes. For instance, hydraulic pressure is used to open bomb bay doors, to bring landing gear into position, and to operate wing flaps. Hydraulic pressure is also needed for the aircraft brakes. If an aircraft were to lose complete hydraulic pressure, any one of a number of things could happen. For example, an aircraft would not be able to get its landing gear down. This would force the pilot to make a belly landing. Hydraulic pressure loss would cause an aircraft to lose its brakes. The aircraft would not be able to stop, and would probably run off the end of the runway. So if you ever respond to an aircraft emergency and are told that the aircraft involved has lost all hydraulic pressure, you can expect one of those things to happen.

The hydraulic system of an aircraft consists mainly of a reservoir of hydraulic fluid, hydraulic pumps, and tubing. The hydraulic system is kept under pressure even when the pumps are not running. Some aircraft have as much as 3,000 psi hydraulic pressure. Stop and think for a minute what would happen to you if you were to accidentally cut through a hydraulic line containing 3,000 pounds of pressure!

About the only time hydraulic fluid will cause a fire is when hydraulic brake lines are leaking and the brakes are overheated due to friction. If the landing gear collapses or shears off, breaking the hydraulic lines, sparks from metal scraping on the concrete can also ignite the hydraulic fluid. Hydraulic fluid is much less flammable than JP fuel, but it has been known to ignite and burn under the conditions mentioned above.

QUESTIONS

Please answer questions on a separate sheet of paper.

1. Why is it necessary for a firefighter to become familiar with the major components of an aircraft? _____

2. Bomb racks can be located _____,
or _____.

3. The common name of the empennage is the _____.

4. LOX is _____, used for _____
in high-altitude aircraft.

5. What type fuel has exceeded the use of gasoline in the Air Force?

6. A standard marking system has been devised to aid in rapid identification of tubing systems, these are:

- a. _____.
- b. _____.
- c. _____.

7. Aircraft batteries may be located in _____
_____ or _____
depending on the type aircraft.

8. What two important tasks must you learn to do quickly, when told to cut the power?

- a. _____.
- b. _____.

9. What three methods are there to safety the ejection system?

- a. _____.
- b. _____.
- c. _____.

Mark the following statements true (T) or false (F).

10. An egress system is a combination of the canopy jettison system and the seat ejection system.



- ___ 11. Egress systems allow pilots to escape from a speeding aircraft if an emergency develops during flight.
- ___ 12. Canopies may be jettisoned before the ejection seat is ejected.
- ___ 13. Canopies can be opened by three methods. They are manual, electrical, and jettison.
- ___ 14. The best method of removing a canopy is to jettison it.
- ___ 15. On most aircraft, canopies are jettisoned by pulling out the jettison lanyard.
- ___ 16. There is a chance of hydraulic fluid catching fire if the fluid from a broken line runs down over hot brakes.
- ___ 17. In some aircraft, the hydraulic pressure may be as high as 3,000 psi.
- ___ 18. The fuselage of an aircraft is the main structure which houses or contains the crew, passengers, or cargo.
- ___ 19. The bulkhead divided, supports, and gives shape to the fuselage of an aircraft.
- ___ 20. The belly is the underside of the fuselage.
- ___ 21. Bomb bay doors will be found in the tail assembly of an aircraft.
- ___ 22. The flight deck of an aircraft is where the pilot would be located.
- ___ 23. Aircraft struts are the metal parts that cover the engine.
- ___ 24. Aircraft engines are always numbered from the pilot's left to his right.
- ___ 25. Bulletproof glass can be found in the forward part of aircraft canopies.
- ___ 26. Forcible entry should always be made through bulletproof glass.
- ___ 27. Plexiglass is the trade name for a glass-like plastic used to cover crew positions such as canopies or windows.
- ___ 28. Triangular shaped wings are called delta wings.
- ___ 29. Most cargo and bomber aircraft use the wings to store fuel.
- ___ 30. In some aircraft, the inside of the wing opens into the fuselage.
- ___ 31. To a firefighter, the wing area of most aircraft could be classed as the safety area.

REFERENCES

IO 00-105E-9, Aircraft Rescue Emergency Information.



RESCUE OPERATIONS

OBJECTIVES

After completing this study guide and classroom instructions, you will be able to:

1. Operate tools and equipment off P-10.
2. Demonstrate normal and emergency entry procedures.
3. Rescue aircrew members.
4. Perform preventive maintenance.

INTRODUCTION

As an Air Force firefighter you must know how to do many different jobs; however, your most important job is RESCUE. In order to rescue a victim, you must know the different methods of getting into an aircraft. When entering a crashed aircraft, you may have to use forcible entry tools. So you must know where to find these tools, and more important, how to use them. You must know how to locate and remove victims.

INFORMATION

TOOL AND EQUIPMENT

Before you can perform a rescue, you must have the tools to work with. It is practically impossible to get into an aircraft with just your bare hands. Aircraft rescue men use tools for forcible entry into crashed aircraft the same as structural firefighters use tools to gain entrance into a burning building. The tools used to forcibly enter crashed aircraft must be carried to the scene in the vehicle made just for that purpose. The Air Force has the P-10 for this. You have already studied this vehicle and the tools found on it.

NORMAL AND EMERGENCY ENTRY PROCEDURES

Normal Entry

It just makes sense to open an aircraft door for entry rather than cutting a hole, breaking a window, or forcing something open. By the term "normal means," we mean opening one of the existing aircraft openings. All aircraft have doors that are designed to be used for passenger and crew entry and exit. Always try one of these entry points before you force your way into an aircraft.

Doors may be found on either or both sides of an aircraft. They usually open outward. The doors are fastened on the inside by latches and almost all doors have handles or latches on the outside as well as the inside. Normal entrance and exit doors also have an emergency release that disconnects the hinges to allow the whole door to fall free. Instructions for operating the emergency release are stenciled close to the door. The emergency release handle is usually painted red.

Most aircraft have openings that are used for escape from an aircraft by other than normal means. These exits are used when normal exits are cut off. All emergency hatches will have release devices that can be operated from the outside, as well as the inside, of the aircraft.

Bomb bay doors can be used as a means of exit on most larger aircraft. They usually open hydraulically or electrically. These doors can be opened manually when power is not available. The operating controls may be found in the pilot's compartment, bombardier's compartment, or in the bomb bay area. Bomb bay doors normally open from the bottom center of the fuselage (belly) outward; however, some may slide upward along the side of the fuselage on tracks. When an aircraft has made a belly landing you cannot get in through the bomb bay doors, so you have to try other entrances to the aircraft.

We cannot state any hard and fast rules for aircraft entry, but it does make sense to use normal methods first. It also makes sense to open a door or hatch before you chop a hole or break a window. In the next few paragraphs we will cover methods of forcible entry.

Emergency Entry

You may need to force your way into an aircraft for any one of many reasons. You may find that normal openings are blocked. If this is the case, the safest and fastest entry method may then be a forcible entry point. As an Apprentice Fire Protection Specialist or Fire Protection Specialist, you will normally not be responsible for selecting the point of entry. Your job is to make the fastest and safest entry at the point where you are told to enter. In this part of the text we will cover

- Forcible entry at doors and hatches.
- Forcible entry of glass areas.
- Forcible entry of fuselage walls.

If a door or hatch is jammed from the impact of a crash, force it open around the frame or at the hinges. You can use a door opener, wracking bar, or crash axe to do this job. Normally, you do not try to force open a jammed door or hatch if there is an easier way into the aircraft.

Areas such as canopies, windows, blisters, and portholes may be forced open for entry. These areas can be entered by removing a broken out section. The pick head part of a crash axe should be driven through the plastic at a point close to the corner or edge. This causes a series of long cracks which will weaken the entire section. The section then can be knocked out in one piece. Four holes made in each corner should allow you to remove a rectangular piece of plastic or Plexiglass. The plastic or Plexiglass in a window frame or bay is fastened into the fuselage by overlapping metal strips and rubber inserts around the edges of the window. By cracking the glass near the outer edge, the rubber strip can be reached and stripped from the slot. This method will release the entire section of Plexiglass. Remember, breaking glass sections may take more time than removing a jammed door or hatch, but it is still faster than cutting through the metal skin of the fuselage.

If entry cannot be made through doors, hatches, or other openings, then as a last resort--and only as a last resort--an opening must be made by cutting through the metal fuselage. TO 1-1-636 states that the fuselage of all multiengine aerospace vehicles (aircraft) must be clearly marked so that openings can be cut through them by rescuemen if the need arises. These areas on the fuselage are picked for cut-in areas because there are no obstacles behind them such as bulkheads, tubing, or electrical wiring. These areas are marked in yellow with red letters one inch high that read "Cut here for emergency rescue." To cut through the metal skin of the fuselage, you must use the metal cutting power saw. When cutting the opening, the three upper sides should be fully cut. The fourth or bottom side is used as a hinge. This piece is bent back to form the opening. Any cut section should always be opened outward rather than into the aircraft so that it will not get in the way while rescue is being made.



RESCUE OF AIRCREW MEMBERS

As we stated, rescue is the main objective of crash firefighting. For this reason, plans should be complete so that a rescue can start as soon as the truck stops in position. The P-10 rescue vehicle should be positioned so that all rescue and forcible entry equipment is as near the point of entry as possible.

The truck should be facing away from the aircraft on the rescue side. Positioning of the P-10 is shown in figure 14. Before rescuemen enter an aircraft, they should be sure that the all needed rescue tools will be within easy reach.

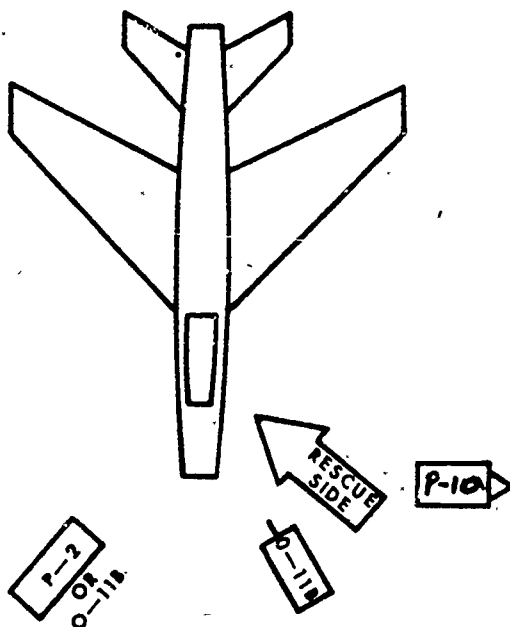

Figure 14. Positioned Rescue Vehicle.

Aircrew members who have escaped may be able to tell rescuemen the number and possible location of crew members that are still inside. If the aircraft is a large cargo or bomber, it may be impossible to make an immediate check on the total crew members and passengers. Never think that all crew members and passengers have escaped. A complete inspection of the aircraft must be made.

Only one rescueman should make the first entry into an aircraft. The other rescuemen should stay at the opening until the first tells him that he needs help. The outside rescueman can also warn the other of fire or explosion dangers that may develop. The rescuemen should approach and enter an aircraft by way of a path cleared by the turrets and handlines. Normally, two rescuemen go to each rescue point; however, only one enters the aircraft.

When you make entry, your first job as a rescueman is to locate personnel. Once you have located them, start removing them. If the inside of the aircraft is on fire, you must call for a handlineman to control the fire while you make rescue. If time permits, turn all master switches off and disconnect the batteries. This will reduce the danger of fuel vapors catching fire from an electrical spark.

Aircrew men may be held in their seats by safety belts or shoulder harnesses. Ejection seats must be safetied before a rescueman can remove an aircrew member. To release the crew member from a safety belt and shoulder harness, he opens the safety release catch in the middle of the belt at the stomach. Figure 15 shows where to



release a safety belt and shoulder harness. If the safety release catch is jammed, you can cut both the seat belt and shoulder harness with a V-blade knife.

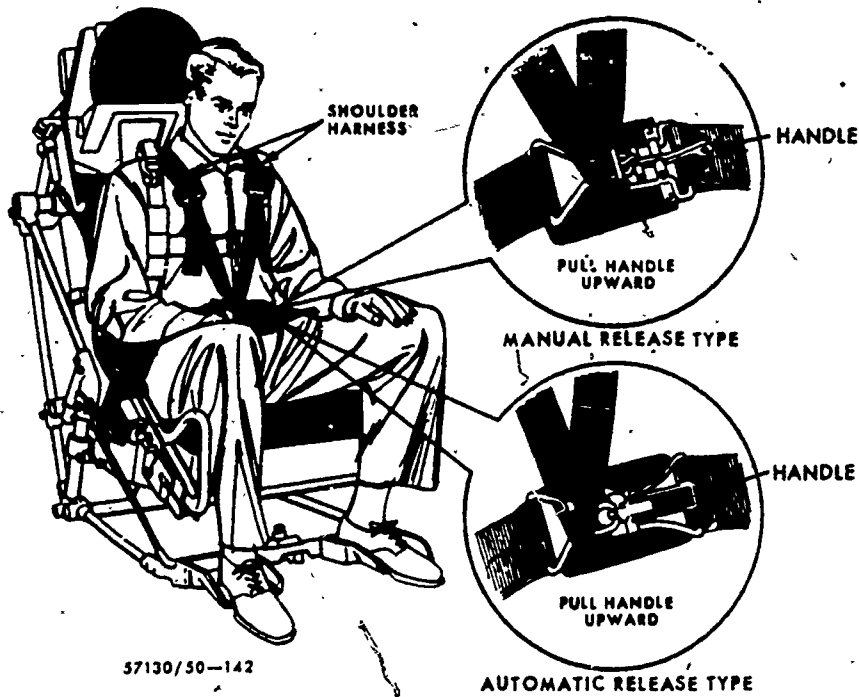

Figure 15. Seat Belt and Shoulder Harness.

Rescue of crew members in the cockpit or flight deck of an aircraft presents some problems. The control stick or wheel may be jammed in a position that pins the victim to the seat. In such instances, it may be faster to remove the cause of the jamming than to try to remove the stick or wheel itself. The stick is connected by cables to the control surfaces. Cutting one of these cables may relieve the pressure.

If members of the aircraft are pinned by wreckage or controls, it may be impossible to release them without help. Additional men or equipment may be needed. If the victim is entangled in cables, tubing, or wreckage, he should be removed carefully to keep from making his injury worse. It may be necessary to get help from the medical officer. However, your duty is to get the victim out with as much care and patience as time and conditions permit. Consider all factors, use good judgment, and remove the victim as soon as possible.

No part of an aircraft structure should be moved unless such a move must be made to make rescue possible. If the aircraft is broken up, electrical cables may be broken. If the master switch and batteries have not been cut off, the smallest movement of the aircraft wreckage may cause a broken cable to spark and ignite gasoline vapors. In spite of the hazards, there are times when an aircraft will be moved. Aircraft may be moved to protect trapped crew men by changing the direction of the fire. If the aircraft is in pieces, large parts of it can be pulled away from the fire area. Small aircraft is in pieces, large parts of it can be pulled away from the fire area. Small aircraft may be pulled away from gasoline spills. The winch and grapnel from the P-10 rescue truck should be used to move these aircraft or sections of aircraft.

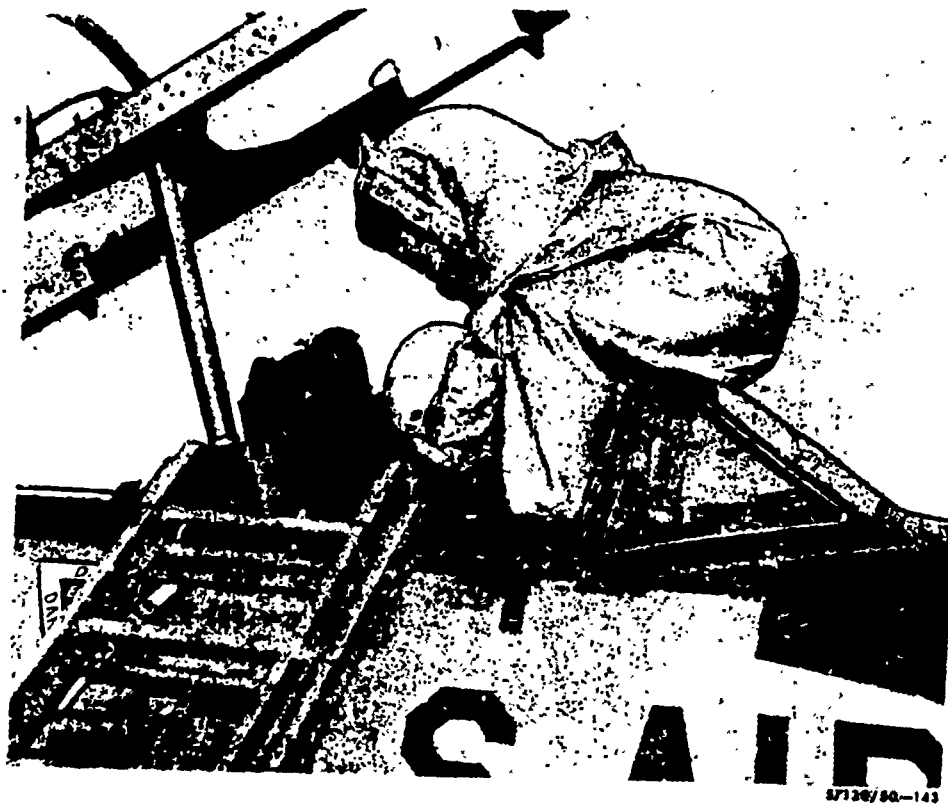

Figure 16. Pilot Removal (Step 1).

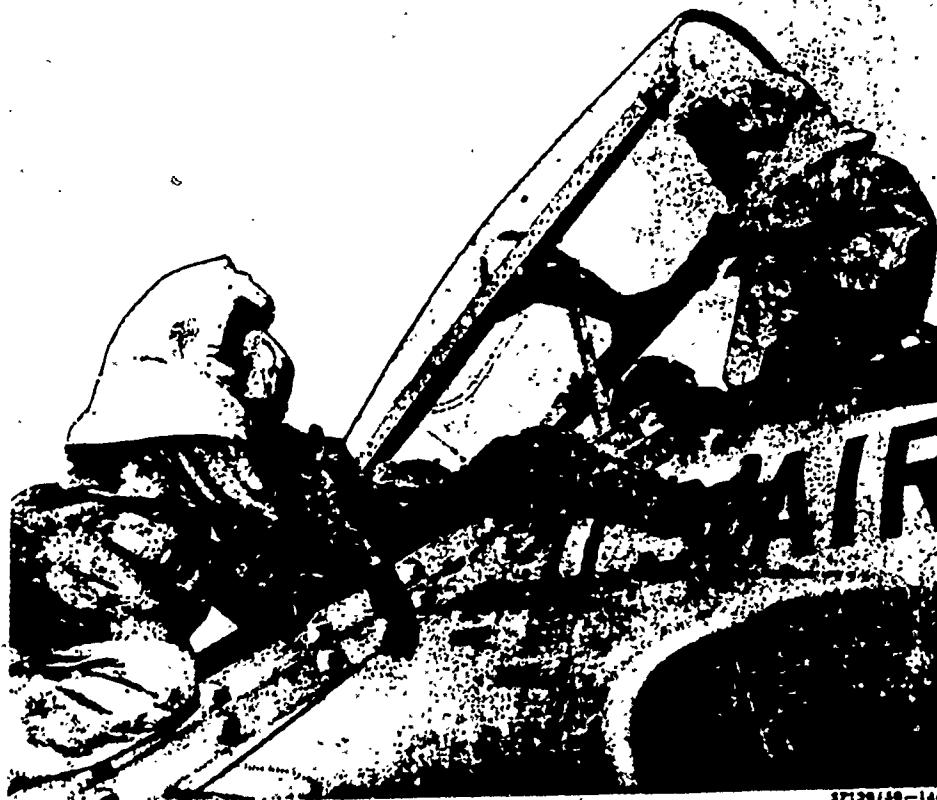

Figure 17. Pilot Removal (Step 2).



37130/30-145

Figure 18. Pilot Removal (Step 3).



37130/30-146

Figure 19. Pilot Removal (Step 4).

The rescue carries that you used in structural firefighting are the same ones used in crash firefighting. The utmost care must be taken not to make a victim's injury worse by an improper rescue carry.

There are several different methods of removing a crew member from an aircraft. One of the most common methods used is shown in figures 16 through 19. These figures show two rescuemen removing a pilot from a jet fighter. One rescueman climbs the ladder and makes the ejection seat and canopy safe. Once this is done, there is no longer any danger while working over the cockpit. A rescueman then straddles the forward portion of the canopy. He removes the pilot's shoulder harness and safety belt. He must disconnect the pilot's shoulder harness and safety belt. He must disconnect the pilot's oxygen mask and in some cases remove the face piece. He then reaches under the pilot's arms, as shown in figure 16, and lifts him up to a sitting position on the edge of the cockpit. (See figure 17.)

A second rescueman standing on the ladder holds the pilot under his arms while the first rescue man lifts the pilot's feet out of the cockpit as shown in figure 18.

The second rescueman then places the pilot's right foot over the right edge of the ladder and his left foot over the left edge of the ladder as shown in figure 19. The rescueman on the ladder slowly descends the ladder one step at a time. When they reach the ground, the pilot is taken to safety. This method of pilot removal is good, but cannot always be used. Many factors must be considered. The most important factor is the extent of the pilot's injury. He may have broken bones, arterial bleeding, or serious burns that may prevent this type of removal. The methods of victim removal and how and when you use them depend greatly on the victim's condition. These are things that all rescuemen must know before they attempt a rescue.

QUESTIONS

Please answer questions on a separate sheet of paper.

Mark the following statements true (T) or false (F).

- ___ 1. It is quicker to break a window and enter an aircraft than to use a crew member's entrance.
- ___ 2. Cutting through the metal skin of an aircraft should only be tried as a last resort.
- ___ 3. If an aircraft has made a belly landing, forcible entry should be tried through the bomb bay area.
- ___ 4. Cut-in areas are picked because they are free of obstacles such as bulkheads, tubing, or wiring.
- ___ 5. A good example of a normal opening in an aircraft would be a Plexiglass window.
- ___ 6. Doors or hatches on aircraft usually open outward.
- ___ 7. Doors and escape hatches can only be opened from the inside.
- ___ 8. Some aircraft may be entered through wings, wheel wells, and bomb bay doors.
- ___ 9. It is more dangerous to enter an aircraft without an egress system than it is to enter one with an egress system.

- ___ 10. Forcible entry methods are normally not used until other entry methods are attempted.
- ___ 11. The most important factor to consider during pilot removal is the extent of the pilot's injury.
- ___ 12. There is always danger of sparks from electrical wiring igniting gasoline vapors during rescue operations.
- ___ 13. A crashed aircraft will never be moved to aid rescue operations.
- ___ 14. The first step in removing a pilot from an aircraft that is equipped with an ejection seat is to release his seat belt and shoulder harness.

REFERENCE

TO 00-105E-9, Aircraft Rescue Emergency Information.



RAMP VEHICLE INSPECTION, MAINTENANCE AND OPERATIONS

OBJECTIVES

After completing this study guide and your classroom instruction, you will be able to:

1. Inspect and perform operator maintenance.
2. Operate the firefighting systems.
3. Perform preventive maintenance.

INTRODUCTION

Prior to the development of the P-13, major pieces of equipment were used for duties such as supporting aerospace vehicle parking areas, ramp fire patrol, aerospace vehicle engine starts and many similar details. This resulted in excessive wear and tear on major pieces of equipment, required three or four persons to operate, and exposed parked aerospace vehicles to unnecessary heavy vehicle traffic. The need for small, highly maneuverable vehicles with radio communication and a small fire suppression capability was very obvious. The P-13 was designed to meet these requirements. The savings, by using a P-13 in lieu of a major piece of equipment for aerospace vehicles support duties, has been tremendous. Use of the P-13 for minor jobs has also increased the in-service time of major pieces of equipment.

INFORMATION

OPERATOR MAINTENANCE

The fire truck is a completely self-contained and mobile fire fighting vehicle. The two firefighting units operate independently of each other with their own chemical and expellant supplies mounted on the vehicle.

Reading Assignment

Read and study the following reading assignment from TO 36A12-8-15-1 for a better understanding of the ramp vehicle.

<u>Page</u>	<u>Paragraph</u>
1-1 through 5-4	1-1 through 5-5

QUESTIONS

Please answer questions on a separate sheet of paper.

1. What are the two firefighting agents on the truck? _____
and _____.
2. Recommended hydrostatic testing time for the dry chemical tank is _____.



3. To refill the Halon 1211 unit, you pressurize the supply tank to _____ psi.
4. When full, Halon 1211 gauge should read _____.
5. What is the purpose of the vent valve?

REFERENCE

TO 36A12-8-15-1, Truck, Firefighting Airfield Ramp A/S32P-13.

44

395

O-11A INSPECTION, MAINTENANCE AND OPERATIONS

OBJECTIVES

After completing this study guide and your classroom instruction, you will be able to:

1. Identify operational procedures on the O-11A.
2. Inspect and perform operator maintenance on the O-11A.

INTRODUCTION

As the Air Force aerospace vehicles became larger, carried more fuel and had more complex systems it was necessary to develop new firefighting equipment. Equipment requirements were to furnish large amounts of water and/or foam at any given emergency, yet be mobile, self-contained and capable of operation in any kind of weather. Due to the possibility of new air fields springing up in short periods of time, another desirable requirement was a firefighting vehicle that could be transported on aerospace vehicles, or by other means, and yet be capable of operation in a matter of minutes. The O-11A was designed to meet these requirements. It is a self-contained vehicle that is versatile and effective if maintained properly.

INFORMATION

OPERATIONAL PROCEDURES

The O-11A carries its own water and foam supply which can be discharged in measured amounts through two remotely controlled cab-roof turrets. The truck originally had three groundsweep nozzles located on the lower front truck panel; however, most O-11A's have been modified with only one groundsweep. We have both types here at Chanute. Two undertruck nozzles are used to prevent flames from going under the truck. The truck also has two 150 foot fog-foam one-inch handlines, one on each side of the truck in individual hose reel compartments.

This vehicle also has a secondary fire extinguishing system consisting of a pressurized tank containing 40 gallons of chlorobromomethane (CB) discharged through a reel wound hoseline located in the CB compartment. This hoseline is accessible from either side of the truck by means of a tunnel arrangement.

A six cylinder inline liquid cooled engine propels the vehicle. The maximum output is 310 horsepower at 2800 rpm. A five man crew is desirable to operate this vehicle and its mounted equipment. The standard crew positions on this vehicle are as follows: crew chief, driver, turret operator, and two handlinemen.

Reading Assignment

Read and study the following reading assignment from TO 36A12-8-9-1 for a better understanding of the O-11A.

<u>Page</u>	<u>Paragraph</u>
1 through 22	1-2 through 1-78
33 through 38	1-102 through 1-108

QUESTIONS

Please answer questions on a separate sheet of paper.

1. What is the primary firefighting appliance on the truck?

2. What is the principle firefighting agent on the truck?

3. What is the recommended number of personnel to crew the O-11A?

4. How much water and foam is carried in the O-11A? _____

5. Where is the foam bag located? _____

List the two advantages of this:

- a. _____
- b. _____

6. Where would you go to check or add hydraulic fluid for the turrets? _____

7. What should the turret hydraulic pressure be? _____
to _____

8. What ways can the turret be operated? _____

9. What valve is closed by opening the foam valve? _____

10. If the temperature of the water in the water tank becomes too low (degrees), what warning will you have? _____

11. How many positions does the diversion valve have? _____

Tell what each position connects. _____

12. What indication of a malfunctioning booster heater will you have? _____



13. Where is the hydraulic reservoir located for the brake system?

14. What daily maintenance is performed on the air system?

15. At what air pressure are you allowed to move these vehicles?

16. There are _____ batteries that are hooked in _____
to provide _____ volt DC.

17. How many positions does the auxiliary generator switch have?

REFERENCE

TO 36A12-8-9-1, Operation and Service Instructions, Truck, Crash, High Pressure Foam (Type O-11A).

O-11B INSPECTION, MAINTENANCE AND OPERATIONS

OBJECTIVES

After completing this study guide and your classroom instruction, you will be able to:

1. Identify operational procedures on the O-11B.
2. Inspect and perform operator maintenance on the O-11B.

INTRODUCTION

As the Air Force constantly builds new and better aerospace vehicles, it builds new and better equipment designed to combat aerospace vehicle fires and save the lives of aircrew members and passengers. However, modern crash and rescue trucks with all their equipment cannot perform this vital duty alone. Men must be trained to operate these units so that they will perform with maximum efficiency in rescue and extinguishment. The degree of success of a crash operation depends on the operator's ability to use the vehicle to the fullest extent. This can be achieved only by a thorough knowledge of the vehicle.

INFORMATION

OPERATIONAL PROCEDURES

The O-11B is a mobile self-contained vehicle capable of operation over rough terrain in all weather. It is equipped with a primary firefighting system of water and foam. The water and/or foam solution can be discharged under pressure through a single turret, a groundswep, two undertruck nozzles and two handlines. A six cylinder, in-line, liquid cooled engine propels the vehicle. The maximum power output is 325 horsepower at 2,800 rpm. A five man crew is desirable to operate the vehicle and the mounted equipment. The driver, turret operator and crew chief occupy the front seats. Two handlinemen ride in compartments on either side of the main engine behind the front seats.

Reading Assignment

Study the following reading assignment from TO 36A12-8-9-1 for a better understanding of the vehicle.

<u>Page</u>	<u>Paragraph</u>
1 through 22	1-1 through 1-82

QUESTIONS

Please answer questions on a separate sheet of paper.

1. What is the capacity of the primary agent tank? _____.
2. The water tank can be filled by _____ or _____.
3. What is the capacity of the foam bag? _____.



4. The foam metering valve and tank suction valves are located in the _____ compartment.
5. The O-11B pump engine is an _____, _____ combustion engine with eight _____ opposed cylinders.
6. The rated discharge capacity of the roof turret of the O-11B is _____ or _____ at _____ psi.
7. What ways can the turret be operated? _____
8. How many foam discharge outlets are on the O-11B? _____
9. When should the churn valve be open? _____
10. The booster heater and circulating switches should be turned _____ and _____ simultaneously.
11. How much pressure is used to expel CB from the agent tank? _____
12. _____ is used to expel the CB.
13. What size ladder is carried on the O-11B? _____
14. The fire pump pressure relief valve is used _____
15. What is the function of the agent control lever? _____
16. The rate control lever is used to select _____

REFERENCE

TO 36A12-8-12-1, Operation and Service Instructions, Truck, Crash, High Pressure Foam (Type O-11B).



P-2 INSPECTION, MAINTENANCE AND OPERATIONS

OBJECTIVES

After completing this study guide and your classroom instruction, you will be able to:

1. Identify operational procedures on P-2.
2. Inspect and perform operator maintenance on the P-2.

INTRODUCTION

The A/S32P-2 is primarily used as an aircraft firefighting vehicle, but it also can be used for structural firefighting. The firefighting system is self-contained in that it requires no outside source for extinguishing agents. It has its own water tank and foam tank plus pumps to deliver both extinguishing agents.

INFORMATION

OPERATIONAL PROCEDURES

The P-2 is intended primarily as an aerospace vehicle firefighting truck, but can be used to fight other types of fires. This truck came into being because of larger aerospace vehicles with more fuel capacity (such as the KC-135, B-52, and C-5A). The P-2 takes the place of two O-11A/B vehicles. It carries 2,500 gallons of agent and discharges more agent twice as fast as other type foam vehicles. The P-2 is designed to respond quickly and is highly maneuverable on most types of terrain. The P-2 is crewed by four men: driver, crew chief, turret operator, and a handlineman sits in the seat on the right side and the crew chief sits in the left seat behind the driver. The purpose of any firefighting vehicle is to deliver agents on a fire in the quickest and safest way possible. The P-2 is designed to do just that, provided that it is in proper working order and can produce full capacity when required. The systems, both foam and water, can be rendered useless by improper care, operation, or by poor inspection and maintenance. If the agent cannot be discharged, of what value is so large and expensive a vehicle? The responsibility rests upon you for operation of this truck.

The P-2 uses a dual-engine drive with power transmitted to all four axles (8 x 8 drive). With 8 x 8 drive, positive traction, and four wheel steering, this truck can maneuver in areas where other fire trucks cannot go. On dry level concrete, a fully loaded P-2 can maintain a speed of 65 mph, and can go from 0 to 55 mph in a maximum of 50 seconds. It weighs 66,800 pounds fully loaded. It is capable of discharging water and foam immediately upon arrival at an emergency. It is also capable of maneuvering at low speeds in difficult terrain and operating the firefighting equipment at full capacity. This truck has two automatic transmissions with a single control shift lever in the cab. For quick and easy stopping, the brake system is an air-assist hydraulic type with power applied to all eight wheels. The trucks firefighting system is self-sufficient in that it requires no outside source for extinguishing agents (water and foam) and contains its own pressure pumps and firefighting equipment. The P-2 does not have a secondary extinguishing system.

Reading Assignment

Study the following reading assignment from TO 36A12-8-13-1 for a better understanding of the P-2.

Page

Paragraph

1-1 through 1-15
4-54 through 4-60

1-2 through 1-69
4-134 through 4-144

QUESTIONS

Please answer questions on a separate sheet of paper.

1. What is the crew capacity of the P-2? _____.
2. Name two major components of the Class II winterization kit?
 - a. _____.
 - b. _____.
3. What heats the components of the Class I winterization kit?
_____.
4. The water tank is located _____ and carries _____ gallons of water.
5. The foam tank is located _____ and carries _____ gallons of foam.
6. List the methods of filling these tanks.
 - a. _____.
 - b. _____.
7. The fire pump is a _____ with a dual inlet, and has a capacity of _____ gpm at _____ psi.
8. A _____ valve is used to engage this pump and is located on the _____.
9. The two _____ volt batteries are connected in _____ to deliver a total voltage of _____ DC.
10. The foam pump discharge capacity is _____ gpm at _____ psi, and is engaged by a _____ located on the _____.
11. By what means do you know when the foam pump is engaged?
_____.
12. How many foam metering valves are there on the P-2 _____, and where are they located? _____.
13. What is the purpose of the foam metering valves? _____.
14. The P-2 has a roof turret which is capable of discharging _____ gpm at _____ psi.
15. The roof turret was primarily designed for _____ operation but, as a last resort, can be _____ operated.

16. Bumper turret is _____ operated at all times, and has a discharging capacity of _____ gpm at _____ psi.

17. The P-2 employs a _____ engine drive and transmits power to all _____ axles.

18. The P-2 has _____ handline the size is _____ which is located in the _____ of the truck and will discharge _____ gpm at _____ psi.

19. Where is the charging valve located for the hand line?

20. What is the blowout valve used for? _____

REFERENCE

TO 36A12-8-13-1, Truck, Firefighting Type, A/S32P-2.



P-4 INSPECTION, MAINTENANCE AND OPERATIONS

OBJECTIVES

After completing this study guide and your classroom instruction, you will be able to:

1. Identify operational procedures on the P-4.
2. Inspect and perform operator maintenance on the P-4.

INTRODUCTION

The air transportable multipurpose firefighting truck, type A/S32P-4, is designed to provide quick response fire suppression capability for control of aircraft crash fires, real material and property fires, and for rescue of entrapped personnel. It is also designed and equipped to operate under a wide range of climatic conditions.

INFORMATION

OPERATIONAL PROCEDURES

The P-4 is intended primarily as an aerospace vehicle firefighting truck, but can be used to fight other types of fires. This truck came into being because of need for a vehicle to be air transportable on C-130 type aircraft. The P-4 takes the place of one O-11A/B vehicle. It carries 1680 gallons of agent and a pump discharge capacity of 1,200 gallons per minute. The P-4 is designed to respond quickly and is highly maneuverable on most types of terrains. The P-4 is crewed by four men: driver, crew chief, turret operator, and a handlineman. The handlineman sits in the seat on the right side and the crew chief sits in the left seat behind the driver. The purpose of any firefighting vehicle is to deliver agents on a fire in the quickest and safest way possible. The P-4 is designed to do just that, provided that it is in proper working order and can produce full capacity when required. The systems, both foam and water, can be rendered useless by improper care, operation, or by poor inspection and maintenance. If the agent cannot be discharged, of what value is so expensive a vehicle? The responsibility rests upon you for operation of this truck.

The P-4 uses a single diesel engine with power transmitted to all three axles (6 x 6 drive). With 6 x 6, positive-traction, and front wheel power steering, this truck can maneuver in areas where other fire trucks cannot. On level, dry concrete, a fully loaded P-4 can maintain a speed of 60 mph, and accelerate from 0 to 60 in a maximum of 60 seconds. It is capable of discharging water and foam immediately upon arrival at an emergency. It is also capable of maneuvering at low speeds in difficult terrain and operating the firefighting equipment at full capacity. This truck has a six forward speed semi-automatic Allison transmission with a single control shift lever in the cab. For quick and easy stopping, the brake system is an air-over-hydraulic type with power applied to all six wheels.

The systems utilized on the A/S32P-4 consist of:

- Fuel system.
- Electric system.
- Air system.
- Hydraulic system.
- Drive train.

Heating and cooling system.
Firefighting system.

Each of the above listed systems require constant inspection. A malfunction in any one of the systems may seriously damage, or cause damage to a related system. All systems are dependent on each other so the inspector must not, under any circumstance, fail to make a complete and thorough inspection of the entire vehicle.

Reading Assignment

Study the following reading assignment from TO 36A2-12-14-1 for a better understanding of the P-4.

<u>Page</u>	<u>Paragraph</u>
1-1 through 1-31	1-2 through 1-51
5-10 through 5-19	5-24 through 5-35

QUESTIONS

Please answer questions on a separate sheet of paper.

1. The alternator is rated at _____.
2. The P-4 operates in temperatures ranging from _____ to _____.
3. What is the rated discharge capacity of the bumper turret?

4. Major circuits are protected against overloads by _____
_____ type _____ breakers.
5. How long is the auxiliary power supply cord _____,
and where is it stored? _____.
6. What type of steering does the P-4 have? _____.
7. What unit is provided for crew comfort in very hot, humid
conditions? _____.
8. What type of alcohol is used in the alcohol injector?
_____.
9. When is the alcohol injector inspected? _____.
10. How many gms does the roof turret discharge? _____.
Bumper turret _____ handline _____.
11. The air system consists of an _____
compressor and _____ air pressure _____.
12. A warning system consists of a _____
and a _____ buzzer.
13. Each component has its own _____
which delivers fuel at the _____ and _____
appropriate for the unit.

305
14. A separate set of fuel lines is provided for the _____,
and for the _____.

15. What is the normal operating air pressure on the A/S32P-4?
_____.

16. Before filling the alcohol injector, what must be accomplished
first? _____.

REFERENCES

TO 36A12-12-14-1, Operation and Maintenance Instructions, Truck,
Firefighting, Multipurpose, Air Transportable, (Type A/S32P-4).

PROCEDURES FOR ON SCENE OPERATIONS

OBJECTIVES

After completing this study guide and your classroom instruction, you will be able to:

1. Identify the procedures for determining proper vehicle approach.
2. Determine the procedures for positioning vehicles.
3. Identify salvage operation procedures.
4. Identify procedures for preserving evidence.

INTRODUCTION

Every unit of an operation should be under the direction of a responsible crew chief. If a single unit is operating unaided at an aerospace vehicle accident, the crew chief of that unit is in charge. When two or more units coordinate in an operation, the senior crew chief at the scene is in overall charge until the arrival of the fire chief or assistant chief.

Note: This is an established written rule. Thus, the responsibilities of the first or senior arriving crew chief are vast and exacting. The initial plan of attack is, in many cases, the deciding factor between success or failure of the operation. When an aerospace vehicle is involved in a fire, the course of action taken to combat the fire is divided into five distinctive steps or procedures. Remember that the firefighting operation must remain flexible. The supervisor may have to vary these procedures to meet particular requirements at an actual emergency.

INFORMATION

APPROACH

The ideal approach to a burning aircraft is upwind. However, the ideal approach may not be in the best interest of a successful rescue. The distance and time required for an upwind approach may be good reasons for rejecting the upwind approach. If time is not primary to the immediate start of a rescue, then the extra time should be used to make an ideal approach.

There are many factors to consider when an aircraft firefighting crew is responding to an emergency. Although an airbase is supposed to be cleared of all air traffic when an aircraft accident occurs, other emergencies may prevent this action. This creates a hazard for the trucks and their crews when they are using the runways as the most direct route to the accident. To guard against the danger of a collision between the responding trucks and a moving aircraft, the crew chief of each truck should assign one man as "watcher" to warn the driver of impending danger and of any control tower light signal. Vigilance on the part of these watchers cannot be over-emphasized, for the safety of all members of the crew is at stake.

If the firefighting crews have been given prior notice of an emergency landing and are positioned along the runway, there is always the danger of the aircraft taking unexpected paths, particularly when landing with faulty landing gear. The malfunction

may divert the aircraft from its original direction on landing. This possibility must be considered when equipment is positioned.

Speed and coordination are essential when a crew is responding to an emergency; just a few seconds may determine the success or failure of rescue efforts. Trucks should travel as fast as air base directives and conditions permit without sacrificing safety for speed. Battles may be won "by them that gets there fustest with the mostest," but they can't be won by those that don't arrive.

Speed is necessary, but recklessness can be dangerous. The overall weight of the truck is a factor that must be considered by the driver when responding to an emergency. He must consider that water weighs 8.35 pounds per gallon and that, in addition to the equipment and personnel on a crash truck, for example, the weight of the water alone is well over 4 tons. A curve taken too sharply will result in the water forced to the outside of the curve, which changes the center of gravity. This could result in tipping over, injury, or death to personnel, and failure in the objectives. Although baffle plates are installed in water tanks to retard motion of the water, they are by no means a cure-all. The trucks are designed as carefully as possible, but placing too great a stress on their parts could result in serious accidents, so we repeat: The truck must arrive at the scene of the emergency in fire-fighting condition if the operation is to be successful.

When a crash occurs on an airfield, the scene of the crash seems to be a gravitational point for a great variety of vehicles, most of which are not authorized to be in the area. This not only creates an additional hazard to emergency vehicles but, in many cases, prevents the firefighting trucks from making a proper approach. The security police, as part of the team, must correct this condition as quickly as possible. Time is a factor, but the driver of the fire truck must combine his driving with good judgement.

When enroute to the scene of an aircraft emergency, all members of the crew should watch for parachutes from the stricken aircraft. During the immediate approach, the terrain should be watched closely for aircrew members who have been thrown clear or jumped from the aircraft before or when it stopped. This practice may aid in determining the number of aircrew remaining in the aircraft.

The approach to any aircraft incident is, in reality, started long before it actually happens. The whole operation has been partially preplanned before you became a fire protection specialist. All of your training has been directed toward the time when you will take your part in preplanned operations. The approach is only a part of the whole operation.

On the approach to the scene of an incident you should maneuver your vehicle to the most advantageous, yet safe, position so that the turret operation will be most effective. If your truck is the first to arrive at the scene, depending upon your fire chief's desires on setting up, you will usually set up on the nose or tail of the aircraft with the other trucks positioning on you. Your department's standing operating procedure is the basis for your setup position, and it will cover the most likely conditions expected to be countered. There may be times, however, when you will have to make the decision as to where the approach will be made so the control of the fire can begin.

Normally, the wind direction will be one of the deciding factors on how the approach will be made. Upwind is the ideal position to take because the turret and handline streams will reach the farthest and the danger to your crew and truck is lessened. This does not always lessen the danger to the personnel trapped in the aircraft. The upwind side may not always be the safe side because of terrain features or armament loads. To get to the upwind side sometimes requires more time than you can afford



to use. The area of the burning fuel may be such as to determine the direction of the approach. The number of personnel involved in the aircraft may also cause a different approach to be used.

In a study of the preplans for incidents, terrain features are one of the main items covered. The effects of high and low areas, what the ground is like after a day's rain or a week of rain, and the routes that are safe and those that should be avoided must be considered. Such obstacles as ditches, pits, rocky areas, fences, and swampy grounds are some of the terrain features you keep in mind when making your approach.

However, there are times when the normal procedures (the first truck being positioned on the nose or tail of the aircraft) should not necessarily be followed. You must use your judgment because the sooner the agents are applied to the whole fuselage, the better the chance for survival of the personnel within the aircraft. Five or ten seconds can truly be a lifetime if you wait for another truck to fill the gap you left open.

POSITIONING

An old adage of aircraft firefighting is "First truck in splits the fuselage." (The first truck arriving at the accident positions on the nose, or the tail, for controlling the fire on both sides of the fuselage.) The adage still remains true in most cases; however, there are no hard and fast rules governing the position of trucks. Good judgment on the part of the crew chief and driver will put the truck in the most effective position.

This judgment requires rapid evaluation of known facts, since the trucks must be placed within range for the use of turrets. It is these turrets that play the most important part in controlling the fire around the fuselage and providing protection for rescuers. The driver must also position the truck so that he can advance or retreat as circumstances indicate.

The normal sequence of positioning trucks on aircraft is as follows: the first truck arriving positions on the nose or tail, the second truck positions on the rescue side of the fuselage, the third truck sets up on the opposite side of the fuselage, and any additional trucks set up as directed by the crew chief around the aircraft until all are in position. There will be accidents that you respond to requiring a different sequence to fit unusual circumstances. The terrain (hilly, smooth, trees, etc.), condition of the ground (dry, swampy, snow, sand, etc.), type of aircraft, and condition of emergency (intact, broken apart, on fire, etc.) are all involved in the positioning of the trucks.

Some types of aircraft create danger zones in the area of their main landing gear wheels. If excessive braking is necessary during the landing roll, tire blowouts, wheel fires, and ignition of flammable liquids in the area may be the result. As we stated before, positioning trucks on aircraft will depend upon existing conditions.

It would be impossible to discuss or illustrate all of the possible setups. There are too many factors to consider when an accident occurs. Some of these factors are weather, wind direction, terrain, type of aircraft involved, location of accident, and number of trucks available. A few basic principles from which you must determine the most acceptable plan of action have been discussed above.

The attack on the fire is started before the positioning of the trucks has been completed. The turrets should be readied for instant operation prior to the attack, and when the truck is within range of the fuselage, the firefighter can start the discharging agent to cool and protect the fuselage. How far away from the aircraft



does the firefighter stop the truck? The answer can only be the safe distance. What is the safe distance? Only the circumstances of the incident and judgment can answer that. Two feet away from the fuselage may be perfectly safe but a deep fuel spill may make it dangerous 20 feet away. The use of the ground sweep may extinguish the fire, but what may happen when the wheels of the truck disturb the foam blanket covering the spill? What may happen when the hand line man dismounts and pulls his line to go into operation? This also disturbs the foam blanket. For small areas under your truck, the use of the undertruck nozzles are usually effective if equipped.

If the incident occurred on a slope, which way would you position the truck? Uphill from the aircraft would be the most logical position because the flow of fuel would be down the hill; however, there are other factors that must be brought into the picture before the final decision is made. The wind velocity and direction, the terrain, the time it takes to position on the uphill side, the steepness of the slope, the area of the fire, the number of personnel on the vehicles are all factors that should be considered. They all affect the approach and positioning of your vehicle. Once the first vehicle is in position, the rest of the vehicles are generally committed to attack from that point.

All of the foregoing material of this section has dealt with the nose or tail approach. Conditions and circumstances may, at time, require a broadside setup to the fuselage. This again requires judgment on your part as a skilled firefighter or supervisor. The requirements to be met on any approach to an aircraft accident are the accessibility to the aircraft for effective use of the turrets and handlines, the speed with which the fire around the fuselage can be controlled, the speed with which the rescue effort can begin, and the reasonable safety of the firefighters.

SALVAGE

Salvage work in crash firefighting consists of preventing excessive damage by fire, smoke, and water. There are only two ways of performing salvage. One way is to remove the material to the outside or to an area that is not involved in the fire. The other way is to protect the material where it stands. The amount of salvage work done at a fire depends on several factors some of which are: the amount of salvage equipment, the number of personnel available, the type and amount of material involved, and the method of storage.

PRESERVATION OF EVIDENCE

When fighting fire or overhauling the aerospace vehicle, it is extremely important that all firefighters look for, recognize, and preserve any evidence required for further investigation. Care should be taken to avoid disturbing any evidence that may aid the investigating officers in determining the cause of the accident or the extent of damage. Any documents or material known to be classified should be shielded from public view or photography. Move only those parts of the aerospace vehicle necessary for the performance of your duties, nothing more. Remember, do whatever is necessary to make sure that wreckage is not moved or tampered with in any way, except to assist or remove persons injured or killed, and eliminate any further hazards. The investigating officers will be looking for evidence during the overhaul operations. All crash crew members must coordinate with and assist these officers to the best of their ability. They are therefore a definite purpose and are a part of the overall team. The aerospace vehicle and all related parts should be washed down and neutralized by foam or large amounts of water. If an aerospace vehicle cannot be moved from the scene of the accident immediately, the fire department must detail a truck and crew to standby. The Security Police will send a detail to guard against unauthorized persons entering the area. The Security Police and any other persons allowed within the area must be informed of the danger of fire. The senior fire officer at the scene exercises control of the operation until such time as he deems the aerospace vehicle and area firesafe.

You should relay all information in your possession to the senior fire official present for proper evaluation. Never pass information to personnel not in the fire department chain of command.

PROTECTIVE CLOTHING

Receiving

Here in Block 5, your instructors will issue you protective clothing. The protective clothing will consist of the following items:

1. Crash hood.
2. Protective coat.
3. Protective trousers.
4. Suspenders.
5. Boots.
6. Protective gloves.

Wearing

The protective clothing that you will receive is designed to protect you when worn properly. Certain adjustments will be necessary for proper fit and should be accomplished to satisfy individual needs. Anytime you are wearing bunker clothes, in Block 5, you will wear standard fatigues under them. You may bring an old pair of fatigues and change daily to save wear on your better clothing. Clothing underneath assists in keeping you cool during hot fires and warm during cold weather. Thick socks will be worn to protect your feet. You may wear sweat shirts, winter underwear or other clothing under fatigues during cold weather. During extremely cold weather, you may wear other items to keep you warm if the items meet the approval of your instructor and the Air Force.

Inspecting

Protective clothing inspection begins just as soon as you receive your equipment. They should be inspected on a regular basis to insure that they stay in a serviceable condition.

Storing

Special protective clothing racks have been designed for Block 5. Your instructor will assign you a rack position which will consist of an upper and lower peg. The clothing will be hung on the top peg in the following manner; trousers hung by the suspenders, coat by the loop and the crash hood by the elastic strap. The boots will be hung in a uniform manner on the bottom peg.

QUESTIONS

Please answer questions on a separate sheet of paper.

Mark the following statements true (T) or false (F).

- _____ 1. To guard against the danger of collision between the crash vehicle and other moving vehicles, the driver should blow his siren and horn.
- _____ 2. Crash trucks should travel only as fast as conditions permit.



- ___ 3. During the approach, you should watch for aircrew members who may have been thrown from the aircraft.
- ___ 4. A factor to consider when making an approach to an aircraft accident or incident is the quickest and safest route to the aircraft.
- ___ 5. One factor to consider when setting up on an aircraft is the wind direction.
- ___ 6. There is no danger when positioning vehicles on an aircraft armed with missiles.

Fill in the blanks.

7. List three things you should watch for when responding to an aerospace vehicle crash.

- a. _____
- b. _____
- c. _____

8. What is the first thing to do after receiving your crash hood? _____

9. As a firefighter, who do you relay information to pertaining to an aerospace vehicle incident? _____

10. When is protective clothing inspected? _____

11. Who is responsible for the care and maintenance of protective clothing? _____

REFERENCE

TO 14P-3-1-12, Use, Care and Operation of Protective Clothing.

EMERGENCY RESPONSE EXERCISES

OBJECTIVES

After completing this study guide and classroom instructions, you will be able to:

1. Operate O-11A/B or F-4.
2. Perform crew duties in drills.
3. Washdown simulated hazardous spills.
4. Perform preventive maintenance.

INTRODUCTION

It can be said that the ultimate goal of your previous training, during this block of instruction, was to prepare you for this study guide. It would be impossible to teach you the procedures to extinguish fires on every type of aerospace vehicle in the USAF. However, the basic operating procedures are the same for all operations. Therefore, you will practice extinguishment of fires as applied to all aerospace vehicles.

The extinguishment of fire is not your primary objective at an aerospace vehicle crash. Rescue is the primary objective, with crash fire extinguishment as a secondary objective. An aerospace vehicle can be replaced; a pilot's life cannot. The crew and crew chief in charge should plan firefighting tactics in accordance with this principle.

INFORMATION

OPERATION

Reading Assignment

Read and study the following reading assignment from TO 36A12-8-9-1 and TO 36A12-8-12-1 so that you will have an understanding of the O-11A and O-11B turrets operation.

<u>TO</u>	<u>Page</u>	<u>Paragraph</u>	<u>Table</u>
36A12-8-9-1	73 through 80A	4 through 20	III
36A12-8-12-1	108 through 113		IVB

CREW DUTIES

Turret Operator

When within turret range (approximately 50 - 75 feet) of the fire area, release the solenoid button and direct a straight stream on the fuselage. Sweep the fuselage from nose section to tail section. This will provide protection for explosives and air crew members located in any part of the aerospace vehicle and will also provide a rescue path on both sides of the fuselage. After this, the fire around the fuselage should be controlled and your truck should be in position to extinguish the outlying fires.

Handlineman

The position of each handlineman is very important when fighting fuel fires. The handlineman in the front is called the lead handlineman. The man in the rear is called the backup man. Each man plays an important part in crash firefighting. The lead lineman makes the initial attack on the fire. He moves slowly forward, extinguishing fire as he goes. He must be careful not to overrun the fire. The backup man takes a position about 6 to 8 feet behind the lead man and stays about 3 feet to the side. His job is to put out any fire that the lead man may have missed, and most important, provide protection to the lead lineman from flashbacks. The backup man can also cool the lead man if he gets too hot from the fire's heat. He does this by spraying foam on the lead man's back and legs. Remember, never use a solid stream to cool a man!

HAND SIGNALS

Whenever people work together as a team to accomplish a goal, signals of some nature are used. The quarterback of a football team calls the signals for the play, so does the crew chief or instructor call the signals for the discharge of agent. Due to the truck engine noise and distance between the turret operator and crew chief, these signals will be visual. The signals given by your instructor or crew chief for the turret operator and handlineman will be as follows:

Move Trucks into Position "A" in Figure 20: Extend arms over head, palms toward individual giving signal, motioning trucks forward.

Throttle Pump Engine Down "B" in Figure 20: Draw finger across throat.

Full Throttle of Pump Engine "C" in Figure 20: Extend arm above the head and rotate in a circular motion.

Full Fog Pattern From Turret "D" in Figure 20: Form large circle with arms overhead and touch fingertips.

Intermediate Pattern From Turret (O-11A Only), "E" in Figure 20: Form a small circle in front of face with thumb and forefinger of the hands. The lever in the cab used to select this stream is labeled "water fog."

Straight Stream From Turret, "F" in Figure 20: Point to the turret with one hand and to the target with the other.

Stop Turret Flow Solenoid Use "G" in Figure 20: Crisscross arms overhead.

Groundsweeps On or Off "H" in Figure 20: Thrust your open hands toward ground-sweep, palms down.

Undertruck Nozzles On or Off, "I" in Figure 20: Thrust your open hands forward in a cupping motion.

When Truck is Out of Agent: The turret operator will turn on the headlights and sound the siren. Handlinemen of the empty vehicle will be backed out of the fire area by an instructor.

Open or Close Handline Nozzle: Firm hand tap on the desired barrel (FOAM OR WATER).

Change Stream Patterns (Handline Nozzle): Place insides of wrists together and clap hands.

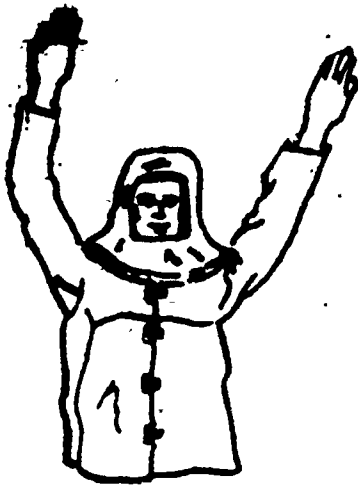

A. MOVE TRUCKS INTO POSITION

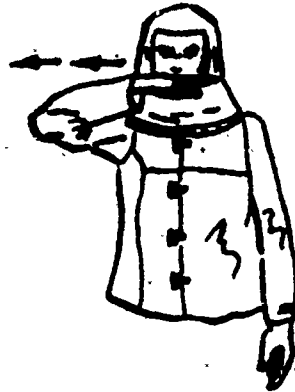

B. THROTTLE PUMP ENGINE DOWN

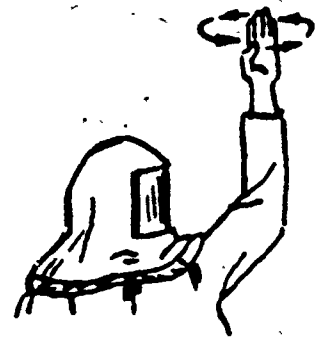

C. FULL THROTTLE-PUMP ENGINE

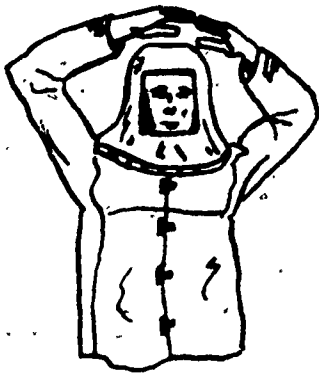

D. FULL FOG PATTERN-TURRET

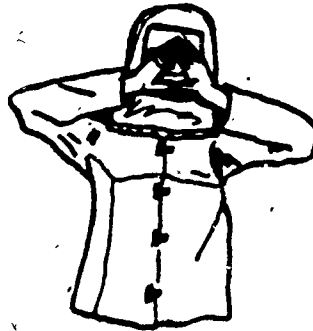

E. INTERMEDIATE PATTERN FROM TURRET

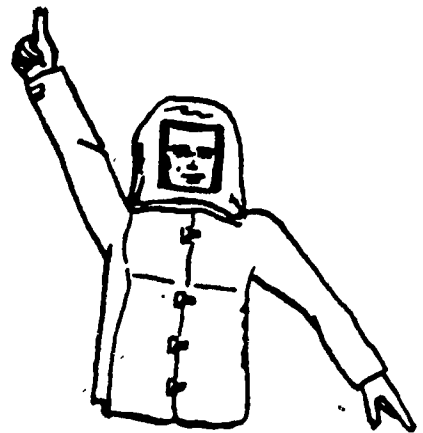

F. STRAIGHT STREAM FROM TURRET

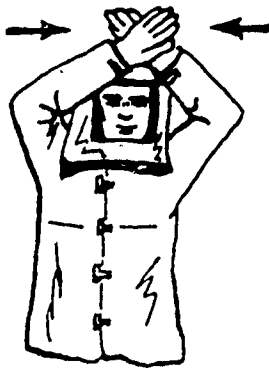

G. STOP TURRET FLOW

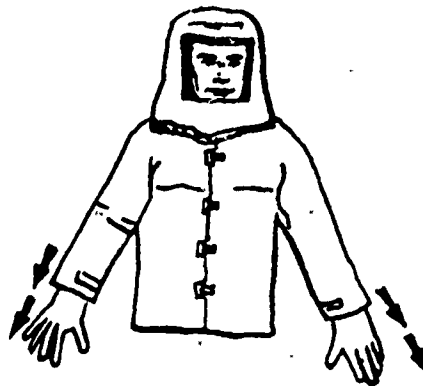

H. GROUNDSWEEPS ON OR OFF

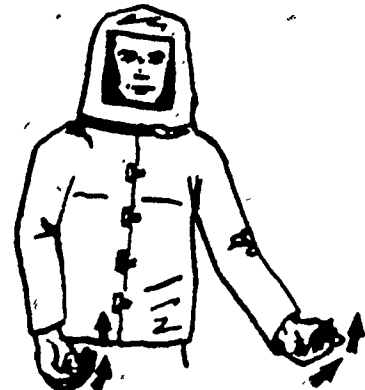

I. UNDER TRUCK NOZZLES ON OR OFF

Figure 20. Hand Signals for Crash Operations.

Advance (Handlineman): Firm pat on the buttocks with the open hand.

373

Back Up or Retreat: Series of pushing motions given with the hands in front of the chest.

Caution: 1. Never direct a straight stream into the fire area as a possible reflash will occur. Always deflect this type of stream from a solid portion of the aerospace vehicle.

2. Turrets should be indexed to intermediate fog or full fog for the purpose of sweeping the wings of the aerospace vehicle and protecting students and instructors.

3. You may have to move the vehicle farther into the fire area to consolidate your gain on the fire. Only instructors will direct the driver to move the vehicle.

4. Always turn the undertruck nozzles on when driving through a spill area.

Safety

The possibility of injury is greater during these exercises than in any other portion of training. Be constantly alert! You are working with high velocity streams. Fuel and fire are added hazards. Each student will follow these instructions.

Wear protective clothing, including hoods, during turret and handline practice and during fires.

Turret-pump operators will have the hood and gloves in the truck within reach.

As soon as possible, report to the instructor all injuries, burns, or illness.

Do not direct straight streams into puddles of burning fuel.

As soon as you feel any part of your body getting slightly uncomfortable from heat, turn to your backup man and signal him to cool you. If you do this at the proper time, you will avoid being blistered. Since the hands are the most likely part of your body to get burned, you should practice slipping your hand in front of your own nozzle stream.

Turret-pump operators will closely observe the entire operation. Immediately discharge foam to cool personnel in danger. Throttle down when a nozzle or handline is out of control. Be extremely cautious when discharging a straight stream. Be constantly alert for signals from instructors.

Safety in Fire Training Area

Stand clear of the vehicle when it is in motion. Never stand behind a vehicle when the engine is running.

Be sure doors are latched and use all hand holds when riding in vehicles. Never ride on top of the vehicle.

No jewelry will be worn during operations requiring performance.

Truck cab windows will be closed at all times when fighting fires.

Don't play at any time during training - no horseplay!

Do not run - walk!

Do not raise your hood or remove any part of your protective clothing during fires.

Don't jump out of vehicles. Use all hand holds and back out.

Never enter the fire area unless accompanied by an instructor.

Fatigues will be worn under the protective clothing at all times during training fires.

Never lay nozzles on the ground.

Hold the nozzle firmly when in use.

HAZARDOUS SPILLS

Fuel spills normally occur in the vicinity of parked aerospace vehicles. Fuel spills can occur in almost any locality where fuel is stored, transported or handled. Once a fuel spill has occurred; it then presents a greater fire hazard because of the possibility of ignition. In order to reduce the hazard, appropriate action must be taken immediately. This situation may be handled by diluting the fuel with water or covering the spill with foam in more serious incidents..

PREVENTIVE MAINTENANCE PROCEDURES

Proper cleaning methods will insure that the exterior paint on the vehicle will not become faded and scratched. When washing the exterior always use cold or lukewarm water, along with a mild soap. Do not wash the truck in the sun or when the painted surface is hot. NOTE: Using a 2-1/2" or 1-1/2" hose under pressure on exterior surfaces may peel the paint. After washing the vehicle with soap and water, a thin coat of a good grade auto wax should be applied to the exterior surface. When removing the wax, a clean soft rag should be used. Never use hydraulic fluid, gasoline or thinner on painted surfaces or tires. When cleaning the tires, wash with soap and water. If black tire paint is available, the tires may be painted.

When cleaning the interior, you should first dust the dash, seats, piping, and other equipment with a soft brush and then use a damp rag to clean the floor. The seats should be wiped regularly with a clean damp cloth. Clean all windows with water or window cleaner, also using a soft clean rag.

Seat belts may be cleaned with mild soap and water. NOTE: Do not use a charged hose line to clean the cab floor, only a damp rag is recommended.

QUESTIONS

Please answer questions on a separate sheet of paper.

1. How is wax removed after it is applied to the surface of the vehicle? _____
2. When improper cleaning methods are used what will happen to the exterior surface? _____
3. How are seat belts cleaned? _____

Mark the following statements true (T) or false (F).

- _____ 4. During aircraft firefighting operations, the backup handlineman extinguishes fires that the lead lineman misses and protects the lead lineman from fire.
- _____ 5. The backup handlineman positions himself 20 to 30 feet behind the lead lineman.
- _____ 6. Handlinemen should cool each other with solid streams from their handline nozzles.

REFERENCES

1. AFR 92-1, Fire Protection Program.
2. TO 36A12-8-9-1, Operation and Service Instructions, Truck, Crash, High Pressure Foam (Type O-11A).
3. TO 36A12-8-12-1, Operation and Service Instructions, Truck, Crash, High Pressure Foam (Type O-11B).

376

EMERGENCY RESPONSE AND AIRCRAFT APPROACH EXERCISES

OBJECTIVES

After completing this study guide and classroom instruction, you will be able to:

1. Operate O-11A/B or P-4.
2. Operate P-2.
3. Perform preventive maintenance.

INTRODUCTION

You will actually put the fire pump into operation and get extinguishing agent out of the turrets on the P-2 and P-4.

INFORMATION

Reading Assignment

Read and study the following reading assignment from TO 36A12-8-13-1 and TO 36A12-12-14-1 so that you will have an understanding of the P-2 and P-4 turret operation.

<u>TO</u>	<u>Page</u>	<u>Paragraph</u>
36A12-8-13-1	4-56A through 4-60	4-128 through 4-142
36A12-12-14-1	5-14 through 5-19	5-32 through 5-34

PREVENTIVE MAINTENANCE PROCEDURES

Proper cleaning methods will insure that the exterior paint on the vehicle will not become faded and scratched. When washing the exterior always use cold or lukewarm water along with a mild soap. Do not wash the truck in the sun or when the painted surface is hot.

Note: Using a 2-1/2" or 1-1/2" hose under pressure on exterior surfaces may peel the paint.

After washing the vehicle with soap and water, a thin coat of a good grade autowax should be applied to the exterior surface. When removing the wax, a clean soft rag should be used. Never use hydraulic fluid, gasoline or thinner on painted surfaces or tires. When cleaning the tires, wash with soap and water. If black tire paint is available, the tires may be painted.

When cleaning the interior, you should first dust the dash, seats, piping and other equipment and then use a soft brush to clean the floor. The seats should be wiped regularly with a clean damp cloth. Clean all windows with water or window cleaner, also using a soft clean rag.

Seat belts may be cleaned with mild soap and water.

Note: Do not use a charged hose line to clean the cab floor, only a damp rag is recommended.

QUESTIONS

Please answer questions on a separate sheet of paper.

1. Why must the flow of the agent from the roof turret be interrupted before changing barrel selector lever? _____

2. What is the purpose of the agent selector lever in the cab? _____

3. What is the minimum pump pressure that ball valve in the roof turret should be opened and closed? _____

4. When the roof turret agent selector is in forward position and the rate selector is in the rear position, how many gallons of agent is being discharged and through which barrels?

- a. _____
- b. _____

REFERENCES

- 1. TO 36A12-8-13-1, Truck Firefighting Type A/S32P-2.
- 2. TO 36A12-12-14-1, Operation and Maintenance Instructions, Truck Firefighting Multipurpose Air Transportable Type A/S32P-4.



CONTROL AND EXTINGUISHMENT ON SMALL FRAME AIRCRAFT FIRES

OBJECTIVES

After completing this study guide and classroom instruction, you will be able to:

1. Perform as a member of a firefighting crew to control and extinguish crash fires.
2. Perform preventive maintenance.

INTRODUCTION

It can be said that the ultimate goal of your previous training during this block of instruction was to prepare you for this day's live fires.

INFORMATION

CRASH FIRES

Control

The control step was also covered in structural firefighting. Remember, we stated that a fire is controlled when it is no longer making headway. In crash firefighting, it is very easy to lose control. You often quickly knock down a fire with mass application of foam. Then a flashback or wind change causes the fire to rage out of control. Again, the main reason for control is rescue. During the control step of aircraft firefighting, a rescue path is opened to the fuselage. This path is made by extinguishing fire around the fuselage area with turrets and handlines. This rescue path is held until the rescue is completed. This "fire free" rescue path allows time for rescuers to enter the aircraft and return with their victims in safety. The fuselage area where firefighters make this path is the part of the fuselage where crew members or passengers are located. Controlling the fire in this area keeps the fuselage cool and reduces the danger of explosion.

Control is actually started during the attack step by using turrets, booms, and ground sweeps. Control of the fire is held during the rescue effort. Handlinemen are used during the control step to knock down and control spot fires around the rescue area that cannot be reached by the turrets. Control, then, is holding the fire off or keeping it away from the rescue area until rescue is completed.

Extinguishment

The next step in aircraft firefighting is extinguishment. This, of course, means to put all the fire out. Total extinguishment does not start until the rescue operation is completed. The reason for this is that it usually takes all available manpower to protect the rescuers and victims during the rescue. Also, we do not know how long it will take to complete the rescue, so the extinguishing agents must be saved to keep a fire safe area until rescue is complete. However, there are times when the type of aircraft and fire can be small enough to completely extinguish the fire and rescue the people at the same time. In addition, when enough equipment, including resupply equipment, is available, a full mass application attack is used.

When an aircraft has crashed, there will probably be broken fuel lines. These must be plugged before complete extinguishment is possible.

When the fire of a crashed aircraft causes magnesium parts to burn, great care should be taken to prevent injury to firefighters. Magnesium combines with oxygen and makes extinguishment a problem. Most extinguishing agents have little or no effect on burning magnesium. Water or foam applied to burning magnesium can cause an explosion that spreads burning pieces all about the area. If burning pieces of magnesium get on the protective clothing of firefighters, they will burn completely through the clothing. The only effective way to fight fire involving magnesium is to use a dry powder agent to put out the fire.

The important fact to remember is that rescue is the most important job during an aircraft crash. The firefighting efforts should focus on making a fire safe rescue area or path with turrets and handlines. Once the rescue operation is complete, then all efforts can be directed toward completely extinguishing the fire.

PREVENTIVE MAINTENANCE

Protective Clothing

You will always want your protective clothing to give you the best possible protection for which it was designed. Remember, we discussed this on your first day in Block V and you were issued a set of aluminized protective clothing. Now, we will prepare them for turn-in. This means you have to wash, clean and dry your protective clothing. You are expected to inspect it and notify your instructor of any tears, breaks, or burn spots that you find on your protective clothing.

Vehicles

You should know how to properly service and maintain the aerospace firefighting vehicles. But, you will get to learn a little more about cleaning and properly maintaining these vehicles. This will still call for work on your part. But remember when you get to your next station, the most important thing you will want to do is to keep your equipment in operation. This starts with your keeping it as clean as possible all the time. During the cleaning process, you are also inspecting for such things as loose parts, broken glass or lenses and dents and scratches in the truck.

QUESTIONS

Please answer questions on a separate sheet of paper.

Mark the following statements true (T) or false (F).

- 1. During the control step of aircraft firefighting, a rescue path to the fuselage is made with turrets and handlinemen.
- 2. Controlling a fire around the aircraft fuselage allows time for rescuemen to complete rescue operations.
- 3. Handlinemen are never used during the control step of aircraft firefighting.
- 4. One of the great dangers during control is a flashback.
- 5. The danger of flashback is only present during the control step of aircraft firefighting.
- 6. Extinguishment of aircraft fires always starts before the rescue operations.



- ___ 7. Water and foam in large amounts should be used to extinguish burning magnesium fires.
- ___ 8. Extinguishment means to put the fire completely out.

REFERENCES

- 1. TO 36A12-8-9-1, Operation and Service Instructions, Truck, Crash, High Pressure Foam (Type O-11A).
- 2. TO 36A12-8-12-1, Operation and Service Instructions, Truck, Crash, High Pressure Foam (Type O-11B).
- 3. TO 36A12-12-14-1, Operation and Maintenance, Instructions, Truck, Firefighting, Multipurpose, Air Transportable, (Type A/S32P-4).

[

CONTROL, EXTINGUISHMENT, OVERHAUL AND RESCUE ON SMALL FRAME AIRCRAFT FIRES

OBJECTIVES

After completing this study guide and classroom instruction, you will be able to:

1. Perform as a crew member to control, extinguish and simulate rescue during aircraft fires.
2. Perform firefighting overhaul clean-up operations.
3. Perform preventive maintenance.

INTRODUCTION

The extinguishment of fire is not your primary objective at an aerospace vehicle crash. Rescue is the primary objective, with crash fire extinguishment as a secondary objective. An aerospace vehicle can be replaced; a pilot's life cannot. The crew and crew chief in charge should plan firefighting tactics in accordance with this principle.

INFORMATION

CREW DUTIES

Rescue

We covered control and extinguishment in the last unit. In this unit, we will cover rescue.

After entrance is gained, the firefighters should first locate and determine the condition of injured personnel. If immediate hazards are beyond control, personnel should be evacuated immediately. If immediate evacuation is not possible due to wreckage or twisted controls, the firefighter should attempt to keep the fire away from the area where personnel are trapped. Extreme care should be used when removing personnel pinned in wreckage, to prevent aggravating existing or causing additional injuries. If possible, medical advice should be obtained before moving injured personnel.

OVERHAUL

After an aerospace vehicle incident, regardless of whether or not a fire has occurred, firefighting personnel must conduct a complete overhaul. This involves a thorough inspection of the entire aerospace vehicle and crash area to make sure that no ignition or reignition will occur. The master switch in the aerospace vehicle must be placed in the "OFF" position, if this has not already been done. The batteries must be disconnected and the terminals taped so there will be no danger of contact if the aerospace vehicle is moved. All hot spots should be cooled. Using the bare hand to feel areas of the fuselage and wings may indicate areas that need cooling. Care must be observed when using the bare hands to locate hot spots. There may be jagged metal edges that could cause severe lacerations. Likely areas for hidden sparks of fires are under aerospace vehicle components resting on the ground, smoldering wire insulation, aerospace vehicle furnishings or baggage, and in concealed spaces or compartments. The bayonet nozzle or crash axe may be needed to get into concealed spaces unless access panels are provided. If there is any fuel spilled on the ground

as a result of the crash, this fuel should be covered with foam to prevent ignition. In some cases, fuel tanks are drained of fuel and purged with water as a preventive measure.

PREVENTIVE MAINTENANCE PROCEDURES

Proper cleaning methods will insure that the exterior paint on the vehicle will not become faded and scratched. When washing the exterior always use cold or lukewarm water, along with a mild soap. Do not wash the truck in the sun or when the painted surface is hot. NOTE: Using a 2-1/2" or 1-1/2" hose under pressure on exterior surfaces may peel the paint. After washing the vehicle with soap and water, a thin coat of a good grade auto wax should be applied to the exterior surface. When removing the wax, a clean soft rag should be used. Never use hydraulic fluid, gasoline or thinner on painted surfaces or tires. When cleaning the tires, wash with soap and water. If black tire paint is available, the tires may be painted.

When cleaning the interior, you should first dust the dash, seats, piping, and other equipment with a soft brush and then use a damp rag to clean the floor. The seats should be wiped regularly with a clean damp cloth. Clean all windows with water or window cleaner, also using a soft clean rag.

Seat belts may be cleaned with mild soap and water. NOTE: Do not use a charged hose line to clean the cab floor, only a damp rag is recommended.

QUESTIONS

Please answer questions on a separate sheet of paper.

Mark the following statements true (T) or false (F).

- _____ 1. Firefighters must perform overhaul after every aircraft incident or accident.
- _____ 2. During overhaul, we completely inspect the aircraft to make sure all fire is out and will not start again.
- _____ 3. Disconnecting the aircraft batteries and turning off the master power switch is part of the overhaul step of aircraft firefighting.
- _____ 4. If an aircraft cannot be moved from the crash scene, the fire department must leave a truck and crew with the aircraft to guard against a restart of the fire.
- _____ 5. Overhaul may start during the approach and attack phase.

REFERENCES

- 1. TO 36A12-12-14-1, Operation and Maintenance Instructions, Truck, Firefighting, Multipurpose, Air Transportable, Type A/S32P-4.
- 2. TO 36A12-8-9-1, Operation and Service Instructions, Truck, Crash, High Pressure Foam (Type O-11A).
- 3. TO 36A12-8-12-1, Operation and Service Instructions, Truck, Crash, High Pressure Foam (Type O-11B).



CONTROL, EXTINGUISHMENT, OVERHAUL AND RESCUE ON MEDIUM FRAME AIRCRAFT FIRES

OBJECTIVES

After completing this study guide and classroom instruction, you will be able to:

1. Perform as a member of a firefighting crew to control and extinguish crash fires.
2. Perform firefighting overhaul cleanup operations.
3. Perform preventive maintenance.

INTRODUCTION

For the last two days of live fires, you have been on small frame aircraft using only two trucks. Now we move to medium frame aircraft and a three truck operation.

INFORMATION

CREW DUTIES

Rescuemen

Rescue is carried out basically the same way except, now you will have three rescuemen instead of two. Now, you will have to search the aircraft fuselage for personnel that may be located there.

Handlinemen

Handlines stay the same. We will still have four handlinemen. The lead lineman makes the initial attack on the fire. The backup man takes a position about 6 to 8 feet behind the lead lineman and stays about 3 feet to the side on the rescue side of the aircraft. The backup lineman cools the rescue point and protects the rescuemen while rescue is being performed.

Turret Operators

For the last two days of training, you have not been discharging on approach. Today, you will discharge for 3 seconds using straight stream on the fuselage.

OVERHAUL

After an aerospace vehicle incident, regardless of whether or not a fire has occurred, firefighting personnel must conduct a complete overhaul. This involves a thorough inspection of the entire aerospace vehicle and crash area to make sure that no ignition or reignition will occur. The master switch in the aerospace vehicle must be placed in the "OFF" position, if this has not already been done. The batteries must be disconnected and the terminals taped so there will be no danger of contact if the aerospace vehicle is moved. All hot spots should be cooled. Using the bare hand to feel areas of the fuselage and wings may indicate areas that need cooling. Care must be observed when using the bare hands to locate hot spots. There may be jagged metal edges that could cause severe lacerations. Likely areas for hidden sparks of fires are under aerospace vehicle components resting on the ground, smoldering wire

insulation, aerospace vehicle furnishings or baggage, and in concealed spaces or compartments. The bayonet nozzle or crash axe may be needed to get into concealed spaces unless access panels are provided. If there is any fuel spilled on the ground as a result of the crash, this fuel should be covered with foam to prevent ignition. In some cases, fuel tanks are drained of fuel and purged with water as a preventive measure.

PREVENTIVE MAINTENANCE

A daily preventive maintenance checklist has been included in your workbook on crash vehicles, and you have been using these checklists as each truck was learned. We cannot overemphasize the importance of daily inspection of the trucks and their mounted equipment. A \$100,000 crash truck is completely useless if it cannot be operated. You are probably wondering, "What is preventive maintenance"? It is usually any minor maintenance that can be performed by firemen with the vehicle in service. The amount of driver maintenance performed will vary from base to base. While making your inspection, any discrepancies you find will be recorded on your check sheet. After the discrepancies have been recorded, you will bring them to the attention of your crew chief who will determine what items will be fixed by his crew, and what items maintenance personnel will repair.

Reservicing crash vehicles consists of not only flushing and refilling the system, but washing and polishing the vehicle. Filth and grime does as much harm to a vehicle as poor maintenance. The following items will be accomplished:

1. Washing.
2. Polishing.
3. Inspection and cleaning of the equipment.
4. Recharging the agent tanks on foam vehicles.

QUESTIONS

Please answer questions on a separate sheet of paper.

1. What items are accomplished during vehicle reservicing?

- a. _____
- b. _____
- c. _____
- d. _____

2. What is preventive maintenance? _____

3. You will discharge from the turret for _____ seconds.

4. The backup linemen stays _____ to _____ feet behind the lead man.

5. On the rescue side, the backup man is responsible for what?

REFERENCES

1. AFR 92-1, Fire Protection Program.
2. TO 36A12-8-13-1, Operation and Service Instructions, Truck, Crash, Fire and Rescue (Type A/S32P-2).
3. TO 36A12-8-9-1, Operation and Service Instructions, Truck, Crash, High Pressure Foam (Type O-11A).
4. TO 36A12-8-12-1, Operation and Service Instructions, Truck, Crash, High Pressure Foam (Type O-11B).
5. TO 36A12-12-14-1, Operation and Maintenance Instructions, Truck, Firefighting, Multipurpose, Air Transportable, Type A/S32P-4.

CONTROL, EXTINGUISHMENT, OVERHAUL AND RESCUE
ON LARGE FRAME AIRCRAFT FIRES

OBJECTIVES

After completing this study guide and classroom instruction, you will be able to:

1. Perform as a member of a firefighting crew to control and extinguish crash fires.
2. Perform firefighting overhaul cleanup operations.
3. Perform preventive maintenance.

INTRODUCTION

Firefighting methods used for aircraft fires are very different from the methods used for structural fires. The big difference is the fuel used in aircraft. Aircraft fuels are high octane gasoline and jet propulsion (JP) fuels. These fuels burn much hotter than fires involving other materials. Because these fuels burn so hot, different firefighting equipment, extinguishing agents, and firefighting methods must be used. Firefighters even have to wear special protective clothing to protect themselves against the fire's heat.

INFORMATION

CREW MEMBER DUTIES

Turret

Remember, we stated that the turret is the main firefighting device on an aircraft firefighting truck. Years ago, firemen used the turrets as little as possible and handlines as much as possible. The idea was that the firefighting agent could be used best when expelled through the handline. Today, we do the opposite. We use the turret as much as possible and the handline is used to mop up. This does not mean that the handline is not important. Good handline operations often mean the difference between success and failure. On the other hand, good turret techniques are more important than they have ever been. This new method involving maximum use of turrets is called "mass application of agent." By this term, we simply mean putting as much agent on the fire as possible in the shortest period of time. The mass application method could include the use of the P-2 bumper turret, however, the O-11B turret and P-2 turret are the main devices for mass application of agent.

Although mass application is a very good method of fighting aircraft fires, it may not always be the best method. For example, if you are stationed at a base that does not have enough firefighting agent and equipment, you cannot use the mass application method on the fire. You have to save your agent to be used for controlling the fire around the rescue area until a rescue is made, the fire might continue to burn. If this happens, rescue can not be completed. These things must be thought out before any attempt is made to use the mass application method of firefighting.

During mass application, the pump engines on the foam trucks are at full throttle with the pumps supplying the turrets with the maximum amount of foam. As the truck approaches the fire, the turrets should be set for a solid stream and at maximum output.

This means that foam can be put on the fire as the vehicle is approaching. The important point to remember is that the fuselage is the target. The turret is used to control and extinguish the fire in the fuselage area first.

A good turret operator knows when to change his turret to dispersed stream. The point to remember here is that the solid stream should be changed to dispersed stream as soon as possible. Remember, the dispersed stream is best. We use the solid stream when approaching the fire because it reaches farther and we can start putting agent on the fire as the vehicles are approaching.

If handlinemen are in front of the truck and in range of the turrets, the turret operator could strike a lineman with a solid stream of agent. Solid streams have enough power to knock a man off his feet. Solid streams from a turret can seriously injure firefighters. So remember this when you are assigned duties as a turret operator.

During all steps of firefighting and rescue, the danger of flashback is present. Application of foam usually starts as the trucks are being positioned. By the time the last truck is positioned, there is normally enough foam discharged to blanket the fuel around the fuselage. A solid stream from a turret can "plow" an opening in the foam blanket, uncovering the fuel. This may cause the fuel to ignite again. This condition is known as "flashback."

Handlineman

The position of each handlineman is very important when fighting fuel fires. The "inverted V" formation will be used by the handlineman. The other lineman sit up behind the one in front of them, keeping the inverted V formation, remember, safety is of prime consideration.

Rescueman/Crew Chief

Lives may depend upon how well you perform rescue. It is rarely possible to complete a rescue operation without first being exposed to some type of hazard. It may be fire, smoke, explosion, or the accidental actuation of an aerospace vehicle ejection seat. Normally, there will be fire, and if rescue operations are necessary, the proper use of special tools and equipment will greatly assist you in your work. Teamwork is also very important in rescue activities where time is a limiting factor. The degree of success depends on a well trained team. Many Air Force personnel have jobs that call for an average amount of accuracy. These jobs do offer an opportunity to do it again if someone makes a mistake. The crash rescueman does not have this second chance. Rescue has to be accomplished during the first try.

OVERHAUL

After an aerospace vehicle incident, regardless of whether or not a fire has occurred, firefighting personnel must conduct a complete overhaul. This involves a thorough inspection of the entire aerospace vehicle and crash area to make sure that no ignition or reignition will occur. The master switch in the aerospace vehicle must be placed in the "OFF" position, if this has not already been done. The batteries must be disconnected and the terminals taped so there will be no danger of contact if the aerospace vehicle is moved. All hot spots should be cooled. Using the bare hand to feel areas of the fuselage and wings may indicate areas that need cooling. Care must be observed when using the bare hands to locate hot spots. There may be jagged metal edges that could cause severe lacerations. Likely areas for hidden sparks of fires are under aerospace vehicle components resting on the ground, smoldering wire insulation, aerospace vehicle furnishings or baggage, and in concealed spaces or compartments. The bayonet nozzle or crash axe may be needed to get into concealed spaces unless access panels are provided. If there is any fuel spilled on the ground

as a result of the crash, this fuel should be covered with foam to prevent ignition. In some cases, fuel tanks are drained of fuel and purged with water as a preventive measure.

PREVENTIVE MAINTENANCE

Clothing

You will always want your protective clothing to give you the best possible protection for which it was designed. Remember, we discussed this on your first day in Block V and you were issued a set of aluminized protective clothing. Now, we will prepare them for turn-in. This means you have to wash, clean and dry your protective clothing. You are expected to inspect it and notify your instructor of any tears, breaks, or burn spots that you find on your protective clothing.

Vehicles

You should know how to properly service and maintain the aerospace firefighting vehicles. But, you will get to learn a little more about cleaning and properly maintaining these vehicles. This will still call for work on your part. But remember when you get to your next station, the most important thing you will want to do is to keep your equipment in operation. This starts with your keeping it as clean as possible all the time. During the cleaning process, you are also inspecting for such things as loose parts, broken glass or lenses and dents and scratches in the truck.

QUESTIONS

Please answer questions on a separate sheet of paper.

- 1. Prior to turning in your protective clothing, you will _____, _____, and _____ them.
- 2. What is the most important thing that you will want to do after you arrive at your next duty station? _____
- 3. You should know how to properly _____ and _____ the aerospace vehicles.
- 4. When inspecting your protective clothing you will report all _____, _____, or _____.
- 5. During the cleaning process of the aerospace vehicles, you should also check for _____, _____, and _____.
- 6. After every aerospace vehicle incident, what four major things must be done on overhaul?
 - a. _____
 - b. _____
 - c. _____
 - d. _____

Mark the following statements true (T) or false (F).

- _____ 7. Mass application means that we use the handlines as much as possible.



- 8. In most cases, the dispersed stream is better than the solid stream.
- 9. Even when fighting a small fire, the turret operator should direct his stream at the fuselage.
- 10. During the attack, the pump engines on the foam trucks should be at full throttle with the pump discharging at full capacity.
- 11. A solid turret stream can knock a firefighter off his feet and possibly cause serious injury.

REFERENCES

- 1. AFR 92-1, Fire Protection Program.
- 2. TO 36A12-12-14-1, Operation and Inspection Instructions, Truck, Firefighting Multipurpose Air Transportable, (Type A/S32P-4).
- 3. TO 36A12-8-9-1, Operation and Service Instructions, Truck, Crash, High Pressure Foam (Type O-11A).
- 4. TO 36A12-8-12-1, Operation and Service Instructions, Truck, Crash, High Pressure Foam (Type O-11B).
- 5. TO 36A12-8-13-1, Operation and Service Instructions, Truck, Crash, Fire and Rescue (Type A/S32P-2).

#



AIRCRAFT ARRESTING SYSTEMS

OBJECTIVE

After completing this study guide and your classroom instructions, you will be able to identify facts relating to assisting the inspection and operation of aircraft arresting systems.

INTRODUCTION

Aircraft barriers serve a very important role in the Air Force mission. They prevent the aircraft from running off the end of the runway. In addition to saving the lives of pilots and crewmen, they prevent damage or destruction of aircraft. They are used at every Air Force installation that has flying aircraft. Barriers are extremely important in combat areas where the aircraft may have had battle damage that would prevent safe stopping of the aircraft after landing. To maintain barriers, you need to know their construction, operation, and maintenance requirements. An effective barrier could save a pilot's life or an aircraft.

INFORMATION

BARRIERS

General

Aircraft arresting barriers are included in the same general classification as ejection seats and parachutes, emergency equipment designed to protect crew members when the condition of their aircraft is unfavorable. This condition could occur either on take-off or landing operations. As such, this equipment must be completely reliable at all times.

Since the primary purpose of barriers is to save pilot's lives and the secondary purpose is to aid in preventing aircraft damage, maintenance of the barriers is of prime importance. The quality of maintenance that must be performed requires absolute technical order compliance and highly qualified personnel.

All aircraft arresting barriers are used for landing and take-off emergencies. They are engaged by the pilot when conditions are such that he cannot complete a take-off or landing without endangering himself, his crew and aircraft. The barriers you will be working with are the MA-1A, BAK-9, BAK-12, and BAK-13. These are the barriers in use throughout the Air Force today. By using components from these barriers they can be interconnected to arrest tail hook or non-hook equipped aircraft. In any case all arresting barriers will consist of three major components the engaging device, energy absorber and rewind system.

MA-1A Barrier

The MA-1A barrier was the first to meet desired requirements for Air Force use. It is designed for a normal runout of 1,000 feet. The barrier is simple in construction and easy to maintain. It is designed to arrest both hook and non-hook equipped aircraft. This engaging ability makes the MA-1A capable of arresting most jet fighter and trainer aircraft. Successful aircraft arrestments can be accomplished only when all systems of the MA-1A barrier have been properly inspected, serviced and maintained.

BAK-9 Barrier

The BAK-9 was the second aircraft barrier introduced into the Air Force inventory that still remains in operation. It was designed as an emergency type barrier in that it does not have a quick recycle capability. It may be interconnected with the MA-1A engaging device to give both a hook and nonhook engaging ability. The energy of the moving aircraft is absorbed by a hydraulic actuated rotary friction brake system. The rewind system is driven by an electric motor.

The BAK-9 differs from other barriers in that it only has one arresting engine (energy absorber).

Bak-12 Barrier

The BAK-12 is an advanced design over the BAK-9. It was intended for use where permanent installation was not feasible or required. However, it may be permanently installed. It is an emergency type barrier with a quick recycle capability allowing engagements at five-minute intervals.

The BAK-12 has two arresting engines, one on each side of the runway. The rewind system consists of two gasoline engines, one on each arresting engine. The hydraulic rotary friction brakes have been modified for water spray cooling during rewind. This prevents the brakes from overheating during rapid cycle engagements.

The BAK-12 barrier is presently installed at many Air Force bases throughout the world. It is air transportable and can be installed in a nonpermanent manner in eight hours by experienced personnel.

BAK-13 Barrier

The BAK-13 barrier is the most advanced design in use by the Air Force today. The BAK-13 is capable of engagements every three minutes. The maximum rewind time is one minute and thirty seconds.

It is designed as an air transportable expeditionary (quickly installed) barrier that can be installed within 100 manhours.

The BAK-9 and BAK-12 barriers use rotary friction brakes to absorb the energy of the engaging aircraft. The BAK-13 uses a liquid turbine as an energy absorber. The BAK-13 has two arresting engines. Rewind power is provided by gasoline engines the same as the BAK-12.

Inspection

The continuous operational readiness of aircraft-arresting systems is an essential mission function. In situations where battle damage is not being routinely incurred, (such as noncombat environment) fire-protection personnel may be required to perform the operation and inspection of the system as specified in AFR 85-5 and as listed below. No additives to the fire protection manpower standard will be recognized for this work. Primary responsibility for the aircraft arresting system remains with the electrical power production shop. Fire protection and electrical power production responsibilities regarding aircraft arresting systems follow:

Fire Protection:

1. During normal duty hours, fire protection personnel assist electrical power production in the operation, inspection, activation or deactivation of aircraft-arresting systems.

2. During other than normal duty hours (including weekends and holidays) fire-protection personnel:

- a. Perform visual inspections and report noted deficiencies immediately to the civil engineering service call desk for corrective action.
- b. Perform activation or deactivation of aircraft-arresting systems as requested by the aircraft control tower.
- c. Accomplish routine inspection and certification required by technical orders after all engagements.

Electrical Power Production:

- 1. Responsible for the maintenance, including installation and removal of aircraft-arresting systems.
 - a. During normal duty hours, performs maintenance on aircraft arresting systems and, with the assistance of fire protection personnel, operates, inspects, resets, activates or deactivates, and certifies aircraft-arresting systems in accordance with applicable technical orders.
 - b. During other than normal duty hours (including weekends and holidays), has the capability to respond to calls for emergency maintenance and operational assistance.
- 2. Provides on-the-job training to selected fire-protection personnel during normal duty hours to preclude degradation of aircraft-arresting capabilities during non-duty hours.

The delineation of responsibilities specified above apply in a noncombat environment. The electrical power production function is totally responsible for all aircraft-arresting systems work, and manned accordingly, in combat situations where battle damage is being incurred on a recurring basis.

Forms

The barrier forms and records will be locally produced and maintained. Although forms may vary, they will primarily be used as a record of maintenance, inspections and tape replacement criteria.

Air Force operational type equipment must have forms and records maintained on them.

Since numerous people work on and maintain this equipment, forms, and records will provide a means of knowing the condition and status of the equipment. The forms will also provide a history of past maintenance and repair work performed.

The forms and records on the barriers are not of standard Air Force design. The forms you will probably use are of local command design.

The forms and records on the barriers must reveal such things as the number of engagements, when the tapes were cropped, turned end-for-end, when the pendant was installed, and when weekly, monthly, and special inspections are due. Each barrier will require a form to be maintained with the desired information.

Safety

We feel that "Safe Practices" should be kept in mind at all times. Safety should be a habit rather than something to correct for after an accident. You will be working



around moving machinery, electrical equipment, and flammable liquids. Do not allow carelessness to be mixed with any of these necessary elements.

Practice safety, fire prevention, first aid, and firefighting in that order. If the first two items are practiced, you may never need to use the last two items.

QUESTIONS

Please answer questions on a separate sheet of paper.

1. What is the primary purpose of runway barriers? _____

2. All barriers are used for _____ and _____ emergencies.

3. BAK-13 maximum rewind line is _____.

4. The BAK-12 is _____ transportable and can be installed in _____ hours.

5. Who is responsible for barrier work during combat situations? _____

REFERENCES

1. TO 35E8-2-2-1, USAF Types MA-1 and MA-1A Runway Overrun Barrier.
2. TO 35E8-2-5-1, Aircraft Arresting Barrier, Model BAK-12/E32A.
3. TO 35E8-2-4-1, Arresting Gear, Aircraft, Model BAK-9/F48A.
4. TO 35E8-2-7-1, Arresting System, Model BAK-13 F48A (E.W. Bliss).
5. Manual P-21, 91, Installation, Operation and Maintenance Manual, Aircraft Arresting System BAK-13/F48A, (E.W. Bliss).
6. AFR 92-1, Fire Protection Program.

BIBLIOGRAPHY

As time permits, study the reference materials listed in this bibliography from the Base Library. After studying the materials listed, you will possess a much broader knowledge of the course than would otherwise be possible from normal classroom instruction.

1. Anderson, Newton H., Aircraft Layout in Detail Design. N.Y., McGraw Hill, 1941.
2. Ashley, Holt, Aerodynamics of Wings and Bodies. Mass., Addison-Wesley, 1965.
3. Bahne, Charles William, Fire Protection for Chemicals. Boston, NFPA, 1961.
4. Barlay, Stephen, The Search for Air Safety. New York, W. Morrow, 1970.
5. Beaty, David, The Human Factor in Aircraft Accidents. New York, Stein and Day, 1969.
6. Bonney, Evedard Arthur, Aerodynamics, Propulsion, Structures. New Jersey, Van Nostrand, 1956.
7. Bridman, Leonard, Janes, All the Worlds Aircraft. London, Lowe and Marston, 1941.
8. Casamastra, Jack V., Jet Aircraft Power System. New York, McGraw Hill, 1965.
9. Factory Mutual Engineering Corp., Handbook of Industrial Loss Prevention. Boston, NFPA, 1959.
10. Flaherty, John Joseph, Fire Alarm, The Story of Fire Fighting. Philadelphia, 1949.
11. Green, William, MacDonald Aircraft Handbook. New York, Dennis I. Punnett, 1966.
12. Green, William, Observers Basic Book of Aircraft. New York, F. Warne, 1967.
13. Jones, Lyod S., U.S. Bombers, B-1, B-70. Calif., Aero Publishers, 1962.
14. Keil, Andrew A., Radiation Control for Fire and Other Emergency Forces. Boston, NFPA, 1960.
15. Lowell, Vernon W., Airline Safety is a Myth. New York, Barlow House, 1967.
16. Mackenzie, Angus, Aircraft of the World. Chicago, P. Baur, 1960.
17. Stinton, Darrel, The Anatomy of the Airplane. Dallas, American Elsevier, 1966.
18. Swansborough, F. G., Military Transports and Training Aircraft of the World. Calif, Aero Publishers, 1965.
19. Taylor, J. W. R., War Planes of the World. New York, Arco, 1966.
20. Taylor, J. W. R., Combat Planes of the World. New York, Puttman, 1969.
21. Wagoner, Ray, American Combat Planes. New York, Hanover House, 1961.





395

Technical Training

Fire Protection Specialist
Crash Firefighter

17-3

AEROSPACE VEHICLE FIREFIGHTING

28 August 1975



CHANUTE TECHNICAL TRAINING CENTER (ATC)

This supersedes 3ABR57130-1-WB-500, 21 May 1973.

OPR: TWS

DISTRIBUTION: X

TWS - 2000; TTVGC - 3

Designed For ATC Course Use

DO NOT USE ON THE JOB

CONTENTS

<u>UNIT</u>	<u>TITLE</u>	<u>PAGE</u>
504	Rescue Operations	1 through 4
505	Ramp Vehicle Inspection, Maintenance and Operations	5 through 8
506	O-11A Inspection, Maintenance and Operations	9 through 12
507	O-11B Inspection, Maintenance and Operations	13 through 16
508	P-2 Inspection, Maintenance and Operations	17 through 21
509	P-4 Inspection, Maintenance and Operations	23 through 26
511	Emergency Response Exercises	27 through 31
512	Emergency Response and Aircraft Approach Exercises	33 through 36
513	Control and Extinguishment of Small Frame Aircraft Fires	37 through 41
514	Control, Extinguishment, Overhaul and Rescue on Small Frame Aircraft Fires	43 through 47
515	Control, Extinguishment, Overhaul and Rescue on Medium Frame Aircraft Fires	49 through 53
516	Control, Extinguishment, Overhaul and Rescue on Large Frame Aircraft Fires	55 through 59



RESCUE OPERATIONS

OBJECTIVES

After completing the study guide, classroom instruction, and this workbook, you will be able to:

1. Operate tools and equipment at a simulated crashed aircraft and using the P-10. All applicable technical order procedures and safety practices must be strictly adhered to with minimum instructor assistance.
2. Demonstrate normal and emergency entry procedures. All procedures must be followed in accordance with TO 00-105E-9. All applicable safety procedures must be strictly adhered to with minimum instructor assistance.
3. Rescue aircrew members try a simulated crashed aircraft in accordance with procedures listed in TO 00-105E-9. All procedures must be followed using all applicable safety practices with minimum instructor assistance.
4. Perform preventive maintenance on the P-10 IAW AFTO Form 433.

EQUIPMENT

Pencil	Basis of Issue
Tire Pressure Gauge	1/student
P-10	1/5 students
Preventive Maintenance Materials	1/5 students
	1/10 students

PROCEDURE

As the instructor covers the information on the P-10 preventive maintenance procedures, answer questions 1 through 5.

QUESTIONS

1. What cleaning materials are used in cleaning the P-10?
 - a. _____
 - b. _____
 - c. _____
 - d. _____
 - e. _____
 - f. _____
2. What type of soap is used during cleaning of the vehicle?

3. Where is water used on electrical circuits? _____
4. Who is responsible for cleaning the vehicle? _____

398

5. What type of wax is used in polishing the vehicle?

Now that you know what is required for the job, we will now perform preventive maintenance IAW AFTO Form 433, figures 1, 2, 3.

OPERATOR'S INSPECTION GUIDE AND TROUBLE REPORT (P-2/4, Q-11A/B, R-2/2A, P-10 FIREFIGHTING VEHICLES)		DATE (MO/YR)
VEHICLE TYPE		REGISTRATION NO.
USING ORGANIZATION	LOCATION	PHONE NO.
VEHICLE CONTROL OFFICER NAME	GRADE	PHONE NO.
ITEMS TO BE CHECKED	OPERATOR SIGNATURE	DAY
1. LUBRICATING OIL LEVELS (engine/trans./gear box/ water pump power dividers)		1
2. COOLANT, FUEL, AND HYDRAULIC LEVELS		2
3. FOR LEAKS (oil, fuel, coolant, hydraulic, air, exhaust, etc.)		3
4. CONDITION OF ALL DRIVE BELTS (visual only)		4
5. TIRES, WHEELS, AND LUG BOLTS, FOR TIGHTNESS, PRESSURE AND DAMAGE		5
6. BATTERIES (front and rear) FOR FLUID LEVEL, DAMAGE, CLEANLINESS, AND SECURITY		6
7. CLEANLINESS, DAMAGE, MISSING ITEMS (all interior and exterior items)		7
8. LUBE/OIL CHANGE		8
9. BRAKES, CLUTCHES (Operation), AIR TANKS (Drain), OPERATE PARKING BRAKE		9
10. STEERING, SPRINGS & SHACKLES FOR OPERATION & DAMAGE		10
11. SAFETY DEVICES (warning lights, buzzers, fire extinguishers, seat belts)		11
12. OPERATION OF ALL LIGHTS, SIRENS, RADIO, HORNS, MIRRORS		12
13. WIRING/CIRCUIT BREAKERS (visual only)		13
14. SPECIAL EQUIPMENT (axe/spanner wrench/power saw and blade wrench/ladder/chin hoist/pike pole/trouble light/ megaphone/breathing apparatus/generator & resuscitator)		14
15. FIREFIGHTING SYSTEM CORROSION/DAMAGE AND FOAM/WATER LEVELS		15
16. ON/OFF BASE GRID MAPS/STATE MAPS		16
17. HEATER/DEFROSTER/AIR CONDITIONER		17
18. WINDSHIELD/WIPERS/WASHERS (condition and operation)		18

Figure 1. AFTO Form 433 (Front).

411

400

ITEMS TO BE CHECKED (CONT'D)		OPERATOR SIGNATURE	DAY
19. INSTRUMENTS AND GAUGES (during operation)			23
20. UNUSUAL NOISES (during operation)			24
21. WINCH/TOWING CONNECTORS (when installed)			25
22. SHIFT TOWER & SWITCHES FOR PROPER OPERATION (trans.)			26
23. ALL HYDRAULIC CYLINDERS FOR OPERATION			27
24. CB FOAM SYSTEM (leaks/proportioning/operation/crystals)			28
25. HOSES/REELS/FOAM METERING VALVE (operation) (left and right)			29
26. HAND LINES/BOOM/GROUND SWEEPS (operation)			30
27. TURRETS (hydraulic and manual) (operation)			31
28. PUMPS, PIPING AND VALVES FOR LEAKS AND CORROSION (during operation)			
29. AUXILIARY GENERATOR/HEATER/LOUVERS (operation)			
30. BOOSTER HEATER (operation)			
31. HAND CIRCULATING PUMP (operation)			
32. RADIATOR SHUTTER CONTROL FOR OPERATION			
33. OPERATE ALL FIREFIGHTING DISPENSING SYSTEMS (all patterns)			
34. ALCOHOL AND ALCOHOL INJECTOR SYS. FOR OPERATION			
35. WINTERIZATION KIT			
36. OPERATE RELIEF VALVE			
37. SPARK CHECK (Weekly and Scheduled Inspection Intervals)			
TYPE INSPECTION (Weekly or Sched)	DATE DUE	DATE ACCOMP	OPERATOR OR MECHANIC SIGNATURE AND GRADE

Figure 3. AFTO Form 433 (Back).

RAM VEHICLE INSPECTION, MAINTENANCE AND OPERATIONS

OBJECTIVES

After completing the study guide, classroom instruction, and this workbook, you will be able to:

1. Inspect and perform operator maintenance on the ramp vehicle. All appropriate items on the checklist must be inspected. Operating maintenance must be accomplished according to the appropriate technical order.

2. Operate the firefighting system(s). All applicable technical order procedures and safety practices must be strictly adhered to with minimum instructor assistance.

3. Perform preventive maintenance on the ramp vehicle IAW AFTO Form 434.

EQUIPMENT

	Basis of Issue
Pencil	1/student
TO 36A12-8-15-1	1/student
P-13	1/5 students
Tire Pressure Gauge	1/5 students
Preventive Maintenance Materials	1/10 students

PROCEDURE

As the instructor covers the information on the subject of inspection, operator maintenance procedures, answer questions 1 through 5. After completing the questions, the class will go out to the vehicle and the instructor will use the AFTO Form 434, figures 4, 5, and 6, in this workbook and inspect the P-13.

QUESTIONS

1. The Halon 1211 level should read? _____
2. The dry chemical unit nitrogen pressure should read _____ PSI.
3. The P-13 should be lubricated at _____ intervals.

4. The nozzles on the Halon and Dry Chemical unit should be checked for?

5. The tire pressure should be _____ PSI.

Note: The AFTO form will be used during the laboratory portion of the class. Class members will use AFTO Form 434 in this workbook to inspect the P-13.

402

During this portion of the course, through group discussion and practical application, you will inspect the P-13 using the standard fire vehicle checklist, AFTO Form 434, Operator's Inspection Guide and Trouble Report, figures 4, 5, and 6. Perform operator preventive maintenance as needed, and be able to locate and state the discrepancies on the various vehicle systems and components.

OPERATOR'S INSPECTION GUIDE AND TROUBLE REPORT (530A/B, 730A, P-4, P-8, P-12, 1000/1500 GALLON WATER DISTRIBUTORS, F-6/F-7 FOAM DISTRIBUTORS)		DATE (MO/YR)
VEHICLE TYPE		REGISTRATION NO.
USING ORGANIZATION	LOCATION	PHONE NO.
VEHICLE CONTROL OFFICER NAME		GRADE
		PHONE NO.
ITEMS TO BE CHECKED	OPERATOR SIGNATURE	DAY
1. LUBRICATING OIL LEVELS (engine/trans./priming pump)		1
2. COOLANT, FUEL, AND HYDRAULIC LEVELS		2
3. FOR LEAKS (oil, fuel, coolant, hydraulic, air, exhaust, etc.)		3
4. CONDITION OF ALL DRIVE BELTS (visual only)		4
5. TIRES, WHEELS AND LUG BOLTS FOR TIGHTNESS, PRESSURE AND DAMAGE		5
6. BATTERIES (front and rear) FOR FLUID LEVEL, DAMAGE, CLEANLINESS AND SECURITY		6
7. CLEANLINESS, DAMAGE, MISSING ITEMS (all interior and exterior items)		7
8. LUBE/OIL CHANGE		8
9. LUBE/OIL CHANGE		9
9. BRAKES, CLUTCHES (Operation), AIR TANKS (Drain), OPERATE PARKING BRAKE		10
10. STEERING, SPRINGS & SHACKLES FOR OPERATION & DAMAGE		11
11. SAFETY DEVICES (warning lights, buzzers, fire extinguishers, seat belts)		12
12. OPERATION OF ALL LIGHTS, SIRENS, RADIO, HORNS, MIRRORS		13
13. WIRING/CIRCUIT BREAKERS (visual only)		14
14. SPECIAL EQUIPMENT (axe, first aid kit, breathing apparatus, ladders, p.a. speakers, hydrant wrench, portable electric lanterns, etc.)		15
15. SPECIAL EQUIPMENT (axe, first aid kit, breathing apparatus, ladders, p.a. speakers, hydrant wrench, portable electric lanterns, etc.)		16
15. FIREFIGHTING SYSTEM FOR CORROSION/DAMAGE AND FOAM/WATER LEVELS (include booster tank)		17
16. ON/OFF BASE GRID MAPS/STATE MAPS		18
17. HEATER/DEPROSTER		19
18. WINDSHIELD/WIPER/WASHERS (condition and operation)		20
19. INSTRUMENTS AND GAUGES (during operation)		21
		22

AFTO FORM 434
JAN 74

PREVIOUS EDITION IS OBSOLETE.

Figure 4. AFTO Form 434 (Front).

404

ITEMS TO BE CHECKED (CONT'D)		OPERATOR SIGNATURE	DAY
20. UNUSUAL NOISES (during operation)			23
21. GREASE SPECIAL LUBE FITTINGS			24
22. 50 FOOT 1½" x 2½" HOSE (couplings) ALL FIRE HOSES FOR DRYNESS AND CORRECT LOADING			25
23. REELS FOR OPERATION			26
24. PUMPS/PIPING/VALVES/COUPLINGS FOR LEAKS AND CORROSION (during operation)			27
25. HANDLINES AND NOZZLES (on/off)			28
26. FOAM SPREADER AND CHAINS			29
27. SUCTION HOSE (gaskets, etc.) AND STRAINER FOR CLEANLINESS			30
28. INSURE AIR VENT HOLE IS OPEN IN PRIMING TANK			31
29. NITROGEN TANK PRESSURE			
30. PRESSURE REGULATOR OR RELIEF VALVE FOR OPERATION			
31. BUST DISC.			
32. OPERATIONS OF CHARGE, VENT AND PURGE FUNCTIONS			
33. DISCHARGE GATES FOR LOCKS AND EASE OF OPERATION (open and close daily)			
34.			
35.			
36.			
37. SPARK CHECK (Weekly and Scheduled Inspection Intervals)			
TYPE INSPECTION (Weekly or Sched)	DATE DUE	DATE ACCOMP	OPERATOR OR MECHANIC SIGNATURE AND GRADE

3

★ U.S. GOVERNMENT PRINTING OFFICE: 1974— 757-167

Figure 6. AFTO Form 434 (Back).

449

O-11A INSPECTION, MAINTENANCE AND OPERATIONS

OBJECTIVES

After completing the study guide, classroom instruction, and this workbook, you will be able to:

1. Identify operational procedures on the O-11A. Eighty percent of the procedures must be identified correctly.
2. Inspect and perform operator maintenance according to the appropriate technical order.

EQUIPMENT

	Basis of Issue
Pencil	1/student
TO 36A12-8-9-1	1/student
D-11A	1/5 students
Tire Pressure Gauge	1/5 students

PROCEDURES

As the instructor covers the information on the subject of inspection, operator maintenance, procedures, answer questions 1 through 5. After completing the questions, the class will go out to the vehicle and the instructor will use the AFTO Form 433, figures 7, 8, and 9 in this workbook and inspect the O-11A.

QUESTIONS

1. The air tanks on the O-11A are located _____

2. The turret hydraulic reservoir is located in the _____

3. The foam metering valve is located _____

4. The O-11A holds _____ gallon of gas.
5. The turrets operate _____ and _____

Note: The AFTO Form will be used during the laboratory portion of the class. Class members will use AFTO Form 433 in this workbook to inspect the O-11A.

During this portion of the course, through group discussion and practical application, you will inspect the O-11A using the standard fire vehicle checklist AFTO Form 433, Operator's Inspection Guide and

406

Trouble Report, figures 7, 8, and 9. Perform operator preventive maintenance as needed, and be able to locate and state the discrepancies on the various vehicle systems and components.

OPERATOR'S INSPECTION GUIDE AND TROUBLE REPORT (P-2/4, G-11A/B, R-2/2A, P-10 FIREFIGHTING VEHICLES)		DATE (MO/YR)
VEHICLE TYPE	REGISTRATION NO.	
USING ORGANIZATION	LOCATION	PHONE NO.
VEHICLE CONTROL OFFICER NAME	GRADE	PHONE NO.
ITEMS TO BE CHECKED	OPERATOR SIGNATURE	DAY
1. LUBRICATING OIL LEVELS (engine/trans./gear box/ water pump/power dividers)		1
2. COOLANT, FUEL, AND HYDRAULIC LEVELS		2
3. FOR LEAKS (oil, fuel, coolant, hydraulic, air, exhaust, etc.)		3
4. CONDITION OF ALL DRIVE BELTS (visual only)		4
5. TIRES, WHEELS, AND LUG BOLTS, FOR TIGHTNESS, PRESSURE AND DAMAGE		5
6. BATTERIES (front and rear) FOR FLUID LEVEL, DAMAGE, CLEANLINESS, AND SECURITY		6
7. CLEANLINESS, DAMAGE, MISSING ITEMS (all interior and exterior items)		7
8. LUBE/OIL CHANGE		8
9. BRAKES, CLUTCHES (Operation), AIR TANKS (Drain), OPERATE PARKING BRAKE		9
10. STEERING, SPRINGS & SHACKLES FOR OPERATION & DAMAGE		10
11. SAFETY DEVICES (warning lights, buzzers, fire extinguishers, seat belts)		11
12. OPERATION OF ALL LIGHTS, SIRENS, RADIO, HORNS, MIRRORS		12
13. WIRING/CIRCUIT BREAKERS (visual only)		13
14. SPECIAL EQUIPMENT (axe/spanner wrench/power saw and blade wrench/ladder/chain hoist/pike pole/trouble light/megaphone/breathing apparatus/generator & resuscitator)		14
15. FIREFIGHTING SYSTEM CORROSION/DAMAGE AND FOAM/WATER LEVELS		15
16. ON/OFF BASE GRID MAPS/STATE MAPS		16
17. HEATER/DEFROSTER/AIR CONDITIONER		17
18. WINDSHIELD/WIPERS/WASHERS (condition and operation)		18

Figure 7. AFTO Form 433 (Front).

451



408

ITEMS TO BE CHECKED (CONT'D)		OPERATOR SIGNATURE	DAY
19. INSTRUMENTS AND GAUGES (during operation)			23
20. UNUSUAL NOISES (during operation)			24
21. WINCH/TOWING CONNECTORS (when installed)			25
22. SHIFT TOWER & SWITCHES FOR PROPER OPERATION (trans.)			26
23. ALL HYDRAULIC CYLINDERS FOR OPERATION			27
24. CB FOAM SYSTEM (leaks/proportioning/operation/crystals)			28
25. HOSES/REELS/FOAM METERING VALVE (operation) (left and right)			29
26. HAND LINES/BOOM/GROUND SWEEPS (operation)			30
27. TURRETS (hydraulic and manual) (operation)			31
28. PUMPS, PIPING AND VALVES FOR LEAKS AND CORROSION (during operation)			
29. AUXILIARY GENERATOR/HEATER/LOUVERS (operation)			
30. BOOSTER HEATER (operation)			
31. HAND CIRCULATING PUMP (operation)			
32. RADIATOR SHUTTER CONTROL FOR OPERATION			
33. OPERATE ALL FIREFIGHTING DISPENSING SYSTEMS (all patterns)			
34. ALCOHOL AND ALCOHOL INJECTOR SYS. FOR OPERATION			
35. WINTERIZATION KIT			
36. OPERATE RELIEF VALVE			
37. SPARK CHECK (Weekly and Scheduled Inspection Intervals)			
TYPE INSPECTION (Weekly or Sched)	DATE DUE	DATE ACCOMP	OPERATOR OR MECHANIC SIGNATURE AND GRADE

Figure 9. AFTO Form 433 (Back).

409

O-11B INSPECTION, MAINTENANCE AND OPERATIONS

OBJECTIVES

After completing the study guide, classroom instruction, and this workbook, you will be able to:

1. Identify operational procedures on the O-11B. Eighty percent of the procedures must be identified correctly.
2. Inspect and perform operator maintenance on the O-11B aerospace crash, fire, and rescue vehicle. All applicable items on the AFTO Form 433 must be inspected. Operator maintenance must be accomplished according to the appropriate technical order.

EQUIPMENT

	Basis of Issue
Pencil or Pen	1/student
TO 36A12-8-12-1	1/student
O-11B	1/5 students
Tire Pressure Gauge	1/5 students

PROCEDURE

As the instructor covers the information on the subject of inspection, operator maintenance and procedures, answer questions 1 through 5. After completing the questions, the class will go out to the vehicle and the instructor will use the AFTO Form 433, figures 10, 11, and 12 in this workbook and inspect the O-11B.

QUESTIONS

1. The steering hydraulic reservoir is located in the _____
_____.
2. The tank suction valve is located in the _____
_____.
3. The steering pressure gauge is located in the _____
_____.
4. The air tanks are located behind the _____
_____.
5. Where do you check the main engine oil on the O-11B? _____

Note: The AFTO Form will be used during the laboratory portion of the class. Class members will use AFTO Form 433 in this workbook to inspect the O-11B.

During this portion of the course, through group discussion and practical application, you will inspect the O-11B using the standard AFTO Form 433, figures 10, 11, and 12. Perform operator preventive maintenance as needed, and be able to locate and state the discrepancies on the various vehicle systems and components.

OPERATOR'S INSPECTION GUIDE AND TROUBLE REPORT (P-2/4, O-11A/B, R-2/2A, P-10 FIREFIGHTING VEHICLES)		DATE (MO/YR)
VEHICLE TYPE		REGISTRATION NO.
USING ORGANIZATION	LOCATION	PHONE NO.
VEHICLE CONTROL OFFICER NAME		GRADE
		PHONE NO.
ITEMS TO BE CHECKED	OPERATOR SIGNATURE	DAY
1. LUBRICATING OIL LEVELS (engine/trans./gear box/water pump/power dividers)		1
2. COOLANT, FUEL, AND HYDRAULIC LEVELS		2
3. FOR LEAKS (oil, fuel, coolant, hydraulic, air, exhaust, etc.)		3
4. CONDITION OF ALL DRIVE BELTS (visual only)		4
5. TIRES, WHEELS, AND LUG BOLTS, FOR TIGHTNESS, PRESSURE AND DAMAGE		5
6. BATTERIES (front and rear) FOR FLUID LEVEL, DAMAGE, CLEANLINESS, AND SECURITY		6
7. CLEANLINESS, DAMAGE, MISSING ITEMS (all interior and exterior items)		7
8. LUBE/OIL CHANGE		8
9. BRAKES, CLUTCHES (Operation), AIR TANKS (Drain), OPERATE PARKING BRAKE		9
10. STEERING, SPRINGS & SHACKLES FOR OPERATION & DAMAGE		10
11. SAFETY DEVICES (warning lights, buzzers, fire extinguishers, seat belts)		11
12. OPERATION OF ALL LIGHTS, SIRENS, RADIO, HORNS, MIRRORS		12
13. WIRING/CIRCUIT BREAKERS (visual only)		13
14. SPECIAL EQUIPMENT (axe/spanner wrench/power saw and blade wrench/ladder/chain hoist/pike pole/trouble light/megaphone/breathing apparatus/generator & resuscitator)		14
15. FIREFIGHTING SYSTEM CORROSION/DAMAGE AND FOAM/WATER LEVELS		15
16. ON/OFF BASE GRID MAPS/STATE MAPS		16
17. HEATER/DEPROSTER/AIR CONDITIONER		17
18. WINDSHIELD/WIPERS/WASHERS (condition and operation)		18

AFTO FORM 433
JAN 74

PREVIOUS EDITION IS OBSOLETE.

Figure 10. AFTO Form 433 (Front).

4/11

O-11B INSPECTION, MAINTENANCE AND OPERATIONS

OBJECTIVES

After completing the study guide, classroom instruction, and this workbook, you will be able to:

1. Identify operational procedures of the O-11B. Eighty percent of the procedures must be identified correctly.
2. Inspect and perform operator maintenance on the O-11B aerospace crash, fire, and rescue vehicle. All applicable items on the AFTO Form 433 must be inspected. Operator maintenance must be accomplished according to the appropriate technical order.

EQUIPMENT

	Basis of Issue
Pencil or Pen	1/student
TO 36A12-8-12-1	1/student
O-11B	1/5 students
Tire Pressure Gauge	1/5 students

PROCEDURE

As the instructor covers the information on the subject of inspection, operator maintenance and procedures, answer questions 1 through 5. After completing the questions, the class will go out to the vehicle and the instructor will use the AFTO Form 433, figures 10, 11, and 12 in this workbook and inspect the O-11B.

QUESTIONS

1. The steering hydraulic reservoir is located in the _____

2. The tank suction valve is located in the _____

3. The steering pressure gauge is located in the _____

4. The air tanks are located behind the _____

5. Where do you check the main engine oil on the O-11B? _____

4/12

Note: The AFTO Form will be used during the laboratory portion of the class. Class members will use AFTO Form 433 in this workbook to inspect the O-11B.

During this portion of the course, through group discussion and practical application, you will inspect the O-11B using the standard AFTO Form 433, figures 10, 11, and 12. Perform operator preventive maintenance as needed, and be able to locate and state the discrepancies on the various vehicle systems and components.

OPERATOR'S INSPECTION GUIDE AND TROUBLE REPORT (P-2/4, O-11A/B, R-2/2A, P-10 FIREFIGHTING VEHICLES)		DATE (MO/YR)
VEHICLE TYPE		REGISTRATION NO.
USING ORGANIZATION	LOCATION	PHONE NO.
VEHICLE CONTROL OFFICER NAME		GRADE
		PHONE NO.
ITEMS TO BE CHECKED	OPERATOR SIGNATURE	DAY
1. LUBRICATING OIL LEVELS (engine/trans./gear box/water pump/power dividers)		1
2. COOLANT, FUEL, AND HYDRAULIC LEVELS		2
3. FOR LEAKS (oil, fuel, coolant, hydraulic, air, exhaust, etc.)		3
4. CONDITION OF ALL DRIVE BELTS (visual only)		4
5. TIRES, WHEELS, AND LUG BOLTS, FOR TIGHTNESS, PRESSURE AND DAMAGE		5
6. BATTERIES (front and rear) FOR FLUID LEVEL, DAMAGE, CLEANLINESS, AND SECURITY		6
7. CLEANLINESS, DAMAGE, MISSING ITEMS (all interior and exterior items)		7
8. LUBE/OIL CHANGE		8
9. BRAKES, CLUTCHES (Operation), AIR TANKS (Drain), OPERATE PARKING BRAKE		9
10. STEERING, SPRINGS & SHACKLES FOR OPERATION & DAMAGE		10
11. SAFETY DEVICES (warning lights, buzzers, fire extinguishers, seat belts)		11
12. OPERATION OF ALL LIGHTS, SIRENS, RADIO, HORNS, MIRRORS		12
13. WIRING/CIRCUIT BREAKERS (visual only)		13
14. SPECIAL EQUIPMENT (axe/spanner wrench/power saw and blade wrench/ledger/chain hoist/pike pole/trouble light/megaphone/breathing apparatus/generator & resuscitator)		14
15. FIREFIGHTING SYSTEM CORROSION/DAMAGE AND FOAM/WATER LEVELS		15
16. ON/OFF BASE GRID MAPS/STATE MAPS		16
17. HEATER/DEFROSTER/AIR CONDITIONER		17
18. WINDSHIELD/WIPERS/WASHERS (condition and operation)		18

AFTO FORM 433
JAN 74

PREVIOUS EDITION IS OBSOLETE.

1

Figure 10. AFTO Form 433 (Front).



414

ITEMS TO BE CHECKED (CONT'D)		OPERATOR SIGNATURE	DAY
19. INSTRUMENTS AND GAUGES (during operation)			23
20. UNUSUAL NOISES (during operation)			24
21. WINCH/TOWING CONNECTORS (when installed)			25
22. SHIFT TOWER & SWITCHES FOR PROPER OPERATION (trans.)			26
23. ALL HYDRAULIC CYLINDERS FOR OPERATION			27
24. CB FOAM SYSTEM (leaks/proportioning/operation/crystals)			28
25. HOSES/REELS/FOAM METERING VALVE (operation) (left and right)			29
26. HAND LINES/BOOM/GROUND SWEEPS (operation)			30
27. TURRETS (hydraulic and manual) (operation)			31
28. PUMPS, PIPING AND VALVES FOR LEAKS AND CORROSION (during operation)			
29. AUXILIARY GENERATOR/HEATER/LOUVERS (operation)			
30. BOOSTER HEATER (operation)			
31. HAND CIRCULATING PUMP (operation)			
32. RADIATOR SHUTTER CONTROL FOR OPERATION			
33. OPERATE ALL FIREFIGHTING DISPENSING SYSTEMS (all patterns)			
34. ALCOHOL AND ALCOHOL INJECTOR SYS. FOR OPERATION			
35. WINTERIZATION KIT			
36. OPERATE RELIEF VALVE			
37. SPARK CHECK (Weekly and Scheduled Inspection Intervals)			
TYPE INSPECTION (Weekly or Sched)	DATE DUE	DATE ACCOMP	OPERATOR OR MECHANIC SIGNATURE AND GRADE

☆ U.S. GOVERNMENT PRINTING OFFICE: 1974-757-168

Figure 12. AFTO Form 433 (Back).



P-2 INSPECTION, MAINTENANCE AND OPERATIONS

OBJECTIVES

After completing the study guide, classroom instruction, and this workbook, you will be able to:

1. Identify operational procedures on the P-2. Eighty percent of the procedures must be identified correctly.
2. Inspect and perform operator maintenance on the P-2. All applicable items on the AFTO Form 433 must be inspected. Operator maintenance must be accomplished according to the appropriate technical order.

EQUIPMENT

	Basis of Issue
Pencil	1/student
TO 36A12-8-13-1	1/student
P-2	1/5 students
Tire Pressure Gauge	1/5 students

PROCEDURES

As the instructor covers the information on the subject of inspection, operator maintenance procedures, answer questions 1 through 5. After completing the questions, the class will go out to the vehicle and the instructor will use the AFTO Form 433, figures 13, 14, and 15 in this workbook and inspect the P-2.

QUESTIONS

1. Where are the air tanks located on the P-2? _____

2. Where do you check the coolant level on the P-2? _____

3. What kind of test do you give the collector gear box? _____

4/16

4. Where do you check the engine oil levels? _____

5. Where are the foam metering valves located? _____

Note: The AFTO form will be used during the laboratory portion of the class. Class members will use AFTO Form 433 in this workbook to inspect the P-2.

During this portion of the course, through group discussion and practical application, you will inspect the P-2 using the standard AFTO Form 433, figures 13, 14 and 15. Perform operator preventive maintenance as needed, and be able to locate and state the discrepancies on the various vehicle systems and components..

463

417

OPERATOR'S INSPECTION GUIDE AND TROUBLE REPORT (P-2/4, O-11A/B, R-2/2A, P-10 FIREFIGHTING VEHICLES)		DATE (MO/YR)
VEHICLE TYPE		REGISTRATION NO.
USING ORGANIZATION	LOCATION	PHONE NO.
VEHICLE CONTROL OFFICER NAME		GRADE
		PHONE NO.
ITEMS TO BE CHECKED	OPERATOR SIGNATURE	DAY
1. LUBRICATING OIL LEVELS (engine/trans./gear box/ water pump/power dividers)		1
2. COOLANT, FUEL, AND HYDRAULIC LEVELS		2
3. FOR LEAKS (oil, fuel, coolant, hydraulic, air, exhaust, etc.)		3
4. CONDITION OF ALL DRIVE BELTS (visual only)		4
5. TIRES, WHEELS, AND LUG BOLTS, FOR TIGHTNESS, PRESSURE AND DAMAGE		5
6. BATTERIES (front and rear) FOR FLUID LEVEL, DAMAGE, CLEANLINESS, AND SECURITY		6
7. CLEANLINESS, DAMAGE, MISSING ITEMS (all interior and exterior items)		7
8. LUBE/OIL CHANGE		8
9. BRAKES, CLUTCHES (Operation), AIR TANKS (Drain), OPERATE PARKING BRAKE		9
10. STEERING, SPRINGS & SHACKLES FOR OPERATION & DAMAGE		10
11. SAFETY DEVICES (warning lights, buzzers, fire extinguishers, seat belts)		11
12. OPERATION OF ALL LIGHTS, SIRENS, RADIO, HORNS, MIRRORS		12
13. WIRING/CIRCUIT BREAKERS (visual only)		13
14. SPECIAL EQUIPMENT (axe/spanner wrench/power saw and blade wrench/ladder/chain hoist/pike pole/trouble light/megaphone/breathing apparatus/generator & resuscitator)		14
15. FIREFIGHTING SYSTEM CORROSION/DAMAGE AND FOAM/WATER LEVELS		15
16. ON/OFF BASE GRID MAPS/STATE MAPS		16
17. HEATER/DEFROSTER/AIR CONDITIONER		17
18. WINDSHIELD/WIPERS/WASHERS (condition and operation)		18
19.		19
20.		20
21.		21
22.		22

AFTO FORM 433 JAN 74 PREVIOUS EDITION IS OBSOLETE.

Figure 13. AFTO Form 433 (Front).



419

ITEMS TO BE CHECKED (CONT'D)				OPERATOR SIGNATURE	DAY
19. INSTRUMENTS AND GAUGES (during operation)					23
20. UNUSUAL NOISES (during operation)					24
21. WINCH-TOWING CONNECTORS (when installed)					25
22. SHIFT TOWER & SWITCHES FOR PROPER OPERATION (trans.)					26
23. ALL HYDRAULIC CYLINDERS FOR OPERATION					27
24. CB FOAM SYSTEM (leaks/proportioning/operation/crystals)					28
25. HOSES/REELS/FOAM METERING VALVE (operation) (left and right)					29
26. HAND LINES/BOOM/GROUND SWEEPS (operation)					30
27. TURRETS (hydraulic and manual) (operation)					31
28. PUMPS, PIPING AND VALVES FOR LEAKS AND CORROSION (during operation)					
29. AUXILIARY GENERATOR/HEATER/LOUVERS (operation)					
30. BOOSTER HEATER (operation)					
31. HAND CIRCULATING PUMP (operation)					
32. RADIATOR FAN/CONTROL FOR OPERATION					
33. OPERATE ALL FIREFIGHTING DISPENSING SYSTEMS (all patterns)					
34. ALCOHOL AND ALCOHOL INJECTOR SYS. FOR OPERATION					
35. WINTERIZATION KIT					
36. OPERATE RELIEF VALVE					
37. SPARK CHECK (Weekly and Scheduled Inspection Intervals)					
TYPE INSPECTION (Weekly or Sched)	DATE DUE	DATE ACCOMP	OPERATOR OR MECHANIC SIGNATURE AND GRADE		

☆ U.S. GOVERNMENT PRINTING OFFICE: 1974-757-168

3

Figure 15. AFTO Form 433 (Back).

463



P-4 INSPECTION, MAINTENANCE AND OPERATIONS

OBJECTIVES

After completing the study guide, classroom instruction, and this workbook, you will be able to:

1. Identify operational procedures on the P-4. Eighty percent of the procedures must be identified correctly.
2. Inspect and perform operator maintenance on the P-4. All applicable items on the AFTO Form 433 must be inspected. Operator maintenance must be accomplished according to the appropriate technical order.

EQUIPMENT

	Basis of Issue
Pencil	1/student
TO 36A12-12-14-1	1/student
P-4	1/5 students
Tire Pressure Gauge	1/5 students

PROCEDURES

As the instructor covers the information on the subject of inspection, operator maintenance procedures, answer questions 1 through 5. After completing the questions, the class will go out to the vehicle and the instructor will use the AFTO Form 433, figures 16, 17, and 18 in this workbook and inspect the P-4.

1. What six components on the vehicle are inspected for oil level daily?

- | | |
|----------|----------|
| a. _____ | d. _____ |
| b. _____ | e. _____ |
| c. _____ | f. _____ |

2. What type of fluid is used in the alcohol injector? _____

3. Where are the power clusters located? _____

4. What type of fluid is used in the power clusters? _____

5. What is the location of the power divider check point? How do you check it? _____

Note: The AFTO form will be used during the laboratory portion of the class. Class members will use AFTO Form 433 in this workbook to inspect the P-4. 421

During this portion of the course, through group discussion and practical application, you will inspect the P-4 using the AFTO Form 433, figures 16, 17 and 18. Perform operator preventive maintenance as needed and be able to locate and state the discrepancies on the various vehicle system and components.

OPERATOR'S INSPECTION GUIDE AND TROUBLE REPORT (P-2/4, O-11A/B, R-2/2A, P-10 FIREFIGHTING VEHICLES)		DATE (MO/YR)
VEHICLE TYPE		REGISTRATION NO.
USING ORGANIZATION	LOCATION	PHONE NO.
VEHICLE CONTROL OFFICER NAME	GRADE	PHONE NO.
ITEMS TO BE CHECKED	OPERATOR SIGNATURE	DAY
1. LUBRICATING OIL LEVELS (engine/trans./gear box/ water pump/power dividers)		1
2. COOLANT, FUEL, AND HYDRAULIC LEVELS		2
3. FOR LEAKS (oil, fuel, coolant, hydraulic, air, exhaust, etc.)		3
4. CONDITION OF ALL DRIVE BELTS (visual only)		4
5. TIRES, WHEELS, AND LUG BOLTS, FOR TIGHTNESS, PRESSURE AND DAMAGE		5
6. BATTERIES (front and rear) FOR FLUID LEVEL, DAMAGE, CLEANLINESS, AND SECURITY		6
7. CLEANLINESS, DAMAGE, MISSING ITEMS (all interior and exterior items)		7
8. LUBE/OIL CHANGE		8
9. BRAKES, CLUTCHES (Operation), AIR TANKS (Drain), OPERATE PARKING BRAKE		9
10. STEERING, SPRINGS & SHACKLES FOR OPERATION & DAMAGE		10
11. SAFETY DEVICES (warning lights, buzzers, fire extinguishers, seat belts)		11
12. OPERATION OF ALL LIGHTS, SIRENS, RADIO, HORNS, MIRRORS		12
13. WIRING/CIRCUIT BREAKERS (visual only)		13
14. SPECIAL EQUIPMENT (axe/spanner wrench/power saw and blade wrench/ladder/chain hoist/pike pole/trouble light/megaphone/breathing apparatus/generator & resuscitator)		14
15. FIREFIGHTING SYSTEM CORROSION/DAMAGE AND FOAM/WATER LEVELS		15
16. ON/OFF BASE GRID MAPS/STATE MAPS		16
17. HEATER/DEFROSTER/AIR CONDITIONER		17
18. WINDSHIELD/WIPERS/WASHERS (condition and operation)		18

Figure 16. AFTO Form 433 (Front).

423

ITEMS TO BE CHECKED (CONT'D)			OPERATOR SIGNATURE	DAY
19. INSTRUMENTS AND GAUGES (during operation)				23
20. UNUSUAL NOISES (during operation)				24
21. WINCH/TOWING CONNECTORS (when installed)				25
22. SHIFT TOWER & SWITCHES FOR PROPER OPERATION (trans.)				26
23. ALL HYDRAULIC CYLINDERS FOR OPERATION				27
24. CB FOAM SYSTEM (leaks/proportioning/operation/crystals)				28
25. HOSES/REELS, FOAM METERING VALVE (operation) (left and right)				29
26. HAND LINES/BOOM/GROUND SWEEPS (operation)				30
27. TURRETS (hydraulic and manual) (operation)				31
28. PUMPS, PIPING AND VALVES FOR LEAKS AND CORROSION (during operation)				
29. AUXILIARY GENERATOR/HEATER/LOUVERS (operation)				
30. BOOSTER HEATER (operation)				
31. HAND CIRCULATING PUMP (operation)				
32. RADIATOR SHUTTER CONTROL FOR OPERATION				
33. OPERATE ALL FIREFIGHTING DISPENSING SYSTEMS (all patterns)				
34. ALCOHOL AND ALCOHOL INJECTOR SYS. FOR OPERATION				
35. WINTERIZATION KIT				
36. OPERATE RELIEF VALVE				
37. SPARK CHECK (Weekly and Scheduled Inspection Intervals)				
TYPE INSPECTION (Weekly or Sched)	DATE DUE	DATE ACCOMP	OPERATOR OR MECHANIC SIGNATURE AND GRADE	

Figure 18. AFTO Form 433 (Back).

429

EMERGENCY RESPONSE EXERCISES

OBJECTIVES

After completing the study guide, classroom instruction, and this workbook, you will be able to:

1. Operate the O-11A/B or P-4 aerospace crash fire and rescue vehicle according to the TO and with minimum instructor assistances.
2. Perform crew duties in aerospace crash/firefighting drills and emergency response exercises, using protective clothing, TO, workbook, and O-11A/B or P-4 aerospace crash fire and rescue vehicle with minimum instructor assistance.
3. Flood or wash down simulated hazardous spills using firefighting vehicles and protective clothing, and following all pertinent safety procedures. Spills must be diluted until the simulated hazardous conditions are eliminated.
4. Perform preventive maintenance on aerospace crash fire and rescue vehicles IAW AFTO Form 433.

EQUIPMENT

	Basis of Issue
Pencil	1/student.
TO 36A12-8-9-1	1/student
TO 36A12-8-12-1	1/student
TO 36A12-12-14-1	1/student
O-11A/B or P-4	1/student
Set of Protective Clothing	1/student
Preventive Maintenance Material	1/student

PROCEDURES

As the instructor covers the information on emergency response exercises, draw in truck and crew position on figure 19 and annotate it to reflect pertinent additional information as directed by the instructor. Then answer questions 1 through 7. At the conclusion of the exercises, you will perform preventive maintenance IAW AFTO Form 433, figure 20, 21, and 22.

QUESTIONS

1. What distance should be maintained between lead and backup linemen? _____

2. Where will the rescuemen meet? _____

425

3. As a landlineman, you attack the fire with the duckbills

_____ and in a _____ motion.

4. Before starting the O-11A pump engine, the throttle should be pulled _____ out.

5. List five safety practices to be observed in the burn area.

a. _____

b. _____

c. _____

d. _____

e. _____

6. Who cleans the trucks? _____

7. What side is rescue pulled from? _____

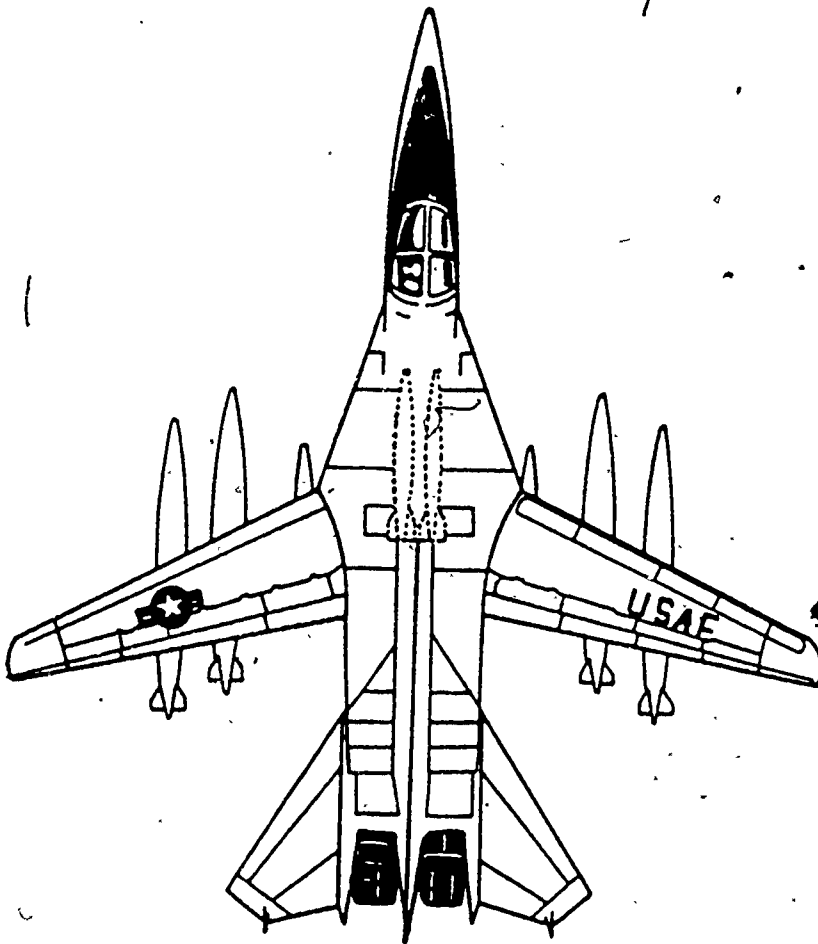

Figure 19. Small Aerospace Vehicle Trainer.

426

OPERATOR'S INSPECTION GUIDE AND TROUBLE REPORT (P-2/4, O-11A/B, R-2/2A, P-10 FIREFIGHTING VEHICLES)		DATE (MO/YR)
VEHICLE TYPE		REGISTRATION NO.
USING ORGANIZATION	LOCATION	PHONE NO.
VEHICLE CONTROL OFFICER NAME		GRADE
		PHONE NO.
ITEMS TO BE CHECKED	OPERATOR SIGNATURE	DAY
1. LUBRICATING OIL LEVELS (engine/trans./gear box/water pump/power dividers)		1
2. COOLANT, FUEL, AND HYDRAULIC LEVELS		2
3. FOR LEAKS (oil, fuel, coolant, hydraulic, air, exhaust, etc.)		3
4. CONDITION OF ALL DRIVE BELTS (visual only)		4
5. TIRES, WHEELS, AND LUG BOLTS, FOR TIGHTNESS, PRESSURE AND DAMAGE		5
6. BATTERIES (front and rear) FOR FLUID LEVEL, DAMAGE, CLEANLINESS, AND SECURITY		6
7. CLEANLINESS, DAMAGE, MISSING ITEMS (all interior and exterior items)		7
8. LUBE/OIL CHANGE		8
9. BRAKES, CLUTCHES (Operation), AIR TANKS (Drain), OPERATE PARKING BRAKE		9
10. STEERING, SPRINGS & SHACKLES FOR OPERATION & DAMAGE		10
11. SAFETY DEVICES (warning lights, buzzers, fire extinguishers, seat belts)		11
12. OPERATION OF ALL LIGHTS, SIRENS, RADIO, HORNS, MIRRORS		12
13. WIRING/CIRCUIT BREAKERS (visual only)		13
14. SPECIAL EQUIPMENT (axe/spanner wrench/power saw and blade wrench/ladder/chain hoist/pike pole/trouble light/megaphone/breathing apparatus/generator & resuscitator)		14
15. FIREFIGHTING SYSTEM CORROSION/DAMAGE AND FOAM/WATER LEVELS		15
16. ON/OFF BASE GRID MAPS/STATE MAPS		16
17. HEATER/DEFROSTER/AIR CONDITIONER		17
18. WINDSHIELD/WIPERS/WASHERS (condition and operation)		18

Figure 20. AFTO Form 433 (Front).



428

ITEMS TO BE CHECKED (CONT'D)		OPERATOR SIGNATURE	DAY
19. INSTRUMENTS AND GAUGES (during operation)			23
20. UNUSUAL NOISES (during operation)			24
21. WINCH/TOWING CONNECTORS (when installed)			25
22. SHIFT TOWER & SWITCHES FOR PROPER OPERATION (trans.)			26
23. ALL HYDRAULIC CYLINDERS FOR OPERATION			27
24. CB FOAM SYSTEM (leaks/proportioning/operation/crystals)			28
25. HOSES/REELS/FOAM METERING VALVE (operation) (left and right)			29
26. HAND LINES/BOOM/GROUND SWEEPS (operation)			30
27. TURRETS (hydraulic and manual) (operation)			31
28. PUMPS, PIPING AND VALVES FOR LEAKS AND CORROSION (during operation)			
29. AUXILIARY GENERATOR/HEATER/LOUVERS (operation)			
30. BOOSTER HEATER (operation)			
31. HAND CIRCULATING PUMP (operation)			
32. RADIATOR SHUTTER CONTROL FOR OPERATION			
33. OPERATE ALL FIREFIGHTING DISPENSING SYSTEMS (all patterns)			
34. ALCOHOL AND ALCOHOL INJECTOR SYS. FOR OPERATION			
35. WINTERIZATION KIT			
36. OPERATE RELIEF VALVE			
37. SPARK CHECK (Weekly and Scheduled Inspection Intervals)			
TYPE INSPECTION (Weekly or Sched)	DATE DUE	DATE ACCOMP	OPERATOR OR MECHANIC SIGNATURE AND GRADE

Figure 22. AFTO Form 433 (Back).

478

429

EMERGENCY RESPONSE AND AIRCRAFT APPROACH EXERCISES

OBJECTIVES

After completing the study guide, classroom instruction and this workbook, you will be able to:

1. Operate the O-11A/B or P-4 according to the TO with minimum instructor assistance.
2. Operate the P-2 according to the TO with minimum instructor assistance.
3. Perform preventive maintenance on aerospace crash, fire, and rescue vehicles IAW AFTO Form 433.

EQUIPMENT

	Basis of Issue
Pencil	1/student
O-11A/B	1/5 students
P-2	1/5 students
P-4	1/5 students
TO 36A12-8-13-1	1/student
TO 36A12-8-9-1	1/student
TO 36A12-8-12-1	1/student
Set of Protective Clothing	1/student
Preventive Maintenance Materials	1/10 students

PROCEDURES

As the instructor covers the information on Emergency Response and Aircraft Approach Exercises, answer questions 1 thru 7.

1. The _____ performs rescue.
2. What is the signal for a malfunction in the fire pump?

3. Who will back up the handlinemen? _____
4. What type of communications will be used in the burn area?

5. What barrel will the backup lineman be on during overhaul?

6. Who sets the pace for the handlinemen in the burn area?

7. What is the signal to get cooled down? _____

430

Now that you know what is required for the job, we will now perform preventive maintenance IAW AFTO Form 433, figures 23, 24, and 25.

OPERATOR'S INSPECTION GUIDE AND TROUBLE REPORT (P-2/4, Q-11A/B, R-2/2A, P-10 FIREFIGHTING VEHICLES)		DATE (MO./YR)
VEHICLE TYPE		REGISTRATION NO.
USING ORGANIZATION	LOCATION	PHONE NO.
VEHICLE CONTROL OFFICER NAME		GRADE
		PHONE NO.
ITEMS TO BE CHECKED	OPERATOR SIGNATURE	DAY
1. LUBRICATING OIL LEVELS (engine/trans./gear box/ water pump/power dividers)		1
2. COOLANT, FUEL, AND HYDRAULIC LEVELS		2
3. FOR LEAKS (oil, fuel, coolant, hydraulic, air, exhaust, etc.)		3
4. CONDITION OF ALL DRIVE BELTS (visual only)		4
5. TIRES, WHEELS, AND LUG BOLTS, FOR TIGHTNESS, PRESSURE AND DAMAGE		5
6. BATTERIES (front and rear) FOR FLUID LEVEL, DAMAGE, CLEANLINESS, AND SECURITY		6
7. CLEANLINESS, DAMAGE, MISSING ITEMS (all interior and exterior items)		7
8. LUBE/OIL CHANGE		8
9. BRAKES, CLUTCHES (Operation), AIR TANKS (Drain), OPERATE PARKING BRAKE		9
10. STEERING, SPRINGS & SHACKLES FOR OPERATION & DAMAGE		10
11. SAFETY DEVICES (warning lights, buzzers, fire extinguishers, seat belts)		11
12. OPERATION OF ALL LIGHTS, SIRENS, RADIO, HORNS, MIRRORS		12
13. WIRING/CIRCUIT BREAKERS (visual only)		13
14. SPECIAL EQUIPMENT (axe, spanner wrench/power saw and blade wrench/ladder chain hoist/pike pole/trouble light/ megaphone breathing apparatus/generator & resuscitator)		14
15. FIREFIGHTING SYSTEM CORROSION/DAMAGE AND FOAM/WATER LEVELS		15
16. ON/OFF BASE GRID MAPS/STATE MAPS		16
17. HEATER/DEFROSTER/AIR CONDITIONER		17
18. WINDSHIELD/WIPERS/WASHERS (condition and operation)		18

AFTO FORM 433
JAN-74

PREVIOUS EDITION IS OBSOLETE.

1

Figure 23. AFTO Form 433 (Front).

480

VEHICLE/EQUIPMENT DISCREPANCY AND MAINTENANCE REPORT

ITEM NO.	OPERATOR REPORT			REPORTED TO MAINTENANCE				MAINTENANCE CONTROL REPORT			
	DISCREPANCY	DATE DISC.		DATE	TIME	MILES/HOURS	INIT.	WORK ORDER NUMBER	DATE	STATUS CODE	INIT

35

STATUS CODES: C=Corrected C-T by Temp Fix C-P by Perm Fix D-Deferred D-P for Parts D-M for Maint D-D for Disposition W=Waiver of Repairs See Sec II, TO 00-208-5

481

Figure 24. AFTO Form 433 (Inside).

432

ITEMS TO BE CHECKED (CONT'D)	OPERATOR SIGNATURE	DAY	
19. INSTRUMENTS AND GAUGES (during operation)		23	
20. UNUSUAL NOISES (during operation)		24	
21. WINCH/TOWING CONNECTORS (when installed)		25	
22. SHIFT TOWER & SWITCHES FOR PROPER OPERATION (trans.)		26	
23. ALL HYDRAULIC CYLINDERS FOR OPERATION		27	
24. CB FOAM SYSTEM (leaks/proportioning/operation/crystals)		28	
25. HOSES/REELS/FOAM METERING VALVE (operation) (left and right)		29	
		30	
26. HAND LINES/BOOM/GROUND SWEEPS (operation)		31	
27. TURRETS (hydraulic and manual) (operation)			
28. PUMPS, PIPING AND VALVES FOR LEAKS AND CORROSION (during operation)			
29. AUXILIARY GENERATOR/HEATER/LOUVERS (operation)			
30. BOOSTER HEATER (operation)			
31. HAND CIRCULATING PUMP (operation)			
32. RADIATOR SHUTTER CONTROL FOR OPERATION			
33. OPERATE ALL FIREFIGHTING DISPENSING SYSTEMS (all patterns)			
34. ALCOHOL AND ALCOHOL INJECTOR SYS. FOR OPERATION			
35. WINTERIZATION KIT			
36. OPERATE RELIEF VALVE			
37. SPARK CHECK (Weekly and Scheduled Inspection Intervals)			
TYPE INSPECTION (Weekly or Sched)	DATE DUE	DATE ACCOMP	OPERATOR OR MECHANIC SIGNATURE AND GRADE

U.S. GOVERNMENT PRINTING OFFICE: 1974-757-168

3

Figure 25. AFTO Form 433 (Back).

483



433

CONTROL AND EXTINGUISHMENT ON SMALL FRAME AIRCRAFT FIRES

OBJECTIVES

After completing the study guide, classroom instruction, and this workbook, you will be able to:

1. Perform as a member of a firefighting crew to control and extinguish aerospace crash fires using an O-11A/B or P-4 aerospace crash, fire, and rescue vehicle, a burning aircraft mockup, protective clothing and technical data. Each fire must be completely extinguished while observing all applicable safety practices.

2. Perform preventive maintenance on aerospace crash, fire, and rescue vehicles IAW AFTO Form 433.

EQUIPMENT

	Basis of Issue
Pencil	1/student
TO 36A12-8-9-1	1/student
TO 36A12-8-12-1	1/student
TO 36A12-12-14-1	1/student
O-11A/B or P-4	1/5 students
Set of Protective Clothing	1/student
Preventive Maintenance Materials	1/10 students

PROCEDURES

As the instructor covers the information on control and extinguishment on small frame aircraft fires, use figure 26 to draw in truck and crew position. Also annotate it to reflect pertinent additional information as directed by the instructor. Then answer questions 1 through 6. At the conclusion of today's fires, you will perform preventive maintenance IAW AFTO Form 433, figures 27, 28 and 29.

QUESTIONS

1. What type of approach are we going to make? _____

2. How will the handlines be checked? _____

3. How will the rescuemen leave the area? _____

4. What is the signal for throttle up? _____

5. What crew member does not need to wear a hood or gloves?

6. Who performs as lead linemen?

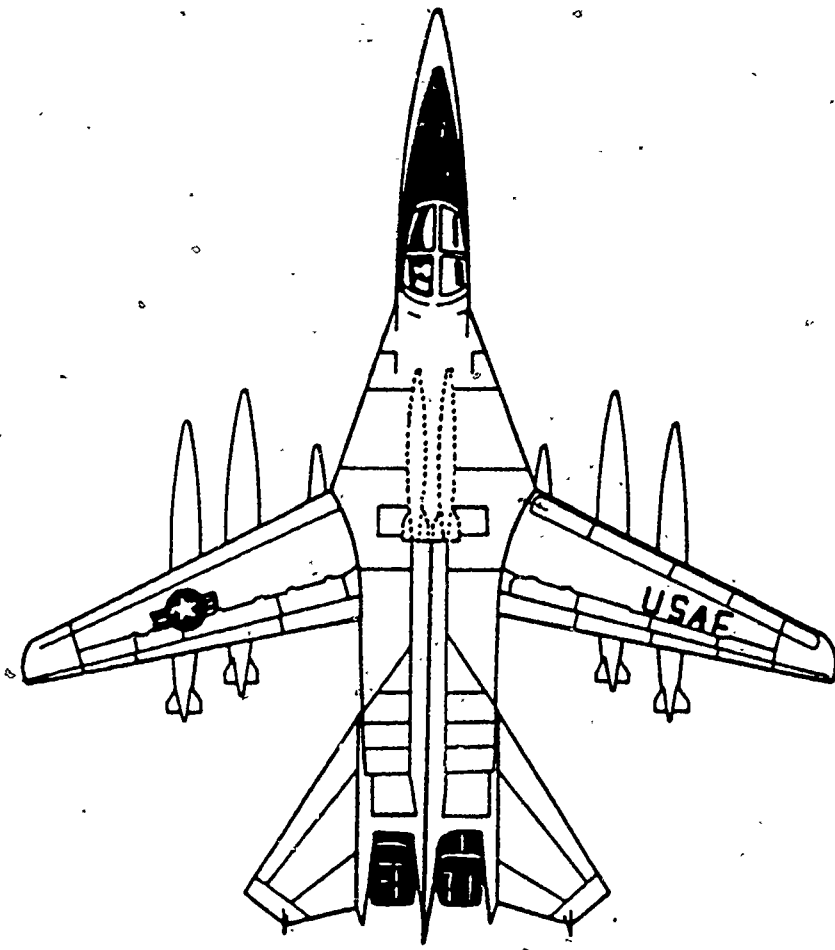

Figure 26. Small Aerospace Vehicle Trainer.

435

OPERATOR'S INSPECTION GUIDE AND TROUBLE REPORT (P-2/4, O-11A/B, R-2/2A, P-10 FIREFIGHTING VEHICLES)		DATE (MO/YR)
VEHICLE TYPE		REGISTRATION NO.
USING ORGANIZATION	LOCATION	PHONE NO.
VEHICLE CONTROL OFFICER NAME		GRADE
		PHONE NO.
ITEMS TO BE CHECKED	OPERATOR SIGNATURE	DAY
1. LUBRICATING OIL LEVELS (engine/trans./gear box/ water pump/power dividers)		1
2. COOLANT, FUEL, AND HYDRAULIC LEVELS		2
3. FOR LEAKS (oil, fuel, coolant, hydraulic, air, exhaust, etc.)		3
4. CONDITION OF ALL DRIVE BELTS (visual only)		4
5. TIRES, WHEELS, AND LUG BOLTS, FOR TIGHTNESS, PRESSURE AND DAMAGE		5
6. BATTERIES (front and rear) FOR FLUID LEVEL, DAMAGE, CLEANLINESS, AND SECURITY		6
7. CLEANLINESS, DAMAGE, MISSING ITEMS (all interior and exterior items)		7
8. LUBE/OIL CHANGE		8
9. BRAKES, CLUTCHES (Operation), AIR TANKS (Drain), OPERATE PARKING BRAKE		9
10. STEERING, SPRINGS & SHACKLES FOR OPERATION & DAMAGE		10
11. SAFETY DEVICES (warning lights, buzzers, fire extinguishers, seat belts)		11
12. OPERATION OF ALL LIGHTS, SIRENS, RADIO, HORNS, MIRRORS		12
13. WIRING/CIRCUIT BREAKERS (visual only)		13
14. SPECIAL EQUIPMENT (axe/spenner wrench/power saw and blade wrench/ladder/chain hoist/pike pole/trouble light/megaphone/breathing apparatus/generator & resuscitator)		14
15. FIREFIGHTING SYSTEM CORROSION/DAMAGE AND FOAM/WATER LEVELS		15
16. ON/OFF BASE GRID MAPS/STATE MAPS		16
17. HEATER/DEFROSTER/AIR CONDITIONER		17
18. WINDSHIELD/WIPERS/WASHERS (condition and operation)		18
19.		19
20.		20
21.		21
22.		22

AFTO FORM 433
JAN 74

PREVIOUS EDITION IS OBSOLETE.

1

Figure 27. AFTO Form 433 (Front).

437

ITEMS TO BE CHECKED. (CONT'D)		OPERATOR SIGNATURE	DAY
19. INSTRUMENTS AND GAUGES (during operation)			23
20. UNUSUAL NOISES (during operation)			24
21. WINCH/TOWING CONNECTORS (when installed)			25
22. SHIFT TOWER & SWITCHES FOR PROPER OPERATION (truss)			26
23. ALL HYDRAULIC CYLINDERS FOR OPERATION			27
24. CB FOAM SYSTEM (leaks/proportioning/operation/crystals)			28
25. HOSES/REELS/FOAM METERING VALVE (operation) (left and right)			29
26. HAND LINES/BOOM/GROUND SWEEPS (operation)			30
27. TURRETS (hydraulic and manual) (operation)			31
28. PUMPS, PIPING AND VALVES FOR LEAKS AND CORROSION (during operation)			
29. AUXILIARY GENERATOR/HEATER/LOUVERS (operation)			
30. BOOSTER HEATER (operation)			
31. HAND CIRCULATING PUMP (operation)			
32. RADIATOR SHUTTER CONTROL FOR OPERATION			
33. OPERATE ALL FIREFIGHTING DISPENSING SYSTEMS (all patterns)			
34. ALCOHOL AND ALCOHOL INJECTOR SYS. FOR OPERATION			
35. WINTERIZATION KIT			
36. OPERATE RELIEF VALVE			
37. SPARK CHECK (Weekly and Scheduled Inspection Intervals)			
TYPE INSPECTION (Weekly or Sched)	DATE DUE	DATE ACCOMP	OPERATOR OR MECHANIC SIGNATURE AND GRADE

☆ U.S. GOVERNMENT PRINTING OFFICE: 1974-157-168

3

Figure 29. AFTO Form 433 (Back).



4. Where do the rescuemen meet before entering the fire area?

438

5. What is the hand signal for ground sweeps operation?

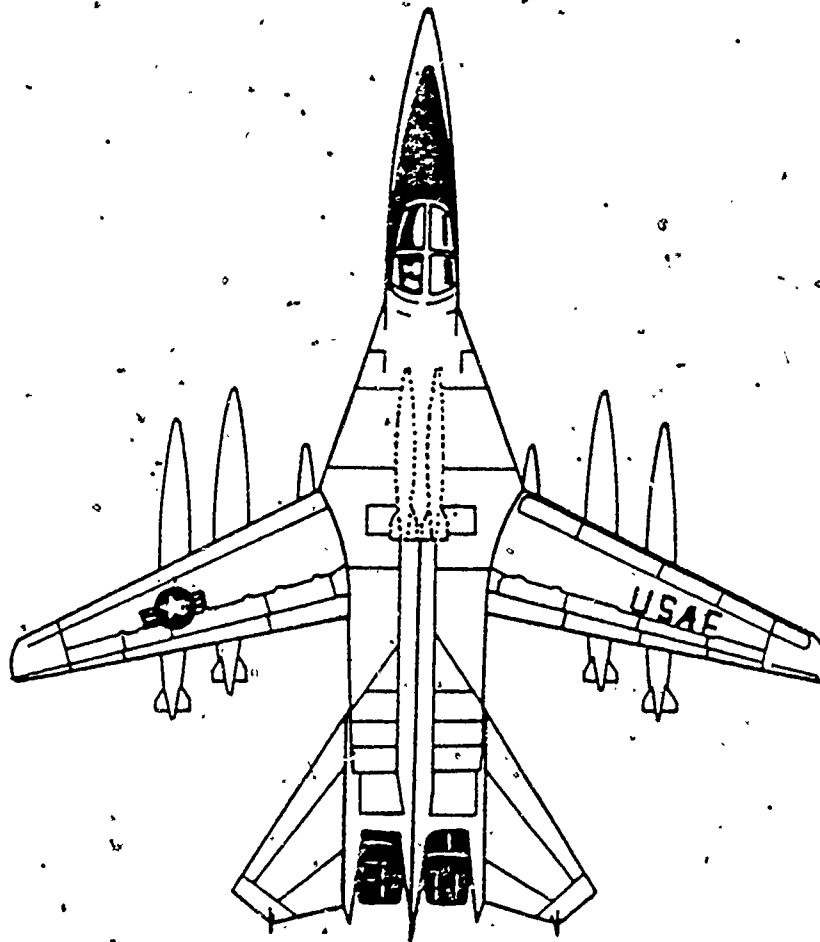

Figure 30. Small Aerospace Vehicle Trainer.

439

CONTROL, EXTINGUISHMENT, OVERHAUL AND RESCUE
ON SMALL FRAME AIRCRAFT FIRES

OBJECTIVES

After completing the study guide, classroom instruction, and this workbook, you will be able to:

1. Perform as a member of a firefighting crew to control and extinguish aerospace crash fires using an O-11A/B or P-4 aerospace crash, fire and rescue vehicle, a burning aircraft mockup, protective clothing and technical data. Each fire must be completely extinguished while observing all applicable safety practices. Simulate rescue from aircraft as required.
2. Perform firefighting overhaul cleanup operations using a simulated aircraft and appropriate cleanup equipment while observing all applicable safety practices with minimum instructor assistance.
3. Perform preventive maintenance on aerospace crash, fire, and rescue vehicles IAW AFTO Form 433.

EQUIPMENT

	Basis of Issue
Pencil	1/student
TO 36A12-8-9-1	1/student
TO 36A12-8-12-1	1/student
TO 36A12-12-14-1	1/student
O-11A/B or P-4	1/5 students
Set of Protective Clothing	1/student
Preventive Maintenance Material	1/10 students

PROCEDURES

As the instructor covers the information on control, extinguishment, overhaul and rescue on small frame aircraft, use figure 30 to draw in trucks and crew positions, include overhaul and rescue points. Then answer questions 1 through 5. At the conclusion of today's fires, you will perform preventive maintenance IAW AFTO Form 433, figures 31, 32, and 33.

1. Who performs overhaul? _____
 2. Where does overhaul start? _____
 3. How do the rescuemen enter the area? _____
- _____
- _____

4. Where do the rescuemen meet before entering the fire area?

440

5. What is the hand signal for ground sweeps operation?

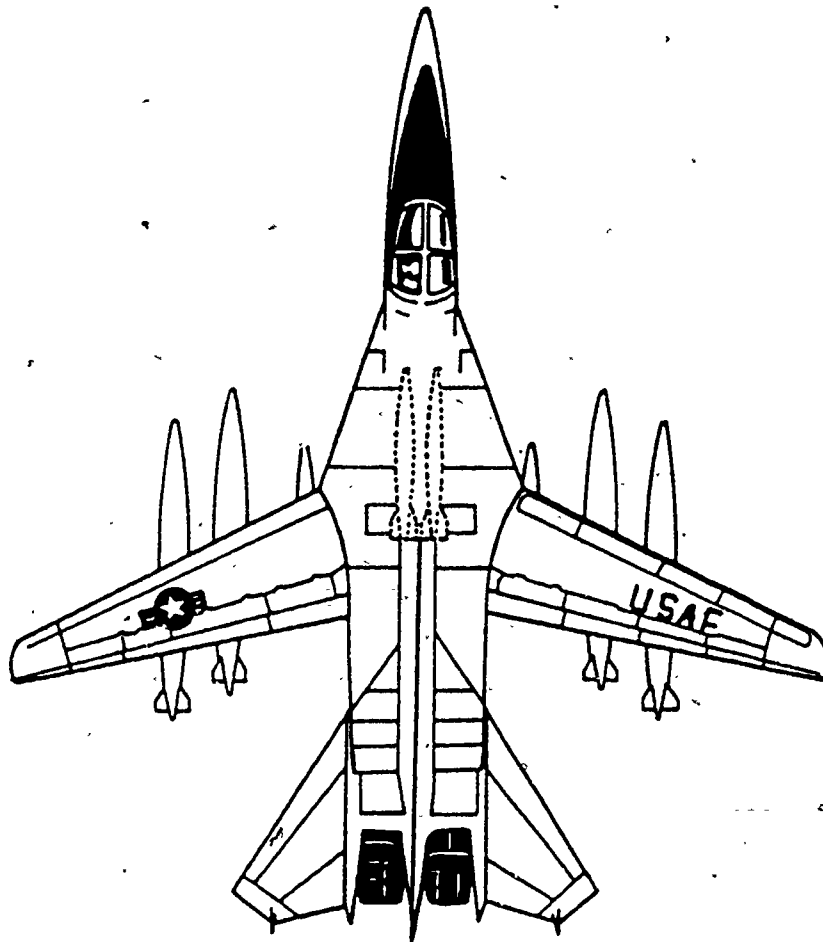

Figure 30. Small Aerospace Vehicle Trainer.

441

OPERATOR'S INSPECTION GUIDE AND TROUBLE REPORT (P-2/4, O-11A/B, R-2/2A, P-10 FIREFIGHTING VEHICLES)		DATE (MO/YR)
VEHICLE TYPE		REGISTRATION NO.
USING ORGANIZATION	LOCATION	PHONE NO.
VEHICLE CONTROL OFFICER NAME		GRADE
		PHONE NO.
ITEMS TO BE CHECKED	OPERATOR SIGNATURE	DAY
1. LUBRICATING OIL LEVELS (engine/trans./gear box/ water pump/power dividers)		1
2. COOLANT, FUEL, AND HYDRAULIC LEVELS		2
3. FOR LEAKS (oil, fuel, coolant, hydraulic, air, exhaust, etc.)		3
4. CONDITION OF ALL DRIVE BELTS (visual only)		4
5. TIRES, WHEELS, AND LUG BOLTS, FOR TIGHTNESS, PRESSURE AND DAMAGE		5
6. BATTERIES (front and rear) FOR FLUID LEVEL, DAMAGE, CLEANLINESS, AND SECURITY		6
7. CLEANLINESS, DAMAGE, MISSING ITEMS (all interior and exterior items)		7
8. LUBE/OIL CHANGE		8
9. BRAKES, CLUTCHES (Operation), AIR TANKS (Drain), OPERATE PARKING BRAKE		9
10. STEERING, SPRINGS & SHACKLES FOR OPERATION & DAMAGE		10
11. SAFETY DEVICES (warning lights, buzzers, fire extinguishers, seat belts)		11
12. OPERATION OF ALL LIGHTS, SIRENS, RADIO, HORNS, MIRRORS		12
13. WIRING/CIRCUIT BREAKERS (visual only)		13
14. SPECIAL EQUIPMENT (axe/spanner wrench/power saw and blade wrench/ladder/chain hoist/pike pole/trouble light/megaphone/breathing apparatus/generator & resuscitator)		14
15. FIREFIGHTING SYSTEM CORROSION/DAMAGE AND FOAM/WATER LEVELS		15
16. ON/OFF BASE GRID MAPS/STATE MAPS		16
17. HEATER/DEFROSTER/AIR CONDITIONER		17
18. WINDSHIELD/WIPERS/WASHERS (condition and operation)		18

AFTO FORM 433
JAN 74

PREVIOUS EDITION IS OBSOLETE.

1

Figure 31. AFTO Form 433 (Front).



443

ITEMS TO BE CHECKED (CONT'D)		OPERATOR SIGNATURE	DAY
19. INSTRUMENTS AND GAUGES (during operation)			23
20. UNUSUAL NOISES (during operation)			24
21. WINCH/TOWING CONNECTORS (when installed)			25
22. SHIFT TOWER & SWITCHES FOR PROPER OPERATION (trans.)			26
23. ALL HYDRAULIC CYLINDERS FOR OPERATION			27
24. CB FOAM SYSTEM (leaks/proportioning/operation/crystals)			28
25. HOSES/REELS/FOAM METERING VALVE (operation) (left and right)			29
26. HAND LINES/BOOM/GROUND SWEEPS (operation)			30
27. TURRETS (hydraulic and manual) (operation)			31
28. PUMPS, PIPING AND VALVES FOR LEAKS AND CORROSION (during operation)			
29. AUXILIARY GENERATOR/HEATER/LOUVERS (operation)			
30. BOOSTER HEATER (operation)			
31. HAND CIRCULATING PUMP (operation)			
32. RADIATOR SHUTTER CONTROL FOR OPERATION			
33. OPERATE ALL FIREFIGHTING DISPENSING SYSTEMS (all patterns)			
34. ALCOHOL AND ALCOHOL INJECTOR SYS. FOR OPERATION			
35. WINTERIZATION KIT			
36. OPERATE RELIEF VALVE			
37. SPARK CHECK (Weekly and Scheduled Inspection Intervals)			
TYPE INSPECTION (Weekly or Sched)	DATE DUE	DATE ACCOMP	OPERATOR OR MECHANIC SIGNATURE AND GRADE

☆ US GOVERNMENT PRINTING OFFICE: 1974- 757-168

Figure 33. AFTO Form 433 (Back).



444

**CONTROL, EXTINGUISHMENT, OVERHAUL AND RESCUE
ON MEDIUM FRAME AIRCRAFT FIRES**

OBJECTIVES

After completing the study guide, classroom instruction, and this workbook, you will be able to:

1. Perform as a member of a firefighting crew to control and extinguish aerospace crash fires using aerospace crash, fire and rescue vehicles, a burning aircraft mockup, protective clothing and technical data. Each fire must be completely extinguished while observing all applicable safety practices. Simulate rescue from aircraft as required.
2. Perform firefighting overhaul cleanup operations, using a simulated aircraft and appropriate cleanup equipment, while observing all applicable safety practices with minimum instructor assistance.
3. Perform preventive maintenance on aerospace crash, fire and rescue vehicles IAW AFTO Form 433.

EQUIPMENT

	Basis of Issue
Pencil	1/student
TO 36A12-8-9-1	1/student
TO 36A12-8-12-1	1/student
TO 36A12-12-14-1	1/student
TO 36A12-8-13-1	1/student
O-11A/B	1/5 students
A/S32P-2	1/5 students
A/S32P-4	1/5 students
Set of Protective Clothing	1/student
Preventive Maintenance Materials	1/10 students

PROCEDURES

As the instructor covers the information on control, extinguishment, overhaul and rescue on medium frame fires, use figure 34 to draw in trucks and crew positions to include overhaul and rescue points. Then answer questions 1 through 5. At the conclusion of today's fires, you will perform preventive maintenance IAW Form 433, figures 35, 36, and 37.

QUESTIONS

1. What is hand signal for stop turret flow? _____
- _____
- _____

445

2. How long will you discharge from the turrets on approach?

3. How many rescuemen will enter the aircraft? _____

4. Where does overhaul start? _____

5. What stream from the turret do you use to protect personnel?

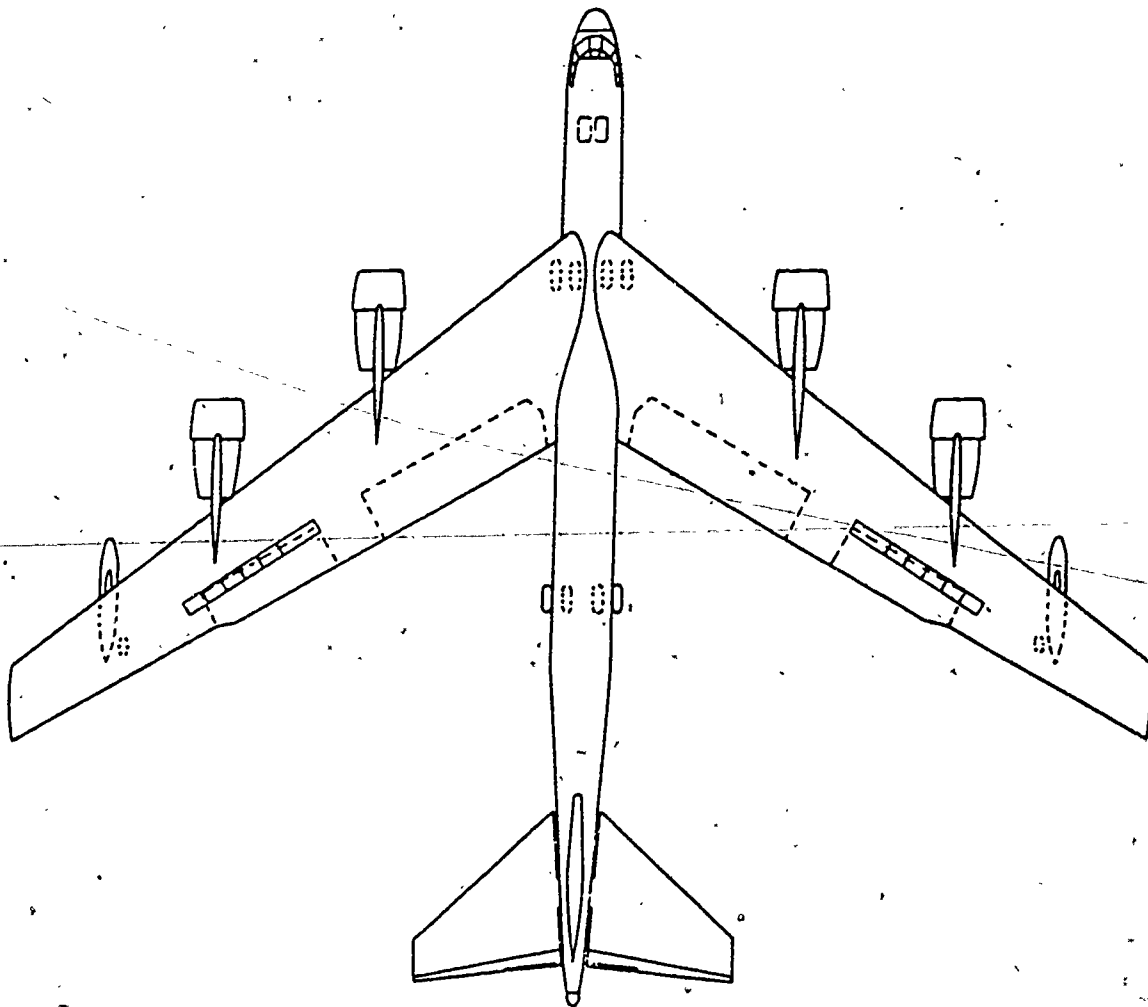

Figure 34. Medium Aerospace Vehicle Trainer.

446

OPERATOR'S INSPECTION GUIDE AND TROUBLE REPORT (P-2/4, O-11A/B, R-2/2A, P-10 FIREFIGHTING VEHICLES)		DATE (MO/YR):
VEHICLE TYPE		REGISTRATION NO.
USING ORGANIZATION	LOCATION	PHONE NO.
VEHICLE CONTROL OFFICER NAME		GRADE
		PHONE NO.
ITEMS TO BE CHECKED	OPERATOR SIGNATURE	DAY
1. LUBRICATING OIL LEVELS (engine/trans./gear box/water pump/power dividers)		1
2. COOLANT, FUEL, AND HYDRAULIC LEVELS		2
3. FOR LEAKS (oil, fuel, coolant, hydraulic, air, exhaust, etc.)		3
4. CONDITION OF ALL DRIVE BELTS (visual only)		4
5. TIRES, WHEELS, AND LUG BOLTS, FOR TIGHTNESS, PRESSURE AND DAMAGE		5
6. BATTERIES (front and rear) FOR FLUID LEVEL, DAMAGE, CLEANLINESS, AND SECURITY		6
7. CLEANLINESS, DAMAGE, MISSING ITEMS (all interior and exterior items)		7
8. LUBE/OIL CHANGE		8
9. BRAKES, CLUTCHES (Operation), AIR TANKS (Drain), OPERATE PARKING BRAKE		9
10. STEERING, SPRINGS & SHACKLES FOR OPERATION & DAMAGE		10
11. SAFETY DEVICES (warning lights, buzzers, fire extinguishers, seat belts)		11
12. OPERATION OF ALL LIGHTS, SIRENS, RADIO, HORNS, MIRRORS		12
13. WIRING/CIRCUIT BREAKERS (visual only)		13
14. SPECIAL EQUIPMENT (axe/spanner wrench/power saw and blade wrench/ladder/chain hoist/pike pole/trouble light/megaphone/breathing apparatus/generator & resuscitator)		14
15. FIREFIGHTING SYSTEM CORROSION/DAMAGE AND FOAM/WATER LEVELS		15
16. ON/OFF BASE GRID MAPS/STATE MAPS		16
17. HEATER/DEPROSTER/AIR CONDITIONER		17
18. WINDSHIELD/WIPERS/WASHERS (condition and operation)		18
19.		19
20.		20
21.		21
22.		22

AFTO FORM 433
JAN 74

PREVIOUS EDITION IS OBSOLETE.

1

Figure 35. AFTO Form 433 (Front).



448

ITEMS TO BE CHECKED (CONT'D)		OPERATOR SIGNATURE	DAY
19. INSTRUMENTS AND GAUGES (during operation)			23
20. UNUSUAL NOISES (during operation)			24
21. WINCH/TOWING CONNECTORS (when installed)			25
22. SHIFT TOWER & SWITCHES FOR PROPER OPERATION (trans.)			26
23. ALL HYDRAULIC CYLINDERS FOR OPERATION			27
24. CB FOAM SYSTEM (leaks/proportioning/operation/crystals)			28
25. HOSES/REELS/FOAM METERING VALVE (operation) (left and right)			29
26. HAND LINES/BOOM/GROUND SWEEPS (operation)			30
27. TURRETS (hydraulic and manual) (operation)			31
28. PUMPS, PIPING AND VALVES FOR LEAKS AND CORROSION (during operation)			
29. AUXILIARY GENERATOR/HEATER/LOUVERS (operation)			
30. BOOSTER HEATER (operation)			
31. HAND CIRCULATING PUMP (operation)			
32. RADIATOR SHUTTER CONTROL FOR OPERATION			
33. OPERATE ALL FIREFIGHTING DISPENSING SYSTEMS (all patterns)			
34. ALCOHOL AND ALCOHOL INJECTOR SYS. FOR OPERATION			
35. WINTERIZATION KIT			
36. OPERATE RELIEF VALVE			
37. SPARK CHECK (Weekly and Scheduled Inspection Intervals)			
TYPE INSPECTION (Weekly or Sched)	DATE DUE	DATE ACCOMP	OPERATOR OR MECHANIC SIGNATURE AND GRADE

☆ U.S. GOVERNMENT PRINTING OFFICE: 1974-757-168

3

Figure 37. AFTO Form 433 (Back).

53

502



449

CONTROL EXTINGUISHMENT, OVERHAUL AND RESCUE
ON LARGE FRAME AIRCRAFT FIRES

OBJECTIVES

After completing the study guide, classroom instruction, and this workbook, you will be able to:

1. Perform as a member of a firefighting crew to control and extinguish aerospace crash fires using aerospace crash, fire and rescue vehicles, a burning aircraft mockup, protective clothing and technical data. Each fire must be completely extinguished while observing all applicable safety practices. Simulate rescue from aircraft as required.
2. Perform firefighting overhaul cleanup operations using a simulated aircraft and appropriate cleanup equipment, while observing all applicable safety practices with minimum instructor assistance.
3. Perform preventive maintenance on aerospace crash, fire and rescue vehicles IAW AFTO Form 433.

EQUIPMENT

	Basis of Issue
Pencil	1/student
TO 36A12-8-9-1	1/student
TO 36A12-8-12-1	1/student
TO 36A12-12-14-1	1/student
TO 36A12-8-13-1	1/student
O-11A/B	1/5 students
A/S32P-2	1/5 students
A/S32P-4	1/5 students
Set of Protective Clothing	1/student
Preventive Maintenance Materials	1/10 students

PROCEDURES

As the instructor covers the information on control, extinguishment, overhaul and rescue on large frame fires. Use figure 38 to draw in trucks and crew positions to include overhaul and rescue points. Then answer questions 1 through 5. At the conclusion of today's fires you will perform preventive maintenance IAW Form 433, figures 39, 40 and 41.

QUESTIONS

1. How many rescuemen go inside the aircraft for rescue? _____
-
-

450

2. What is hand signal for undertruck nozzles? _____

3. What handlinemen protects the rescuemen? _____

4. Who overhauls the outside engine ped? _____

5. What is the hand signal for throttle down? _____

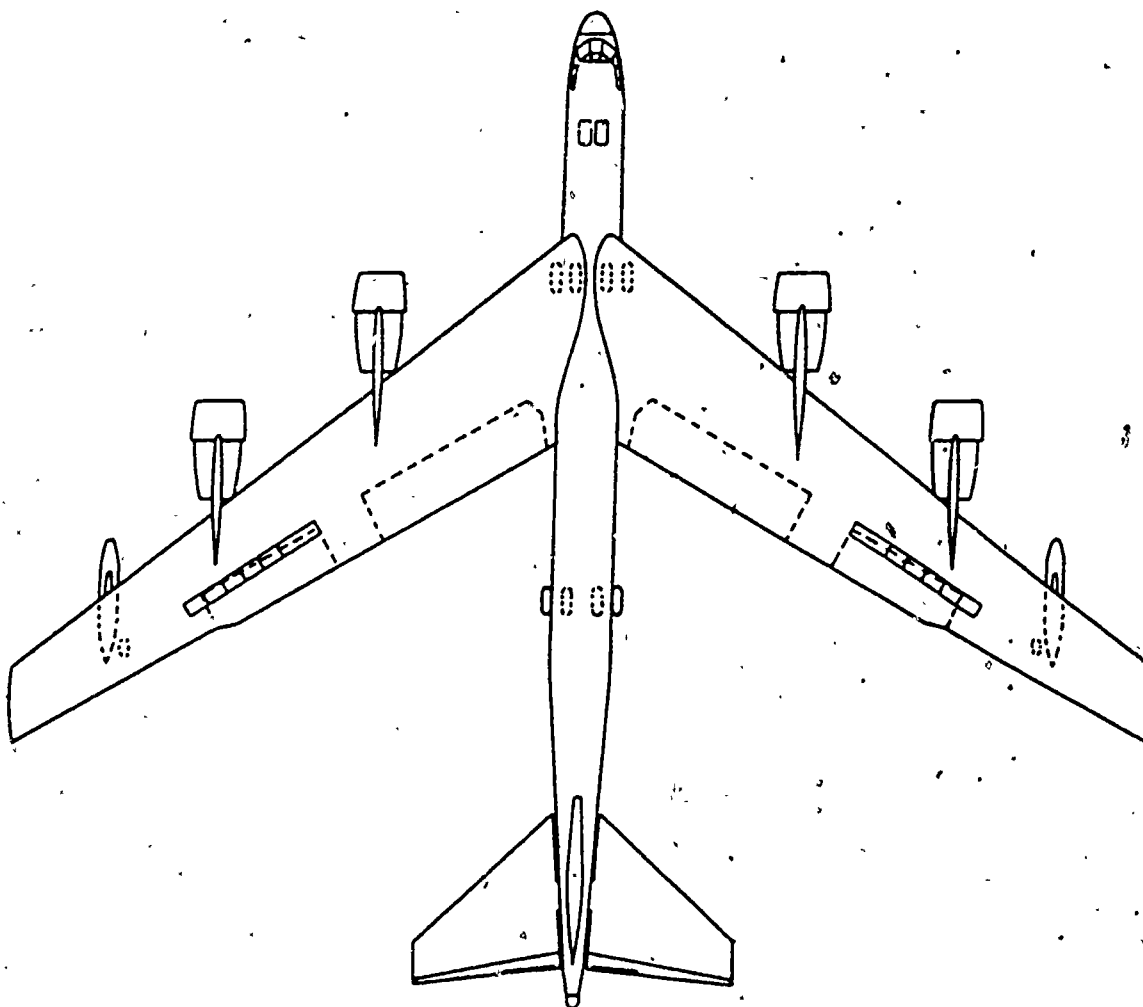

Figure 38. Large Aerospace Vehicle Trainer.

451

OPERATOR'S INSPECTION GUIDE AND TROUBLE REPORT (P-2/4, O-11A/B, R-2/2A, P-10 FIREFIGHTING VEHICLES)		DATE (MO/YR)
VEHICLE TYPE	REGISTRATION NO.	
USING ORGANIZATION	LOCATION	PHONE NO.
VEHICLE CONTROL OFFICER NAME	GRADE	PHONE NO.
ITEMS TO BE CHECKED	OPERATOR SIGNATURE	DAY
1. LUBRICATING OIL LEVELS (engine/trans./gear box/ water pump/power dividers)		1
2. COOLANT, FUEL, AND HYDRAULIC LEVELS		2
3. FOR LEAKS (oil, fuel, coolant, hydraulic, air, exhaust, etc.)		3
4. CONDITION OF ALL DRIVE BELTS (visual only)		4
5. TIRES, WHEELS, AND LUG BOLTS, FOR TIGHTNESS, PRESSURE AND DAMAGE		5
6. BATTERIES (front and rear) FOR FLUID LEVEL, DAMAGE, CLEANLINESS AND SECURITY		6
7. CLEANLINESS, DAMAGE, MISSING ITEMS (all interior and exterior items)		7
8. LUBE/OIL CHANGE		8
9. F 15; CLUTCHES (Operation), AIR TANKS (Drain), TE PARKING BRAKE		9
10. STEERING, SPRINGS & SHACKLES FOR OPERATION & DAMAGE		10
11. SAFETY DEVICES (warning lights, buzzers, fire extinguishers, seat belts)		11
12. OPERATION OF ALL LIGHTS, SIRENS, RADIO, HORNS, MIRRORS		12
13. WIRING/CIRCUIT BREAKERS (visual only)		13
14. SPECIAL EQUIPMENT (axe/spanner wrench/power saw and blade wrench/ladder/chain hoist/pike pole/trouble light/megaphone/breathing apparatus/generator & resuscitator)		14
15. FIREFIGHTING SYSTEM CORROSION/DAMAGE AND FOAM/WATER LEVELS		15
16. ON/OFF BASE GRID MAPS/STATE MAPS		16
17. HEATER/DEFROSTER/AIR CONDITIONER		17
18. WINDSHIELD/WIPERS/WASHERS (condition and operation)		18
19.		19
20.		20
21.		21
22.		22

AFTO FORM 433 JAN 74 PREVIOUS EDITION IS OBSOLETE.

Figure 39. AFTO Form 433 (Front).

453

ITEMS TO BE CHECKED (CONT'D)		OPERATOR SIGNATURE	DAY
19. INSTRUMENTS AND GAUGES (during operation)			23
20. UNUSUAL NOISES (during operation)			24
21. WINCH/TOWING CONNECTORS (when installed)			25
22. SHIFT TOWER & SWITCHES FOR PROPER OPERATION (trans.)			26
23. ALL HYDRAULIC CYLINDERS FOR OPERATION			27
24. CB FOAM SYSTEM (leaks/proportioning/operation crystals)			28
25. HOSES/REELS/FOAM METERING VALVE (operation) (left and right)			29
26. HAND LINES/BOOM/GROUND SWEEPS (operation)			30
27. TURRETS (hydraulic and manual, operation)			31
28. PUMPS, PIPING AND VALVES FOR LEAKS AND CORROSION (during operation)			
29. AUXILIARY GENERATOR/HEATER/LOUVERS (operation)			
30. BOOSTER HEATER (operation)			
31. HAND CIRCULATING PUMP (operation)			
32. RADIATOR SHUTTER CONTROL FOR OPERATION			
33. OPERATE ALL FIREFIGHTING-DISPENSING SYSTEMS (all patterns)			
34. ALCOHOL AND ALCOHOL INJECTOR SYS. FOR OPERATION			
35. WINTERIZATION KIT			
36. OPERATE RELIEF VALVE			
37. SPARK CHECK (Weekly and Scheduled Inspection Intervals)			
TYPE INSPECTION (Weekly or Sched)	DATE DUE	DATE ACCOMP	OPERATOR OR MECHANIC SIGNATURE AND GRADE

☆ U.S. GOVERNMENT PRINTING OFFICE: 1974- 757-168

3

Figure 41. AFTO Form 433 (Back).

☆ U.S. GOVERNMENT PRINTING OFFICE: 1975-671-585/48

ATC 48

59

508

