

DOCUMENT RESUME

ED 224 984

CE 034 826

TITLE Energy Efficient Homes and Small Buildings. Vocational Education, Industrial Arts Curriculum Guide. Bulletin 1698.

INSTITUTION Louisiana State Dept. of Education, Baton Rouge. Div. of Vocational Education.

PUB DATE [81]

NOTE 120p.; For a related document see CE 034 827.

PUB TYPE Guides - Classroom Use - Guides (For Teachers) (052)

EDRS PRICE MF01/PC05 Plus Postage.

DESCRIPTORS *Building Design; Building Trades; Carpentry; Conservation Education; Construction (Process); Curriculum Guides; Design Requirements; Drafting; *Energy Conservation; *Facility Improvement; High Schools; *Housing; *Industrial Arts; Instructional Materials; Landscaping; Learning Activities; Trade and Industrial Education

IDENTIFIERS *Insulation; *Retrofitting

ABSTRACT

This curriculum guide provides high school carpentry, construction, or drafting course teachers with material related to retrofitting a building for energy conservation. Section 1 discusses how design and construction methods affect energy use. Section 2 focuses on care and maintenance of energy efficient buildings. In addition to informative materials, a student's study guide, answer key, and a student activity are provided. Section 3 offers suggestions and activities for improving energy conservation through landscaping. Information on the effect of geographic location is provided in section 4. Section 5 focuses on building insulation. Topics are an analysis of insulation materials and their uses as well as attic, floor, and duct insulation. Five study guides are provided on the type and amount of insulation to use; insulation in the floor, walls, basement and crawl space; and installing vapor barriers. Section 6 contains informative materials on selecting and installing storm windows and doors. Topics are installation of weather stripping and caulking, types of windows to use, and door improvement. Study guides on types of windows and provision for energy efficiency are also included. A summary test (with answer key) for all of the material is provided. Transparency masters are appended. (YLB)

 * Reproductions supplied by EDRS are the best that can be made *
 * from the original document. *

LA 8113303

ENERGY EFFICIENT HOMES AND SMALL BUILDINGS

ED224984

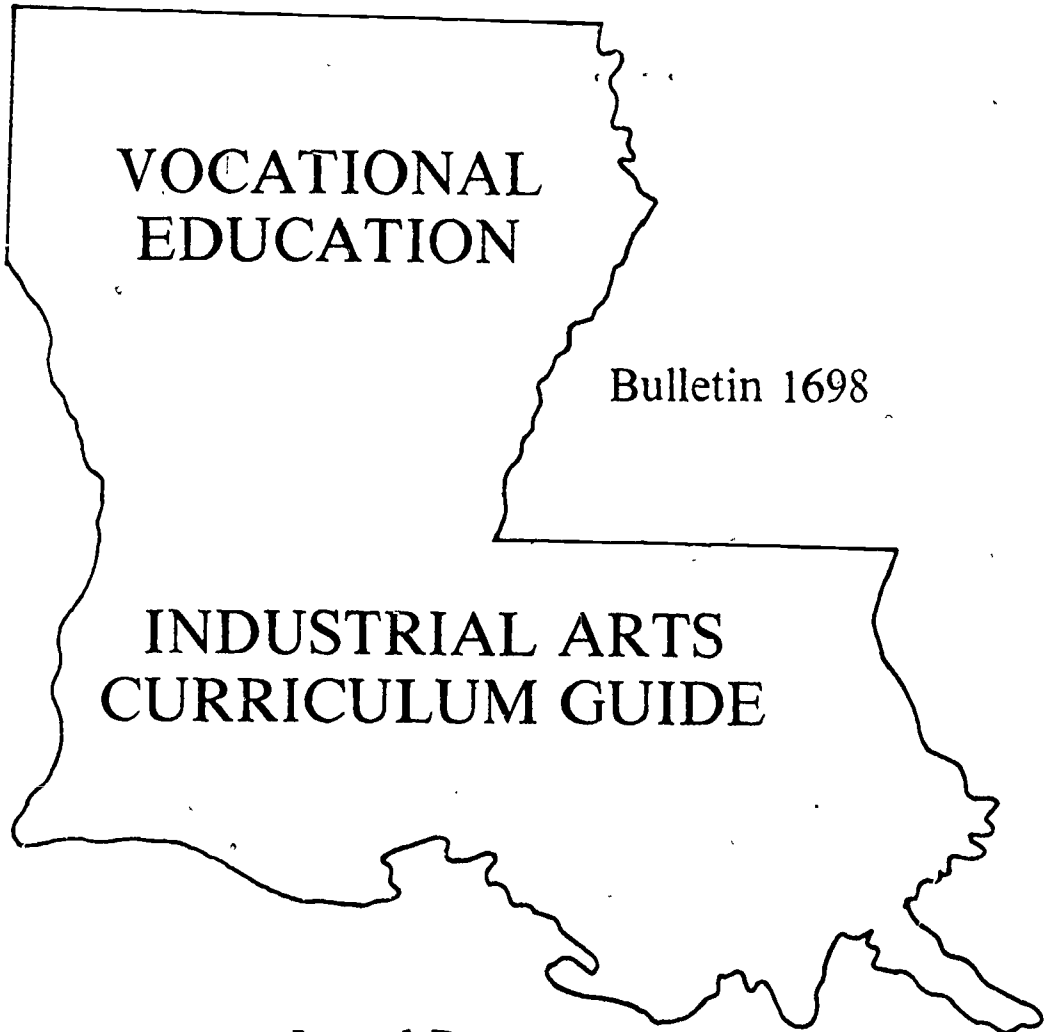

VOCATIONAL
EDUCATION

Bulletin 1698

INDUSTRIAL ARTS
CURRICULUM GUIDE

Issued By
Louisiana Department of Education

J. KELLY NIX
State Superintendent

U.S. DEPARTMENT OF EDUCATION
NATIONAL INSTITUTE OF EDUCATION
EDUCATIONAL RESOURCES INFORMATION
CENTER (ERIC)

This document has been reproduced as received from the person or organization originating it. Minor changes have been made to improve reproduction quality.

Points of view or opinions stated in this document do not necessarily represent official NIE position or policy.

PERMISSION TO REPRODUCE THIS MATERIAL HAS BEEN GRANTED BY

S Ebarb

TO THE EDUCATIONAL RESOURCES INFORMATION CENTER (ERIC)."

CE034826

EQUAL OPPORTUNITY STATEMENT

In compliance with Title VI, Title IX and Section 504 of the Rehabilitation Act of 1973 this Educational Agency upholds the following policy:

THIS IS AN EQUAL OPPORTUNITY SCHOOL AND IS DEDICATED TO A POLICY OF NON-DISCRIMINATION IN EMPLOYMENT OR TRAINING. QUALIFIED STUDENTS, APPLICANTS OR EMPLOYEES WILL NOT BE EXCLUDED FROM ANY COURSE OR ACTIVITY BECAUSE OF AGE, RACE, CREED, COLOR, SEX, RELIGION, NATIONAL ORIGIN, OR QUALIFIED HANDICAP. ALL STUDENTS HAVE EQUAL RIGHTS TO COUNSELING AND TRAINING.

This guide was printed at a cost of \$2.00 per copy by the Department of Education for the purpose of improving Vocational Education programs under the authority of P.L. 94-482 as amended and regulations issued thereunder. This material was printed in accordance with the standards for printing by state agencies established pursuant to R.S. 43:31.

Table of Contents

Introduction	1
How Design and Construction Methods Affect Energy Use	3
Care and Maintenance of Energy Efficient Buildings	7
Student's Study Guide or Test	11
Key to Items on Student's Study Guide	16
Exercise: Developing Energy Saving Habits	17
Activities that Improve Energy Conservation	19
Landscaping for Energy Conservation	20
How Geographic Locations Affect Energy Use in Buildings	24
Building Insulation	31
An Analysis of Insulation Materials and Their Uses	32
How Much Insulation Should Be Placed in the Attic	37
Attic Ventilation	42
Floor Insulation	43
Duct Insulation	48
Study Guide: Type and Amount of Insulation to Use	50
Key to Study Guide: Type and Amount of Insulation to Use	54
Study Guide or Test: Insulation in the Floor	56
Study Guide: Insulation in the Walls	58
Study Guide or Test: Insulation in Basement and Crawl Space	60
Study Guide or Test: Installing Vapor Barriers	61
Selecting and Installing Storm Windows and Doors	62
Study Guide or Test: Installing Weatherstripping and Caulking	63
What Types of Windows to Use	65
Study Guide: What Types of Windows to Use	70
How to Install Storm Windows	71
Types of Doors	74
How to Install Storm Doors	79
Door Improvements	81
Study Guide: Providing for Energy Efficiency in Homes and Small Buildings	86
Summary Test	90
Key to Test Questions	93
Appendix	1
Resources	XVII

ACKNOWLEDGEMENTS

I wish to acknowledge with thanks the use of maps and drawings from Energy and the Family by Gulf States Utilities, from Home Improvement Projects by Louisiana Power and Light Company, and from Providing for Energy Efficiency in Homes and Small Buildings by the U. S. Department of Energy, Washington, D.C. 20585. I also wish to thank Energy and the Family for the use of much of their data from the section entitled "Better Living with Less Energy."

I further wish to thank Scott Roberson, science teacher, Homer High School, Homer, Louisiana, for his assistance in formulating the test items at the end of the Guide. Thanks to Clayton A. Wiley and Samuel U. Walton of Grambling State University Industrial Education and Technology faculty for kindly consenting to read the document.

Finally, thanks to Dr. Joseph W. Capers of Grambling State University, dean of Continuing Education, and his assistant, Furman Davis, for providing office space and furnishings as well as encouragement and assistance all along the way.

INTRODUCTION

Conservation of energy is a popular subject at present. The general public is somewhat more aware of the critical role energy plays in the overall scheme of things in any society, but particularly in modern industrial societies. Industrial societies, in general, and ours especially, are energy intensive societies. Through the use of machines (which, of course, use huge amounts of energy), the output per man-hour has doubled and quadrupled in the factories and on the farms of America. As a result of this level of productivity, the work week has been shortened; standards of living have risen for many of the people, and leisure time activities have become an industry in their own right. The role of cheap, plentiful energy in the above-mentioned developments cannot be over-emphasized. The fact that energy is no longer cheap, and that fossil energy very definitely is no longer plentiful, means that major adjustments must be made regarding our energy future.

Despite the fact that America represents only six percent of the earth's population, we consume more than 30 percent of the world's energy.

We consume twice as much energy per capita as West Germany, Japan, Great Britain, and France, yet their economies and living standards are as high as ours. We could reduce our energy consumption by 50 percent without adversely affecting our economy or our life-styles. In other words our most valuable contribution to overcoming the energy shortage is conservation.

Persons who have the skills and knowledge to introduce conservation measures into the home, small business, and other commercial establishments in an effective manner are going to be in great demand.

For example, the high school graduate who understands retrofitting a building and has the skills to carry out the process will play an important role in our economy. The following module "Retrofitting for Energy Conservation" is intended to provide that knowledge and skill. This activity can be carried out as part of a course in carpentry, or construction, or drafting.

We begin by studying the exterior of a building, noting whether it is rectangular or L-shaped. Next, we note its orientation on site. Does it face north, south, east, or west? Does it have any trees, shrubs, protective walls, or soil embankments to shield it to some degree from winter winds or summer sun? Each climate zone requires a somewhat different approach in order to develop maximum comfort with minimum consumption of energy. All of these small factors influence energy expenditures in homes or small buildings.

Building shape and orientation are addressed in DOE Bulletin, IR, 06065-1 Pt. 1. Pages 4-6 consist of figures presenting building shapes and orientations found in three climate zones. The drawings are recommendations for three zones: temperate, hot-humid, and hot-arid. The hot-humid zone covers most of the Louisiana area. The teachers can use these drawings as transparencies in their classrooms.

HOW DESIGN AND CONSTRUCTION METHODS AFFECT ENERGY USE

Several factors influence the amount of energy used in buildings.

Planning an energy-efficient home or building begins with the selection of the site, followed by the proper orientation of the building on the site. Design of the structure, arrangement of rooms, selection of materials and mechanical equipment are of equal importance in an energy-efficient building. Your understanding of design and construction methods will help you save energy in your building.

From this section you will be able to describe how design and construction methods affect energy use. They are discussed under the following headings:

1. Effect of Site Location
2. Effect of Design
3. Effect of Materials Used
4. Effect of Insulation
5. Effect of Vapor Barriers
6. Effect of Weatherstripping and Caulking
7. Effect of Windows and Doors
8. Effect of Ventilation Methods

1. EFFECT OF SITE LOCATION

Site location and the orientation of buildings on the site affect the amount of energy used in heating and cooling. The sun and wind are two major factors that influence energy use.

Hill tops, ridges, and higher elevations have more exposure to the wind and are colder in winter and cooler in the summer. In cold climates, select southern exposures are protected by land of higher elevations. Flat sites are open to full sweeps of wind. Air temperatures near large bodies of water are tempered by wind.

Some trees make good wind screens. Deciduous trees are excellent summer shelters, while evergreens provide shelter the year round.

Room orientation is also important. Rooms of major use oriented to the southern, warmer side of a building capitalize on solar energy.

Energy consumption can be reduced by choosing the site carefully. Site location should vary, depending on the climatic zone. Site locations should be considered for each of the zones as follows.

a. Cold Zone

A house built on the northern or western slope with little or no protection from the prevailing winds will use more energy than one situated on the southern or eastern slope (Figure 1).

Vegetative protection can also be a factor in energy use.

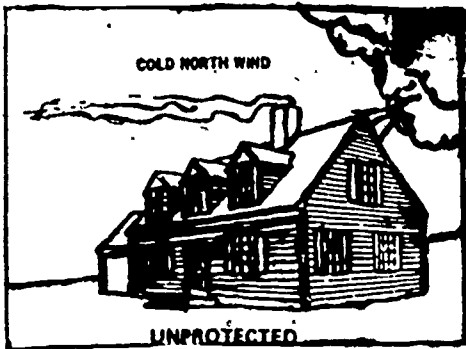

Figure 1. Buildings exposed to cold prevailing winds will use more energy for heating than those protected.

Temperate Zone

A balance is needed in the temperate zone between protection from wind in winter and access to air in summer. Also, vegetative protection that is used in winter may be used as shade in summer (Figure 2).

Hot-Humid Zone

Summer comfort is more important than winter heat in the hot-humid zone. If air circulation is inadequate during summer, excessive energy will be needed for cooling. Houses should be situated on southern and northern slopes with vegetative shade provided (Figure 3).

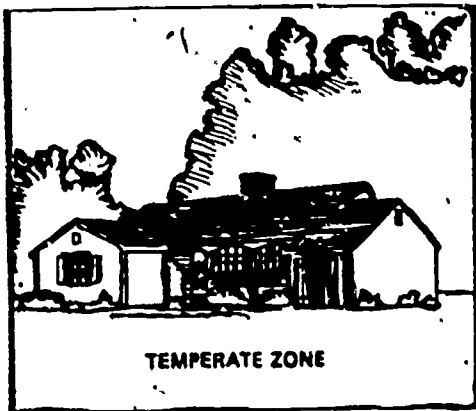

Figure 2. A building in the temperate zone should be moderately protected.

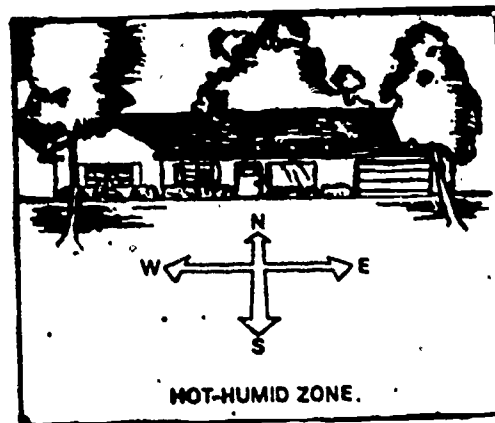

Figure 3. Buildings in the hot-humid zone should be oriented toward the north or south with ample shade for summer.

d. Hot-Arid Zone

Houses should be oriented toward the east with afternoon shading (Figure 4). Wind is not important here, because it is generally not too cold in winter and it is hot and dry in summer. It is best if you can shield the building from summer prevailing winds.

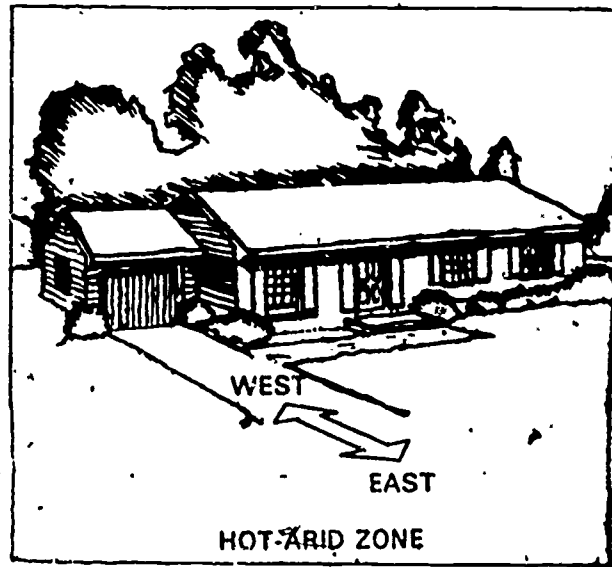
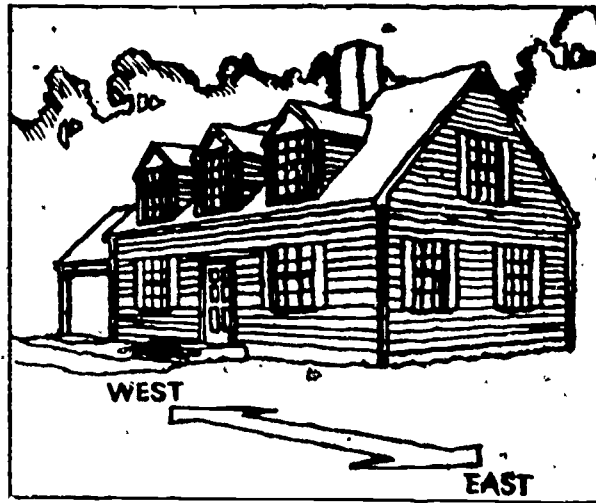

Figure 4. Buildings in the arid west should face the east and utilize afternoon shading whenever possible.

- Figure 5. Rectangular houses oriented toward east and west generally use less energy year round.



2. EFFECTS OF DESIGN

The shape of a building also has an effect on the amount of energy used. Generally, a rectangular house oriented east and west will use the least amount of energy (Figure 5).

Design should allow for exposure of windows to sun in winter and shade in summer (Figure 6). Shades may be used effectively.

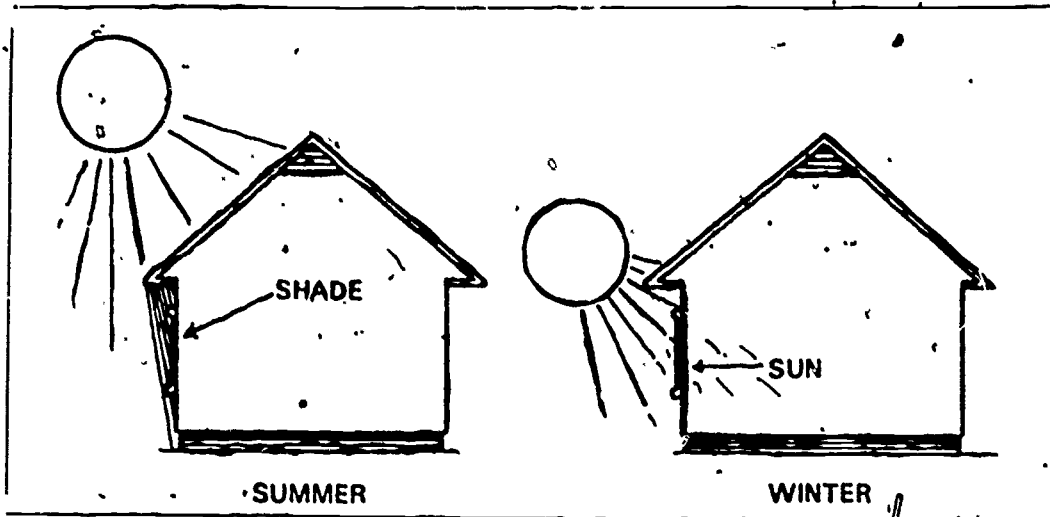

Figure 6. Windows should be exposed to sun in winter and should be shaded during summer.

CARE AND MAINTENANCE OF ENERGY EFFICIENT BUILDINGS

Maintenance and care are important to the efficient functioning of buildings. A schedule should be established for carrying out maintenance activities. No matter how well the work is carried out originally, periodic checks should be made of all parts of the building. In the fall, for example, one should check the insulation and weatherstripping. The furnace filter should be checked and changed if necessary.

Window air conditioning units should be covered outside with a weatherproof covering to protect them from the heat of sun and excessive rain and freezing temperatures.

The hot water tank should be covered with an insulating jacket that will reduce the loss of heat to the surrounding area. It should be drained periodically to eliminate the sediment that collects in the bottom of the tank.

Leaky faucets are a source of energy loss. All leaky faucets should be repaired as soon as they are detected.

Supplying electricity to a community is different from supplying other forms of energy. The electric utility must provide sufficient generating potential to handle the electricity required at peak hours. But once past the peak hours, much of the generating capacity stands idle. This adds considerably to the overall cost of electric power. If users were to spread the use of electric power more evenly, the cost of generating power would be reduced. According to Gulf States Utilities, those peak hours are from two o'clock to six o'clock p.m. daily.

Another area of concern in homes and small buildings is attic

ventilation. This is especially important in spring and summer, but proper attic ventilation is necessary all year. A poorly ventilated attic may have a summer temperature as high as 130°F.

To protect windows from the summer sun, one may plant shrubs on the south and west sides of the buildings. Awnings and roof overhangs may also be employed to protect the building from the heat of the summer's sun. Other energy saving practices are cutting off the pilot of the furnace during the summer and keeping dryer vents cleared.

Remember, the energy efficiency of a building can be improved by the cooperation of all persons using the building. Inspection should be carried out regularly by skilled persons. Records of cost benefits should be kept. This can be done by comparing costs of energy before conservation measures were introduced with costs after their introduction, using comparable time periods.

Developing Energy Saving Habits

The nation must conserve energy while developing alternate sources. The demand for energy must be decelerated by reducing waste and making wiser use of available supplies. Energy conservation is everybody's concern. One can begin by keeping the thermostat at 68°F in winter and 78°F in summer. By setting the thermostat at 78°F instead of 70°F one saves 10 percent on cooling costs.

Window draperies exposed to the sun in winter should be kept open in the day to let in the sun, and closed at night to keep the warm air inside. In summer, draperies should be drawn during the day if they are exposed to the sun. In winter, only those rooms that are being used

should be heated. If the house is heated by a fireplace, one should make provision to supply outside air to the firebox.

Attic ventilators are necessary to reduce attic temperature. Air conditioners should be operated only as needed, and window units should have their vents turned downward.

Heating and lighting are closely related. Since lights also give off heat, they contribute to the amount of heat produced in a building. Fluorescent lights should be used wherever possible, because they are four times as efficient as incandescent lights and last seven times longer.

Lights and television sets or stereo systems should be turned off when not in use. Fluorescent lights should be turned off if you are out of the room more than fifteen minutes.

Refrigerator doors should be opened only when necessary and closed immediately following use. Hot dishes should never be placed in the refrigerator, nor should frozen foods be placed in the oven. Dishwashers should be operated only with a full load.

One should bake only when he has a full oven rather than heating the oven several times for one item.

When washing clothes, use cold or warm water where feasible. The energy saving is worthwhile. When drying, operate the dryer only until clothes are almost dry. The heat of the dryer will complete the drying process, thereby saving energy. Not only can energy be saved at home, but also in all public buildings, office buildings, hospitals, and schools if the users or tenants will cooperate in following energy saving practices. The best procedure is to assign responsibilities to the people involved.

Energy surveys are helpful because they bring to light immediately any malfunctioning equipment, broken windows, or ill-fitting doors. Steps can be taken to correct the problem at once.

The following study guide items are designed to point out those activities and precautions that, though relatively easy to introduce, will make large contributions to energy conservation.

Care and Maintenance of Energy Efficient Buildings
PROVIDING FOR ENERGY EFFICIENCY IN HOMES AND SMALL BUILDINGS

STUDENT'S STUDY GUIDE OR TEST:

Circle the letter representing correct answer, unless instructed otherwise.

1. Good maintenance is necessary for energy efficiency in buildings.
 - a. True.
 - b. False.
2. Things to check in the fall are:
 - a. Insulation.
 - b. Weatherstripping.
 - c. Furnace filters.
 - d. All of the above.
3. Window air conditioning units should be:
 - a. Operated intermittently.
 - b. Covered outside with a weatherproof covering.
4. Hot water tanks should be:
 - a. Emptied.
 - b. Partially drained.
 - c. Painted.
5. Leaky faucets should be ignored.
 - a. True.
 - b. False.
6. Using electricity during non-peak hours will help save energy.
 - a. True.
 - b. False.
7. In the spring and summer, attics should be:
 - a. Well ventilated.
 - b. Heated.
 - c. Cooled.
8. In the spring and summer, windows should be:
 - a. Exposed to the sun.
 - b. Shaded.
 - c. Closed.
9. Leave pilot light on furnaces:
 - a. Year round.
 - b. During heating season.
 - c. During summer.
10. Dryer vents should be cleaned each season.
 - a. True.
 - b. False.
11. The energy efficiency of public buildings can be improved by:
 - a. Cooperative groups.
 - b. Good communication systems.
 - c. Training programs.
 - d. Assignments of responsibilities.
 - e. All of the above.
12. An inspection and maintenance schedule is:
 - a. Not important.
 - b. Important.
13. Inspection and maintenance are best done by:
 - a. Interested persons.
 - b. Skilled persons.
 - c. Anyone.

14. If you are not certain about installation and maintenance jobs:
 - a. Go ahead by trial and error.
 - b. Read the newspaper.
 - c. Get expert advice.

15. Records of cost benefits are:
 - a. Not important.
 - b. Important.
 - c. Submitted to the government.

16. Energy conservation is:
 - a. The government's job.
 - b. Everybody's job.
 - c. The responsibility of the manufacturer.

EXERCISE:

Your teacher will provide homes and buildings for evaluation.

Make an inspection of the components that contribute to the use of energy and make recommendations for improvement. Follow suggestions in the guide.

<u>Building Component</u>	<u>Suggestions for Improvement</u>
_____	_____
_____	_____
_____	_____
_____	_____
_____	_____
_____	_____
_____	_____
_____	_____
_____	_____
_____	_____

Developing Energy Saving Habits

PROVIDING FOR ENERGY EFFICIENCY IN HOMES AND SMALL BUILDINGS

STUDENT'S STUDY GUIDE OR TEST

Circle the letter representing correct answer, unless otherwise instructed.

1. With regard to energy, the nation must:
 - a. Conserve energy.
 - b. Develop alternate sources of energy.
 - c. Slow down the acceleration in new demands for energy.
2. The chief concern of the individual is:
 - a. Developing alternate sources of energy.
 - b. Conserving energy.
 - c. Repair and maintenance.
3. To conserve energy in summer, set thermostat at:
 - a. 68°F.
 - b. 72°F.
 - c. 78°F.
4. To conserve energy in winter, set thermostat at:
 - a. 78°F.
 - b. 72°F.
 - c. 68°F.
5. Keep window draperies exposed to sun during winter:
 - a. Drawn at night, open during the day.
 - b. Open during the night, drawn during the day.
 - c. Open all the time.
6. Windows draperies exposed to sun during summer are:
 - a. Open during the day.
 - b. Drawn during the day.
 - c. Closed all the time.
7. To conserve energy:
 - a. Operate furnace at full capacity at all times.
 - b. Heat half the building at a time.
 - c. Heat only rooms that are being used.
8. When using a fireplace:
 - a. Keep windows open.
 - b. Keep damper closed.
 - c. Provide outside air to fire box if possible.
9. Attic ventilators are used to:
 - a. Supplement the air conditioning.
 - b. Reduce the temperature in the attic.
 - c. Provide for higher temperatures.
10. Air conditioner vents should be adjusted:
 - a. Upward.
 - b. Downward.
11. The heating system is aided by lighting.
 - a. True.
 - b. False.
12. Kitchen and bathroom vent fans should be operated:
 - a. Continually.
 - b. Intermittently.
 - c. Only when needed.

13. Air conditioners should be operated:
 - a. Continually.
 - b. Intermittently.
 - c. Only when needed.
14. The difference in energy use with the air conditioner set at 78°F instead of 70°F would be:
 - a. 40 percent.
 - b. 10 percent.
 - c. 60 percent.
15. The most efficient lighting is:
 - a. Incandescent.
 - b. Fluorescent.
 - c. Iridescent.
16. Ways to save lighting energy are to:
 - a. Use dimmer switches.
 - b. Use lower watt bulbs.
 - c. Turn lights off when not in use.
 - d. Do all of the above.
17. Incandescent lights should be turned off:
 - a. Each time you leave the room.
 - b. If you are going to be gone for at least 15 minutes.
18. Fluorescent lights should be turned off:
 - a. Each time you leave the room.
 - b. If you are going to be gone for at least 15 minutes.
19. Refrigerator doors should be opened:
 - a. All the way.
 - b. As infrequently as possible.
 - c. Remain closed.
20. Place hot dishes in the refrigerator:
 - a. Immediately.
 - b. Only after they have cooled.
 - c. Gradually.
21. Use dishwasher:
 - a. As often as you have dirty dishes.
 - b. Only when you have a load.
 - c. To wash glasses only.
22. When baking:
 - a. Try to fill the oven.
 - b. Cook one panful at a time.
 - c. Leave the oven door cracked open for ventilation.
23. When boiling water:
 - a. Leave the pot open.
 - b. Keep a lid on the pot.
 - c. Use a baking dish.
24. When cooking frozen foods:
 - a. Allow them to thaw or partially thaw before cooking.
 - b. Cook them immediately after removing from the freezer.
 - c. Keep them in the original container.
25. Microwave ovens are:
 - a. Good for frying foods.
 - b. More efficient than infrared ovens.
 - c. Low in proteins.

26. Aluminum pots are the most efficient.
- True.
 - False.
27. Aluminum foil is recommended to line:
- The oven.
 - The reflector pans under electric burners.
28. When washing clothes:
- Use hot water.
 - Use cold water.
 - Use salt water.
29. Dry clothes:
- As rapidly as possible.
 - Only until dry.
 - Past the drying cycle to reduce wrinkles.
30. Energy can be saved:
- At home.
 - In public buildings.
 - In office buildings.
 - In hospitals and schools.
 - In all of the above.
31. Whose responsibility is it to save energy at school?
- The teachers.
 - The students.
 - The building superintendent.
 - All of the above.
32. The same rules for conserving energy in the home generally apply to other buildings.
- True.
 - False.
33. Energy surveys are:
- Important.
 - A waste of time.
 - Expensive.
34. The best procedure for energy saving in buildings is to:
- Assign responsibilities.
 - Let everyone decide what to do.
 - Turn the lights out when not in use.
35. The design and maintenance of public buildings are:
- Important to energy saving.
 - Not important.
 - Always done with energy efficiency in mind.
36. A planned use of buildings can contribute to energy efficiency.
- True.
 - False.
37. When providing food service in buildings:
- It is best to cater foods.
 - Efficiency measures are similar to those for the home.
 - Cook only one meal per day.

KEY TO ITEMS ON STUDENT STUDY GUIDE TEST, PAGE 11 to PAGE 15

- | | | |
|-------|-------|-------|
| 1. a | 1. d | 21. b |
| 2. d | 2. b | 22. a |
| 3. b | 3. a | 23. b |
| 4. b | 4. a | 24. a |
| 5. b | 5. b | 25. b |
| 6. a | 6. b | 26. b |
| 7. a | 7. c | 27. a |
| 8. b | 8. c | 28. a |
| 9. b | 9. b | 29. b |
| 10. a | 10. b | 30. e |
| 11. e | 11. a | 31. d |
| 12. b | 12. c | 32. a |
| 13. b | 13. c | 33. a |
| 14. c | 14. b | 34. a |
| 15. b | 15. b | 35. a |
| 16. b | 16. d | 36. a |
| | 17. a | 37. b |
| | 18. b | |
| | 19. b | |
| | 20. b | |

EXERCISE: Developing Energy Saving Habits

Have students take a personal inventory of their energy saving habits and activities. Check the techniques practiced at home, at school, and in other public buildings.

See lists in the manual.

<u>Energy Saving Practices</u>	<u>Personal Participation</u>			
	<u>Yes</u>	<u>No</u>		
1. Clean heating systems.			19. Don't stay in shower too long.	
2. Adjust thermostats.	___	___	20. Wash only full load of dishes.	___
3. Use electric blankets,	___	___	21. Bake as many items as possible in one oven at a time.	___
4. Close and open drapes as needed.	___	___	22. Cook thawed or partially thawed food.	___
5. Use fireplaces sparingly.	___	___	23. Use a microwave oven.	___
6. Keep heating and cooling vents clear.	___	___	24. Use copper or stainless steel cooking utensils.	___
7. Use a ceiling fan instead of air conditioning on cool nights.	___	___	25. Use a pressure cooker when possible.	___
8. Adjust air heating vents downward.	___	___	26. Turn off oven 5 minutes ahead of time.	___
9. Adjust heating vents downward.	___	___	27. Wash full loads of clothes.	___
10. Avoid unnecessary lighting.	___	___	28. Wash clothes in cold water.	___
11. Open windows and doors sparingly.	___	___	29. Never overdry clothes.	___
12. Use kitchen and bathroom vents only when needed.	___	___	30. Keep the lint filter clean on dryers.	___
13. Use fluorescent lights when possible.	___	___	31. When away from home, be conscious of energy saving just as much as when at home.	___
14. Use dimmer switches when available.	___	___	32. Participate in energy efficiency activities.	___
15. Never stand and hold refrigerator door open.	___	___		
16. Keep refrigerator defrosted.	___	___		
17. Keep dishes covered in refrigerator.	___	___		
18. Never put hot dishes in refrigerator.	___	___		

Energy Saving Practices	Personal Participation		
	Yes	No	
33. Read and try to keep up with energy saving techniques.	___	___	38. See that thermostats are turned down or up when not in use in accordance with the building plan.
34. Try to encourage others to become energy conscious.	___	___	39. Seek to learn the energy efficiency plan for the building you are in and adhere to it.
35. Make energy surveys.	___	___	
36. Present them to persons in authority.	___	___	
37. See that lights are turned off when not in use in accordance with the building plan.	___	___	

The preceding 39 items represent a personal inventory of energy saving habits. All statements represent preferred or correct procedures. The student is asked to indicate which of these energy saving practices he/she carries out constantly. If he/she, for example, helps with or cleans the heating systems, he checks the column under Yes. If he does not, he/she checks the column under No.

ACTIVITIES THAT IMPROVE ENERGY CONSERVATION

Clearly, in retrofitting a house, nothing can be done to improve site orientation, but one can recognize the influence of orientation on cooling and heating a structure. The planting of shrubbery can be advocated in situations in which such a practice would prove feasible. The following four pages represent the findings and recommendations of the Louisiana State Cooperative Extension Service. We present it here (with their permission) as a productive suggestion for small building site improvement. This is followed by an analysis of the insulation needs of residences and small buildings. These materials provide detailed instructions on how to figure the amount of insulation needed for the various parts of a building. R-value is defined and explained. The map on page 44 will be useful in helping determine the R-value recommended for this particular climatic area. The various drawings help one to get a better picture of how and where insulating materials should be installed. These illustrative drawings are furnished by the courtesy and permission of the U. S. Department of Energy, Providing for Energy Efficiency in Homes and Small Buildings, Part III, June 1980, Washington, D.C.

The load on your heating and cooling equipment can be reduced by as much as 25 to 30 percent through careful use of grass, paving, shrubs, trees, and fences around your home, research has indicated.

In order to use these landscape elements to achieve this saving, you must understand the principle of heat gain and loss in landscape elements on the environment around the building.

Heat gains and losses through the shell of a house are due to radiation, air leakage and conductive heat transfer. Landscaping can be beneficial in reducing these heat gains or losses in the following ways:

- Reducing direct solar radiation, sky reradiation, and reflected ground radiation at windows during the summer.
- Reducing air leakage in all seasons through cracks and joints around windows and doors, at roof eaves, building corners and at the foundation line by lowering the wind velocity at the building surfaces.
- Reducing the heat transmission of windows and to a lesser degree other building elements, since modifying the amount of wind, sun, and rain that strikes the building's surfaces can decrease the temperature difference between indoors and outdoors.

GROUND SURFACES

Ground surfaces around houses affect the heat gain and losses of windows and walls. They reflect solar radiation through windows and cause local changes in outdoor air temperatures by storing warmth and coldness in surrounding materials. Light colored materials are usually reflective and will increase the heat load immediately by indirect radiation,

while dark-colored materials will store large amounts of solar radiation and thus delay the heat load. Plant materials, on the other hand, because of their dark color, large surface area and evaporative cooling, neither reflect heat toward a building nor store heat for later reradiation to the building.

Grass or other plant materials used as ground covers can significantly reduce air and surface temperature when compared to concrete and asphalt surfaces. One researcher reported that under sunny conditions, temperature measured at the surface of grass at 89°F; asphalt at 106°F; and concrete at 111°F. On an August day in Texas, temperature recordings of 125°F were made immediately above unshaded asphalt pavement and a temperature of 98°F above a shaded grass area 30 feet away.

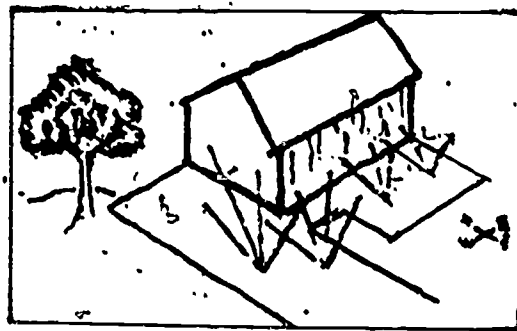

Hard surfaces reflect and store heat.

Paving on the south and west of a house in a warm climate can increase the air conditioning load significantly. Therefore, hard surfaced drives and patios should be located on the north or east side of the house, or shaded with trees and shrubs.

SHRUBS

Dense shrubs such as viburnum, ligustrum or pittosporum, when planted close to a building, affect its outside surface temperature by blocking the wind, creating shade and reducing air movement between the shrub and the building.

Low shrubs will have a limited benefit in conserving energy, but more homeowners should consider dense shrubs four feet or higher located on west, south and north exposures as an energy saver.

Another way to reduce energy consumption with shrubs and/or trees is to provide shade for the outside portion of an air conditioning system. A study by the American Refrigeration Institute shows that shading of the condensing unit and compressor can reduce the temperature inside the home as much as 3°F.

However, shrubs planted too close to the unit obstruct the air flow or access for needed service. Screening the outside unit with shrubs also enhances the esthetic value of the home.

ESPALIERS AND VINES

Plants can protect walls from heat and cold. Vines, shrubs, and some trees can be used as espaliers, (plants trained to grow flat against walls). The foliage cover

insulates the wall against summer heat and cold winter winds.

There are several ways to support plants against walls. Some vines, such as Little Leaf Fig and English Ivy, cling to surfaces by aerial rootlets. However, such vines may cause wooden structures to rot.

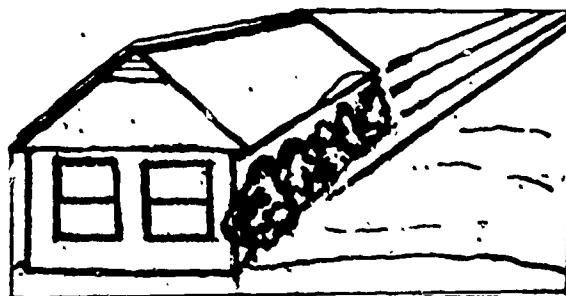

A dense shrub planting helps save energy.

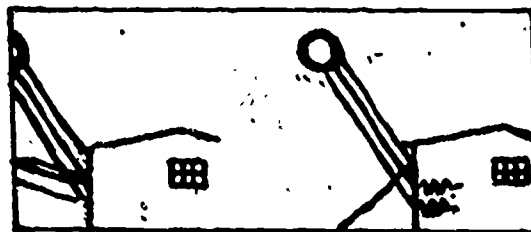

An air conditioning unit on a south or west wall should be protected from the sun.

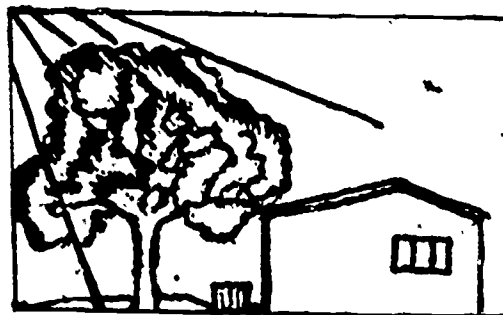

Plants trained on a wall moderate indoor air temperature.

TREES

Free standing trees provide an effective shading device that can affect not only the walls of a building, but also its roof. Deciduous trees let the sun in during the winter and provide shade during the summer. Evergreen trees provide constant shade and this may be undesirable during winter. As the number of trees increase, their effect on the house will change. A grove of trees will not only provide shade and wind protection, but also modify outside air temperature through evaporative cooling.

Air conditioners in a fully shaded house have been shown to work only half as much as the ones in a house which has its walls and roof exposed to the sun. Experiments have shown a difference in shaded and unshaded outdoor wall surfaces of 8°F. Other research reports show that shade trees will reduce heat gains by 40 to 80 percent, depending upon their placement and density. Even a sparse shade tree may be a better energy saver than an interior venetian blind.

A good builder considers the trees that are already on the site before he cuts them, locates the house or plants additional trees. In southern latitudes, shade trees are more effective on the east and west sides of a house.

OVERHEAD STRUCTURES

Arbors and slatted wooden overhead structures can be effective either attached or adjacent to the home or farther out in the landscape. If adjacent to the home, they provide the bonus of shading walls and windows, thus reducing heat and glare, providing cool, restful sitting and viewing areas.

If wooden structures are used, the 1 or 2 inch strips or treated pine, redwood, cedar or other long-lasting wood are usually spaced 1 to 1 1/2 inches apart. This spacing provides adequate shade while allowing the air to circulate freely. If vines are used as a partial or complete cover, the structure is referred to as an arbor.

Grape arbors, once as common as patios are today, can serve as attractive, practical additions to the landscape. Muscadines are excellent for arbors since they require little or no spraying for insects and disease problems and are attractive plants which produce tasty fruit. Vegetable pear (mirliton) is fast growing, gives quick shade and produces edible fruit. Wisteria; Carolina Jessamine and grapes are other popular choices which are well adapted to most of the state.



An arbor reduces heat and glare and provides a cool, attractive sitting area.

WINDBREAK

A windbreak can be any barrier to wind; a row of evergreen trees spaced close together, a fence, a wall or even a garage. A windbreak is used to control wind speed and direction. Depending on the location and design of the windbreak, it can either act as a barrier, reducing wind pressure around a house, or as a funnel, increasing pressure and improving ventilation through a house.

Trees and shrubs act as obstructing barrier to reduce wind speed. Trees with dense foliage extending to the ground create a solid barrier while trees with sparse foliage and removed lower branches form an incomplete barrier. Evergreens that branch to the ground are the most effective year-round plants for wind control.

Plants not only slow down or deflect the wind for cold protection, they also serve to guide the wind in a desired direction to provide a degree of coolness during the summer. For example, plants placed on the northwest side of your home may protect it from cold winter winds and also direct summer breezes around it. In North Louisiana and the open prairie areas of the state, windbreaks should be used for wind control.

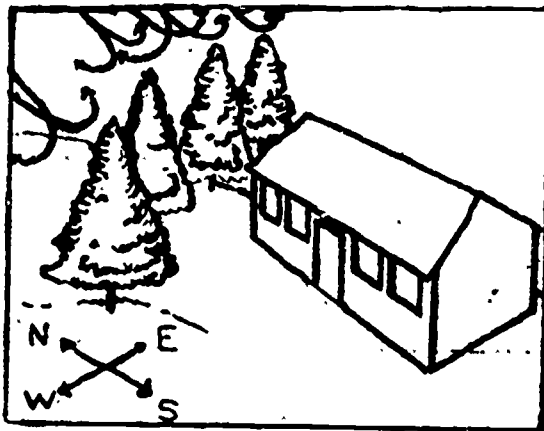

Windbreaks help control wind speed and direction

By: Thomas E. Pope

Louisiana State University and Agricultural & Mechanical College Cooperative Extension Service; Denver T. Loupe, Vice-Chancellor and Director; Issued in furtherance of Cooperative Extension work, Acts of Congress of May 8 and June 10, 1914, in cooperation with the U. S. Department of Agriculture.

HOW GEOGRAPHIC LOCATIONS AFFECT ENERGY USE IN BUILDINGS

Energy requirements of buildings vary with the geographic location. For example, in cold locations more energy is required for heating (Figure 7). For example, it takes three times as much fuel to heat a house in New York as it does the same type of house in Georgia (Table 1).

TABLE 1. COMPARISON OF ENERGY REQUIREMENTS TO HEAT SIMILAR HOUSES IN FOUR DIFFERENT CLIMATIC ZONES

Bismark	New York	Denver	Atlanta
Billion Joules			
528	211	148	72
Million BTU			
500	200	140	67

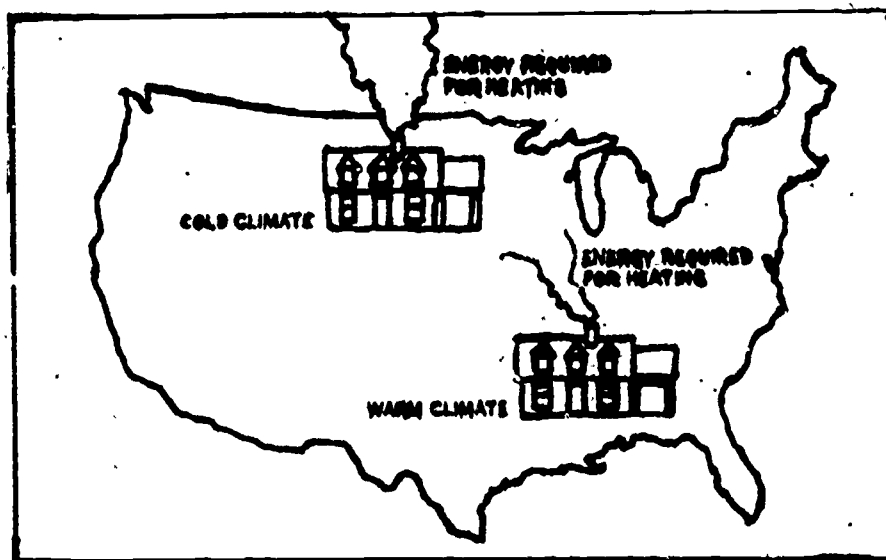

Figure 7. In cold climates, more energy is required for heating than in warm climates.

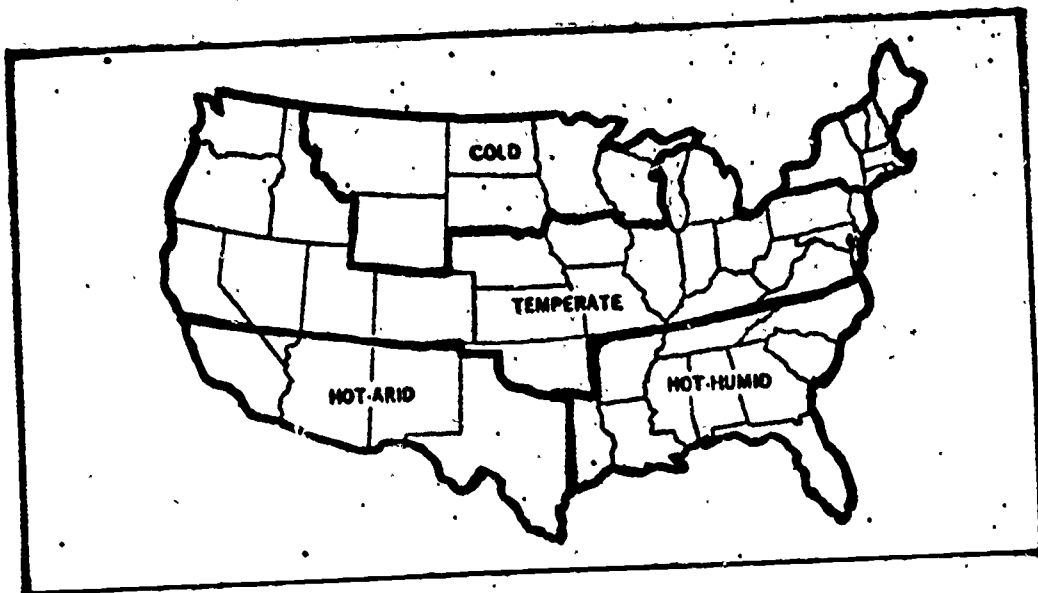

FIGURE 8. Climatic regions in the United States.

1. TEMPERATURE

Temperature is the most important factor in energy use in buildings: As you know, the winter temperature is maintained in most buildings at 20°C (68°F) to 21°C (70°F). When the temperature outside is lower than 18°C (65°F), energy is required to raise the temperature inside the building (Figure 9).

Inside temperature is maintained at 26°C (78°F) during the summer. When the outside temperature is greater than this, energy is required to lower the temperature inside (Figure 9). The energy required in both instances is to maintain a 6°C (22°F) difference in temperature.

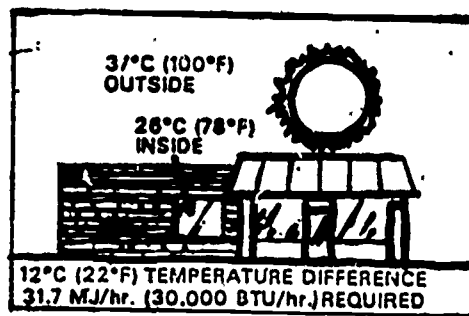
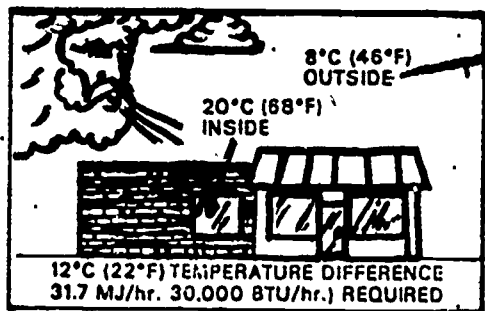

FIGURE 9. Energy is required to maintain the temperature within a building at a comfortable level.

The United States is divided into four geographical zones for design purposes (Figure 8). With the addition of Alaska and Hawaii, two more zones are added.

Table II gives climatic conditions that influence energy use in buildings.

From your study of this section, you will be able to explain how geographic location affects energy use in buildings.

Four factors are involved. They are discussed under the following headings:

1. Temperature
2. Moisture
3. Wind
4. Sun

TABLE II: CLIMATIC CONDITIONS THAT INFLUENCE ENERGY USE IN BUILDINGS

N. Ohio	Cold	Hot	Humid	Windy	2200
N. Minnesota	Cold	Hot	Humid	Windy	2200
Oregon	Mild	Mild	Wet	Moderate	1800
N. Mississippi	Cold	Hot	Humid	Windy	2600
Gulf Coast	Cool	Hot	Humid	Moderate	2600
S. Florida	Warm	Hot	Humid	Moderate	2800
Colorado	Cold	Mild	Dry	Windy	3600
S. West	Mild	Hot	Dry	Windy	4000

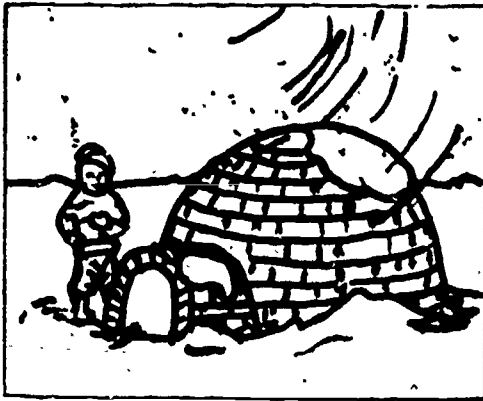

FIGURE 10. Ice-constructed igloos insulate against cold.

Early settlers of this continent built for environmental comfort without using extensive amounts of energy. In cool regions, snow provided thermal insulation as it enclosed space. The smooth, interior ice lining sealed against outside air infiltration and loss of inside heat (Figure 10).

Animal skins draped on the inside surface of igloos reduced radiant heat loss from occupants.

In hot-arid regions the thick adobe construction used for roof and wall constructions delayed the impact of solar radiation until late in the day (Figure 11). Adobe construction also retained heat for a long period of time, thus providing warmth during cold evenings. Small openings, such as doors and windows, minimized direct transmission of solar radiation and hot air. Shelters were oriented in a north-south direction to minimize the impact of a hot, rising sun or an even hotter setting sun.

2. MOISTURE

The relative humidity is important in designing housing. Chill factors are partially determined by the amount of moisture in the air. Most people are comfortable at 40-60°F.

-27-

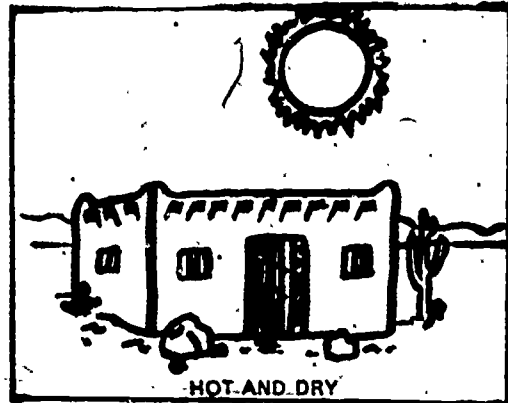

Figure 11. Adobe construction protects against heat.

percent relative humidity. Relative humidity is the amount of moisture in the air compared to the amount that could be there. You are more comfortable when the air is dry and cold than when it is damp and cold (Figure 13).



FIGURE 12. Shade and ventilation protect from heat in hot-humid regions.



FIGURE 13. Damp and cold are more uncomfortable than dry and cold.

In hot-humid regions, overhangs provide shade on the structure to reduce solar radiation (Figure 12). Breezes are desirable so open walls and elevated floors allow air circulation for cooling by natural ventilation.

If your building is damp, a higher temperature is needed for comfort; thus more energy is required.

Also, you are more comfortable when the air is dry and hot than when it is moist and hot.

3. WIND

The wind is also a factor in energy use in homes. Where practical, your house should be protected against cold prevailing winds (Figure 14). Infiltration of cold air through cracks and crevices increases energy use considerably. A house without caulking and weatherstripping may use twice as much energy as one with caulking and weatherstripping.

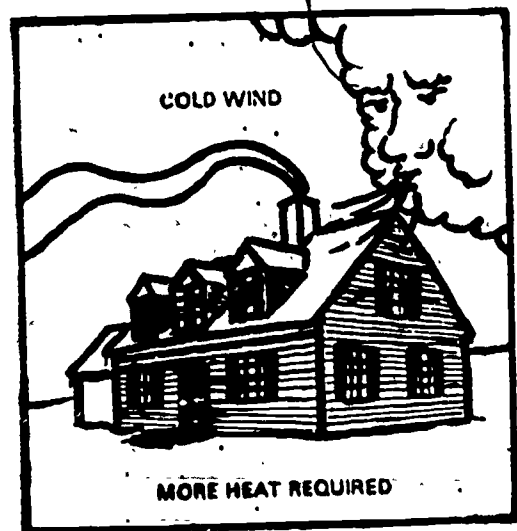

FIGURE 14. Cold winds increase the use of energy in buildings.

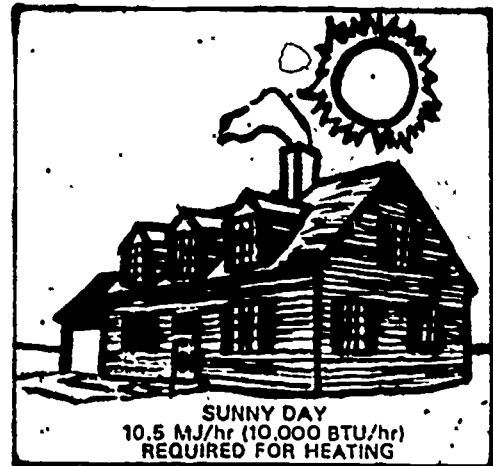
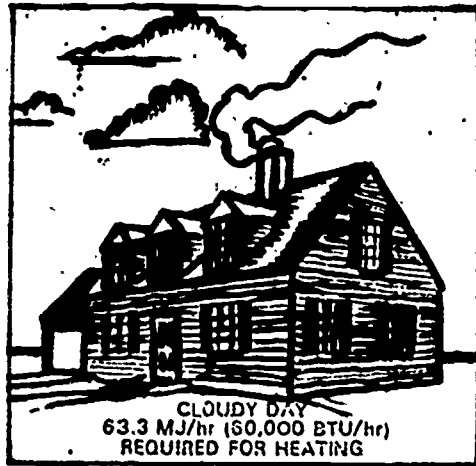

Figure 15. More energy is required for heating on a cloudy day than on a sunny day.

On the other hand, a breeze can be quite welcome in the summer. The desire to use nature's air conditioning probably inspired the innovation of the porch. The old possum run or dog trot houses in the south provide comfort by channeling prevailing summer breezes (Figure 16). Air conditioning systems have not duplicated the effect of a fresh breeze.



Figure 16. Porches and breezeways help cool houses.

Drawings Courtesy U. S. Department of Energy, Providing for Energy Efficiency in Homes and Small Buildings, Office of Consumer Affairs Education Division, Washington, D.C.

Long ago farmers, who lived close to nature, learned things

about the wind that we should use. They learned that trees can divert the wind's direction. Farmers built their houses and animal shelters downwind of, and adjacent to, windbreaks. Claims are made that when houses are placed in these windshield areas, as much as 20 percent of fuel cost is saved.

4. SUN

Sunshine aids in reducing energy needs for buildings (Figure 16). On the other hand, it increases the need for cooling. There are certain parts of the country that have more sunshine than others. Usually, these are in the warmer climates.

The sun is high in summer, low in winter. The sun's path is precise and predictable (Figure 17). Designers use this fact as an opportunity to control the sun's effect on energy use in buildings.

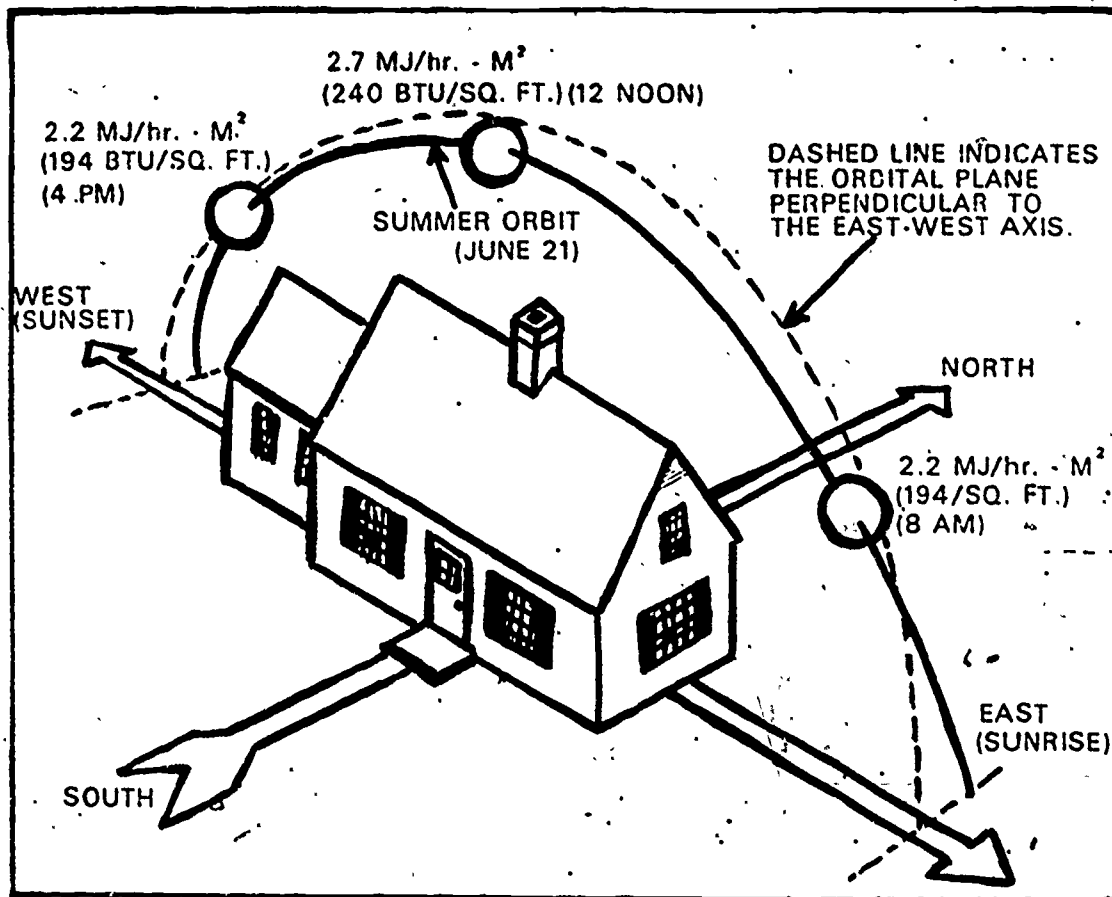

Figure 17. The path of the sun influences the use of energy in buildings.

Figure 17 is a transparency designed to help the student understand how construction and orientation to site can be used to conserve energy. Southerly roof overhang will protect small buildings from direct sun rays in the summer but will permit the sun to shine through south facing windows in winter. Likewise, shrubbery can be used to take advantage of the sun's orbit.

BUILDING INSULATION

Once the shape of the building has been determined, the next step is to assess the requirements for adequate insulation. The amount of insulation needed depends on energy cost, insulation cost, climate, or geographic location.

The map on page 25 shows the climatic regions of the Continental United States. The map and the accompanying illustrations are furnished through the courtesy of the U. S. Department of Energy Bulletin IR/06065-1 part 1.

Students will examine these illustrations and gain insights into how builders have taken advantage of terrain, prevailing winds, and structural design to produce maximum comfort and utility for building occupants.

Pages 33, 34, 35, and 36 provide an analysis of insulation needs. This will enable the instructor to demonstrate to pupils just how the amount of materials and costs might be figured. The heating factor for this latitude is 0.50. The recommended R-value for this climate is as follows: Ceilings: R-26, Walls: R-19, Floors: R-13 (See map, page 44). R-value is explained at the top of page 33.

AN ANALYSIS OF INSULATION MATERIALS AND THEIR USES

There are several different kinds of building insulation materials on the market. Some are, of course, more expensive than others; however, the key to the choice is R-value. The job to be done may determine whether the worker will use batts, blankets, loose fill, rigid board or foamed-in-place insulation. These different forms of insulation may be of any of the following compositions: glass fiber, rockwool, cellulose, extruded polystyrene, bead board, urethane board; or for the foamed-in type, polyurethane. Page 40 outlines the thickness in inches of insulation required to achieve the desired R-value.

Insulation can be carried out effectively by adhering to the directions given on the following pages, with the possible exception of foaming insulation into already finished walls. This will require the services and equipment of a professional.

As the class discusses the kinds and qualities of insulation available, the instructor will want to obtain from local building materials' agencies samples of each of the materials described in the following pages. Special notice should be given to R-values of the different kinds of insulation as they appear on packing or labels on the insulating materials.

Ordering the correct amount of insulating fiber is determined by the number of square feet to be covered and the R-value one wishes to achieve. Page 40 provides the information necessary for figuring how much of what kind of insulating materials one will need to achieve a certain R-value.

See information from Project Retrotech, conservation papers 28A, 28C, and 28D, from the Federal Energy Administration, Washington, D.C.

ANALYZING YOUR INSULATION NEEDS:

One important way to evaluate insulation is by comparing R-values. R stands for resistance to heat; R-values measure how well a material blocks the flow of heat. The higher the number, the greater the insulating power of the material. By finding out the R-value recommended for where you live, you can determine how thick a layer of insulation you need and the type of insulation best suited to different areas of your home.

R-VALUES NEEDED	ATTIC	UNHEATED FLOORS	EXTERIOR WALLS
A. The R-value needed in key areas of your home will vary depending upon the climate where you live. What R-values are recommended for your region? (See map on page 44. See also transparency XI in Appendix.)	A _____	A _____	A _____
B. Use the chart below to estimate the R-value of any insulation which already exists in your home:	B _____	B _____	B _____
Batt or blankets: 3-4 inches, R-11 2 inches or less, R-6			
Loose fill: 3-4 inches, R-9			
C. To determine the R-value needed to bring your home up to recommended level, subtract the R-value of the existing insulation, B, from the recommended R-value, A. If this R-value is not available, round off to the next higher number.	C _____	C _____	C _____
	R-Values to be installed		

To compensate for space occupied by doors and windows on exterior walls, measure each one, multiply width times height, add together and subtract from total above, for exterior walls.

SQUARE FEET OF INSULATION NEEDED

A certain part of any area you will insulate is taken by joists (support posts) which are spaced either 16 or 24 inches apart. The calculations below account for your "joist factor," and will give you the precise number of square feet of insulation you'll need.

Measure space between joists in area to be insulated: _____ 16 inches
_____ 24 inches

Area to be insulated	X	X	=
A (above)	Joist Factor	Number of layers	Number of sq. ft. of insulation needed
	.90 for 16 in.	(Use one layer for loose fill)	
	.94 for 24 in.		

INSULATION SAVINGS

The purpose of installing insulation is to save money on fuel. The amount you will save may help determine the amount you are willing to spend on insulation. This worksheet will help you calculate the cost of insulating a key area in your home, estimate your fuel savings and determine the time it will take for savings to offset expenditures. (Use a separate copy of this sheet to repeat your calculations for each area of the house: attic, basement, and unheated floors, and exterior walls.)

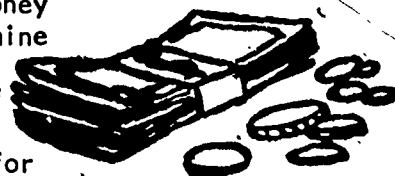

COST FOR INSULATION

Number of sq. ft. of insulation needed	Number of sq. ft. covered by package	Number of packages needed	X \$ Cost per package	= Cost for insulation
			package	tion

TOTAL COSTS: INSULATION PLUS INSTALLATION

(If you are using a contractor to do the job, just insert his fee in "Total Cost" box.)

Cost for insulation	+ \$ Cost for installation (contractor's fees, tools, etc.)	= Total cost
---------------------	---	--------------

NUMBER OF LAYERS OF INSULATION NEEDED:

(Fill out this section only if you are installing batts or blankets.)

ATTIC

$$\frac{\text{R-value to be installed C (above)}}{\quad} + \frac{\text{R-value of insulation}}{\quad} = \frac{\text{Number of layers needed for attic}}{\quad}$$

UNHEATED FLOORS

$$\frac{\text{R-value to be installed C (above)}}{\quad} + \frac{\text{R-value or insulation}}{\quad} = \frac{\text{Number of layers needed for basement and unheated floors}}{\quad}$$

EXTERIOR WALLS

$$\frac{\text{R-value to be installed C (above)}}{\quad} + \frac{\text{R-value or insulation}}{\quad} = \frac{\text{Number of layers needed for exterior walls}}{\quad}$$

HOW MUCH INSULATION WILL YOU NEED?

Every home has different insulation needs. This worksheet will help you figure out how much insulation you need in three key areas: The attic, basement and unheated floors, and exterior walls.

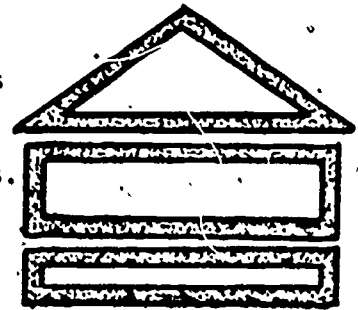

SIZE OF AREA TO BE INSULATED

Calculate the number of square feet in each area which needs insulation. If the wall, floor or ceiling is a regular rectangle, multiply length times width. If the area is irregular, divide it into rectangles, multiply length times width for each rectangle, and add the areas together.

ATTIC FLOOR

$$\text{Length} \times \text{Width} = \text{Area to be insulated}$$

UNHEATED FLOORS

$$\text{Length} \times \text{Width} = \text{Area to be insulated}$$

EXTERIOR WALL

WALL $\frac{\text{Length}}{\text{Width}} \times \text{Width} = \text{Area to be insulated}$

SAVINGS

$\frac{\text{Fuel bill last year}}{\text{Savings factor (see box)}} = \text{Estimated savings per year}$

If you are insulating	Your savings factor is	These savings factors are taken from Tips for Energy Savers, published by the U.S. Department of Energy. Your savings may be more or less depending upon other variables such as the cost of fuel, the climate, storm windows, weatherstripping, etc.
the attic	.20	
floors	.08	
exterior walls	.12	

YEARS FOR PAYBACK

$\frac{\$ \text{Total Cost B (above)}}{\$ \text{Estimated savings per year C (above)}} = \text{Number of years for payback. It will take you this amount of time savings to offset your expenditure.}$

HOW MUCH INSULATION SHOULD YOU HAVE IN THE ATTIC?

Your attic may already have some insulation. After you have determined how much you have, the following charts can help you determine how much insulation you will need.

The effectiveness of insulation is measured by its "R" value. The R-value is the ability of insulation to slow

the transfer of heat. The higher "R" values represent more insulating ability. You should insulate your attic to at least R30 and even R38 in colder climates.

BATTS OR BLANKETS

INSULATION VALUE	GLASS MINERAL FIBER	ROCK MINERAL FIBER
	INCHES	INCHES
R-11	3 1/2	3
R-13	3 5/8	3 1/2
R-19	6	5 1/2
R-22	6 1/2	6
R-26	8 1/4	7
R-30	9 1/2	8 1/2
R-38	12	11

The thickness of batt insulation is measured in inches. The best way to measure the amount of additional loose-fill insulation is to refer to the number of bags. The chart below indicates the minimum number of bags for each 1,000 square feet of ceiling area. The bags in this chart are 25 pounds (for glassfiber) and 30 pounds (for rock wool and cellulose fiber).

LOOSE FILL (POURED OR BLOWN)



INSULATION VALUE	GLASS MINERAL FIBER		ROCK MINERAL FIBER		CELLULOSE FIBER INCHES
	INCHES	BAGS/1000 SQ. FT.	INCHES	BAGS/1000 SQ. FT.	
R-11	5	11	3 3/4	23	3
R-13	6	13 1/2	4 3/4	29	3 1/2
R-19	8 3/4	20	6 1/2	38	5 1/8
R-22	10	22	7 1/2	45	6
R-26	12	27	9 1/2	54	7
R-30	15 3/4	30	11 1/4	62	8 1/8
R-38	17 1/2	40	12 3/4	77	10 1/4

**Blown mineral fiber insulation has both a depth and density relationship. R-values depend upon both number of inches and bags per 1,000 square feet of insulation.

***See bottom of page 38.

HOW TO INSULATE YOUR UNFINISHED ATTIC

Install batts or blankets between the joists or trusses in your attic.

OR

Pour in loose fill between the joists or trusses.

OR

Lay in batts or pour in loose fill over existing insulation if you've decided you don't have enough already. Don't add a vapor barrier if you're installing additional insulation.



Temporary lighting.



Temporary flooring.

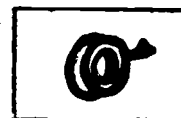

Duct or masking tape (2" wide).



Heavy duty staple gun and staples or hammer and tacks.

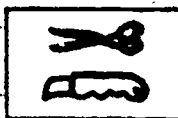

Heavy duty shears or knife to cut batts, blankets and plastic for barrier.



Caulking gun and cartridges.

SAFETY

- *Provide good lighting.
- *Lay boards or plywood sheets down over the tops of the joists or trusses to form a walkway (ceiling below won't support your weight).
- *Be careful of roofing nails protruding through roof sheathing. Wear a protective hat.
- *If you use glass fiber or mineral wool, wear gloves and breathing mask and keep the material wrapped until you're ready to put it in place.
- *Do not cover recessed light fixtures or contact flue vents with insulation.

- *Do not block combustion air openings if fossil fueled heating.

MATERIALS

What You'll Need

- Batts: glass fiber or rock wool
- OR
- Blankets: glass fiber or rock wool
- OR
- Loose fill: rock wool, cellulose or vermiculite.

VAPOR BARRIERS

- If one installs batt or blanket, insulation in an uninsulated attic, one may need a vapor barrier.

***According to the National Cellulose Insulation Manufacturers Association, blown cellulose insulation shall have an R-value that is greater than or equal to 3.70 per inch of thickness with a density not to exceed 3 pounds per cubic foot. According to the 1972 ASHRAE Handbook, the maximum R-value acceptable is 3/7 inch.

Buy the batts or blankets with the vapor barrier attached. Install them with the vapor barrier side toward the living space.

If one installs additional insulation over existing insulation, either use poured insu-

lation or an unfaced batt (no vapor barrier). When vapor barriers are placed between existing and added insulation, moisture is trapped, reducing the insulation value, and could cause structural damage.

BACKGROUND

Most homes, built in the days when energy was plentiful and cheap, don't have enough insulation, but insulation can be added to any house. Insulating an attic, where savings generally will be greatest, usually can be done by the home owner himself.

The exact amount of money you will save is affected, of course, by the rates you pay for fuel and electricity. However, no matter what those rates are, if you make energy-conserving improvements to your home now, you can expect even greater dollar savings in the future as energy costs rise with inflation.

Considerable space is given to attic insulation in the subsequent pages. This is intentional, because it is the single area in a house where the greatest savings or loss in energy can occur. It is also the area easiest to insulate in an older house. By following the directions laid out here, the owner can do the job himself.

HOW BIG IS YOUR ATTIC

To compute your attic area, you don't even have to go up into the attic. Find out the area of the first floor of your home, not counting the garage, porch, and other unheated areas, and it will be the same as the area of your attic.

If It's A Rectangle

Measure its length and width in feet to the nearest foot, and multiply them together.

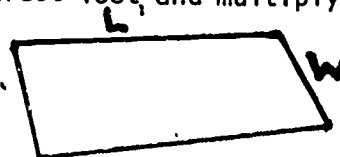

Length X Width = Area

_____ x _____ = _____

If It's A Combination

Break it down into rectangles, find the area of each one, then add the areas to get the total.

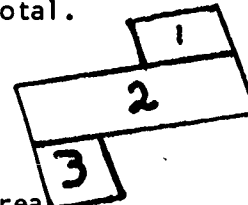

Length X Width = Area

1. _____ x _____ = _____
 2. _____ x _____ = _____
 3. _____ x _____ = _____
 Total Area _____

HOW TO INSULATE YOUR FINISHED ATTIC

GENERAL

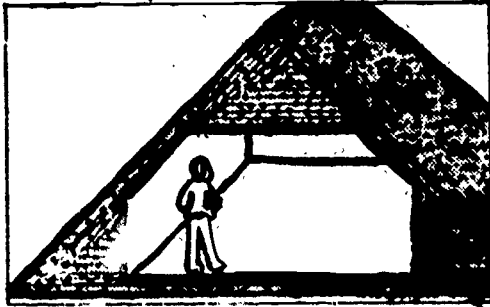

Some homes have attics that are completely or partially finished. This attic area should be insulated with the same amount of insulation as an unfinished attic. Some of the areas that need insulation may be difficult to get to. Since there are so many variations, it would be a good idea to check with your power company representative or a contractor to get specific suggestions for your own home. Here are some general guidelines for those areas where insulation will improve the comfort and energy efficiency of a home.

the roof for proper attic ventilation)

3. Knee walls
4. Outer attic floors
5. Block openings

TYPES OF INSULATION

For all vertical and sloping surfaces, you will have to use batt insulation. You can use either batts or blown insulation for the horizontal areas like the attic ceiling or attic floors.

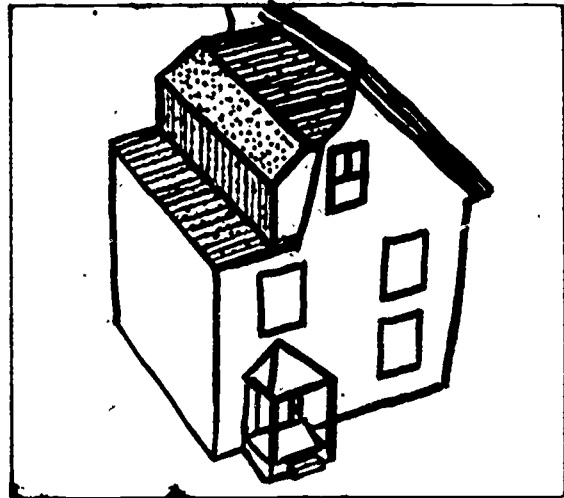

WHERE YOU WILL NEED INSULATION

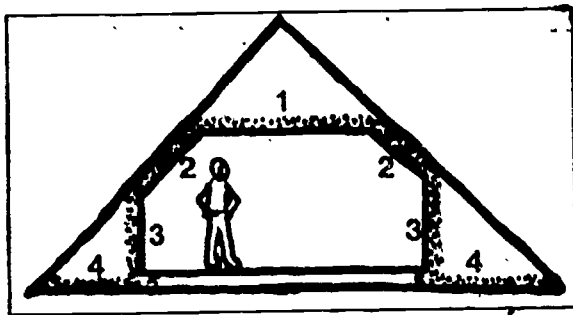

1. Attic ceiling
2. Rafters (be sure to leave at least an inch of space between the insulation and

Loose Fill

(poured-in)
glass fiber, rock wool,
cellulose, vermiculite,
perlite

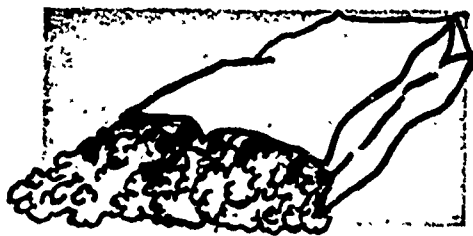

Loose Fill

(blown-in)
glass fiber, rock wool,
cellulose

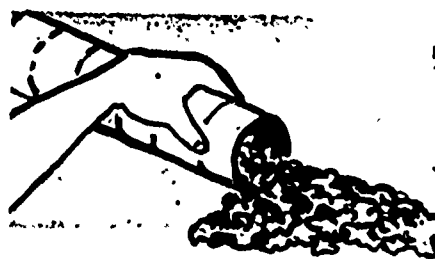

Where It's Used To Insulate

- *Unfinished attic floors.
- *Vapor barrier bought and applied separately.
- *Best suited for non-standard or irregular joist spacing or when space between joists has many obstructions.
- *Cellulose chemically treated to be fire resistant; check to be sure that bags indicate material meets Federal Specifications. If they do, they'll be clearly labelled.
- *All are easy to install.
- *R-value and coverage varies according to bag size and insulation type. Consult the label on the bag.

Where It's Used To Insulate

- *Unfinished attic.
Finished frame walls.
- *A contractor is needed.
- *Vapor barrier bought separately.
- *Same physical properties as poured-in loose fill.
- *Because it consists of smaller tufts, cellulose gets into small nooks and corners more consistently than rock wool or glass fiber when blown into closed spaces, such as walls or joist spaces.
- *When any of these materials are blown into a closed space, enough must be blown in to fill the whole space.
- *Achieved R-value varies according to insulating material when installed in a wall.

ATTIC VENTILATION

When the outside temperature is in the 90's, your attic temperature could easily reach 140°. Even if the attic is well-insulated, these high temperatures will make your air conditioner work harder and could cause early deterioration of asphalt roofing materials.

Two primary means of attic ventilation are available to the homeowner: (1) Natural and (2) Powered.

Either could be more desirable depending on the existing attic conditions. The principle involved with either involves replacing hot attic air which is exhausted through vents located near the peak of the roof with cooler air which is brought in at a low level.

(1) Proper natural ventilation may be attained by locating high and low level vents (about 50 percent of each) to allow intake of cool air (low) and release of hot air (high).

Two methods of natural ventilation may be used:

Natural Ventilation Method	Recommended Net Vent Area
1) Continuous ridge vents plus soffit	1) 1.5 sq. inches/sq. foot of ceiling area
2) Gable, roofs, or turbine vents plus soffit	2) 3.0 sq. inches/sq. foot of ceiling area

Regardless of the choice, the key is "net vent area."

(2) Powered ventilation consists of a thermostatically controlled vent placed near the peak of the roof in the center of the attic. If the house is large (over 2,000 sq. ft.), or has a "T" or "L" shaped configuration, more than one is needed. The fan capacity of the ventilator should provide a minimum of 1.5 CFM (cubic feet per minute) per square foot of ceiling area. Soffit vents, which provide intake air, should have a minimum of 80 sq. in. of net free area for each 100 CFM of ventilator capacity. The thermostat should be set to turn on at 100° and off at 85°.

TYPES OF ATTIC VENTILATION

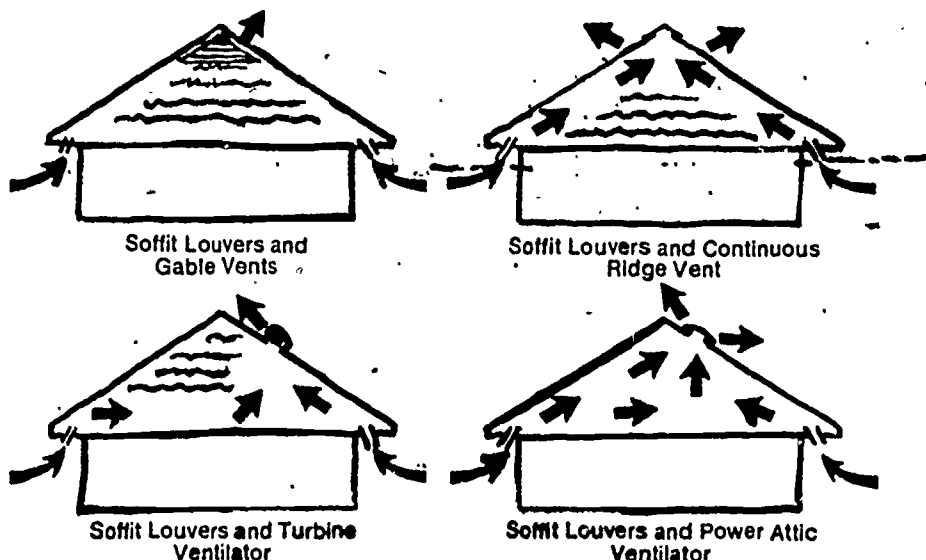

FLOOR INSULATION

Floor insulation and crawl space insulation are more tedious than any other part of the structure. Access is limited by the fact that one usually has to lie on the ground in order to reach the underside of floors and crawl space. However, it is necessary that these areas be insulated because large amounts of heat are lost through floors and crawl spaces. Thus, it is important to carefully assess one's needs before beginning.

Such things as tools, special lighting, a small electric fan, and support for insulation should all be within easy reach before actual work begins.

WEATHERIZING IN NEW CONSTRUCTION OR OLDER BUILDINGS

The following projects may be carried out in a retrofitting process or in new construction. The instructor may choose to carry out these activities in the shop by constructing a small model house in the industrial arts shop area; or he may choose to take his class to a house already built, but one that needs weatherizing. Project Number Two lists the supplies and equipment needed to carry out the activities.

The teacher needs to provide tools so that each student can be an active participant in the process. Some students will be assigned to select the insulating materials to be used; another group will measure and mark insulation, while still another group cuts and fits, and another group installs and staples. The activities may be alternated so that each student acquires some practice in each step of the process.

Weatherizing covers the area of insulation, weatherstripping

and caulking. All of these reduce heat loss in winter and heat gain in summer. The map below gives the recommended level of R-values to be used in the different insulating zones. These R-value guidelines eliminate the guesswork in choosing the amount of insulation needed for different parts of a building. These are minimum recommendations and may be increased to suit the occupant.

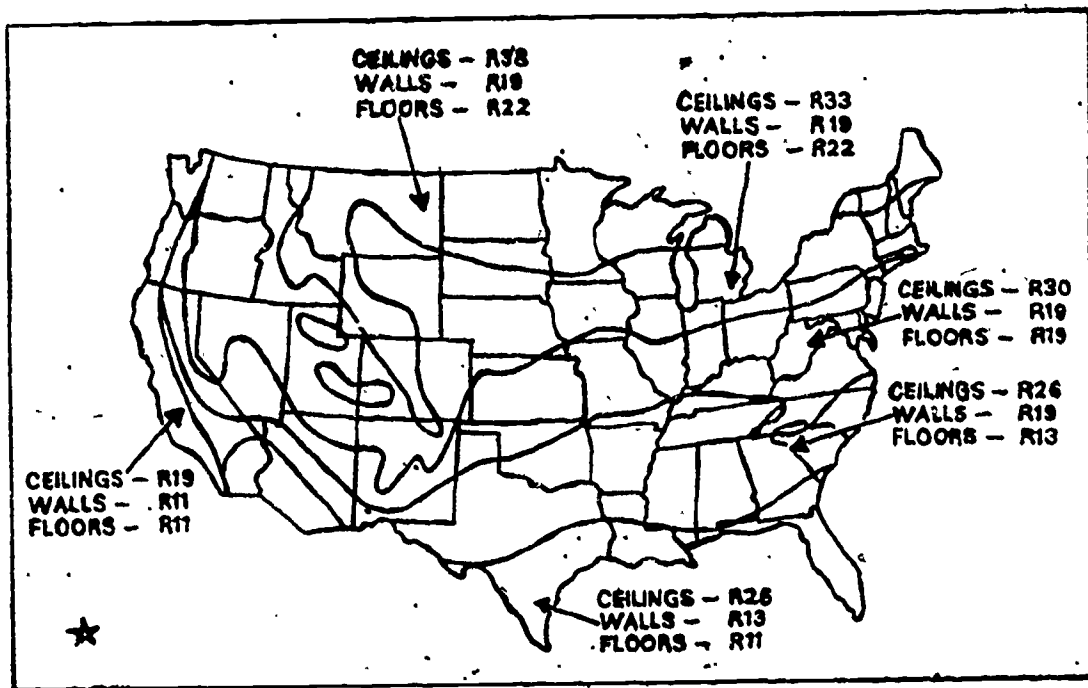

Figure 18. This map shows minimum insulation recommendations for ceilings/walls/floors in six (6) different insulating zones of the United States. The R-value guidelines are for the economical amounts of insulation considering climate, energy costs, insulation price, and other factors (Owens-Corning).

*This map courtesy of U.S. Department of Energy, Providing for Energy Efficiency in Homes and Small Buildings, Pt. II. June, 1980, Washington, D. C.

Many insulation recommendations have been made by housing agencies, contractors, and insulation manufacturers. The map in Figure 18 shows minimal insulation recommendations (R-value) for six insulating zones of the United States.

Table III, page 49, gives the thickness of insulation needed for certain R-values. This will be useful to the worker in determining the amount of insulation needed for new construction as well as in adding new insulation to an already insulated building.

The written quiz which follows is designed to check for teaching results.

EFFECT ON CONSTRUCTION METHODS

Heating and cooling requirements vary from one region of the United States to the other. And, even though building materials are quite similar throughout the country, construction methods do vary from one climate to another. In the case of insulation, the temperature variation in a given region or location is the basic reason for the construction method used. One needs to realize that an ordinary wall without insulation is seldom sufficient to provide comfort in either warm or cold climates. Walls, ceilings, and floors seldom provide enough resistance to heat transfer without some form of insulation. Therefore, the selection of insulation provides the opportunity to make building energy-saving and comfortable.

FLOOR INSULATION

BACKGROUND

Floors over unheated areas such as crawl spaces, garages, or basements, can be a major source in heat loss in an otherwise well-insulated house. The main goal in this project is floors that are exposed to the outside.

The job is quite easy to-do in most cases. If you are insulating over a crawl space, there may be some problems with access or working room, but careful planning can make things go much more smoothly and easily.

SAFETY

- * Provide adequate temporary lighting.
- * Wear gloves and breathing mask when working with glassfiber or rockwool.
- * Provide adequate ventilation.
- * Keep lights and all wires off wet ground.
- * It would be good to inspect for insects, bees, wasps, and so forth, under the house. Use a spray, insecticide, or other necessary protection.

TOOLS

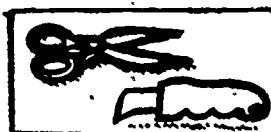

Heavy duty shears or linoleum knife



Temporary lighting with connectors



Portable fan or blower to provide ventilation



Tape measure

Heavy duty staple gun and staples

MATERIALS



R-19 (6") batts or blankets or rock wool or glass fiber, preferably with foil facing



Metal insulation support rods



Or wire mesh or chicken wire of convenient width for handling in tight space



6 mil polyethylene sheets (if the insulation does not have a vapor barrier)

HOW MUCH

See page 39: You figure the area as you would your attic space.

See also page 56 for study items on floor insulation.

TO INSULATE THE FLOOR AREA

INSTALLATION

One way to install batts or blankets between the floor joists is by stapling wire mesh or chicken wire to the bottom of the joists and sliding the batts or blankets in on top of the wire. (If a polyethylene vapor barrier is used, apply this in strips between the joists first.)



An easier way is to use insulation supports, which are metal rods the size of coat hanger wire. Check your floor joist spacing; this method will work best with standard 16" or 24" joist spacing. If you have non-standard or irregular spacing, there will be more cutting and fitting and some waste of material.

UNCOVERED GROUND IN CRAWL SPACE

Lay a vapor-resistant ground cover, such as 4- or 6-mil polyethylene film, on the ground in the crawl space to stop the rise of water vapor from the ground. Provide foundation vents to let the moisture escape from the crawl space.

Start at a wall at one end of the joists and work out. Staple the wire to the bottom of the joists and at right angles to them. Slide batts in on top of the wire. Work with short sections of wire and batts so that it won't be too difficult to get the insulation in place. Plan sections to begin and end at obstructions, such as cross bracing.

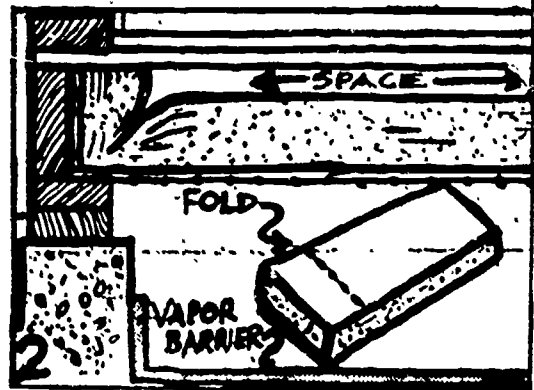

Insulation backed by a vapor barrier is recommended. Install the vapor facing up toward the inside of the house. Be sure to fold the ends of the batts to fit snugly up against the bottom of the floor to prevent loss of heat. Don't block combustion air openings for furnaces or other flame-type appliances.

DUCT INSULATION

BACKGROUND

Generally, you will not need insulation for heating and air-conditioning ducts that are enclosed in already well-insulated portions of your house. But, if the ducts for either your heating or your air-conditioning system run above the ceiling or below the floors, they should be insulated.

TOOLS

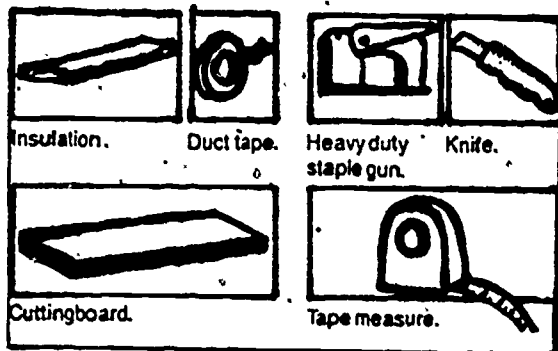

SAFETY

- * Provide good lighting.
- * In the attic, lay boards or plywood sheets down over the tops of the joists or trusses to form a walkway (the ceiling below won't support your weight).
- * Be careful of roofing nails protruding through roof sheathing. Wear some kind of protective hat.
- * If you use glass fiber or mineral wool, wear gloves and breathing mask, and keep the material wrapped until you're ready to put it in place.

HOW TO INSULATE THE DUCTS

PREPARATION

All joints and fittings should be taped before the insulation is added. This will eliminate air leaks and moisture damage to the insulation when you operate the heating or cooling system.

INSTALLATION

Determine where the ducts are located. They may be furred down into the conditioned space or may be in exposed areas such as the attic or under the floor.

The ducts that are furred down generally need no additional insulation. These should be installed in an area which is sealed air tight from the attic space.

If the ducts are in the attic or beneath the floor, the following directions should apply.

Wrap all ducts with insulating blankets. At least two inches of insulation is desirable. Tape all duct joints and seams before insulating the ducts to prevent air leakage. Cut insulation long enough

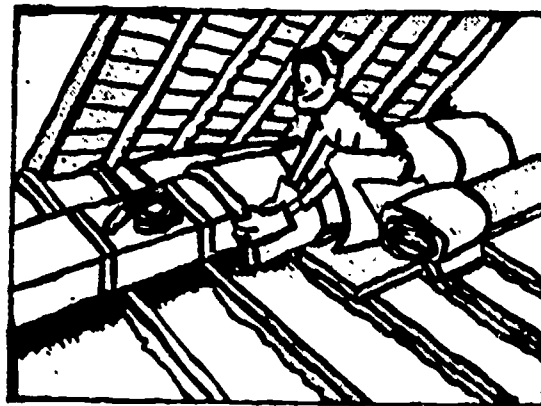

for a two-inch overlap of vapor barrier. This overlap is needed in order to staple insulation. Place vapor barrier (foil or vinyl side) away from ducts.

TABLE III. THICKNESS OF INSULATION NEEDED FOR CERTAIN R-VALUES

R-VALUE	BATTS OR BLANKETS				LOOSE FILL (POURED-IN)			
	Glass Fiber		Rock Wool		Glass Fiber		Rock Wool	
SI (US)	CM	(IN)	CM	(IN)	CM	(IN)	CM	(IN)
1.9 (11)	9-10	(3.5-4)	7.6	(3.0)	13	(5.0)	10	(4.0)
3.3 (19)	15-16	(6-6.5)	13	(5.25)	20-23	(8-9)	15-18	(6-7)
3.9 (22)	16	(6.5)	15	(6.0)	25	(10.0)	18-20	(7-8)
5.3 (30)	24-27	(9.5-10.5)	23	(9.0)	33-36	(13-14)	25-28	(10-11)
6.7 (30)	31-33	(12-13)	27	(10.5)	43-46	(17-18)	33-36	(13-14)

Table III can help you determine the amount of some of the more common insulations to use in order to obtain suggested R-Values.

a. 15.2 cm (6 in) Stud Walls

Increase wall thickness by using 5.1 x 15.2 cm (2x6 inches) wall studs and add more insulation.

Now, with an actual 14 cm (5 1/2 inches) for insulation, recalculate the total wall resistance for various insulators.

Note! Some local codes do not allow this construction for dry wall. Check your code.

	SI	US
Vermiculite or Perlite	3.0	16.9
Fiberglass	3.5	19.7
Mineral wool	3.5	19.7
Cellulose fiber	3.5	22.4
Polystyrene	4.4	25.2
Polyurethane	6.9	38.9

Thus, with 5.1 x 15.2 cm (2x6 in) stud walls, we have achieved an approximate R-20 or better for most of the insulations. This construction method would allow us several choices of insulation based on cost rather than on R-Value.

Using 5.1 x 15.2 cm (2x6 inches) studs on 61 cm (24 inches) centers, rather than 5.1 x 10.2 cm (2x4 inches) studs on 40.6 cm (16 inches) centers, will increase our materials cost only slightly. Because wood conducts heat so much faster than the insulations listed, the heat loss due only to the spread-out arrangement is reduced by about 5 percent. The additional 5.1 cm (2 inches) of space that the 5.1 x 15.2 cm (2x6 inches) provides for insulation reduces the heat loss to the point where the total saving is about 35 percent.

b. 10.2 cm (4 inches) Stud Walls

One inch of polystyrene (white) will increase the total R-value by .07 (4).

Where polystyrene is used for sheathing, corner braces must be installed.

What Type and How Much Insulation to Use

PROVIDING FOR ENERGY EFFICIENCY IN HOMES AND SMALL BUILDINGS

Circle the letter(s) that represent the correct answer(s), unless instructed otherwise.

1. The purpose of insulation is to:
 - a. Increase heat transfer.
 - b. Reduce heat transfer.
 - c. Improve appearance.
2. Energy moves from:
 - a. A high to a low temperature.
 - b. Top to bottom.
 - c. A low to a high temperature.
3. Insulation quality is usually based on the amount of:
 - a. Glass.
 - b. Vapor barrier.
 - c. Air space within the insulation.
4. R-value is:
 - a. The resistance of air flow.
 - b. The rate of heat transfer.
 - c. The resistance of energy flow.
5. Types of insulation are as follows:
 - a. Fiberglass.
 - b. Rock wool.
 - c. Cellulose.
 - d. Polyurethane.
 - e. All of the above.
6. Characteristics of insulation to look for are:
 - a. Fire resistance.
 - b. R-value.
 - c. Form.
 - d. All of the above.
7. Forms of insulation are:
 - a. Blankets.
 - b. Batts.
 - c. Loose-fill.
 - d. Masonry.
 - e. All of the above.
8. Blown-in insulation comes in:
 - a. Batts.
 - b. Plastic sheets.
 - c. Loose-granules or cellulose.
9. Fiberglass comes in:
 - a. Rolls.
 - b. Batts.
 - c. Both.
10. Rock wool is made from:
 - a. Rocks.
 - b. Wool.
 - c. Cellulose.
11. The R-value of insulation sheeting per inch thickness is:
 - a. 10.
 - b. 6.
 - c. 2.
12. Cellulose fiber:
 - a. Is fire resistant.
 - b. Must be treated for fire resistance.
 - c. Comes in batts.
13. Polystyrene has an R-value per inch thickness of:
 - a. 4 to 5.
 - b. 5 to 10.
 - c. 2 to 3.

Installing Insulation in the Ceiling

PROVIDING FOR ENERGY EFFICIENCY IN HOMES AND SMALL BUILDINGS

STUDENT'S STUDY GUIDE OR TEST:

Circle the letter representing the correct answer, unless instructed otherwise.

1. Insulation should be installed in a new or remodeled building:
 - a. As each component part is completed.
 - b. After all framing is done and electrical, plumbing, heating, and cooling are roughed in.
 - c. After the building is completed.
2. The purpose of insulation is to:
 - a. Keep out moisture.
 - b. Strengthen the structure against wind and snow load.
 - c. Improve thermal efficiency.
3. Insulation should be placed in the following ceilings:
 - a. All ceilings.
 - b. Only ceilings exposed to unheated attics or directly covered by roofs.
 - c. Only ceilings directly covered by roofs.
4. For buildings with no attic, insulation is installed next to the roof because:
 - a. Air space is required between insulation and roof.
 - b. Air space is not required.
 - c. Air space is required between insulation and ceiling.
5. What types of insulation may be used in the ceiling?
 - a. Flexible insulation.
 - b. Loose-fill insulation.
 - c. Rigid insulation.
 - d. Reflective insulation.
 - e. All of the above.
6. If the insulation has a vapor barrier, the vapor barrier should be placed:
 - a. Next to the heated side.
 - b. Next to the exposed (cold) side.
 - c. Anyplace, as it doesn't matter.
7. Vapor barriers should:
 - a. Have holes punched for air circulation.
 - b. Have no holes or torn places.
8. Blanket insulation comes in rolls up to $3\frac{1}{2}$ inches thick and 16 or 24 inches wide.
 - a. True.
 - b. False.
9. Batt insulation comes in sections up to 6 inches thick and 16 to 24 inches wide.
 - a. True.
 - b. False.

10. Blanket insulation with a paper or vapor barrier (non-foil) backing may be stapled:
- To the outside of the joists.
 - To the inside edge of the joists.
 - Either way.
11. If the vapor-barrier backing is a reflective foil:
- The backing must be stapled to the inside edge of the joists and an air space provided.
 - The backing must be stapled to the outside edge of the joist.
12. When installing a blanket or batt insulation:
- Leave space between joists for expansion.
 - Pack insulation in tightly.
 - Place insulation loosely, leaving no spaces between joists or around receptacles and pipes.
13. When adding flexible insulation to the ceiling:
- Lay all blankets or batts parallel to joist.
 - Lay insulation parallel to joists until space is filled, then lay extra insulation at right angles to joist.
 - Lay all insulation at right angles to joists.
14. When installing flexible insulation:
- Wear short sleeves and loose fitting clothes.
 - Wear a chemical respirator.
 - Wear safety goggles, dust mask, and clothes that fit tight around the neck and wrists.
15. When installing flexible or loose-fill insulation in the attic:
- Be sure to pack insulation against the cornices to prevent air from entering the attic through the soffit vents.
 - Avoid restricting attic ventilation through the soffit vents.
16. Recessed light fixtures must be protected against contact with insulation.
- True.
 - False.
17. When using loose-fill insulation, vapor barriers are not required.
- True.
 - False.
18. Loose-fill insulation may be installed by:
- Pouring.
 - Blowing.
 - Either method.
19. Rigid insulation is used:
- Where the roof and ceiling structure is one, such as a cathedral ceiling.
 - Between stories.
20. A combination of rigid and flexible insulation may be used in sloped ceilings framed with rafters.
- True.
 - False.

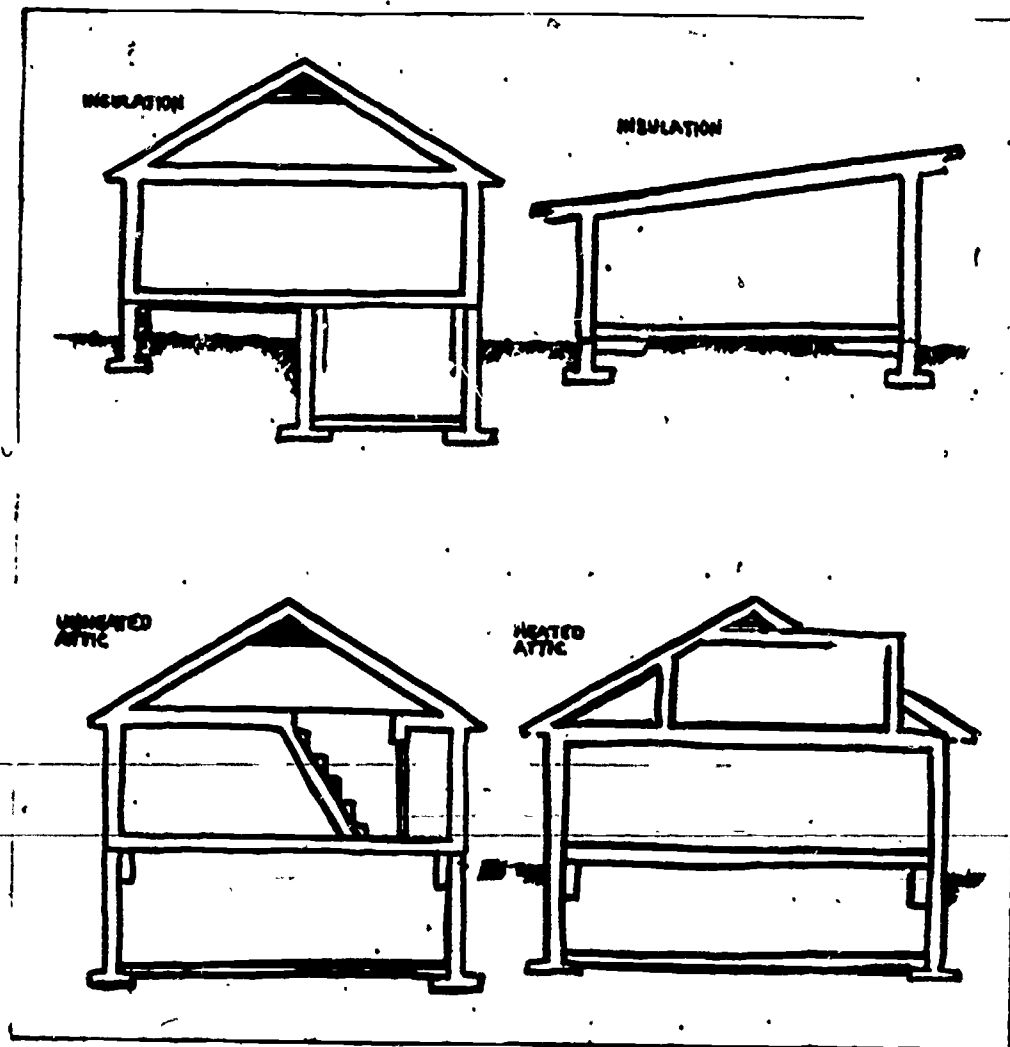

FIGURE 19 - ACTIVITY

Students should take pencils and darken areas of each drawing to indicate where insulation should be placed, marking each area with the recommended R-value for that area, e.g., attic, floors, exterior walls, etc., using as a guide the map on page 44.

Installing Insulation in the Floor.

PROVIDING FOR ENERGY EFFICIENCY IN HOMES AND SMALL BUILDINGS

STUDENT'S STUDY GUIDE OR TEST:

Circle the letter representing the correct answer, unless instructed otherwise.

1. Insulation should be installed in floors:
 - a. Exposed to unheated areas only.
 - b. Wherever they are found.
 - c. Only if they are made of hardwood.
2. What types of insulation are generally used in floors?
 - a. Flexible.
 - b. Rigid.
 - c. Reflective.
 - d. All of the above.
3. Flexible insulation is easier to install in floors:
 - a. Before the subfloor is laid.
 - b. After the house is finished.
4. Flexible insulation with vapor barrier backing has:
 - a. The vapor barrier installed toward the ground.
 - b. The vapor barrier installed next to the heated side.
5. Flexible insulation is supported under finished floors by:
 - a. Heavy gauge (stiff) wire.
 - b. Wire mesh.
 - c. Either of the above.
6. Loose-fill insulation is not generally used in floors.
 - a. True.
 - b. False.
7. Rigid insulation may be used in the following types of floors:
 - a. Existing slab floors.
 - b. Wood floors.
 - c. New slab floors.
 - d. All of the above.
8. Rigid insulation is placed under the vapor barrier under concrete slab floors.
 - a. True.
 - b. False.
9. In Figure 19, page 55, indicate type and location of insulation to be installed in the floor.

EXERCISE: Installing Insulation in the Floor

Your teacher will provide different types of insulation, a section of flooring, tools, and safety equipment.

Install a section of insulation as directed. Follow procedures given in the preceding pages.

Rigid Board

extruded polystyrene, bead board (expanded polystyrene) glass fiber.

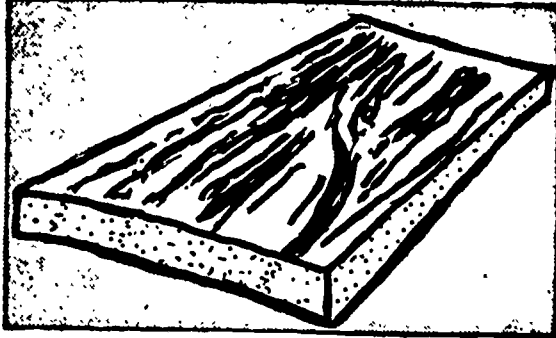

Where It's Used to Insulate

Basement wall, exterior walls and foundation, interior walls.

Note: When used on the interior of the home, polystyrene and urethane rigid board insulation must be covered with $\frac{1}{2}$ " fire-rated gypsum wallboard to assure fire safety.

- * Extruded polystyrene and urethane are their own vapor barriers--bead board and glass fiber are not.
- * High insulating value for relatively small thickness, particularly urethane.
- * Comes in 24" or 48" widths by 96" lengths.
- * Variety of thickness form $\frac{1}{2}$ " to 4".

Foamed in Place

polyurethane

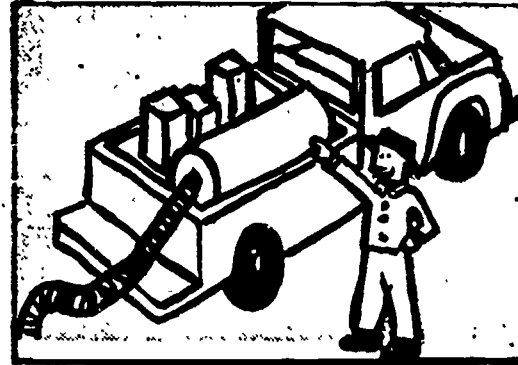

Where It's Used to Insulate

Finished frame walls.

- * A contractor is needed; quality of application to date has been somewhat inconsistent; choose a qualified contractor who will guarantee his work.
- * More expensive than blown-in materials.

Drawing courtesy of Home Improvement Projects by Louisiana Power and Light Company, New Orleans, Louisiana 70101

Installing Insulation in the Walls

PROVIDING FOR ENERGY EFFICIENCY IN HOMES AND SMALL BUILDINGS

Circle the letter representing the correct answer, unless instructed otherwise.

1. Insulation should be placed in the following walls:
 - a. All walls.
 - b. Only walls exposed to unheated areas.
 - c. Only brick walls.
2. What types of insulation may be used in walls?
 - a. Flexible.
 - b. Loose-fill.
 - c. Rigid.
 - d. Reflective.
 - e. Foam.
 - f. All of the above.
3. If the insulation has a vapor barrier, the vapor barrier should be placed:
 - a. Next to the exposed (cold) side.
 - b. Next to the heated side.
 - c. Anywhere, as it doesn't matter.
4. Vapor barriers should:
 - a. Have no holes or torn places.
 - b. Have holes punched for air circulation.
5. Blanket insulation with a paper vapor barrier (non-foil) backing may be stapled:
 - a. To the outside of the stud.
 - b. To the inside of the stud.
 - c. Either way.
6. If the vapor barrier backing is a reflective foil:
 - a. The backing must be stapled to the inside edge of the studs and an air space provided.
 - b. The backing must be stapled to the outside edge of the studs.
7. When installing blanket or batt insulation:
 - a. Leave spaces between joists for expansion.
 - b. Pack insulation tightly around receptacles and pipes.
8. Wood is just as good an insulator as fiberglass.
 - a. True.
 - b. False.
9. Safety equipment to be worn when installing flexible insulation in walls includes:
 - a. Short sleeves and loose fitting clothes.
 - b. Chemical respirator.
 - c. Safety goggles, dust mask, and clothes that fit tightly around neck and wrists.

10. When installing loose-fill insulation in walls in old buildings:
 - a. Fill to fire stop from top.
 - b. Fill to fire stop from bottom.
 - c. Check for fire stop and fill both sides.
11. When using rigid insulation on walls:
 - a. No other insulation is needed.
 - b. It is usually used in conjunction with other types of insulation.
12. When using rigid insulation:
 - a. Corner bracing is usually necessary.
 - b. Corner bracing is not necessary.
13. Rigid insulation is available in the following types:
 - a. Accordion.
 - b. Reflective one side.
 - c. Reflective both sides.
 - d. All of the above.
14. Urethane foams are sprayed on the job.
 - a. True.
 - b. False
15. In Figure 19, page 55, indicate type and location of insulation to be installed in the walls.

**EXERCISE: Installing Insulation
in the Walls**

Your teacher will provide different types of insulation, a section of wall, tools and safety equipment.

Install a section of insulation as directed. Follow procedures in the preceding pages.

Installing Insulation in the Basement and Crawl Space

PROVIDING FOR ENERGY EFFICIENCY IN HOMES AND SMALL BUILDINGS

STUDENT'S STUDY GUIDE OR TEST:

Circle the letter representing the correct answer, unless instructed otherwise.

1. Insulation should be placed in the crawl space walls:
 - a. If the floor is insulated.
 - b. To prevent rats and mice from entering.
 - c. If the floor is not insulated.
2. What types of insulation should be used in the crawl space?
 - a. Flexible.
 - b. Loose-fill.
 - c. Rigid.
 - d. Reflective.
3. Place the vapor barrier:
 - a. On the side next to the foundation wall.
 - b. On the ground surface of the crawl space.
4. When insulating the crawl space, never insulate the band joist.
 - a. True.
 - b. False.
5. If heating and cooling ducts are in the basement, it is not necessary to insulate the basement walls.
 - a. True.
 - b. False.
6. On masonry walls, flexible insulation:
 - a. May be attached to furring strips on the foundation wall.
 - b. May be used to fill cores of concrete blocks.
 - c. May be stapled to concrete block.
7. Loose-fill insulation is used only to pour into cores of concrete blocks.
 - a. True.
 - b. False.
8. Rigid insulation may be glued to masonry walls.
 - a. True.
 - b. False.
9. In Figure 19, page 55, indicate type and location of insulation to be installed in the crawl space and basement.

**EXERCISE: Installing Insulation in
the Basement and Crawl Space**

Your teacher will provide different types of insulation, a section of basement wall or crawl space, tools, and safety equipment.

Install a section of insulation as directed. Follow procedures in the manual.

Installing Vapor Barriers

PROVIDING FOR ENERGY EFFICIENCY IN HOMES AND SMALL BUILDINGS

STUDENT'S STUDY GUIDE OR TEST:

Circle the letter representing the correct answer, unless instructed otherwise.

1. The purpose of the vapor barrier is to:
 - a. Prevent water vapor from condensing on the warm side.
 - b. Keep insulation dry.
 - c. Keep structure dry.
 - d. Accomplish all of the above.
2. In figure 19, page 55, indicate the location of vapor barriers (consider that the buildings are in a cold climate).
3. Vapor barriers also help reduce air infiltration.
 - a. True.
 - b. False.
4. Vapor barriers should have some scatter holes for ventilation.
 - a. True.
 - b. False.
5. Aluminum paint may be applied to old ceilings to provide a vapor barrier.
 - a. True.
 - b. False.
6. Two vapor barriers are better than one.
 - a. True.
 - b. False.
7. Types of vapor barriers are as follows:
 - a. Polyethylene film.
 - b. Aluminum foil.
 - c. Waterproof paints and other finishes.
 - d. All of the above.
8. Some insulation is available with vapor barrier attached.
 - a. True.
 - b. False.

Selecting and Installing Storm Windows and Doors

To Conserve Energy

The selection and installation of storm doors and windows requires considerably more skill and know-how than are required for installing insulation and weatherstripping or caulking. This is retrofitting of a more technical nature than anything we have thus far encountered. Manufacturers produce several different types of windows. The more common types are illustrated in figure 20 on the following pages. The choice will be determined by such things as difficulty of installation, insulating quality, costs, and climate of the areas where one lives.

There is the single glazed storm sash, the double glazed, and triple glazed. The R-value is, of course, influenced by whether the sash is single, double, or triple glazed (see figures 22 and 23 on page 68).

The choice of storm doors is even more crucial because of the substantial costs of good storm doors. However, the savings in energy cost will more than make the outlay worth while. The types of doors are outlined in figures 26 through 29 in the succeeding pages.

Additional useful information is available in Project-Retro-Tech, Conservation Paper number 28A; Home Weatherization Job Book for Priority Setting B, Conservation Paper Number 28C; and Home Weatherization Job Book DOC/CS-0040/2. All can be secured without cost from U. S. Department of Energy, Office of Weatherization Assistance Programs, Washington D.C.

EXERCISE: Installing Vapor Barriers

Your teacher will provide vapor barrier material, a wall section, tools, and safety equipment.

Install a section of vapor barrier as directed. Follow procedures in the manual.

Installing Weatherstripping and Caulking

PROVIDING FOR ENERGY EFFICIENCY IN HOMES AND SMALL BUILDINGS

STUDENT'S STUDY GUIDE OR TEST:

Circle the letter representing the correct answer, unless instructed otherwise.

1. The purpose of weatherstripping and caulking is to reduce _____.
2. Weatherstripping is used primarily on _____ and _____.
3. Adjustable thresholds are available to reduce infiltration under doors.
 - a. True.
 - b. False.
4. Weatherstripping procedures vary with the type of window.
 - a. True.
 - b. False.
5. Types of weatherstripping are as follows:
 - a. Adhesive-backed foam.
 - b. Felt strips.
 - c. Foam-edged wood.
 - d. Spring metal.
 - e. All of the above.
6. Caulking is used to stop cracks in outside walls whenever they occur.
 - a. True.
 - b. False.
7. Weatherstripping may be:
 - a. Self-adhesive.
 - b. Tacked on.
 - c. Either.
8. A caulking gun should be held at a:
 - a. 20 degree angle.
 - b. 45 degree angle.
 - c. 90 degree angle.
9. Move caulking gun away from the direction in which it is pointed.
 - a. True.
 - b. False.
10. In Figure 19, page 55, indicate the points where caulking may be needed.

Key to Items on Pages 56-61:

<u>Page 56</u>	<u>Page 57</u>	<u>Page 58</u>	<u>Page 59</u>	<u>Page 60</u>	<u>Page 61</u>
1. a	1. a	10. c	1. c	1. d	1. reduce air in- filtration
2. b	2. f	11. b	2. a	2. --	
3. a	3. b	12. a	3. b	3. a	2. windows and doors
4. b	4. b	13. --	4. a	4. b	3. a
5. c	5. b		5. b	5. a	4. a
6. a	6. a		6. a	6. b	5. e
7. d	7. b		7. b	7. d	6. a
8. a	8. b		8. a	8. a	7. c
9. --	9. c		9. --		8. b
					9. a
					10. --

67

What Type of Windows to Use

There are several types of windows for both homes and commercial buildings. The type of window selected is a matter of owner/builder preference. The right window in the right place gives a home natural light, fresh air, good looks and convenience.

The major decision related to energy-saving, however, is the number of layers of glass to choose for a particular climate. There are choices between insulated glass or storm windows and even justification for triple glazing in some locations. From this section, you will be able to list the factors for selecting types of windows for energy efficiency.

1. Types of Windows.
2. Effect of Climate.
3. Effect of Insulating Quality.
4. Effect on Energy Use.
5. Effect on Cost Benefits.

1. TYPES OF WINDOWS

Builders have a choice of several types of windows. Window sash is made primarily of wood or metal with some plastics being used for weather protection. We will discuss both the prime windows and storm windows. The original (or inside) windows in a home are referred to as prime windows--the first windows. Storm windows are secondary windows.

The various types of prime windows used in houses and other small buildings are shown in Figure 20.

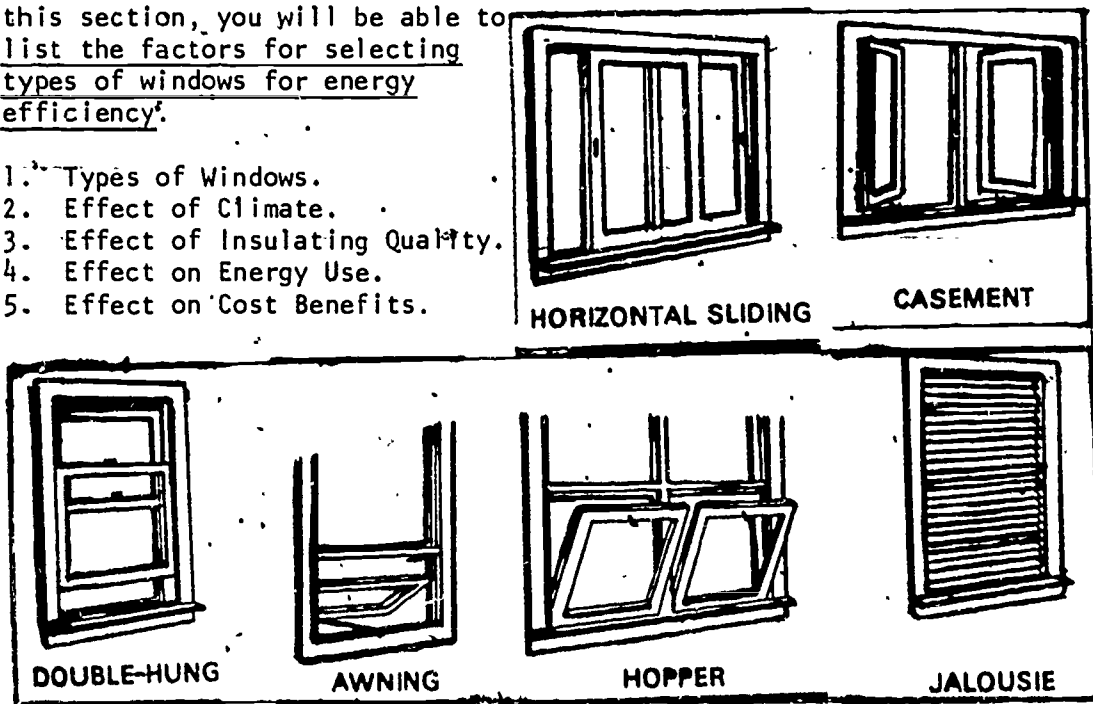

a. Double-Hung Windows

The conventional double-hung window usually has two sashes that operate vertically. They are found in most homes and are adaptable to any architecture.

Double-hung windows usually have a separate wood or metal-frame storm window attached on the outside of the window casing. Metal-frame storm windows are lighter in weight and easier to handle. They are often sold as combination storm-screen units which allow for self-storing of the screen or second glass. The higher heat conductivity of metal, however, makes them about 20 percent less efficient than wood-frame units.

b. Horizontal Sliding Windows

The sashes in this type of window slide horizontally. Usually there are two movable sashes; sometimes one is fixed. These windows may be equipped with insulating glass, a conventional storm window attached to the outside frame, or a storm panel that attaches directly to the window sash.

c. Caseament Windows

Caseament windows swing outward on hinges attached at the side. A storm window must be attached directly to the sash or on the inside frame. If an inside storm is used, no ventilation is possible during the heating season.

d. Awning Windows

Hinged at the top, they are manufactured as a single unit or as several sashes stacked together in one frame. When open, the sashes project at an angle like awnings. Inside storm sash or

storm panels must be used, with the same limitations as described for casement windows.

e. In-Swinging (Hopper) Windows

These can be either bottom-hinged hopper windows or top-hinged windows such as those often used in basements. They can be equipped with a storm sash on the outside or a storm panel attached to the prime window. Both out-swinging and in-swinging windows offer an adjustable ventilation. When used with fixed-sash, they provide air flow for picture windows.

f. Jalousie Windows

A series of small horizontal glass slats make up a jalousie window. They are held by an end frame, pivot in unison like a venetian blind and open outward. Jalousie windows are not satisfactory as prime windows for an area to be heated as they are very difficult to seal, even with the use of a storm panel on the inside.

2. EFFECT OF CLIMATE

Our elements of weather--sunshine, temperature, wind, moisture--must all be considered when selecting and placing windows.

Since windows are a source of heat gain and loss, we will want to place windows on the south and southeast side to receive solar radiation for warming in the winter and to avoid cold winds from the northwest.

Glass is a good conductor of heat; therefore, the greater the temperature difference between the interior and exterior surfaces of the glass the greater the heat loss or gain. Extremes in temperature

require the use of insulating air spaces between two or more layers of glass to make windows less conductive.

The infiltration or air leakage around a window frame or sash is also affected by temperature and moisture. Wood reacts to moisture variations by swelling or shrinking. The result is a crack or space around the window or frame for air to leak in or out.

Condensation is another problem. The source of condensation, or "sweating" on windows, is humidity, or invisible water vapor in the air. A cold window surface allows the water vapor in the air to condense rather than be absorbed. By "insulating" our windows through the use of storm windows or thermo-layers, we increase the inside temperature of the glass surface and reduce condensation. Humidity control within the building is also an important factor.

3. EFFECT OF INSULATING QUALITY

In a well-insulated house with as little as 10 percent of the wall area in glass, as much as 25 percent of the total heat loss may be through the glass. In the summer, glass admits the radiant energy of the sun which is converted into heat. Storm windows or multi-pane windows reduce the heat loss or gain by more than half (Figure 21). They are discussed as follows:

a. Storm Windows

Storm windows are usually more efficient and economical than insulating glass (factory sealed) for the following reasons:

- The storm window provides a separate seal of the cracks around the windows.
- The air space between the two layers of glass is greater, providing more insulation.
- Using a storm window does not require replacement of good prime windows to obtain an insulating sash.

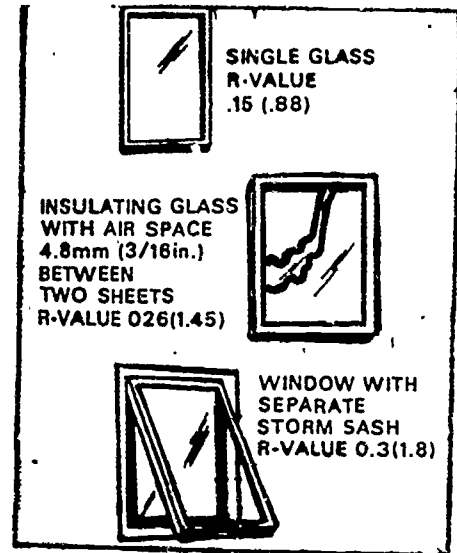

Figure 21. R-values for window with storm sash or double-insulated glass.

b. Multi-Pane Windows

Multi-pane windows are sometimes referred to as insulated windows. They have two or more panes of glass with an air space between.

The teacher may wish to visit a building supply dealer and with the class examine the different types of windows shown here. In many instances, the windows will be exhibited as they appear when installed.

For additional insulation, add a storm window to a double pane glass or use triple glazing.

Triple glazing (insulating glass plus a separate storm sash, or new factory-sealed triple unit) can often be justified in areas with 6,000 or more seasonal degree days in houses that are also centrally cooled. They may also be justified when using electric heating. Figure 22 illustrates the R-values for triple glazing.

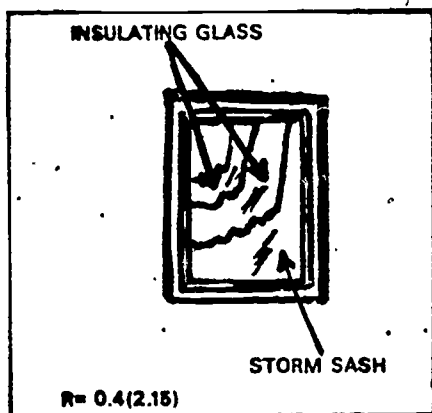

Figure 22. R-values for triple glazing.

Triple glazing is also an effective barrier for noise and is sometimes used for this reason alone in houses near airports, for example.

An increase in comfort for room occupants usually accompanies the use of storm windows or insulating glass. This fact is illustrated in Figure 23 which shows the dramatic increase in the inside temperature of the surface when two or more layers of glass are used.

The problem of moisture condensation can be almost eliminated with the use of insulating glass

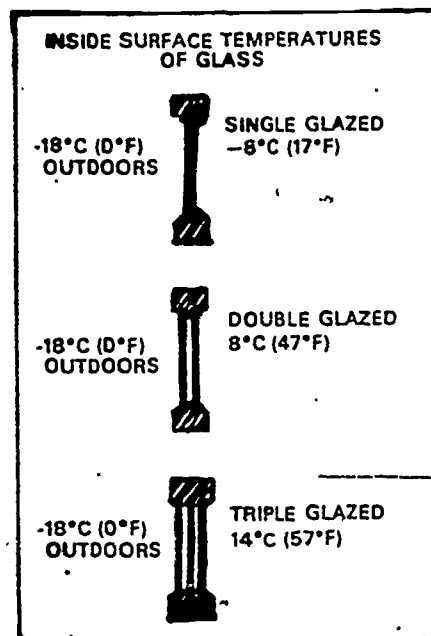

Figure 23. Inside temperature of glass for single-glazed and triple-glazed windows.

and storm windows and weep holes. When the outdoor air is 22°C (0°F), moisture condensation will occur on the glass when the relative humidity inside the house is only 12 percent. With insulating glass, condensation will occur until the relative humidity is 30 percent. With insulating glass and a storm window, condensation will not occur until the relative humidity is 37 percent.

4. Effect on Energy Use

It has already been stated that windows can be the biggest cause of home energy loss. They may be costing a home or building owner up to a third of his heating and air conditioning expense.

Poorly designed, improperly installed and used, or old, defective windows can lose energy in two important ways. They are as follows:

a. Excessive Heat Conduction

Glass is not a good insulator against heat conduction. Heat will travel through a glass window pane quite easily (Figure 24). One square meter (foot) of single-pane glass conducts at least ten times as much heat as one square meter (foot) of insulated wall.

Just as an example, each ordinary .9 x 1.5 m (3 feet by 5 feet) window can lose the equivalent of over a .5 liter (pint) of heating oil, or about seven cents-worth, every day. And we haven't considered the effect of leakage yet.

b. Air Leakage (Infiltration)

If our .9 by 1.5 m (3 feet by 5 feet) window has a crack just 1.5 m (1/16 inches) wide all around its frame, that crack adds up to 84 cm² (13 in²)--just like having a hole in your wall the size of a brick (Figure 25). If you have 12 windows like this in your home, you've got the equivalent of a hole the size of 12 bricks! This is the reason that a large portion of heat loss from a house is due to air leakage. Even the smallest cracks can add up!

Air leakage and conduction together can account for as much heat loss through a .9 by 1.5 m (3 feet by 5 feet) window as a hole in the wall the size of four bricks. Twelve bad windows means you have the equivalent of a hole in your wall the size of 48 bricks. That means you're trying to heat and cool your home with a .5 by .9 m (1 1/2 feet by 3 feet) hole in the wall directly to the outside (Figure 25). Be careful about shutting off all air to combustion-type furnaces.

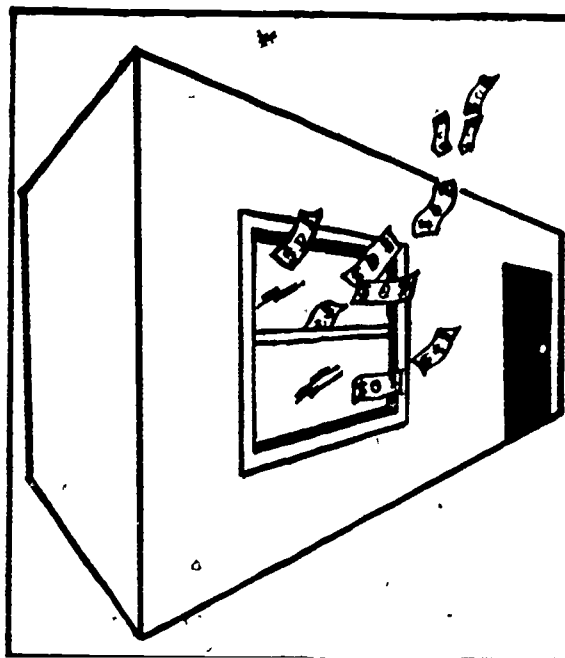

Figure 24. Glass is not a good insulator for heat. When heat is lost, money is lost.

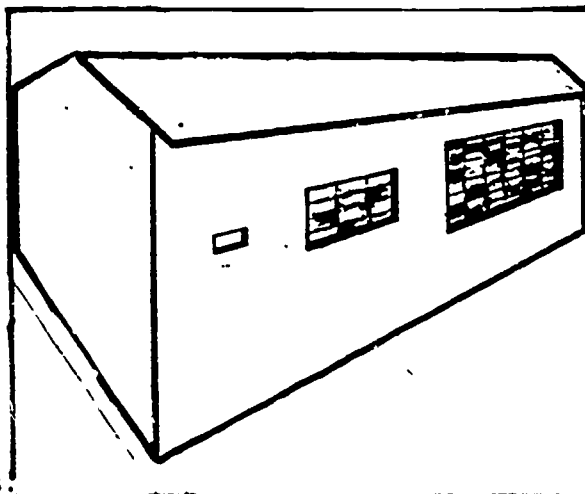

Figure 25 Cracks around windows are equivalent to holes in the walls.

What Types of Windows to Use

PROVIDING FOR ENERGY EFFICIENCY IN HOMES AND SMALL BUILDINGS

STUDENT'S STUDY GUIDE OR TEST:

Circle the letters that represent the correct answer(s), unless instructed otherwise.

1. Types of windows are as follows:
 - a. Double hung.
 - b. Horizontal sliding.
 - c. Casement.
 - d. Awning.
 - e. All of the above.
2. Aluminum-frame windows have a lower R-value than wooden frame windows.
 - a. True.
 - b. False.
3. Jalousie windows are energy efficient.
 - a. True.
 - b. False.
4. Window space in a building:
 - a. Improves energy efficiency.
 - b. Reduces energy efficiency.
 - c. Makes no difference in energy efficiency.
5. To improve the efficiency of windows:
 - a. Add storm windows.
 - b. Install triple glazed windows.
 - c. Add plastic sheeting.
 - d. None of the above.
6. Windows may lose energy by:
 - a. Excessive heat conduction.
 - b. Infiltration.
 - c. Improper shades and drapes.
 - d. Improving R-value.
7. Windows help prevent infiltration.
 - a. True.
 - b. False.

EXERCISE:

Visit your local supplier and report on type and availability of windows.

Check on type and availability of exterior doors and storm doors. Using the information given in Figures 27, 28, and 29, figure out the approximate R-value of different doors. (See pages 75 and 76).

How to Install Storm Windows

1. Plastic Storm Windows

You should know that it is not the storm window itself that keeps the warmth inside in winter and outside in summer. It is actually the dead-air space--at least $3/4$ inch--between the two windows that saves energy. It used to be that storm windows were suitable only for homes in the northern states during raging winters. Studies have now shown that these "storm" windows are effective in saving energy and providing comfort both in the winter months and in the summer months. You might want to look at several options for improving your windows, going from the most simple and economic to more costly and permanent installations.

TOOLS

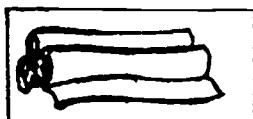

Six mil thick polyethylene plastic in rolls or kits

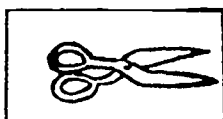

Shears to cut and trim plastic

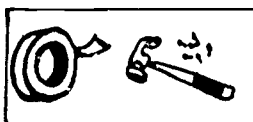

2" wide masking tape or hammer and tacks



$1/4$ x $1 1/4$ wood slats

Installation

Measure the width of your larger windows to determine the width of the plastic rolls to buy. Measure the length of your windows to see how many linear feet and, therefore, how many rolls or the proper kit size you need to buy.

Attach the plastic to the inside or outside of the frame so that the plastic will block airflow around the moveable parts of the window. If you attach the plastic to the outside, use the slats and tacks. If you attach it to the inside, masking tape will work.

Inside installation is easier and will provide greater protection to the plastic. Outside installation is more difficult, especially on a two-story house, and the plastic is more likely to be damaged by the elements.

Be sure to install tightly and securely, and remove all excess. Besides looking better, this will make the plastic less susceptible to deterioration.



Tack the plastic sheets over the outside of your windows or tape sheets over the inside instead of installing permanent type storm windows.

A plastic sheet can be placed over the window to create a partial dead air space. If you want to put off buying storm windows for a year or so, you might consider this as a temporary solution.

2. Single-Pane Storm Windows

Storm window suppliers will build single-pane storm windows to your measurements. You then install these windows yourself. Another method is to make your own with aluminum, do-it-yourself materials available at most hardware stores.



Ladder



Caulking gun and cartridges



Tape measure

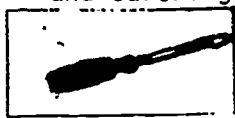

Putty knife or large screwdriver

Advantages and Disadvantages

Single-pane storm windows aren't as expensive as the double-track or triple-track combination windows. The major disadvantage of the single-pane windows is that you can't open them easily after they're installed.

Selection: Judging Quality

Frame Finish

A mill finish (plain aluminum) will oxidize quickly and degrade appearance. Windows with an anodized or baked enamel finish look better.

Weatherstripping

The side of the aluminum frame that touches the window frame should have a permanently installed weatherstrip or gasket to seal the crack between the window and the single-pane storm window frames. This helps to prevent the window frame from sweating.

Installation

Determine how you want the windows to sit in the frame. Your measurements will be the outside measurements of the storm window. Be as accurate as possible, then allow 1/8" along each edge for clearance. You'll be responsible for any errors in measurement, so do a good job.

When your windows are delivered, check the actual measurements carefully against your order.

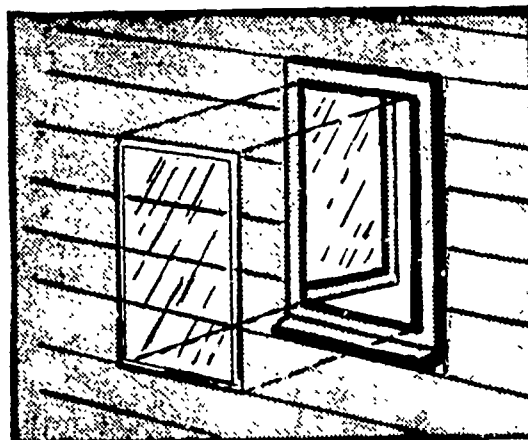

Storm windows should be properly installed and fit tightly to do the most good. To ensure a tight fit, permanent storm windows should be sealed to the outer window frame with caulking compound or other sealing material.

75

HOW TO INSTALL STORM WINDOWS

3. Sliding Storm Windows

Installation

Sliding storm windows can be opened and closed. They are installed permanently and include a screen which allows you to ventilate the house whenever you choose.

You can save a few dollars by installing the windows yourself. Make sure the instructions from the manufacturer or supplier are sufficient.

Instead of installing the storm windows yourself, one may want to have a supplier install the windows for you.

Two very important items should be checked to make sure the installation is properly done: 1. Make sure that both the window sashes, and screen sash move smoothly and seal tightly when closed after installation. Poor installation can cause misalignment. 2. Be sure there is a tightly caulked seal around the edge of the storm windows. Leaks can hurt the performance of storm windows a lot.

TOOLS

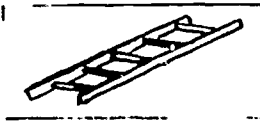

Ladder

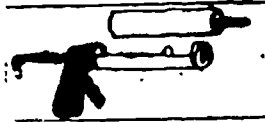

Caulking gun and cartridges

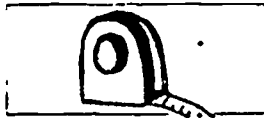

Tape measure

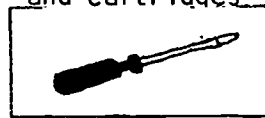

Putty knife or large screwdriver

SELECTION: JUDGING QUALITY

Frame Finish

A mill finish (plain aluminum) will oxidize and reduce the ease of operation. An anodized or baked enamel finish is better looking and will last longer.

Hardware Quality

The quality of locks and catches has a direct effect on durability and is a good indicator of overall construction quality.

Corner Joints

Quality of construction affects the strength and performance of storm windows. Corners are a good place to check construction. They should be strong and air tight. Normally, overlapped corner joints are better than mitered. If you can see through the joints, they will leak air.

Sash Tracks and Weatherstripping

Storm windows are supposed to reduce air leakage around windows.



The amount of energy and money your windows are losing depends entirely upon the type and condition of the windows and the location of your home. If your windows are in pretty good shape--that means minor air-leakage--you will still be losing energy through conduction. If your windows are

old and loose-fitting, you have air leakage as well as conduction problems. This is particularly true if you have a fireplace with an open flue.

EFFECT ON COST BENEFITS

Refer to Table IV for general recommendations.

WHAT TYPE OF DOORS TO USE

Aside from beauty and durability, one should select exterior doors with their insulating quality in mind. Interior doors do not have this requirement.

Exterior doors in common use for most living spaces and commercial buildings are either of wooden or metal construction. Glass area varies in doors and can greatly affect the insulating value of a door. Metal frame doors with insulating glass, thermo-barriers, and good weatherseals can be as effective as storm doors. Fiber glass doors are just beginning to enter the market.

From this section, you will be able to describe the characteristics of doors under the following headings:

1. Types of Doors
2. Effect of Climate
3. Effect of Insulating Quality
4. Effect on Energy Use
5. Effect on Cost Benefits

1. TYPES OF DOORS

Doors, like windows, affect heat loss and gain by both conduction and air infiltration. Once the air infiltration factor is solved with caulking and weatherstripping, the insulating

value of the door becomes significant. Three main types of doors are used in light building construction. They are as follows

a. Hollow-Core Doors

Most hollow-core doors used today consist of a solid wood frame with a veneer of birch or mahogany. They are used mainly for interior doors, but sometimes are used as an exit door to an attached garage.

b. Solid-Wood Doors

Solid-wood doors are commonly made from pine, oak, or maple.

c. Steel-Clad, Foam-Center Doors

Most modern builders use steel-clad exterior doors for building entrances or exits (Figure 26). These doors have a urethane foam insulating core.

To function as good thermal barriers, doors need good weatherstripping and thresholds.

2. EFFECT OF CLIMATE

Doors need protection from the elements of weather to do their job most efficiently. Doors can do very little, however, to add heat from

radiation as do windows. Their main job is to keep the cold air out. To remain in good condition, doors should be protected by overhangs, vestibules or storm doors. Placement on sides other than the northern exposure will protect against most winter storms. Landscaping can provide shelter for entrances which would otherwise receive the full force of wind and snow.

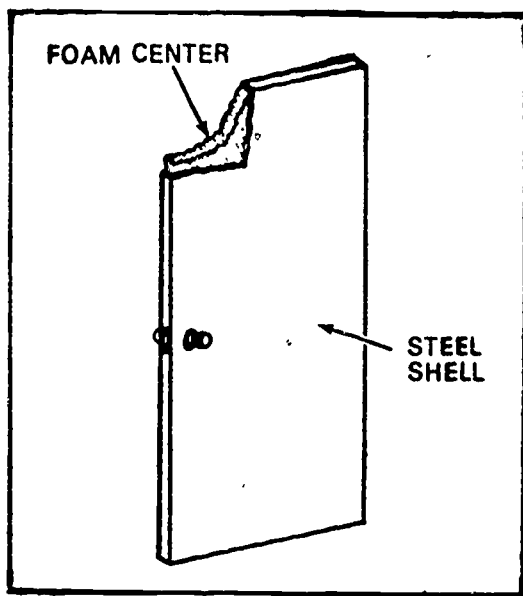

Figure 26. A steel-clad, foam center door has good insulating quality.

3. Effect of Insulating Quality

Doors have different insulating qualities. They are discussed as follows:

a. Solid Wood Doors

Wooden doors are usually solid core, or solid frame with panels. Solid-wood prime doors alone without storms would have R-Values as shown in Figure 27.

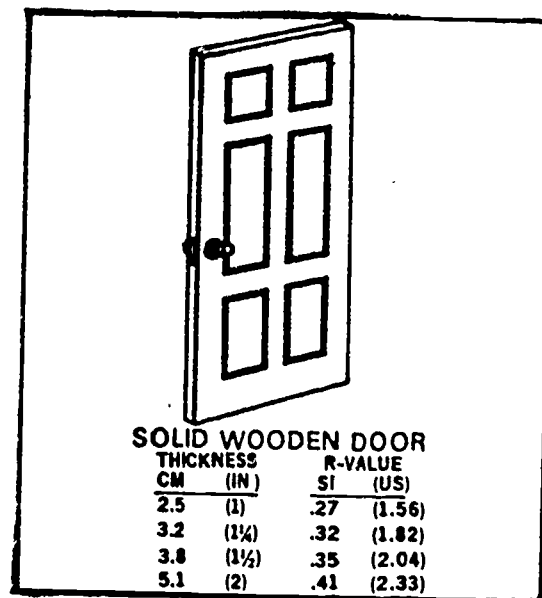

Figure 27. R-Values for solid wooden doors.

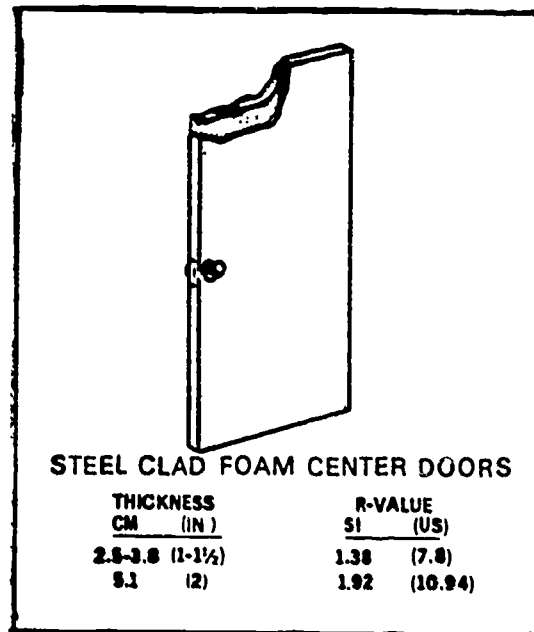

Figure 28. R-Values for steel-clad, foam center doors.

Wood frame doors with panels would have about 60 percent of the resistance values as a solid door.

b. Steel-Clad, Foam Center Doors

Metal doors are usually sheet metal over a metal or wood frame with an insulation core. Metal-clad doors with an insulating core would have R-values as shown in Figure 28.

c. Storm Doors

The most effective step in reducing heat loss through doors is to install a storm door. A wood storm door with about 50 percent glass area can reduce the heat loss by 45 to 50 percent. A metal storm door, regardless of the percentage of glass, will reduce the heat loss by only 30 to 35 percent.

The type of storm door that has a wood frame with about an 80% glass area, to better display a prime door, has an insulating value similar to that of a metal storm door.

A comparison of various door arrangements and their R-values is shown in Figure 29.

4. EFFECT ON ENERGY USE

The better insulated outside doors you have, the more energy you will save.

5. EFFECT ON COST BENEFITS

It pays to have well-insulated outside doors. In extreme climates, your money will be returned in savings on heating and cooling bills.

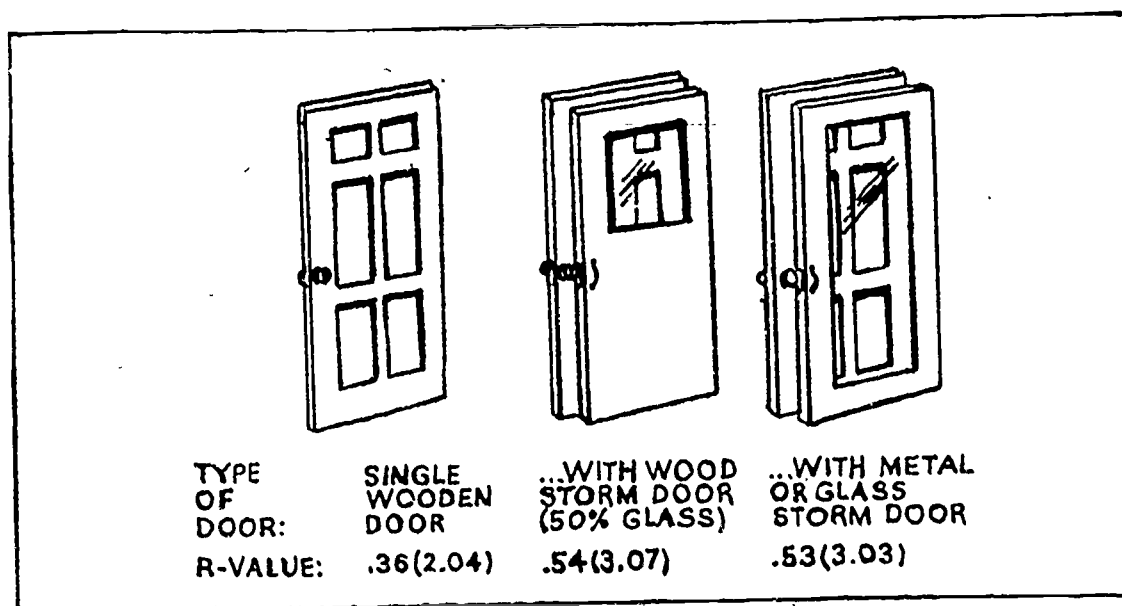

Figure 29. R-Values for different types of doors.

6. Installing Storm Doors

The R-value can almost be doubled by placing a wood storm door over a wood exterior door. The aluminum storm door will perform only half as well, but if it has good weatherstripping, it will cut down greatly on infiltration. Procedures are given under the following headings:

- a. Installing Wood Storm Door
- b. Installing Aluminum Storm Doors

a. Installing Wood Storm Doors

Wood storm doors are hung to the brick mold or the outside casing of the door. Briefly, these are the steps (Figure 30):

- (1) Trim the storm door to fit the opening, making it 3 to 5 mm (1/8 to 3/16 inches) narrower and shorter than the opening.

If the opening is not square, be sure to make the door fit any variations.

- (2) Mark the location and outline of the hinges on the edge of the door and inside edge of the brick mold or the outside casing.
- (3) With a chisel, cut the gains for the hinges into the edge of the door and inside edge of the brick mold or the outside casing.
- (4) Slip the pins out of the hinges and screw each half of the hinge into place.
- (5) Put the door up and put the

pins back into the hinges to hold the door into place.

- (6) Install the latch according to the instructions.
- (7) Install and adjust the door closer and wind check according to the instructions.

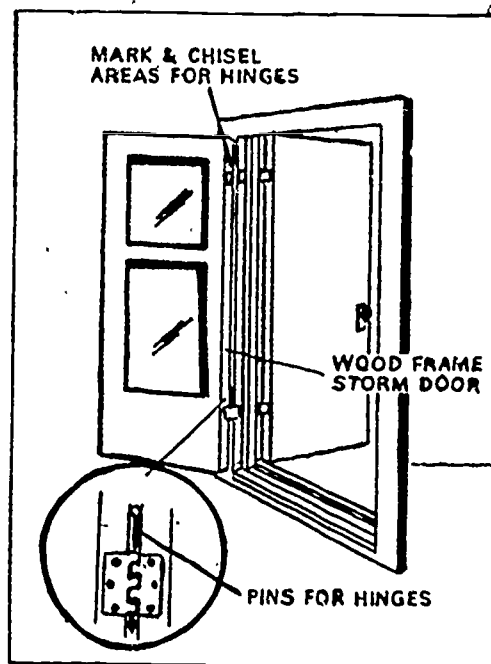

Figure 30. Installing Wood Storm Doors.

b. Installing Aluminum Storm Doors

Aluminum storm doors are usually purchased pre-hung, meaning that the aluminum door is already hung to a frame around both sides and the top. The frame pieces are called Z bars. There will be spaces between the frame and the door. Leave them there until the door is set in place. The following steps are taken when hanging an aluminum storm door (Figure 31):

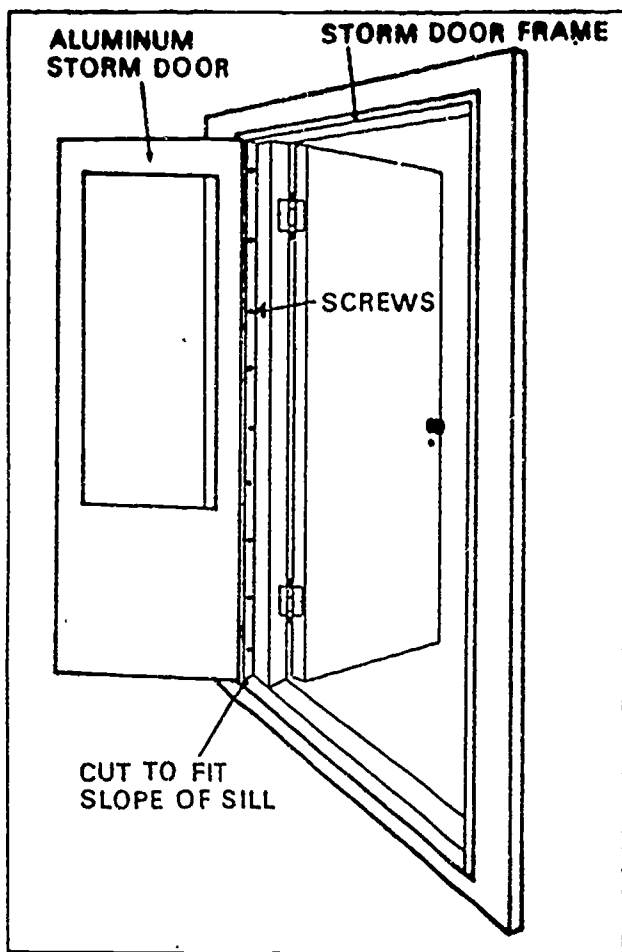

Figure 31. Installing aluminum storm door.

1. Measure the opening between the inside edges of the brick mold or outside casing for the width and between the inside edge of the head trim and the door sill for the height.

Check the frame for squareness also.

2. Check the width and length of the storm door frame to see if it will fit the opening.
3. Measure along the side frames and mark them to the proper length.
4. Cut the bottom ends off the side frames (Z bars), square across the front and about 3 mm (1/8 in) shorter in the back.

This type of cut will give them an angle that will correspond with the slope of the door sill.
5. Put the door and frame assembly into the opening, center it and screw it into place with 4 screws.
6. Remove the spacers from between the door and frame into the trim.
7. Install the door latch according to the instructions.
8. Install the automatic door closer according to the instructions.
9. Install the wind check unit according to the instructions.
10. Adjust the automatic door closer and make sure the door closes freely, latches, but does not hang.

HOW TO INSTALL STORM DOORS

1. COMBINATION STORM DOORS

Exterior doors, especially hollowcore wood, account for a large portion of heat loss and heat gain. The addition of storm doors is a relatively inexpensive way to correct the problem. A slightly more expensive method of providing more insulation value is to replace exterior wood doors with insulated core doors, often made of metal.

INSTALLATION

Dollars can be saved by installing doors yourself, but you need some tools--drill, screwdriver, hammer and weatherstripping. In most cases, it will be easier to have the supplier install the doors himself.

Before the installer leaves, be sure the doors operate smoothly and close tightly. Check for cracks around the jamb and make sure the seal is as air tight as possible. Also, remove and replace the exchangeable panels (window and screen) to make sure they fit properly and with a weather tight seal.

SELECTION: JUDGING QUALITY

Door Finish

A mill finish (plain aluminum) will oxidize and reduce ease of operation. An anodized or baked enamel finish is better looking and longer lasting.

Corner Joints

Quality of construction affects the strength and effectiveness of storm doors. Corners are a good place to check construction. They should be strong and air tight. If you can see through the joints, they will leak air.

Weatherstripping

Storm doors are supposed to reduce air leakage around your doors. Weatherstripping quality makes a big difference in how well storm doors can do this. Compare several types.

HOW TO INSTALL STORM DOORS

2. INSULATED CORE DOORS

INSTALLATION

A number of manufacturers offer a new type of door, which usually has a metal jacket and is filled with highly efficient foam-type insulation.

While these door systems are pre-hung to make installation easier, they are somewhat difficult to install. Only the more experienced handyman should try this job.

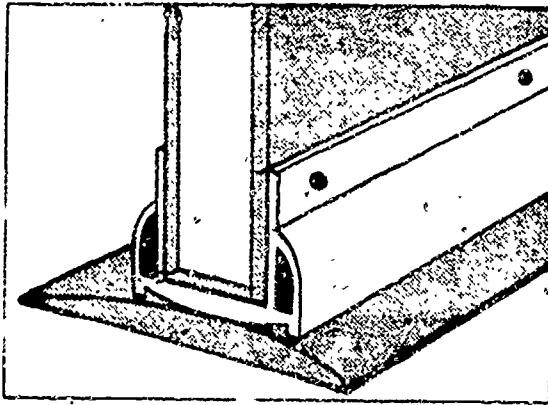

Although they cost about the same, or a little bit more, than solid wood doors with storm doors, they provide about four times as much resistance to heat transfer. Tight-fitting rubber gaskets around the doors reduce drafts and heat loss. These doors are very durable, resist cracking and warping, and are as attractive as wood doors. If you decide to replace a present door with one of these and if you want a glass area in the door, be sure that double-pane glass is specified. See pages 88-92. See also page 93 for Student's Study Guide.

DOOR IMPROVEMENTS

BACKGROUND

Even in a well-insulated house, a major source of heat loss is from air leaks, particularly around doors. Apart from keeping doors closed as much as possible during heating and cooling periods, you can best insulate the door areas by weatherstripping and caulking. In addition, you may want to look at adding storm doors or a door replacement if the present doors are not suitable for energy conservation.

TOOLS



Heavy duty staple gun and staples or hammer and tacks



Caulking gun and cartridges

CAULKING THE DOORS

Follow the general directions for caulking the windows. Inspect the total door frame. If any old caulking compound has become brittle or has fallen out, replace it with fresh compound. Be sure to fill extra wide cracks like those at door sills with oakum, glass fiber insulation strips, etc. In places where you can't quite fill the gaps, finish the job with caulking compound.

You will need approximately a half cartridge per door, 4 cartridges for the foundation sill, and 2 cartridges for a two story chimney.

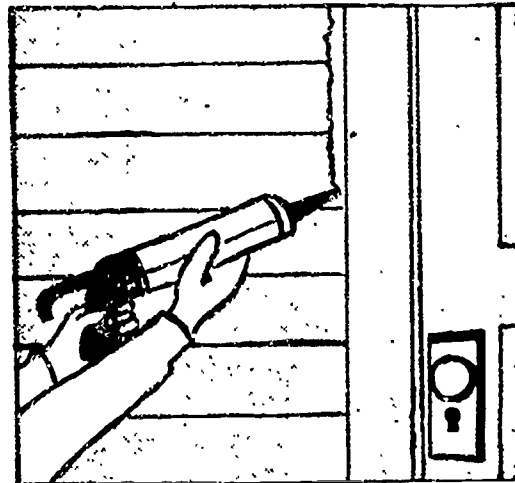

Other Areas That Need To Be Caulked

- * At corners formed by siding
- * At sill where the structure meets the foundation
- * Outside water faucets or other special breaks in the outside house surface
- * Where pipes and wires penetrate the ceiling and floors
- * Between porches and main body of the house
- * Where chimney or masonry meets siding

3. FOAM RUBBER WITH WOOD BACKING

These long pieces of wood with foam attached should be positioned so that the foam fits snugly against the closed door.

TOOLS

Hammer, nails; hand saw; tape measure.

INSTALLATION

4. THIN SPRING METAL

These long strips of metal are fitted to the inside of the door jamb. The outside metal edge should fit tightly against the door when you close it.

TOOLS

Tin snips; hammer, nails; tape measure.

INSTALLATION

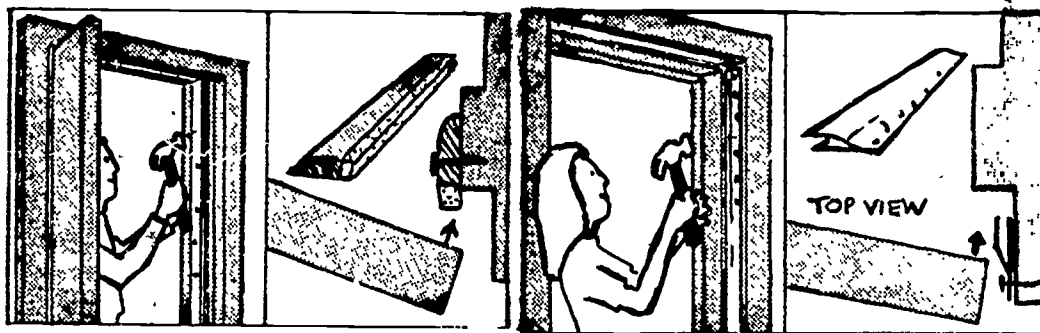

Nail strip so that it fits snugly against the closed door. Space nails 8 to 12 inches apart.

EVALUATION

Easy to install: visible when installed, not very durable.

Cut to length and tack in place. Lift outer edge of strip with screwdriver after tacking, for better seal.

EVALUATION

Easy to install, invisible when installed, extremely durable.

HOW TO WEATHERSTRIP THE DOORS - ALTERNATIVES

SWEEPS

These metal strips with rubber or plastic extensions should be fitted to the bottom of the doors to keep air from passing underneath.

TOOLS

Screwdriver; hacksaw; tape measure.

INSTALLATION

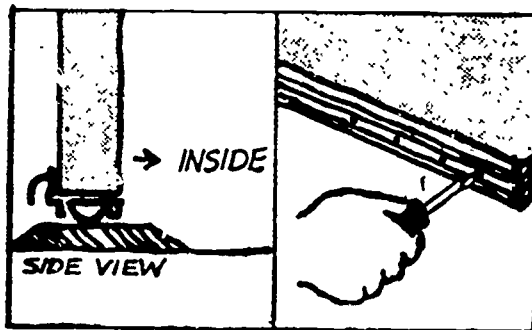

Cut sweep to fit 1/6 inch from the edges of the door. Some sweeps are installed on the inside and some outside. Check instructions for your particular type.

EVALUATION

Useful for flat thresholds, may drag on carpet or rug.

DOOR SHOES

These metal strips are fastened underneath the door. A rubber or plastic gasket fits into the metal slots, thus giving a tight seal against air leakage.

TOOLS

Screwdriver; hacksaw; plane tape measure.

INSTALLATION

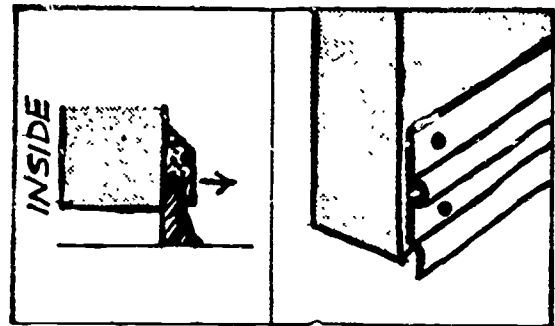

Remove door and trim required amount off bottom. Bottom should have about 1/8" bevel to seal against vinyl. Be sure bevel is cut in right direction for opening.

EVALUATION

Useful where there is no threshold or wooden one is worn out, difficult to install, vinyl will wear, but replacements are available.

ALUMINUM FOIL

Aluminum foil vapor barriers, usually part of insulation rolls or boards, are placed so that they are toward the warm, interior living space. Joints should be taped with aluminized tape to make a tighter air and vapor seal.

In the case of foil-backed gypsum board, the foil side is placed against the wall studs or ceiling rafters which are insulated with a non-vapor barrier material.

WHAT TYPE AND HOW MUCH WEATHERSTRIPPING AND CAULKING TO USE

Weatherstripping and caulking can have dramatic results in terms of both comfort and energy saving. These are two jobs that home or building owners (or renters) can do themselves and at little cost.

Weatherstripping and caulking are perhaps the most important jobs you can do to save energy in buildings.

Weatherstripping is placed around windows and doors in such a way that they can close more tightly than before, yet can still be opened. Weatherstripping is usually applied with either nails or glue. Sometimes it is self-adhesive, with a paper peel-off back.

There are many different kinds of weatherstripping on the market, most of which do an adequate job. You will want to choose weatherstripping on the basis of ease of application, appearance and expense.

PAINTS AND OTHER FINISHES

Various paints and other water resistant finishes may be used on interior room surfaces as a moisture barrier when other methods are not feasible--such as, in older buildings where interior walls and ceilings are not being replaced. Aluminum paint, rubber base paints, varnish and some urethane finishes serve this purpose.

Caulking is used to fill cracks around the frames of windows and doors. It can seal cracks under eaves (if not for ventilation), around flashing, between bricks and in basement walls.

The ideal caulking will adhere to both sides of the opening to be closed and remain resilient to permit movement between the two materials without cracking. Usually, the more expensive caulking do a better job sealing and last longer.

From this section, you will be able to describe the types of weatherstripping and caulking and explain how they can be used to make buildings more energy-efficient. This information is presented under the following headings:

1. Types of Weatherstripping and Caulking Available
2. Effect on Energy Use
3. Effect on Cost Benefits

1. TYPES OF WEATHERSTRIPPING AND CAULKING AVAILABLE

Weatherstripping and caulking are described under the following headings:

- a. Weatherstripping
- b. Caulking

a. Weatherstripping

Of the several types of weatherstripping, all are available to the consumer. Although different situations call for different types of material, most can be used for either doors or windows.

Types of weatherstripping include felt-fabric strips, metal strips, and wide, flexible weatherstripping for garage doors.

There is transparent weatherstripping which is pressed on to the outside of the window along the frame and trim. There is flexible, putty-like material that is easy to apply and suitable for windows which are rarely, if ever, opened, such as in the attic or basement.

For outdoor entrances, there are special strips of plastics that are attached to the bottom of each door itself. They're called thresholds with gasket strips which are usually screwed into place.

Some weatherstripping depends upon the compression of resilient material between one or two moving surfaces; others depend upon a mechanical interlocking of two parts.

b. Caulking

Although the air leaks around windows and doors can be sealed with weatherstripping, other cracks can exist which allow the passage of heated or cooled air. Caulking is used to seal cracks between similar or dissimilar building materials.

Cracks between two different materials are called "moving joints," because the joints expand and contract due to the fact that different materials expand and contract at different rates depending on changes in temperature, moisture, or pressure.

A number of small cracks can add up to a lot of leakage, which is energy lost. Moisture can enter and cause rotting. Insects and other pests can also enter and cause problems. Thus, caulking is sometimes just as important as weatherstripping.

Caulking comes in several forms. The most popular is the cartridge due to its ease of application with a caulking gun. Caulk also comes in squeezable tubes as well as cans for application with a putty knife. Another type is called rope caulk because it consists of strands of caulk packaged in a roll.

Buying caulk in bulk is most economical for industrial users or contractors. However, since shelf life is short, the homeowner should buy only the amount that will be used in one season.

2. EFFECT ON ENERGY USE

A crack or crevice that allows air to pass reduces the effectiveness of your insulation. Weather-

stripping and caulking will increase the efficiency of your building.

3. EFFECT ON COST BENEFITS

You can't go wrong on spending money for weatherstripping and caulking. You will save enough on energy bills to recover it.

PROVIDING FOR ENERGY EFFICIENCY IN HOMES AND SMALL BUILDINGS

STUDENT'S STUDY GUIDE OR TEST:

Circle the letter(s) that represent the correct answer(s), unless instructed otherwise.

1. Three advantages of caulking and weatherstripping are to:
 - a. Increase the U-value.
 - b. Reduce the air exchange.
 - c. Keep out insects.
 - d. Reduce energy use.
 - e. All of the above.
2. Weatherstripping is used on:
 - a. Doors and windows that open and close.
 - b. Cracks around window frames.
 - c. Soffit vents.
3. Types of weatherstripping are:
 - a. Pressure sensitive foam.
 - b. Metal spring.
 - c. Felt.
 - d. Flexible plastic.
 - e. All of the above.
4. Weatherstripping and caulking are:
 - a. Easy to install.
 - b. Difficult to install.
5. All caulking is the same.
 - a. True.
 - b. False.
6. Types of caulking most desirable are:
 - a. Latex base.
 - b. Butyl hose.
 - c. Neoprene rubber.
 - d. All of the above.
7. Weatherstripping and caulking should be done:
 - a. As a last resort.
 - b. Frequently.

EXERCISE:

Visit your local supplier and report on types and availability of caulking and weatherstripping.

STUDENT'S STUDY GUIDE OR TEST:

Circle the letter representing the correct answer, unless instructed otherwise.

1. Circle the four main climatic factors that influence energy use in buildings:
 - a. Temperature.
 - b. Moisture.
 - c. Wind.
 - d. Sun.
 - e. Soil.
2. Space conditioning is controlling _____ at a comfortable level.
3. Which of the following is the most comfortable in regard to the temperature/moisture factor?

How Design and Construction Methods Affect Energy Use

Ref: PROVIDING FOR ENERGY EFFICIENCY IN HOMES AND SMALL BUILDINGS

STUDENT'S STUDY GUIDE OR TEST:

Circle the letter representing the correct answer, unless instructed otherwise.

1. Match each statement about site location and orientation with one of the four climatic zones.
 - _____ a. Vegetation used for winter wind protection can also be used as shade in summer.
 - _____ b. Orientation toward the east with afternoon shading.
 - _____ c. Locate buildings on south or east slope for protection from prevailing winds.
 - _____ d. Situate houses on south or north slopes with vegetation and shade.
1. Cold zone.
 2. Temperate zone.
 3. Hot-humid zone.
 4. Hot-arid zone.

2. A rectangular building oriented north and south will generally use the least amount of energy.
 - a. True.
 - b. False.
3. Insulation works on the principle that trapped air is a poor heat conductor.
 - a. True.
 - b. False.
4. The primary source of aluminum foil on the inside surface of an insulating material functions as a:
 - a. Wind barrier.
 - b. Heat barrier.
 - c. Moisture barrier.
 - d. Energy barrier.
5. Buildings in some regions may require as much energy for cooling as for heating.
 - a. True.
 - b. False.
6. Without ventilation, attic temperatures may get as high as:
 - a. 100°F.
 - b. 120°F.
 - c. 140°F.
 - d. 160°F.



General Recommendations for Energy Efficiency in Residences
 PROVIDING FOR ENERGY EFFICIENCY IN HOMES AND SMALL BUILDINGS

EXERCISE:

Complete the following:

1. Name five steps for improving the energy efficiency of your home.

2. From Figure 18, list the R-values needed in your home for the following (See page 44):

<hr/>	Ceilings
<hr/>	Walls
<hr/>	Floors

The following test items may be used by the teacher as study items or as a summary test in order to determine how well students have mastered the subject matter. Then the teacher may select certain items for specific study questions for a shorter test. In any event, the materials should prove useful in stimulating interest in the subject matter of the course..

The items cover a cross section of the energy conservation problem, including major energy sources, renewable sources, and the amount of energy used by the energy intensive societies (as compared to the developing countries). It covers small steps that a individual or family can take to move toward energy efficiency.

TEST QUESTIONS

1. Heat loss is normally measured by the: (1) BTU, (2) Fahrenheit unit, (3) kilogram, (4) heating units.
2. A BTU is the amount of heat it takes to raise the temperature of one pound of water by: (1) 1° Fahrenheit (2) 4° Fahrenheit (3) 3° Fahrenheit, (4) 1 kilowatt-hour.
3. Another way of 'sizing' a BTU is to say it is about the amount of heat given off when: (1) a gallon of gas is burned completely, (2) a wooden match is burned completely, (3) a quart of oil is burned completely, (4) an explosion occurs.
4. Using 1 kilowatt-hour of electricity releases: (1) 2,412 BTU, (2) 3,412 BTU, (3) 8,000 BTU, (4) 1,215 BTU.
5. Some types of insulation for houses are: (1) rockwool, (2) polyethylene, (3) batt insulation, (4) loose fill.
6. Vapor barriers are installed to reduce the: (1) flow of heat, (2) flow of moisture, (3) flow of radiation, (4) flow of conduction.
7. Vapor barriers should always be installed on the: (1) cold side, (2) warm side, (3) top side, (4) outside.
8. The insulation with vapor barriers attached are: (1) blanket, or batt insulation, (2) fiberglass or wool, (3) loose fill, (4) rigid insulation.
9. The insulating value of roof and ceiling sections can be determined by: (1) the size of the house, (2) adding the R-value of each of the materials making up the sections, (3) the type of construction, (4) style of house.
10. Any building will constantly exchange air with its environment if: (1) outside air leaks in, (2) top air leaks in, (3) inside air leaks out, (4) bottom air leaks in.
11. This leakage or infiltration is caused by: (1) poor construction, (2) wind, (3) the building acting as a chimney, (4) the opening of outside doors.
12. When air in a building is warmer than the outside air, the entire building acts as a: (1) heater, (2) stove, (3) chimney, (4) wind storm.

13. To determine leakage around sills and cellar windows, examine the structure from the inside. Look for: (1) cracks, (2) daylight between the sill and the foundations, (3) poor construction, and (4) feel for drafts at cellar windows.
14. Apply caulking compound only during: (1) cold weather, (2) hot weather, (3) warm weather, (4) high humidity.
15. The temperature for applying caulking compound should be above: (1) 30°F, (2) 20°F, (3) 40°F, (4) 50°F.
16. When applying caulking compound, one should ensure that the surfaces are (1) clean and wet, (2) clean and dry, (3) clean and flaking with paint, (4) clean with loose dirt.
17. Do not use caulking compound between surfaces that are to be: (1) finished, (2) moved, (3) taped, (4) painted.
18. Use weatherstripping in areas where one surface has to be: (1) painted, (2) moved, (3) undercoated.
19. In applying blanket type of insulation, be sure to apply the vapor barrier on the (1) warm side of the insulation, (2) cold side of the insulation, (3) underside of the insulation, (4) moisture side of the insulation.
20. Do not use insulation with a vapor barrier when: (1) insulating a new home, (2) re-insulating over an already insulated area, (3) using loose fill insulation, (4) using rockwool.
21. When insulating the attic, one must ensure that the attic is insulated to: (1) R-7 standards, (2) R-19 standards, (3) R-30 standards, (4) R-20 standards.
22. Exterior walls should be insulated to: (1) R-0 standards, (2) R-11 standards, (3) R-16 standards, (4) R-30 standards.
23. Metal ductwork in the attic or under the house on piers should be: (1) removed, (2) re-surfaced, (3) insulated, (4) painted.
24. Heating and cooling costs are reduced by about: (1) \$220 per year by caulking, (2) \$185 per year by caulking, (3) \$500 per year by caulking, (4) \$195 per year by caulking.
25. Heating and cooling cost are reduced by about: (1) \$195 per year by weatherstripping three-by-six foot windows, (2) \$200 per year by weatherstripping three-by-six foot windows, (3) \$175 per year by weatherstripping three-by-six foot windows.
26. Tools for insulation: (1) hacksaw, (2) screwdriver, (3) crowbar, (4) tape measure.

27. You can save a few dollars by insulating doors using: (1) contractor, (2) yourself, (3) a friend, (4) worker.
28. When insulating ducts, one should wrap all ducts with insulating: (1) batts, (2) blankets, (3) rockwool, (4) fiberglass.
29. When the outside temperature is in the 90's, the attic temperature could easily reach: (1) 140 degrees, (2) 170 degrees, (3) 130 degrees, (4) 175 degrees.
30. A periodic checkup and maintenance of heating and cooling equipment can reduce: (1) heating, (2) energy consumption, (3) conduction, (4) energy conduction.

ESSAY QUESTIONS

1. What is the main purpose of Seed, a public service program developed by Tenneco?

2. Why should one use vapor barriers in insulation?

Key to test question at end of unit. (see page 87)

<u>No.</u>	<u>Answer</u>	<u>No.</u>	<u>Answer</u>
1.	1	16.	2
2.	1	17.	2
3.	2	18.	2
4.	2	19.	1
5.	All	20.	2
6.	All of these	21.	4
7.	2	22.	2
8.	1	23.	3
9.	2	24.	1
10.	1, 3	25.	3
11.	All of these	26.	All of these
12.	3	27.	2
13.	All of these	28.	2
14.	2	29.	3
15.	3	30.	2

Essay Question No. 1. on page 88.

The main purpose of Seed publication is to alert school personnel to the great opportunity to conserve energy and thereby slow down the increasing cost of energy in schools.

Essay Question No. 2. on page 88.

Vapor barriers are used to prevent vapor from the air from reaching the interior of the building where it can cause damage to the structure.

A P P E N D I X

TRANSPARENCIES

APPENDIX

Transparencies

Control The Sun and The Wind I, II, III
Caulking IV
Weatherstripping VIII
How Thick Insulation Should Be XIII
Where to Insulate XIV
Roof Vents XV

CONTROL THE SUN AND THE WIND

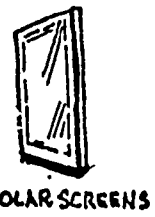
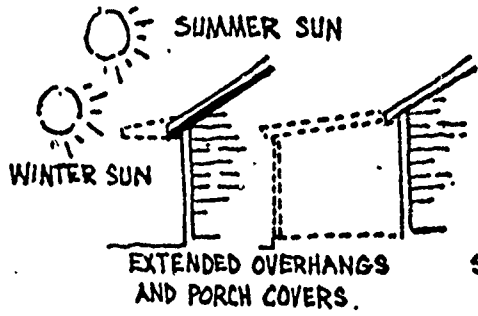

VARIOUS METHODS OF SHADING

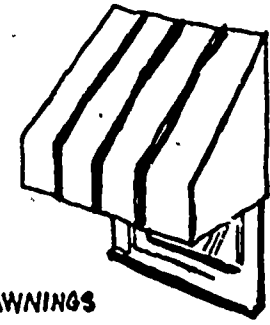
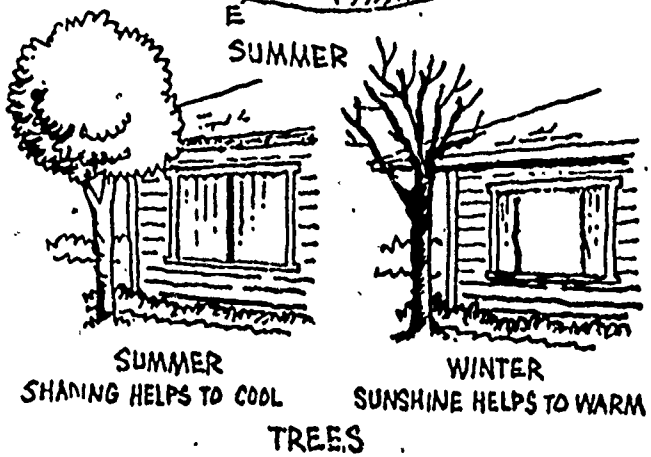
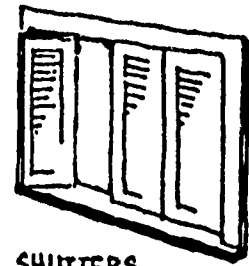
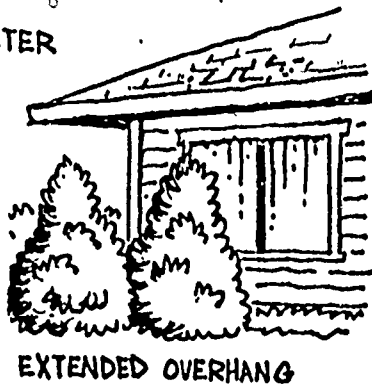
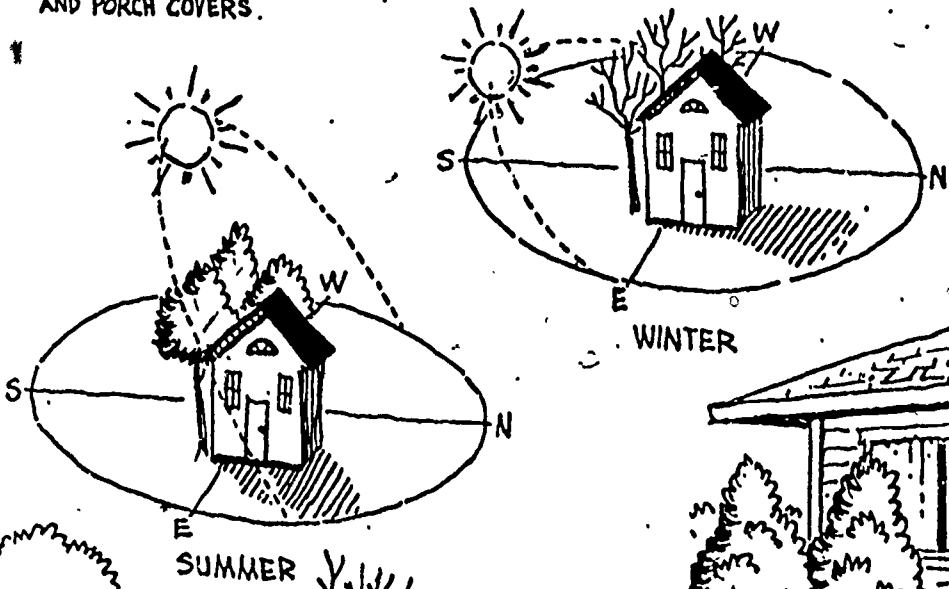

PLANT EVERGREEN TREES ON THE NORTH, NORTHEAST AND NORTHWEST. THEY WILL ALSO HELP BLOCK THE COLD WIND IN THE WINTER.

TREES AND LARGE SHRUBS ACT AS WIND BREAKS AGAINST COLD NORTHERS.

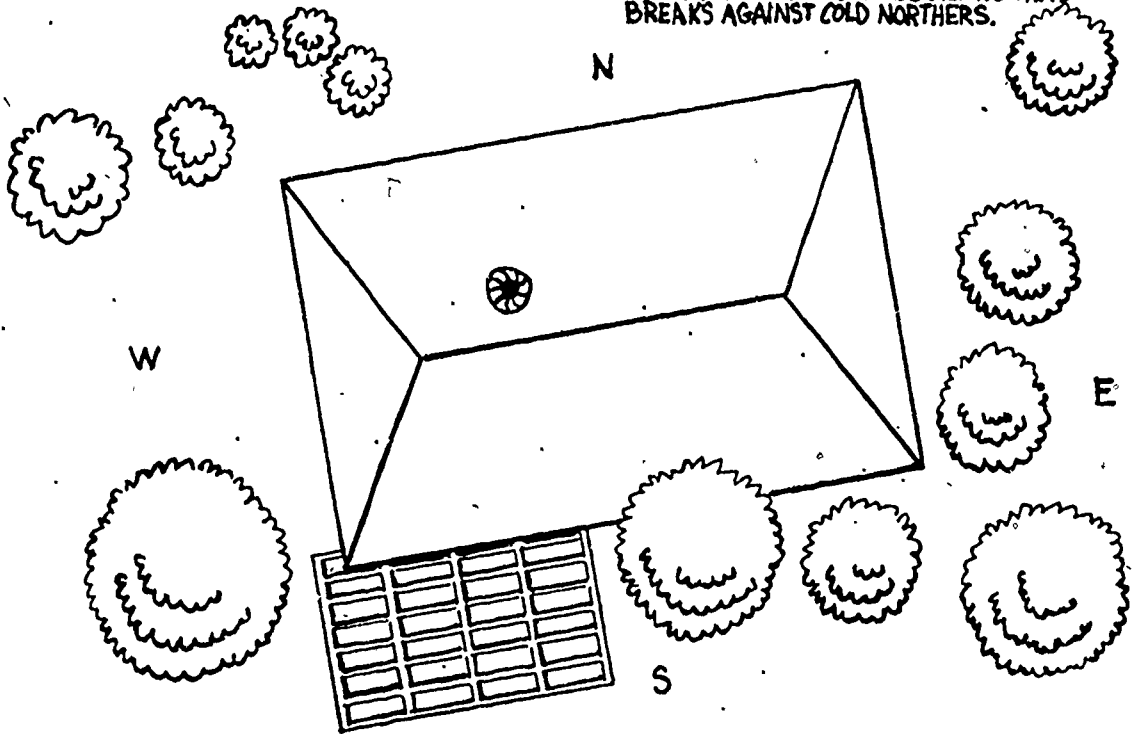

PORCH TRELLIS MAY BE PLANTED WITH DECIDUOUS VINE TO PROVIDE SHADED OUTDOOR AREA IN SUMMER AND SUNNY AREA IN WINTER.

LARGE DECIDUOUS TREES ON THE SOUTH, EAST AND WEST SHADE THE HOUSE FROM THE SUMMER SUN, DO NOT BLOCK THE WIND, AND LET THE WINTER SUNSHINE IN.

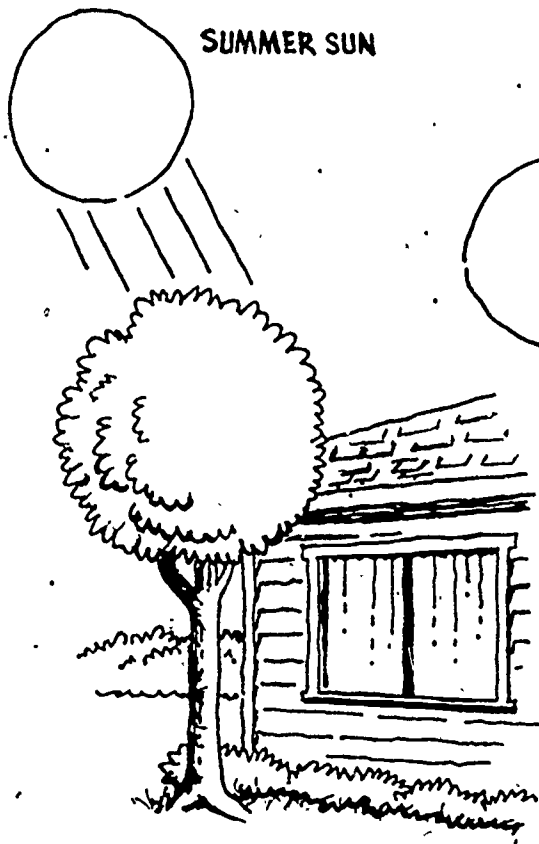

SUMMER SUN

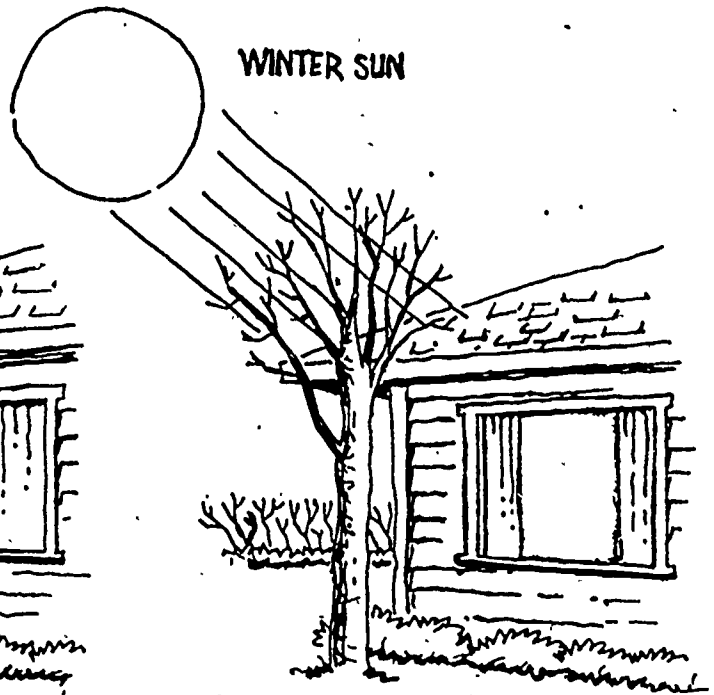

WINTER SUN

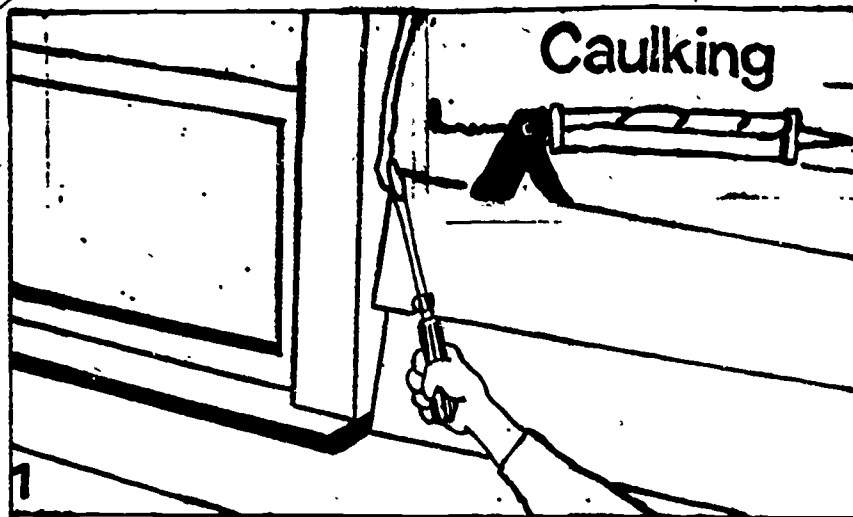

Before applying caulking compound, clean area of paint build-up, dirt, or deteriorated caulk with solvent and putty knife or large screwdriver.

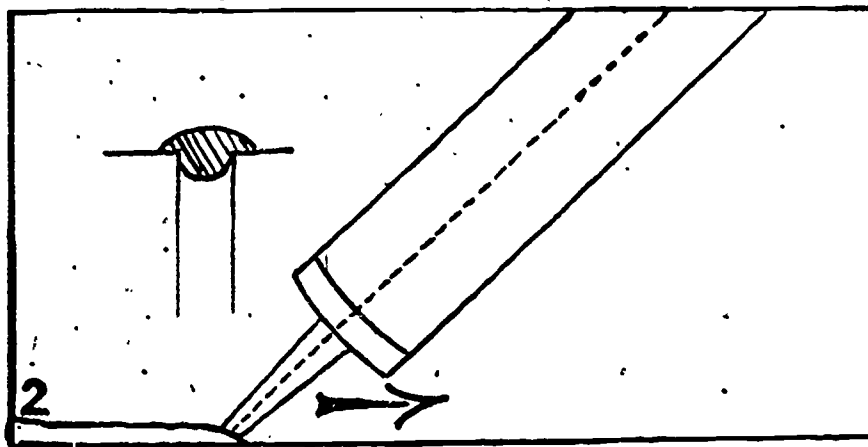

Drawing a good bead of caulk will take a little practice. First attempts may be a bit messy. Make sure the bead overlaps both sides for a tight seal.

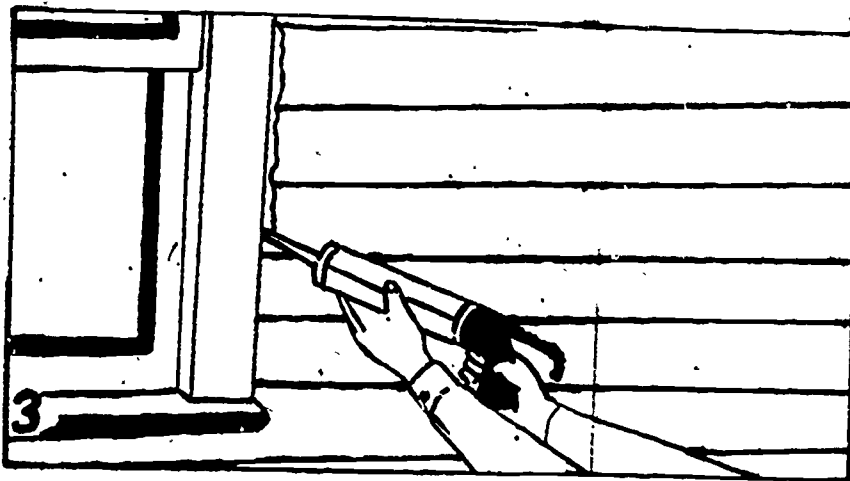

A wide bead may be necessary to make sure caulk adheres to both sides.

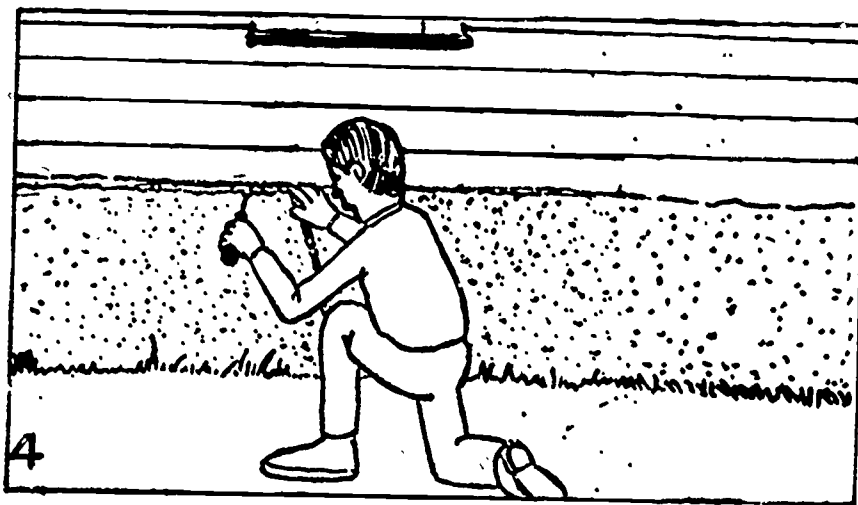

Fill extra wide cracks like those at the sills (where the house meets the foundation) with oakum, glass fiber insulation strips, etc.

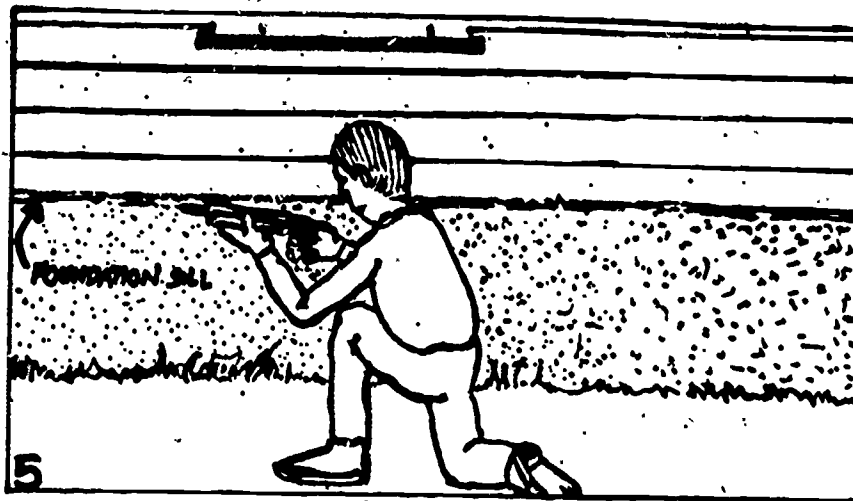

In places where you can't quite fill the gaps, finish the job with caulk.

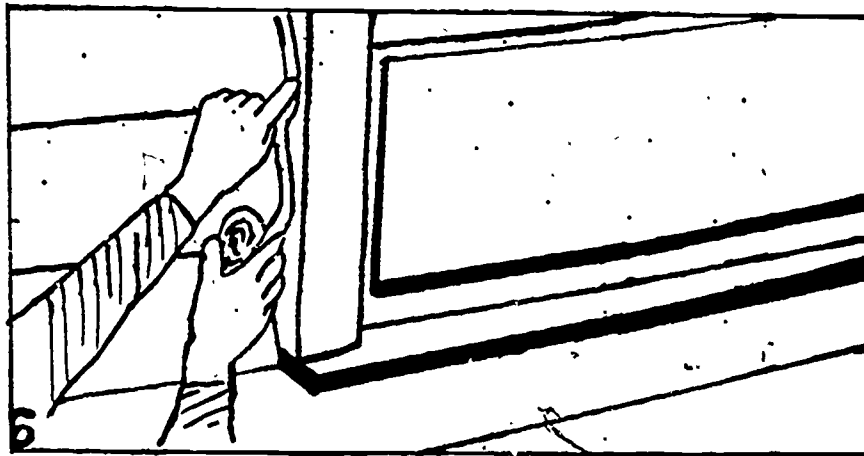

Caulking compound also comes in rope form. Unwind it and force it into cracks with your fingers. You can fill extra long cracks easily this way.

Installation:

Caulking should be applied outside
around window and door frames...

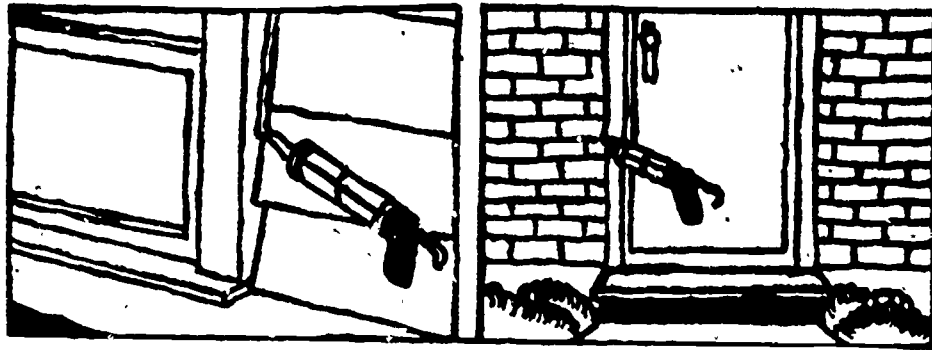

...and wherever else two different
materials or parts of the house meet.

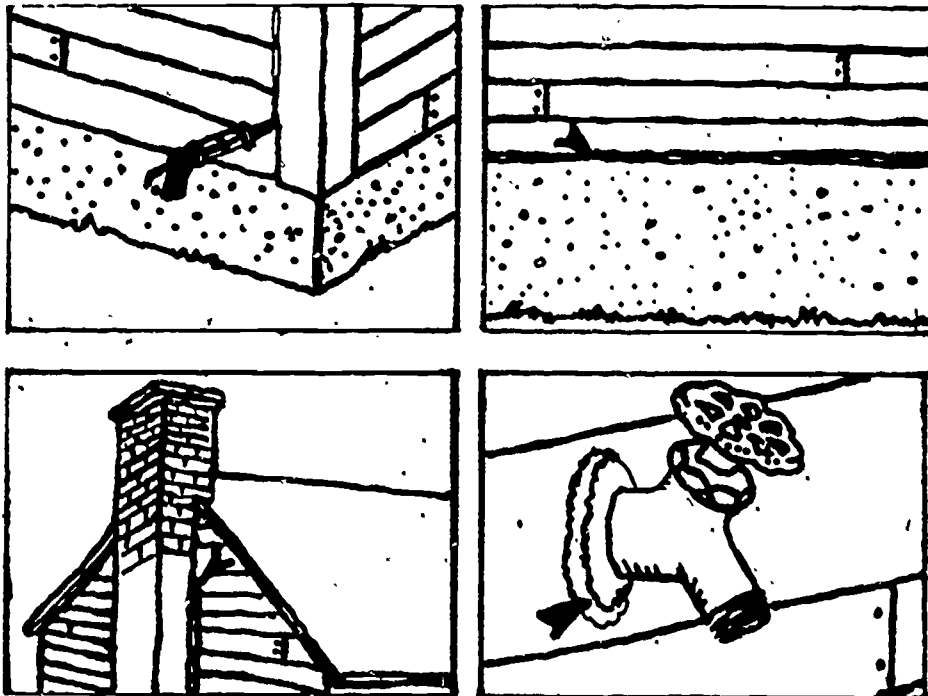

Caulking Guns and Arrows Show Where Caulking Compounds
Should be Applied.

Spring metal:

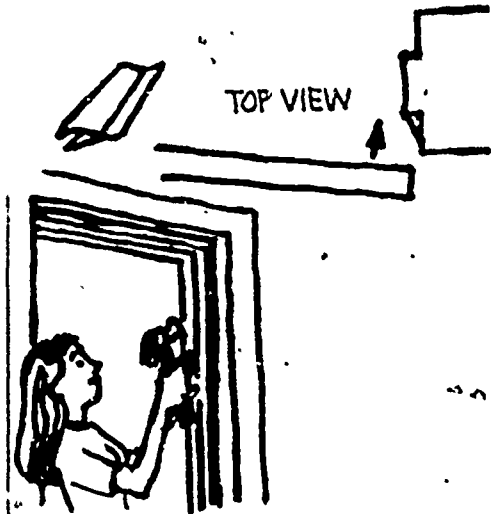

Foam rubber with gummed backing:

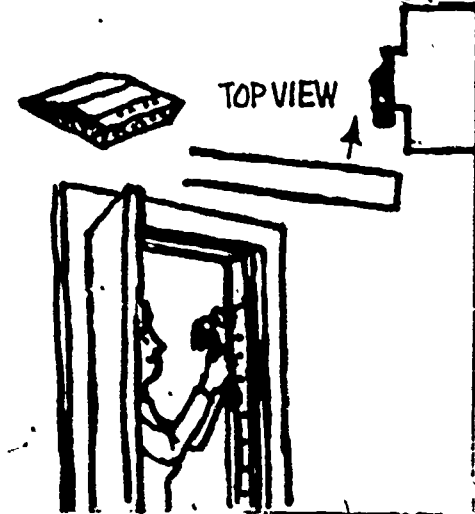

Rolled vinyl with aluminum channel backing:

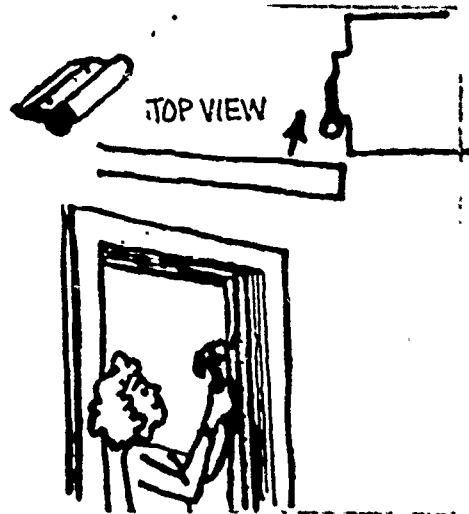

Sweeps

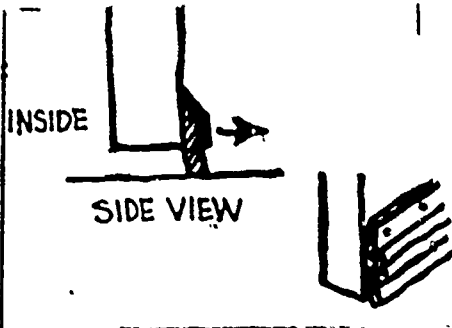

Vinyl bulb threshold:

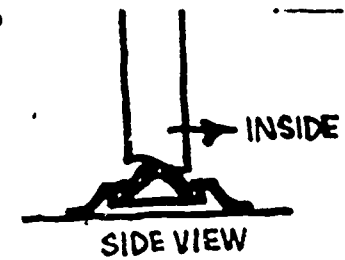

Different Kinds of Weatherstripping.

TYPES OF WEATHERSTRIPPING

Rolled Vinyl
with rigid
Metal Backing

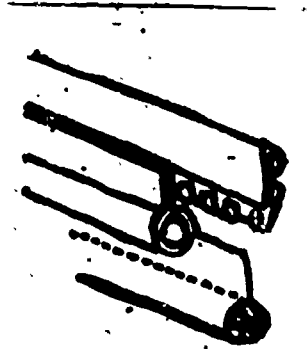

5 years

Must make
complete
contact for
proper seal.

Foam Rubber
and Felt

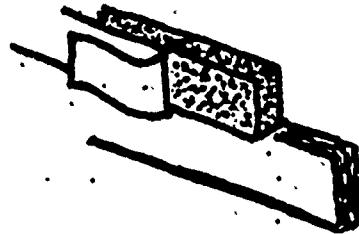

1 - 2
years

Easy to apply.
Short life
span:

Thin Spring
Metal

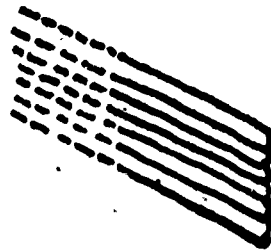

5 years
and up

May lose some
flexibility in
time and
therefore lose
its sealing
ability.

Weatherstripping should be checked every year for its condition. If installed correctly the first time, it will be effective for years.

Look for other types of weatherstripping that may suit your needs, such as interlocking thresholds, doorsweeps, etc.

Attached
to window
frame

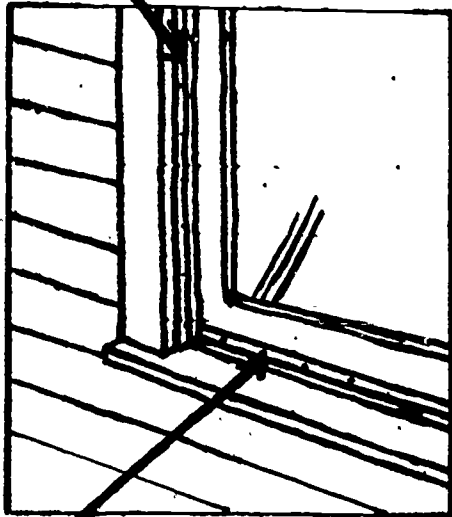

Attached
to window
base

Rolled vinyl with aluminum channel backing

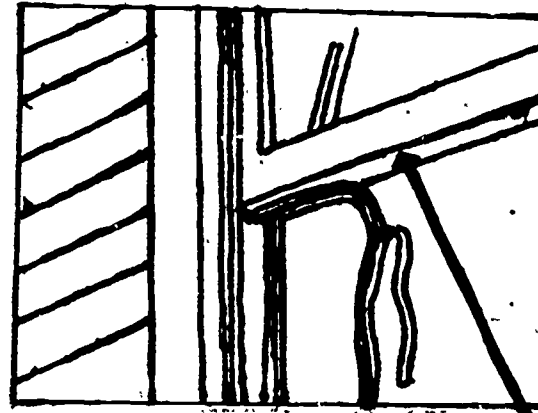

The base of the window
is the only place to
try to use foam strips

Foam rubber with gummed backing

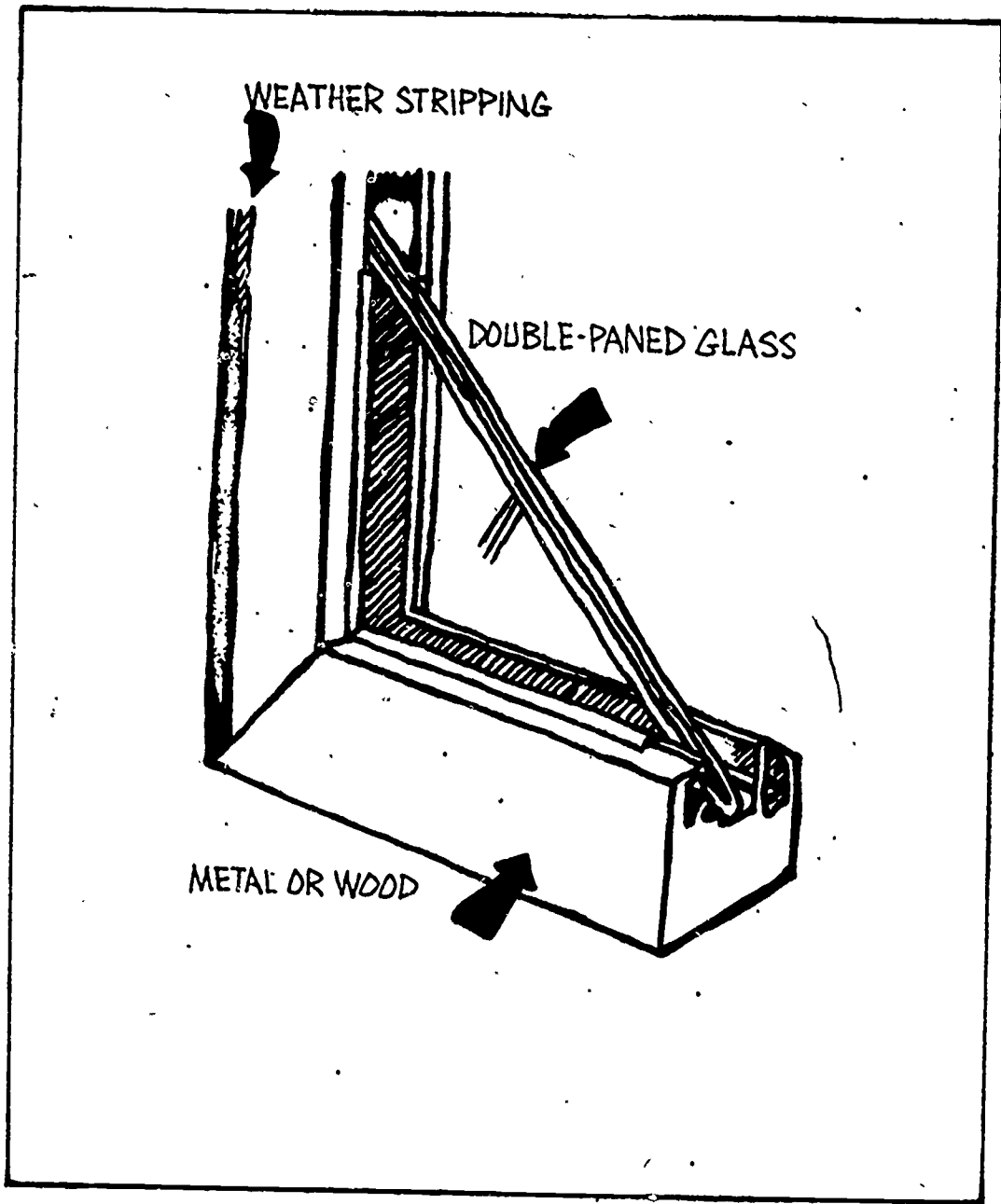

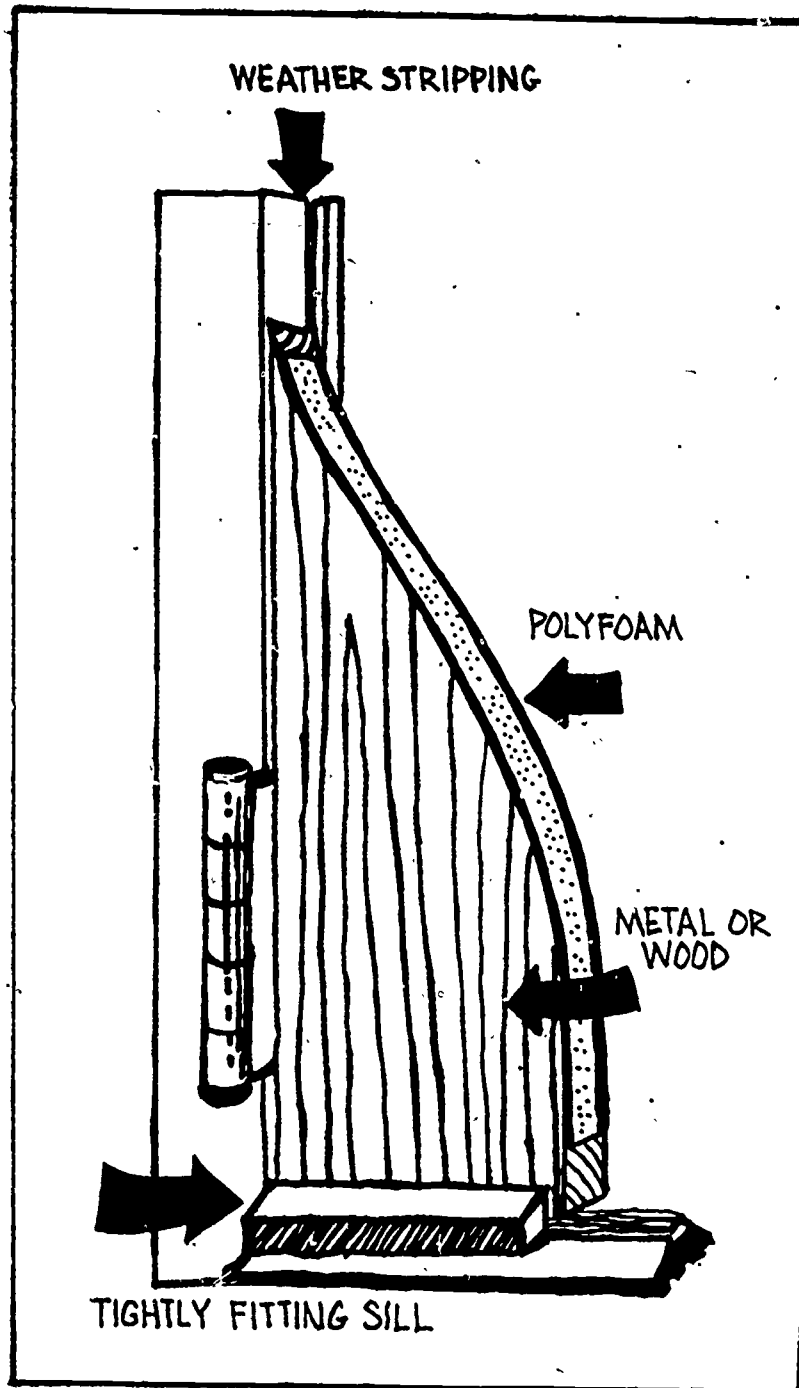

HOW THICK YOUR INSULATION SHOULD BE:



The R-Value, or Resistance Value, of insulation measures how well a material retards the flow of heat in or out of a building--the higher the R-Value, the more effective the thermal protection.

Always specify insulation on the basis of the desired R-Value and not in "inches," since different materials have different R-Values per inch of thickness.

Suggested R-Values for insulation installed in this climate area are as follows:

	Recommended Levels	Minimum Levels
ceilings and attics	R-26 to R-30	R-19
floors over garage, porch or open crawl space	R-19	R-11
enclosed crawl space	R-11	R-11
exterior walls	R-13 to R-18	R-11
perimeter of concrete slab on grade	R-7	R-0

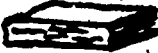
TYPE OF INSULATION

	BATTS OR BLANKETS		LOOSE FILL (POURED-IN)			
						
	glass fiber	rock wool	glass fiber	rock wool	cellulosic fiber	
R-11	3½"-4"	3"	5"	4"	3"	R-11
R-19	6"-6½"	5¼"	8"-9"	6"-7"	5"	R-19
R-22	6½"	6"	10"	7"-8"	6"	R-22
R-30	9½"-10½**	9**	13"-14"	10"-11"	8"	R-30
R-38	12"-13**	10½**	17"-18"	13"-14"	10"-11"	R-38

*two batts or blankets required.

IN THE BANK...OR UP THE CHIMNEY

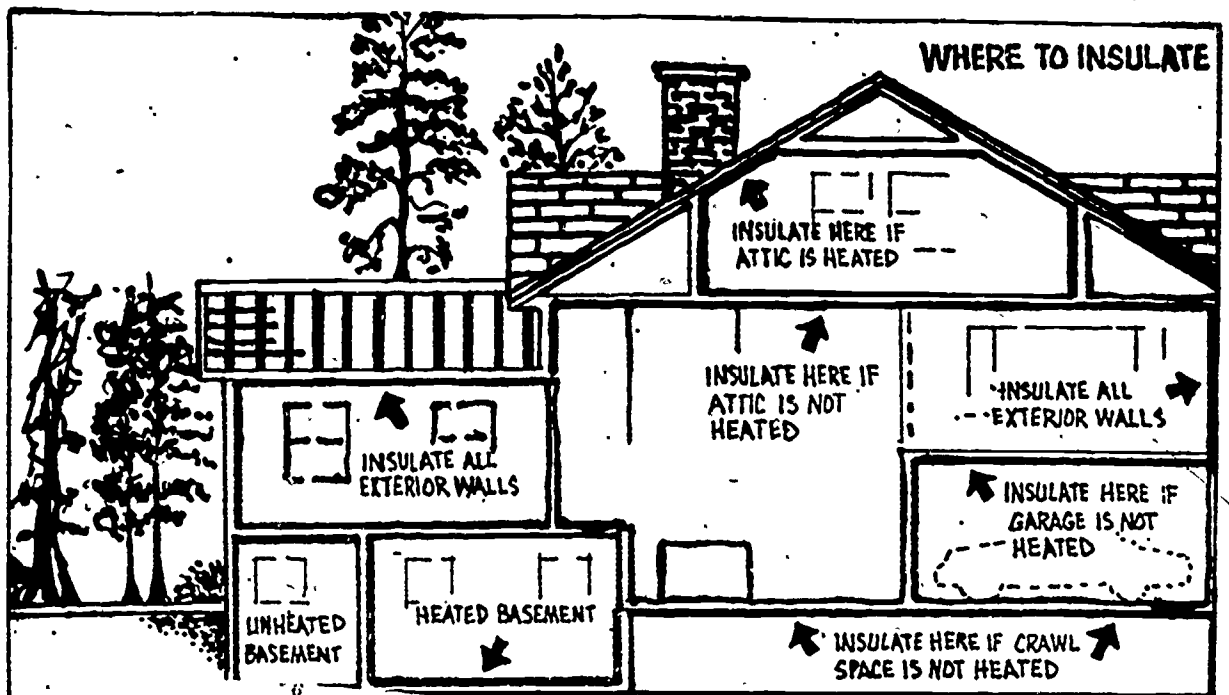

INSULATION

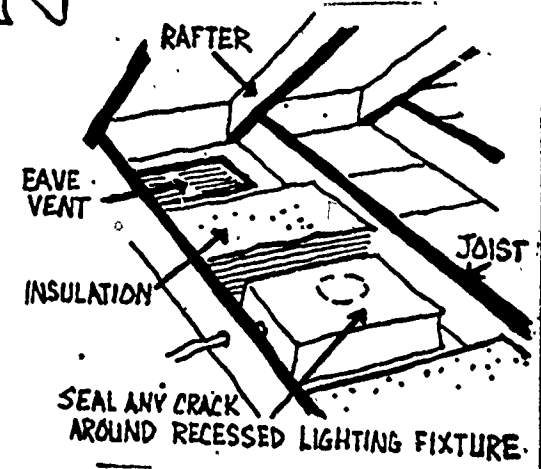
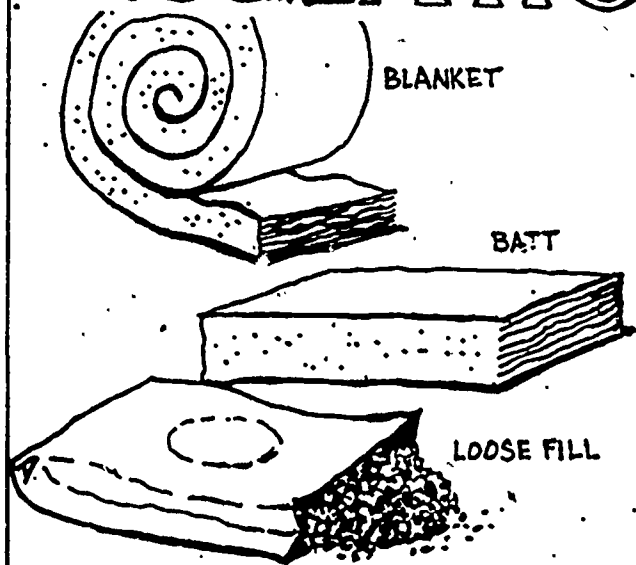

UNDERSIDE OF FLOOR OVER CRAWL SPACE

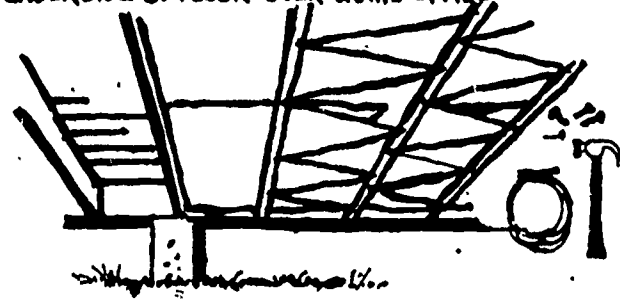

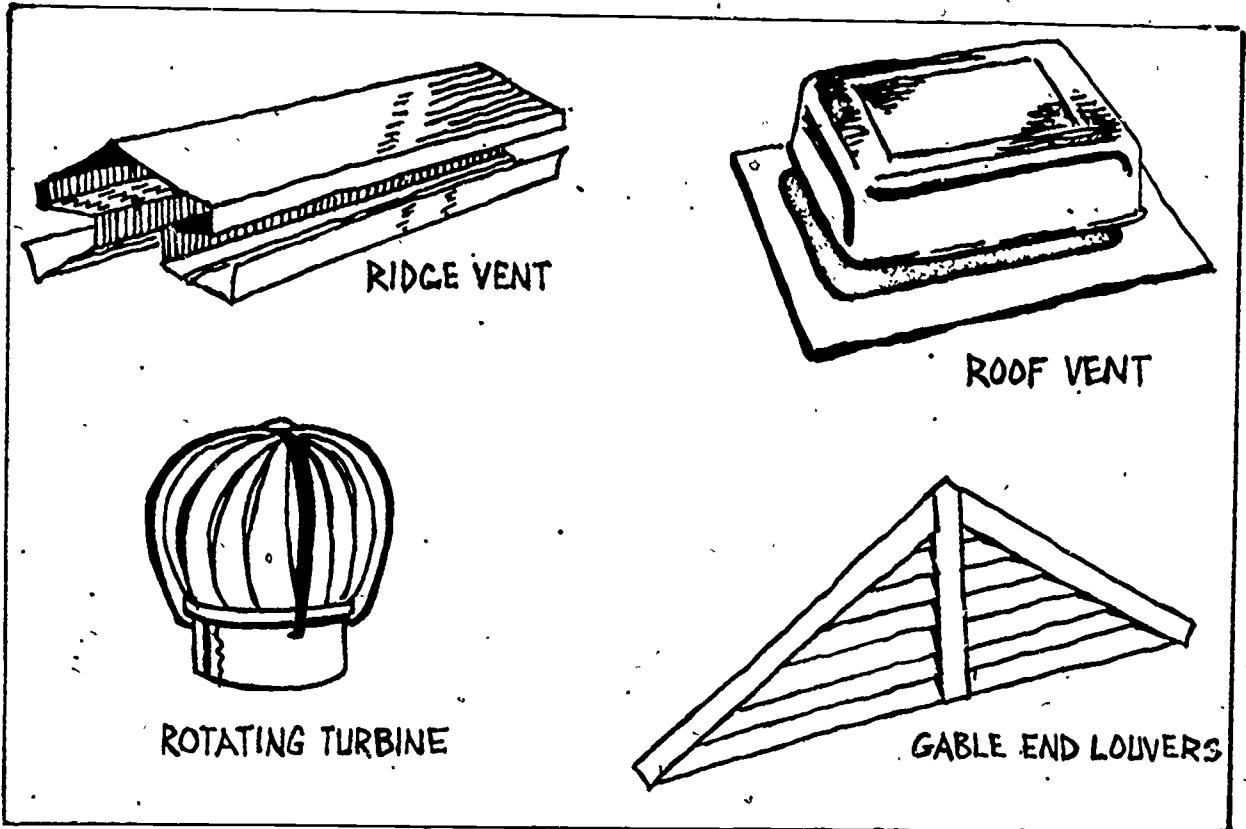

The Different Types of Roof Vents.

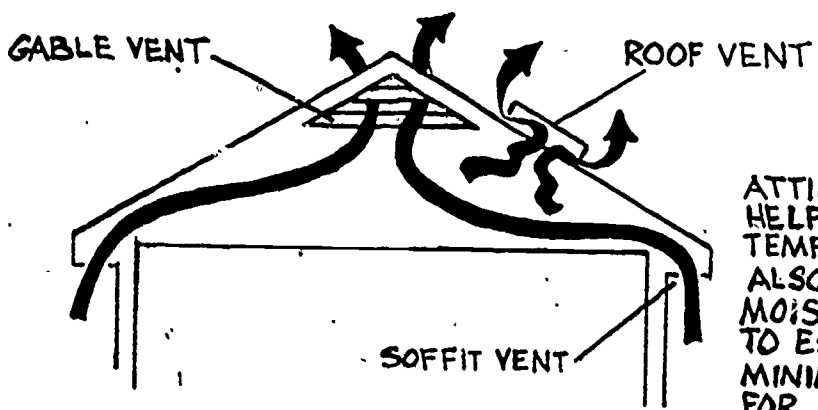

ATTIC VENTILATION
HELPS LOWER SUMMER
TEMPERATURES.
ALSO ALLOWS
MOISTURE VAPOR
TO ESCAPE IN WINTER
MINIMIZING CHANCE
FOR CONDENSATION.

ATTIC VENTILATION.

R E S O U R C E S

RESOURCES

American Gas Association - Educational Services Energy Report.
Vol. 7, No. 1; Vol. 8, No. 1, No. 3, No. 4; Vol. 9, No. 1;
Vol. 10, No. 1 and No. 2.

Award Winning Energy Education Activities. U. S. Department of
Energy, Office of Education Business and Labor Affairs.

Energy and the Family. Gulf States Utilities Company, Inc.

Energy Conservation. Thomas Alva Edison Foundation.

Energy Conservation in Journal of Special Issues. Vol. 37, No. 2;
1981.

Allen, Rodney. Energy Education: Goals and Practices. Phi Delta
Kappa Education Foundation.

The Energy Future Today; Grades 7, 8, and 9, Social Studies by
U. S. Department of Energy, Office of Consumer Affairs, Contract,
Number EC-79-C-01-6083, April, 1980.

"Energy: The Case for Conservation", Hayes, Denis in World Watch
Paper, No. 4, January, 1976.

Fact Book on Non-Conventional Energy Technologies. Library of
Congress; Washington, D.C.

Home Improvement Projects. Louisiana Power and Light Company,
New Orleans.

The Household Energy Diet. Houston Lighting and Power Company.

Jackson, Janyth M., et. al. The K-6 of Energy. Gulf States
Utilities and East Baton Rouge Parish Schools, June, 1980.

Pennsylvania's Energy Curriculum for the Secondary Grades -
Industrial Arts, Pennsylvania Department of Education.

Project Retro-Tech: Home Weatherization. Federal Energy Admini-
stration.

Duckert, Joseph M. A Short Energy History of the United States.

Kinet, Stanley J. Jr., and William L. Rader. Teacher Resources for
Energy Economics.

Tips for Energy Savers: U. S. Department of Energy Editorial
Services Office Public Affairs.

Today's Technologies, Tomorrow's Alternatives. Electric Power
Research Institute.

U. S. Department of Energy - Providing for Energy Efficiency in
Homes and Small Buildings DE-IR-06065-1 pt. 1,2,3, and 5.

Bryant, Lloyd R. We Can Save Ourselves. Edison Electric Institute.

Nesbitt, William. World Energy: Will There be Enough in 2020?
Decision Makers Bookshelf.