

DOCUMENT RESUME

ED 220 324

SE 039 086

AUTHOR Bernstein-Sidney, Ethel
TITLE Weather Predictions - USMES Teacher Resource Book. Fourth Edition. Trial Edition.
INSTITUTION Education Development Center, Inc., Newton, Mass.; Unified Science and Mathematics for Elementary Schools, Newton, Mass.
SPONS AGENCY National Science Foundation, Washington, D.C.
REPORT NO ISBN-0-89292-026-2
PUB DATE 76
GRANT SED-69-01071
NOTE 178p.; For related documents see SE 039 060-098 and ED 142 362.
AVAILABLE FROM ERIC Clearinghouse for Science, Mathematics, and Environmental Education, 1200 Chambers Rd., 3rd Floor, Columbus, OH 43212 (\$5.00).
EDRS PRICE MF01 Plus Postage. PC Not Available from EDRS.
DESCRIPTORS Elementary Education; *Elementary School Mathematics; *Elementary School Science; Interdisciplinary Approach; Language Arts; Learning Activities; Mathematics Education; Meteorology; Physical Sciences; Prediction; *Problem Solving; Process Education; Resource Materials; *Science Activities; Science Course Improvement Projects; Science Education; Social Studies; Teaching Guides; Teaching Methods; *Unified Studies Curriculum; *Weather.
IDENTIFIERS National Science Foundation; *Unified Science Mathematics for Elementary Schools

ABSTRACT

Because student activities are often restricted by inclement weather, this Unified Sciences and Mathematics for Elementary Schools (USMES) unit challenges students to predict weather to help them plan activities and schedules. The challenge is general enough to apply to many problem-solving situations in mathematics, science, social science, and language arts at any elementary school level (grades 1-8). The Teacher Resource Book for the unit is divided into five sections. Section I describes the USMES approach to student-initiated investigations of real problems, including a discussion of the nature of USMES "challenges." Section II provides an overview of possible student activities with comments on prerequisite skills, instructional strategies, suggestions when using the unit with primary grades, a flow chart illustrating how investigations evolve from students' discussions of weather prediction problems, and a hypothetical account of intermediate-level class activities. Section III provides documented events of actual class activities from grades 2/3, 5, and 6. Section IV includes lists of "How To" cards and background papers, bibliography of non-USMES materials, and a glossary. Section V consists of charts identifying skills, concepts, processes, and areas of study learned as students become involved with weather prediction activities. (JN)

ED220324

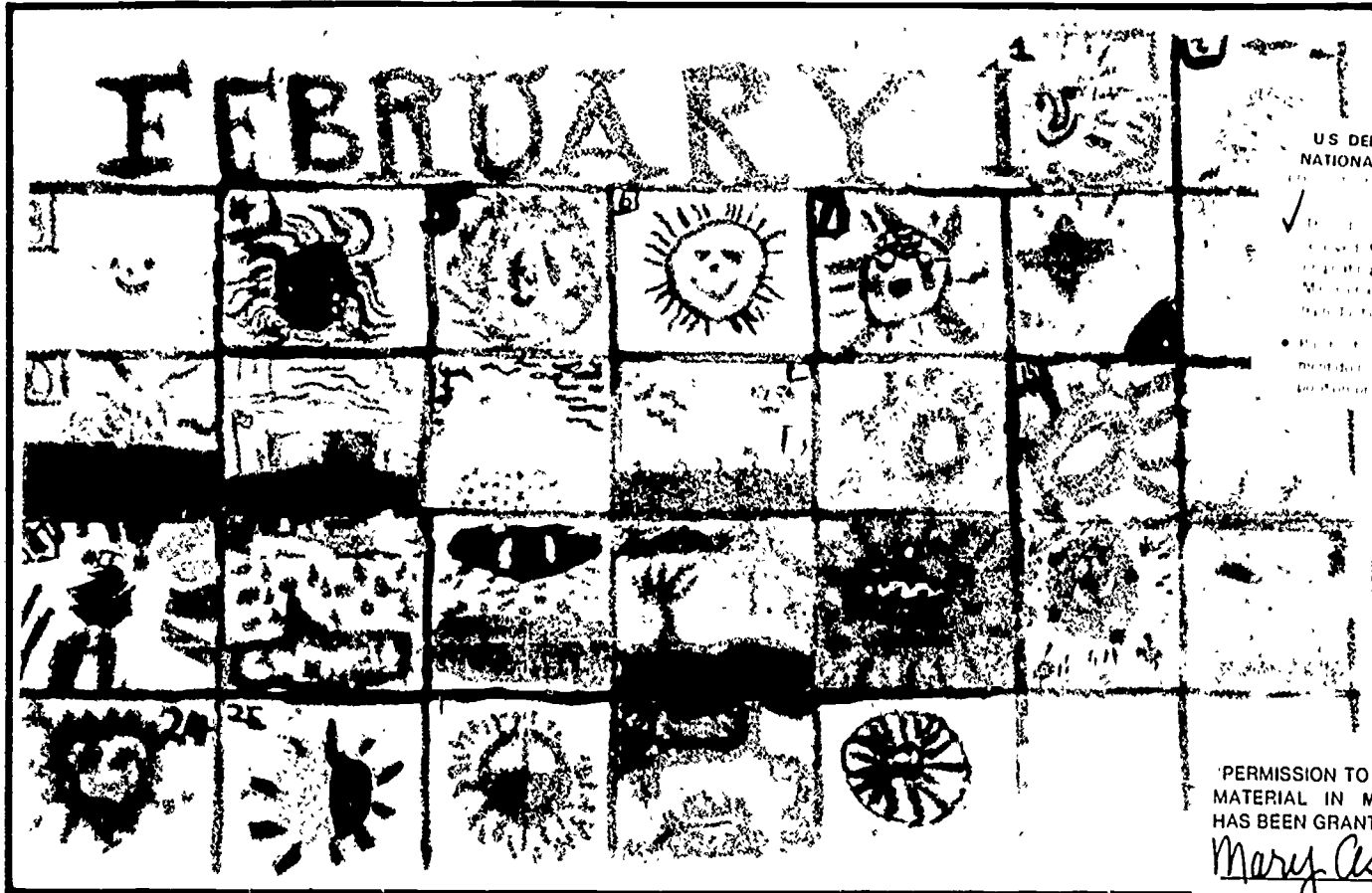

U.S. DEPARTMENT OF EDUCATION
NATIONAL INSTITUTE OF EDUCATION

ENTER ERIC

✓ This material is available in microfiche format as well as in print. The microfiche format is available for \$1.00 per microfiche card. The print format is available for \$1.00 per page. For more information, contact the National Institute of Education, 1800 M Street, N.W., Washington, D.C. 20037.

PERMISSION TO REPRODUCE THIS MATERIAL IN MICROFICHE ONLY HAS BEEN GRANTED BY

Mary Ashford

TO THE EDUCATIONAL RESOURCES INFORMATION CENTER (ERIC)™

Weather Predictions

039 086

This material is based upon research supported by the National Science Foundation under Grant No. SED69-01071. Any opinions, findings, and conclusions or recommendations expressed in this publication are those of the authors and do not necessarily reflect the views of the National Science Foundation.

Contributors

USMES CENTRAL STAFF

Earle Lomon, *Director*
Betty M. Beck, *Associate Director for Development*
Quinton E. Baker, *Associate Director for Administration*
L. Ray Brady, Jr., *Editor/Production Manager*
Ethel Bernstein-Sidney, *Associate Editor*
John Saalfeld, *Graphic Designer*
Nancy C. Brady, Martha Allegro, Lois Finstein, Phyllis
Gentile, Felicia Weitzel, Annette Thompson,
Administrative Staff

UNIVERSITY CONTENT AND CURRICULUM SPECIALISTS

Jack Borsting, U.S. Naval Postgraduate School, Monterey, CA
Edward Liddle, Oakland University, Rochester, MI
Robert Renard, U.S. Naval Postgraduate School, Monterey, CA

CLASSROOM TEACHERS

Gary Childs, Monte Vista School, Monterey, CA
Janet Cornella, Browne School, Watertown, MA
Cathy Daane, Northwestern School, Eaton Rapids, MI
Florence Duncan, Horn School, Iowa City, IA
Eugene Gehrke, Woodmere School, Portland, OR
O. Leath Gold, Monte Vista School, Monterey, CA
Judith Gray, Stillman School, Plainfield, NJ
Carol Hardy, Hilsman Middle School, Athens, GA
Cecilia Houck, Graebner School, Sterling Heights, MI
Margaret E. Jackson, Garrison Elementary School,
Washington, DC

Minnette Jeske, Peirce School, Arlington, MA
Veneta Lambros, Lafayette School, Washington, DC
Mary Helen Lyn, Dallin School, Arlington, MA
Bonnie Rollenhagen, Allen Street School, Lansing, MI
Betty Roth, Carmelo School, Carmel, CA
Dorothy Salvato, Hosmer School, Watertown, MA
Diane Singleton, James Island Middle School,
Charleston, SC
Ronald Spangler, Rolling Hills School, Los Gatos, CA
Patricia Wallace, Hardy School, Arlington, MA
Mary Ellen Warner, Wallace Middle School, Charleston, SC

This edition of Weather Predictions written and edited by Ethel Bernstein-Sidney, supervising editors Betty M. Beck and L. Ray Brady, Jr. Production work performed by L. Ray Brady, Jr., Nancy C. Brady, and Martha Allegro. Cover design by John W. Saalfeld.

UNIFIED SCIENCES AND MATHEMATICS FOR ELEMENTARY SCHOOLS:
Mathematics and the Natural, Social, and Communications Sciences in
Real Problem Solving.

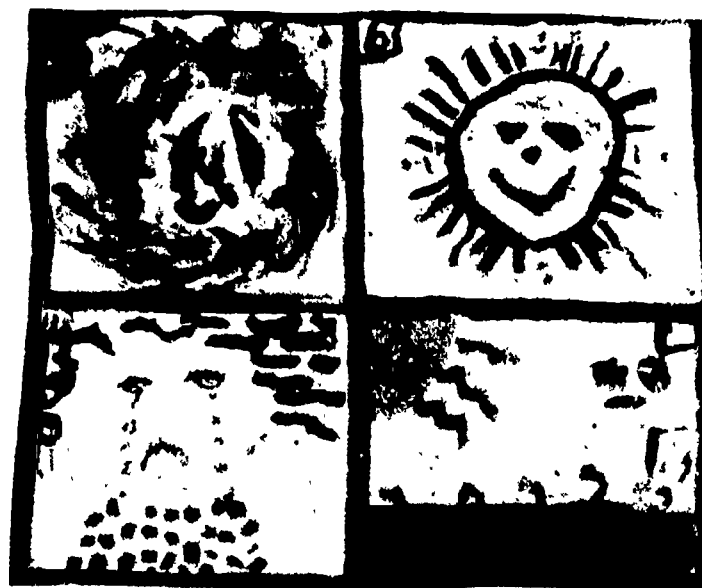

Weather Predictions

Fourth Edition

Education Development Center, Inc.

55 Chapel Street

Newton, MA 02160

Trial Edition

Complete USMES Library ISBN: 0-89292-033-5
Weather Predictions ISBN: 0-89292-026-2
Education Development Center, Inc., Newton 02160

© 1976, 1974, 1973, 1972 by Education Development Center, Inc.
All rights reserved

Printed in the United States of America

*CHALLENGE: MAKE YOUR OWN WEATHER PREDICTIONS (FOR THIS AFTERNOON,
TOMORROW, OR A SPECIAL OCCASION).*

Table of Contents

Preface	ix
INTRODUCTION	1
A. REAL PROBLEM SOLVING AND USMES	3
B. GENERAL PAPERS ON WEATHER PREDICTIONS	
1. Overview of Activities	13
2. Classroom Strategy for Weather Predictions	15
3. Use of Weather Predictions in the Primary Grades	21
4. Flow Chart	22
5. A Composite Log	26
6. Questions to Stimulate Further Investigation and Analysis	39
C. DOCUMENTATION	
1. Log by Judith Gray (Grade 2/3)	41
2. Log by Cathy Daane (Grade 5)	57
3. Log by Gary Childs (Grade 6)	69
D. REFERENCES	
1. List of "How To" Cards	86
2. List of Background Papers	87
3. Bibliography of Non-USMES Materials	88
4. Glossary	91
E. SKILLS, PROCESSES, AND AREAS OF STUDY UTILIZED IN WEATHER PREDICTIONS	101

Preface

The USMES Project

Unified Sciences and Mathematics for Elementary Schools: Mathematics and the Natural, Social, and Communications Sciences in Real Problem Solving (USMES) was formed in response to the recommendations of the 1967 Cambridge Conference on the Correlation of Science and Mathematics in the Schools.* Since its inception in 1970, USMES has been funded by the National Science Foundation to develop and carry out field trials of interdisciplinary units centered on long-range investigations of real and practical problems (or "challenges") taken from the local school/community environment. School planners can use these units to design a flexible curriculum for grades one through eight in which real problem solving plays an important role.

Development and field trials were carried out by teachers and students in the classroom with the assistance of university specialists at workshops and at occasional other meetings. The work was coordinated by a staff at the Education Development Center in Newton, Massachusetts. In addition, the staff at EDC coordinated implementation programs involving schools, districts, and colleges that are carrying out local USMES implementation programs for teachers and schools in their area.

Trial editions of the following units are currently available:

Advertising	Nature Trails
Bicycle Transportation	Orientation
Classroom Design	Pedestrian Crossings
Classroom Management	Play Area Design and Use
Consumer Research	Protecting Property
Describing People	#School Rules
Designing for Human Proportions	School Supplies
#Design Lab Design	School Zoo
#Eating in School	Soft Drink Design
Getting There	Traffic Flow
Growing Plants	#Using Free Time
Manufacturing	Ways to Learn/Teach
Mass Communications	Weather Predictions

*See *Goals for the Correlation of Elementary Science and Mathematics*, Houghton Mifflin Co., Boston, 1969.

#Available fall 1976.

In responding to a long-range challenge, the students and teachers often have need of a wide range of resources. In fact, all of the people and materials in the school and community are important resources for USMES activities. USMES provides resources in addition to these. One resource for students is the Design Lab or its classroom equivalent: using the tools and supplies available, children can follow through on their ideas by constructing measuring tools, testing apparatus, models, etc. Another resource for students is the "How To" Cards. Each set of cards gives information about a specific problem; the students use a set only when they want help on that particular problem.

Several types of resources are available for teachers: the *USMES Guide*, a *Teacher Resource Book* for each challenge, *Background Papers*, a *Design Lab Manual*, and a *Curriculum Correlation Guide*. A complete set of all these written materials comprise what is called the USMES library. This library, which should be available in each school using USMES units, contains the following:

1. *The USMES Guide*

The USMES Guide is a compilation of materials that may be used for long-range planning of a curriculum that incorporates the USMES program. In addition to basic information about the project, the challenges, and related materials, it contains charts assessing the strengths of the various challenges in terms of their possible subject area content.

2. *Teacher Resource Books* (one for each challenge)

Each book contains a description of the USMES approach to real problem-solving activities, general information about the particular unit, edited logs of class activities, other written materials relevant to the unit, and charts that indicate the basic skills, processes, and areas of study that may be learned and utilized as students become engaged in certain possible activities.

3. *Design Lab Manual*

This contains sections on the style of Design Lab activities, safety considerations, and an inventory

of tools and supplies. Because many "hands-on" activities may take place in the classroom, the Design Lab Manual should be made available to each USMES teacher.

4. "How To" Cards

These short sets of cards provide information to students about specific problems that may arise during USMES units. Particular computation, graphing, and construction problems are discussed. A complete list of the "How To" Cards can be found in the USMES Guide.

5. Background Papers

These papers are written to provide information for the teachers on technical problems that might arise as students carry on various investigations. A complete list of the Background Papers can be found in the USMES Guide.

6. Curriculum Correlation Guide

This volume is intended to coordinate other curriculum materials with the Teacher Resource Books and to provide the teacher with the means to integrate USMES easily into other school activities and lessons.

The preceding materials are described in brief in the USMES brochure, which can be used by teachers and administrators to disseminate information about the program to the local community. A variety of other dissemination and implementation materials are also available for individuals and groups involved in local implementation programs. They include *Preparing People for USMES: An Implementation Resource Book*, the USMES slide/tape show, the Design Lab slide/tape show, the Design Lab brochure, the USMES newsletter, videotapes of classroom activities, a general report on evaluation results, a map showing the locations of schools conducting local implementation of USMES, a list of experienced USMES teachers and university consultants, and newspaper and magazine articles.

Besides the contributors listed at the beginning of the book, we are deeply indebted to the many elementary school

Acknowledgments

children whose investigations of the challenge form the basis for this book. Without their efforts this book would not have been possible. Many thanks to the Planning Committee for their years of service and advice. Many thanks also to other members of the USMES staff for their suggestions and advice and for their help in staffing and organizing the development workshops. Special thanks also go to Christopher Hale for his efforts as Project Manager during the development of this book.

*

*

*

Because Tri-Wall was the only readily available brand of three-layered cardboard at the time the project began, USMES has used it at workshops and in schools; consequently, references to Tri-Wall can be found throughout the Teacher Resource Books. The addresses of companies that supply three-layered cardboard can be found in the Design Lab Manual.

Introduction

Using the Teacher Resource Book

When teachers try a new curriculum for the first time, they need to understand the philosophy behind the curriculum. The USMES approach to student-initiated investigations of real problems is outlined in section A of this Teacher Resource Book.

Section B starts with a brief overview of possible student activities arising from the challenge; comments on prerequisite skills are included. Following that is a discussion of the classroom strategy for USMES real problem-solving activities, including introduction of the challenge, student activity, resources, and Design Lab use. Subsequent pages include a description of the use of the unit in primary grades, a flow chart and a composite log that indicate the range of possible student work, and a list of questions that the teacher may find useful for focusing the students' activities on the challenge.

Because students initiate all the activities in response to the challenge and because the work of one class may differ from that undertaken by other classes, teachers familiar with USMES need to read only sections A and B before introducing the challenge to students.

Section C of this book is the documentation section. These edited teachers' logs show the variety of ways in which students in different classes have worked at finding a solution to the challenge.

Section D contains a list of the titles of relevant sets of "How To" Cards and brief descriptions of the Background Papers pertaining to the unit. Also included in section D is a glossary of the terms used in the Teacher Resource Book and an annotated bibliography.

Section E contains charts that indicate the comparative strengths of the unit in terms of real problem solving, mathematics, science, social science, and language arts. It also contains a list of explicit examples of real problem solving and other subject area skills, processes, and areas of study learned and utilized in the unit. These charts and lists are based on documentation of activities that have taken place in USMES classes. Knowing ahead of time which basic skills and processes are likely to be utilized, teachers can postpone teaching that part of their regular program until later in the year. At that time students can study them in the usual way if they have not already learned them as part of their USMES activities.

A. Real Problem Solving and USMES

*If life were of such a constant nature that there were only a few chores to do and they were done over and over in exactly the same way, the case for knowing how to solve problems would not be so compelling. All one would have to do would be to learn how to do the few jobs at the outset. From then on he could rely on memory and habit. Fortunately--or unfortunately depending upon one's point of view--life is not simple and unchanging. Rather it is changing so rapidly that about all we can predict is that things will be different in the future. In such a world the ability to adjust and to solve one's problems is of paramount importance.**

Real Problem Solving

USMES is based on the beliefs that real problem solving is an important skill to be learned and that many math, science, social science, and language arts skills may be learned more quickly and easily within the context of student investigations of real problems. Real problem solving, as exemplified by USMES, implies a style of education which involves students in investigating and solving real problems. It provides the bridge between the abstractions of the school curriculum and the world of the student. Each USMES unit presents a problem in the form of a challenge that is interesting to children because it is both real and practical. The problem is real in several respects: (1) the problem applies to some aspect of student life in the school or community, (2) a solution is needed and not presently known, at least for the particular case in question, (3) the students must consider the entire situation with all the accompanying variables and complexities, and (4) the problem is such that the work done by the students can lead to some improvement in the situation. This expectation of useful accomplishment provides the motivation for children to carry out the comprehensive investigations needed to find some solution to the challenge.

The level at which the children approach the problems, the investigations that they carry out, and the solutions

*Kenneth B. Henderson and Robert E. Pingry, "Problem-Solving in Mathematics," in *The Learning of Mathematics: Its Theory and Practice*, Twenty-first Yearbook of the National Council of Teachers of Mathematics (Washington, D.C.: The Council, 1953), p. 233.

that they devise may vary according to the age and ability of the children. However, real problem solving involves them, at some level, in all aspects of the problem solving process: definition of the problem; determination of the important factors in the problem; observation; measurement; collection of data; analysis of the data using graphs, charts, statistics, or whatever means the students can find; discussion; formulation and trial of suggested solutions; clarification of values; decision making; and communications of findings to others. In addition, students become more inquisitive, more cooperative in working with others, more critical in their thinking, more self-reliant, and more interested in helping to improve social conditions.

The USMES Approach

To learn the process of real problem solving, the students must encounter, formulate, and find some solution to complete and realistic problems. The students themselves, not the teacher, must analyze the problem, choose the variables that should be investigated, search out the facts, and judge the correctness of their hypotheses and conclusions. In real problem-solving activities, the teacher acts as a coordinator and collaborator, not an authoritative answer-giver.

The problem is first reworded by students in specific terms that apply to their school or community, and the various aspects of the problem are discussed by the class. The students then suggest approaches to the problem and set priorities for the investigations they plan to carry out. A typical USMES class consists of several groups working on different aspects of the problem. As the groups report periodically to the class on their progress, new directions are identified and new task forces are formed as needed. Thus, work on an USMES challenge provides students with a "discovery-learning" or "action-oriented" experience.

Real problem solving does not rely solely on the discovery-learning concept. In the real world people have access to certain facts and techniques when they recognize the need for them. The same should be true in the classroom. When the students find that certain facts and skills are necessary for continuing their investigation, they learn willingly and quickly in a more directed way to acquire these facts and skills. Consequently, the students should have available different resources that they may use as they recognize the need for them, but they should still be left with a wide scope to explore their own ideas and methods.

Certain information on specific skills is provided by the sets of USMES "How To" Cards. The students are referred only to the set for which they have clearly identified a need and only when they are unable to proceed on their own. Each "How To" Cards title clearly indicates the skill involved--"How to Use a Stopwatch," "How to Make a Bar Graph Picture of Your Data," etc. (A complete list of the "How To" Cards can be found in Chapter IX of the USMES Guide.)

Another resource provided by USMES is the Design Lab or its classroom equivalent. The Design Lab provides a central location for tools and materials where devices may be constructed and tested without appreciably disrupting other classroom activities. Ideally, it is a separate room with space for all necessary supplies and equipment and work space for the children. However, it may be as small as a corner of the classroom and may contain only a few tools and supplies. Since the benefits of real problem solving can be obtained by the students only if they have a means to follow up their ideas, the availability of a Design Lab can be a very important asset.

Optimally, the operation of the school's Design Lab should be such as to make it available to the students whenever they need it. It should be as free as possible from set scheduling or programming. The students use the Design Lab to try out their own ideas and/or to design, construct, test, and improve many devices initiated by their responses to the USMES challenges. While this optimum operation of the Design Lab may not always be possible due to various limitations, "hands-on" activities may take place in the classroom even though a Design Lab may not be available. (A detailed discussion of the Design Lab can be found in Chapter VI of the USMES Guide, while a complete list of "How To" Cards covering such Design Lab skills as sawing, gluing, nailing, soldering, is contained in Chapter IX.)

Work on all USMES challenges is not only sufficiently complex to require the collaboration of the whole class but also diverse enough to enable each student to contribute according to his/her interest and ability. However, it should be noted that if fewer than ten to twelve students from the class are carrying out the investigation of a unit challenge, the extent of their discovery and learning can be expected to be less than if more members of the class are involved. While it is possible for a class to work on two related units at the same time, in many classes the students progress better with just one.

The amount of time spent each week working on an USMES challenge is crucial to a successful resolution of the

problem. Each challenge is designed so that the various investigations will take from thirty to forty-five hours, depending on the age of the children, before some solution to the problem is found and some action is taken on the results of the investigations. Unless sessions are held at least two or three times a week, it is difficult for the children to maintain their interest and momentum and to become involved intensively with the challenge. The length of each session depends upon the age level of the children and the nature of the challenge. For example, children in the primary grades may proceed better by working on the challenge more frequently for shorter periods of time, perhaps fifteen to twenty minutes, while older children may proceed better by working less frequently for much longer periods of time.

Student interest and the overall accomplishments of the class in finding and implementing solutions to the challenge indicate when the class's general participation in unit activities should end. (Premature discontinuance of work on a specific challenge is often due more to waning interest on the part of the teacher than to that of the students.) However, some students may continue work on a voluntary basis on one problem, while the others begin to identify possible approaches to another USMES challenge.

Importance of the Challenge

Although individual (or group) discovery and student initiation of investigations is the process in USMES units, this does not imply the constant encouragement of random activity. Random activity has an important place in children's learning, and opportunities for it should be made available at various times. During USMES activities, however, it is believed that children learn to solve real problems only when their efforts are focused on finding some solution to the real and practical problem presented in the USMES challenge. It has been found that students are motivated to overcome many difficulties and frustrations in their efforts to achieve the goal of effecting some change or at least of providing some useful information to others. Because the children's commitment to finding a solution to the challenge is one of the keys to successful USMES work, it is extremely important that the challenge be introduced so that it is accepted by the class as an important problem to which they are willing to devote a considerable amount of time.

The challenge not only motivates the children by stating the problem but also provides them with a criterion for judging their results. This criterion--if it works, it's right (or if it helps us find an answer to our problem, it's

a good thing to do)--gives the children's ideas and results a meaning within the context of their goal. Many teachers have found this concept to be a valuable strategy that not only allows the teacher to respond positively to all of the children's ideas but also helps the children themselves to judge the value of their efforts.

Role of the Teacher

With all of the above in mind, it can be said that the teacher's responsibility in the USMES strategy for open classroom activities is as follows:

1. Introduce the challenge in a meaningful way that not only allows the children to relate it to their particular situation but also opens up various avenues of approach.
2. Act as a coordinator and collaborator. Assist, not direct, individuals or groups of students as they investigate different aspects of the problem.
3. Hold USMES sessions at least two or three times a week so that the children have a chance to become involved in the challenge and carry out comprehensive investigations.
4. Provide the tools and supplies necessary for initial hands-on work in the classroom or make arrangements for the children to work in the Design Lab.
5. Be patient in letting the children make their own mistakes and find their own way. Offer assistance or point out sources of help for specific information (such as the "How To" Cards) only when the children become frustrated in their approach to the problem. Conduct skill sessions as necessary.
6. Provide frequent opportunities for group reports and student exchanges of ideas in class discussions. In most cases, students will, by their own critical examination of the procedures they have used, improve or set new directions in their investigations.

7. If necessary, ask appropriate questions to stimulate the students' thinking so that they will make more extensive and comprehensive investigations or analyses of their data.
8. Make sure that a sufficient number of students (usually ten to twelve) are working on the challenge so that activities do not become fragmented or stall.

Student success in USMES unit activities is indicated by the progress they make in finding some solution to the challenge, not by following a particular line of investigation nor by obtaining specified results. The teacher's role in the USMES strategy is to provide a classroom atmosphere in which all students can, in their own way, search out some solution to the challenge.

USMES in the Total School Program

Today many leading educators feel that real problem solving (under different names) is an important skill to be learned. In this mode of learning particular emphasis is placed on developing skills to deal with real problems rather than the skills needed to obtain "correct" answers to contrived problems. Because of this and because of the interdisciplinary nature of both the problems and the resultant investigations, USMES is ideal for use as an important part of the elementary school program. Much of the time normally spent in the class on the traditional approaches to math, science, social science, and language arts skills can be safely assigned to USMES activities. In fact, as much as one-fourth to one-third of the total school program might be allotted to work on USMES challenges. Teachers who have worked with USMES for several years have each succeeding year successfully assigned to USMES activities the learning of a greater number of traditional skills. In addition, reports have indicated that students retain for a long time the skills and concepts learned and practiced during USMES activities. Therefore, the time normally spent in reinforcing required skills can be greatly reduced if these skills are learned and practiced in the context of real problem solving.

Because real problem-solving activities cannot possibly cover all the skills and concepts in the major subject areas, other curricula as well as other learning modes (such as "lecture method," "individual study topics," or programmed instruction) need to be used in conjunction with USMES in an optimal education program. However, the other

instruction will be enhanced by the skills, motivation, and understanding provided by real problem solving, and, in some cases, work on an USMES challenge provides the context within which the skills and concepts of the major subject areas find application.

In order for real problem solving taught by USMES to have an optimal value in the school program, class time should be apportioned with reason and forethought, and the sequence of challenges investigated by students during their years in elementary school should involve them in a variety of skills and processes. Because all activities are initiated by students in response to the challenge, it is impossible to state unequivocally which activities will take place. However, it is possible to use the documentation of activities that have taken place in USMES trial classes to schedule instruction on the specific skills and processes required by the school system. Teachers can postpone the traditional way of teaching the skills that might come up in work on an USMES challenge until later in the year. At that time students can learn the required skills in the usual way if they have not already learned them during their USMES activities.

These basic skills, processes, and areas of study are listed in charts and lists contained in each Teacher Resource Book. A teacher can use these charts to decide on an overall allocation of class time between USMES and traditional learning in the major subject disciplines. Examples of individual skills and processes are also given so that the teacher can see beforehand which skills a student may encounter during the course of his investigations. These charts and lists may be found in section E.

As the foregoing indicates, USMES differs significantly from other curricula. Real problem solving develops the problem-solving ability of students and does it in a way (learning-by-doing) that leads to a full understanding of the process. Because of the following differences, some teacher preparation is necessary. Some teachers may have been introduced by other projects to several of the following new developments in education, but few teachers have integrated all of them into the new style of teaching and learning that real problem solving involves.

1. New Area of Learning--Real problem solving is a new area of learning, not just a new approach or a new content within an already-defined subject area. Although many subject-matter curricula

27

Ways In Which USMES Differs From Other Curricula

include something called problem solving, much of this problem solving involves contrived problems or fragments of a whole situation and does not require the cognitive skills needed for the investigation of real and practical problems. Learning the cognitive strategy required for real problem solving is different from other kinds of learning.

3. Interdisciplinary Education--Real problem solving integrates the disciplines in a natural way; there is no need to impose a multi-disciplinary structure. Solving real and practical problems requires the application of skills, concepts, and processes from many disciplines. The number and range of disciplines are unrestricted and the importance of each is demonstrated in working toward the solution of practical problems.
3. Student Planning--To learn the process of problem solving, the students themselves, not the teacher, must analyze the problem, choose the variables that should be investigated, search out the facts, and judge the correctness of the hypotheses and conclusions. In real problem-solving activities the teacher acts as a coordinator and collaborator, not as an authoritative source of answers.
4. Learning-by-Doing--Learning-by-doing, or discovery learning as it is sometimes called, comes about naturally in real problem solving since the problems tackled by each class have unique aspects; for example, different lunchrooms or pedestrian crossings have different problems associated with them and, consequently, unique solutions. The challenge, as defined in each situation, provides the focus for the children's hands-on learning experiences, such as collecting real data; constructing measuring instruments, scale models, test equipment, etc.; trying their suggested improvements; and (in some units) preparing reports and presentations of their findings for the proper authorities.
5. Learning Skills and Concepts as Needed--Skills and concepts are learned in real problem solving

as the need for them arises in the context of the work being done, rather than having a situation imposed by the teacher or the text-book being used. Teachers may direct this learning when the need for it arises, or students may search out information themselves from resources provided.

6. Group Work--Progress toward a solution to a real problem usually requires the efforts of groups of students, not just individual students working alone. Although some work may be done individually, the total group effort provides good opportunities for division of labor and exchange of ideas among the groups and individuals. The grouping is flexible and changes in order to meet the needs of the different stages of investigation.
7. Student Choice--Real problem solving offers classes the opportunity to work on problems that are real to them, not just to the adults who prepare the curriculum. In addition, students may choose to investigate particular aspects of the problem according to their interest. The variety of activities ensuing from the challenge allows each student to make some contribution towards the solution of the problem according to his or her ability and to learn specific skills at a time when he or she is ready for that particular intellectual structure.

B. General Papers on Weather Predictions.

*

1. OVERVIEW OF ACTIVITIES

Challenge:

Make your own weather predictions (for this afternoon, tomorrow, or a special occasion).

Most children have been disappointed by "bad" weather: a picnic cancelled because of rain, a family outing postponed because of fog, etc. Such an event will serve to call the children's attention to the effect weather has on people's lives. It is the perfect time for the Weather Predictions challenge to be introduced to the class.

Preliminary activities which might lead naturally to the Weather Predictions challenge include work on Play Area Design and Use, Using Free Time, or Nature Trails. During investigations of each of these challenges; students may be faced with the problem of having their activities restricted by inclement weather. They may want to predict the weather in an attempt to help them plan their activities and schedule.

The simple question--"What difference does the weather make to you?"--posed by a teacher is the basis for a lively discussion. After outdoor observation, the class might discuss the things they think make the weather. The students might guess what the weather will be that afternoon or the next day. In response to their teacher's question--"How will you know which guess was right?"--the students might suggest that the guesses be recorded as a basis for comparison. The children may then decide to work in small groups to investigate certain factors they think are important, such as cloud type, temperature, precipitation, pressure, wind speed or direction. The flow chart suggests some activities that might take place. Motivated by their own experiences and curiosity, some groups may want to construct simple weather instruments; these may be calibrated using local weather data. A few children may decide to check on the records of past weather and the factors present at the time.

The data collection scheme should be designed by the children with help as needed from the teacher or from the "How To" Cards. Data may be represented in several ways; many groups may choose to construct line graphs. A wind direction group may make a circular scatter graph. Other scatter graphs may be constructed to compare the data of two groups. Histograms may be plotted to show the number of days it rained or was sunny vs. changes of pressure.

Predictions should be correlated with observations as early as possible in the unit. This might be brought about by a simple challenge: "What do you think the weather will



*Collecting weather data.
Bonnie Rollenhagen, Grades 4-6.*

be for the game (or other event) today?" Representation of data on pegboards may help the children correlate weather factors with the actual weather. The class may decide to issue short-range local weather predictions for the school. Some competition with other classes or schools may be worked out.

As the children collect the data and make their observations and predictions, they may see the need for more data or for a different type of data. Other activities may include the comparison of the student's measurements with the weather forecaster's measurements or the introduction of another factor, such as high and low pressure areas, on which to base their predictions. Class discussions and informal discussions with other students may provide suggestions for possible improvements to their predictions and information necessary for documentation.

It is hoped that the unit might culminate in some action. The children might set up a weather station in school and post day-to-day weather predictions or write up predictions for the school newspaper; they might establish a service to make weather predictions for special events. While seeking different ways to publicize their predictions, the children might decide to investigate the challenge of Mass Communications.

Although many of these activities may require skills and concepts new to the children, there is no need for preliminary work on these skills and concepts because the children can learn them when the need arises. In fact, children learn more quickly and easily when they have a need to learn. Consider counting: whereas children usually learn to count by rote, they can, through USMES gain a better understanding of counting by learning or practicing it within real contexts. In working on Weather Predictions children also learn and practice graphing, measuring, working with decimals, and dividing. Although dividing seems necessary to compare fractions or ratios, primary children can make comparisons graphically; sets of data can also be compared graphically or by subtracting medians (half-way values). Furthermore instead of using division to make scale drawings, younger children can convert their measurements to spaces on graph paper. Division may be introduced during calculation of percentages or averages.

2. CLASSROOM STRATEGY FOR WEATHER PREDICTIONS

The Weather Predictions unit is centered on a challenge-- a statement that says, "Solve this problem." Its success or failure in a classroom depends largely on (1) the relevance of the problem for the students and (2) the process by which they define and accept the challenge. If the children see the problem as a real one, they will be committed to finding a solution; they will have a focus and purpose for their activities. If the students do not think the problem affects them, their attempts at finding solutions will likely be disjointed and cursory.

The Weather Predictions challenge--"Make your own weather predictions (for this afternoon, tomorrow, or a special occasion)"--is general enough to apply to many situations. Students in different classes define and reword the challenge to fit their particular situation and thus arrive at a specific class challenge. For example, second- and third-grade students in one school were challenged to make daily predictions for the school.

The Process of Introducing the Challenge

Given that a problem exists how can a teacher, without being directive, help the students identify the challenge that they will work on as a group? There is no set method because of variations among teachers, classes, and schools. However, USMES teachers have found that certain general techniques in introducing the challenge are helpful.

One such technique is to turn a discussion of some recent event toward a related challenge. For example, on a stormy day or after a flood or hurricane, a teacher might focus a discussion of the weather on a Weather Predictions challenge. (This may be a particularly useful strategy if some class outing was cancelled because of the bad weather.) The children may be asked whether knowing ahead of time what the weather may be would help people prepare for it.

A combination second/third-grade class began their investigations of the Weather Predictions challenge through a discussion of what the weather meant to them. Their city had been flooded during the summer because of heavy rains. Each student related how the flood had affected him/her. The children discussed the weather changes they had observed before the flood.

The Weather Predictions challenge may also be introduced during or after work on another USMES challenge. For example, children working on the Play Area Design and Use challenge whose investigations are interrupted by inclement weather may decide to work on the Weather Predictions challenge. When children encounter a problem that leads to a related USMES challenge, one group of children may begin work on the second challenge while the rest of the class continues with the first challenge. However, there should be at least ten to twelve students working on any one challenge; otherwise, the children's work may be fragmented or superficial or may break down completely.

An USMES challenge may also evolve from a discussion of a specific topic being studied by the class. The topic itself may lead directly to certain aspects of weather, and the challenge then puts the study of weather into the context of a real problem. For example, children involved in the study of geography of their own area may become interested in predicting weather for the school or community.

Experience in classrooms has shown that the children's progress on any USMES challenge may be poor because of lack of an initial challenge or lack of continuous focus on the challenge. If the challenge is not given at all or if it is given and then divided by the teacher into a sequence of activities, the work becomes purposeless in the children's minds. The motivation inherent in searching for a solution to a real problem is missing, and the children quickly lose interest. Work on the Weather Predictions challenge can easily degenerate into a study of weather (with subsequent loss of interest) unless the work is focused on first making, and then improving, predictions of the weather.

A primary teacher working on the Weather Predictions challenge failed to issue a challenge. Instead, the children investigated various elements of the weather as independent areas of study, e.g., wind, rain. The children were engaged in many "hands-on" activities, such as feeling hot and cold places, taking different temperature readings, blowing bubbles to see the direction of the wind, and using hygroscope cards; yet, the activities were fragmented. Each activity briefly gained the interest of the children and occasionally involved prediction, but the children did not develop the momentum usually attained when work is focused toward the solution of a real problem.

An intermediate-grade teacher periodically issued what she said were class challenges but which were, in fact, study topics rather than real problems, e.g., "What is the relationship of the sun, moon, and tides?" "What makes clouds?" The children researched the questions, conducted experiments, and viewed films. Class attention gradually focused on observations of the weather and collection of data on weather factors, and although construction of weather instruments was begun, it was without a purpose.

A third problem that has in the past blocked significant progress on the Weather Predictions challenge occurs when too much emphasis is placed on facts; that is, exact measurements, terminology, etc., and not enough emphasis is placed on day-to-day changes and on forecasting based on these changes.

A sixth-grade class investigating the Weather Predictions challenge became involved in making outside observations, collecting data from weather instruments and newspapers, and formulating predictions. However, very little use was made of the weather patterns and trends indicated by the day-to-day changes in the weather contained in the data collected by the class. Thus, an important way to improve predictions was ignored.

In summary, the Weather Predictions challenge should focus on making predictions from the very beginning. Children should be encouraged to guess what the weather will be and record both their guesses and the accuracy of their guesses. It is only in this way, with the children keeping records of their early predictions and results, that the students are able to compare later predictions with early ones, evaluate their efforts, and make necessary changes to improve their accuracy.

Once a class has decided to work on the Weather Predictions challenge, USMES sessions should be held several times a week, but they need not be rigidly scheduled. When sessions are held after long intervals, students often have difficulty remembering exactly where they were in their investigations and their momentum diminishes.

Initial Work on the Challenge

Next the students usually assign priorities to the various tasks that must be performed so that some groups do not become stalled on their progress because others have not completed their tasks. The students then form groups to attack different aspects of the problem. For example, in one class students working to formulate daily weather predictions for the school population formed different groups to accomplish this. Some students charted daily outside observations; one group collected data from commercial weather instruments; others designed, built, and used simple weather instruments; another group collected weather data from the local newspaper and plotted it on a large plastic map of the United States that they had constructed. Each aspect required comprehensive investigation by both groups and individuals, and the work was then correlated and used by students to formulate weather predictions. However, the teacher may find that having too many groups of only two or three students attacking different aspects of the problem at the same time not only makes it difficult to be aware of the progress or problems of each group, but also makes it difficult for thorough investigations of the challenge to be performed by the class; the larger the number of groups, the smaller the membership of each group, thus lessening the chance for varied student input and interaction. As initial work is completed, students regroup to investigate other parts of the problem.

Focusing on the Challenge

As a class works on a challenge, the children's attention should, from time to time, be refocused on that challenge so that they do not lose sight of their overall goal. Refocusing is particularly important with younger children because they have a shorter attention span. Teachers find it helpful to hold periodic class discussions that include group reports. Such sessions help the students review what they have accomplished and what they still need to do in order to find some solutions to the problem. These discussions also provide an opportunity for students to participate both in evaluating their own work and in exchanging ideas with their classmates. (Another consequence of having too many groups is that not every group can be given enough time to report to the class, thereby increasing the possibility that the children's efforts will overlap unnecessarily.)

A combination class of second- and third-grade students met for class discussions many times during

the course of their investigations. The teacher took these opportunities to refocus on the prediction aspect of the challenge, thus insuring that her students' efforts were in response to the real problem of making a daily school-wide forecast.

Resources for Work on the Challenge

When children try to decide on solutions before collecting and analyzing enough data or encounter difficulties during their investigations, an USMES teacher helps out. Instead of giving answers or suggesting specific procedures, the teacher asks open-ended questions that stimulate the students to think more comprehensively and creatively about their work. For example, instead of telling students involved in a Weather Prediction investigation what information they will need to make their predictions, the teacher might ask, "What do you think makes the weather?" or "What information would help you most in predicting the weather?" Examples of other nondirective, thought-provoking questions are given in the Teacher Resource Book.

The teacher may also refer students to the "How To" Cards, which provide information about specific skills, such as using a stopwatch or drawing graphs. If many students, or even the entire class, need help in particular areas, such as using fractions to calibrate weather instruments or to make graphs of weather data, the teacher should conduct skill sessions as these needs arise. (Background Papers provide teachers with additional information on specific problems associated with some challenges and on general topics applicable to most challenges.)

USMES teachers can also assist students by making it possible for them to carry out tasks involving hands-on activities. If children need to collect weather data outside of their classroom, the teacher can help with scheduling and supervision. If the children's tasks require them to design and construct items, the teacher should make sure that they have access to a Design Lab. Any collection of tools and materials kept in a central location (in part of the classroom, on a portable cart, or in a separate room) can be called a Design Lab.

Valuable as it is, a Design Lab is not necessary to begin work on an USMES challenge. The Design Lab is used only when needed, and this need may not arise during early work on the challenge. To carry out construction activities in schools without Design Labs, students may scrounge or borrow tools and supplies from parents, local businesses, or other members of the community.

*Constructing anemometer and wind vane.
Bonnie Rollenhagen, Grades 4-6.*



Fifth graders in one class worked successfully on the Weather Predictions challenge without the use of a Design Lab. Data collection activities were begun immediately. A plastic map of the continental United States on which weather data was recorded was constructed. As the need for more data arose, children became involved in the construction of weather instruments in the classroom. Initial construction activities focused on wind instruments; the classroom teacher supplemented the materials brought in by the students with supplies from the art room. A rain gauge, simple hair hygrometer, and a portable weather station were designed and built in the classroom.

Another fifth-grade class began work on the Weather Predictions unit before the school's Design Lab opened for use. Data collection, which was begun immediately, showed the need for more weather instruments. Students built a thermometer in the room. Scrounging in the community and an Open House for parents provided enough materials to set up a mini-Design Lab in the classroom. Students continued to build weather instruments, e.g., mineral oil barometer, anemometer, weather vane, thermometer shelter, to facilitate data collection and weather prediction.

The extent to which any Design Lab is used varies with different classes and schools because the children themselves determine the direction of the investigations and because construction activities are more likely to occur in some units than in others.

Culminating Activities

Student investigations generally continue until the children have agreed upon and implemented some solution to the problem. One class accurately predicted the weather for Thanksgiving vacation in spite of conflicting forecasts from the weather bureau. Other classes formed groups to make competitive predictions and to broadcast daily weather predictions over the school's public address system.

3. USE OF WEATHER PREDICTIONS IN THE PRIMARY GRADES

Children in the primary grades may become very involved in the Weather Predictions unit while working on a series of class challenges to predict the weather for certain times or certain days. By examining weather variables, such as temperature, clouds, wind, and rain, they will determine what information helps them most in accurately predicting the weather. Although their entry level to the challenge and sophistication with the investigation will certainly be different than that of intermediate-grade children, they will be able to realize both how the weather affects their lives and how they can anticipate it, thereby making prediction useful in planning their activities. A cancelled excursion or several days of indoor recess because of an unexpected storm may be the basis for a lively discussion in response to the teacher's question, "What difference does the weather make to you?"

Second and third graders react enthusiastically to discussions of their own experiences with weather and what it means to them. In order to maintain the motivation and interest of young children, one must acknowledge the egocentrism inherent in their stage of development and focus investigations around their experiences. Past work has shown that this is essential to the success of the unit with primary-aged children.

Multi-sensory experiences and outside observations, when followed by discussions of how each child feels, lead naturally to a series of class challenges--"Predict what the weather will be for gym today." "Will we be able to go outside?" Observations made by the children are recorded on the daily calendar which is a standard learning material in many primary classes. The range of their observations is wide: some examples are sunny, rainy, dark clouds, trees blowing, cold, and warm.

The teacher and children may record their ongoing predictions on a chart or in their weather books. This can be accomplished by using symbols or words. A combination of such symbols or words recorded in individual logs is an effective and personal way to teach them to read. These predictions are then compared with the actual weather by the children during later discussions of the weather and what it means to them. The children begin to think about ways they can improve their predictions; for example, "Is it more likely to rain (or snow) when it is getting colder or when it is getting warmer?" "Is it more likely to rain when the wind is blowing hard or when it is calmer?" It is advisable for the teacher to ask questions which directly

pertain to the children's experiences and make them aware of some ways that the ability to predict the weather helps them, e.g., "How do we know whether to wear a raincoat or snowpants?" "Why does the wind make it harder at times to walk to school?"

In order to collect data, the children must learn to read simple thermometers; the task is made easier by the fact that they have a reason to learn it. They might want to construct simple weather instruments such as wind vanes and rain gauges. After observing the clouds, the children compare clouds they have seen with pictures of clouds and begin to discuss what the different clouds indicate about the weather. The children can then make simple bar graphs and other simple representations of the data collected. This helps them to focus on the quantitative aspect of the data collected and relate it to the weather. For example, some questions raised by the class are "How much colder was it yesterday than it is today, and how does that affect the clothing we are wearing?" "How much rain fell last week as compared with the amount that fell this week?" "Did we spend more days outside last week or this week?"

As these activities continue, the children's own weather logs or class log may show improvement in their predictions. They can tally the number of right and wrong predictions made and consider why one forecast was more accurate than another. The discussion may center on the kinds of information which were collected in their correct predictions, and a pattern may begin to emerge.

USMES' goal of imparting to children the power of using concrete investigations as the basis for decision making can be realized in the primary grades. The interdisciplinary nature of USMES activities is especially helpful in the development of the "whole" child. Pursuit of solutions to the class challenge involve language arts, mathematics and science activities. The children are now ready to use their knowledge of weather predictions to help them schedule other class trips, predict the weather for recess or lunchtime, or predict the weather for a holiday weekend.

The following flow chart presents some of the student activities--discussions, observations, calculations, constructions--that may occur during work on the Weather Predictions challenge. Because each class will choose its own

4. FLOW CHART

approach to the challenge, the sequences of events given here represent only a few of the many possible variations. Furthermore, no one class is expected to undertake all the activities listed.

The flow chart is not a lesson plan and should not be used as one. Instead it illustrates how comprehensive investigations evolve from the students' discussion of a problem.

*Measuring wind direction.
Florence Duncan, Grade 6.*



Challenge: Make your own weather predictions (for this afternoon, tomorrow, or a special occasion).

Optional Preliminary Activities:

USMES Units:

- Growing Plants
- Nature Trails
- Play Area Design and Use

Study of geography

Study of weather.

Possible Student Activities:

Class Discussion: What difference does the weather make to you? What are the different types of weather? Would knowing ahead of time what the weather will be help people?

Observation of weather on a particular day.

Class Discussion: Report on observations, e.g., "sky was cloudy, it was dark." Directions to watch for weather changes.

Simple predictions and verification: guessing, persistence, trends, Farmer's Almanac, folklore.

Daily observations and forecasts. Chart of observations: notation of changes.

TV or newspaper forecasts.

Class Discussion: Review of list of observations and types of weather. Information needed for predictions. Identification of variables.

Precipitation: Construction of rain gauge. Collection of newspaper data.

Clouds: Type and direction. Weather associated with different types.

Temperature: Use of thermometer.

Barometric pressure: Construction of simple barometer. Collection of newspaper data.

Wind Speed and Direction: Construction of wind vane. Observation of weather from various directions. Beaufort scale of wind speed.

Relative humidity: Construction of psychrometer, hygrometer. Collection of newspaper data.

Representation of data on charts.

Representation of data on circular scatter graphs.

Representation of data on line graphs, bar graphs.

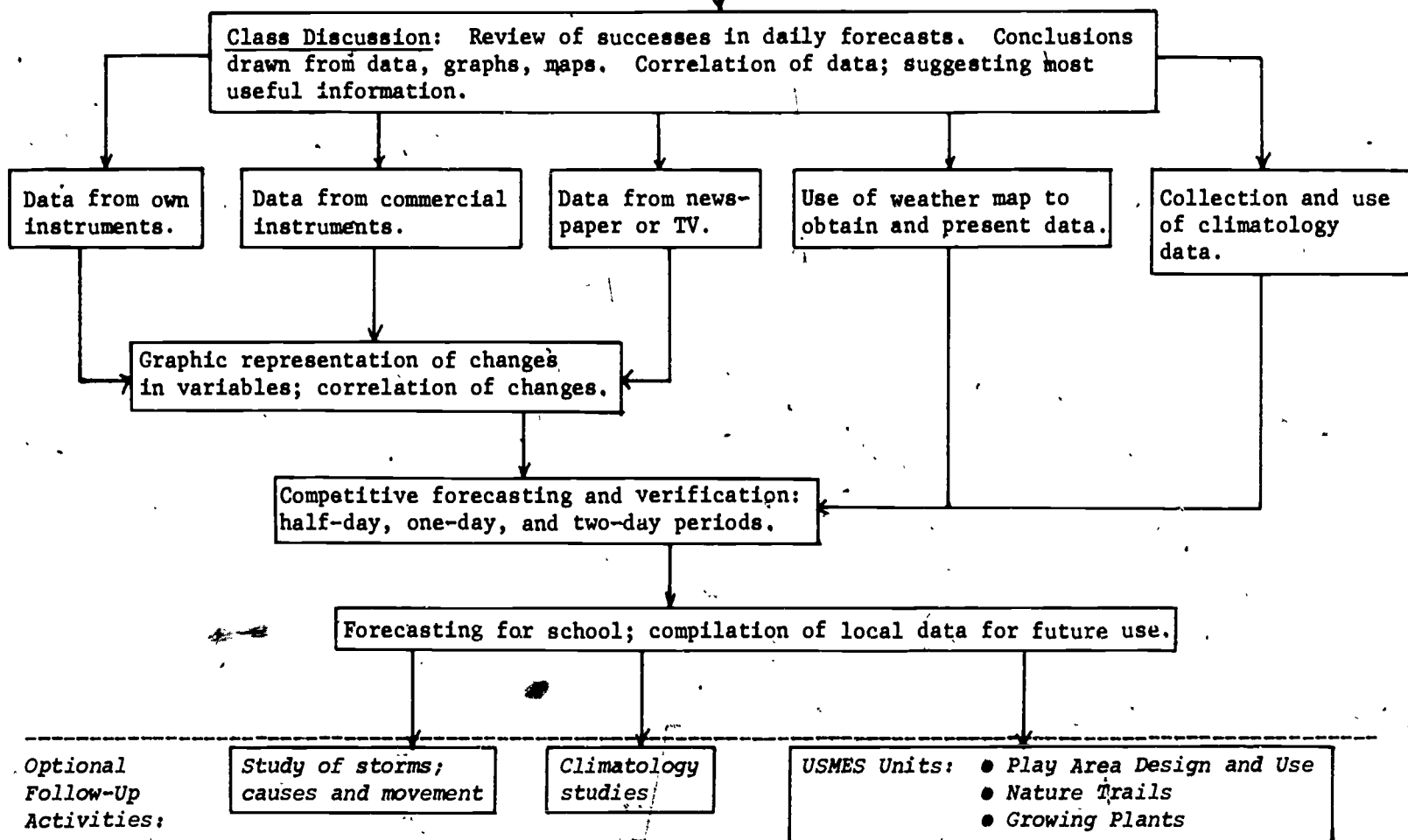

5. A COMPOSITE LOG*

This hypothetical account of an intermediate-level class describes many of the activities and discussions mentioned in the flow chart. The composite log shows only one of the many progressions of events that might develop as a class investigates the Weather Predictions challenge. Documented events from actual classes are italicized and set apart from the text. Weather data used is that for the Boston, Massachusetts area.

"I'm going to get soaked going home," means one student watching the rain pour onto the playground. "I didn't know it was going to rain, and I didn't bring a rain jacket."

"Maybe it will stop soon," replies a classmate.

"I hope so!"

Hearing this exchange, the teacher asks the class, "What difference does the weather make to you?" Some children reply that someone has to come and pick them up on rainy days and that they cannot go outside to play. On sunny days they have fun walking to school and playing outside during recess and lunch periods. Their opinions are listed on the board in columns labeled "good weather" and "bad weather." The list is expanded when the teacher asks what difference weather makes to other people.

The teacher next asks whether knowing ahead of time what the weather might be would help people. The children's answers vary and include the fact that forecasts are often wrong. The class lists different types of weather: rainy, sunny, windy, foggy, snowy, cold, hot, sandstormy, etc.

The teacher then takes the class outside to observe everything they can about the weather on that day. When they come in again, the children discuss what they saw. Their comments vary: "It was raining." "It was dark." "The sky was cloudy."

A sixth-grade class in Monterey, California, listed the following observations about the weather after observing outdoors: warm, windy, not too hot, breezy, trees moving, some clouds very high, clouds were moving, moving to the north (teacher notes they were actually moving to the east), weather is "green." Two days later the children listed observations as follows: heat, clouds, wind, haze, blue sky, cold, green, sun, clouds moving, wind from the southwest, wind gusty, and wind breezy. (See log by Gary Childs.)

A fourth/fifth/sixth-grade class in Lansing, Michigan, responded in many different ways to the questions, "How does daily weather affect us?" "Why do we listen to the weather forecast on TV or radio?" Their answers were as follows:

*Written by USMES staff.

1. People who are travelling want to know what the weather is going to be.
2. So we know what clothes to wear,
3. To plan a camping trip, baseball or football game, a picnic.
4. For safety--floods, tornadoes.

The children then listed rain, snow, sleet, hail, floods, sunny, cold, clouds, fog, tornadoes, typhoons, hurricanes, and windy as types of weather. At the next session, they grouped the above-listed types of weather into four categories: water, air, wind, and clouds. (From log by Bonnie Rollenhagen.)

As the session draws to a close, the teacher asks them to guess what the weather will be for the next day. Most of the students agree that it will be rainy, but some say it will be warm and others say it will be cool. One girl says she thinks it will be clearing because it isn't raining as hard as it was in the morning.

The next morning brings a light rain but by midmorning the skies begin to clear. A discussion ensues centered on the question of who was right. They decide that everyone was right in this instance but that in future predictions they will have to be more specific with regard to rainfall.

"If you say it's going to be fair, and it rains, then your prediction is wrong," states one boy.

"But what if it's only a brief shower?" another child asks.

"People would still get wet," he replies. The children then decide to limit their predictions to temperature, rain/no rain, and cloudy/partly cloudy/sunny.

"How will we know who's right and who's wrong?" one girl asks. In response, another girl suggests that they record their guesses in special weather log booklets. The class enthusiastically agrees with this idea. They decide to start with four columns on each page to record the data, their prediction for that data, their observations of the weather on that data, and whether the prediction was right. (See Figure B5-1). One boy also suggests that they make their observations and predictions in the morning around 9:00 A.M.

DATE	PREDICTION FOR TODAY	WEATHER OBSERVATIONS	WAS PREDICTION CORRECT?

Figure B5-1

Second graders in Plainfield, New Jersey, each had a weather book as part of their investigation of the Weather Predictions challenge. In

the book the children recorded new weather-related vocabulary along with their meanings, sketches of weather instruments, and their weather predictions. Temperature readings were also charted individually in the books as well as on a class chart, and the children calculated average temperatures. (See log by Judith Gray.)

Each morning for the next two weeks the class goes outside for a short time to observe the weather. Upon their return to the room, the students form groups to guess what the next day's weather will be. This is then written in the proper column for the next day in their weather booklet. To measure the outside temperature, one child suggests taking the classroom thermometer outside.

Sixth-grade students in Charleston, South Carolina, began their investigation of the Weather Predictions unit by doing some "preliminary" work on learning about different weather variables. Soon challenged to predict the weather, they first predicted the high temperature range for the day. As their confidence grew, this changed to the exact high temperature. Simultaneously, groups formed to collect data on different weather variables using homemade and commercial instruments, and the data was charted as it was collected. They were elated when their first public weather prediction for the October PTA meeting was correct. (From log by Mary Ellen Warner.)

Fourth graders in Iowa City, Iowa, focused on predicting the weather for their schoolmates early in their investigations. Everyone agreed that the class needed a system for recording the weather information they obtained. One child prepared a chart on which to record their data. The children selected the following variables to follow: temperature, humidity, cloud cover, and wind speed and direction. The class met at the end of each day, read the weather information that had been recorded earlier on the chart, and formulated a weather prediction for after school. Students went to other classes and shared their prediction with schoolmates in a way most comfortable for them--spoken or written. (From log by Florence Duncan.)

Sometime during the third week, the teacher reviews their original lists of what difference weather makes to people and asks the children how accurate their forecasts, have been and whether they think they can improve the accuracy of their predictions of what the weather will be like the next day. The children examine their weather logs to calculate the accuracy of their predictions. They compare the percentages of correct forecasts and find that two groups have a record of 70%, one has a record of 60%, and two have a record of 50%.

The teacher then asks the children whether any weather characteristics seem to change when the weather changes. The children quickly see that it changed from partly cloudy to cloudy before it rained and that the wind changed directions as it cleared. Other characteristics such as temperature have not changed so consistently. Another student mentions that the clouds on different days haven't looked the same. She reports that a book she found in the library shows many different types of clouds and gives the types of weather that usually come with each type of cloud. She suggests adding cloud type to the list. The teacher asks the children to listen to weather forecasts that evening on TV or radio or to read them in the newspapers to see whether the forecaster talks about anything they don't have on their charts.

Next day, after reviewing the previous day's list of changes in weather characteristics, the teacher asks the children whether anything should be added. One child says that they should add "pressure" because it was on the TV but that he doesn't know what it is. The teacher tells them that pressure is related to wind and asks them if they can think of a way to make a wind in the room. The children decide that there must be an excess of air in one spot and a lack of air in an adjacent spot in order for the wind to blow. The teacher then explains that the amount of air in (or over) a certain spot causes what is called air pressure on that spot. If there is a lot of air over a place, the pressure is high; if there isn't as much air, then the pressure is lower. The teacher then adds that the air pressure can be measured.*

As the teacher is adding pressure to the list of charac-

*The explanation of pressure can be made more elaborate with older children. The standard "crushed" can experiment is a good one, but a complete explanation is a bit complicated. To initiate another, perhaps simpler, experiment, the children could be asked to figure out how they get milk to go up a straw or how to get liquid into a medicine dropper.--ED.

teristics to be watched, one boy suggests that they add two more columns to their weather booklets, one for the TV, newspaper, or radio forecast and one for whether it was right. The class agrees that this will be a further check on the accuracy of their predictions.

Children in the Iowa City class checked the accuracy of their weather predictions daily. After the class formulated their afterschool forecast based on data they had collected, other students called the local radio station, asked for the station's forecast and compared it with their own. (From log by Florence Duncan.)

The teacher then asks the children whether they think they can forecast the weather more accurately by using one or more of the characteristics they have listed. She also asks how they can make their observations more accurate and what characteristics can be measured. Groups are formed to discuss the problems involved with each characteristic: wind direction, cloud types, temperature, and pressure. Some groups decide to construct crude instruments. Some of the ideas for the instruments come from the students, other ideas come from library books or the "How To" Cards.

The students in Plainfield became interested in building an anemometer. They listed the materials they would need, gathered them, and built an anemometer with a minimum amount of teacher input. They also constructed a simple rain gauge and construction paper thermometers that helped them to understand and to learn how to read their commercial outdoor thermometers. (See log by Judith Gray.)

Groups of children in the Monterey class spent many periods in the Design Lab constructing measuring instruments. The Temperature Group started taking data with commercial thermometers (both centigrade and Fahrenheit) but then constructed several colored water thermometers in the lab. The Pressure Group constructed coffee can and mineral oil barometers, with varying degrees of success. Various types of hair hygrometers were tried by the Humidity Group, while the Wind Group made a number of successful improvements to their wind vane and anemometer before working instruments were achieved. Rain gauges were also constructed. The Cloud

WEATHER DATA CHART					
Date	Temperature	Wind Direction	Barometric Pressure	Cloud Type	Rainfall (or snow)

Figure B5-2

57

Group made daily visual observations of clouds and also constructed a device that formed a cloud in a bottle. (See log by Gary Childs.)

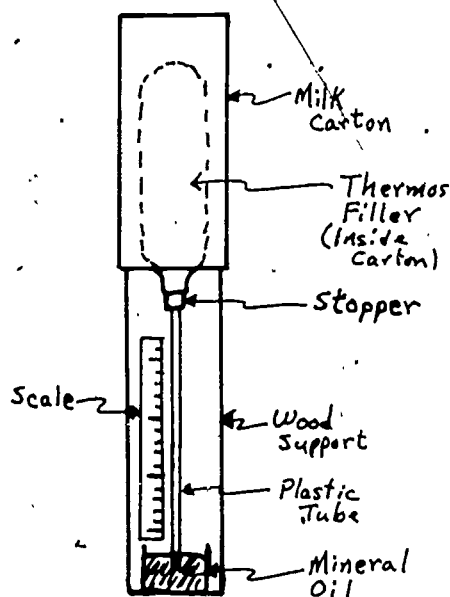

Figure B5-3

WEATHER DATA CHART					
Date	Temperature (°C)	Wind Direction	Barometric Pressure (in.)	Cloud Type	Rainfall (or snow) (in.)
Oct. 1	15°	SW	30.3	High, thin cirrus	0
2	16°	SW	30.3	Nimbo-stratus	Trace
3	17°	S	30.0	Nimbo-stratus	0.26
4	20°	SE	30.0	Stratus	0
5	18°	NE	29.8	Nimbo-stratus	0.10
6	NO SCHOOL				
7	NO SCHOOL				
8	13°	NW	30.2	None	0
9	13°	NW	30.2	None	0
10	11°	None	30.3	Stratus	Trace
11	10°	None	30.3	Stratus	Trace
12	16°	NW	30.2	None	0
13					

Figure B5-4

While working on their instruments, the class continues their observations and decides that they need to keep a large chart on the wall to display the measurements they plan to take. Each day the groups (Wind Direction, Cloud Type, Pressure, Temperature) will measure their characteristics and record them on the chart. When one boy points out that they haven't said anything about rain or snow, the Cloud Type Group offers to construct a simple rain gauge. Until they finish it, they decide to use rainfall measurements given in the newspaper. They agree that they need six columns, one for the date and five for recording the measurements. Their chart looks like the one in Figure B5-2. (They still keep a record of their predictions, the TV prediction, and the actual weather in their weather logs.)

After a few days work, the various groups making instruments report to the class. They explain the instruments, including their good points and the difficulties encountered during construction, while students in other groups make suggestions for improvements of the instruments.

The Temperature Group reports that, although constructing a thermometer is possible and is interesting, the commercial ones are so inexpensive and so much more accurate that they intend to use a commercial thermometer. The Wind Direction Group displays the wind vane they have built, and the Cloud Type Group shows the class their rain gauge.

The Pressure Group notes the difficulties that they have encountered while constructing a mineral oil barometer. They report that they can't get the mineral oil into the tube and that they can't get a proper seal around the stopper. (See Figure B5-3 for a sketch of their barometer.) Someone suggests they use a rubber stopper for a seal, which they agree to try.

The students agree that each group should start collecting data to add to the class chart of weather measurements each day. The teacher also asks the groups to think about ways to show their data.

The groups work for several weeks collecting data to record on their chart (see Figure B5-4) and improving their instruments. The Temperature Group is now using the average reading from several thermometers to record the outside temperature. On their first day they report their readings.

"I got 60°," says one boy.

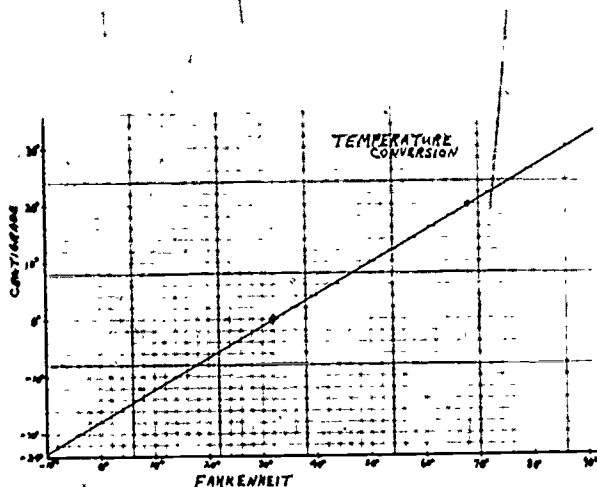

Figure B5-5

"That's wrong," says a girl, "my thermometer read 16°!" They soon discover that two of their thermometers are centigrade and two are Fahrenheit. Although they find a formula relating the two scales in a book, they feel that is too cumbersome to use every day.

"Why don't you make a graph that converts one reading to the other," suggests the teacher, directing them to the "How To" Cards on conversion graphs. From their book the students find that $0^{\circ}\text{C} = 32^{\circ}\text{F}$. and that $20^{\circ}\text{C} = 68^{\circ}\text{F}$.; these two points are enough to construct the conversion graph shown in Figure B5-5. To gain further experience with the metric system, the students decide to record temperatures in degrees centigrade.

The Pressure Group puts the finishing touches on their barometer. To get the mineral oil into the tube, they have used a hair dryer to heat the inside of the vacuum bottle. Immediately inverting the apparatus with the tube in the mineral oil, they find that the oil rises slowly in the tube as the inside of the vacuum bottle cools.

While finishing their barometer, they take readings with an aneroid barometer that one student has brought from home, and they record this data on the chart and in their weather logs. When comparing these readings to the changes in their homemade barometer, they find some discrepancies. One student notices that when their homemade barometer is placed in the sun, the pressure seems to fall, but when it is moved to a cool spot, the pressure seems to rise. They conclude that the temperature is affecting their barometer, too, and they decide to keep it in a closet in the room, away from any source of heat (radiators, sun) and out of drafts. This, they feel, should make the pressure readings fairly consistent.

One group of fifth graders in an Arlington, Massachusetts, class had difficulty in constructing their mineral oil barometer. After several attempts they were able to seal it using a rubber stopper instead of a cork stopper, and they succeeded in getting the mineral oil to go into the tube by warming the inside with warm water. After placing it to avoid temperature effects, they were able to record changes in barometric pressure with reasonable accuracy. (From log by Minette Jeske.)

To display their data to the rest of the class, they decide to plot the barometric pressure on a pegboard graph.

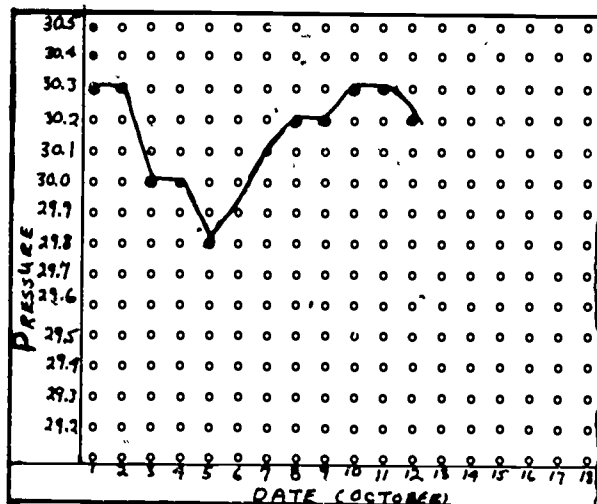

Figure B5-6

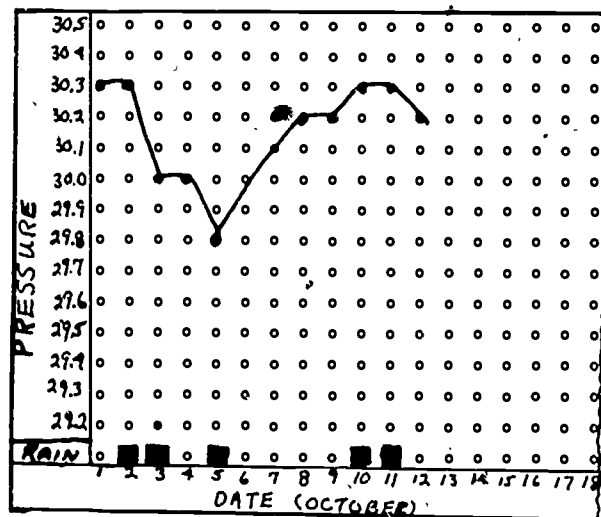

Figure B5-7

	BAROMETER UP	BAROMETER DOWN	NO CHANGE
RAIN	I $\frac{1}{3}$ = 33%	III $\frac{2}{3}$ = 67%	I $\frac{1}{2}$ = 50%
NO RAIN	II $\frac{2}{3}$ = 67%	I $\frac{1}{3}$ = 40%	I $\frac{1}{2}$ = 50%

Figure B5-8

This they construct by putting a vertical scale (the rows of holes marked in inches of mercury) for pressure on the left and a scale (the columns of holes marked in days of the month) for time on the bottom. Each point is plotted by placing a wooden peg in the proper hole to represent the pressure for that day. Then they loop yarn around the pegs across the board to make a line chart. (See Figure B5-6.)

One girl mentions that the TV forecaster had said that the pressure was falling and that rain was likely. The Pressure group then immediately checks the class chart to note the days that it rained so that they can add this information to their graph.

After they have indicated the rainy days by blue Tri-Wall squares along the bottom of their graph (see Figure B5-7), they notice from their ten days of observation that three times out of five it rained when the pressure fell and that two times out of three it cleared when the pressure rose. They are eager to report to the class that they have found, a way to predict the weather more accurately using data from their instrument. However, one member suggests they make a chart showing the percentages for each type of change because, she notes, it also rained on some days when the pressure had risen.

They construct the chart shown in Figure B5-8, and show the class that 60% of the time it rained when the pressure fell and 67% of the time it cleared or was fair when the pressure rose. Since absolute accuracy doesn't seem necessary, they feel that even their homemade mineral oil barometer will be useful to show changes in pressure. When one classmate points out that their results are based on only two weeks of observation and don't show much difference, especially since 40% of the time the barometer fell with no rainfall, the group agrees that more data is needed to increase their accuracy.

The sixth-grade students in Monterey plotted the daily temperature readings for the month of January on a 4' x 8' pegboard by placing red squares on the appropriate peg for each day. When the teacher asked how they could show whether it rained or not on a certain day, the students said they would use a yellow square for days it didn't rain. Other students then plotted barometric pressure on the pegboard placing the scale on the opposite side of the board from the temperature scale. (See log by Gary Childs.)

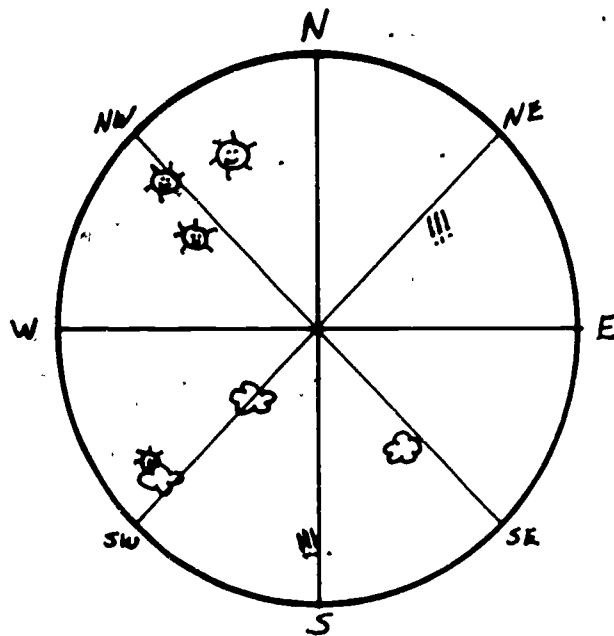

- Sunny
 - Partly cloudy
 - Cloudy
 - Rain or snow
- Figure B5-9

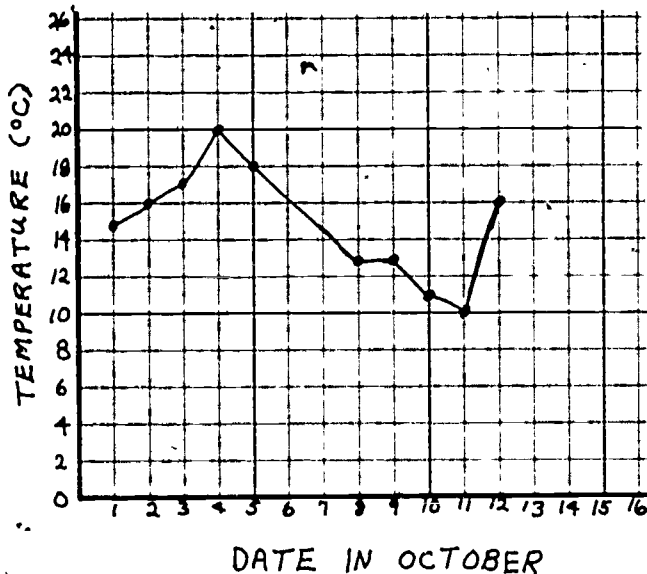

Figure B5-10

Meanwhile, the Cloud Type Group has been recording the various cloud types. Their library research has shown them that there are many different types of clouds and that certain types of clouds have certain types of weather associated with them. To help with forecasting, they prepare a large chart with the more common cloud types grouped according to the type of weather they produce. They also post a large color chart that shows each type of cloud in detail.

During their investigations of the Weather Predictions unit, the Arlington class saw a film on clouds that motivated them to make outside observations of cloud types. One student developed a short course on clouds that she shared with the class. The course included basic information on cloud formation and cloud types and the correlation of cloud types with specific types of weather. (From log by Minette Jeske.)

Having constructed a working wind vane, the Wind Direction Group begins to take measurements. However, they find that near the building, the wind direction is highly variable; and they decide to measure it on the large playing field away from buildings and trees.

To plot their data on wind direction, they construct a circular scatter graph (see Figure B5-9). On a circle marked with compass directions they draw a symbol to represent the type of weather that comes from that direction. They find that when the wind is from the northwest, the weather is sunny, but when the wind is from the northeast or southwest, the weather is cloudy or rainy. They note that they need more observations to be able to determine percentages for accurate forecasting although one boy adds that his grandfather says that the weather is often bad when the wind is from the northeast.

The Temperature Group has a little trouble at the start, obtaining somewhat high temperatures. When they explain their measuring procedures to the rest of the class, one student remarks that they have been taking their measurements near the building and in the sun. The group then realizes that they haven't been getting a true temperature reading and decide to measure the temperature in the shade of a tree as far from the building as they can get. Even though they are recording the daily temperature on the class chart, they further decide to draw a line chart of the temperature, to add to it each day, and to keep the graph posted on the wall for everyone to see. (See Figure B5-10.)

Each group (precipitation, wind speed, humidity, temperature, barometric pressure) in one fifth-grade class in Eaton Rapids, Michigan, used either bar graphs or line charts to show the data collected from their homemade instruments. At first they made charts, but later, at a student's suggestion, they plotted the data directly on the graphs. Each day one boy put white and pink arrows on a circle which had compass directions on it. The pink arrow pointed to wind direction when he left school one day; the white arrow showed the wind direction the next morning. (See log by Cathy Daane.)

Each group continues to forecast the weather based on their own data on one weather characteristic, predicting temperature, rain/no rain, and cloudy/partly cloudy/sunny. A record is kept of the accuracy of the predictions. A few weeks later the teacher asks the children whether they can improve their forecasting accuracy by using more than one factor as a basis for their forecasts. Because each of the groups has been wrong in some portion of their forecast several times, most agree and debate which factors are the best to use.

The Pressure Group reports on their data for the last ten weeks. They note that on fifteen of twenty-two days, or 68% of the time, it rained when the pressure fell and that on seventeen out of twenty days, or 85% of the time, it was sunny or clearing when the pressure rose. They further noted that on those days when the pressure didn't change, the weather remained the same as the day before. The class agrees that change in pressure should be one of the factors used for forecasting.

The Wind Direction Group reports on their scatter graph. They have found that most of the time the wind is from either the northwest, west, or southwest. They note that 80% of the time that the wind was from the northwest, the weather became fair, while 54% of the time that the wind was from the southwest, the weather was cloudy and rainy. They further explain that when the wind is easterly (anywhere between northeast and southeast), the weather is cloudy and rainy 80% of the time. This, they say, indicates that when the wind is from the west or northwest, the weather will most likely become or remain fair; further, when the wind is from an easterly direction, cloudy and rainy weather is likely.

"That must be what the TV weatherman means when he says '20% chance of rain'!" exclaims one child.

Noting the similarity to the data offered by the Pressure Group, another student remarks, "He probably figures the pressure and the wind direction together and has lots of data to work from."

One member of the Pressure Group then notes, "Anyway, we can say from our information that if the wind is from the east and the pressure drops, it almost certainly will rain, and if the wind is from the northwest and the pressure rises, it almost certainly will clear."

"What about when the wind is from the southwest?" asks the teacher.

The Wind Direction Group notes that 55% of the time it rains when the wind is from the southwest and 45% of the time, it is clear. "Then, we need the pressure change to decide what to predict," says one of the group members. "If the pressure is falling, we should predict rain, and if it's rising, we should predict fair weather."

The Temperature Group reports that they haven't noticed much correlation between the temperature and the type of weather (fair or rainy). However, they point out that the two times it snowed, the temperature had dropped. They feel that the temperature determines whether the precipitation will be rain, snow, or sleet, which is very important in predicting the weather.

After an unusual snowfall, the Monterey class checked their data and noted that the pressure had been falling for four days and that the temperature had been dropping rapidly on the day before. They decided that these factors and knowledge of past weather when such conditions were present had enabled one forecaster to predict the snow. (See log by Gary Childs.)

The class decides to divide into two groups--the Thunderheads and the Northeasters--to compete each day in forecasting the weather for the next day. The class further agrees that forecasts may be updated before everyone leaves for the day. The Thunderheads plan to use barometric pressure, wind direction, temperature, and weather maps. The Northeasters argue that weather moves from place to place, and if they know what the weather is like before it gets to their location, they can forecast much more accurately. The teacher asks how fast they think the weather moves. The children say they will find out by checking old weather maps. This group collects daily weather maps and studies the locations of the high and low pressure areas and the

movement of weather fronts.

In the Eaton Rapids class a weather map group reported daily on conditions around the country, especially in Michigan. They transferred some of the information from the map in the local paper to a plastic sheet overlying a map of the U.S. After the presentation each day, a group of students wrote on the board their prediction for the next day based on weather map information and on their own data. The following day the forecasting group was rated by the class on a scale of one to ten for accuracy. At the same time, the students' forecast was compared to the local weather bureau forecast. (See log by Cathy Daane.)

The competition continues for several weeks with both groups preparing fairly accurate forecasts. One day the Thunderheads predict that it will rain the next day, but the Northeasters predict only partly cloudy skies. Because of the rain, the Thunderheads predict the temperature will be 13°C to 18°C , while the Northeasters predict it will be 18°C to 22°C .

When the students arrive at school the next morning, the sky is dark and overcast; by recess time it is raining and the temperature is 16°C . "How did you know it would rain?" asks one boy. "We looked at the weather map, and the closest weather front was moving very slowly."

One girl replies, "We used our cloud chart. In the morning we saw high cirrus clouds; then lower clouds came in, and we saw a halo around the sun. Our chart shows this is usually followed by rain in about ten hours." The Northeasters later find out that the warm front on their weather map began to move more rapidly and arrived sooner than they had predicted.

The children in the Charleston class predicted the weather for Thanksgiving vacation and had it announced on the school's public address system. On the day the prediction was made, data was collected hourly. Their prediction was for fair and warm weather, while the TV forecaster predicted rain. They held firm to their prediction based on the data they collected despite pressure from another class. The weekend weather was fair and warm! (From log by Mary Ellen Warner.)

The Eaton Rapids class decided to pit boys against girls in predicting the weather. They decided to forecast four items: temperature, wind speed, chance of precipitation, and general conditions. Each group received some part of twenty points for each item, depending on the accuracy of the prediction. (See log by Cathy Daane.)

The Thunderheads are declared the winners of the competition, and the teacher asks the class whether they would like to post weather forecasts on a school bulletin board and give a forecast over the public-address system. They think this will be fun and decide to give a forecast in the morning for the afternoon and also to give one for the next morning. They agree that they should use pressure, temperature, cloud type, wind direction, and weather maps in their forecasting and that they should predict a temperature range, chance of rain (as a percentage), amount of cloudiness (sunny/partly cloudy/cloudy).

The class divides into four groups with each group to be responsible for the forecast for one week at a time. The accuracy of each group will be tallied on a large chart and at the end of the school year the group that is ahead in the competition will win a prize.

Near the end of the year the class discusses their results. All the groups have been quite accurate in their forecasting. They have found that the short-range (afternoon) forecast is easier to make and more accurate than the longer-range (next day) forecast. Further, they have found that they usually agree with the TV forecaster and that their predictions are wrong about as often as those of the TV forecaster.

The primary students in the Plainfield class took turns preparing a daily weather forecast, including cloud cover, temperature, and wind. They then read the forecast over the school's public address system. (See log by Judith Gray.)

The Monterey class formed six groups to make short- and long-range predictions of the weather. Each group submitted a prediction consisting of six items: chance of rain (in per cent), high and low temperatures, relative humidity (in per cent), wind speed, wind direction, and cloud cover (in per cent). Each group received one to six

points based on the accuracy of their predictions; the winning group received free ice cream at the end of the week. (See log by Gary Childs.)

6. QUESTIONS TO STIMULATE FURTHER INVESTIGATION AND ANALYSIS

- What difference does it make when the weather is bad?...is good?
- What weather do you like best?
- What do you think the weather will be like tomorrow?
- What do you think makes the weather?
- What information would help you most in predicting the weather?
- How could you measure the temperature?...the amount of clouds?...the wind direction?...the pressure of the air?...the amount of water in the air?
- How can you tell what direction the wind is coming from?
- What different types of clouds have you seen?
- What is a good way to keep a record of your data?
- What is a good way to make a picture of your data?
- How can you find out if your data is correct?
- How does your temperature (cloud, wind speed, pressure, humidity) data help you predict the weather?
- Does your temperature or pressure (cloud or wind speed, etc.) data help you more in making good predictions?
- How can weather maps help you predict the weather?
- How can you use records of past weather data in making predictions?
- Do past records of weather or present readings help you more in making good predictions? How can you prove it?
- How often do you think you can beat Mrs. X's class in predicting the weather?

C. Documentation

1. LOG ON WEATHER PREDICTIONS

by Judith Gray*
Stillman School, Grades 2-3
Plainfield, New Jersey
(September 1973-March 1974)

ABSTRACT

These second- and third-grade students began their investigation of the Weather Predictions challenge with a class discussion of what weather meant to them. Daily weather observations were posted next to the monthly calendar which was consulted daily. The children read newspapers to collect weather data and learn about weather symbols and maps; many listened to the television and radio weather reports in the evenings. The children were challenged to predict the weather for the next day. This activity continued throughout the school year. Predictions were verified and their accuracy was discussed. Temperature differences were often calculated in the course of class discussions; this helped strengthen the children's computation skills and encouraged them to use them more. Children learned about simple weather instruments such as thermometers, rain gauges, and anemometers as their interest directed them. During the construction of some of the instruments and the use of all of them, the children learned about fractions, compass directions, and the differences between the Fahrenheit and centigrade temperature scales. The data and background information they collected was represented in charts and murals on cloud types and temperatures. Both second and third graders were motivated to learn about averaging while preparing their temperature charts. On a student's suggestion, daily forecasts were announced on the school's public address system.

My class began working on Weather Predictions by discussing what the weather meant to them. There responses were--

1. how it feels outside
2. rain
3. wind
4. when the sun is shining
5. when it is cold

*Edited by USMES staff

I asked the children if they thought weather was only one of the factors cited or if they were a combination of the things on their list. After a class discussion, the children agreed that it was all of the things mentioned. The students were anxious to relate their own experiences with the weather. Because of heavy rains, Plainfield was flooded during the summer, and each child told how the flood affected him. The children discussed the changes they saw take place before the flood, e.g., how dark the sun became. One girl drew a picture of her experience in the flood.





Discussions of weather and its effects on us continued for several sessions. I asked the children to think of major weather changes during the year. They cited spring, winter, summer, and fall. We talked about these different times of year and shared pictures collected outside of school. Acknowledging their need for our investigations to relate directly to them, we talked about how one season "feels different" from another. In response to a question I raised concerning how one keeps track of the seasons, the class and I discussed the uses of a calendar.

Because of the age of my students our preliminary efforts with the unit were concentrated on producing in the children an increased awareness of the weather. Next to the class calendar the children hung 9" x 12" pieces of construction paper; the children decided to post the day's weather observations on these papers. Cards were made to describe the weather, e.g., sunny, cloudy, rainy, windy, cold. Each day a different child placed cards for his/her observation on the wall. Outside observations and follow-up discussions took place several times during the day. Finally the whole class discussed the observations and listed them on the board. One day they included the following items:

1. leaves changing color, falling
2. sunny
3. windy
4. cold
5. feeling they weren't dressed warmly enough

During one class discussion when the children were asked to describe the day's weather, many said that it was "cold and winter" outside. One child also remarked that she thought it would be warmer in the afternoon. The child had no explanation for her prediction. The rest of the class voted on whether it would be warmer or the same that afternoon. The results of the vote were recorded: eight voted that it would be warmer, sixteen voted that it would remain

the same. The class went outside after lunch and observed; they concluded that it felt warmer.

The children were asked to bring in weather maps from the local newspaper. We discussed the symbols on the map, e.g.,  rain,  snow,  showers,  flurries. The children found the areas on the maps that indicated the above conditions. We located the temperatures for New York City and New Jersey. We discussed the meaning of the word forecast. Initially, the children thought that it meant the temperature. By the end of the class session they agreed that forecasts told all about the weather. A bulletin board display of the weather maps was put up in the room. While they were involved in this activity, the children realized that they were looking at a map of the United States; they began to talk about the locations of various places where they had visited or lived, and this led to a discussion of directions.

Children began listening to weather reports in the evening. Most could not remember them by the time they came to school the next day. On one particular school day, two children did remember that the forecast was for a partly sunny day. I asked the class how hot they thought it would get that day. Three temperatures were suggested by the class: 49°, 70°, 82°.* We voted on the three numbers predicted: four children predicted 49°, twelve children predicted 70°, and seven children predicted 82°. We asked the school secretary to listen to the weather report during her lunch hour and send us the information. The children were very excited about involving the school secretary. The twelve people who voted for 70° were the winners.

The class challenge presented to the children was, "What will the weather be tomorrow?" After some discussion the class voted: four children thought it would remain the same, thirteen children felt it would change and five children did not know and did not want to vote. Two children asked if they could bring a portable radio to class so that the entire class could listen to the weather report. The following day the class divided into two groups to listen to the 1:30 P.M. weather report to verify their predictions. The temperature reading reported was 60°. The temperature had dropped but it remained cloudy. I asked the children which of their classmates had made the correct prediction. One little girl answered that both groups were right; her

*The temperatures given in the log are in Fahrenheit degrees, the Fahrenheit scale being the most commonly used scale in the U.S.--ED.

reasoning was that although it had gotten colder, it had remained cloudy. We talked about how much colder it had become and how we could find out just how many degrees the temperature had dropped. Someone called out, "You subtract 60° from 70° ." Another student said that it was 10° colder. I put the problem on the board:

$$\begin{array}{r} 70^{\circ} \text{ yesterday} \\ - 60^{\circ} \text{ today} \\ \hline 10^{\circ} \text{ difference} \end{array}$$

The children were very excited when they arrived at school several days later. There was a very heavy rainfall that the children had to walk through to get to school. We discussed their reactions during the morning meeting. Several children in the class said that the amount of water in gutters reminded them of the flood that Plainfield had in August of 1973; others thought that this was silly because, according to their observations, it was not raining as hard. One child suggested that we take a vote which led into a discussion of prediction and whether or not voting and predicting were the same thing. The children decided that in this case they were the same. The results of the vote were recorded:

- 8 children predicted a flood
- 9 children predicted continued rain
- 7 children predicted that it would stop raining and clear up before the school day was over.

At the end of the day we had a class meeting to discuss the information we had gathered during the day through observation, from parents and from the radio weather report as told to us by another teacher. The children decided that they were all partly right based on the information received. The very heavy rains in the morning had flooded the streets and the playground; many sections of the highway were flooded and the water was moving very fast. The class decided that this could be called a flood even though it did not compare to the flood that occurred during the summer. The group of children who predicted rain had not set a time limit and since it had stopped raining before school dismissal, the rest of the class felt that they were correct also. The children and I discussed the importance of giving a complete prediction; they learned much from this experience.

During the morning meeting held the next day we opened the blinds and spent several minutes observing the weather.

I asked the children to compare it with yesterday's weather. I listed their observations on the board:

1. . it was not raining anymore
2. cool
3. cold
4. sunny
5. partly windy
6. muddy
7. damp
8. wet,
9. partly cloudy

I discussed with them what it meant to observe and closed the meeting by asking them to look up the meaning of the words "prediction" and "observe" and record them in the weather books they had begun. We met at the end of the day to share what we had discovered.

During the next class session I asked the children if they could tell me (by guessing) what the temperature was outside. Three students responded immediately: 30°, 32°, 34°. We talked about ways that we could accurately determine the temperature. Several students suggested using a thermometer. Discussion showed that most of the children knew what a thermometer looked like and what it did but that no one knew how to read one. I carried out a skills session with the children on reading the thermometer. First we reviewed how to count by twos and threes. I related this to a thermometer by pointing out to the children the graduation lines on it. Several children placed the thermometer outside* and timed a twenty minute period. We brought the thermometer inside and a third grader read it: it registered 42°. After the child read the thermometer, other children became extremely interested in learning about this weather instrument. Many of them drew a picture of a thermometer, color-coding the different parts, in their weather books. One student's work is shown in Figure C1-1.

Observation activities continued throughout the day and we met as a group to discuss the observations and record them. The students noted the following observations:

*Some consideration should be given to whether the thermometer is in the shade or in direct sunlight. The children might discuss what effect a different location might have on the thermometer reading.--ED.

11/6/73

cold
Sunny
Windy

32° is the freezing point. It snowed early this morning.

It is 42° outside. Draw a thermometer

The room temperature is 80°
11:30

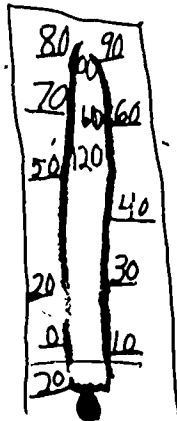

Figure C1-1

1. It was cold, sunny, and windy.
2. It snowed early in the morning.
3. It was 42° outside the school at 11:30 A.M.
4. The room temperature at 11:30 A.M. was 74°.

We examined the outside temperature reading and discussed the freezing point. The children knew that the freezing point is 32°; I asked them how many degrees above freezing 42° was. We put the problem on the board and determined that it was 10° above freezing.

Each child in the class made a construction paper model of a thermometer with a movable part. (See Figure C1-2.) I felt that the children would benefit greatly from practice in reading different temperatures on the model and being able to locate other temperatures on it. The models were eventually mounted and displayed on a bulletin board.

On the next day we began our class meeting with a weather observation. The consensus was that it was sunny and cold. I asked the children what they thought the temperature was outside. Their replies were 42°, 30°, 32°, 50°. We placed the thermometer outside while we continued our discussion.

I asked the class what they thought the temperature was in the classroom. Their replies ranged from 32° to 90° . One girl said she thought it was 74° ; I asked her why she picked that particular number. She replied, "Because it was 74° in the room yesterday and it feels the same to me."

I used this opportunity to explain that this was one simple method of prediction: the use of previously collected data to predict future weather. Students went outside and brought in the thermometer; a student read it-- 49° *. Then, we placed the thermometer in the room; the reading taken after lunch was 87° . We continued to take indoor and outdoor temperature readings and compare them with the readings from the previous day.

Work on the Weather Predictions unit was suspended for several weeks because of vacations and the holiday season. We picked up our investigations at a class meeting where we discussed weather and listened to a long-playing record about weather called "Spare Songs." I followed the listening activity with a discussion of what they had heard. The children showed a continued interest in the unit and the data collection we had been doing. One student read the morning newspaper weather report to the class. The bureau report indicated that we would have a cloudy, mild day with a chance of rain and temperatures ranging from 48° to 52° . Then we compared the newspaper forecast with our own. I asked my students if they knew of any way we could keep a record of the temperature readings collected each day to determine whether they fell within the predicted range of temperatures. Students suggested that we make a temperature chart. I took this opportunity to ask the children if they had heard of the word average; they had not. I explained it to them by working with them first to find out the number of children in three classrooms and then to determine how many children would be in each room if they were evenly distributed. I took them through the steps involved in solving the problem: adding the number of students in each classroom together and dividing the total number of children by the number of classrooms. We discussed each step of the process. The addition involved was new to the second graders but not to the third graders; the division was new to all of the children and generated much interest.

The children decided to take three readings a day at predetermined times and average them at the end of the day.

*If the thermometer were not read while it was still outside, it had a chance to warm up while it was being brought in. Consequently, the outside temperature might have been lower than 49° .--ED.

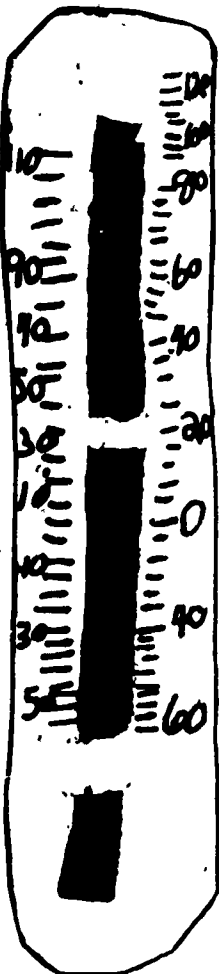

Figure C1-2

The three times chosen were: 9:00 A.M. (at the beginning of the school day), 11:30 A.M. (at lunch time), and 2:30 P.M. (at the end of the school day). We prepared our chart. A page from one child's weather book is shown in Figure C1-3.

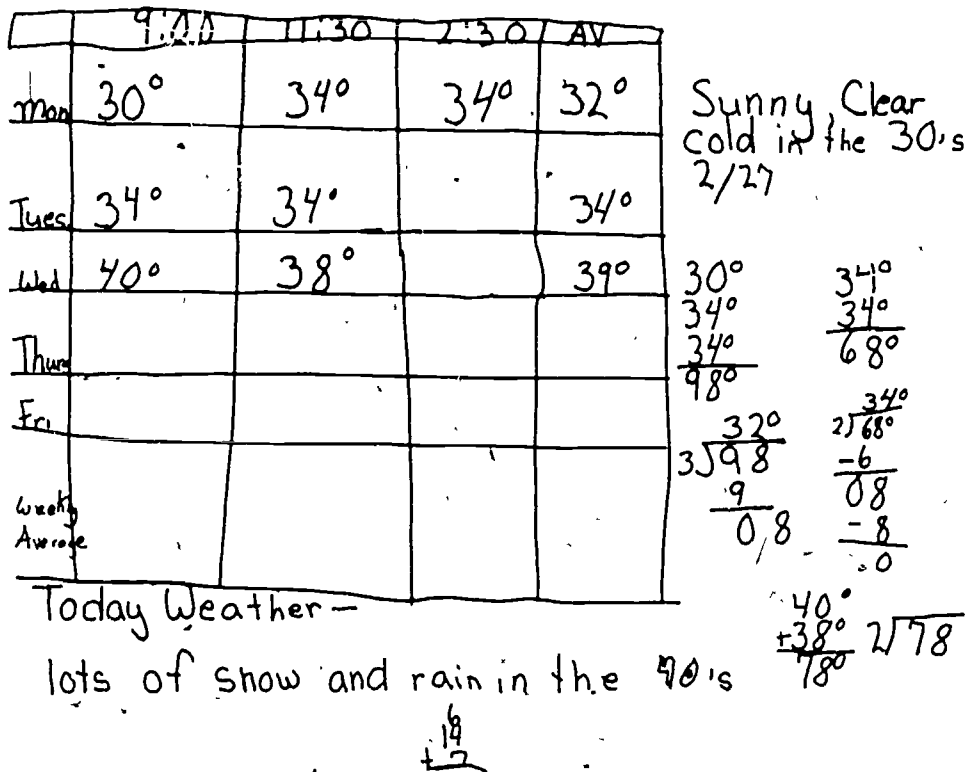

Figure C1-3

The class was very excited about the prospects of dividing. Temperatures were read and recorded on the chart. Each day the entire class, with my help, computed the average. The second graders began to participate more as their confidence increased. One day we did not have enough time to average the temperatures as a class. I asked a third-grade student if he could do it for us and was pleased to learn that he could. All of the students decided to work hard on improving their mathematical skills so that they, too, could find the average.

A third-grade student asked if we could have a weatherman and make a weather report over the public address system every morning. The rest of the class eagerly agreed to participate. I advised the girl who had made the suggestion to speak with our principal. A meeting was arranged with the principal that afternoon at which time a student presented

the idea. The principal approved the idea and it was scheduled for the next week. New temperature charts were made each week. The children demonstrated that they knew and understood how to find an average by finding the average temperatures for certain times during the day in addition to the daily average, e.g., the 9:00 A.M. averages for the week, the 11:30 A.M. averages for the week.

At one class meeting a child shared with the class the information that she had been getting up every morning at 6:30 A.M. to read her father's thermometer that was hung in the garage. This is but one example of the amount of interest and involvement on the part of the students. One parent stopped in the classroom to tell me how excited her child was about the unit.

The P.A. system weather reporting began. The children were not yet comfortable giving their own forecast and chose, instead, to begin with the weather bureau, radio, or newspaper report. Two, as yet, unknown words came up in discussion, "fog" and "frost." The children added them to their weather books. Unit activities became integrated into much of their work, and they spent an average of five to six hours on the unit each week.

During one session, after we had charted the temperature readings, I asked the children if there were a difference between the meanings of the word temperature and the word weather; this related to an earlier discussion. One child responded that weather is everything. When asked to expand his idea, he replied, "It is the sun, the rain, the wind, the heat, the cold." Another child raised her hand and responded that temperature is how hot or cold it is.

As our temperature data collection activities continued, I advised the children to be sure not to touch the bulb of the thermometer and the children asked why. I gave the thermometer to one student and asked him to touch the bulb while the others observed. The child noticed immediately that the temperature rose. The class decided that a "true" outside reading could not be taken if the bulb of the thermometer were accidentally touched.

About this time, I had to fly to California; it was my first flight and the children anxiously awaited my return so we could discuss the event! I told them that one of the most exciting things to me was going through the clouds. I asked them if they would tell me what they thought one would find above the clouds. It was a very interesting discussion. Some children responded that one would find heaven and God; one little girl had just flown in from the Virgin Islands,

and she said that it was sunny above the clouds. I explained that her observation was correct. The class concluded that clouds blocked the sun. I asked them if they thought that the clouds could be of use in predicting the weather; they responded affirmatively. I asked them how, and one child said that when the clouds are very dark it might rain. The children wanted to learn more about clouds and worked individually to uncover more information. Many children used the library as a resource while others used available materials in the room. Each day we discussed their progress.

The children used the information they had obtained about clouds and made charts of blue and white construction paper showing the shape of different clouds and their relative heights. (See Figure C1-4.) One group made a large wall mural showing many different cloud types with their heights. This was then placed up on the wall where everyone could see it. A sketch of this chart is shown in Figure C1-5. We also discussed using clouds as a source in predicting the weather.*

During this time the daily weather reports continued; temperature readings were recorded and averaged. One student excitedly told me that she had learned a lot about clouds on her own and had just identified the type of clouds in the sky. She believed that they were stratus clouds. The two of us went outside to look again, and she verified her earlier identification. I asked her to share her observation with the rest of the class by writing what she saw on the board, and the class then discussed her observation.

The children continued to add new weather vocabulary words to their weather books as they came up in the context of the unit. In addition to the class temperature chart on which the children took turns making entries, each student kept a weekly chart in his or her own weather book. The children continued to be very interested in averaging the temperatures. We attacked the problem as a class; even the second graders began to participate in the activity. We talked about the process of averaging: what is involved and how to remember the procedure. On occasion, the children were able to estimate correctly the average temperature without doing the computation. They based their work on the temperature readings and average temperature that they

*The children could observe the cloud types each day and include that observation in their weather books along with the day's weather. They might later be able to associate certain cloud types with certain types of weather.--ED.



Figure C1-4

Figure C1-5

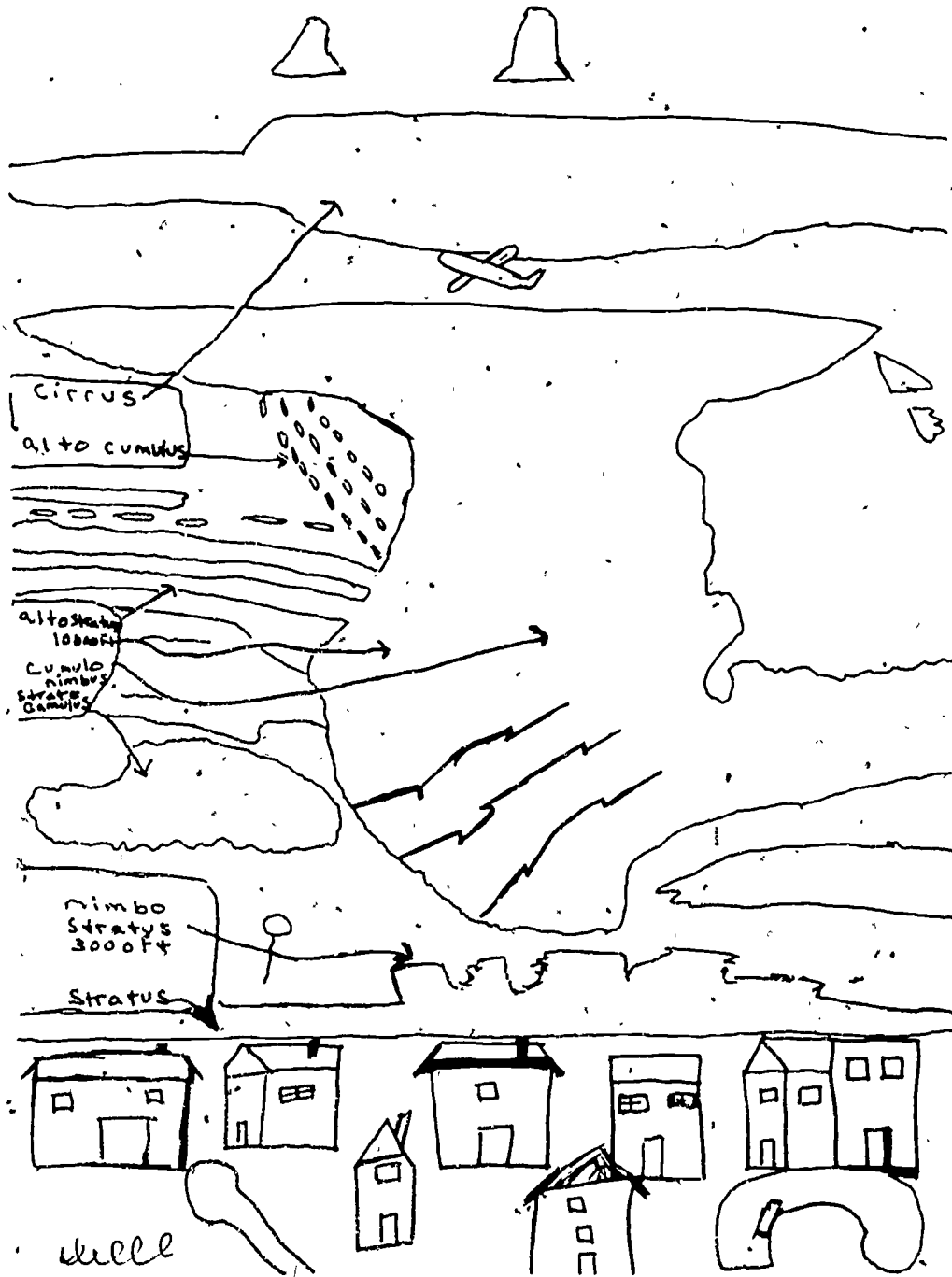

had already calculated for the previous day. The children enjoyed this aspect of their investigations so much that they asked for additional division problems.

I received an order of erasable card thermometers and distributed them to the class. We took the 9:00 A.M. temperature reading; it was 36° . Many had difficulty; I asked them if they noticed any differences between the scale on our erasable thermometers and the scale on the one we were using for outdoor readings. The majority of the students said yes but were unable to identify the difference. After some discussion, one child was able to verbalize it. She said that there was a difference because the graduations on the erasable thermometers were by fives while they were by twos on the outdoor thermometer. We practiced counting by fives and examined the sketch I made on the board of the new thermometers. The children were paired up (second graders with third graders) and practiced counting by twos and fives to 100.

During our next session, while working on our temperature chart, nine children voiced their opinion that the averages for the last two days should be the same. When they reexamined the data, they found that this was not so because the three temperature readings were different. We worked out the average and discovered that there was a 5° difference between the two averages.*

On a rainy Friday morning I introduced the children to rain gauges. I showed a commercial gauge to them and asked if anyone knew what it was and how it was used. One child immediately identified it and explained its purpose to the class (she had seen one before). One of the third graders looked up the definition of gauge and read it aloud--an instrument for measuring. I asked the class if they knew of another way to measure rain. One boy suggested using a can and a ruler. He collected both materials and we placed them outside along with the commercial rain gauge at 10:50 A.M. The children decided to bring them in at 11:30 A.M. to measure the amount of rainfall. The rain had stopped by that time and both gauges were empty.** It began to rain again and both instruments were placed outside in a place where they would not be moved by children or the wind. The children planned to check them when they returned to school on Monday.

*The teacher might ask for volunteers to try to make up two sets of temperature readings which included different temperatures but had the same averages.--ED.

**The children might discuss why there was no water in either gauge.--ED.

On Monday, the gauges were brought into class; I asked the children to record their own readings in their weather books sometime during the day, and we would discuss them the following day.

The next day, I asked them what they could tell me about the rainfall during the weekend. One girl commented that the rain water in the coffee can was gone. I asked if the can had been overturned; all responses were negative. One child commented that it had disappeared. I asked the class what they knew about water that disappeared like our rain water. When there was no response, I asked, "What happens to the rain puddles that appear when it rains and disappear afterwards?" One girl said that the water evaporates, and this led to an interesting discussion of the water cycle.

Then, we focused our attention on the commercial rain gauge which still had water in it. I asked for their opinion on the amount of rain in the gauge. Almost the entire class said there was one inch of water in the gauge. I drew a picture of the gauge on the board with the different graduations and the water level clearly marked. One of my students noticed the decimal point in front of the 1 mark but did not know what it meant nor how to read it.

I told the class it meant $1/10$ and that that meant the rain gauge had collected $1/10$ of an inch of rain water. This led into a session devoted to fractions; most of the children had never been introduced to the concept of fractions. I asked ten children to join me at the front of the room. I explained that together they were one whole. Then, I moved them physically to show that each person represented $1/10$ of the whole. We did this with thirds, fourths, and eights; the children seemed to understand. One student observed that it would have to rain a lot for us to collect one inch of rain.*

A newspaper article in the local newspaper prompted me to ask my students if any of them had ever heard of an instrument called a weather vane. Several children said yes and were able to describe one. I then asked if someone could tell me the use of a weather vane. One third grader responded that it was "to show the way the wind was blowing." He further explained that the arrow pointed out the direction of the wind.** This led naturally to a review

*The children might discuss the construction of the commercial rain gauge and why the 0.1 inch marking was more than 0.1 inch from the bottom of the gauge.--ED:

**The children might decide to find out whether the arrow points to the direction toward which the wind is blowing or to the direction from which the wind is blowing.--ED.

of compass directions. The session ended with my reading the newspaper article aloud to the class. There were several words that the children did not understand. I asked them to look up their meanings and record them in their weather books. In addition, I encouraged my students to find out everything they could about weather vanes.

During the next class session, one student gave his report on weather vanes. The class was very interested. The report included a reference to the word anemometer. I asked the children if anyone knew the difference between an anemometer and a weather vane. One of my third graders correctly defined an anemometer as an instrument that tells you how fast the wind is blowing while a weather vane tells you the wind direction. Another student asked if wind direction could be included in the daily weather report. Of course I said yes.

On the following day, one of my students wanted to find out the wind direction. I suggested that the entire class go outside to see if we could determine it. After ten minutes we returned to the room to discuss what we had seen. The class voted on the direction they thought the wind was blowing: twelve said north, three said south, one said east, one said west, and five had no opinion. I asked the children for the basis of their votes. They explained that their votes were based on their observations of the directions the leaves were blowing, the way my hair was blowing, and the way the paper was blowing in the room.

Several students were interested in building an anemometer. They listed the materials they would need, including milk cartons, medicine droppers, scissors, paper clips, and clothes hangers. The children worked on the project together and were able to complete it with a minimum amount of teacher input.

One day after a month of reading researched weather forecasts over the public address system, I asked a student to be the class weather reporter for the next day. He was hesitant and, when questioned, shared the reasons for his hesitation with the class: he did not have a telephone on which he could call the Weather Bureau and his mother did not subscribe to the daily newspaper. The class discussed other ways of getting weather information. Their initial responses included the television, radio, newspaper, and Weather Bureau. After several more minutes, one student became very excited and suggested that the class could predict the weather as we sometimes do in the room.

We discussed some different ways of making predictions. One student suggested that if it were sunny one day, it would more likely be sunny the next day. Someone said, "We

could look at the sky." Another child said we could look at the clouds. I related to them that some people predict rain whenever a certain part of their body hurts, e.g., a toe, hand; several students had parents who did this.* All of the children agreed to try their own predictions. Four children made predictions for the following day on which the class voted. One student counted the number of children in the room and added up the total votes to be sure that each child had participated. The predictions and votes are listed below.

<u>Prediction</u>	<u>Votes</u>
1. windy, cold, temperature in the 30s	10
2. cold, sunny, 40 ^o temperature *	4
3. sunny, temperature in the 60s	1
4. sunny and cool	2

The following day we verified the predictions by comparing them with the actual weather. The second prediction came very close; it was cold and sunny with temperatures in the 40s. Another prediction was made on the next day; three children made predictions based on outside observations as follows:

1. partly sunny, cold
2. cold, sunny
3. cold, sunny, cloudy**

Following this lead, I explained to the children that they were going to begin group predictions which would be used in their public address system broadcast. Two groups of children formed; each met in a different section of the room to discuss the weather among themselves and formulate a prediction for the next day. The results can be seen on the following page.

*The children might agree to use the various methods to predict the weather and keep records of the actual weather to see which method worked best.--ED.

**The student might be asked to explain her prediction, e.g., does she mean that it would be partly sunny the whole day, or sunny one part of the day and cloudy another part of the day. The class could then discuss whether they were predicting the weather for the whole day or for a certain time of day.--ED.

Group A - partly sunny, cool and in the 40s
(based on observation)

Group B - sunny, windy, cold and in the 40s
(based on observation)

Group predictions continued to be made throughout the semester. They were verified daily.

The children's interest was high throughout unit activities. They have developed an awareness of weather and an understanding of the importance of knowing what the weather will be on a given day. While working on the Weather Predictions challenge, the children did much work on their art, math, science, and dictionary skills. The children really enjoyed the computation involved in some of their data collection activities.

2. LOG ON WEATHER PREDICTIONS

by Cathy Daane*
Northwestern School, Grade 5
Eaton Rapids, MI
(September 1972-March 1973)

ABSTRACT

Students in this fifth-grade class were challenged early in the school year to predict the weather for their area. They identified specific weather variables that would be important to watch and began data collection activities immediately using a variety of sources, for example, home-made and commercial instruments, their senses, as well as newspaper, TV, and radio forecasts. As the data was accumulated it was charted, mapped, and graphed in a variety of ways and analyzed for weather patterns and trends. In addition to six weather topics groups, the children broke into small groups to predict the weather on a rotating basis. Group membership was not static but rather changed as the needs and interests of the students did. Competitive predictions were instituted and the predictions were shared with schoolmates. The Michigan class exchanged weather and geographical information through the mail with another class working on the unit in California.

Early in the school year I asked my class whether they could predict the weather. During the discussion they noted wind, rain, clouds, and temperature as things to watch. They began collecting data immediately, recording the high and low temperatures for each day in September. By listening to the radio and by watching the TV weather report, they gathered other data, including chance of rain and the outcome of forecasts. It wasn't long before they raised the question of why the weather forecaster was wrong so often.

As the children began to follow the daily weather reports, they had questions concerning the high and low pressure areas to which the weather forecaster kept referring. To answer some of their questions, I brought to class a large piece of plastic on which one of the students drew a map of the continental United States. To keep track of the directions in which the high and low pressure areas were moving and to see what was happening in those areas, one of the students each day plotted the locations of the areas, and we then discussed what effects they had on Michigan.

*Edited by USMES staff

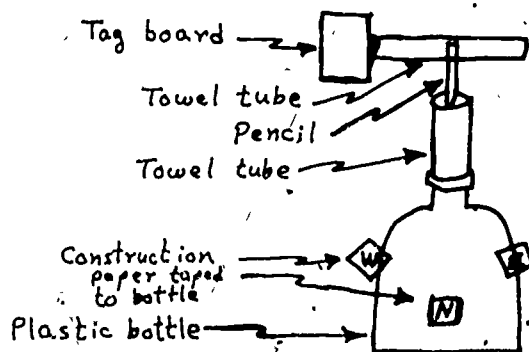
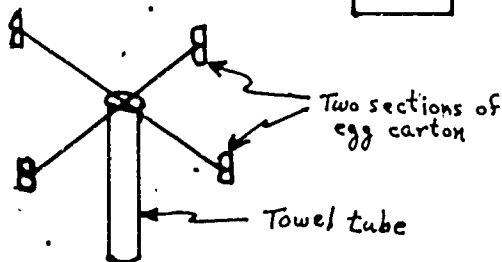
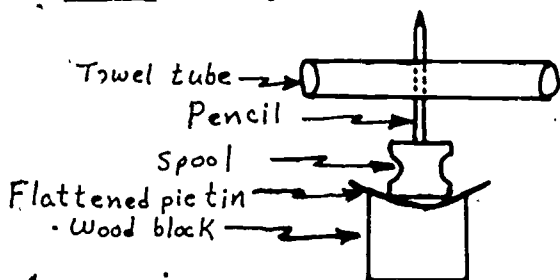
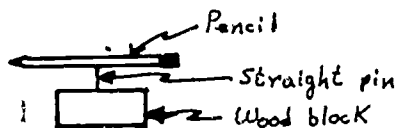
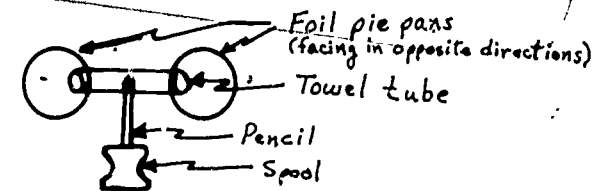

Figure C2-1

The children quickly began to see that air pressure had a lot to do with weather conditions.

Using a barometer and relative humidity gauge (hygrometer) that I had bought, the students recorded the rise and fall of the barometric pressure and correlated it with the highs and lows coming into the area. Thus, the children became directly involved in taking their own readings rather than just recording the readings reported by the weather bureau. An indoor/outdoor thermometer was installed so that the children could compare the temperatures and follow the outside temperature changes hourly.

During the course of their investigations, the children decided to begin constructing wind instruments, and we discussed in class what materials might be used. Asked to bring materials from home, the students contributed--

straws	nails
milk cartons	foil
spools	styrofoam
pieces of wood	egg cartons
string	bottle caps
paper tubes	popsicle sticks
screws	

I supplied the remainder of the needed materials from the art room.* The children constructed their instruments according to their own designs, some of which are sketched in Figure C2-1.

In the afternoon the children tested the finished constructions and discovered that most of the wind vanes were perpendicular to the wind. They also found that there had to be at least three arms on an anemometer in order for it to turn. The students worked for the next week to improve their instruments, some of which eventually worked quite well.

Two groups attempted to make air barometers, one of which was made by heating a glass jar, quickly covering the opening with a balloon, and sealing it with a rubber band. The other was made in a similar manner, but the jar was not heated. For an indicator, a straw was glued to the balloon. However, the balloon later ripped because it had been stretched too much, and the children found no way to seal the barometer that would avoid this problem.

A few sessions later the children broke into six groups for reporting the weather--barometers, temperature, rain,

*Because of lack of space in the school a Design Lab was not available.--ED.

wind, weather maps, and humidity. Each group worked to perfect their measuring instruments and gathered data pertaining to their topic from commercial instruments and from newspapers and TV. Most of the groups began keeping charts and graphs of their data, continuing this throughout the year; weekends were excluded for the most part. The groups worked regularly and simultaneously with periodic class sessions during which each group reported its progress and discussed the problems that it had encountered. In order to provide continuity, this log documents the activities of four groups separately.

Wind Group

One group of children investigating wind built an anemometer using wood, nails, and the bottoms of four plastic cups attached to each end of two sticks. One child noted, "If it is windy, the instrument will spin. If it is not windy, the instrument will not spin."

The anemometer was refined when the children discovered that the light, plastic cups they had used were not heavy enough. When it was windy, the instrument spun too fast to enable the children to count the rotations. They then redesigned the instruments using heavier waxed paper cups.

Initially, the group had decided to have each cup touch a clicker so that in a specified amount of time the clicks could be counted and the wind speed determined. One student noted, however, "But then we'd have four clicks for every turn. We should have only one click in every turn." "We could make one cup larger," suggested another.

"But that would throw off the instrument. The bigger cup would be heavier;" replied the first student.

"We can put stiff paper or something light on one cup. Everytime that cup goes around, we could count that click."

Later in the session the group took the anemometer outdoors. Because the school had sheltered them from the wind, they went away from the school to the top of a small hill. When they attempted to measure the wind speed, however, the students became somewhat confused. They thought that if the anemometer turned eleven times in one minute then the wind speed was eleven miles per hour. I asked them to think about it because turns per minute was not the same as miles per hour.

Humidity Group

The group working on humidity designed and constructed a simple but accurate hair hygrometer, shown in the sketch which follows:

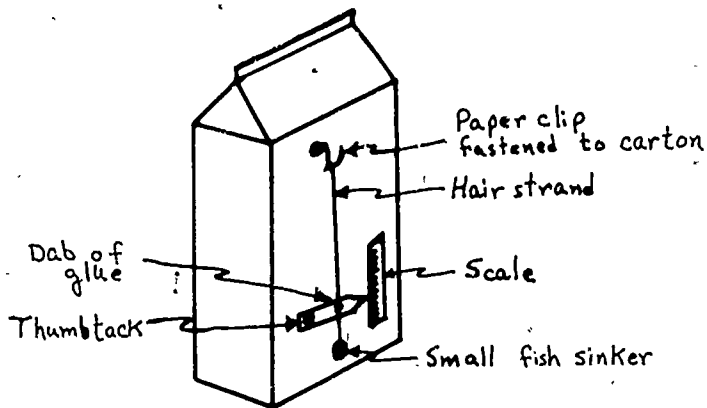

One student explained the instrument to an USMES observer. "When it's dry, the hair contracts, pulls the fish sinker up, and the pointer moves up, too. When it's humid, the hair stretches, the fish sinker falls, and the pointer moves towards the bottom of the scale."

Rain Group

The group measuring rainfall used a glass container to catch the rain. They had marked it with nail polish at $1/8$ ", $1/4$ ", $1/2$ ", and 1". One member of the group was responsible for putting the jar outside every afternoon and bringing it in every morning.

Throughout the time spent on the Weather Predictions challenge, each group kept charts and graphs of their data. From the data in their chart (see Figure C2-2) the temperature group made a line chart of the high and low temperatures (see Figure C2-3); the two temperature readings were differentiated by using a different color for each. The children made sure to take all the readings outdoors.

Weather Map Group

The weather map group reported conditions daily around the country with emphasis on Michigan. Using the weather map from the daily *Detroit Free Press*, they transferred the information to the plastic map of the United States. Through this daily use of the map, the students gained knowledge of geography and social studies.

Two months after beginning the unit, the children in the six weather topics groups assigned each member one day

SEPTEMBER 1972			
SEPT. 5	High 73	Low 44	Sunny & clear 10% rain
SEPT. 6	High 78	Low 44	Partly cloudy 20% rain
SEPT. 7	High 68	Low 57	cloudy & rainy 40% rain
SEPT. 8	High 70	Low 61	30% rain
SEPT. 11	High 67	Low 61	Rainy
SEPT. 12	High 67	Low 62	Rainy 50% rain
SEPT. 13	High 75	Low 64	Rainy 30% rain
SEPT. 14	High 70	Low 44	20% rain
SEPT. 15	High	Low	
SEPT. 18	High 69	Low 55	Partly Cloudy
SEPT. 19	High 69	Low 54	clear
SEPT. 20	High 73	Low 58	cloudy
SEPT. 21	High	Low	
SEPT. 22	High	Low	
SEPT. 25	High 73	Low 65	Rainy
SEPT. 26	High 73	Low 65	80% rain

Figure C2-2

DEBBIE

KEY:
Low
High

Figure C2-3

95

96

per week on which that person was to be responsible for presenting the group's information to the entire class. The information included barometric pressure, temperature, amount of rain, wind speed and direction, general trends from the weather maps, and relative humidity.

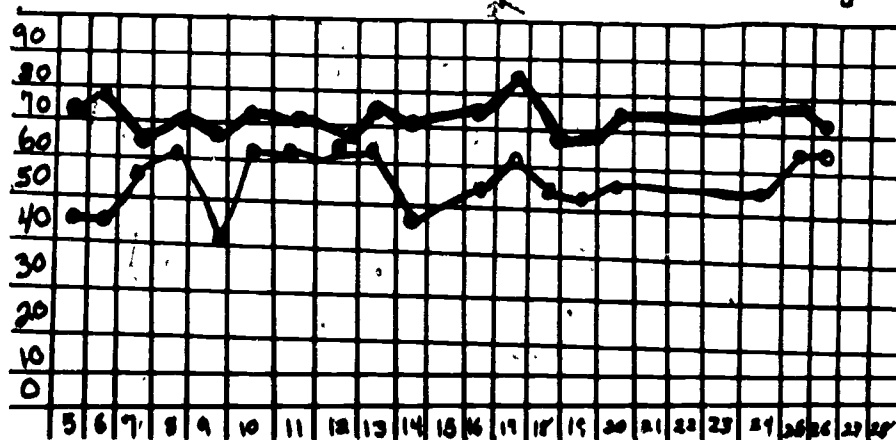
As an ongoing activity, the students divided into groups of three to use the given information to predict the weather for the following day; these groups then made predictions on a rotating basis. The remainder of the students in the class then discussed the prediction, voicing agreement or disagreement.

TEACHER: How many agree with the forecast? How many disagree?

STUDENT: The temperature should be higher.

STUDENT: No, it should be lower.

STUDENT: They said it's going to be colder tomorrow, but the temperature they predict is higher than today's.

STUDENT: It can't be colder if the temperature is higher.

STUDENT: If you say it's going to be colder, then you have to say that it will be below 23 (today's temperature).

A comparison was made daily to the weather bureau forecast for that day and to the *Farmer's Almanac*. The daily forecasts by the class and the weather bureau were recorded on a chart made by the class. Each day the three students who had forecast the weather for that day were rated by the class on a scale of one to ten for accuracy. At the end of the month the groups' scores were compared; except for the amount of snow, the predictions were very accurate.

What follows is an excerpt from a class discussion of daily weather data.

TEACHER: Remember how much snow we had? Well, this is how much water it yielded (rain gauge shown to class).

STUDENT: Wow! Snow is pretty heavy.

STUDENT: No, I think snow is light water.

STUDENT: A snowflake is smaller than a water drop.

STUDENT: In snow the molecules are expanded.

STUDENT: No, they are contracted.

STUDENT: The molecules are spread out in the snow.

TEACHER: When a snowflake lands on your hand, how big is it? What happens to it?

STUDENT: When it melts, it's just a drop.

STUDENT: It's a lot smaller when it's water,...the molecules are more together.

TEACHER: How much water is in here? This line is $1/4$, this one is $2/4$, and the water level is midway between them. (Pause) This line is $1/8$, this one is $2/8$, this one is $4/8$.

STUDENT: It's $3/8$ of an inch.

The children compiled monthly charts of measurements of the different variables--precipitation, cloud cover, humidity, wind speed, and barometric pressure. In addition, two girls worked together to construct a chart that represented several sets of data on one chart. A sketch of their chart is shown in in Figure C2-4 (original chart is nonreproducible), and examples of the graphs that the children constructed from their data are shown in Figures C2-5 through C2-10.

TEMP.	HUM.	B.P.	W.S.	CLOUDS	RESULTS
same (seasonal)	falling	rising (rapidly)	changed from NE & ENE to SE blowing wind	none	clouds thin sand temp. no rain
"	falling	falling	changed from SE to S increase in speed	overcast gray full, low, cover	rain
"	rising (slightly)	rising (slightly)	SW increasing	full, low	rain
cold	rising	rising (slightly)	SW to NW to W	full cloud cover. Poor visibility	rained then cleared
colder	falling	falling	NE decreasing	full	rain
cold	falling	rising	NW	full, high	cold weather no rain

Figure C2-4

One of the students suggested that the data be put directly on the graphs each day instead of making the data charts and then transferring the information. The student felt that this would make changes in conditions more apparent to those reading the chart. The class readily accepted this suggestion.

Another class in the school asked my class for their daily predictions and also asked to see the charts and graphs of the weather data. The children were quite pleased to comply.

Later that week two boys decided that the hair hygrometer being used outside had to be improved. As it was now mid-winter, the hair in the hygrometer kept freezing when placed outside. They decided to construct a box that would keep the wind from blowing on the hair.

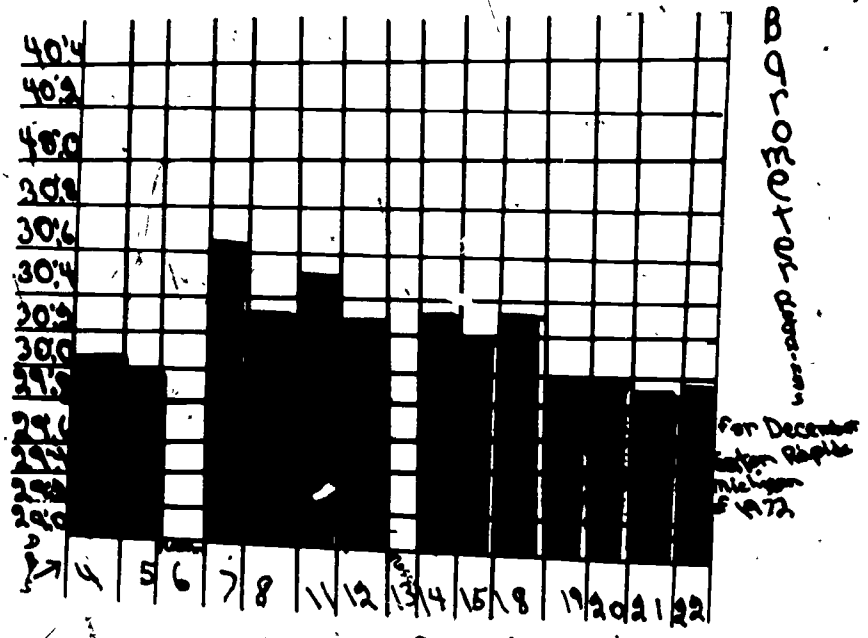
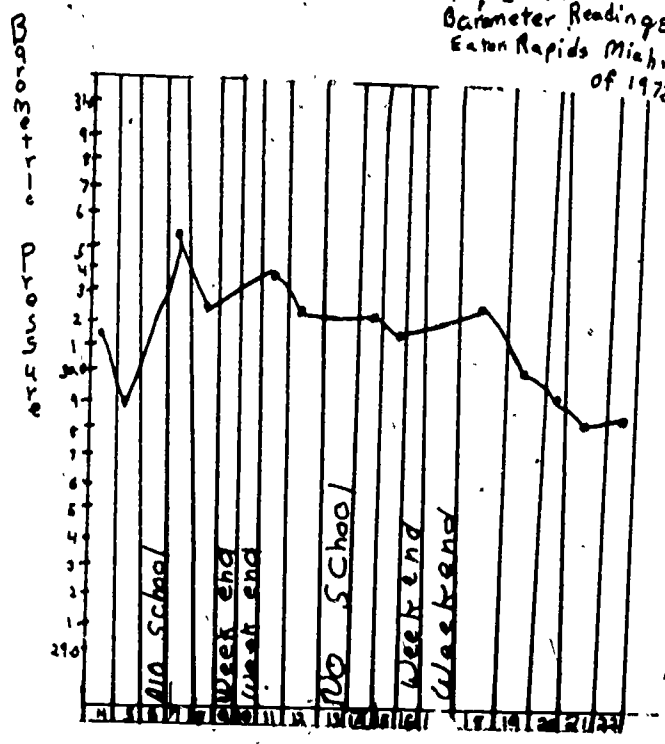

Figure C2-5

Barometer Readings for December Eaton Rapids Michigan 1972

Days of December
Greg Bradford
Barometer Readings
Eaton Rapids Michigan
of 1972



Days of December

Figure C2-7

Northwestern
Wind Speed
Miss
Dane
Room 119
Eaton
Rapid
Mich.

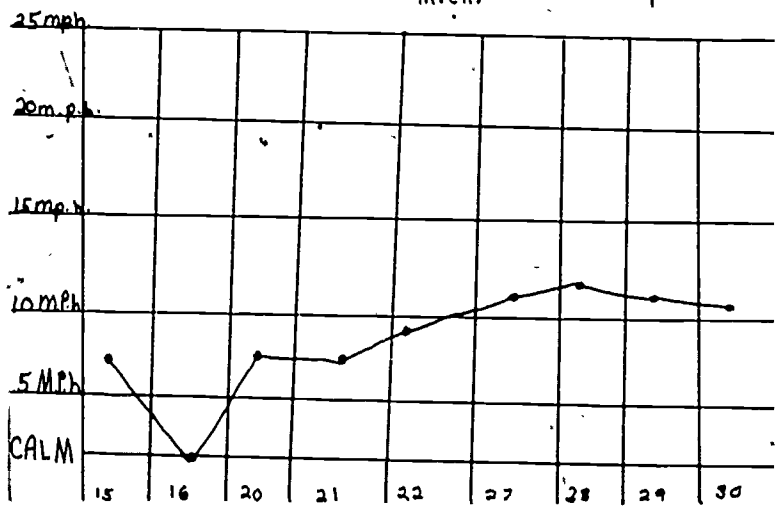

Figure C2-6

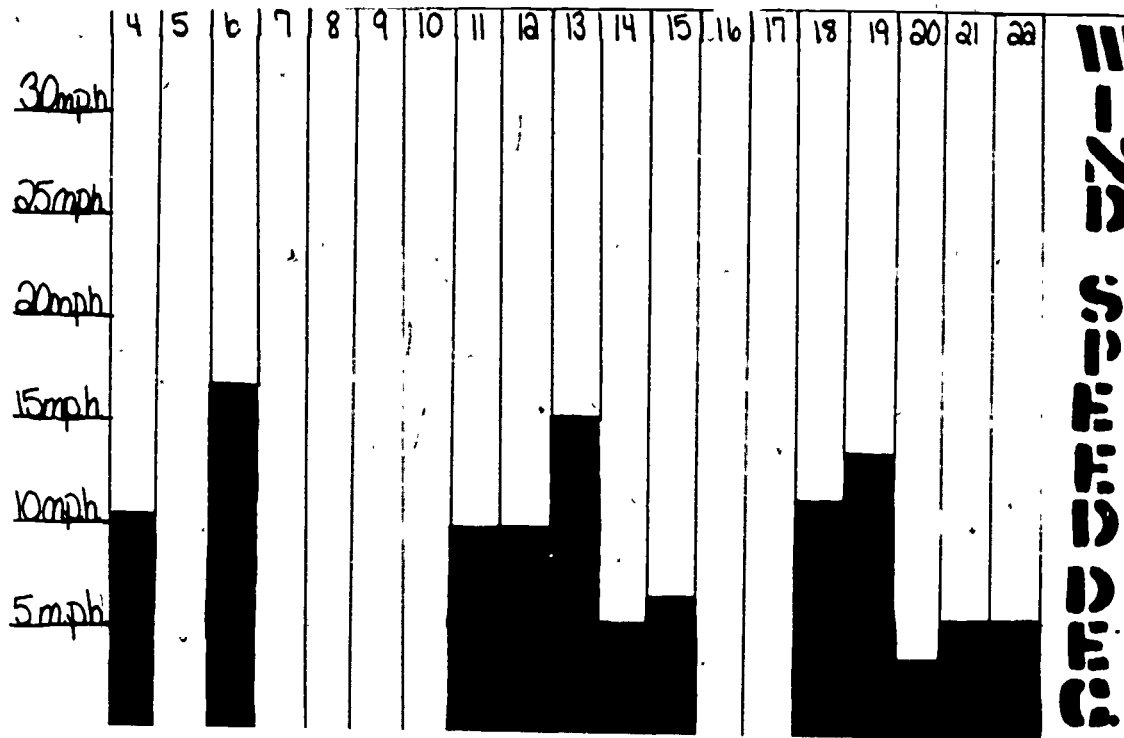

Figure C2-8

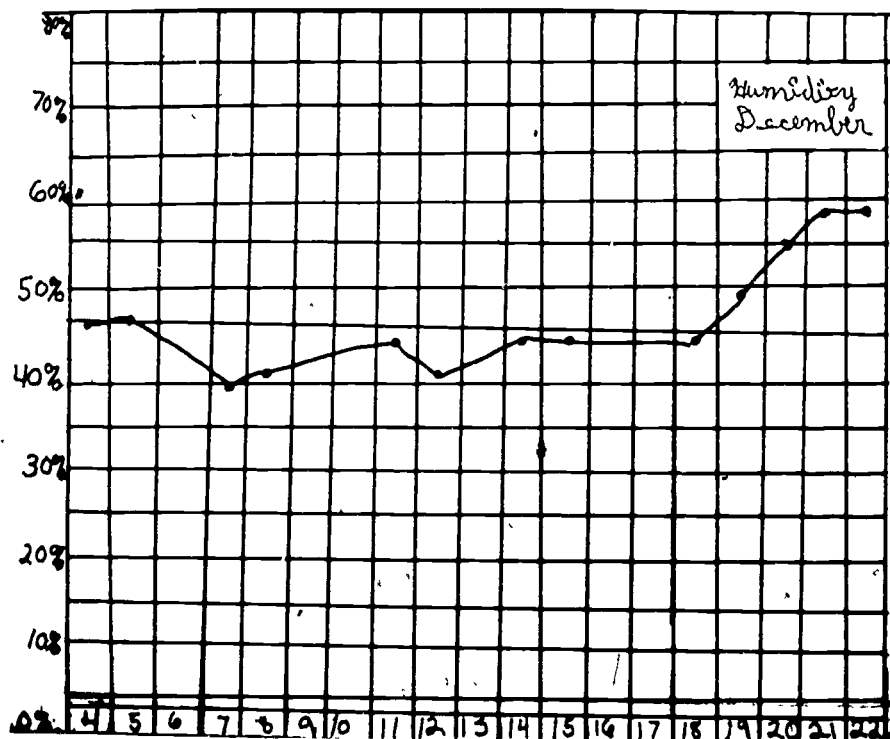

Figure C2-9

101

102

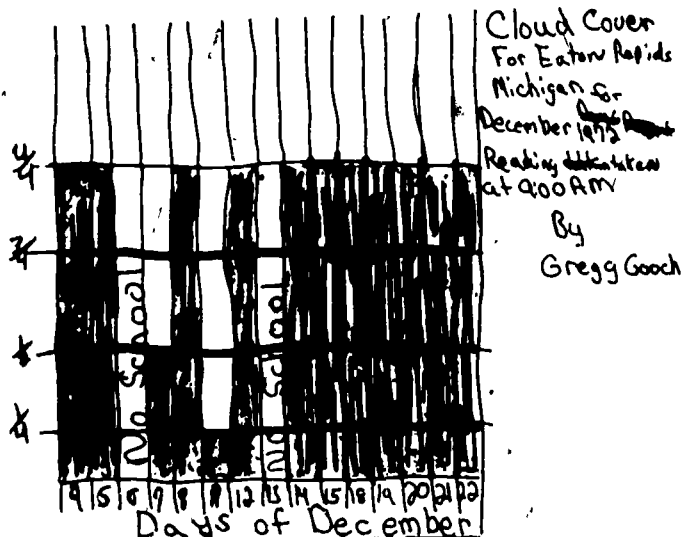
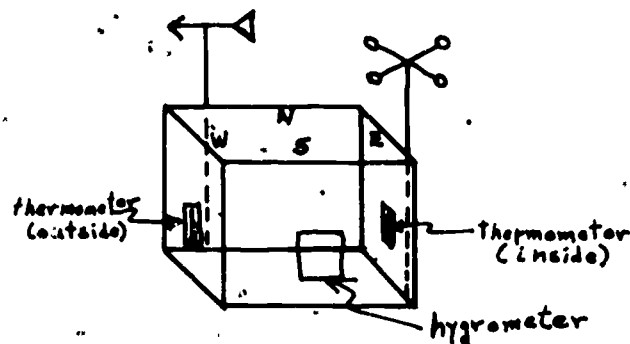

Figure C2-10

After the box was built, the boys decided to add to it, saying, "Why not make it a weather station?" They attached two thermometers to the box, one inside and one outside. They also attached a chart on which they could keep track of the temperature. Then they added an anemometer and a wind vane that had been constructed by their classmates. Each day they took the weather station outside and recorded the data. The children compared the data obtained by their weather station with that of the weather bureau and found that the information was the same. A sketch of their portable weather station is shown below.



As the students continued to forecast the weather, their accuracy improved as did their awareness of the importance of wind and the changes in wind direction. To keep track of wind direction, one boy made a circle with the cardinal compass directions on it. To this he attached two arrows, one pink and one white. He set the pink arrow to the direction of the wind when we left school in the afternoon; when he arrived at school the next day, he set the white arrow to the direction of the wind that morning. He compiled his data on a chart to show what happened in our area as the wind changed direction.

The students continued to make their daily forecasts, both the group of three responsible for the day and each student individually. These were then compared with the weather bureau forecasts. The accuracies of all these forecasts were compared using their one-to-ten scale (one being the highest rating). In addition, the daily charts and weather map were marked with the day's data. However, student interest began to decline somewhat, and the students discussed ways of forecasting and collecting data that would be both interesting and challenging to them. One means of rekindling interest was the students' regrouping so that they could work on different facets of the

weather.

Another result of our class discussion was that the class divided into two groups, boys and girls, to compete in forecasting the weather. Each group made a daily prediction for the time period from 3:30 P.M. to 9:00 A.M. the next day. The temperature prediction was to coincide with the temperature recorded between 8:00 A.M. and 9:00 A.M. the next morning. They had some difficulty in deciding how to determine chance of precipitation. They decided that there would not be any sense in allowing a 50% guess on precipitation and ruled it out.* The accuracy was based on the following score chart:

Temperature: twenty points--one point subtracted for each degree of difference between the prediction and the actual reading

Wind Speed: twenty points--one point subtracted for each degree [sic] off from prediction

Chance of Precipitation: twenty points--based on chart below

Prediction	Snow#	No snow#
10%	-18	- 2
20	-16	- 4
30	-14	- 6
40	-12	- 8
50	-10	-10
60	- 8	-12
70	- 6	-14
80	- 4	-16
90	- 2	-18

#The numbers indicate points off. Thus, if a group predicted 70% chance of precipitation and it snowed, they would receive twenty minus six, or fourteen, points. If it did not snow, they would receive only six points.

General Conditions: twenty points--ten for temperature change and ten for cloud cover

*Nonetheless, a prediction of 50% chance of rain is just as possible and reasonable as any other if the weather data warrant it.--ED.

Because of a few severe miscalculations in their forecasts, the children became involved in looking for ways to correlate various weather factors. The students began to plot their data in order to make general predictions for Michigan, such as wind direction changes, barometric pressure changes, and temperature changes, and they began to look for basic trends in their weather data.

During the course of the unit the students made many maps, including one to show the various precipitation regions of the continental United States and another to show the movement of high and low pressure areas and weather fronts. Charts were used by the children to aid them in their reports to the class, e.g., one student used a chart to show how the wind and the temperature combine to affect exposed flesh in his report on the windchill index.

Experiments were performed by students as another aid in understanding facets of the weather. In one of these, two boys showed how a cloud forms by placing a tray of ice cubes on top of a jar of hot water. The room was darkened and a flashlight was shined on the jar. While the class watched, a cloud slowly formed in the jar. In a later discussion, the children talked about the reasons for the formation of the cloud and related it to the process by which land heats during the day and cools at night.

In January, graphs made by my class using the weather data they had collected were sent to a sixth-grade class in Monterey, California. These children were also involved with Weather Predictions, and we asked them to record weather information for Monterey on the days that my class had reported. When the information was received, the class analyzed the data, responded to letters written by the California students, and sent general information about the winter weather in Lansing. The interchange stimulated new interest in the unit and carried over to other areas, such as social studies in learning about the new geography, climate, and people in a different place.

100

3. LOG ON WEATHER PREDICTIONS

by Gary Childs*
 Monte Vista School, Grade 6
 Monterey, California
 (September 1972-March 1973)

ABSTRACT

The challenge was introduced to this class of sixth-grade students after the children discussed their weather experiences and made outside observations using their five senses. Children formed a library committee to gather reference materials for a weather area in the room. Other groups formed to investigate and collect data on the various facets of weather. The class spent much time in the Design Lab where weather instruments including thermometers, barometers, a comb nephoscope, a balance, and a sling psychrometer were constructed. Data was collected with these home-made instruments and represented on graphs and charts. In addition to interpreting the data, children began to correlate it and use the information as the basis for short- and long-range predictions. The importance of climatological data was discussed as groups formed to begin competitive predictions. A point system for evaluation of the predictions was developed in addition to a list of items to be included in each group's predictions. Children exchanged information on the progress of the unit with a fifth-grade class in Michigan that was also working on the Weather Predictions challenge.

During a general discussion of weather at the beginning of the school year, each student was encouraged to personalize his experiences with weather. Most of the experiences related by the students concerned those with bad weather. The majority of the class had not lived outside of the school neighborhood, were aware only of fog and rain as types of bad weather, and knew that it had snowed one time.

The class went outside to use only their five senses to observe the weather. The students took notebooks to list their observations. When they returned to the classroom, they listed their observations on the board:

warm
 windy
 not too hot
 not too cool
 "green"

breezy
 trees moving
 very high clouds moving to the
 north (in fact, they were
 moving east)

*Edited by USMES staff

107

General agreement on our observations emerged during the discussion which followed.

The students began watching the weather forecaster on television. The challenge that was presented to the class was, "Can we predict the weather locally using instruments which we can build ourselves?"* I asked the children what we would have to do in order to accomplish this, mentioning that the weather bureau has many instruments to aid it in its work. After a brief class discussion a committee was formed to go to the library to check out all available material on the subject of weather. In addition, children were urged to bring in instruments from home if they could.

Discussion was held during the next class session to talk about any observations that might have been made since the previous session. Many of the students had done some reading and had discussed the topic with their parents. One student suggested that the class go outside to observe the weather again and compare these observations with those of the initial session. After fifteen minutes we returned and listed on the board the following observations:

heat	sun
clouds	clouds moving
wind	wind from the southwest
haze	wind gusty
blue sky	wind breezy
cold	

Soon after the second set of observations were made, the class discussed the number of things to be done in order to set up a weather station. I asked them how they thought we should proceed, and their reply was that--

1. We should bring money from home to purchase the necessary weather instruments.
2. We could bring some instruments from home to the classroom, i.e., thermometers, barometers, rain gauges, relative humidity gauges, etc.

*This class was one of the first to work on the unit. The challenge has since been reworded to emphasize prediction, for which instrument-building is only a part. In fact, relatively accurate forecasts can be devised without using any instruments.--ED.

3. The class should be divided into groups with each group responsible for a certain aspect of the study.

A list of some of the facets of weather, including temperature, barometric pressure, wind, wind speed, and cloud direction, was put on the board. Groups were formed based on this list; children chose to work on the topic that interested them. The groups spent the rest of the session in discussion. We held ongoing discussions of the challenge, and a large number of students began to take an active part in the collection of data to facilitate making short-range predictions and in the preparation of instruments.

As their work on weather predicting continued, the students formed more groups to investigate related problems posed by the challenge. One group of children began to compile some history of the weather. They used the television as a source of information. There is one channel that has a sweep of such things as temperature, barometric pressure, relative humidity, wind direction and speed, and time. This is shown as a public service, and we used this television data to calibrate our own instruments.

Another group of students constructed a convection box shown in a high school science text to show the reasons for wind. This was demonstrated with great success and helped bring about a general understanding of one of the factors of wind: heated air rising causes cooler air to be drawn into the void left by the heated air; this movement of air masses is one explanation of wind.

A group of six girls gathered data on the temperature by keeping a record of the temperature around the school. They gathered a dozen thermometers of varying precision, two of which were centigrade and the remainder Fahrenheit. One of the thermometers was capable of recording both the high and the low temperature, and one was capable of indoor/outdoor measurements. They placed these thermometers around the school: four were hung in a tree, approximately six feet from the ground, two were placed in direct sunlight, others were in hallways. The girls soon noted a difference in temperature that depended upon the location of the thermometer. They also made provisions for data collection to take place during the week-ends. However, the weekend readings were not taken at the school and the data proved to be somewhat different at various locations around the (Monterey) peninsula for the same time on a given day. The group also learned to convert from centigrade to

FAHRENHEIT-CENTIGRADE

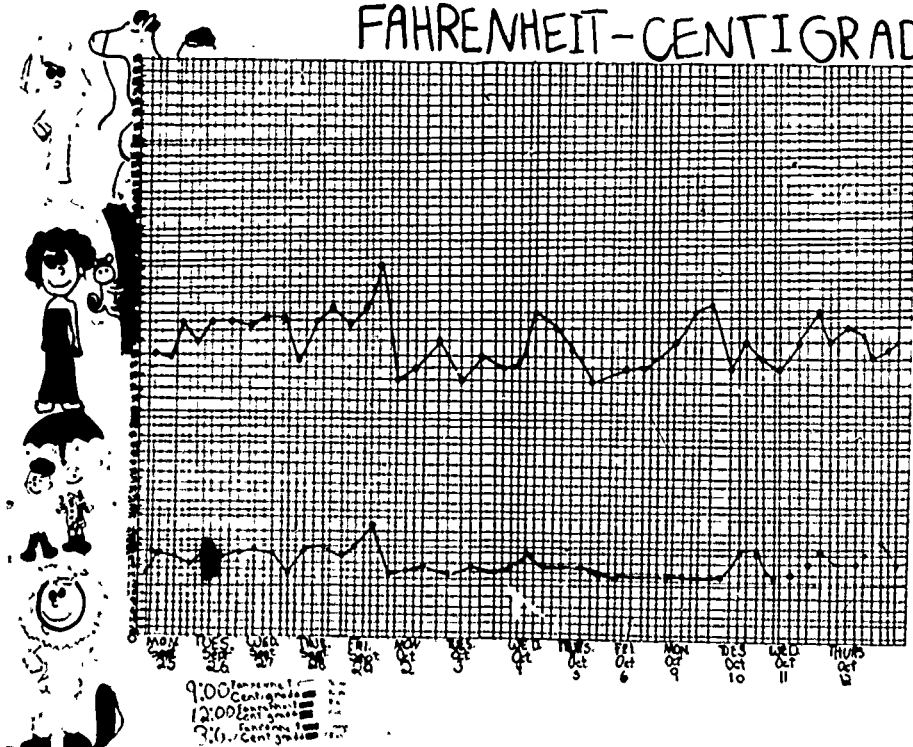
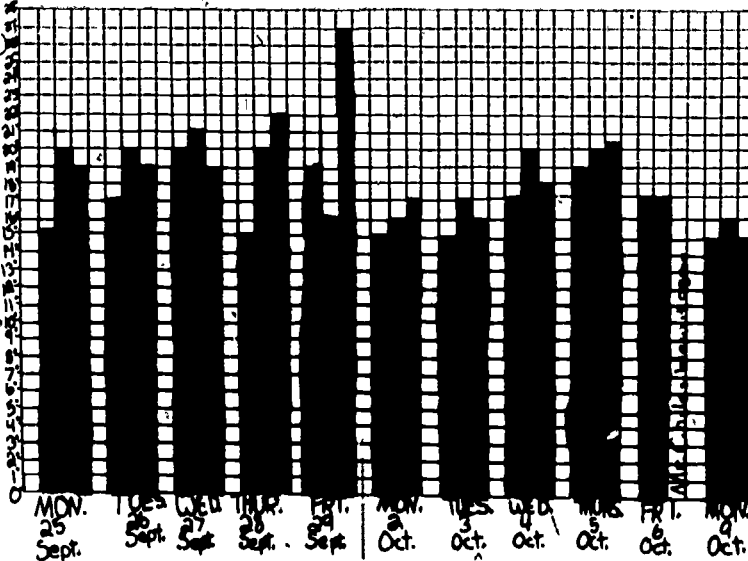

Figure C3-1

9:00 av = 15.36 CENTIGRADE 9:00 = Mod 15 9:00 = 5
 12:00 av = 18.72 12:00 = Mod 20 12:00 = 13
 3:00 av = 18.9 3:00 = Mod 19 3:00 = 17
 4:00 range = 14.5 12:00 range = 5 3:00 range = 17

Figure C3-2



Fahrenheit using the formulas: $F = 9/5 C + 32^{\circ}$ and $C = 5/9(F - 32^{\circ})$.

The group of students collecting data on temperature designed line charts and bar graphs to show their information better. Examples of their graphs can be seen in Figures C3-1 and C3-2.

On a permanent pegboard that served as a combination tally and graph, the temperature group plotted the temperature readings over a period of days and observed changes in the temperature that indicated other changes in the weather.

The group investigating barometric pressure constructed various types of barometers. What follows is the explanation of the construction of a coffee-can barometer to an USMES observer by one of the students: "We're making a barometer. We're using a full can of coffee which is vacuum sealed. Now we're starting to solder a metal tube to the top. Then we're going to drill a hole through the tube and attach a stick which will indicate on a ruler how high the barometric pressure is." (See sketch below.)

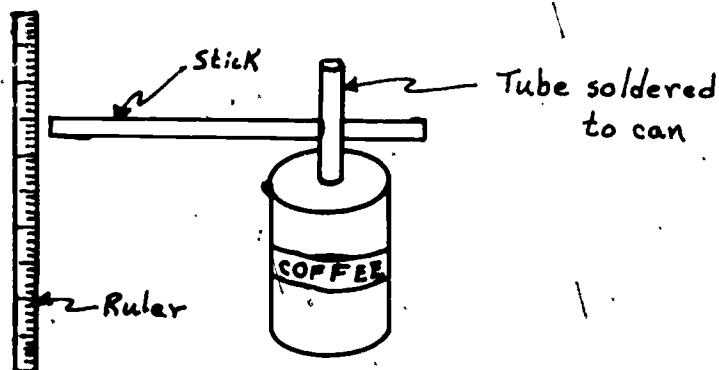
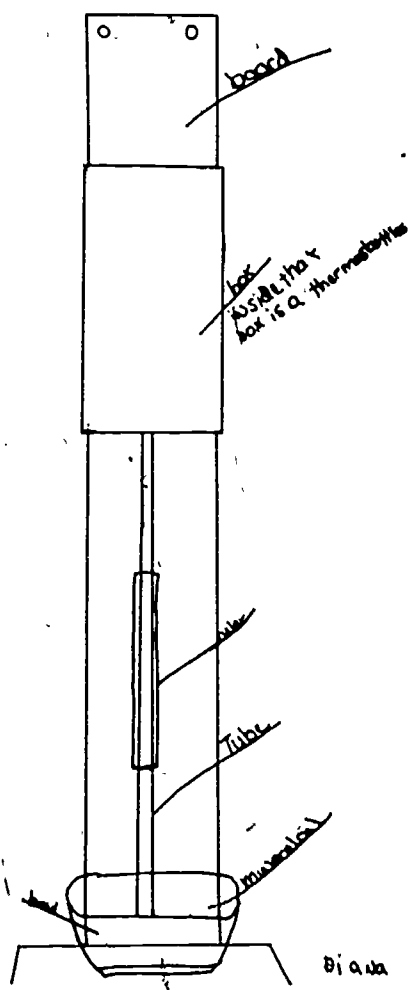

Three different groups of students constructed mineral oil barometers which proved to be less effective. They were built in the classroom in an attempt to build a barometer without using mercury. The construction of each followed the same design (see Figure C3-3). (A Thermos filler, or a vacuum bottle, is placed in an insulated box, a glass tube is inserted into a stopper that is then sealed to the Thermos bottle. The apparatus is then inverted in a jar of mineral oil after a partial vacuum is created in the vacuum bottle. See "How To" Cards for details.)

Other instruments constructed in the Design Lab included

Figure C3-3

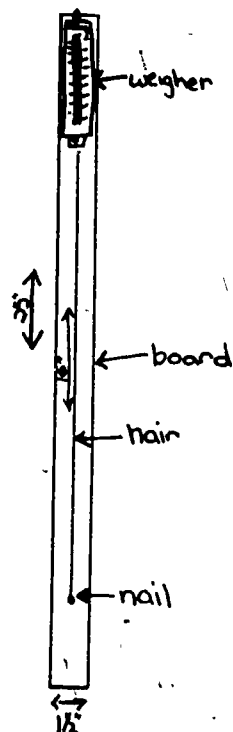

The hair is attached to the nail and the scale. When the humidity goes up the weight goes down and when the humidity goes down it goes up again.

3"=foot

Figure C3-4

a hair hygrometer and a comb nephoscope.* The hair hygrometer (see Figure C3-4) was mounted on the wall and used to measure the degree of moisture of the atmosphere. One student offered this explanation of the hair hygrometer to an USMES observer: "The hair will lengthen and shorten according to the amount of moisture in the air. The amount of change will register on the spring scale." The children experienced a certain amount of frustration as a result of the instrument's limitations: the slightest bump moved the counter and there was difficulty with calibration.

Moisture in the air became an area of concern for the class. A group of boys devoted themselves to gathering data on evaporation. They logged the different variables which affect evaporation, e.g., temperature, relative humidity.

At a class meeting held less than a month into the semester, the class brought up the fact that the students had not been predicting what the weather was going to be but rather recording what the weather was. Some other students remarked that we were unable to predict the weather without the instruments that are available to the weather stations.** When challenged to state the chief difference, one boy responded, "Even though I constructed a barometer, it doesn't work like the one on TV." A fellow classmate responded that anyone could buy a barometer but she thought hers was better because she had made it.

One day in November, we received a great number of materials from the Naval Postgraduate School Station in Monterey, including maps, charts, pictures, graphs, films, filmstrips, etc. The students exhibited all of the materials around the room. There was a great deal of discussion among the children about these aids. The children and I felt that it would be very beneficial for us to make a field trip to the school. This was scheduled late in the term so that class time could be spent preparing a list of questions for the people at the school.

*The comb nephoscope is an instrument to measure the speed of clouds. The students needed the help of the teacher and the Design Lab manager to construct it. Any measurements taken with it required the use of a complicated conversion formula that the students had difficulty in using. Consequently, its usefulness to the unit is marginal and the students might investigate other ways to obtain an approximate idea of the wind speed.--ED.

**The students might be asked how sailors and farmers predict the weather without using instruments.--ED.



During the first six weeks of our study, no attempt was made to relate our "local" observations to the weather of a larger area. At a class session a few days after receiving the information from the Naval Postgraduate School, we began a discussion of weather maps. A large poster map of the United States was constructed by the students. It consisted of a mounted, printed map of the United States, covered with plastic. Each day a group of students wrote what the weather was directly on the map. This was copied from the national weather map published in the paper. Notes were made on the prediction and a record was kept of the "actual" weather as compared with the prediction. Observations were made three times daily based on such questions as--

"Were there scattered clouds?"

"Was the temperature at a high of 65°?"

"Was it foggy in the A.M.?"

A few days later, a small weather map (4" x 6") was placed on the opaque projector. It was an uncomplicated map with easy-to-understand symbols. In this way, we began to discuss the reading of graphs, charts, pictures, etc. The map showed weather fronts, high and low pressure areas, and a simple legend illustrating rain, showers, snow, and flurries. The map shown at this time showed a large low pressure area written with the "L" directly over Monterey. There was some discrepancy as the three barometers stationed in the classroom had not indicated any change from 29.5 while we were experiencing warm weather. There was no sign of the weather that the class was associating with a low pressure area. This led to much discussion concerning the possibility that there were other variables in weather prediction than the barometric pressure measurements that the class had been considering.

The class then began to make a list of the specialized vocabulary that is used by the weather service. They divided into groups of two to six children and attempted to discover the meanings of the various symbols. As meanings were found, the group would write the word or symbol on the board along with their names. Groups were responsible for explanations of their words or symbols to the class.

The following day I asked the class if they could determine how we could apply some of the data that we had collected to predicting the weather. To this point the different groups had been collecting data by taking readings from their instruments, the television, or the newspaper. I

suggested that the groups meet to attempt to determine if a correlation between their charts and graphs did exist. Until this time there had been little effort by the class to put all of the data together. For example, the groups that worked with barometric pressure had been of the opinion that once they had constructed a barometer, they would be able to predict the weather. During the discussions between groups, the class realized that there are a great many variables that make up the weather. One group explained to another that a change in barometric pressure did not necessarily mean a measurable change in the weather. Some of the groups decided to combine their data. This was the first time that the class had worked as a total group at their own initiative.

I suggested that the class go outside and note the elements of weather that they could determine through observation. When they returned, their observations were listed on the chalkboard. The following are some of the things they listed:

Scattered clouds at about 10,000-15,000 feet.
The clouds were not rain clouds...they were not dark and they were too high.
The temperature was estimated at 60-70°F.
Windy.

The children were asked how much wind they had observed when they listed that there was wind. Their response was "some." Some of the students had recorded the wind direction; however, there was no general agreement on it.

The class decided that wind direction was important and made plans to construct some apparatus to measure the wind direction and speed. It was noted by the class that most of them were much more aware of the weather but still couldn't predict what it would be.* The groups that had been collecting data from their instruments were certain that they could predict within their group what would take place the next day, i.e., the temperature group could predict the temperature, the barometer group could predict the barometric pressure, etc. Their reasoning was that over the period of time that they had been collecting data there had not been much variation from day to day.

*The students are still relying too heavily on instrument readings and are not focusing on predicting the weather. They could attain some accuracy merely by predicting that the weather would be the same.--ED.

How to Make a Sling Psychrometer

Use and Building

The use of a sling psychrometer is to measure the amount of moisture (water) in the air also called relative humidity. This instrument is most important in predicting rain. The way to build this is to have a thermometer that has its bulb covered with a piece of gauze (from the first aid kit), that has been dipped in some water (see ex.)

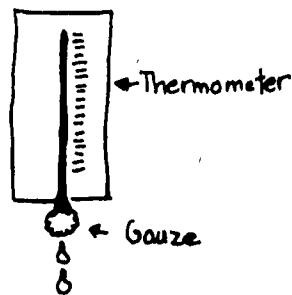

Mount the thermometer on a board with a revolving handle. (see ex.)

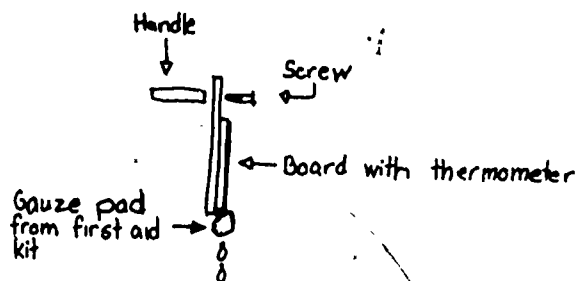

When this is done take outside and swing board in rotating fashion (see ex.)

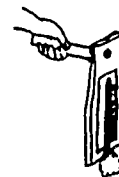

When cloth is dry compare with a regular thermometer (without a wet cloth) that has been in the same temperature. (You can also mount the dry thermometer with the wet and swing it around) Read the difference, consult chart. That will be your relative humidity. Remember, the closer to 100% moisture in the air, the more likely to rain.

Figure C3-5

The group responsible for charting the weather each day was more aware of the daily weather than those who were not involved. They were aware of movements of fronts, highs and lows, as well as the general movement of the weather. The group began to prepare two maps per day: one map was prepared using the weather prediction of earlier maps; after this one was completed, another map was prepared based on the weather report from the daily paper. Both maps, prediction and fact, were logged, noting the consistency of their prediction. This activity represented the first attempt at weather prediction.

At this point in our study of weather predictions, we needed further discussion of relative humidity and decided to build a sling psychrometer. One student's description and design are shown in Figure C3-5. After the psychrometers were constructed, the groups went outside to whirl the thermometers until evaporation had dried the gauze. Readings were taken and compared with other thermometers that were not wet. All of the students in the class gathered data and recorded their data.

We discussed what had been done. The thermometers had been wet and then spun dry. Readings were taken from both the wet thermometer and the dry one at the same time and the data was recorded. After a great deal of discussion we determined what was being measured: how much water vapor is in the air at an exact temperature, as opposed to how much is in the air when the air can't hold any more at the same temperature. Many of the students were able to understand that relative humidity is the amount of vapor the air is holding, expressed as a percentage of the maximum amount the air could hold at that particular temperature.

Four different groups of students constructed balances to measure relative humidity (see Figure C3-6). One student said, "We're putting silicone on one side and weights on the other side to balance. The silicone will collect moisture from the air and we'll be able to tell the exact amount by reading the scale."

The balance worked but with limitations. Wind of any kind caused the balance to tip making it difficult to calibrate and use.

We attempted to calibrate the hygrometers and balances that had been constructed to measure relative humidity with data from the sling psychrometer. The groups that had constructed these devices were aware that their instruments were capable of measurement but were unable to see beyond the movement of the measuring device. Each group measured

(How to) construct a simple balance Hygrometer

(Dupliex needed), a piece of 1 by 5 1/2 about 20" long and another one about 9" long, one 16 common nail and a balance scale, and three small nails.

First you nail (with two small nails) the 20" board to the 9" board

Then pound the 16 common nail about 1/4 of an inch from the top and in the middle of the board



Now slip the nail through the hole in the top of the balance scale

Now put balance weights on one side and on the other side put powdered silicone

Figure C3-6

the relative humidity and then set their instrument at that calculation. I aided each group to make sure that their calculations were somewhat accurate. The groups who had constructed hair hygrometers simply put a mark on the scale and wrote the humidity finding beside it. The findings were duplicated until consistency was achieved; however, the silicone balances could not be calibrated.

A portion of the room was set aside for a weather predictions interest area. Students suspended Tri-Wall sheets to isolate the section from the rest of the room. All materials pertaining to the unit were concentrated in this area: study pictures, filmstrips, movies, books, magazines, and charts.

One class session was spent discussing the first weather bureau. The historical side of the study interested the children very much. It was encouraging for them to learn that the first stations consisted of nothing more than the simple equipment that we had in our school: thermometer, barometer, psychrometer.

During this time period, class discussions focused on two other areas:

1. The fact that different groups of people need to "know" what the weather was going to be, e.g., the farmer whose entire crop might be wiped out by drought, floods, or late frost.
2. A report by five students from my class who attended sessions at the Naval Postgraduate School that determining the height of clouds was not as important as determining what kind of cloud it was and what the cloud movement was.

The children and I began to investigate correlation as it might pertain to the Weather Predictions unit. The bar graphs, line graphs, and charts made by the children demonstrated an understanding of graphing techniques; however, there had been little application of the data collected by the children to the unit challenge.

To begin applying correlation to their data, three students went to the pegboard and charted the November temperature readings with pegs and red squares; they had previously averaged the three daily readings. I asked the children how they could show whether or not it rained on a specific day, and they suggested using a different-colored square. When asked if there would be a correlation between temperature



and rainfall when the temperature was about the same every day and it also rained every day, the class responded yes.

I asked the class if something else could be charted on the pegboard. A student responded, "The barometric pressure." It was decided to put the barometric pressure on the far end of the board; the axis was marked with tape.* (See sketch below.)

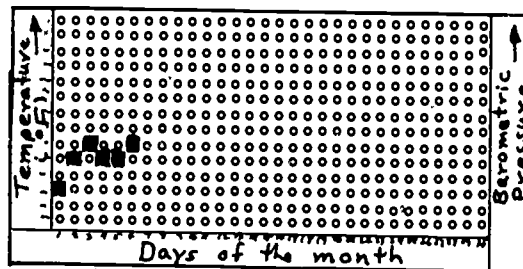

Later that month a meteorologist from the Naval Post-graduate School, Dr. Renard, visited the class and discussed precipitation. The class was interested and responsive. The discussion covered--

- various forms of precipitation
- how the form of precipitation is controlled by the temperature (i.e., warm/rain, cold/hail, snow)
- the variation of temperature within clouds
- the effect which the ground has on the snow (i.e., slushy snow caused by warm, wet ground)

Dr. Renard predicted snow for that night and the next day. Because snow in Monterey is highly unusual, the class was very skeptical of the prediction. Their skepticism was also a result of the following information:

- our barometers were holding steady at 29.08.
- There were clouds, but not too much rain.
- The temperature had dropped a great deal on the average for the week.

*Other variables which may be graphed are temperature and change in barometric pressure or temperature and relative humidity. See the composite log and background papers for ways to graph data so that correlations can be easily noted.--ED.

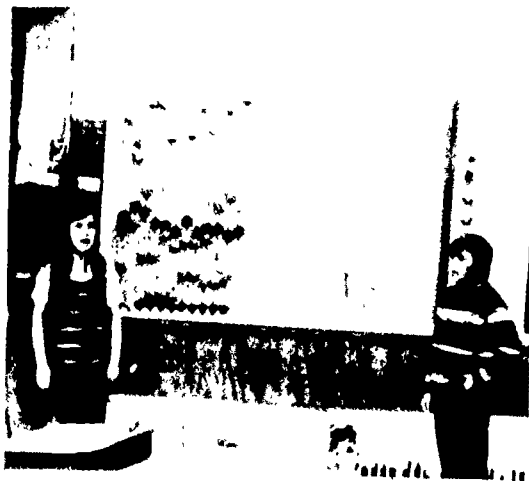

The first thing in the morning after Dr. Renard's visit, the students discussed the possibility of snow but were not convinced that the day was any different from the days when it had only rained. Then, it began to snow--quite an event! The last time it had snowed in Monterey was in January of 1961. Most of the class had not been born then.)

On their return to school on Monday, we discussed Dr. Renard's visit to the class and his prediction at that time. He had told the class that the conditions present at the time of his visit were capable of producing snow because the conditions of January 1961, the time of the last snowfall in Monterey, were identical to those of December 7, 1972, hence, the snow prediction.

Although Dr. Renard had not cited the role of climatology in his prediction, it had been the basis for it. We then discussed climatology and the prediction of weather through the climatology records, which seemed more practical for the class than weather predictions based solely on instrument readings. I duplicated some of the information on climatology that Professor Renard had furnished for Monterey over the past 20 years and made it available to the class. They discussed the possibilities of forecasts based upon these records, and there was comment as to how the weather correlation on the pegboard was similar to the record of climatology.

We then attempted some long- and short-range forecasting. Each student noted the weather as it was then: temperature, rain/no rain, wind, cloud cover, etc. We made a written prediction for the weather in one minute, one hour, twelve hours, one day, two days, one week, one month. This exercise was carried out by the students independently and the predictions were discussed. There was general agreement on the one minute and one hour forecasts. Discussion centered around the long-range predictions: the children agreed that they were simply guesses and that greater amounts of information were needed to make more accurate long-range predictions.

The class divided into six groups to predict the weather for the following day. It was decided that each group would submit a prediction that included the following:

1. rain vs. no rain
2. relative humidity
3. wind direction and speed
4. cloud cover
5. barometric pressure
6. high and low temperatures

No mention was made of competition between groups nor thought given to right vs. wrong prediction.

The next day, the chairman of each of the six groups went to the board and wrote down his/her group's prediction. Each group worked independently. The method of prediction, in addition to the results, varied.

1. Group I predicted possible showers.
2. Groups III and IV had taken their information from the paper and said, "Rain with temperatures in the 50s, and winds from 0-15 mph."
3. Group VI predicted a 75% chance of rain, clouds at 5000 ft., wind from the north, temperatures from 40-50° F.
4. Group II had predicted the relative humidity at 80% and the barometric pressure at 29.8 inches.

After the groups wrote their predictions on the board, a general class discussion followed to determine which group had been most accurate. The students used the newspaper, our rain gauges, our barometers, and the Postgraduate School's hourly temperature readings to determine the most accurate prediction. It was generally agreed that Group VI had been most complete and accurate.

After the groups met to make predictions for the following day, the class discussed having a competition between groups with a winner. Since ice cream sales were held Thursday after school, it was decided that the winning group would get free ice cream and be allowed to make a prediction for the school paper. This same prediction would be placed in the outside showcase for the whole school to read. This decision gave purpose to the predictions; it offered a practical use for the children's efforts.

The next day the class used the same procedure for relating their predictions and determining which one was best: the chairman of each group wrote his/her group's predictions on the board and general class discussion was held to determine the group that had been most accurate. Each group gathered the same kinds of data that the winning group of the previous day had used. The basis of the predictions was chance of rain expressed in percentage, height of clouds, wind direction, and temperature. Each of the six groups predicted between 75-100% chance of rain. Also included in some cases were relative humidity, wind speed, and both the high and low temperatures.

The groups were asked to justify their predictions. Some said it was easy to predict the rain or lack of it because

it had rained every day for months. Some said that conditions were the same as those of the day before; still others reported that the television and radio predictions supported the prediction of their group.

After a great deal of discussion a set of criteria was drawn up on which to judge the predictions. Each group had to predict the following:

1. chance of rain (in %)
2. temperature--high and low
3. relative humidity (in %)
4. wind velocity
5. cloud cover (in %)

Barometric pressure was not listed as one of the criteria. The class decided that you could not feel barometric pressure in the way that you could feel temperature or humidity, and so they determined it to be a tool for predicting the weather. Each of the criteria was considered equally. If a group predicted a 95% chance of rain and it rained, the group would receive no points or one point. All other groups would receive one through six points based on the accuracy of their prediction. The group with the fewest number of points at the end of the week would be designated as the winning group. Friday predictions were for a three-day period--Saturday, Sunday, and Monday. Each group also kept a log of its predictions; a sample page of one such log is shown in Figure C3-7.

In order to make their three-day predictions, the groups used the weather predictions from the newspapers and the television's five-day forecast. Each day's prediction was handled separately. Every Friday afternoon the three-day predictions were collected and put in the bottom desk drawer; they were not seen until Monday afternoon at 2:00 p.m.

A great deal of information was received from a fifth-grade class in Lansing, Michigan, that was also involved in the Weather Predictions unit. The Michigan class sent us their records for the month of January, 1973. The information included the high and low temperatures, barometric pressure, relative humidity, wind speed, and direction. Space had been left for my students to record comparative information. It was then to be returned. An interesting discussion followed in which it was noted that the only similarity was in barometric pressure. Temperature range differences were vast, as were wind speeds. Monterey had more precipitation. This led to a discussion of the geography of Michigan and California, their similarities and differences.

Weather Predicting

<p>March Fri. 16.</p> <p>Rain% 0%</p> <p>Temp. Hi Low 70's Low Hi 50's</p> <p>Rel. Hum. Low 60's</p>	<p>March Sat. 17.</p> <p>Rain% 2%</p> <p>Temp. Hi Low 60's Low Hi 50's</p> <p>Rel. Hum. 79%</p>	<p>March Sun. 18</p> <p>Rain% 5%</p> <p>Temp. Hi Low 60's Low Hi 50's</p> <p>Rel. Hum. 80%</p>	<p>March Mon. 19.</p> <p>Rain% 6%</p> <p>Temp. Hi Low 60's Low Hi 50's</p>
<p>March Tues. 20</p> <p>Rain% 55%</p> <p>Temp. Hi Low 50's Low Low 40's</p> <p>Rel. Hum. 75% to 85%</p>	<p>March Wed. 21.</p> <p>Rain% 95%</p> <p>Temp. Low 40's Hi Hi 40's</p> <p>Rel. Hum. 90%</p>	<p>March Thurs. 22</p> <p>Rain% 15%</p> <p>Temp. Low 40's Hi Low 50's</p> <p>Rel. Hum. 80%</p>	<p>March Fri. 23</p> <p>Rain% 20%</p> <p>Temp. Low Hi 40 Hi Hi 50's</p> <p>Rel. Hum. 60+70</p> <p>Wind "V" 2 to 4 miles</p> <p>Wind "D" north westerly</p>

Figure C3-7

122

129

The class then undertook a new project. The students examined their weather log for the month of January and exchanged weather information with the class in Lansing. All relevant data except precipitation readings were sent. The Lansing class was asked to evaluate the data and to decide if it had rained on a given day. My class did the same with their data, determining what kind of precipitation fell, if any fell at all.

When the class took their field trip to the Naval Post-graduate School, they were given a brief description of the facility and divided into two groups. One group went to the map room to learn about plotting weather maps, and the other learned about the use of weather balloons. Finally, they all watched the plotting of the picture from a weather satellite.

As the children continued making their short-range predictions and evaluating the outcome, the amount of time required for them to accomplish this decreased. I suggested that the television, local newspaper, and radio be included in the competition. The groups were interested in the competitive aspect of the predictions. Some of the groups took "long-shots" in their group predictions.

They said that everything had been a challenge--from the building of instruments to our present emphasis on competitive prediction that they planned to continue. The class was unanimous in their agreement that we should have begun predicting the weather at an earlier date.

D. References

1. LIST OF "HOW TO" CARDS

Below are listed the current "How To" Card titles that students working on the Weather Predictions challenge might find useful. A complete listing of both the "How To" Cards and the Design Lab "How To" Cards is contained in the USMES Guide. In addition, the Design Lab Manual contains the list of Design Lab "How To" Cards.

GRAPHING

- GR 1 How to Make a Bar Graph Picture of Your Data
- GR 2 How to Show the Differences in Many Measurements or Counts of the Same Thing by Making a Histogram
- GR 3 How to Make a Line Graph Picture of Your Data
- GR 4 How to Decide Whether to Make a Bar Graph Picture or a Line Graph Picture of Your Data
- GR 5 How to Find Out if There is any Relationship Between Two Things by Making a Scatter Graph
- GR 6 How to Make Predictions by Using a Scatter Graph
- GR 7 How to Show Several Sets of Data on One Graph

MEASUREMENT

- M 9 How to Make a Conversion Graph to Use in Changing Measurements from One Unit to Another Unit
- M 10 How to Use a Conversion Graph to Change Any Measurement in One Unit to Another Unit
- M 11 How to Measure the Amount of Water in the Air with a Psychrometer
- M 12 How to Measure the Amount of Water in the Air with a Hygrometer
- M 13 How to Measure the Amount of Rainfall
- M 14 How to Find Wind Speed by Watching What the Wind Does
- M 15 How to Find Wind Direction with a Wind Vane
- M 16 How to Measure the Pressure of the Air with a Mineral Oil Barometer

PROBABILITY AND STATISTICS

- PS 2 How to Record Data by Tallying
- PS 3 How to Describe Your Set of Data by Finding the Average
- PS 4 How to Describe Your Set of Data by Using the Middle Piece (Median)
- PS 5 How to Find the Median of a Set of Data from a Histogram

131

132

New titles to be added in 1976:

How to Round Off Data
How to Make and Use a Cumulative Distribution Graph

A cartoon-style set of "How To" Cards for primary grades is being developed from the present complete set. In most cases titles are different and contents have been rearranged among the various titles. It is planned that this additional set will be available early in 1977.

2. LIST OF BACKGROUND PAPERS

As students work on USMES challenges, teachers may need background information that is not readily accessible elsewhere. The Background Papers fulfill this need and often include descriptions of activities and investigations that students might carry out.

Below are listed titles of current Background Papers that teachers may find pertinent to Weather Predictions. The papers are grouped in the categories shown, but in some cases the categories overlap. For example, some papers about graphing also deal with probability and statistics.

The Background Papers are being revised, reorganized, and rewritten. As a result, many of the titles will change.

GRAPHING

- GR 3 *Using Graphs to Understand Data* by Earle Lomon
- GR 4 *Representing Several Sets of Data on One Graph* by Betty Beck
- GR 5 *Plotting Weather Predictions Data on Three-Dimensional Pegboard Graphs* (based on suggestions by Jack Borsting and Leland Webb)
- GR 6 *Using Scatter Graphs to Spot Trends* by Earle Lomon

MEASUREMENT

- M 3 *Determining the Best Instrument to Use for a Certain Measurement* by USMES Staff
- M 7 *Weather Factors and Their Measurement* by Ray Brady, Jr.

PROBABILITY

- PS 3 *Weather Prediction* by Bob Renard

3. BIBLIOGRAPHY OF NON-USMES MATERIALS

The following materials are references that may be of some use during work on Weather Predictions. The teacher is advised to check directly with the publisher regarding current prices. A list of references on general mathematics and science topics can be found in the *USMES Guide*.

Resource Books for Teachers

Inwards, R. *Weather Lore*. Ed. by E.L. Hawke. Reprint. New York: Dover Publications, 1970.
Excellent collection of classic weather rules and adages culled from world's literature.

Laird, Charles, and Laird, Ruth. *Weathercasting*. Englewood Cliffs: Prentice Hall, 1955.
For amateur meteorologists.

Scorer, Richard, and Wexler, Harry. *Cloud Studies in Colour*. London: Pergamon Press, 1967.
An excellent color plate section of photographs of cloud formations. The same section also contains descriptions of each photograph which might be useful to the children.

Yates, Raymond F. *The Weather For a Hobby*. New York: Dodd, Mead and Co., 1956:
Guide to the construction and use of weather instruments for amateurs.

4-H Weather Project Booklets. Cooperative Extension Service, Michigan State University, East Lansing, Michigan. Bulletins 150.2(A-E) and 350.2.
Very good discussion of instrument construction and weather. Similar Guides may be available from local colleges or state 4-H groups.

Various pamphlets available from U.S. Weather Bureau or U.S. Government Printing Office. Write: Superintendent of Documents, Government Printing Office, Washington, D.C. 20402..

Resource Books for Children

Bonsall, George. *The How and Why Book of Weather*. New York: Grossett and Dunlap, 1960.
This book is for science-minded children and teachers, too. Simple facts and simple experiments help readers remember many weather hows and whys.

- Fisher, R.M. *How About the Weather?* Second edition. New York: Harper, 1958.
A readable nontechnical book which discusses the elementary physics of the atmosphere and shows how to forecast from newspaper weather maps and local signs.
- Lehr, Paul E., Burnett, R. Will, and Zim, Herbert S. *Weather: Air Masses, Clouds, Rainfall, Storms, Weather Maps, Climate* (Golden Nature Guide). New York: Simon and Schuster, 1957.
What makes the weather, how it is studied and forecast. Elementary guide to meteorological phenomena and processes with beautiful color illustrations.
- Longstreth, T. Morris. *Understanding the Weather*. New York: MacMillan, 1953.
Short, interesting description of the atmosphere, weather, and forecasting, written in popular style. Suitable as a first book on weather.
- Schneider, Herman. *Everyday Weather and How It Works*. Revised Edition. New York: Whittlesey House, 1961.
Instructions for easily constructed instruments, description of the atmosphere. Written on an elementary and junior high level.
- Sloane, Eric. *Eric Sloane's Weather Book*. Des Moines: Meredith Press, 1952.
Interesting explanation of weather phenomena in which author incorporates drawings, charts and literature into text. Written on an intermediate and junior high level.
- Sloane, Eric. *How You Can Forecast the Weather*. Greenwich, Connecticut: Fawcett's, (paperback).
- Spar, Jerome. *The Way of the Weather*. Mankato, Minnesota: Creative Education Society, 1957.
Designed for grade school use, abundantly illustrated.
- Spilhaus, A.F. *Weathercraft*. New York: Viking Press, 1951.
Description of weather, how to forecast it, and construction of instruments.

Tannehill, Ivan R. *All About the Weather*. New York:
Random House, 1953.
Simple but accurate.

Thompson, Philip D., and O'Brien, Robert. *Weather*. New
York: Time, 1965. (Life Science Library).
Good drawings and pictures, very readable general
discussion.

Weiss, Malcolm E. *Storms--from the Inside Out*. New York:
Julian Messner, Division of Simon and Schuster, 1973.
An interesting description of the way clouds can be
used to predict different types of storms. Explanations
of the storms and the work of meteorologists are also in-
cluded in this book.

133

4. GLOSSARY

The following definitions may be helpful to a teacher whose class is investigating a Weather Predictions challenge. Some of the words are included to give the teacher an understanding of technical terms; others are included because they are commonly used throughout the resource book.

These terms may be used when they are appropriate for the children's work. For example, a teacher may tell the children that when they conduct surveys, they are collecting data. It is not necessary for the teacher or students to learn the definitions nor to use all of the terms while working on their challenge. Rather, the children will begin to use the words and understand the meanings as they become involved in their investigations.

Anemometer

An instrument for measuring wind speed.

Average

The numerical value obtained by dividing the sum of the elements of a set of data by the number of elements in that set. Also called the mean.

Barometer

An instrument for measuring atmospheric pressure. The pressure is usually expressed in terms of the height in inches of a column of mercury. Normal sea level pressure is taken as 29.92 inches of mercury, this being the height of a column of mercury that weighs the same as the column of air above it at sea level.

Aneroid Barometer

A barometer in which changes in atmospheric pressure cause compression or expansion of a diaphragm that moves a pointer.

Mercury Barometer

A barometer in which changes in atmospheric pressure cause corresponding changes in the height of a column of mercury.

Calibration

Setting and marking an instrument to correspond to standard measurements.

Climate

Average weather conditions of an area.

Climatology

The branch of science that deals with the accumulated data of weather conditions of an area.

Cloud

A collection of water droplets or ice crystals formed by condensation when moist air cools, usually by rising.

Cirrus Cloud

Highest-level cloud, made up of ice crystals. (Often called "mare's tails.")

Cumulus Cloud

A puffy middle-level cloud formed by rising air currents. (Often called "fair weather" clouds.)

Nimbus Cloud

A type of rain cloud (dark, ragged, and low) of uniform grayness that covers the entire sky. Now used chiefly as a combining form, as in cumulo-nimbus (rainy cumulus) or nimbo-stratus (rainy stratus).

Stratus Cloud

A low-level, smooth, shapeless gray cloud having little vertical motion. Fog is a stratus cloud on or near the ground.

Conversion

A change from one form to another. Generally associated in mathematics and science with the change from one unit of measure to another or the change from one form of energy to another.

Correlation

A relationship between two sets of data.

Data

Any facts, quantitative information, or statistics.

Dew Point Temperature

The temperature at which the air becomes saturated with water vapor, i.e., the relative humidity is 100%. If the temperature drops below the dew point, dew or frost will form.

Distribution

The spread of data over the range of possible results.

Event

A happening; an occurrence; something that takes place.
Example: a day on which it rains.

Fog

Tiny droplets of water (condensed water vapor) suspended in the air and reducing visibility.

Ground Fog

The shallow layer of surface fog that forms when the ground is cooled to the dew point temperature by radiating its heat.

Forecast

A prediction of future occurrences based on an analysis of present and past data.

Frequency

The number of times a certain event occurs in a given unit of time or in a given total number of events.

Front
The boundary between two air masses.

Frost
Ice crystals that are deposited from the air on surfaces that cool by radiating their heat.

Graph
A drawing or a picture of one or several sets of data.

Bar Graph

A graph of a set of measures or counts whose sizes are represented by the vertical (or horizontal) lengths of bars of equal widths. Example: the cloud cover each day for a given period of time.

DATE	CLOUD COVER (%)
4	100
5	100
6	100
7	75
8	25
9	0
10	75
11	100
12	50
13	0
14	0
15	0

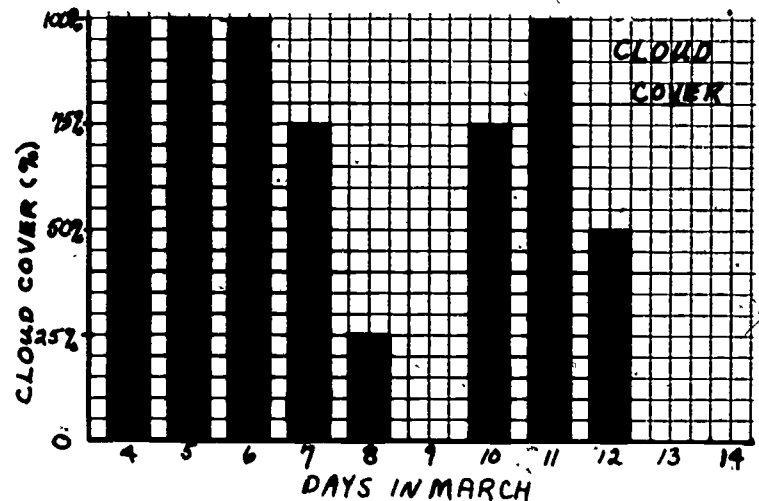

Conversion Graph

A line graph that is used to change one unit of measurement to another. For example, changing centigrade temperature to Fahrenheit temperature.

FAHRENHEIT TEMPERATURE	CENTIGRADE TEMPERATURE
32°	0°
86°	30°

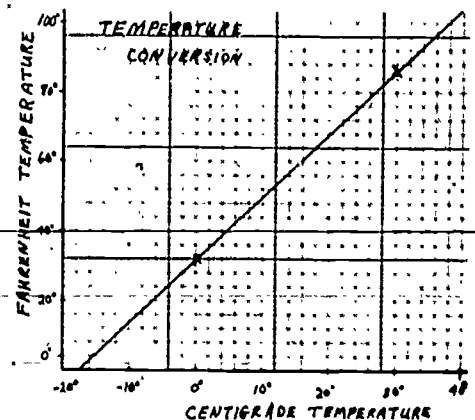

Cumulative Distribution Graph

A graph that can be constructed from a histogram by computing running totals from the histogram data. The first running total is the first value in the histogram data (see table of values). The second running total is the sum of the first and second values of the histogram, the third is the sum of the first, second, and third values, and so on. The horizontal scale on the graph is similar to that of the histogram; the vertical scale goes from 0 to the total number of events observed or samples taken (in the example, the total number of days the temperature was recorded). Each vertical distance on the graph shows the running total of the number of samples taken that are less than or equal to the value shown on the horizontal scale; thus the graph below indicates that on eighteen days (or 72% of the total) the temperature was 16°C or less.

9:00 A.M. TEMPERATURE (°C)	NUMBER OF DAYS- RUNNING TOTALS
10° or less	1
11° " "	3
12° " "	6
13° " "	8
14° " "	9
15° " "	12
16° " "	15
17° " "	18
18° " "	21
19° " "	23
20° " "	25

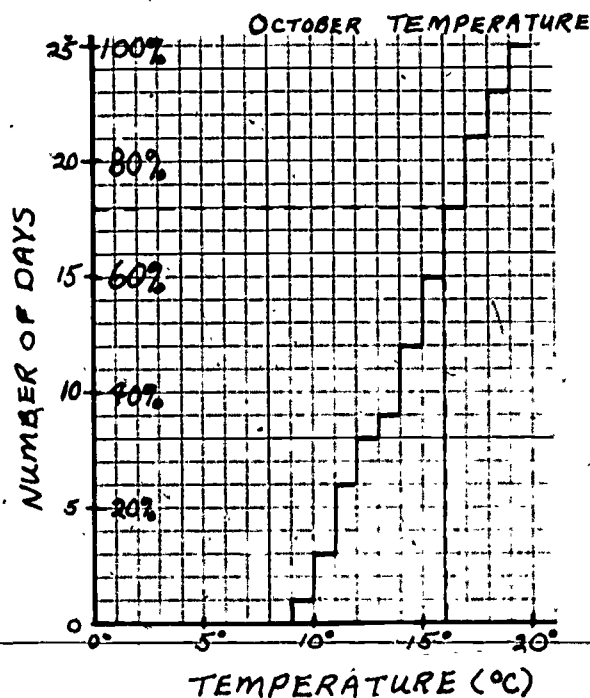

Histogram

A type of bar graph that shows the distribution of the number of times that different measures or counts of the same event have occurred. A histogram always shows ordered numerical data on the horizontal axis. Example: the number of days the temperature was a given value (or in a given range of values).

9:00 A.M. TEMPERATURE (°C)	NUMBER OF DAYS
10°	1
11°	2
12°	3
13°	2
14°	1
15°	3
16°	3
17°	3
18°	3
19°	2
20°	2

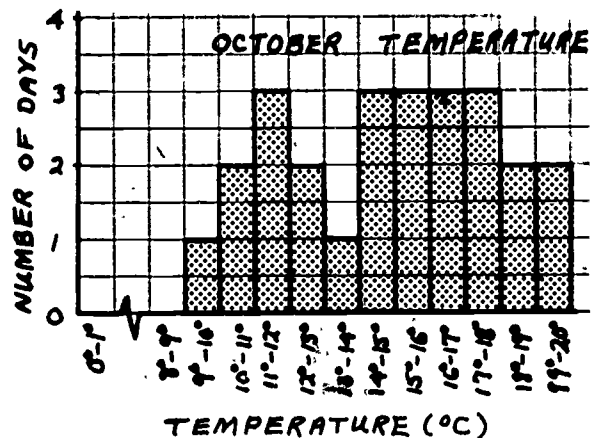

Line Chart

A bar graph that is represented by circles, triangles, or crosses with lines connecting them so that it has the appearance of a line graph. (See Line Graph.) This is a useful representation to show clearly the fluctuations in one set of data and to show two or more sets of data on the same graph. Example: the daily barometric pressure readings.

DATE	PRESSURE (in.)
Oct. 1	30.3
2	30.3
3	30.0
4	30.0
5	29.9
6	30.2
7	30.2
8	30.2
9	30.2
10	30.3
11	30.3
12	30.2
13	30.0
14	29.7
15	29.6

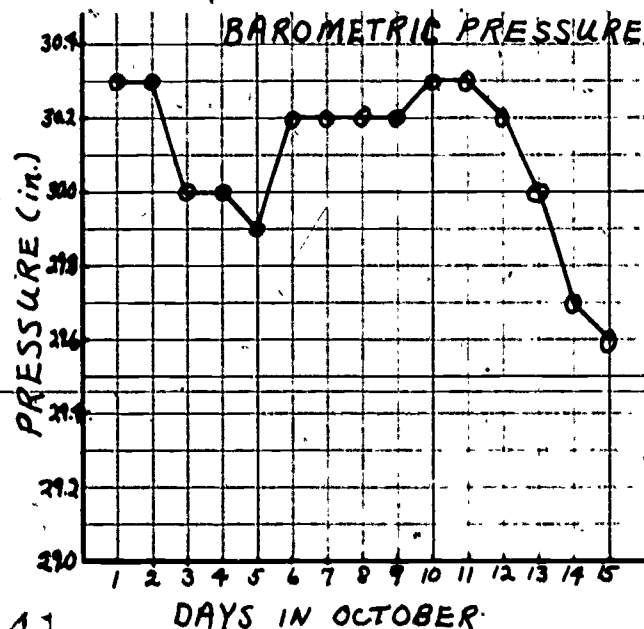

Line Graph

A graph in which a smooth line or line segments pass through or near points representing members of a set of data. Since the line represents an infinity of points, the variable on the horizontal axis must be continuous. If the spaces between the markings on the horizontal axis have no meaning, then the graph is not a line graph, but a line chart (see Line Chart), even if the data points are connected by lines. Example: the hourly temperature readings for a given day. (This is a line graph because the approximate temperature at any time of day can be found, even though it may not have been measured at that time. Thus, at 11:30 P.M. the temperature was about 16.5°C .)

TIME	TEMPERATURE ($^{\circ}\text{C}$)
9:00 A.M.	11 $^{\circ}$
10:00 A.M.	13 $^{\circ}$
11:00 A.M.	15 $^{\circ}$
12:00 A.M.	18 $^{\circ}$
1:00 P.M.	19 $^{\circ}$
2:00 P.M.	20 $^{\circ}$
3:00 P.M.	19 $^{\circ}$

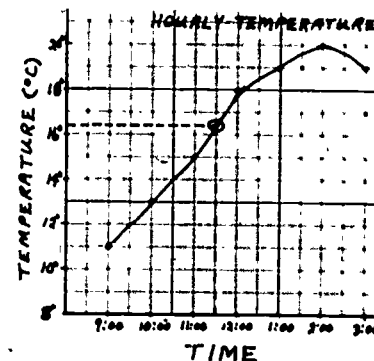

Scatter Graph

CHANGE IN PRESSURE (in.)	RAINFALL (in.)		
-1.0	0.97	+ 0.1	1.28
-0.8	0.37		TRACE
-0.6	2.07		0
-0.5	0	+ 0.2	TRACE
	0.73		0
	0.31		0
-0.3	0.01	+ 0.3	0
	0		0
	0		0
-0.2	0.09	+ 0.4	TRACE
	0.05		0
	0.02	+ 0.5	0
	TRACE		0
	0		0
	0		0
	0		0
-0.1	0.04	+ 0.8	0
	0.01	+ 0.9	0
0	0.04		
	0.01		
	0		
	0		
	0		

A graph showing a scatter of points, each of which represents two characteristics of the same thing. For example, in the graph below, each point represents a day; the position of the point indicates the change in pressure from the previous day and the amount of rainfall in that time.

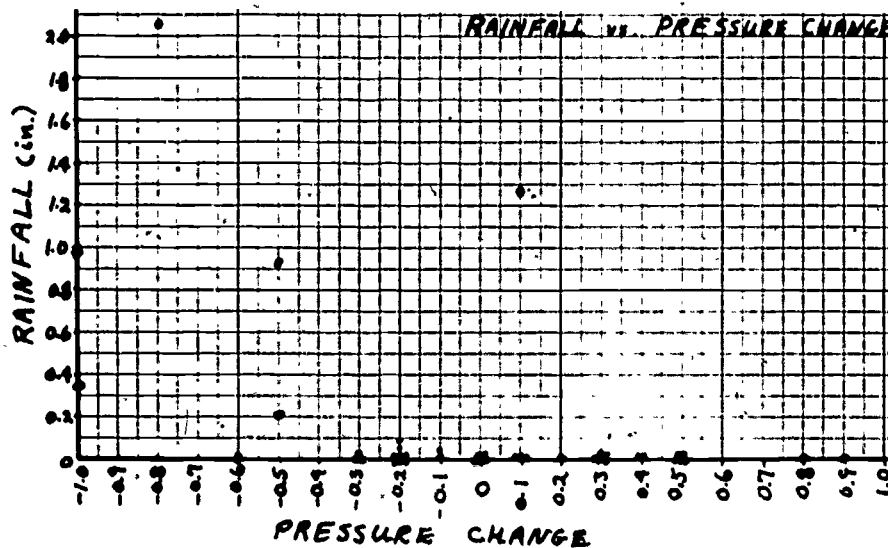

112

113

High Pressure Region

A region where air collects, cools, compresses, and sinks-- associated with fair weather. The atmospheric pressure in such a region is higher than that outside it.

Histogram

See *Graph*.

Humidity

A measure of the water vapor content of air.

Hurricane

A violent storm, formed over tropical water, with very low central pressure, accompanied by winds of at least 75 m.p.h., torrential rainfall, and heavy seas.

Hygrometer

An instrument used to measure the relative humidity in the atmosphere.

Hypothesis

A tentative conclusion made in order to test its implications or consequences.

Inference

An assumption derived from facts or information considered to be valid and accurate.

Isobar

A line on a weather map connecting points of equal pressure.

Jet Stream

A long narrow meandering stream of high-speed winds blowing from a westerly direction at an altitude of seven to ten miles, often exceeding a speed of 250 miles per hour.

Lightning

An electrical flash neutralizing a strong buildup of positive and negative charges between clouds or between a cloud and the ground.

Low Pressure Region

A region where the air expands and rises--usually associated with stormy weather. The atmospheric pressure in such a region is lower than that outside it.

Mean

See *Average*.

Median

The middle value of a set of data in which the elements have been ordered from smallest to largest. The median value has as many elements above it as below it.

Meteorology

The study of weather and atmospheric phenomena.

Millibar

A unit of measurement of pressure, usually atmospheric pressure. Standard atmospheric pressure at sea level is 1013 millibars.

Mode	The element or elements that occur most often in a set of data.
Nephoscope	An instrument for measuring the speed of clouds.
Ordered Set	A set of data arranged from smallest to largest.
Per Cent	Literally per hundred. A ratio in which the denominator is always 100, e.g., 72 per cent = $72/100 = 0.72 = 72\%$, where the symbol % represents $1/100$.
Percentage	A part of a whole expressed in hundredths.
Precipitation	Rain, snow, hail, sleet, or freezing rain. Produced when water vapor in the air forms droplets or crystals heavy enough to fall earthward.
Pressure, Atmospheric	The force per unit area exerted by the atmosphere. At sea level the average atmospheric pressure is 14.7 lb./in. ² (or 1013 millibars or 29.92 inches of mercury).
Probability	The likelihood or chance (expressed numerically) of one event occurring out of several possible events.
Proportion	A statement of equality of two ratios, i.e., the first term divided by the second term equals the third term divided by the fourth term, e.g., $5/100 = 1/2$. Also a synonym for ratio: when two quantities are in direct proportion, their ratios are the same.
Psychrometer	An instrument used to measure the wet-bulb and dry-bulb temperatures of the air. Relative humidity can then be found by using a table of data for that purpose.
Quartile	
First	The first quartile is the value of the quarter-way piece of data in an ordered set of data.
Third	The third quartile is the value of the three-quarter-way piece of data in an ordered set of data.
Interquartile Range	The range or length of the middle 50% of an ordered set of data; the difference between the first and third quartile.
Rain	Precipitation in the form of water drops at least 0.02 inches in diameter.

Range	Mathematical: the difference between the smallest and the largest values in a set of data.
Rank	To order the members of a set according to some criterion, such as size or importance. Example: to put pieces of data from smallest to largest.
Ratio	The quotient of two denominate numbers or values indicating the relationship in quantity, size, or amount between two different things. For example, the per cent accuracy of the children's forecasts is the ratio of the number of correct forecasts to the total number of forecasts made, expressed as a percentage.
Relative Humidity	The amount of water vapor present in the air divided by the maximum amount of water vapor the air could hold at that temperature, expressed as a percentage.
Sample	A representative fraction of a population studied to gain information about the whole population.
Sample Size	The number of elements in a sample.
Saturation Point	The point (combination of temperature and water vapor content) at which the relative humidity is 100 per cent.
Sea Breeze	A breeze blowing from cool water to replace the rising warmed air over adjacent land areas.
Sleet	Rain that freezes at a low level and then passes through a warm level nearer the ground.
Smog	A combination of smoke and fog usually associated with industrial regions.
Snow	White or transparent crystals or flakes that form when water vapor crystallizes, usually on small particles in the clouds.
Statistics	The science of drawing conclusions or making predictions using a collection of quantitative data.
Tally	A visible record used to keep a count of some set of data, especially a record of the number of times one or more events occur. Example: number of days it rained when the pressure fell.

Temperature

A measure of hotness or coldness. Technically, an indication of the average kinetic energy of molecules. Temperature is commonly measured in degrees Fahrenheit or degrees centigrade (Celsius).

**Thermometer, Centigrade
(or Celsius)**

A thermometer on which the interval between the normal freezing and boiling points of water is divided into 100 parts or degrees, ranging from 0°C to 100°C .

Thermometer, Fahrenheit

A thermometer on which the interval between the normal freezing and boiling points of water is divided into 180 parts or degrees, ranging from 32°F to 212°F .

Visibility

A measure of how clear the atmosphere is. Technically, the horizontal distance at which an object can be recognized by the unaided eye.

Weather

Condition of the atmosphere in terms of heat, pressure, wind, and moisture.

Wind

Air in motion.

147

E. Skills, Processes, and Areas of Study Utilized in Weather Predictions

The unique aspect of USMES is the degree to which it provides experience in the process of solving real problems. Many would agree that this aspect of learning is so important as to deserve a regular place in the school program even if it means decreasing to some extent the time spent in other important areas. Fortunately, real problem solving is also an effective way of learning many of the skills, processes, and concepts in a wide range of school subjects.

On the following pages are five charts and an extensive, illustrative list of skills, processes, and areas of study that are utilized in USMES. The charts rate Weather Predictions according to its potential for learning in various categories of each of five subject areas--real problem solving, mathematics, science, social science, and language arts. The rating system is based on the amount that each skill, process, or area of study within the subject areas is used--extensive (1), moderate (2), some (3), little or no use (-). (The USMES Guide contains a chart that rates all USMES units in a similar way.)

The chart for real problem solving presents the many aspects of the problem-solving process that students generally use while working on an USMES challenge. A number of the steps in the process are used many times and in different orders, and many of the steps can be performed concurrently by separate groups of students. Each aspect listed in the chart applies not only to the major problem stated in the unit challenge but also to many of the tasks each small group undertakes while working on a solution to the major problem. Consequently, USMES students gain extensive experience with the problem-solving process.

The charts for mathematics, science, social science, and language arts identify the specific skills, processes, and areas of study that may be learned by students as they respond to a Weather Predictions challenge and become involved with certain activities. Because the students initiate the activities, it is impossible to state unequivocally which activities will take place. It is possible, however, to document activities that have taken place in USMES classes and identify those skills and processes that have been used by the students.

Knowing in advance which skills and processes are likely to be utilized in Weather Predictions and knowing the extent that they will be used, teachers can postpone the teaching

of those skills in the traditional manner until later in the year. If the students have not learned them during their USMES activities by that time, they can study them in the usual way. Further, the charts enable a teacher to integrate USMES more readily with other areas of classroom work. For example, teachers may teach fractions during math period when fractions are also being learned and utilized in the students' USMES activities. Teachers who have used USMES for several successive years have found that students are more motivated to learn basic skills when they have determined a need for them in their USMES activities. During an USMES session the teacher may allow the students to learn the skills entirely on their own or from other students, or the teacher may conduct a skill session as the need for a particular skill arises.

Because different USMES units have differing emphases on the various aspects of problem solving and varying amounts of possible work in the various subject areas, teachers each year might select several possible challenges, based on their students' previous work in USMES, for their class to consider. This choice should provide students with as extensive a range of problems and as wide a variety of skills, processes, and areas of study as possible during their years in school. The charts and lists on the following pages can also help teachers with this type of planning.

Some USMES teachers have used a chart similar to the one given here for real problem solving as a record-keeping tool, noting each child's exposure to the various aspects of the process. Such a chart might be kept current by succeeding teachers and passed on as part of a student's permanent record. Each year some attempt could be made to vary a student's learning not only by introducing different types of challenges but also by altering the specific activities in which each student takes part. For example, children who have done mostly construction work in one unit may be encouraged to take part in the data collection and data analysis in their next unit.

Following the rating charts are the lists of explicit examples of real problem solving and other subject area skills, processes, and areas of study learned and utilized in Weather Predictions. Like the charts, these lists are based on documentation of activities that have taken place in USMES classes. The greater detail of the lists allows teachers to see exactly how the various basic skills, processes, and areas of study listed in the charts may arise in Weather Predictions.

The number of examples in the real problem solving list have been limited because the list itself would be unreasonably long if all the examples were listed for some of the categories. It should also be noted that the example(s) in the first category--*Identifying and Defining Problems*--have been limited to the major problem that is the focus of the unit. During the course of their work, the students will encounter and solve many other, secondary problems, such as the problem of how to display their data or how to draw a scale layout.

Breaking down an interdisciplinary curriculum like USMES into its various subject area components is a difficult and highly inexact procedure. Within USMES the various subject areas overlap significantly, and any subdivision must be to some extent arbitrary. For example, where does measuring as a mathematical skill end and measurement as science and social science process begin? How does one distinguish between the processes of real problem solving, of science, and of social science? Even within one subject area, the problem still remains--what is the difference between graphing as a skill and graphing as an area of study? This problem has been partially solved by judicious choice of examples and extensive cross-referencing.

Because of this overlap of subject areas, there are clearly other outlines that are equally valid. The scheme presented here was developed with much care and thought by members of the USMES staff with help from others knowledgeable in the fields of mathematics, science, social science, and language arts. It represents one method of examining comprehensively the scope of USMES and in no way denies the existence of other methods.

REAL PROBLEM SOLVING

Overall
Rating

Identifying and defining problem.	1
Deciding on information and investigations needed.	1
Determining what needs to be done first, setting priorities.	2
Deciding on best ways to obtain information needed.	1
Working cooperatively in groups on tasks.	1
Making decisions as needed.	1
Utilizing and appreciating basic skills and processes.	1
Carrying out data collection procedures-- observing, surveying, researching, measuring, classifying, experimenting, constructing.	1
Asking questions, inferring.	1
Distinguishing fact from opinion, relevant from irrelevant data, reliable from unreliable sources.	1

REAL PROBLEM SOLVING

Overall
Rating

Evaluating procedures used for data collection and analysis. Detecting flaws in process or errors in data.	1
Organizing and processing data or information.	1
Analyzing and interpreting data or information.	1
Predicting, formulating hypotheses, suggesting possible solutions based on data collected.	1
Evaluating proposed solutions in terms of practicality, social values, efficacy, aesthetic values.	1
Trying out various solutions and evaluating the results, testing hypotheses.	1
Communicating and displaying data or information.	1
Working to implement solution(s) chosen by the class.	1
Making generalizations that might hold true under similar circumstances; applying problem-solving process to other real problems.	1

KEY: 1 = extensive use, 2 = moderate use, 3 = some use, - = little or no use

131

132

MATHEMATICS	Overall Rating
<u>Basic Skills</u>	
Classifying/Categorizing	3
Counting	1
Computation Using Operations	
Addition/Subtraction	1
Multiplication/Division	1
Fractions/Ratios/Percentages	1
Business and Consumer Mathematics/ Money and Finance	-
Measuring	1
Comparing	1
Estimating/Approximating/Rounding Off	1
Organizing Data	1
Statistical Analysis	1
Opinion Surveys/Sampling Techniques	-
Graphing	1
Spatial Visualization/Geometry	3
<u>Areas of Study</u>	
Numeration Systems	2
Number Systems and Properties	1
Denominate Numbers/Dimensions	1
Scaling	3
Symmetry/Similarity/Congruence	-
Accuracy/Measurement Error/ Estimation/Approximation	1
Statistics/Random Processes/Probability	1
Graphing/Functions	1
Fraction/Ratio	1
Maximum and Minimum Values	3
Equivalence/Inequality/Equations	1
Money/Finance	-
Set Theory	-

SCIENCE	Overall Rating
<u>Processes</u>	
Observing/Describing	1
Classifying	1
Identifying Variables	1
Defining Variables Operationally	1
Manipulating, Controlling Variables/ Experimenting	3
Designing and Constructing Measuring Devices and Equipment	1
Inferring/Predicting/Formulating, Testing Hypotheses/Modeling	1
Measuring/Collecting, Recording Data	1
Organizing, Processing Data	1
Analyzing, Interpreting Data	1
Communicating, Displaying Data	1
Generalizing/Applying Process to New Problems	1
<u>Areas of Study</u>	
Measurement	1
Motion	2
Force	1
Mechanical Work and Energy	-
Solids, Liquids, and Gases	1
Electricity	3
Heat	1
Light	3
Sound	3
Animal and Plant Classification	-
Ecology/Environment	1
Nutrition/Growth	-
Genetics/Hereditiy/Propagation	-
Animal and Plant Behavior	-
Anatomy/Physiology	-

KEY: 1 = extensive use, 2 = moderate use, 3 = some use, - = little or no use

SOCIAL SCIENCE	Overall Rating
<u>Process</u>	
Observing/Describing/Classifying	2
Identifying Problems, Variables	1
Manipulating, Controlling Variables/ Experimenting	3
Inferring/Predicting/Formulating, Testing Hypotheses	3
Collecting, Recording Data/Measuring	-
Organizing, Processing Data	-
Analyzing, Interpreting Data	-
Communicating, Displaying Data	-
Generalizing/Applying Process to Daily Life	3
<u>Attitudes/Values</u>	
Accepting responsibility for actions and results	1
Developing interest and involvement in human affairs	1
Recognizing the importance of individual and group contributions to society	1
Developing inquisitiveness, self-reliance, and initiative	1
Recognizing the values of cooperation, group work, and division of labor	1
Understanding modes of inquiry used in the sciences, appreciating their power and precision	1
Respecting the views, thoughts, and feelings of others	1
Being open to new ideas and information	1
Learning the importance and influence of values in decision making	1
<u>Areas of Study</u>	
Anthropology	-
Economics	-
Geography/Physical Environment	1
Political Science/Government Systems	-
Recent Local History	1
Social Psychology/Individual and Group Behavior	-
Sociology/Social Systems	-

LANGUAGE ARTS	Overall Rating
<u>Basic Skills</u>	
Reading	
Literal Comprehension: Decoding Words, Sentences, Paragraphs	1
Critical Reading: Comprehending Meanings, Interpretation	1
Oral Language	
Speaking	1
Listening	1
Memorizing	-
Written Language	
Spelling	3
Grammar: Punctuation, Syntax, Usage	3
Composition	3
Study Skills	
Outlining/Organizing	3
Using References and Resources	1
<u>Attitudes/Values</u>	
Appreciating the value of expressing ideas through speaking and writing	1
Appreciating the value of written resources	1
Developing an interest in reading and writing	2
Making judgments concerning what is read	1
Appreciating the value of different forms of writing, different forms of communication	1

KEY: 1 = extensive use, 2 = moderate use
3 = some use, - = little or no use

REAL PROBLEM SOLVING IN WEATHER PREDICTIONS

Identifying and Defining Problems

- Students decide that predicting the weather for weekend activities is a problem for them.
- See also SOCIAL SCIENCE list: *Identifying Problems, Variables.*

Deciding on Information Needed

- After a discussion students decide they need to collect information on various weather characteristics, such as temperature, pressure, wind direction, and cloud types.

Determining What Needs to Be Done First, Setting Priorities

- Students decide first to observe weather and make simple predictions; students later decide to use data from instruments in their predictions.
- Students decide to record weather data in logbooks and then to graph it.

Deciding on Best Ways to Obtain Information Needed

- Children establish a schedule for daily measurements of weather data, such as wind direction, temperature, barometric pressure, cloud cover.
- Children decide that, as a check, at least two children will read each thermometer, barometer, etc., when taking measurements.
- Children decide to do research in library on weather topics.

Working Cooperatively in Groups on Tasks

- Students form groups to collect data on different weather variables and to make daily predictions.

Making Decisions as Needed

- Students decide to work in groups so that more can be accomplished.
- Students decide that certain data collection procedures or construction designs are best.
- Students decide to make a presentation to the principal requesting permission to announce school-wide forecasts on the PA system.

Utilizing and Appreciating Basic Skills and Processes

- Children measure temperatures at different times of the day to verify their predictions.
- Children prepare graphs of their weather data.

Utilizing and Appreciating Basic Skills and Processes (cont.)

- Students recognize that making accurate weather predictions and communicating them to others will help many people besides themselves.
- Students write letters to and exchange information with children in other parts of the country.
- See also MATHEMATICS, SCIENCE, SOCIAL SCIENCE, and LANGUAGE ARTS lists.

**Carrying Out Data Collection Procedures--
Opinion Surveying, Researching,
Measuring, Classifying, Experimenting,
Constructing**

- Students conduct opinion survey to see whether other students are interested in receiving their weather report.
- Students research weather topics in the library.
- Students measure different weather variables, for example, temperature, relative humidity, barometric pressure.
- Students categorize different types of weather, types of clouds.
- Students devise experiments to demonstrate different weather phenomena.
- Students construct simple weather instruments.
- See also MATHEMATICS list: *Classifying/Categorizing; Measuring.*
- See also SCIENCE list: *Observing/Describing; Classifying; Manipulating, Controlling Variables/Experimenting; Designing and Constructing Measuring Devices and Equipment; Measuring/Collecting, Recording Data.*
- See also SOCIAL SCIENCE list: *Observing/Describing/Classifying; Manipulating, Controlling Variables/Experimenting; Collecting, Recording Data/Measuring.*

Asking Questions, Inferring

- Students ask whether watching certain weather characteristics will enable them to predict the weather and infer from correct forecasts that it will.
- Students ask whether there is a relationship between changes in barometric pressure and the future weather and infer from observations that there is.
- Students ask whether knowing the weather ahead of time will help them plan their after-school activities.
- See also SCIENCE list: *Inferring/Predicting/Formulating, Testing Hypotheses/Modeling.*
- See also SOCIAL SCIENCE list: *Inferring/Predicting/Formulating, Testing Hypotheses.*

150

*Distinguishing Fact from Opinion,
Relevant from Irrelevant Data,
Reliable from Unreliable Sources*

- Students realize that some folklore about weather is non-sense (such as the groundhog's shadow presaging more winter) and some is based on scientific fact (such as a ring, or halo, around the moon or sun foretelling rain).
- Students realize that certain variables (such as wind direction, cloud types, pressure change) are more relevant to predicting the weather than others (such as amount of rainfall or wind speed).
- Students find that their own forecasts or those of the weather bureau, TV, or newspaper are more reliable than the *Farmer's Almanac*.

*Evaluating Procedures Used for Data
Collection and Analysis, Detecting
Flaws in Process or Errors in Data*

- Children decide to record their weather predictions as they formulate them so that they can be verified.
- Students measuring outside temperature under a variety of conditions obtain widely varying results. They discuss the discrepancies and choose one location in which to take the measurements.
- Children agree that the information given on weather maps should be considered when they make predictions.
- See also MATHEMATICS list: *Estimating/Approximating/Rounding Off*.

Organizing and Processing Data

- Students record their temperature data on a chart.
- Students add the record of actual weather to the record of predictions.
- See also MATHEMATICS list: *Organizing Data*.
- See also SCIENCE and SOCIAL SCIENCE lists: *Organizing, Processing Data*.

Analyzing and Interpreting Data

- Students find average temperatures for a certain period of time.
- Students analyze data to see whether changes in pressure produce certain types of weather.
- See also MATHEMATICS list: *Comparing; Statistical Analysis; Opinion Surveys/Sampling Techniques; Maximum and Minimum Values; Graphing*.
- See also SCIENCE and SOCIAL SCIENCE lists: *Analyzing, Interpreting Data*.

*Predicting, Formulating Hypotheses,
Suggesting Possible Solutions Based
on Data Collected*

- Students hypothesize that they can predict the weather with reasonable accuracy by using their data.
- After successfully formulating short-term predictions for a certain amount of time, students suggest making daily predictions on the school's public address system.
- See also SCIENCE list: *Inferring/Predicting/Formulating, Testing Hypotheses/Modeling.*
- See also SOCIAL SCIENCE list: *Inferring/Predicting/Formulating, Testing Hypotheses.*

*Evaluating Proposed Solutions in Terms of
Practicality, Social Values, Efficacy,
Aesthetic Values*

- Children discuss how accurate their predictions have been and what effects the knowledge has had on other students.

*Trying Out Various Solutions and
Evaluating the Results, Testing
Hypotheses*

- Students predict the weather using different combinations of factors to find those that work best.
- Students use best combination of weather characteristics to make forecasts.
- See also SCIENCE list: *Inferring/Predicting/Formulating, Testing Hypotheses/Modeling.*
- See also SOCIAL SCIENCE list: *Inferring/Predicting/Formulating, Testing Hypotheses.*

*Communicating and Displaying Data
or Information*

- Children make a line chart to show variation in temperature readings for a two-week period.
- Students keep a chart of their daily weather predictions and of the actual weather.
- See also MATHEMATICS list: *Graphing, Scaling.*
- See also SCIENCE and SOCIAL SCIENCE lists: *Communicating, Displaying Data.*
- See also LANGUAGE ARTS list.

*Working to Implement Solution(s)
Chosen by the Class*

- Students present their plan for school-wide daily weather predictions to the principal.

*Making Generalizations that Might Hold
True Under Similar Circumstances; Applying
Problem-Solving Process to Other Real
Problems*

- Students who have drawn graphs to display data in one instance more readily draw graphs in other instances.
- Students working on Weather Predictions apply skills they have acquired to their work on Nature Trails.
- See also SCIENCE list: *Generalizing/Applying Process to New Problems.*
- See also SOCIAL SCIENCE list: *Generalizing/Applying Process to Daily Life.*

ACTIVITIES IN WEATHER PREDICTIONS UTILIZING MATHEMATICS

Basic Skills

Classifying/Categorizing

- Categorizing characteristics or properties of weather.
- Categorizing characteristics or properties of weather in more than one way.
- Using the concepts of sets (subsets, unions, intersections, set notation) for discussing weather factors.
- See also SCIENCE list: *Classifying*.
- See also SOCIAL SCIENCE list: *Observing/Describing/Classifying*.

Counting

- Counting the number of days when forecast was accurate.
- Counting and tallying votes on the accuracy of a prediction.
- Counting to read scales on instruments, such as thermometer, barometer.
- Counting by sets to find scale for graph axes.

Computation Using Operations:
Addition/Subtraction

- Adding one- or two-digit whole numbers to find total tally or total measurement, such as rainfall during a one-week period, etc.
- Subtracting to find differences between predicted and actual measurements, such as temperature, relative humidity, etc.
- Subtracting one-, two-, or three-digit whole numbers to find ranges for graph axes or for measurement data.

Computation Using Operations:
Multiplication/Division

- Multiplying or dividing to find scale for graph axes.
- Multiplying and dividing to convert temperature readings from centigrade to Fahrenheit and vice versa.
- Dividing to calculate averages, such as temperature, rainfall, etc.
- Dividing to calculate ratios, fractions, or percentages, such as percentages of correct predictions over a given amount of time.

Computation Using Operations:
Fractions/Ratios/Percentages

- Using mixed numbers to perform calculations, such as calculating total precipitation for a given period.
- Changing fractions to higher or lower terms (equivalent fractions) to perform operations such as calculating total amount of rainfall.

Computation Using Operations:
Fractions/Ratios/Percentages (cont.)

- Using ratios and fractions to convert from centigrade to Fahrenheit and vice versa.
- Using fractions in measurement, graphing, or graphic comparisons.
- Calculating percentage of accurate weather predictions.
- Using decimal fractions to express barometric pressure or rainfall.
- Using percentage to express relative humidity.
- Using percentages to express chance of rain or to measure cloud cover.

Measuring

- Using different standard units of measure, for example, measuring temperature in degrees Fahrenheit and degrees centigrade.
- Reading measuring devices accurately when measuring air pressure, temperature, humidity, etc.
- Taking repeated measurements and using the median measurement.
- See also SCIENCE list: *Measuring/Collecting, Recording Data.*
- See also SOCIAL SCIENCE list: *Collecting, Recording Data/Measuring.*

Comparing

- Comparing quantitative data gathered from various sources, such as data from different indoor and outdoor thermometers or data from their instruments with that from newspapers or TV.
- Comparing qualitative information gathered from various sources, such as weather folklore.
- Comparing qualitative with quantitative data.
- Comparing predicted weather data and actual weather data.
- Making graphic comparisons of fractions and ratios when analyzing data, such as the proportionate number of days it rained in a month.
- Comparing costs of various construction materials.
- Using the concept of *greater than* and *less than*, e.g., in making comparisons of changes in barometric pressure readings, temperature readings.
- See also SCIENCE list: *Analyzing, Interpreting Data.*
- See also SOCIAL SCIENCE list: *Analyzing, Interpreting Data.*

Estimating/Approximating/Rounding Off

- Estimating error in measurements or readings of instrument scale or error in qualitative judgments on daily weather predictions.

Estimating/Approximating/Rounding Off (cont.)

- Determining when a measurement is likely to be accurate enough for a particular purpose.
- Using approximation in constructing weather instruments.
- Rounding off measurements, for example, wind speed, barometric pressure, temperature, to nearest whole number.
- Estimating wind speed.
- Calibrating a homemade instrument.

Organizing Data

- Organizing and classifying sets of weather observations.
- Recording data on actual weather so that it corresponds to data on predictions and weather factors.
- Tallying on bar graphs or histograms.
- Ordering real numbers on a number line or graph axis.
- Ordering the steps in a process.
- Ordering inches, feet, yards, degrees.
- See also SCIENCE list: *Organizing, Processing Data*.
- See also SOCIAL SCIENCE list: *Organizing, Processing Data*.

Statistical Analysis

- Interpreting bar graphs, histograms, scatter graphs, etc.
- Finding the mean and mode in an ordered set of temperature data.
- Assessing the predictability of weather based on climatology data.
- Correlating actual weather with changes in weather factors.
- Determining range of temperature data (e.g., for a given month).
- Compiling quantitative data on wind direction.
- Making short- and long-range predictions based on climatology data, instrument readings, weather maps.
- See also SCIENCE list: *Analyzing, Interpreting Data*.
- See also SOCIAL SCIENCE list: *Analyzing, Interpreting Data*.

Opinion Surveys/Sampling Techniques

- Conducting survey to determine interest of others in receiving daily weather forecasts.
- See also SCIENCE list: *Analyzing, Interpreting Data*.
- See also SOCIAL SCIENCE list: *Analyzing, Interpreting Data*.

103

Graphing

- Using alternative methods of displaying data, e.g., temperature data, barometric pressure data.
- Making a graph form--dividing axes into parts, deciding on an appropriate scale.
- Representing data on graphs.
 - Bar graph--percentage of correct forecasts for different combinations of weather factors.
 - Conversion graph--measurements of temperature in degrees Fahrenheit vs. degrees centigrade.
 - Cumulative distribution graph--number of days the maximum temperature was a certain value or less.
 - Histogram--number of days the temperature was a certain value in a given period of time.
 - Line chart--daily barometric pressure or temperature readings for a two-week (or longer) period.
 - Line graph--hourly temperature readings on a given day.
 - Scatter graph--change in barometric pressure vs. amount of rainfall on the same day.
- Representing several sets of data on one graph.
- Obtaining information from graphs.
- See also SCIENCE list: *Communicating, Displaying Data.*
- See also SOCIAL SCIENCE list: *Communicating, Displaying Data.*

Spatial Visualization/Geometry

- Constructing and using geometric figures, for example, triangles, circles, in the construction of weather instruments.
- Using the concept of *greater than* and *less than* to compare geometric figures.
- Measuring and constructing weather instruments using rulers, compasses, and protractors.

Areas of Study

Numeration Systems

- Using the decimal system in measuring rainfall, barometric pressure.
- Using fractions when measuring while constructing weather instruments.
- See also *Computation Using Operations: Fractions/Ratios/Percentages.*

Number Systems and Properties

- See *Computation Using Operations.*

Denominate Numbers/Dimensions

- See *Measuring*.

Scaling

- Using maps to chart and derive weather information, such as data on fronts, locations of high pressure and low pressure regions.

Accuracy/Measurement Error/
Estimation/Approximation

- See *Measuring and Estimating/Approximating/Rounding Off*.

Statistics/Random Processes/Probability

- See *Statistical Analysis*.

Graphing/Functions

- See *Graphing*.

Fraction/Ratio

- See *Computation Using Operations: Fractions/Ratios/Percentages*.

Maximum and Minimum Values

- Finding most efficient way to make accurate weather predictions.
- Recording and graphing maximum and minimum daily temperatures.

Equivalence/Inequality/Equations

- See *Comparing and Computation Using Operations*.

Set Theory

- See *Classifying/Categorizing*.

ACTIVITIES IN WEATHER PREDICTIONS UTILIZING SCIENCE

Process

Observing/Describing

- Observing/describing the weather after an outside observation.
- Observing/describing cloud types.
- Observing changes in temperature by reading a homemade or commercial thermometer.
- Observing early morning dew on grass during outside observation.
- See also SOCIAL SCIENCE list: *Observing/Describing/Classifying*.

Classifying

- Determining which portions of the yard are shaded and which are not.
- Classifying clouds into their various categories.
- Classifying the day's weather as clear, rainy, cloudy, etc.
- See also MATHEMATICS list: *Classifying/Categorizing*.
- See also SOCIAL SCIENCE list: *Observing/Describing/Classifying*.

Identifying Variables

- Identifying weather variables important to accurate predictions.
- Identifying temperature, wind direction, barometric pressure, cloud cover, rainfall, and relative humidity, as things to be measured.
- Identifying time of day as one of the things to be controlled.
- See also SOCIAL SCIENCE list: *Identifying Problems/Variables*.

Defining Variables Operationally

- Defining outside temperature as the temperature measured by a thermometer in degrees centigrade (or Fahrenheit) at some given point on the school grounds (or as the average taken at several points).
- Defining wind direction as the compass direction from which the wind blows.
- Defining the value of the barometric pressure as the value shown on the scale of an aneroid barometer.
- Defining cloudy as 75% or more of the sky covered, sunny as 25% or less of the sky covered, and partly cloudy as anything between these two.

Defining Variables Operationally (cont.)

- Defining rainfall as the amount of water in inches collected in the rain gauge in a twenty-four hour period.
- Defining relative humidity as the percentage read from a table based on the difference in the readings of a wet-bulb thermometer and a dry-bulb thermometer.

Manipulating, Controlling Variables/ Experimenting

- Measuring temperature, pressure, and/or relative humidity under various conditions--certain time of day, certain place around school, etc.
- Designing and conducting experiments to explain various weather phenomena.
- See also SOCIAL SCIENCE list: *Manipulating, Controlling Variables/Experimenting.*

Designing and Constructing Measuring Devices and Equipment

- Constructing weather instruments to build a school weather station, for example, wind vane, rain gauge, mineral oil barometer, psychrometer.

Inferring/Predicting/Formulating, Testing Hypotheses/Modeling

- Inferring from observation data that a correlation exists between wind direction and the weather it brings.
- Inferring from observation data that a correlation exists between rainy or cloudy weather and barometric pressure.
- Using data and observation to predict the weather for the next day.
- Hypothesizing that the weather can be more accurately predicted by using all available observation data; comparing accuracy of predictions made using various numbers of weather factors.
- Hypothesizing that mineral oil barometer will be more accurate if it is kept at constant temperature; moving barometer and comparing accuracy of results in the two locations.
- See also SOCIAL SCIENCE list: *Inferring/Predicting/Formulating, Testing Hypotheses.*

Measuring/Collecting, Recording Data

- Using thermometers to measure temperature, barometers to measure barometric pressure, etc., and recording readings on weather charts and graphs.
- Noting and writing down weather that is associated with various types of clouds.
- See also MATHEMATICS list: *Measuring.*
- See also SOCIAL SCIENCE list: *Collecting, Recording Data/Measuring.*

Organizing, Processing Data

- Ordering temperature (pressure, humidity, rainfall, etc.) data according to time of day and day of week.
- Counting and tallying number of days of certain types of weather (rain, snow, cloudy, partly cloudy, sunny) for different wind directions (for different cloud types, for changes in pressure).
- See also MATHEMATICS list: *Organizing Data*.
- See also SOCIAL SCIENCE list: *Organizing, Processing Data*.

Analyzing, Interpreting Data

- Calculating average temperature readings for a week.
- Spotting patterns and trends in climatological data: correlating changes in pressure (wind direction, humidity, temperature) with weather that follows such changes.
- See also MATHEMATICS list: *Comparing; Statistical Analysis; Opinion Surveys/Sampling Techniques; Graphing; Maximum and Minimum Values*.
- See also SOCIAL SCIENCE list: *Analyzing, Interpreting Data*.

Communicating, Displaying Data

- Showing weather data on graphs and charts.
- Posting written forecast on bulletin board or giving oral forecast over intercom.
- See also MATHEMATICS list: *Graphing*.
- See also LANGUAGE ARTS list.

Generalizing/Applying Process to New Problems

- Applying skills acquired from work on Weather Predictions to Play Area Design and Use.
- Using knowledge acquired from working on Weather Predictions to predict the weather for a camping trip to another section of state.
- See also SOCIAL SCIENCE list: *Generalizing/Applying Process to Daily Life*.

Areas of Study

Measurement

- Measuring temperature with Fahrenheit and centigrade thermometers; measuring pressure using various types of barometers; etc.
- Using different measuring tools to measure different weather variables, for example, wind direction, temperature, barometric pressure.

Measurement (cont.)

- See also *Measuring/Collecting, Recording Data*.
- See also MATHEMATICS list: *Measuring*.

Motion

Speed/Velocity

- Observing that wind varies in speed and direction.
- Observing that as wind speed increases, different objects (leaves, flags, tree branches, etc.) are set in motion.

Force

- Observing that force must be exerted to hammer nails into wood, noting that the hammer multiplies the force that is exerted (when constructing weather instruments).

Air Pressure

- Observing that weather often becomes or remains fair when atmospheric pressure remains steady or goes up.
- Observing that weather often becomes or remains poor when atmospheric pressure falls steadily or rapidly.
- Observing changes in barometric pressure by reading home-made or commercial liquid-filled barometers or aneroid barometers.
- Observing that differences in air pressure cause a liquid to rise in a tube containing a partial vacuum.

Solids, Liquids, and Gases

States of Matter

- Observing dew or frost condensed on the inside of a window or on the grass.
- Observing the air around them and various forms of precipitation.
- Observing that snow collected outside turns to water when brought into the classroom.
- Noting that the weight of the jar containing snow is the same as the weight of the jar containing the melted snow.
- Observing that just before it rains, there is either a sharp increase in humidity while the temperature remains the same, or a drop in temperature while the humidity remains the same because warm air holds more moisture (water vapor) than cold air.
- Noting that a change in cirrus clouds to lower types of rain or snow clouds is often followed by rain or snow.

Properties of Matter

- Observing that different construction materials, such as lumber and Tri-Wall have different properties that make them useful for different tasks.

Electricity

- Observing that mechanical energy of cloud movement can be transformed into electrical energy in lightning.
- Observing that electricity can be transformed into mechanical energy (saber saw, electric drill, etc.), into heat energy (glue gun, etc.), into chemical energy (battery charger).

Heat Temperature

- Observing and measuring changes in temperature by reading a homemade or commercial thermometer.
- Observing that a clear night is colder than a cloudy night because clouds tend to prevent the heat of the earth's surface from escaping.
- Observing that high pressure areas and low pressure areas move across the country because of upper air winds created by unequal heating of earth's surface and rotation of the earth.
- Observing that winds blow from places of high atmospheric pressure to places of low atmospheric pressure because of unequal heating of the atmosphere.
- Observing land and sea breezes caused by unequal heating and cooling of bodies of land and water.
- Observing that clouds change from cumulus to towering cumulonimbus (thunderheads) before a thunderstorm as clouds are pushed upward by temperature differences.

Light

- Observing ring (halo) around sun or moon due to refraction of light through ice particles in cirrostratus clouds.
- Observing rainbow (separation of white light into colors) due to refraction of light through water droplets.
- Observing alternating dark and light areas as clouds block direct sunlight from reaching the ground.
- Observing reflection of light off water droplets in clouds.
- Observing flash of lightning as electrical energy is transformed into light energy.

Sound

- Observing that the sound of thunder arrives later than the flash of lightning that caused it because sound travels much more slowly than light.

Sound (cont.)

- Estimating distance of thunderstorm by using conversion of five seconds (between flash of lightning and sound of thunder) for each mile of distance to storm, based on speed of sound of about 1100 ft/sec.

Ecology/Environment

- Observing that weather plays a key role in determining the environment and ecological cycles in a given region.
- Noting that seasonal changes in weather determine types of plants and animals in a given area.

171

ACTIVITIES IN WEATHER PREDICTIONS UTILIZING SOCIAL SCIENCE

Process

Observing/Describing/Classifying

- Organizing and classifying sets of ideas or information.
- Observing and describing the effects of weather on schoolmates, for example, indoor recess on rainy days.
- See also MATHEMATICS list: *Classifying/Categorizing*.
- See also SCIENCE list: *Observing/Describing/Classifying*.

Identifying Problems, Variables

- Identifying the problems weather creates for people, for example, discomfort, making travelling hazardous, forcing the cancellation of school or school activities.
- Identifying variables that affect the results of an opinion survey, e.g., recent bad weather, age and habits of people.
- See also SCIENCE list: *Identifying Variables*.

Manipulating, Controlling Variables/
Experimenting

- Determining if there is a correlation between the relative humidity and the discomfort a person feels.
- Conducting an opinion survey using a stratified random sample of students.
- See also SCIENCE list: *Manipulating, Controlling Variables/Experimenting*.

Inferring/Predicting/Formulating,
Testing Hypotheses

- Inferring that knowing the weather ahead of time benefits people.
- Hypothesizing that others in the school would like to hear (or read) their weather report; conducting opinion survey to determine if this is so.
- Inferring that the results of an opinion survey based on a stratified random sample reflect the opinions of all students.
- See also SCIENCE list: *Inferring/Predicting/Formulating, Testing Hypotheses/Modeling*.

Collecting, Recording Data/Measuring

- Conducting opinion survey, counting responses.
- See also MATHEMATICS list: *Counting; Measuring*.
- See also SCIENCE list: *Measuring/Collecting, Recording Data*.

Organizing, Processing Data

- Tallying opinion survey data.
- See also MATHEMATICS list: *Organizing Data*.
- See also SCIENCE list: *Organizing, Processing Data*.

Analyzing, Interpreting Data

- Comparing survey responses to determine that others do want the weather forecast.
- Comparing survey data obtained from different groups of people or samples of different size.
- Evaluating the way the survey was administered, the size and makeup of the sample.
- See also MATHEMATICS list: *Comparing; Statistical Analysis; Opinion Surveys/Sampling Techniques; Graphing; Maximum and Minimum Values*.
- See also SCIENCE list: *Analyzing, Interpreting Data*.

Communicating, Displaying Data

- See MATHEMATICS list: *Graphing*.
- See SCIENCE list: *Communicating, Displaying Data*
- See LANGUAGE ARTS list.

Generalizing/Applying Process to Daily Life

- Using knowledge and techniques acquired from predicting weather daily to help in making decisions that are affected by weather, e.g., what to wear.
- Using the knowledge acquired to help predict the weather for special events outside of school.
- Using one's knowledge of opinion surveys on other surveys.
- See also SCIENCE list: *Generalizing/Applying Process to New Problems*.

Attitudes/Values

Accepting Responsibility for Actions and Results

- Making sure that various tasks (e.g., collecting weather data from instruments, newspapers) are done.
- Scheduling hours and personnel to take the various measurements.
- Scheduling and giving presentations to person in authority, such as the principal, to obtain approval for proposed changes, for example, school-wide forecasting service.
- Scheduling and giving forecasts.

Developing Interest and Involvement in Human Affairs

- Informing schoolmates of weather predictions to help them in the planning of their activities.
- Noting that weather affects people everywhere and that being able to anticipate storms, floods, drought, etc., will benefit the community.

Recognizing the Importance of Individual and Group Contributions to Society

- Recognizing that accurate weather predictions benefit others in the school, not only themselves.
- Assessing the effects of group action on school regulations.

Developing Inquisitiveness, Self-Reliance, and Initiative

- Conducting group sessions with help from teacher.
- Finding their own solutions to problems encountered in addition to the main problem of the challenge.
- Choosing and developing the best way of presenting a plan to the principal.

Recognizing the Values of Cooperation, Group Work, and Division of Labor

- Finding that work on making accurate weather predictions progresses more rapidly and smoothly when they work in groups.
- Eliminating needless overlap in work.
- Finding that work is more fun and proceeds more smoothly when people cooperate.

Understanding Modes of Inquiry Used in the Sciences, Appreciating Their Power and Precision

- Using scientific modes of inquiry to investigate weather and make accurate predictions.
- Using data, charts, graphs, and other supportive material to share collected data with others, to spot trends, and to make accurate predictions.
- See also MATHEMATICS and SCIENCE lists.

Respecting the Views, Thoughts, and Feelings of Others

- Considering all suggestions and assessing their merits.
- Recognizing differences in values according to age, experience, occupation, income, interests, culture, race, religion, and ethnic background.
- Recognizing core values of daily living: fair play and justice, free speech, opportunity for decision making, opportunity for self-respect, freedom of choice, right to privacy, acceptance of the life styles of the community, group identity.

Being Open to New Ideas and Information

- Considering other ways of doing various tasks.
- Conducting library research in various aspects of problem.
- Asking other members of the class for ideas and suggestions.
- Asking other people, such as weather forecasters/meteorologists, for opinions, ideas, and information.

Learning the Importance and Influence of Values in Decision Making

- Recognizing that facts alone do not determine decisions, that problematic situations have no set answers.
- Recognizing that different people have different vocations/avocations that affect the type of weather they would prefer, for example, members of the tennis team might prefer dry, clear weather while those people with gardens might prefer some wet days.

Areas of Study

Geography/Physical Environment

- Investigating differences in weather due to differences in geography of regions.
- Introducing the children to geography through the use of weather maps and climatology data.

Recent Local History

- Finding and using climatological data for local region.
- Noting that climatological data is the weather history of an area.

ACTIVITIES IN WEATHER PREDICTIONS UTILIZING LANGUAGE ARTS

Basic Skills

Reading:

Literal Comprehension--Decoding
Words, Sentences, and Paragraphs

- Decoding words, sentences, and paragraphs while reading books on weather topics, newspaper weather forecasts.

Reading:

Critical Reading--Comprehending
Meanings, Interpretation

- Obtaining factual information about clouds, weather fronts, various forms of precipitation, barometric pressure.
- Understanding what is read about clouds, weather fronts, various forms of precipitation.
- Interpreting what is read, such as weather forecasting, clouds, weather fronts.

Oral Language:

Speaking

- Offering ideas, suggestions, and criticisms during discussions in small group work and during class discussions on problems and proposed solutions.
- Reporting to class about data collection, predictions, construction activities, etc.
- Responding to criticisms of activities.
- Preparing, practicing, and giving effective oral presentations to principal requesting permission to implement a weather prediction service.
- Preparing, practicing, and giving weather reports on school intercom.
- Using the telephone properly and effectively to obtain information, arrange a field trip, or to invite a resource person to speak to the class.
- Using rules of grammar in speaking.

Oral Language:

Listening

- Following spoken directions.
- Listening to group reports.

Oral Language:

Memorizing

- Memorizing portions of oral presentations.

Written Language:

Spelling

- Using correct spelling in writing.

Written Language:
Grammar--Punctuation, Syntax, Usage

- Using rules of grammar in writing.

Written Language:
Composition

- Writing to communicate effectively:
 - preparing written reports and letters using notes, data, graphs, charts, etc., communicating need for proposed action.
 - preparing written forecasts for school community.
 - corresponding with classes in other regions of the country about weather.

Study Skills:
Outlining/Organizing

- Taking notes.
- Planning and preparing drafts of letters, reports, or forecasts for critical review by the class before final copy is written.
- Organizing ideas, facts, data for inclusion in letters, reports, presentations, etc.

Study Skills:
Using References and Resources

- Using library to research information on weather topics.
- Using various reference volumes (dictionary, encyclopedia, etc.) to locate information.
- Finding a meteorologist and inviting him/her to speak to the class and answer questions for them.
- Using indexes and tables of contents of books to locate desired information.
- Using "How To" Cards for information on graphing, weather instruments, etc.

Attitudes/Values

Appreciating the Value of Expressing Ideas Through Speaking and Writing

- Finding that the principal may be persuaded to approve a daily public address weather broadcast when presented with definite, documented reasons for doing so.

Appreciating the Value of Written Resources

- Finding that certain desired information can be found in books on weather.

Developing an Interest in Reading and Writing

- Willingly looking up information on weather topics.
- Looking up further or more detailed information on air pressure, wind speed, etc.
- Showing desire to work on drafting letters, reports, etc.

Making Judgments Concerning What is Read

- Deciding whether what is read is applicable to the particular problem.
- Deciding how reliable the information obtained from reading is.
- Deciding whether the written material is appropriate, whether it says what it is supposed to say, whether it may need improvement.

Appreciating the Value of Different Forms of Writing, Different Forms of Communication

- Finding that certain data or information can be best conveyed by writing it down, by preparing graphs or charts, etc.
- Finding that certain data or information should be written down so that it can be referred to at a later time.
- Finding that spoken instructions are sometimes better than written instructions and vice versa.